



# West Elm Work Collection Specification Guide

## Availability

**Electronic price list updated** with release 204.B (U.S.) and 158.B (Canada), dated April 20, 2026.

All specifications subject to change without notice. Reference the electronic catalog/Hedberg for current pricing.

Transitional products in this specification guide are **maintained for existing customers only** and are likely to be phased out over time. These products are indicated with a . Products that are scheduled to be culled are indicated with an , followed by the last order entry date.

## Surface Materials

**The surface materials team** has announced the launch of the Finish Library, found at [www.steelcase.com/finishlibrary/](http://www.steelcase.com/finishlibrary/).

► For a list of all trademarks, refer to the last page of this specification guide. © 2026 Steelcase Inc.



## For Canadian Pricing

Canadian factor can be found at [www.steelcase.com/CADpricing/](http://www.steelcase.com/CADpricing/).

Calculate in the following order to avoid rounding errors:

- Multiply the base price and each option by the Canadian factor.
- Round each to the nearest dollar.
- Add base and options for total list price.

## Additional Resources

2

## Statement of Line

4

## West Elm – Steelcase

### Seating

Belle	16
Boardwalk	20
Brighton	24
Mesa	28
Willow	32
Slope	34
Sterling	38
Kent	42
Lucas	46
Fulton	48

### Furniture

Greenpoint	51
Sutton	76

## West Elm – Licensed

### Seating

Nimbus	81
Slope	82

### Furniture

Lily Pad	86
Linear	87
Maisie	88
Mesa	89

## Specifying

West Elm – Steelcase	91
West Elm – Licensed	231

## Resources and Surface Materials

241

# Additional Resources

**The West Elm Work Collection** is supported with an array of informational materials, tools, and software to help you plan and install efficiently.

## Surface Materials

**West Elm Work Collection Materials Swatches** Individual swatches, larger memo samples, and family group swatch cards are available by contacting Ad Stock at 1.800.784.0358 or by ordering electronically at [village.steelcase.com](http://village.steelcase.com).

## Computer Tools

**Digital Publications** You can access these digital publications at [www.steelcase.com](http://www.steelcase.com) or [village.steelcase.com](http://village.steelcase.com).

## Electronic Catalog

Accurate sales quotations and purchase orders for West Elm products are created with specification software that uses West Elm Electronic Catalog data. Use the data to specify and price style numbers and options for every West Elm product. The data is updated bimonthly by Steelcase and provided to software programs like the Hedberg Business System, 20-20 CAP Studio.

## Furniture Symbol Graphic Data

Steelcase creates 2D and 3D furniture symbols (with attributes) for planning and initially specifying Steelcase products. This data is incorporated into several add-on software packages that work in either a Microstation or an AutoCAD drafting environment.

For more information about these and other software tools to help you plan effective work environments, please email [fsl@steelcase.com](mailto:fsl@steelcase.com).

## Support

### Steelcase Capabilities

Steelcase products are distributed, installed, and serviced through a network of more than 600 dealers worldwide. Steelcase is also represented with offices and corporate showrooms in 26 U.S. cities, 4 Canadian cities, and in France, Germany, Great Britain, and Japan. Every Steelcase product meets our exceptionally high standards of quality and durability and comes with the Steelcase assurance of excellence in service.

### For ordering or product assistance,

call your local dealer, the Steelcase Solutions Resource Team, or the Steelcase Solutions Fulfillment Team at 1.888.STEELCASE or send an e-mail to [lineone@steelcase.com](mailto:lineone@steelcase.com).

Call the Steelcase Solutions Resource Team prior to placing an order, when working on a bid, or when you need information about product applications and specifications.

Call the Steelcase Solutions Fulfillment Team if you have submitted an order to Steelcase and you need to speak to your Solutions Fulfillment Team Representative about the order. Also call if you have any post-shipment quality concerns or service parts questions.

For warranty information, please go to <http://www.steelcase.com/warranty/>.

Outside the U.S.A., Canada, Mexico, Puerto Rico, and the U.S. Virgin Islands, call 1.616.247.2500.



# Statement of Line

West Elm – Steelcase

## Seating

### Belle

#### Lounge Seating

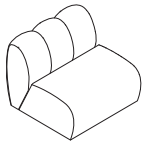

**Belle One-Seat Lounge**

Understanding  
▶ Page 16  
Specifying  
▶ Page 92

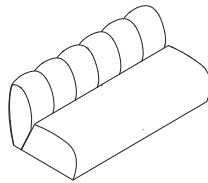

**Belle Two-Seat Lounge**

Understanding  
▶ Page 16  
Specifying  
▶ Page 94

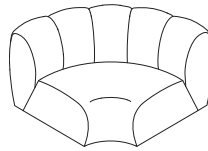

**Belle Corner Lounge**

Understanding  
▶ Page 16  
Specifying  
▶ Page 96

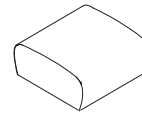

**Belle Ottoman**

Understanding  
▶ Page 16  
Specifying  
▶ Page 98

### Boardwalk

#### Lounge Seating

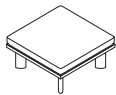

**Boardwalk One-Seat Lounge**

Understanding  
▶ Page 20  
Specifying  
▶ Page 100

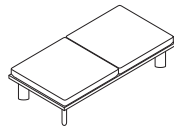

**Boardwalk Two-Seat Lounge**

Understanding  
▶ Page 20  
Specifying  
▶ Page 102

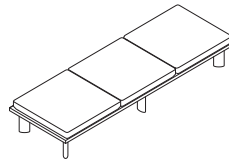

**Boardwalk Three-Seat Lounge**

Understanding  
▶ Page 20  
Specifying  
▶ Page 104

#### Occasional Tables

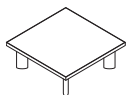

**Boardwalk 30\"/>**

Understanding  
▶ Page 20  
Specifying  
▶ Page 107

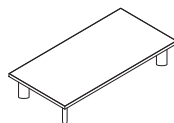

**Boardwalk 30\"/>**

Understanding  
▶ Page 20  
Specifying  
▶ Page 108

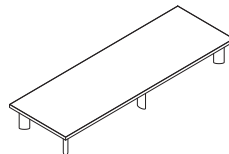

**Boardwalk 30\"/>**

Understanding  
▶ Page 20  
Specifying  
▶ Page 109

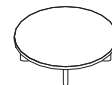

**Boardwalk 40\"/>**

Understanding  
▶ Page 20  
Specifying  
▶ Page 110

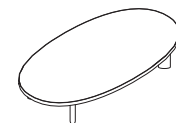

**Boardwalk 35\"/>**

Understanding  
▶ Page 20  
Specifying  
▶ Page 111

#### Accessories

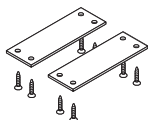

**Ganging Kit**

Understanding  
▶ Page 21  
Specifying  
▶ Page 112

## Seating, continued

### Brighton

#### Lounge Seating



**Brighton One-Seat Lounge**  
Understanding  
▶ Page 24  
Specifying  
▶ Page 114

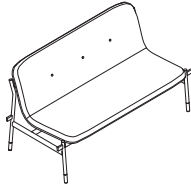

**Brighton Two-Seat Lounge**  
Understanding  
▶ Page 24  
Specifying  
▶ Page 116



**Brighton Ottoman**  
Understanding  
▶ Page 24  
Specifying  
▶ Page 118

#### Occasional Tables



**Brighton 60° Ganging Table**  
Understanding  
▶ Page 24  
Specifying  
▶ Page 119



**Brighton 90° Ganging Table**  
Understanding  
▶ Page 24  
Specifying  
▶ Page 120

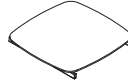

**Brighton Straight Ganging Table**  
Understanding  
▶ Page 24  
Specifying  
▶ Page 121



**Brighton End Table**  
Understanding  
▶ Page 24  
Specifying  
▶ Page 122



**Brighton Square Table**  
Understanding  
▶ Page 24  
Specifying  
▶ Page 123



**Brighton Rectangle Table**  
Understanding  
▶ Page 24  
Specifying  
▶ Page 124

#### Accessories

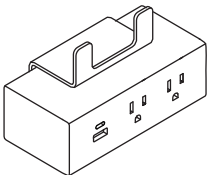

**Brighton Module Power**  
Specifying  
▶ Page 125

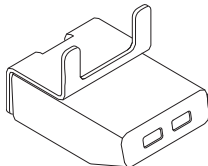

**Brighton USB Power**  
Specifying  
▶ Page 125

**Seating, continued**

**Mesa**

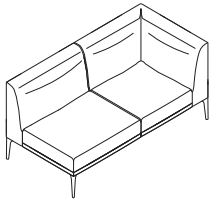

**Mesa Left-Hand Chaise Lounge**  
Understanding  
▶ Page 28  
Specifying  
▶ Page 126

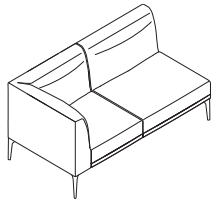

**Mesa Right-Hand Chaise Lounge**  
Understanding  
▶ Page 28  
Specifying  
▶ Page 127

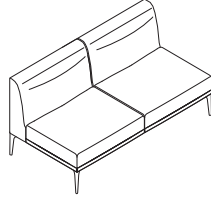

**Mesa Two-Seat Lounge**  
Understanding  
▶ Page 28  
Specifying  
▶ Page 128

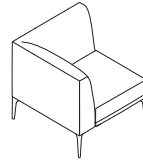

**Mesa Corner Lounge**  
Understanding  
▶ Page 28  
Specifying  
▶ Page 129

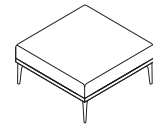

**Ottoman**  
Understanding  
▶ Page 28  
Specifying  
▶ Page 130

**Willow**

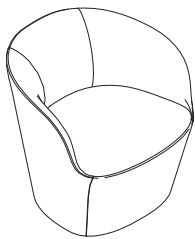

**Willow Fixed Base Lounge**  
Understanding  
▶ Page 32  
Specifying  
▶ Page 132

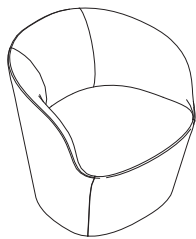

**Willow Swivel Base Lounge**  
Understanding  
▶ Page 32  
Specifying  
▶ Page 134

**Slope**

**Guest Chairs and Stools**



**Slope Guest Chair**  
Understanding  
▶ Page 34  
Specifying  
▶ Page 136



**Slope Lounge Chair**  
Understanding  
▶ Page 34  
Specifying  
▶ Page 137

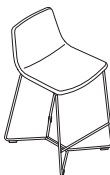

**Slope Counter-Height Stool**  
Understanding  
▶ Page 34  
Specifying  
▶ Page 138



**Slope Bar-Height Stool**  
Understanding  
▶ Page 34  
Specifying  
▶ Page 139



**Slope Stacking Chair**  
Understanding  
▶ Page 34  
Specifying  
▶ Page 141

## Seating, continued

### Conference Chairs



#### Slope Conference Chair

Understanding  
 ▶ Page 34  
 Specifying  
 ▶ Page 140

## Sterling

### Guest Chairs and Stools

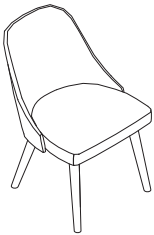

#### Sterling Guest Chair-Armless

Understanding  
 ▶ Page 38  
 Specifying  
 ▶ Page 142

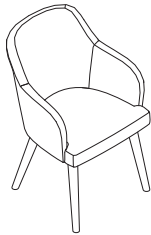

#### Sterling Guest Chair

Understanding  
 ▶ Page 38  
 Specifying  
 ▶ Page 143



#### Sterling Counter Height Stool

Understanding  
 ▶ Page 39  
 Specifying  
 ▶ Page 144



#### Sterling Bar Height Stool

Understanding  
 ▶ Page 39  
 Specifying  
 ▶ Page 145

### Conference Chairs



#### Sterling Conference Chair—Five-Star Armless

Understanding  
 ▶ Page 38  
 Specifying  
 ▶ Page 146



#### Sterling Conference Chair—Five-Star with Arms

Understanding  
 ▶ Page 38  
 Specifying  
 ▶ Page 147



#### Sterling Conference Chair—Four-Star Armless

Understanding  
 ▶ Page 39  
 Specifying  
 ▶ Page 148



#### Sterling Conference Chair—Four-Star with Arms

Understanding  
 ▶ Page 38  
 Specifying  
 ▶ Page 149

**Seating, continued**

**Sterling, continued**

**Lounge**

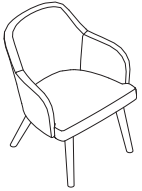

**Sterling Lounge**  
Understanding  
▶ Page 39  
Specifying  
▶ Page 150



**Sterling Health Guest Chairs**  
Specifying  
▶ Page 151

**Kent**

**Conference Chairs**



**Kent Conference Chair—Five-Star with Arms**  
Understanding  
▶ Page 42  
Specifying  
▶ Page 153



**Kent Conference Chair—Five-Star Armless**  
Understanding  
▶ Page 42  
Specifying  
▶ Page 154



**Kent Conference Chair—Four-Star with Arms**  
Understanding  
▶ Page 42  
Specifying  
▶ Page 155



**Kent Conference Chair—Four-Star Armless**  
Understanding  
▶ Page 42  
Specifying  
▶ Page 156

**Guest Chairs**

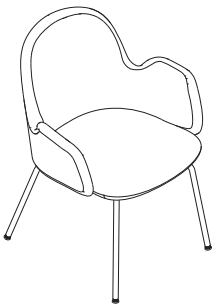

**Kent Guest Chair Four Legs with Arms**  
Understanding  
▶ Page 42  
Specifying  
▶ Page 157



**Kent Guest Chair Four Legs Armless**  
Understanding  
▶ Page 42  
Specifying  
▶ Page 158

**Conference Stools**

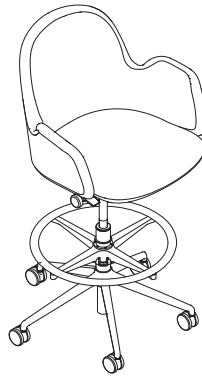

**Kent Conference Stool—Five-Star with Arms**  
Understanding  
▶ Page 42  
Specifying  
▶ Page 159

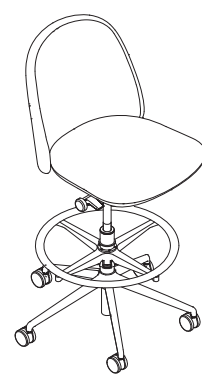

**Kent Conference Stool—Five-Star Armless**  
Understanding  
▶ Page 42  
Specifying  
▶ Page 160

**Seating, continued**

**Lucas**

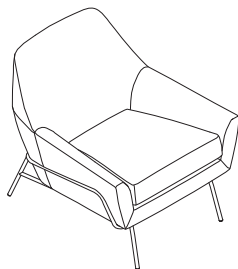

**Lucas Wire Chair**  
Understanding  
▶ Page 46  
Specifying  
▶ Page 161

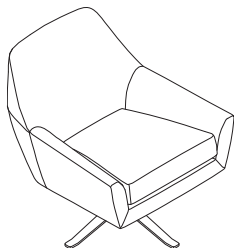

**Lucas Swivel Chair**  
Understanding  
▶ Page 46  
Specifying  
▶ Page 162

**Fulton**



**Fulton Guest Chair**  
Understanding  
▶ Page 48  
Specifying  
▶ Page 163

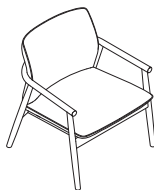

**Fulton Lounge Chair**  
Understanding  
▶ Page 48  
Specifying  
▶ Page 164

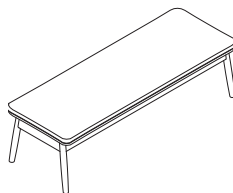

**Fulton Bench**  
Understanding  
▶ Page 48  
Specifying  
▶ Page 165

**Furniture**

**Greenpoint Private Office**

**Desks and Returns**

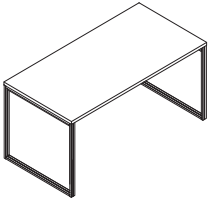

**Private Desk**  
Understanding  
▶ Page 52  
Specifying  
▶ Page 166

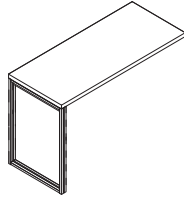

**Desk Return with Leg**  
Understanding  
▶ Page 52  
Specifying  
▶ Page 167

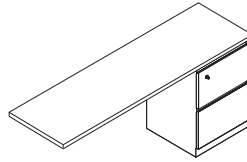

**Desk Return with Pedestal**  
Understanding  
▶ Page 52  
Specifying  
▶ Page 168

**Modesty Panel**

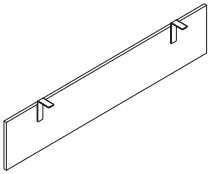

Understanding  
▶ Page 52  
Specifying  
▶ Page 170

**Credenzas**

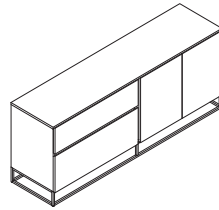

**Filing Credenza**  
Understanding  
▶ Page 53  
Specifying  
▶ Page 171

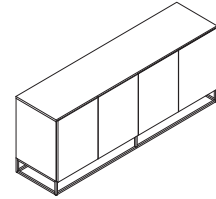

**Storage Credenza**  
Understanding  
▶ Page 53  
Specifying  
▶ Page 172

**Wood Lateral File**

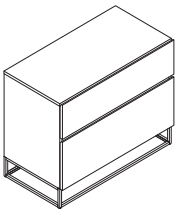

Understanding  
▶ Page 53  
Specifying  
▶ Page 173

**Furniture, continued**

**Greenpoint Private Office, continued**

**Bookcases**



**Open Bookcase—  
Low**  
Understanding  
▶ Page 54  
Specifying  
▶ Page 174



**Open Bookcase—  
Narrow**  
Understanding  
▶ Page 54  
Specifying  
▶ Page 175



**Open Bookcase—  
Tall**  
Understanding  
▶ Page 54  
Specifying  
▶ Page 176



**Storage Bookcase**  
Understanding  
▶ Page 54  
Specifying  
▶ Page 177

**Metal Mobile Pedestal**

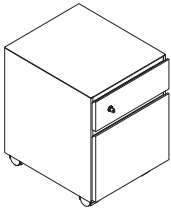

Understanding  
▶ Page 54  
Specifying  
▶ Page 178

**Basic Cushion Enhanced**

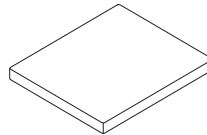

Understanding  
▶ Page 54  
Specifying  
▶ Page 179

**Wire Managers**



**Wire Clip**  
Specifying  
▶ Page 180



**2½" Round Grommet**  
Specifying  
▶ Page 180

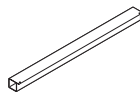

**Wire Manager**  
Specifying  
▶ Page 180

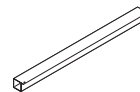

**1¾"D Wire Managers**  
Specifying  
▶ Page 181

**Power and Data**

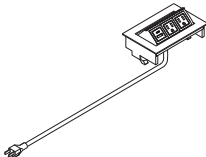

**Greenpoint  
Desk Power Unit**  
Specifying  
▶ Page 182



**Greenpoint  
Round/Square  
Power Unit**  
Specifying  
▶ Page 183

**Furniture, continued**

**Greenpoint Benching**

**Worksurfaces and Returns**

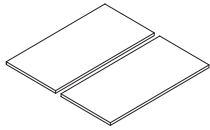

Dual-Sided

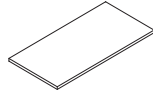

Single-Sided

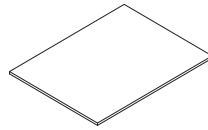

Continuous Top

Understanding  
 ▶ Page 60  
 Specifying  
 ▶ Pages 184-192

**Greenpoint 24"D or 30"D Worksurfaces**

	Dual-Sided Leg/Leg	Dual-Sided Leg/Credenza*	Dual-Sided Credenza/Credenza*	Single-Sided Leg/Leg	Single-Sided Leg/Credenza*	Single-Sided Credenza/Credenza*	Continuous Top Leg/Leg	Continuous Top Leg/Credenza	Continuous Top Credenza/Credenza
48"W	●	●	●	●	●	●	●	●	●
54"W	●	●	●	●	●	●	●	●	●
60"W	●	●	●	●	●	●	●	●	●
66"W	●	●	●	●	●	●	●	●	●
72"W	●	●	●	●	●	●	●	●	●
78"W	●	●	●	●	●	●	●	●	●

\*Add 3"W to the leg/credenza work surface and 6"W to the credenza/credenza work surface.

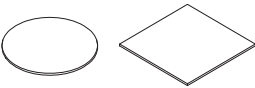

Understanding  
 ▶ Page 62  
 Specifying  
 ▶ Pages 193–194

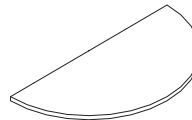

Understanding  
 ▶ Page 62  
 Specifying  
 ▶ Page 195

**Round and Square**

	48"W	60"W
48"D/Dia.	●	
60"D/Dia.		●

**Half-Round**

	48"W	60"W
24"D	●	
30"D		●

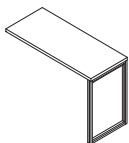

Understanding  
 ▶ Page 64  
 Specifying  
 ▶ Page 196

**Greenpoint Bench Returns**

	42"W	48"W	54"W	60"W
18"D	●	●	●	●
24"D	●	●	●	●

## Furniture, continued

### Greenpoint Benching, continued

#### Legs

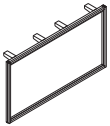

#### Greenpoint Dual-Sided End Leg

Understanding  
 ▶ Page 63  
 Specifying  
 ▶ Page 197



#### Greenpoint Single-Sided End Leg

Understanding  
 ▶ Page 63  
 Specifying  
 ▶ Page 198

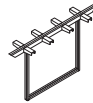

#### Greenpoint Dual-Sided Intermediate Leg

Understanding  
 ▶ Page 63  
 Specifying  
 ▶ Page 199



#### Greenpoint Single-Sided Intermediate Leg

Understanding  
 ▶ Page 63  
 Specifying  
 ▶ Page 200

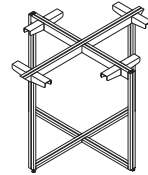

#### Greenpoint Round and Square Top, X-Leg

Understanding  
 ▶ Page 63  
 Specifying  
 ▶ Page 201

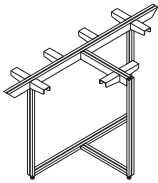

#### Greenpoint Half-Round Top, T-Leg

Understanding  
 ▶ Page 63  
 Specifying  
 ▶ Page 202

#### Credenzas

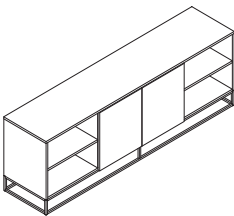

#### Greenpoint End Credenza

Understanding  
 ▶ Page 64  
 Specifying  
 ▶ Page 203

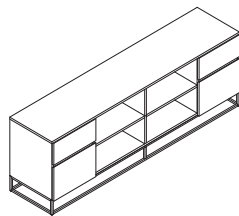

#### Greenpoint Personal Credenza

Understanding  
 ▶ Page 64  
 Specifying  
 ▶ Page 204

#### Center Screens

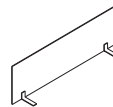

#### Greenpoint Glass Center Screen

Understanding  
 ▶ Page 64  
 Specifying  
 ▶ Page 205

**Furniture, continued**

**Greenpoint Benching, continued**

**Power and Data**

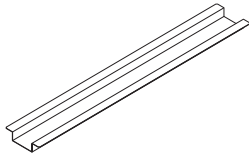

**Greenpoint Dual-Sided Power Support**  
Understanding  
▶ Page 65  
Specifying  
▶ Page 206

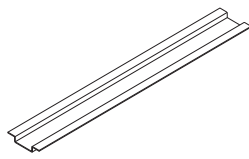

**Greenpoint Single-Sided Power Support**  
Understanding  
▶ Page 65  
Specifying  
▶ Page 206

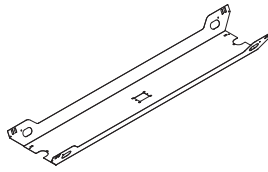

**Greenpoint Dual-Sided Tray**  
Understanding  
▶ Page 65  
Specifying  
▶ Page 207

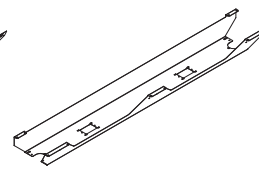

**Greenpoint Single-Sided Tray**  
Understanding  
▶ Page 65  
Specifying  
▶ Page 207

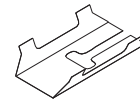

**Greenpoint Dual-Sided Extension Tray**  
Understanding  
▶ Page 65  
Specifying  
▶ Page 208

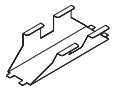

**Greenpoint Single-Sided Extension Tray**  
Understanding  
▶ Page 65  
Specifying  
▶ Page 208

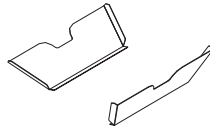

**Greenpoint Dual-Sided End Cap Tray**  
Understanding  
▶ Page 65  
Specifying  
▶ Page 208

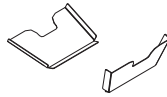

**Greenpoint Single-Sided End Cap Tray**  
Understanding  
▶ Page 65  
Specifying  
▶ Page 208

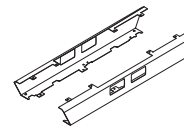

**Greenpoint Dual-Sided Power Cover**  
Understanding  
▶ Page 65  
Specifying  
▶ Page 209

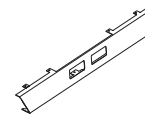

**Greenpoint Single-Sided Power Cover**  
Understanding  
▶ Page 65  
Specifying  
▶ Page 209

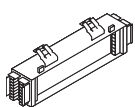

**Modular Power Block—Standard-Capacity**  
Specifying  
▶ Page 210

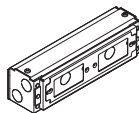

**Chicago Hardwire Power Kit**  
Specifying  
▶ Page 211



**Duplex Receptacle**  
Specifying  
▶ Page 212



**USB Receptacle**  
Specifying  
▶ Page 213



**Filler Package—Power/Data**  
Specifying  
▶ Page 213

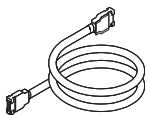

**Modular Harnesses**  
Specifying  
▶ Page 214

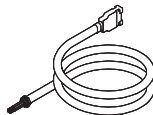

**Hardwire-to-Modular Power Infeed**  
Specifying  
▶ Page 215

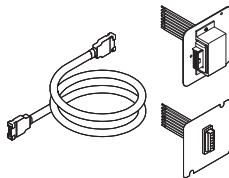

**Modular-to-Modular Power Infeed**  
Specifying  
▶ Page 215

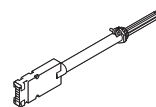

**San Francisco Power Infeed**  
Specifying  
▶ Page 216

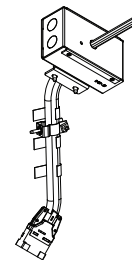

**New York City Power Infeed**  
Specifying  
▶ Page 216

**Furniture, continued**

**Greenpoint Benching, continued**

**Power and Data, continued**

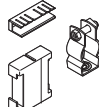

**Bracket Kit Power**  
Specifying  
▶ Page 217



**Vertebral Cable Riser**  
Specifying  
▶ Page 218



**Extension Vertebral Cable Riser**  
Specifying  
▶ Page 218

**Sutton**



Understanding  
▶ Page 76  
Specifying  
▶ Page 220–222

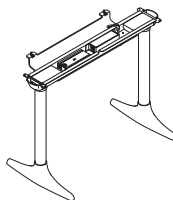

Understanding  
▶ Page 76  
Specifying  
▶ Pages 224–226

**Rectangle Height-Adjustable Desks**

	46"W	52"W	58"W	64"W	70"W
23"D	●	●	●	●	●
29"D	●	●	●	●	●

Tip: Widths are parametric to 1/16" from 46"–72".

**Rectangle Height-Adjustable Bases**

	46"W	52"W	58"W	64"W	70"W
23"D	●	●	●	●	●
29"D	●	●	●	●	●

Tip: Widths are parametric to 1/16" from 46"–72".

**Accessories**

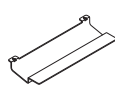

**Cable Tray**  
Understanding  
▶ Page 77  
Specifying  
▶ Page 228

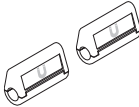

**Magnetic Cable Clips**  
Understanding  
▶ Page 77  
Specifying  
▶ Page 228

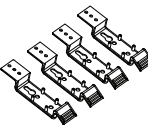

**Cable Brackets**  
Understanding  
▶ Page 77  
Specifying  
▶ Page 229

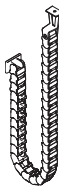

**Cable Riser**  
Understanding  
▶ Page 77  
Specifying  
▶ Page 229

# Belle Lounge Seating

**Belle lounge** features deco inspired tufted forms and soft curves that have been expertly tailored to create an inviting venue for solo work and coworker congregations alike. Each modular piece has been thoughtfully designed to function either freestanding or connected, setting the stage for applications that are both expressive and memorable. Generous corners and versatile ottomans allow limitless flexibility in planning, where Belle's curves can be appreciated from any angle.

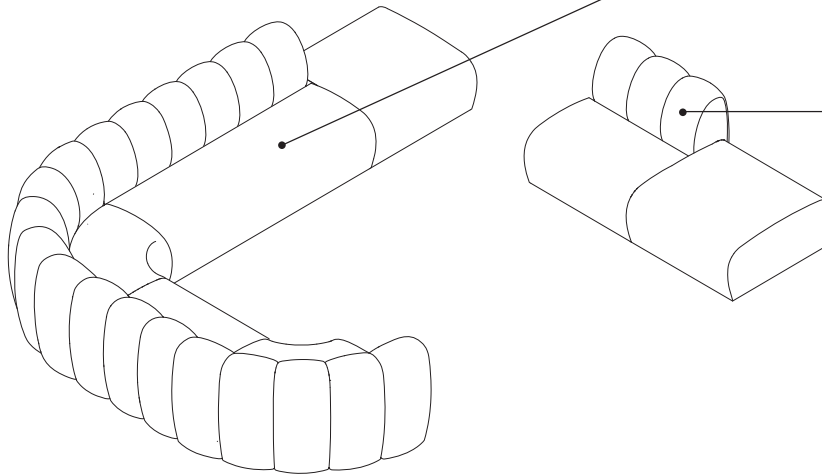

**Lounge units** are available in one-seat lounge, two-seat lounge, and corner lounge.

**Lounge units** can be connected together to create a wide range of configurations.

**Upholstered seat and back cushions** are attached.

**Integrated ganging brackets** are included.

**Glides** are not adjustable.

**Product Details**

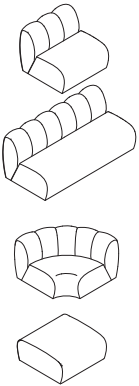

**Lounge seating** features four fully upholstered, complementary models: one-seat lounge, two-seat lounge, corner lounge, and ottoman. Legs are concealed for a streamlined profile.

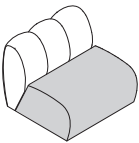

**Lounges** are available in contrasting seat and back fabrics. Seat and back fabrics do not have to be in the same fabric family.

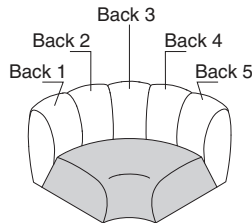
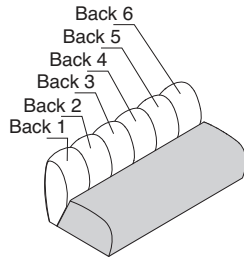
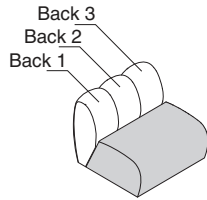

**Contrasting all option** is available on the one-seat lounge, two-seat lounge, and corner lounge. Back channels and seat can be specified separately.  
*Tip: Contrasting back channels must be in the same fabric family.*

**Contrasting fabrics** are specified from the right handed seated position.

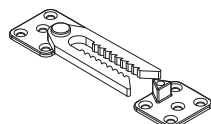

**Integrated ganging device** is included and keeps units aligned.

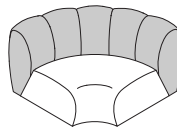
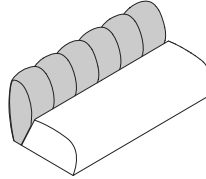
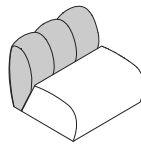

**Crown of back channels** may vary depending on stiffness of fabric. It is recommended to use the same back fabric when connecting multiple pieces.

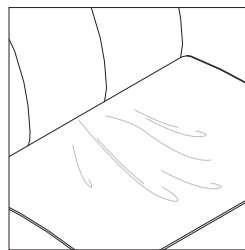

**Comfort wrinkles** are expected to occur over time. Smooth the cushion fabric with a sweeping/wiping motion to reduce the definition.

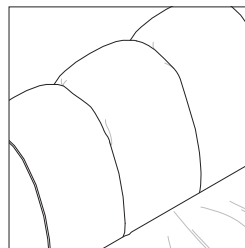

**Tufted seams** can loosen over time or during installation and may require occasional manual adjustment by pushing fabric into seams.

**Surface Materials**

**Upholstery**

- Fabric
- ▶ See *Surface Materials*, page 242 for specific availability, or refer to the *Surface Materials Reference Manual* for further information.

Visit <https://srh.steelcase.com/comcalculator.aspx> for Steelcase Textile calculator.

**Dimensions**

▶ Page 18





# Boardwalk Lounge Seating and Occasional Tables

**East** meets west in the design of our modular Boardwalk system. Pillow-like cushions inspired by Japanese "zaisu" are lifted off the ground by a simple modular platform with natural wood detailing—a nod to California-cool residential design. In a celebration of minimalism, Boardwalk offers a respite within an office landscape and configures to provide seating, table surfaces, and power access.

**Boardwalk lounge system** is based on a 30"D x 30"W planning module with platforms available in 30"D x 30"W, 30"D x 60"W, and 30"D x 90"W sizes.

**Cushions or open table positions** can be specified in each 30" module. Cushions can be specified as single seat only, mid back, left corner, or right corner.

**Edge finish** has an edge band that is defaulted to match the laminate surface, or can be specified in another color.

**Mounting holes for cushions** are symmetrical, allowing for them to be positioned facing any direction.

**Lounge units** can be connected together to create a variety of configurations.

**Connector brackets** are not included with lounge units but can be ordered separately as style number: **TS31410**.

**When a module** is specified with no cushion, that module is left open as a table position. It will have a surface in the finish specified for the rest of the platform with no holes or cutouts for mounting cushions. Cushions are not retro-fittable.

**Cushions** are bolted to the seating platform. They are not retro-fittable to open table positions. Legs, platform, and cushions ship separately and require assembly.

**Legs** are hardwood oak and available in several hardwood finishes that complement platform finishes.

**Units** specified with seat cushions can be used to create ottomans or benches.

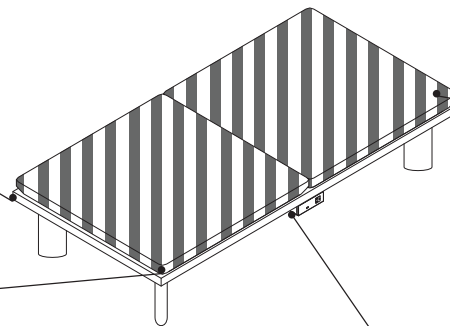
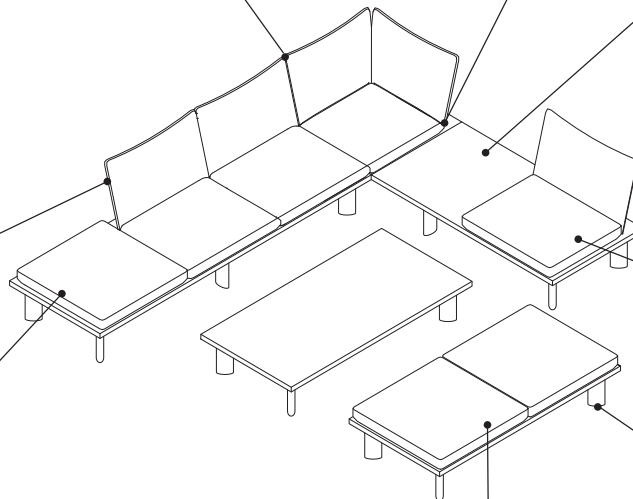

**Cushion orientation** can be changed or determined in the field. However, specifiers should be mindful of fabric direction when using directional or patterned fabrics on adjacent cushions.

**Power units** can be installed beneath lounges and tables. All lounge and table platforms are shipped with inserts on the underside for power units to be mounted. Power style number (**COSISPWR**) must be ordered separately. ▶ See *Coalesse Seating Specification Guide*.

**Product Details**



Single Seat



Mid Back Seat



Corner Seat

**Cushions** can be specified as seat only, mid back, left corner, and right corner. Lounge styles must have at least one cushion specified.



Single Platform

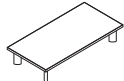

Double Platform

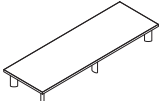

Triple Platform

**Platforms and tables** come in three sizes: 30" x 30", 30" x 60", and 30" x 90". Platforms are 11"H with a seat height of 16<sup>3</sup>/<sub>4</sub>", when a cushion is specified. Tables are available in 11"H or 15"H. The same platform is used in both the seating and the 11"H table applications.

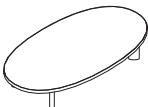

**Tables** are also available in a 40" round and 65" x 35" oval version.

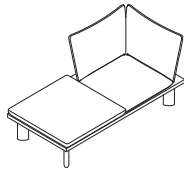

Left Corner

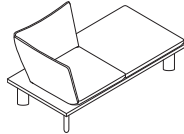

Right Corner

**Corner cushions** can be specified as left or right. Orientation is determined in the seated position. Corners are symmetrical; however, the fabric direction for the seat is determined by left or right specification.

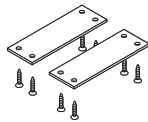

**Ganging plate (TS31410)** can be ordered separately to permanently gang units.

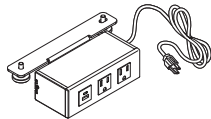

**Power block style number (COSISPWR)** can be mounted to any platform.   
▶ See *Coalesse Seating Specification Guide*.

**Power blocks** can be specified with either two power, one USB A+C 20W port or one power, or one USB C single 60"W.

**Surface Materials**

**Upholstery**

- Fabric
- Leather
- Vinyl

*Tip: Contrasting fabric is not an option.*

▶ See *Surface Materials*, page 242 for specific availability, or refer to the *Surface Materials Reference Manual* for further information.

Visit <https://srh.steelcase.com/comcalculator.aspx> for Steelcase Textile calculator.

**Platform**

- High-Pressure Laminate
  - Veneer
- ▶ See *Surface Materials*, page 242

**Edge**

- Plastic

*Tip: Edge finish has an edge band that is defaulted to match the laminate surface, or can be specified in another color.*

**Leg**

- Customiz stain
- VP01 Oak Light
- VP03 Black Oak
- VP05 White Oak

**Leg Bracket**

- 0835 Black

**Dimensions**

▶ Page 22

# Dimensions

## Boardwalk Lounge Seating

Features	Overall Depth	Width	Height	Functional Seat Depth	Seat Width	Seat Height from Floor	Back Width	Back Height from Seat
<b>Boardwalk</b>								
<b>Lounge Seating</b>								
One-Seat Platform	30"	30"	11"	N.A.	N.A.	N.A.	N.A.	N.A.
Two-Seat Platform	30"	60"	11"	N.A.	N.A.	N.A.	N.A.	N.A.
Three-Seat Platform	30"	90"	11"	N.A.	N.A.	N.A.	N.A.	N.A.
Seat Cushion	30"	30"	16¾"	30"	30"	16¾"	30"	N.A.
Mid Back	30"	30"	31"	22½"	30"	16¾"	30"	20"
Corner Cushion	30"	30"	31"	22½"	22½"	16¾"	30"	20"
<b>Occasional Tables</b>								
Square Table	30"	30"	11" or 15"	N.A.	N.A.	N.A.	N.A.	N.A.
Rectangle Table	30"	60"	11" or 15"	N.A.	N.A.	N.A.	N.A.	N.A.
Rectangle Table	30"	90"	11" or 15"	N.A.	N.A.	N.A.	N.A.	N.A.
Round Table	N.A.	40" Dia.	11" or 15"	N.A.	N.A.	N.A.	N.A.	N.A.
Oval Table	35"	65"	11" or 15"	N.A.	N.A.	N.A.	N.A.	N.A.

Tip: Height and seat height dimensions are included for cushion mounted to platform.



# Brighton Lounge Seating

**Inspired by the traditional wood frame joinery of mid-century design,** Brighton lounge seating offers an updated take with sleek metal construction while optional brass accents add a deco-friendly spark. It's configurability allows Brighton to arrange into infinite formations, while freestanding lounge and table options create even more choice.

**One and two seat lounges** can be specified with ganging hardware for attached table.

**Lounge seat and backs** are fully upholstered. Back shells can be specified with contrasting fabric.

**Frame caps** can be specified to match or contrast the frame. Caps are offered in a range of powder coat finishes, antique brass, and brushed nickel.

**Arms** are available on lounge units. Arm caps are solid oak and can be specified in a range of finishes.

**Frames** are offered in a range of powder coat finishes.

**Tables** are available in laminate and veneer. Frames are offered in a range of powder coat finishes.

**Frame foot** can be specified to match or contrast the frame. Feet are offered in a range of powder coat finishes, antique brass, and brushed nickel.

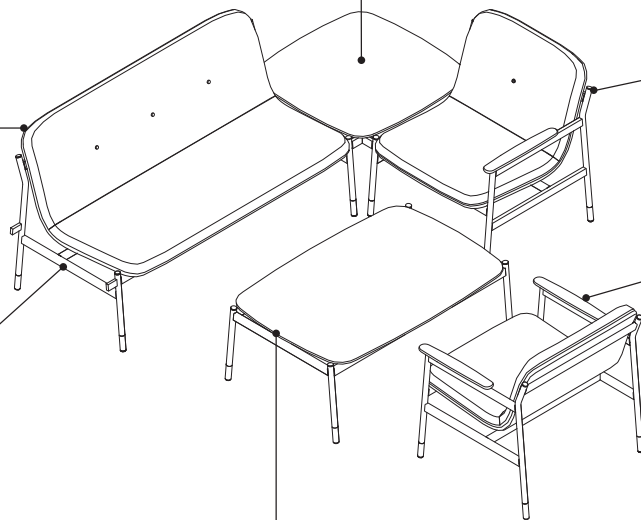

**Product Details**

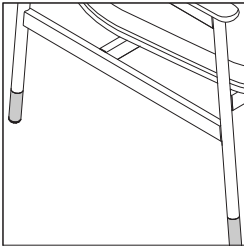

**Frame feet** can be specified to match or contrast the frame. Feet are offered in a range of powder coat finishes, antique brass, and brushed nickel.

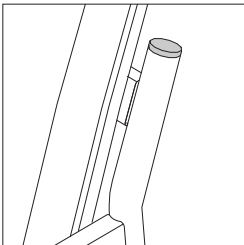

**Frame caps** can be specified to match or contrast the frame. Caps are offered in a range of powder coat finishes, antique brass, and brushed nickel.

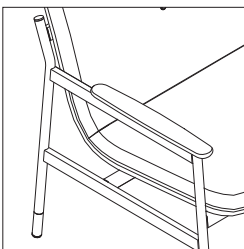

**Armcaps** are solid oak wood and are available on both one- and two-seat lounges in a range of wood finishes.

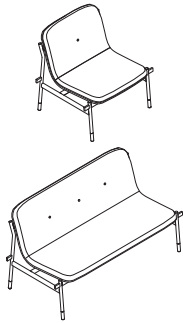

**Button tufting** is standard on all lounges that are upholstered in fabric, vinyl, and faux-leather. One-seat lounges come standard with one button, two-seat lounges come with three buttons. There will be no button tufting when leather upholstery is specified.

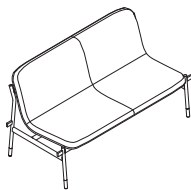

**When leather is specified on the two-seat lounge**, there will be an additional seam down the center of the seat and back.

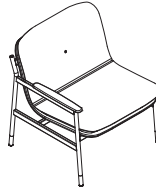
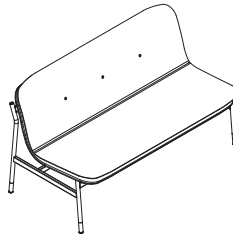

Arm Right

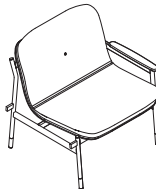

Arm Left

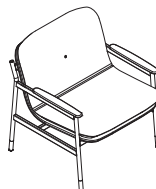

**One- and two-seat lounges** are available with and without arms and can be specified with ganging hardware or as freestanding.

**Lounges** must be specified with ganging hardware when used with end or ganging tables. Ganging hardware and arms cannot be specified on the same side of a lounge unit.

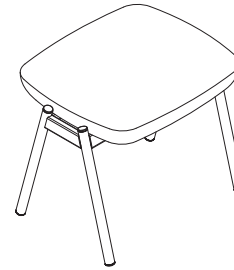

**Ottoman** is upholstered with a metal frame that is available in a range of powder coat finishes. Contrasting frame caps are optional.

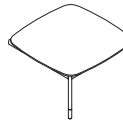

**Ganging tables** are available in three options: 60°, 90° and straight. Tables can be attached facing either direction and must be attached between lounge units.



**End table** is available in one size 28" square and can be added to either side of a lounge unit.

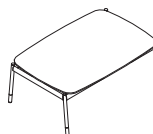

**Freestanding tables** are available in 28" square and 28"D x 42"W rectangle.

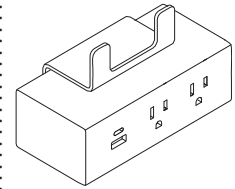

**Power module** has a 9' cord.

**Surface Materials**

**Upholstery**

(available in contrasting front and back)

- Fabric
- Leather
- Vinyl

▶ See *Surface Materials*, page 242 for specific availability, or refer to the *Surface Materials Reference Manual* for further information.

Visit <https://srh.steelcase.com/comcalculator.aspx> for Steelcase Textile calculator.

**Table tops**

- High-Pressure Laminate
  - Veneer
- ▶ See *Surface Materials*, page 242

**Frames**

- Paint
- Accent paint
- Lux Coatings

▶ See *Surface Materials*, page 242

**Feet and caps**

- Paint
- Accent paint
- Lux Coatings
- WE03 Antique Brass
- WE04 Brushed Nickel

**Arms**

- Customiz stain
- VP01 Light Oak
- VP03 Black Oak
- VP04 Gray Oak
- VP05 White Oak

**Power**

- 6000 Black
- 6052 Milk

**Dimensions**

▶ Page 26

# Dimensions

## Brighton Lounge Seating

Features	Overall Depth	Width	Height	Functional Seat Depth	Seat Width	Seat Height from Floor
----------	------------------	-------	--------	-----------------------------	---------------	---------------------------------

### Brighton

#### Lounge Seating

One-Seat Lounge	29 <sup>3</sup> / <sub>4</sub> "	29 <sup>7</sup> / <sub>8</sub> "	33 <sup>1</sup> / <sub>16</sub> "	19 <sup>7</sup> / <sub>16</sub> "	26 <sup>1</sup> / <sub>4</sub> "	17 <sup>7</sup> / <sub>16</sub> "
Two-Seat Lounge	29 <sup>3</sup> / <sub>4</sub> "	57 <sup>9</sup> / <sub>16</sub> "	33 <sup>1</sup> / <sub>16</sub> "	19 <sup>7</sup> / <sub>16</sub> "	54"	17 <sup>7</sup> / <sub>16</sub> "
Ottoman	16 <sup>31</sup> / <sub>32</sub> "	19 <sup>15</sup> / <sub>32</sub> "	16 <sup>23</sup> / <sub>32</sub> "	N.A.	N.A.	N.A.
60° Ganging Table	28 <sup>1</sup> / <sub>4</sub> "	37 <sup>3</sup> / <sub>4</sub> "	15 <sup>11</sup> / <sub>16</sub> "	N.A.	N.A.	N.A.
90° Ganging Table	29"	29"	15 <sup>11</sup> / <sub>16</sub> "	N.A.	N.A.	N.A.
End Table	28 <sup>1</sup> / <sub>2</sub> "	28 <sup>1</sup> / <sub>4</sub> "	15 <sup>11</sup> / <sub>16</sub> "	N.A.	N.A.	N.A.
Square Table	28 <sup>1</sup> / <sub>2</sub> "	28 <sup>1</sup> / <sub>4</sub> "	15 <sup>11</sup> / <sub>16</sub> "	N.A.	N.A.	N.A.
Rectangle Table	28 <sup>1</sup> / <sub>2</sub> "	42"	15 <sup>11</sup> / <sub>16</sub> "	N.A.	N.A.	N.A.



# Mesa Lounge Seating

**Mesa lounge seating** adds style to any workspace with its modern form and tapered legs. Modular pieces can easily create common areas of any size.

**Connector brackets** are standard with all lounges and ottomans.

**Lounge units** can be connected together to create an L- or U-configuration. Two corners can be used together for a two-seat sofa.

**Lounge units** are available in two-seat lounge, right- and left-hand chaise lounge, and corner lounge.

**Upholstered seat and back cushions** are attached.

**Tapered legs** are cast aluminum and coated in WE01 Antique Bronze.

**Frame** is a unibody construction with finger jointed plywood.

**Ottoman** can be freestanding or connected to other lounge units.

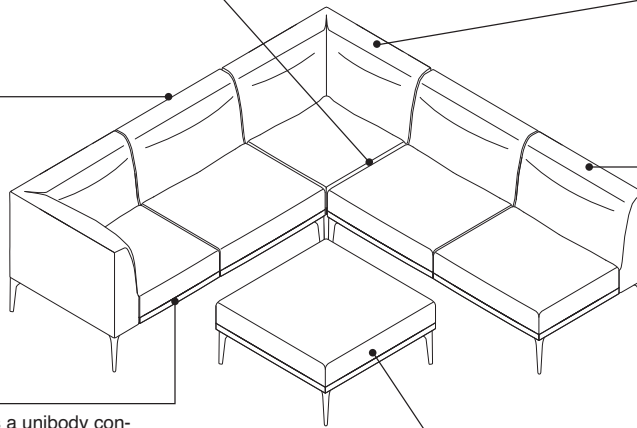

**Product Details**

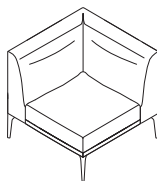
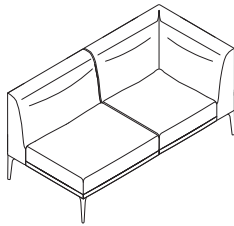
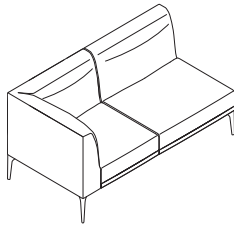
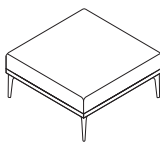
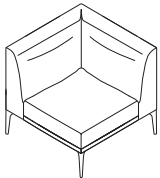
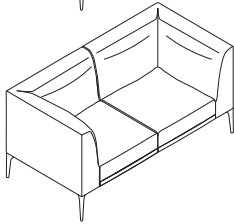
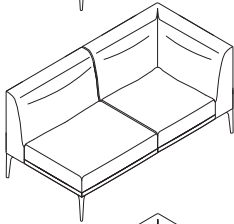
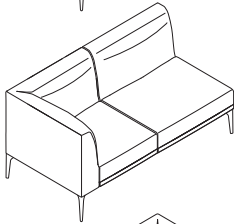
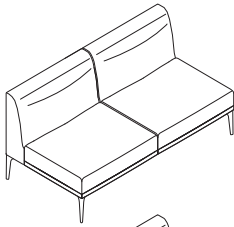

**Chaise lounge** can be specified in a right- or left-hand configuration.  
*Tip: Handedness is determined while in the seated position.*

**The corner unit** is not handed and can be connected on either side with other units. Avoid using directional fabrics as it may not align with adjacent pieces.

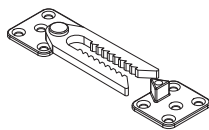

**Integrated ganging device** is included and keeps units aligned.

**Lounge seating** features five fully upholstered, complementary models: two-seater lounge, right-hand chaise lounge, left-hand chaise lounge, corner lounge, and ottoman. All models feature a four-leg, cast aluminum base with a powder coat painted finish.

**Surface Materials**

**Upholstery**

► See *Surface Materials*, page 242 for specific availability, or refer to the *Surface Materials Reference Manual* for further information.

Visit <https://srh.steelcase.com/comcalculator.aspx> for Steelcase Textile calculator.

**Legs**

- WE01 Antique Bronze  
*Tip: Contrasting fabric is not available on Mesa.*

**Dimensions**

► Page 30

# Dimensions

## Mesa Lounge Seating

• Features	• Overall Depth	Width	Height	• Functional Seat Depth	• Seat Width	• Seat Height from Floor
<b>Mesa</b>						
<b>Lounge Seating</b>						
Two-Seat	32 <sup>1</sup> / <sub>4</sub> "	64 <sup>1</sup> / <sub>4</sub> "	28 <sup>3</sup> / <sub>4</sub> "	22 <sup>3</sup> / <sub>4</sub> "	64 <sup>1</sup> / <sub>4</sub> "	18 <sup>3</sup> / <sub>4</sub> "
Chaise	32 <sup>1</sup> / <sub>4</sub> "	64 <sup>1</sup> / <sub>4</sub> "	28 <sup>3</sup> / <sub>4</sub> "	22 <sup>3</sup> / <sub>4</sub> "	55"	18 <sup>3</sup> / <sub>4</sub> "
Corner	32 <sup>1</sup> / <sub>4</sub> "	32 <sup>1</sup> / <sub>4</sub> "	28 <sup>3</sup> / <sub>4</sub> "	22 <sup>3</sup> / <sub>4</sub> "	22 <sup>3</sup> / <sub>4</sub> "	18 <sup>3</sup> / <sub>4</sub> "
Ottoman	32 <sup>1</sup> / <sub>4</sub> "	32 <sup>1</sup> / <sub>4</sub> "	18 <sup>3</sup> / <sub>4</sub> "	N.A.	N.A.	N.A.
:	:	:	:	:	:	:



# Willow Seating

**Willow** is a fresh take on the classic club chair. Sporting either a smooth upholstered interior for a clean and versatile look or soft upholstery treatment that's casual and elevated, Willow can blend in or stand out.

**Willow** comes in either a fixed or 360 swivel base.

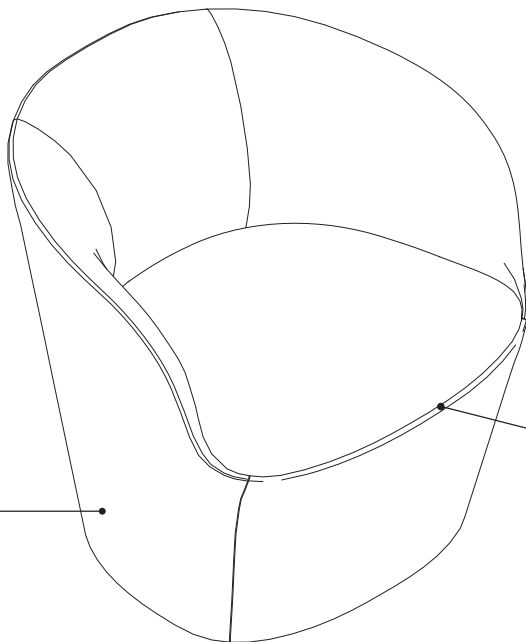

**Seat height** is 19" from the ground.

**Upholstery treatment** is available in smooth or soft and refers to the inside of the back of the chair.

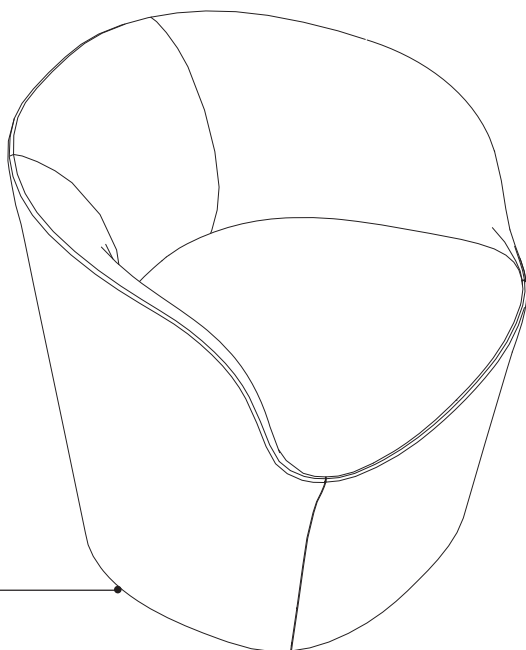

**The base of the chair** has 1 1/2" of clearance for both the fixed and swivel bases.

**Fabric** is applied in vertical direction. Optional contrasting fabric is available between the seat interior and outer shell.

## Product Details

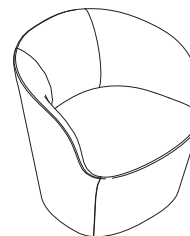

**An optional 360° swivel base** is available.

**All product in the Willow product line** ships fully assembled in one package.

## Surface Materials

**See surface materials matrix** on page 256 for upholstery options.

**Optional contrasting fabric** is available between the seat interior and outer shell.

Visit <https://srh.steelcase.com/comcalculator.aspx> for Steelcase Textile calculator.

## Dimensions

► Page 33

# Dimensions

## Willow Seating

• Features	• Base Depth	• Width	• Overall Height	• Seat Height	• Weight (lb)
<b>Willow Seating</b>					
<b>Fixed Base Lounge</b>					
	30"	31 <sup>9</sup> / <sub>10</sub> "	29 <sup>1</sup> / <sub>2</sub> "	19"	58 lb
<b>Swivel Base Lounge</b>					
	30"	31 <sup>9</sup> / <sub>10</sub> "	29 <sup>1</sup> / <sub>2</sub> "	19"	78 lb

# Slope Seating

**Simple yet timeless design** allows the Slope family of seating to blend seamlessly into the modern office. A wide range of paint colors and upholstery options ranging from muted to playful add personality.

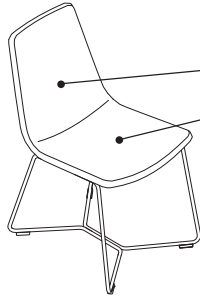

**Seat and back** are always fully upholstered.

**The double-needle stitch down the center of the slope seat and back** is an iconic detail of the slope chair. As an option, slope upholstery can be specified with this seam.

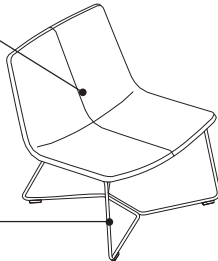

**Wire frame base** is painted and available in a range of standard, accent and Lux Coatings.

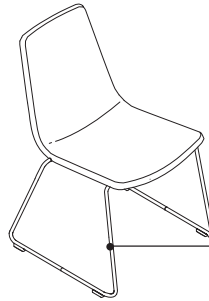

**Stackable base configuration** allows for easier storage and cleaning. Stacking chairs can be stacked up to five high.

**Seat height** adjusts 4", from 17½"H to 20½"H, with a pneumatic adjustment mechanism.

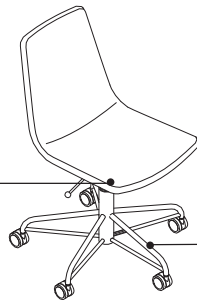

**Glides** are polyethylene for superior durability on carpeted and hard floors. Glides are available in milk or black.

**Five-star base** is available in hot rolled steel finish only.

## Product Details



Guest chair



Stacking chair



Lounge chair



Counter-height stool



Conference chair



Bar-height stool

**Five-star and wire-frame bases** are available for guest chair and stool.

**Slope wire frame stool** is available in two heights to pair with counter and bar height tables.

**360° adjustable height swivel mechanism** is standard on five-star base models.

**Slope** ships knocked down and the seat must be assembled to the frame on site, with the exception of the stacker with arms and the guest chair with arms which ship fully assembled. All slope styles come in a single carton.

**Arms** are available as an option for guest, stacking, and conference chair.

**Slope stacking chairs** can be stacked up to five chairs high.

	Made-to-order	Stocked
Guest Chair	<b>WESSLPCG</b>	<b>WEM1</b>
Stacking Chair	<b>WESSLPCS</b>	N.A.
Lounge Chair	<b>WESSLPCL</b>	<b>WEM2</b>
Conference Chair	<b>WESSLPCC</b>	<b>WEM3</b>
Counter Stool	<b>WESSLPSC</b>	<b>WEM50</b>
Bar Stool	<b>WESSLPSB</b>	<b>WEM66</b>
Height-Adjustable Bar Stool	N.A.	<b>WEM67</b>

*Tip: Slope is available made-to-order in a broad selection of frame colors and upholstery options. Slope is also available stocked in West Elm leather and a single frame color. Stocked styles are shipped with a rapid 2-week lead time and have specific style numbers. Please refer to the table above for the made-to-order and stocked style numbers.*

## Adjustment Features

Adjustability instructions are included with every swivel-base chair. Instructions can also be found at [www.steelcase.com](http://www.steelcase.com).

### Seat Adjustments

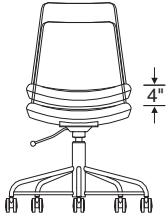

### Conference Chair

#### Seat height adjusts

pneumatically. To lower, pull lever up while seated. To raise, pull lever up and keep your weight off the chair.

#### Other features

**Soft wheel casters for hard floors on five-star base models** are available for specific applications.

## Surface Materials

**Stocked Slope chairs** are only available in pre-configured base color and leather combinations. When Saddle or Fog leather are specified, the base will be Hot Rolled Steel. When Aegean leather is specified, the base will be Antique Brass.

#### Seat and back upholstery

▶ See *Surface Materials*, page 242 for specific availability, or refer to the *Surface Materials Reference Manual* for further information.

Visit <https://srh.steelcase.com/comcalculator.aspx> for Steelcase Textile calculator.

#### Wire frame base

- Paint
- Accent paint
- Lux Coatings
- ▶ See *Surface Materials*, page 242

#### Five-star base

- Hot-rolled steel

#### Casters

- 6205 Black

#### Glides

- 6205 Black
- 6052 Milk

*Tip: 6052 Milk glides are available on 4242 Milk wire frame painted bases only, all other colors will have black glides.*

**All Steelcase seating with standard upholstery fabrics** complies with requirements of the State of California Technical Bulletin 117-2013. All standard seating is labeled to be in compliance with California 117-2013.

## Dimensions

▶ Page 36

# Dimensions

## Slope Seating

• Features	• Overall Depth	Width	Height	• Functional Seat Depth	• Seat Width	• Seat Height from Floor	• Back Width	• Back Height from Seat	• Weight
<b>Slope Seating</b>									
<b>Guest Chair</b>									
	21½"	19¼"	33¼"	17¾"	17¾"	18¾"	16¾"	18¾"	33.15 lb
<b>Stacking Chair</b>									
	21½"	19¼"	33¼"	17¾"	17¾"	18¾"	16¾"	18¾"	N.A.
<b>Lounge Chair</b>									
	26½"	26½"	28"	21¾"	26½"	15¾"	25¾"	19¼"	28 lb
<b>Counter Stool</b>									
	21½"	19"	35¾"	17¾"	17¾"	25¼"	16¾"	13"	35.75 lb
<b>Bar Stool</b>									
	21½"	19¼"	40"	17¾"	17¾"	29½"	14¼"	13"	40 lb
<b>Conference Chair</b>									
	21½"	19¼"	32" – 36"	17¾"	17¾"	17½" – 20½"	16¾"	18¾"	28.25 lb

\* Overall width does not include the base.

Tip: The diameter of the chair with the five-arm base is 25".



# Sterling Seating

**Sterling** is a family of seating inspired by classic mid-century design. The style and generous sit brings retro-inspired comfort to the office. Hardwood legs or a classic aluminum base and arm options make the Sterling collection relevant across the floor plan.

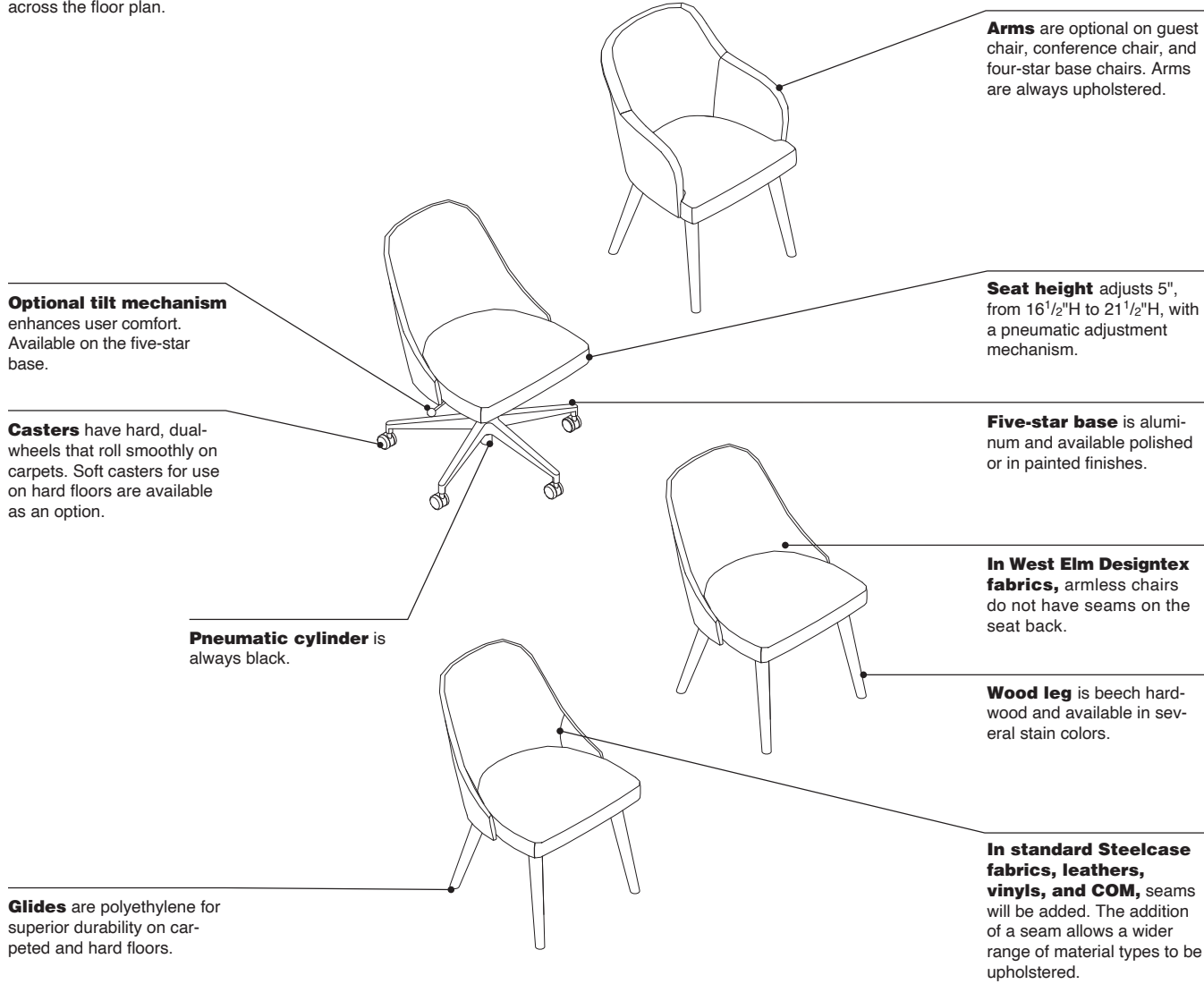

**Sterling stools** have a 360° swivel feature that comes standard and does not have auto-return feature.

**Sterling stools** include footrest for added comfort.  
*Tip: The footrest is 8½" from the ground on the counter-height stool and 14¼" on the bar-height stool.*

**Glides** are polyethylene for superior durability on carpeted and hard floors.

**Sterling lounge** is available with arms only.

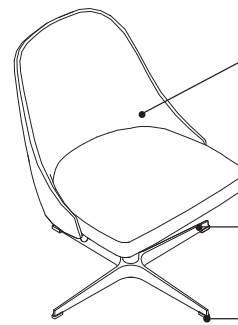
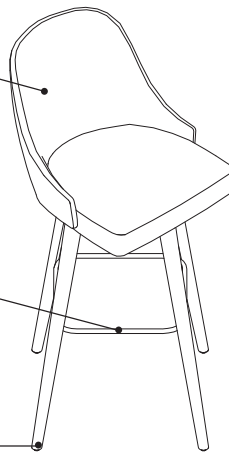

**Sterling four-star chair** comes with 360° swivel and height adjustable mechanism. It does not have an auto-return feature or tilt option.

**Four-star base** is available in polished aluminum only.

**Glides** are polyethylene for superior durability on carpeted and hard floors. Casters are not available.

**Sterling lounge** has a seat height of 17¼" and more reclined seat and back to encourage a more relaxed posture.

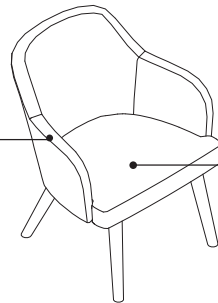

**Product Details**



**Five-star, four-star, and four-leg** chairs are available with and without arms.

**Optional tilt mechanism** is available on five-star chairs and has 10° rearward and 2° forward tilt range. The seat and back always remain in a fixed position relative to each other (i.e. no recline).

**360° adjustable height swivel mechanism** is standard on five-star and four-star base models.

**Adjustment Features**

Adjustability instructions are included with every swivel-base chair. Instructions can also be found at [www.steelcase.com](http://www.steelcase.com).

**Seat Adjustments**

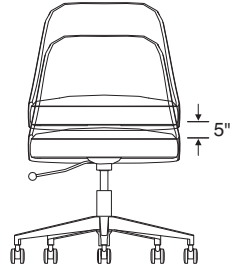

**Seat height** adjusts pneumatically. To lower, pull lever up while seated. To raise, pull lever up and keep your weight off the chair.

**Other features**

**Soft wheel casters for hard floors on five-star base models** are available for specific applications.

**Surface Materials**

**Upholstery**

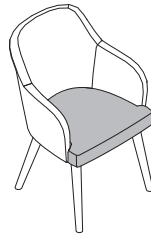

**Optional contrasting fabric** is available between the seat and back/arms.

- Fabric
- Leather
- Vinyl

▶ See *Surface Materials*, page 242 for specific availability, or refer to the *Surface Materials Reference Manual* for further information.

Customer's Own Material (COM)

**Four-leg and stool base**

- Customiz stain
- VP01 Light Oak
- VP03 Black Oak
- VP04 Grey Oak
- VP05 White Oak

**Five-star base**

- 0835 Black
- 4242 Milk
- 4B22 Matte Brass
- 4B24 Night Bronze
- 7278 Dark Bronze
- 8046 Polished Aluminum

**Four-star base**

- 8046 Polished Aluminum

**Casters and glides**

- 6205 Black

**All Steelcase seating with standard upholstery fabrics** complies with requirements of the State of California Technical Bulletin 117-2013. All standard seating is labeled to be in compliance with California 117-2013.

**Dimensions**

▶ Page 41

# Dimensions

## Sterling Seating

Features	Overall Depth	Width	Height	Functional Seat Depth	Seat Width	Seat Height from Floor	Back Width	Back Height from Seat	Arm Height from Floor
<b>West Elm Work Sterling</b>									
<b>Guest Chairs</b>									
	25 <sup>1</sup> / <sub>8</sub> "	26 <sup>3</sup> / <sub>4</sub> "	32 <sup>5</sup> / <sub>8</sub> "	18 <sup>5</sup> / <sub>8</sub> "	22"	18 <sup>1</sup> / <sub>2</sub> "	21"	15 <sup>1</sup> / <sub>2</sub> "	26 <sup>1</sup> / <sub>2</sub> "
<b>Guest Chairs—Armless</b>									
	24 <sup>1</sup> / <sub>2</sub> "	23 <sup>1</sup> / <sub>2</sub> "	32 <sup>5</sup> / <sub>8</sub> "	18 <sup>5</sup> / <sub>8</sub> "	22"	18 <sup>1</sup> / <sub>2</sub> "	21"	15 <sup>1</sup> / <sub>2</sub> "	N.A.
<b>Conference Chairs—Five-Star with Arms</b>									
	25 <sup>1</sup> / <sub>8</sub> "	26 <sup>3</sup> / <sub>4</sub> "	31 <sup>3</sup> / <sub>4</sub> "—36 <sup>3</sup> / <sub>4</sub> "	18 <sup>5</sup> / <sub>8</sub> "	22"	16 <sup>1</sup> / <sub>2</sub> "—21 <sup>1</sup> / <sub>2</sub> "	21"	15 <sup>1</sup> / <sub>2</sub> "	25 <sup>1</sup> / <sub>2</sub> "—30 <sup>1</sup> / <sub>2</sub> "
<b>Conference Chairs—Five-Star Armless</b>									
	24 <sup>1</sup> / <sub>2</sub> "	23 <sup>1</sup> / <sub>2</sub> "	31 <sup>3</sup> / <sub>4</sub> "—36 <sup>3</sup> / <sub>4</sub> "	18 <sup>5</sup> / <sub>8</sub> "	22"	16 <sup>1</sup> / <sub>2</sub> "—21 <sup>1</sup> / <sub>2</sub> "	21"	15 <sup>1</sup> / <sub>2</sub> "	N.A.
<b>Counter Height Stool</b>									
	26 <sup>1</sup> / <sub>4</sub> "	26 <sup>1</sup> / <sub>4</sub> "	38"	17"	17 <sup>1</sup> / <sub>2</sub> "	26"	19 <sup>1</sup> / <sub>4</sub> "	12 <sup>3</sup> / <sub>8</sub> "	N.A.
<b>Bar Height Stool</b>									
	26 <sup>1</sup> / <sub>4</sub> "	26 <sup>1</sup> / <sub>4</sub> "	44"	17"	17 <sup>1</sup> / <sub>2</sub> "	32"	19 <sup>1</sup> / <sub>4</sub> "	12 <sup>3</sup> / <sub>8</sub> "	N.A.
<b>Conference Chairs—Four-Star with Arms</b>									
	25 <sup>1</sup> / <sub>8</sub> "	26 <sup>3</sup> / <sub>4</sub> "	30"—35"	18 <sup>5</sup> / <sub>8</sub> "	22"	15 <sup>3</sup> / <sub>16</sub> "—20 <sup>3</sup> / <sub>16</sub> "	21"	15 <sup>1</sup> / <sub>2</sub> "	23 <sup>1</sup> / <sub>2</sub> "—28 <sup>1</sup> / <sub>2</sub> "
<b>Conference Chairs—Four-Star Armless</b>									
	24 <sup>1</sup> / <sub>2</sub> "	23 <sup>1</sup> / <sub>2</sub> "	30"—35"	18 <sup>5</sup> / <sub>8</sub> "	22"	15 <sup>3</sup> / <sub>16</sub> "—20 <sup>3</sup> / <sub>16</sub> "	21"	15 <sup>1</sup> / <sub>2</sub> "	N.A.
<b>Lounge</b>									
	25 <sup>1</sup> / <sub>4</sub> "	26 <sup>3</sup> / <sub>4</sub> "	30"	18 <sup>5</sup> / <sub>8</sub> "	22"	17 <sup>1</sup> / <sub>4</sub> "	21"	15 <sup>1</sup> / <sub>2</sub> "	24"

\*Overall width does not include the base.  
 The diameter of the chair with the five-star base is 26".  
 The diameter of the chair with the four-star base is 26<sup>1</sup>/<sub>2</sub>".

# Kent Seating

**Soft, modern minimalism** meets the performance and comfort needed for today's collaborative workplace with West Elm Work Kent seating. The broad collection offers a range of application possibilities – from meeting rooms to the private office.

**Kent** is available in five base options and three seat backs. Base options are five-star, four-star (with glides or casters), guest chair (four-leg), or stool. Seat back options are armless, with arms, and high-back with arms.

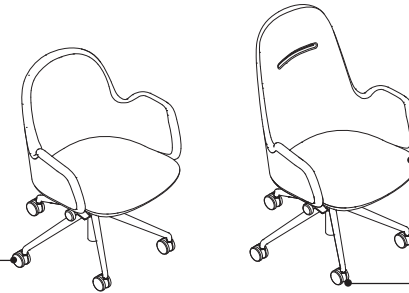

**Five-star seat height** adjusts 5" from 17<sup>1</sup>/<sub>4</sub>" to 22<sup>1</sup>/<sub>4</sub>".

**Hard, dual wheeled casters** are standard for use on carpets. Soft, roll-control, dual-wheel casters are available for use on hard floors or chair mats. Casters are 2<sup>1</sup>/<sub>2</sub>" diameter.

*Tip: Do not roll the chair across asphalt during installation as this may damage the casters.*

**Five-star base** is only available with casters.

**The five-star base** includes tilt and lock features on the standard application.



**Four-star base** swivels and is not height adjustable. It is available with casters or glides.

**Stool seat height** adjusts 7", from 25" to 32".

**Stool** cannot be specified with a high-back.



**If arms are specified,** they are always upholstered.

**Glides** come standard in black.

**Product Details**

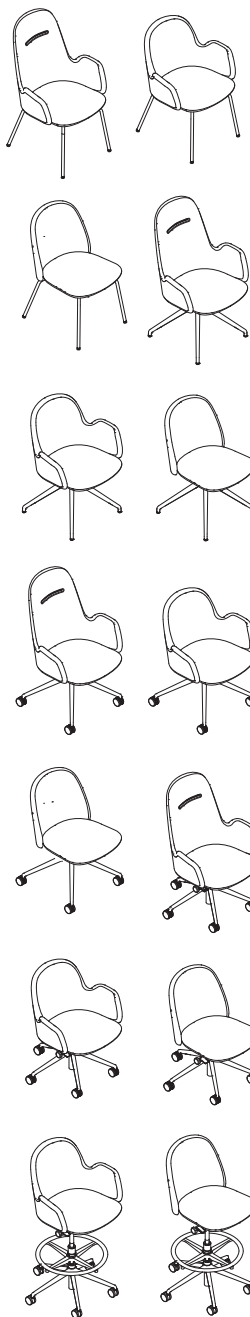

**All products in the Kent product line** ship in one package. The four-leg guest chair ships fully assembled. Four-star, five-star, and stools ship knocked down and feature a tool-less assembly.

**Adjustment Features**

Adjustability instructions are included with every swivel-base chair. Instructions can also be found at [www.steelcase.com](http://www.steelcase.com).

**Seat Adjustments**

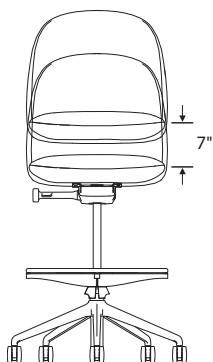
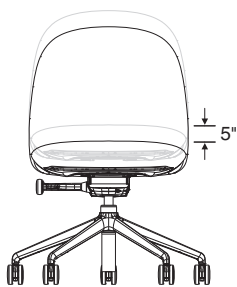

**Seat height** adjusts pneumatically. To lower, pull lever up while seated. To raise, pull lever up and keep your weight off the chair.

**Surface Materials**

**Upholstery**

► See *Surface Materials*, page 256 for upholstery options.

Visit <https://srh.steelcase.com/comcalculator.aspx> for Steelcase Textile calculator.



**Fabric** is applied in the vertical direction. Optional contrasting fabric is available between the seat and back/arms.

**Five-star, four-star, and stool bases** are available to be painted or in 8046 Polished Aluminum.

**Guest (four-leg) bases** are available to be painted or in 9201 Chrome.

**Pneumatic cylinders**

- 6205 Black

**Foot ring**

- 6205 Black

**Dimensions**

► Page 44

# Dimensions

## Kent Seating

### Features

Base	Depth	Width	Seat Height	Arm Height	Overall Height	Weight (lb)
<b>Kent</b>						
<b>Conference Chairs—Five-Star with Arms</b>						
	27"	25 <sup>3</sup> / <sub>16</sub> "	17 <sup>5</sup> / <sub>16</sub> " – 22 <sup>3</sup> / <sub>16</sub> "	25 <sup>1</sup> / <sub>2</sub> "	31 <sup>5</sup> / <sub>8</sub> " – 36 <sup>1</sup> / <sub>2</sub> "	29 lb
<b>Conference Chairs—Five-Star High Back with Arms</b>						
	27"	25 <sup>3</sup> / <sub>16</sub> "	17 <sup>5</sup> / <sub>16</sub> " – 22 <sup>3</sup> / <sub>16</sub> "	25 <sup>1</sup> / <sub>2</sub> "	38 <sup>1</sup> / <sub>2</sub> " – 43 <sup>5</sup> / <sub>16</sub> "	30 lb
<b>Conference Chairs—Five-Star Armless</b>						
	27"	25 <sup>3</sup> / <sub>16</sub> "	17 <sup>5</sup> / <sub>16</sub> " – 22 <sup>3</sup> / <sub>16</sub> "		31 <sup>5</sup> / <sub>8</sub> " – 36 <sup>1</sup> / <sub>2</sub> "	28 lb
<b>Conference Chairs—Four-Star with Arms</b>						
	24 <sup>5</sup> / <sub>16</sub> "	24 <sup>11</sup> / <sub>16</sub> "	19"	25 <sup>1</sup> / <sub>2</sub> "	33 <sup>5</sup> / <sub>16</sub> "	29 lb
<b>Conference Chairs—Four-Star High Back with Arms</b>						
	24 <sup>5</sup> / <sub>16</sub> "	24 <sup>11</sup> / <sub>16</sub> "	19"	25 <sup>1</sup> / <sub>2</sub> "	40 <sup>3</sup> / <sub>16</sub> "	30 lb
<b>Conference Chairs—Four-Star Armless</b>						
	24 <sup>5</sup> / <sub>16</sub> "	19 <sup>13</sup> / <sub>16</sub> "	19"		33 <sup>5</sup> / <sub>16</sub> "	28 lb
<b>Guest Chairs—Four-Legs with Arms</b>						
	23 <sup>7</sup> / <sub>8</sub> "	25 <sup>3</sup> / <sub>16</sub> "	19"	25 <sup>1</sup> / <sub>2</sub> "	33 <sup>5</sup> / <sub>16</sub> "	29 lb
<b>Guest Chairs—Four-Legs High Back with Arms</b>						
	23 <sup>7</sup> / <sub>8</sub> "	25 <sup>3</sup> / <sub>16</sub> "	19"	25 <sup>1</sup> / <sub>2</sub> "	40 <sup>3</sup> / <sub>16</sub> "	30 lb
<b>Guest Chairs—Four-Legs Armless</b>						
	23 <sup>7</sup> / <sub>8</sub> "	19 <sup>13</sup> / <sub>16</sub> "	19"		33 <sup>5</sup> / <sub>16</sub> "	28 lb
<b>Conference Stools—Five-Star with Arms</b>						
	27"	25 <sup>3</sup> / <sub>16</sub> "	25" – 32"	25 <sup>1</sup> / <sub>2</sub> "	38 <sup>5</sup> / <sub>16</sub> " – 45 <sup>13</sup> / <sub>16</sub> "	29 lb
<b>Conference Stools—Five-Star Armless</b>						
	27"	25 <sup>3</sup> / <sub>16</sub> "	25" – 32"		38 <sup>5</sup> / <sub>16</sub> " – 45 <sup>13</sup> / <sub>16</sub> "	28 lb

\*Overall width does not include the base.

The diameter of the chair with the five-star base is 26".

The diameter of the chair with the four-star base is 26<sup>1</sup>/<sub>2</sub>".



# Lucas Seating

**Modern lines** give Lucas a streamlined look, while a wide seat and reclined pitch make it a comfortable spot to sit during long meetings and busy days.

**Lucas** comes standard with arms at a height of 20½".

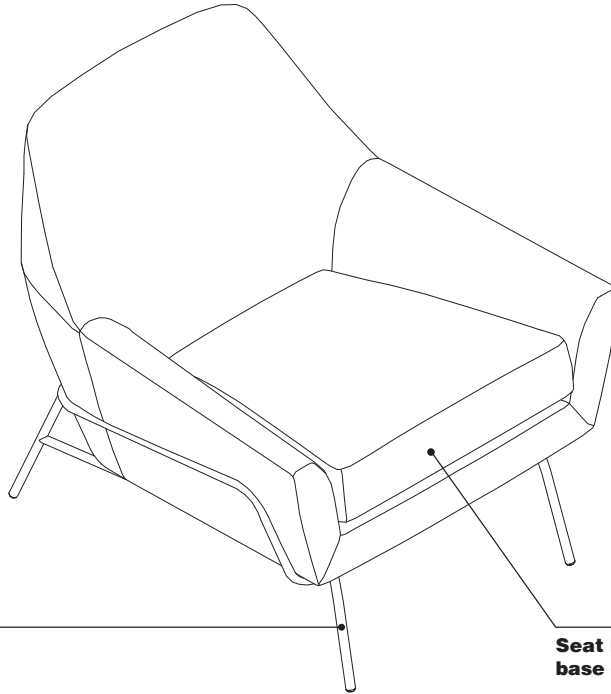

**The wire base** comes standard in West Elm WE05 Burnished Bronze with black glides.

**Seat height on wire base chair** is fixed at 18½".

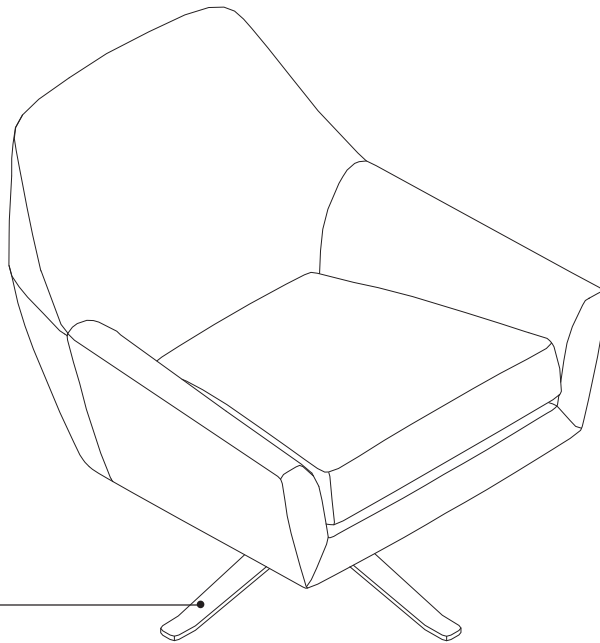

**Swivel base** comes standard in 8046 Polished Aluminum. Swivel is a full 360° without an automatic return.

## Product Details

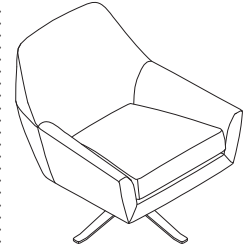

**Cushion** is detachable.

**All product in the Lucas product line** ships fully assembled.

## Surface Materials

**Swivel base** is 8046 Polished Aluminum. The base of the Lucas swivel chair will match the previous style number **WEM3598978**.

**Wire base** is WE05 West Elm Burnished Bronze. The base of the Lucas wire base will match the previous style number **WEM3406073**.

**Contrasting fabric** is not available.

Visit <https://srh.steelcase.com/comcalculator.aspx> for Steelcase Textile calculator.

# Dimensions

Dimensions

## Lucas Seating

Features	Overall Depth	Width	Height	Seat Depth	Seat Width	Seat Height	Arm Height	Weight
<b>Lucas Seating</b>								
<b>Wire Base Chair</b>								
	32"	30½"	31"	21"	22"	18½"	20½"	53.7 lb
<b>Swivel Base Chair</b>								
	32"	30½"	31"	21"	22"	20¾"	20½"	60.1 lb

Seating

# Fulton Seating

**Fulton** is a timeless wood-frame collection of a guest chair, lounge chair, and bench; great for shared spaces and private offices.

**Upholstery treatment** is available in contrasting or non-contrasting cord, which wraps around the perimeter of the seat and back cushions. Cord wraps around seat cushion of the bench.

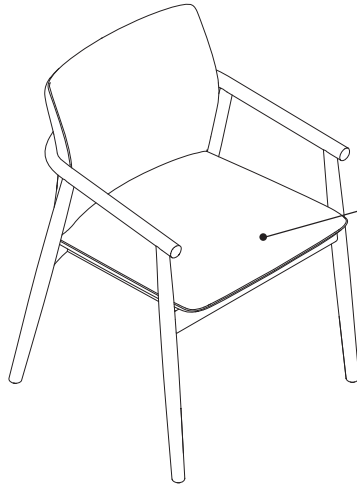

**Seat height for the guest chair is 18<sup>3</sup>/<sub>4</sub>"H.**

**The frame of the guest chair, lounge chair, and bench** comes in stained ash.

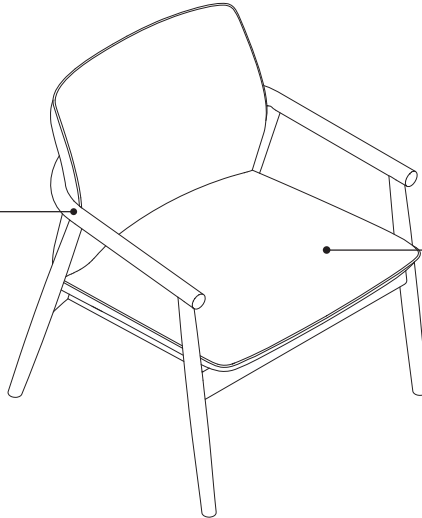

**Seat height for the lounge chair is 17<sup>1</sup>/<sub>4</sub>"H.**

**Seat height for the bench is 17<sup>3</sup>/<sub>4</sub>".**

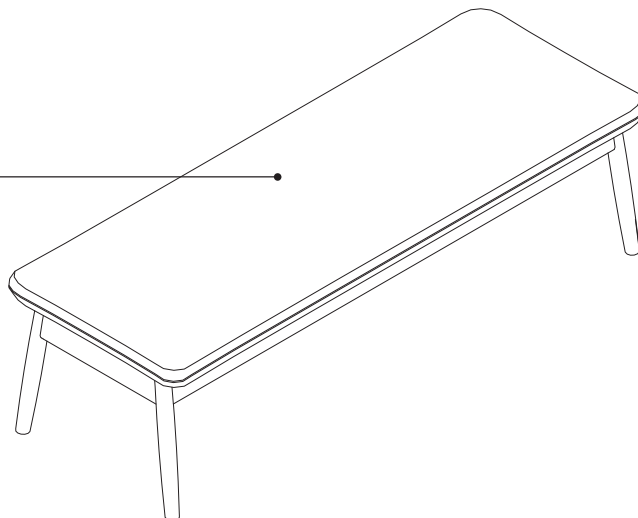

## Product Details

**All products** include plastic glides.

**All product in the Fulton product line** ships fully assembled in one package.

## Surface Materials

**Optional contrasting cord** is available on the perimeter of the seat and back.

Visit <https://srh.steelcase.com/comcalculator.aspx> for Steelcase Textile calculator.

**See surface materials matrix** on page 256 for upholstery options.

# Dimensions

Dimensions

## Fulton Seating

Features	Depth	Width	Overall Height	Seat Height	Arm Height at Front	Seat Depth
<b>Fulton Seating</b>						
<b>Guest Chair</b>						
	22"	22 <sup>1</sup> / <sub>4</sub> "	32"	18 <sup>3</sup> / <sub>4</sub> "	24 <sup>3</sup> / <sub>4</sub> "	18 <sup>1</sup> / <sub>4</sub> "
<b>Lounge Chair</b>						
	28 <sup>3</sup> / <sub>4</sub> "	27 <sup>3</sup> / <sub>4</sub> "	30 <sup>3</sup> / <sub>4</sub> "	17 <sup>1</sup> / <sub>4</sub> "	21 <sup>1</sup> / <sub>2</sub> "	20 <sup>1</sup> / <sub>2</sub> "
<b>Bench</b>						
	22"	58 <sup>1</sup> / <sub>2</sub> "	17 <sup>3</sup> / <sub>4</sub> "	17 <sup>3</sup> / <sub>4</sub> "	N.A.	N.A.

Seating



---

# Understanding Greenpoint

<b>Private Office</b>	<b>52</b>
Storage Capacities	<b>58</b>
<b>Benching</b>	<b>60</b>
Storage Capacities	<b>66</b>
Universal Tackable Center Screens	<b>67</b>
Power Routing Harness Chart	<b>68</b>
Distribution and Access	<b>70</b>
Building Interface	<b>72</b>
Stability Guidelines	<b>74</b>
Directional Laminate and Edge Profile Detail	<b>75</b>

# Greenpoint Private Office

## Greenpoint private office

offers a contemporary take on the private office with its distinct visual language and fresh material options.

**A power cutout** can be specified in the center, the left, or the right side of the desk worksurface. The desk power unit is ordered separately.

*Tip: The style number for desk power unit is **WESINDPWR**.*

**A modesty panel** is available and ordered separately, in widths from 48" to 78". They can be specified in either wood veneer or High-Pressure Laminate. Modesty panels are specified one size smaller than the desk to allow for 3" clearance on both ends to accommodate the legs. Modesty panel can be mounted flush or inset.

**Leveling glides** provide 1½" adjustment.

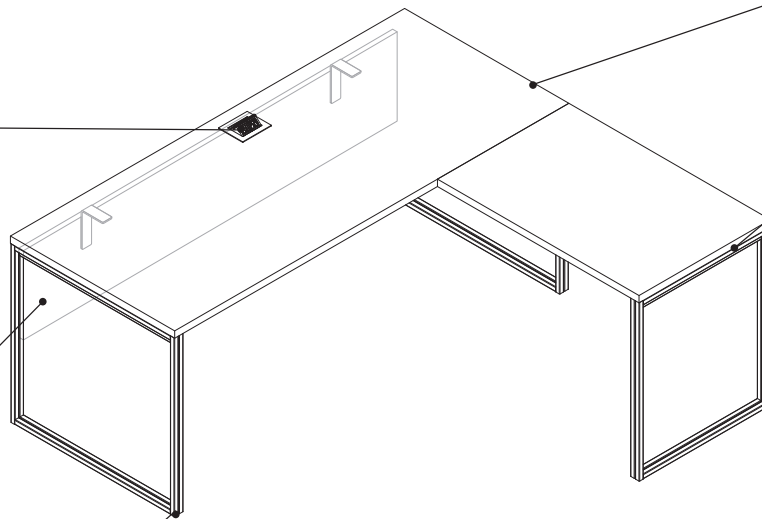

**Private desk work-surfaces** are 1⅛" thick. They can be specified with either wood veneer or High-Pressure Laminate. Height of the private desk is 29½".

**Desk returns** are available for private desks and can be specified with a leg or pedestal support.

**Product Details**

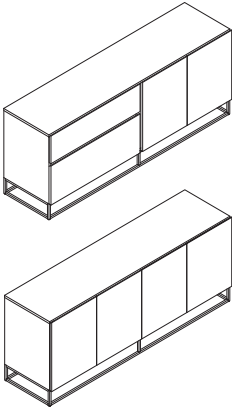

**Credenzas** come in two non-locking configurations—storage and filing. Storage credenzas have two sets of doors with adjustable shelves. Filing credenzas have two drawers and a set of doors with adjustable shelves. Back panels are finished. Leveling glides provide 1½" adjustment.

**Counterweights** are included with filing credenza.

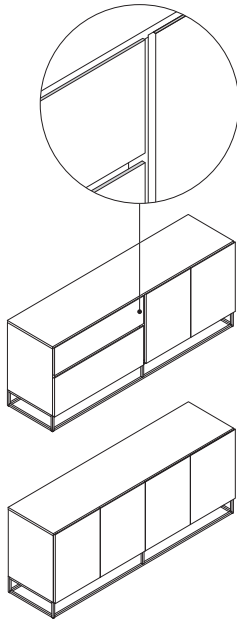

**Door and drawer fronts on credenzas, lateral files, and pedestals** that are specified in High-Pressure Laminate have a corresponding painted top edge. For more information, see the matrix in *Surface Materials* section.

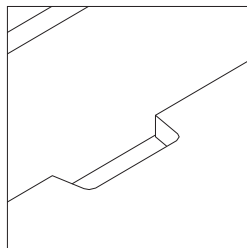

**Cutout in lower cabinet shelf** is standard on all credenzas to allow cord pass-through.

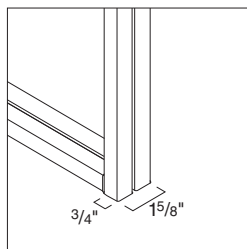

**Legs** are welded metal.

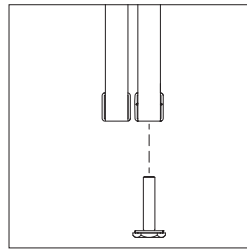

**Glides** are adjustable and provide 1½" adjustment.

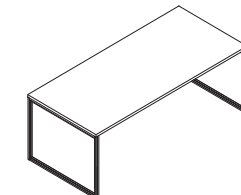
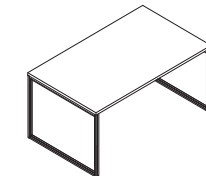
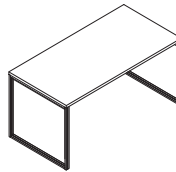

**Private desks** are available in a range of sizes and come standard with two legs. Desk returns and modesty panels are also available. Power cutouts are available in center, left, and right.

▶ See wiring on cabling, page 56.

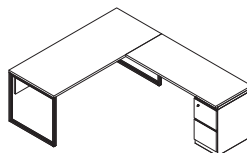
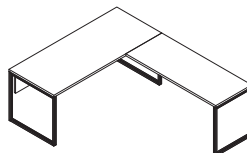

**Desk returns** are used with private desks to form L-shape configurations, where everything is in reach. Specify with leg or pedestal support.

**Modesty panels** cannot be used on the return side of this configuration.

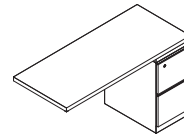

File/file

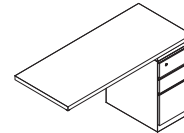

Box/box/file

**Under-worksurface pedestals** are available 18"D and 24"D for desk returns. Pedestals are available in file/file or box/box/file configurations.

**Lock** comes standard on pedestals.

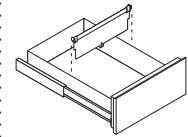
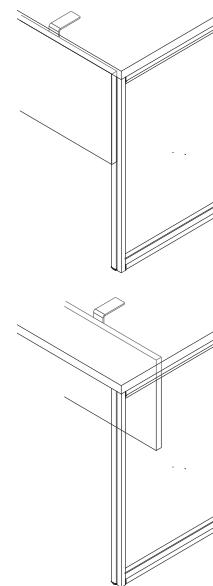

**Box drawers** are a welded steel construction and available with wide integral pull fronts. One divider is included with each box drawer.

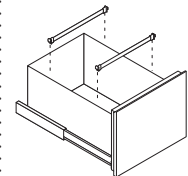

**File drawers** are a welded steel construction and available with wide integral pull fronts. Drawer body sides are full height and accommodate front-to-back filing of hanging letter-size file folders.

**Optional rails** accommodate side-to-side filing of letter-, A4-, and legal-size hanging folders. *Exception: Legal-size file folders cannot be filed in 17½"D or 18¾"D pedestals.*

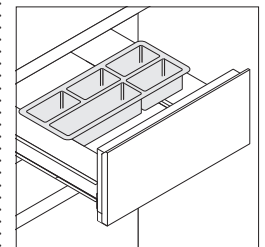

**Pencil tray to hold small office supplies** comes standard with each box/box/file and mobile pedestal, but can be excluded in the basic drawer option.

**Optional basic drawer interior** allows box/box/file pedestals to be ordered without rails, box drawer dividers, or pencil trays.

**Modesty panel** can be mounted flush or inset. Height can be adjusted to provide cord pass-through.

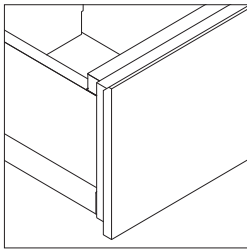

**Pull on drawer and door fronts** is full width and integral.

**Drawer and door fronts** are available in wood veneer or High-Pressure Laminate.

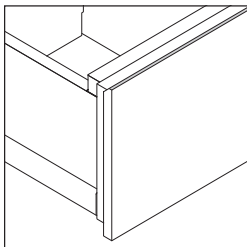

**Door and drawer fronts on credenzas, lateral files, and pedestals** that are specified in High-Pressure Laminate have a corresponding painted top edge. For more information, see the table *High-Pressure Laminate Top Edge* from the next page.

**3"H base** is integral to pedestal and lateral cases.

**Leveling glides** adjust to install under-worksurface pedestals and lateral files on uneven floors.

**Lateral files** are ideal for high-density paper storage.

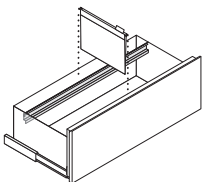

**Hanging folder bar** accommodates side-to-side filing of letter-, A4 international-, and legal-size hanging folders.

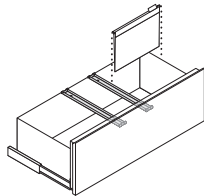

**Rails** accommodate front-to-back filing of letter-, A4 international-, and legal-size hanging folders. Rail packages accommodate two rows of letter-size files in 30"W and 36"W drawers.

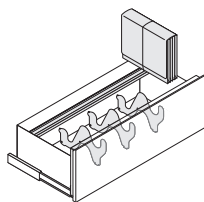

**Dividers** accommodate side-to-side filing of expandable folders and other objects. Divider packages include three dividers and one hanging folder bar per drawer.

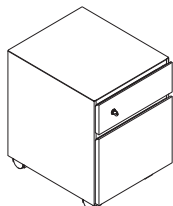

**Metal lateral files and mobile pedestals** have limited finishes.

**Metal mobile pedestals** are 18"D. Clearance from the ground to the bottom of the pedestal is 2½".

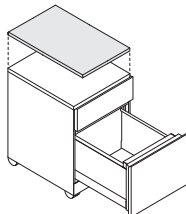

**Basic cushion enhanced** is ordered separately for use on mobile pedestals. Basic cushion enhanced is field-installed and attaches to the existing top with hook and loop fastener.

**Counterweight packages** are required to ensure product stability and are ordered as an option or separately.

**Four casters** are hard composition and non-locking, with a full-rotation swivel mechanism. Casters are exposed at the base of box/file pedestals.

**Bookcases** offer convenient storage for binders, books, and other objects.



Tall Open

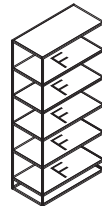

Low Open

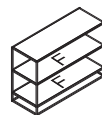

Narrow Open

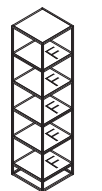

Narrow Open

F - Fixed shelf

**Bookcases**, are available in several different configurations and ship fully assembled. Shelf inside storage bookcase is adjustable. Shelves are standard ½" thick and can carry a load of 100 pounds. Back panels are finished. Shelf inside storage bookcase is adjustable.

**Bookcases and lateral files** cannot be used to support worksurfaces.

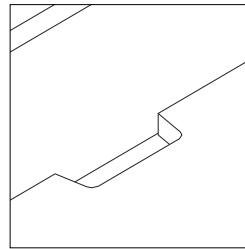

**Cutout** in lower cabinet shelf is standard on storage bookcase to allow cord pass-through.

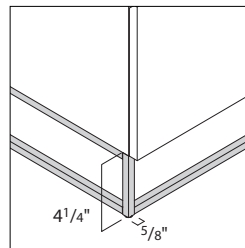

**Metal bases** are standard on all credenzas, bookcases, and wood lateral files. Leveling glides provide 1½" adjustment.

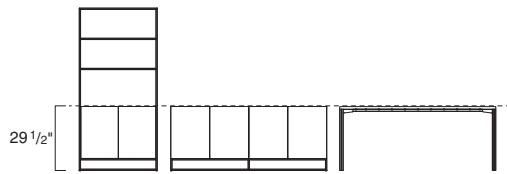

**Storage bookcases** align with private desks and storage or filing credenzas.

**High-Pressure Laminate Top Edge**

<b>Door and Drawer Front HPL Finish</b>	<b>Top Edge Corresponding Paint Color</b>	<b>Door and Drawer Front HPL Finish</b>	<b>Top Edge Corresponding Paint Color</b>
2406 Clear Cherry	CLRF Clear	2HAA Persian Salt	CLRF Clear
2409 Clear Maple	4700 Warm White	2HAB Rose	CLRF Clear
2410 Graphite Walnut	4238 Mocha	2HAC Indigo	CLRF Clear
2412 Natural Cherry	CLRF Clear	2HAD Green Citrine	CLRF Clear
2422 Medium Cherry	7278 Dark Bronze	2HAE Dark Olivine	CLRF Clear
24H4 Satin Mocha	CLRF Clear	2HAF Cloudy	CLRF Clear
2511 Winter on Maple	4700 Warm White	2HAK Clear Oak	4242 Milk
2535 Virginia Walnut	7225 Sand	2HAN Ash Noce	4242 Milk
2536 Blackwood	4B24 Night Bronze	2HAT Acacia	4700 Warm White
2538 Clear Walnut	7278 Dark Bronze	2HAW Ash Wenge	4242 Milk
2592 Blonde on Maple	4700 Warm White	2HBN Bisque Noce	4242 Milk
2612 Marbled Maple	4700 Warm White	2HBW Bisque Wenge	4242 Milk
2614 Chocolate Walnut	7278 Dark Bronze	2HCN Clay Noce	4242 Milk
2615 Marbled Cherry V2	4700 Warm White	2HCW Clay Wenge	4242 Milk
2714 Natural Walnut	7278 Dark Bronze	2HMG Merle	7360 Merle
2722 Cream	4700 Warm White	2HSN Storm Noce	7360 Merle
2730 Arctic White	4231 Arctic White	2HSW Storm Wenge	7360 Merle
2746 Black	0835 Black	2HWB Planked Walnut	7278 Dark Bronze
2759 Warm White	4700 Warm White	2TH2 Fawn Cypress	4700 Warm White
2811 Mist	7243 Seagull	2TH4 Saddle Oak	7207 Black
2820 Coffee Speckle	4700 Warm White	2TH5 Veranda Teak	7225 Sand
2823 Driftwood Speckle	4700 Warm White	2TH7 Walnut Heights	4239 Clay
2824 Smoke Speckle	7243 Seagull	2UH1 Reclaimed Aggregate	4242 Milk
2825 Vanadium Speckle	4242 Milk	2UH2 Reclaimed Gravel	7360 Merle
2850 Vanadium Fiber	4231 Arctic White	2UH4 Cement	4242 Milk
2852 Tungsten Fiber	7243 Seagull	2UH6 Sheetrock	4242 Milk
2854 Vellum Fiber	4700 Warm White	WE40 Natural Oak	CLRF Clear
2860 Granite Fiber	7360 Merle	WE41 Black Walnut	7238 Fieldstone
2862 Stucco Fiber	7243 Seagull	WE42 Gray Ash	4B24 Night Bronze
2870 Blonde Bronze Patina	4700 Warm White		
2873 Instant Iron Patina	7360 Merle		
2883 Seagull	7243 Seagull		
2884 Milk	4242 Milk		
2885 Dune	4242 Milk		
2897 Desert Oak	4700 Warm White		
2920 Marl Micro	7243 Seagull		
2921 Gypsum Micro	4242 Milk		
2922 Clay Micro	4700 Warm White		

**Lock and Keying**

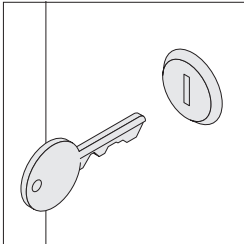

**Locks** are available field-installed. Field-installed locks are available with consecutive, specific, and random keying options. Master-keyed locks are also available. Lock cylinders must be specified separately.

**Locks** are standard on under-worksurface pedestals, metal pedestals, and metal lateral files. Lock is located in the top drawer. Key will lock both drawers if applicable. Locks are standard factory installed, keyed random.

▶ *Lock and Keying*, page 258

**Wiring and Cabling**



**Field-installed 2½" grommet**, ordered separately, provides wire and cable management for workspaces.

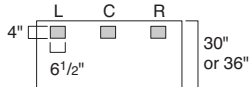

**Worksurface power modules** are available on executive and private desks. Cutouts can be specified for left, center, and right locations.

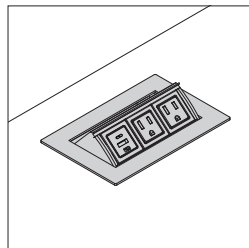
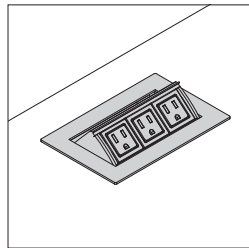

**Power modules** are available in three simplex and two simplex/USB A+C 20W configurations. The one-touch retractable door allows easy access.

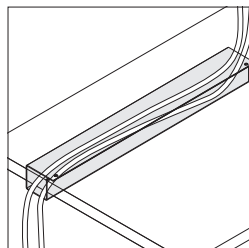

**Cable tray** is available to keep cords and cables out of the way.

**Application Topics**

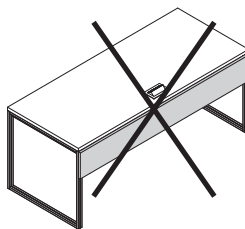
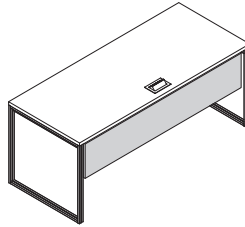

**Modesty panels** are specified one size smaller than the desk to allow for 3" clearance on both ends to accommodate the legs.

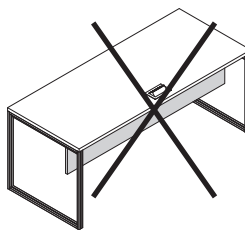
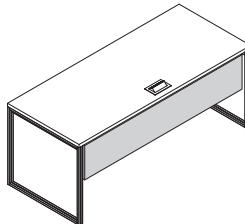

**When a power cutout** has been specified, modesty panel must be mounted flush to front of desk.

**Storage Capacities and Dimensions**

▶ Page 58

**Surface Materials**

**Private desk and personal desk worksurface**

- High-Pressure Laminate
- Wood veneer

**Desk return with pedestal**

- Drawer fronts are available in limited High-Pressure Laminate and veneer finishes.

**Drawer and door fronts**

- High-Pressure Laminate
- Wood veneer

**Modesty panels**

- High-Pressure Laminate
- Wood veneer

**Credenzas, bookcases, and lateral files**

- High-Pressure Laminate
- Wood veneer

**Metal lateral files, and metal mobile pedestal**

Drawer fronts are available in limited High-Pressure Laminate and veneer finishes:

- 2884 Milk
- 2HAN Ash Noce
- 2HMG Merle
- 36A2 Volcanic Oak
- 37A2 Thunder Walnut
- WE20 Natural Oak
- WE40 Natural Oak
- WE41 Gray Ash
- WE42 Black Walnut

**Metal storage cases and metal bases**

- 0835 Black
- 4B22 Matte Brass
- 4B24 Night Brass
- 4242 Milk
- 7278 Dark Bronze

**Basic cushion enhanced**

- Fabric

**Lock**

- 9201 Polished Chrome
- 9250 Ember Chrome

**Desk power unit**

- 6000 Black
- 6052 Milk

**2½" round grommet**

- 0835 Black
- 4799 Platinum Metallic
- 7241 Arctic White
- 7278 Dark Bronze
- 9201 Polished Chrome
- 9211 Nickel



*Tip: When selecting a Steelcase top surface finish, a corresponding Steelcase edge finish must be selected. When selecting West Elm top surface finish, a corresponding West Elm edge finish must be selected.*



# Greenpoint Private Office

## Storage Capacities

### Greenpoint Storage

Box Drawer	Size/Type	Inside Dimensions		
		D	W	H
	• Return pedestal	15 1/8"	12"	4 1/4" (includes drawer front) 2 3/4" (box drawer body only)
File Drawer	Size/Type	Inside Dimensions		
		D	W	H
	• Return pedestals	15 1/8"	12"	10 1/2" (includes drawer front)
	• Mobile pedestals	15 1/8"	12"	9 1/4" (file drawer body only)
Wood Lateral File Drawer	Size/Type	Inside Dimensions		
		D	W	H
	• Wood lateral	13"	32"	8 1/10" (includes drawer front)

*Tip: When specified in High-Pressure Laminate, the drawer fronts will be painted according to the matrix in the Surface Materials section.*

*Tip: Drawer fronts on pedestal and metal lateral files are available in limited High-Pressure Laminate and veneer finishes. See Surface Materials section for more information.*

## Greenpoint Storage, continued

### Filing Credenza

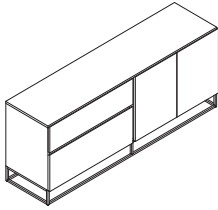

#### Size/Type

- Top drawer 13" 31½" 8<sup>1</sup>/<sub>10</sub>" (includes drawer front)
- Bottom drawer 13" 31½" 11<sup>3</sup>/<sub>8</sub>" (file drawer body only)
- Storage cabinet 17<sup>3</sup>/<sub>16</sub>" 34" 22½"

#### Inside Dimensions

**D W H**

13" 31½" 8<sup>1</sup>/<sub>10</sub>" (includes drawer front)  
13" 31½" 11<sup>3</sup>/<sub>8</sub>" (file drawer body only)  
17<sup>3</sup>/<sub>16</sub>" 34" 22½"

#### Outside Dimensions

**D W H**

18<sup>3</sup>/<sub>4</sub>" 72" 29½"

\*Five holes for adjustable shelf  
1½" apart—first hole from top and  
bottom = 8¼".

### Storage Credenza

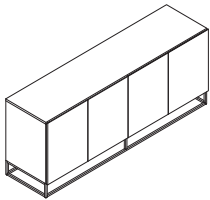

#### Size/Type

- Storage cabinet 17<sup>3</sup>/<sub>16</sub>" 34" 22½" (per opening)

#### Inside Dimensions

**D W H**

17<sup>3</sup>/<sub>16</sub>" 34" 22½" (per opening)

#### Outside Dimensions

**D W H**

18<sup>3</sup>/<sub>4</sub>" 72" 29½"

\*Five holes for adjustable shelf  
1½" apart—first hole from top and  
bottom = 8¼".

### Bookcase Storage

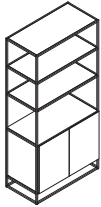

#### Size/Type

- Open shelf 18" 36" 75"
- Storage cabinet 17" 32¼" 22¼" (1 shelf at ¾" = 22<sup>3</sup>/<sub>8</sub>" )

#### Inside Dimensions

**D W H**

18" 36" 75"  
17" 32¼" 22¼" (1 shelf at ¾" = 22<sup>3</sup>/<sub>8</sub>" )

\*Five holes for adjustable shelf  
1½" apart—first hole from top and  
bottom = 8¼".

### Bookcases

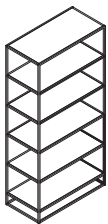

#### Size/Type

- Storage 18" 36" 75"
- Tall open 18" 36" 75"
- Low open 18" 48" 33"
- Narrow open 18" 18" 75"

#### Outside Dimensions

**D W H**

18" 36" 75"  
18" 36" 75"  
18" 48" 33"  
18" 18" 75"

### Lateral File

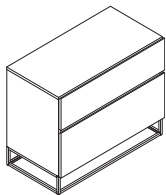

#### Outside Dimensions

**D W H**  
18<sup>3</sup>/<sub>4</sub>" 36" 29½"

# Greenpoint Benching

## Greenpoint benching

is designed to keep things simple while providing a rich range of design options that blends performance with a light and airy appeal.

**Privacy screens** provide privacy and are available for single- or dual-sided applications. Available in tackable fabric and glass. Glass options include clear or fluted.

**A 2 1/2" gap between worksurfaces** accommodates screens, worktools, and cords.

**Credenzas** can be used to support worksurfaces and provide storage. All brackets and mounting hardware are included.

**Optional center power cutout** is available. Power units are specified separately.

**End legs** are available on dual-sided units in 48" and 60" widths. End legs are designed to be flush with the corners of the worksurface and include all brackets and mounting hardware. Leveling glides provide 1 1/2" adjustment. Legs are fixed height with top of surface at 28 1/2"H.

**Dual-sided worksurfaces** are available in overall depths of 24" and 30". Worksurfaces are 1 1/8" thick and can be supported by legs or credenzas. Widths range from 48" to 78".

**Intermediate legs** are used to connect dual-sided units. Intermediate legs are 30"W for 48"W and 60"W dual-sided worksurfaces and include all brackets and mounting hardware. Leveling glides provide 1 1/2" adjustment. Legs are fixed height with top of surface at 28 1/2"H.

**End legs** are available on single-sided units in 24" and 30" depths. End legs are designed to be flush with the corners of the worksurface and include all brackets and mounting hardware. Leveling glides provide 1 1/2" adjustment. Legs are fixed height with top of surface at 28 1/2"H.

**A modesty panel** is available and ordered separately, in widths from 48" to 78". They can be specified in either wood veneer or High-Pressure Laminate. Modesty panels are specified one size smaller than the desk to allow for 3" clearance on both ends to accommodate the legs. Modesty panel can be mounted flush or inset.

**Intermediate legs** are used to connect single-sided units. Intermediate legs are available in 24" and 30" depths to match the depth of the worksurface and include all brackets and mounting hardware. Leveling glides provide 1 1/2" adjustment. Legs are fixed height with top of surface at 28 1/2"H.

**Leveling glides** provide 1 1/2" adjustment.

**Bench returns** offer additional worksurface space and are available in depths of 18" or 24" and widths of 42", 48", 54", and 60" for single- and dual-sided applications.

**Continuous tops** are available in a depth of 48". Worksurfaces are 1 1/8" thick and can be supported by legs or credenzas. Widths range from 48" to 78".

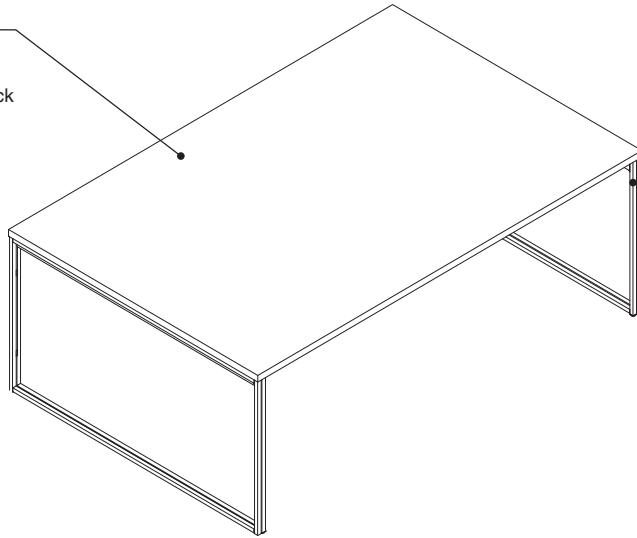

**End legs** are designed to be flush with the corners of the worksurface and include all brackets and mounting hardware. Leveling glides provide 1 1/2" adjustment. Legs are fixed height with top of surface at 28 1/2"H.

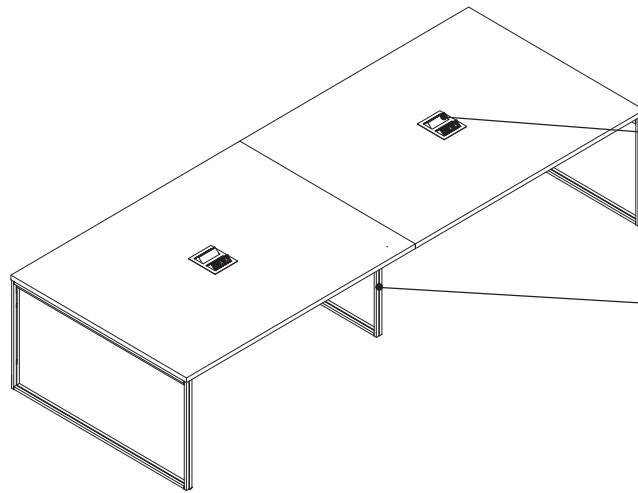

**Optional center power cutout** is available. Power units are specified separately.

**Intermediate legs** are used to connect continuous tops. Intermediate legs are 30"W for the 48"D continuous top worksurface and include all brackets and mounting hardware. Leveling glides provide 1 1/2" adjustment. Legs are fixed height with top of surface at 28 1/2"H.

# Greenpoint Benching

Round, Square, and Half-Round Tables

**Round tops** are available in 48" or 60" diameters. The worksurface is 1 1/8" thick.

**Square tops** are available in 48" x 48" or 60" x 60". The worksurface is 1 1/8" thick.

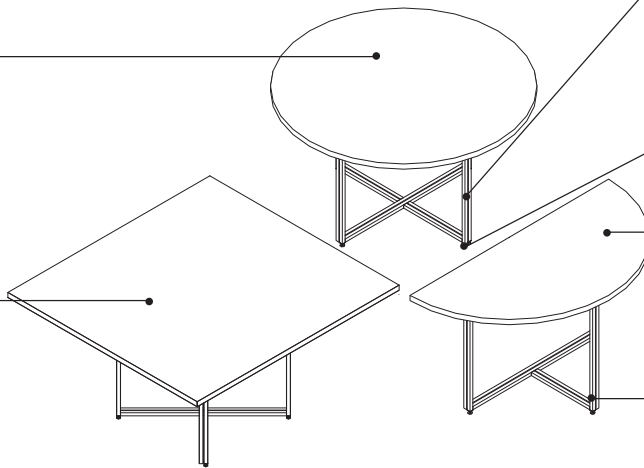

**Legs for both the 48" round and square tops** are inset by 4 3/4" and 7 1/2" from the edge of the worksurface. Legs for both the 60" round and square tops are inset by 5 7/8" and 9 1/8" from the edge of the worksurface.

**Leveling glides** provide 1 1/2" adjustment. Legs are fixed height with top surface at 28 1/2"H.

**Half-round tops** are available in 48" or 60" diameters.

**Half-round tops** must attach to a continuous top or dual-sided bench of the same dimension.

**Legs for the half-round tops** are inset by 8 7/8" for the 48"W and 10 3/8" for the 60"W from the edge of the worksurface.

**Half-round legs** include all brackets and hardware to attach a half-round top to either a continuous top or dual-sided bench.

**Actual Dimensions**

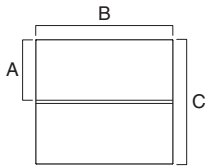

**Dual-Sided**

A	24" or 30"
B	48", 54", 60", 66", 72", 78"
C	50 1/2" or 62 1/5"

Thickness 1 1/8"

\*78"W not available in credenza/credenza application.

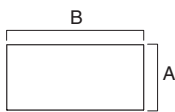

**Single-Sided**

A	24" or 30"
B	48", 54", 60", 66", 72", 78"

Thickness 1 1/8"

\*78"W not available in credenza/credenza application.

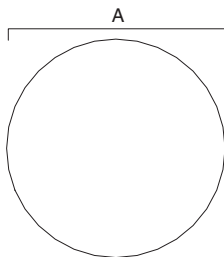

**Round**

A	48" or 60"
---	------------

Thickness 1 1/8"

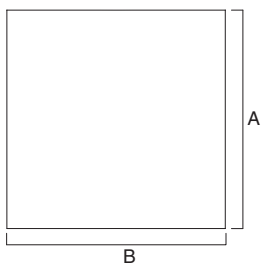

**Square**

A	48" or 60"
B	48" or 60"

Thickness 1 1/8"

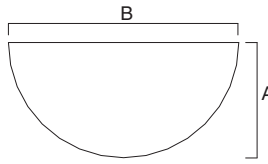

**Half-Round**

A	24" or 30"
---	------------

B	48" or 60"
---	------------

Thickness 1 1/8"

**Product Details**

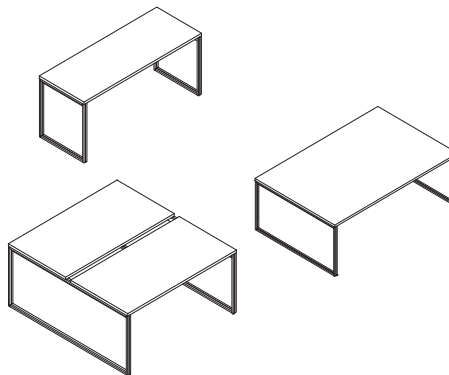

**Worksurfaces** are available for single-, dual-sided, or continuous top applications in depths of 24" or 30" for single- and dual-sided, and 48" for continuous top, and widths of 48", 54", 60", 66", 72", and 78". Leg and credenza supports are sold separately.

*Tip: 78"W not available in credenza/credenza application.*

**Half-round worksurfaces** must attach to a continuous top or dual-sided bench of the same dimension.

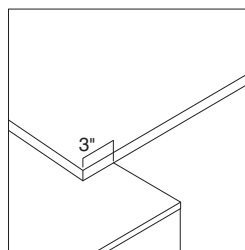

**Worksurfaces** using one credenza support are 3" wider than those used between leg supports. Worksurfaces used with credenza supports on both ends are 6" wider. Mounting hardware is included with credenzas for applications with credenza support.

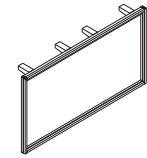

Dual Sided End Leg

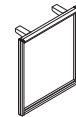

Single Sided End Leg

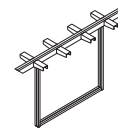

Dual Sided Intermediate Leg

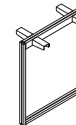

Single Sided Intermediate Leg

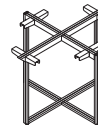

X-Leg

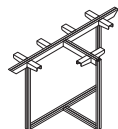

T-Leg

**Leg** support single- and dual-sided applications used to support worksurfaces at the end-of-run or intermediately.

**24"W or 30"W single-sided end legs** are to be used with 24"W or 30"W single-sided worksurfaces.

**48"W or 60"W dual-sided end legs** are to be used with 48"W or 60"W dual-sided worksurfaces.

**Round and square worksurfaces** must be specified with round/square legs. Half-round worksurfaces must be specified with half-round legs and be adjacent to a continuous top or dual-sided bench.

**Intermediate legs** are to be used between a run of worksurfaces. Dual-sided intermediate legs are 30"D and work for both 48"D and 60"D worksurfaces. Single-sided intermediate legs are available in 24"D and 30"D.

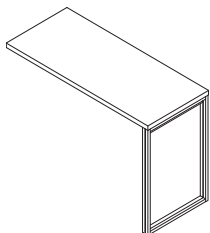

**Bench returns** are available on dual- and single-sided applications in depths of 18" or 24" and widths of 42", 48", 54", and 60".

**Bench returns** include return worksurface, leg support, all brackets, and mounting hardware.

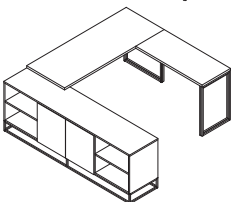
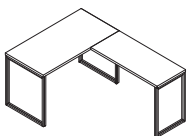

**Bench returns** can be used with a leg-leg work surface or leg-credenza work surface.

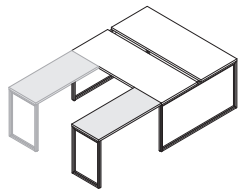

**Returns** must be placed flush to either end of the work surface.

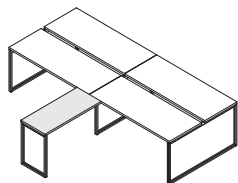

**Returns** can span equally across adjoining work surfaces.

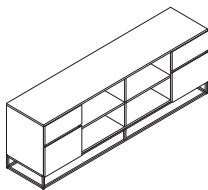

Personal credenza

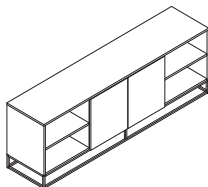

End credenza

**Credenzas** are available in two configurations – personal and end. The case can be specified as an inward or outward orientation, and single or dual-sided application, resulting in the correct hardware. If specifying as a stand-alone credenza, the orientation and application do not matter.

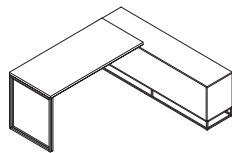
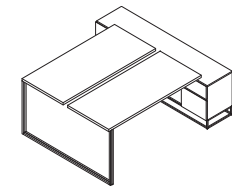

**Personal credenzas** can be used facing inwards or outwards in dual-sided applications. Specify with 24"D worksurfaces when orienting towards the user to allow easier access to storage drawers. In single-sided applications, the credenza must face outward.

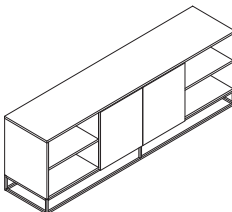

**End credenzas** can face inward or outward in 24"D single-sided applications. When 30" single-sided is specified, inward facing end credenza is not allowed. In dual-sided applications, credenza must face outward. Both open and closed sections come with adjustable shelves.

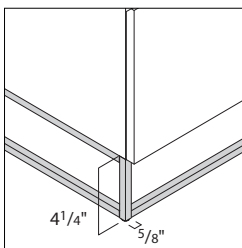

**Steel bases** are standard on credenzas.

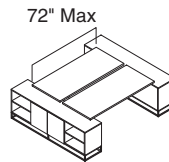

**Dual- and single-sided worksurfaces** using credenza/credenza support cannot exceed 72"W.

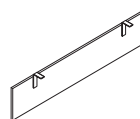

**A modesty panel** is available and ordered separately, in widths from 48" to 78". They can be specified in either wood veneer or High-Pressure Laminate. Modesty panels are specified one size smaller than the desk to allow for 3" clearance on both ends to accommodate the legs. Modesty panel can be mounted flush or inset.

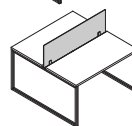
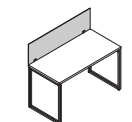

**Glass screens** are available for single- or dual-sided applications. Worksurface mounting brackets are included. Screens align with a 42"H datum from the floor.

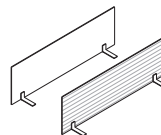

**Glass screens** are available in clear or fluted glass.

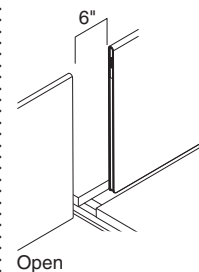

Open

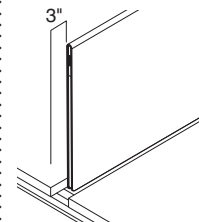

Full

**Universal screens** will have a 3" gap to the end of a bench run and 6" gap between screens. Screens do not run full work surface width.

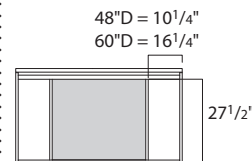

**48"D desks** have 10 1/4" clearance to intermediate leg. 60"D desks have 16 1/4" clearance.

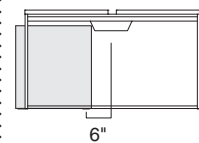

**Storage** must be at least 6" from centerline when trays are used.

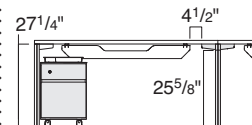

**Storage** can nest under the bench. The clearance is 27 1/4" except when within 4 1/2" of an intermediate leg, the clearance is 25 5/8".

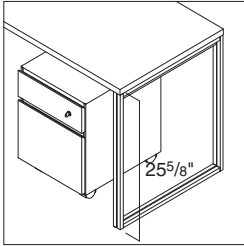

**Storage** can nest under the return. The clearance is 25<sup>5</sup>/<sub>8</sub>".

**Wiring and Cabling**

**Modular power** cannot be routed through personal and end credenzas in any configuration.

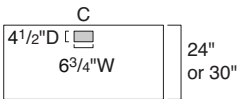

**Worksurface power modules** are available on dual- and single-sided bench units. Cutouts are centered on the worksurface.

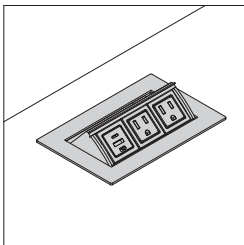
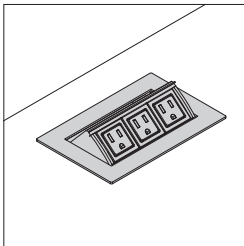

**Power modules** are available in three simplex and two simplex/USB A+C 20W configurations. The one-touch retractable door allows easy access.

*Tip: When using modular power under the worksurface, specify 18" L cord length.*

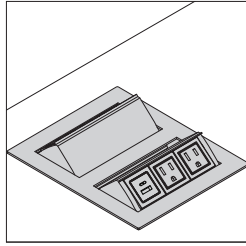

**Continuous top power modules** are available in six simplex and four simplex/USB A+C 20W configurations. The one-touch retractable door allows easy access.

*Tip: When using modular power under the worksurface, specify 18" L cord length.*

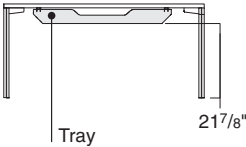

**Power trays** are optional and provide under the surface cord management and accommodate standard capacity power only. Power trays include all brackets and mounting hardware.

**Power trays** work with single-sided and dual-sided benches as well as continuous tops.

**If center cutout** is specified on single-sided worksurfaces, specify either left-hand or right-hand power tray.

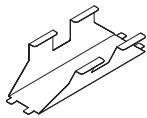

Single-sided tray extension

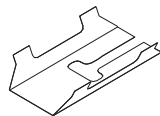

Dual-sided tray extension

**Extension trays** conceal conduit or wires between sections using power trays. They also allow for wires or conduit to be brought up through the bottom.

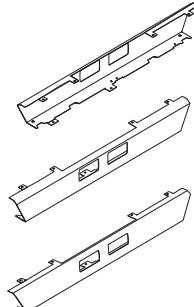

**Power covers** can be added to provide decorative trim around receptacles. Power covers are available for dual- and single-sided applications.

**If power covers** are not selected, any connection points on modular power blocks not being used by a harness, infeed, or connector must be filled with dust covers. Order style number (**FMVBK**) separately.

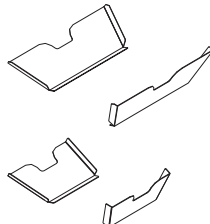

**End caps** can be added to power trays and are sold in pairs. End caps are painted metal.

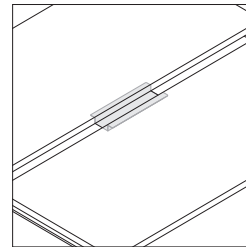
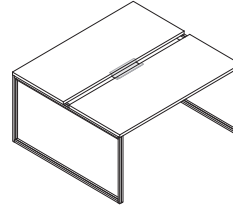

**Power support** is required when using modular power and provides an attachment location for a modular power block. Location is centered between worksurfaces for dual-sided applications and off-center for single-sided applications.

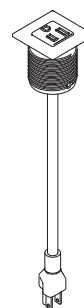
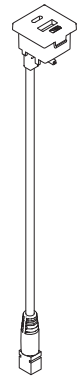

**Round and square worksurfaces** can be specified with a power cutout. Round/square power comes in configurations of 1 power or USB A+C 20W and has a 72" cord length.

**Related Products**

The following monitor arms work with the Greenpoint bench dual- and single-sided worksurfaces: **CFINTRO** and **CFINTROSLIDE**, with c-clamp mounting bracket. For more information, see *Worktools Specification Guide*.

*Tip: Dual monitor mounts are not approved on 24"D worksurface applications.*

**Surface Materials**

**Worksurfaces and returns**

- High-Pressure Laminate
- Wood veneer

**Modesty panels**

- High-Pressure Laminate
- Wood veneer

**Credenzas**

- High-Pressure Laminate
- Wood veneer

*Tip: Credenzas specified in High-Pressure Laminate, will have a corresponding painted pull, according to the matrix in the Surface Materials section.*

**Legs, trays, extensions, end caps, and covers**

- Paint

**Desk power unit**

- 6000 Black
- 6052 Milk

**Glass screen**

- 6500 Clear Glass
- WE80 Fluted Glass

*Tip: When selecting a Steelcase top surface finish, a corresponding Steelcase edge finish must be selected. When selecting West Elm top surface finish, a corresponding West Elm edge finish must be selected.*

# Greenpoint Benching

## Storage Capacities

### Greenpoint Storage

#### End Credenza

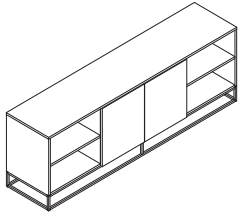

#### Size/Type

- Storage cabinet
- Open section
- Closed section

#### Inside Dimensions

D	W	H
18"	80"	27 <sup>1</sup> / <sub>4</sub> "
17 <sup>1</sup> / <sub>8</sub> "	17 <sup>1</sup> / <sub>4</sub> "	20 <sup>1</sup> / <sub>4</sub> "
17 <sup>1</sup> / <sub>8</sub> "	34 <sup>1</sup> / <sub>2</sub> "	20 <sup>1</sup> / <sub>4</sub> "

#### Outside Dimensions

D	W	H
18"	80"	27 <sup>1</sup> / <sub>4</sub> "

#### Personal Credenza

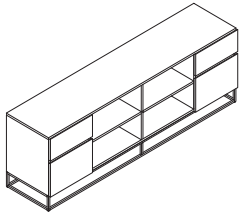

#### Size/Type

- Storage cabinet
- Top drawer
- Bottom drawer

#### Inside Dimensions

D	W	H
18"	80"	27 <sup>1</sup> / <sub>4</sub> "

#### Outside Dimensions

D	W	H
18"	80"	27 <sup>1</sup> / <sub>4</sub> "

# Universal Tackable Center Screens

For Use with Greenpoint

Universal Tackable Center Screens

**Universal tackable center screens** provide a boundary element along the bench. They are available in two heights to accommodate varying levels of privacy.

► Specifying, page 205

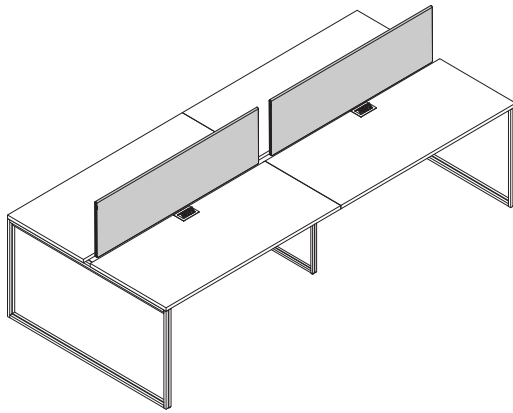

## Product Details

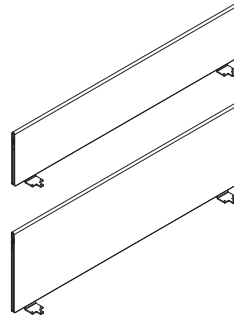

**Universal tackable center screens** are tackable and available in 13½"H and 19½"H. These screens are available in widths from 48"W-78"W.

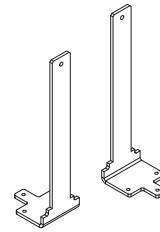

**Brackets** are included with screens. Two brackets are used on all screens.

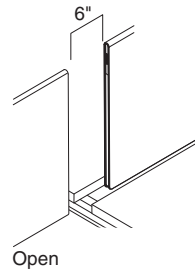

Open

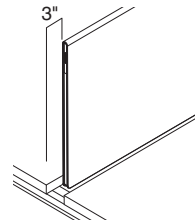

Full

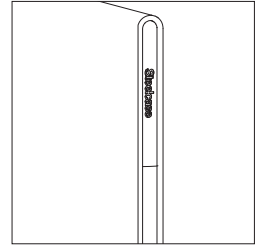

**The edge of the screen** is comprised of two different materials. The upper segment is merle plastic. The lower portion is PET which can be specified in medium heather grey to provide contrast or dark heather grey for a uniform visual.

## Surface Materials

### Fabric

► See *Surface Materials*, page 242

### Edge

- P630 Medium Heather Grey PET
- P631 Dark Heather Grey PET

### Brackets

► See *Surface Materials*, page 242

Front



Back



**All fabrics** are wrapped over the top of the screen. Approved fabrics are non-directional, and non-patterned.

## Actual Dimensions

	13½" Screen	19½" Screen
<b>Height</b>	12½"	18½"
<b>Thickness</b>	¾"	¾"
<b>Width</b>	48", 54", 60", 66", 72", or 78"	48", 54", 60", 66", 72", or 78"

*Tip: 13½"H screen aligns with a 40½"H datum from the floor. 19½"H screen aligns with a 46½"H datum from the floor.*

*Tip: Screens will have a 3" gap to the end of a bench run and a 6" gap between screens. Screens do not run full worksurface width.*

# Greenpoint Benching

## Power Routing Harness Chart

### Dual-Sided Benches

#### Bench A

Bench B	Bench A					
	48	54	60	66	72	78
48	45	48	51	54	57	60
54	48	51	54	57	60	63
60	51	54	57	60	63	66
66	54	57	60	63	66	69
72	57	60	63	66	69	72
78	60	63	66	69	72	75

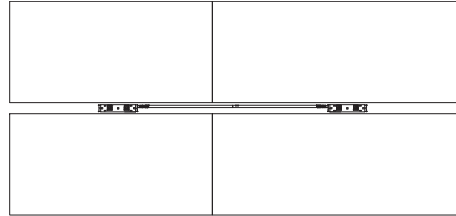

### Single-Sided Benches, Left to Left or Right to Right

#### Bench A

Bench B	Bench A					
	48	54	60	66	72	78
48	45	48	51	54	57	60
54	48	51	54	57	60	63
60	51	54	57	60	63	66
66	54	57	60	63	66	69
72	57	60	63	66	69	72
78	60	63	66	69	72	75

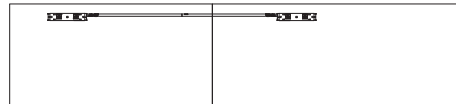

### Single-Sided Benches, Right to Left

#### Bench A

Bench B	Bench A					
	48	54	60	66	72	78
48	27	30	33	36	39	42
54	30	33	36	39	42	45
60	33	36	39	42	45	48
66	36	39	42	45	48	51
72	39	42	45	48	51	54
78	42	45	48	51	54	57

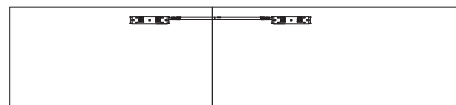

Tip: When skipping over a bench, add the width of the bench to the calculations above.

Tip: Power module is always mounted in the center for dual-sided benches.

Tip: Power modules are mounted off-center for single-sided benches.

**Single-Sided Benches, Left to Right**

**Bench A**

		<b>48</b>	<b>54</b>	<b>60</b>	<b>66</b>	<b>72</b>	<b>78</b>
<b>Bench B</b>	<b>48</b>	66	69	72	75	78	
	<b>54</b>	69	72	75	78		
	<b>60</b>	72	75	78			
	<b>66</b>	75	78				
	<b>72</b>	78					
	<b>78</b>						

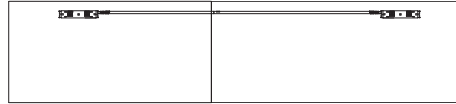

- Tip: When skipping over a bench, add the width of the bench to the calculations above.*
- Tip: Power module is always mounted in the center for dual-sided benches.*
- Tip: Power modules are mounted off-center for single-sided benches.*

# Greenpoint Benching

## Distribution and Access

**Power blocks** can be attached to power supports that are mounted to the underside of the worksurface. The location is centered on dual-sided application and off-center on single-sided applications.

**Because single-sided application** is off-centered, the power tray (**WESINDPTSS**) is either left- or right-handed.

**Standard-capacity power** includes one power block, provides back-to-back power, and accepts two receptacles per side.

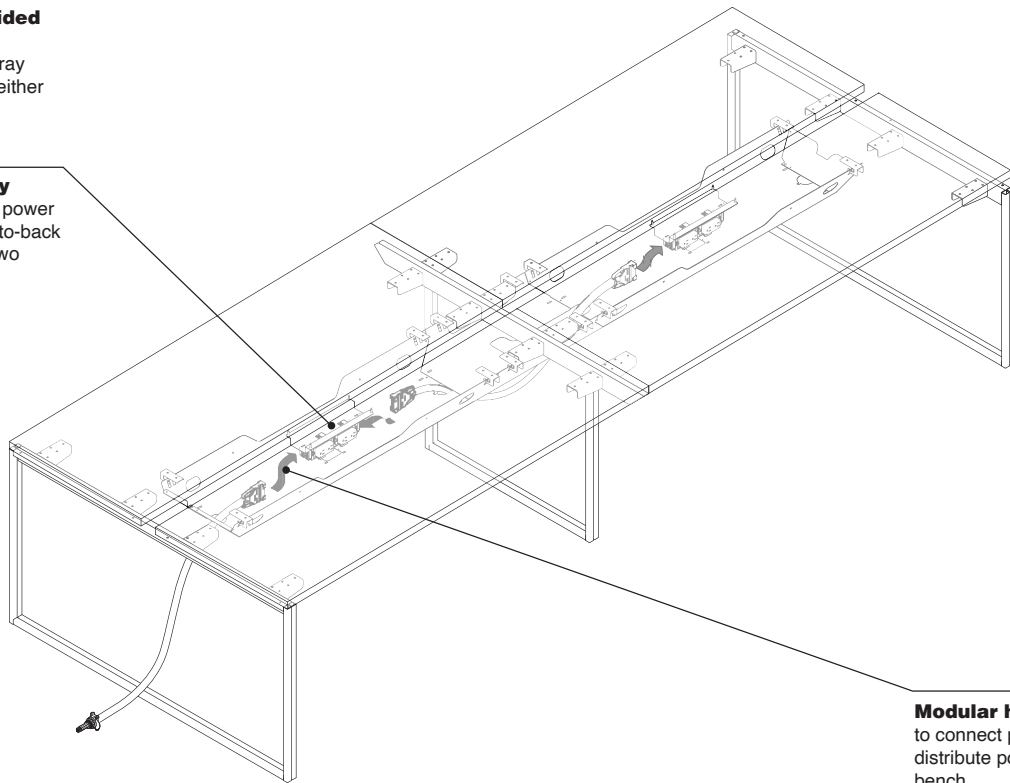

**Modular harness** is used to connect power blocks and distribute power through the bench.

## Wiring and Cabling

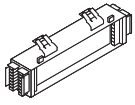

**Standard-capacity power** includes one power block, provides back-to-back power, and accepts two receptacles per side.

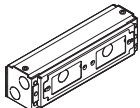

**Chicago hardwire box** is available. It accommodates two receptacles per side.



**Duplex receptacles** are available in 15- and 20-amps, isolated or system ground, with multiple line options. Receptacles have two outlets and are ordered separately.



**USB receptacles** are available in three wiring schematics with multiple line options. USB receptacles offer easy access to two charging ports. Each port provides 1 ampere of output. USB receptacles conveniently charge a wide range of electronic devices. Some devices may not be compatible.

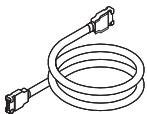

**Modular harnesses** are used to connect power blocks.

► See *Power Routing Harness Chart*, page 68, to determine lengths needed.

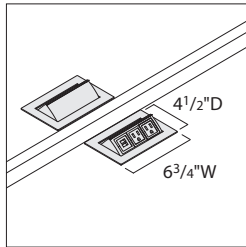

**Power unit** can be added when a worksurface cutout is specified. It is centered on the surface and provides user access to power.

**If power unit and cutout** is not specified, power and data is accessible under the worksurface. Dual-sided power trays can be removed without tools to provide additional clearance to plug in devices if needed. Single-sided power trays require tools to remove.

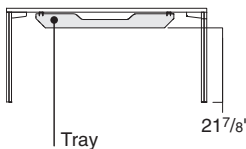

**Power trays** are available on dual- and single-sided units. Power trays hang from the underside of the worksurface and include all brackets and mounting hardware to provide cord management and conceal the standard capacity power blocks and conduit.

**Modular power in a dual-sided base or extension unit**, without trays, must be secured with a strain relief bracket. Order style number (**FMBVK**) for each unit.

**Power infeed on single- and dual-sided applications** must be secured with a strain relief bracket. To order one, use style number (**FMBVK**) for each unit.

**Filler packages** are available to fill unused power or data options. Order separately in packages of 20.

**Three wiring schematics** are available—3+1, 2+2, and three circuits with separate neutrals (3SN). All the components in an electrical distribution system must use the same wiring schematic. For safety, the components are keyed, labeled, and color-coded to make it impossible to connect mismatched parts.

**All electrical components** are cULus listed to the appropriate industry standards in accordance with the National and Canadian Electrical code.

**Local electrical codes vary**, so consult with your local authority having jurisdiction as they have final say if the products as installed are compliant with local code. Consult a qualified electrical contractor or engineer for the proper installation of all electrical components.

# Greenpoint Benching

## Building Interface

**Building power and data** can interface with the bench from floor or wall. Both modular and hardwire infeeds are available.

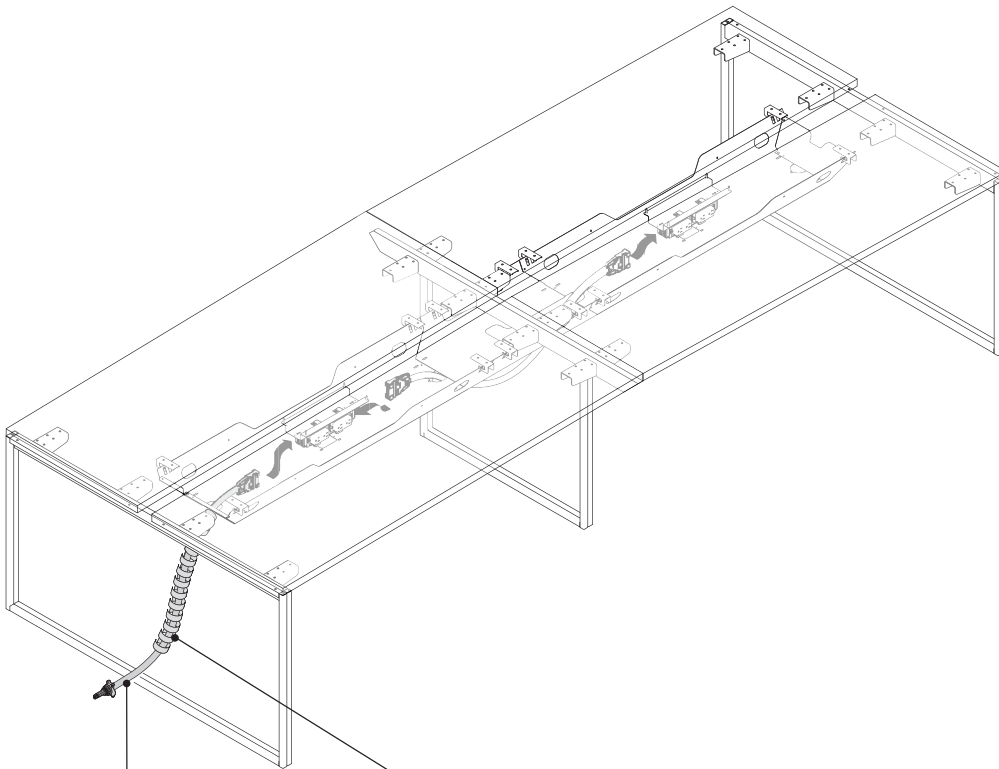

**Infeeds** can enter anywhere along the bench. If power trays are being used, infeeds can enter approximately 18" from either end of the bench section.

**A vertebral riser** is available to conceal the power and data.



**Hardwire-to-modular power infeed** is available in 6, 12, and 24 foot lengths. If a shorter harness is needed, it can be cut by the electrician. The hard-wired end is connected by an electrician to a junction box wherever it is located in the building. The harness is routed into the bench and connected to a power block. Non-PVC is standard. PVC version can be optioned.

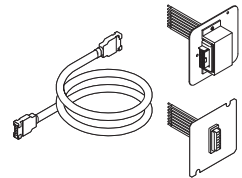

**Modular-to-modular power infeed** is available in 6, 12, and 24 foot lengths. A straight/flush modular junction box faceplate cover is standard and is wired to a 4<sup>1</sup>/<sub>16</sub>" square junction box located in the building. The harness is then routed into the bench and connected to a power block. A 90° junction box faceplate can be optioned and is recommended for use at a wall or column. The straight/flush is generally used in the floor. Non-PVC is standard. PVC version can be optioned.

Straight/  
Flush

90°

**Modular junction box faceplate** can be ordered separately and used with any modular harness length when 12 and 24 foot lengths are not appropriate. Straight/flush and 90° faceplates are available. A 90° junction box faceplate is recommended for use at a wall or column. Non-PVC is standard. PVC version can be optioned.

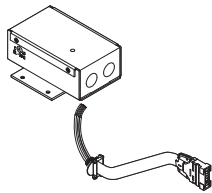

**New York power infeeds** are available. The junction box is mounted to the underside of the desk. A 50" harness is included to reach the first power block in the bench. If a shorter harness is needed, it can be cut by the electrician. Non-PVC is standard. PVC version can be optioned. Hardwire-to-modular infeeds can also be used.

**Hardwired/Chicago power infeeds** are supplied by the electrician.

**San Francisco** can use hardwire or modular infeeds. When infeed is coming from floor or wall, liquid tight metallic conduit may be required. In this case, order infeed specific to San Francisco.

**Base power infeeds** are not available.

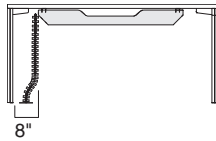

**Vertebral riser** can attach to the lower tray or simple tray. Its position is approximately 18" from either end of the desk unit. Length is 30".



**Extension vertebral riser** can be used to conceal conduit and cables along the floor. Length is 15". Risers can be linked to each other for longer length requirements.

**Power and data** can enter the bench through the end of the power tray. The opening is approximately 14" from the end of the desk.

**Three wiring schematics** are available—3+1, 2+2, and three circuits with separate neutrals (3SN). All the components in an electrical distribution system must use the same wiring schematic. For safety, the components are keyed, labeled, and color-coded to make it impossible to connect mismatched parts.

**Non-PVC modular electrical components** are the standard offering with the option to order PVC on some components. For those trying to gain the LEED Innovation and Design credit, non-PVC should be selected.

**All electrical components** are cULus listed to the appropriate industry standards in accordance with the National and Canadian Electrical code.

**Local electrical codes vary**, so consult with your local authority having jurisdiction as they have final say if the products as installed are compliant with local code. Consult a qualified electrical contractor or engineer for the proper installation of all electrical components.

# Greenpoint Benching

## Stability Guidelines

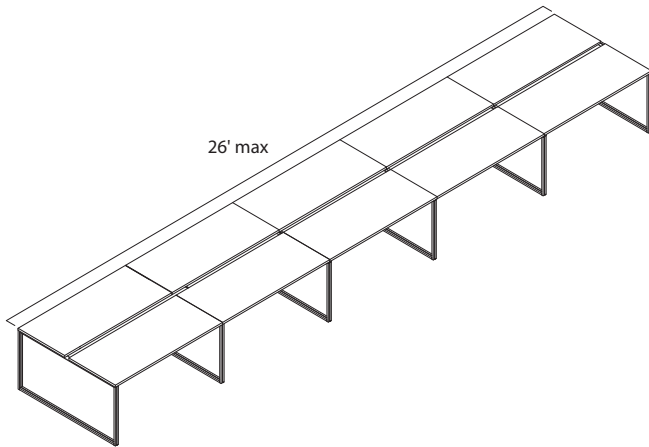

Maximum run on dual-sided and extension is 26'.

▶ See the *Steelcase Worktools Specification Guide* for approved monitor arm on dual-sided worksurfaces.

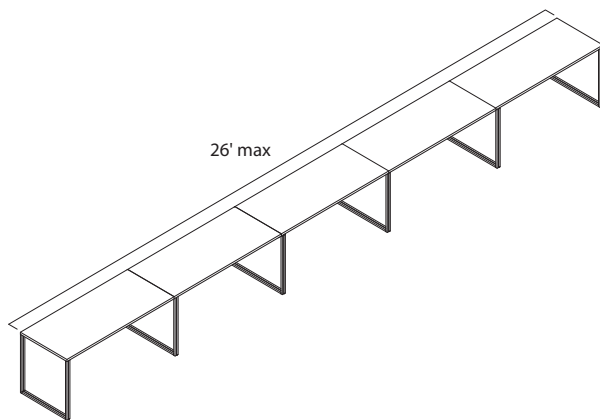

Maximum run on single-sided and extension is 26'.

▶ See the *Steelcase Worktools Specification Guide* for approved monitor arm on dual-sided worksurfaces.

# Greenpoint Benching

## Directional Laminate and Edge Profile Detail

**The appearance of laminate** may change slightly depending on the angle from which it is viewed. This natural phenomenon is called polarization, and it can be seen on natural veneer, and to a lesser extent on composite veneer. Polarization is often noticed on worksurfaces installed at a 90° angle with each other. Please refer to the following illustrations for an understanding of grain direction on your installation.

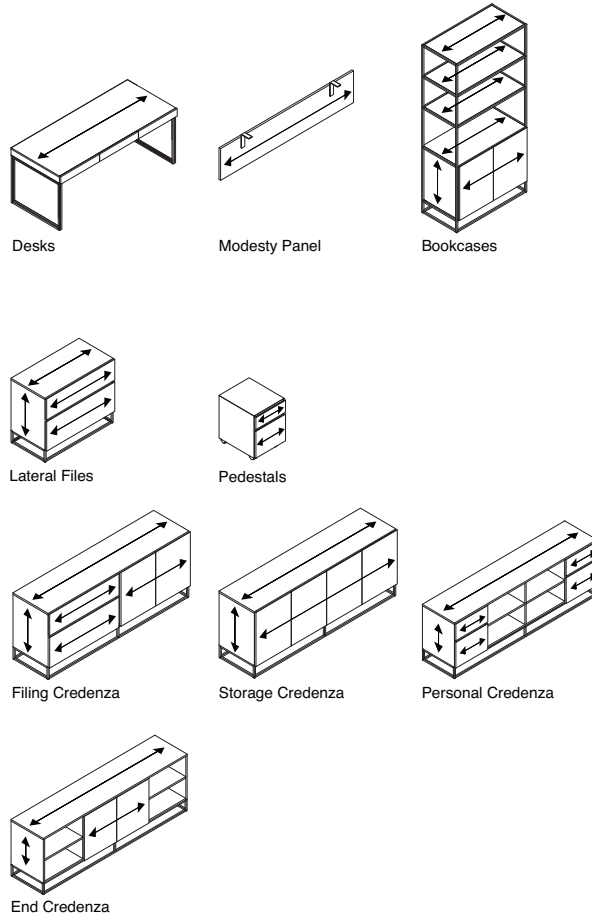

### Product Details



**3 mm radius front edge profile**  
(1 1/8" thick)

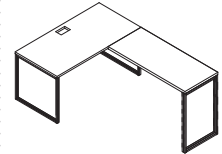

**3 mm edge profile** is on all four work surface sides.

# Sutton

## Rectangle Height-Adjustable Desks and Bases

**Rectangle height-adjustable desks** bring mobility and wellbeing, allowing users to change posture and location to suit their work needs. Optional integrated power includes a single power cord that comes out of the desk for ease of movement.  
▶ Specifying pages 232-236

**Desk** has a wood core with a High-Pressure Laminate or wood veneer surface, and is 1" thick.

**Radius corners** are available with a square edge profile. Corners feature a 2" radius.

**Square edge** is available in 3 mm edge profile, when High-Pressure Laminate or wood veneer is selected.

**Basic height-adjustable base** adjusts from 27<sup>3</sup>/<sub>8</sub>"H–46<sup>9</sup>/<sub>10</sub>"H in any increment.

**Square corners** are available with a square edge or blade edge.

**Extended height-adjustable base** adjusts from 22<sup>3</sup>/<sub>8</sub>"H to 48<sup>7</sup>/<sub>10</sub>"H in any increment.

**Leveling glides** adjust 1/2" to install desk on uneven floors. Glides are black.

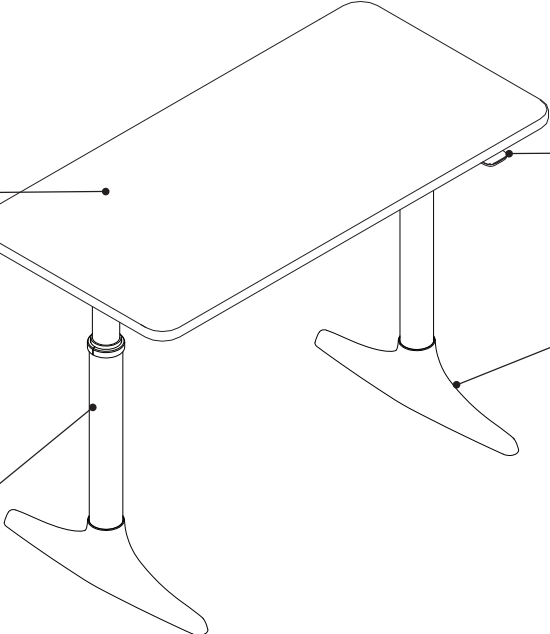

**Push button simple touch controller** adjusts height at a rate of 1 1/2" per second.

**Base** supports a maximum distributed weight load of 360 pounds (2-leg).  
*Tip: When calculating lifting capacity, subtract the weight of the worksurface, understructure, and options selected.*  
▶ See page 80 for worksurface weights.

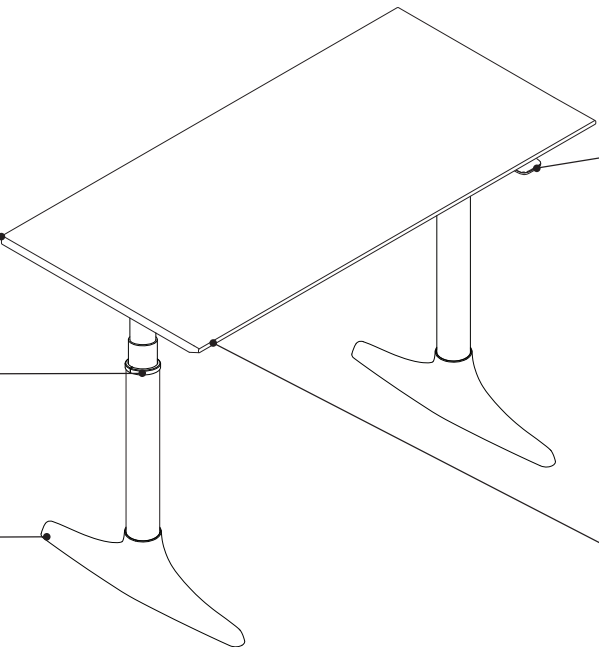

**Active touch controller** is Bluetooth-enabled; is standard and includes digital display, two preset buttons, double-tap automatic drive, and active motion posture reminders.  
*Tip: Steelcase Rise mobile app is available that pairs with any active touch controller to support preferences, presets, and activity tracking.*

**Lifting column** is controlled by central control box for synchronization. Columns are precision surface balanced to minimize surface vibrations.

**Blade edge** is available on the front user edge when square corners are selected.

## Product Details

**Radius corners** have rounded 2" corners on all four sides with a continuous user edge. Radius corners eliminate sharp edges and are appropriate for free-standing furniture. Radius corners are not available in combination with a blade edge profile.

**Square corners** have a 90 degree corner on all four sides.

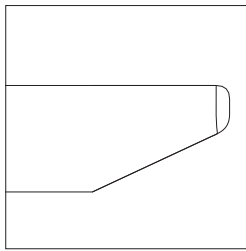

**Blade edge profile** is available on the front user edge with a clear coat over MDF. It is not available on desks with radius corners.

**Desk overhang** is not available. Distance from edge of worksurface to lift column is 4.96".

## High-Pressure Laminate Desks

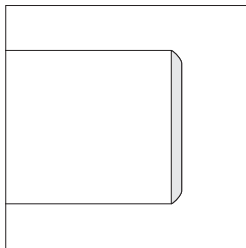

**Edge profile** is available in 3 mm edge profile for desks with radius corners and square corners. Blade edge profile is not available on desks with radius corner profile.

**PVC-free, 3 mm edge profiles** are proprietary polyolefin blend for all solid colors and woodgrain finishes.

**Edge profile finishes** are specified separately from laminate color.

## Wood Veneer Desks

**Edge profile** is available in 3 mm edge profile for desks with radius corners and square corners. Blade edge profile is not available on desks with radius corner profile.

**Simple touch controller** is available as an option and easily adjusts height of desk, at a rate of 1 1/2" per second, by lifting or pressing down on the controller.

**Active touch controller** is Bluetooth-enabled; is standard and includes digital display, two preset buttons, double-tap automatic drive, and active motion posture reminders.  
*Tip: Mobile app is available that pairs with any active touch controller to support preferences, presets, and activity tracking.*

**Obstruction sensing technology** is standard with all desks. The worksurface will backtrack when it makes contact with an object.

**The overall depth of the worksurface** is 23"D or 29"D.

**Extended height desks and bases** adjust 22 3/8"H to 48 7/10"H in any increment.

**Basic height-adjustable desks and bases** adjust from 27 3/8"H to 46 9/10"H in any increment.

**Desk sizes** are listed in actual dimensions to allow for 1" gap to adjacent furniture, eliminating any pinch points.

## Wiring and Cabling

**Low surge electric motor with quiet operation** adjusts at 1 1/2" per second. Motor is 110V and includes a 10' power cord. Motor has 0.1W standby power.

**Chicago** requires that desks shipping into Illinois ship with a 9' power cord.

**Sutton desks and bases** are listed by ETL.

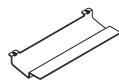

**Cable trays** are available as an option or can be ordered separately. 46"W–57 15/16"W desks use the 28" cable tray. 58"W–72"W desks use the 40"W cable tray.

**Integrated power** is optional and is located in the understructure of a desk. Integrated power consolidates technology to provide one cord out of the desk for convenience to the user. Two versions are available: underworksurface only and underworksurface plus worksurface clamp on convenience power. Worksurface power has two power outlet options, either USB A+C 20W or USB-C. Desks 57 15/16"W and under receive three power outlets in the understructure and desks 58"W and above receive five power outlets. Over-current power protection is standard on the integrated power option. If the over-current protection trips, reset by pushing the button located on the face of the understructure.

**Integrated power** is standard with a 10' standard black power cord. A 20' cord option is available if additional length is needed. For extra color, braided cord option is available.

**Integrated power** is available with either a standard three prong NEMA plug for use with standard receptacles or with Steelcase's proprietary thread low-profile plug for use with one-door and two-door low-profile connectors.

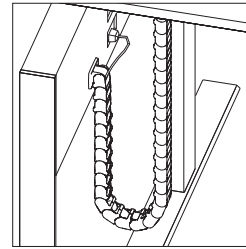

**Cable riser, with fence connection, inside dimensions** are 1"D x 1"W to accommodate a variety of cord sizes. Overall depth is 2". Order style number **OLCR** separately.

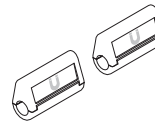

**Magnetic cable clips** are optimized for the braided one-cord out solution. However, the magnetic cable clips will work on Sutton, Ology, Migration SE, and the standard Flex power cords. The clips are used to manage power cords out of the users way. Order style numbers **FLXMCC2** or **FLXMCC10** separately.

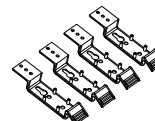

**Cable brackets**, ordered separately, support horizontal cable management below the worksurface. Order style number **FLXCBK4** separately.

**Inside dimensions of cable brackets** are 6"D x 2 1/4"W x 1/16"H.

## Surface Materials

### High-Pressure Laminate Desk

- Laminate
- ▶ See *Surface Materials Reference Manual*.
- Open Line laminate (option)  
A program including non-Steelcase laminates which are suitable for use on Steelcase products.
- ▶ See *Surface Materials Reference Manual*.

### 3 mm edge profile

- Plastic

### Blade edge profile

- Clear coat

### Wood Veneer Desk

- Wood veneer (standard)
- Full-fill finish (option)
- Customiz stain (option)

### Square 3 mm edge profile

- Wood veneer to match desk

### Blade edge profile

- Clear coat

### Height-adjustable base

- 4799 Platinum Metallic
- 7207 Black
- 7243 Seagull
- 7360 Merle

### Foot

- Paint
- Accent paint
- Lux Coatings

### Ring

- Paint
- Accent paint
- Lux Coatings
- WE04 Brushed Nickel
- WE06 Smooth Brass
- 9201 Polished Chrome

**Braided Cord Color Matrix**

**Braided cord samples** are not available to order. Use matrix below that compares the braided cord finish to the nearest Steelcase finish color for color reference purposes.  
*Tip: Braided cord color is defaulted to 9007 Sterling.*

Finish	Similar Steelcase Color
9003 Fuchsia	4BQ7 Fuchsia
9004 Marlin	4AZ5 Marlin
9006 Chili	6338 Chili
9007 Sterling*	6059 Sterling Dark Solid
9008 Honey	4CZ5 Honey
9009 Black	0835 Black
9010 Light Peacock	4CZ8 Light Peacock
9011 Seagull	4858 Seagull

\*Default finish on integrated power.

**Application Topics**

**Moving desks** can collide with other components. Do not install overhead storage, desk-height power, or desk accessories in the path of height-adjustable desks.

**Universal boundary screens** are not permitted on height-adjustable desks, as they do not pass minimum safety requirements which could result in the desk tipping over.

**Sarto screens** are recommended to be used with Sutton height-adjustable desks. Universal and Soffio screens are also compatible.

**On extended height desks, any storage higher than 19"** will impede the height range of the desk. On basic height desks, any storage higher than 23<sup>7</sup>/<sub>10</sub>" will impede the height range of the desk.  
*Tip: Do not place storage underneath controller.*

**CPU holders** are not allowed for use on Sutton. There is no overhang option available to support CPU holders.

**All assemblies** meet or exceed ANSI/BIFMA standards.

**WARNING**

Read base only warranty limitations.

**Keyboard assemblies** are not allowed for use on height-adjustable desks. They do not meet minimum safety requirements.

**A modesty panel** is available and ordered separately, in widths from 48" to 78". They can be specified in either wood veneer or High-Pressure Laminate. Modesty panels are specified one size smaller than the desk to allow for 2" clearance on both ends to accommodate the legs. Modesty panel can be mounted flush or inset.

**Modesty panels** may be inset from the back edge of the worksurface to allow for worktool clamps.

**For monitor arms**, only single and dual flat panel monitor arm applications are permitted for use with height adjustable desks. For further information, see the *Steelcase Worktools Specification Guide*.

**Dual monitor arms** are not allowed on 23"D worksurfaces.

Height-Adjustable Desks Comparison Chart

**Rectangle Height-Adjustable Desks**

Basic Height

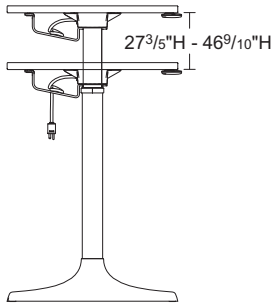

Extended Height

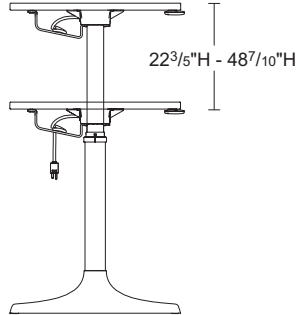

**Enhanced sit-to-stand height-adjustability**

A push button delivers electric adjustability up to 1 1/2" per second. Includes two controller options:

- Simple touch
- Active touch

	<b>Weight Capacity</b>
Sutton Desk	360 lb

*Tip: When calculating lifting capacity, subtract the weight of the worksurface, understructure, and options selected.*

**Adjustables Comparison Chart**

	<b>Sutton Desk</b> Sit-to-Stand
<b>Range of Adjustment</b>	Extended height: 22 <sup>3</sup> / <sub>5</sub> " – 48 <sup>7</sup> / <sub>10</sub> " Basic height: 27 <sup>3</sup> / <sub>5</sub> " – 46 <sup>9</sup> / <sub>10</sub> "
<b>Type of Adjustment</b>	Electric
<b>Distributed Weight Capacity</b>	360 lb
<b>Worksurface Weight</b>	See page 80 for worksurface weights
<b>Worksurface Thickness</b>	1"
<b>Controller</b>	Simple touch, Active touch
<b>Integrated Rail</b>	No
<b>Integrated Soft Edge</b>	No
<b>Integrated Power</b>	Yes
<b>Motor</b>	Enclosed
<b>Decibel Rating</b>	< 45 dBA
<b>Volts</b>	120v AC
<b>Input Amps</b>	2.5A
<b>Watts</b>	300W
<b>Standby Power</b>	0.1W
<b>Frequency and Phase</b>	60 Hz Single Phase
<b>Adjustability Speed</b>	1 1/2" per second
<b>Stretcher or Understructure Design</b>	Fixed
<b>Base Only Availability</b>	Yes
<b>ANSI/BIFMA (29"D Knee depth requirement for worksurface)</b>	Meet or Exceed

## Sutton, Height-Adjustable Desks Comparison Chart, continued

### Installation

**Desks** ship with pre-drilled holes for mounting bases.

**Height-adjustable base** requires attachment to the worksurface.

Base supports a maximum distributed weight capacity of 360 pounds.

*Tip: When calculating lifting capacity, subtract the weight of the worksurface, understructure, and options.*

*Tip: A label applied to the underside of the worksurface will include the load-capacity for each desk.*

### Worksurface Weight

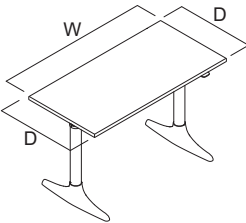
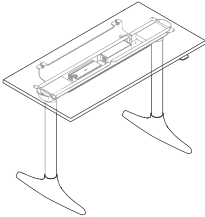
Worksurface Shape	W	D	Worksurface Weight	Understructure Weight	Leg Clearance (A)	Options	
						Integrated Power Weight	
		46"	23"	27 lb	7.1 lb	9 <sup>1</sup> / <sub>2</sub> "	5.0 lb
		58"	23"	35 lb	9.4 lb	9 <sup>1</sup> / <sub>2</sub> "	5.0 lb
		70"	23"	42 lb	11.7 lb	9 <sup>1</sup> / <sub>2</sub> "	5.0 lb
		46"	29"	34 lb	7.1 lb	12 <sup>1</sup> / <sub>2</sub> "	5.0 lb
		58"	29"	43 lb	9.4 lb	12 <sup>1</sup> / <sub>2</sub> "	5.0 lb
		70"	29"	52 lb	11.7 lb	12 <sup>1</sup> / <sub>2</sub> "	5.0 lb

**Nimbus** has a soft, inviting profile making it a comfortable conference seating option.

**The Nimbus conference chair** has a product height of 31.5" with an adjustable base.



**The Nimbus conference chair** has a width of 26" and depth of 24.4".

## Product Details

**Nimbus** has an adjustable base height.

**Seat** includes a foam base for a comfortable sit.

**Ships in one box,** knocked down.

**Assembly directions** included in the box.

## Surface Materials

### Chair

- Platinum upholstered fabric

### Base

- Antique bronze

# Slope Guest (Licensed)

**Slope** has a sloped seat for added comfortability and metal base style.



**The Slope guest chair** has a depth of 21.5" and width of 19.25".

## Product Details

Limited finishes offered.

## Surface Materials

### Chair

Aniline-dyed leather:

- Saddle
- Fog

### Frame

- Hot-rolled steel

# Slope Conference Chair (Licensed)

Slope Conference Chair  
(Licensed)

**Slope** has a sloped seat for added comfortability and sleek 5-star base.

## Product Details

Adjustable 5-star base.

## Surface Materials

### Chair

Aniline-dyed leather:  
• Saddle

**The Slope conference chair** has a depth of 21.5" and width of 19.25".



# Slope Stools (Licensed)

**The Slope bar stool** has a depth of 21.5" and width of 19.25". The product height is 40" and a seat height of 29.5".



**The Slope counter stool** has a depth of 21.5" and width of 19". The product height is 35.75" and a seat height of 25.25".

**The Slope height adjustable stool** has a depth of 21.5" and width of 19". The product height is 40.25" with adjustable base.



## Product Details

Three different bases are offered for versatility.

## Surface Materials

### Stool

Available in  
Aniline-dyed leather:  
• Saddle

### Base

• Hot-rolled steel

# Slope Lounge (Licensed)

Slope Lounge (Licensed)

**Slope** has a sloped seat for added comfortability and metal base style.

**The Slope lounge** has a product height of 31.5" and seat height of 15.75".

**The Slope lounge** has a depth of 24.4" and width of 26".



## Product Details

Limited finishes offered.

## Surface Materials

### Seat

Available in Aniline-dyed leather:

- Saddle

# Lily Pad Nesting Tables (Licensed)

**Lily Pad tables** are offered in three heights.

**The Lily Pad nesting tables** have a depth of 25" and width of 30" for all height options.

**The Lily Pad nesting tables** have heights of 16", 18", and 20".



## Product Details

Three available heights to mix and match.

## Surface Materials

### Table top

- Walnut veneer
- White marble

### Base

- Antique brass

# Linear C Table (Licensed)

Linear C Table  
(Licensed)

**Linear C table** is a mobile, makeshift workplace that fits under chairs and sofas.

The **Linear C table** has a depth of 13.5", width of 24", and 26.5" height.



## Product Details

A steel and natural oak mobile laptop table.

## Surface Materials

**Top**  
• Natural oak

**Base**  
• Hot-rolled steel powder coated charcoal

# Maisie Side Table (Licensed)

**Maisie side table** is offered in two heights.

**The Maisie short side table** has a diameter of 18" and height of 22".



**The Maisie tall side table** has a diameter of 18" and height of 25".



## Product Details

Available in two heights.

## Surface Materials

### Top

- Walnut
- White marble

### Base

- Antique brass

# Mesa Coffee Table (Licensed)

Mesa Coffee Table  
(Licensed)

**Mesa coffee table** is designed for any common area.

**The Mesa coffee table** has a depth of 32" and width of 32". With a height of 12".



## Product Details

**Table** comes with black marble tabletop and burnished bronze legs.

## Surface Materials

**Top**  
• Black marble

**Legs**  
• Burnished bronze

Maise Side Table



# West Elm—Steelcase

## Specifying

### Seating

#### Belle

Lounge Seating **92**

#### Boardwalk

Lounge Seating **100**

Occasional Tables **107**

Accessories **112**

#### Brighton

Lounge Seating **114**

Occasional Tables **119**

Power **125**

#### Mesa

Lounge Seating **126**

#### Willow

Lounge Seating **132**

#### Slope

Guest Chairs and Stools **136**

Conference Chair **140**

Stacking Chair **141**

#### Sterling

Guest Chairs and Stools **142**

Conference Chairs **146**

Lounge **150**

#### Sterling Health

Guest Chairs **151**

#### Kent

Conference Chairs **153**

Guest Chairs **157**

Stools **159**

#### Lucas

Lounge **161**

#### Fulton

Guest Chair **163**

Lounge Chair **164**

Bench **165**

### Furniture

#### Greenpoint Private Office

Desks and Returns **166**

Modesty Panels **170**

Credenzas **171**

Wood Lateral File **173**

Bookcases **174**

Metal Mobile Pedestal **178**

Basic Cushions Enhanced **179**

Accessories **180**

Power Units **182**

#### Greenpoint Bench

Worksurfaces and Returns **184**

Legs **197**

Credenzas **203**

Center Screens **205**

#### Power and Data

Power Supports **206**

Power Trays **208**

Power Covers **209**

Modular Power Blocks **210**

Chicago Hardwire Box **211**

Power and Data Receptacles and Filler Package **212**

Modular Harnesses **214**

Power Infeeds **215**

Bracket Kit **217**

Vertebral Risers **218**

#### Sutton

Desks **220**

Bases **224**

Accessories **228**

# Belle One Seat Lounge

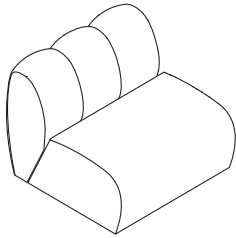

*Tip: Contrasting back channels can have contrasting color within the same fabric family. (For example, 59DB Birdseye specified on back channel 1 and 59DB Birdseye specified on back channel 2; both are Birdseye by DesignTex.)*

*Tip: Contrasting seat and back can be from two different fabric families.*

*Tip: Contrasting back channel fabrics are specified from the right handed seated position.*

Standard Includes		Required to Specify	
<ul style="list-style-type: none"> <li>▶ Need help? Product details, page 16</li> </ul>	<ul style="list-style-type: none"> <li>Fully upholstered non-contrasting lounge: fabric price group 1</li> <li>Plastic ganging brackets</li> <li>Glides</li> </ul>	<ul style="list-style-type: none"> <li>1 Style number</li> <li>2 Fabric color number for lounge</li> <li>3 Options, if selected (see below)</li> <li>▶ See <i>Surface Materials</i>, page 242.</li> </ul>	
Color Scheme	Options	U.S. Price	Required to Specify
	<ul style="list-style-type: none"> <li>Non contrasting</li> <li>Contrasting seat and back</li> <li>Contrasting all surfaces</li> </ul>	<ul style="list-style-type: none"> <li>No cost</li> <li>+\$ 181</li> <li>+\$ 326</li> </ul>	<ul style="list-style-type: none"> <li>Specify <i>with non contrasting</i>.</li> <li>Specify <i>with contrasting seat and back</i>.</li> <li>Specify <i>with contrasting all channels</i>.</li> </ul>
Surface Materials	Seat		
	<ul style="list-style-type: none"> <li>Customer's Own Material (COM)</li> <li>Fabric price group 1</li> <li>Fabric price group 2</li> <li>Fabric price group 3</li> <li>Fabric price group 4</li> <li>Fabric price group 5</li> <li>Fabric price group 6</li> <li>Fabric price group 7</li> <li>Fabric price group 8</li> <li>Fabric price group 9</li> <li>Fabric price group 10</li> </ul>	<ul style="list-style-type: none"> <li>No cost</li> <li>No cost</li> <li>+\$ 12</li> <li>+\$ 65</li> <li>+\$ 123</li> <li>+\$ 223</li> <li>+\$ 330</li> <li>+\$ 460</li> <li>+\$ 597</li> <li>+\$ 735</li> <li>+\$ 867</li> </ul>	<ul style="list-style-type: none"> <li>▶ See <i>Surface Materials Reference Manual</i>.</li> <li>Specify fabric color number.</li> <li>Specify fabric color number.</li> <li>Specify fabric color number.</li> <li>Specify fabric color number.</li> <li>Specify fabric color number.</li> <li>Specify fabric color number.</li> <li>Specify fabric color number.</li> <li>Specify fabric color number.</li> <li>Specify fabric color number.</li> <li>Specify fabric color number.</li> </ul>
	Back		
	<ul style="list-style-type: none"> <li>Customer's Own Material (COM)</li> <li>Fabric price group 1</li> <li>Fabric price group 2</li> <li>Fabric price group 3</li> <li>Fabric price group 4</li> <li>Fabric price group 5</li> <li>Fabric price group 6</li> <li>Fabric price group 7</li> <li>Fabric price group 8</li> <li>Fabric price group 9</li> <li>Fabric price group 10</li> </ul>	<ul style="list-style-type: none"> <li>No cost</li> <li>No cost</li> <li>+\$ 12</li> <li>+\$ 102</li> <li>+\$ 198</li> <li>+\$ 351</li> <li>+\$ 522</li> <li>+\$ 732</li> <li>+\$ 942</li> <li>+\$1167</li> <li>+\$1383</li> </ul>	<ul style="list-style-type: none"> <li>▶ See <i>Surface Materials Reference Manual</i>.</li> <li>Specify fabric color number.</li> <li>Specify fabric color number.</li> <li>Specify fabric color number.</li> <li>Specify fabric color number.</li> <li>Specify fabric color number.</li> <li>Specify fabric color number.</li> <li>Specify fabric color number.</li> <li>Specify fabric color number.</li> <li>Specify fabric color number.</li> <li>Specify fabric color number.</li> </ul>
	Back channel 1		
	<ul style="list-style-type: none"> <li>Customer's Own Material (COM)</li> <li>Fabric price group 1</li> <li>Fabric price group 2</li> <li>Fabric price group 3</li> <li>Fabric price group 4</li> <li>Fabric price group 5</li> <li>Fabric price group 6</li> <li>Fabric price group 7</li> <li>Fabric price group 8</li> <li>Fabric price group 9</li> <li>Fabric price group 10</li> </ul>	<ul style="list-style-type: none"> <li>No cost</li> <li>No cost</li> <li>+\$ 4</li> <li>+\$ 34</li> <li>+\$ 66</li> <li>+\$ 117</li> <li>+\$ 174</li> <li>+\$ 244</li> <li>+\$ 314</li> <li>+\$ 389</li> <li>+\$ 461</li> </ul>	<ul style="list-style-type: none"> <li>▶ See <i>Surface Materials Reference Manual</i>.</li> <li>Specify fabric color number.</li> <li>Specify fabric color number.</li> <li>Specify fabric color number.</li> <li>Specify fabric color number.</li> <li>Specify fabric color number.</li> <li>Specify fabric color number.</li> <li>Specify fabric color number.</li> <li>Specify fabric color number.</li> <li>Specify fabric color number.</li> <li>Specify fabric color number.</li> </ul>
	Back channel 2		
	<ul style="list-style-type: none"> <li>Customer's Own Material (COM)</li> <li>Fabric price group 1</li> <li>Fabric price group 2</li> <li>Fabric price group 3</li> <li>Fabric price group 4</li> <li>Fabric price group 5</li> <li>Fabric price group 6</li> <li>Fabric price group 7</li> <li>Fabric price group 8</li> <li>Fabric price group 9</li> <li>Fabric price group 10</li> </ul>	<ul style="list-style-type: none"> <li>No cost</li> <li>No cost</li> <li>+\$ 4</li> <li>+\$ 34</li> <li>+\$ 66</li> <li>+\$ 117</li> <li>+\$ 174</li> <li>+\$ 244</li> <li>+\$ 314</li> <li>+\$ 389</li> <li>+\$ 461</li> </ul>	<ul style="list-style-type: none"> <li>▶ See <i>Surface Materials Reference Manual</i>.</li> <li>Specify fabric color number.</li> <li>Specify fabric color number.</li> <li>Specify fabric color number.</li> <li>Specify fabric color number.</li> <li>Specify fabric color number.</li> <li>Specify fabric color number.</li> <li>Specify fabric color number.</li> <li>Specify fabric color number.</li> <li>Specify fabric color number.</li> <li>Specify fabric color number.</li> </ul>

▶ Options, continued on next page



## For Canadian Pricing

Multiply U.S. Price by the Canadian price factor.

▶ See page 1 for details.

► Options, continued from previous page

Options	U.S. Price	Required to Specify
<b>Surface Materials, continued</b>		
<b>Back channel 3</b>		► See <i>Surface Materials Reference Manual</i> .
• Customer's Own Material (COM)	No cost	Specify fabric color number.
• Fabric price group 1	No cost	Specify fabric color number.
• Fabric price group 2	+\$ 4	Specify fabric color number.
• Fabric price group 3	+\$ 34	Specify fabric color number.
• Fabric price group 4	+\$ 66	Specify fabric color number.
• Fabric price group 5	+\$117	Specify fabric color number.
• Fabric price group 6	+\$174	Specify fabric color number.
• Fabric price group 7	+\$244	Specify fabric color number.
• Fabric price group 8	+\$314	Specify fabric color number.
• Fabric price group 9	+\$389	Specify fabric color number.
• Fabric price group 10	+\$461	Specify fabric color number.

**Specification Information**

Style Number	U.S. Base Price
WESBELLNG1	\$3559

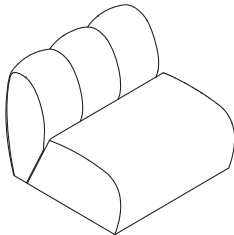

 **For Canadian Pricing**  
 Multiply U.S. Price by the Canadian price factor.  
 ► See page 1 for details.

# Belle Two Seat Lounge

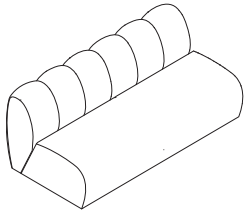

Tip: Contrasting back channels can have contrasting color within the same fabric family. (For example, 59DB Birdseye specified on back channel 1 and 59DB Birdseye specified on back channel 2; both are Birdseye by Designtex.)

Tip: Contrasting seat and back can be from two different fabric families.

Tip: Contrasting back channel fabrics are specified from the right handed seated position.

Standard Includes		Required to Specify	
<ul style="list-style-type: none"> <li>▶ Need help? Product details, page 16</li> </ul>	<ul style="list-style-type: none"> <li>Fully upholstered non-contrasting lounge: fabric price group 1</li> <li>Plastic ganging brackets</li> <li>Glides</li> </ul>	<ul style="list-style-type: none"> <li>1 Style number</li> <li>2 Fabric color number for lounge</li> <li>3 Options, if selected (see below)</li> </ul>	<ul style="list-style-type: none"> <li>▶ See <i>Surface Materials</i>, page 242.</li> </ul>
Color Scheme	Options	U.S. Price	Required to Specify
	<ul style="list-style-type: none"> <li>Non contrasting</li> <li>Contrasting seat and back</li> <li>Contrasting all surfaces</li> </ul>	<ul style="list-style-type: none"> <li>No cost</li> <li>+\$ 181</li> <li>+\$ 919</li> </ul>	<ul style="list-style-type: none"> <li>Specify <i>with non contrasting</i>.</li> <li>Specify <i>with contrasting seat and back</i>.</li> <li>Specify <i>with contrasting all channels</i>.</li> </ul>
Surface Materials	Seat		
	<ul style="list-style-type: none"> <li>Customer's Own Material (COM)</li> <li>Fabric price group 1</li> <li>Fabric price group 2</li> <li>Fabric price group 3</li> <li>Fabric price group 4</li> <li>Fabric price group 5</li> <li>Fabric price group 6</li> <li>Fabric price group 7</li> <li>Fabric price group 8</li> <li>Fabric price group 9</li> <li>Fabric price group 10</li> </ul>	<ul style="list-style-type: none"> <li>No cost</li> <li>No cost</li> <li>+\$ 22</li> <li>+\$ 95</li> <li>+\$ 187</li> <li>+\$ 338</li> <li>+\$ 495</li> <li>+\$ 691</li> <li>+\$ 896</li> <li>+\$1105</li> <li>+\$1304</li> </ul>	<ul style="list-style-type: none"> <li>▶ See <i>Surface Materials Reference Manual</i>.</li> <li>Specify fabric color number.</li> <li>Specify fabric color number.</li> <li>Specify fabric color number.</li> <li>Specify fabric color number.</li> <li>Specify fabric color number.</li> <li>Specify fabric color number.</li> <li>Specify fabric color number.</li> <li>Specify fabric color number.</li> <li>Specify fabric color number.</li> <li>Specify fabric color number.</li> </ul>
	Back		
	<ul style="list-style-type: none"> <li>Customer's Own Material (COM)</li> <li>Fabric price group 1</li> <li>Fabric price group 2</li> <li>Fabric price group 3</li> <li>Fabric price group 4</li> <li>Fabric price group 5</li> <li>Fabric price group 6</li> <li>Fabric price group 7</li> <li>Fabric price group 8</li> <li>Fabric price group 9</li> <li>Fabric price group 10</li> </ul>	<ul style="list-style-type: none"> <li>No cost</li> <li>No cost</li> <li>+\$ 24</li> <li>+\$ 204</li> <li>+\$ 396</li> <li>+\$ 702</li> <li>+\$1044</li> <li>+\$1464</li> <li>+\$1884</li> <li>+\$2334</li> <li>+\$2766</li> </ul>	<ul style="list-style-type: none"> <li>▶ See <i>Surface Materials Reference Manual</i>.</li> <li>Specify fabric color number.</li> <li>Specify fabric color number.</li> <li>Specify fabric color number.</li> <li>Specify fabric color number.</li> <li>Specify fabric color number.</li> <li>Specify fabric color number.</li> <li>Specify fabric color number.</li> <li>Specify fabric color number.</li> <li>Specify fabric color number.</li> <li>Specify fabric color number.</li> </ul>
	Back channel 1		
	<ul style="list-style-type: none"> <li>Customer's Own Material (COM)</li> <li>Fabric price group 1</li> <li>Fabric price group 2</li> <li>Fabric price group 3</li> <li>Fabric price group 4</li> <li>Fabric price group 5</li> <li>Fabric price group 6</li> <li>Fabric price group 7</li> <li>Fabric price group 8</li> <li>Fabric price group 9</li> <li>Fabric price group 10</li> </ul>	<ul style="list-style-type: none"> <li>No cost</li> <li>No cost</li> <li>+\$ 4</li> <li>+\$ 34</li> <li>+\$ 66</li> <li>+\$ 117</li> <li>+\$ 174</li> <li>+\$ 244</li> <li>+\$ 314</li> <li>+\$ 389</li> <li>+\$ 461</li> </ul>	<ul style="list-style-type: none"> <li>▶ See <i>Surface Materials Reference Manual</i>.</li> <li>Specify fabric color number.</li> <li>Specify fabric color number.</li> <li>Specify fabric color number.</li> <li>Specify fabric color number.</li> <li>Specify fabric color number.</li> <li>Specify fabric color number.</li> <li>Specify fabric color number.</li> <li>Specify fabric color number.</li> <li>Specify fabric color number.</li> <li>Specify fabric color number.</li> </ul>
	Back channel 2		
	<ul style="list-style-type: none"> <li>Customer's Own Material (COM)</li> <li>Fabric price group 1</li> <li>Fabric price group 2</li> <li>Fabric price group 3</li> <li>Fabric price group 4</li> <li>Fabric price group 5</li> <li>Fabric price group 6</li> <li>Fabric price group 7</li> <li>Fabric price group 8</li> <li>Fabric price group 9</li> <li>Fabric price group 10</li> </ul>	<ul style="list-style-type: none"> <li>No cost</li> <li>No cost</li> <li>+\$ 4</li> <li>+\$ 34</li> <li>+\$ 66</li> <li>+\$ 117</li> <li>+\$ 174</li> <li>+\$ 244</li> <li>+\$ 314</li> <li>+\$ 389</li> <li>+\$ 461</li> </ul>	<ul style="list-style-type: none"> <li>▶ See <i>Surface Materials Reference Manual</i>.</li> <li>Specify fabric color number.</li> <li>Specify fabric color number.</li> <li>Specify fabric color number.</li> <li>Specify fabric color number.</li> <li>Specify fabric color number.</li> <li>Specify fabric color number.</li> <li>Specify fabric color number.</li> <li>Specify fabric color number.</li> <li>Specify fabric color number.</li> <li>Specify fabric color number.</li> </ul>

▶ Options, continued on next page



## For Canadian Pricing

Multiply U.S. Price by the Canadian price factor.

▶ See page 1 for details.

► Options, continued from previous page

Options	U.S. Price	Required to Specify	
<b>Surface Materials, continued</b>	<b>Back channel 3</b>		
	• Customer's Own Material (COM)	No cost	► See <i>Surface Materials Reference Manual</i> . Specify fabric color number.
	• Fabric price group 1	No cost	Specify fabric color number.
	• Fabric price group 2	+\$ 4	Specify fabric color number.
	• Fabric price group 3	+\$ 34	Specify fabric color number.
	• Fabric price group 4	+\$ 66	Specify fabric color number.
	• Fabric price group 5	+\$117	Specify fabric color number.
	• Fabric price group 6	+\$174	Specify fabric color number.
	• Fabric price group 7	+\$244	Specify fabric color number.
	• Fabric price group 8	+\$314	Specify fabric color number.
	• Fabric price group 9	+\$389	Specify fabric color number.
• Fabric price group 10	+\$461	Specify fabric color number.	
	<b>Back channel 4</b>		
	• Customer's Own Material (COM)	No cost	► See <i>Surface Materials Reference Manual</i> . Specify fabric color number.
	• Fabric price group 1	No cost	Specify fabric color number.
	• Fabric price group 2	+\$ 4	Specify fabric color number.
	• Fabric price group 3	+\$ 34	Specify fabric color number.
	• Fabric price group 4	+\$ 66	Specify fabric color number.
	• Fabric price group 5	+\$117	Specify fabric color number.
	• Fabric price group 6	+\$174	Specify fabric color number.
	• Fabric price group 7	+\$244	Specify fabric color number.
	• Fabric price group 8	+\$314	Specify fabric color number.
	• Fabric price group 9	+\$389	Specify fabric color number.
• Fabric price group 10	+\$461	Specify fabric color number.	
	<b>Back channel 5</b>		
	• Customer's Own Material (COM)	No cost	► See <i>Surface Materials Reference Manual</i> . Specify fabric color number.
	• Fabric price group 1	No cost	Specify fabric color number.
	• Fabric price group 2	+\$ 4	Specify fabric color number.
	• Fabric price group 3	+\$ 34	Specify fabric color number.
	• Fabric price group 4	+\$ 66	Specify fabric color number.
	• Fabric price group 5	+\$117	Specify fabric color number.
	• Fabric price group 6	+\$174	Specify fabric color number.
	• Fabric price group 7	+\$244	Specify fabric color number.
	• Fabric price group 8	+\$314	Specify fabric color number.
	• Fabric price group 9	+\$389	Specify fabric color number.
• Fabric price group 10	+\$461	Specify fabric color number.	
	<b>Back channel 6</b>		
	• Customer's Own Material (COM)	No cost	► See <i>Surface Materials Reference Manual</i> . Specify fabric color number.
	• Fabric price group 1	No cost	Specify fabric color number.
	• Fabric price group 2	+\$ 4	Specify fabric color number.
	• Fabric price group 3	+\$ 34	Specify fabric color number.
	• Fabric price group 4	+\$ 66	Specify fabric color number.
	• Fabric price group 5	+\$117	Specify fabric color number.
	• Fabric price group 6	+\$174	Specify fabric color number.
	• Fabric price group 7	+\$244	Specify fabric color number.
	• Fabric price group 8	+\$314	Specify fabric color number.
	• Fabric price group 9	+\$389	Specify fabric color number.
• Fabric price group 10	+\$461	Specify fabric color number.	



**Specification Information**

Style Number	U.S. Base Price
WESBELLNG2	\$6234

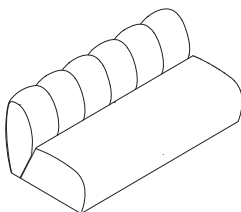

# Belle Corner Lounge

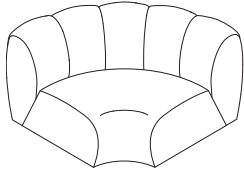

*Tip: Contrasting back channels can have contrasting color within the same fabric family. (For example, 59DB Birdseye specified on back channel 1 and 59DB Birdseye specified on back channel 2; both are Birdseye by DesignTex.)*

*Tip: Contrasting seat and back can be from two different fabric families.*

*Tip: Contrasting back channel fabrics are specified from the right handed seated position.*

Standard Includes		Required to Specify
<ul style="list-style-type: none"> <li>▶ Need help? Product details, page 16</li> </ul>	<ul style="list-style-type: none"> <li>Fully upholstered non-contrasting lounge: fabric price group 1</li> <li>Plastic ganging brackets</li> <li>Glides</li> </ul>	<ol style="list-style-type: none"> <li>1 Style number</li> <li>2 Fabric color number for lounge</li> <li>3 Options, if selected (see below)</li> </ol> <ul style="list-style-type: none"> <li>▶ See <i>Surface Materials</i>, page 242.</li> </ul>

Options	U.S. Price	Required to Specify									
<b>Color Scheme</b>	<ul style="list-style-type: none"> <li>• Non contrasting No cost</li> <li>• Contrasting seat and back +\$ 181</li> <li>• Contrasting all surfaces +\$ 592</li> </ul>	<ul style="list-style-type: none"> <li>Specify <i>with non contrasting</i>.</li> <li>Specify <i>with contrasting seat and back</i>.</li> <li>Specify <i>with contrasting all channels</i>.</li> </ul>									
<b>Surface Materials</b>	<table border="0"> <tr> <td><b>Seat</b></td> <td> <ul style="list-style-type: none"> <li>• Customer's Own Material (COM) No cost</li> <li>• Fabric price group 1 No cost</li> <li>• Fabric price group 2 +\$ 13</li> <li>• Fabric price group 3 +\$ 75</li> <li>• Fabric price group 4 +\$ 145</li> <li>• Fabric price group 5 +\$ 257</li> <li>• Fabric price group 6 +\$ 381</li> <li>• Fabric price group 7 +\$ 528</li> <li>• Fabric price group 8 +\$ 687</li> <li>• Fabric price group 9 +\$ 848</li> <li>• Fabric price group 10 +\$ 999</li> </ul> </td> <td rowspan="3"> <ul style="list-style-type: none"> <li>▶ See <i>Surface Materials Reference Manual</i>.</li> <li>Specify fabric color number.</li> <li>Specify fabric color number.</li> <li>Specify fabric color number.</li> <li>Specify fabric color number.</li> <li>Specify fabric color number.</li> <li>Specify fabric color number.</li> <li>Specify fabric color number.</li> <li>Specify fabric color number.</li> <li>Specify fabric color number.</li> <li>Specify fabric color number.</li> </ul> </td> </tr> <tr> <td><b>Back</b></td> <td> <ul style="list-style-type: none"> <li>• Customer's Own Material (COM) No cost</li> <li>• Fabric price group 1 No cost</li> <li>• Fabric price group 2 +\$ 20</li> <li>• Fabric price group 3 +\$ 170</li> <li>• Fabric price group 4 +\$ 330</li> <li>• Fabric price group 5 +\$ 585</li> <li>• Fabric price group 6 +\$ 870</li> <li>• Fabric price group 7 +\$1220</li> <li>• Fabric price group 8 +\$1570</li> <li>• Fabric price group 9 +\$1945</li> <li>• Fabric price group 10 +\$2305</li> </ul> </td> </tr> <tr> <td><b>Back channel 1</b></td> <td> <ul style="list-style-type: none"> <li>• Customer's Own Material (COM) No cost</li> <li>• Fabric price group 1 No cost</li> <li>• Fabric price group 2 +\$ 4</li> <li>• Fabric price group 3 +\$ 34</li> <li>• Fabric price group 4 +\$ 66</li> <li>• Fabric price group 5 +\$ 117</li> <li>• Fabric price group 6 +\$ 174</li> <li>• Fabric price group 7 +\$ 244</li> <li>• Fabric price group 8 +\$ 314</li> <li>• Fabric price group 9 +\$ 389</li> <li>• Fabric price group 10 +\$ 461</li> </ul> </td> </tr> <tr> <td><b>Back channel 2</b></td> <td> <ul style="list-style-type: none"> <li>• Customer's Own Material (COM) No cost</li> <li>• Fabric price group 1 No cost</li> <li>• Fabric price group 2 +\$ 4</li> <li>• Fabric price group 3 +\$ 34</li> <li>• Fabric price group 4 +\$ 66</li> <li>• Fabric price group 5 +\$ 117</li> <li>• Fabric price group 6 +\$ 174</li> <li>• Fabric price group 7 +\$ 244</li> <li>• Fabric price group 8 +\$ 314</li> <li>• Fabric price group 9 +\$ 389</li> <li>• Fabric price group 10 +\$ 461</li> </ul> </td> <td> <ul style="list-style-type: none"> <li>▶ See <i>Surface Materials Reference Manual</i>.</li> <li>Specify fabric color number.</li> <li>Specify fabric color number.</li> <li>Specify fabric color number.</li> <li>Specify fabric color number.</li> <li>Specify fabric color number.</li> <li>Specify fabric color number.</li> <li>Specify fabric color number.</li> <li>Specify fabric color number.</li> <li>Specify fabric color number.</li> <li>Specify fabric color number.</li> </ul> </td> </tr> </table>	<b>Seat</b>	<ul style="list-style-type: none"> <li>• Customer's Own Material (COM) No cost</li> <li>• Fabric price group 1 No cost</li> <li>• Fabric price group 2 +\$ 13</li> <li>• Fabric price group 3 +\$ 75</li> <li>• Fabric price group 4 +\$ 145</li> <li>• Fabric price group 5 +\$ 257</li> <li>• Fabric price group 6 +\$ 381</li> <li>• Fabric price group 7 +\$ 528</li> <li>• Fabric price group 8 +\$ 687</li> <li>• Fabric price group 9 +\$ 848</li> <li>• Fabric price group 10 +\$ 999</li> </ul>	<ul style="list-style-type: none"> <li>▶ See <i>Surface Materials Reference Manual</i>.</li> <li>Specify fabric color number.</li> <li>Specify fabric color number.</li> <li>Specify fabric color number.</li> <li>Specify fabric color number.</li> <li>Specify fabric color number.</li> <li>Specify fabric color number.</li> <li>Specify fabric color number.</li> <li>Specify fabric color number.</li> <li>Specify fabric color number.</li> <li>Specify fabric color number.</li> </ul>	<b>Back</b>	<ul style="list-style-type: none"> <li>• Customer's Own Material (COM) No cost</li> <li>• Fabric price group 1 No cost</li> <li>• Fabric price group 2 +\$ 20</li> <li>• Fabric price group 3 +\$ 170</li> <li>• Fabric price group 4 +\$ 330</li> <li>• Fabric price group 5 +\$ 585</li> <li>• Fabric price group 6 +\$ 870</li> <li>• Fabric price group 7 +\$1220</li> <li>• Fabric price group 8 +\$1570</li> <li>• Fabric price group 9 +\$1945</li> <li>• Fabric price group 10 +\$2305</li> </ul>	<b>Back channel 1</b>	<ul style="list-style-type: none"> <li>• Customer's Own Material (COM) No cost</li> <li>• Fabric price group 1 No cost</li> <li>• Fabric price group 2 +\$ 4</li> <li>• Fabric price group 3 +\$ 34</li> <li>• Fabric price group 4 +\$ 66</li> <li>• Fabric price group 5 +\$ 117</li> <li>• Fabric price group 6 +\$ 174</li> <li>• Fabric price group 7 +\$ 244</li> <li>• Fabric price group 8 +\$ 314</li> <li>• Fabric price group 9 +\$ 389</li> <li>• Fabric price group 10 +\$ 461</li> </ul>	<b>Back channel 2</b>	<ul style="list-style-type: none"> <li>• Customer's Own Material (COM) No cost</li> <li>• Fabric price group 1 No cost</li> <li>• Fabric price group 2 +\$ 4</li> <li>• Fabric price group 3 +\$ 34</li> <li>• Fabric price group 4 +\$ 66</li> <li>• Fabric price group 5 +\$ 117</li> <li>• Fabric price group 6 +\$ 174</li> <li>• Fabric price group 7 +\$ 244</li> <li>• Fabric price group 8 +\$ 314</li> <li>• Fabric price group 9 +\$ 389</li> <li>• Fabric price group 10 +\$ 461</li> </ul>	<ul style="list-style-type: none"> <li>▶ See <i>Surface Materials Reference Manual</i>.</li> <li>Specify fabric color number.</li> <li>Specify fabric color number.</li> <li>Specify fabric color number.</li> <li>Specify fabric color number.</li> <li>Specify fabric color number.</li> <li>Specify fabric color number.</li> <li>Specify fabric color number.</li> <li>Specify fabric color number.</li> <li>Specify fabric color number.</li> <li>Specify fabric color number.</li> </ul>
<b>Seat</b>	<ul style="list-style-type: none"> <li>• Customer's Own Material (COM) No cost</li> <li>• Fabric price group 1 No cost</li> <li>• Fabric price group 2 +\$ 13</li> <li>• Fabric price group 3 +\$ 75</li> <li>• Fabric price group 4 +\$ 145</li> <li>• Fabric price group 5 +\$ 257</li> <li>• Fabric price group 6 +\$ 381</li> <li>• Fabric price group 7 +\$ 528</li> <li>• Fabric price group 8 +\$ 687</li> <li>• Fabric price group 9 +\$ 848</li> <li>• Fabric price group 10 +\$ 999</li> </ul>	<ul style="list-style-type: none"> <li>▶ See <i>Surface Materials Reference Manual</i>.</li> <li>Specify fabric color number.</li> <li>Specify fabric color number.</li> <li>Specify fabric color number.</li> <li>Specify fabric color number.</li> <li>Specify fabric color number.</li> <li>Specify fabric color number.</li> <li>Specify fabric color number.</li> <li>Specify fabric color number.</li> <li>Specify fabric color number.</li> <li>Specify fabric color number.</li> </ul>									
<b>Back</b>	<ul style="list-style-type: none"> <li>• Customer's Own Material (COM) No cost</li> <li>• Fabric price group 1 No cost</li> <li>• Fabric price group 2 +\$ 20</li> <li>• Fabric price group 3 +\$ 170</li> <li>• Fabric price group 4 +\$ 330</li> <li>• Fabric price group 5 +\$ 585</li> <li>• Fabric price group 6 +\$ 870</li> <li>• Fabric price group 7 +\$1220</li> <li>• Fabric price group 8 +\$1570</li> <li>• Fabric price group 9 +\$1945</li> <li>• Fabric price group 10 +\$2305</li> </ul>										
<b>Back channel 1</b>	<ul style="list-style-type: none"> <li>• Customer's Own Material (COM) No cost</li> <li>• Fabric price group 1 No cost</li> <li>• Fabric price group 2 +\$ 4</li> <li>• Fabric price group 3 +\$ 34</li> <li>• Fabric price group 4 +\$ 66</li> <li>• Fabric price group 5 +\$ 117</li> <li>• Fabric price group 6 +\$ 174</li> <li>• Fabric price group 7 +\$ 244</li> <li>• Fabric price group 8 +\$ 314</li> <li>• Fabric price group 9 +\$ 389</li> <li>• Fabric price group 10 +\$ 461</li> </ul>										
<b>Back channel 2</b>	<ul style="list-style-type: none"> <li>• Customer's Own Material (COM) No cost</li> <li>• Fabric price group 1 No cost</li> <li>• Fabric price group 2 +\$ 4</li> <li>• Fabric price group 3 +\$ 34</li> <li>• Fabric price group 4 +\$ 66</li> <li>• Fabric price group 5 +\$ 117</li> <li>• Fabric price group 6 +\$ 174</li> <li>• Fabric price group 7 +\$ 244</li> <li>• Fabric price group 8 +\$ 314</li> <li>• Fabric price group 9 +\$ 389</li> <li>• Fabric price group 10 +\$ 461</li> </ul>	<ul style="list-style-type: none"> <li>▶ See <i>Surface Materials Reference Manual</i>.</li> <li>Specify fabric color number.</li> <li>Specify fabric color number.</li> <li>Specify fabric color number.</li> <li>Specify fabric color number.</li> <li>Specify fabric color number.</li> <li>Specify fabric color number.</li> <li>Specify fabric color number.</li> <li>Specify fabric color number.</li> <li>Specify fabric color number.</li> <li>Specify fabric color number.</li> </ul>									

▶ Options, continued on next page



## For Canadian Pricing

Multiply U.S. Price by the Canadian price factor.

▶ See page 1 for details.

► Options, continued from previous page

Options	U.S. Price	Required to Specify
<b>Surface Materials, continued</b>		
<b>Back channel 3</b>		
• Customer's Own Material (COM)	No cost	► See <i>Surface Materials Reference Manual</i> . Specify fabric color number.
• Fabric price group 1	No cost	
• Fabric price group 2	+\$ 4	
• Fabric price group 3	+\$ 34	
• Fabric price group 4	+\$ 66	
• Fabric price group 5	+\$117	
• Fabric price group 6	+\$174	
• Fabric price group 7	+\$244	
• Fabric price group 8	+\$314	
• Fabric price group 9	+\$389	
• Fabric price group 10	+\$461	
<b>Back channel 4</b>		
• Customer's Own Material (COM)	No cost	► See <i>Surface Materials Reference Manual</i> . Specify fabric color number.
• Fabric price group 1	No cost	
• Fabric price group 2	+\$ 4	
• Fabric price group 3	+\$ 34	
• Fabric price group 4	+\$ 66	
• Fabric price group 5	+\$117	
• Fabric price group 6	+\$174	
• Fabric price group 7	+\$244	
• Fabric price group 8	+\$314	
• Fabric price group 9	+\$389	
• Fabric price group 10	+\$461	
<b>Back channel 5</b>		
• Customer's Own Material (COM)	No cost	► See <i>Surface Materials Reference Manual</i> . Specify fabric color number.
• Fabric price group 1	No cost	
• Fabric price group 2	+\$ 4	
• Fabric price group 3	+\$ 34	
• Fabric price group 4	+\$ 66	
• Fabric price group 5	+\$117	
• Fabric price group 6	+\$174	
• Fabric price group 7	+\$244	
• Fabric price group 8	+\$314	
• Fabric price group 9	+\$389	
• Fabric price group 10	+\$461	

**Specification Information**

Style Number	U.S. Base Price
WESBELC	\$4809

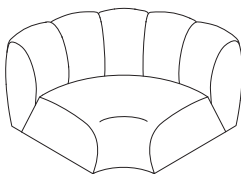

Belle

 **For Canadian Pricing**  
Multiply U.S. Price by the Canadian price factor.  
► See page 1 for details.

# Belle Ottoman

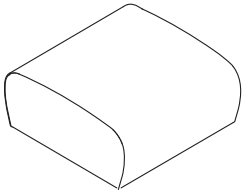

	Standard Includes	Required to Specify
▶ Need help? Product details, page 16	<ul style="list-style-type: none"> <li>Fully upholstered ottoman: fabric price group 1</li> <li>Plastic ganging brackets</li> <li>Glides</li> </ul>	1 Style number 2 Fabric color number for ottoman 3 Options, if selected (see below) ▶ See <i>Surface Materials</i> , page 242.

	Options	U.S. Price	Required to Specify
<b>Surface Materials</b>	<ul style="list-style-type: none"> <li>Customer's Own Material (COM)</li> <li>Fabric price group 1</li> <li>Fabric price group 2</li> <li>Fabric price group 3</li> <li>Fabric price group 4</li> <li>Fabric price group 5</li> <li>Fabric price group 6</li> <li>Fabric price group 7</li> <li>Fabric price group 8</li> <li>Fabric price group 9</li> <li>Fabric price group 10</li> </ul>	No cost No cost +\$ 24 +\$ 104 +\$ 202 +\$ 359 +\$ 528 +\$ 737 +\$ 955 +\$1175 +\$1389	▶ See <i>Surface Materials Reference Manual</i> . Specify fabric color number. Specify fabric color number. Specify fabric color number. Specify fabric color number. Specify fabric color number. Specify fabric color number. Specify fabric color number. Specify fabric color number. Specify fabric color number.

Specification Information	
• Style Number	• U.S. Base Price
WESBELO	\$2076
.	.
.	.



**For Canadian Pricing**  
 Multiply U.S. Price by the Canadian price factor.  
 ▶ See page 1 for details.



# Boardwalk One Seat Lounge

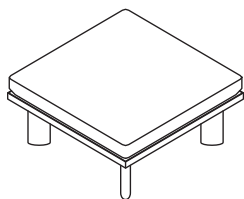

Tip: To gang Boardwalk lounge seating, order ganging kit **TS31410**.

Standard Includes	Required to Specify
<ul style="list-style-type: none"> <li>▶ Need help? Product details, page 20</li> <li>• Modular platform: High-Pressure Laminate price group 1 with 3 mm plastic edge</li> <li>• Fully upholstered cushion, if selected: fabric price group 1</li> <li>• Legs: veneer price group 1</li> <li>• Leg brackets: paint</li> <li>• Requires assembly</li> </ul>	<ol style="list-style-type: none"> <li>1 Style number</li> <li>2 High-Pressure Laminate color number for platform</li> <li>3 Veneer color number for legs</li> <li>4 Plastic color number for edge</li> <li>5 Paint color number for leg brackets</li> <li>6 Fabric color number for cushion, if selected</li> <li>7 Options, if selected (see below)</li> </ol> <p>▶ See <i>Surface Materials</i>, page 242.</p>

Options	U.S. Price	Required to Specify
<b>Cushion</b>		
• Seat	+\$ 744	Specify <i>with seat cushion</i> .
• Mid back	+\$1412	Specify <i>with mid back cushion</i> .
• Left corner	+\$1926	Specify <i>with left corner cushion</i> .
• Right corner	+\$1926	Specify <i>with right corner cushion</i> .
<b>Surface Materials</b>		
<b>Platform</b>		
• High-Pressure Laminate price group 1	No cost	Specify laminate color number.
• Customiz stain	No cost	Specify <i>with Customiz stain</i> . ▶ See <i>Surface Materials Reference Manual</i> .
• High-Pressure Laminate price group 2	+\$ 165	Specify laminate color number.
• Composite veneer price group 1	+\$ 651	Specify wood color number.
• Composite veneer price group 2	+\$ 787	Specify wood color number.
• Veneer price group 1	+\$ 716	Specify wood color number.
• Full-fill finish on wood	+\$ 866	Specify full-fill finish number.
• Open Line laminate	+\$ 111 plus cost of laminate	▶ See <i>Surface Materials Reference Manual</i> .
<b>Leg</b>		
• Customiz stain	No cost	Specify <i>with Customiz stain</i> . ▶ See <i>Surface Materials Reference Manual</i> .
• Veneer price group 1	No cost	Specify wood color number.

## Cushion

	Options (Add \$ to Base Price)		
	Seat	Mid Back	Left or Right Corner
Fabric Price Group 1	No cost	No cost	No cost
Fabric Price Group 2	+\$ 8	+\$ 17	+\$ 22
Vinyl Price Group 2	+\$ 8	+\$ 17	+\$ 22
Fabric Price Group 3	+\$ 50	+\$ 81	+\$ 95
Fabric Price Group 4	+\$ 94	+\$ 156	+\$ 187
Fabric Price Group 5	+\$211	+\$ 346	+\$ 417
Fabric Price Group 6	+\$250	+\$ 411	+\$ 495
Fabric Price Group 7	+\$345	+\$ 575	+\$ 691
Fabric Price Group 8	+\$448	+\$ 747	+\$ 896
Fabric Price Group 9	+\$532	+\$ 887	+\$1062
Fabric Price Group 10	+\$650	+\$1083	+\$1304
COM	No cost	No cost	No cost
COL	+\$214	+\$ 214	+\$ 214
Leather Price Group 1	+\$712	+\$1187	+\$1519
Leather Price Group 2	+\$878	+\$1459	+\$1869



**For Canadian Pricing**  
Multiply U.S. Price by the Canadian price factor.  
▶ See page 1 for details.

### Specification Information

Style Number	U.S. Base Price
WESHTSLNG1	\$1340

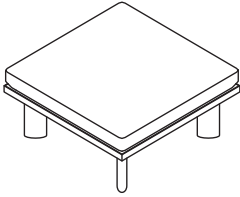

#### For Canadian Pricing

Multiply U.S. Price by the Canadian price factor.

▶ See page 1 for details.

# Boardwalk Two Seat Lounge

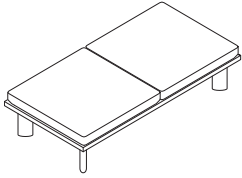

Tip: To gang Boardwalk lounge seating order ganging kit **TS31410**.

	Standard Includes	Required to Specify
▶ Need help? Product details, page 20	<ul style="list-style-type: none"> <li>Modular platform: High-Pressure Laminate price group 1 with 3 mm plastic edge</li> <li>Fully upholstered cushion, if selected: fabric price group 1</li> <li>Legs: veneer price group 1</li> <li>Leg brackets: paint</li> <li>Requires assembly</li> </ul>	<ol style="list-style-type: none"> <li>Style number</li> <li>High-Pressure Laminate color number for platform</li> <li>Veneer color number for legs</li> <li>Plastic color number for edge</li> <li>Paint color number for leg brackets</li> <li>Fabric color number for cushion, if selected</li> <li>Options, if selected (see below)</li> </ol> <p>▶ See <i>Surface Materials</i>, page 242.</p>

	Options	U.S. Price	Required to Specify
<b>Right Position</b>	<ul style="list-style-type: none"> <li>No cushion</li> <li>Seat</li> <li>Mid back</li> <li>Left corner</li> <li>Right corner</li> </ul>	<ul style="list-style-type: none"> <li>No cost</li> <li>+\$ 744</li> <li>+\$1412</li> <li>+\$1926</li> <li>+\$1926</li> </ul>	<ul style="list-style-type: none"> <li>Specify <i>with no cushion</i>.</li> <li>Specify <i>with seat cushion</i>.</li> <li>Specify <i>with mid back cushion</i>.</li> <li>Specify <i>with left corner cushion</i>.</li> <li>Specify <i>with right corner cushion</i>.</li> </ul>
<b>Left Position</b>	<ul style="list-style-type: none"> <li>No cushion</li> <li>Seat</li> <li>Mid back</li> <li>Left corner</li> <li>Right corner</li> </ul>	<ul style="list-style-type: none"> <li>No cost</li> <li>+\$ 744</li> <li>+\$1412</li> <li>+\$1926</li> <li>+\$1926</li> </ul>	<ul style="list-style-type: none"> <li>Specify <i>with no cushion</i>.</li> <li>Specify <i>with seat cushion</i>.</li> <li>Specify <i>with mid back cushion</i>.</li> <li>Specify <i>with left corner cushion</i>.</li> <li>Specify <i>with right corner cushion</i>.</li> </ul>
<b>Surface Materials</b>	<p><b>Platform</b></p> <ul style="list-style-type: none"> <li>High-Pressure Laminate price group 1</li> <li>Customiz stain</li> <li>High-Pressure Laminate price group 2</li> <li>Composite veneer price group 1</li> <li>Composite veneer price group 2</li> <li>Veneer price group 1</li> <li>Full-fill finish on wood</li> <li>Open Line laminate</li> </ul> <p><b>Leg</b></p> <ul style="list-style-type: none"> <li>Customiz stain</li> <li>Veneer price group 1</li> </ul>	<ul style="list-style-type: none"> <li>No cost</li> <li>No cost</li> <li>+\$ 178</li> <li>+\$ 781</li> <li>+\$ 956</li> <li>+\$ 859</li> <li>+\$ 914</li> <li>+\$ 111 plus cost of laminate</li> <li>No cost</li> <li>No cost</li> </ul>	<ul style="list-style-type: none"> <li>Specify laminate color number.</li> <li>Specify <i>with Customiz stain</i>.</li> <li>▶ See <i>Surface Materials Reference Manual</i>.</li> <li>Specify laminate color number.</li> <li>Specify wood color number.</li> <li>Specify wood color number.</li> <li>Specify wood color number.</li> <li>Specify full-fill finish number.</li> <li>▶ See <i>Surface Materials Reference Manual</i>.</li> <li>Specify <i>with Customiz stain</i>.</li> <li>▶ See <i>Surface Materials Reference Manual</i>.</li> <li>Specify wood color number.</li> </ul>

▶ Options, continued on next page



## For Canadian Pricing

Multiply U.S. Price by the Canadian price factor.

▶ See page 1 for details.

## ► Options, continued from previous page

**Cushion—Right Position**

	Options (Add \$ to Base Price)		
	Seat	Mid Back	Left or Right Corner
Fabric Price Group 1	No cost	No cost	No cost
Fabric Price Group 2	+\$ 8	+\$ 17	+\$ 22
Vinyl Price Group 2	+\$ 8	+\$ 17	+\$ 22
Fabric Price Group 3	+\$ 50	+\$ 81	+\$ 95
Fabric Price Group 4	+\$ 94	+\$ 156	+\$ 187
Fabric Price Group 5	+\$211	+\$ 346	+\$ 417
Fabric Price Group 6	+\$250	+\$ 411	+\$ 495
Fabric Price Group 7	+\$345	+\$ 575	+\$ 691
Fabric Price Group 8	+\$448	+\$ 747	+\$ 896
Fabric Price Group 9	+\$532	+\$ 887	+\$1062
Fabric Price Group 10	+\$650	+\$1083	+\$1304
COM	No cost	No cost	No cost
COL	+\$214	+\$ 214	+\$ 214
Leather Price Group 1	+\$712	+\$1187	+\$1519
Leather Price Group 2	+\$878	+\$1459	+\$1869

**Cushion—Left Position**

Fabric Price Group 1	No cost	No cost	No cost
Fabric Price Group 2	+\$ 8	+\$ 17	+\$ 22
Vinyl Price Group 2	+\$ 8	+\$ 17	+\$ 22
Fabric Price Group 3	+\$ 50	+\$ 81	+\$ 95
Fabric Price Group 4	+\$ 94	+\$ 156	+\$ 187
Fabric Price Group 5	+\$211	+\$ 346	+\$ 417
Fabric Price Group 6	+\$250	+\$ 411	+\$ 495
Fabric Price Group 7	+\$345	+\$ 575	+\$ 691
Fabric Price Group 8	+\$448	+\$ 747	+\$ 896
Fabric Price Group 9	+\$532	+\$ 887	+\$1062
Fabric Price Group 10	+\$650	+\$1083	+\$1304
COM	No cost	No cost	No cost
COL	+\$214	+\$ 214	+\$ 214
Leather Price Group 1	+\$712	+\$1187	+\$1519
Leather Price Group 2	+\$878	+\$1459	+\$1869

**Specification Information**

• Style Number	• U.S. Base Price
WESHTSLNG2	\$1842

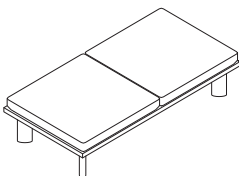

# Boardwalk Three Seat Lounge

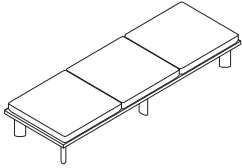

Tip: To gang Boardwalk lounge seating order ganging kit **TS31410**.

	Standard Includes	Required to Specify
▶ Need help? Product details, page 20	<ul style="list-style-type: none"> <li>Modular platform: High-Pressure Laminate price group 1 with 3 mm plastic edge</li> <li>Fully upholstered cushion, if selected: fabric price group 1</li> <li>Legs: veneer price group 1</li> <li>Leg brackets: paint</li> <li>Requires assembly</li> </ul>	<ol style="list-style-type: none"> <li>Style number</li> <li>High-Pressure Laminate color number for platform</li> <li>Veneer color number for legs</li> <li>Plastic color number for edge</li> <li>Paint color number for leg brackets</li> <li>Fabric color number for cushion, if selected</li> <li>Options, if selected (see below)</li> </ol> <p>▶ See <i>Surface Materials</i>, page 242.</p>

	Options	U.S. Price	Required to Specify
<b>Right Position</b>	<ul style="list-style-type: none"> <li>No cushion</li> <li>Seat</li> <li>Mid back</li> <li>Left corner</li> <li>Right corner</li> </ul>	<ul style="list-style-type: none"> <li>No cost</li> <li>+\$ 744</li> <li>+\$1412</li> <li>+\$1926</li> <li>+\$1926</li> </ul>	<ul style="list-style-type: none"> <li>Specify <i>with no cushion</i>.</li> <li>Specify <i>with seat cushion</i>.</li> <li>Specify <i>with mid back cushion</i>.</li> <li>Specify <i>with left corner cushion</i>.</li> <li>Specify <i>with right corner cushion</i>.</li> </ul>
<b>Center Position</b>	<ul style="list-style-type: none"> <li>No cushion</li> <li>Seat</li> <li>Mid back</li> <li>Left corner</li> <li>Right corner</li> </ul>	<ul style="list-style-type: none"> <li>No cost</li> <li>+\$ 744</li> <li>+\$1412</li> <li>+\$1926</li> <li>+\$1926</li> </ul>	<ul style="list-style-type: none"> <li>Specify <i>with no cushion</i>.</li> <li>Specify <i>with seat cushion</i>.</li> <li>Specify <i>with mid back cushion</i>.</li> <li>Specify <i>with left corner cushion</i>.</li> <li>Specify <i>with right corner cushion</i>.</li> </ul>
<b>Left Position</b>	<ul style="list-style-type: none"> <li>No cushion</li> <li>Seat</li> <li>Mid back</li> <li>Left corner</li> <li>Right corner</li> </ul>	<ul style="list-style-type: none"> <li>No cost</li> <li>+\$ 744</li> <li>+\$1412</li> <li>+\$1926</li> <li>+\$1926</li> </ul>	<ul style="list-style-type: none"> <li>Specify <i>with no cushion</i>.</li> <li>Specify <i>with seat cushion</i>.</li> <li>Specify <i>with mid back cushion</i>.</li> <li>Specify <i>with left corner cushion</i>.</li> <li>Specify <i>with right corner cushion</i>.</li> </ul>
<b>Surface Materials</b>	<p><b>Platform</b></p> <ul style="list-style-type: none"> <li>High-Pressure Laminate price group 1</li> <li>Customiz stain</li> <li>High-Pressure Laminate price group 2</li> <li>Composite veneer price group 1</li> <li>Composite veneer price group 2</li> <li>Veneer price group 1</li> <li>Full-fill finish on wood</li> <li>Open Line laminate</li> </ul> <p><b>Leg</b></p> <ul style="list-style-type: none"> <li>Customiz stain</li> <li>Veneer price group 1</li> </ul>	<ul style="list-style-type: none"> <li>No cost</li> <li>No cost</li> <li>+\$ 195</li> <li>+\$ 976</li> <li>+\$1189</li> <li>+\$1074</li> <li>+\$1245</li> <li>+\$ 111 plus cost of laminate</li> <li>No cost</li> <li>No cost</li> </ul>	<ul style="list-style-type: none"> <li>Specify laminate color number.</li> <li>Specify <i>with Customiz stain</i>.</li> <li>▶ See <i>Surface Materials Reference Manual</i>.</li> <li>Specify laminate color number.</li> <li>Specify wood color number.</li> <li>Specify wood color number.</li> <li>Specify wood color number.</li> <li>Specify full-fill finish number.</li> <li>▶ See <i>Surface Materials Reference Manual</i>.</li> <li>Specify <i>with Customiz stain</i>.</li> <li>▶ See <i>Surface Materials Reference Manual</i>.</li> <li>Specify wood color number.</li> </ul>

▶ Options, continued on next page



**For Canadian Pricing**  
Multiply U.S. Price by the Canadian price factor.  
▶ See page 1 for details.

## ► Options, continued from previous page

**Cushion—Right Position**

	Options (Add \$ to Base Price)		
	Seat	Mid Back	Left or Right Corner
Fabric Price Group 1	No cost	No cost	No cost
Fabric Price Group 2	+\$ 8	+\$ 17	+\$ 22
Vinyl Price Group 2	+\$ 8	+\$ 17	+\$ 22
Fabric Price Group 3	+\$ 50	+\$ 81	+\$ 95
Fabric Price Group 4	+\$ 94	+\$ 156	+\$ 187
Fabric Price Group 5	+\$211	+\$ 346	+\$ 417
Fabric Price Group 6	+\$250	+\$ 411	+\$ 495
Fabric Price Group 7	+\$345	+\$ 575	+\$ 691
Fabric Price Group 8	+\$448	+\$ 747	+\$ 896
Fabric Price Group 9	+\$532	+\$ 887	+\$1062
Fabric Price Group 10	+\$650	+\$1083	+\$1304
COM	No cost	No cost	No cost
COL	+\$214	+\$ 214	+\$ 214
Leather Price Group 1	+\$712	+\$1187	+\$1519
Leather Price Group 2	+\$878	+\$1459	+\$1869

**Cushion—Center Position**

Fabric Price Group 1	No cost	No cost	No cost
Fabric Price Group 2	+\$ 8	+\$ 17	+\$ 22
Vinyl Price Group 2	+\$ 8	+\$ 17	+\$ 22
Fabric Price Group 3	+\$ 50	+\$ 81	+\$ 95
Fabric Price Group 4	+\$ 94	+\$ 156	+\$ 187
Fabric Price Group 5	+\$211	+\$ 346	+\$ 417
Fabric Price Group 6	+\$250	+\$ 411	+\$ 495
Fabric Price Group 7	+\$345	+\$ 575	+\$ 691
Fabric Price Group 8	+\$448	+\$ 747	+\$ 896
Fabric Price Group 9	+\$532	+\$ 887	+\$1062
Fabric Price Group 10	+\$650	+\$1083	+\$1304
COM	No cost	No cost	No cost
COL	+\$214	+\$ 214	+\$ 214
Leather Price Group 1	+\$712	+\$1187	+\$1519
Leather Price Group 2	+\$878	+\$1459	+\$1869

## ► Options, continued on next page

**For Canadian Pricing**

Multiply U.S. Price by the  
Canadian price factor.

► See page 1 for details.

► **Options, continued from previous page**

**Cushion—Left Position**

	<b>Options</b> (Add \$ to Base Price)		
	Seat	Mid Back	Left or Right Corner
Fabric Price Group 1	No cost	No cost	No cost
Fabric Price Group 2	+\$ 8	+\$ 17	+\$ 22
Vinyl Price Group 2	+\$ 8	+\$ 17	+\$ 22
Fabric Price Group 3	+\$ 50	+\$ 81	+\$ 95
Fabric Price Group 4	+\$ 94	+\$ 156	+\$ 187
Fabric Price Group 5	+\$211	+\$ 346	+\$ 417
Fabric Price Group 6	+\$250	+\$ 411	+\$ 495
Fabric Price Group 7	+\$345	+\$ 575	+\$ 691
Fabric Price Group 8	+\$448	+\$ 747	+\$ 896
Fabric Price Group 9	+\$532	+\$ 887	+\$1062
Fabric Price Group 10	+\$650	+\$1083	+\$1304
COM	No cost	No cost	No cost
COL	+\$214	+\$ 214	+\$ 214
Leather Price Group 1	+\$712	+\$1187	+\$1519
Leather Price Group 2	+\$878	+\$1459	+\$1869

**Specification Information**

<b>Style Number</b>	<b>U.S. Base Price</b>
<b>WESHTSLNG3</b>	\$2343

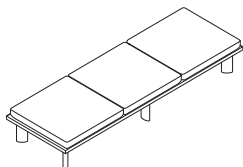

 **For Canadian Pricing**  
 Multiply U.S. Price by the Canadian price factor.  
 ► See page 1 for details.

# Boardwalk 30"D x 30"W Square Table

Boardwalk 30"D x 30"W  
Square Table

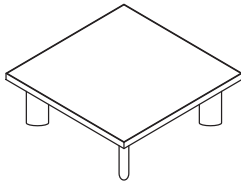

Tip: To gang Boardwalk lounge seating order ganging kit **TS31410**.

Standard Includes		Required to Specify
<ul style="list-style-type: none"> <li>▶ Need help? Product details, page 20</li> </ul>	<ul style="list-style-type: none"> <li>Table: High-Pressure Laminate price group 1 with 3 mm plastic edge</li> <li>Legs: veneer price group 1</li> <li>Leg brackets: paint</li> <li>Requires assembly</li> </ul>	<ol style="list-style-type: none"> <li>Style number</li> <li>High-Pressure Laminate color number for platform</li> <li>Veneer color number for legs</li> <li>Plastic color number for edge</li> <li>Paint color number for leg brackets</li> <li>Options, if selected (see below)</li> </ol> <ul style="list-style-type: none"> <li>▶ See <i>Surface Materials</i>, page 242.</li> </ul>

	Options	U.S. Price	Required to Specify
<b>Table Height</b>	<ul style="list-style-type: none"> <li>11"</li> <li>15"</li> </ul>	<ul style="list-style-type: none"> <li>No cost</li> <li>+\$ 56</li> </ul>	<ul style="list-style-type: none"> <li>Specify with 11"H table.</li> <li>Specify with 15"H table.</li> </ul>
<b>Surface Materials</b>	<p><b>Platform</b></p> <ul style="list-style-type: none"> <li>High-Pressure Laminate price group 1</li> <li>Customiz stain</li> </ul> <p>High-Pressure Laminate price group 2</p> <ul style="list-style-type: none"> <li>Composite veneer price group 1</li> <li>Composite veneer price group 2</li> <li>Veneer price group 1</li> <li>Full-fill finish on wood</li> <li>Open Line laminate</li> </ul>	<ul style="list-style-type: none"> <li>No cost</li> <li>No cost</li> <li>+\$165</li> <li>+\$651</li> <li>+\$787</li> <li>+\$716</li> <li>+\$789</li> <li>+\$111 plus cost of laminate</li> </ul>	<ul style="list-style-type: none"> <li>Specify laminate color number.</li> <li>Specify with <i>Customiz stain</i>.</li> <li>▶ See <i>Surface Materials Reference Manual</i>. Specify laminate color number.</li> <li>Specify wood color number.</li> <li>Specify wood color number.</li> <li>Specify wood color number.</li> <li>Specify full-fill finish number.</li> <li>▶ See <i>Surface Materials Reference Manual</i>.</li> </ul>
	<p><b>Leg</b></p> <ul style="list-style-type: none"> <li>Customiz stain</li> <li>Veneer price group 1</li> </ul>	<ul style="list-style-type: none"> <li>No cost</li> <li>No cost</li> </ul>	<ul style="list-style-type: none"> <li>Specify with <i>Customiz stain</i>.</li> <li>▶ See <i>Surface Materials Reference Manual</i>. Specify wood color number.</li> </ul>

Specification Information	
Style Number	U.S. Base Price
WESHTSTBL30	\$1649

Boardwalk

 **For Canadian Pricing**  
Multiply U.S. Price by the Canadian price factor.  
▶ See page 1 for details.

# Boardwalk Boardwalk 30"D x 60"W Rectangle Table

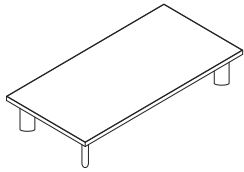

Tip: To gang Boardwalk lounge seating order ganging kit **TS31410**.

	Standard Includes	Required to Specify
▶ Need help? Product details, page 20	<ul style="list-style-type: none"> <li>Table: High-Pressure Laminate price group 1 with 3 mm plastic edge</li> <li>Legs: veneer price group 1</li> <li>Leg brackets: paint</li> <li>Requires assembly</li> </ul>	<ol style="list-style-type: none"> <li>Style number</li> <li>High-Pressure Laminate color number for platform</li> <li>Veneer color number for legs</li> <li>Plastic color number for edge</li> <li>Paint color number for leg brackets</li> <li>Options, if selected (see below)</li> </ol> <p>▶ See <i>Surface Materials</i>, page 242.</p>

	Options	U.S. Price	Required to Specify
<b>Table Height</b>	<ul style="list-style-type: none"> <li>11"</li> <li>15"</li> </ul>	<ul style="list-style-type: none"> <li>No cost</li> <li>+\$ 56</li> </ul>	<ul style="list-style-type: none"> <li>Specify with 11"H table.</li> <li>Specify with 15"H table.</li> </ul>
<b>Surface Materials</b>	<p><b>Platform</b></p> <ul style="list-style-type: none"> <li>High-Pressure Laminate price group 1</li> <li>Customiz stain</li> <li>High-Pressure Laminate price group 2</li> <li>Composite veneer price group 1</li> <li>Composite veneer price group 2</li> <li>Veneer price group 1</li> <li>Full-fill finish on wood</li> <li>Open Line laminate</li> </ul> <p><b>Leg</b></p> <ul style="list-style-type: none"> <li>Customiz stain</li> <li>Veneer price group 1</li> </ul>	<ul style="list-style-type: none"> <li>No cost</li> <li>No cost</li> <li>+\$178</li> <li>+\$781</li> <li>+\$956</li> <li>+\$859</li> <li>+\$981</li> <li>+\$111 plus cost of laminate</li> <li>No cost</li> <li>No cost</li> </ul>	<ul style="list-style-type: none"> <li>Specify laminate color number.</li> <li>Specify with <i>Customiz stain</i>.</li> <li>▶ See <i>Surface Materials Reference Manual</i>. Specify laminate color number.</li> <li>Specify wood color number.</li> <li>Specify wood color number.</li> <li>Specify wood color number.</li> <li>Specify full-fill finish number.</li> <li>▶ See <i>Surface Materials Reference Manual</i>.</li> <li>Specify with <i>Customiz stain</i>.</li> <li>▶ See <i>Surface Materials Reference Manual</i>. Specify wood color number.</li> </ul>

Specification Information	
Style Number	U.S. Base Price
WESHTSTBL60	\$1891



**For Canadian Pricing**  
 Multiply U.S. Price by the Canadian price factor.  
 ▶ See page 1 for details.

# Boardwalk 30"D x 90"W Rectangle Table

Boardwalk 30"D x 90"W  
Rectangle Table

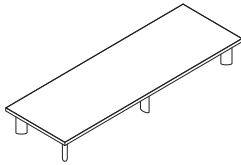

Tip: To gang Boardwalk lounge seating order ganging kit **TS31410**.

Standard Includes		Required to Specify
<ul style="list-style-type: none"> <li>▶ Need help? Product details, page 20</li> </ul>	<ul style="list-style-type: none"> <li>• Table: High-Pressure Laminate price group 1 with 3 mm plastic edge</li> <li>• Legs: veneer price group 1</li> <li>• Leg brackets: paint</li> <li>• Requires assembly</li> </ul>	<ol style="list-style-type: none"> <li>1 Style number</li> <li>2 High-Pressure Laminate color number for platform</li> <li>3 Veneer color number for legs</li> <li>4 Plastic color number for edge</li> <li>5 Paint color number for leg brackets</li> <li>6 Options, if selected (see below)</li> </ol> <ul style="list-style-type: none"> <li>▶ See <i>Surface Materials</i>, page 242.</li> </ul>

Options	U.S. Price	Required to Specify
<b>Table Height</b>	<ul style="list-style-type: none"> <li>• 11" No cost</li> <li>• 15" +\$ 88</li> </ul>	<ul style="list-style-type: none"> <li>Specify with 11"H table.</li> <li>Specify with 15"H table.</li> </ul>
<b>Surface Materials</b>	<p><b>Platform</b></p> <ul style="list-style-type: none"> <li>• High-Pressure Laminate price group 1 No cost</li> <li>• Customiz stain No cost</li> <li>• High-Pressure Laminate price group 2 +\$ 195</li> <li>• Composite veneer price group 1 +\$ 976</li> <li>• Composite veneer price group 2 +\$1189</li> <li>• Veneer price group 1 +\$1074</li> <li>• Full-fill finish on wood +\$1245</li> <li>• Open Line laminate +\$ 111 plus cost of laminate</li> </ul> <p><b>Leg</b></p> <ul style="list-style-type: none"> <li>• Customiz stain No cost</li> <li>• Veneer price group 1 No cost</li> </ul>	<ul style="list-style-type: none"> <li>Specify laminate color number.</li> <li>Specify with <i>Customiz stain</i>.</li> <li>▶ See <i>Surface Materials Reference Manual</i>.</li> <li>Specify laminate color number.</li> <li>Specify wood color number.</li> <li>Specify wood color number.</li> <li>Specify wood color number.</li> <li>Specify full-fill finish number.</li> <li>▶ See <i>Surface Materials Reference Manual</i>.</li> <li>Specify with <i>Customiz stain</i>.</li> <li>▶ See <i>Surface Materials Reference Manual</i>.</li> <li>Specify wood color number.</li> </ul>

Specification Information	
Style Number	U.S. Base Price
<b>WESHTSTBL90</b>	\$2723

Boardwalk

 **For Canadian Pricing**  
Multiply U.S. Price by the Canadian price factor.  
▶ See page 1 for details.

# Boardwalk 40"D Round Table

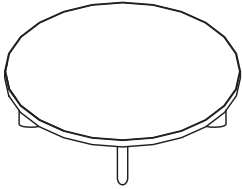

Tip: To gang Boardwalk lounge seating order ganging kit **TS31410**.

Standard Includes		Required to Specify
<ul style="list-style-type: none"> <li>▶ Need help? Product details, page 20</li> <li>• Table: High-Pressure Laminate price group 1 with 3 mm plastic edge</li> <li>• Legs: veneer price group 1</li> <li>• Leg brackets: paint</li> <li>• Requires assembly</li> </ul>	<ul style="list-style-type: none"> <li>1 Style number</li> <li>2 High-Pressure Laminate color number for platform</li> <li>3 Veneer color number for legs</li> <li>4 Plastic color number for edge</li> <li>5 Paint color number for leg brackets</li> <li>6 Options, if selected (see below)</li> <li>▶ See <i>Surface Materials</i>, page 242.</li> </ul>	

Options	U.S. Price	Required to Specify
<b>Table Height</b>		
• 11"	No cost	Specify with 11"H table.
• 15"	+\$ 56	Specify with 15"H table.
<b>Surface Materials</b>		
<b>Platform</b>		
• High-Pressure Laminate price group 1	No cost	Specify laminate color number.
• Customiz stain	No cost	Specify with <i>Customiz stain</i> .
		▶ See <i>Surface Materials Reference Manual</i> .
• High-Pressure Laminate price group 2	+\$178	Specify laminate color number.
• Composite veneer price group 1	+\$710	Specify wood color number.
• Composite veneer price group 2	+\$897	Specify wood color number.
• Veneer price group 1	+\$781	Specify wood color number.
• Full-fill finish on wood	+\$915	Specify full-fill finish number.
• Open Line laminate	+\$111 plus cost of laminate	▶ See <i>Surface Materials Reference Manual</i> .
<b>Leg</b>		
• Customiz stain	No cost	Specify with <i>Customiz stain</i> .
		▶ See <i>Surface Materials Reference Manual</i> .
• Veneer price group 1	No cost	Specify wood color number.

Specification Information	
Style Number	U.S. Base Price
WESHTSTBLRD40	\$1849



**For Canadian Pricing**  
 Multiply U.S. Price by the Canadian price factor.  
 ▶ See page 1 for details.

# Boardwalk 35"D x 65"D Oval Table

Boardwalk 35"D x 65"D Oval Table

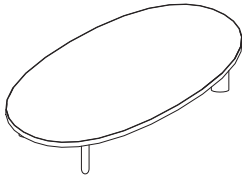

Tip: To gang Boardwalk lounge seating order ganging kit **TS31410**.

Standard Includes		Required to Specify
<ul style="list-style-type: none"> <li>▶ Need help? Product details, page 20</li> </ul>	<ul style="list-style-type: none"> <li>• Table: High-Pressure Laminate price group 1 with 3 mm plastic edge</li> <li>• Legs: veneer price group 1</li> <li>• Leg brackets: paint</li> <li>• Requires assembly</li> </ul>	<ol style="list-style-type: none"> <li>1 Style number</li> <li>2 High-Pressure Laminate color number for platform</li> <li>3 Veneer color number for legs</li> <li>4 Plastic color number for edge</li> <li>5 Paint color number for leg brackets</li> <li>6 Options, if selected (see below)</li> </ol> <ul style="list-style-type: none"> <li>▶ See <i>Surface Materials</i>, page 242.</li> </ul>

Options	U.S. Price	Required to Specify
<b>Table Height</b> <ul style="list-style-type: none"> <li>• 11"</li> <li>• 15"</li> </ul>	No cost +\$ 56	Specify with 11"H table. Specify with 15"H table.
<b>Surface Materials</b> <ul style="list-style-type: none"> <li>• High-Pressure Laminate price group 1</li> <li>• Customiz stain</li> <li>• High-Pressure Laminate price group 2</li> <li>• Composite veneer price group 1</li> <li>• Composite veneer price group 2</li> <li>• Veneer price group 1</li> <li>• Full-fill finish on wood</li> <li>• Open Line laminate</li> </ul>	No cost No cost +\$ 178 +\$ 841 +\$1062 +\$ 925 +\$1097 +\$ 111 plus cost of laminate	Specify laminate color number. Specify with <i>Customiz stain</i> . ▶ See <i>Surface Materials Reference Manual</i> . Specify laminate color number. Specify wood color number. Specify wood color number. Specify wood color number. Specify full-fill finish number. ▶ See <i>Surface Materials Reference Manual</i> .
<b>Leg</b> <ul style="list-style-type: none"> <li>• Customiz stain</li> <li>• Veneer price group 1</li> </ul>	No cost No cost	Specify with <i>Customiz stain</i> . ▶ See <i>Surface Materials Reference Manual</i> . Specify wood color number.

Specification Information	
Style Number	U.S. Base Price
WESHTSTBLOV65	\$2048

Boardwalk

 **For Canadian Pricing**  
 Multiply U.S. Price by the Canadian price factor.  
 ▶ See page 1 for details.

# Boardwalk Ganging Kit

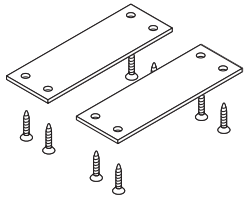

Standard Includes		Required to Specify
<ul style="list-style-type: none"> <li>▶ Need help? Product details, page 20</li> </ul>	<ul style="list-style-type: none"> <li>• Ganging kit</li> <li>• Two plates</li> <li>• Attachment hardware</li> </ul>	<ul style="list-style-type: none"> <li>Style number</li> </ul>
Specification Information		
• Style Number	• U.S. Price	
TS31410	\$47	



**For Canadian Pricing**  
 Multiply U.S. Price by the Canadian price factor.  
 ▶ See page 1 for details.



# Brighton One Seat Lounge Chair

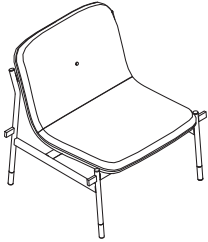

	Standard Includes	Required to Specify
▶ Need help? Product details, page 24	<ul style="list-style-type: none"> <li>Fully upholstered lounge chair: fabric price group 1</li> <li>Frame: paint price group 1</li> <li>Frame caps: paint price group 1</li> <li>Frame feet: paint price group 1</li> <li>Arms, if selected: veneer price group 1</li> </ul>	<ol style="list-style-type: none"> <li>Style number</li> <li>Fabric color number for chair</li> <li>Paint color number for frame</li> <li>Paint color number for frame caps</li> <li>Paint color number for frame feet</li> <li>Wood color number for arms, if selected</li> <li>Options, if selected (see below)</li> </ol> <p>▶ See <i>Surface Materials</i>, page 242.</p>

	Options	U.S. Price	Required to Specify
<b>Color Scheme</b>	<ul style="list-style-type: none"> <li>Non contrasting</li> <li>Contrasting</li> </ul>	<p>No cost</p> <p>+\$180</p>	<p>Specify with <i>non contrasting</i>.</p> <p>Specify with <i>contrasting</i>.</p>
<b>Surface Materials</b>	<p><b>Inner</b></p> <ul style="list-style-type: none"> <li>Customer's Own Material (COM)</li> <li>Fabric price group 1</li> <li>Fabric price group 2</li> <li>Vinyl price group 2</li> <li>Fabric price group 3</li> <li>Fabric price group 4</li> <li>Customer's Own Leather (COL)</li> <li>Fabric price group 5</li> <li>Fabric price group 6</li> <li>Fabric price group 7</li> <li>Fabric price group 8</li> <li>Fabric price group 9</li> <li>Fabric price group 10</li> <li>Leather price group 1</li> <li>Leather price group 2</li> </ul> <p><b>Outer</b></p> <ul style="list-style-type: none"> <li>Customer's Own Material (COM)</li> <li>Fabric price group 1</li> <li>Fabric price group 2</li> <li>Vinyl price group 2</li> <li>Fabric price group 3</li> <li>Fabric price group 4</li> <li>Customer's Own Leather (COL)</li> <li>Fabric price group 5</li> <li>Fabric price group 6</li> <li>Fabric price group 7</li> <li>Fabric price group 8</li> <li>Fabric price group 9</li> <li>Fabric price group 10</li> <li>Leather price group 1</li> <li>Leather price group 2</li> </ul> <p><b>Frame</b></p> <ul style="list-style-type: none"> <li>Paint price group 1</li> <li>Paint price group 2</li> <li>Paint price group 3</li> </ul> <p><b>Arms</b></p> <ul style="list-style-type: none"> <li>Customiz stain</li> <li>Veneer price group 1</li> <li>Veneer price group 2</li> </ul> <p><b>Foot</b></p> <ul style="list-style-type: none"> <li>Paint price group 1</li> <li>Paint price group 2</li> <li>Paint price group 3</li> </ul> <p><b>Cap</b></p> <ul style="list-style-type: none"> <li>Paint price group 1</li> <li>Paint price group 2</li> <li>Paint price group 3</li> </ul>	<p>No cost</p> <p>No cost</p> <p>+\$ 5</p> <p>+\$ 5</p> <p>+\$ 34</p> <p>+\$ 63</p> <p>+\$109</p> <p>+\$113</p> <p>+\$166</p> <p>+\$231</p> <p>+\$300</p> <p>+\$369</p> <p>+\$435</p> <p>+\$474</p> <p>+\$586</p> <p>No cost</p> <p>No cost</p> <p>+\$ 5</p> <p>+\$ 5</p> <p>+\$ 34</p> <p>+\$ 63</p> <p>+\$109</p> <p>+\$113</p> <p>+\$166</p> <p>+\$231</p> <p>+\$300</p> <p>+\$369</p> <p>+\$435</p> <p>+\$474</p> <p>+\$586</p> <p>No cost</p> <p>+\$ 84</p> <p>+\$178</p> <p>No cost</p> <p>No cost</p> <p>+\$ 30</p> <p>No cost</p> <p>+\$ 9</p> <p>+\$ 24</p> <p>No cost</p> <p>+\$ 3</p> <p>+\$ 5</p>	<p>▶ See <i>Surface Materials Reference Manual</i>.</p> <p>Specify fabric color number.</p> <p>Specify fabric color number.</p> <p>Specify vinyl color number.</p> <p>Specify fabric color number.</p> <p>Specify fabric color number.</p> <p>▶ See <i>Surface Materials Reference Manual</i>.</p> <p>Specify fabric color number.</p> <p>Specify fabric color number.</p> <p>Specify fabric color number.</p> <p>Specify fabric color number.</p> <p>Specify fabric color number.</p> <p>Specify fabric color number.</p> <p>Specify leather color number.</p> <p>Specify leather color number.</p> <p>▶ See <i>Surface Materials Reference Manual</i>.</p> <p>Specify fabric color number.</p> <p>Specify fabric color number.</p> <p>Specify vinyl color number.</p> <p>Specify fabric color number.</p> <p>Specify fabric color number.</p> <p>▶ See <i>Surface Materials Reference Manual</i>.</p> <p>Specify fabric color number.</p> <p>Specify fabric color number.</p> <p>Specify fabric color number.</p> <p>Specify fabric color number.</p> <p>Specify fabric color number.</p> <p>Specify leather color number.</p> <p>Specify leather color number.</p> <p>Specify paint color number.</p> <p>Specify paint color number.</p> <p>Specify paint color number.</p> <p>Specify with <i>Customiz stain</i>.</p> <p>▶ See <i>Surface Materials Reference Manual</i>.</p> <p>Specify wood color number.</p> <p>Specify wood color number.</p> <p>Specify paint color number.</p> <p>Specify paint color number.</p> <p>Specify paint color number.</p> <p>Specify paint color number.</p> <p>Specify paint color number.</p> <p>Specify paint color number.</p>

▶ Options, continued on next page

 **For Canadian Pricing**  
Multiply U.S. Price by the Canadian price factor.  
▶ See page 1 for details.

► Options, continued from previous page

	Options	U.S. Price	Required to Specify
<b>Arm Position</b>	• No arms	No cost	Specify with <i>no arms</i> .
	• Arm left	+\$260	Specify with <i>left-hand arm</i> .
	• Arm right	+\$260	Specify with <i>right-hand arm</i> .
	• Arms—left and right	+\$519	Specify with <i>arms left and right</i> .
<b>Ganging</b>	• Not ganging	No cost	Specify with <i>no ganging</i> .
	• Left	+\$ 61	Specify with <i>ganging left</i> .
	• Right	+\$ 61	Specify with <i>ganging right</i> .
	• Left and right	+\$122	Specify with <i>ganging left and right</i> .

Tip: Handedness is determined while in the seated position.

Specification Information

Style Number	U.S. Base Price
WESARYLNG1	\$2412

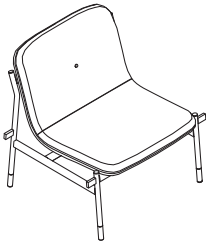

**For Canadian Pricing**  
Multiply U.S. Price by the Canadian price factor.  
► See page 1 for details.

# Brighton Two Seat Lounge Chair

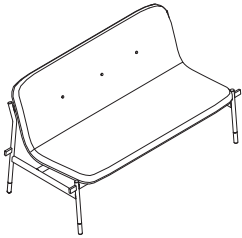

▶ Need help?  
Product details,  
page 24

## Standard Includes

- Fully upholstered lounge chair: fabric price group 1
- Frame: paint price group 1
- Frame caps: paint price group 1
- Frame feet: paint price group 1
- Arms, if selected: veneer price group 1

## Required to Specify

- 1 Style number
  - 2 Fabric color number for chair
  - 3 Paint color number for frame
  - 4 Paint color number for frame caps
  - 5 Paint color number for frame feet
  - 6 Wood color number for arms, if selected
  - 7 Options, if selected (see below)
- ▶ See *Surface Materials*, page 242.

	Options	U.S. Price	Required to Specify
<b>Color Scheme</b>	<ul style="list-style-type: none"> <li>• Non contrasting</li> <li>• Contrasting</li> </ul>	<ul style="list-style-type: none"> <li>No cost</li> <li>+\$ 180</li> </ul>	<ul style="list-style-type: none"> <li>Specify with <i>non contrasting</i>.</li> <li>Specify with <i>contrasting</i>.</li> </ul>
<b>Surface Materials</b>	<p><b>Inner</b></p> <ul style="list-style-type: none"> <li>• Customer's Own Material (COM)</li> <li>• Fabric price group 1</li> <li>• Fabric price group 2</li> <li>• Vinyl price group 2</li> <li>• Fabric price group 3</li> <li>• Customer's Own Leather (COL)</li> <li>• Fabric price group 4</li> <li>• Fabric price group 5</li> <li>• Fabric price group 6</li> <li>• Fabric price group 7</li> <li>• Fabric price group 8</li> <li>• Fabric price group 9</li> <li>• Fabric price group 10</li> <li>• Leather price group 1</li> <li>• Leather price group 2</li> </ul> <p><b>Outer</b></p> <ul style="list-style-type: none"> <li>• Customer's Own Material (COM)</li> <li>• Fabric price group 1</li> <li>• Fabric price group 2</li> <li>• Vinyl price group 2</li> <li>• Fabric price group 3</li> <li>• Customer's Own Leather (COL)</li> <li>• Fabric price group 4</li> <li>• Fabric price group 5</li> <li>• Fabric price group 6</li> <li>• Fabric price group 7</li> <li>• Fabric price group 8</li> <li>• Fabric price group 9</li> <li>• Fabric price group 10</li> <li>• Leather price group 1</li> <li>• Leather price group 2</li> </ul> <p><b>Frame</b></p> <ul style="list-style-type: none"> <li>• Paint price group 1</li> <li>• Paint price group 2</li> <li>• Paint price group 3</li> </ul> <p><b>Arms</b></p> <ul style="list-style-type: none"> <li>• Customiz stain</li> <li>• Veneer price group 1</li> <li>• Veneer price group 2</li> </ul> <p><b>Foot</b></p> <ul style="list-style-type: none"> <li>• Paint price group 1</li> <li>• Paint price group 2</li> <li>• Paint price group 3</li> </ul> <p><b>Cap</b></p> <ul style="list-style-type: none"> <li>• Paint price group 1</li> <li>• Paint price group 2</li> <li>• Paint price group 3</li> </ul>	<ul style="list-style-type: none"> <li>No cost</li> <li>No cost</li> <li>+\$ 12</li> <li>+\$ 12</li> <li>+\$ 65</li> <li>+\$ 109</li> <li>+\$ 127</li> <li>+\$ 224</li> <li>+\$ 331</li> <li>+\$ 461</li> <li>+\$ 601</li> <li>+\$ 737</li> <li>+\$ 867</li> <li>+\$ 947</li> <li>+\$1168</li> <li>No cost</li> <li>No cost</li> <li>+\$ 12</li> <li>+\$ 12</li> <li>+\$ 65</li> <li>+\$ 109</li> <li>+\$ 127</li> <li>+\$ 224</li> <li>+\$ 331</li> <li>+\$ 461</li> <li>+\$ 601</li> <li>+\$ 737</li> <li>+\$ 867</li> <li>+\$ 947</li> <li>+\$1168</li> <li>No cost</li> <li>+\$ 111</li> <li>+\$ 247</li> <li>No cost</li> <li>No cost</li> <li>+\$ 30</li> <li>No cost</li> <li>+\$ 9</li> <li>+\$ 24</li> <li>No cost</li> <li>+\$ 3</li> <li>+\$ 5</li> </ul>	<ul style="list-style-type: none"> <li>▶ See <i>Surface Materials Reference Manual</i>. Specify fabric color number.</li> <li>Specify fabric color number.</li> <li>Specify vinyl color number.</li> <li>Specify fabric color number.</li> <li>▶ See <i>Surface Materials Reference Manual</i>. Specify fabric color number.</li> <li>Specify fabric color number.</li> <li>Specify fabric color number.</li> <li>Specify fabric color number.</li> <li>Specify fabric color number.</li> <li>Specify fabric color number.</li> <li>Specify fabric color number.</li> <li>Specify fabric color number.</li> <li>Specify fabric color number.</li> <li>Specify leather color number.</li> <li>Specify leather color number.</li> <li>▶ See <i>Surface Materials Reference Manual</i>. Specify fabric color number.</li> <li>Specify fabric color number.</li> <li>Specify vinyl color number.</li> <li>Specify fabric color number.</li> <li>▶ See <i>Surface Materials Reference Manual</i>. Specify fabric color number.</li> <li>Specify fabric color number.</li> <li>Specify fabric color number.</li> <li>Specify fabric color number.</li> <li>Specify fabric color number.</li> <li>Specify fabric color number.</li> <li>Specify fabric color number.</li> <li>Specify leather color number.</li> <li>Specify leather color number.</li> <li>Specify paint color number.</li> <li>Specify paint color number.</li> <li>Specify paint color number.</li> <li>Specify with <i>Customiz stain</i>.</li> <li>▶ See <i>Surface Materials Reference Manual</i>. Specify wood color number.</li> <li>Specify wood color number.</li> <li>Specify paint color number.</li> <li>Specify paint color number.</li> <li>Specify paint color number.</li> <li>Specify paint color number.</li> <li>Specify paint color number.</li> </ul>

▶ Options, continued on next page



### For Canadian Pricing

Multiply U.S. Price by the Canadian price factor.

▶ See page 1 for details.

► Options, continued from previous page

*Tip: Handedness is determined while in the seated position.*

	Options	U.S. Price	Required to Specify
<b>Arm Position</b>	• No arms	No cost	Specify with <i>no arms</i> .
	• Arm left	+\$260	Specify with <i>left-hand arm</i> .
	• Arm right	+\$260	Specify with <i>right-hand arm</i> .
	• Arms—left and right	+\$519	Specify with <i>arms left and right</i> .
<b>Ganging</b>	• Not ganging	No cost	Specify with <i>no ganging</i> .
	• Left	+\$ 61	Specify with <i>ganging left</i> .
	• Right	+\$ 61	Specify with <i>ganging right</i> .
	• Left and right	+\$122	Specify with <i>ganging left and right</i> .

**Specification Information**

Style Number	U.S. Base Price
<b>WESARYLNG2</b>	\$3598

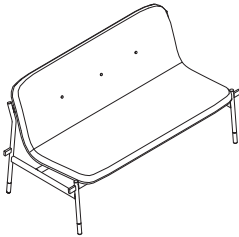

 **For Canadian Pricing**  
Multiply U.S. Price by the Canadian price factor.  
► See page 1 for details.

# Brighton Ottoman



Standard Includes		Required to Specify
<ul style="list-style-type: none"> <li>▶ Need help? Product details, page 24</li> </ul>	<ul style="list-style-type: none"> <li>Fully upholstered ottoman: fabric price group 1</li> <li>Frame: paint price group 1</li> <li>Frame caps: paint price group 1</li> </ul>	<ol style="list-style-type: none"> <li>Style number</li> <li>Fabric color number for ottoman</li> <li>Paint color number for frame</li> <li>Paint color number for frame caps</li> <li>Options, if selected (see below)</li> </ol> <ul style="list-style-type: none"> <li>▶ See <i>Surface Materials</i>, page 242.</li> </ul>

Options	U.S. Price	Required to Specify
<b>Surface Materials</b>		
<b>Upholstery</b>		
• Customer's Own Material (COM)	No cost	▶ See <i>Surface Materials Reference Manual</i> . Specify fabric color number.
• Fabric price group 1	No cost	Specify fabric color number.
• Fabric price group 2	+\$ 1	Specify vinyl color number.
• Vinyl price group 2	+\$ 1	Specify fabric color number.
• Fabric price group 3	+\$ 5	Specify fabric color number.
• Fabric price group 4	+\$ 13	Specify fabric color number.
• Fabric price group 5	+\$ 27	Specify fabric color number.
• Fabric price group 6	+\$ 39	Specify fabric color number.
• Fabric price group 7	+\$ 57	Specify fabric color number.
• Fabric price group 8	+\$ 75	Specify fabric color number.
• Fabric price group 9	+\$ 91	Specify fabric color number.
• Fabric price group 10	+\$110	Specify fabric color number.
• Leather price group 1	+\$117	Specify leather color number.
• Leather price group 2	+\$146	Specify leather color number.
• Customer's Own Leather (COL)	+\$214	▶ See <i>Surface Materials Reference Manual</i> .
<b>Frame</b>		
• Paint price group 1	No cost	Specify paint color number.
• Paint price group 2	+\$ 36	Specify paint color number.
• Paint price group 3	+\$ 68	Specify paint color number.
<b>Cap</b>		
• Paint price group 1	No cost	Specify paint color number.
• Paint price group 2	+\$ 3	Specify paint color number.
• Paint price group 3	+\$ 5	Specify paint color number.

Specification Information	
• Style Number	• U.S. Base Price
WESARYO	\$759



**For Canadian Pricing**  
 Multiply U.S. Price by the Canadian price factor.  
 ▶ See page 1 for details.

# Brighton 60° Ganging Table

Brighton 60° Ganging Table

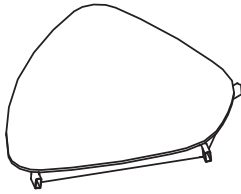

*Tip: Ganging tables or end table must be used when specifying ganging hardware on lounge units. Ganging hardware and arms cannot be specified on the same side of a lounge unit.*

Standard Includes	Required to Specify
<ul style="list-style-type: none"> <li>▶ Need help? Product details, page 24</li> <li>• Table: High-Pressure Laminate price group 1 with 3 mm plastic edge</li> <li>• Frame: paint price group 1</li> <li>• Plastic ganging brackets</li> </ul>	<ol style="list-style-type: none"> <li>1 Style number</li> <li>2 High-Pressure Laminate color number for table</li> <li>3 Plastic color number for edge</li> <li>4 Paint color number for frame</li> <li>5 Options, if selected (see below)</li> </ol> <p>▶ See <i>Surface Materials</i>, page 242.</p>

Surface Materials	Options	U.S. Price	Required to Specify
	<b>Frame</b>		
	<ul style="list-style-type: none"> <li>• Paint price group 1</li> <li>• Paint price group 2</li> <li>• Paint price group 3</li> </ul>	<p>No cost</p> <p>+\$ 34</p> <p>+\$ 59</p>	<p>Specify paint color number.</p> <p>Specify paint color number.</p>
	<b>Top</b>		
	<ul style="list-style-type: none"> <li>• High-Pressure Laminate price group 1</li> <li>• Customiz stain</li> <li>• High-Pressure Laminate price group 2</li> <li>• Composite veneer price group 1</li> <li>• Composite veneer price group 2</li> <li>• Veneer price group 1</li> <li>• Full-fill finish on wood</li> <li>• Veneer price group 3</li> <li>• Open Line laminate</li> </ul>	<p>No cost</p> <p>No cost</p> <p>+\$ 104</p> <p>+\$ 608</p> <p>+\$ 730</p> <p>+\$ 669</p> <p>+\$ 744</p> <p>+\$1338</p> <p>+\$ 111 plus cost of laminate</p>	<p>Specify laminate color number.</p> <p>Specify <i>with Customiz stain</i>.</p> <p>▶ See <i>Surface Materials Reference Manual</i>. Specify laminate color number.</p> <p>Specify wood color number.</p> <p>Specify wood color number.</p> <p>Specify wood color number.</p> <p>Specify full-fill finish number.</p> <p>Specify wood color number.</p> <p>▶ See <i>Surface Materials Reference Manual</i>.</p>

Specification Information	
Style Number	U.S. Base Price
<b>WESARYTBL60</b>	\$1263



**For Canadian Pricing**  
 Multiply U.S. Price by the Canadian price factor.  
 ▶ See page 1 for details.

# Brighton 90° Ganging Table

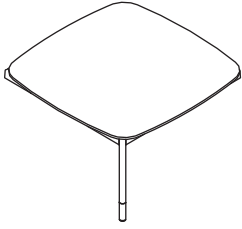

*Tip: Ganging tables or end table must be used when specifying ganging hardware on lounge units. Ganging hardware and arms cannot be specified on the same side of a lounge unit.*

Standard Includes	Required to Specify
<ul style="list-style-type: none"> <li>▶ Need help? Product details, page 24</li> <li>• Table: High-Pressure Laminate price group 1 with 3 mm plastic edge</li> <li>• Frame: paint price group 1</li> <li>• Frame feet: paint price group 1</li> <li>• Plastic ganging brackets</li> </ul>	<ol style="list-style-type: none"> <li>1 Style number</li> <li>2 High-Pressure Laminate color number for table</li> <li>3 Plastic color number for edge</li> <li>4 Paint color number for frame</li> <li>5 Paint color number for feet</li> <li>6 Options, if selected (see below)</li> </ol> <p>▶ See <i>Surface Materials</i>, page 242.</p>

Surface Materials	Options	U.S. Price	Required to Specify
	<b>Frame</b>		
	• Paint price group 1	No cost	Specify paint color number.
	• Paint price group 2	+\$ 39	Specify paint color number.
	• Paint price group 3	+\$ 78	Specify paint color number.
	<b>Top</b>		
	• High-Pressure Laminate price group 1	No cost	Specify laminate color number.
	• Customiz stain	No cost	Specify <i>with Customiz stain</i> . ▶ See <i>Surface Materials Reference Manual</i> . Specify laminate color number.
	• High-Pressure Laminate price group 2	+\$ 118	
	• Composite veneer price group 1	+\$ 622	Specify wood color number.
	• Composite veneer price group 2	+\$ 745	Specify wood color number.
• Veneer price group 1	+\$ 685	Specify wood color number.	
• Full-fill finish on wood	+\$ 759	Specify full-fill finish number.	
• Veneer price group 3	+\$1369	Specify wood color number.	
• Open Line laminate	+\$ 111 plus cost of laminate	▶ See <i>Surface Materials Reference Manual</i> .	
	<b>Foot</b>		
	• Paint price group 1	No cost	Specify paint color number.
	• Paint price group 2	+\$ 9	Specify paint color number.
	• Paint price group 3	+\$ 24	Specify paint color number.

Specification Information	
• Style Number	• U.S. Base Price
WESARYTBL90	\$1337



**For Canadian Pricing**  
Multiply U.S. Price by the Canadian price factor.  
▶ See page 1 for details.

# Brighton Straight Ganging Table

Brighton Straight Ganging Table

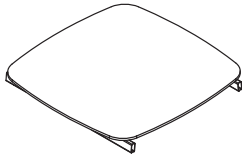

*Tip: Ganging tables or end table must be used when specifying ganging hardware on lounge units. Ganging hardware and arms cannot be specified on the same side of a lounge unit.*

Standard Includes	Required to Specify
<ul style="list-style-type: none"> <li>▶ Need help? Product details, page 24</li> <li>• Table: High-Pressure Laminate price group 1 with 3 mm plastic edge</li> <li>• Frame: paint price group 1</li> <li>• Plastic ganging brackets</li> </ul>	<ol style="list-style-type: none"> <li>1 Style number</li> <li>2 High-Pressure Laminate color number for table</li> <li>3 Plastic color number for edge</li> <li>4 Paint color number for frame</li> <li>5 Options, if selected (see below)</li> </ol> <ul style="list-style-type: none"> <li>▶ See <i>Surface Materials</i>, page 242.</li> </ul>

Surface Materials	Options	U.S. Price	Required to Specify
	<b>Frame</b> <ul style="list-style-type: none"> <li>• Paint price group 1</li> <li>• Paint price group 2</li> <li>• Paint price group 3</li> </ul>	No cost +\$ 39 +\$ 78	Specify paint color number. Specify paint color number. Specify paint color number.
	<b>Top</b> <ul style="list-style-type: none"> <li>• High-Pressure Laminate price group 1</li> <li>• Customiz stain</li> <li>• High-Pressure Laminate price group 2</li> <li>• Composite veneer price group 1</li> <li>• Composite veneer price group 2</li> <li>• Veneer price group 1</li> <li>• Full-fill finish on wood</li> <li>• Veneer price group 3</li> <li>• Open Line laminate</li> </ul>	No cost No cost +\$ 118 +\$ 622 +\$ 745 +\$ 685 +\$ 759 +\$1369 +\$ 111 plus cost of laminate	Specify laminate color number. Specify <i>with Customiz stain</i> . ▶ See <i>Surface Materials Reference Manual</i> . Specify laminate color number. Specify wood color number. Specify wood color number. Specify wood color number. Specify full-fill finish number. Specify wood color number. ▶ See <i>Surface Materials Reference Manual</i> .

Specification Information	
Style Number	U.S. Base Price
<b>WESARYTBSG</b>	\$1263

Brighton

 **For Canadian Pricing**  
 Multiply U.S. Price by the Canadian price factor.  
 ▶ See page 1 for details.

# Brighton End Table

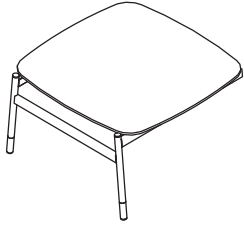

► Need help?  
Product details,  
page 24

## Standard Includes

- Table: High-Pressure Laminate price group 1 with 3 mm plastic edge
- Frame: paint price group 1
- Frame feet: paint price group 1
- Frame caps: paint price group 1
- Plastic ganging brackets

## Required to Specify

- 1 Style number
  - 2 High-Pressure Laminate color number for table
  - 3 Plastic color number for edge
  - 4 Paint color number for frame
  - 5 Paint color number for frame feet
  - 6 Paint color number for frame caps
  - 7 Options, if selected (see below)
- See *Surface Materials*, page 242.

	Options	U.S. Price	Required to Specify
<b>Surface Materials</b>	<b>Frame</b>		
	• Paint price group 1	No cost	Specify paint color number.
	• Paint price group 2	+\$ 44	Specify paint color number.
	• Paint price group 3	+\$ 83	Specify paint color number.
	<b>Top</b>		
	• High-Pressure Laminate price group 1	No cost	Specify laminate color number.
	• Customiz stain	No cost	Specify <i>with Customiz stain</i> .
	• High-Pressure Laminate price group 2	+\$ 118	► See <i>Surface Materials Reference Manual</i> . Specify laminate color number.
	• Composite veneer price group 1	+\$ 622	Specify wood color number.
	• Composite veneer price group 2	+\$ 745	Specify wood color number.
• Veneer price group 1	+\$ 685	Specify wood color number.	
• Full-fill finish on wood	+\$ 759	Specify full-fill finish number.	
• Veneer price group 3	+\$1369	Specify wood color number.	
• Open Line laminate	+\$ 111 plus cost of laminate	► See <i>Surface Materials Reference Manual</i> .	
	<b>Foot</b>		
	• Paint price group 1	No cost	Specify paint color number.
	• Paint price group 2	+\$ 9	Specify paint color number.
	• Paint price group 3	+\$ 24	Specify paint color number.
	<b>Cap</b>		
	• Paint price group 1	No cost	Specify paint color number.
	• Paint price group 2	+\$ 3	Specify paint color number.
	• Paint price group 3	+\$ 5	Specify paint color number.
	<b>Ganging</b>		
	• Left	No cost	Specify <i>with ganging left</i> .
	• Right	No cost	Specify <i>with ganging right</i> .

*Tip: Ganging tables or end table must be used when specifying ganging hardware on lounge units. Ganging hardware and arms cannot be specified on the same side of a lounge unit.*

## Specification Information

• Style Number	• U.S. Base Price
WESARYTBLED	\$1403



### For Canadian Pricing

Multiply U.S. Price by the Canadian price factor.

► See page 1 for details.

# Brighton Square Table

Brighton Square Table

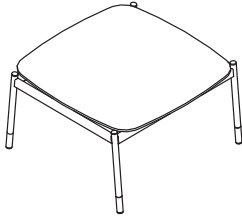

► Need help?  
Product details,  
page 24

## Standard Includes

- Table: High-Pressure Laminate price group 1 with 3 mm plastic edge
- Frame: paint price group 1
- Frame feet: paint price group 1
- Frame caps: paint price group 1

## Required to Specify

- 1 Style number
  - 2 High-Pressure Laminate color number for table
  - 3 Plastic color number for edge
  - 4 Paint color number for frame
  - 5 Paint color number for frame feet
  - 6 Paint color number for frame caps
  - 7 Options, if selected (see below)
- See *Surface Materials*, page 242.

	Options	U.S. Price	Required to Specify
<b>Surface Materials</b>	<b>Frame</b>		
	• Paint price group 1	No cost	Specify paint color number.
	• Paint price group 2	+\$ 52	Specify paint color number.
	• Paint price group 3	+\$ 95	Specify paint color number.
	<b>Top</b>		
	• High-Pressure Laminate price group 1	No cost	Specify laminate color number.
	• Customiz stain	No cost	Specify with <i>Customiz stain</i> . ► See <i>Surface Materials Reference Manual</i> . Specify laminate color number.
	• High-Pressure Laminate price group 2	+\$ 118	
	• Composite veneer price group 1	+\$ 622	Specify wood color number.
	• Composite veneer price group 2	+\$ 745	Specify wood color number.
	• Veneer price group 1	+\$ 685	Specify wood color number.
	• Full-fill finish on wood	+\$ 759	Specify full-fill finish number.
• Veneer price group 3	+\$1369	Specify wood color number.	
• Open Line laminate	+\$ 111 plus cost of laminate	► See <i>Surface Materials Reference Manual</i> .	
<b>Foot</b>			
• Paint price group 1	No cost	Specify paint color number.	
• Paint price group 2	+\$ 9	Specify paint color number.	
• Paint price group 3	+\$ 24	Specify paint color number.	
<b>Cap</b>			
• Paint price group 1	No cost	Specify paint color number.	
• Paint price group 2	+\$ 3	Specify paint color number.	
• Paint price group 3	+\$ 5	Specify paint color number.	

## Specification Information

Style Number	U.S. Base Price
WESARYTBSQ	\$1547

Brighton



### For Canadian Pricing

Multiply U.S. Price by the Canadian price factor.

► See page 1 for details.

# Brighton Rectangle Table

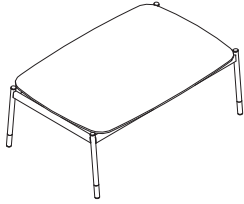

► Need help?  
Product details,  
page 24

## Standard Includes

- Table: High-Pressure Laminate price group 1 with 3 mm plastic edge
- Frame: paint price group 1
- Frame feet: paint price group 1
- Frame caps: paint price group 1

## Required to Specify

- 1 Style number
  - 2 High-Pressure Laminate color number for table
  - 3 Plastic color number for edge
  - 4 Paint color number for frame
  - 5 Paint color number for frame feet
  - 6 Paint color number for frame caps
  - 7 Options, if selected (see below)
- See *Surface Materials*, page 242.

	Options	U.S. Price	Required to Specify
<b>Surface Materials</b>	<b>Frame</b>		
	• Paint price group 1	No cost	Specify paint color number.
	• Paint price group 2	+\$ 59	Specify paint color number.
	• Paint price group 3	+\$ 104	Specify paint color number.
	<b>Top</b>		
	• High-Pressure Laminate price group 1	No cost	Specify laminate color number.
	• Customiz stain	No cost	Specify <i>with Customiz stain</i> . ► See <i>Surface Materials Reference Manual</i> . Specify laminate color number.
	• High-Pressure Laminate price group 2	+\$ 134	
	• Composite veneer price group 1	+\$ 739	Specify wood color number.
	• Composite veneer price group 2	+\$ 885	Specify wood color number.
• Veneer price group 1	+\$ 812	Specify wood color number.	
• Full-fill finish on wood	+\$ 885	Specify full-fill finish number.	
• Veneer price group 3	+\$1623	Specify wood color number.	
• Open Line laminate	+\$ 111 plus cost of laminate	► See <i>Surface Materials Reference Manual</i> .	
<b>Foot</b>			
• Paint price group 1	No cost	Specify paint color number.	
• Paint price group 2	+\$ 9	Specify paint color number.	
• Paint price group 3	+\$ 24	Specify paint color number.	
<b>Cap</b>			
• Paint price group 1	No cost	Specify paint color number.	
• Paint price group 2	+\$ 3	Specify paint color number.	
• Paint price group 3	+\$ 5	Specify paint color number.	

## Specification Information

• Style Number	• U.S. Base Price
WESARYTLRT	\$1758



### For Canadian Pricing

Multiply U.S. Price by the Canadian price factor.

► See page 1 for details.

## Brighton Module Power

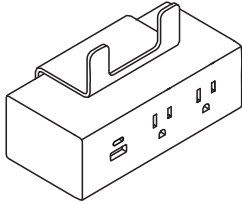

	Standard Includes	Required to Specify
▶ Need help? Product details, page 25	<ul style="list-style-type: none"> <li>Power module:                             <ul style="list-style-type: none"> <li>– 6000 Black</li> <li>– 6052 Milk</li> </ul> </li> <li>9' cord with three-prong plug: black plastic only</li> </ul>	<ul style="list-style-type: none"> <li>1 Style number</li> <li>2 Plastic color number for power module</li> <li>3 Options, if selected (see below)</li> </ul>

	Options	U.S. Price	Required to Specify
<b>Power Configuration</b>	<ul style="list-style-type: none"> <li>2 power 1 USB A+C 20W</li> <li>1 power 1 USBC</li> </ul>	No cost +\$133	Specify with 2 power 1 USB A+C 20W. Specify with 1 power 1 USBC.

Specification Information	
• Style Number	• U.S. Base Price
WESARYPWR	\$460
⋮	⋮

## Brighton USB Power

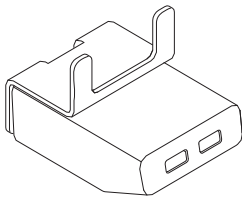

	Standard Includes	Required to Specify
▶ Need help? Product details, page 25	<ul style="list-style-type: none"> <li>Power module:                             <ul style="list-style-type: none"> <li>– 6000 Black</li> <li>– 6052 Milk</li> </ul> </li> <li>9' cord with three-prong plug: black plastic only</li> </ul>	<ul style="list-style-type: none"> <li>1 Style number</li> <li>2 Plastic color number for power</li> </ul>

Specification Information	
• Style Number	• U.S. Price
WESARYUSB	\$304
⋮	⋮

Brighton

 **For Canadian Pricing**  
Multiply U.S. Price by the Canadian price factor.  
▶ See page 1 for details.

# Mesa Chaise Lounge—Left Hand

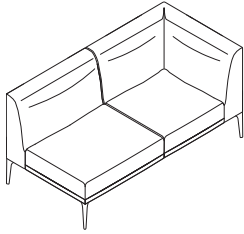

Tip: Contrasting fabric is not available on Mesa lounge seating.

Tip: Handedness is determined while in the seated position.

Standard Includes		Required to Specify
▶ Need help? Product details, page 28	<ul style="list-style-type: none"> <li>Fully upholstered non-contrasting lounge: fabric price group 1</li> <li>Four leg cast aluminum base: WE01 Antique Bronze</li> <li>Plastic ganging brackets</li> </ul>	1 Style number 2 Fabric color number for lounge 3 Options, if selected (see below) ▶ See <i>Surface Materials</i> , page 242.

Options	U.S. Price	Required to Specify
<b>Surface Materials</b>		
<b>Inner</b>		
• Customer's Own Material (COM)	No cost	▶ See <i>Surface Materials Reference Manual</i> . Specify fabric color number.
• Fabric price group 1	No cost	Specify fabric color number.
• Fabric price group 2	+\$ 34	Specify fabric color number.
• Customer's Own Leather (COL)	+\$ 109	▶ See <i>Surface Materials Reference Manual</i> . Specify fabric color number.
• Fabric price group 3	+\$ 155	Specify fabric color number.
• Fabric price group 4	+\$ 301	Specify fabric color number.
• Fabric price group 5	+\$ 535	Specify fabric color number.
• Fabric price group 6	+\$ 791	Specify fabric color number.
• Fabric price group 7	+\$1105	Specify fabric color number.
• Fabric price group 8	+\$1432	Specify fabric color number.
• Fabric price group 9	+\$1769	Specify fabric color number.
• Fabric price group 10	+\$2082	Specify fabric color number.
• Leather price group 1	+\$2278	Specify leather color number.
• Leather price group 2	+\$2806	Specify leather color number.
<b>Outer</b>		
• Customer's Own Material (COM)	No cost	▶ See <i>Surface Materials Reference Manual</i> . Specify fabric color number.
• Fabric price group 1	No cost	Specify fabric color number.
• Fabric price group 2	+\$ 8	Specify fabric color number.
• Fabric price group 3	+\$ 51	Specify fabric color number.
• Fabric price group 4	+\$ 101	Specify fabric color number.
• Customer's Own Leather (COL)	+\$ 109	▶ See <i>Surface Materials Reference Manual</i> . Specify fabric color number.
• Fabric price group 5	+\$ 178	Specify fabric color number.
• Fabric price group 6	+\$ 265	Specify fabric color number.
• Fabric price group 7	+\$ 369	Specify fabric color number.
• Fabric price group 8	+\$ 479	Specify fabric color number.
• Fabric price group 9	+\$ 590	Specify fabric color number.
• Fabric price group 10	+\$ 694	Specify fabric color number.
• Leather price group 1	+\$ 760	Specify leather color number.
• Leather price group 2	+\$ 936	Specify leather color number.

Specification Information	
Style Number	U.S. Base Price
WESMESCHLH	\$5650



**For Canadian Pricing**  
 Multiply U.S. Price by the Canadian price factor.  
 ▶ See page 1 for details.

# Mesa Chaise Lounge—Right Hand

Mesa Chaise Lounge—  
Right Hand

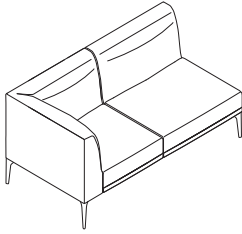

*Tip: Contrasting fabric is not available on Mesa lounge seating.*

*Tip: Handedness is determined while in the seated position.*

Standard Includes		Required to Specify
<ul style="list-style-type: none"> <li>▶ Need help? Product details, page 28</li> </ul>	<ul style="list-style-type: none"> <li>Fully upholstered non-contrasting lounge: fabric price group 1</li> <li>Four leg cast aluminum base: WE01 Antique Bronze</li> <li>Plastic ganging brackets</li> </ul>	<ol style="list-style-type: none"> <li>Style number</li> <li>Fabric color number for lounge</li> <li>Options, if selected (see below)</li> </ol> <ul style="list-style-type: none"> <li>▶ See <i>Surface Materials</i>, page 242.</li> </ul>

Options	U.S. Price	Required to Specify
<b>Surface Materials</b>		
<b>Inner</b>		
• Customer's Own Material (COM)	No cost	<ul style="list-style-type: none"> <li>▶ See <i>Surface Materials Reference Manual</i>. Specify fabric color number.</li> <li>▶ See <i>Surface Materials Reference Manual</i>. Specify fabric color number.</li> <li>Specify fabric color number.</li> <li>Specify fabric color number.</li> <li>Specify fabric color number.</li> <li>Specify fabric color number.</li> <li>Specify fabric color number.</li> <li>Specify fabric color number.</li> <li>Specify fabric color number.</li> <li>Specify fabric color number.</li> </ul>
• Fabric price group 1	No cost	
• Fabric price group 2	+\$ 34	
• Customer's Own Leather (COL)	+\$ 109	
• Fabric price group 3	+\$ 155	
• Fabric price group 4	+\$ 301	
• Fabric price group 5	+\$ 535	
• Fabric price group 6	+\$ 791	
• Fabric price group 7	+\$1105	
• Fabric price group 8	+\$1432	
• Fabric price group 9	+\$1769	
• Fabric price group 10	+\$2082	
• Leather price group 1	+\$2278	
• Leather price group 2	+\$2806	
<b>Outer</b>		
• Customer's Own Material (COM)	No cost	<ul style="list-style-type: none"> <li>▶ See <i>Surface Materials Reference Manual</i>. Specify fabric color number.</li> <li>Specify fabric color number.</li> <li>Specify fabric color number.</li> <li>Specify fabric color number.</li> <li>Specify fabric color number.</li> <li>▶ See <i>Surface Materials Reference Manual</i>. Specify fabric color number.</li> <li>Specify fabric color number.</li> <li>Specify fabric color number.</li> <li>Specify fabric color number.</li> <li>Specify fabric color number.</li> <li>Specify fabric color number.</li> <li>Specify fabric color number.</li> <li>Specify fabric color number.</li> <li>Specify leather color number.</li> <li>Specify leather color number.</li> </ul>
• Fabric price group 1	No cost	
• Fabric price group 2	+\$ 8	
• Fabric price group 3	+\$ 51	
• Fabric price group 4	+\$ 101	
• Customer's Own Leather (COL)	+\$ 109	
• Fabric price group 5	+\$ 178	
• Fabric price group 6	+\$ 265	
• Fabric price group 7	+\$ 369	
• Fabric price group 8	+\$ 479	
• Fabric price group 9	+\$ 590	
• Fabric price group 10	+\$ 694	
• Leather price group 1	+\$ 760	
• Leather price group 2	+\$ 936	

Specification Information	
Style Number	U.S. Base Price
WESMESCHRH	\$5650

 **For Canadian Pricing**  
Multiply U.S. Price by the Canadian price factor.  
▶ See page 1 for details.

# Mesa Armless Lounge

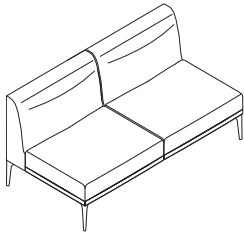

Tip: Contrasting fabric is not available on Mesa lounge seating.

Standard Includes		Required to Specify
<ul style="list-style-type: none"> <li>▶ Need help? Product details, page 28</li> </ul>	<ul style="list-style-type: none"> <li>Fully upholstered non-contrasting lounge: fabric price group 1</li> <li>Four leg cast aluminum base: WE01 Antique Bronze</li> <li>Plastic ganging brackets</li> </ul>	<ul style="list-style-type: none"> <li>1 Style number</li> <li>2 Fabric color number for lounge</li> <li>3 Options, if selected (see below)</li> <li>▶ See <i>Surface Materials</i>, page 242.</li> </ul>

Options	U.S. Price	Required to Specify	
<b>Surface Materials</b>			
<b>Inner</b>			
• Customer's Own Material (COM)	No cost	▶ See <i>Surface Materials Reference Manual</i> . Specify fabric color number.	
• Fabric price group 1	No cost		
• Fabric price group 2	+\$ 30		
• Customer's Own Leather (COL)	+\$ 109		
• Fabric price group 3	+\$ 143		
• Fabric price group 4	+\$ 275		
• Fabric price group 5	+\$ 495		
• Fabric price group 6	+\$ 731		
• Fabric price group 7	+\$1019		
• Fabric price group 8	+\$1321		
• Fabric price group 9	+\$1628	▶ See <i>Surface Materials Reference Manual</i> . Specify fabric color number.	
• Fabric price group 10	+\$1921		
• Leather price group 1	+\$2098		
• Leather price group 2	+\$2584		
<b>Outer</b>			
• Customer's Own Material (COM)	No cost		▶ See <i>Surface Materials Reference Manual</i> . Specify fabric color number.
• Fabric price group 1	No cost		
• Fabric price group 2	+\$ 8		
• Fabric price group 3	+\$ 49		
• Fabric price group 4	+\$ 91		
• Customer's Own Leather (COL)	+\$ 109		
• Fabric price group 5	+\$ 166		
• Fabric price group 6	+\$ 244		
• Fabric price group 7	+\$ 341		
• Fabric price group 8	+\$ 440		
• Fabric price group 9	+\$ 543	▶ See <i>Surface Materials Reference Manual</i> . Specify fabric color number.	
• Fabric price group 10	+\$ 641		
• Leather price group 1	+\$ 698		
• Leather price group 2	+\$ 863		

Specification Information	
Style Number	U.S. Base Price
WESMES2SEAT	\$5128



**For Canadian Pricing**  
Multiply U.S. Price by the Canadian price factor.  
▶ See page 1 for details.

# Mesa Corner Lounge Unit

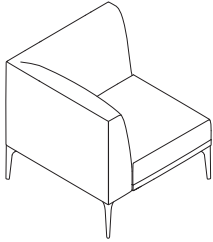

Tip: Contrasting fabric is not available on Mesa lounge seating.

Tip: The corner unit is not handed and can be connected on either side with other units. Avoid using directional fabrics as it may not align with adjacent pieces.

Standard Includes		Required to Specify
<ul style="list-style-type: none"> <li>▶ Need help? Product details, page 28</li> </ul>	<ul style="list-style-type: none"> <li>Fully upholstered non-contrasting lounge: fabric price group 1</li> <li>Four leg cast aluminum base: WE01 Antique Bronze</li> <li>Plastic ganging brackets</li> </ul>	<ol style="list-style-type: none"> <li>Style number</li> <li>Fabric color number for lounge</li> <li>Options, if selected (see below)</li> </ol> <ul style="list-style-type: none"> <li>▶ See <i>Surface Materials</i>, page 242.</li> </ul>

Options	U.S. Price	Required to Specify	
<b>Surface Materials</b>			
<b>Inner</b>			
• Customer's Own Material (COM)	No cost	▶ See <i>Surface Materials Reference Manual</i> . Specify fabric color number.	
• Fabric price group 1	No cost		
• Fabric price group 2	+\$ 18		
• Fabric price group 3	+\$ 89		
• Customer's Own Leather (COL)	+\$ 109		
• Fabric price group 4	+\$ 174		
• Fabric price group 5	+\$ 309		
• Fabric price group 6	+\$ 460		
• Fabric price group 7	+\$ 638		
• Fabric price group 8	+\$ 827		
• Fabric price group 9	+\$1021	▶ See <i>Surface Materials Reference Manual</i> . Specify fabric color number.	
• Fabric price group 10	+\$1203		
• Leather price group 1	+\$1315		
• Leather price group 2	+\$1623		
<b>Outer</b>			
• Customer's Own Material (COM)	No cost		▶ See <i>Surface Materials Reference Manual</i> . Specify fabric color number.
• Fabric price group 1	No cost		
• Fabric price group 2	+\$ 4		
• Fabric price group 3	+\$ 30		
• Fabric price group 4	+\$ 59		
• Fabric price group 5	+\$ 104		
• Customer's Own Leather (COL)	+\$ 109		
• Fabric price group 6	+\$ 153		
• Fabric price group 7	+\$ 213		
• Fabric price group 8	+\$ 275		
• Fabric price group 9	+\$ 341	▶ See <i>Surface Materials Reference Manual</i> . Specify fabric color number.	
• Fabric price group 10	+\$ 402		
• Leather price group 1	+\$ 438		
• Leather price group 2	+\$ 538		

Specification Information	
Style Number	U.S. Base Price
WESMESC	\$3334

 **For Canadian Pricing**  
 Multiply U.S. Price by the Canadian price factor.  
 ▶ See page 1 for details.

# Mesa Ottoman

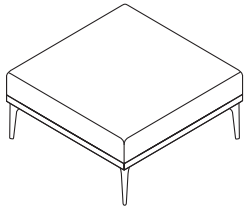

Standard Includes		Required to Specify
<ul style="list-style-type: none"> <li>▶ Need help? Product details, page 28</li> </ul>	<ul style="list-style-type: none"> <li>Fully upholstered ottoman: fabric price group 1</li> <li>Four leg cast aluminum base: WE01 Antique Bronze</li> <li>Plastic ganging brackets</li> </ul>	<ul style="list-style-type: none"> <li>1 Style number</li> <li>2 Fabric color number for ottoman</li> <li>3 Options, if selected (see below)</li> <li>▶ See <i>Surface Materials</i>, page 242.</li> </ul>

Options	U.S. Price	Required to Specify
<b>Upholstery</b>		
• Customer's Own Material (COM)	No cost	▶ See <i>Surface Materials Reference Manual</i> .
• Fabric price group 1	No cost	Specify fabric color number.
• Fabric price group 2	+\$ 13	Specify fabric color number.
• Fabric price group 3	+\$ 75	Specify fabric color number.
• Fabric price group 4	+\$ 145	Specify fabric color number.
• Customer's Own Leather (COL)	+\$ 214	▶ See <i>Surface Materials Reference Manual</i> .
• Fabric price group 5	+\$ 257	Specify fabric color number.
• Fabric price group 6	+\$ 381	Specify fabric color number.
• Fabric price group 7	+\$ 528	Specify fabric color number.
• Fabric price group 8	+\$ 687	Specify fabric color number.
• Fabric price group 9	+\$ 848	Specify fabric color number.
• Fabric price group 10	+\$ 999	Specify fabric color number.
• Leather price group 1	+\$1090	Specify leather color number.
• Leather price group 2	+\$1344	Specify leather color number.

Specification Information	
• Style Number	• U.S. Base Price
WESMESO	\$2279



**For Canadian Pricing**  
 Multiply U.S. Price by the Canadian price factor.  
 ▶ See page 1 for details.



# Willow Fixed Base Lounge

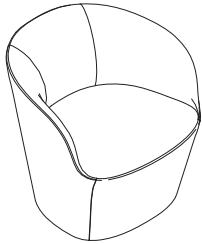

Standard Includes		Required to Specify	
<ul style="list-style-type: none"> <li>▶ Need help? Product details, page 32</li> </ul>	<ul style="list-style-type: none"> <li>Fully upholstered non-contrasting seat with back: fabric price group 1</li> <li>Back detail: smooth</li> <li>Glides</li> </ul>	<ul style="list-style-type: none"> <li>1 Style number</li> <li>2 Fabric color number for chair</li> <li>3 Options, if selected (see below)</li> <li>▶ See <i>Surface Materials</i>, page 242.</li> </ul>	
Options	U.S. Price	Required to Specify	
<b>Color Scheme</b>	<ul style="list-style-type: none"> <li>Non contrasting No cost</li> <li>Contrasting inner and outer +\$ 140</li> </ul>	<ul style="list-style-type: none"> <li>Specify <i>with non contrasting</i>.</li> <li>Specify <i>with contrasting</i>.</li> </ul>	
<b>Surface Materials</b>	<b>Upholstery</b>		
	<ul style="list-style-type: none"> <li>Customer's Own Material (COM) No cost</li> <li>Fabric price group 1 No cost</li> <li>Fabric price group 2 +\$ 61</li> <li>Vinyl price group 2 +\$ 61</li> <li>Fabric price group 3 +\$ 145</li> <li>Customer's Own Leather (COL) +\$ 195</li> <li>Fabric price group 4 +\$ 292</li> <li>Fabric price group 5 +\$ 418</li> <li>Fabric price group 6 +\$ 686</li> <li>Fabric price group 7 +\$ 812</li> <li>Fabric price group 8 +\$1123</li> <li>Fabric price group 9 +\$1332</li> <li>Fabric price group 10 +\$1518</li> <li>Leather price group 1 +\$1869</li> <li>Leather price group 2 +\$2185</li> </ul>	<ul style="list-style-type: none"> <li>▶ See <i>Surface Materials Reference Manual</i>. Specify fabric color number.</li> <li>Specify fabric color number.</li> <li>Specify vinyl color number.</li> <li>Specify fabric color number.</li> <li>▶ See <i>Surface Materials Reference Manual</i>. Specify fabric color number.</li> <li>Specify fabric color number.</li> <li>Specify fabric color number.</li> <li>Specify fabric color number.</li> <li>Specify fabric color number.</li> <li>Specify fabric color number.</li> <li>Specify fabric color number.</li> <li>Specify leather color number.</li> <li>Specify leather color number.</li> </ul>	
	<b>Inner</b>		
	<ul style="list-style-type: none"> <li>Customer's Own Material (COM) No cost</li> <li>Fabric price group 1 No cost</li> <li>Fabric price group 2 +\$ 31</li> <li>Vinyl price group 2 +\$ 31</li> <li>Fabric price group 3 +\$ 73</li> <li>Fabric price group 4 +\$ 146</li> <li>Customer's Own Leather (COL) +\$ 195</li> <li>Fabric price group 5 +\$ 209</li> <li>Fabric price group 6 +\$ 343</li> <li>Fabric price group 7 +\$ 405</li> <li>Fabric price group 8 +\$ 561</li> <li>Fabric price group 9 +\$ 666</li> <li>Fabric price group 10 +\$ 760</li> <li>Leather price group 1 +\$ 936</li> <li>Leather price group 2 +\$1092</li> </ul>	<ul style="list-style-type: none"> <li>▶ See <i>Surface Materials Reference Manual</i>. Specify fabric color number.</li> <li>Specify fabric color number.</li> <li>Specify vinyl color number.</li> <li>Specify fabric color number.</li> <li>Specify fabric color number.</li> <li>▶ See <i>Surface Materials Reference Manual</i>. Specify fabric color number.</li> <li>Specify fabric color number.</li> <li>Specify fabric color number.</li> <li>Specify fabric color number.</li> <li>Specify fabric color number.</li> <li>Specify fabric color number.</li> <li>Specify leather color number.</li> <li>Specify leather color number.</li> </ul>	
	<b>Outer</b>		
	<ul style="list-style-type: none"> <li>Customer's Own Material (COM) No cost</li> <li>Fabric price group 1 No cost</li> <li>Fabric price group 2 +\$ 32</li> <li>Vinyl price group 2 +\$ 32</li> <li>Fabric price group 3 +\$ 73</li> <li>Fabric price group 4 +\$ 146</li> <li>Customer's Own Leather (COL) +\$ 195</li> <li>Fabric price group 5 +\$ 209</li> <li>Fabric price group 6 +\$ 343</li> <li>Fabric price group 7 +\$ 406</li> <li>Fabric price group 8 +\$ 561</li> <li>Fabric price group 9 +\$ 666</li> <li>Fabric price group 10 +\$ 760</li> <li>Leather price group 1 +\$ 937</li> <li>Leather price group 2 +\$1092</li> </ul>	<ul style="list-style-type: none"> <li>▶ See <i>Surface Materials Reference Manual</i>. Specify fabric color number.</li> <li>Specify fabric color number.</li> <li>Specify vinyl color number.</li> <li>Specify fabric color number.</li> <li>Specify fabric color number.</li> <li>▶ See <i>Surface Materials Reference Manual</i>. Specify fabric color number.</li> <li>Specify fabric color number.</li> <li>Specify fabric color number.</li> <li>Specify fabric color number.</li> <li>Specify fabric color number.</li> <li>Specify fabric color number.</li> <li>Specify leather color number.</li> <li>Specify leather color number.</li> </ul>	
<b>Back Detail</b>	<ul style="list-style-type: none"> <li>Smooth No cost</li> <li>Soft +\$ 217</li> </ul>	<ul style="list-style-type: none"> <li>Specify <i>with smooth back detail</i>.</li> <li>Specify <i>with soft back detail</i>.</li> </ul>	



**For Canadian Pricing**  
 Multiply U.S. Price by the Canadian price factor.  
 ▶ See page 1 for details.

**Specification Information**

<b>Style Number</b>	<b>U.S. Base Price</b>
<b>WESWL0LNGF</b>	\$2717

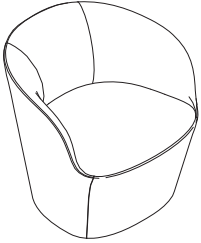

  
**For Canadian Pricing**  
Multiply U.S. Price by the  
Canadian price factor.  
▶ See page 1 for details.



# Willow Swivel Base Lounge

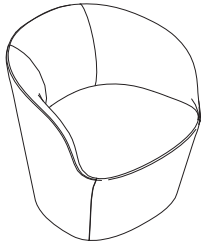

Standard Includes		Required to Specify	
<ul style="list-style-type: none"> <li>▶ Need help? Product details, page 32</li> </ul>	<ul style="list-style-type: none"> <li>Fully upholstered non-contrasting seat with back: fabric price group 1</li> <li>Back detail: smooth</li> <li>Swivel base</li> </ul>	<ul style="list-style-type: none"> <li>1 Style number</li> <li>2 Fabric color number for chair</li> <li>3 Options, if selected (see below)</li> <li>▶ See <i>Surface Materials</i>, page 242.</li> </ul>	
Options		U.S. Price	Required to Specify
<b>Color Scheme</b>	<ul style="list-style-type: none"> <li>Non contrasting</li> <li>Contrasting inner and outer</li> </ul>	<ul style="list-style-type: none"> <li>No cost</li> <li>+\$ 140</li> </ul>	<ul style="list-style-type: none"> <li>Specify <i>with non contrasting</i>.</li> <li>Specify <i>with contrasting</i>.</li> </ul>
<b>Surface Materials</b>	<p><b>Upholstery</b></p> <ul style="list-style-type: none"> <li>Customer's Own Material (COM)</li> <li>Fabric price group 1</li> <li>Fabric price group 2</li> <li>Vinyl price group 2</li> <li>Fabric price group 3</li> <li>Customer's Own Leather (COL)</li> <li>Fabric price group 4</li> <li>Fabric price group 5</li> <li>Fabric price group 6</li> <li>Fabric price group 7</li> <li>Fabric price group 8</li> <li>Fabric price group 9</li> <li>Fabric price group 10</li> <li>Leather price group 1</li> <li>Leather price group 2</li> </ul> <p><b>Inner</b></p> <ul style="list-style-type: none"> <li>Customer's Own Material (COM)</li> <li>Fabric price group 1</li> <li>Fabric price group 2</li> <li>Vinyl price group 2</li> <li>Fabric price group 3</li> <li>Fabric price group 4</li> <li>Customer's Own Leather (COL)</li> <li>Fabric price group 5</li> <li>Fabric price group 6</li> <li>Fabric price group 7</li> <li>Fabric price group 8</li> <li>Fabric price group 9</li> <li>Fabric price group 10</li> <li>Leather price group 1</li> <li>Leather price group 2</li> </ul> <p><b>Outer</b></p> <ul style="list-style-type: none"> <li>Customer's Own Material (COM)</li> <li>Fabric price group 1</li> <li>Fabric price group 2</li> <li>Vinyl price group 2</li> <li>Fabric price group 3</li> <li>Fabric price group 4</li> <li>Customer's Own Leather (COL)</li> <li>Fabric price group 5</li> <li>Fabric price group 6</li> <li>Fabric price group 7</li> <li>Fabric price group 8</li> <li>Fabric price group 9</li> <li>Fabric price group 10</li> <li>Leather price group 1</li> <li>Leather price group 2</li> </ul>	<ul style="list-style-type: none"> <li>No cost</li> <li>No cost</li> <li>+\$ 61</li> <li>+\$ 61</li> <li>+\$ 145</li> <li>+\$ 195</li> <li>+\$ 292</li> <li>+\$ 418</li> <li>+\$ 686</li> <li>+\$ 812</li> <li>+\$1123</li> <li>+\$1332</li> <li>+\$1518</li> <li>+\$1869</li> <li>+\$2185</li> <li>No cost</li> <li>No cost</li> <li>+\$ 31</li> <li>+\$ 31</li> <li>+\$ 73</li> <li>+\$ 146</li> <li>+\$ 195</li> <li>+\$ 209</li> <li>+\$ 343</li> <li>+\$ 405</li> <li>+\$ 561</li> <li>+\$ 666</li> <li>+\$ 760</li> <li>+\$ 936</li> <li>+\$1092</li> <li>No cost</li> <li>No cost</li> <li>+\$ 32</li> <li>+\$ 32</li> <li>+\$ 73</li> <li>+\$ 146</li> <li>+\$ 195</li> <li>+\$ 209</li> <li>+\$ 343</li> <li>+\$ 406</li> <li>+\$ 561</li> <li>+\$ 666</li> <li>+\$ 760</li> <li>+\$ 937</li> <li>+\$1092</li> </ul>	<ul style="list-style-type: none"> <li>▶ See <i>Surface Materials Reference Manual</i>. Specify fabric color number.</li> <li>Specify fabric color number.</li> <li>Specify vinyl color number.</li> <li>Specify fabric color number.</li> <li>▶ See <i>Surface Materials Reference Manual</i>. Specify fabric color number.</li> <li>Specify fabric color number.</li> <li>Specify fabric color number.</li> <li>Specify fabric color number.</li> <li>Specify fabric color number.</li> <li>Specify fabric color number.</li> <li>Specify fabric color number.</li> <li>Specify fabric color number.</li> <li>Specify leather color number.</li> <li>Specify leather color number.</li> <li>▶ See <i>Surface Materials Reference Manual</i>. Specify fabric color number.</li> <li>Specify fabric color number.</li> <li>Specify fabric color number.</li> <li>Specify vinyl color number.</li> <li>Specify fabric color number.</li> <li>Specify fabric color number.</li> <li>▶ See <i>Surface Materials Reference Manual</i>. Specify fabric color number.</li> <li>Specify fabric color number.</li> <li>Specify fabric color number.</li> <li>Specify fabric color number.</li> <li>Specify fabric color number.</li> <li>Specify fabric color number.</li> <li>Specify fabric color number.</li> <li>Specify leather color number.</li> <li>Specify leather color number.</li> <li>Specify leather color number.</li> </ul>
<b>Back Detail</b>	<ul style="list-style-type: none"> <li>Smooth</li> <li>Soft</li> </ul>	<ul style="list-style-type: none"> <li>No cost</li> <li>+\$ 217</li> </ul>	<ul style="list-style-type: none"> <li>Specify <i>with smooth back detail</i>.</li> <li>Specify <i>with soft back detail</i>.</li> </ul>

 **For Canadian Pricing**  
 Multiply U.S. Price by the Canadian price factor.  
 ▶ See page 1 for details.

**Specification Information**

<b>Style Number</b>	<b>U.S. Base Price</b>
<b>WESWLNLNGS</b>	\$3103

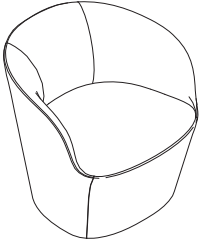

  
**For Canadian Pricing**  
Multiply U.S. Price by the  
Canadian price factor.  
▶ See page 1 for details.



# Slope Guest Chair

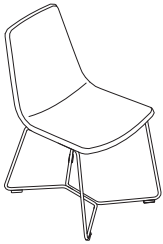

Tip: Slope guest chair with arms is shipped fully assembled; without arms will require assembly.

Tip: Upholstery and paint available on Steelcase Slope. Licensed Slope (stocked) guest chair available in saddle or fog with a hot rolled steel frame. Licensed Slope guest chair is also available in aegean leather with antique brass frame.

Standard Includes		Required to Specify
<ul style="list-style-type: none"> <li>▶ Need help? Product details, page 34</li> </ul>	<ul style="list-style-type: none"> <li>Fully upholstered seat with back: fabric price group 1</li> <li>Wire frame base: paint price group 1</li> <li>Glides:                             <ul style="list-style-type: none"> <li>– Natural</li> <li>– Black</li> </ul> </li> </ul>	<ol style="list-style-type: none"> <li>Style number</li> <li>Fabric color number for chair</li> <li>Paint color number for base</li> <li>Color color number for glides</li> <li>Options, if selected (see below)</li> </ol> <ul style="list-style-type: none"> <li>▶ See <i>Surface Materials</i>, page 242.</li> </ul>

Options	U.S. Price	Required to Specify
<b>Surface Materials</b>	<b>Upholstery</b> <ul style="list-style-type: none"> <li>Customer's Own Material (COM) No cost</li> <li>Fabric price group 1 No cost</li> <li>Fabric price group 2 +\$ 5</li> <li>Fabric price group 3 +\$ 34</li> <li>Fabric price group 4 +\$ 63</li> <li>Fabric price group 5 +\$140</li> <li>Fabric price group 6 +\$166</li> <li>Customer's Own Leather (COL) +\$214</li> <li>Fabric price group 7 +\$231</li> <li>Fabric price group 8 +\$300</li> <li>Fabric price group 9 +\$354</li> <li>Fabric price group 10 +\$435</li> <li>Leather price group 1 +\$476</li> <li>Leather price group 2 +\$587</li> </ul>	<ul style="list-style-type: none"> <li>▶ See <i>Surface Materials Reference Manual</i>. Specify fabric color number.</li> <li>Specify fabric color number.</li> <li>Specify fabric color number.</li> <li>Specify fabric color number.</li> <li>Specify fabric color number.</li> <li>Specify fabric color number.</li> <li>▶ See <i>Surface Materials Reference Manual</i>. Specify fabric color number.</li> <li>Specify fabric color number.</li> <li>Specify fabric color number.</li> <li>Specify fabric color number.</li> <li>Specify leather color number.</li> <li>Specify leather color number.</li> </ul>
	<b>Base</b> <ul style="list-style-type: none"> <li>Paint price group 1 No cost</li> <li>Paint price group 2 +\$ 44</li> <li>Paint price group 3 +\$ 90</li> </ul>	<ul style="list-style-type: none"> <li>Specify paint color number.</li> <li>Specify paint color number.</li> <li>Specify paint color number.</li> </ul>
<b>Vertical Seam</b> <ul style="list-style-type: none"> <li>Without seam</li> <li>With seam</li> </ul>	<ul style="list-style-type: none"> <li>No cost</li> <li>+\$ 12</li> </ul>	<ul style="list-style-type: none"> <li>Specify <i>without seam</i>.</li> <li>Specify <i>with seam</i>.</li> </ul>
<b>Arm Type</b> <ul style="list-style-type: none"> <li>Without arm</li> <li>With arm</li> </ul>	<ul style="list-style-type: none"> <li>No cost</li> <li>+\$173</li> </ul>	<ul style="list-style-type: none"> <li>Specify <i>without arm</i>.</li> <li>Specify <i>with arm</i>.</li> </ul>

Specification Information	
Style Number	U.S. Base Price
WESSLPCG	\$953

 **For Canadian Pricing**  
 Multiply U.S. Price by the Canadian price factor.  
 ▶ See page 1 for details.



# Slope Counter-Height Stool

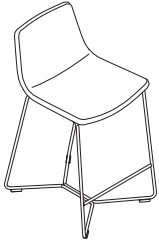

Tip: Upholstery and paint available on Steelcase Slope. Licensed Slope (stocked) counter height stool only available in saddle with hot rolled steel frame.

Standard Includes		Required to Specify
<ul style="list-style-type: none"> <li>▶ Need help? Product details, page 34</li> </ul>	<ul style="list-style-type: none"> <li>Fully upholstered seat with back: fabric price group 1</li> <li>Wire frame base: paint price group 1</li> <li>Glides:                             <ul style="list-style-type: none"> <li>– Natural</li> <li>– Black</li> </ul> </li> <li>Requires assembly</li> </ul>	<ol style="list-style-type: none"> <li>Style number</li> <li>Fabric color number for stool</li> <li>Paint color number for base</li> <li>Color number for glides</li> <li>Options, if selected (see below)</li> </ol> <ul style="list-style-type: none"> <li>▶ See <i>Surface Materials</i>, page 242.</li> </ul>

Options	U.S. Price	Required to Specify
<b>Surface Materials</b>		
<b>Upholstery</b> <ul style="list-style-type: none"> <li>Customer's Own Material (COM)                             <ul style="list-style-type: none"> <li>Fabric price group 1</li> <li>Fabric price group 2</li> <li>Fabric price group 3</li> <li>Fabric price group 4</li> <li>Fabric price group 5</li> <li>Fabric price group 6</li> </ul> </li> <li>Customer's Own Leather (COL)                             <ul style="list-style-type: none"> <li>Fabric price group 7</li> <li>Fabric price group 8</li> <li>Fabric price group 9</li> <li>Fabric price group 10</li> <li>Leather price group 1</li> <li>Leather price group 2</li> </ul> </li> </ul>	<ul style="list-style-type: none"> <li>No cost</li> <li>No cost</li> <li>+\$ 5</li> <li>+\$ 34</li> <li>+\$ 63</li> <li>+\$140</li> <li>+\$166</li> <li>+\$214</li> <li>+\$231</li> <li>+\$300</li> <li>+\$354</li> <li>+\$435</li> <li>+\$476</li> <li>+\$587</li> </ul>	<ul style="list-style-type: none"> <li>▶ See <i>Surface Materials Reference Manual</i>. Specify fabric color number.</li> <li>Specify fabric color number.</li> <li>Specify fabric color number.</li> <li>Specify fabric color number.</li> <li>Specify fabric color number.</li> <li>Specify fabric color number.</li> <li>▶ See <i>Surface Materials Reference Manual</i>. Specify fabric color number.</li> <li>Specify fabric color number.</li> <li>Specify fabric color number.</li> <li>Specify fabric color number.</li> <li>Specify leather color number.</li> <li>Specify leather color number.</li> </ul>
<b>Base</b> <ul style="list-style-type: none"> <li>Paint price group 1</li> <li>Paint price group 2</li> <li>Paint price group 3</li> </ul>	<ul style="list-style-type: none"> <li>No cost</li> <li>+\$ 44</li> <li>+\$ 90</li> </ul>	<ul style="list-style-type: none"> <li>Specify paint color number.</li> <li>Specify paint color number.</li> <li>Specify paint color number.</li> </ul>
<b>Vertical Seam</b> <ul style="list-style-type: none"> <li>Without seam</li> <li>With seam</li> </ul>	<ul style="list-style-type: none"> <li>No cost</li> <li>+\$ 12</li> </ul>	<ul style="list-style-type: none"> <li>Specify <i>without seam</i>.</li> <li>Specify <i>with seam</i>.</li> </ul>

Specification Information	
Style Number	U.S. Base Price
WESSLPSC	\$1187

 **For Canadian Pricing**  
 Multiply U.S. Price by the Canadian price factor.  
 ▶ See page 1 for details.

# Slope Bar-Height Stool

Slope Bar-Height Stool

Slope

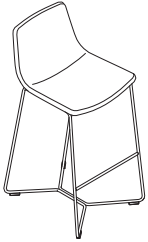

*Tip: Upholstery and paint available on Steelcase Slope. Licensed Slope (stocked) bar height stool is only available in saddle with hot rolled steel frame.*

Standard Includes		Required to Specify
▶ Need help? Product details, page 34	<ul style="list-style-type: none"> <li>Fully upholstered seat with back: fabric price group 1</li> <li>Wire frame base: paint price group 1</li> <li>Glides:                             <ul style="list-style-type: none"> <li>Natural</li> <li>Black</li> </ul> </li> <li>Requires assembly</li> </ul>	<ul style="list-style-type: none"> <li>1 Style number</li> <li>2 Fabric color number for stool</li> <li>3 Paint color number for base</li> <li>4 Color number for glides</li> <li>5 Options, if selected (see below)</li> </ul> <p>▶ See <i>Surface Materials</i>, page 242.</p>

Options	U.S. Price	Required to Specify
<b>Surface Materials</b>	<b>Upholstery</b> <ul style="list-style-type: none"> <li>Customer's Own Material (COM) No cost</li> <li>Fabric price group 1 No cost</li> <li>Fabric price group 2 +\$ 5</li> <li>Fabric price group 3 +\$ 34</li> <li>Fabric price group 4 +\$ 63</li> <li>Fabric price group 5 +\$140</li> <li>Fabric price group 6 +\$166</li> <li>Customer's Own Leather (COL) +\$214</li> <li>Fabric price group 7 +\$231</li> <li>Fabric price group 8 +\$300</li> <li>Fabric price group 9 +\$354</li> <li>Fabric price group 10 +\$435</li> <li>Leather price group 1 +\$476</li> <li>Leather price group 2 +\$587</li> </ul>	<ul style="list-style-type: none"> <li>▶ See <i>Surface Materials Reference Manual</i>. Specify fabric color number.</li> <li>Specify fabric color number.</li> <li>Specify fabric color number.</li> <li>Specify fabric color number.</li> <li>Specify fabric color number.</li> <li>Specify fabric color number.</li> <li>▶ See <i>Surface Materials Reference Manual</i>. Specify fabric color number.</li> <li>Specify fabric color number.</li> <li>Specify fabric color number.</li> <li>Specify fabric color number.</li> <li>Specify leather color number.</li> <li>Specify leather color number.</li> </ul>
	<b>Base</b> <ul style="list-style-type: none"> <li>Paint price group 1 No cost</li> <li>Paint price group 2 +\$ 44</li> <li>Paint price group 3 +\$ 90</li> </ul>	<ul style="list-style-type: none"> <li>Specify paint color number.</li> <li>Specify paint color number.</li> <li>Specify paint color number.</li> </ul>
<b>Vertical Seam</b>	<ul style="list-style-type: none"> <li>Without seam No cost</li> <li>With seam +\$ 12</li> </ul>	<ul style="list-style-type: none"> <li>Specify <i>without seam</i>.</li> <li>Specify <i>with seam</i>.</li> </ul>

Specification Information	
Style Number	U.S. Base Price
WESSLPSB	\$1242

 **For Canadian Pricing**  
 Multiply U.S. Price by the Canadian price factor.  
 ▶ See page 1 for details.

# Slope Height-Adjustable Conference Chair

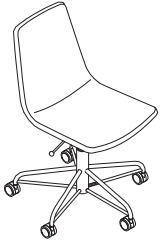

Tip: Upholstery and paint available on Steelcase Slope. Licensed Slope (stocked) conference chair only available in saddle and fog with hot rolled steel frame.

Standard Includes		Required to Specify
<ul style="list-style-type: none"> <li>▶ Need help? Product details, page 34</li> </ul>	<ul style="list-style-type: none"> <li>Fully upholstered seat with back: fabric price group 1</li> <li>Five-star adjustable base: hot-rolled steel finish</li> <li>Hard casters: 6205 Black</li> <li>Requires assembly</li> </ul>	<ol style="list-style-type: none"> <li>1 Style number</li> <li>2 Fabric color number for chair</li> <li>3 Options, if selected (see below)</li> </ol> <ul style="list-style-type: none"> <li>▶ See <i>Surface Materials</i>, page 242.</li> </ul>

Options	U.S. Price	Required to Specify
<b>Surface Materials</b>	<b>Upholstery</b> <ul style="list-style-type: none"> <li>Customer's Own Material (COM) No cost</li> <li>Fabric price group 1 No cost</li> <li>Fabric price group 2 +\$ 5</li> <li>Fabric price group 3 +\$ 34</li> <li>Fabric price group 4 +\$ 63</li> <li>Fabric price group 5 +\$140</li> <li>Fabric price group 6 +\$166</li> <li>Customer's Own Leather (COL) +\$214</li> <li>Fabric price group 7 +\$231</li> <li>Fabric price group 8 +\$300</li> <li>Fabric price group 9 +\$354</li> <li>Fabric price group 10 +\$435</li> <li>Leather price group 1 +\$476</li> <li>Leather price group 2 +\$587</li> </ul>	<ul style="list-style-type: none"> <li>▶ See <i>Surface Materials Reference Manual</i>. Specify fabric color number.</li> <li>Specify fabric color number.</li> <li>Specify fabric color number.</li> <li>Specify fabric color number.</li> <li>Specify fabric color number.</li> <li>Specify fabric color number.</li> <li>▶ See <i>Surface Materials Reference Manual</i>. Specify fabric color number.</li> <li>Specify fabric color number.</li> <li>Specify fabric color number.</li> <li>Specify fabric color number.</li> <li>Specify fabric color number.</li> <li>Specify leather color number.</li> <li>Specify leather color number.</li> </ul>
<b>Vertical Seam</b> <ul style="list-style-type: none"> <li>Without seam</li> <li>With seam</li> </ul>	<ul style="list-style-type: none"> <li>No cost</li> <li>+\$ 12</li> </ul>	<ul style="list-style-type: none"> <li>Specify <i>without seam</i>.</li> <li>Specify <i>with seam</i>.</li> </ul>
<b>Arm Type</b> <ul style="list-style-type: none"> <li>Without arm</li> <li>With arm</li> </ul>	<ul style="list-style-type: none"> <li>No cost</li> <li>+\$173</li> </ul>	<ul style="list-style-type: none"> <li>Specify <i>without arm</i>.</li> <li>Specify <i>with arm</i>.</li> </ul>
<b>Caster</b> <ul style="list-style-type: none"> <li>Hard casters</li> <li>Soft casters</li> </ul>	<ul style="list-style-type: none"> <li>No cost</li> <li>+\$ 38</li> </ul>	<ul style="list-style-type: none"> <li>Specify <i>with hard casters</i>.</li> <li>Specify <i>with soft casters</i>.</li> </ul>

Specification Information	
Style Number	U.S. Base Price
WESSLPCC	\$1300

 **For Canadian Pricing**  
 Multiply U.S. Price by the Canadian price factor.  
 ▶ See page 1 for details.



# Sterling 4-Legs Armless Guest Chair

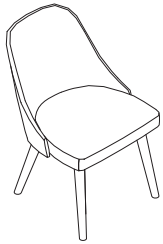

Standard Includes		Required to Specify
<ul style="list-style-type: none"> <li>▶ Need help? Product details, page 38</li> </ul>	<ul style="list-style-type: none"> <li>Fully upholstered non-contrasting seat with back: fabric price group 1</li> <li>Legs (base): veneer price group 1</li> <li>Glides: plastic</li> </ul>	<ol style="list-style-type: none"> <li>Style number</li> <li>Fabric color number for chair</li> <li>Wood color number for legs (base)</li> <li>Plastic color number for glides</li> <li>Options, if selected (see below)</li> </ol> <ul style="list-style-type: none"> <li>▶ See <i>Surface Materials</i>, page 242.</li> </ul>

Options	U.S. Price	Required to Specify
<b>Color Scheme</b> <ul style="list-style-type: none"> <li>Non contrasting</li> <li>Contrasting</li> </ul>	No cost +\$191	Specify <i>with non contrasting</i> . Specify <i>with contrasting</i> .
<b>Surface Materials</b>		
<b>Back</b> <ul style="list-style-type: none"> <li>Customer's Own Material (COM)</li> <li>Fabric price group 1</li> <li>Fabric price group 2</li> <li>Vinyl price group 2</li> <li>Fabric price group 3</li> <li>Fabric price group 4</li> <li>Customer's Own Leather (COL)</li> <li>Fabric price group 5</li> <li>Fabric price group 6</li> <li>Fabric price group 7</li> <li>Fabric price group 8</li> <li>Fabric price group 9</li> <li>Fabric price group 10</li> <li>Leather price group 1</li> <li>Leather price group 2</li> </ul>	No cost No cost +\$ 5 +\$ 5 +\$ 39 +\$ 80 +\$109 +\$173 +\$206 +\$287 +\$372 +\$442 +\$543 +\$592 +\$730	<ul style="list-style-type: none"> <li>▶ See <i>Surface Materials Reference Manual</i>. Specify fabric color number.</li> <li>Specify fabric color number.</li> <li>Specify vinyl color number.</li> <li>Specify fabric color number.</li> <li>Specify fabric color number.</li> <li>▶ See <i>Surface Materials Reference Manual</i>. Specify fabric color number.</li> <li>Specify fabric color number.</li> <li>Specify fabric color number.</li> <li>Specify fabric color number.</li> <li>Specify fabric color number.</li> <li>Specify fabric color number.</li> <li>Specify fabric color number.</li> <li>Specify leather color number.</li> <li>Specify leather color number.</li> </ul>
<b>Seat</b> <ul style="list-style-type: none"> <li>Customer's Own Material (COM)</li> <li>Fabric price group 1</li> <li>Fabric price group 2</li> <li>Vinyl price group 2</li> <li>Fabric price group 3</li> <li>Fabric price group 4</li> <li>Customer's Own Leather (COL)</li> <li>Fabric price group 5</li> <li>Fabric price group 6</li> <li>Fabric price group 7</li> <li>Fabric price group 8</li> <li>Fabric price group 9</li> <li>Fabric price group 10</li> <li>Leather price group 1</li> <li>Leather price group 2</li> </ul>	No cost No cost +\$ 5 +\$ 5 +\$ 34 +\$ 63 +\$109 +\$140 +\$166 +\$231 +\$300 +\$354 +\$435 +\$476 +\$587	<ul style="list-style-type: none"> <li>▶ See <i>Surface Materials Reference Manual</i>. Specify fabric color number.</li> <li>Specify fabric color number.</li> <li>Specify vinyl color number.</li> <li>Specify fabric color number.</li> <li>Specify fabric color number.</li> <li>▶ See <i>Surface Materials Reference Manual</i>. Specify fabric color number.</li> <li>Specify fabric color number.</li> <li>Specify fabric color number.</li> <li>Specify fabric color number.</li> <li>Specify fabric color number.</li> <li>Specify fabric color number.</li> <li>Specify fabric color number.</li> <li>Specify leather color number.</li> <li>Specify leather color number.</li> </ul>
<b>Base</b> <ul style="list-style-type: none"> <li>Customiz stain</li> <li>Veneer price group 1</li> <li>Veneer price group 2</li> </ul>	No cost No cost +\$ 44	Specify <i>with Customiz stain</i> . ▶ See <i>Surface Materials Reference Manual</i> . Specify wood color number. Specify wood color number.

Specification Information	
Style Number	U.S. Base Price
WESMDC4NA	\$1197

**For Canadian Pricing**  
 Multiply U.S. Price by the Canadian price factor.  
 ▶ See page 1 for details.

# Sterling 4-Legs with Arms Guest Chair

Sterling 4-Legs with Arms  
Guest Chair

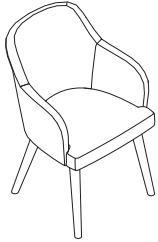

Standard Includes		Required to Specify
<ul style="list-style-type: none"> <li>▶ Need help? Product details, page 38</li> </ul>	<ul style="list-style-type: none"> <li>Fully upholstered non-contrasting seat with back: fabric price group 1</li> <li>Legs (base): veneer price group 1</li> <li>Glides: plastic</li> </ul>	<ol style="list-style-type: none"> <li>Style number</li> <li>Fabric color number for chair</li> <li>Wood color number for legs (base)</li> <li>Plastic color number for glides</li> <li>Options, if selected (see below)</li> </ol> <ul style="list-style-type: none"> <li>▶ See <i>Surface Materials</i>, page 242.</li> </ul>

Options	U.S. Price	Required to Specify
<b>Color Scheme</b>		
<ul style="list-style-type: none"> <li>Non contrasting</li> <li>Contrasting</li> </ul>	<p>No cost</p> <p>+\$191</p>	<p>Specify <i>with non contrasting</i>.</p> <p>Specify <i>with contrasting</i>.</p>
<b>Surface Materials</b>		
<b>Back</b>		
<ul style="list-style-type: none"> <li>Customer's Own Material (COM)</li> <li>Fabric price group 1</li> <li>Fabric price group 2</li> <li>Vinyl price group 2</li> <li>Fabric price group 3</li> <li>Fabric price group 4</li> <li>Customer's Own Leather (COL)</li> <li>Fabric price group 5</li> <li>Fabric price group 6</li> <li>Fabric price group 7</li> <li>Fabric price group 8</li> <li>Fabric price group 9</li> <li>Fabric price group 10</li> <li>Leather price group 1</li> <li>Leather price group 2</li> </ul>	<p>No cost</p> <p>No cost</p> <p>+\$ 8</p> <p>+\$ 8</p> <p>+\$ 50</p> <p>+\$ 94</p> <p>+\$109</p> <p>+\$211</p> <p>+\$250</p> <p>+\$345</p> <p>+\$448</p> <p>+\$532</p> <p>+\$650</p> <p>+\$712</p> <p>+\$878</p>	<ul style="list-style-type: none"> <li>▶ See <i>Surface Materials Reference Manual</i>. Specify fabric color number.</li> <li>Specify fabric color number.</li> <li>Specify vinyl color number.</li> <li>Specify fabric color number.</li> <li>Specify fabric color number.</li> <li>▶ See <i>Surface Materials Reference Manual</i>. Specify fabric color number.</li> <li>Specify fabric color number.</li> <li>Specify fabric color number.</li> <li>Specify fabric color number.</li> <li>Specify fabric color number.</li> <li>Specify fabric color number.</li> <li>Specify fabric color number.</li> <li>Specify leather color number.</li> <li>Specify leather color number.</li> </ul>
<b>Seat</b>		
<ul style="list-style-type: none"> <li>Customer's Own Material (COM)</li> <li>Fabric price group 1</li> <li>Fabric price group 2</li> <li>Vinyl price group 2</li> <li>Fabric price group 3</li> <li>Fabric price group 4</li> <li>Customer's Own Leather (COL)</li> <li>Fabric price group 5</li> <li>Fabric price group 6</li> <li>Fabric price group 7</li> <li>Fabric price group 8</li> <li>Fabric price group 9</li> <li>Fabric price group 10</li> <li>Leather price group 1</li> <li>Leather price group 2</li> </ul>	<p>No cost</p> <p>No cost</p> <p>+\$ 5</p> <p>+\$ 5</p> <p>+\$ 34</p> <p>+\$ 63</p> <p>+\$109</p> <p>+\$140</p> <p>+\$166</p> <p>+\$231</p> <p>+\$300</p> <p>+\$354</p> <p>+\$435</p> <p>+\$476</p> <p>+\$587</p>	<ul style="list-style-type: none"> <li>▶ See <i>Surface Materials Reference Manual</i>. Specify fabric color number.</li> <li>Specify fabric color number.</li> <li>Specify vinyl color number.</li> <li>Specify fabric color number.</li> <li>Specify fabric color number.</li> <li>▶ See <i>Surface Materials Reference Manual</i>. Specify fabric color number.</li> <li>Specify fabric color number.</li> <li>Specify fabric color number.</li> <li>Specify fabric color number.</li> <li>Specify fabric color number.</li> <li>Specify fabric color number.</li> <li>Specify fabric color number.</li> <li>Specify leather color number.</li> <li>Specify leather color number.</li> </ul>
<b>Base</b>		
<ul style="list-style-type: none"> <li>Customiz stain</li> <li>Veneer price group 1</li> <li>Veneer price group 2</li> </ul>	<p>No cost</p> <p>No cost</p> <p>+\$ 44</p>	<p>Specify <i>with Customiz stain</i>.</p> <ul style="list-style-type: none"> <li>▶ See <i>Surface Materials Reference Manual</i>. Specify wood color number.</li> <li>Specify wood color number.</li> </ul>

Specification Information	
Style Number	U.S. Base Price
WESMDC4WA	\$1337

 **For Canadian Pricing**  
Multiply U.S. Price by the Canadian price factor.  
▶ See page 1 for details.

Sterling

# Sterling Armless Counter-Height Stool



Standard Includes		Required to Specify
<ul style="list-style-type: none"> <li>▶ Need help? Product details, page 38</li> </ul>	<ul style="list-style-type: none"> <li>Fully upholstered non-contrasting seat with back: fabric price group 1</li> <li>Legs (base): veneer price group 1</li> <li>Glides: plastic</li> </ul>	<ol style="list-style-type: none"> <li>Style number</li> <li>Fabric color number for chair</li> <li>Wood color number for legs (base)</li> <li>Plastic color number for glides</li> <li>Options, if selected (see below)</li> </ol> <ul style="list-style-type: none"> <li>▶ See <i>Surface Materials</i>, page 242.</li> </ul>

Options	U.S. Price	Required to Specify
<b>Color Scheme</b>		
<ul style="list-style-type: none"> <li>Non contrasting</li> <li>Contrasting</li> </ul>	<ul style="list-style-type: none"> <li>No cost</li> <li>+\$191</li> </ul>	<ul style="list-style-type: none"> <li>Specify <i>with non contrasting</i>.</li> <li>Specify <i>with contrasting</i>.</li> </ul>
<b>Surface Materials</b>		
<b>Back</b>		
<ul style="list-style-type: none"> <li>Customer's Own Material (COM)</li> <li>Fabric price group 1</li> <li>Fabric price group 2</li> <li>Vinyl price group 2</li> <li>Fabric price group 3</li> <li>Fabric price group 4</li> <li>Customer's Own Leather (COL)</li> <li>Fabric price group 5</li> <li>Fabric price group 6</li> <li>Fabric price group 7</li> <li>Fabric price group 8</li> <li>Fabric price group 9</li> <li>Fabric price group 10</li> <li>Leather price group 1</li> <li>Leather price group 2</li> </ul>	<ul style="list-style-type: none"> <li>No cost</li> <li>No cost</li> <li>+\$ 5</li> <li>+\$ 5</li> <li>+\$ 39</li> <li>+\$ 80</li> <li>+\$109</li> <li>+\$173</li> <li>+\$206</li> <li>+\$287</li> <li>+\$372</li> <li>+\$442</li> <li>+\$543</li> <li>+\$592</li> <li>+\$730</li> </ul>	<ul style="list-style-type: none"> <li>▶ See <i>Surface Materials Reference Manual</i>. Specify fabric color number.</li> <li>Specify fabric color number.</li> <li>Specify vinyl color number.</li> <li>Specify fabric color number.</li> <li>Specify fabric color number.</li> <li>▶ See <i>Surface Materials Reference Manual</i>. Specify fabric color number.</li> <li>Specify fabric color number.</li> <li>Specify fabric color number.</li> <li>Specify fabric color number.</li> <li>Specify fabric color number.</li> <li>Specify fabric color number.</li> <li>Specify fabric color number.</li> <li>Specify leather color number.</li> <li>Specify leather color number.</li> </ul>
<b>Seat</b>		
<ul style="list-style-type: none"> <li>Customer's Own Material (COM)</li> <li>Fabric price group 1</li> <li>Fabric price group 2</li> <li>Vinyl price group 2</li> <li>Fabric price group 3</li> <li>Fabric price group 4</li> <li>Customer's Own Leather (COL)</li> <li>Fabric price group 5</li> <li>Fabric price group 6</li> <li>Fabric price group 7</li> <li>Fabric price group 8</li> <li>Fabric price group 9</li> <li>Fabric price group 10</li> <li>Leather price group 1</li> <li>Leather price group 2</li> </ul>	<ul style="list-style-type: none"> <li>No cost</li> <li>No cost</li> <li>+\$ 5</li> <li>+\$ 5</li> <li>+\$ 34</li> <li>+\$ 63</li> <li>+\$109</li> <li>+\$140</li> <li>+\$166</li> <li>+\$231</li> <li>+\$300</li> <li>+\$354</li> <li>+\$435</li> <li>+\$476</li> <li>+\$587</li> </ul>	<ul style="list-style-type: none"> <li>▶ See <i>Surface Materials Reference Manual</i>. Specify fabric color number.</li> <li>Specify fabric color number.</li> <li>Specify vinyl color number.</li> <li>Specify fabric color number.</li> <li>Specify fabric color number.</li> <li>▶ See <i>Surface Materials Reference Manual</i>. Specify fabric color number.</li> <li>Specify fabric color number.</li> <li>Specify fabric color number.</li> <li>Specify fabric color number.</li> <li>Specify fabric color number.</li> <li>Specify fabric color number.</li> <li>Specify fabric color number.</li> <li>Specify leather color number.</li> <li>Specify leather color number.</li> </ul>
<b>Base</b>		
<ul style="list-style-type: none"> <li>Customiz stain</li> <li>Veneer price group 1</li> <li>Veneer price group 2</li> </ul>	<ul style="list-style-type: none"> <li>No cost</li> <li>No cost</li> <li>+\$ 63</li> </ul>	<ul style="list-style-type: none"> <li>Specify <i>with Customiz stain</i>.</li> <li>▶ See <i>Surface Materials Reference Manual</i>. Specify wood color number.</li> <li>Specify wood color number.</li> </ul>

Specification Information	
Style Number	U.S. Base Price
WESMDCSCHNA	\$1422

 **For Canadian Pricing**  
 Multiply U.S. Price by the Canadian price factor.  
 ▶ See page 1 for details.

# Sterling Armless Bar-Height Stool

Sterling Armless Bar-Height Stool

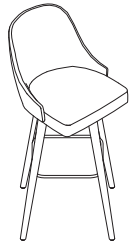

Standard Includes		Required to Specify
▶ Need help? Product details, page 38	<ul style="list-style-type: none"> <li>Fully upholstered non-contrasting seat with back: fabric price group 1</li> <li>Legs (base): veneer price group 1</li> <li>Glides: plastic</li> </ul>	<ol style="list-style-type: none"> <li>Style number</li> <li>Fabric color number for chair</li> <li>Wood color number for legs (base)</li> <li>Plastic color number for glides</li> <li>Options, if selected (see below)</li> </ol> <p>▶ See <i>Surface Materials</i>, page 242.</p>

Options	U.S. Price	Required to Specify																																																																																
<b>Color Scheme</b>	<ul style="list-style-type: none"> <li>Non contrasting</li> <li>Contrasting+\$191</li> </ul>	No cost Specify with <i>non contrasting</i> . Specify with <i>contrasting</i> .																																																																																
<b>Surface Materials</b>	<table border="0"> <thead> <tr> <th>Back</th> <th>U.S. Price</th> <th>Required to Specify</th> </tr> </thead> <tbody> <tr> <td>Customer's Own Material (COM)</td> <td>No cost</td> <td rowspan="10">▶ See <i>Surface Materials Reference Manual</i>. Specify fabric color number.</td> </tr> <tr> <td>Fabric price group 1</td> <td>No cost</td> </tr> <tr> <td>Fabric price group 2</td> <td>+\$ 5</td> </tr> <tr> <td>Vinyl price group 2</td> <td>+\$ 5</td> </tr> <tr> <td>Fabric price group 3</td> <td>+\$ 39</td> </tr> <tr> <td>Fabric price group 4</td> <td>+\$ 80</td> </tr> <tr> <td>Customer's Own Leather (COL)</td> <td>+\$109</td> </tr> <tr> <td>Fabric price group 5</td> <td>+\$173</td> </tr> <tr> <td>Fabric price group 6</td> <td>+\$206</td> </tr> <tr> <td>Fabric price group 7</td> <td>+\$287</td> </tr> <tr> <td>Fabric price group 8</td> <td>+\$372</td> <td rowspan="10">▶ See <i>Surface Materials Reference Manual</i>. Specify fabric color number.</td> </tr> <tr> <td>Fabric price group 9</td> <td>+\$442</td> </tr> <tr> <td>Fabric price group 10</td> <td>+\$543</td> </tr> <tr> <td>Leather price group 1</td> <td>+\$592</td> </tr> <tr> <td>Leather price group 2</td> <td>+\$730</td> </tr> <tr> <td colspan="3"><b>Seat</b></td> </tr> <tr> <td>Customer's Own Material (COM)</td> <td>No cost</td> <td rowspan="10">▶ See <i>Surface Materials Reference Manual</i>. Specify fabric color number.</td> </tr> <tr> <td>Fabric price group 1</td> <td>No cost</td> </tr> <tr> <td>Fabric price group 2</td> <td>+\$ 5</td> </tr> <tr> <td>Vinyl price group 2</td> <td>+\$ 5</td> </tr> <tr> <td>Fabric price group 3</td> <td>+\$ 34</td> </tr> <tr> <td>Fabric price group 4</td> <td>+\$ 63</td> </tr> <tr> <td>Customer's Own Leather (COL)</td> <td>+\$109</td> </tr> <tr> <td>Fabric price group 5</td> <td>+\$140</td> </tr> <tr> <td>Fabric price group 6</td> <td>+\$166</td> </tr> <tr> <td>Fabric price group 7</td> <td>+\$231</td> </tr> <tr> <td>Fabric price group 8</td> <td>+\$300</td> <td rowspan="10">▶ See <i>Surface Materials Reference Manual</i>. Specify fabric color number.</td> </tr> <tr> <td>Fabric price group 9</td> <td>+\$354</td> </tr> <tr> <td>Fabric price group 10</td> <td>+\$435</td> </tr> <tr> <td>Leather price group 1</td> <td>+\$476</td> </tr> <tr> <td>Leather price group 2</td> <td>+\$587</td> </tr> <tr> <td colspan="3"><b>Base</b></td> </tr> <tr> <td>Customiz stain</td> <td>No cost</td> <td rowspan="2">Specify with <i>Customiz stain</i>. ▶ See <i>Surface Materials Reference Manual</i>. Specify wood color number.</td> </tr> <tr> <td>Veneer price group 1</td> <td>No cost</td> </tr> <tr> <td>Veneer price group 2</td> <td>+\$ 63</td> <td></td> </tr> </tbody> </table>	Back	U.S. Price	Required to Specify	Customer's Own Material (COM)	No cost	▶ See <i>Surface Materials Reference Manual</i> . Specify fabric color number.	Fabric price group 1	No cost	Fabric price group 2	+\$ 5	Vinyl price group 2	+\$ 5	Fabric price group 3	+\$ 39	Fabric price group 4	+\$ 80	Customer's Own Leather (COL)	+\$109	Fabric price group 5	+\$173	Fabric price group 6	+\$206	Fabric price group 7	+\$287	Fabric price group 8	+\$372	▶ See <i>Surface Materials Reference Manual</i> . Specify fabric color number.	Fabric price group 9	+\$442	Fabric price group 10	+\$543	Leather price group 1	+\$592	Leather price group 2	+\$730	<b>Seat</b>			Customer's Own Material (COM)	No cost	▶ See <i>Surface Materials Reference Manual</i> . Specify fabric color number.	Fabric price group 1	No cost	Fabric price group 2	+\$ 5	Vinyl price group 2	+\$ 5	Fabric price group 3	+\$ 34	Fabric price group 4	+\$ 63	Customer's Own Leather (COL)	+\$109	Fabric price group 5	+\$140	Fabric price group 6	+\$166	Fabric price group 7	+\$231	Fabric price group 8	+\$300	▶ See <i>Surface Materials Reference Manual</i> . Specify fabric color number.	Fabric price group 9	+\$354	Fabric price group 10	+\$435	Leather price group 1	+\$476	Leather price group 2	+\$587	<b>Base</b>			Customiz stain	No cost	Specify with <i>Customiz stain</i> . ▶ See <i>Surface Materials Reference Manual</i> . Specify wood color number.	Veneer price group 1	No cost	Veneer price group 2	+\$ 63	
Back	U.S. Price	Required to Specify																																																																																
Customer's Own Material (COM)	No cost	▶ See <i>Surface Materials Reference Manual</i> . Specify fabric color number.																																																																																
Fabric price group 1	No cost																																																																																	
Fabric price group 2	+\$ 5																																																																																	
Vinyl price group 2	+\$ 5																																																																																	
Fabric price group 3	+\$ 39																																																																																	
Fabric price group 4	+\$ 80																																																																																	
Customer's Own Leather (COL)	+\$109																																																																																	
Fabric price group 5	+\$173																																																																																	
Fabric price group 6	+\$206																																																																																	
Fabric price group 7	+\$287																																																																																	
Fabric price group 8	+\$372	▶ See <i>Surface Materials Reference Manual</i> . Specify fabric color number.																																																																																
Fabric price group 9	+\$442																																																																																	
Fabric price group 10	+\$543																																																																																	
Leather price group 1	+\$592																																																																																	
Leather price group 2	+\$730																																																																																	
<b>Seat</b>																																																																																		
Customer's Own Material (COM)	No cost		▶ See <i>Surface Materials Reference Manual</i> . Specify fabric color number.																																																																															
Fabric price group 1	No cost																																																																																	
Fabric price group 2	+\$ 5																																																																																	
Vinyl price group 2	+\$ 5																																																																																	
Fabric price group 3	+\$ 34																																																																																	
Fabric price group 4	+\$ 63																																																																																	
Customer's Own Leather (COL)	+\$109																																																																																	
Fabric price group 5	+\$140																																																																																	
Fabric price group 6	+\$166																																																																																	
Fabric price group 7	+\$231																																																																																	
Fabric price group 8	+\$300	▶ See <i>Surface Materials Reference Manual</i> . Specify fabric color number.																																																																																
Fabric price group 9	+\$354																																																																																	
Fabric price group 10	+\$435																																																																																	
Leather price group 1	+\$476																																																																																	
Leather price group 2	+\$587																																																																																	
<b>Base</b>																																																																																		
Customiz stain	No cost		Specify with <i>Customiz stain</i> . ▶ See <i>Surface Materials Reference Manual</i> . Specify wood color number.																																																																															
Veneer price group 1	No cost																																																																																	
Veneer price group 2	+\$ 63																																																																																	

Specification Information	
Style Number	U.S. Base Price
WESMDCSBHNA	\$1547

 **For Canadian Pricing**  
 Multiply U.S. Price by the Canadian price factor.  
 ▶ See page 1 for details.

# Sterling Armless 5-Star Conference Chair



Standard Includes		Required to Specify
<ul style="list-style-type: none"> <li>▶ Need help? Product details, page 38</li> </ul>	<ul style="list-style-type: none"> <li>Fully upholstered seat with back: fabric price group 1</li> <li>Five-star adjustable base: hot-rolled steel finish</li> <li>Hard casters: 6205 Black</li> </ul>	<ol style="list-style-type: none"> <li>Style number</li> <li>Fabric color number for chair</li> <li>Paint color number for base</li> <li>Options, if selected (see below)</li> </ol> <ul style="list-style-type: none"> <li>▶ See <i>Surface Materials</i>, page 242.</li> </ul>

Options	U.S. Price	Required to Specify
<b>Color Scheme</b>		
<ul style="list-style-type: none"> <li>Non contrasting</li> <li>Contrasting</li> </ul>	<ul style="list-style-type: none"> <li>No cost</li> <li>+\$191</li> </ul>	<ul style="list-style-type: none"> <li>Specify <i>with non contrasting</i>.</li> <li>Specify <i>with contrasting</i>.</li> </ul>

Surface Materials	Back	U.S. Price	Required to Specify
	<ul style="list-style-type: none"> <li>Customer's Own Material (COM)</li> <li>Fabric price group 1</li> <li>Fabric price group 2</li> <li>Vinyl price group 2</li> <li>Fabric price group 3</li> <li>Fabric price group 4</li> <li>Customer's Own Leather (COL)</li> <li>Fabric price group 5</li> <li>Fabric price group 6</li> <li>Fabric price group 7</li> <li>Fabric price group 8</li> <li>Fabric price group 9</li> <li>Fabric price group 10</li> <li>Leather price group 1</li> <li>Leather price group 2</li> </ul>	<ul style="list-style-type: none"> <li>No cost</li> <li>No cost</li> <li>+\$ 5</li> <li>+\$ 5</li> <li>+\$ 39</li> <li>+\$ 80</li> <li>+\$109</li> <li>+\$173</li> <li>+\$206</li> <li>+\$287</li> <li>+\$372</li> <li>+\$442</li> <li>+\$543</li> <li>+\$592</li> <li>+\$730</li> </ul>	<ul style="list-style-type: none"> <li>▶ See <i>Surface Materials Reference Manual</i>. Specify fabric color number.</li> <li>Specify fabric color number.</li> <li>Specify vinyl color number.</li> <li>Specify fabric color number.</li> <li>Specify fabric color number.</li> <li>▶ See <i>Surface Materials Reference Manual</i>. Specify fabric color number.</li> <li>Specify fabric color number.</li> <li>Specify fabric color number.</li> <li>Specify fabric color number.</li> <li>Specify fabric color number.</li> <li>Specify fabric color number.</li> <li>Specify fabric color number.</li> <li>Specify leather color number.</li> <li>Specify leather color number.</li> </ul>

	Seat	U.S. Price	Required to Specify
	<ul style="list-style-type: none"> <li>Customer's Own Material (COM)</li> <li>Fabric price group 1</li> <li>Fabric price group 2</li> <li>Vinyl price group 2</li> <li>Fabric price group 3</li> <li>Fabric price group 4</li> <li>Customer's Own Leather (COL)</li> <li>Fabric price group 5</li> <li>Fabric price group 6</li> <li>Fabric price group 7</li> <li>Fabric price group 8</li> <li>Fabric price group 9</li> <li>Fabric price group 10</li> <li>Leather price group 1</li> <li>Leather price group 2</li> </ul>	<ul style="list-style-type: none"> <li>No cost</li> <li>No cost</li> <li>+\$ 5</li> <li>+\$ 5</li> <li>+\$ 34</li> <li>+\$ 63</li> <li>+\$109</li> <li>+\$140</li> <li>+\$166</li> <li>+\$231</li> <li>+\$300</li> <li>+\$354</li> <li>+\$435</li> <li>+\$476</li> <li>+\$587</li> </ul>	<ul style="list-style-type: none"> <li>▶ See <i>Surface Materials Reference Manual</i>. Specify fabric color number.</li> <li>Specify fabric color number.</li> <li>Specify vinyl color number.</li> <li>Specify fabric color number.</li> <li>Specify fabric color number.</li> <li>▶ See <i>Surface Materials Reference Manual</i>. Specify fabric color number.</li> <li>Specify fabric color number.</li> <li>Specify fabric color number.</li> <li>Specify fabric color number.</li> <li>Specify fabric color number.</li> <li>Specify fabric color number.</li> <li>Specify fabric color number.</li> <li>Specify leather color number.</li> <li>Specify leather color number.</li> </ul>

	Base	U.S. Price	Required to Specify
	<ul style="list-style-type: none"> <li>Paint price group 1</li> <li>Paint price group 2</li> <li>Paint price group 3</li> <li>Polished aluminum</li> </ul>	<ul style="list-style-type: none"> <li>No cost</li> <li>+\$ 44</li> <li>+\$ 90</li> <li>+\$136</li> </ul>	<ul style="list-style-type: none"> <li>Specify paint color number.</li> <li>Specify paint color number.</li> <li>Specify paint color number.</li> <li>Specify <i>with polished aluminum</i>.</li> </ul>

	Caster	U.S. Price	Required to Specify
	<ul style="list-style-type: none"> <li>Hard casters</li> <li>Soft casters</li> </ul>	<ul style="list-style-type: none"> <li>No cost</li> <li>+\$ 38</li> </ul>	<ul style="list-style-type: none"> <li>Specify <i>with hard casters</i>.</li> <li>Specify <i>with soft casters</i>.</li> </ul>

	Tilt Mechanism	U.S. Price	Required to Specify
	<ul style="list-style-type: none"> <li>Without tilt</li> <li>With tilt</li> </ul>	<ul style="list-style-type: none"> <li>No cost</li> <li>+\$106</li> </ul>	<ul style="list-style-type: none"> <li>Specify <i>without tilt</i>.</li> <li>Specify <i>with tilt</i>.</li> </ul>

Specification Information	
Style Number	U.S. Base Price
WESMDC5NA	\$1349

 **For Canadian Pricing**  
 Multiply U.S. Price by the Canadian price factor.  
 ▶ See page 1 for details.

# Sterling 5-Star Conference Chair With Arms

Sterling 5-Star Conference  
Chair With Arms



Standard Includes		Required to Specify
▶ Need help? Product details, page 38	<ul style="list-style-type: none"> <li>Fully upholstered seat with back: fabric price group 1</li> <li>Five-star adjustable base: hot-rolled steel finish</li> <li>Hard casters: 6205 Black</li> </ul>	1 Style number 2 Fabric color number for chair 3 Paint color number for base 4 Options, if selected (see below) ▶ See <i>Surface Materials</i> , page 242.

	Options	U.S. Price	Required to Specify
<b>Color Scheme</b>	<ul style="list-style-type: none"> <li>Non contrasting</li> <li>Contrasting</li> </ul>	No cost +\$191	Specify <i>with non contrasting</i> . Specify <i>with contrasting</i> .
<b>Surface Materials</b>	<b>Back</b> <ul style="list-style-type: none"> <li>Customer's Own Material (COM)</li> <li>Fabric price group 1</li> <li>Fabric price group 2</li> <li>Vinyl price group 2</li> <li>Fabric price group 3</li> <li>Fabric price group 4</li> <li>Customer's Own Leather (COL)</li> <li>Fabric price group 5</li> <li>Fabric price group 6</li> <li>Fabric price group 7</li> <li>Fabric price group 8</li> <li>Fabric price group 9</li> <li>Fabric price group 10</li> <li>Leather price group 1</li> <li>Leather price group 2</li> </ul>	No cost No cost +\$ 8 +\$ 8 +\$ 50 +\$ 94 +\$109 +\$211 +\$250 +\$345 +\$448 +\$532 +\$650 +\$712 +\$878	▶ See <i>Surface Materials Reference Manual</i> . Specify fabric color number. Specify fabric color number. Specify vinyl color number. Specify fabric color number. Specify fabric color number. ▶ See <i>Surface Materials Reference Manual</i> . Specify fabric color number. Specify fabric color number. Specify fabric color number. Specify fabric color number. Specify fabric color number. Specify fabric color number. Specify fabric color number. Specify leather color number. Specify leather color number.
	<b>Seat</b> <ul style="list-style-type: none"> <li>Customer's Own Material (COM)</li> <li>Fabric price group 1</li> <li>Fabric price group 2</li> <li>Vinyl price group 2</li> <li>Fabric price group 3</li> <li>Fabric price group 4</li> <li>Customer's Own Leather (COL)</li> <li>Fabric price group 5</li> <li>Fabric price group 6</li> <li>Fabric price group 7</li> <li>Fabric price group 8</li> <li>Fabric price group 9</li> <li>Fabric price group 10</li> <li>Leather price group 1</li> <li>Leather price group 2</li> </ul>	No cost No cost +\$ 5 +\$ 5 +\$ 34 +\$ 63 +\$109 +\$140 +\$166 +\$231 +\$300 +\$354 +\$435 +\$476 +\$587	▶ See <i>Surface Materials Reference Manual</i> . Specify fabric color number. Specify fabric color number. Specify vinyl color number. Specify fabric color number. Specify fabric color number. ▶ See <i>Surface Materials Reference Manual</i> . Specify fabric color number. Specify fabric color number. Specify fabric color number. Specify fabric color number. Specify fabric color number. Specify fabric color number. Specify leather color number. Specify leather color number.
	<b>Base</b> <ul style="list-style-type: none"> <li>Paint price group 1</li> <li>Paint price group 2</li> <li>Paint price group 3</li> <li>Polished aluminum</li> </ul>	No cost +\$ 44 +\$ 90 +\$136	Specify paint color number. Specify paint color number. Specify paint color number. Specify <i>with polished aluminum</i> .
<b>Caster</b>	<ul style="list-style-type: none"> <li>Hard casters</li> <li>Soft casters</li> </ul>	No cost +\$ 38	Specify <i>with hard casters</i> . Specify <i>with soft casters</i> .
<b>Tilt Mechanism</b>	<ul style="list-style-type: none"> <li>Without tilt</li> <li>With tilt</li> </ul>	No cost +\$106	Specify <i>without tilt</i> . Specify <i>with tilt</i> .

Specification Information	
• Style Number	• U.S. Base Price
WESMDC5WA	\$1473

 **For Canadian Pricing**  
 Multiply U.S. Price by the Canadian price factor.  
 ▶ See page 1 for details.

Sterling

# Sterling 4-Star Armless Conference Chair

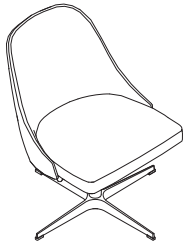

Standard Includes		Required to Specify
<ul style="list-style-type: none"> <li>▶ Need help? Product details, page 38</li> </ul>	<ul style="list-style-type: none"> <li>Fully upholstered seat with back: fabric price group 1</li> <li>Four-star base: 8046 Polished aluminum</li> <li>Glides: plastic</li> </ul>	<ol style="list-style-type: none"> <li>Style number</li> <li>Fabric color number for chair</li> <li>Plastic color number for glides</li> <li>Options, if selected (see below)</li> </ol> <ul style="list-style-type: none"> <li>▶ See <i>Surface Materials</i>, page 242.</li> </ul>

Options	U.S. Price	Required to Specify
<b>Color Scheme</b> <ul style="list-style-type: none"> <li>Non contrasting</li> <li>Contrasting</li> </ul>	No cost +\$191	Specify <i>with non contrasting</i> . Specify <i>with contrasting</i> .

Surface Materials	Back	U.S. Price	Required to Specify
	<ul style="list-style-type: none"> <li>Customer's Own Material (COM)</li> <li>Fabric price group 1</li> <li>Fabric price group 2</li> <li>Vinyl price group 2</li> <li>Fabric price group 3</li> <li>Fabric price group 4</li> <li>Customer's Own Leather (COL)</li> <li>Fabric price group 5</li> <li>Fabric price group 6</li> <li>Fabric price group 7</li> <li>Fabric price group 8</li> <li>Fabric price group 9</li> <li>Fabric price group 10</li> <li>Leather price group 1</li> <li>Leather price group 2</li> </ul>	No cost No cost +\$ 5 +\$ 5 +\$ 39 +\$ 80 +\$109 +\$173 +\$206 +\$287 +\$372 +\$442 +\$543 +\$592 +\$730	<ul style="list-style-type: none"> <li>▶ See <i>Surface Materials Reference Manual</i>. Specify fabric color number.</li> <li>Specify fabric color number.</li> <li>Specify vinyl color number.</li> <li>Specify fabric color number.</li> <li>Specify fabric color number.</li> <li>▶ See <i>Surface Materials Reference Manual</i>. Specify fabric color number.</li> <li>Specify fabric color number.</li> <li>Specify fabric color number.</li> <li>Specify fabric color number.</li> <li>Specify fabric color number.</li> <li>Specify fabric color number.</li> <li>Specify fabric color number.</li> <li>Specify leather color number.</li> <li>Specify leather color number.</li> </ul>

Surface Materials	Seat	U.S. Price	Required to Specify
	<ul style="list-style-type: none"> <li>Customer's Own Material (COM)</li> <li>Fabric price group 1</li> <li>Fabric price group 2</li> <li>Vinyl price group 2</li> <li>Fabric price group 3</li> <li>Fabric price group 4</li> <li>Customer's Own Leather (COL)</li> <li>Fabric price group 5</li> <li>Fabric price group 6</li> <li>Fabric price group 7</li> <li>Fabric price group 8</li> <li>Fabric price group 9</li> <li>Fabric price group 10</li> <li>Leather price group 1</li> <li>Leather price group 2</li> </ul>	No cost No cost +\$ 5 +\$ 5 +\$ 34 +\$ 63 +\$109 +\$140 +\$166 +\$231 +\$300 +\$354 +\$435 +\$476 +\$587	<ul style="list-style-type: none"> <li>▶ See <i>Surface Materials Reference Manual</i>. Specify fabric color number.</li> <li>Specify fabric color number.</li> <li>Specify vinyl color number.</li> <li>Specify fabric color number.</li> <li>Specify fabric color number.</li> <li>▶ See <i>Surface Materials Reference Manual</i>. Specify fabric color number.</li> <li>Specify fabric color number.</li> <li>Specify fabric color number.</li> <li>Specify fabric color number.</li> <li>Specify fabric color number.</li> <li>Specify fabric color number.</li> <li>Specify fabric color number.</li> <li>Specify leather color number.</li> <li>Specify leather color number.</li> </ul>

Specification Information	
Style Number	U.S. Base Price
WESMDC4CNFNA	\$1126

 **For Canadian Pricing**  
 Multiply U.S. Price by the Canadian price factor.  
 ▶ See page 1 for details.

# Sterling 4-Star Conference Chair with Arms

Sterling 4-Star Conference  
Chair with Arms



Standard Includes		Required to Specify
<ul style="list-style-type: none"> <li>▶ Need help? Product details, page 38</li> </ul>	<ul style="list-style-type: none"> <li>Fully upholstered seat with back: fabric price group 1</li> <li>Four-star base: 8046 Polished aluminum</li> <li>Glides: plastic</li> </ul>	<ol style="list-style-type: none"> <li>Style number</li> <li>Fabric color number for chair</li> <li>Plastic color number for glides</li> <li>Options, if selected (see below)</li> </ol> <ul style="list-style-type: none"> <li>▶ See <i>Surface Materials</i>, page 242.</li> </ul>

Options	U.S. Price	Required to Specify
<b>Color Scheme</b>		
<ul style="list-style-type: none"> <li>Non contrasting</li> <li>Contrasting</li> </ul>	<p>No cost</p> <p>+\$191</p>	<p>Specify <i>with non contrasting</i>.</p> <p>Specify <i>with contrasting</i>.</p>
<b>Surface Materials</b>		
<b>Back</b>		
<ul style="list-style-type: none"> <li>Customer's Own Material (COM)</li> <li>Fabric price group 1</li> <li>Fabric price group 2</li> <li>Vinyl price group 2</li> <li>Fabric price group 3</li> <li>Fabric price group 4</li> <li>Customer's Own Leather (COL)</li> <li>Fabric price group 5</li> <li>Fabric price group 6</li> <li>Fabric price group 7</li> <li>Fabric price group 8</li> <li>Fabric price group 9</li> <li>Fabric price group 10</li> <li>Leather price group 1</li> <li>Leather price group 2</li> </ul>	<p>No cost</p> <p>No cost</p> <p>+\$ 8</p> <p>+\$ 8</p> <p>+\$ 50</p> <p>+\$ 94</p> <p>+\$109</p> <p>+\$211</p> <p>+\$250</p> <p>+\$345</p> <p>+\$448</p> <p>+\$532</p> <p>+\$650</p> <p>+\$712</p> <p>+\$878</p>	<ul style="list-style-type: none"> <li>▶ See <i>Surface Materials Reference Manual</i>. Specify fabric color number.</li> <li>Specify fabric color number.</li> <li>Specify vinyl color number.</li> <li>Specify fabric color number.</li> <li>Specify fabric color number.</li> <li>▶ See <i>Surface Materials Reference Manual</i>. Specify fabric color number.</li> <li>Specify fabric color number.</li> <li>Specify fabric color number.</li> <li>Specify fabric color number.</li> <li>Specify fabric color number.</li> <li>Specify fabric color number.</li> <li>Specify fabric color number.</li> <li>Specify leather color number.</li> <li>Specify leather color number.</li> </ul>
<b>Seat</b>		
<ul style="list-style-type: none"> <li>Customer's Own Material (COM)</li> <li>Fabric price group 1</li> <li>Fabric price group 2</li> <li>Vinyl price group 2</li> <li>Fabric price group 3</li> <li>Fabric price group 4</li> <li>Customer's Own Leather (COL)</li> <li>Fabric price group 5</li> <li>Fabric price group 6</li> <li>Fabric price group 7</li> <li>Fabric price group 8</li> <li>Fabric price group 9</li> <li>Fabric price group 10</li> <li>Leather price group 1</li> <li>Leather price group 2</li> </ul>	<p>No cost</p> <p>No cost</p> <p>+\$ 5</p> <p>+\$ 5</p> <p>+\$ 34</p> <p>+\$ 63</p> <p>+\$109</p> <p>+\$140</p> <p>+\$166</p> <p>+\$231</p> <p>+\$300</p> <p>+\$354</p> <p>+\$435</p> <p>+\$476</p> <p>+\$587</p>	<ul style="list-style-type: none"> <li>▶ See <i>Surface Materials Reference Manual</i>. Specify fabric color number.</li> <li>Specify fabric color number.</li> <li>Specify vinyl color number.</li> <li>Specify fabric color number.</li> <li>Specify fabric color number.</li> <li>▶ See <i>Surface Materials Reference Manual</i>. Specify fabric color number.</li> <li>Specify fabric color number.</li> <li>Specify fabric color number.</li> <li>Specify fabric color number.</li> <li>Specify fabric color number.</li> <li>Specify fabric color number.</li> <li>Specify fabric color number.</li> <li>Specify leather color number.</li> <li>Specify leather color number.</li> </ul>

Specification Information	
Style Number	U.S. Base Price
WESMDC4CNFWA	\$1240

 **For Canadian Pricing**  
Multiply U.S. Price by the Canadian price factor.  
▶ See page 1 for details.

Sterling

# Sterling Lounge

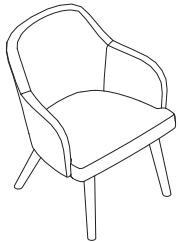

Standard Includes		Required to Specify
<ul style="list-style-type: none"> <li>▶ Need help? Product details, page 38</li> </ul>	<ul style="list-style-type: none"> <li>Fully upholstered seat with back: fabric price group 1</li> <li>Legs (base): veneer price group 1</li> <li>Glides: plastic</li> </ul>	<ol style="list-style-type: none"> <li>Style number</li> <li>Fabric color number for chair</li> <li>Wood color number for legs (base)</li> <li>Plastic color number for glides</li> <li>Options, if selected (see below)</li> </ol> <ul style="list-style-type: none"> <li>▶ See <i>Surface Materials</i>, page 242.</li> </ul>

Options	U.S. Price	Required to Specify
<b>Color Scheme</b>		
<ul style="list-style-type: none"> <li>Non contrasting</li> <li>Contrasting</li> </ul>	<ul style="list-style-type: none"> <li>No cost</li> <li>+\$191</li> </ul>	<ul style="list-style-type: none"> <li>Specify <i>with non contrasting</i>.</li> <li>Specify <i>with contrasting</i>.</li> </ul>
<b>Surface Materials</b>		
<b>Back</b>		
<ul style="list-style-type: none"> <li>Customer's Own Material (COM)</li> <li>Fabric price group 1</li> <li>Fabric price group 2</li> <li>Vinyl price group 2</li> <li>Fabric price group 3</li> <li>Fabric price group 4</li> <li>Customer's Own Leather (COL)</li> <li>Fabric price group 5</li> <li>Fabric price group 6</li> <li>Fabric price group 7</li> <li>Fabric price group 8</li> <li>Fabric price group 9</li> <li>Fabric price group 10</li> <li>Leather price group 1</li> <li>Leather price group 2</li> </ul>	<ul style="list-style-type: none"> <li>No cost</li> <li>No cost</li> <li>+\$ 8</li> <li>+\$ 8</li> <li>+\$ 50</li> <li>+\$ 94</li> <li>+\$109</li> <li>+\$211</li> <li>+\$250</li> <li>+\$345</li> <li>+\$448</li> <li>+\$532</li> <li>+\$650</li> <li>+\$712</li> <li>+\$878</li> </ul>	<ul style="list-style-type: none"> <li>▶ See <i>Surface Materials Reference Manual</i>. Specify fabric color number.</li> <li>Specify fabric color number.</li> <li>Specify vinyl color number.</li> <li>Specify fabric color number.</li> <li>Specify fabric color number.</li> <li>▶ See <i>Surface Materials Reference Manual</i>. Specify fabric color number.</li> <li>Specify fabric color number.</li> <li>Specify fabric color number.</li> <li>Specify fabric color number.</li> <li>Specify fabric color number.</li> <li>Specify fabric color number.</li> <li>Specify fabric color number.</li> <li>Specify leather color number.</li> <li>Specify leather color number.</li> </ul>
<b>Seat</b>		
<ul style="list-style-type: none"> <li>Customer's Own Material (COM)</li> <li>Fabric price group 1</li> <li>Fabric price group 2</li> <li>Vinyl price group 2</li> <li>Fabric price group 3</li> <li>Fabric price group 4</li> <li>Customer's Own Leather (COL)</li> <li>Fabric price group 5</li> <li>Fabric price group 6</li> <li>Fabric price group 7</li> <li>Fabric price group 8</li> <li>Fabric price group 9</li> <li>Fabric price group 10</li> <li>Leather price group 1</li> <li>Leather price group 2</li> </ul>	<ul style="list-style-type: none"> <li>No cost</li> <li>No cost</li> <li>+\$ 5</li> <li>+\$ 5</li> <li>+\$ 34</li> <li>+\$ 63</li> <li>+\$109</li> <li>+\$140</li> <li>+\$166</li> <li>+\$231</li> <li>+\$300</li> <li>+\$354</li> <li>+\$435</li> <li>+\$476</li> <li>+\$587</li> </ul>	<ul style="list-style-type: none"> <li>▶ See <i>Surface Materials Reference Manual</i>. Specify fabric color number.</li> <li>Specify fabric color number.</li> <li>Specify vinyl color number.</li> <li>Specify fabric color number.</li> <li>Specify fabric color number.</li> <li>▶ See <i>Surface Materials Reference Manual</i>. Specify fabric color number.</li> <li>Specify fabric color number.</li> <li>Specify fabric color number.</li> <li>Specify fabric color number.</li> <li>Specify fabric color number.</li> <li>Specify fabric color number.</li> <li>Specify fabric color number.</li> <li>Specify leather color number.</li> <li>Specify leather color number.</li> </ul>
<b>Base</b>		
<ul style="list-style-type: none"> <li>Customiz stain</li> <li>Veneer price group 1</li> <li>Veneer price group 2</li> </ul>	<ul style="list-style-type: none"> <li>No cost</li> <li>No cost</li> <li>+\$ 44</li> </ul>	<ul style="list-style-type: none"> <li>Specify <i>with Customiz stain</i>.</li> <li>▶ See <i>Surface Materials Reference Manual</i>. Specify wood color number.</li> <li>Specify wood color number.</li> </ul>

Specification Information	
Style Number	U.S. Base Price
WESMDC4LNG	\$1335

 **For Canadian Pricing**  
 Multiply U.S. Price by the Canadian price factor.  
 ▶ See page 1 for details.

# Sterling Health—Armless Guest Chair with Metal Leg

Sterling Health—Armless Guest Chair with Metal Leg



Standard Includes		Required to Specify
<ul style="list-style-type: none"> <li>▶ Need help? Product details, page 38</li> </ul>	<ul style="list-style-type: none"> <li>Fully upholstered non-contrasting chair: fabric price group 1</li> <li>Legs (base): paint price group 1</li> <li>Glides: plastic</li> </ul>	<ol style="list-style-type: none"> <li>Style number</li> <li>Fabric color number for chair</li> <li>Paint color number for legs (base)</li> <li>Plastic color number for glides</li> <li>Options, if selected (see below)</li> </ol> <ul style="list-style-type: none"> <li>▶ See <i>Surface Materials</i>, page 242.</li> </ul>

Options	U.S. Price	Required to Specify
<b>Color Scheme</b>		
<ul style="list-style-type: none"> <li>Non contrasting</li> <li>Contrasting</li> </ul>	<p>No cost</p> <p>+\$191</p>	<p>Specify with <i>non contrasting</i>.</p> <p>Specify with <i>contrasting</i>.</p>
<b>Surface Materials</b>		
<b>Back</b>		
<ul style="list-style-type: none"> <li>Customer's Own Material (COM)</li> <li>Fabric price group 1</li> <li>Fabric price group 2</li> <li>Vinyl price group 2</li> <li>Fabric price group 3</li> <li>Fabric price group 4</li> <li>Customer's Own Leather (COL)</li> <li>Fabric price group 5</li> <li>Fabric price group 6</li> <li>Fabric price group 7</li> <li>Fabric price group 8</li> <li>Fabric price group 9</li> <li>Fabric price group 10</li> <li>Leather price group 1</li> <li>Leather price group 2</li> </ul>	<p>No cost</p> <p>No cost</p> <p>+\$ 5</p> <p>+\$ 5</p> <p>+\$ 39</p> <p>+\$ 80</p> <p>+\$109</p> <p>+\$173</p> <p>+\$206</p> <p>+\$287</p> <p>+\$372</p> <p>+\$442</p> <p>+\$543</p> <p>+\$592</p> <p>+\$730</p>	<ul style="list-style-type: none"> <li>▶ See <i>Surface Materials Reference Manual</i>. Specify fabric color number.</li> <li>Specify fabric color number.</li> <li>Specify vinyl color number.</li> <li>Specify fabric color number.</li> <li>Specify fabric color number.</li> <li>▶ See <i>Surface Materials Reference Manual</i>. Specify fabric color number.</li> <li>Specify fabric color number.</li> <li>Specify fabric color number.</li> <li>Specify fabric color number.</li> <li>Specify fabric color number.</li> <li>Specify fabric color number.</li> <li>Specify fabric color number.</li> <li>Specify fabric color number.</li> <li>Specify leather color number.</li> <li>Specify leather color number.</li> </ul>
<b>Seat</b>		
<ul style="list-style-type: none"> <li>Customer's Own Material (COM)</li> <li>Fabric price group 1</li> <li>Fabric price group 2</li> <li>Vinyl price group 2</li> <li>Fabric price group 3</li> <li>Fabric price group 4</li> <li>Customer's Own Leather (COL)</li> <li>Fabric price group 5</li> <li>Fabric price group 6</li> <li>Fabric price group 7</li> <li>Fabric price group 8</li> <li>Fabric price group 9</li> <li>Fabric price group 10</li> <li>Leather price group 1</li> <li>Leather price group 2</li> </ul>	<p>No cost</p> <p>No cost</p> <p>+\$ 5</p> <p>+\$ 5</p> <p>+\$ 34</p> <p>+\$ 63</p> <p>+\$109</p> <p>+\$140</p> <p>+\$166</p> <p>+\$231</p> <p>+\$300</p> <p>+\$354</p> <p>+\$435</p> <p>+\$476</p> <p>+\$587</p>	<ul style="list-style-type: none"> <li>▶ See <i>Surface Materials Reference Manual</i>. Specify fabric color number.</li> <li>Specify fabric color number.</li> <li>Specify vinyl color number.</li> <li>Specify fabric color number.</li> <li>Specify fabric color number.</li> <li>▶ See <i>Surface Materials Reference Manual</i>. Specify fabric color number.</li> <li>Specify fabric color number.</li> <li>Specify fabric color number.</li> <li>Specify fabric color number.</li> <li>Specify fabric color number.</li> <li>Specify fabric color number.</li> <li>Specify fabric color number.</li> <li>Specify fabric color number.</li> <li>Specify leather color number.</li> <li>Specify leather color number.</li> </ul>
<b>Base</b>		
<ul style="list-style-type: none"> <li>Paint price group 1</li> <li>Paint price group 2</li> <li>Paint price group 3</li> </ul>	<p>No cost</p> <p>+\$ 44</p> <p>+\$ 90</p>	<p>Specify paint color number.</p> <p>Specify paint color number.</p> <p>Specify paint color number.</p>

Specification Information	
Style Number	U.S. Base Price
WEHMDC4MNA	\$1613

 **For Canadian Pricing**  
 Multiply U.S. Price by the Canadian price factor.  
 ▶ See page 1 for details.

Sterling Health

# Sterling Health—Guest Chair with Arms and Metal Legs



Standard Includes		Required to Specify
<ul style="list-style-type: none"> <li>▶ Need help? Product details, page 38</li> </ul>	<ul style="list-style-type: none"> <li>Fully upholstered non-contrasting chair: fabric price group 1</li> <li>Legs (base): paint price group 1</li> <li>Glides: plastic</li> </ul>	<ol style="list-style-type: none"> <li>Style number</li> <li>Fabric color number for chair</li> <li>Paint color number for legs (base)</li> <li>Plastic color number for glides</li> <li>Options, if selected (see below)</li> </ol> <ul style="list-style-type: none"> <li>▶ See <i>Surface Materials</i>, page 242.</li> </ul>

Options	U.S. Price	Required to Specify
<b>Color Scheme</b>		
<ul style="list-style-type: none"> <li>Non contrasting</li> <li>Contrasting</li> </ul>	No cost +\$191	Specify <i>with non contrasting</i> . Specify <i>with contrasting</i> .
<b>Surface Materials</b>		
<b>Back</b>		
<ul style="list-style-type: none"> <li>Customer's Own Material (COM)</li> <li>Fabric price group 1</li> <li>Fabric price group 2</li> <li>Vinyl price group 2</li> <li>Fabric price group 3</li> <li>Fabric price group 4</li> <li>Customer's Own Leather (COL)</li> <li>Fabric price group 5</li> <li>Fabric price group 6</li> <li>Fabric price group 7</li> <li>Fabric price group 8</li> <li>Fabric price group 9</li> <li>Fabric price group 10</li> <li>Leather price group 1</li> <li>Leather price group 2</li> </ul>	No cost No cost +\$ 8 +\$ 8 +\$ 50 +\$ 94 +\$109 +\$211 +\$250 +\$345 +\$448 +\$532 +\$650 +\$712 +\$878	<ul style="list-style-type: none"> <li>▶ See <i>Surface Materials Reference Manual</i>. Specify fabric color number.</li> <li>Specify fabric color number.</li> <li>Specify vinyl color number.</li> <li>Specify fabric color number.</li> <li>Specify fabric color number.</li> <li>▶ See <i>Surface Materials Reference Manual</i>. Specify fabric color number.</li> <li>Specify fabric color number.</li> <li>Specify fabric color number.</li> <li>Specify fabric color number.</li> <li>Specify fabric color number.</li> <li>Specify fabric color number.</li> <li>Specify fabric color number.</li> <li>Specify leather color number.</li> <li>Specify leather color number.</li> </ul>
<b>Seat</b>		
<ul style="list-style-type: none"> <li>Customer's Own Material (COM)</li> <li>Fabric price group 1</li> <li>Fabric price group 2</li> <li>Vinyl price group 2</li> <li>Fabric price group 3</li> <li>Fabric price group 4</li> <li>Customer's Own Leather (COL)</li> <li>Fabric price group 5</li> <li>Fabric price group 6</li> <li>Fabric price group 7</li> <li>Fabric price group 8</li> <li>Fabric price group 9</li> <li>Fabric price group 10</li> <li>Leather price group 1</li> <li>Leather price group 2</li> </ul>	No cost No cost +\$ 5 +\$ 5 +\$ 34 +\$ 63 +\$109 +\$140 +\$166 +\$231 +\$300 +\$354 +\$435 +\$476 +\$587	<ul style="list-style-type: none"> <li>▶ See <i>Surface Materials Reference Manual</i>. Specify fabric color number.</li> <li>Specify fabric color number.</li> <li>Specify vinyl color number.</li> <li>Specify fabric color number.</li> <li>Specify fabric color number.</li> <li>▶ See <i>Surface Materials Reference Manual</i>. Specify fabric color number.</li> <li>Specify fabric color number.</li> <li>Specify fabric color number.</li> <li>Specify fabric color number.</li> <li>Specify fabric color number.</li> <li>Specify fabric color number.</li> <li>Specify fabric color number.</li> <li>Specify leather color number.</li> <li>Specify leather color number.</li> </ul>
<b>Base</b>		
<ul style="list-style-type: none"> <li>Paint price group 1</li> <li>Paint price group 2</li> <li>Paint price group 3</li> </ul>	No cost +\$ 44 +\$ 90	Specify paint color number. Specify paint color number. Specify paint color number.

Specification Information	
Style Number	U.S. Base Price
WEHMDC4MWA	\$1752

 **For Canadian Pricing**  
 Multiply U.S. Price by the Canadian price factor.  
 ▶ See page 1 for details.

# Kent 5-Star Conference Chair with Arms

Kent 5-Star Conference  
Chair with Arms



Standard Includes		Required to Specify	
<ul style="list-style-type: none"> <li>▶ Need help? Product details, page 42</li> </ul>	<ul style="list-style-type: none"> <li>Fully upholstered non-contrasting seat with back: fabric price group 1</li> <li>Five-star adjustable base: paint price group 1</li> <li>Hard casters: 6205 Black</li> <li>Requires assembly</li> </ul>	<ol style="list-style-type: none"> <li>Style number</li> <li>Fabric color number for chair</li> <li>Paint color number for base</li> <li>Options, if selected (see below)</li> </ol>	<ul style="list-style-type: none"> <li>▶ See <i>Surface Materials</i>, page 242.</li> </ul>
Options		U.S. Price	Required to Specify
<b>Color Scheme</b>	<ul style="list-style-type: none"> <li>Non contrasting</li> <li>Contrasting</li> </ul>	No cost +\$166	Specify <i>with non contrasting</i> . Specify <i>with contrasting</i> .
<b>Back</b>	<ul style="list-style-type: none"> <li>Low back</li> <li>High back</li> </ul>	No cost +\$377	Specify <i>with low back</i> . Specify <i>with high back</i> .
<b>Surface Materials</b>	<p><b>Back</b></p> <ul style="list-style-type: none"> <li>Customer's Own Material (COM)</li> <li>Fabric price group 1</li> <li>Fabric price group 2</li> <li>Vinyl price group 2</li> <li>Fabric price group 3</li> <li>Customer's Own Leather (COL)</li> <li>Fabric price group 4</li> <li>Fabric price group 5</li> <li>Fabric price group 6</li> <li>Fabric price group 7</li> <li>Fabric price group 8</li> <li>Leather price group 1</li> <li>Fabric price group 9</li> <li>Leather price group 2</li> <li>Fabric price group 10</li> </ul> <p><b>Seat</b></p> <ul style="list-style-type: none"> <li>Customer's Own Material (COM)</li> <li>Fabric price group 1</li> <li>Fabric price group 2</li> <li>Vinyl price group 2</li> <li>Fabric price group 3</li> <li>Fabric price group 4</li> <li>Customer's Own Leather (COL)</li> <li>Fabric price group 5</li> <li>Fabric price group 6</li> <li>Fabric price group 7</li> <li>Fabric price group 8</li> <li>Fabric price group 9</li> <li>Leather price group 1</li> <li>Fabric price group 10</li> <li>Leather price group 2</li> </ul> <p><b>Base</b></p> <ul style="list-style-type: none"> <li>Paint price group 1</li> <li>Paint price group 2</li> <li>Paint price group 3</li> <li>Polished aluminum</li> </ul>	No cost No cost +\$ 22 +\$ 22 +\$ 52 +\$ 95 +\$118 +\$193 +\$358 +\$488 +\$630 +\$679 +\$753 +\$836 +\$884  No cost No cost +\$ 9 +\$ 9 +\$ 28 +\$ 65 +\$ 95 +\$104 +\$195 +\$266 +\$342 +\$409 +\$455 +\$482 +\$553  No cost +\$ 44 +\$ 87 +\$131	<ul style="list-style-type: none"> <li>▶ See <i>Surface Materials Reference Manual</i>. Specify fabric color number.</li> <li>Specify fabric color number.</li> <li>Specify vinyl color number.</li> <li>Specify fabric color number.</li> <li>▶ See <i>Surface Materials Reference Manual</i>. Specify fabric color number.</li> <li>Specify fabric color number.</li> <li>Specify fabric color number.</li> <li>Specify fabric color number.</li> <li>Specify fabric color number.</li> <li>Specify leather color number.</li> <li>Specify fabric color number.</li> <li>Specify leather color number.</li> <li>Specify fabric color number.</li> <li>Specify fabric color number.</li> <li>▶ See <i>Surface Materials Reference Manual</i>. Specify fabric color number.</li> <li>Specify fabric color number.</li> <li>Specify fabric color number.</li> <li>Specify fabric color number.</li> <li>Specify fabric color number.</li> <li>Specify leather color number.</li> <li>Specify fabric color number.</li> <li>Specify leather color number.</li> </ul>
<b>Caster</b>	<ul style="list-style-type: none"> <li>Hard casters</li> <li>Soft casters</li> </ul>	No cost +\$ 35	Specify <i>with hard casters</i> . Specify <i>with soft casters</i> .

Specification Information	
Style Number	U.S. Base Price
WESKNT5CWA	\$1794

 **For Canadian Pricing**  
Multiply U.S. Price by the Canadian price factor.  
▶ See page 1 for details.



# Kent 5-Star Armless Conference Chair



Standard Includes		Required to Specify	
<ul style="list-style-type: none"> <li>▶ Need help? Product details, page 42</li> </ul>	<ul style="list-style-type: none"> <li>Fully upholstered non-contrasting seat with back: fabric price group 1</li> <li>Five-star adjustable base: paint price group 1</li> <li>Hard casters: 6205 Black</li> <li>Requires assembly</li> </ul>	<ol style="list-style-type: none"> <li>Style number</li> <li>Fabric color number for chair</li> <li>Paint color number for base</li> <li>Options, if selected (see below)</li> </ol>	<ul style="list-style-type: none"> <li>▶ See <i>Surface Materials</i>, page 242.</li> </ul>
Options		U.S. Price	Required to Specify
<b>Color Scheme</b>	<ul style="list-style-type: none"> <li>Non contrasting</li> <li>Contrasting</li> </ul>	No cost +\$166	Specify <i>with non contrasting</i> . Specify <i>with contrasting</i> .
<b>Surface Materials</b>	<p><b>Back</b></p> <ul style="list-style-type: none"> <li>Customer's Own Material (COM) No cost</li> <li>Fabric price group 1 No cost</li> <li>Fabric price group 2 +\$ 9</li> <li>Vinyl price group 2 +\$ 9</li> <li>Fabric price group 3 +\$ 28</li> <li>Fabric price group 4 +\$ 65</li> <li>Customer's Own Leather (COL) +\$ 95</li> <li>Fabric price group 5 +\$104</li> <li>Fabric price group 6 +\$195</li> <li>Fabric price group 7 +\$266</li> <li>Fabric price group 8 +\$342</li> <li>Fabric price group 9 +\$409</li> <li>Leather price group 1 +\$455</li> <li>Fabric price group 10 +\$482</li> <li>Leather price group 2 +\$553</li> </ul> <p><b>Seat</b></p> <ul style="list-style-type: none"> <li>Customer's Own Material (COM) No cost</li> <li>Fabric price group 1 No cost</li> <li>Fabric price group 2 +\$ 9</li> <li>Vinyl price group 2 +\$ 9</li> <li>Fabric price group 3 +\$ 28</li> <li>Fabric price group 4 +\$ 65</li> <li>Customer's Own Leather (COL) +\$ 95</li> <li>Fabric price group 5 +\$104</li> <li>Fabric price group 6 +\$195</li> <li>Fabric price group 7 +\$266</li> <li>Fabric price group 8 +\$342</li> <li>Fabric price group 9 +\$409</li> <li>Leather price group 1 +\$455</li> <li>Fabric price group 10 +\$482</li> <li>Leather price group 2 +\$553</li> </ul> <p><b>Base</b></p> <ul style="list-style-type: none"> <li>Paint price group 1 No cost</li> <li>Paint price group 2 +\$ 44</li> <li>Paint price group 3 +\$ 87</li> <li>Polished aluminum +\$131</li> </ul>		<ul style="list-style-type: none"> <li>▶ See <i>Surface Materials Reference Manual</i>. Specify fabric color number.</li> <li>Specify fabric color number.</li> <li>Specify vinyl color number.</li> <li>Specify fabric color number.</li> <li>Specify fabric color number.</li> <li>▶ See <i>Surface Materials Reference Manual</i>. Specify fabric color number.</li> <li>Specify fabric color number.</li> <li>Specify fabric color number.</li> <li>Specify fabric color number.</li> <li>Specify fabric color number.</li> <li>Specify leather color number.</li> <li>Specify fabric color number.</li> <li>Specify leather color number.</li> <li>▶ See <i>Surface Materials Reference Manual</i>. Specify fabric color number.</li> <li>Specify fabric color number.</li> <li>Specify vinyl color number.</li> <li>Specify fabric color number.</li> <li>Specify fabric color number.</li> <li>▶ See <i>Surface Materials Reference Manual</i>. Specify fabric color number.</li> <li>Specify fabric color number.</li> <li>Specify fabric color number.</li> <li>Specify fabric color number.</li> <li>Specify fabric color number.</li> <li>Specify leather color number.</li> <li>Specify fabric color number.</li> <li>Specify leather color number.</li> </ul>
<b>Caster</b>	<ul style="list-style-type: none"> <li>Hard casters</li> <li>Soft casters</li> </ul>	No cost +\$ 35	Specify <i>with hard casters</i> . Specify <i>with soft casters</i> .

## Specification Information

Style Number	U.S. Base Price
WESKNT5CNA	\$1629



**For Canadian Pricing**  
 Multiply U.S. Price by the Canadian price factor.  
 ▶ See page 1 for details.

# Kent 4-Star Conference Chair with Arms

Kent 4-Star Conference  
Chair with Arms



Standard Includes		Required to Specify
<ul style="list-style-type: none"> <li>▶ Need help? Product details, page 42</li> </ul>	<ul style="list-style-type: none"> <li>Fully upholstered non-contrasting seat with back: fabric price group 1</li> <li>Four-star adjustable base: paint price group 1</li> <li>Hard casters: 6205 Black</li> <li>Requires assembly</li> </ul>	<ol style="list-style-type: none"> <li>Style number</li> <li>Fabric color number for chair</li> <li>Paint color number for base</li> <li>Options, if selected (see below)</li> </ol> <ul style="list-style-type: none"> <li>▶ See <i>Surface Materials</i>, page 242.</li> </ul>

Options	U.S. Price	Required to Specify
<b>Color Scheme</b>		
<ul style="list-style-type: none"> <li>Non contrasting</li> <li>Contrasting</li> </ul>	<ul style="list-style-type: none"> <li>No cost</li> <li>+\$166</li> </ul>	<ul style="list-style-type: none"> <li>Specify <i>with non contrasting</i>.</li> <li>Specify <i>with contrasting</i>.</li> </ul>
<b>Back</b>		
<ul style="list-style-type: none"> <li>Low back</li> <li>High back</li> </ul>	<ul style="list-style-type: none"> <li>No cost</li> <li>+\$377</li> </ul>	<ul style="list-style-type: none"> <li>Specify <i>with low back</i>.</li> <li>Specify <i>with high back</i>.</li> </ul>

Surface Materials	Back	U.S. Price	Required to Specify
	<ul style="list-style-type: none"> <li>Customer's Own Material (COM)</li> <li>Fabric price group 1</li> <li>Fabric price group 2</li> <li>Vinyl price group 2</li> <li>Fabric price group 3</li> <li>Customer's Own Leather (COL)</li> <li>Fabric price group 4</li> <li>Fabric price group 5</li> <li>Fabric price group 6</li> <li>Fabric price group 7</li> <li>Fabric price group 8</li> <li>Leather price group 1</li> <li>Fabric price group 9</li> <li>Leather price group 2</li> <li>Fabric price group 10</li> </ul>	<ul style="list-style-type: none"> <li>No cost</li> <li>No cost</li> <li>+\$ 22</li> <li>+\$ 22</li> <li>+\$ 52</li> <li>+\$ 95</li> <li>+\$118</li> <li>+\$193</li> <li>+\$358</li> <li>+\$488</li> <li>+\$630</li> <li>+\$679</li> <li>+\$753</li> <li>+\$836</li> <li>+\$884</li> </ul>	<ul style="list-style-type: none"> <li>▶ See <i>Surface Materials Reference Manual</i>. Specify fabric color number.</li> <li>Specify fabric color number.</li> <li>Specify vinyl color number.</li> <li>Specify fabric color number.</li> <li>▶ See <i>Surface Materials Reference Manual</i>. Specify fabric color number.</li> <li>Specify fabric color number.</li> <li>Specify fabric color number.</li> <li>Specify fabric color number.</li> <li>Specify fabric color number.</li> <li>Specify leather color number.</li> <li>Specify fabric color number.</li> <li>Specify leather color number.</li> <li>Specify fabric color number.</li> </ul>

Seat	U.S. Price	Required to Specify
<ul style="list-style-type: none"> <li>Customer's Own Material (COM)</li> <li>Fabric price group 1</li> <li>Fabric price group 2</li> <li>Vinyl price group 2</li> <li>Fabric price group 3</li> <li>Fabric price group 4</li> <li>Customer's Own Leather (COL)</li> <li>Fabric price group 5</li> <li>Fabric price group 6</li> <li>Fabric price group 7</li> <li>Fabric price group 8</li> <li>Fabric price group 9</li> <li>Leather price group 1</li> <li>Fabric price group 10</li> <li>Leather price group 2</li> </ul>	<ul style="list-style-type: none"> <li>No cost</li> <li>No cost</li> <li>+\$ 9</li> <li>+\$ 9</li> <li>+\$ 28</li> <li>+\$ 65</li> <li>+\$ 95</li> <li>+\$104</li> <li>+\$195</li> <li>+\$266</li> <li>+\$342</li> <li>+\$409</li> <li>+\$455</li> <li>+\$482</li> <li>+\$553</li> </ul>	<ul style="list-style-type: none"> <li>▶ See <i>Surface Materials Reference Manual</i>. Specify fabric color number.</li> <li>Specify fabric color number.</li> <li>Specify vinyl color number.</li> <li>Specify fabric color number.</li> <li>Specify fabric color number.</li> <li>▶ See <i>Surface Materials Reference Manual</i>. Specify fabric color number.</li> <li>Specify fabric color number.</li> <li>Specify fabric color number.</li> <li>Specify fabric color number.</li> <li>Specify fabric color number.</li> <li>Specify leather color number.</li> <li>Specify fabric color number.</li> <li>Specify leather color number.</li> </ul>

Base	U.S. Price	Required to Specify
<ul style="list-style-type: none"> <li>Paint price group 1</li> <li>Paint price group 2</li> <li>Paint price group 3</li> <li>Polished aluminum</li> </ul>	<ul style="list-style-type: none"> <li>No cost</li> <li>+\$ 44</li> <li>+\$ 87</li> <li>+\$131</li> </ul>	<ul style="list-style-type: none"> <li>Specify paint color number.</li> <li>Specify paint color number.</li> <li>Specify paint color number.</li> <li>Specify <i>with polished aluminum</i>.</li> </ul>

Caster	U.S. Price	Required to Specify
<ul style="list-style-type: none"> <li>Hard casters</li> <li>Soft casters</li> </ul>	<ul style="list-style-type: none"> <li>No cost</li> <li>+\$ 35</li> </ul>	<ul style="list-style-type: none"> <li>Specify <i>with hard casters</i>.</li> <li>Specify <i>with soft casters</i>.</li> </ul>

Specification Information	
Style Number	U.S. Base Price
WESKNT4CWA	\$1794

 **For Canadian Pricing**  
Multiply U.S. Price by the Canadian price factor.  
▶ See page 1 for details.

# Kent 4-Star Armless Conference Chair



Standard Includes		Required to Specify	
<ul style="list-style-type: none"> <li>▶ Need help? Product details, page 42</li> </ul>	<ul style="list-style-type: none"> <li>Fully upholstered non-contrasting seat with back: fabric price group 1</li> <li>Four-star base: paint price group 1</li> <li>Hard casters: 6205 Black</li> <li>Requires assembly</li> </ul>	<ol style="list-style-type: none"> <li>Style number</li> <li>Fabric color number for chair</li> <li>Paint color number for base</li> <li>Options, if selected (see below)</li> </ol>	<ul style="list-style-type: none"> <li>▶ See <i>Surface Materials</i>, page 242.</li> </ul>
Options		U.S. Price	Required to Specify
<b>Color Scheme</b>	<ul style="list-style-type: none"> <li>Non contrasting</li> <li>Contrasting</li> </ul>	No cost +\$166	Specify <i>with non contrasting</i> . Specify <i>with contrasting</i> .
<b>Surface Materials</b>	<p><b>Back</b></p> <ul style="list-style-type: none"> <li>Customer's Own Material (COM) No cost</li> <li>Fabric price group 1 No cost</li> <li>Fabric price group 2 +\$ 9</li> <li>Vinyl price group 2 +\$ 9</li> <li>Fabric price group 3 +\$ 28</li> <li>Fabric price group 4 +\$ 65</li> <li>Customer's Own Leather (COL) +\$ 95</li> <li>Fabric price group 5 +\$104</li> <li>Fabric price group 6 +\$195</li> <li>Fabric price group 7 +\$266</li> <li>Fabric price group 8 +\$342</li> <li>Fabric price group 9 +\$409</li> <li>Leather price group 1 +\$455</li> <li>Fabric price group 10 +\$482</li> <li>Leather price group 2 +\$553</li> </ul> <p><b>Seat</b></p> <ul style="list-style-type: none"> <li>Customer's Own Material (COM) No cost</li> <li>Fabric price group 1 No cost</li> <li>Fabric price group 2 +\$ 9</li> <li>Vinyl price group 2 +\$ 9</li> <li>Fabric price group 3 +\$ 28</li> <li>Fabric price group 4 +\$ 65</li> <li>Customer's Own Leather (COL) +\$ 95</li> <li>Fabric price group 5 +\$104</li> <li>Fabric price group 6 +\$195</li> <li>Fabric price group 7 +\$266</li> <li>Fabric price group 8 +\$342</li> <li>Fabric price group 9 +\$409</li> <li>Leather price group 1 +\$455</li> <li>Fabric price group 10 +\$482</li> <li>Leather price group 2 +\$553</li> </ul> <p><b>Base</b></p> <ul style="list-style-type: none"> <li>Paint price group 1 No cost</li> <li>Paint price group 2 +\$ 44</li> <li>Paint price group 3 +\$ 87</li> <li>Polished aluminum +\$131</li> </ul>	No cost No cost +\$ 9 +\$ 9 +\$ 28 +\$ 65 +\$ 95 +\$104 +\$195 +\$266 +\$342 +\$409 +\$455 +\$482 +\$553	<ul style="list-style-type: none"> <li>▶ See <i>Surface Materials Reference Manual</i>. Specify fabric color number.</li> <li>Specify fabric color number.</li> <li>Specify vinyl color number.</li> <li>Specify fabric color number.</li> <li>Specify fabric color number.</li> <li>▶ See <i>Surface Materials Reference Manual</i>. Specify fabric color number.</li> <li>Specify fabric color number.</li> <li>Specify fabric color number.</li> <li>Specify fabric color number.</li> <li>Specify fabric color number.</li> <li>Specify leather color number.</li> <li>Specify fabric color number.</li> <li>Specify leather color number.</li> </ul>
<b>Caster</b>	<ul style="list-style-type: none"> <li>Hard casters</li> <li>Soft casters</li> </ul>	No cost +\$ 35	Specify <i>with hard casters</i> . Specify <i>with soft casters</i> .

## Specification Information

Style Number	U.S. Base Price
WESKNT4CNA	\$1629



**For Canadian Pricing**  
 Multiply U.S. Price by the Canadian price factor.  
 ▶ See page 1 for details.

# Kent 4-Leg Guest Chair with Arms

Kent 4-Leg Guest  
Chair with Arms



Standard Includes		Required to Specify
<ul style="list-style-type: none"> <li>▶ Need help? Product details, page 42</li> </ul>	<ul style="list-style-type: none"> <li>Fully upholstered non-contrasting seat with back: fabric price group 1</li> <li>Legs (base): paint price group 1</li> <li>Glides: plastic</li> </ul>	<ol style="list-style-type: none"> <li>Style number</li> <li>Fabric color number for chair</li> <li>Paint color number for base</li> <li>Plastic color number for glides</li> <li>Options, if selected (see below)</li> </ol> <ul style="list-style-type: none"> <li>▶ See <i>Surface Materials</i>, page 242.</li> </ul>

Options	U.S. Price	Required to Specify
<b>Color Scheme</b>		
<ul style="list-style-type: none"> <li>Non contrasting</li> <li>Contrasting</li> </ul>	<ul style="list-style-type: none"> <li>No cost</li> <li>+\$166</li> </ul>	<ul style="list-style-type: none"> <li>Specify <i>with non contrasting</i>.</li> <li>Specify <i>with contrasting</i>.</li> </ul>
<b>Back</b>		
<ul style="list-style-type: none"> <li>Low back</li> <li>High back</li> </ul>	<ul style="list-style-type: none"> <li>No cost</li> <li>+\$229</li> </ul>	<ul style="list-style-type: none"> <li>Specify <i>with low back</i>.</li> <li>Specify <i>with high back</i>.</li> </ul>
<b>Surface Materials</b>		
<b>Back</b>		
<ul style="list-style-type: none"> <li>Customer's Own Material (COM)</li> <li>Fabric price group 1</li> <li>Fabric price group 2</li> <li>Vinyl price group 2</li> <li>Fabric price group 3</li> <li>Customer's Own Leather (COL)</li> <li>Fabric price group 4</li> <li>Fabric price group 5</li> <li>Fabric price group 6</li> <li>Fabric price group 7</li> <li>Fabric price group 8</li> <li>Leather price group 1</li> <li>Fabric price group 9</li> <li>Leather price group 2</li> <li>Fabric price group 10</li> </ul>	<ul style="list-style-type: none"> <li>No cost</li> <li>No cost</li> <li>+\$ 22</li> <li>+\$ 22</li> <li>+\$ 52</li> <li>+\$ 95</li> <li>+\$118</li> <li>+\$193</li> <li>+\$358</li> <li>+\$488</li> <li>+\$630</li> <li>+\$679</li> <li>+\$753</li> <li>+\$836</li> <li>+\$884</li> </ul>	<ul style="list-style-type: none"> <li>▶ See <i>Surface Materials Reference Manual</i>. Specify fabric color number.</li> <li>Specify fabric color number.</li> <li>Specify vinyl color number.</li> <li>Specify fabric color number.</li> <li>▶ See <i>Surface Materials Reference Manual</i>. Specify fabric color number.</li> <li>Specify fabric color number.</li> <li>Specify fabric color number.</li> <li>Specify fabric color number.</li> <li>Specify fabric color number.</li> <li>Specify fabric color number.</li> <li>Specify leather color number.</li> <li>Specify fabric color number.</li> <li>Specify leather color number.</li> <li>Specify fabric color number.</li> </ul>
<b>Seat</b>		
<ul style="list-style-type: none"> <li>Customer's Own Material (COM)</li> <li>Fabric price group 1</li> <li>Fabric price group 2</li> <li>Vinyl price group 2</li> <li>Fabric price group 3</li> <li>Fabric price group 4</li> <li>Customer's Own Leather (COL)</li> <li>Fabric price group 5</li> <li>Fabric price group 6</li> <li>Fabric price group 7</li> <li>Fabric price group 8</li> <li>Fabric price group 9</li> <li>Leather price group 1</li> <li>Fabric price group 10</li> <li>Leather price group 2</li> </ul>	<ul style="list-style-type: none"> <li>No cost</li> <li>No cost</li> <li>+\$ 9</li> <li>+\$ 9</li> <li>+\$ 28</li> <li>+\$ 65</li> <li>+\$ 95</li> <li>+\$104</li> <li>+\$195</li> <li>+\$266</li> <li>+\$342</li> <li>+\$409</li> <li>+\$455</li> <li>+\$482</li> <li>+\$553</li> </ul>	<ul style="list-style-type: none"> <li>▶ See <i>Surface Materials Reference Manual</i>. Specify fabric color number.</li> <li>Specify fabric color number.</li> <li>Specify vinyl color number.</li> <li>Specify fabric color number.</li> <li>Specify fabric color number.</li> <li>▶ See <i>Surface Materials Reference Manual</i>. Specify fabric color number.</li> <li>Specify fabric color number.</li> <li>Specify fabric color number.</li> <li>Specify fabric color number.</li> <li>Specify fabric color number.</li> <li>Specify fabric color number.</li> <li>Specify leather color number.</li> <li>Specify fabric color number.</li> <li>Specify leather color number.</li> </ul>
<b>Base</b>		
<ul style="list-style-type: none"> <li>Paint price group 1</li> <li>Paint price group 2</li> <li>Paint price group 3</li> <li>Polished chrome</li> </ul>	<ul style="list-style-type: none"> <li>No cost</li> <li>+\$ 44</li> <li>+\$ 87</li> <li>+\$131</li> </ul>	<ul style="list-style-type: none"> <li>Specify paint color number.</li> <li>Specify paint color number.</li> <li>Specify paint color number.</li> <li>Specify <i>with polished chrome</i>.</li> </ul>

Specification Information	
Style Number	U.S. Base Price
WESKNT4LWA	\$1545

 **For Canadian Pricing**  
Multiply U.S. Price by the Canadian price factor.  
▶ See page 1 for details.



# Kent 4-Leg Armless Guest Chair



Standard Includes		Required to Specify
<ul style="list-style-type: none"> <li>▶ Need help? Product details, page 42</li> </ul>	<ul style="list-style-type: none"> <li>Fully upholstered non-contrasting seat with back: fabric price group 1</li> <li>Legs (base): paint price group 1</li> <li>Glides: plastic</li> </ul>	<ol style="list-style-type: none"> <li>Style number</li> <li>Fabric color number for chair</li> <li>Paint color number for base</li> <li>Plastic color number for glides</li> <li>Options, if selected (see below)</li> </ol> <ul style="list-style-type: none"> <li>▶ See <i>Surface Materials</i>, page 242.</li> </ul>

Options	U.S. Price	Required to Specify
<b>Color Scheme</b>		
<ul style="list-style-type: none"> <li>Non contrasting</li> <li>Contrasting</li> </ul>	<ul style="list-style-type: none"> <li>No cost</li> <li>+\$166</li> </ul>	<ul style="list-style-type: none"> <li>Specify <i>with non contrasting</i>.</li> <li>Specify <i>with contrasting</i>.</li> </ul>
<b>Surface Materials</b>		
<b>Back</b>		
<ul style="list-style-type: none"> <li>Customer's Own Material (COM)</li> <li>Fabric price group 1</li> <li>Fabric price group 2</li> <li>Vinyl price group 2</li> <li>Fabric price group 3</li> <li>Fabric price group 4</li> <li>Customer's Own Leather (COL)</li> <li>Fabric price group 5</li> <li>Fabric price group 6</li> <li>Fabric price group 7</li> <li>Fabric price group 8</li> <li>Fabric price group 9</li> <li>Leather price group 1</li> <li>Fabric price group 10</li> <li>Leather price group 2</li> </ul>	<ul style="list-style-type: none"> <li>No cost</li> <li>No cost</li> <li>+\$ 9</li> <li>+\$ 9</li> <li>+\$ 28</li> <li>+\$ 65</li> <li>+\$ 95</li> <li>+\$104</li> <li>+\$195</li> <li>+\$266</li> <li>+\$342</li> <li>+\$409</li> <li>+\$455</li> <li>+\$482</li> <li>+\$553</li> </ul>	<ul style="list-style-type: none"> <li>▶ See <i>Surface Materials Reference Manual</i>. Specify fabric color number.</li> <li>Specify fabric color number.</li> <li>Specify vinyl color number.</li> <li>Specify fabric color number.</li> <li>Specify fabric color number.</li> <li>▶ See <i>Surface Materials Reference Manual</i>. Specify fabric color number.</li> <li>Specify fabric color number.</li> <li>Specify fabric color number.</li> <li>Specify fabric color number.</li> <li>Specify fabric color number.</li> <li>Specify fabric color number.</li> <li>Specify leather color number.</li> <li>Specify fabric color number.</li> <li>Specify leather color number.</li> </ul>
<b>Seat</b>		
<ul style="list-style-type: none"> <li>Customer's Own Material (COM)</li> <li>Fabric price group 1</li> <li>Fabric price group 2</li> <li>Vinyl price group 2</li> <li>Fabric price group 3</li> <li>Fabric price group 4</li> <li>Customer's Own Leather (COL)</li> <li>Fabric price group 5</li> <li>Fabric price group 6</li> <li>Fabric price group 7</li> <li>Fabric price group 8</li> <li>Fabric price group 9</li> <li>Leather price group 1</li> <li>Fabric price group 10</li> <li>Leather price group 2</li> </ul>	<ul style="list-style-type: none"> <li>No cost</li> <li>No cost</li> <li>+\$ 9</li> <li>+\$ 9</li> <li>+\$ 28</li> <li>+\$ 65</li> <li>+\$ 95</li> <li>+\$104</li> <li>+\$195</li> <li>+\$266</li> <li>+\$342</li> <li>+\$409</li> <li>+\$455</li> <li>+\$482</li> <li>+\$553</li> </ul>	<ul style="list-style-type: none"> <li>▶ See <i>Surface Materials Reference Manual</i>. Specify fabric color number.</li> <li>Specify fabric color number.</li> <li>Specify vinyl color number.</li> <li>Specify fabric color number.</li> <li>Specify fabric color number.</li> <li>▶ See <i>Surface Materials Reference Manual</i>. Specify fabric color number.</li> <li>Specify fabric color number.</li> <li>Specify fabric color number.</li> <li>Specify fabric color number.</li> <li>Specify fabric color number.</li> <li>Specify fabric color number.</li> <li>Specify leather color number.</li> <li>Specify fabric color number.</li> <li>Specify leather color number.</li> </ul>
<b>Base</b>		
<ul style="list-style-type: none"> <li>Paint price group 1</li> <li>Paint price group 2</li> <li>Paint price group 3</li> <li>Polished chrome</li> </ul>	<ul style="list-style-type: none"> <li>No cost</li> <li>+\$ 44</li> <li>+\$ 87</li> <li>+\$131</li> </ul>	<ul style="list-style-type: none"> <li>Specify paint color number.</li> <li>Specify paint color number.</li> <li>Specify paint color number.</li> <li>Specify <i>with polished chrome</i>.</li> </ul>

Specification Information	
Style Number	U.S. Base Price
WESKNT4LNA	\$1377

 **For Canadian Pricing**  
 Multiply U.S. Price by the Canadian price factor.  
 ▶ See page 1 for details.

# Kent 5-Star Conference Stool with Arms

Kent 5-Star Conference  
Stool with Arms

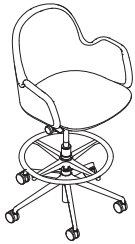

Standard Includes		Required to Specify
<ul style="list-style-type: none"> <li>▶ Need help? Product details, page 42</li> </ul>	<ul style="list-style-type: none"> <li>Fully upholstered non-contrasting seat with back: fabric price group 1</li> <li>Five-star adjustable base with stool ring: paint price group 1</li> <li>Hard casters: 6205 Black</li> <li>Requires assembly</li> </ul>	<ol style="list-style-type: none"> <li>Style number</li> <li>Fabric color number for stool</li> <li>Paint color number for base</li> <li>Options, if selected (see below)</li> </ol> <ul style="list-style-type: none"> <li>▶ See <i>Surface Materials</i>, page 242.</li> </ul>

Options	U.S. Price	Required to Specify
<b>Color Scheme</b>		
<ul style="list-style-type: none"> <li>Non contrasting</li> <li>Contrasting</li> </ul>	<p>No cost</p> <p>+\$166</p>	<p>Specify <i>with non contrasting</i>.</p> <p>Specify <i>with contrasting</i>.</p>
<b>Surface Materials</b>		
<b>Back</b>		
<ul style="list-style-type: none"> <li>Customer's Own Material (COM)</li> <li>Fabric price group 1</li> <li>Fabric price group 2</li> <li>Vinyl price group 2</li> <li>Fabric price group 3</li> <li>Customer's Own Leather (COL)</li> <li>Fabric price group 4</li> <li>Fabric price group 5</li> <li>Fabric price group 6</li> <li>Fabric price group 7</li> <li>Fabric price group 8</li> <li>Leather price group 1</li> <li>Fabric price group 9</li> <li>Fabric price group 10</li> <li>Leather price group 2</li> </ul>	<p>No cost</p> <p>No cost</p> <p>+\$ 20</p> <p>+\$ 20</p> <p>+\$ 49</p> <p>+\$ 95</p> <p>+\$109</p> <p>+\$175</p> <p>+\$326</p> <p>+\$445</p> <p>+\$572</p> <p>+\$679</p> <p>+\$685</p> <p>+\$803</p> <p>+\$836</p>	<ul style="list-style-type: none"> <li>▶ See <i>Surface Materials Reference Manual</i>. Specify fabric color number.</li> <li>Specify fabric color number.</li> <li>Specify vinyl color number.</li> <li>Specify fabric color number.</li> <li>▶ See <i>Surface Materials Reference Manual</i>. Specify fabric color number.</li> <li>Specify fabric color number.</li> <li>Specify fabric color number.</li> <li>Specify fabric color number.</li> <li>Specify fabric color number.</li> <li>Specify fabric color number.</li> <li>Specify leather color number.</li> <li>Specify fabric color number.</li> <li>Specify fabric color number.</li> <li>Specify leather color number.</li> </ul>
<b>Seat</b>		
<ul style="list-style-type: none"> <li>Customer's Own Material (COM)</li> <li>Fabric price group 1</li> <li>Fabric price group 2</li> <li>Vinyl price group 2</li> <li>Fabric price group 3</li> <li>Fabric price group 4</li> <li>Customer's Own Leather (COL)</li> <li>Fabric price group 5</li> <li>Fabric price group 6</li> <li>Fabric price group 7</li> <li>Fabric price group 8</li> <li>Fabric price group 9</li> <li>Leather price group 1</li> <li>Fabric price group 10</li> <li>Leather price group 2</li> </ul>	<p>No cost</p> <p>No cost</p> <p>+\$ 9</p> <p>+\$ 9</p> <p>+\$ 28</p> <p>+\$ 65</p> <p>+\$ 95</p> <p>+\$104</p> <p>+\$195</p> <p>+\$266</p> <p>+\$342</p> <p>+\$409</p> <p>+\$455</p> <p>+\$482</p> <p>+\$553</p>	<ul style="list-style-type: none"> <li>▶ See <i>Surface Materials Reference Manual</i>. Specify fabric color number.</li> <li>Specify fabric color number.</li> <li>Specify vinyl color number.</li> <li>Specify fabric color number.</li> <li>Specify fabric color number.</li> <li>▶ See <i>Surface Materials Reference Manual</i>. Specify fabric color number.</li> <li>Specify fabric color number.</li> <li>Specify fabric color number.</li> <li>Specify fabric color number.</li> <li>Specify fabric color number.</li> <li>Specify leather color number.</li> <li>Specify fabric color number.</li> <li>Specify leather color number.</li> </ul>
<b>Base</b>		
<ul style="list-style-type: none"> <li>Paint price group 1</li> <li>Paint price group 2</li> <li>Paint price group 3</li> <li>Polished aluminum</li> </ul>	<p>No cost</p> <p>+\$ 44</p> <p>+\$ 87</p> <p>+\$131</p>	<p>Specify paint color number.</p> <p>Specify paint color number.</p> <p>Specify paint color number.</p> <p>Specify <i>with polished aluminum</i>.</p>
<b>Caster</b>		
<ul style="list-style-type: none"> <li>Hard casters</li> <li>Soft casters</li> </ul>	<p>No cost</p> <p>+\$ 35</p>	<p>Specify <i>with hard casters</i>.</p> <p>Specify <i>with soft casters</i>.</p>

Specification Information	
Style Number	U.S. Base Price
WESKNT5SWA	\$2334

 **For Canadian Pricing**  
Multiply U.S. Price by the Canadian price factor.  
▶ See page 1 for details.



# Kent 5-Star Armless Conference Stool

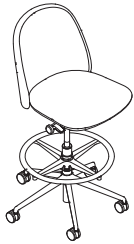

Standard Includes		Required to Specify
<ul style="list-style-type: none"> <li>▶ Need help? Product details, page 42</li> </ul>	<ul style="list-style-type: none"> <li>Fully upholstered non-contrasting seat with back: fabric price group 1</li> <li>Five-star adjustable base with stool ring: paint price group 1</li> <li>Hard casters: 6205 Black</li> <li>Requires assembly</li> </ul>	<ol style="list-style-type: none"> <li>Style number</li> <li>Fabric color number for stool</li> <li>Paint color number for base</li> <li>Options, if selected (see below)</li> </ol> <ul style="list-style-type: none"> <li>▶ See <i>Surface Materials</i>, page 242.</li> </ul>

Options	U.S. Price	Required to Specify
<b>Color Scheme</b>		
<ul style="list-style-type: none"> <li>Non contrasting</li> <li>Contrasting</li> </ul>	<ul style="list-style-type: none"> <li>No cost</li> <li>+\$166</li> </ul>	<ul style="list-style-type: none"> <li>Specify <i>with non contrasting</i>.</li> <li>Specify <i>with contrasting</i>.</li> </ul>
<b>Surface Materials</b>		
<b>Back</b>		
<ul style="list-style-type: none"> <li>Customer's Own Material (COM)</li> <li>Fabric price group 1</li> <li>Fabric price group 2</li> <li>Vinyl price group 2</li> <li>Fabric price group 3</li> <li>Fabric price group 4</li> <li>Customer's Own Leather (COL)</li> <li>Fabric price group 5</li> <li>Fabric price group 6</li> <li>Fabric price group 7</li> <li>Fabric price group 8</li> <li>Fabric price group 9</li> <li>Leather price group 1</li> <li>Fabric price group 10</li> <li>Leather price group 2</li> </ul>	<ul style="list-style-type: none"> <li>No cost</li> <li>No cost</li> <li>+\$ 9</li> <li>+\$ 9</li> <li>+\$ 28</li> <li>+\$ 65</li> <li>+\$ 95</li> <li>+\$104</li> <li>+\$195</li> <li>+\$266</li> <li>+\$342</li> <li>+\$409</li> <li>+\$455</li> <li>+\$482</li> <li>+\$553</li> </ul>	<ul style="list-style-type: none"> <li>▶ See <i>Surface Materials Reference Manual</i>. Specify fabric color number.</li> <li>Specify fabric color number.</li> <li>Specify vinyl color number.</li> <li>Specify fabric color number.</li> <li>Specify fabric color number.</li> <li>▶ See <i>Surface Materials Reference Manual</i>. Specify fabric color number.</li> <li>Specify fabric color number.</li> <li>Specify fabric color number.</li> <li>Specify fabric color number.</li> <li>Specify fabric color number.</li> <li>Specify fabric color number.</li> <li>Specify leather color number.</li> <li>Specify fabric color number.</li> <li>Specify leather color number.</li> </ul>
<b>Seat</b>		
<ul style="list-style-type: none"> <li>Customer's Own Material (COM)</li> <li>Fabric price group 1</li> <li>Fabric price group 2</li> <li>Vinyl price group 2</li> <li>Fabric price group 3</li> <li>Fabric price group 4</li> <li>Customer's Own Leather (COL)</li> <li>Fabric price group 5</li> <li>Fabric price group 6</li> <li>Fabric price group 7</li> <li>Fabric price group 8</li> <li>Fabric price group 9</li> <li>Leather price group 1</li> <li>Fabric price group 10</li> <li>Leather price group 2</li> </ul>	<ul style="list-style-type: none"> <li>No cost</li> <li>No cost</li> <li>+\$ 9</li> <li>+\$ 9</li> <li>+\$ 28</li> <li>+\$ 65</li> <li>+\$ 95</li> <li>+\$104</li> <li>+\$195</li> <li>+\$266</li> <li>+\$342</li> <li>+\$409</li> <li>+\$455</li> <li>+\$482</li> <li>+\$553</li> </ul>	<ul style="list-style-type: none"> <li>▶ See <i>Surface Materials Reference Manual</i>. Specify fabric color number.</li> <li>Specify fabric color number.</li> <li>Specify vinyl color number.</li> <li>Specify fabric color number.</li> <li>Specify fabric color number.</li> <li>▶ See <i>Surface Materials Reference Manual</i>. Specify fabric color number.</li> <li>Specify fabric color number.</li> <li>Specify fabric color number.</li> <li>Specify fabric color number.</li> <li>Specify fabric color number.</li> <li>Specify fabric color number.</li> <li>Specify leather color number.</li> <li>Specify fabric color number.</li> <li>Specify leather color number.</li> </ul>
<b>Base</b>		
<ul style="list-style-type: none"> <li>Paint price group 1</li> <li>Paint price group 2</li> <li>Paint price group 3</li> <li>Polished aluminum</li> </ul>	<ul style="list-style-type: none"> <li>No cost</li> <li>+\$ 44</li> <li>+\$ 87</li> <li>+\$131</li> </ul>	<ul style="list-style-type: none"> <li>Specify paint color number.</li> <li>Specify paint color number.</li> <li>Specify paint color number.</li> <li>Specify <i>with polished aluminum</i>.</li> </ul>
<b>Caster</b>		
<ul style="list-style-type: none"> <li>Hard casters</li> <li>Soft casters</li> </ul>	<ul style="list-style-type: none"> <li>No cost</li> <li>+\$ 35</li> </ul>	<ul style="list-style-type: none"> <li>Specify <i>with hard casters</i>.</li> <li>Specify <i>with soft casters</i>.</li> </ul>

Specification Information	
Style Number	U.S. Base Price
WESKNT5SNA	\$2165

 **For Canadian Pricing**  
 Multiply U.S. Price by the Canadian price factor.  
 ▶ See page 1 for details.

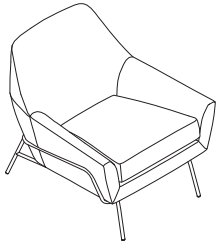

Standard Includes		Required to Specify
<ul style="list-style-type: none"> <li>▶ Need help? Product details, page 46</li> </ul>	<ul style="list-style-type: none"> <li>Fully upholstered seat with back: fabric price group 1</li> <li>Wire frame base: WE05 West Elm Burnished Bronze</li> </ul>	<ul style="list-style-type: none"> <li>1 Style number</li> <li>2 Fabric color number for chair</li> <li>3 Options, if selected (see below)</li> <li>▶ See <i>Surface Materials</i>, page 242.</li> </ul>

Options	U.S. Price	Required to Specify
<b>Upholstery</b>		
• Customer's Own Material (COM)	No cost	▶ See <i>Surface Materials Reference Manual</i> . Specify fabric color number.
• Fabric price group 1	No cost	Specify vinyl color number.
• Vinyl price group 2	+\$ 68	Specify fabric color number.
• Fabric price group 2	+\$ 68	Specify fabric color number.
• Fabric price group 3	+\$ 158	Specify fabric color number.
• Customer's Own Leather (COL)	+\$ 195	▶ See <i>Surface Materials Reference Manual</i> . Specify fabric color number.
• Fabric price group 4	+\$ 318	Specify fabric color number.
• Fabric price group 5	+\$ 456	Specify fabric color number.
• Fabric price group 6	+\$ 747	Specify fabric color number.
• Fabric price group 7	+\$ 885	Specify fabric color number.
• Fabric price group 8	+\$1223	Specify fabric color number.
• Fabric price group 9	+\$1453	Specify fabric color number.
• Fabric price group 10	+\$1654	Specify fabric color number.
• Leather price group 1	+\$2222	Specify leather color number.
• Leather price group 2	+\$2595	Specify leather color number.

Specification Information	
Style Number	U.S. Base Price
<b>WESLUCW</b>	\$2892



 **For Canadian Pricing**  
 Multiply U.S. Price by the Canadian price factor.  
 ▶ See page 1 for details.

# Lucas Swivel Chair

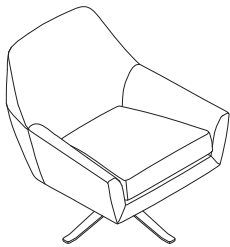

Standard Includes		Required to Specify
▶ Need help? Product details, page 46	<ul style="list-style-type: none"> <li>Fully upholstered seat with back: fabric price group 1</li> <li>Swivel base: 8046 Polished Aluminum</li> </ul>	1 Style number 2 Fabric color number for chair 3 Options, if selected (see below) ▶ See <i>Surface Materials</i> , page 242.

Options	U.S. Price	Required to Specify
<b>Upholstery</b>		
• Customer's Own Material (COM)	No cost	▶ See <i>Surface Materials Reference Manual</i> .
• Fabric price group 1	No cost	Specify fabric color number.
• Vinyl price group 2	+\$ 68	Specify vinyl color number.
• Fabric price group 2	+\$ 68	Specify fabric color number.
• Fabric price group 3	+\$ 158	Specify fabric color number.
• Customer's Own Leather (COL)	+\$ 195	▶ See <i>Surface Materials Reference Manual</i> .
• Fabric price group 4	+\$ 318	Specify fabric color number.
• Fabric price group 5	+\$ 456	Specify fabric color number.
• Fabric price group 6	+\$ 747	Specify fabric color number.
• Fabric price group 7	+\$ 885	Specify fabric color number.
• Fabric price group 8	+\$1223	Specify fabric color number.
• Fabric price group 9	+\$1453	Specify fabric color number.
• Fabric price group 10	+\$1654	Specify fabric color number.
• Leather price group 1	+\$2222	Specify leather color number.
• Leather price group 2	+\$2595	Specify leather color number.

Specification Information	
• Style Number	• U.S. Base Price
WESLUCS	\$3111

 **For Canadian Pricing**  
 Multiply U.S. Price by the Canadian price factor.  
 ▶ See page 1 for details.

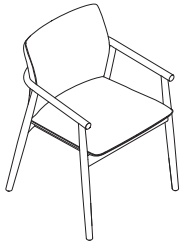

Standard Includes	Required to Specify
<ul style="list-style-type: none"> <li>▶ Need help? Product details, page 48</li> <li>Fully upholstered non-contrasting seat with back: fabric price group 1</li> <li>Frame: veneer price group 1</li> <li>Glides</li> </ul>	<ol style="list-style-type: none"> <li>Style number</li> <li>Fabric color number for chair</li> <li>Wood color number for frame</li> <li>Options, if selected (see below)</li> </ol> <ul style="list-style-type: none"> <li>▶ See <i>Surface Materials</i>, page 242.</li> </ul>

Options	U.S. Price	Required to Specify
<p><b>Surface Materials</b></p> <p><b>Upholstery</b></p> <ul style="list-style-type: none"> <li>Customer's Own Material (COM) No cost</li> <li>Fabric price group 1 No cost</li> <li>Vinyl price group 2 +\$ 19</li> <li>Fabric price group 2 +\$ 19</li> <li>Fabric price group 3 +\$ 65</li> <li>Customer's Own Leather (COL) +\$ 109</li> <li>Fabric price group 4 +\$ 137</li> <li>Fabric price group 5 +\$ 257</li> <li>Fabric price group 6 +\$ 333</li> <li>Fabric price group 7 +\$ 429</li> <li>Fabric price group 8 +\$ 516</li> <li>Fabric price group 9 +\$ 591</li> <li>Fabric price group 10 +\$ 688</li> <li>Leather price group 1 +\$1162</li> <li>Leather price group 2 +\$1426</li> </ul> <p><b>Frame</b></p> <ul style="list-style-type: none"> <li>Customiz stain No cost</li> <li>Veneer price group 1 No cost</li> <li>Veneer price group 2 +\$ 62</li> </ul> <p><b>Color cord</b></p> <ul style="list-style-type: none"> <li>Non contrasting No cost</li> <li>Contrasting +\$ 32</li> </ul> <p><b>Cord</b></p> <ul style="list-style-type: none"> <li>Customer's Own Material (COM) No cost</li> <li>Fabric price group 1 No cost</li> <li>Vinyl price group 2 +\$ 5</li> <li>Fabric price group 2 +\$ 5</li> <li>Fabric price group 3 +\$ 16</li> <li>Customer's Own Leather (COL) +\$ 16</li> <li>Fabric price group 4 +\$ 35</li> <li>Fabric price group 5 +\$ 65</li> <li>Fabric price group 6 +\$ 83</li> <li>Fabric price group 7 +\$ 107</li> <li>Fabric price group 8 +\$ 129</li> <li>Fabric price group 9 +\$ 148</li> <li>Fabric price group 10 +\$ 172</li> <li>Leather price group 1 +\$ 291</li> <li>Leather price group 2 +\$ 357</li> </ul>		<ul style="list-style-type: none"> <li>▶ See <i>Surface Materials Reference Manual</i>. Specify fabric color number. Specify vinyl color number. Specify fabric color number.</li> <li>▶ See <i>Surface Materials Reference Manual</i>. Specify fabric color number. Specify fabric color number. Specify fabric color number. Specify fabric color number. Specify fabric color number. Specify fabric color number. Specify fabric color number. Specify fabric color number. Specify fabric color number. Specify leather color number. Specify leather color number.</li> <li>Specify with <i>Customiz stain</i>.</li> <li>▶ See <i>Surface Materials Reference Manual</i>. Specify wood color number. Specify wood color number.</li> <li>Specify with <i>non contrasting</i>. Specify with <i>contrasting</i>.</li> <li>▶ See <i>Surface Materials Reference Manual</i>. Specify fabric color number. Specify vinyl color number. Specify fabric color number. Specify fabric color number.</li> <li>▶ See <i>Surface Materials Reference Manual</i>. Specify fabric color number. Specify fabric color number. Specify fabric color number. Specify fabric color number. Specify fabric color number. Specify fabric color number. Specify fabric color number. Specify fabric color number. Specify leather color number. Specify leather color number.</li> </ul>

Specification Information	
Style Number	U.S. Base Price
WESFTNCG	\$1942

**For Canadian Pricing**  
 Multiply U.S. Price by the Canadian price factor.  
 ▶ See page 1 for details.



# Fulton Lounge Chair

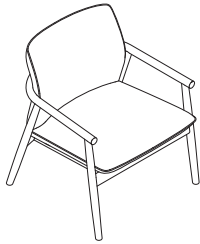

Standard Includes		Required to Specify
<ul style="list-style-type: none"> <li>▶ Need help? Product details, page 48</li> </ul>	<ul style="list-style-type: none"> <li>Fully upholstered non-contrasting seat with back: fabric price group 1</li> <li>Frame: veneer price group 1</li> <li>Glides</li> </ul>	<ol style="list-style-type: none"> <li>1 Style number</li> <li>2 Fabric color number for chair</li> <li>3 Wood color number for frame</li> <li>4 Options, if selected (see below)</li> </ol> <ul style="list-style-type: none"> <li>▶ See <i>Surface Materials</i>, page 242.</li> </ul>

Options	U.S. Price	Required to Specify
<b>Surface Materials</b>		
<b>Upholstery</b> <ul style="list-style-type: none"> <li>Customer's Own Material (COM) No cost</li> <li>Fabric price group 1 No cost</li> <li>Vinyl price group 2 +\$ 26</li> <li>Fabric price group 2 +\$ 26</li> <li>Fabric price group 3 +\$ 87</li> <li>Customer's Own Leather (COL) +\$ 109</li> <li>Fabric price group 4 +\$ 183</li> <li>Fabric price group 5 +\$ 343</li> <li>Fabric price group 6 +\$ 444</li> <li>Fabric price group 7 +\$ 572</li> <li>Fabric price group 8 +\$ 688</li> <li>Fabric price group 9 +\$ 787</li> <li>Fabric price group 10 +\$ 916</li> <li>Leather price group 1 +\$1549</li> <li>Leather price group 2 +\$1902</li> </ul>		<ul style="list-style-type: none"> <li>▶ See <i>Surface Materials Reference Manual</i>. Specify fabric color number. Specify vinyl color number. Specify fabric color number. Specify fabric color number.</li> <li>▶ See <i>Surface Materials Reference Manual</i>. Specify fabric color number. Specify fabric color number. Specify fabric color number. Specify fabric color number. Specify fabric color number. Specify fabric color number. Specify fabric color number. Specify fabric color number. Specify fabric color number. Specify leather color number. Specify leather color number.</li> </ul>
<b>Frame</b> <ul style="list-style-type: none"> <li>Customiz stain No cost</li> <li>Veneer price group 1 No cost</li> <li>Veneer price group 2 +\$ 62</li> </ul>		<ul style="list-style-type: none"> <li>Specify with <i>Customiz stain</i>.</li> <li>▶ See <i>Surface Materials Reference Manual</i>. Specify wood color number. Specify wood color number.</li> </ul>
<b>Color cord</b> <ul style="list-style-type: none"> <li>Non contrasting No cost</li> <li>Contrasting +\$ 32</li> </ul>		<ul style="list-style-type: none"> <li>Specify with <i>non contrasting</i>.</li> <li>Specify with <i>contrasting</i>.</li> </ul>
<b>Cord</b> <ul style="list-style-type: none"> <li>Customer's Own Material (COM) No cost</li> <li>Fabric price group 1 No cost</li> <li>Vinyl price group 2 +\$ 6</li> <li>Fabric price group 2 +\$ 6</li> <li>Fabric price group 3 +\$ 22</li> <li>Customer's Own Leather (COL) +\$ 22</li> <li>Fabric price group 4 +\$ 45</li> <li>Fabric price group 5 +\$ 85</li> <li>Fabric price group 6 +\$ 112</li> <li>Fabric price group 7 +\$ 142</li> <li>Fabric price group 8 +\$ 172</li> <li>Fabric price group 9 +\$ 197</li> <li>Fabric price group 10 +\$ 229</li> <li>Leather price group 1 +\$ 387</li> <li>Leather price group 2 +\$ 476</li> </ul>		<ul style="list-style-type: none"> <li>▶ See <i>Surface Materials Reference Manual</i>. Specify fabric color number. Specify vinyl color number. Specify fabric color number. Specify fabric color number.</li> <li>▶ See <i>Surface Materials Reference Manual</i>. Specify fabric color number. Specify fabric color number. Specify fabric color number. Specify fabric color number. Specify fabric color number. Specify fabric color number. Specify fabric color number. Specify fabric color number. Specify leather color number. Specify leather color number.</li> </ul>

Specification Information	
Style Number	U.S. Base Price
WESFTNCL	\$2776

 **For Canadian Pricing**  
 Multiply U.S. Price by the Canadian price factor.  
 ▶ See page 1 for details.

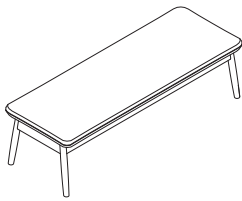

Standard Includes	Required to Specify
<ul style="list-style-type: none"> <li>▶ Need help? Product details, page 48</li> <li>Fully upholstered non-contrasting seat: fabric price group 1</li> <li>Frame: veneer price group 1</li> <li>Glides</li> </ul>	<ol style="list-style-type: none"> <li>Style number</li> <li>Fabric color number for bench</li> <li>Wood color number for frame</li> <li>Options, if selected (see below)</li> </ol> <ul style="list-style-type: none"> <li>▶ See <i>Surface Materials</i>, page 242.</li> </ul>

Options	U.S. Price	Required to Specify
<p><b>Surface Materials</b></p> <ul style="list-style-type: none"> <li>Customer's Own Material (COM)</li> <li>Fabric price group 1</li> <li>Vinyl price group 2</li> <li>Fabric price group 2</li> <li>Fabric price group 3</li> <li>Customer's Own Leather (COL)</li> <li>Fabric price group 4</li> <li>Fabric price group 5</li> <li>Fabric price group 6</li> <li>Fabric price group 7</li> <li>Fabric price group 8</li> <li>Fabric price group 9</li> <li>Fabric price group 10</li> <li>Leather price group 1</li> <li>Leather price group 2</li> </ul>	<ul style="list-style-type: none"> <li>No cost</li> <li>No cost</li> <li>+\$ 26</li> <li>+\$ 26</li> <li>+\$ 87</li> <li>+\$ 109</li> <li>+\$ 183</li> <li>+\$ 343</li> <li>+\$ 444</li> <li>+\$ 572</li> <li>+\$ 688</li> <li>+\$ 787</li> <li>+\$ 917</li> <li>+\$1549</li> <li>+\$1902</li> </ul>	<ul style="list-style-type: none"> <li>▶ See <i>Surface Materials Reference Manual</i>. Specify fabric color number.</li> <li>Specify vinyl color number.</li> <li>Specify fabric color number.</li> <li>Specify fabric color number.</li> <li>▶ See <i>Surface Materials Reference Manual</i>. Specify fabric color number.</li> <li>Specify fabric color number.</li> <li>Specify fabric color number.</li> <li>Specify fabric color number.</li> <li>Specify fabric color number.</li> <li>Specify fabric color number.</li> <li>Specify fabric color number.</li> <li>Specify fabric color number.</li> <li>Specify fabric color number.</li> <li>Specify leather color number.</li> <li>Specify leather color number.</li> </ul>
<p><b>Frame</b></p> <ul style="list-style-type: none"> <li>Customiz stain</li> <li>Veneer price group 1</li> <li>Veneer price group 2</li> </ul>	<ul style="list-style-type: none"> <li>No cost</li> <li>No cost</li> <li>+\$ 62</li> </ul>	<ul style="list-style-type: none"> <li>Specify with <i>Customiz stain</i>.</li> <li>▶ See <i>Surface Materials Reference Manual</i>. Specify wood color number.</li> <li>Specify wood color number.</li> </ul>
<p><b>Color cord</b></p> <ul style="list-style-type: none"> <li>Non contrasting</li> <li>Contrasting</li> </ul>	<ul style="list-style-type: none"> <li>No cost</li> <li>+\$ 32</li> </ul>	<ul style="list-style-type: none"> <li>Specify with <i>non contrasting</i>.</li> <li>Specify with <i>contrasting</i>.</li> </ul>
<p><b>Cord</b></p> <ul style="list-style-type: none"> <li>Customer's Own Material (COM)</li> <li>Fabric price group 1</li> <li>Vinyl price group 2</li> <li>Fabric price group 2</li> <li>Fabric price group 3</li> <li>Customer's Own Leather (COL)</li> <li>Fabric price group 4</li> <li>Fabric price group 5</li> <li>Fabric price group 6</li> <li>Fabric price group 7</li> <li>Fabric price group 8</li> <li>Fabric price group 9</li> <li>Fabric price group 10</li> <li>Leather price group 1</li> <li>Leather price group 2</li> </ul>	<ul style="list-style-type: none"> <li>No cost</li> <li>No cost</li> <li>+\$ 6</li> <li>+\$ 6</li> <li>+\$ 22</li> <li>+\$ 22</li> <li>+\$ 45</li> <li>+\$ 85</li> <li>+\$ 112</li> <li>+\$ 142</li> <li>+\$ 172</li> <li>+\$ 197</li> <li>+\$ 229</li> <li>+\$ 387</li> <li>+\$ 476</li> </ul>	<ul style="list-style-type: none"> <li>▶ See <i>Surface Materials Reference Manual</i>. Specify fabric color number.</li> <li>Specify vinyl color number.</li> <li>Specify fabric color number.</li> <li>Specify fabric color number.</li> <li>▶ See <i>Surface Materials Reference Manual</i>. Specify fabric color number.</li> <li>Specify fabric color number.</li> <li>Specify fabric color number.</li> <li>Specify fabric color number.</li> <li>Specify fabric color number.</li> <li>Specify fabric color number.</li> <li>Specify fabric color number.</li> <li>Specify fabric color number.</li> <li>Specify fabric color number.</li> <li>Specify leather color number.</li> <li>Specify leather color number.</li> </ul>

Specification Information	
• Style Number	• U.S. Base Price
WESFTNBH	\$2220

**For Canadian Pricing**  
 Multiply U.S. Price by the Canadian price factor.  
 ▶ See page 1 for details.



# Greenpoint Private Office Desk

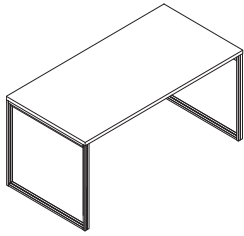

Tip: Edge will be matching veneer flat profile on side and back edges when wood top surface is selected, or 3 mm plastic edge when laminate top surface is selected.

Standard Includes		Required to Specify
<ul style="list-style-type: none"> <li>▶ Need help? Product details, page 52</li> </ul>	<ul style="list-style-type: none"> <li>• Desk worksurface: High-Pressure Laminate price group 1</li> <li>• Square tube legs (frame): paint price group 1</li> <li>• 1½" leveling glides</li> </ul>	<ol style="list-style-type: none"> <li>1 Style number</li> <li>2 Specify depth</li> <li>3 Specify width</li> <li>4 Laminate color number for worksurface</li> <li>5 Paint color number for legs (frame)</li> <li>6 Options, if selected (see below)</li> </ol> <ul style="list-style-type: none"> <li>▶ See <i>Surface Materials</i>, page 242.</li> </ul>

	Options	U.S. Price	Required to Specify
<b>Depth</b>	<ul style="list-style-type: none"> <li>• 30"</li> <li>• 36"</li> </ul>	Prices below Prices below	Select 30" depth. Select 36" depth.
<b>Width</b>	<ul style="list-style-type: none"> <li>• 60"</li> <li>• 66"</li> <li>• 72"</li> </ul>	Prices below Prices below Prices below	Select 60" width. Select 66" width. Select 72" width.
<b>Surface Materials</b>	<p><b>Top</b></p> <ul style="list-style-type: none"> <li>• High-Pressure Laminate price group 1</li> <li>• High-Pressure Laminate price group 2</li> <li>• Veneer price group 1</li> <li>• West Elm veneer</li> </ul> <p><b>Frame</b></p> <ul style="list-style-type: none"> <li>• Paint price group 1</li> <li>• Paint price group 2                             <ul style="list-style-type: none"> <li>– 30"D</li> <li>– 36"D</li> </ul> </li> <li>• Paint price group 3                             <ul style="list-style-type: none"> <li>– 30"D</li> <li>– 36"D</li> </ul> </li> </ul>	Prices below Prices below Prices below Prices below No cost +\$ 44 +\$ 52 +\$ 90 +\$104	Specify laminate color number. Specify laminate color number. Specify wood color number. Specify West Elm wood color number. Specify paint color number. Specify paint color number. Specify paint color number. Specify paint color number.
<b>Cutout Type</b>	<ul style="list-style-type: none"> <li>• No cutout</li> <li>• Cutout center</li> <li>• Cutout left</li> <li>• Cutout right</li> </ul>	No cost +\$ 75 +\$ 75 +\$ 75	Specify <i>with no cutout</i> . Specify <i>with center cutout</i> . Specify <i>with left cutout</i> . Specify <i>with right cutout</i> .

## Specification Information

Style Number	Depth	U.S. Base Prices		
		60"W	66"W	72"W
:	:	:	:	:

### High-Pressure Laminate Price Group 1

WESINDPD	Depth	60"W	66"W	72"W
	30"	\$2326	\$2392	\$2460
	36"	N.A.	N.A.	\$2593

### High-Pressure Laminate Price Group 2

WESINDPD	Depth	60"W	66"W	72"W
	30"	\$2497	\$2565	\$2630
	36"	N.A.	N.A.	\$2764

### West Elm Veneer

WESINDPD	Depth	60"W	66"W	72"W
	30"	\$2771	\$2839	\$2905
	36"	N.A.	N.A.	\$3037

### Veneer Price Group 1

WESINDPD	Depth	60"W	66"W	72"W
	30"	\$3201	\$3306	\$3407
	36"	N.A.	N.A.	\$3615

 **For Canadian Pricing**  
Multiply U.S. Price by the Canadian price factor.  
▶ See page 1 for details.

# Greenpoint Private Office Desk Return with Leg

Greenpoint Private Office  
Desk Return with Leg

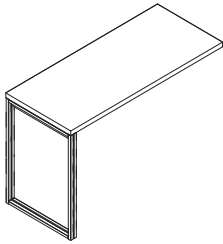

*Tip: Edge will be matching veneer flat profile on side and back edges when wood top surface is selected, or 3 mm plastic edge when laminate top surface is selected.*

Standard Includes		Required to Specify
<ul style="list-style-type: none"> <li>▶ Need help? Product details, page 52</li> <li>• Desk worksurface: High-Pressure Laminate price group 1</li> <li>• Square tube legs (frame): paint price group 1</li> <li>• 1½" leveling glides</li> </ul>		<ul style="list-style-type: none"> <li>1 Style number</li> <li>2 Specify depth</li> <li>3 Specify width</li> <li>4 Laminate color number for worksurface</li> <li>5 Paint color number for legs (frame)</li> <li>6 Options, if selected (see below)</li> <li>▶ See <i>Surface Materials</i>, page 242.</li> </ul>

	Options	U.S. Price	Required to Specify
<b>Depth</b>	<ul style="list-style-type: none"> <li>• 18"</li> <li>• 24"</li> </ul>	Prices below Prices below	Select 18" depth. Select 24" depth.
<b>Width</b>	<ul style="list-style-type: none"> <li>• 42"</li> <li>• 48"</li> <li>• 54"</li> <li>• 60"</li> </ul>	Prices below Prices below Prices below Prices below	Select 42" width. Select 48" width. Select 54" width. Select 60" width.
<b>Surface Materials</b>	<p><b>Top</b></p> <ul style="list-style-type: none"> <li>• High-Pressure Laminate price group 1</li> <li>• High-Pressure Laminate price group 2</li> <li>• Veneer price group 1</li> <li>• West Elm veneer</li> </ul> <p><b>Frame</b></p> <ul style="list-style-type: none"> <li>• Paint price group 1</li> <li>• Paint price group 2                             <ul style="list-style-type: none"> <li>– 18"D</li> <li>– 24"D</li> </ul> </li> <li>• Paint price group 3                             <ul style="list-style-type: none"> <li>– 18"D</li> <li>– 24"D</li> </ul> </li> </ul>	Prices below Prices below Prices below Prices below No cost +\$16 +\$20 +\$30 +\$37	Specify laminate color number. Specify laminate color number. Specify wood color number. Specify West Elm wood color number. Specify paint color number. Specify paint color number. Specify paint color number. Specify paint color number.

## Specification Information

• Style Number	• Depth	• U.S. Base Prices			
		• 42"W	• 48"W	• 54"W	• 60"W
•	•	•	•	•	•

### High-Pressure Laminate Price Group 1

WESINDRL	18"	24"	42"W	48"W	54"W	60"W
	\$1207	\$1285	\$1273	\$1349	\$1341	\$1409

### High-Pressure Laminate Price Group 2

WESINDRL	18"	24"	42"W	48"W	54"W	60"W
	\$1335	\$1409	\$1402	\$1474	\$1467	\$1609

### West Elm Veneer

WESINDRL	18"	24"	42"W	48"W	54"W	60"W
	\$1490	\$1563	\$1556	\$1628	\$1623	\$1762

### Veneer Price Group 1

WESINDRL	18"	24"	42"W	48"W	54"W	60"W
	\$1662	\$1779	\$1727	\$1845	\$1839	\$2030

 **For Canadian Pricing**  
Multiply U.S. Price by the Canadian price factor.  
▶ See page 1 for details.

Greenpoint  
Private Office

# Greenpoint Private Office Desk Return with Pedestal

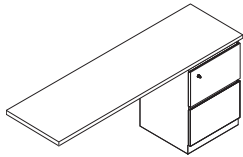

► Need help? Product details, page 52

## Standard Includes

- Desk worksurface: High-Pressure Laminate price group 1
- Under worksurface file/file pedestal case: paint price group 1
- Under worksurface file/file pedestal front: High-Pressure Laminate price group 1
- Basic pedestal configuration
- Lock on pedestal
- 1½" leveling glides

## Required to Specify

- 1 Style number
  - 2 Specify depth
  - 3 Specify width
  - 4 Laminate color number for worksurface
  - 5 Paint color number for pedestal case
  - 6 Laminate color number for pedestal front
  - 7 Options, if selected (see below)
- See *Surface Materials*, page 242.

*Tip: Edge will be matching veneer flat profile on side and back edges when wood top surface is selected, or 3 mm plastic edge when laminate top surface is selected.*

*Tip: When specified in High-Pressure Laminate, the pull of the drawer will be painted according to the matrix in the *Surface Materials* section.*

*Tip: Drawer fronts on pedestal are available in limited High-Pressure Laminate and veneer finishes. See *Surface Materials* section for more information.*

	Options	U.S. Price	Required to Specify
<b>Depth</b>	<ul style="list-style-type: none"> <li>• 18"</li> <li>• 24"</li> </ul>	Prices at right Prices at right	Specify 18" depth. Specify 24" depth.
<b>Width</b>	<ul style="list-style-type: none"> <li>• 42"</li> <li>• 48"</li> <li>• 54"</li> <li>• 60"</li> </ul>	Prices at right Prices at right Prices at right Prices at right	Specify 42" width. Specify 48" width. Specify 54" width. Specify 60" width.
<b>Surface Materials</b>	<p><b>Top</b></p> <ul style="list-style-type: none"> <li>• High-Pressure Laminate price group 1</li> <li>• High-Pressure Laminate price group 2</li> <li>• Veneer price group 1</li> <li>• West Elm veneer</li> </ul> <p><b>Case</b></p> <ul style="list-style-type: none"> <li>• Paint price group 1</li> <li>• Paint price group 2</li> <li>• Paint price group 3</li> </ul> <p><b>Front</b></p> <ul style="list-style-type: none"> <li>• Wood veneer</li> <li>• West Elm open pore</li> <li>• High-Pressure Laminate price group 1</li> <li>• High-Pressure Laminate price group 2</li> </ul> <p><b>Lock</b></p> <ul style="list-style-type: none"> <li>• Ember chrome</li> <li>• Polished chrome</li> </ul>	Prices at right Prices at right Prices at right Prices at right No cost +\$ 44 +\$ 81 No cost No cost No cost No cost No cost No cost	Specify laminate color number. Specify laminate color number. Specify wood color number. Specify West Elm wood color number. Specify paint color number. Specify paint color number. Specify paint color number. Specify wood color number. Specify West Elm wood color number. Specify laminate color number. Specify laminate color number. Specify with 9250 Ember Chrome lock. Specify with 9201 Polished Chrome lock.
<b>Lock and Keying</b>	<ul style="list-style-type: none"> <li>• Keying</li> </ul>	No cost	► See <i>Lock and Keying</i>
<b>Drawer Configuration</b>	<ul style="list-style-type: none"> <li>• File/file</li> <li>• Box/box/file</li> </ul>	No cost +\$174	Specify with <i>file/file pedestal</i> . Specify with <i>box/box/file pedestal</i> .
<b>Drawer Interior</b>	<ul style="list-style-type: none"> <li>• Basic drawer</li> <li>• Full drawer</li> </ul>	No cost +\$ 75	Specify with <i>basic drawer</i> . Specify with <i>full drawer</i> .
<b>Drawer Accessories</b>	<ul style="list-style-type: none"> <li>• No rail</li> <li>• With rail</li> </ul>	No cost No cost	Specify with <i>no rail</i> . Specify with <i>with rail</i> .



### For Canadian Pricing

Multiply U.S. Price by the Canadian price factor.

► See page 1 for details.

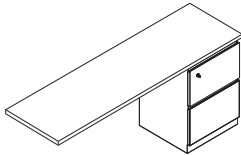

**Specification Information**

• Style Number	• Depth	• U.S. Base Prices			
		42"W	48"W	54"W	60"W

**High-Pressure Laminate Price Group 1**

WESINDRP	Depth	42"W	48"W	54"W	60"W
	18"	\$2130	\$2196	\$2264	\$2332
	24"	\$2213	\$2278	\$2345	\$2414

**High-Pressure Laminate Price Group 2**

WESINDRP	Depth	42"W	48"W	54"W	60"W
	18"	\$2258	\$2325	\$2390	\$2459
	24"	\$2339	\$2405	\$2473	\$2538

**West Elm Veneer**

WESINDRP	Depth	42"W	48"W	54"W	60"W
	18"	\$2413	\$2479	\$2546	\$2612
	24"	\$2493	\$2559	\$2626	\$2692

**Veneer Price Group 1**

WESINDRP	Depth	42"W	48"W	54"W	60"W
	18"	\$2626	\$2692	\$2803	\$2872
	24"	\$2752	\$2821	\$2938	\$3005

 **For Canadian Pricing**  
Multiply U.S. Price by the Canadian price factor.  
▶ See page 1 for details.

# Greenpoint Private Office Modesty Panel

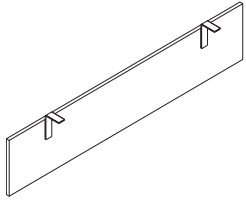

*Tip: A modesty panel is available and ordered separately, in widths from 48" to 78". They can be specified in either wood veneer or High-Pressure Laminate. Modesty panels are specified one size smaller than the desk to allow for 3" clearance on both ends to accommodate the legs. Modesty panel can be mounted flush or inset with the edge of the worksurface. Modesty panel allows for 1" cord gap between the surface.*

Standard Includes		Required to Specify
▶ Need help? Product details, page 52	<ul style="list-style-type: none"> <li>Modesty panel: High-Pressure Laminate price group 1</li> <li>Mounting brackets: black paint</li> </ul>	1 Style number 2 Laminate color number for modesty panel 3 Options, if selected (see below) ▶ See <i>Surface Materials</i> , page 242.

Options	U.S. Price	Required to Specify
<b>Width</b>		
• 42"	Prices below	Specify 42" width.
• 48"	Prices below	Specify 48" width.
• 54"	Prices below	Specify 54" width.
• 60"	Prices below	Specify 60" width.
• 72"	Prices below	Specify 72" width.
• 78"	Prices below	Specify 78" width.
<b>Surface Materials</b>		
• High-Pressure Laminate price group 1	Prices below	Specify laminate color number.
• High-Pressure Laminate price group 2	Prices below	Specify laminate color number.
• Veneer price group 1	Prices below	Specify wood color number.
• West Elm veneer	Prices below	Specify West Elm wood color number.

Specification Information							
Style Number	Depth	U.S. Base Prices					
		42"W	48"W	54"W	60"W	72"W	78"W
•	•	•	•	•	•	•	•
•	•	•	•	•	•	•	•

## High-Pressure Laminate Price Group 1

WESINDMP	12 1/2"	\$487	\$517	\$546	\$577	\$ 605	\$ 635
•	•	•	•	•	•	•	•

## High-Pressure Laminate Price Group 2

WESINDMP	12 1/2"	\$582	\$615	\$643	\$673	\$ 702	\$ 733
•	•	•	•	•	•	•	•

## West Elm Veneer

WESINDMP	12 1/2"	\$745	\$775	\$804	\$836	\$ 865	\$ 894
•	•	•	•	•	•	•	•

## Veneer Price Group 1

WESINDMP	12 1/2"	\$857	\$887	\$932	\$961	\$1079	\$1109
•	•	•	•	•	•	•	•



**For Canadian Pricing**  
 Multiply U.S. Price by the Canadian price factor.  
 ▶ See page 1 for details.

# Greenpoint Private Office Filing Credenza

Greenpoint Private Office  
Filing Credenza

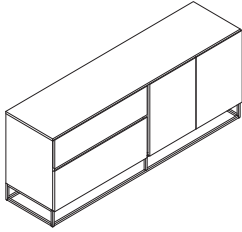

*Tip: When specified in High-Pressure Laminate, the pull of the drawer will be painted according to the matrix in the Surface Materials section.*

Standard Includes	Required to Specify
<ul style="list-style-type: none"> <li>▶ Need help? Product details, page 52</li> <li>• Credenza: High-Pressure Laminate price group 1</li> <li>• Square tube legs (frame): paint price group 1</li> <li>• 1½" leveling glides</li> </ul>	<ol style="list-style-type: none"> <li>1 Style number</li> <li>2 Laminate color number for modesty panel</li> <li>3 Paint color number for legs (frame)</li> <li>4 Options, if selected (see below)</li> </ol> <p>▶ See <i>Surface Materials</i>, page 242.</p>

Options	U.S. Price	Required to Specify
<b>Surface Materials</b> <ul style="list-style-type: none"> <li>• High-Pressure Laminate price group 1</li> <li>• High-Pressure Laminate price group 2</li> <li>• West Elm veneer</li> <li>• Veneer price group 1</li> </ul>	<ul style="list-style-type: none"> <li>No cost</li> <li>+\$ 970</li> <li>+\$1430</li> <li>+\$6291</li> </ul>	<ul style="list-style-type: none"> <li>Specify laminate color number.</li> <li>Specify laminate color number.</li> <li>Specify West Elm wood color number.</li> <li>Specify wood color number.</li> </ul>
<b>Frame</b> <ul style="list-style-type: none"> <li>• Paint price group 1</li> <li>• Paint price group 2</li> <li>• Paint price group 3</li> </ul>	<ul style="list-style-type: none"> <li>No cost</li> <li>+\$ 44</li> <li>+\$ 78</li> </ul>	<ul style="list-style-type: none"> <li>Specify paint color number.</li> <li>Specify paint color number.</li> <li>Specify paint color number.</li> </ul>

Specification Information	
Style Number	U.S. Base Price
WESINDFC	\$5658

 **For Canadian Pricing**  
Multiply U.S. Price by the Canadian price factor.  
▶ See page 1 for details.

# Greenpoint Private Office Storage Credenza

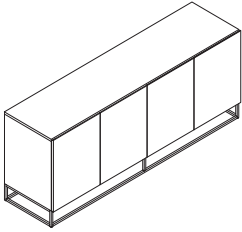

Tip: When specified in High-Pressure Laminate, the pull of the drawer will be painted according to the matrix in the Surface Materials section.

Standard Includes		Required to Specify
<ul style="list-style-type: none"> <li>▶ Need help? Product details, page 52</li> </ul>	<ul style="list-style-type: none"> <li>• Credenza: High-Pressure Laminate price group 1</li> <li>• Square tube legs (frame): paint price group 1</li> <li>• 1½" leveling glides</li> </ul>	<ul style="list-style-type: none"> <li>1 Style number</li> <li>2 High-Pressure Laminate color number for credenza</li> <li>3 Paint color number for legs (frame)</li> <li>4 Options, if selected (see below)</li> <li>▶ See <i>Surface Materials</i>, page 242.</li> </ul>

Options	U.S. Price	Required to Specify
<b>Surface Materials</b>		
<b>Case</b> <ul style="list-style-type: none"> <li>• High-Pressure Laminate price group 1</li> <li>• High-Pressure Laminate price group 2</li> <li>• West Elm veneer</li> <li>• Veneer price group 1</li> </ul>	<ul style="list-style-type: none"> <li>No cost</li> <li>+\$1110</li> <li>+\$1423</li> <li>+\$6122</li> </ul>	<ul style="list-style-type: none"> <li>Specify laminate color number.</li> <li>Specify laminate color number.</li> <li>Specify West Elm wood color number.</li> <li>Specify wood color number.</li> </ul>
<b>Frame</b> <ul style="list-style-type: none"> <li>• Paint price group 1</li> <li>• Paint price group 2</li> <li>• Paint price group 3</li> </ul>	<ul style="list-style-type: none"> <li>No cost</li> <li>+\$ 44</li> <li>+\$ 78</li> </ul>	<ul style="list-style-type: none"> <li>Specify paint color number.</li> <li>Specify paint color number.</li> <li>Specify paint color number.</li> </ul>

Specification Information	
• Style Number	• U.S. Base Price
WESINDSC	\$4924



**For Canadian Pricing**  
 Multiply U.S. Price by the Canadian price factor.  
 ▶ See page 1 for details.

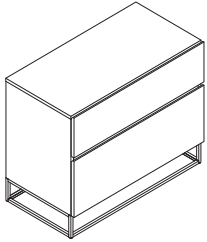

*Tip: When specified in High-Pressure Laminate, the pull of the drawer will be painted according to the matrix in the Surface Materials section.*

Standard Includes	Required to Specify
<ul style="list-style-type: none"> <li>▶ Need help? Product details, page 52</li> <li>• Lateral file: High-Pressure Laminate price group 1</li> <li>• Square tube legs (frame): paint price group 1</li> <li>• 1½" leveling glides</li> </ul>	<ul style="list-style-type: none"> <li>1 Style number</li> <li>2 High-Pressure Laminate color number for credenza</li> <li>3 Paint color number for legs (frame)</li> <li>4 Options, if selected (see below)</li> <li>▶ See <i>Surface Materials</i>, page 242.</li> </ul>

Options	U.S. Price	Required to Specify
<b>Surface Materials</b> <ul style="list-style-type: none"> <li>• High-Pressure Laminate price group 1</li> <li>• High-Pressure Laminate price group 2</li> <li>• West Elm veneer</li> <li>• Veneer price group 1</li> </ul>	<ul style="list-style-type: none"> <li>No cost</li> <li>+\$ 535</li> <li>+\$ 896</li> <li>+\$3319</li> </ul>	<ul style="list-style-type: none"> <li>Specify laminate color number.</li> <li>Specify laminate color number.</li> <li>Specify West Elm wood color number.</li> <li>Specify wood color number.</li> </ul>
<b>Frame</b> <ul style="list-style-type: none"> <li>• Paint price group 1</li> <li>• Paint price group 2</li> <li>• Paint price group 3</li> </ul>	<ul style="list-style-type: none"> <li>No cost</li> <li>+\$ 24</li> <li>+\$ 37</li> </ul>	<ul style="list-style-type: none"> <li>Specify paint color number.</li> <li>Specify paint color number.</li> <li>Specify paint color number.</li> </ul>

Specification Information	
Style Number	U.S. Base Price
WESINDLF	\$3782

 **For Canadian Pricing**  
Multiply U.S. Price by the Canadian price factor.  
▶ See page 1 for details.

# Greenpoint Private Office Low Open Bookcase

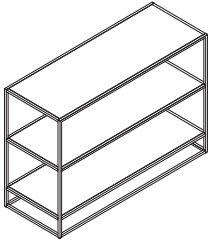

Standard Includes		Required to Specify
<ul style="list-style-type: none"> <li>▶ Need help? Product details, page 52</li> </ul>	<ul style="list-style-type: none"> <li>• Bookcase shelf: High-Pressure Laminate price group 1</li> <li>• Square tube legs (frame): paint price group 1</li> <li>• 1½" leveling glides</li> </ul>	<ol style="list-style-type: none"> <li>1 Style number</li> <li>2 High-Pressure Laminate color number for bookcase shelf</li> <li>3 Paint color number for legs (frame)</li> <li>4 Options, if selected (see below)</li> </ol> <ul style="list-style-type: none"> <li>▶ See <i>Surface Materials</i>, page 242.</li> </ul>

Options	U.S. Price	Required to Specify
<b>Surface Materials</b> <b>Shelf</b> <ul style="list-style-type: none"> <li>• High-Pressure Laminate price group 1</li> <li>• High-Pressure Laminate price group 2</li> <li>• West Elm veneer</li> <li>• Veneer price group 1</li> </ul>	No cost +\$224 +\$224 +\$757	Specify laminate color number. Specify laminate color number. Specify West Elm wood color number. Specify wood color number.
<b>Frame</b> <ul style="list-style-type: none"> <li>• Paint price group 1</li> <li>• Paint price group 2</li> <li>• Paint price group 3</li> </ul>	No cost +\$ 44 +\$ 90	Specify paint color number. Specify paint color number. Specify paint color number.

Specification Information	
• Style Number	• U.S. Base Price
WESINDLOB	\$2716



**For Canadian Pricing**  
 Multiply U.S. Price by the Canadian price factor.  
 ▶ See page 1 for details.

# Greenpoint Private Office Narrow Open Bookcase

Greenpoint Private Office  
Narrow Open Bookcase

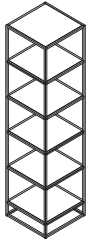

Standard Includes	Required to Specify
<ul style="list-style-type: none"> <li>▶ Need help? Product details, page 52</li> <li>• Bookcase shelf: High-Pressure Laminate price group 1</li> <li>• Square tube legs (frame): paint price group 1</li> <li>• 1½" leveling glides</li> </ul>	<ol style="list-style-type: none"> <li>1 Style number</li> <li>2 High-Pressure Laminate color number for bookcase shelf</li> <li>3 Paint color number for legs (frame)</li> <li>4 Options, if selected (see below)</li> </ol> <p>▶ See <i>Surface Materials</i>, page 242.</p>

Options	U.S. Price	Required to Specify
<b>Surface Materials</b> <ul style="list-style-type: none"> <li>• High-Pressure Laminate price group 1</li> <li>• High-Pressure Laminate price group 2</li> <li>• West Elm veneer</li> <li>• Veneer price group 1</li> </ul>	<ul style="list-style-type: none"> <li>No cost</li> <li>+\$224</li> <li>+\$224</li> <li>+\$455</li> </ul>	<ul style="list-style-type: none"> <li>Specify laminate color number.</li> <li>Specify laminate color number.</li> <li>Specify West Elm wood color number.</li> <li>Specify wood color number.</li> </ul>
<b>Frame</b> <ul style="list-style-type: none"> <li>• Paint price group 1</li> <li>• Paint price group 2</li> <li>• Paint price group 3</li> </ul>	<ul style="list-style-type: none"> <li>No cost</li> <li>+\$ 39</li> <li>+\$ 78</li> </ul>	<ul style="list-style-type: none"> <li>Specify paint color number.</li> <li>Specify paint color number.</li> <li>Specify paint color number.</li> </ul>

Specification Information	
Style Number	U.S. Base Price
<b>WESINDNOB</b>	\$3010

 **For Canadian Pricing**  
Multiply U.S. Price by the Canadian price factor.  
▶ See page 1 for details.

# Greenpoint Private Office Tall Open Bookcase

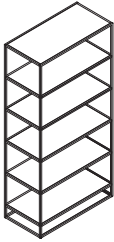

Standard Includes		Required to Specify
<ul style="list-style-type: none"> <li>▶ Need help? Product details, page 52</li> </ul>	<ul style="list-style-type: none"> <li>• Bookcase shelf: High-Pressure Laminate price group 1</li> <li>• Square tube legs (frame): paint price group 1</li> <li>• 1½" leveling glides</li> </ul>	<ol style="list-style-type: none"> <li>1 Style number</li> <li>2 High-Pressure Laminate color number for bookcase shelf</li> <li>3 Paint color number for legs (frame)</li> <li>4 Options, if selected (see below)</li> </ol> <ul style="list-style-type: none"> <li>▶ See <i>Surface Materials</i>, page 242.</li> </ul>

Options	U.S. Price	Required to Specify
<b>Surface Materials</b> <b>Shelf</b> <ul style="list-style-type: none"> <li>• High-Pressure Laminate price group 1</li> <li>• High-Pressure Laminate price group 2</li> <li>• West Elm veneer</li> <li>• Veneer price group 1</li> </ul>	No cost +\$ 260 +\$ 260 +\$1571	Specify laminate color number. Specify laminate color number. Specify West Elm wood color number. Specify wood color number.
<b>Frame</b> <ul style="list-style-type: none"> <li>• Paint price group 1</li> <li>• Paint price group 2</li> <li>• Paint price group 3</li> </ul>	No cost +\$ 71 +\$ 149	Specify paint color number. Specify paint color number. Specify paint color number.

Specification Information	
• Style Number	• U.S. Base Price
WESINDOB	\$3764



**For Canadian Pricing**  
 Multiply U.S. Price by the Canadian price factor.  
 ▶ See page 1 for details.

# Greenpoint Private Office Storage Bookcase

Greenpoint Private Office  
Storage Bookcase

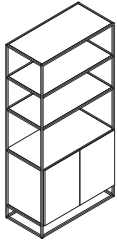

Standard Includes		Required to Specify
<ul style="list-style-type: none"> <li>▶ Need help? Product details, page 52</li> </ul>	<ul style="list-style-type: none"> <li>• Bookcase shelf: High-Pressure Laminate price group 1</li> <li>• Square tube legs (frame): paint price group 1</li> <li>• 1½" leveling glides</li> </ul>	<ol style="list-style-type: none"> <li>1 Style number</li> <li>2 High-Pressure Laminate color number for bookcase shelf</li> <li>3 Paint color number for legs (frame)</li> <li>4 Options, if selected (see below)</li> </ol> <p>▶ See <i>Surface Materials</i>, page 242.</p>

	Options	U.S. Price	Required to Specify
<b>Surface Materials</b>	<b>Shelf</b>		
	• High-Pressure Laminate price group 1	No cost	Specify laminate color number.
	• High-Pressure Laminate price group 2	+\$ 372	Specify laminate color number.
	• West Elm veneer	+\$ 372	Specify West Elm wood color number.
	• Veneer price group 1	+\$3001	Specify wood color number.
	<b>Frame</b>		
	• Paint price group 1	No cost	Specify paint color number.
	• Paint price group 2	+\$ 71	Specify paint color number.
	• Paint price group 3	+\$ 149	Specify paint color number.

Specification Information	
Style Number	U.S. Base Price
WESINDSB	\$5121



**For Canadian Pricing**  
Multiply U.S. Price by the Canadian price factor.  
▶ See page 1 for details.

# Greenpoint Private Office Metal Mobile Box/File Pedestal

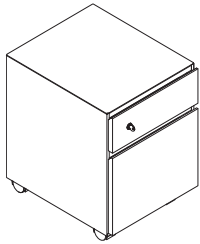

Tip: Drawer fronts on pedestal are available in limited High-Pressure Laminate and veneer finishes. See Surface Materials section for more information.

Tip: When specified in High-Pressure Laminate, the pull of the drawer will be painted according to the matrix in the Surface Materials section.

Standard Includes		Required to Specify
<ul style="list-style-type: none"> <li>▶ Need help? Product details, page 52</li> </ul>	<ul style="list-style-type: none"> <li>• 18"D X 15"W mobile pedestal: paint price group 1</li> <li>• Box/file configuration with full drawer</li> <li>• Lock</li> <li>• Casters: black plastic</li> </ul>	<ul style="list-style-type: none"> <li>1 Style number</li> <li>2 Paint color number for pedestal case</li> <li>3 Options, if selected (see below)</li> <li>▶ See <i>Surface Materials</i>, page 242.</li> </ul>

	Options	U.S. Price	Required to Specify
<b>Surface Materials</b>	<b>Case</b>		
	• Paint price group 1	No cost	Specify paint color number.
	• Paint price group 2	+\$ 26	Specify paint color number.
	• Paint price group 3	+\$ 44	Specify paint color number.
	<b>Front</b>		
	• Solid High-Pressure Laminate	No cost	Specify laminate color number.
	• Woodgrain High-Pressure Laminate price group 1	No cost	Specify laminate color number.
	• Woodgrain High-Pressure Laminate price group 2	+\$ 44	Specify laminate color number.
	• West Elm open pore	+\$148	Specify West Elm wood color number.
	• Natural veneer	+\$193	Specify wood color number.
	<b>Lock</b>		
	• Ember chrome	No cost	Specify with 9250 Ember Chrome lock.
	• Polished chrome	No cost	Specify with 9201 Polished Chrome lock.
<b>Lock and Keying</b>	• Keying	No cost	▶ See <i>Lock and Keying</i> .
<b>Drawer Interior</b>	• Full drawer	No cost	Specify with full drawer.
	• Basic drawer	-\$ 76	Specify with basic drawer.
<b>Drawer Accessories</b>	• No rail	No cost	Specify with no rail.
	• With rail	No cost	Specify with rail.

Specification Information	
• Style Number	• U.S. Base Price
WESINDMPM	\$1334

 **For Canadian Pricing**  
 Multiply U.S. Price by the Canadian price factor.  
 ▶ See page 1 for details.

# Greenpoint Private Office Basic Cushions Enhanced

Greenpoint Private Office  
Basic Cushions Enhanced

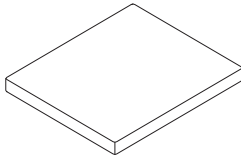

*Tip: Basic cushion enhanced is field-installed and supplies to attach are included.*

*Tip: Basic cushion enhanced is constructed with a thin solid base.*

*Tip: For both cushion top and basic cushion enhanced: fabric patterns with a linear design will always be applied from the front to back of the unit (depth of the unit).*

*Tip: For both cushion top and basic cushion enhanced: pattern matching will not be done on COM.*

*Tip: Support brace is for 30"W and 36" steel laterals with an open configuration.*

Standard Includes	Required to Specify
<ul style="list-style-type: none"> <li>▶ Need help? Product details, page 52</li> <li>• Enhanced cushion top: fabric price group 1</li> <li>• Attachment supplies: hook and loop fastener</li> </ul>	<ol style="list-style-type: none"> <li>1 Style number</li> <li>2 Fabric color number for enhanced cushion</li> <li>3 Options, if selected (see below)</li> </ol> <ul style="list-style-type: none"> <li>▶ See <i>Surface Materials</i>, page 242.</li> </ul>

Options	U.S. Price	Required to Specify
<b>Surface Materials</b> <ul style="list-style-type: none"> <li>• Upholstery</li> <li>• Fabric price group 1</li> <li>• Fabric price group 2</li> <li>• Customer's Own Material (COM)</li> <li>• Fabric price group 3</li> <li>• Fabric price group 4</li> <li>• Fabric price group 5</li> <li>• Fabric price group 6</li> <li>• Fabric price group 7</li> <li>• Fabric price group 8</li> <li>• Fabric price group 9</li> <li>• Fabric price group 10</li> </ul>	<ul style="list-style-type: none"> <li>• No cost</li> <li>• +\$ 13</li> <li>• +\$ 25</li> <li>• +\$ 63</li> <li>• +\$ 79</li> <li>• +\$ 99</li> <li>• +\$139</li> <li>• +\$167</li> <li>• +\$242</li> <li>• +\$309</li> <li>• +\$377</li> </ul>	<ul style="list-style-type: none"> <li>• Specify fabric color number.</li> <li>• Specify fabric color number.</li> <li>▶ See <i>Surface Materials Reference Manual</i>.</li> <li>• Specify fabric color number.</li> <li>• Specify fabric color number.</li> <li>• Specify fabric color number.</li> <li>• Specify fabric color number.</li> <li>• Specify fabric color number.</li> <li>• Specify fabric color number.</li> <li>• Specify fabric color number.</li> <li>• Specify fabric color number.</li> </ul>
<b>Storage Bracing</b> <ul style="list-style-type: none"> <li>• Bracing for 30"W storage</li> <li>• Bracing for 36"W storage</li> </ul>	<ul style="list-style-type: none"> <li>• +\$ 83</li> <li>• +\$ 83</li> </ul>	<ul style="list-style-type: none"> <li>• Specify with bracing for 30"W storage.</li> <li>• Specify with bracing for 36"W storage.</li> </ul>

Specification Information				
Dimensions			Style Number	U.S. Base Price
D	W	H		
17½"	15"	1½"	<b>RCHE1715</b>	\$299
18"	30"	1½"	<b>RCHE1830</b>	\$405
18"	36"	1½"	<b>RCHE1836</b>	\$430
:	:	:	:	:

 **For Canadian Pricing**  
Multiply U.S. Price by the Canadian price factor.  
▶ See page 1 for details.

Greenpoint  
Private Office

# Greenpoint Private Office

Accessories

## Wire Clip



Standard Includes	Required to Specify
<ul style="list-style-type: none"> <li>▶ Need help? Product details, page 52</li> <li>• Carton of six wire clips: black plastic only</li> <li>• Foam tape</li> <li>• Mounting screws</li> </ul>	<ul style="list-style-type: none"> <li>Style number</li> </ul>

Specification Information	
• Style Number	• U.S. Price

Wire Clip, Package of 6	
999CHT	\$118

## 2½" Round Grommet



Tip: Grommet **AWAG2** is for use on worksurfaces only.

Standard Includes	Required to Specify
<ul style="list-style-type: none"> <li>▶ Need help? Product details, page 52</li> <li>• Grommet: paint or metal</li> <li>• Installation instructions</li> </ul>	<ul style="list-style-type: none"> <li>1 Style number</li> <li>2 Color number for grommet</li> <li>▶ See <i>Surface Materials</i>, page 242.</li> </ul>

Specification Information	
• Style Number	• U.S. Price

AWAG2	\$110

## Wire Manager

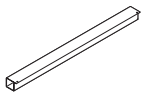

Standard Includes	Required to Specify
<ul style="list-style-type: none"> <li>▶ Need help? Product details, page 52</li> <li>• 25" wire manager with double-sided tape: black plastic</li> <li>• Attachment hardware</li> </ul>	<ul style="list-style-type: none"> <li>Style number</li> </ul>

Specification Information	
• Style Number	• U.S. Price

AWVW	\$24



**For Canadian Pricing**  
 Multiply U.S. Price by the Canadian price factor.  
 ▶ See page 1 for details.

## 1 3/4"D Wire Managers

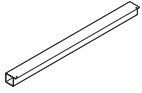

Standard Includes		Required to Specify
<ul style="list-style-type: none"> <li>▶ Need help? Product details, page 52</li> </ul>	<ul style="list-style-type: none"> <li>• Wire manager: 6000 Black</li> <li>• Attachment hardware</li> </ul>	Style number

Specification Information					
Dimensions			Weight	Style Number	U.S. Price
D	W	H			
1 3/4"	12"	1 3/4"	0.24 lb	<b>AWM12</b>	\$50
1 3/4"	18"	1 3/4"	0.34 lb	<b>AWM18</b>	\$57
1 3/4"	23"	1 3/4"	0.44 lb	<b>AWM23</b>	\$65
1 3/4"	30"	1 3/4"	0.56 lb	<b>AWM30</b>	\$76
1 3/4"	35"	1 3/4"	0.65 lb	<b>AWM35</b>	\$83
1 3/4"	42"	1 3/4"	0.77 lb	<b>AWM42</b>	\$92
:	:	:	:	:	:

 **For Canadian Pricing**  
 Multiply U.S. Price by the Canadian price factor.  
 ▶ See page 1 for details.

# Greenpoint Private Office

Power Units

## Greenpoint Power Unit

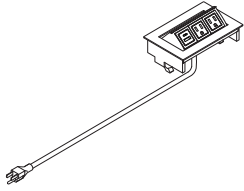

Tip: When using modular power under the worksurface specify 18" L cord length.

Standard Includes		Required to Specify	
-------------------	--	---------------------	--

- |   |   |  |
|---|---|--|
| <ul style="list-style-type: none"> <li>▶ Need help? Product details, page 52</li> </ul> | <ul style="list-style-type: none"> <li>• Power unit: paint</li> <li>• 18" cord</li> </ul> | <ul style="list-style-type: none"> <li>1 Style number</li> <li>2 Paint color number for power unit</li> <li>3 Options, if selected (see below)</li> <li>▶ See <i>Surface Materials</i>, page 242.</li> </ul> |
|---|---|--|

	Options	U.S. Price	Required to Specify
--	---------	------------	---------------------

- |                            |  |   |  |
|----------------------------|--|---|--|
| <b>Power Configuration</b> | <ul style="list-style-type: none"> <li>• 3 power</li> <li>• 2 power 1 USB A+C 20W</li> </ul> | <ul style="list-style-type: none"> <li>No cost</li> <li>+\$146</li> </ul> | <ul style="list-style-type: none"> <li>Specify with 3 power.</li> <li>Specify with 2 power 1 USB A+C 20W.</li> </ul> |
| <b>Cord Length</b>         | <ul style="list-style-type: none"> <li>• 18"</li> <li>• 108"</li> </ul>                      | <ul style="list-style-type: none"> <li>No cost</li> <li>+\$ 13</li> </ul> | <ul style="list-style-type: none"> <li>Specify with 18" cord.</li> <li>Specify with 108" cord.</li> </ul>            |

### Specification Information

Style Number	U.S. Base Price
WESINDPWR	\$436

## Greenpoint Power Unit for Use with Continuous Top

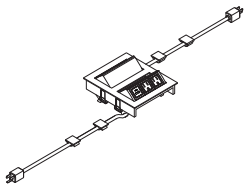

Standard Includes		Required to Specify	
-------------------	--	---------------------	--

- |   |   |  |
|---|---|--|
| <ul style="list-style-type: none"> <li>▶ Need help? Product details, page 52</li> </ul> | <ul style="list-style-type: none"> <li>• Power unit: paint</li> <li>• 18" cord</li> </ul> | <ul style="list-style-type: none"> <li>1 Style number</li> <li>2 Paint color number for power unit</li> <li>3 Options, if selected (see below)</li> <li>▶ See <i>Surface Materials</i>, page 242.</li> </ul> |
|---|---|--|

	Options	U.S. Price	Required to Specify
--	---------	------------	---------------------

- |                            |  |   |  |
|----------------------------|--|---|--|
| <b>Power Configuration</b> | <ul style="list-style-type: none"> <li>• 6 power</li> <li>• 4 power 1 USB A+C 20W</li> </ul> | <ul style="list-style-type: none"> <li>No cost</li> <li>+\$291</li> </ul> | <ul style="list-style-type: none"> <li>Specify with 6 power.</li> <li>Specify with 4 power 1 USB A+C 20W.</li> </ul> |
| <b>Cord Length</b>         | <ul style="list-style-type: none"> <li>• 18"</li> <li>• 108"</li> </ul>                      | <ul style="list-style-type: none"> <li>No cost</li> <li>+\$ 28</li> </ul> | <ul style="list-style-type: none"> <li>Specify with 18" cord.</li> <li>Specify with 108" cord.</li> </ul>            |

### Specification Information

Style Number	U.S. Base Price
WESINDPWRCT	\$734



### For Canadian Pricing

Multiply U.S. Price by the Canadian price factor.

▶ See page 1 for details.

## Greenpoint Round/Square Power Unit

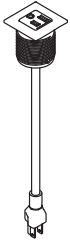

Standard Includes		Required to Specify
<ul style="list-style-type: none"> <li>▶ Need help? Product details, page 52</li> </ul>	<ul style="list-style-type: none"> <li>• Power unit: plastic</li> </ul>	<ul style="list-style-type: none"> <li>1 Style number</li> <li>2 Plastic color number for power unit</li> <li>3 Options, if selected (see below)</li> <li>▶ See <i>Surface Materials</i>, page 242.</li> </ul>

Options	U.S. Price	Required to Specify
<ul style="list-style-type: none"> <li>• 1 power</li> <li>• 1 USB A+C</li> </ul>	<p>No cost +\$107</p>	<p>Specify with 1 power. Specify with 1 USB A+C.</p>

Specification Information	
Style Number	U.S. Base Price
<b>WESINDPWRFR</b>	\$140
.	.

 **For Canadian Pricing**  
 Multiply U.S. Price by the Canadian price factor.  
 ▶ See page 1 for details.

# Greenpoint Bench Dual Sided Worksurface— Leg/Leg Application

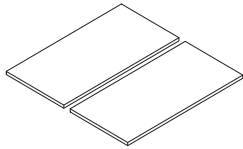

Tip: Edge will be matching veneer flat profile on side and back edges when wood top surface is selected, or 3 mm plastic edge when laminate top surface is selected.

Standard Includes	Required to Specify
<ul style="list-style-type: none"> <li>▶ Need help? Product details, page 60</li> <li>• Worksurface: High-Pressure Laminate price group 1 with 3 mm plastic edge</li> </ul>	<ol style="list-style-type: none"> <li>1 Style number</li> <li>2 Select depth</li> <li>3 Select width</li> <li>4 Laminate color number for worksurface</li> <li>5 Options, if selected (see below)</li> </ol> <ul style="list-style-type: none"> <li>▶ See <i>Surface Materials</i>, page 242.</li> </ul>

	Options	U.S. Price	Required to Specify
<b>Depth</b>	<ul style="list-style-type: none"> <li>• 24"</li> <li>• 30"</li> </ul>	Prices below Prices below	Select 24" depth. Select 30" depth.
<b>Width</b>	<ul style="list-style-type: none"> <li>• 48"</li> <li>• 54"</li> <li>• 60"</li> <li>• 66"</li> <li>• 72"</li> <li>• 78"</li> </ul>	Prices below Prices below Prices below Prices below Prices below Prices below	Select 48" width. Select 54" width. Select 60" width. Select 66" width. Select 72" width. Select 78" width.
<b>Surface Materials</b>	<b>Top</b> <ul style="list-style-type: none"> <li>• High-Pressure Laminate price group 1</li> <li>• High-Pressure Laminate price group 2</li> <li>• Veneer price group 1</li> <li>• West Elm veneer</li> </ul>	Prices below Prices below Prices below Prices below	Specify laminate color number. Specify laminate color number. Specify wood color number. Specify West Elm wood color number.
<b>Cutout Type</b>	<ul style="list-style-type: none"> <li>• Cutout center</li> <li>• No cutout</li> </ul>	No cost No cost	Specify <i>with center cutout</i> . Specify <i>with no cutout</i> .

Specification Information		U.S. Base Prices					
Style Number	Depth	48"W	54"W	60"W	66"W	72"W	78"W
•	•	•	•	•	•	•	•

## High-Pressure Laminate Price Group 1

WESINDWLLDS	Depth	48"W	54"W	60"W	66"W	72"W	78"W
	24"	\$1320	\$1452	\$1588	\$1724	\$1854	\$1996
	30"	\$1604	\$1738	\$1870	\$2006	\$2136	\$2274

## High-Pressure Laminate Price Group 2

WESINDWLLDS	Depth	48"W	54"W	60"W	66"W	72"W	78"W
	24"	\$1662	\$1798	\$1928	\$2064	\$2196	\$2330
	30"	\$1942	\$2082	\$2212	\$2348	\$2482	\$2614

## West Elm Veneer

WESINDWLLDS	Depth	48"W	54"W	60"W	66"W	72"W	78"W
	24"	\$2210	\$2346	\$2478	\$2610	\$2742	\$2876
	30"	\$2494	\$2622	\$2760	\$2890	\$3024	\$3158

## Veneer Price Group 1

WESINDWLLDS	Depth	48"W	54"W	60"W	66"W	72"W	78"W
	24"	\$2804	\$2996	\$3188	\$3382	\$3576	\$3770
	30"	\$3230	\$3424	\$3616	\$3814	\$4002	\$4194



**For Canadian Pricing**  
 Multiply U.S. Price by the Canadian price factor.  
 ▶ See page 1 for details.

# Greenpoint Bench Dual Sided Worksurface— Leg/Credenza Application

Greenpoint Bench Dual  
Sided Worksurface—Leg/  
Credenza Application

Greenpoint  
Bench

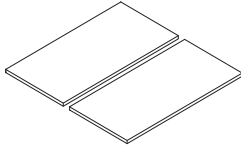

*Tip: Edge will be matching veneer flat profile on side and back edges when wood top surface is selected, or 3 mm plastic edge when laminate top surface is selected.*

Standard Includes		Required to Specify
▶ Need help? Product details, page 60	<ul style="list-style-type: none"> <li>• Worksurface: High-Pressure Laminate price group 1 with 3 mm plastic edge</li> </ul>	1 Style number 2 Select depth 3 Select width 4 Laminate color number for worksurface 5 Options, if selected (see below) ▶ See <i>Surface Materials</i> , page 242.

	Options	U.S. Price	Required to Specify
<b>Depth</b>	<ul style="list-style-type: none"> <li>• 24"</li> <li>• 30"</li> </ul>	Prices below Prices below	Select 24" depth. Select 30" depth.
<b>Width</b>	<ul style="list-style-type: none"> <li>• 48"</li> <li>• 54"</li> <li>• 60"</li> <li>• 66"</li> <li>• 72"</li> <li>• 78"</li> </ul>	Prices below Prices below Prices below Prices below Prices below Prices below	Select 48" width. Select 54" width. Select 60" width. Select 66" width. Select 72" width. Select 78" width.
<b>Surface Materials</b>	<b>Top</b> <ul style="list-style-type: none"> <li>• High-Pressure Laminate price group 1</li> <li>• High-Pressure Laminate price group 2</li> <li>• Veneer price group 1</li> <li>• West Elm veneer</li> </ul>	Prices below Prices below Prices below Prices below	Specify laminate color number. Specify laminate color number. Specify wood color number. Specify West Elm wood color number.
<b>Cutout Type</b>	<ul style="list-style-type: none"> <li>• Cutout center</li> <li>• No cutout</li> </ul>	No cost No cost	Specify <i>with center cutout</i> . Specify <i>with no cutout</i> .

Specification Information		U.S. Base Prices					
Style Number	Depth	48"W	54"W	60"W	66"W	72"W	78"W
:	:	:	:	:	:	:	:
:	:	:	:	:	:	:	:

## High-Pressure Laminate Price Group 1

WESINDWLCDS	Depth	48"W	54"W	60"W	66"W	72"W	78"W
	24"	\$1394	\$1526	\$1662	\$1798	\$1928	\$2070
	30"	\$1678	\$1812	\$1944	\$2080	\$2210	\$2348

## High-Pressure Laminate Price Group 2

WESINDWLCDS	Depth	48"W	54"W	60"W	66"W	72"W	78"W
	24"	\$1736	\$1872	\$2002	\$2138	\$2270	\$2404
	30"	\$2017	\$2156	\$2287	\$2422	\$2557	\$2688

## West Elm Veneer

WESINDWLCDS	Depth	48"W	54"W	60"W	66"W	72"W	78"W
	24"	\$2284	\$2420	\$2552	\$2684	\$2816	\$2950
	30"	\$2568	\$2696	\$2834	\$2964	\$3098	\$3232

## Veneer Price Group 1

WESINDWLCDS	Depth	48"W	54"W	60"W	66"W	72"W	78"W
	24"	\$2878	\$3070	\$3262	\$3456	\$3650	\$3844
	30"	\$3304	\$3498	\$3690	\$3888	\$4076	\$4268



**For Canadian Pricing**  
Multiply U.S. Price by the  
Canadian price factor.  
▶ See page 1 for details.

# Greenpoint Bench Dual Sided Worksurface— Credenza/Credenza Application

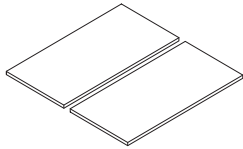

Tip: Edge will be matching veneer flat profile on side and back edges when wood top surface is selected, or 3 mm plastic edge when laminate top surface is selected.

	Standard Includes	Required to Specify
▶ Need help? Product details, page 60	• Worksurface: High-Pressure Laminate price group 1 with 3 mm plastic edge	1 Style number 2 Select depth 3 Select width 4 Laminate color number for worksurface 5 Options, if selected (see below) ▶ See <i>Surface Materials</i> , page 242.

	Options	U.S. Price	Required to Specify
<b>Depth</b>	• 24" • 30"	Prices below Prices below	Select 24" depth. Select 30" depth.
<b>Width</b>	• 48" • 54" • 60" • 66" • 72"	Prices below Prices below Prices below Prices below Prices below	Select 48" width. Select 54" width. Select 60" width. Select 66" width. Select 72" width.
<b>Surface Materials</b>	<b>Top</b> • High-Pressure Laminate price group 1 • High-Pressure Laminate price group 2 • Veneer price group 1 • West Elm veneer	Prices below Prices below Prices below Prices below	Specify laminate color number. Specify laminate color number. Specify wood color number. Specify West Elm wood color number.
<b>Cutout Type</b>	• Cutout center • No cutout	No cost No cost	Specify <i>with center cutout</i> . Specify <i>with no cutout</i> .

Specification Information						
Style Number	Depth	U.S. Base Prices				
		48"W	54"W	60"W	66"W	72"W
•	•	•	•	•	•	•
•	•	•	•	•	•	•

## High-Pressure Laminate Price Group 1

WESINDWCCDS	Depth	48"W	54"W	60"W	66"W	72"W
	24"	\$1454	\$1586	\$1722	\$1858	\$1988
	30"	\$1738	\$1872	\$2004	\$2140	\$2270

## High-Pressure Laminate Price Group 2

WESINDWCCDS	Depth	48"W	54"W	60"W	66"W	72"W
	24"	\$1796	\$1932	\$2062	\$2198	\$2330
	30"	\$2076	\$2216	\$2346	\$2482	\$2616

## West Elm Veneer

WESINDWCCDS	Depth	48"W	54"W	60"W	66"W	72"W
	24"	\$2344	\$2480	\$2612	\$2744	\$2876
	30"	\$2628	\$2756	\$2894	\$3024	\$3158

## Veneer Price Group 1

WESINDWCCDS	Depth	48"W	54"W	60"W	66"W	72"W
	24"	\$2938	\$3130	\$3322	\$3516	\$3710
	30"	\$3364	\$3558	\$3750	\$3948	\$4136



**For Canadian Pricing**  
Multiply U.S. Price by the Canadian price factor.  
▶ See page 1 for details.

# Greenpoint Bench Single Sided Worksurface— Leg/Leg Application

Greenpoint Bench Single  
Sided Worksurface—Leg/  
Leg Application

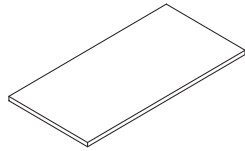

*Tip: Edge will be matching veneer flat profile on side and back edges when wood top surface is selected, or 3 mm plastic edge when laminate top surface is selected.*

Standard Includes	Required to Specify
<ul style="list-style-type: none"> <li>▶ Need help? Product details, page 60</li> <li>• Worksurface: High-Pressure Laminate price group 1 with 3 mm plastic edge</li> </ul>	<ol style="list-style-type: none"> <li>1 Style number</li> <li>2 Select depth</li> <li>3 Select width</li> <li>4 Laminate color number for worksurface</li> <li>5 Options, if selected (see below)</li> </ol> <p>▶ See <i>Surface Materials</i>, page 242.</p>

Options	U.S. Price	Required to Specify
<b>Depth</b>		
• 24"	Prices below	Select 24" depth.
• 30"	Prices below	Select 30" depth.
<b>Width</b>		
• 42"	Prices below	Select 42" width.
• 48"	Prices below	Select 48" width.
• 54"	Prices below	Select 54" width.
• 60"	Prices below	Select 60" width.
• 66"	Prices below	Select 66" width.
• 72"	Prices below	Select 72" width.
• 78"	Prices below	Select 78" width.
<b>Surface Materials</b>		
<b>Top</b>		
• High-Pressure Laminate price group 1	Prices below	Specify laminate color number.
• High-Pressure Laminate price group 2	Prices below	Specify laminate color number.
• Veneer price group 1	Prices below	Specify wood color number.
• West Elm veneer	Prices below	Specify West Elm wood color number.
<b>Cutout Type</b>		
• Cutout center	No cost	Specify <i>with center cutout</i> .
• No cutout	No cost	Specify <i>with no cutout</i> .

## Specification Information

Style Number	Depth	U.S. Base Prices						
		42"W	48"W	54"W	60"W	66"W	72"W	78"W
•	•	•	•	•	•	•	•	•

### High-Pressure Laminate Price Group 1

WESINDWLLSS	Depth	42"W	48"W	54"W	60"W	66"W	72"W	78"W
	24"	\$ 499	\$ 664	\$ 731	\$ 798	\$ 864	\$ 932	\$ 998
	30"	\$ 738	\$ 803	\$ 871	\$ 937	\$1004	\$1074	\$1140

### High-Pressure Laminate Price Group 2

WESINDWLLSS	Depth	42"W	48"W	54"W	60"W	66"W	72"W	78"W
	24"	\$ 670	\$ 837	\$ 901	\$ 968	\$1034	\$1104	\$1170
	30"	\$ 907	\$ 976	\$1044	\$1110	\$1176	\$1244	\$1309

### West Elm Veneer

WESINDWLLSS	Depth	42"W	48"W	54"W	60"W	66"W	72"W	78"W
	24"	\$1040	\$1107	\$1172	\$1241	\$1307	\$1374	\$1440
	30"	\$1182	\$1248	\$1315	\$1381	\$1446	\$1516	\$1580

### Veneer Price Group 1

WESINDWLLSS	Depth	42"W	48"W	54"W	60"W	66"W	72"W	78"W
	24"	\$1337	\$1402	\$1499	\$1597	\$1692	\$1788	\$1884
	30"	\$1521	\$1619	\$1716	\$1810	\$1908	\$2003	\$2100



**For Canadian Pricing**  
Multiply U.S. Price by the  
Canadian price factor.  
▶ See page 1 for details.

# Greenpoint Bench Single Sided Worksurface— Leg/Credenza Application

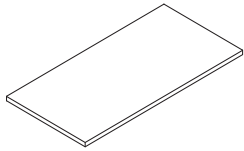

*Tip: Edge will be matching veneer flat profile on side and back edges when wood top surface is selected, or 3 mm plastic edge when laminate top surface is selected.*

Standard Includes	Required to Specify
<ul style="list-style-type: none"> <li>▶ Need help? Product details, page 60</li> <li>• Worksurface: High-Pressure Laminate price group 1 with 3 mm plastic edge</li> </ul>	<ol style="list-style-type: none"> <li>1 Style number</li> <li>2 Select depth</li> <li>3 Select width</li> <li>4 Laminate color number for worksurface</li> <li>5 Options, if selected (see below)</li> </ol> <ul style="list-style-type: none"> <li>▶ See <i>Surface Materials</i>, page 242.</li> </ul>

	Options	U.S. Price	Required to Specify
<b>Depth</b>	<ul style="list-style-type: none"> <li>• 24"</li> <li>• 30"</li> </ul>	Prices below Prices below	Select 24" depth. Select 30" depth.
<b>Width</b>	<ul style="list-style-type: none"> <li>• 48"</li> <li>• 54"</li> <li>• 60"</li> <li>• 66"</li> <li>• 72"</li> <li>• 78"</li> </ul>	Prices below Prices below Prices below Prices below Prices below Prices below	Select 48" width. Select 54" width. Select 60" width. Select 66" width. Select 72" width. Select 78" width.
<b>Surface Materials</b>	<b>Top</b> <ul style="list-style-type: none"> <li>• High-Pressure Laminate price group 1</li> <li>• High-Pressure Laminate price group 2</li> <li>• Veneer price group 1</li> <li>• West Elm veneer</li> </ul>	Prices below Prices below Prices below Prices below	Specify laminate color number. Specify laminate color number. Specify wood color number. Specify West Elm wood color number.
<b>Cutout Type</b>	<ul style="list-style-type: none"> <li>• Cutout center</li> <li>• No cutout</li> </ul>	No cost No cost	Specify <i>with center cutout</i> . Specify <i>with no cutout</i> .

Specification Information		U.S. Base Prices					
Style Number	Depth	48"W	54"W	60"W	66"W	72"W	78"W

## High-Pressure Laminate Price Group 1

WESINDWLCSS	Depth	48"W	54"W	60"W	66"W	72"W	78"W
	24"	\$ 697	\$ 763	\$ 831	\$ 899	\$ 964	\$1035
	30"	\$ 839	\$ 906	\$ 972	\$1040	\$1105	\$1174

## High-Pressure Laminate Price Group 2

WESINDWLCSS	Depth	48"W	54"W	60"W	66"W	72"W	78"W
	24"	\$ 868	\$ 936	\$1001	\$1069	\$1135	\$1202
	30"	\$1008	\$1078	\$1143	\$1211	\$1278	\$1344

## West Elm Veneer

WESINDWLCSS	Depth	48"W	54"W	60"W	66"W	72"W	78"W
	24"	\$1142	\$1210	\$1276	\$1342	\$1408	\$1475
	30"	\$1284	\$1348	\$1417	\$1482	\$1549	\$1616

## Veneer Price Group 1

WESINDWLCSS	Depth	48"W	54"W	60"W	66"W	72"W	78"W
	24"	\$1439	\$1535	\$1631	\$1728	\$1825	\$1922
	30"	\$1652	\$1749	\$1845	\$1944	\$2038	\$2134



**For Canadian Pricing**  
 Multiply U.S. Price by the Canadian price factor.  
 ▶ See page 1 for details.

# Greenpoint Bench Single Sided Worksurface— Credenza/Credenza Application

Greenpoint Bench Single  
Sided Worksurface—  
Credenza/Credenza  
Application

Greenpoint  
Bench

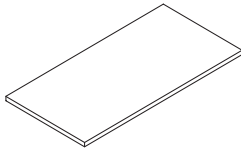

Standard Includes		Required to Specify
▶ Need help? Product details, page 60	• Worksurface: High-Pressure Laminate price group 1 with 3 mm plastic edge	1 Style number 2 Select depth 3 Select width 4 Laminate color number for worksurface 5 Options, if selected (see below) ▶ See <i>Surface Materials</i> , page 242.

*Tip: Edge will be matching veneer flat profile on side and back edges when wood top surface is selected, or 3 mm plastic edge when laminate top surface is selected.*

	Options	U.S. Price	Required to Specify
<b>Depth</b>	• 24" • 30"	Prices below Prices below	Select 24" depth. Select 30" depth.
<b>Width</b>	• 48" • 54" • 60" • 66" • 72"	Prices below Prices below Prices below Prices below Prices below	Select 48" width. Select 54" width. Select 60" width. Select 66" width. Select 72" width.
<b>Surface Materials</b>	<b>Top</b> • High-Pressure Laminate price group 1 • High-Pressure Laminate price group 2 • Veneer price group 1 • West Elm veneer	Prices below Prices below Prices below Prices below	Specify laminate color number. Specify laminate color number. Specify wood color number. Specify West Elm wood color number.
<b>Cutout Type</b>	• Cutout center • No cutout	No cost No cost	Specify <i>with center cutout</i> . Specify <i>with no cutout</i> .

Specification Information						
Style Number	Depth	U.S. Base Prices				
		48"W	54"W	60"W	66"W	72"W
•	•	•	•	•	•	•
•	•	•	•	•	•	•
•	•	•	•	•	•	•

## High-Pressure Laminate Price Group 1

WESINDWCCSS	Depth	48"W	54"W	60"W	66"W	72"W
	24"	\$ 727	\$ 793	\$ 861	\$ 929	\$ 994
	30"	\$ 869	\$ 936	\$1002	\$1070	\$1135

## High-Pressure Laminate Price Group 2

WESINDWCCSS	Depth	48"W	54"W	60"W	66"W	72"W
	24"	\$ 898	\$ 966	\$1031	\$1099	\$1165
	30"	\$1038	\$1108	\$1173	\$1241	\$1308

## West Elm Veneer

WESINDWCCSS	Depth	48"W	54"W	60"W	66"W	72"W
	24"	\$1172	\$1240	\$1306	\$1372	\$1438
	30"	\$1314	\$1378	\$1447	\$1512	\$1579

## Veneer Price Group 1

WESINDWCCSS	Depth	48"W	54"W	60"W	66"W	72"W
	24"	\$1469	\$1565	\$1661	\$1758	\$1855
	30"	\$1682	\$1779	\$1875	\$1974	\$2068



**For Canadian Pricing**  
Multiply U.S. Price by the  
Canadian price factor.  
▶ See page 1 for details.

# Greenpoint Bench Continuous Worksurface— Leg/Leg Application

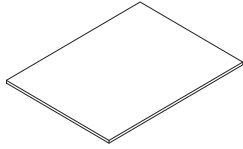

*Tip: Edge will be matching veneer flat profile on side and back edges when wood top surface is selected, or 3 mm plastic edge when laminate top surface is selected.*

Standard Includes	Required to Specify
<ul style="list-style-type: none"> <li>▶ Need help? Product details, page 62</li> <li>• 48"D worksurface: High-Pressure Laminate price group 1 with 3 mm plastic edge</li> </ul>	<ol style="list-style-type: none"> <li>1 Style number</li> <li>2 Select width</li> <li>3 Laminate color number for worksurface</li> <li>4 Options, if selected (see below)</li> </ol> <ul style="list-style-type: none"> <li>▶ See <i>Surface Materials</i>, page 242.</li> </ul>

Options	U.S. Price	Required to Specify
<b>Width</b> <ul style="list-style-type: none"> <li>• 48"</li> <li>• 54"</li> <li>• 60"</li> <li>• 66"</li> <li>• 72"</li> <li>• 78"</li> </ul>	Prices below Prices below Prices below Prices below Prices below Prices below	Select 48" width. Select 54" width. Select 60" width. Select 66" width. Select 72" width. Select 78" width.
<b>Surface Materials</b> <ul style="list-style-type: none"> <li>• <b>Top</b></li> <li>• High-Pressure Laminate price group 1</li> <li>• High-Pressure Laminate price group 2</li> <li>• Veneer price group 1</li> </ul>	Prices below Prices below Prices below	Specify laminate color number. Specify laminate color number. Specify wood color number.
<b>Cutout Type</b> <ul style="list-style-type: none"> <li>• Cutout center</li> <li>• No cutout</li> </ul>	No cost No cost	Specify <i>with center cutout</i> . Specify <i>with no cutout</i> .

## Specification Information

• Style Number	• Depth	• U.S. Base Prices					
		• 48"W	• 54"W	• 60"W	• 66"W	• 72"W	• 78"W
•	•	•	•	•	•	•	•

### High-Pressure Laminate Price Group 1

WESINDWLLCT	48"	\$ 882	\$1016	\$1149	\$1284	\$1417	\$1553
•	•	•	•	•	•	•	•

### High-Pressure Laminate Price Group 2

WESINDWLLCT	48"	\$1225	\$1359	\$1493	\$1627	\$1762	\$1894
•	•	•	•	•	•	•	•

### Veneer Price Group 1

WESINDWLLCT	48"	\$1920	\$2052	\$2187	\$2319	\$2453	\$2586
•	•	•	•	•	•	•	•



**For Canadian Pricing**  
 Multiply U.S. Price by the Canadian price factor.  
 ▶ See page 1 for details.

# Greenpoint Bench Continuous Worksurface— Leg/Credenza Application

Greenpoint Bench  
Continuous Worksurface—  
Leg/Credenza Application

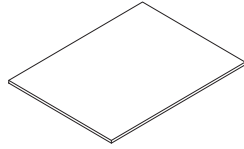

*Tip: Edge will be matching veneer flat profile on side and back edges when wood top surface is selected, or 3 mm plastic edge when laminate top surface is selected.*

Standard Includes	Required to Specify
<ul style="list-style-type: none"> <li>▶ Need help? Product details, page 62</li> <li>• 48"D worksurface: High-Pressure Laminate price group 1 with 3 mm plastic edge</li> </ul>	<ol style="list-style-type: none"> <li>1 Style number</li> <li>2 Select width</li> <li>3 Laminate color number for worksurface</li> <li>4 Options, if selected (see below)</li> </ol> <ul style="list-style-type: none"> <li>▶ See <i>Surface Materials</i>, page 242.</li> </ul>

Options	U.S. Price	Required to Specify
<b>Width</b> <ul style="list-style-type: none"> <li>• 48"</li> <li>• 54"</li> <li>• 60"</li> <li>• 66"</li> <li>• 72"</li> <li>• 78"</li> </ul>	Prices below Prices below Prices below Prices below Prices below Prices below	Select 48" width. Select 54" width. Select 60" width. Select 66" width. Select 72" width. Select 78" width.
<b>Surface Materials</b> <ul style="list-style-type: none"> <li>• <b>Top</b></li> <li>• High-Pressure Laminate price group 1</li> <li>• High-Pressure Laminate price group 2</li> <li>• Veneer price group 1</li> </ul>	Prices below Prices below Prices below	Specify laminate color number. Specify laminate color number. Specify wood color number.
<b>Cutout Type</b> <ul style="list-style-type: none"> <li>• Cutout center</li> <li>• No cutout</li> </ul>	No cost No cost	Specify <i>with center cutout</i> . Specify <i>with no cutout</i> .

## Specification Information

Style Number	Depth	U.S. Base Prices					
		48"W	54"W	60"W	66"W	72"W	78"W
•	•	•	•	•	•	•	•

### High-Pressure Laminate Price Group 1

WESINDWLCCT	48"	\$ 917	\$1051	\$1184	\$1319	\$1452	\$1588
•	•	•	•	•	•	•	•

### High-Pressure Laminate Price Group 2

WESINDWLCCT	48"	\$1260	\$1394	\$1528	\$1662	\$1797	\$1929
•	•	•	•	•	•	•	•

### Veneer Price Group 1

WESINDWLCCT	48"	\$1955	\$2087	\$2222	\$2354	\$2488	\$2621
•	•	•	•	•	•	•	•

 **For Canadian Pricing**  
Multiply U.S. Price by the Canadian price factor.  
▶ See page 1 for details.

# Greenpoint Bench Continuous Worksurface— Credenza/Credenza Application

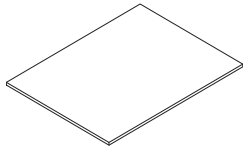

Standard Includes	Required to Specify
<ul style="list-style-type: none"> <li>▶ Need help? Product details, page 62</li> <li>• 48"D worksurface: High-Pressure Laminate price group 1 with 3 mm plastic edge</li> </ul>	<ol style="list-style-type: none"> <li>1 Style number</li> <li>2 Select width</li> <li>3 Laminate color number for worksurface</li> <li>4 Options, if selected (see below)</li> </ol> <ul style="list-style-type: none"> <li>▶ See <i>Surface Materials</i>, page 242.</li> </ul>

*Tip: Edge will be matching veneer flat profile on side and back edges when wood top surface is selected, or 3 mm plastic edge when laminate top surface is selected.*

Options	U.S. Price	Required to Specify
<b>Width</b> <ul style="list-style-type: none"> <li>• 48"</li> <li>• 54"</li> <li>• 60"</li> <li>• 66"</li> <li>• 72"</li> <li>• 78"</li> </ul>	<ul style="list-style-type: none"> <li>Prices below</li> <li>Prices below</li> <li>Prices below</li> <li>Prices below</li> <li>Prices below</li> <li>Prices below</li> </ul>	<ul style="list-style-type: none"> <li>Select 48" width.</li> <li>Select 54" width.</li> <li>Select 60" width.</li> <li>Select 66" width.</li> <li>Select 72" width.</li> <li>Select 78" width.</li> </ul>
<b>Surface Materials</b> <ul style="list-style-type: none"> <li>• <b>Top</b></li> <li>• High-Pressure Laminate price group 1</li> <li>• High-Pressure Laminate price group 2</li> <li>• Veneer price group 1</li> </ul>	<ul style="list-style-type: none"> <li>Prices below</li> <li>Prices below</li> <li>Prices below</li> </ul>	<ul style="list-style-type: none"> <li>Specify laminate color number.</li> <li>Specify laminate color number.</li> <li>Specify wood color number.</li> </ul>
<b>Cutout Type</b> <ul style="list-style-type: none"> <li>• Cutout center</li> <li>• No cutout</li> </ul>	<ul style="list-style-type: none"> <li>No cost</li> <li>No cost</li> </ul>	<ul style="list-style-type: none"> <li>Specify <i>with center cutout</i>.</li> <li>Specify <i>with no cutout</i>.</li> </ul>

## Specification Information

• Style Number	• Depth	• U.S. Base Prices					
		• 48"W	• 54"W	• 60"W	• 66"W	• 72"W	• 78"W
•	•	•	•	•	•	•	•

### High-Pressure Laminate Price Group 1

WESINDWCCCT	48"	\$ 945	\$1079	\$1212	\$1347	\$1480	\$1616
•	•	•	•	•	•	•	•

### High-Pressure Laminate Price Group 2

WESINDWCCCT	48"	\$1288	\$1422	\$1556	\$1690	\$1825	\$1957
•	•	•	•	•	•	•	•

### Veneer Price Group 1

WESINDWCCCT	48"	\$1983	\$2115	\$2250	\$2382	\$2516	\$2649
•	•	•	•	•	•	•	•



**For Canadian Pricing**  
Multiply U.S. Price by the Canadian price factor.  
▶ See page 1 for details.

# Greenpoint Bench Round Worksurface

Greenpoint Bench Round  
Worksurface

Greenpoint  
Bench

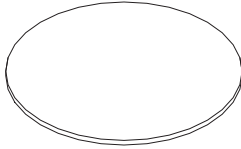

Standard Includes	Required to Specify
<ul style="list-style-type: none"> <li>▶ Need help? Product details, page 62</li> <li>• Worksurface: High-Pressure Laminate price group 1 with 3 mm plastic edge</li> </ul>	<ol style="list-style-type: none"> <li>1 Style number</li> <li>2 Select diameter</li> <li>3 Laminate color number for worksurface</li> <li>4 Options, if selected (see below)</li> </ol> <ul style="list-style-type: none"> <li>▶ See <i>Surface Materials</i>, page 242.</li> </ul>

Options	U.S. Price	Required to Specify
<b>Diameter</b> <ul style="list-style-type: none"> <li>• 48"</li> <li>• 60"</li> </ul>	Prices below Prices below	Select 48" diameter. Select 60" diameter.
<b>Surface Materials</b> <ul style="list-style-type: none"> <li>• <b>Top</b></li> <li>• High-Pressure Laminate price group 1</li> <li>• High-Pressure Laminate price group 2</li> <li>• Veneer price group 1</li> </ul>	Prices below Prices below Prices below	Specify laminate color number. Specify laminate color number. Specify wood color number.
<b>Cutout Type</b> <ul style="list-style-type: none"> <li>• Cutout center</li> <li>• No cutout</li> </ul>	No cost No cost	Specify <i>with center cutout</i> . Specify <i>with no cutout</i> .

### Specification Information

• Style Number	• Diameter	• U.S. Base Price
•	•	•
•	•	•
•	•	•

### High-Pressure Laminate Price Group 1

WESINDWFR	Diameter	U.S. Price
•	48"	\$ 863
•	60"	\$1507
•	•	•

### High-Pressure Laminate Price Group 2

WESINDWFR	Diameter	U.S. Price
•	48"	\$1192
•	60"	\$1835
•	•	•

### Veneer Price Group 1

WESINDWFR	Diameter	U.S. Price
•	48"	\$1863
•	60"	\$2508
•	•	•

**For Canadian Pricing**  
 Multiply U.S. Price by the Canadian price factor.  
 ▶ See page 1 for details.

# Greenpoint Bench Square Worksurface

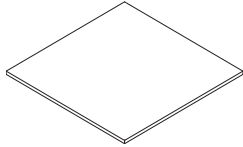

	Standard Includes	Required to Specify
▶ Need help? Product details, page 62	<ul style="list-style-type: none"> <li>• Worksurface: High-Pressure Laminate price group 1 with 3 mm plastic edge</li> </ul>	<ol style="list-style-type: none"> <li>1 Style number</li> <li>2 Select depth and width</li> <li>3 Laminate color number for worksurface</li> <li>4 Options, if selected (see below)</li> </ol> <p>▶ See <i>Surface Materials</i>, page 242.</p>

	Options	U.S. Price	Required to Specify
<b>Depth and Width</b>	<ul style="list-style-type: none"> <li>• 48"</li> <li>• 60"</li> </ul>	<p>Prices below</p> <p>Prices below</p>	<p>Select 48".</p> <p>Select 60".</p>
<b>Surface Materials</b>	<p><b>Top</b></p> <ul style="list-style-type: none"> <li>• High-Pressure Laminate price group 1</li> <li>• High-Pressure Laminate price group 2</li> <li>• Veneer price group 1</li> </ul>	<p>Prices below</p> <p>Prices below</p> <p>Prices below</p>	<p>Specify laminate color number.</p> <p>Specify laminate color number.</p> <p>Specify wood color number.</p>
<b>Cutout Type</b>	<ul style="list-style-type: none"> <li>• Cutout center</li> <li>• No cutout</li> </ul>	<p>No cost</p> <p>No cost</p>	<p>Specify <i>with center cutout</i>.</p> <p>Specify <i>with no cutout</i>.</p>

## Specification Information

Style Number	Dimensions	U.S. Base Price
.....	.....	.....

### High-Pressure Laminate Price Group 1

WESINDWSQ	Dimensions	U.S. Price
	48"	\$ 863
	60"	\$1507
.....	.....	.....

### High-Pressure Laminate Price Group 2

WESINDWSQ	Dimensions	U.S. Price
	48"	\$1192
	60"	\$1835
.....	.....	.....

### Veneer Price Group 1

WESINDWSQ	Dimensions	U.S. Price
	48"	\$1863
	60"	\$2508
.....	.....	.....



**For Canadian Pricing**  
 Multiply U.S. Price by the Canadian price factor.  
 ▶ See page 1 for details.

# Greenpoint Bench Half-Round Worksurface

Greenpoint Bench Half-Round Worksurface

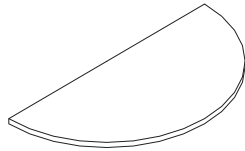

Standard Includes		Required to Specify
▶ Need help? Product details, page 62	• Worksurface: High-Pressure Laminate price group 1 with 3 mm plastic edge	1 Style number 2 Select width 3 Laminate color number for worksurface 4 Options, if selected (see below) ▶ See <i>Surface Materials</i> , page 242.

Options		U.S. Price	Required to Specify
<b>Width</b>	• 48" • 60"	Prices below Prices below	Select 48" width. Select 60" width.
<b>Surface Materials</b>	<b>Top</b> • High-Pressure Laminate price group 1 • High-Pressure Laminate price group 2 • Veneer price group 1	Prices below Prices below Prices below	Specify laminate color number. Specify laminate color number. Specify wood color number.

Specification Information		
• Style Number	• Width	• U.S. Base Price
•	•	•
•	•	•
•	•	•

## High-Pressure Laminate Price Group 1

WESINDWHR	Width	U.S. Price
	48"	\$ 682
	60"	\$ 946
•	•	•

## High-Pressure Laminate Price Group 2

WESINDWHR	Width	U.S. Price
	48"	\$ 848
	60"	\$1111
•	•	•

## Veneer Price Group 1

WESINDWHR	Width	U.S. Price
	48"	\$1217
	60"	\$1483
•	•	•

Greenpoint Bench

 **For Canadian Pricing**  
Multiply U.S. Price by the Canadian price factor.  
▶ See page 1 for details.

# Greenpoint Bench Worksurface—Return

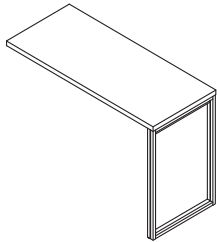

*Tip: Edge will be matching veneer flat profile on side and back edges when wood top surface is selected, or 3 mm plastic edge when laminate top surface is selected.*

Standard Includes		Required to Specify
<ul style="list-style-type: none"> <li>▶ Need help? Product details, page 62</li> </ul>	<ul style="list-style-type: none"> <li>• Worksurface: High-Pressure Laminate price group 1 with 3 mm plastic edge</li> <li>• Square tube leg (frame): paint price group 1</li> <li>• Height: 28½"H</li> </ul>	<ol style="list-style-type: none"> <li>1 Style number</li> <li>2 Select depth</li> <li>3 Select width</li> <li>4 Laminate color number for worksurface</li> <li>5 Paint color number for leg (frame)</li> <li>6 Options, if selected (see below)</li> </ol> <ul style="list-style-type: none"> <li>▶ See <i>Surface Materials</i>, page 242.</li> </ul>

	Options	U.S. Price	Required to Specify
<b>Depth</b>	<ul style="list-style-type: none"> <li>• 18"</li> <li>• 24"</li> </ul>	Prices below Prices below	Select 18" depth. Select 24" depth.
<b>Width</b>	<ul style="list-style-type: none"> <li>• 42"</li> <li>• 48"</li> <li>• 54"</li> <li>• 60"</li> </ul>	Prices below Prices below Prices below Prices below	Select 42" width. Select 48" width. Select 54" width. Select 60" width.
<b>Surface Materials</b>	<b>Top</b> <ul style="list-style-type: none"> <li>• High-Pressure Laminate price group 1</li> <li>• High-Pressure Laminate price group 2</li> <li>• Veneer price group 1</li> <li>• West Elm veneer</li> </ul>	Prices below Prices below Prices below Prices below	Specify laminate color number. Specify laminate color number. Specify wood color number. Specify West Elm wood color number.
<b>Frame</b>	<ul style="list-style-type: none"> <li>• Paint price group 1</li> <li>• Paint price group 2                             <ul style="list-style-type: none"> <li>– 18"D</li> <li>– 24"D</li> </ul> </li> <li>• Paint price group 3                             <ul style="list-style-type: none"> <li>– 18"D</li> <li>– 24"D</li> </ul> </li> </ul>	No cost +\$16 +\$20 +\$30 +\$37	Specify paint color number. Specify paint color number. Specify paint color number. Specify paint color number. Specify paint color number.

## Specification Information

Style Number	Depth	U.S. Base Prices			
		42"W	48"W	54"W	60"W
.....	.....	.....	.....	.....	.....

### High-Pressure Laminate Price Group 1

WESINDRB	18"	24"	42"W	48"W	54"W	60"W
	\$1220	\$1298	\$1286	\$1362	\$1354	\$1422
.....	.....	.....	.....	.....	.....	.....

### High-Pressure Laminate Price Group 2

WESINDRB	18"	24"	42"W	48"W	54"W	60"W
	\$1348	\$1422	\$1415	\$1487	\$1480	\$1549
.....	.....	.....	.....	.....	.....	.....

### West Elm Veneer

WESINDRB	18"	24"	42"W	48"W	54"W	60"W
	\$1503	\$1576	\$1569	\$1641	\$1636	\$1702
.....	.....	.....	.....	.....	.....	.....

### Veneer Price Group 1

WESINDRB	18"	24"	42"W	48"W	54"W	60"W
	\$1675	\$1792	\$1740	\$1858	\$1852	\$1916
.....	.....	.....	.....	.....	.....	.....

 **For Canadian Pricing**  
 Multiply U.S. Price by the Canadian price factor.  
 ▶ See page 1 for details.

# Greenpoint Bench Dual Leg

Greenpoint Bench Dual Leg

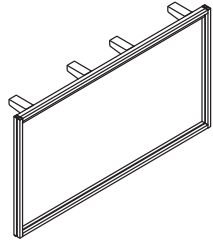

Greenpoint  
Bench

Standard Includes		Required to Specify
<ul style="list-style-type: none"> <li>▶ Need help? Product details, page 62</li> </ul>	<ul style="list-style-type: none"> <li>• Square tube leg (frame): paint price group 1</li> <li>• 1½"H leveling glides</li> </ul>	<ol style="list-style-type: none"> <li>1 Style number</li> <li>2 Select depth</li> <li>3 Paint color number for leg (frame)</li> <li>4 Options, if selected (see below)</li> </ol> <ul style="list-style-type: none"> <li>▶ See <i>Surface Materials</i>, page 242.</li> </ul>

Options	U.S. Price	Required to Specify
<b>Depth</b> <ul style="list-style-type: none"> <li>• 48"</li> <li>• 60"</li> </ul>	Prices below Prices below	Select 48" depth. Select 60" depth.
<b>Surface Materials</b>	<b>Frame</b> <ul style="list-style-type: none"> <li>• Paint price group 1</li> <li>• Paint price group 2               <ul style="list-style-type: none"> <li>– 48"D +\$39</li> <li>– 60"D +\$44</li> </ul> </li> <li>• Paint price group 3               <ul style="list-style-type: none"> <li>– 48"D +\$78</li> <li>– 60"D +\$90</li> </ul> </li> </ul>	No cost  Specify paint color number.  Specify paint color number. Specify paint color number.  Specify paint color number. Specify paint color number.

Specification Information		
Style Number	Depth	U.S. Base Price
<b>WESINDELDS</b>	48"	\$727
	60"	\$844

 **For Canadian Pricing**  
 Multiply U.S. Price by the Canadian price factor.  
 ▶ See page 1 for details.

# Greenpoint Bench Single Sided End Leg

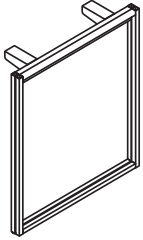

Standard Includes		Required to Specify
<ul style="list-style-type: none"> <li>▶ Need help? Product details, page 62</li> </ul>	<ul style="list-style-type: none"> <li>• Square tube leg (frame): paint price group 1</li> <li>• 1½"H leveling glides</li> </ul>	<ol style="list-style-type: none"> <li>1 Style number</li> <li>2 Select depth</li> <li>3 Paint color number for leg (frame)</li> <li>4 Options, if selected (see below)</li> </ol> <ul style="list-style-type: none"> <li>▶ See <i>Surface Materials</i>, page 242.</li> </ul>

Options	U.S. Price	Required to Specify	
<b>Depth</b> <ul style="list-style-type: none"> <li>• 24"</li> <li>• 30"</li> </ul>	Prices below Prices below	Select 24" depth. Select 30" depth.	
<b>Surface Materials</b>	<b>Frame</b> <ul style="list-style-type: none"> <li>• Paint price group 1</li> <li>• Paint price group 2               <ul style="list-style-type: none"> <li>– 24"D</li> <li>– 30"D</li> </ul> </li> <li>• Paint price group 3               <ul style="list-style-type: none"> <li>– 24"D</li> <li>– 30"D</li> </ul> </li> </ul>	No cost +\$20 +\$24 +\$37 +\$44	Specify paint color number. Specify paint color number. Specify paint color number. Specify paint color number. Specify paint color number.

Specification Information		
Style Number	Depth	U.S. Base Price
WESINDELSS	24"	\$551
	30"	\$587



**For Canadian Pricing**  
 Multiply U.S. Price by the Canadian price factor.  
 ▶ See page 1 for details.

# Greenpoint Bench Single Sided End Leg

Greenpoint Bench Single  
Sided End Leg

Greenpoint  
Bench

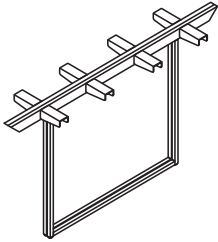

Standard Includes		Required to Specify
<ul style="list-style-type: none"> <li>▶ Need help? Product details, page 62</li> </ul>	<ul style="list-style-type: none"> <li>• Square tube leg (frame): paint price group 1</li> <li>• 1½"H leveling glides</li> </ul>	<ul style="list-style-type: none"> <li>1 Style number</li> <li>2 Paint color number for leg (frame)</li> <li>3 Options, if selected (see below)</li> <li>▶ See <i>Surface Materials</i>, page 242.</li> </ul>

Options	U.S. Price	Required to Specify
<b>Surface Materials</b> <ul style="list-style-type: none"> <li>• Paint price group 1</li> <li>• Paint price group 2</li> <li>• Paint price group 3</li> </ul>	<b>Frame</b> <ul style="list-style-type: none"> <li>• No cost</li> <li>• +\$39</li> <li>• +\$78</li> </ul>	<ul style="list-style-type: none"> <li>Specify paint color number.</li> <li>Specify paint color number.</li> <li>Specify paint color number.</li> </ul>

Specification Information	
Style Number	U.S. Base Price
WESINDILDS	\$622

 **For Canadian Pricing**  
Multiply U.S. Price by the Canadian price factor.  
▶ See page 1 for details.

# Greenpoint Bench Intermediate Single Leg

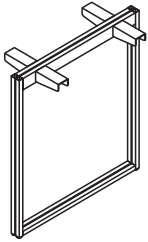

Standard Includes		Required to Specify
<ul style="list-style-type: none"> <li>▶ Need help? Product details, page 62</li> </ul>	<ul style="list-style-type: none"> <li>• Square tube leg (frame): paint price group 1</li> <li>• 1½"H leveling glides</li> </ul>	<ol style="list-style-type: none"> <li>1 Style number</li> <li>2 Select depth</li> <li>3 Paint color number for leg (frame)</li> <li>4 Options, if selected (see below)</li> </ol> <ul style="list-style-type: none"> <li>▶ See <i>Surface Materials</i>, page 242.</li> </ul>

Options	U.S. Price	Required to Specify
<b>Depth</b> <ul style="list-style-type: none"> <li>• 24"</li> <li>• 30"</li> </ul>	Prices below Prices below	Select 24" depth. Select 30" depth.
<b>Surface Materials</b>	<b>Frame</b> <ul style="list-style-type: none"> <li>• Paint price group 1</li> <li>• Paint price group 2               <ul style="list-style-type: none"> <li>– 24"D +\$20</li> <li>– 30"D +\$24</li> </ul> </li> <li>• Paint price group 3               <ul style="list-style-type: none"> <li>– 24"D +\$37</li> <li>– 30"D +\$44</li> </ul> </li> </ul>	No cost Specify paint color number. Specify paint color number. Specify paint color number.

Specification Information		
Style Number	Depth	U.S. Base Price
WESINDILSS	24"	\$515
	30"	\$551



**For Canadian Pricing**  
 Multiply U.S. Price by the Canadian price factor.  
 ▶ See page 1 for details.

# Greenpoint Bench Round/Square Leg

Greenpoint Bench Round/  
Square Leg

Greenpoint  
Bench

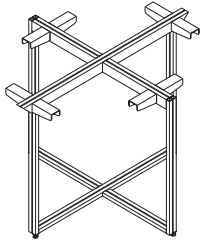

Standard Includes		Required to Specify
<ul style="list-style-type: none"> <li>▶ Need help? Product details, page 62</li> </ul>	<ul style="list-style-type: none"> <li>• Square tube leg (frame): paint price group 1</li> <li>• 1½"H leveling glides</li> <li>• Height: 28½"H</li> </ul>	<ol style="list-style-type: none"> <li>1 Style number</li> <li>2 Select depth</li> <li>3 Paint color number for leg (frame)</li> <li>4 Options, if selected (see below)</li> </ol> <ul style="list-style-type: none"> <li>▶ See <i>Surface Materials</i>, page 242.</li> </ul>

	Options	U.S. Price	Required to Specify
<b>Depth</b>	<ul style="list-style-type: none"> <li>• 48"</li> <li>• 60"</li> </ul>	Prices below Prices below	Select 48" depth. Select 60" depth.
<b>Surface Materials</b>	<b>Frame</b> <ul style="list-style-type: none"> <li>• Paint price group 1</li> <li>• Paint price group 2                             <ul style="list-style-type: none"> <li>– 48"D</li> <li>– 60"D</li> </ul> </li> <li>• Paint price group 3                             <ul style="list-style-type: none"> <li>– 48"D</li> <li>– 60"D</li> </ul> </li> </ul>	No cost +\$ 59 +\$ 65 +\$115 +\$129	Specify paint color number. Specify paint color number. Specify paint color number. Specify paint color number. Specify paint color number.

### Specification Information

Style Number	Depth	U.S. Base Price
<b>WESINDLFR</b>	48"	\$1357
	60"	\$1453

 **For Canadian Pricing**  
 Multiply U.S. Price by the Canadian price factor.  
 ▶ See page 1 for details.

# Greenpoint Bench Intermediate Single Leg

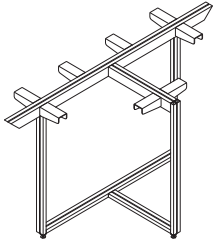

Standard Includes		Required to Specify
<ul style="list-style-type: none"> <li>▶ Need help? Product details, page 62</li> </ul>	<ul style="list-style-type: none"> <li>• Square tube leg (frame): paint price group 1</li> <li>• 1½"H leveling glides</li> <li>• Height: 28½"H</li> </ul>	<ol style="list-style-type: none"> <li>1 Style number</li> <li>2 Select depth</li> <li>3 Paint color number for leg (frame)</li> <li>4 Options, if selected (see below)</li> </ol> <ul style="list-style-type: none"> <li>▶ See <i>Surface Materials</i>, page 242.</li> </ul>

Options		U.S. Price	Required to Specify
<b>Depth</b>	<ul style="list-style-type: none"> <li>• 48"</li> <li>• 60"</li> </ul>	Prices below Prices below	Select 48" depth. Select 60" depth.
<b>Surface Materials</b>	<b>Frame</b> <ul style="list-style-type: none"> <li>• Paint price group 1</li> <li>• Paint price group 2                             <ul style="list-style-type: none"> <li>– 48"D</li> <li>– 60"D</li> </ul> </li> <li>• Paint price group 3                             <ul style="list-style-type: none"> <li>– 48"D</li> <li>– 60"D</li> </ul> </li> </ul>	No cost +\$ 59 +\$ 65 +\$115 +\$129	Specify paint color number. Specify paint color number. Specify paint color number. Specify paint color number.

Specification Information		
• Style Number	• Depth	• U.S. Base Price
WESINDLHR	48"	\$1018
	60"	\$1092



**For Canadian Pricing**  
 Multiply U.S. Price by the Canadian price factor.  
 ▶ See page 1 for details.

# Greenpoint Bench End Credenza

Greenpoint Bench  
End Credenza

Greenpoint  
Bench

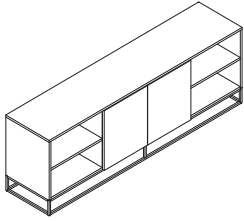

*Tip: When specified in High-Pressure Laminate, the pull of the drawer will be painted according to the matrix in the Surface Materials section.*

Standard Includes		Required to Specify
<ul style="list-style-type: none"> <li>▶ Need help? Product details, page 66</li> </ul>	<ul style="list-style-type: none"> <li>• Credenza: High-Pressure Laminate price group 1</li> <li>• Square tube leg (frame): paint price group 1</li> <li>• 1½"H leveling glides</li> </ul>	<ul style="list-style-type: none"> <li>1 Style number</li> <li>2 Laminate color number for case</li> <li>3 Paint color number for leg (frame)</li> <li>4 Options, if selected (see below)</li> <li>▶ See <i>Surface Materials</i>, page 242.</li> </ul>

	Options	U.S. Price	Required to Specify
<b>Surface Materials</b>	<b>Case</b>		
	• High-Pressure Laminate price group 1	No cost	Specify laminate color number.
	• High-Pressure Laminate price group 2	+\$ 737	Specify laminate color number.
	• West Elm veneer	+\$1052	Specify West Elm wood color number.
	• Veneer price group 1	+\$6649	Specify wood color number.
	<b>Frame</b>		
	• Paint price group 1	No cost	Specify paint color number.
	• Paint price group 2	+\$ 39	Specify paint color number.
	• Paint price group 3	+\$ 78	Specify paint color number.
<b>Case Orientation</b>	• Inward	No cost	Specify <i>with inward orientation</i> .
	• Outward	No cost	Specify <i>with outward orientation</i> .
<b>Application</b>	• Dual sided	No cost	Specify <i>with dual-sided application</i> .
	• Single sided	No cost	Specify <i>with single-sided application</i> .

Specification Information	
• Style Number	• U.S. Base Price
WESINDEC	\$4924

 **For Canadian Pricing**  
Multiply U.S. Price by the Canadian price factor.  
▶ See page 1 for details.

# Greenpoint Bench Personal Credenza

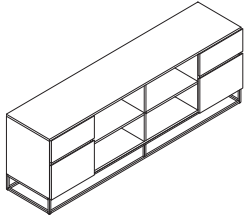

*Tip: When specified in High-Pressure Laminate, the pull of the drawer will be painted according to the matrix in the Surface Materials section.*

Standard Includes	Required to Specify
<ul style="list-style-type: none"> <li>▶ Need help? Product details, page 66</li> <li>• Credenza: High-Pressure Laminate price group 1</li> <li>• Square tube leg (frame): paint price group 1</li> <li>• 1½"H leveling glides</li> </ul>	<ul style="list-style-type: none"> <li>1 Style number</li> <li>2 Laminate color number for case</li> <li>3 Paint color number for leg (frame)</li> <li>4 Options, if selected (see below)</li> <li>▶ See <i>Surface Materials</i>, page 242.</li> </ul>

Options	U.S. Price	Required to Specify
<b>Surface Materials</b> <ul style="list-style-type: none"> <li>• <b>Case</b></li> <li>• High-Pressure Laminate price group 1</li> <li>• High-Pressure Laminate price group 2</li> <li>• West Elm veneer</li> <li>• Veneer price group 1</li> </ul>	<ul style="list-style-type: none"> <li>No cost</li> <li>+\$1079</li> <li>+\$1437</li> <li>+\$7129</li> </ul>	<ul style="list-style-type: none"> <li>Specify laminate color number.</li> <li>Specify laminate color number.</li> <li>Specify West Elm wood color number.</li> <li>Specify wood color number.</li> </ul>
<ul style="list-style-type: none"> <li>• <b>Frame</b></li> <li>• Paint price group 1</li> <li>• Paint price group 2</li> <li>• Paint price group 3</li> </ul>	<ul style="list-style-type: none"> <li>No cost</li> <li>+\$ 39</li> <li>+\$ 78</li> </ul>	<ul style="list-style-type: none"> <li>Specify paint color number.</li> <li>Specify paint color number.</li> <li>Specify paint color number.</li> </ul>
<b>Case Orientation</b> <ul style="list-style-type: none"> <li>• Inward</li> <li>• Outward</li> </ul>	<ul style="list-style-type: none"> <li>No cost</li> <li>No cost</li> </ul>	<ul style="list-style-type: none"> <li>Specify <i>with inward orientation</i>.</li> <li>Specify <i>with outward orientation</i>.</li> </ul>
<b>Application</b> <ul style="list-style-type: none"> <li>• Dual sided</li> <li>• Single sided</li> </ul>	<ul style="list-style-type: none"> <li>No cost</li> <li>No cost</li> </ul>	<ul style="list-style-type: none"> <li>Specify <i>with dual-sided application</i>.</li> <li>Specify <i>with single-sided application</i>.</li> </ul>

Specification Information	
• Style Number	• U.S. Base Price
WESINDPC	\$5716
•	•
•	•



**For Canadian Pricing**  
 Multiply U.S. Price by the Canadian price factor.  
 ▶ See page 1 for details.

# Greenpoint Bench Glass Screen

Greenpoint Bench Glass  
Screen

Greenpoint  
Bench

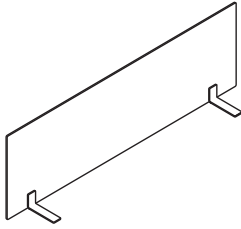

Standard Includes	Required to Specify
<ul style="list-style-type: none"> <li>▶ Need help? Product details, page 67</li> <li>• Screen: glass price group 1</li> <li>• Brackets: paint price group 1</li> </ul>	<ol style="list-style-type: none"> <li>1 Style number</li> <li>2 Specify width</li> <li>3 Glass color number for screen</li> <li>4 Paint color number for brackets</li> <li>5 Options, if selected (see below)</li> </ol> <p>▶ See <i>Surface Materials</i>, page 242.</p>

Options	U.S. Price	Required to Specify	
<b>Width</b> <ul style="list-style-type: none"> <li>• 48"</li> <li>• 54"</li> <li>• 60"</li> <li>• 66"</li> <li>• 72"</li> <li>• 78"</li> </ul>	<ul style="list-style-type: none"> <li>No cost</li> <li>+\$ 36</li> <li>+\$ 75</li> <li>+\$111</li> <li>+\$147</li> <li>+\$183</li> </ul>	<ul style="list-style-type: none"> <li>Select 48" width.</li> <li>Select 54" width.</li> <li>Select 60" width.</li> <li>Select 66" width.</li> <li>Select 72" width.</li> <li>Select 78" width.</li> </ul>	
<b>Surface Materials</b>	<b>Glass</b> <ul style="list-style-type: none"> <li>• Glass price group 1</li> <li>• Glass price group 2</li> </ul>	<ul style="list-style-type: none"> <li>No cost</li> <li>+\$370</li> </ul>	<ul style="list-style-type: none"> <li>Specify glass color number.</li> <li>Specify glass color number.</li> </ul>
	<b>Bracket</b> <ul style="list-style-type: none"> <li>• Paint price group 1</li> <li>• Paint price group 2</li> <li>• Paint price group 3</li> </ul>	<ul style="list-style-type: none"> <li>No cost</li> <li>+\$ 20</li> <li>+\$ 44</li> </ul>	<ul style="list-style-type: none"> <li>Specify paint color number.</li> <li>Specify paint color number.</li> <li>Specify paint color number.</li> </ul>

Specification Information	
Style Number	U.S. Base Price
WESINDCSG	\$778

 **For Canadian Pricing**  
Multiply U.S. Price by the Canadian price factor.  
▶ See page 1 for details.

# Power and Data

Standard Includes	Required to Specify
<ul style="list-style-type: none"> <li>▶ Need help? Product details, page 70</li> <li>• Power support: black paint</li> <li>• Attachment hardware</li> </ul>	Style number

Specification Information	
• Style Number	• U.S. Price

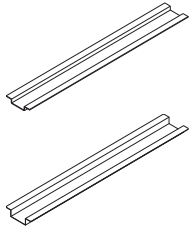

<b>Greenpoint Single Sided Power Support</b>	
<b>WESINDPSSS</b>	\$64

<b>Greenpoint Dual Sided Power Support</b>	
<b>WESINDPSDS</b>	\$64



**For Canadian Pricing**  
 Multiply U.S. Price by the Canadian price factor.  
 ▶ See page 1 for details.

## Greenpoint Dual-Sided Power Cover

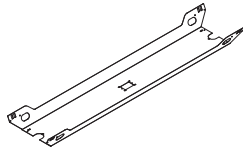

Standard Includes		Required to Specify
<ul style="list-style-type: none"> <li>Need help? Product details, page 70</li> <li>Power tray: black paint</li> <li>Attachment hardware</li> </ul>		<ul style="list-style-type: none"> <li>1 Style number</li> <li>2 Specify width</li> <li>3 Options, if selected (see below)</li> </ul>

Options	U.S. Price	Required to Specify
<b>Width</b>		
• 48"	No cost	Select 48" width.
• 54"	+\$ 5	Select 54" width.
• 60"	+\$13	Select 60" width.
• 66"	+\$23	Select 66" width.
• 72"	+\$28	Select 72" width.
• 78"	+\$36	Select 78" width.

Specification Information	
Style Number	U.S. Base Price
WESINDPTDS	\$206

Power and Data

## Greenpoint Single-Sided Power Cover

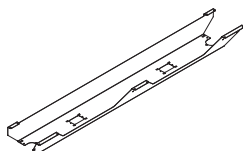

Standard Includes		Required to Specify
<ul style="list-style-type: none"> <li>Need help? Product details, page 70</li> <li>Power tray: black paint</li> <li>Attachment hardware</li> </ul>		<ul style="list-style-type: none"> <li>1 Style number</li> <li>2 Specify width</li> <li>3 Options, if selected (see below)</li> </ul>

Options	U.S. Price	Required to Specify
<b>Width</b>		
• 48"	No cost	Select 48" width.
• 54"	+\$ 5	Select 54" width.
• 60"	+\$13	Select 60" width.
• 66"	+\$23	Select 66" width.
• 72"	+\$28	Select 72" width.
• 78"	+\$36	Select 78" width.
<b>Handedness</b>		
• Left hand	No cost	Specify <i>with left hand</i> .
• Right hand	No cost	Specify <i>with right hand</i> .

Specification Information	
Style Number	U.S. Base Price
WESINDPTSS	\$183

 **For Canadian Pricing**  
 Multiply U.S. Price by the Canadian price factor.  
 ▶ See page 1 for details.

# Power and Data

## Power Trays

Standard Includes	Required to Specify
<ul style="list-style-type: none"> <li>▶ Need help? Product details, page 70</li> </ul>	<ul style="list-style-type: none"> <li>• Tray end cap or extension: black paint</li> <li>• Attachment hardware</li> </ul>

Specification Information	
• Style Number	• U.S. Price

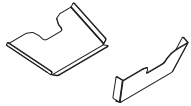

### Greenpoint Single Sided Tray End Cap

**WESINDCTSS**    \$42

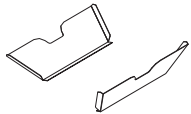

### Greenpoint Dual Sided Tray End Cap

**WESINDCTDS**    \$42

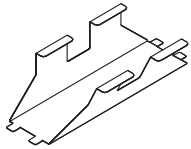

### Greenpoint Single Sided Tray Extension

**WESINDETSS**    \$75

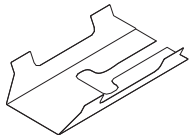

### Greenpoint Dual Sided Tray Extension

**WESINDETDS**    \$75



#### For Canadian Pricing

Multiply U.S. Price by the Canadian price factor.

▶ See page 1 for details.

## Power Covers

*Tip: If power covers are not selected, any connection points on modular power blocks not being used by a harness, infeed, or connector must be filled with dust covers. Order style number **FMVBK** separately.*

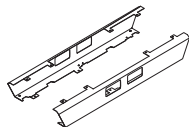
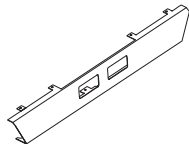

Standard Includes		Required to Specify
▶ Need help? Product details, page 70	<ul style="list-style-type: none"> <li>• Power cover: black paint</li> <li>• Attachment hardware</li> </ul>	Style number

### Specification Information

Style Number	U.S. Price
--------------	------------

#### Greenpoint Single Sided Power Cover

<b>WESINDPCSS</b>	\$51
-------------------	------

#### Greenpoint Dual Sided Power Cover

<b>WESINDPCDS</b>	\$51
-------------------	------

 **For Canadian Pricing**  
Multiply U.S. Price by the Canadian price factor.  
▶ See page 1 for details.

# Power and Data Power Block—Standard Capacity

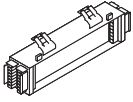

Standard Includes		Required to Specify
<ul style="list-style-type: none"> <li>▶ Need help? Product details, page 70</li> </ul>	<ul style="list-style-type: none"> <li>• Non-PVC power block</li> </ul>	<ul style="list-style-type: none"> <li>1 Style number</li> <li>2 Options, if selected (see below)</li> </ul>

Options	U.S. Price	Required to Specify
<ul style="list-style-type: none"> <li>• 2+2</li> </ul>	No cost	Specify with 2+2 power.
<ul style="list-style-type: none"> <li>• 3+1</li> </ul>	No cost	Specify with 3+1 power.
<ul style="list-style-type: none"> <li>• 3SN</li> </ul>	No cost	Specify with 3SN power.

Specification Information	
Style Number	U.S. Price
FMVPBS	\$273
.	.



**For Canadian Pricing**  
 Multiply U.S. Price by the Canadian price factor.  
 ▶ See page 1 for details.

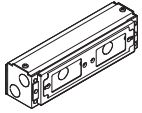

Standard Includes	Required to Specify
<ul style="list-style-type: none"> <li>▶ Need help? Product details, page 70</li> <li>• Hardwire box: black</li> </ul>	<ul style="list-style-type: none"> <li>Style number</li> </ul>

Specification Information	
• Style Number	• U.S. Price

Power Kit—Chicago Hardwire	
FMVCP	\$403

Power and Data

 **For Canadian Pricing**  
Multiply U.S. Price by the Canadian price factor.  
▶ See page 1 for details.

# Power and Data

## Power and Data Receptacles and Filler Package

### Receptacle—Duplex



Tip: For designation of controlled receptacles, order permanent ink stamp with controlled icon; service part **1063909001SR**. It includes a pair of stamps, one white and one black. Appropriate receptacles can be stamped at the job site during installation.

Standard Includes		Required to Specify
<ul style="list-style-type: none"> <li>▶ Need help? Product details, page 70</li> </ul>	<ul style="list-style-type: none"> <li>• 15-amp, system ground duplex receptacle:                             <ul style="list-style-type: none"> <li>– 6000 Black</li> <li>– 6009 Arctic White</li> <li>– 6527 Merle</li> <li>– 6899 Platinum Metallic</li> </ul> </li> </ul>	<ul style="list-style-type: none"> <li>1 Style number</li> <li>2 Plastic color number for receptacle</li> <li>3 Options, if selected (see below)</li> </ul>

	Options	U.S. Price	Required to Specify
<b>3+1 Power</b>	<ul style="list-style-type: none"> <li>• Line 1</li> <li>• Line 2</li> <li>• Line 3</li> <li>• Line 4</li> </ul>	<ul style="list-style-type: none"> <li>No cost</li> <li>No cost</li> <li>No cost</li> <li>No cost</li> </ul>	<ul style="list-style-type: none"> <li>Specify with line 1 3+1 power.</li> <li>Specify with line 2 3+1 power.</li> <li>Specify with line 3 3+1 power.</li> <li>Specify with line 4 3+1 power.</li> </ul>
<b>2+2 Power</b>	<ul style="list-style-type: none"> <li>• Line 1</li> <li>• Line 2</li> <li>• Line 3</li> <li>• Line 4</li> </ul>	<ul style="list-style-type: none"> <li>No cost</li> <li>No cost</li> <li>No cost</li> <li>No cost</li> </ul>	<ul style="list-style-type: none"> <li>Specify with line 1 2+2 power.</li> <li>Specify with line 2 2+2 power.</li> <li>Specify with line 3 2+2 power.</li> <li>Specify with line 4 2+2 power.</li> </ul>
<b>3SN Power</b>	<ul style="list-style-type: none"> <li>• Line 1</li> <li>• Line 2</li> <li>• Line 3</li> </ul>	<ul style="list-style-type: none"> <li>No cost</li> <li>No cost</li> <li>No cost</li> </ul>	<ul style="list-style-type: none"> <li>Specify with line 1 3SN power.</li> <li>Specify with line 2 3SN power.</li> <li>Specify with line 3 3SN power.</li> </ul>
<b>Amperage</b>	<ul style="list-style-type: none"> <li>• 15 amp</li> <li>• 20 amp</li> </ul>	<ul style="list-style-type: none"> <li>No cost</li> <li>+\$37</li> </ul>	<ul style="list-style-type: none"> <li>Specify with 15 amp.</li> <li>Specify with 20 amp.</li> </ul>
<b>Ground Type</b>	<ul style="list-style-type: none"> <li>• System</li> <li>• Isolated</li> </ul>	<ul style="list-style-type: none"> <li>No cost</li> <li>+\$21</li> </ul>	<ul style="list-style-type: none"> <li>Specify with system ground.</li> <li>Specify with isolated ground.</li> </ul>
<b>Controlled Stamp</b>	<ul style="list-style-type: none"> <li>• No stamp</li> <li>• With controlled stamp</li> </ul>	<ul style="list-style-type: none"> <li>No cost</li> <li>+\$ 5</li> </ul>	<ul style="list-style-type: none"> <li>Specify with no stamp.</li> <li>Specify with controlled stamp.</li> </ul>

Specification Information	
Style Number	U.S. Base Price
FMVRD	\$52



#### For Canadian Pricing

Multiply U.S. Price by the Canadian price factor.

▶ See page 1 for details.

## Receptacle—USB



Standard Includes		Required to Specify
<ul style="list-style-type: none"> <li>▶ Need help? Product details, page 70</li> </ul>	<ul style="list-style-type: none"> <li>• USB receptacle:                             <ul style="list-style-type: none"> <li>– 6000 Black</li> <li>– 6009 Arctic White</li> <li>– 6527 Merle</li> <li>– 6899 Platinum Metallic</li> </ul> </li> </ul>	<ul style="list-style-type: none"> <li>1 Style number</li> <li>2 Plastic color number for receptacle</li> <li>3 Options, if selected (see below)</li> </ul>

	Options	U.S. Price	Required to Specify
<b>3+1 Power</b>	<ul style="list-style-type: none"> <li>• Line 1</li> <li>• Line 2</li> <li>• Line 3</li> <li>• Line 4</li> </ul>	<ul style="list-style-type: none"> <li>No cost</li> <li>No cost</li> <li>No cost</li> <li>No cost</li> </ul>	<ul style="list-style-type: none"> <li>Specify with line 1 3+1 power.</li> <li>Specify with line 2 3+1 power.</li> <li>Specify with line 3 3+1 power.</li> <li>Specify with line 4 3+1 power.</li> </ul>
<b>2+2 Power</b>	<ul style="list-style-type: none"> <li>• Line 1</li> <li>• Line 2</li> <li>• Line 3</li> <li>• Line 4</li> </ul>	<ul style="list-style-type: none"> <li>No cost</li> <li>No cost</li> <li>No cost</li> <li>No cost</li> </ul>	<ul style="list-style-type: none"> <li>Specify with line 1 2+2 power.</li> <li>Specify with line 2 2+2 power.</li> <li>Specify with line 3 2+2 power.</li> <li>Specify with line 4 2+2 power.</li> </ul>
<b>3SN Power</b>	<ul style="list-style-type: none"> <li>• Line 1</li> <li>• Line 2</li> <li>• Line 3</li> </ul>	<ul style="list-style-type: none"> <li>No cost</li> <li>No cost</li> <li>No cost</li> </ul>	<ul style="list-style-type: none"> <li>Specify with line 1 3SN power.</li> <li>Specify with line 2 3SN power.</li> <li>Specify with line 3 3SN power.</li> </ul>

Specification Information	
Style Number	U.S. Price
FMVRUSB	\$122

## Filler Package



Standard Includes		Required to Specify
<ul style="list-style-type: none"> <li>▶ Need help? Product details, page 70</li> </ul>	<ul style="list-style-type: none"> <li>• Package of 20 fillers:                             <ul style="list-style-type: none"> <li>– 6000 Black</li> <li>– 6009 Arctic White</li> <li>– 6527 Merle</li> <li>– 6899 Platinum Metallic</li> </ul> </li> </ul>	<ul style="list-style-type: none"> <li>1 Style number</li> <li>2 Plastic color number for filler</li> </ul>

Specification Information	
Style Number	U.S. Price
FMVF	\$55

 **For Canadian Pricing**  
 Multiply U.S. Price by the Canadian price factor.  
 ▶ See page 1 for details.

# Power and Data

## Modular Harnesses

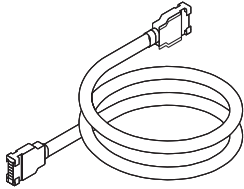

Tip: Refer to Power Routing Harness Chart for recommended harness lengths.

	Standard Includes	Required to Specify
▶ Need help? Product details, page 72	<ul style="list-style-type: none"> <li>Non-PVC modular harness</li> </ul>	1 Style number 2 Options, if selected (see below)

	Options	U.S. Price	Required to Specify
<b>Power Schematic</b>	<ul style="list-style-type: none"> <li>2+2</li> <li>3+1</li> <li>3SN</li> </ul>	No cost No cost No cost	Specify with 2+2 power. Specify with 3+1 power. Specify with 3SN power.
<b>PVC</b>	<ul style="list-style-type: none"> <li>With PVC</li> <li>Non PVC</li> </ul>	-\$13 No cost	Specify with PVC. Specify with non PVC.

Specification Information		
Length	Style Number	U.S. Base Price
24"	<b>FMVH24</b>	\$189
27"	<b>FMVH27</b>	\$189
30"	<b>FMVH30</b>	\$189
33"	<b>FMVH33</b>	\$189
36"	<b>FMVH36</b>	\$189
39"	<b>FMVH39</b>	\$189
42"	<b>FMVH42</b>	\$189
45"	<b>FMVH45</b>	\$209
48"	<b>FMVH48</b>	\$209
51"	<b>FMVH51</b>	\$209
54"	<b>FMVH54</b>	\$209
57"	<b>FMVH57</b>	\$209
60"	<b>FMVH60</b>	\$239
63"	<b>FMVH63</b>	\$239
66"	<b>FMVH66</b>	\$239
69"	<b>FMVH69</b>	\$239
72"	<b>FMVH72</b>	\$263
:	:	:



### For Canadian Pricing

Multiply U.S. Price by the Canadian price factor.

▶ See page 1 for details.

## Power Infeeds, Hardwire to Modular

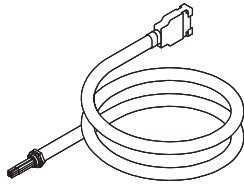

Standard Includes		Required to Specify
<ul style="list-style-type: none"> <li>▶ Need help? Product details, page 72</li> </ul>	<ul style="list-style-type: none"> <li>• Non-PVC infeed harness</li> </ul>	<ul style="list-style-type: none"> <li>1 Style number</li> <li>2 Options, if selected (see below)</li> </ul>

Options	U.S. Price	Required to Specify
<b>Power Schematic</b> <ul style="list-style-type: none"> <li>• 2+2</li> <li>• 3+1</li> <li>• 3SN</li> </ul>	<ul style="list-style-type: none"> <li>No cost</li> <li>No cost</li> <li>No cost</li> </ul>	<ul style="list-style-type: none"> <li>Specify with 2+2 power.</li> <li>Specify with 3+1 power.</li> <li>Specify with 3SN power.</li> </ul>
<b>PVC</b> <ul style="list-style-type: none"> <li>• With PVC</li> <li>• Non PVC</li> </ul>	<ul style="list-style-type: none"> <li>-\$13</li> <li>No cost</li> </ul>	<ul style="list-style-type: none"> <li>Specify with PVC.</li> <li>Specify with non PVC.</li> </ul>

Specification Information		
Length	Style Number	U.S. Base Price
6"	<b>FMVI6H</b>	\$301
12"	<b>FMVI12H</b>	\$386
24"	<b>FMVI24H</b>	\$557
:	:	:

Power and Data

## Power Infeeds, Modular to Modular

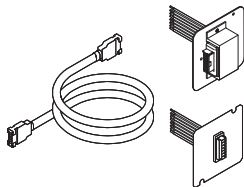

Standard Includes		Required to Specify
<ul style="list-style-type: none"> <li>▶ Need help? Product details, page 72</li> </ul>	<ul style="list-style-type: none"> <li>• Non-PVC infeed harness</li> <li>• Straight/flush junction box faceplate</li> </ul>	<ul style="list-style-type: none"> <li>1 Style number</li> <li>2 Options, if selected (see below)</li> </ul>

Options	U.S. Price	Required to Specify
<b>Power Schematic</b> <ul style="list-style-type: none"> <li>• 2+2</li> <li>• 3+1</li> <li>• 3SN</li> </ul>	<ul style="list-style-type: none"> <li>No cost</li> <li>No cost</li> <li>No cost</li> </ul>	<ul style="list-style-type: none"> <li>Specify with 2+2 power.</li> <li>Specify with 3+1 power.</li> <li>Specify with 3SN power.</li> </ul>
<b>Plate Type</b> <ul style="list-style-type: none"> <li>• Straight/flush faceplate</li> <li>• 90° faceplate</li> </ul>	<ul style="list-style-type: none"> <li>No cost</li> <li>+\$66</li> </ul>	<ul style="list-style-type: none"> <li>Specify with straight/flush faceplate.</li> <li>Specify with 90° faceplate.</li> </ul>
<b>PVC</b> <ul style="list-style-type: none"> <li>• With PVC</li> <li>• Non PVC</li> </ul>	<ul style="list-style-type: none"> <li>-\$13</li> <li>No cost</li> </ul>	<ul style="list-style-type: none"> <li>Specify with PVC.</li> <li>Specify with non PVC.</li> </ul>

Specification Information		
Length	Style Number	U.S. Base Price
6"	<b>FMVI6M</b>	\$408
12"	<b>FMVI12M</b>	\$509
24"	<b>FMVI24M</b>	\$680
:	:	:

 **For Canadian Pricing**  
 Multiply U.S. Price by the Canadian price factor.  
 ▶ See page 1 for details.

## Power Infeed—San Francisco

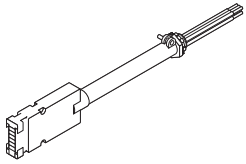

Standard Includes		Required to Specify	
▶ Need help? Product details, page 72	<ul style="list-style-type: none"> <li>• 12' PVC infeed harness with liquid tight metallic conduit</li> </ul>	1 Style number	2 Options, if selected (see below)
Options		U.S. Price	Required to Specify
<b>Power Schematic</b>	<ul style="list-style-type: none"> <li>• 2+2</li> <li>• 3+1</li> <li>• 3SN</li> </ul>	No cost No cost No cost	Specify with 2+2 power. Specify with 3+1 power. Specify with 3SN power.
Specification Information			
<b>Style Number</b>	<b>U.S. Price</b>		
FMVISS	\$483		

## Ology Infeed—New York

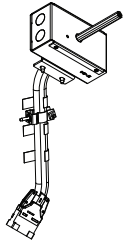

Standard Includes		Required to Specify	
▶ Need help? Product details, page 72	<ul style="list-style-type: none"> <li>• 50" non-PVC infeed harness</li> <li>• Junction box</li> <li>• Strain relief brackets</li> </ul>	1 Style number	2 Options, if selected (see below)
Options		U.S. Price	Required to Specify
<b>Wiring Schematic</b>	<ul style="list-style-type: none"> <li>• 2+2</li> <li>• 3 separate neutrals</li> <li>• 3+1</li> </ul>	No cost No cost No cost	Specify with 2+2 power. Specify with 3 separate neutrals. Specify with 3+1 power.
<b>PVC</b>	<ul style="list-style-type: none"> <li>• With PVC</li> </ul>	-\$13	Specify with PVC.
Specification Information			
<b>Style Number</b>	<b>U.S. Base Price</b>		
OLBVINN	\$306		



**For Canadian Pricing**  
Multiply U.S. Price by the Canadian price factor.  
▶ See page 1 for details.

## Bracket Kit

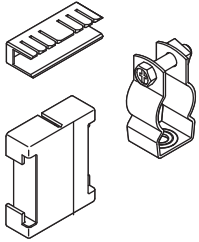

Standard Includes	Required to Specify
<ul style="list-style-type: none"> <li>▶ Need help? Product details, page 70</li> <li>• Brackets and dust covers</li> </ul>	<ul style="list-style-type: none"> <li>Style number</li> </ul>

Specification Information	
Style Number	U.S. Price
<b>FMVBK</b>	\$60
·	·

 **For Canadian Pricing**  
 Multiply U.S. Price by the Canadian price factor.  
 ▶ See page 1 for details.

# Power and Data

## Vertabral Risers

### Wire Manager Assembly—Vertabral

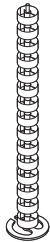

Standard Includes		Required to Specify
<ul style="list-style-type: none"> <li>▶ Need help? Product details, page 72</li> </ul>	<ul style="list-style-type: none"> <li>• Wire manager</li> </ul>	Style number
Specification Information		
• Style Number	• U.S. Price	
FMVC	\$261	
•	•	

### Wire Manager Assembly—Vertabral Extension



Standard Includes		Required to Specify
<ul style="list-style-type: none"> <li>▶ Need help? Product details, page 72</li> </ul>	<ul style="list-style-type: none"> <li>• Wire manager</li> </ul>	Style number
Specification Information		
• Style Number	• U.S. Price	
FMVCE	\$76	
•	•	



#### For Canadian Pricing

Multiply U.S. Price by the Canadian price factor.

▶ See page 1 for details.



# Sutton Basic Height-Adjustable Desks

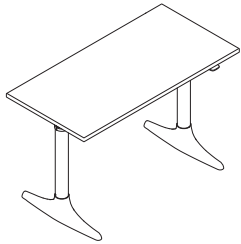

► Need help?  
Product details,  
page 76

## Standard Includes

- Basic height-adjustable desk
- Worksurface:
  - High-Pressure Laminate price group 1 with 3 mm plastic edge
  - Wood group 1 veneer with matching 3 mm square edge, if selected
- Electric height-adjustable sit-to-stand base: paint price group 1
- Simple touch controller
- Foot: paint price group 1
- Leg ring: paint price group 1
- Modular widths: 46", 52", 58", 64", or 70"
- Attachment hardware
- Power cord: 10' with standard plug

## Required to Specify

- 1 Style number
  - 2 High-Pressure Laminate or wood color number for worksurface
  - 3 Paint color number for base
  - 4 Paint color number for foot
  - 5 Paint color number for leg ring
  - 6 Options, if selected (see below)
- See *Surface Materials*, page 242.

	Options	U.S. Price	Required to Specify
<b>Size</b>	<ul style="list-style-type: none"> <li>• Modular</li> <li>• Parametric</li> </ul>	No cost No cost	Specify modular. Specify parametric.
<b>Surface Materials</b>	<p><b>Top</b></p> <ul style="list-style-type: none"> <li>• Customiz stain</li> <li>• High-Pressure Laminate price group 1</li> <li>• High-Pressure Laminate price group 2                             <ul style="list-style-type: none"> <li>– 46"W–54"W</li> <li>– 54<sup>1</sup>/<sub>16</sub>"W–66"W</li> <li>– 66<sup>1</sup>/<sub>16</sub>"W–72"W</li> </ul> </li> <li>• High-Pressure Laminate price group 3                             <ul style="list-style-type: none"> <li>– 46"W–54"W</li> <li>– 54<sup>1</sup>/<sub>16</sub>"W–66"W</li> <li>– 66<sup>1</sup>/<sub>16</sub>"W–72"W</li> </ul> </li> <li>• Composite veneer price group 1</li> <li>• Composite veneer price group 2</li> <li>• Veneer price group 1</li> <li>• Veneer full-fill</li> <li>• Veneer price group 3</li> <li>• West Elm veneer</li> <li>• Open Line laminate</li> </ul> <p><b>Foot</b></p> <ul style="list-style-type: none"> <li>• Paint price group 1</li> <li>• Paint price group 2</li> <li>• Paint price group 3</li> <li>• Polished aluminum</li> </ul> <p><b>Base</b></p> <ul style="list-style-type: none"> <li>• Paint price group 1</li> <li>• Paint price group 2</li> </ul> <p><b>Leg ring</b></p> <ul style="list-style-type: none"> <li>• Paint price group 1</li> <li>• Paint price group 2</li> <li>• Paint price group 3</li> <li>• Polished chrome</li> </ul>	No cost Prices at right +\$ 27 +\$ 36 +\$ 44 +\$ 53 +\$ 71 +\$ 89 Prices at right +\$108 Prices at right +\$118 +\$417 +\$478 +\$111 plus cost of laminate No cost +\$ 24 +\$ 44 +\$ 44 No cost +\$ 24 No cost +\$ 5 +\$ 16 +\$ 22	Specify <i>with Customiz stain</i> . ► See <i>Surface Materials Reference Manual</i> . Specify laminate color number. Specify laminate color number. Specify laminate color number. Specify laminate color number. Specify laminate color number. Specify laminate color number. Specify composite veneer color number. Specify composite veneer color number. Specify veneer color number. Specify full-fill veneer color number. Specify veneer color number. Specify West Elm veneer color number. ► See <i>Surface Materials Reference Manual</i> . Specify paint color number. Specify paint color number. Specify paint color number. Specify <i>with polished aluminum</i> . Specify paint color number. Specify paint color number. Specify paint color number. Specify <i>with polished chrome</i> .
<b>Edge Type</b>	<ul style="list-style-type: none"> <li>• 3 mm plastic edge</li> <li>• 3 mm wood edge</li> <li>• Blade edge</li> </ul>	No cost No cost +\$349	Specify <i>with 3 mm plastic edge</i> and select plastic color number. Specify <i>with 3 mm wood edge</i> . Specify <i>with blade edge</i> .
<b>Corner</b>	<ul style="list-style-type: none"> <li>• Square corner</li> <li>• Radius corner</li> </ul>	No cost +\$ 99	Specify <i>with square corner</i> . Specify <i>with radius corner</i> .

► Options, continued on next page



### For Canadian Pricing

Multiply U.S. Price by the Canadian price factor.

► See page 1 for details.

► Options, continued from previous page

Options	U.S. Price	Required to Specify
<b>Cable Tray</b>	<ul style="list-style-type: none"> <li>No cable tray</li> <li>With cable tray</li> </ul>	No cost Prices below
<b>Controller</b>	<ul style="list-style-type: none"> <li>Simple touch controller</li> <li>Active touch controller</li> </ul>	No cost +\$ 79
<b>Power Configuration</b>	<ul style="list-style-type: none"> <li>No under worksurface power</li> <li>Under worksurface clamp with USB A+C                             <ul style="list-style-type: none"> <li>– 46"W–57<sup>1</sup>/<sub>16</sub>"W</li> <li>– 58"W–72"W</li> </ul> </li> <li>Under worksurface clamp with USB-C                             <ul style="list-style-type: none"> <li>– 46"W–57<sup>1</sup>/<sub>16</sub>"W</li> <li>– 58"W–72"W</li> </ul> </li> <li>Under worksurface only                             <ul style="list-style-type: none"> <li>– 46"W–57<sup>1</sup>/<sub>16</sub>"W</li> <li>– 58"W–72"W</li> </ul> </li> </ul>	No cost +\$ 853 +\$ 888 +\$1195 +\$1229 +\$ 507 +\$ 541
<b>Power Cord</b>	<ul style="list-style-type: none"> <li>10' standard cord</li> <li>9' standard cord</li> <li>10' braided cord</li> <li>20' standard cord</li> <li>20' braided cord</li> <li>8' curly cord</li> </ul>	No cost No cost +\$ 79 +\$ 79 +\$ 234 +\$ 340
<b>Power Plug Type</b>	<ul style="list-style-type: none"> <li>Standard NEMA 5-15 3-prong</li> <li>Thread low profile plug</li> </ul>	No cost +\$ 43
<b>PVC</b>	<ul style="list-style-type: none"> <li>With PVC</li> <li>Non PVC</li> </ul>	No cost +\$ 36

Tip: Plastic selection will be required if clamp is selected.

Sutton

Specification Information

Style Number	Depth	U.S. Base Prices						Option (Add \$ to Base Price) Cable Tray
		Modular 46"W	52"W	58"W	64"W	70"W	76"W	
		46"W	48 <sup>1</sup> / <sub>16</sub> "W	54 <sup>1</sup> / <sub>16</sub> "W	60 <sup>1</sup> / <sub>16</sub> "W	66 <sup>1</sup> / <sub>16</sub> "W	72"W	
		48"W	54"W	60"W	66"W	72"W		

High-Pressure Laminate Price Group 1

WESSUTSRQ	Depth	46"W	52"W	58"W	64"W	70"W	Option
	23"	\$2304	\$2375	\$2449	\$2523	\$2597	+\$195
	29"	\$2588	\$2669	\$2751	\$2834	\$2918	+\$218

Composite Veneer Price Group 1

WESSUTSRQ	Depth	46"W	52"W	58"W	64"W	70"W	Option
	23"	\$3057	\$3151	\$3249	\$3347	\$3446	+\$195
	29"	\$3362	\$3468	\$3574	\$3681	\$3790	+\$218

Veneer Price Group 1

WESSUTSRQ	Depth	46"W	52"W	58"W	64"W	70"W	Option
	23"	\$3132	\$3230	\$3329	\$3429	\$3532	+\$195
	29"	\$3439	\$3548	\$3656	\$3766	\$3878	+\$218

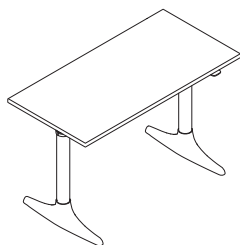

**For Canadian Pricing**  
Multiply U.S. Price by the Canadian price factor.  
► See page 1 for details.

# Sutton Extended Height-Adjustable Desks

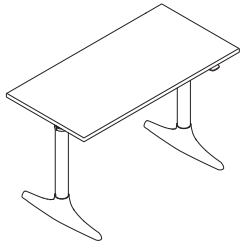

► Need help?  
Product details,  
page 76

## Standard Includes

- Extended height-adjustable desk
- Worksurface:
  - High-Pressure Laminate price group 1 with 3 mm plastic edge
  - Wood group 1 veneer with matching 3 mm square edge, if selected
- Electric height-adjustable sit-to-stand base: paint price group 1
- Simple touch controller
- Foot: paint price group 1
- Leg ring: paint price group 1
- Modular widths: 46", 52", 58", 64", or 70"
- Attachment hardware
- Power cord: 10' with standard plug

## Required to Specify

- 1 Style number
  - 2 High-Pressure Laminate or wood color number for worksurface
  - 3 Paint color number for base
  - 4 Paint color number for foot
  - 5 Paint color number for leg ring
  - 6 Options, if selected (see below)
- See *Surface Materials*, page 242.

	Options	U.S. Price	Required to Specify
<b>Size</b>	<ul style="list-style-type: none"> <li>• Modular</li> <li>• Parametric</li> </ul>	No cost No cost	Specify modular. Specify parametric.
<b>Surface Materials</b>	<p><b>Top</b></p> <ul style="list-style-type: none"> <li>• Customiz stain</li> <li>• High-Pressure Laminate price group 1</li> <li>• High-Pressure Laminate price group 2                             <ul style="list-style-type: none"> <li>– 46"W–54"W</li> <li>– 54<sup>1</sup>/<sub>16</sub>"W–66"W</li> <li>– 66<sup>1</sup>/<sub>16</sub>"W–72"W</li> </ul> </li> <li>• High-Pressure Laminate price group 3                             <ul style="list-style-type: none"> <li>– 46"W–54"W</li> <li>– 54<sup>1</sup>/<sub>16</sub>"W–66"W</li> <li>– 66<sup>1</sup>/<sub>16</sub>"W–72"W</li> </ul> </li> <li>• Composite veneer price group 1</li> <li>• Composite veneer price group 2</li> <li>• Veneer price group 1</li> <li>• Veneer full-fill</li> <li>• Veneer price group 3</li> <li>• West Elm veneer</li> <li>• Open Line laminate</li> </ul> <p><b>Foot</b></p> <ul style="list-style-type: none"> <li>• Paint price group 1</li> <li>• Paint price group 2</li> <li>• Paint price group 3</li> <li>• Polished aluminum</li> </ul> <p><b>Base</b></p> <ul style="list-style-type: none"> <li>• Paint price group 1</li> <li>• Paint price group 2</li> </ul> <p><b>Leg ring</b></p> <ul style="list-style-type: none"> <li>• Paint price group 1</li> <li>• Paint price group 2</li> <li>• Paint price group 3</li> <li>• Polished chrome</li> </ul>	No cost Prices at right +\$ 27 +\$ 36 +\$ 44 +\$ 53 +\$ 71 +\$ 89 Prices at right +\$108 Prices at right +\$118 +\$417 +\$478 +\$111 plus cost of laminate No cost +\$ 24 +\$ 44 +\$ 44 No cost +\$ 24 No cost +\$ 5 +\$ 16 +\$ 22	Specify <i>with Customiz stain</i> . ► See <i>Surface Materials Reference Manual</i> . Specify laminate color number. Specify laminate color number. Specify laminate color number. Specify laminate color number. Specify laminate color number. Specify laminate color number. Specify composite veneer color number. Specify composite veneer color number. Specify veneer color number. Specify full-fill veneer color number. Specify veneer color number. Specify West Elm veneer color number. ► See <i>Surface Materials Reference Manual</i> . Specify paint color number. Specify paint color number. Specify paint color number. Specify <i>with polished aluminum</i> . Specify paint color number. Specify paint color number. Specify paint color number. Specify <i>with polished chrome</i> .
<b>Edge Type</b>	<ul style="list-style-type: none"> <li>• 3 mm plastic edge</li> <li>• 3 mm wood edge</li> <li>• Blade edge</li> </ul>	No cost No cost +\$349	Specify <i>with 3 mm plastic edge</i> and select plastic color number. Specify <i>with 3 mm wood edge</i> . Specify <i>with blade edge</i> .
<b>Corner</b>	<ul style="list-style-type: none"> <li>• Square corner</li> <li>• Radius corner</li> </ul>	No cost +\$ 99	Specify <i>with square corner</i> . Specify <i>with radius corner</i> .

► Options, continued on next page

 **For Canadian Pricing**  
Multiply U.S. Price by the Canadian price factor.  
► See page 1 for details.

► Options, continued from previous page

Options	U.S. Price	Required to Specify
<b>Cable Tray</b>	<ul style="list-style-type: none"> <li>No cable tray</li> <li>With cable tray</li> </ul>	No cost Prices below Specify with no cable tray. Specify with cable tray.
<b>Controller</b>	<ul style="list-style-type: none"> <li>Simple touch controller</li> <li>Active touch controller</li> </ul>	No cost +\$ 79 Specify with simple touch controller. Specify with active touch controller.
<b>Power Configuration</b>	<ul style="list-style-type: none"> <li>No under worksurface power</li> <li>Under worksurface clamp with USB A+C               <ul style="list-style-type: none"> <li>– 46"W–57<sup>1</sup>/<sub>16</sub>"W</li> <li>– 58"W–72"W</li> </ul> </li> <li>Under worksurface clamp with USB-C               <ul style="list-style-type: none"> <li>– 46"W–57<sup>1</sup>/<sub>16</sub>"W</li> <li>– 58"W–72"W</li> </ul> </li> <li>Under worksurface only               <ul style="list-style-type: none"> <li>– 46"W–57<sup>1</sup>/<sub>16</sub>"W</li> <li>– 58"W–72"W</li> </ul> </li> </ul>	No cost +\$ 853 +\$ 888 +\$1195 +\$1229 +\$ 507 +\$ 541 Specify with no under worksurface power. Specify with under worksurface clamp with USB A+C. Specify with under worksurface clamp with USB A+C. Specify with under worksurface clamp with USB-C. Specify with under worksurface clamp with USB-C. Specify with under worksurface power. Specify with under worksurface power.
<b>Power Cord</b>	<ul style="list-style-type: none"> <li>10' standard cord</li> <li>9' standard cord</li> <li>10' braided cord</li> <li>20' standard cord</li> <li>20' braided cord</li> <li>8' curly cord</li> </ul>	No cost No cost +\$ 79 +\$ 79 +\$ 234 +\$ 340 Specify with 10' standard cord. Specify with 9' standard cord. Specify with 10' braided cord and select finish. Specify with 20' standard cord. Specify with 20' braided cord and select finish. Specify with 8' curly cord.
<b>Power Plug Type</b>	<ul style="list-style-type: none"> <li>Standard NEMA 5-15 3-prong</li> <li>Thread low profile plug</li> </ul>	No cost +\$ 43 Specify with standard NEMA 5-15 3-prong. Specify with thread low profile plug.
<b>PVC</b>	<ul style="list-style-type: none"> <li>With PVC</li> <li>Non PVC</li> </ul>	No cost +\$ 36 Specify with PVC. Specify with non PVC.



**Specification Information**

Style Number	Depth	U.S. Base Prices						Option (Add \$ to Base Price) Cable Tray
		Modular 46"W	52"W	58"W	64"W	70"W	76"W	
		46"W	48 <sup>1</sup> / <sub>16</sub> "W	54 <sup>1</sup> / <sub>16</sub> "W	60 <sup>1</sup> / <sub>16</sub> "W	66 <sup>1</sup> / <sub>16</sub> "W	72"W	
		48"W	54"W	60"W	66"W	72"W		

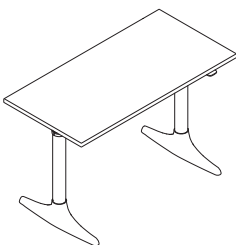

**High-Pressure Laminate Price Group 1**

WEISSUTERQ	Depth	46"W	52"W	58"W	64"W	70"W	Option
	23"	\$2512	\$2589	\$2669	\$2749	\$2832	+\$195
	29"	\$2821	\$2909	\$2998	\$3089	\$3182	+\$218

**Composite Veneer Price Group 1**

WEISSUTERQ	Depth	46"W	52"W	58"W	64"W	70"W	Option
	23"	\$3265	\$3365	\$3469	\$3573	\$3681	+\$195
	29"	\$3595	\$3708	\$3821	\$3936	\$4054	+\$218

**Veneer Price Group 1**

WEISSUTERQ	Depth	46"W	52"W	58"W	64"W	70"W	Option
	23"	\$3340	\$3444	\$3549	\$3655	\$3767	+\$195
	29"	\$3672	\$3788	\$3903	\$4021	\$4142	+\$218

**For Canadian Pricing**  
 Multiply U.S. Price by the Canadian price factor.  
 ► See page 1 for details.

# Sutton Basic Height-Adjustable Bases

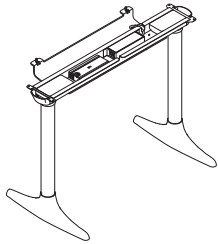

► Need help?  
Product details,  
page 76

## Standard Includes

- Basic height-adjustable base
- Electric height-adjustable sit-to-stand base: paint price group 1
- Foot: paint price group 1
- Leg ring: paint price group 1
- Simple touch controller
- Modular widths: 46", 52", 58", 64", or 70"
- Attachment hardware
- Power cord: 10' with standard plug

## Required to Specify

- 1 Style number
  - 2 Paint color number for base
  - 3 Paint color number for foot
  - 4 Paint color number for leg ring
  - 5 Options, if selected (see below)
- See *Surface Materials*, page 242.

	Options	U.S. Price	Required to Specify	
<b>Size</b>	<ul style="list-style-type: none"> <li>• Modular</li> <li>• Parametric</li> </ul>	No cost No cost	Specify modular. Specify parametric.	
<b>Surface Materials</b>	<b>Foot</b>			
	<ul style="list-style-type: none"> <li>• Paint price group 1</li> <li>• Paint price group 2</li> <li>• Paint price group 3</li> <li>• Polished aluminum</li> </ul>	No cost +\$ 24 +\$ 44 +\$ 44	Specify paint color number. Specify paint color number. Specify paint color number. Specify with polished aluminum.	
	<b>Base</b>			
	<ul style="list-style-type: none"> <li>• Paint price group 1</li> <li>• Paint price group 2</li> </ul>	No cost +\$ 24	Specify paint color number. Specify paint color number.	
	<b>Leg ring</b>			
	<ul style="list-style-type: none"> <li>• Paint price group 1</li> <li>• Paint price group 2</li> <li>• Paint price group 3</li> <li>• Polished chrome</li> </ul>	No cost +\$ 5 +\$ 16 +\$ 22	Specify paint color number. Specify paint color number. Specify paint color number. Specify with polished aluminum.	
	<b>Cable Tray</b>	<ul style="list-style-type: none"> <li>• No cable tray</li> <li>• With cable tray</li> </ul>	No cost Prices at right	Specify with no cable tray. Specify with cable tray.
	<b>Controller</b>	<ul style="list-style-type: none"> <li>• Simple touch controller</li> <li>• Active touch controller</li> </ul>	No cost +\$ 79	Specify with simple touch controller. Specify with active touch controller.
<b>Power Configuration</b>	<ul style="list-style-type: none"> <li>• No under worksurface power</li> </ul>	No cost	Specify with no under worksurface power.	
	<ul style="list-style-type: none"> <li>• Under worksurface clamp with USB A+C</li> </ul>			
	<ul style="list-style-type: none"> <li>– 46"W–57<sup>1</sup>/<sub>16</sub>"W</li> <li>– 58"W–72"W</li> </ul>	+\$ 853 +\$ 888	Specify with under worksurface clamp with USB A+C. Specify with under worksurface clamp with USB A+C.	
	<ul style="list-style-type: none"> <li>• Under worksurface clamp with USB-C</li> </ul>			
	<ul style="list-style-type: none"> <li>– 46"W–57<sup>1</sup>/<sub>16</sub>"W</li> <li>– 58"W–72"W</li> </ul>	+\$1195 +\$1229	Specify with under worksurface clamp with USB-C. Specify with under worksurface clamp with USB-C.	
	<ul style="list-style-type: none"> <li>• Under worksurface only</li> </ul>			
<ul style="list-style-type: none"> <li>– 46"W–57<sup>1</sup>/<sub>16</sub>"W</li> <li>– 58"W–72"W</li> </ul>	+\$ 507 +\$ 541	Specify with under worksurface power. Specify with under worksurface power.		
<b>Power Cord</b>	<ul style="list-style-type: none"> <li>• 10' standard cord</li> <li>• 9' standard cord</li> <li>• 10' braided cord</li> </ul>	No cost No cost +\$ 79	Specify with 10' standard cord. Specify with 9' standard cord. Specify with 10' braided cord and select finish.	
	<ul style="list-style-type: none"> <li>• 20' standard cord</li> <li>• 20' braided cord</li> </ul>	+\$ 79 +\$ 234	Specify with 20' standard cord. Specify with 20' braided cord and select finish.	
	<ul style="list-style-type: none"> <li>• 8' curly cord</li> </ul>	+\$ 340	Specify with 8' curly cord.	
	<b>Power Plug Type</b>	<ul style="list-style-type: none"> <li>• Standard NEMA 5-15 3-prong</li> </ul>	No cost	Specify with standard NEMA 5-15 3-prong.
		<ul style="list-style-type: none"> <li>• Thread low profile plug</li> </ul>	+\$ 43	Specify with thread low profile plug.
	<b>PVC</b>	<ul style="list-style-type: none"> <li>• With PVC</li> </ul>	No cost	Specify with PVC.
<ul style="list-style-type: none"> <li>• Non PVC</li> </ul>		+\$ 36	Specify with non PVC.	



**For Canadian Pricing**  
Multiply U.S. Price by the  
Canadian price factor.  
► See page 1 for details.

**Specification Information**

• Style Number	• Depth	• U.S. Base Prices					• Option (Add \$ to Base Price) Cable Tray	
		Modular	46"W	52"W	58"W	64"W		70"W
		Parametric	46"W-	48 1/16"W	54 1/16"W	60 1/16"W	66 1/16"W	
			48"W	-54"W	-60"W	-66"W	-72"W	
<b>WESSUTSRQB</b>	23"		\$2110	\$2153	\$2247	\$2318	\$2389	+\$195
	29"		\$2380	\$2456	\$2479	\$2529	\$2548	+\$218

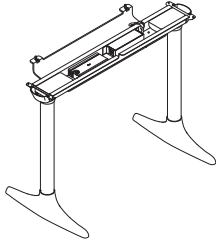

 **For Canadian Pricing**  
 Multiply U.S. Price by the Canadian price factor.  
 ▶ See page 1 for details.

# Sutton Extended Height-Adjustable Bases

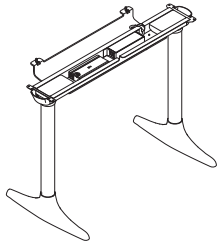

► Need help?  
Product details,  
page 76

## Standard Includes

- Extended height-adjustable base
- Electric height-adjustable sit-to-stand base: paint price group 1
- Foot: paint price group 1
- Leg ring: paint price group 1
- Simple touch controller
- Modular widths: 46", 52", 58", 64", or 70"
- Attachment hardware
- Power cord: 10' with standard plug

## Required to Specify

- 1 Style number
  - 2 Paint color number for base
  - 3 Paint color number for foot
  - 4 Paint color number for leg ring
  - 5 Options, if selected (see below)
- See *Surface Materials*, page 242.

	Options	U.S. Price	Required to Specify	
<b>Size</b>	<ul style="list-style-type: none"> <li>• Modular</li> <li>• Parametric</li> </ul>	No cost No cost	Specify modular. Specify parametric.	
<b>Surface Materials</b>	<b>Foot</b>			
	<ul style="list-style-type: none"> <li>• Paint price group 1</li> <li>• Paint price group 2</li> <li>• Paint price group 3</li> <li>• Polished aluminum</li> </ul>	No cost +\$ 24 +\$ 44 +\$ 44	Specify paint color number. Specify paint color number. Specify paint color number. Specify with polished aluminum.	
	<b>Base</b>			
	<ul style="list-style-type: none"> <li>• Paint price group 1</li> <li>• Paint price group 2</li> </ul>	No cost +\$ 24	Specify paint color number. Specify paint color number.	
	<b>Leg ring</b>			
	<ul style="list-style-type: none"> <li>• Paint price group 1</li> <li>• Paint price group 2</li> <li>• Paint price group 3</li> <li>• Polished chrome</li> </ul>	No cost +\$ 5 +\$ 16 +\$ 22	Specify paint color number. Specify paint color number. Specify paint color number. Specify with polished aluminum.	
	<b>Cable Tray</b>	<ul style="list-style-type: none"> <li>• No cable tray</li> <li>• With cable tray</li> </ul>	No cost Prices at right	Specify with no cable tray. Specify with cable tray.
	<b>Controller</b>	<ul style="list-style-type: none"> <li>• Simple touch controller</li> <li>• Active touch controller</li> </ul>	No cost +\$ 79	Specify with simple touch controller. Specify with active touch controller.
<b>Power Configuration</b>	<ul style="list-style-type: none"> <li>• No under worksurface power</li> </ul>	No cost	Specify with no under worksurface power.	
	<ul style="list-style-type: none"> <li>• Under worksurface clamp with USB A+C</li> </ul>			
	<ul style="list-style-type: none"> <li>– 46"W–57<sup>1</sup>/<sub>16</sub>"W</li> <li>– 58"W–72"W</li> </ul>	+\$ 853 +\$ 888	Specify with under worksurface clamp with USB A+C. Specify with under worksurface clamp with USB A+C.	
	<ul style="list-style-type: none"> <li>• Under worksurface clamp with USB-C</li> </ul>			
	<ul style="list-style-type: none"> <li>– 46"W–57<sup>1</sup>/<sub>16</sub>"W</li> <li>– 58"W–72"W</li> </ul>	+\$1195 +\$1229	Specify with under worksurface clamp with USB-C. Specify with under worksurface clamp with USB-C.	
	<ul style="list-style-type: none"> <li>• Under worksurface only</li> </ul>			
<ul style="list-style-type: none"> <li>– 46"W–57<sup>1</sup>/<sub>16</sub>"W</li> <li>– 58"W–72"W</li> </ul>	+\$ 507 +\$ 541	Specify with under worksurface power. Specify with under worksurface power.		
<b>Power Cord</b>	<ul style="list-style-type: none"> <li>• 10' standard cord</li> <li>• 9' standard cord</li> <li>• 10' braided cord</li> </ul>	No cost No cost +\$ 79	Specify with 10' standard cord. Specify with 9' standard cord. Specify with 10' braided cord and select finish.	
	<ul style="list-style-type: none"> <li>• 20' standard cord</li> <li>• 20' braided cord</li> </ul>	+\$ 79 +\$ 234	Specify with 20' standard cord. Specify with 20' braided cord and select finish.	
	<ul style="list-style-type: none"> <li>• 8' curly cord</li> </ul>	+\$ 340	Specify with 8' curly cord.	
	<b>Power Plug Type</b>	<ul style="list-style-type: none"> <li>• Standard NEMA 5-15 3-prong</li> </ul>	No cost	Specify with standard NEMA 5-15 3-prong.
		<ul style="list-style-type: none"> <li>• Thread low profile plug</li> </ul>	+\$ 43	Specify with thread low profile plug.
	<b>PVC</b>	<ul style="list-style-type: none"> <li>• With PVC</li> </ul>	No cost	Specify with PVC.
<ul style="list-style-type: none"> <li>• Non PVC</li> </ul>		+\$ 36	Specify with non PVC.	



**For Canadian Pricing**  
Multiply U.S. Price by the  
Canadian price factor.  
► See page 1 for details.

**Specification Information**

• Style Number	• Depth	• U.S. Base Prices					• Option (Add \$ to Base Price) Cable Tray	
		Modular	46"W	52"W	58"W	64"W		70"W
		Parametric	46"W-48"W	48 1/16"W-54"W	54 1/16"W-60"W	60 1/16"W-66"W	66 1/16"W-72"W	
<b>WESSUTERQB</b>	23"		\$2281	\$2355	\$2431	\$2533	\$2611	+\$195
	29"		\$2602	\$2684	\$2709	\$2763	\$2784	+\$218

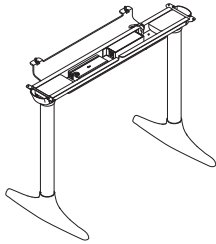

 **For Canadian Pricing**  
 Multiply U.S. Price by the Canadian price factor.  
 ▶ See page 1 for details.

**Cable Tray**

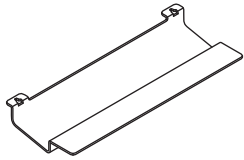

Standard Includes	Required to Specify
<ul style="list-style-type: none"> <li>▶ Need help? Product details, page 76</li> <li>• Cable tray: P631 Dark Heather Grey molded PET felt</li> <li>• Attachment hardware</li> <li>• 28"W cable tray, if 46"W–57<sup>15</sup>/<sub>16</sub>"W worksurface selected</li> <li>• 40"W cable tray, if 58"W–72"W worksurface selected</li> </ul>	<ul style="list-style-type: none"> <li>1 Style number</li> <li>2 Select worksurface depth</li> <li>3 Select worksurface width</li> </ul>

Specification Information			
• Style Number	• Worksurface Width	• U.S. Prices • Worksurface Depth	
WESSUTCT	46"–72"	\$195	\$218

**Magnetic Cable Clips**

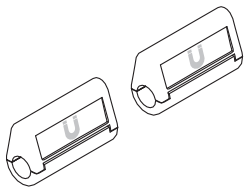

Standard Includes	Required to Specify
<ul style="list-style-type: none"> <li>▶ Need help? Product details, page 76</li> <li>• Magnetic clips: 6053 Seagull</li> </ul>	<ul style="list-style-type: none"> <li>Style number</li> </ul>

Specification Information	
• Style Number	• U.S. Price
<b>Quantity 2</b>	
FLXMCC2	\$106
<b>Quantity 10</b>	
FLXMCC10	\$418

**For Canadian Pricing**  
Multiply U.S. Price by the Canadian price factor.  
▶ See page 1 for details.

## Cable Brackets

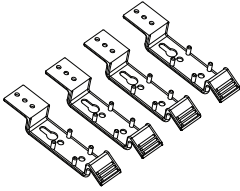

Standard Includes	Required to Specify
<ul style="list-style-type: none"> <li>Need help? Product details, page 76</li> <li>Cable brackets, quantity of four: 6527 Merle</li> </ul>	Style number

### Specification Information

Style Number	U.S. Price
FLXCBK4	\$51

Sutton

## Cable Riser

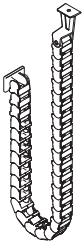

Standard Includes	Required to Specify
<ul style="list-style-type: none"> <li>Need help? Product details, page 76</li> <li>Cable riser with fence connection: 7360 Merle paint</li> <li>Attachment hardware</li> </ul>	1 Style number 2 Options, if selected (see below)

Options	U.S. Price	Required to Specify
<b>Connection Type</b> <ul style="list-style-type: none"> <li>Fence connection</li> <li>Leg connection</li> </ul>	No cost +\$165	Specify with fence connection. Specify with leg connection.

### Specification Information

Style Number	U.S. Base Price
OLCR	\$113



**For Canadian Pricing**  
 Multiply U.S. Price by the Canadian price factor.  
 ▶ See page 1 for details.



---

# West Elm—Licensed Specifying

## Seating

### Nimbus

Conference Chair 232

### Slope

Guest Chairs and Stools 233

Conference Chair 236

## Furniture

### Lily Pad

Occasional Tables 237

### Linear

Occasional Tables 238

### Maisie

Occasional Tables 239

### Mesa

Coffee Table 240

# Nimbus

Conference Chair



	Standard Includes	Required to Specify
▶ Need help? Product details, page 81	<ul style="list-style-type: none"> <li>• Chair: platinum</li> <li>• Depth 24.4"</li> <li>• Width 26"</li> <li>• Height 31.5"</li> <li>• Weight 40 lbs</li> <li>• Warranty 5 years</li> <li>• Certification BIFMA compliant</li> </ul>	Style number

Specification Information	
Style Number	U.S. Price
WEM70	\$1187



**For Canadian Pricing**  
 Multiply U.S. Price by the Canadian price factor.  
 ▶ See page 1 for details.

# Slope

## Guest Chairs and Stools

### Slope Lounge Chair



Standard Includes	Required to Specify
<ul style="list-style-type: none"> <li>▶ Need help? Product details, page 85</li> <li>• Chair: saddle</li> <li>• Depth 24.4"</li> <li>• Width 26"</li> <li>• Height 31.5"</li> <li>• Weight 40 lbs</li> <li>• 5 years warranty</li> <li>• Certification: BIFMA compliant</li> </ul>	Style number

Specification Information	
• Style Number	• U.S. Price
WEM2	\$1293

### Slope Bar Stool



Standard Includes	Required to Specify
<ul style="list-style-type: none"> <li>▶ Need help? Product details, page 84</li> <li>• Stool: saddle</li> <li>• Depth 21.5"</li> <li>• Width 19.25"</li> <li>• Height 40"</li> <li>• Weight 29 lbs</li> <li>• 5 years warranty</li> <li>• Certification: BIFMA compliant</li> </ul>	Style number

Specification Information	
• Style Number	• U.S. Price
WEM66	\$1113

West Elm—Licensed

**For Canadian Pricing**  
 Multiply U.S. Price by the Canadian price factor.  
 ▶ See page 1 for details.

### Slope Counter Stool



Standard Includes		Required to Specify
<ul style="list-style-type: none"> <li>▶ Need help? Product details, page 84</li> </ul>	<ul style="list-style-type: none"> <li>• Stool: saddle</li> <li>• Depth 21.5"</li> <li>• Width 19"</li> <li>• Height 35.75"</li> <li>• Weight 28 lbs</li> <li>• 5 years warranty</li> <li>• Certification: BIFMA compliant</li> </ul>	Style number
Specification Information		
• Style Number	• U.S. Price	
WEM50	\$1113	

### Slope Guest Chair



Standard Includes		Required to Specify
<ul style="list-style-type: none"> <li>▶ Need help? Product details, page 82</li> </ul>	<ul style="list-style-type: none"> <li>• Chair: fog or saddle</li> <li>• Depth 21.5"</li> <li>• Width 19.25"</li> <li>• Height 33.25"</li> <li>• Weight 27 lbs</li> <li>• 5 years warranty</li> <li>• Certification: BIFMA compliant</li> </ul>	1 Style number 2 Color number for chair
Specification Information		
• Style Number	• U.S. Price	
WEM1	\$1022	



**For Canadian Pricing**  
 Multiply U.S. Price by the Canadian price factor.  
 ▶ See page 1 for details.

## Slope Height Adjustable Bar Stool



	Standard Includes	Required to Specify
▶ Need help? Product details, page 84	<ul style="list-style-type: none"> <li>• Stool: saddle</li> <li>• Depth 21.5"</li> <li>• Width 19"</li> <li>• Height 34.25"–40.25"</li> <li>• Weight 41 lbs</li> <li>• 5 years warranty</li> <li>• Certification: BIFMA compliant</li> </ul>	Style number

Specification Information	
• Style Number	• U.S. Price
<b>WEM67</b>	\$1369



**For Canadian Pricing**  
Multiply U.S. Price by the  
Canadian price factor.  
▶ See page 1 for details.

# Slope

## Conference Chair



	Standard Includes	Required to Specify
▶ Need help? Product details, page 83	<ul style="list-style-type: none"> <li>• Chair: saddle</li> <li>• Depth 21.5"</li> <li>• Width 19.25"</li> <li>• Height 32"–36"</li> <li>• Weight 38 lbs</li> <li>• Warranty 5 years</li> <li>• Certification BIFMA compliant</li> </ul>	Style number

Specification Information	
Style Number	U.S. Price
WEM3	\$1293



**For Canadian Pricing**  
 Multiply U.S. Price by the  
 Canadian price factor.  
 ▶ See page 1 for details.

# Lily Pad

Occasional Tables

## 16" Lily Pad Nesting Table



Standard Includes		Required to Specify
<ul style="list-style-type: none"> <li>▶ Need help? Product details, page 86</li> </ul>	<ul style="list-style-type: none"> <li>• Depth 25"</li> <li>• Width 30"</li> <li>• Height 16"</li> <li>• Weight 16 lbs</li> <li>• 5 years warranty</li> <li>• Certification: BIFMA compliant</li> </ul>	<ul style="list-style-type: none"> <li>1 Style number</li> <li>2 Color number for table</li> <li>3 Options, if selected (see below)</li> </ul>

Options	U.S. Price	Required to Specify
<b>Color</b> <ul style="list-style-type: none"> <li>• Walnut</li> <li>• White marble</li> </ul>	<ul style="list-style-type: none"> <li>No cost</li> <li>+\$530</li> </ul>	<ul style="list-style-type: none"> <li>Select walnut.</li> <li>Select white marble.</li> </ul>

Specification Information	
Style Number	U.S. Base Price
WEM7	\$1132

## 18" Lily Pad Nesting Table



Standard Includes		Required to Specify
<ul style="list-style-type: none"> <li>▶ Need help? Product details, page 86</li> </ul>	<ul style="list-style-type: none"> <li>• Depth 25"</li> <li>• Width 30"</li> <li>• Height 18"</li> <li>• Weight 18 lbs</li> <li>• 5 years warranty</li> <li>• Certification: BIFMA compliant</li> </ul>	<ul style="list-style-type: none"> <li>1 Style number</li> <li>2 Color number for table</li> <li>3 Options, if selected (see below)</li> </ul>

Options	U.S. Price	Required to Specify
<b>Color</b> <ul style="list-style-type: none"> <li>• Walnut</li> <li>• White marble</li> </ul>	<ul style="list-style-type: none"> <li>No cost</li> <li>+\$529</li> </ul>	<ul style="list-style-type: none"> <li>Select walnut.</li> <li>Select white marble.</li> </ul>

Specification Information	
Style Number	U.S. Base Price
WEM59	\$1176

West Elm—Licensed

 **For Canadian Pricing**  
 Multiply U.S. Price by the Canadian price factor.  
 ▶ See page 1 for details.

Lily Pad, Occasional Tables, continued

**20" Lily Pad Nesting Table**



Standard Includes		Required to Specify
<ul style="list-style-type: none"> <li>▶ Need help? Product details, page 86</li> </ul>	<ul style="list-style-type: none"> <li>• Depth 25"</li> <li>• Width 30"</li> <li>• Height 20"</li> <li>• Weight 20 lbs</li> <li>• 5 years warranty</li> <li>• Certification: BIFMA compliant</li> </ul>	<ul style="list-style-type: none"> <li>1 Style number</li> <li>2 Color number for table</li> <li>3 Options, if selected (see below)</li> </ul>

Options	U.S. Price	Required to Specify
<b>Color</b> <ul style="list-style-type: none"> <li>• Walnut</li> <li>• White marble</li> </ul>	<ul style="list-style-type: none"> <li>No cost</li> <li>+\$530</li> </ul>	<ul style="list-style-type: none"> <li>Select walnut.</li> <li>Select white marble.</li> </ul>

Specification Information	
Style Number	U.S. Base Price
WEM60	\$1219

**Linear C Table**



Standard Includes		Required to Specify
<ul style="list-style-type: none"> <li>▶ Need help? Product details, page 87</li> </ul>	<ul style="list-style-type: none"> <li>• Table: natural oak</li> <li>• Depth 13.5"</li> <li>• Width 24"</li> <li>• Height 26.5"</li> <li>• Weight 38 lbs</li> <li>• 5 years warranty</li> <li>• Certification: BIFMA compliant</li> </ul>	<ul style="list-style-type: none"> <li>Style number</li> </ul>

Specification Information	
Style Number	U.S. Price
WEM8	\$728



**For Canadian Pricing**  
 Multiply U.S. Price by the Canadian price factor.  
 ▶ See page 1 for details.

# Maisie

Occasional Tables

## 22" Maisie Side Table



Standard Includes		Required to Specify
<ul style="list-style-type: none"> <li>▶ Need help? Product details, page 88</li> </ul>	<ul style="list-style-type: none"> <li>• Table: walnut</li> <li>• Diameter 18"</li> <li>• Height 22"</li> <li>• Weight 35 lbs</li> <li>• 5 years warranty</li> <li>• Certification: BIFMA compliant ISCS Indoor Advantage</li> </ul>	<ul style="list-style-type: none"> <li>1 Style number</li> <li>2 Color number for table</li> <li>3 Options, if selected (see below)</li> </ul>

Options	U.S. Price	Required to Specify
<b>Color</b> <ul style="list-style-type: none"> <li>• Walnut</li> <li>• Marble</li> </ul>	No cost +\$241	Specify walnut. Specify marble.

Specification Information	
Style Number	U.S. Base Price
WEM11	\$920

## 25" Maisie Side Table



Standard Includes		Required to Specify
<ul style="list-style-type: none"> <li>▶ Need help? Product details, page 88</li> </ul>	<ul style="list-style-type: none"> <li>• Table: walnut</li> <li>• Diameter 18"</li> <li>• Height 25"</li> <li>• Weight 35 lbs</li> <li>• 5 years warranty</li> <li>• Certification: BIFMA compliant</li> </ul>	<ul style="list-style-type: none"> <li>1 Style number</li> <li>2 Color number for table</li> <li>3 Options, if selected (see below)</li> </ul>

Options	U.S. Price	Required to Specify
<b>Color</b> <ul style="list-style-type: none"> <li>• Walnut</li> <li>• Marble</li> </ul>	No cost +\$248	Specify walnut. Specify marble.

Specification Information	
Style Number	U.S. Base Price
WEM4	\$956

West Elm—Licensed

 **For Canadian Pricing**  
 Multiply U.S. Price by the Canadian price factor.  
 ▶ See page 1 for details.

# Mesa

Coffee Table



Standard Includes		Required to Specify
<ul style="list-style-type: none"> <li>▶ Need help? Product details, page 89</li> </ul>	<ul style="list-style-type: none"> <li>• Table: black</li> <li>• Depth 32"</li> <li>• Width 32"</li> <li>• Height 12"</li> <li>• Weight 20 lbs</li> <li>• Limited lifetime warranty</li> <li>• Certification: BIFMA compliant</li> </ul>	<ul style="list-style-type: none"> <li>• Style number</li> </ul>

Specification Information	
• Style Number	• U.S. Price
<b>WEM68</b>	\$1757



**For Canadian Pricing**  
 Multiply U.S. Price by the Canadian price factor.  
 ▶ See page 1 for details.

---

# Resources and Surface Materials

<b>Surface Materials</b>	<b>242</b>
<b>Color Availability Matrix</b>	
Plastic, Metal, and Paint Availability Matrix	<b>244</b>
Laminate Availability Matrix	<b>248</b>
Wood Availability Matrix	<b>252</b>
<b>Upholstery Matrix</b>	<b>256</b>
<b>Lock and Keying Options</b>	<b>258</b>
<b>Style Number Index</b>	<b>260</b>

# Surface Materials

## Wood

*Tip: Known for its uniqueness, planked veneer has intentional and natural variations that include, but are not limited to: character marks, grain pattern, color, and natural color aging.*

### Select Surfaces

For information on products within Select Surfaces, including accent paints and fabrics from Designtex, Gabriel, Kvadrat, and Pollack, please refer to the *Surface Materials Reference Manual* or visit [steelcase.com/surface-materials](http://steelcase.com/surface-materials) under the Select Surfaces section.

### Composite Veneer

Composite veneers are an engineered wood intended to create specific grain patterns and characteristics. They are pre-stained and finished with Steelcase's Clarity water-borne UV topcoat, which protects the environment while providing durability and clarity. Only open-pore finishes are available on composite wood. Composite veneers with natural solid nosings because composite and natural wood grain and color matching are rarely compatible. Composite veneers are Select Surfaces and available as Wood Group 1 pricing.

## Upholstery

### Select Surfaces Program: Upholstery

Applies to:

- Belle
- Boardwalk
- Brighton
- Mesa
- Willow
- Slope
- Sterling

### A collection of textiles

are available as part of a Select Surfaces Program. The collection from the leading suppliers in the market consists of high-performance textiles.

To order these fabrics, enter the finish code which corresponds with the fabric price group.

Price Group	Finish Code
1	59DA
2	59DB
3	59DC
4	59DD
5	59DE
6	59DF
7	59DG
8	59DH
9	59DJ
10	59DK

Then enter the fabric information in the Special Fabric Information pop up window.

### Custom Surfaces

#### Price Group COM (Customer's Own Material)

**Fabric Approval and Yardage** To confirm whether a particular COM material has already been tested for use on a specific Steelcase product or to determine actual yardage requirements:

- Visit [www.steelcase.com](http://www.steelcase.com)

Visit <https://srh.steelcase.com/comcalculator.aspx> for Steelcase Textile calculator.

### For additional information regarding Customer's Own Material, call

1.888.STEELCASE (1.888.783.3522) or send an e-mail to [lineone@steelcase.com](mailto:lineone@steelcase.com).

## Laminate

*Tip: When selecting a Steelcase top surface finish, a corresponding Steelcase edge finish must be selected. When selecting West Elm top surface finish, a corresponding West Elm edge finish must be selected.*



# Color Availability Matrix

## Plastic, Metal, and Paint Availability Matrix

### Legend

- = Not available
- = Available
- = Available with exceptions
- Ⓢ = Excluded
- ▶ See specification pages for details.

		Plastic Price Group 1		Paint Price Group 1 (Accessory)		Paint Price Group 1 (Smooth)		Paint Price Group 1 (Textured)														
		6000 Black	6052 Milk	4140 Arctic White Gloss	4144 Black Gloss	4238 Mocha	4239 Clay	4240 Chalk	4242 Milk	4710 Low Gloss Black	WE00 Hot Rolled Steel	WE01 Antique Bronze	7207 Black	7225 Sand	7237 Slate	7238 Fieldstone	7239 Midnight Ⓢ	7241 Arctic White	7243 Seagull	7250 Sterling Dark Solid		
<b>Boardwalk</b>	Platform	•	•	•	•	•	•	•	•	•	•	•	•	•	•	•	•	•	•	•	•	
	Legs	•	•	•	•	•	•	•	•	•	•	•	•	•	•	•	•	•	•	•	•	
<b>Brighton</b>	Table top	•	•	•	•	•	•	•	•	•	•	•	•	•	•	•	•	•	•	•	•	
	Frame	•	•	■	■	■	■	■	■	■	■	■	■	■	■	■	■	■	■	■	■	
	Foot and frame caps	•	•	■	■	■	■	■	■	■	■	■	■	■	■	■	■	■	■	■	■	
	Hardwood arms	•	•	•	•	•	•	•	•	•	•	•	•	•	•	•	•	•	•	•	•	
	Power	■	■	•	•	•	•	•	•	•	•	•	•	•	•	•	•	•	•	•	•	
<b>Mesa</b>	Feet	•	•	•	•	•	•	•	•	•	•	■	•	•	•	•	•	•	•	•	•	
<b>Willow</b>	Fixed base	•	•	•	•	•	•	•	•	•	•	•	•	•	•	•	•	•	•	•	•	
	Swivel base	•	•	•	•	•	•	•	•	•	•	•	•	•	•	•	•	•	•	•	•	
<b>Slope*</b>	Wire frame base	•	•	■	■	■	■	■	■	■	■	■	■	■	■	■	■	■	■	■	■	
	Five-star base	•	•	•	•	•	•	•	•	•	■	•	•	•	•	•	•	•	•	•	•	
<b>Sterling</b>	Five-star base	•	•	•	•	•	•	•	•	■	■	•	•	•	•	•	•	•	•	•	•	
	Four-star base	•	•	•	•	•	•	•	•	•	•	•	•	•	•	•	•	•	•	•	•	
	Hardwood legs	•	•	•	•	•	•	•	•	•	•	•	•	•	•	•	•	•	•	•	•	
<b>Kent</b>	Five-star base	•	•	■	■	■	■	■	■	■	■	■	■	■	■	■	■	■	■	■	■	
	Four-star base	•	•	■	■	■	■	■	■	■	■	■	■	■	■	■	■	■	■	■	■	
	Four-leg base	•	•	■	■	■	■	■	■	■	■	■	■	■	■	■	■	■	■	■	■	
	Stool	•	•	■	■	■	■	■	■	■	■	■	■	■	■	■	■	■	■	■	■	
<b>Greenpoint</b>	Desk and bench frames	•	•	■	■	■	■	■	■	■	■	■	■	■	■	■	■	■	■	■	■	
	Desk and bench worksurfaces	•	•	•	•	•	•	•	•	•	•	•	•	•	•	•	•	•	•	•	•	
	Storage frames and metal bodies	•	•	■	■	■	■	■	■	■	■	■	■	■	■	■	■	■	■	■	■	
	Wood storage—bodies, faces, and shelves	•	•	•	•	•	•	•	•	•	•	•	•	•	•	•	•	•	•	•	•	
	Metal storage—faces and shelves	•	•	•	•	•	•	•	•	•	•	•	•	•	•	•	•	•	•	•	•	
	Power	•	•	•	■	■	■	■	■	■	■	■	■	■	■	■	■	■	■	■	■	■
	Brackets	•	•	■	■	■	■	■	■	■	■	■	■	■	■	■	■	■	■	■	■	■
<b>Sutton HAD</b>	Top	•	•	•	•	•	•	•	•	•	•	•	•	•	•	•	•	•	•	•	•	
	Foot	•	•	•	•	•	•	•	•	•	•	•	•	•	•	•	•	•	•	•	•	
	Base	•	•	•	•	•	•	•	•	•	•	•	•	■	•	•	•	•	■	•	•	
	Leg Ring	•	•	■	■	■	■	■	■	■	■	■	■	■	■	■	■	■	■	■	■	

\* Paint options available on Steelcase Slope shown. Licensed Slope (stocked) frame will be defaulted to WE00 Hot Rolled Steel.  
 Exception: Aegean leather Slope (stocked) frame is defaulted to Antique Brass.



**Plastic, Metal, and Paint Availability Matrix, continued**

**Legend**

- = Not available
- = Available
- = Available with exceptions
- ▶ See specification pages for details.

		Paint Price Group 3 (Accent)								Paint Price Group 3 (Smooth)	Paint Price Group 3 (Coatings)	Paint Price Group 3 (Lux Coatings)																															
		1ATG	Rose Quartz	4AV3	Blue Jay	4AV4	Baltic	4AX1	Citron	4AY2	Chili	4AZ5	Marlin	4CZ5	Honey	4CZ6	Lagoon	4CZ8	Light Peacock	WE03	Antique Brass	1ATT	Cast Shadow	4B20	Obsidian	4B22	Matte Brass	4B23	Burnished Bronze	4B24	Night Bronze	4B25	Matte Copper	4B26	Smoked Mica	4B29	Cast Iron						
<b>Boardwalk</b>	Platform	•	•	•	•	•	•	•	•	•	•	•	•	•	•	•	•	•	•	•	•	•	•	•	•	•	•	•	•	•	•	•	•	•	•	•	•	•					
	Legs	•	•	•	•	•	•	•	•	•	•	•	•	•	•	•	•	•	•	•	•	•	•	•	•	•	•	•	•	•	•	•	•	•	•	•	•	•	•				
<b>Brighton</b>	Table top	•	•	•	•	•	•	•	•	•	•	•	•	•	•	•	•	•	•	•	•	•	•	•	•	•	•	•	•	•	•	•	•	•	•	•	•	•	•				
	Frame	■	■	■	■	■	■	■	■	■	■	■	■	■	■	■	■	■	■	■	■	■	■	■	■	■	■	■	■	■	■	■	■	■	■	■	■	■	■	■			
	Foot and frame caps	■	■	■	■	■	■	■	■	■	■	■	■	■	■	■	■	■	■	■	■	■	■	■	■	■	■	■	■	■	■	■	■	■	■	■	■	■	■	■			
	Hardwood arms	•	•	•	•	•	•	•	•	•	•	•	•	•	•	•	•	•	•	•	•	•	•	•	•	•	•	•	•	•	•	•	•	•	•	•	•	•	•	•			
	Power	•	•	•	•	•	•	•	•	•	•	•	•	•	•	•	•	•	•	•	•	•	•	•	•	•	•	•	•	•	•	•	•	•	•	•	•	•	•	•			
	<b>Mesa</b>	Feet	•	•	•	•	•	•	•	•	•	•	•	•	•	•	•	•	•	•	•	•	•	•	•	•	•	•	•	•	•	•	•	•	•	•	•	•	•	•	•		
<b>Willow</b>	Fixed base	•	•	•	•	•	•	•	•	•	•	•	•	•	•	•	•	•	•	•	•	•	•	•	•	•	•	•	•	•	•	•	•	•	•	•	•	•	•	•			
	Swivel base	•	•	•	•	•	•	•	•	•	•	•	•	•	•	•	•	•	•	•	•	•	•	•	•	•	•	•	•	•	•	•	•	•	•	•	•	•	•	•			
<b>Slope*</b>	Wire frame base	■	■	■	■	■	■	■	■	■	■	■	■	■	■	■	■	■	■	•	■	■	■	■	■	■	■	■	■	■	■	■	■	■	■	■	■	■	■	■	■		
	Five-star base	•	•	•	•	•	•	•	•	•	•	•	•	•	•	•	•	•	•	•	•	•	•	•	•	•	•	•	•	•	•	•	•	•	•	•	•	•	•	•	•		
<b>Sterling</b>	Five-star base	•	•	•	•	•	•	•	•	•	•	•	•	•	•	•	•	•	•	•	•	•	•	•	•	■	•	■	•	■	•	■	•	■	•	■	•	■	•	■	•		
	Four-star base	•	•	•	•	•	•	•	•	•	•	•	•	•	•	•	•	•	•	•	•	•	•	•	•	•	•	•	•	•	•	•	•	•	•	•	•	•	•	•	•		
	Hardwood legs	•	•	•	•	•	•	•	•	•	•	•	•	•	•	•	•	•	•	•	•	•	•	•	•	•	•	•	•	•	•	•	•	•	•	•	•	•	•	•	•		
<b>Kent</b>	Five-star base	■	■	■	■	■	■	■	■	■	■	■	■	■	■	■	■	■	■	•	■	■	■	■	■	■	■	■	■	■	■	■	■	■	■	■	■	■	■	■	■	■	
	Four-star base	■	■	■	■	■	■	■	■	■	■	■	■	■	■	■	■	■	■	•	■	■	■	■	■	■	■	■	■	■	■	■	■	■	■	■	■	■	■	■	■	■	
	Four-leg base	■	■	■	■	■	■	■	■	■	■	■	■	■	■	■	■	■	■	•	■	■	■	■	■	■	■	■	■	■	■	■	■	■	■	■	■	■	■	■	■	■	
	Stool	■	■	■	■	■	■	■	■	■	■	■	■	■	■	■	■	■	■	•	■	■	■	■	■	■	■	■	■	■	■	■	■	■	■	■	■	■	■	■	■	■	
<b>Greenpoint</b>	Desk and bench frames	■	■	■	■	■	■	■	■	■	■	■	■	■	■	■	■	■	■	■	■	■	■	■	■	■	■	■	■	■	■	■	■	■	■	■	■	■	■	■	■	■	
	Desk and bench worksurfaces	•	•	•	•	•	•	•	•	•	•	•	•	•	•	•	•	•	•	•	•	•	•	•	•	•	•	•	•	•	•	•	•	•	•	•	•	•	•	•	•	•	
	Storage frames and metal bodies	■	■	■	■	■	■	■	■	■	■	■	■	■	■	■	■	■	■	■	■	■	■	■	■	■	■	■	■	■	■	■	■	■	■	■	■	■	■	■	■	■	■
	Wood storage—bodies, faces, and shelves	•	•	•	•	•	•	•	•	•	•	•	•	•	•	•	•	•	•	•	•	•	•	•	•	•	•	•	•	•	•	•	•	•	•	•	•	•	•	•	•	•	
	Metal storage—faces and shelves	•	•	•	•	•	•	•	•	•	•	•	•	•	•	•	•	•	•	•	•	•	•	•	•	•	•	•	•	•	•	•	•	•	•	•	•	•	•	•	•	•	
	Power	•	•	•	•	•	•	•	•	•	•	•	•	•	•	•	•	•	•	•	•	•	•	•	•	•	•	•	•	•	•	•	•	•	•	•	•	•	•	•	•	•	
<b>Brackets</b>		■	■	■	■	■	■	■	■	■	■	■	■	■	■	■	■	■	■	•	■	■	■	■	■	■	■	■	■	■	■	■	■	■	■	■	■	■	■	■	■	■	■
<b>Sutton HAD</b>	Top	•	•	•	•	•	•	•	•	•	•	•	•	•	•	•	•	•	•	•	•	•	•	•	•	•	•	•	•	•	•	•	•	•	•	•	•	•	•	•	•	•	
	Foot	■	■	■	■	■	■	■	■	■	■	■	■	■	■	■	■	■	■	■	■	■	■	■	■	■	■	■	■	■	■	■	■	■	■	■	■	■	■	■	■	■	■
	Base	□	□	□	□	□	□	□	□	□	□	□	□	□	□	□	□	□	□	□	□	□	□	□	■	■	■	■	■	■	■	■	■	■	■	■	■	■	■	■	■	■	■
	Leg Ring	■	■	■	■	■	■	■	■	■	■	■	■	■	■	■	■	■	■	■	•	■	■	■	■	■	■	■	■	■	■	■	■	■	■	■	■	■	■	■	■	■	■

\* Paint options available on Steelcase Slope shown. Licensed Slope (stocked) frame will be defaulted to WE00 Hot Rolled Steel. Exception: Aegean leather Slope (stocked) frame is defaulted to Antique Brass.



**Laminate Availability Matrix**

**Legend**

- = Not available
- = Available
- = Available with exceptions
- Ⓢ = Excluded
- ▶ See specification pages for details.

		HPL Price Group 1 (Woodgrain)	2406	2409	2410	2412	2422	2503	2511	2535	2536	2538	2539	2592	2614	2615	2714	2759	2772	2822	2851	2923	2HAK	2HAN	
			Clear Cherry Ⓢ	Clear Maple	Graphite Walnut	Natural Cherry	Medium Cherry Ⓢ	Brushed Silver	Winter on Maple Ⓢ	Virginia Walnut	Blackwood	Clear Walnut	Warm Oak	Blonde on Maple Ⓢ	Chocolate Walnut	Marbled Cherry V2	Natural Walnut Ⓢ	Warm White	Medium Mahogany on Walnut	Woodrose Speckle	Rhyme Fiber	Shadow Micro	Clear Oak	Ash Noce	
<b>Boardwalk</b>	Platform	■	■	■	■	■	■	■	■	■	■	■	■	■	■	■	■	■	■	■	■	■	■	■	
	Legs	•	•	•	•	•	•	•	•	•	•	•	•	•	•	•	•	•	•	•	•	•	•	•	
<b>Brighton</b>	Table top	■	■	■	■	■	•	■	■	■	■	■	■	■	■	■	■	•	■	•	•	•	■	■	
	Frame	•	•	•	•	•	•	•	•	•	•	•	•	•	•	•	•	•	•	•	•	•	•	•	
	Foot and frame caps	•	•	•	•	•	•	•	•	•	•	•	•	•	•	•	•	•	•	•	•	•	•	•	
	Hardwood arms	•	•	•	•	•	•	•	•	•	•	•	•	•	•	•	•	•	•	•	•	•	•	•	
	Power	•	•	•	•	•	•	•	•	•	•	•	•	•	•	•	•	•	•	•	•	•	•	•	
<b>Mesa</b>	Feet	•	•	•	•	•	•	•	•	•	•	•	•	•	•	•	•	•	•	•	•	•	•	•	
<b>Willow</b>	Fixed base	•	•	•	•	•	•	•	•	•	•	•	•	•	•	•	•	•	•	•	•	•	•	•	
	Swivel base	•	•	•	•	•	•	•	•	•	•	•	•	•	•	•	•	•	•	•	•	•	•	•	
<b>Slope</b>	Wire frame base	•	•	•	•	•	•	•	•	•	•	•	•	•	•	•	•	•	•	•	•	•	•	•	
	Five-star base	•	•	•	•	•	•	•	•	•	•	•	•	•	•	•	•	•	•	•	•	•	•	•	
<b>Sterling</b>	Five-star base	•	•	•	•	•	•	•	•	•	•	•	•	•	•	•	•	•	•	•	•	•	•	•	
	Four-star base	•	•	•	•	•	•	•	•	•	•	•	•	•	•	•	•	•	•	•	•	•	•	•	
	Hardwood legs	•	•	•	•	•	•	•	•	•	•	•	•	•	•	•	•	•	•	•	•	•	•	•	
<b>Kent</b>	Five-star base	•	•	•	•	•	•	•	•	•	•	•	•	•	•	•	•	•	•	•	•	•	•	•	
	Four-star base	•	•	•	•	•	•	•	•	•	•	•	•	•	•	•	•	•	•	•	•	•	•	•	
	Four-leg base	•	•	•	•	•	•	•	•	•	•	•	•	•	•	•	•	•	•	•	•	•	•	•	
	Stool	•	•	•	•	•	•	•	•	•	•	•	•	•	•	•	•	•	•	•	•	•	•	•	
<b>Greenpoint</b>	Desk and bench frames	•	•	•	•	•	•	•	•	•	•	•	•	•	•	•	•	•	•	•	•	•	•	•	
	Desk and bench worksurfaces	■	■	■	■	■	•	■	■	■	■	■	■	■	■	■	■	•	■	•	•	•	■	■	
	Storage frames and metal bodies	•	•	•	•	•	•	•	•	•	•	•	•	•	•	•	•	•	•	•	•	•	•	•	
	Wood storage—bodies, faces, and shelves	□	□	□	□	□	•	□	□	□	□	□	□	□	□	□	□	•	□	•	•	•	□	■	
	Metal storage—faces and shelves	•	•	•	•	•	•	•	•	•	•	•	•	•	•	•	•	•	•	•	•	•	•	■	
Power	•	•	•	•	•	•	•	•	•	•	•	•	•	•	•	•	•	•	•	•	•	•	•	•	
<b>Sutton HAD</b>	Top	■	■	■	■	■	■	•	•	•	•	■	•	■	■	•	•	■	■	■	■	■	•	•	
	Foot	■	■	■	■	■	■	■	■	■	■	■	■	■	■	■	■	■	■	■	■	■	■	■	■
	Base	■	■	■	■	■	■	■	■	■	■	■	■	■	■	■	■	■	■	■	■	■	■	■	■
	Leg Ring	■	■	■	■	■	■	■	■	■	■	■	■	■	■	■	■	■	■	■	■	■	■	■	■



**Laminate Availability Matrix, continued**

**Legend**

- = Not available
- = Available
- = Available with exceptions
- ⓔ = Excluded
- ▶ See specification pages for details.

		HPL Price Group 1 (Patina)			HPL Price Group 1 (Solid)							HPL Price Group 1 (Speckle)				HPL Price Group 2 (Textured)							
		2870	2871	2873	2722	2730	2746	2759	2811	2883	2884	2885	2HMG	2820	2823	2824	2825	2TH2	2TH4	2TH5	2TH7	2UH1	
		Blonde Bronze Patina	Blackened Bronze Patina	Instant Iron Patina	Cream ⓔ	Arctic White	Black	Warm White	Mist ⓔ	Seagull	Milk	Dune	Merle	Coffee Speckle ⓔ	Driftwood Speckle	Smoke Speckle	Vanadium Speckle	Fawn Cypress	Saddle Oak	Veranda Teak	Walnut Heights	Reclaimed Aggregate	
<b>Boardwalk</b>	Platform	■	■	■	■	■	■	■	■	■	■	■	■	■	■	■	■	■	■	■	■	■	■
	Legs	•	•	•	•	•	•	•	•	•	•	•	•	•	•	•	•	•	•	•	•	•	•
<b>Brighton</b>	Table top	■	■	■	■	■	■	■	■	■	■	■	■	■	■	■	■	■	■	■	■	■	■
	Frame	•	•	•	•	•	•	•	•	•	•	•	•	•	•	•	•	•	•	•	•	•	•
	Foot and frame caps	•	•	•	•	•	•	•	•	•	•	•	•	•	•	•	•	•	•	•	•	•	•
	Hardwood arms	•	•	•	•	•	•	•	•	•	•	•	•	•	•	•	•	•	•	•	•	•	•
	Power	•	•	•	•	•	•	•	•	•	•	•	•	•	•	•	•	•	•	•	•	•	•
<b>Mesa</b>	Feet	•	•	•	•	•	•	•	•	•	•	•	•	•	•	•	•	•	•	•	•	•	•
<b>Willow</b>	Fixed base	•	•	•	•	•	•	•	•	•	•	•	•	•	•	•	•	•	•	•	•	•	•
	Swivel base	•	•	•	•	•	•	•	•	•	•	•	•	•	•	•	•	•	•	•	•	•	•
<b>Slope</b>	Wire frame base	•	•	•	•	•	•	•	•	•	•	•	•	•	•	•	•	•	•	•	•	•	•
	Five-star base	•	•	•	•	•	•	•	•	•	•	•	•	•	•	•	•	•	•	•	•	•	•
<b>Sterling</b>	Five-star base	•	•	•	•	•	•	•	•	•	•	•	•	•	•	•	•	•	•	•	•	•	•
	Four-star base	•	•	•	•	•	•	•	•	•	•	•	•	•	•	•	•	•	•	•	•	•	•
	Hardwood legs	•	•	•	•	•	•	•	•	•	•	•	•	•	•	•	•	•	•	•	•	•	•
<b>Kent</b>	Five-star base	•	•	•	•	•	•	•	•	•	•	•	•	•	•	•	•	•	•	•	•	•	•
	Four-star base	•	•	•	•	•	•	•	•	•	•	•	•	•	•	•	•	•	•	•	•	•	•
	Four-leg base	•	•	•	•	•	•	•	•	•	•	•	•	•	•	•	•	•	•	•	•	•	•
	Stool	•	•	•	•	•	•	•	•	•	•	•	•	•	•	•	•	•	•	•	•	•	•
<b>Greenpoint</b>	Desk and bench frames	•	•	•	•	•	•	•	•	•	•	•	•	•	•	•	•	•	•	•	•	•	•
	Desk and bench worksurfaces	■	■	■	■	■	■	■	■	■	■	■	■	■	■	■	■	■	■	■	■	■	■
	Storage frames and metal bodies	•	•	•	•	•	•	•	•	•	•	•	•	•	•	•	•	•	•	•	•	•	•
	Wood storage—bodies, faces, and shelves	□	□	□	□	□	□	□	□	□	■	□	■	□	□	□	□	□	□	□	□	□	□
	Metal storage—faces and shelves	•	•	•	•	•	•	•	•	•	■	•	■	•	•	•	•	•	•	•	•	•	•
	Power	•	•	•	•	•	•	•	•	•	•	•	•	•	•	•	•	•	•	•	•	•	•
<b>Sutton HAD</b>	Top	■	•	■	•	•	•	•	•	•	•	•	•	•	•	•	•	•	•	•	•	•	•
	Foot	■	■	■	■	■	■	■	■	■	■	■	■	■	■	■	■	■	■	■	■	■	■
	Base	■	■	■	■	■	■	■	■	■	■	■	■	■	■	■	■	■	■	■	■	■	■
	Leg Ring	■	■	■	■	■	■	■	■	■	■	■	■	■	■	■	■	■	■	■	■	■	■



**Wood Availability Matrix**

**Legend**

- = Not available
- = Available
- = Available with exceptions
- ⓔ = Excluded
- ▶ See specification pages for details.

		Wood	Price Group 1 (Flat Cut)																				
			Cherry			Maple			Walnut														
			3402	3412	3422	V1AC	V1CC	3522	3592	35A2	V1AM	3062	3082	3342	3702	3712	3752	3762	3772	37A2	V1EW		
			FC/OP Clear Cherry (Aged)	FC/OP Natural Cherry ⓔ	FC/OP Medium Cherry	FC/OP Natural Cherry	FC/OP Medium Amber Cherry	FC/OP Clear Maple	FC/OP Blonde on Maple ⓔ	FC/OP Blanch Maple	FC/OP Clear Maple	FC/OP Graphite Walnut	FC/OP Washed Walnut	FC/OP Black Walnut	FC/OP Clear Walnut	FC/OP Natural Walnut	FC/OP Medium Walnut ⓔ	FC/OP Dark Walnut	FC/OP Medium Mahogany on Walnut	FC/OP Thunder Walnut	FC/OP Dark Walnut		
<b>Boardwalk</b>	Platform		•	•	•	•	•	•	•	•	•	•	•	•	•	•	•	•	•	•	•	•	
	Legs		•	•	•	•	•	•	•	•	•	•	•	•	•	•	•	•	•	•	•	•	•
<b>Brighton</b>	Table top		■	■	■	■	■	■	■	■	■	■	■	■	■	■	■	■	■	■	■	■	
	Frame		•	•	•	•	•	•	•	•	•	•	•	•	•	•	•	•	•	•	•	•	
	Foot and frame caps		•	•	•	•	•	•	•	•	•	•	•	•	•	•	•	•	•	•	•	•	
	Hardwood arms		•	•	•	•	•	•	•	•	•	•	•	•	•	•	•	•	•	•	•	•	
	Power		•	•	•	•	•	•	•	•	•	•	•	•	•	•	•	•	•	•	•	•	
<b>Mesa</b>	Feet		•	•	•	•	•	•	•	•	•	•	•	•	•	•	•	•	•	•	•	•	
<b>Willow</b>	Fixed base		•	•	•	•	•	•	•	•	•	•	•	•	•	•	•	•	•	•	•	•	
	Swivel base		•	•	•	•	•	•	•	•	•	•	•	•	•	•	•	•	•	•	•	•	
<b>Slope</b>	Wire frame base		•	•	•	•	•	•	•	•	•	•	•	•	•	•	•	•	•	•	•	•	
	Five-star base		•	•	•	•	•	•	•	•	•	•	•	•	•	•	•	•	•	•	•	•	
<b>Sterling</b>	Five-star base		•	•	•	•	•	•	•	•	•	•	•	•	•	•	•	•	•	•	•	•	
	Four-star base		•	•	•	•	•	•	•	•	•	•	•	•	•	•	•	•	•	•	•	•	
	Hardwood legs		•	•	•	•	•	•	•	•	•	•	•	•	•	•	•	•	•	•	•	•	
<b>Kent</b>	Five-star base		•	•	•	•	•	•	•	•	•	•	•	•	•	•	•	•	•	•	•	•	
	Four-star base		•	•	•	•	•	•	•	•	•	•	•	•	•	•	•	•	•	•	•	•	
	Four-leg base		•	•	•	•	•	•	•	•	•	•	•	•	•	•	•	•	•	•	•	•	
	Stool		•	•	•	•	•	•	•	•	•	•	•	•	•	•	•	•	•	•	•	•	
<b>Greenpoint</b>	Desk and bench frames		•	•	•	•	•	•	•	•	•	•	•	•	•	•	•	•	•	•	•	•	
	Desk and bench worksurfaces		■	■	■	•	•	■	■	■	•	■	•	■	■	■	■	■	■	■	■	■	•
	Storage frames and metal bodies		•	•	•	•	•	•	•	•	•	•	•	•	•	•	•	•	•	•	•	•	
	Wood storage—bodies, faces, and shelves		□	□	□	•	•	□	□	□	•	□	•	□	□	□	□	□	□	□	■	•	
	Metal storage—faces and shelves		•	•	•	•	•	•	•	•	•	•	•	•	•	•	•	•	•	•	■	•	
Power		•	•	•	•	•	•	•	•	•	•	•	•	•	•	•	•	•	•	•	•	•	
<b>Sutton HAD</b>	Top		•	•	•	■	■	•	•	•	■	•	•	•	•	•	•	•	•	•	•	■	
	Foot		■	■	■	■	■	■	■	■	■	■	■	■	■	■	■	■	■	■	■	■	■
	Base		■	■	■	■	■	■	■	■	■	■	■	■	■	■	■	■	■	■	■	■	■
	Leg Ring		■	■	■	■	■	■	■	■	■	■	■	■	■	■	■	■	■	■	■	■	■



**Wood Availability Matrix, continued**

**Legend**

- = Not available
- = Available
- = Available with exceptions
- ⊖ = Excluded
- ▶ See specification pages for details.

		Wood, continued				Price Group 1 (Planked)					Price Group 1 (Hardwood)				
		Price Group 1 (Rift Cut)				Cherry	Maple	Oak	Walnut	Oak					
		3602 RC/OP Desert Oak	3611 RC/OP Natural Oak	3612 RC/OP Warm Oak	36A2 RC/OP Volcanic Oak	3P41 OP Planked Cherry	3P51 OP Planked Maple	3P61 OP Planked Oak	3VFX OP Natural Recon	WE20 OP Natural Oak	3P71 OP Planked Walnut	VP01 RC/LS Light Oak	VP03 RC/LS Black Oak	VP04 RC/LS Gray Oak	VP05 RC/LS White Oak
<b>Boardwalk</b>	Platform	■	■	■	■	•	•	■	■	•	•	•	•	•	•
	Legs	•	•	•	•	•	•	•	•	•	•	■	■	•	■
<b>Brighton</b>	Table top	■	■	■	■	■	■	■	■	•	■	•	•	•	•
	Frame	•	•	•	•	•	•	•	•	•	•	•	•	•	•
	Foot and frame caps	•	•	•	•	•	•	•	•	•	•	•	•	•	•
	Hardwood arms	•	•	•	•	•	•	•	•	•	•	■	■	■	■
	Power	•	•	•	•	•	•	•	•	•	•	•	•	•	•
<b>Mesa</b>	Feet	•	•	•	•	•	•	•	•	•	•	•	•	•	•
<b>Willow</b>	Fixed base	•	•	•	•	•	•	•	•	•	•	•	•	•	•
	Swivel base	•	•	•	•	•	•	•	•	•	•	•	•	•	•
<b>Slope</b>	Wire frame base	•	•	•	•	•	•	•	•	•	•	•	•	•	•
	Five-star base	•	•	•	•	•	•	•	•	•	•	•	•	•	•
<b>Sterling</b>	Five-star base	•	•	•	•	•	•	•	•	•	•	•	•	•	•
	Four-star base	•	•	•	•	•	•	•	•	•	•	■	■	■	■
	Hardwood legs	•	•	•	•	•	•	•	•	•	•	■	■	■	■
<b>Kent</b>	Five-star base	•	•	•	•	•	•	•	•	•	•	•	•	•	•
	Four-star base	•	•	•	•	•	•	•	•	•	•	•	•	•	•
	Four-leg base	•	•	•	•	•	•	•	•	•	•	•	•	•	•
	Stool	•	•	•	•	•	•	•	•	•	•	•	•	•	•
<b>Greenpoint</b>	Desk and bench frames	•	•	•	•	•	•	•	•	•	•	•	•	•	•
	Desk and bench worksurfaces	■	•	•	■	■	■	■	■	■	■	•	•	•	•
	Storage frames and metal bodies	•	•	•	•	•	•	•	•	•	•	•	•	•	•
	Wood storage—bodies, faces, and shelves	□	•	•	■	□	□	□	□	■	□	•	•	•	•
	Metal storage—faces and shelves	•	•	•	■	•	•	•	•	■	•	•	•	•	•
Power	•	•	•	•	•	•	•	•	•	•	•	•	•	•	
<b>Sutton HAD</b>	Top	•	•	•	•	•	•	•	•	•	•	•	•	•	•

Price Group 2 (Flat Cut)		Cherry	Maple	Walnut			Comp Veneer
		<b>3404</b> FC/FF Clear Cherry (Aged) <b>E</b>					
		<b>3414</b> FC/FF Natural Cherry <b>E</b>					
		<b>3424</b> FC/FF Medium Cherry <b>E</b>					
		<b>3524</b> FC/FF Clear Maple <b>E</b>					
		<b>3544</b> FC/FF Blonde Maple <b>E</b>					
		<b>3064</b> FC/FF Graphite Walnut <b>E</b>					
		<b>3704</b> FC/FF Clear Walnut <b>E</b>					
		<b>3714</b> FC/FF Natural Walnut <b>E</b>					
		<b>3734</b> FC/FF Black Walnut <b>E</b>					
		<b>3754</b> FC/FF Medium Walnut <b>E</b>					
		<b>3764</b> FC/FF Dark Walnut <b>E</b>					
		<b>3774</b> FC/FF Medium Mahogany on Walnut <b>E</b>					
		<b>3LHX</b> FC/OP Espresso on Walnut Composite					
Price Group 2 (Quarter Cut)		Maple	Walnut			Composite Veneer	
		<b>3224</b> QC/FF Clear Maple <b>E</b>					
		<b>3294</b> QC/FF Blonde on Maple <b>E</b>					
		<b>3304</b> QC/FF Clear Walnut <b>E</b>					
		<b>3314</b> QC/FF Natural Walnut <b>E</b>					
		<b>3324</b> QC/FF Dark Mahogany on Walnut					
		<b>3354</b> QC/FF Medium Walnut <b>E</b>					
		<b>3364</b> QC/FF Dark Walnut <b>E</b>					
		<b>3374</b> QC/FF Medium Mahogany on Walnut <b>E</b>					
		<b>3384</b> QC/FF Graphite Walnut <b>E</b>					
		<b>3394</b> QC/FF Black Walnut <b>E</b>					
		<b>3LEX</b> QC/OP Desert Oak on Oak Composite					
		<b>3LGX</b> QC/OP Chai on Walnut Composite					
		<b>3LJX</b> QC/OP Ebony on Walnut Composite					
Price Group 2 (Rift Cut)		Oak					
		<b>3604</b> RC/FF Desert Oak					
		<b>3614</b> RC/FF Warm Oak					

Resources and Surface Materials

# Upholstery Matrix

## Legend

- = Available in the default direction
- V = Only available in the vertical direction
- H = Only available in the horizontal direction
- = Not available

	Price Group	Belle	Boardwalk	Brighton	Kent	Lucas Wire and Swivel	Mesa	Slope	Sterling	Willow
3014 Speckle Boucle	6	•	■	H	■	■	■	•	■	■
3018 Cube Geo	6	V	■	H	■	•	•	•	■	•
3019 Boucle Houndstooth	6	V	■	H	■	■	■	H	■	■
3020 Plush Grid	6	•	■	•	■	•	•	•	•	•
3063 Cozy Texture	4	V	•	H	•	•	■	H	■	•
3064 Tweedy Twill	4	V	■	H	■	■	■	H	■	■
3170 Corded	7	•	•	H	•	■	■	•	■	■
3171 Boucle Melange	7	V	■	H	■	■	■	•	■	■
3172 Chunky Tweed	7	•	•	H	•	■	■	H	■	■
3173 Chenille Chevron	7	•	•	H	•	•	•	■	■	•
3722 Tweed Multi	3	V	■	■	■	■	■	■	■	■
3741 Tiny Herringbone	6	V	■	■	■	■	•	■	■	•
3746 Bark Cloth	6	V	■	■	■	■	■	■	■	■
3747 Reppweave	5	V	■	H	■	■	■	•	■	■
3748 Starburst	7	V	■	•	■	•	•	•	■	•
3749 Tack Cloth	6	V	■	•	■	•	•	■	■	•
3752 Hem Stitch	5	V	■	■	■	■	■	•	■	■
3761 Hatchmark	8	V	■	■	■	■	•	■	■	•
3762 Crossweave	4	V	■	■	■	■	■	■	■	■
3797 Brushed Flannel	4	V	■	■	■	■	■	■	■	■
3815 Big Texture	7	V	■	■	■	■	■	■	■	■
3928 Linen Like	5	V	■	■	•	•	■	■	■	•
3931 Fomo	5	V	■	■	■	■	■	V	■	■
3935 Distressed Texture	7	V	■	■	•	•	■	■	■	•
4142 Birdseye	2	V	■	■	■	■	■	•	■	■
4144 Cloud Velvet	4	V	■	■	■	■	■	■	■	■
Mont Blanc - Moore & Giles	L	•	■	H	■	■	■	•	■	■

\* Upholstery available on Steelcase Slope shown.  
 Licensed slope available only in saddle, fog, and aegean leather.

**Legend**

- = Not available
- = Available
- = Available with exceptions
- Ⓢ = Excluded
- ▶ See specification pages for details.

**Steelcase**

**Price Group 1**

	Belle	Boardwalk	Brighton	Fulton	Kent	Mesa	Willow	Slope*	Sterling
Buzz2	■	■	■	■	■	■	■	■	■
Era	■	■	■	■	■	■	■	■	■
Foundation	•	■	■	■	■	•	■	•	■
Jacks Ⓢ	■	■	■	■	■	■	•	■	■
Link	•	■	■	■	■	■	■	■	■
New Black: Henry and Bruce	■	■	■	■	■	■	■	■	■

**Price Group 2**

Chainmail	■	■	■	■	■	■	■	■	■
Cogent: Connect	■	■	■	■	■	■	■	■	■
Dovetail by Designtex	■	■	■	■	■	■	■	■	■
New Black: James, Harley, Jack	■	■	■	■	■	■	■	■	■
Nitelights	■	■	■	■	■	■	■	■	■
SoftNext	■	■	■	■	■	■	■	■	■
Spyder	•	■	■	•	■	■	•	•	■
Stand In	•	•	■	■	■	•	■	•	•

**Price Group 3**

Billiard Multi-Use by Designtex	■	■	■	■	■	■	■	■	■
Gaja	■	■	■	■	■	■	■	■	■
Redeem	■	■	■	■	■	■	■	■	■
Retrieve	■	■	■	■	■	■	■	■	■
Tweed Multi by Designtex**	•	•	•	■	■	•	■	•	•

**Price Group 4**

Cloud Velvet by Designtex***	•	•	•	■	■	•	■	•	•
------------------------------	---	---	---	---	---	---	---	---	---

**Price Group 5**

Bo Peep	•	■	■	■	■	■	■	■	■
Remix	■	■	■	■	■	■	■	■	■
Silk	■	■	■	■	■	■	■	■	■

**Price Group 6**

Brisa	•	■	■	■	■	■	■	■	■
-------	---	---	---	---	---	---	---	---	---

**Price Group 7**

Steelcut Trio	•	■	■	■	■	■	■	■	■
---------------	---	---	---	---	---	---	---	---	---

**Leather Price Group 1**

Cafe	•	■	■	■	■	■	•	•	■
Steelcase Leather Ⓢ	•	■	■	■	■	■	•	•	■

**Leather Price Group 2**

Elmosoft	•	■	■	■	■	■	■	■	■
----------	---	---	---	---	---	---	---	---	---

\* Upholstery available on Steelcase Slope shown. Licensed Slope available only in saddle, fog, and aegean leather.

\*\* Tweed Multi available in medium grey, medium blue, light grey, and all other finishes are available as graded-in.

\*\*\* Cloud Velvet available in light mocha, black indigo, slate, and all other finishes are available as graded-in.

# Lock and Keying Options

## Greenpoint Pedestals and Greenpoint Lateral Files

**All locking products** are standard with factory-installed, keyed-random locks. Consecutive, specific, and random keying are available as field-installed options.

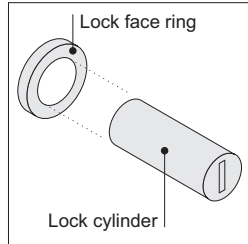

**Locks** consist of a field-installed lock cylinder and a factory-installed lock face ring.

**Two types of locks** are available — the standard keying system (FR series) and the master keying system (XF series). All the locks in the XF series can be opened with a single master key.

### Field-Installed Keying

**Field-installed locks** are only available on products that include factory-installed lock mechanisms.

**Specify "plug"** when specifying furniture, and the product will ship with a plastic plug in place of the lock cylinder.

*Tip: For products with optional lock colors, make sure to specify the color for both the lock and lock face ring.*

**Front-removable lock cylinders** must be specified separately. You must also order a special lock tool to install or remove lock cylinders in the field.

*Tip: Lock tools are reusable. You do not need to order additional lock tools with every furniture order.*

**Lock cylinders** will be shipped separately so that you can install the locks when you are ready.

**Three keying choices** are available for field installation—random (standard), specific, and consecutive. All three are also available with master keying, which means that all locks can be opened with a single master key.

**Key random** means that the locks will be assigned arbitrarily at the factory with key numbers ranging from FR305 to FR999 (Master keying numbers: XF1001 to XF3000).

*Tip: Random keying can mean that different furniture units will have the same key number. If you must have all locks keyed differently, you should specify key specific or key consecutive lock cylinders.*

**Key specific** means that you can specify any key number from FR305 to FR999 (Master keying numbers: XF1001 to XF3000). This option can be used to key all the furniture units in a workstation or department the same.

*Tip: Designate the quantity per key number in your specification.*

▶ See below.



**Key consecutive** means that you can specify lock numbers in a consecutive order to ensure that no two locks have the same key number until the key sequence repeats. You must select a beginning key number from FR305 to FR999 (Master keying numbers: XF1001 to XF3000).

**Example** of a typical lock cylinder specification is shown below:



10	LOCKFR FR320
5	LOCKFR FR350
15	LOCKXF XF1100

30	Total
1	877102003SR standard lock tool
1	877102002SR master lock tool



#### Key Random

 FR305  
 FR421  
 FR305



or

 XF1011 }  
 XF1042 } XF Master Key  
 XF1011 }



#### Key Specific

 FR350  
 FR350  
 FR350



or

 XF1020 }  
 XF1020 } XF Master Key  
 XF1020 }

#### Key Consecutive

 FR350  
 FR351  
 FR352

or

 XF1020 }  
 XF1021 } XF Master Key  
 XF1022 }

## Lock Cylinders

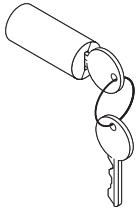

Tip: Lock price is included in price of furniture with locks.

Tip: For replacement lock cylinders, refer to Service Parts.

Tip: You can change lock cylinders in the field by using the appropriate lock tool.

Standard Includes	Required to Specify
<ul style="list-style-type: none"> <li>Lock cylinder, keyed random</li> <li>Two keys</li> </ul>	1 Style number 2 Lock finish 9201 Polished Chrome 9250 Ember Chrome 3 Options, if selected (see below)

Options	Price	Required to Specify
<b>Key specific</b>	No cost	Select key number from FR305–FR999.
<b>Key consecutive</b>	No cost	Specify <i>key consecutive</i> and must select beginning key number from FR305–FR999.
<b>Master key random</b>	+\$39 each	Specify master key random.
<b>Master key specific</b>	+\$39 each	Specify key number from XF1001–XF3000.
<b>Master key consecutive</b>	+\$39 each	Specify <i>master key consecutive</i> and must select beginning key number from XF1001–XF3000.

### Specification Information

Style Number	Base Price

### FR Series (Standard Keying System)—Lock Cylinder

<b>LOCKFR</b>	No cost
---------------	---------

### Standard Lock Tool

<b>877102003SR</b>	\$39
--------------------	------

### XF Series (Master Keying System)—Lock Cylinder

<b>LOCKXF</b>	No additional cost. Price included in price of furniture with master-keyed locks.
---------------	---

### Master Lock Tool

<b>877102002SR</b>	\$39
--------------------	------

 **For Canadian Pricing**  
 Multiply U.S. Price by the Canadian price factor.  
 ▶ See page 1 for details.

# Style Number Index

Style Number	Page	Description
<b>877102002SR</b>	259	Master Lock Tool
<b>877102003SR</b>	259	Standard Lock Tool
<b>999CHT</b>	180	Wire Clips
<b>AWAG2</b>	180	2½" Round Grommet
<b>AWM12</b>	181	12" Wire Manager
<b>AWM18</b>	181	18" Wire Manager
<b>AWM23</b>	181	23" Wire Manager
<b>AWM30</b>	181	30" Wire Manager
<b>AWM35</b>	181	35" Wire Manager
<b>AWM42</b>	181	42" Wire Manager
<b>AWVW</b>	180	Wire Mgr
<b>FLXCBK4</b>	229	Cable Brackets
<b>FLXMCC10</b>	228	Magnetic Cable Clips
<b>FLXMCC2</b>	228	Magnetic Cable Clips
<b>FMVBK</b>	217	Brckt Kit for Dsk w/Pwer and No Power Tray
<b>FMVC</b>	218	Vertebral Riser
<b>FMVCE</b>	218	Vertebral Riser
<b>FMVCP</b>	211	Chicago Hardwire Box
<b>FMVF</b>	213	Filler Pkg Pwr/Data
<b>FMVH24</b>	214	Modular Harness
<b>FMVH27</b>	214	Modular Harness
<b>FMVH30</b>	214	Modular Harness
<b>FMVH33</b>	214	Modular Harness
<b>FMVH36</b>	214	Modular Harness
<b>FMVH39</b>	214	Modular Harness
<b>FMVH42</b>	214	Modular Harness
<b>FMVH45</b>	214	Modular Harness
<b>FMVH48</b>	214	Modular Harness
<b>FMVH51</b>	214	Modular Harness
<b>FMVH54</b>	214	Modular Harness
<b>FMVH57</b>	214	Modular Harness
<b>FMVH60</b>	214	Modular Harness
<b>FMVH63</b>	214	Modular Harness
<b>FMVH66</b>	214	Modular Harness
<b>FMVH69</b>	214	Modular Harness
<b>FMVH72</b>	214	Modular Harness
<b>FMVI12H</b>	215	Hardwire-to-Modular Power Infeed
<b>FMVI12M</b>	215	Modular-to-Modular Power Infeed
<b>FMVI24H</b>	215	Hardwire-to-Modular Power Infeed
<b>FMVI24M</b>	215	Modular-to-Modular Power Infeed
<b>FMVI6H</b>	215	Hardwire-to-Modular Power Infeed
<b>FMVI6M</b>	215	Modular-to-Modular Power Infeed
<b>FMVISS</b>	216	San Francisco Power Infeed
<b>FMVPBS</b>	210	Modular Power Block—Standard-Capacity
<b>FMVRD</b>	212	Duplex Receptacle
<b>FMVRUSB</b>	213	USB Receptacle
<b>LOCKFR</b>	259	Lock Cylinder
<b>LOCKXF</b>	259	Lock Cylinder
<b>OLBVINN</b>	216	New York Power Infeed
<b>OLCR</b>	229	Cable Riser
<b>RCHE1715</b>	179	Bsc Cushion E
<b>RCHE1830</b>	179	Bsc Cushion E
<b>RCHE1836</b>	179	Bsc Cushion E
<b>TS31410</b>	112	Alight Ganging Kit
<b>WEHMDC4MNA</b>	151	Sterling—Health Guest Chair
<b>WEHMDC4MWA</b>	152	Sterling—Health Guest Chair
<b>WEM1</b>	234	Slope Guest Chair
<b>WEM11</b>	239	Maisie Side Table
<b>WEM2</b>	233	Slope Lounge Chair
<b>WEM3</b>	236	Slope Conference Chair
<b>WEM4</b>	239	Maisie Side Table

Style Number	Page	Description
<b>WEM50</b>	234	Slope Counter Stool
<b>WEM59</b>	237	Lily Pad Nesting Table
<b>WEM60</b>	238	Lily Pad Nesting Table
<b>WEM66</b>	233	Slope Bar Stool
<b>WEM67</b>	235	Slope Bar Stool
<b>WEM68</b>	240	Mesa Sectional Coffee Table
<b>WEM7</b>	237	Lily Pad Nesting Table
<b>WEM70</b>	232	Nimbus Conference Chair
<b>WEM8</b>	238	Linear C Table
<b>WESARYLNG1</b>	115	Brighton One Seat
<b>WESARYLNG2</b>	117	Brighton Two Seat
<b>WESARYO</b>	118	Brighton Ottoman
<b>WESARYPWR</b>	125	Brighton Module Power
<b>WESARYTBL60</b>	119	Brighton Ganging Table
<b>WESARYTBL90</b>	120	Brighton Ganging Table
<b>WESARYTBLED</b>	122	Brighton End Table
<b>WESARYTBLRT</b>	124	Brighton Rectangle Table
<b>WESARYTBLSG</b>	121	Brighton Occasional Tables
<b>WESARYTBLSQ</b>	123	Brighton Square Table
<b>WESARYUSB</b>	125	Brighton USB Power
<b>WESBELC</b>	97	Belle Corner Lounge
<b>WESBELLNG1</b>	93	Belle One-Seat Lounge
<b>WESBELLNG2</b>	95	Belle Two-Seat Lounge
<b>WESBELO</b>	98	Belle Ottoman
<b>WESFTNBH</b>	165	Fulton Bench
<b>WESFTNCG</b>	163	Fulton Guest Chair
<b>WESFTNCL</b>	164	Fulton Lounge Chair
<b>WESHTSLNG1</b>	101	Boardwalk One-Seat Lounge
<b>WESHTSLNG2</b>	103	Boardwalk Two-Seat Lounge
<b>WESHTSLNG3</b>	106	Boardwalk Three Seat
<b>WESHTSTBL30</b>	107	Boardwalk Square Table
<b>WESHTSTBL60</b>	108	Boardwalk Rectangle Table
<b>WESHTSTBL90</b>	109	Boardwalk Rectangle Table
<b>WESHTSTBLOV65</b>	111	Boardwalk Oval Table
<b>WESHTSTBLRD40</b>	110	Boardwalk Round Table
<b>WESINDCSG</b>	205	Greenpoint Glass Screen
<b>WESINDCTDS</b>	208	Greenpoint Tray End
<b>WESINDCTSS</b>	208	Greenpoint Tray End
<b>WESINDEC</b>	203	Greenpoint End Credenza
<b>WESINDELDS</b>	197	Greenpoint Leg
<b>WESINDELSS</b>	198	Greenpoint Leg
<b>WESINDETDS</b>	208	Greenpoint Tray Extension
<b>WESINDETSS</b>	208	Greenpoint Tray Extension
<b>WESINDFC</b>	171	Greenpoint Filing Credenza
<b>WESINDILDS</b>	199	Greenpoint Leg
<b>WESINDILSS</b>	200	Greenpoint Leg
<b>WESINDLF</b>	173	Greenpoint Lateral File
<b>WESINDLFR</b>	201	Greenpoint Leg Round/Square
<b>WESINDLHR</b>	202	Greenpoint Leg Half Round
<b>WESINDLOB</b>	174	Greenpoint Bookcase
<b>WESINDMP</b>	170	Greenpoint Modesty Panel
<b>WESINDMPM</b>	178	Greenpoint Mobile Ped
<b>WESINDNOB</b>	175	Greenpoint Bookcase
<b>WESINDOB</b>	176	Greenpoint Bookcase
<b>WESINDPC</b>	204	Greenpoint Personal Credenza
<b>WESINDPCDS</b>	209	Greenpoint Power Cover
<b>WESINDPCSS</b>	209	Greenpoint Power Cover
<b>WESINDPD</b>	166	Greenpoint Private Desk
<b>WESINDPSDS</b>	206	Greenpoint Power Support
<b>WESINDPSSS</b>	206	Greenpoint Power Support
<b>WESINDPTDS</b>	207	Greenpoint Tray

Style Number	Page	Description
WESINDPTSS	207	Greenpoint Tray
WESINDPWR	182	Greenpoint Power Unit
WESINDPWRCT	182	Greenpoint Continuous Top Power
WESINDPWRFR	183	Greenpoint Round/Square Power Unit
WESINDRB	196	Greenpoint Bench Return
WESINDRL	167	Greenpoint Desk Return
WESINDRP	169	Greenpoint Desk Return
WESINDSB	177	Greenpoint Bookcase
WESINDSC	172	Greenpoint Credenza
WESINDWCCCT	192	Greenpoint Continuous Top, Cred/Cred
WESINDWCCDS	186	Greenpoint Worksurface
WESINDWCCSS	189	Greenpoint Worksurface
WESINDWFR	193	Greenpoint Worksurface Round
WESINDWHR	195	Greenpoint Worksurface Round
WESINDWLCCT	191	Greenpoint Continuous Top, Leg/Cred
WESINDWLCDS	185	Greenpoint Worksurface
WESINDWLCSS	188	Greenpoint Worksurface
WESINDWLLCT	190	Greenpoint Continuous Top, Leg/Leg
WESINDWLLDS	184	Greenpoint Worksurface
WESINDWLLSS	187	Greenpoint Worksurface
WESINDWSQ	194	Greenpoint Worksurface Square
WESKNT4CNA	156	Kent Conference Chair
WESKNT4CWA	155	Kent Conference Chair
WESKNT4LNA	158	Kent Guest Chair
WESKNT4LWA	157	Kent Guest Chair
WESKNT5CNA	154	Kent Conference Chair
WESKNT5CWA	153	Kent Conference Chair
WESKNT5SNA	160	Kent Conference Stool
WESKNT5SWA	159	Kent Conference Stool
WESLUCS	162	Lucas Swivel Chair
WESLUCW	161	Lucas Wire Chair
WESMDC4CNFNA	148	Sterling Conference Chair
WESMDC4CNFWA	149	Sterling Conference Chair
WESMDC4LNG	150	Sterling Lounge Chair
WESMDC4NA	142	Sterling Guest Chair
WESMDC4WA	143	Sterling Guest Chair
WESMDC5NA	146	Sterling Conference Chair
WESMDC5WA	147	Sterling Conference Chair
WESMDCSBHNA	145	Sterling Guest Stool
WESMDCSCHNA	144	Sterling Guest Stool
WESMES2SEAT	128	Mesa Two-Seat Lounge
WESMESC	129	Mesa Corner Lounge
WESMESCHLH	126	Mesa Two Seat Chaise
WESMESCHRH	127	Mesa Two-Seat Chaise
WESMESO	130	Mesa Ottoman
WESSLPCC	140	Slope Conference Chair
WESSLPCG	136	Slope Guest Chair
WESSLPCL	137	Slope Lounge Chair
WESSLPCS	141	Slope Stacking Chair
WESSLPSB	139	Slope Bar Stool
WESSLPSC	138	Slope Counter Stool
WESSUTCT	228	Sutton Cable Tray
WESSUTERQ	223	Sutton Extended Height-Adjustable Desk
WESSUTERQB	227	Sutton Extended Height-Adjustable Base
WESSUTSRQ	221	Sutton Basic Height-Adjustable Desk
WESSUTSRQB	225	Sutton Basic Height-Adjustable Base
WESWLONLGF	133	Willow Lounge Seating
WESWLONLGS	135	Willow Lounge Seating

# Trademark List

™/® The following is a non-exhaustive list of trademarks and registered trademarks for products of Steelcase Inc. or one of its related corporate entities: Agree, Airtouch, Aisla, Alight, Amia, Answer, Apprise, Aspekt, Avenir, Await, B-Free, Ballet, Bassline, Bindu, Bivi, Bix, Bottomline, Brody, Buoy, Cachet, Campfire, Capa, CF Series, CG\_1, Chord, Circa, Clipper, Cobi, Collaboration, Convene, Coupe, Cura, Currency, dash, Divisio, Duo, E-Table 2, Edge Series, Elbrook, Elective Elements, Embold, Empath, Everwall, Exponents, Folio, FrameOne, Gesture, Groupwork, Host, Hosu, i2i, Jenny, Kart, Kathryn, Kick, Lagunitas, Leap, Leela, LessThanFive, LiveBack, LiveSeat, Mackinac, Marien152, Max-Stacker, media:scape, Migration, Millbrae, Mineral, Mitra, Montage, Montara650, MoreThanFive, Move, Node, Ocular, Ology, Opus, Paperflo, Passerelle, Player, Pocket, Potrero415, QiVi, Radia, Regard, Relay, Reply, Ripple, Roam, Sarto, Scoop, Sebastopol, Senti Series, Senza, Shortcut, Sidewalk, Siento, Sieste, SILQ, Soffio, Sorrel, SOTO, Steelcase Eclipse, Steelcase Flex, Steelcase Karman, Steelcase Relay, Steelcase Rise, Steelcase Series, Surround, SW\_1, Switch, Sync, Tava, Tenor, Think, Thoughtful, Thread, Together, Train, Trees, Turnstone, Umami, Underscore, V.I.A., Verb, Verge, Verlay, Victor2, Visalia, WorkValet, and X-tenz.

™/® The following are trademarks or registered trademarks of AMQ Solutions, LLC: 3F, Activ, Amobi, Bixby, Bodi, Cluvo, Concur, Embank, FL-X, Iline, Jaku, Kinex, Personality Plus, Revi, S-Series, Siya, Tektis, Tizu, Uptake, and Zilo.

™/® The following are trademarks or registered trademarks of Orangebox Ltd., Cardiff, UK: Air3, Aspect, Avi, Away from the Desk, Border, Campers & Dens, Coppice, Cubb, Kirm, On the QT, Ramsey, Skomer, Sully, Track-B, and Vale.

™/® The following are trademarks or registered trademarks of Viccarbe Habitat, S.L.: Aleta, Cambio, Designed in The Sun, Foro, Funda, Holy Day, Kelly, Last Minute, Noha, Savina, Sistema, Sistema, Viable, and Wrapp.

® The following are registered brands of Steelcase Inc. and its family of companies: Steelcase, AMQ, Coalesse, Designtex, Halcon, Orangebox, Smith System, and Viccarbe.

® The following registered trademarks are under license from AWI Licensing Company, Dover, DE: SoundScapes, DuraBrite, BioBlock, and Armstrong.

® The following registered trademarks are under license from Byrne Electrical, Rockford, MI: Interport, Mini-Port, Axil Z, and Ellora.

® The following is a registered trademark of DuPont, Wilmington, DE: Corian.

® The following is a registered trademark of Genlyte Thomas Company, Louisville, KY: Lightolier.

® The following is a registered trademark of Hilti Corporation, FL-9494 Schaan, Principality of Liechtenstein: Hilti.

® The following is a registered trademark of Leviton Manufacturing Company, Little Neck, NY: Decora.

® The following is a registered trademark of Mechanical Plastics Corp, Elmsford, NY: Toggler.

® The following is a registered trademark of Microsoft Corporation, Redmond, WA: Microsoft.

® The following are registered trademarks of Orangebox Ltd., Cardiff, UK: Orangebox.

® The following is a registered trademark of Panduit Corporation, Lockport, IL: Panduit.

® The following is a registered trademark of Trav (Press), Cuneo, Italy: Assisa.

® The following is a registered trademark of Virtual Ink, Boston, MA: mimioActive.

® The following registered trademarks are under license from Wilkhahn Furniture Products: Avera, Senzo, Versal, and Wilkhahn FS.

® The following are registered trademarks of Polyvision Corp: Flow, Motif, Polyvision, Sans, and Serif.

® The following is a registered trademark of Wilsonart International, Temple, TX: Chemsurf.

® The following is a registered trademark of Wiremold, West Hartford, CT: Wiremold.

® The following is a registered trademark of EMU Group S.P.A., Perugia, Italy: EMU.

® The following is a registered trademark of Security People, Inc.: Digilock.

® The following are registered trademarks of Natural Capital Partners Europe Limited: CarbonNeutral and the CarbonNeutral Certified logo.

™ The following is a trademark of Microsoft Corporation, Redmond, WA: Windows.

™ The following is a trademark of Rodman Industries, Inc., Oconomowoc, WI: ResinCore1.

™ The following is a trademark of Ultrafabrics, LLC, Elmsford, NY: Ultraleather.

™ The following trademarks are under license from Wilkhahn Furniture products: Cana, Linus, Logon, Picto, Range, Stitz, Thema, Timetable, and Tubis.

™ The following trademarks are under license from Walter Knoll: Andoo, Bob, Lazlo, Lox, Ribbon, and Together.

™ The following trademarks are under license from PP Mobler: Bar and Flag Halyard.

™ The following trademarks are under license from Carl Hansen: Elbow, Paddle, Shell, Wing, and Wishbone.

™ The following trademarks are under license from Cambridge Sound Management, LLC Cambridge, MA: QtPro Soundmasking, Qt Quiet Technology, and Sonet Qt.

™ The following is a trademark of Electri-Cable Assemblies, Shelton, CT: Interact.

™ The following is a trademark of Clestra Hauserman: IRYS.

™ The following is a trademark of Wiesner-Hager Möbel GmbH: Nooi.

™ The following are trademarks of Polyvision: Accord, a3, e3, Boundri, and Nota.

™ The following is a trademark of Bostock Company, Inc: SnapCab.

™ The following is a trademark of Williams-Sonoma, Inc: West Elm.

™ The following is a trademark of Elena Marquina Testor: nanimarquina.

™ The following is a trademark of Forbo International SA: Forbo.

Trademarks used herein are the property of Steelcase Inc. or their respective owners.