



IM#: 20-0136340

Storage Solutions

Steelcase



The Organized Workplace.

Without proper organization, workers waste time sifting through cluttered spaces and searching for items they need in order to complete tasks. With easy access to tools and personal storage, they can fully utilize their workspace, making the most of valuable time.

To accommodate the diverse needs of workers and their spaces, Steelcase® storage solutions come in many shapes and sizes and account for a range of items such as bags, mobile devices and documents.

CONTENTS

3 PRODUCTS

- 4 TS Series
- 6 Universal Storage
- 8 c:scape
- 10 High Density
- 12 Duo
- 14 Flex Active Frames
- 16 Currency Enhanced
- 18 Elective Elements

21 CATEGORIES

- 22 Pedestals
- 26 Bins and Shelves
- 32 Laterals
- 36 Credenzas
- 38 Towers and Wardrobes
- 42 Lockers
- 46 Cabinets and Bookcases
- 50 File Surrounds

PRODUCTS

**Effective Solutions.
Consistent Design.**

Steelcase offers a range of product lines designed to bring a consistent aesthetic to the workplace. With attractive and effective solutions for workspaces ranging from open-plan settings to private offices, organizations choose from a diverse collection of storage products built for the modern workplace.

- 4 TS Series
- 6 Universal Storage
- 8 c:scape
- 10 High Density
- 12 Duo
- 14 Flex Active Frames
- 16 Currency Enhanced
- 18 Elective Elements



IM#: 18-0101746

TS Series

With a fundamental and clean design, TS Series storage is a hard-working, economical steel-based solution that can flexibly integrate into a wide range of Steelcase workplace applications.

STATEMENT OF LINE

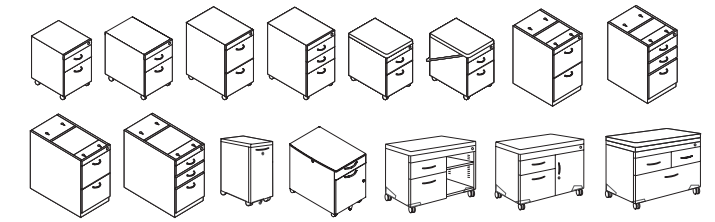

Pedestals

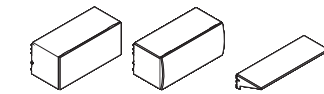

Bins and Shelves

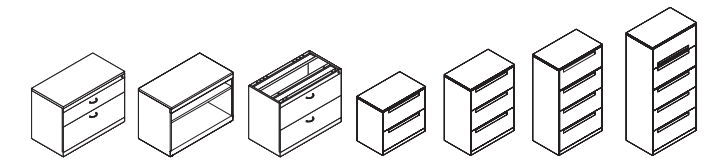

Laterals

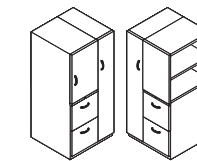

Towers

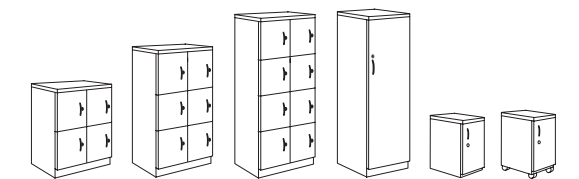
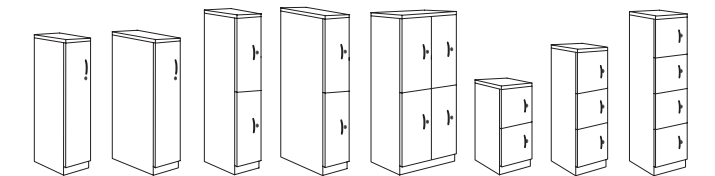

Lockers

Universal Storage

Designed to evolve with changing storage needs, Universal Storage offers a range of steel storage sizes, interiors and aesthetic choices. Choosing and designing storage is simplified with a highly versatile, premium line.



IM#: 16-0067493

STATEMENT OF LINE

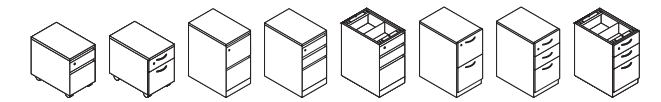

Pedestals

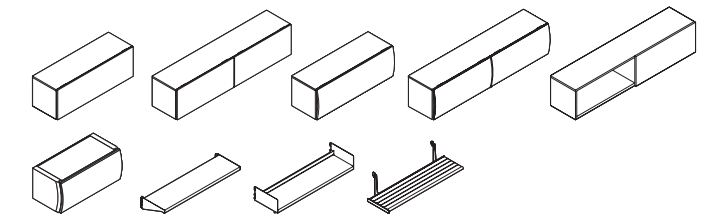

Bins and Shelves

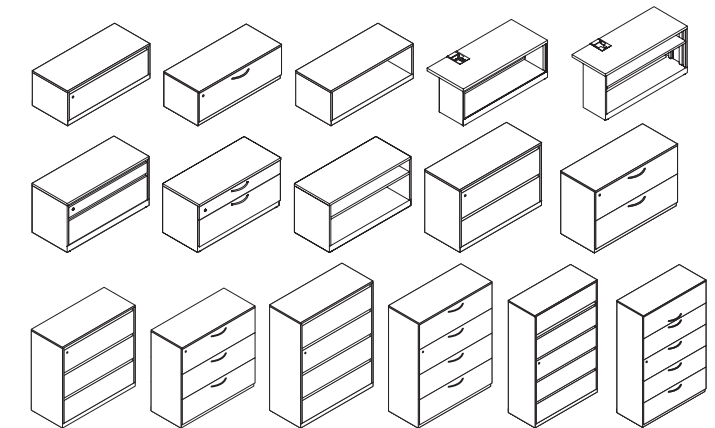

Laterals

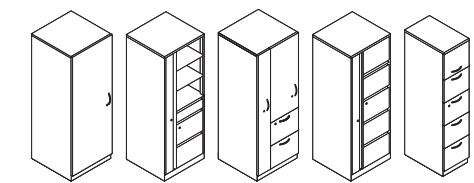

Towers

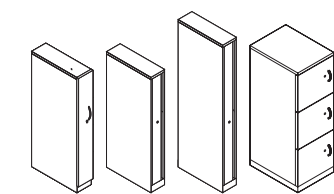

Lockers

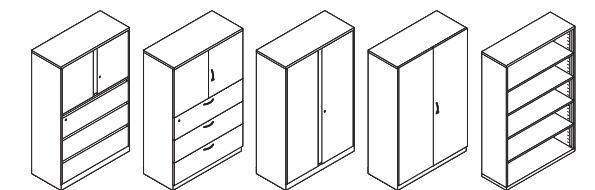

Cabinets and Bookcases



IM#: 13-0004828

STATEMENT OF LINE

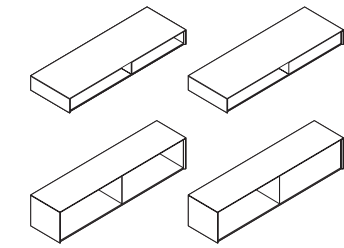

Mid Storage

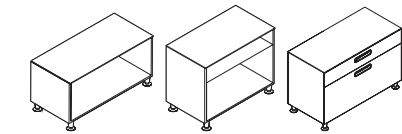

Laterals

c:scape

Built to promote trust among coworkers, as well as inspire innovation, c:scape® removes visual and social barriers in the workplace, while providing adaptable storage. Made of simple components, c:scape can be configured and reconfigured according to workspace needs, giving workers better access to each other, information and technology.

High Density

High Density storage helps workers keep documents and personal belongings organized to support both mobile and resident workflows. The bag drop style offers temporary storage and ease of access while the shelf version provides resident workers room for papers, files and supplies. Everything stays visible and close at hand.



IM#: 16-0042665

STATEMENT OF LINE

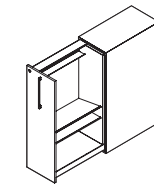

Bag Drop

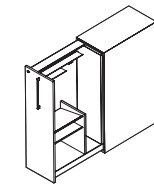

Bag Drop with Coat Closet

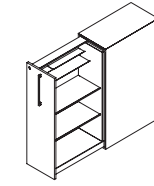

Shelf

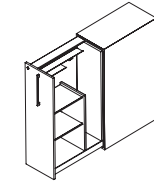

Shelf with Coat Closet

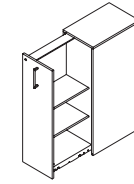

Value Package Shelf

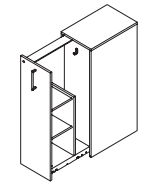

Value Package Shelf with Coat Closet



IM#: 17-0078368

STATEMENT OF LINE

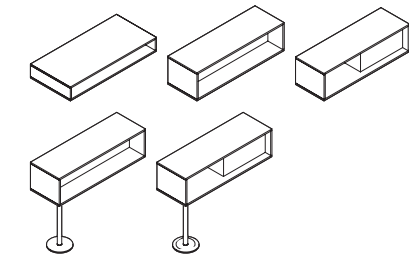

Tall and Slim Storage

Duo

Created specifically to provide an integrated storage solution as well as facilitate collaborative work, the Duo™ Storage portfolio includes Duo Overhead, Duo Slim and Duo Tall Storage.



IM#: 20-0143510

STATEMENT OF LINE

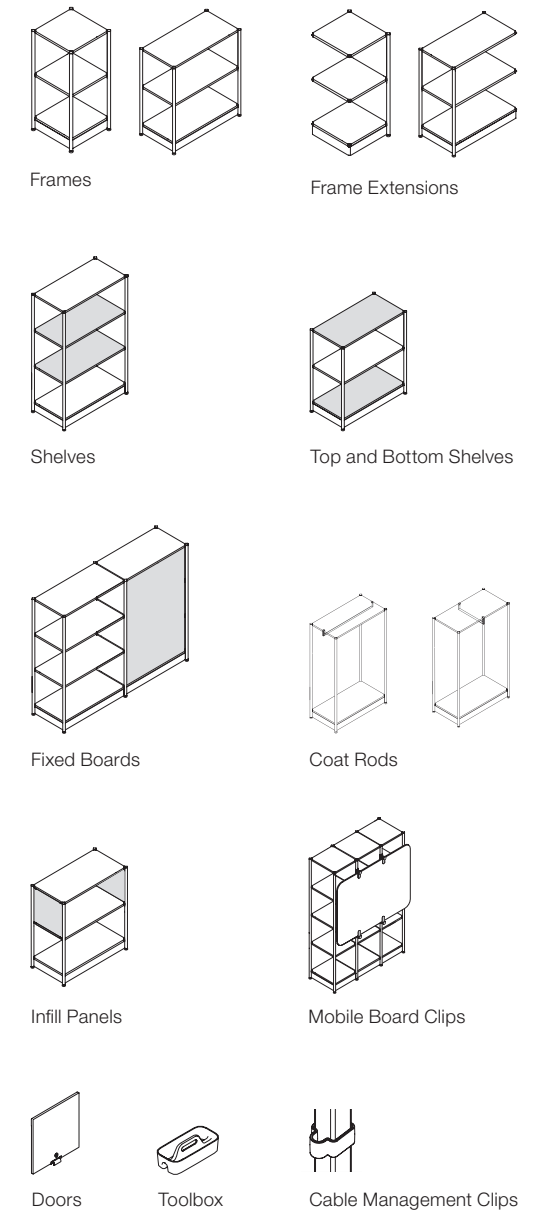

Flex Active Frames

Steelcase Flex Active Frames are adaptable structures that define space by creating productive, flexible and inspiring homes for teams. With a broad range of customizable configurations, Active Frames provide shelter, privacy and space for teams to collaborate and do their best work.

Currency Enhanced

Durable and cost effective, Currency Enhanced is a broad portfolio of laminate desking, storage and conferencing solutions that work hard and look great in settings of all types – from private offices to the open plan and everywhere in between.



IM#: 21-0158036

STATEMENT OF LINE

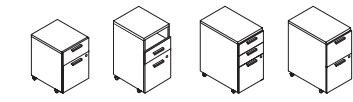

Mobile Pedestals

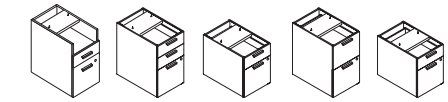

Pedestals

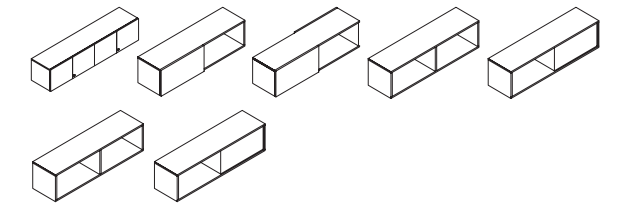

Bins and Organizers

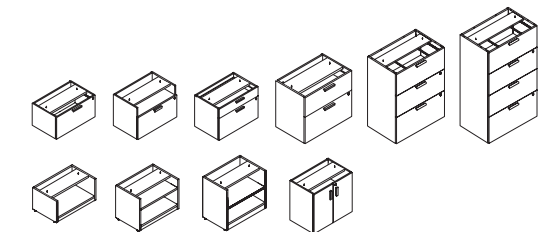

Laterals

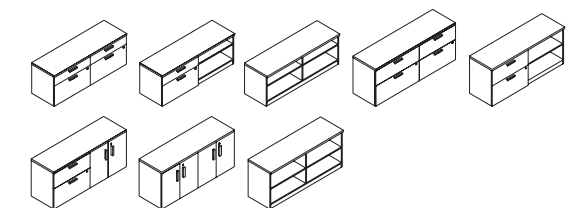

Credenzas

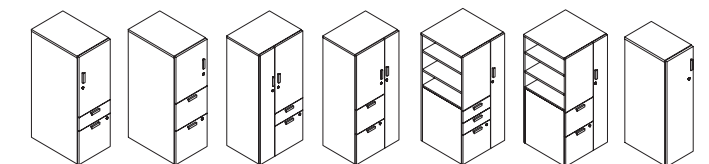

Towers and Wardrobes

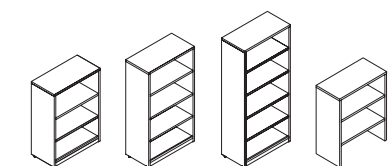

Bookcases



IM#: 16-0015445

Elective Elements

Highly coveted. Highly versatile. Refined, sophisticated design. Rich, extensive material options. Flexible, purposeful applications. Elective Elements® seamlessly blends style, craftsmanship and performance to support today's diverse and demanding workplaces.

Note: Most pieces available in plinth or leg-base models. Plinth base shown.

STATEMENT OF LINE

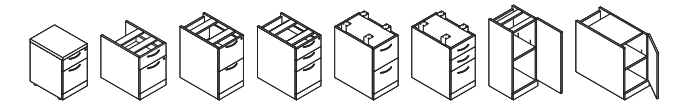

Pedestals

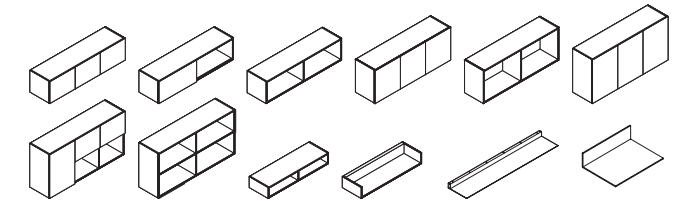

Bins and Shelves

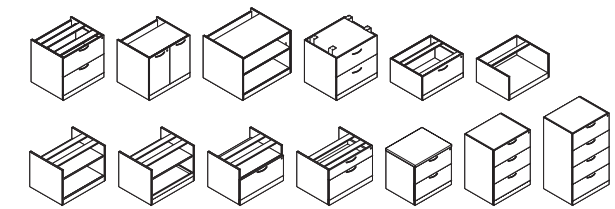

Laterals

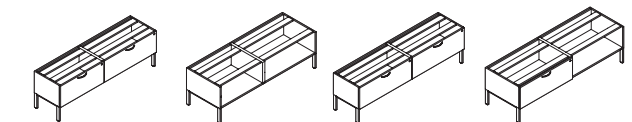

Credenzas

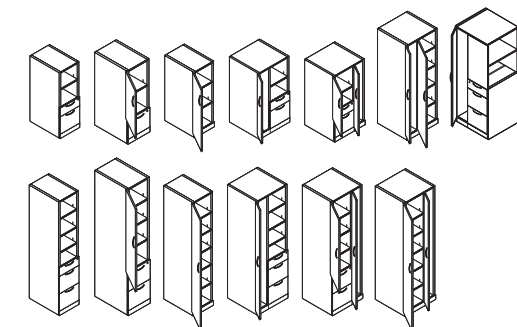

Towers

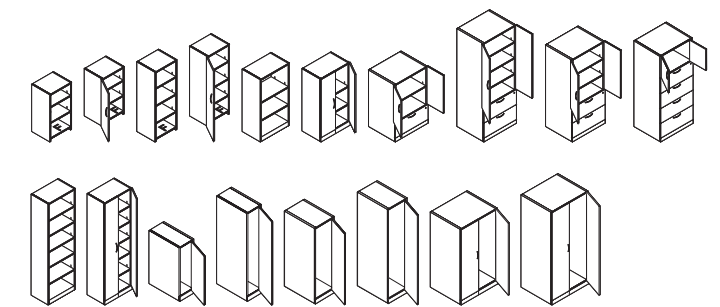

Cabinets and Bookcases

CATEGORIES

Tailored Storage Solutions.

Steelcase offers a wide variety of storage options, each with a diverse range of sizes and designs. Providing solutions such as paper and file storage or stowing personal items like coats and laptops, each product category offers unique solutions for storage needs.

- 22 Pedestals
- 26 Bins and Shelves
- 32 Laterals
- 36 Credenzas
- 38 Towers and Wardrobes
- 42 Lockers
- 46 Cabinets and Bookcases
- 50 File Surrounds

Pedestals

Providing a small, yet highly efficient storage option, pedestals promote organization without occupying extra space.

TS SERIES FIXED AND MOBILE



FEATURES

- Proud steel front with choice of pull
- Drawer fronts are removable and interchangeable

- Three pull styles: contemporary, handle and ledge
- Steel or cushion top with or without handle available for mobile pedestal

DIMENSIONS

Fixed	Mobile with steel top	Mobile with seat cushion
H: 27"	H: 21", 26 ⁵ / ₈ "	H: 22 ³ / ₄ "
W: 15 ¹ / ₄ "	W: 15 ¹ / ₄ "	W: 15 ¹ / ₄ ", 16 ¹ / ₄ "
D: 22", 28"	D: 19", 22"	D: 22 ¹ / ₂ "

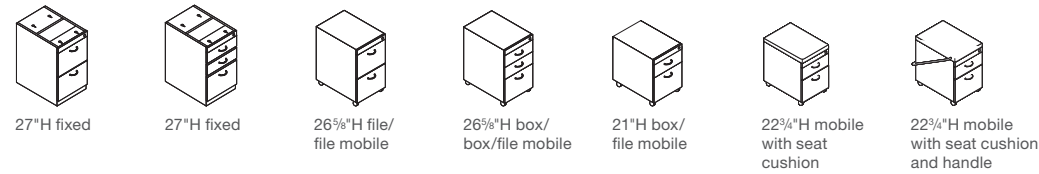

TS SERIES MINI LOCKER



FEATURES

- Opens either right or left to allow easy access to personal items
- Proud steel front with choice of pull
- Caster or glide base available. Standard includes small casters. Mini locker is 20"H with glide option

- Three pull styles: contemporary, handle and ledge

DIMENSIONS

Mobile
H: 21 ³ / ₄ "
W: 10"
D: 18 ¹ / ₄ "



21³/₄"H

TS SERIES SLIM PEDESTAL



FEATURES

- Compressed footprint to aid with workstation compression
- Proud steel front with choice of pull
- Specifiable side access

- Three pull styles: contemporary, handle and ledge
- Steel or cushion top with or without handle available for mobile pedestal

DIMENSIONS

Mobile
H: 20"
W: 12"
D: 18 ⁷ / ₈ "



20"H

TS SERIES HINGE TOP MOBILE PEDESTAL



FEATURES

- Opens either right or left to allow easy access to personal items
- Proud steel front with choice of pull
- 24"D comes standard with bag-drop area

- Three pull styles: contemporary, handle and ledge
- Cushion or laminate top available

DIMENSIONS

Mobile
H: 23"
W: 15 ¹ / ₄ "
D: 18", 24"



23"H

UNIVERSAL STORAGE FIXED AND MOBILE



FEATURES

- Three front styles: flush steel, proud steel and proud wood
- Drawer fronts are removable and interchangeable
- Five pull styles: integral (flush only), contemporary, jazz, bar and handle (proud only)

- Optional individual drawer locks
- Optional tops for mobile pedestal include 1" steel, laminate, wood and cushion, with or without handle

DIMENSIONS

Fixed	Mobile
H: 25 ¹ / ₂ ", 27"	H: 21", 17"
W: 15"	W: 15"
D: 17 ¹ / ₂ ", 22 ⁵ / ₈ ", 28 ⁵ / ₈ "	D: 17 ¹ / ₂ ", 22 ⁵ / ₈ " *Add 7/8" for proud

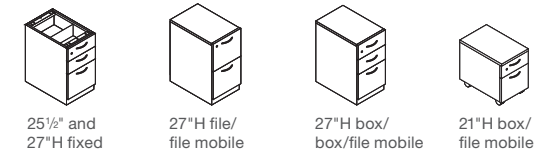

CURRENCY ENHANCED FIXED AND MOBILE



FEATURES

- Laminate case/front with choice of pull
- Eight pull styles available: handle, ledge, jazz, transitional, bar, nile, beam and inset
- File drawers open their full depth for total access to contents
- Box drawers and file drawers have a black laminate body

- while the drawer fronts are available in a variety of laminate colors
- Tops, drawers and cases can all be specified with different laminates
- Cushion top available for mobile pedestal

DIMENSIONS

Fixed	Mobile
H: 21 ³ / ₈ ", 27 ⁵ / ₁₆ "	H: 23 ³ / ₈ ", 27"
W: 15 ³ / ₄ "	W: 15 ³ / ₄ "
D: 18 ⁷ / ₈ ", 22 ⁷ / ₈ ", 24", 27 ⁷ / ₁₆ ", 30"	D: 18 ⁷ / ₈ ", 22"

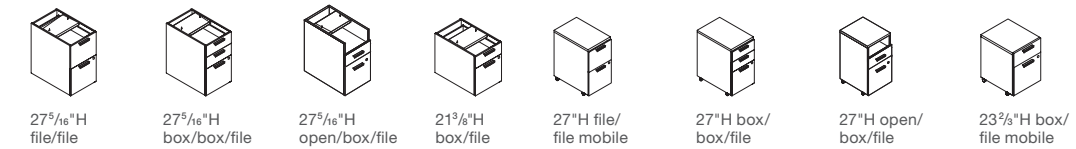

ELECTIVE ELEMENTS SINGLE/DOUBLE



FEATURES

- Wood drawer interiors
- Proud wood and proud laminate styles
- Eight pull styles: contemporary, jazz, inset, transitional, bar, nile, integral (wood front only) and beam
- All wood, all laminate or laminate case with wood front

- Lock included on single pedestal, and available on double except with door with integral or beam pulls
- Adjustable shelves available in wood or metal
- Cushion top optional
- Also available in leg base

DIMENSIONS

Single with hinged door	Open book case	Mobile
H: 27½"	H: 27½"	H: 23"
W: 15", 18"	W: 15", 18", 30", 36"	W: 15½"
D: 17¼", 23¼"	D: 16¼", 22¼", 28¼"	D: 22¾"



27½"H file/file



27½"H box/box/file



27½"H single with hinged door



27½"H double with hinged door



23"H mobile box/file

ELECTIVE ELEMENTS HIGH PEDESTAL



FEATURES

- All wood, all laminate or laminate case with wood front
- Eight pull styles: contemporary, jazz, inset, transitional, bar, nile, integral (wood front only) and beam
- Adjustable shelf

- Proud wood and proud laminate styles
- Adjustable shelves available in wood or metal
- Also available in leg base

DIMENSIONS

Hinged door	Open
H: 35⅞"	H: 35⅞"
W: 15"	W: 15"
D: 15¾"	D: 15"

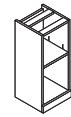

35⅞"H

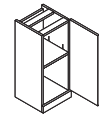

35⅞"H

ELECTIVE ELEMENTS ADJUSTABLE HEIGHT



FEATURES

- Wood drawer interiors
- Eight pull styles: contemporary, jazz, inset, transitional, bar, nile, integral (wood front only) and beam

- Proud wood and proud laminate styles
- All wood, all laminate or laminate case with wood front
- Lock included
- Adjusts 3" up in ½" increments

DIMENSIONS

H: 27½" to 30½"
W: 15"
D: 23¼", 29¼"

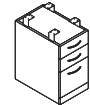

Box/box/file

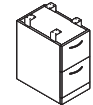

File/file

Bins and Shelves

Bins and shelves keep space organized and offer quick access to personal items like bags and umbrellas.

TS SERIES FLAT AND RADIUS FRONT BINS



FEATURES

- Door available flat or radius steel
- Able to mount on Answer and Kick
- Quiet-close door
- Backstop prevents notebooks and equipment from damaging the surface of the panels or wall
- Wall-mountable when used with wall channels
- Flexible markerboard surface available (ordered separately)

DIMENSIONS

H: 16¼"
W: 24", 30", 36", 42", 48", 60", 72"
D: 15¾"

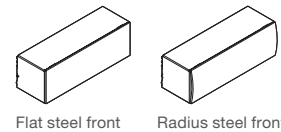

Flat steel front Radius steel front

UNIVERSAL STORAGE SLIDING DOOR BIN



FEATURES

- Door available in painted steel or wood
- On-module attachment brackets are used to mount bins on panels
- Recess beneath unit can accommodate a shelf light
- Steel and wood front doors glide smoothly from one side of the case to the other
- Able to mount on Answer, Kick, Montage, Series 9000 and Avenir panel systems as well as V.I.A. and Privacy Wall
- Wall-mountable when used with wall channels

DIMENSIONS

H: 16¼"
W: 35", 36", 42", 45", 48", 60", 66", 70", 72", 75"
D: 15¾"

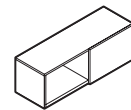

Sliding door bin

UNIVERSAL STORAGE OVER THE CASE



FEATURES

- Door available flat or radius steel
- Optional door assist
- Off-module connection available
- Able to upmount on all panel systems
- Frosted acrylic, markerboard or glass door options
- Able to mount on Answer, Kick, Montage, Series 9000 and Avenir panel systems as well as V.I.A. and Privacy Wall
- Wall-mountable when used with wall channels

DIMENSIONS

H: 16¼"
W: 24", 25", 30", 35", 36", 42", 45", 48", 60", 66", 70", 72", 75"
D: 15¾"

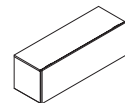

Over the case bin

UNIVERSAL STORAGE IN THE CASE



FEATURES

- Door available flat or radius steel
- Optional door assist
- Off-module connection available
- Able to upmount on all panel systems
- Frosted acrylic, markerboard or glass door options

- Able to mount on Answer, Kick, Montage, Series 9000 and Avenir panel systems as well as V.I.A. and Privacy Wall
- Wall-mountable when used with wall channels

DIMENSIONS

H: 16¼"
W: 24", 25", 30", 35", 36", 42", 45"
D: 15¾"

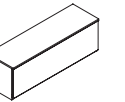

In the case bin

C:SCAPE MID STORAGE



FEATURES

- Available open or with in-line slider
- Option to get the interior or in-line slider a different paint finish than the case

DIMENSIONS

Personal and shared tall storage H: 15" W: 30", 36", 42", 48", 60", 66", 72", 78" D: 17"	Wall-mounted tall storage H: 15" W: 60", 66", 72", 78" D: 17"	Personal and shared slim storage H: 7½" W: 30", 36", 42", 48", 60", 66", 72", 78" D: 17", 24"	Wall-mounted slim storage H: 7½" W: 60", 66", 72", 78" D: 17"
---	--	--	--

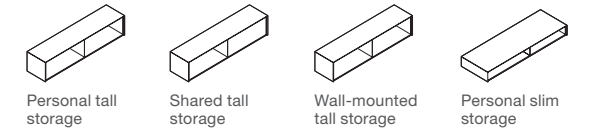

Personal tall storage Shared tall storage Wall-mounted tall storage Personal slim storage

DUO TALL AND SLIM STORAGE



FEATURES

- Laminate construction with painted steel divider
- Compatible with Answer and Post and Beam

DIMENSIONS

Tall storage H: 15" W: 54", 66", 78" D: 18"	Slim storage H: 7½" W: 54", 66" D: 25"
--	---

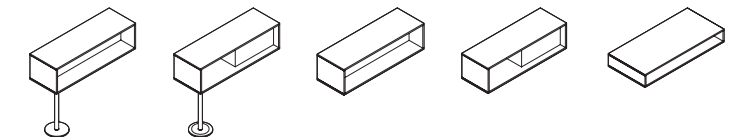

Individual tall storage with leg Shared tall storage with leg Individual tall storage Shared tall storage Slim storage

CURRENCY ENHANCED WALL-MOUNTED OVERHEAD AND ORGANIZERS

FEATURES

- Laminate case/front
- Markerboard front available with sliding doors
- Doors and cases can all be specified with different laminates
- Lock included
- Mount on Answer as face mount, top-cap mount and perpendicular face mount applications
- Mount parallel or perpendicular on FrameOne

DIMENSIONS

H: 8 27/32", 15"
 W: 36", 42", 48", 54", 60", 61 1/2", 63", 66", 67 1/2", 69", 72", 73 1/2", 75"
 D: 15", 16"

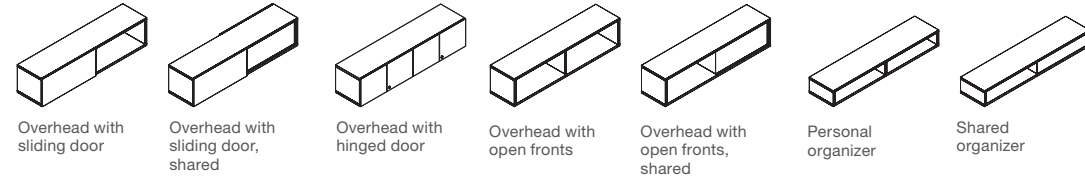

ELECTIVE ELEMENTS DOUBLE HIGH OVERHEAD

FEATURES

- All wood, all laminate or laminate case with wood front
- Proud wood and proud laminate styles
- Glass doors are available on wood cases with combination overheads
- Can be wall-mounted or suspended between two towers
- Locks are an available option on the far left and far right hinged doors, non-glass only
- Products with adjustable shelves are available in wood or metal

DIMENSIONS

H: 30"
 W: 60", 66", 72", 78", 84", 90", 96"
 D: 15" (open), 15 5/8" (doors)

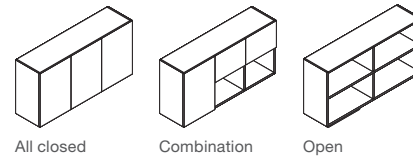

ELECTIVE ELEMENTS SINGLE HIGH OVERHEAD STORAGE

FEATURES

- All wood, all laminate or laminate case with wood front
- Proud wood and proud laminate styles
- Glass doors are available on wood cases with sliding doors or hinged doors greater than 36"W
- Can be wall-mounted, attached to Montage, Answer, Technology Wall or Privacy Wall, or suspended between two towers and 15"H on V.I.A.
- Locks are an available option on the far left and far right hinged doors, non-glass only

DIMENSIONS

Open H: 15", 22" W: 30", 36", 42", 48", 54", 60", 66", 72", 78", 84", 90", 96" D: 15", 17 1/4"	Sliding door H: 15" W: 36", 42", 48", 54", 60", 66", 72", 78", 84", 90", 96" D: 15 3/4", 18"	Hinged door H: 15", 22" W: 30", 36", 42", 48", 54", 60", 66", 72", 78", 84", 90", 96" D: 15 3/4", 18"
---	---	--

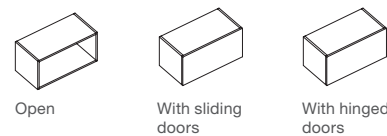

TS SERIES LAMINATE COMMON SHELVES

FEATURES

- Wood core with low-pressure or high-pressure laminate
- Field-installed reinforcing for heavy loads

DIMENSIONS

H: 7 3/4"
 W: 24", 30", 36", 42", 48"
 D: 15"

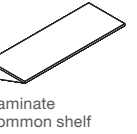

UNIVERSAL STORAGE SHELF

FEATURES

- Recess beneath unit to accommodate shelf light
- Shelf backstop
- On-module attachment hooks with safety catch
- Able to mount on Answer, Kick, Montage, Series 9000 and Avenir panel systems as well as V.I.A. and Privacy Wall
- Wall-mountable when used with wall channels

DIMENSIONS

H: 16 1/4"
 W: 24", 25", 30", 35", 36", 42", 45", 48", 60", 66", 70", 72", 75"
 D: 15 3/4"

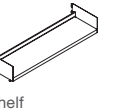

UNIVERSAL STORAGE PERSONAL SHELF

FEATURES

- Recess beneath unit to accommodate shelf light
- On-module attachment hooks with safety catch
- Able to mount on Answer, Kick, Montage, Series 9000 and Avenir panel systems as well as V.I.A. and Privacy Wall
- Wall-mountable when used with wall channels

DIMENSIONS

W: 24", 25", 30", 35", 36", 42", 45", 48"
 D: 13 1/16"



UNIVERSAL STORAGE SLIM SHELF

FEATURES

- Can mount off-module on any panel system
- Able to mount on Answer, Kick, Montage, Series 9000 and Avenir panel systems as well as V.I.A. and Privacy Wall
- Wall-mountable when used with wall channels

DIMENSIONS

W: 24", 25", 30", 35", 36", 42", 45", 48", 60", 70", 72", 96"
 D: 6"

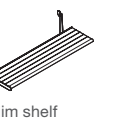

ELECTIVE ELEMENTS SHELVES



FEATURES

- Laminate or wood
- Can be wall-mounted, attached to Montage, Answer, Technology Wall or Privacy Wall, or suspended between two towers and 15"H on V.I.A.
- Accessory shelves can be attached to the bottom of an overhead or organizer, service module or open-shelf integral pulls
- Proud wood and proud laminate styles
- Glass doors (no locks) are available on wood cases

DIMENSIONS

Blade accessory*	Open	Organizer
H: 3 ³ / ₁₆ "	H: 7 ¹ / ₂ "	H: 7 ¹ / ₂ "
W**: 47 ³ / ₄ ", 53 ³ / ₄ "	W: 30", 36", 42", 48", 54", 60"	W: 30", 36", 42", 48", 54", 60"
59 ³ / ₄ ", 65 ³ / ₄ ", 71 ³ / ₄ ", 77 ³ / ₄ ", 83 ³ / ₈ ", 95 ³ / ₄ "	D: 15"	D: 15", 17 ¹ / ₄ "
D: 14 ¹ / ₈ "		

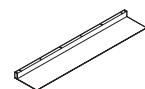

Blade accessory

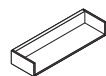

Open

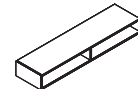

Organizer

*For overhead applications
 **Version for service modules and two-sided hutch kits are 1.45" less

ELECTIVE ELEMENTS FLOATING SHELF WITH BACK PANEL



FEATURES

- Laminate or wood
- Can be wall-mounted
- Standard horizontal grain direction with optional vertical grain direction on 60"W or less
- Designed for light weight storage settings
- An additional floating back panel can be ordered separately to create more applications

DIMENSIONS

H: 15", 22", 30"
W: 36", 54", 72", 90"
D: 6", 12"

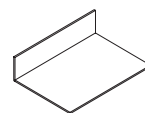

Floating shelf

Laterals

Laterals efficiently organize documents, archives and project files with easy-to-access, high-volume storage.

TS SERIES



FEATURES

- Proud steel front with choice of pull
- Three pull styles: contemporary, handle and ledge
- 1.5H laterals have finished top, are freestanding and are available in open/open and drawer/drawer configurations
- Two-high laterals have open top to support worksurfaces and are available in drawer/drawer configuration

DIMENSIONS

H: 27"
W: 30½", 36"
D: 18"

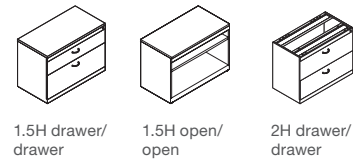

1.5H drawer/drawer 1.5H open/open 2H drawer/drawer

UNIVERSAL STORAGE



FEATURES

- Three front styles: flush steel, proud steel and proud wood
- Drawer fronts are removable and interchangeable
- Five pull styles: contemporary, jazz, bar, handle and c:scape
- Lift-up door with fixed shelf in top openings of 65½"H supports binder storage
- Optional tops include laminate, wood, security, no top or cushion top for 1H, 1.5H and 2H
- Optional individual drawer locks

DIMENSIONS

Proud	Flush
H: 16", 22", 28", 40", 52", 65½"	H: 16", 22", 28", 40", 52", 65½"
W: 30", 36", 42"	W: 30", 36", 42"
D: 18⅞", 24"	D: 18", 23⅞"

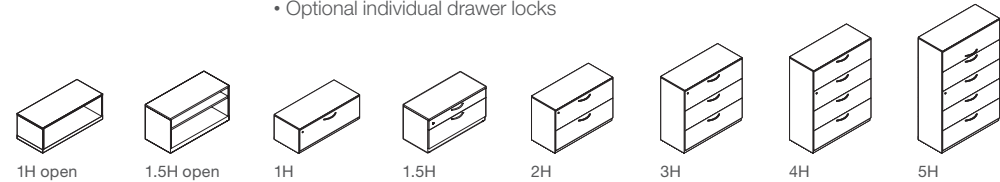

1H open 1.5H open 1H 1.5H 2H 3H 4H 5H

UNIVERSAL STORAGE OPEN LATERAL WITH HEIGHT-ADJUSTABLE DESK INTEGRATION



FEATURES

- Integrates the Ology or Migration SE desk leg into Universal storage
- Top is available in laminate and wood veneer
- Removable interior cover provides access to power outlets
- Usable depth for Ology is 12"D; usable depth for Migration SE is 11"D
- Grommet provides a clean area where the desk leg integrates
- Wire manager keeps wires tidy and functionally flexes vertically

DIMENSIONS

Ology Proud	Ology Flush
H: 16", 22"	H: 16", 22"
W: 30", 36", 42"	W: 30", 36", 42"
D: 18⅞"	D: 18"
Migration SE Proud	Migration SE Flush
H: 16", 22"	H: 16", 22"
W: 30", 36", 42"	W: 30", 36", 42"
D: 18⅞"	D: 18"

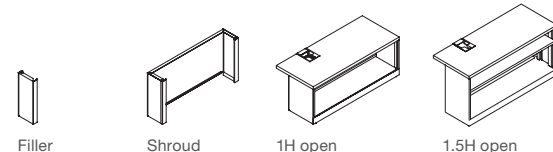

Filler Shroud 1H open 1.5H open

C:SCAPE LOW STORAGE



FEATURES

- Two front styles: flush steel and wood veneer
- Available with c:scape Integral pull
- Drawers open full depth for total access to their contents
- Optional tops include no top or wood veneer top
- Connect zone, available on 1.5H storage, gives the user easy access to both power and data while also managing cords
- Rail on back of connect zone allows for attachment of personal/modesty screens and worktools

DIMENSIONS

H: 18⅞", 24"
W: 30", 36", 42"
D: 17"

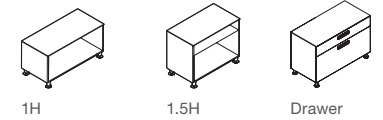

1H 1.5H Drawer

CURRENCY ENHANCED



FEATURES

- Laminate case/front with choice of pull
- Eight pull styles available: handle, ledge, jazz, transitional, bar, Nile, beam and inset
- File drawers open full depth for total access to contents
- Box drawers and file drawers have a black laminate body while the drawer fronts are available in a variety of laminate colors
- Optional tops include laminate, no top or cushion top for 1H, 1.5H and 2H
- Tops, drawers and cases can all be specified with different laminates

DIMENSIONS

H: 15⅞", 21⅞", 27⅞", 39⅞", 51⅞"
W: 30", 36"
D: 18 7/8", 22 3/4", 24"D

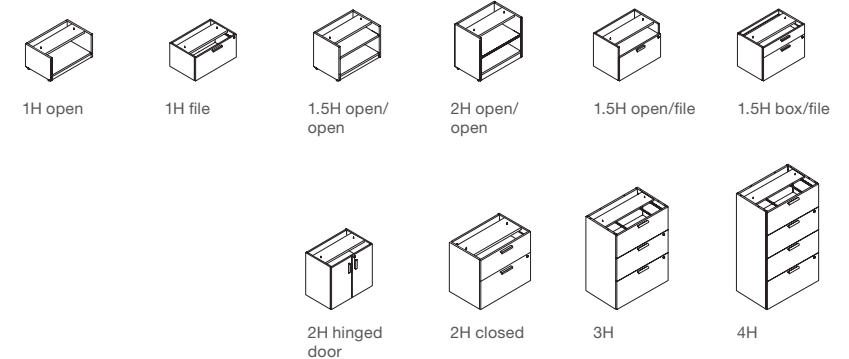

1H open 1H file 1.5H open/open 2H open/open 1.5H open/file 1.5H box/file
2H hinged door 2H closed 3H 4H

ELECTIVE ELEMENTS



FEATURES

- Eight pull styles: contemporary, jazz, inset, transitional, bar, nile, integral (wood front only) and beam
- All wood, all laminate or laminate case with wood front
- Lock included
- Proud wood and proud laminate styles
- Two-high has worksurface top
- Adjustable shelves available in wood or metal
- Cushion top available
- Also available in leg base

DIMENSIONS

Freestanding lateral file	File drawer	Open bookcase
H: 29"; 41¼"; 51¼"	H: 15½", 21½", 27½"	H: 15½", 21½", 27½"
W: 30"; 36"	W: 30"; 36"	W: 30"; 36"
D: 24"	D: 17¼", 23¼"	D: 16¼", 22¼"

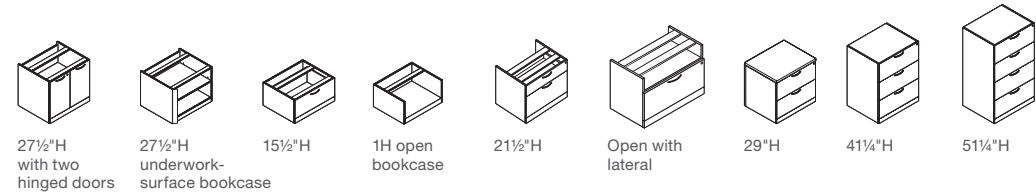

CURRENCY ENHANCED WITH OLOGY, MIGRATION SE, OR SLIM LEG HAD INTEGRATION



FEATURES

- Integrates height adjustable leg into Currency storage
- Top and case available in LPL and HPL
- Removable interior cover provides access to power outlets
- Usable depth is 12"
- Tops are specified separately; common tops also available
- Grommet provides a clean area where the desk leg integrates
- Integrated Ology, Migration SE, or Slim Leg HAD Desk leg into Currency Enhanced storage
- Wire manager keeps wires tidy and functionally fixes vertically

DIMENSIONS

H: 15 3/8", 21 3/8"
W: 30", 36", 42", 48", 60", 72"
D: 18 7/8"

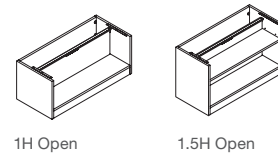

ELECTIVE ELEMENTS WITH OLOGY INTEGRATION



FEATURES

- Integrates Ology leg into Elective Elements storage
- Removable interior cover provides access to power outlets
- Usable depth is 12"
- Grommet provides a clean area where the desk leg integrates
- Wire manager keeps wires tidy and functionally fixes vertically

DIMENSIONS

H: 15½", 21"
W: 24", 30", 36", 42"
D: 18 7/8"

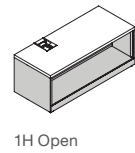

Credenzas

Credenzas solve the storage needs of meeting spaces while providing a visually appealing alternative to typical solutions.

CURRENCY ENHANCED CRENZAS



FEATURES

- Laminate case/front with choice of pull
- Eight pull styles available: handle, ledge, jazz, transitional, bar, Nile, beam and inset
- Available with doors, drawers, or open
- Option of HPL or LPL
- Tops, doors and cases can all be specified with different laminates
- Lock included

DIMENSIONS

H: 21³/₈" , 27⁵/₁₆"
 W: 42", 48", 60", 66", 72"
 D: 17"

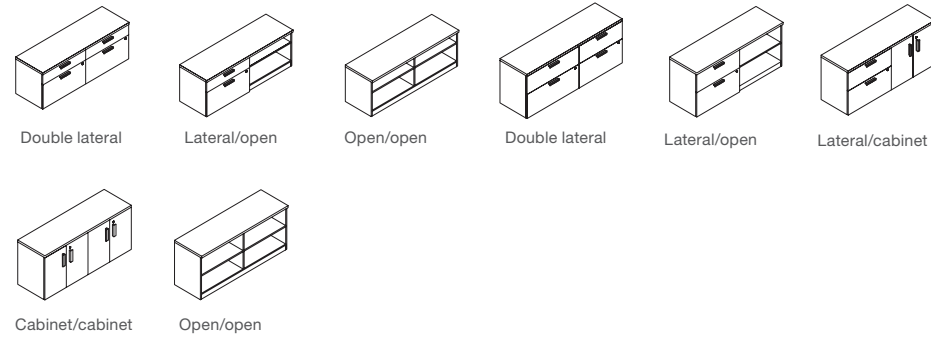

ELECTIVE ELEMENTS LEG BASE AND RETURN CRENZAS



FEATURES

- Wood drawer interiors
- Eight pull styles: contemporary, jazz, bar, Nile, integral (wood front only), inset, transitional and beam
- Proud wood and proud laminate styles
- All wood, all laminate or laminate case with wood front
- Lock included
- Adjustable shelves available in wood or metal
- Leg base only

DIMENSIONS

H: 21¹/₂" , 27¹/₂"
 W: 60", 72"
 D: 18", 24"

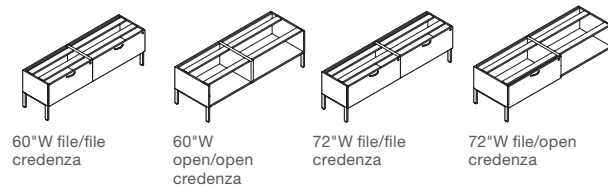

Towers and Wardrobes

Hardworking options that vertically store a variety of items, towers and wardrobes provide high-volume storage with a smaller footprint. High Density Storage offers ample organizational space with the added benefit of expandable privacy.

TS SERIES TOWER TOO™



FEATURES

- Right- or left-handed
- File/file or box/box/file
- Wardrobe specifiable with coat hook or shelf with rod
- Available with optional individual locks
- Optional dome top
- Three pull styles: contemporary, handle and ledge
- Fixed shelves
- Open side shelf available in place of upper cabinet

DIMENSIONS

H: 54", 66"
W: 24"
D: 24"

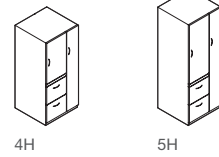

TS SERIES TOWER TOO™, SIDE ACCESS



FEATURES

- Right- or left-handed
- File/file or box/box/file
- Wardrobe specifiable with coat hook or shelf with rod
- Available with optional individual locks
- Optional dome top
- Handle pull
- Fixed shelves
- Three pull styles: contemporary, handle and ledge

DIMENSIONS

H: 48", 54", 66"
W: 24"
D: 24"

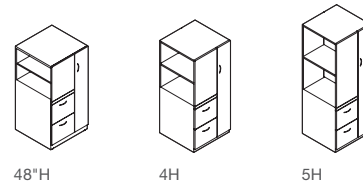

UNIVERSAL STORAGE OPEN SIDE



FEATURES

- Three front styles: flush steel, proud steel and proud wood
- Six pull styles: integral, jazz, contemporary, bar, handle and c:scape
- Drawer fronts are removable and interchangeable
- Optional tops include laminate, wood and glass skylight
- Optional glass shelves

DIMENSIONS

H: 47½", 52", 65½"
W: 24"
D*: 18", 23⅜", 29⅞"
*Add ⅞" for proud fronts

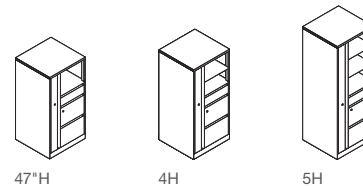

UNIVERSAL STORAGE VERTICAL DRAWER



FEATURES

- Three front styles: flush steel, proud steel and proud wood
- Six pull styles: integral, jazz, contemporary, bar, handle and c:scape
- Drawer fronts are removable and interchangeable
- Optional tops include laminate or wood
- Lift-up door with fixed shelf in top opening of 65½"H supports binder storage

DIMENSIONS

H: 52", 65½"
W: 24"
D*: 23⅜", 29⅞"
*Add ⅞" for proud fronts

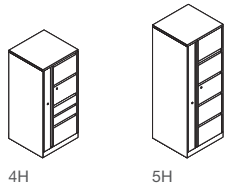

UNIVERSAL STORAGE FULL FRONT



FEATURES

- Three front styles: flush steel, proud steel and proud wood
- Six pull styles: integral, jazz, contemporary, bar, handle and c:scape
- Optional tops include laminate or wood
- Variety of drawer and shelf interiors

DIMENSIONS

H: 52", 65½"
W: 24"
D*: 23⅜"
*Add ⅞" for proud fronts

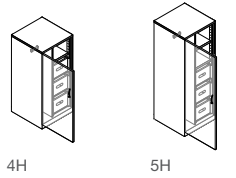

UNIVERSAL STORAGE WORKSTATION VERTICAL



FEATURES

- Three front styles: flush steel, proud steel and proud wood
- Six pull styles: integral, jazz, contemporary, bar, handle and c:scape
- Drawer fronts are removable and interchangeable
- Optional tops include laminate or wood
- Lift-up door with fixed shelf in top opening of 65½"H supports binder storage

DIMENSIONS

H: 52", 65½"
W: 15"
D*: 23⅜", 29⅞"
*Add ⅞" for proud fronts

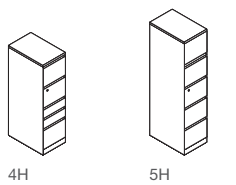

UNIVERSAL STORAGE DUAL DOOR TOWER



FEATURES

- Three front styles: flush steel, proud steel and proud wood
- Six pull styles: integral, jazz, contemporary, bar, handle and c:scape
- Drawer fronts are removable and interchangeable
- Optional tops include laminate, wood and glass skylight

DIMENSIONS

H: 47½", 52", 65½"
W: 24"
D*: 18", 23⅜"
*Add ⅞" for proud fronts

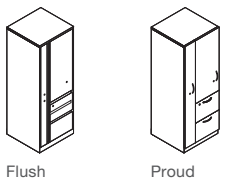

Shown with optional FrameOne foot base

CURRENCY ENHANCED



FEATURES

- Laminate case/front
- Doors and cases can all be specified with different laminates
- Lock included
- Eight pull styles available: handle, ledge, jazz, transitional, bar, Nile, beam and inset

DIMENSIONS

Single door H: 41 ²⁵ / ₃₂ " 47 ³¹ / ₃₂ " 54 ¹ / ₈ " 66 ¹ / ₂ " W: 15 ³ / ₄ " D: 24"	Dual door H: 41 ²⁵ / ₃₂ " 47 ³¹ / ₃₂ " 54 ¹ / ₈ " 66 ¹ / ₂ " W: 24" D: 18 ⁷ / ₈ " 24"	Side access H: 41 ²⁵ / ₃₂ " 47 ³¹ / ₃₂ " 54 ¹ / ₈ " 66 ¹ / ₂ " W: 24" D: 18" 24"
---	---	--

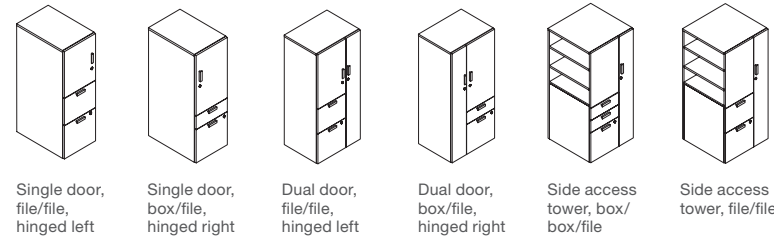

Single door, file/file, hinged left Single door, box/file, hinged right Dual door, file/file, hinged left Dual door, box/file, hinged right Side access tower, box/box/file Side access tower, file/file

HIGH DENSITY STORAGE



FEATURES

- Proud front style: laminate or veneer
- Interior: painted finished steel
- Four pull styles: Nile, contemporary, jazz and bar
- Value Package unit available in shelf configuration with or without coat closet. All laminates and pulls are available on Value Package

DIMENSIONS

- Four interior configurations: bag drop, bag drop with coat closet, shelf and shelf with coat closet
- Lock included

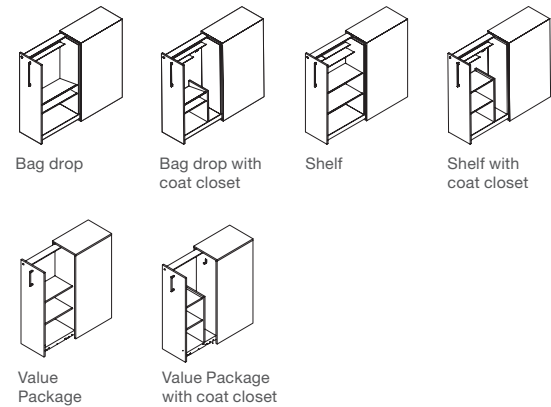

Bag drop Bag drop with coat closet Shelf Shelf with coat closet
Value Package Value Package with coat closet

CURRENCY ENHANCED WARDROBE CABINET



FEATURES

- Proud front style: laminate
- Eight pull styles available: handle, ledge, jazz, transitional, bar, Nile, beam and inset
- Tops, doors and cases can all be specified with different laminates
- Lock included
- Single wardrobe needs to be ganged or mounted

DIMENSIONS

H: 41 ²⁵ / ₃₂ " 47 ³¹ / ₃₂ " 54 ¹ / ₈ " W: 12" D: 18 ⁷ / ₈ " 24"
--

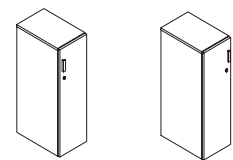

Door hinged right Door hinged left

ELECTIVE ELEMENTS FULL HEIGHT WITH DOORS



FEATURES

- All wood, all laminate or laminate case with wood front
- Eight pull styles: contemporary, jazz, inset, transitional, bar, Nile, integral (wood front only) and beam
- Lock included on all units except doors with integral pulls; on 24"W units, only the wardrobe door will lock
- Proud wood and proud laminate styles
- Products with adjustable shelves are available in wood or metal
- Glass doors (no locks) are available on wood cases, except on wardrobe doors
- Also available in leg base

DIMENSIONS

Single door H: 45" 55 ¹ / ₄ " 65 ⁵ / ₈ " 72 ¹ / ₂ " 77 ¹ / ₂ " W: 15 ¹ / ₂ " D: 18" 24"	With wardrobe H: 65 ⁵ / ₈ " 72 ¹ / ₂ " 77 ¹ / ₂ " W: 24" D: 24" 30"
--	--

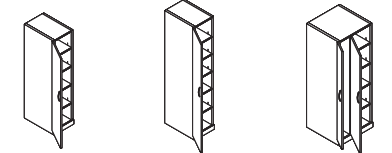

55¹/₄"H 5H 65⁵/₈"H 6H 55¹/₄"H 5H with wardrobe

ELECTIVE ELEMENTS DOORS AND DRAWERS



FEATURES

- Eight pull styles: contemporary, jazz, inset, transitional, bar, Nile, integral (wood front only) and beam
- All wood, all laminate or laminate case with wood front
- Lock included on all units except doors with integral pulls; on 24"W units, only the wardrobe door will lock
- Proud wood and proud laminate styles
- Products with adjustable shelves are available in wood or metal
- Glass doors (no locks) are available on wood cases, except on wardrobe doors
- Also available in leg base

DIMENSIONS

Single door H: 45" 65 ⁵ / ₈ " 72 ¹ / ₂ " 77 ¹ / ₂ " W: 15 ¹ / ₂ " D: 24"	With wardrobe H: 45" 55 ¹ / ₄ " 65 ⁵ / ₈ " 72 ¹ / ₂ " 77 ¹ / ₂ " W: 24" D: 18" 24"
---	---

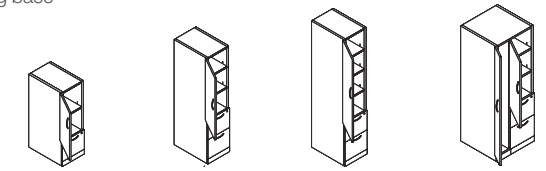

45"H 65⁵/₈"H 72¹/₂"H 72¹/₂"H with wardrobe

ELECTIVE ELEMENTS OPEN SHELVES AND DRAWERS



FEATURES

- Eight pull styles: contemporary, jazz, inset, transitional, bar, Nile, integral (wood front only) and beam
- Locks included on drawers and doors, except doors with integral pulls
- Proud wood and proud laminate styles
- Products with adjustable shelves are available in wood or metal
- Also available in leg base

DIMENSIONS

Open shelves and drawers H: 45" 55 ¹ / ₄ " 65 ⁵ / ₈ " 72 ¹ / ₂ " 77 ¹ / ₂ " W: 15 ¹ / ₂ " D: 18" 24"	With wardrobe H: 45" 65 ⁵ / ₈ " 72 ¹ / ₂ " 77 ¹ / ₂ " W: 24" D: 24"	Open side H: 65 ⁵ / ₈ " W: 24" D: 24"
---	--	--

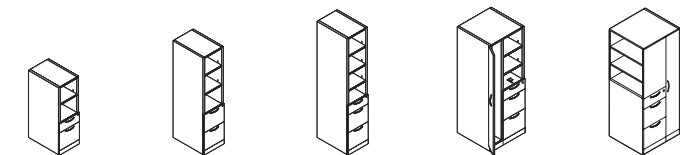

45"H 4H 65⁵/₈"H 5H 72¹/₂"H 7H 72¹/₂"H 6H with wardrobe 72¹/₂"H 6H with wardrobe and open side shelf

Lockers

Lockers create a secure space for personal items, in both shared or owned areas, providing convenience and safety.

TS SERIES SINGLE, DOUBLE AND QUAD LOCKER



FEATURES

- Single locker option of two coat hooks or one coat rod
- Single locker optional shelf available
- Double and quad lockers come standard with two coat hooks per opening
- Three pull choices: handle, ledge and contemporary
- Optional electronic lock
- Right- or left-handed
- Lock cylinders specified separately
- Single locker needs to be ganged or mounted

DIMENSIONS

Single	Double	Quad
H: 40", 52", 65½"	H: 65½"	H: 65½"
W: 12", 18"	W: 12", 18"	W: 24"
D: 18", 24"	D: 18", 24"	D: 18"



Single

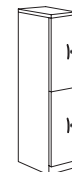

Double



Quad

TS SERIES SINGLE AND DOUBLE CUBBY LOCKER



FEATURES

- Proud front style: steel
- Three pull choices: handle, ledge and contemporary
- Optional electronic lock
- Right- or left-handed
- Lock cylinders specified separately
- Single locker needs to be ganged or mounted

DIMENSIONS

Single	Double
H: 40", 52", 65½"	H: 40", 52", 65½"
W: 12"	W: 24"
D: 18"	D: 18"

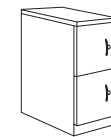

Single

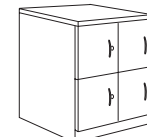

Double

TS SERIES MULTIPURPOSE LOCKER



FEATURES

- Wardrobe hook
- Fixed shelf on top with three adjustable shelves
- Pull out hanging file rack
- Proud front style: steel
- Three pull choices: handle, ledge and contemporary
- Optional electronic lock
- Right- or left-handed
- Lock cylinders specified separately
- Single locker needs to be ganged or mounted

DIMENSIONS

H: 66"
W: 18"
D: 18"

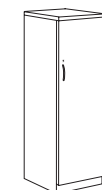

Locker

UNIVERSAL STORAGE PERSONAL LOCKERS



FEATURES

- Optional adjustable shelf (additional shelves available through Service Parts)
- Optional coat rod or coat hook
- Right- or left-handed
- Four front styles: flush, proud steel, proud laminate or proud wood
- Six pull styles: integral, jazz, contemporary, bar, handle and c:scape

- Top choices available in steel, laminate wood or no top for use with a common top
- Lock included
- Single locker needs to be ganged or mounted

DIMENSIONS

Single door
 H: 42", 48", 52", 65½"
 W: 9", 12"
 D*: 18", 23½"
 *Add ⅞" for proud fronts



Single door

UNIVERSAL STORAGE CUBBY LOCKER



FEATURES

- Right- or left-handed
- Four front styles: flush, proud steel, proud laminate or proud wood

- Six pull styles: integral, jazz, contemporary, bar, handle and c:scape
- Top choices available in steel, laminate wood or no-top for use with a common top
- Lock included
- Single locker needs to be ganged or mounted

DIMENSIONS

Two or three door
 H: 52", 65½"
 W: 18"
 D*: 18", 23½"
 *Add ⅞" for proud fronts

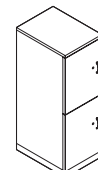

Two door

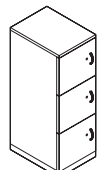

Three door

CURRENCY ENHANCED WARDROBE CABINET



FEATURES

- Proud front style: laminate
- Eight pull styles available: handle, ledge, jazz, transitional, bar, Nile, beam and inset

- Tops, doors and cases can all be specified with different laminates
- Lock included
- Single wardrobe needs to be ganged or mounted

DIMENSIONS

H: 41²⁵/₃₂", 47³¹/₃₂", 54¹/₈"
 W: 12"
 D: 18⁷/₈", 24"



Door hinged right

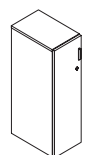

Door hinged left

FLEX ACTIVE FRAMES



FEATURES

- Steel frames with high-pressure laminate shelves
- Infill panels and fixed boards options for enclosure
- Doors offered with or without locking
- Accessories: Pin-tackable PET, marker boards, coat rods, bookends, mobile board clips and cable management clip.

DIMENSIONS

Wide Frame
 H: 15³/₄" 31¹/₂" 45¹/₄" 63"
 W: 15³/₄" 31¹/₂"
 D: 15³/₄"

Frame extensions
 H: 15³/₄" 31¹/₂" 45¹/₄" 63"
 W: 15³/₄" 31¹/₂"
 D: 15³/₄"

Shelves
 H: 3³/₈"
 W: 15³/₄" 31¹/₂"
 D: 15³/₄"

Doors
 H: 15³/₄"
 W: 15³/₄" 31¹/₂"
 D: 3³/₈"

Infill panels
 H: 15³/₄"
 W: 15³/₄" 31¹/₂"
 D: 3³/₈"

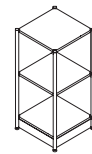

Frames

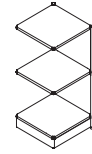
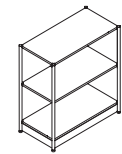

Frame Extensions

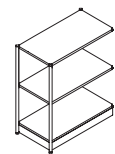

Doors

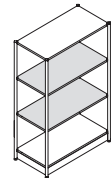

Shelves

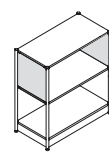

Infill panels

Cabinets and Bookcases

Effective storage for both personal and work-related items, cabinets and bookcases meet a variety of storage needs.

UNIVERSAL STORAGE COMBINATION CABINET



FEATURES

- Three front styles: flush steel, proud steel and proud wood
- Five pull styles: integral, jazz, contemporary, bar and handle
- Two door options: steel and glass
- Drawer fronts are removable and interchangeable
- Optional tops include laminate, wood, security or no top

DIMENSIONS

H: 52", 65½", 83½"
 W: 30", 36", 42"
 D*: 18", 23⅞"
 *Add ⅞" for proud fronts

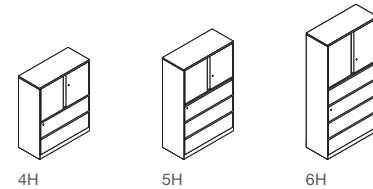

UNIVERSAL STORAGE STORAGE CABINET



FEATURES

- Three front styles: flush steel, proud steel and proud wood
- Five pull styles: integral, jazz, contemporary, bar and handle
- Optional tops include laminate, wood, security or no top

DIMENSIONS

H: 28", 40", 52", 65½", 83½"
 W: 30", 36", 42"
 D*: 18", 23⅞"
 *Add ⅞" for proud fronts

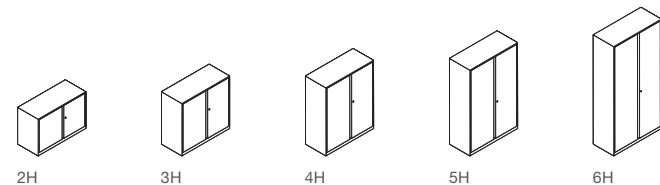

UNIVERSAL STORAGE WARDROBE CABINET



FEATURES

- Three front styles: flush steel, proud steel and proud wood
- Five pull styles: integral, jazz, contemporary, bar and handle
- Optional tops include laminate, wood, security or no top

DIMENSIONS

H: 52", 65½", 83½"
 W: 30", 36"
 D*: 23⅞"
 *Add ⅞" for proud fronts

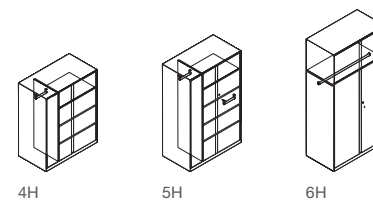

UNIVERSAL STORAGE BOOKCASE



FEATURES

- Optional tops include laminate, wood security or no top
- Optimized for binder storage on all shelves
- Optional hinged-glass doors available
- Display shelf available

DIMENSIONS

H: 28", 40", 53½", 65½", 83½"
 W: 24", 30", 36", 42"
 D: 15"

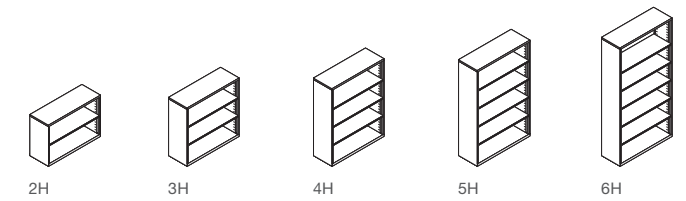

UNIVERSAL STORAGE OVERFILE CABINET



FEATURES

- Flush front style: steel
- Available with or without sliding door with integral pulls

DIMENSIONS

H: 18", 31½"
 W: 30", 36", 42"
 D: 18"

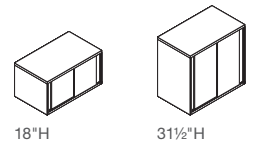

CURRENCY ENHANCED BOOKCASE



FEATURES

- Shelves adjust in ¼" increments using a reversible bracket
- Heights will be flush with Answer panel at same height with thin trim selected
- Option of LPL or HPL case

DIMENSIONS

H: 41²⁵/₃₂", 47³¹/₃₂", 54¹/₈", 66¹/₂", 72¹¹/₁₆"
 W: 30", 36"
 D: 15"

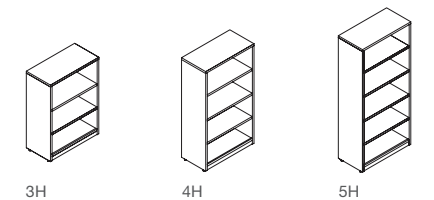

CURRENCY ENHANCED STACKING BOOKCASE



FEATURES

- Laminate case
- Adjustable shelves
- Heights align with tall storage when placed on 2H storage

DIMENSIONS

H: 25⁵/₈" , 37³¹/₃₂" , 44³/₁₆"
 W: 30" , 36"
 D: 15"

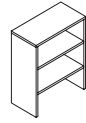

Stacking bookcase

ELECTIVE ELEMENTS VERTICAL CABINET



FEATURES

- Eight pull styles: contemporary, jazz, inset, transitional, bar, nile, integral (wood front only) and beam
- Locks included on drawers and doors, except doors with integral pulls
- Also available in leg base
- Proud wood and proud laminate styles
- Products with adjustable shelves are available in wood or metal
- Glass doors (no locks) are available on wood cases

DIMENSIONS

H: 45" , 65⁵/₈" , 72¹/₂" , 77¹/₂"
 W: 30"
 D: 24" , 30"

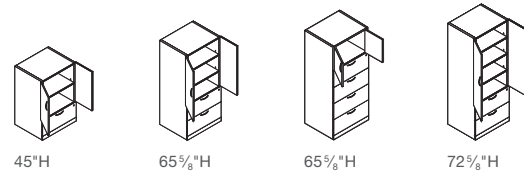

45"H

65⁵/₈"H

65⁵/₈"H

72¹/₂"H

ELECTIVE ELEMENTS WARDROBE



FEATURES

- Eight pull styles: contemporary, jazz, inset, transitional, bar, nile, integral (wood front only) and beam
- All wood, all laminate or laminate case with wood front
- Lock included except with integral pulls
- Proud wood and proud laminate styles
- Glass doors (no locks) are available on wood cases
- Also available in leg base

DIMENSIONS

Personal wardrobe	Wardrobe
H: 45" , 55 ¹ / ₄ " , 65 ⁵ / ₈ " , 72 ¹ / ₂ " , 77 ¹ / ₂ "	H: 65 ⁵ / ₈ " , 72 ⁵ / ₈ " , 72 ¹ / ₂ "
W: 12"	W: 15" single door , 30" double door
D: 18" , 24"	D: 24"

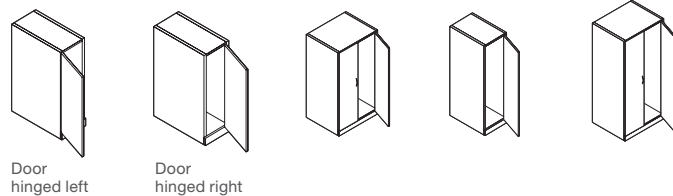

Door hinged left

Door hinged right

ELECTIVE ELEMENTS FREESTANDING AND STACKING BOOKCASE



FEATURES

- Eight pull styles: contemporary, jazz, inset, transitional, bar, nile, integral (wood front only) and beam
- All wood, all laminate or laminate case with wood front
- Freestanding bookcase also available in leg base
- Proud wood and proud laminate styles
- Products with adjustable shelves are available in wood or metal

DIMENSIONS

Freestanding bookcase	Stacking bookcase
H: 45" , 65 ⁵ / ₈ " , 72 ¹ / ₂ " , 77 ¹ / ₂ "	H: 32 ¹ / ₄ " , 36 ⁵ / ₈ " , 43 ¹ / ₂ " , 48 ⁹ / ₁₆ "
W: 24" , 30" , 36"	W: 15" , 18" , 30" , 36"
D: 15" (open) , 15 ³ / ₄ " (doors)	D: 15" , 17 ¹ / ₄ " (open) , 15 ³ / ₄ " , 18" (doors)

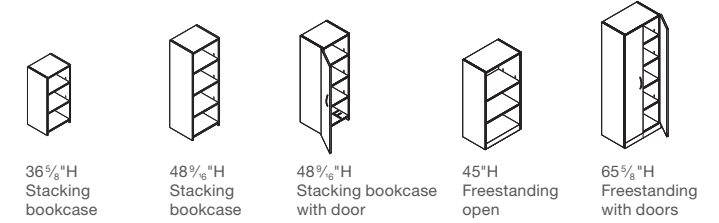

36⁵/₈"H Stacking bookcase

48⁵/₈"H Stacking bookcase

48⁵/₈"H Stacking bookcase with door

45"H Freestanding open

65⁵/₈"H Freestanding with doors

FLEX ACTIVE FRAMES BOOKCASE



FEATURES

- Steel frames with high-pressure laminate shelves
- Infill panels and fixed boards option for enclosure
- Doors offered with or without locking
- Accessories: Pin-tackable PET, marker boards, coat rods, bookends, mobile board clips and cable management clip

DIMENSIONS

Wide Frame	Frame extensions	Shelves
H: 15 ³ / ₄ " , 31 ¹ / ₂ " , 45 ¹ / ₄ " , 63"	H: 15 ³ / ₄ " , 31 ¹ / ₂ " , 45 ¹ / ₄ " , 63"	H: 3 ⁵ / ₈ "
W: 15 ³ / ₄ " , 31 ¹ / ₂ "	W: 15 ³ / ₄ " , 31 ¹ / ₂ "	W: 15 ³ / ₄ " , 31 ¹ / ₂ "
D: 15 ³ / ₄ "	D: 15 ³ / ₄ "	D: 15 ³ / ₄ "
	Infill panels	
	H: 15 ³ / ₄ "	
	W: 15 ³ / ₄ " , 31 ¹ / ₂ "	
	D: 3 ⁵ / ₈ "	

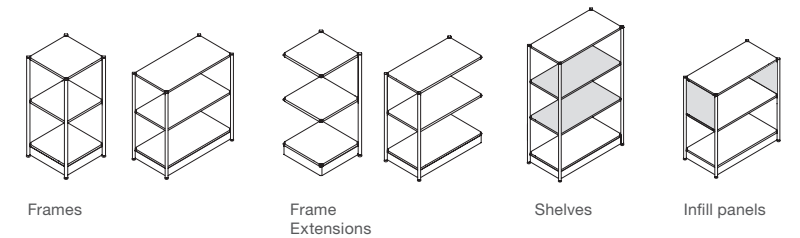

Frames

Frame Extensions

Shelves

Infill panels

File Surrounds

File surrounds encase storage to create elegant islands, informal meeting spaces and additional collaborative spaces while providing a seamless, finished look.

UNIVERSAL FILE SURROUND



FEATURES

- High-Pressure Laminate or Wood Veneer
- Can be specified with a single or sectioned top
- Can specify .5/1mm or 3mm edgeband for each side of the top
- Up to 72"W unsupported open space between storage units to provide touchdown space
- Available with or without back panel (proud, flush or inset)
- Available with one or two end panels
- Specifiable through SmartTools only

DIMENSIONS

Top thickness: 1 3/16"
 H: 15"-67"
 W: 15"-356 7/8"
 D: 15"-58 1/4"

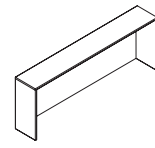

With back panel

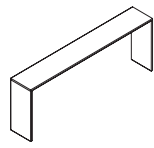

Without back panel

ELECTIVE ELEMENTS FILE SURROUND



FEATURES

- High-Pressure Laminate or Wood Veneer
- Can be specified with a single or sectioned top
- Can specify .5/1mm or 3mm edgeband for each side of the top
- Up to 90"W unsupported open space between storage units to provide touchdown space
- For use with Universal lateral files only
- Available with or without back panel (proud, flush or inset)
- Available with one or two end panels
- Specifiable through SmartTools only

DIMENSIONS

Top thickness: 1 1/2"
 H: 15"-67"
 W: 15"-356 7/8"
 D: 15"-58 1/4"

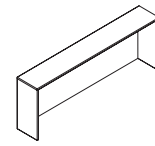

With back panel

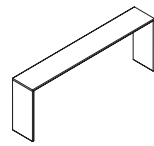

Without back panel

Steelcase®

Call 800.333.9939 or visit [Steelcase.com](https://www.steelcase.com)

 [facebook.com/Steelcase](https://www.facebook.com/Steelcase)

 twitter.com/Steelcase

 [youtube.com/SteelcaseTV](https://www.youtube.com/SteelcaseTV)

Item #17-0005303 3/22 ©2022 Steelcase Inc. All rights reserved. All specifications subject to change without notice. Trademarks used herein are the property of Steelcase Inc. or of their respective owners.