



Steelcase Worktools Specification Guide

Availability

Electronic price list updated with release 204.C (U.S.) and 158.C (Canada), dated June 15, 2026.

All specifications subject to change without notice. Reference the electronic catalog/Hedberg for current pricing.

Transitional products in this specification guide are **maintained for existing customers only** and are likely to be phased out over time. These products are indicated with a . Products that are scheduled to be culled are indicated with an , followed by the last order entry date.

Surface Materials

The surface materials team has announced the launch of the Finish Library, found at www.steelcase.com/finishlibrary/.

► For a list of all trademarks, refer to the last page of this specification guide. © 2026 Steelcase Inc.

Working With This Specification Guide

Ten Tips: How to Get the Most Out of This Book	2
Additional Resources	4
Worktools Intro Collection	5

Understanding and Specifying

Organizational Worktools	7
Victor2	53
Lighting	63
Computer Support Tools	117
Screens	171
Power and Cable Management	181
Universal Modular Power System	211
Relay Modular Power System	239
Steelcase Flex Collection	257

Surface Materials	263
--------------------------	------------

Resources	267
------------------	------------



For Canadian Pricing

Canadian factor can be found at www.steelcase.com/CADpricing/. Calculate in the following order to avoid rounding errors:

- Multiply the base price and each option by the Canadian factor.
- Round each to the nearest dollar.
- Add base and options for total list price.

Ten Tips: How to Get the Most Out of This Book

Tip 1

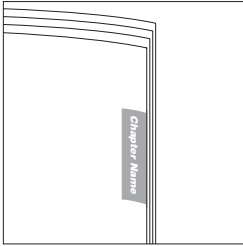

Watch the tabs on the right-hand edges of the pages. They'll always indicate which chapter you are in.

Tip 2

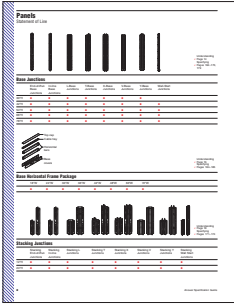

Use the Statement of Line pages for an overview of the available components, their sizes, and page references for additional information. Each *Understanding* chapter includes a statement of line after the table of contents.

Tip 3



Find cross references by looking for page numbers flagged with an arrow.

Tip 4

Study the product detail pages in the *Understanding* section to learn everything an expert knows about specific products. Each product detail page in this section contains the following features, where applicable:

- Product Drawing
- Actual Dimensions
- Product Details
- Connections
- Wiring and Cabling
- Surface Materials
- Application Topics

Product Drawing shows you what the product looks like and points out important features.

Product Details gives specific information on the product and how it is used.

Connections describes how the product is assembled or how it attaches to another product.

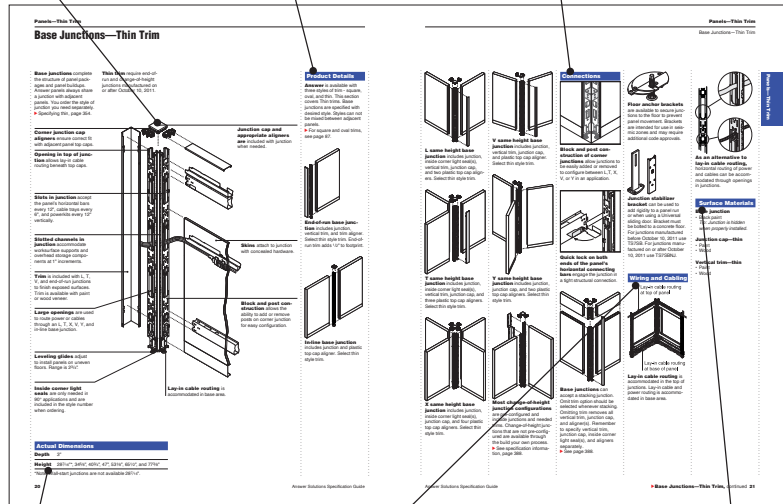

Actual Dimensions table lists the dimensions of the product.

Wiring and Cabling details the power and cable-management and cable routing capabilities of the product.

Surface Materials lists what material is used for each part of the product.

Tip 5

Refer to the specifying pages for all the information needed to order a product. Each product specifying page contains a variety of elements to help you complete a specification:

- Product Drawing
- Standard Includes
- Required to Specify
- Options
- Related Products
- Specification Information
 - Dimensions
 - Style Number
 - Price

Product Drawing shows you what the product looks like.

Standard Includes (under the red or dark grey band) provides a list of what comes standard with the product.

Required to Specify (under the red or dark grey band) itemizes the information that you must provide to order the standard product and the preferred sequence for specification.

Specification Information (under the teal or light grey band) provides product dimensions, style numbers, and prices for the standard product and any surface material choices that are available.

Standard Includes

- Standard length (100, 120, 144, 168, 192) (see page 19)
- Base trim with no backcoat (see 197) (see page 19)
- Base trim with backcoat (197) (see page 19)
- Color Guard® (see page 19)

Options

Option	Unit Price	Required to Specify
Paint (see page 19)	10.00	Specify paint (see page 19)
Paint (see page 19)	10.00	Specify paint (see page 19)
Paint (see page 19)	10.00	Specify paint (see page 19)

Required to Specify

Option	Unit Price	Required to Specify
Paint (see page 19)	10.00	Specify paint (see page 19)
Paint (see page 19)	10.00	Specify paint (see page 19)
Paint (see page 19)	10.00	Specify paint (see page 19)

Specification Information

Style Number	Dimensions	Unit Price	Option
100	100	10.00	None
120	120	10.00	None
144	144	10.00	None
168	168	10.00	None
192	192	10.00	None

Options (under the black band) lists all the options that apply to the product, their price, and what is required to specify.

Related Products provide specification information for products that are directly related.

Tip 6

Required to Specify

Specify with *Customiz Stain*

Italic typeface on specifying pages usually identifies wording that you should use in your order.

i

Tip 7

To determine how many skins are needed to complete a panel, consult the table at the right.
Tip: Remember to order skins for both sides of the panel buildup.

Watch for tips throughout the text that give you explanations and helpful instructions.

Tip 8

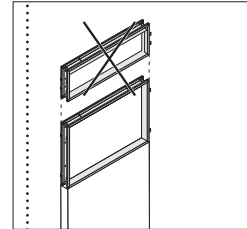

Learn what you cannot do by looking for drawings crossed out with an "X."

Tip 9

Use the surface materials listings in the Surface Materials section of this book to find surface material color numbers.

Tip 10

Style Number	Page
TS7042BL	131
TS7042S	130
TS7048BL	131
TS7048S	130
TS7060BL	131
TS7060S	130
TS7072BL	131

Refer to the style number index when you need a style number and you need to find the page that has more details about the product.

Additional Resources

Worktools products are supported with informational materials, tools, and software to help you plan, specify, and order an installation efficiently.

Product brochures and planning tools can be ordered through your Steelcase area office by calling 1.800.784.0358 or through the Marketing Resources web site at village.steelcase.com.

Worktool photos are available to download at no charge. Photos can be found at village.steelcase.com.

Express Program Specification Guide
This specification guide describes all Steelcase and Coalesce products including the finishes and options that are available as Express orders - manufactured and shipped within 7 business days.

Printed Materials

Surface Materials Reference Manual
This publication provides surface material information for Steelcase products:

- An explanation of the surface materials
- "Available on" matrices
- Vertical surface fabric selection listing
- Technical data for surface materials
- Surface material care and cleaning instructions

Other Specification Guides

Steelcase offers a comprehensive portfolio of furniture and solutions. For the full offering of products, refer to the individual product specification guides. These can be accessed at the www.steelcase.com web site or at village.steelcase.com.

Planning Tools

Mock-Ups
Mock-ups are available for dealers to order single units at a nominal cost to show as samples. Contact the Steelcase Solutions Fulfilled Team (SFT) at 888.783.3522. Use village.steelcase.com to look up Reps by Regional Assignment.

Computer Tools

Electronic Catalog
Accurate sales quotations and purchase orders for Steelcase products are created with specification software that uses Steelcase Electronic Catalog data. Use the data to specify and price style numbers and options for every Steelcase product. The data is updated bimonthly by Steelcase and provided to software programs including: the Hedberg Business System, SmartTools – Steelcase's design and specification software (for more information on SmartTools, please email SmartTools@steelcase.com, the ProjectMatrix ProjectSymbols libraries, as well as 20-20 CAP Studio.

Furniture Symbol Graphic Data
Steelcase creates 2D and 3D furniture symbols (with attributes) for planning and initially specifying Steelcase products. This data is incorporated into several add-on software packages that work in either a Microstation or an AutoCAD drafting environment.

Digital Publications
You can access these digital publications at www.steelcase.com or village.steelcase.com.

Product Training
Basic training for many Steelcase products is part of the Building Product Muscle (BPM) curriculum on the Steelcase University Web site at village.steelcase.com.

Support

Steelcase Capabilities
Steelcase products are distributed, installed, and serviced through a network of more than 600 dealers worldwide. Steelcase is also represented with offices and corporate showrooms in 26 U.S. cities, 4 Canadian cities, and in France, Germany, Great Britain, and Japan. Every Steelcase product meets our exceptionally high standards of quality and durability and comes with the Steelcase assurance of excellence in service.

For ordering or product assistance, please call your local dealer, the Steelcase Solutions Resource Team, or the Steelcase Solutions Fulfillment Team at 1.888.STEELCASE (1.888.783.3522) or send an e-mail to lineone@steelcase.com.

Call the Steelcase Solutions Resource Team prior to placing an order, when working on a bid, or when you need information about product applications and specifications.

Call the Steelcase Solutions Fulfillment Team if you have submitted an order to Steelcase and you need to speak to your Solutions Fulfillment Team Representative about the order. Also call if you have any post-shipment quality concerns or service parts questions.

For warranty information, please go to <http://www.steelcase.com/warranty/>.

Outside the U.S.A., Canada, Mexico, Puerto Rico, and the U.S. Virgin Islands, call 1.616.247.2500.

For information about Steelcase, the name of your nearest Steelcase dealer, or for product literature, call 1.800.333.9939 or visit our web site: www.steelcase.com.

Steelcase Lineone

For all questions including product specification and application information call the Lineone support line at 888.783.3522, Option 1 for lineone, Option 7 for worktools, or email lineone@steelcase.com.

Specials

To adapt an existing worktools product or develop a totally unique concept, contact Specials. For application information or to specify a product, submit a request on village.steelcase.com using the Specials RFQ E-Quote process. Please note: To ensure accurate pricing and timely delivery, a valid quote number is required on every order.

Sustainability

At Steelcase, we believe business can be a force for good. We create long-lasting products that are better for people and better for the planet. Our products and operations use life cycle thinking to meet our commitment to reducing climate change. This commitment is reinforced by practices such as designing to minimize global warming and other life cycle impacts, ensuring material health, and enabling end-of-use strategies.

To learn more at a corporate level, visit: <https://www.steelcase.com/discover/steelcase/esg-overview/environmental/>

Product Environmental Profiles, which provide key environmental attributes such as recycled content, embodied carbon and recyclability, as well as product certifications can be found by searching for Steelcase at Origin.build.

Curated from our portfolio, the Worktools Intro Collection includes these featured accessories.

LED Intro Task Light

The LED Intro Task Light provides high quality illumination. Available in a single or dual-arm configuration, with three finishes and a transitional look that works everywhere always.

► Page 93

Powerstrip Intro

Power a personal device, monitor, or LED Intro Light. Powerstrip Intro puts convenient desktop power within reach. It is available in multiple power and USB configurations and two classic finishes.

► Page 199

CF Series Intro Monitor Arm

Position work where needed. Advanced features allow for precise adjustments to support preferences and healthy postures.

► Page 152

SOTO Worktools

Keep things tidy and convenient. SOTO Personal Hook keeps bags, keys, and headsets off desk and within arm's reach for convenience.

► Page 47

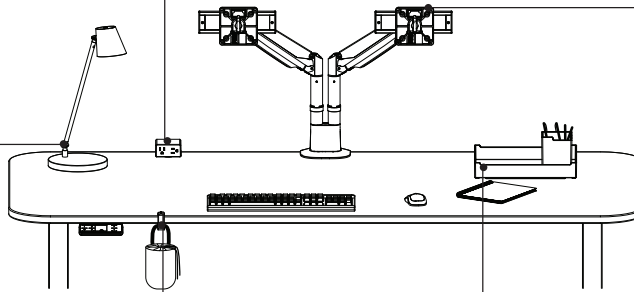

Statement of Line

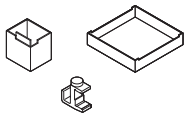

SOTO Intro Bundle PCDB1

Includes personal box, tool box, personal hook

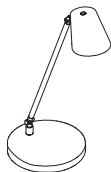

SOTO Intro Bundle LSCTSKLIGHT1

(Single Arm)

LSCTSKLIGHT2

(Double Arm)

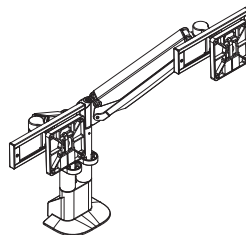

CF Series Intro Monitor Arm

CFINTRO

(CF Series Intro Dual)

CFINTROSLIDE

(CF Series Intro Dual)

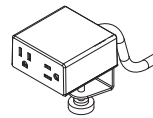

Powerstrip Intro DSPINTRO



Organizational Worktools

Statement of Line	8
--------------------------	----------

Slatwall	
Understanding	12
Specifying	14
SlatRail	
Understanding	18
Specifying	20
Slatwall, SlatRail, and Freestanding Worktools	
Understanding	23
Specifying	29
SOTO Worktools	
Understanding	38
Specifying	44

Statement of Line

Slatwall

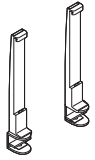

Understanding
 ▶ Page 12
 Specifying
 ▶ Page 14

Freestanding Slatwall Stanchions

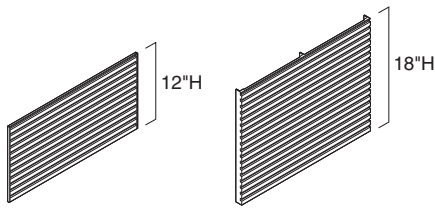

Understanding
 ▶ Page 12
 Specifying
 ▶ Page 15

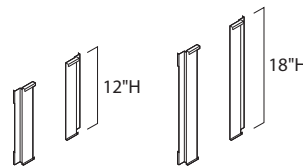

Understanding
 ▶ Page 12
 Specifying
 ▶ Page 16

Slatwall Tiles

	24"W	30"W	36"W	42"W	45"W	48"W	60"W
12"H	●	●	●	●	●	●	●
18"H	●	●	●	●	●	●	●

Slatwall Panel-Mount Brackets

	12"H	18"H
	●	●

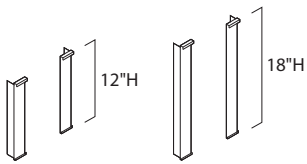

Understanding
 ▶ Page 13
 Specifying
 ▶ Page 16

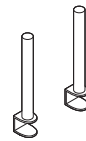

Understanding
 ▶ Page 19
 Specifying
 ▶ Page 20

Slatwall Wall-Mount Brackets

	12"H	18"H
	●	●

Freestanding SlatRail Stanchions

SlatRail

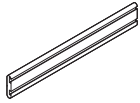

Understanding
▶ Page 18
Specifying
▶ Page 21



Understanding
▶ Page 18
Specifying
▶ Page 22

SlatRail

24"W	30"W	36"W	42"W	45"W	48"W	60"W
●	●	●	●	●	●	●

SlatRail Panel-Mount Brackets

Slatwall, SlatRail, and Freestanding Worktools

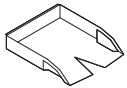

10" Portrait Letter Tray
Understanding
▶ Page 23
Specifying
▶ Page 29

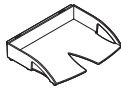

12" Landscape Letter Tray
Understanding
▶ Page 23
Specifying
▶ Page 29

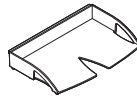

15" Landscape Legal Tray
Understanding
▶ Page 23
Specifying
▶ Page 29



Binder Holder
Understanding
▶ Page 23
Specifying
▶ Page 29

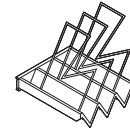

PaperFlo Manager
Understanding
▶ Page 23
Specifying
▶ Page 30

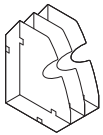

Universal Shelves
Understanding
▶ Page 24
Specifying
▶ Page 30

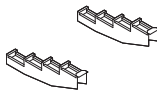

Hanging Brackets
Understanding
▶ Page 24
Specifying
▶ Page 31



Pen/Pencil Cup
Understanding
▶ Page 24
Specifying
▶ Page 31



Double Square Dish
Understanding
▶ Page 25
Specifying
▶ Page 32

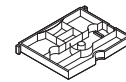

Office in a File
Understanding
▶ Page 25
Specifying
▶ Page 32



Mini Shelf
Understanding
▶ Page 25
Specifying
▶ Page 33

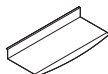

Personal Shelf
Understanding
▶ Page 26
Specifying
▶ Page 33



Telephone Caddy
Understanding
▶ Page 26
Specifying
▶ Page 34



Tackstrip
Understanding
▶ Page 26
Specifying
▶ Page 34



Work Tags
Understanding
▶ Page 26
Specifying
▶ Page 35

Slatwall, SlatRail, and Freestanding Worktools, continued

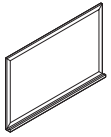

Markerboard

Understanding
 ▶ Page 27
 Specifying
 ▶ Page 35

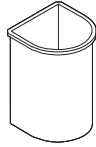

Wastebasket

Understanding
 ▶ Page 27
 Specifying
 ▶ Page 35



Coat Hook

Understanding
 ▶ Page 27
 Specifying
 ▶ Page 36

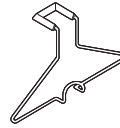

Flat Top Hanger

Understanding
 ▶ Page 27
 Specifying
 ▶ Page 36

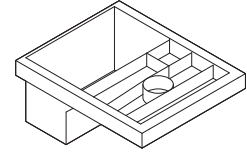

Pelican Pencil Drawers

Understanding
 ▶ Page 28
 Specifying
 ▶ Page 37

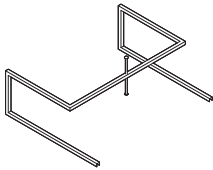

Pelican Installation Bar

Understanding
 ▶ Page 28
 Specifying
 ▶ Page 37

SOTO Worktools

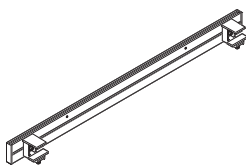

Understanding
 ▶ Page 38
 Specifying
 ▶ Page 44

SOTO Rails

28"W 34"W 40"W 46"W 52"W 58"W 64"W

• • • • • • •

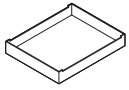
SOTO Worktools, continued**SOTO Pile Box**

Understanding
 ▶ Page 38
 Specifying
 ▶ Page 44

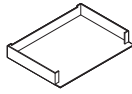
**SOTO Landscape Letter Box**

Understanding
 ▶ Page 38
 Specifying
 ▶ Page 45

**SOTO Tool Box**

Understanding
 ▶ Page 39
 Specifying
 ▶ Page 45

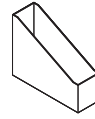
**SOTO Diagonal File Box**

Understanding
 ▶ Page 39
 Specifying
 ▶ Page 7

**SOTO Utility Box**

Understanding
 ▶ Page 39
 Specifying
 ▶ Page 46

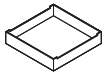
**SOTO Personal Box**

Understanding
 ▶ Page 39
 Specifying
 ▶ Page 46

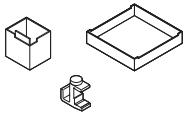
**SOTO Intro Bundle**

Specifying
 ▶ Page 7

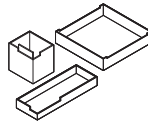
**SOTO Box Bundle**

Specifying
 ▶ Page 47

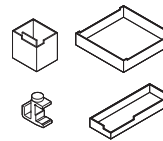
**SOTO Essential Bundle**

Specifying
 ▶ Page 7

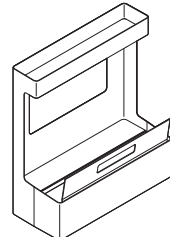
**SOTO Mobile Caddy**

Understanding
 ▶ Page 40
 Specifying
 ▶ Page 48

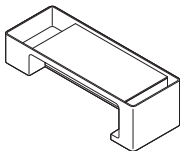
**SOTO Launch Pad**

Understanding
 ▶ Page 40
 Specifying
 ▶ Page 48

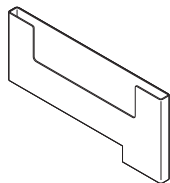
**SOTO Functional Screen**

Understanding
 ▶ Page 41
 Specifying
 ▶ Page 49

**SOTO Personal Pocket**

Understanding
 ▶ Page 41
 Specifying
 ▶ Page 7

**SOTO Cable Clip**

Understanding
 ▶ Page 41
 Specifying
 ▶ Page 49

**SOTO Personal Hook**

Understanding
 ▶ Page 41
 Specifying
 ▶ Page 50

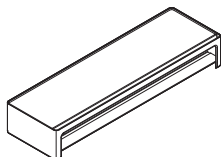
**SOTO Monitor Bridge**

Understanding
 ▶ Page 42
 Specifying
 ▶ Page 50

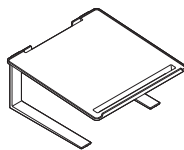
**SOTO Laptop Shelf**

Understanding
 ▶ Page 42
 Specifying
 ▶ Page 51

Slatwall

Slatwall allows for vertical stacking anywhere on the tile.

► Specifying, page 14

Slatwall tiles are standard in 12" or 18" heights and seven different widths.

Mounting brackets are available to correspond with selected furniture system and are ordered separately.

Slatwall can be panel-mounted or wall-mounted. 12" high Slatwall can be freestanding.

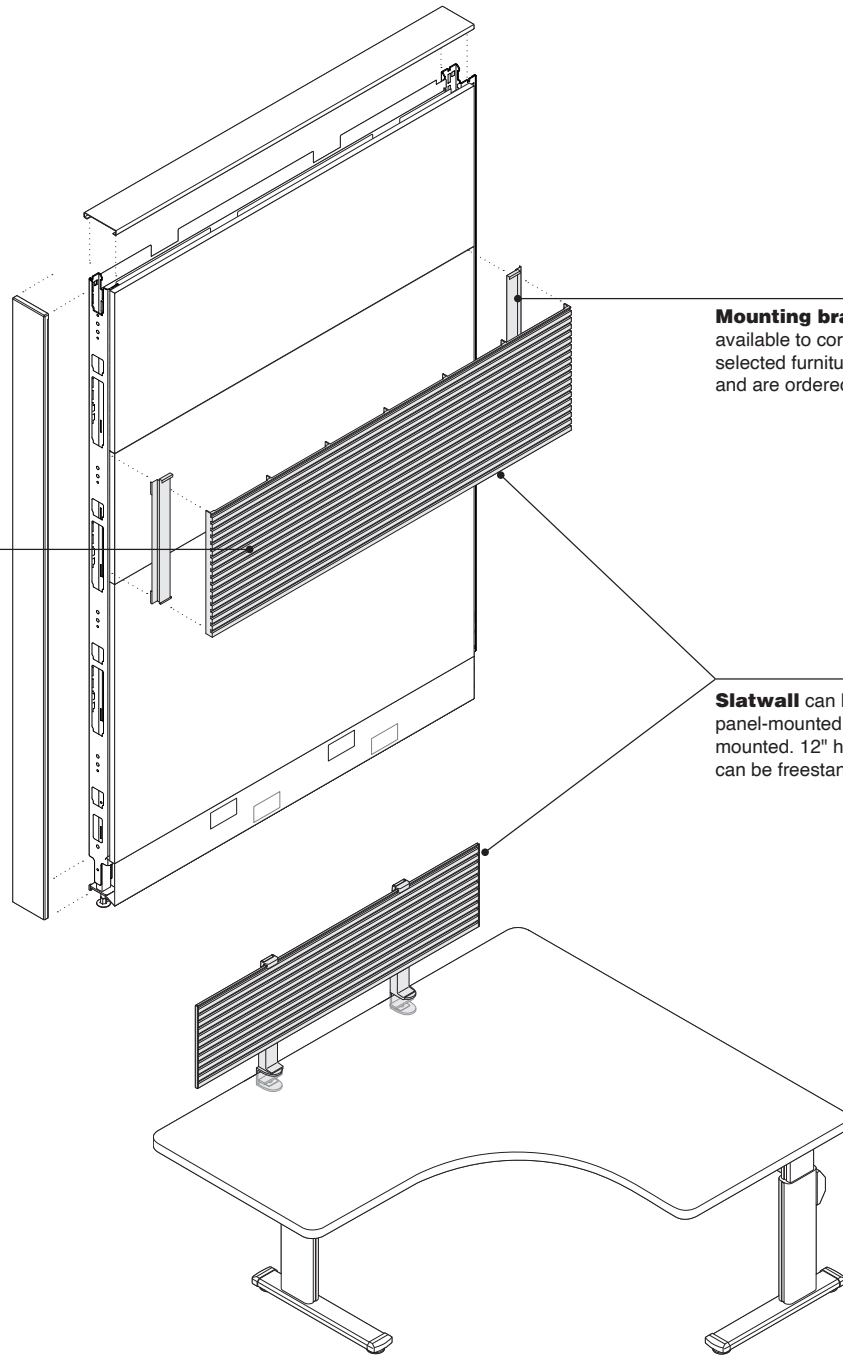

Actual Dimensions

	Freestanding slatwall stanchions	Slatwall tiles	Slatwall brackets
Depth	3"	1/2"	N.A.
Width	3 1/2"	24", 30", 36", 42", 45", 48", or 60"	2"
Height	16"	12" or 18"	12 1/3" or 18"

Product Details

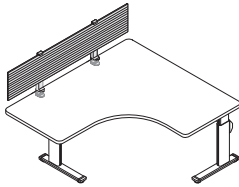

Slatwall tiles are available for straight mounting applications only.

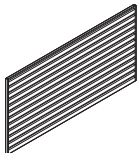

Slatwall tiles support a maximum of 60 lb.

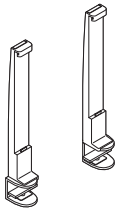

Freestanding Slatwall stanchions are for use with 12"H Slatwall tiles only. Stanchions and Slatwall tiles must be ordered separately.

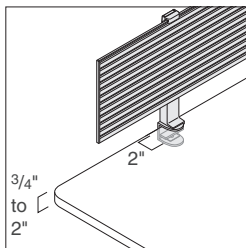

Freestanding Slatwall stanchions clamp to work surfaces 3/4" to 2" thick and uses a 2" footprint on the work surface.

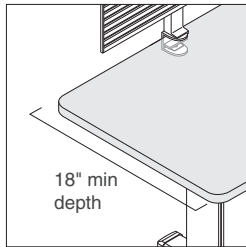

Worksurface must be a minimum depth of 18" and able to support a maximum weight of 60 lb when using freestanding Slatwall stanchions.

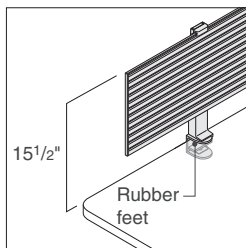

In freestanding application, top of Slatwall is 15 1/2" above mounting surface and is a fixed height. Rubber feet under stanchions ensure a tight fit without marring work surface.

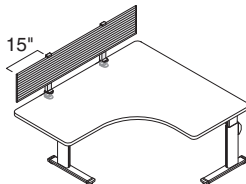
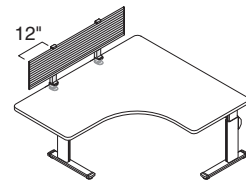

Slatwall can overhang freestanding stanchions by 12" for tiles 48"W or less and 15" for 60"W tiles.

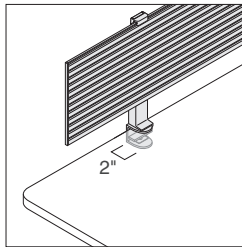

When using freestanding Slatwall stanchions, a 2" clearance is required below work surface to accommodate C-clamp.

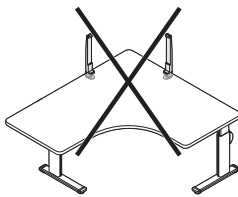

Freestanding Slatwall stanchions cannot work in a corner application.

Freestanding Slatwall stanchions are not for use with glass, bullnose, knife edge, or other non-standard work surface edges.

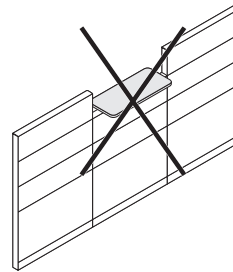

Panel mount Slatwall brackets cannot be used with transaction top work surfaces.

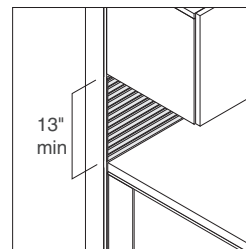

Panel or wall-mount applications require a minimum of 13" vertical space between work surface and overhead bins or shelves.

Wall mount brackets must be installed in a wall stud.

Surface Materials

Slatwall tiles, stanchions, and brackets

- 0835 Black
- 4750 Champagne
- 4799 Platinum

Slatwall

Freestanding Slatwall Stanchions

For Use on Worksurfaces $\frac{3}{4}$ " to 2" thick

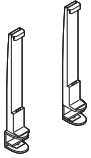

Tip: Positions top of Slatwall a fixed height of 15½" above mounting surface.

Tip: Slatwall can overhang stanchions up to 12".

Tip: Worksurfacetable must be able to support 60 lb.

Tip: Stanchion cannot be used in a corner application or on a glass surface.

Tip: Requires 18"D work-surface and uses 2" surface footprint.

Tip: Freestanding Slatwall stanchion is for use with 12"H tiles only.

Standard Includes	Required to Specify
<ul style="list-style-type: none"> ▶ Need help? Product details, page 12 • Pair of Slatwall stanchions: paint • Non-marring rubber feet 	<ul style="list-style-type: none"> 1 Style number 2 Paint color number for slatwall brackets: <ul style="list-style-type: none"> 0835 Black 4750 Champagne 4799 Platinum

Related Products
<ul style="list-style-type: none"> • Slatwall tiles ▶ Page 15

Specification Information					
• Dimensions			• Weight	• Style Number	• U.S. Price
D	W	H	:	:	:
3"	3½"	16"	3.5 lb	WFCS	\$238
:	:	:	:	:	:
:	:	:	:	:	:



For Canadian Pricing

Multiply U.S. Price by the Canadian price factor.

▶ See page 1 for details.

Slatwall Tiles

Tip: Total dimensions of Worktools specified should not exceed Slatwall dimensions.

Tip: Slatwall is not dedicated to the exact panel width; a 12" overhang is acceptable.

Tip: Two Slatwall tiles cannot be used in a corner application.

Tip: Tiles require a minimum worksurface depth of 18" for stability.

Tip: A clearance of 2" is required under worksurface to accommodate C-clamp.

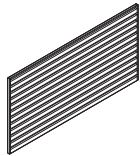

Tip: 12"H slatwall tiles support a maximum of 60 lb.

Tip: A limit of one monitor arm may be attached to 12"H slatwall tiles.

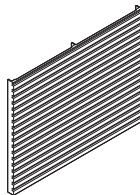

Tip: Tiles cannot be used on glass, bullnose, knife edge, or other non-standard worksurface edges.

Tip: Supports up to 140 lb.

Tip: Slatwall is 1/8" shorter than stated without end caps installed.

Tip: A limit of two monitor arms may be attached to 18"H slatwall tiles.



For Canadian Pricing

Multiply U.S. Price by the Canadian price factor.

▶ See page 1 for details.

Standard Includes	Required to Specify
<ul style="list-style-type: none"> ▶ Need help? Product details, page 12 • Slatwall tile: paint 	<ul style="list-style-type: none"> 1 Style number 2 Paint color number for slatwall tile: <ul style="list-style-type: none"> 0835 Black 4799 Platinum 4750 Champagne

Related Products	
<ul style="list-style-type: none"> • Slatwall brackets • Freestanding Slatwall stanchions • Slatwall and SlatRail worktools 	<ul style="list-style-type: none"> ▶ Page 16 ▶ Page 14 ▶ Page 29

Specification Information

Dimensions			Weight	Style Number	U.S. Price
D	W	H			
12"H Tiles					
1/2"	24"	12"	4.5 lb	WS24	\$190
1/2"	30"	12"	5.7 lb	WS30	\$213
1/2"	36"	12"	6.8 lb	WS36	\$238
1/2"	42"	12"	8 lb	WS42	\$277
1/2"	45"	12"	8.5 lb	WS45	\$295
1/2"	48"	12"	9.1 lb	WS48	\$317
1/2"	60"	12"	11.4 lb	WS60	\$395

18"H Tiles					
1 1/8"	24"	18"	4.04 lb	WS2418H	\$400
1 1/8"	30"	18"	11.5 lb	WS3018H	\$459
1 1/8"	36"	18"	13.16 lb	WS3618H	\$513
1 1/8"	42"	18"	15.62 lb	WS4218H	\$564
1 1/8"	45"	18"	16.5 lb	WS4518H	\$621
1 1/8"	48"	18"	17.28 lb	WS4818H	\$678
1 1/8"	60"	18"	19 lb	WS6018H	\$734

Slatwall Brackets

Tip: Wall-mount brackets must be mounted to a wall stud.

Tip: Brackets for use with 42"H panels cannot be used with transaction top worksurfaces.

*Tip: **WSW42AN** positions the slatwall tile in the top position on the panel. Use this bracket with Answer 30"H, 36"H, and 42"H and Kick 42"H panels.*

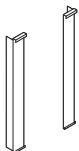
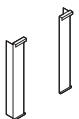
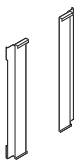
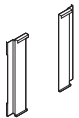

Standard Includes	Required to Specify
-------------------	---------------------

<ul style="list-style-type: none"> ▶ Need help? Product details, page 12 • Pair of slatwall brackets: paint 	<ul style="list-style-type: none"> 1 Style number 2 Paint color number for slatwall brackets: <ul style="list-style-type: none"> 0835 Black 4750 Champagne 4799 Platinum
-------------------------------------------------------------------------------------------------------------------------------------	----------------------------------------------------------------------------------------------------------------------------------------------------------------------------------------------------------------------------------------------------------------

Related Products

- Slatwall tiles ▶ Page 15

Specification Information			
Dimensions	Weight	Style Number	U.S. Price
W	H		

12"H Panel-Mount Brackets

For Use with Answer, Kick, and Privacy Wall

2"	12 $\frac{1}{3}$ "	2 lb	WSWANS	\$ 61
----	--------------------	------	---------------	-------

For Use with Avenir

2"	12 $\frac{1}{3}$ "	2 lb	WSWUSA	\$ 61
----	--------------------	------	---------------	-------

For Use with Answer 30"H, 36"H, and 42"H and Kick 42"H Panels

2"	12 $\frac{1}{3}$ "	2 lb	WSW42AN	\$118
----	--------------------	------	----------------	-------

18"H Panel-Mount Brackets

Standard

2"	18"	3.5 lb	WSWUSA18	\$171
----	-----	--------	-----------------	-------

For Use with Answer, Kick, and Privacy Wall

2"	18"	3.5 lb	WSWANS18	\$171
----	-----	--------	-----------------	-------

Wall-Mount Brackets

12"H Standard

2"	12 $\frac{1}{3}$ "	2 lb	WSWM	\$ 57
----	--------------------	------	-------------	-------

18"H Standard

2"	18"	3.5 lb	WSWM18	\$171
----	-----	--------	---------------	-------



For Canadian Pricing

Multiply U.S. Price by the Canadian price factor.

▶ See page 1 for details.

SlatRail

SlatRail allows for utilizing maximum space above and below worksurface.
 ▶ Specifying, page 20

SlatRail tiles are standard 4"H and six different widths.

Mounting brackets are available to correspond with selected furniture system and are ordered separately.

SlatRail can be panel-mounted, wall-mounted, or freestanding.

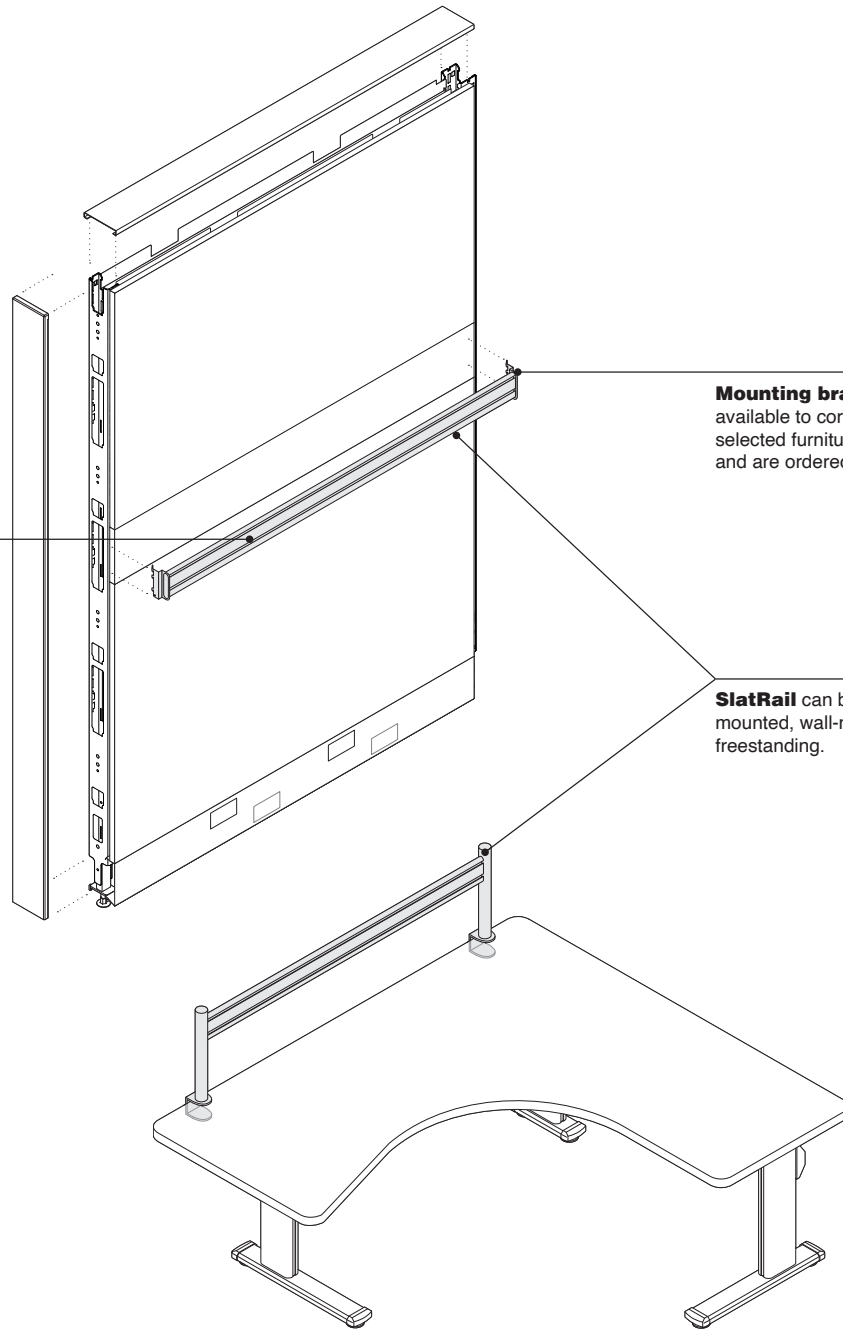

Actual Dimensions

	Freestanding SlatRail stanchions	SlatRail	SlatRail panel-mount brackets	SlatRail wall-mount brackets
Depth	1½"	¾"	N.A.	2¾"
Width	1½"	24", 30", 36", 42", 48", or 60"	2½"	¾"
Height	13½"	4"	4½"	4¾"

Product Details

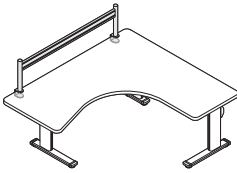

SlatRail tiles are available for straight mounting applications only.

SlatRail tiles support a maximum of 100 lb.

Freestanding SlatRail stanchions and SlatRail tiles must be ordered separately.

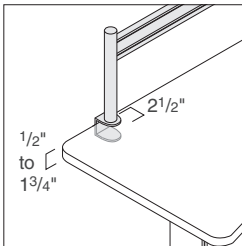

Freestanding SlatRail stanchions clamp to work-surfaces $\frac{1}{2}$ " to $\frac{3}{4}$ " thick and uses a $2\frac{1}{2}$ " footprint on the worksurface.

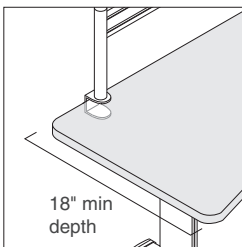

Worksurface must be a minimum depth of 18" and able to support a maximum weight of 100 lb when using freestanding SlatRail stanchions.

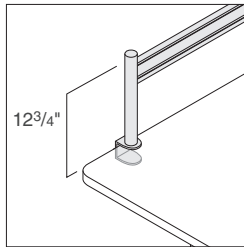

In freestanding application, top of SlatRail is $12\frac{3}{4}$ " above mounting surface and is a fixed height.

SlatRail cannot overhang freestanding stanchions.

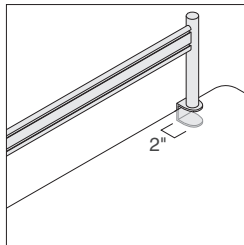

When using freestanding SlatRail stanchions, a 2" clearance is required below worksurface to accommodate C-clamp.

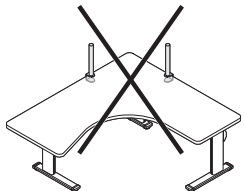

Freestanding SlatRail stanchions cannot work in a corner application.

Freestanding SlatRail stanchions are not for use with glass, bullnose, knife edge, or other non-standard worksurfaces.

Wall mount brackets must be installed in a wall stud.

Surface Materials

SlatRail tiles, stanchions, and brackets

- 0835 Black
- 4750 Champagne
- 4799 Platinum

Application Topics

When mounting SlatRail with stanchions in combination with a cableway or determining appropriate SlatRail width for use with height-adjustable desks see *Height-Adjustable Desks Specification Guide*.

SlatRail

Freestanding SlatRail Stanchions

For Use on Worksurfaces and Materials 1/2" to 1 3/4" thick

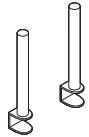

Tip: Positions top of SlatRail a fixed height of 12 3/4" above mounting surface.

Tip: Worksurface/table must be able to support 100 lb.

Tip: Stanchion cannot be used in a corner application or on a glass surface.

Tip: Requires 18"D worksurface and uses 2 1/2" surface footprint.

Tip: A clearance of 2" is required under worksurface to accommodate C-clamp.

Tip: Actual width of usable SlatRail is 3 1/8" less than stated when installed using freestanding stanchions.

Standard Includes	Required to Specify
-------------------	---------------------

<ul style="list-style-type: none"> ▶ Need help? Product details, page 19 • Pair of SlatRail stanchions: paint 	<ul style="list-style-type: none"> 1 Style number 2 Paint color number for SlatRail stanchions: <ul style="list-style-type: none"> 0835 Black 4750 Champagne 4799 Platinum
---------------------------------------------------------------------------------------------------------------------------------------	----------------------------------------------------------------------------------------------------------------------------------------------------------------------------------------------------------------------------------------------------

Related Products

<ul style="list-style-type: none"> • SlatRail 	▶ Page 21
--------------------------------------------------------------	-----------

Specification Information					
• Dimensions			• Weight	• Style Number	• U.S. Price
D	W	H			

1 1/2"	1 1/2"	13 1/2"	4 lb	WSRFS	\$210
--------	--------	---------	------	--------------	-------



For Canadian Pricing

Multiply U.S. Price by the Canadian price factor.

▶ See page 1 for details.

SlatRail

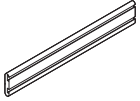

Tip: When mounting SlatRail with stanchions in combination with a cableway, see Worktools Compatibility Charts, in Height-Adjustable Desks Specification Guide.

Tip: To determine appropriate SlatRail with stanchions width when mounting to height-adjustable work-surfaces, see Worktools Compatibility Charts, in Height-Adjustable Desks Specification Guide.

Tip: SlatRail requires a minimum worksurface depth of 18" for stability.

Tip: Total dimensions of Worktools specified should not exceed SlatRail dimensions.

Tip: Two SlatRails cannot be used in a corner application.

Tip: Not applicable on glass surfaces.

Tip: Actual width of usable SlatRail is 3/8" less than stated when installed using freestanding stanchions.

Tip: Supports up to 100 lb.

Standard Includes	Required to Specify
<ul style="list-style-type: none"> ▶ Need help? Product details, page 18 • SlatRail: paint 	<ul style="list-style-type: none"> 1 Style number 2 Paint color number for SlatRail: <ul style="list-style-type: none"> 0835 Black 4750 Champagne 4799 Platinum

Related Products
<ul style="list-style-type: none"> • Freestanding SlatRail stanchions ▶ Page 20 • SlatRail panel-mount brackets ▶ Page 22 • Slatwall and SlatRail worktools ▶ Page 29

Specification Information					
Dimensions			Weight	Style Number	U.S. Price
D	W	H			
3/4"	24"	4"	2 lb	WSR24	\$111
3/4"	30"	4"	3 lb	WSR30	\$133
3/4"	36"	4"	3 lb	WSR36	\$153
3/4"	42"	4"	3.5 lb	WSR42	\$173
3/4"	48"	4"	4 lb	WSR48	\$195
3/4"	60"	4"	4.5 lb	WSR60	\$236
.



For Canadian Pricing

Multiply U.S. Price by the Canadian price factor.

▶ See page 1 for details.

SlatRail Panel-Mount Brackets



Tip: Answer, Avenir, Kick, and Privacy Wall accommodate the SlatRail panel-mount brackets.

Standard Includes	Required to Specify
<ul style="list-style-type: none"> ▶ Need help? Product details, page 18 • Pair of SlatRail panel-mount brackets: paint 	<ul style="list-style-type: none"> 1 Style number 2 Paint color number for SlatRail panel-mount brackets: <ul style="list-style-type: none"> 0835 Black 4750 Champagne 4799 Platinum

Related Products
<ul style="list-style-type: none"> • SlatRail

▶ Page 21

Specification Information				
• Dimensions		• Weight	• Style Number	• U.S. Price
W	H	:	:	:
2½"	4½"	1.5 lb	WSRU1	\$64
:	:	:	:	:



For Canadian Pricing
 Multiply U.S. Price by the Canadian price factor.
 ▶ See page 1 for details.

Trays

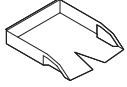

► Specifying, page 29

Product Details

Trays are available to accommodate letter, legal, and A4 filing.

Trays may be used with Slatwall, SlatRail, or freestanding applications.

Trays are 2½"H and stackable.

Tray holds a maximum weight of 7 lb per tray.

Trays stack four high on 12"H Slatwall and six high on 18" Slatwall.

Surface Materials

Tray

- 6000 Black
- 6009 Arctic White
- 6544 Frost
- 6546 Rain

Actual Dimensions

Letter tray

Depth 12½"

Width 10³/₁₆"

Height 2½"

Weight 1.5 lb

Landscape letter tray

Depth 10"

Width 12½"

Height 2½"

Weight 1.5 lb

Landscape legal tray

Depth 10"

Width 15½"

Height 2½"

Weight 1.75 lb

Binder Holder

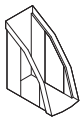

Tip: Binder holder requires 9½" of clearance under overhead bins and shelves.

► Specifying, page 29

Product Details

Binder holder may be used with Slatwall, SlatRail, or freestanding applications.

Binder holder mounts in tall orientation for most materials or short orientation for large binders.

Binder holder holds a maximum weight of 10 lb and holds up to 4" of materials.

Surface Materials

Binder holder

- 6000 Black
- 6009 Arctic White
- 6544 Frost
- 6546 Rain

Actual Dimensions

Depth 9½"

Width 4¾"

Height 11³/₈"

Weight 1.2 lb

PaperFlo Manager

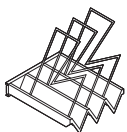

Tip: PaperFlo Manager requires 11" of clearance under overhead bins and shelves.

► Specifying, page 30

Product Details

PaperFlo Manager may be used with Slatwall, SlatRail, or freestanding applications.

PaperFlo Manager is standard with three sloped slots with non-handed wire dividers and sturdy base.

Blank identification tags are included.

PaperFlo Manager holds a maximum weight of 15 lb.

Surface Materials

PaperFlo Manager

- 6000 Black
- 6009 Arctic White
- 6544 Frost
- 6546 Rain

Actual Dimensions

Depth 12"

Width 9¾"

Height 9¾"

Weight 2 lb

Universal Shelves

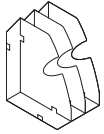

► Specifying, page 30

Product Details

Universal shelves are sloped for storing 2³/₄" of materials.

Universal shelves may be positioned vertically for letter-size material or horizontally for legal-size material.

Universal shelves are available in either a single pack or three pack.

Universal shelf holds a maximum weight of 7 lb per shelf.

Surface Materials

Universal shelves

- 6000 Black
- 6009 Arctic White
- 6544 Frost
- 6546 Rain

Actual Dimensions

Depth 9¹/₂"

Width 2³/₄"

Height 12"

Weight 0.5 lb

Slatwall Width

Maximum Number of Shelves

24"W	6
30"W	9
36"W	11
42"W	13
45"W	14
48"W	15
60"W	19

Hanging Brackets

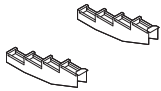

Tip: Hanging brackets are recommended for use in pairs only. Brackets should not be shared with mounting multiple brackets side by side.

► Specifying, page 31

Product Details

Hanging brackets are solid and four stepped for displaying hanging files.

Hanging brackets are not recommended for use on stanchion-mounted brackets mounted on SlatRail.

Hanging brackets require 6" clearance from top step of bracket to access files under bin and 9" clearance from the bottom step to allow files to hang freely.

Surface Materials

Hanging brackets

- 6000 Black
- 6009 Arctic White
- 6544 Frost
- 6546 Rain

Actual Dimensions

Depth 9³/₄"

Width 1¹/₂"

Height 1¹/₄"

Weight 1 lb

Pen/Pencil Cup



► Specifying, page 31

Product Details

Pen/Pencil cup is 2³/₈" in diameter.

Surface Materials

Pen/Pencil cup

- 6000 Black
- 6009 Arctic White
- 6544 Frost
- 6546 Rain

Actual Dimensions

Depth 4"

Width 3¹/₄"

Height 3⁵/₈"

Weight 0.5 lb

Double Square Dish



► Specifying, page 32

Product Details

Double square dish may be used with Slatwall, SlatRail, or freestanding applications.

Surface Materials

Double square dish

- 6000 Black
- 6009 Arctic White
- 6544 Frost
- 6546 Rain

Actual Dimensions

Small square

Depth 2⁷/₈"

Width 2⁵/₈"

Large square

Depth 2⁷/₈"

Width 5⁵/₈"

Outside dimensions

Depth 4"

Width 9³/₄"

Height 1¹/₂"

Weight 0.5 lb

Office in a File



► Specifying, page 32

Product Details

Office in a File may be used with Slatwall, SlatRail, hanging brackets, or free-standing applications.

Office in a File is portable and standard with seven compartments and translucent cover.

Office in a File is standard with built-in tape dispenser.

Translucent cover may be used as a writing surface.

Surface Materials

Office in a File

- 6000 Black
- 6009 Arctic White
- 6544 Frost
- 6546 Rain

Actual Dimensions

Depth 9⁵/₈"

Width 12¹/₄"

Height 1³/₈"

Weight 1.5 lb

Mini Shelf



► Specifying, page 32

Product Details

Mini shelf organizes small personal technology items.

Mini shelf indents in back to allow mini cable to pass through.

Mini shelf holds a maximum weight of 5 lb.

Surface Materials

Mini shelf

- 6000 Black
- 6009 Arctic White
- 6544 Frost
- 6546 Rain

Actual Dimensions

Depth 10"

Width 8"

Height 1⁷/₈"

Weight 0.5 lb

Personal Shelf

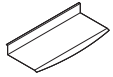

► Specifying, page 33

Product Details

Personal shelf is standard with raised front edge to prevent items from falling.

Surface Materials

- Personal shelf**
- 0835 Black
 - 4750 Champagne
 - 7018 Pewter

Actual Dimensions

Depth 5"

Height 13½"

Weight 3 lb

Telephone Caddy



Tip: Telephone caddy is not compatible with Cisco phones.

► Specifying, page 34

Product Details

Telephone caddy mounts off desktop at an optimal angle to view numbers and dialing.

Telephone caddy is standard with vertical channel for managing telephone cable.

4¾" clearance required to mount on Slatwall or SlatRail.

Surface Materials

- Telephone caddy**
- 0835 Black
 - 4750 Champagne
 - 7018 Pewter

Actual Dimensions

Depth 2"

Width 8"

Height 11"

Weight 6 lb

Tackstrip



► Specifying, page 34

Product Details

Tackstrip is a slim tackable surface for posting reminders or photos.

Tackstrip surface is self-filling, reducing the sight of holes from frequent use.

Surface Materials

- Tackstrip**
- 6000 Black

Actual Dimensions

Depth 5/16"

Width 15"

Height 3 1/8"

Weight 0.5 lb

Work Tags



Tip: Marker is included.

► Specifying, page 35

Product Details

Reusable work tags are wet-erase and allow user to label materials.

Work Tags clip to Organizational Worktools and SOTO boxes.

Surface Materials

- Work tags**
- 6544 Frost

Actual Dimensions

Depth 1½"

Width 2 3/8"

Height 5/16"

Weight 1 lb

Markerboard

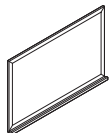

Tip: Markers are not included.

Tip: Markerboard is not recommended for use with SlatRail.

► Specifying, page 35

Product Details

Markerboard is standard with dry-erase surface and integrated marker holder.

Surface Materials

Markerboard

- Dry-erase surface

Frame

- Aluminum

Actual Dimensions

Depth 1"

Width 17³/₄"

Height 11³/₄"

Weight 1.75 lb

Wastebasket

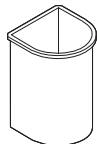

► Specifying, page 35

Product Details

Wastebasket design allows wastebasket to hug wall and provide greater foot room underneath worksurface.

Wastebasket is made of recycled materials.

Capacity of wastebasket is four gallons.

Surface Materials

Wastebasket

- 6000 Black

Actual Dimensions

Depth 10"

Width 10"

Height 15"

Weight 5 lb

Coat Hook

Tip: Coat hook is not recommended for use at end of panel run configurations.

► Specifying, page 36

Product Details

Coat hook is one piece, solid steel and for use with Answer, Avenir, and Kick.

Surface Materials

Coat hook

- 0835 Black
- 7018 Pewter

Actual Dimensions

Depth 7/8"

Width 2¹/₂"

Height 2¹/₄"

Weight 0.15 lb

Flat Top Hanger

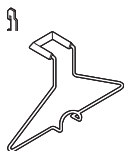

► Specifying, page 36

Product Details

Flat top hanger is one piece and solid steel construction.

Flat top hanger is standard with single rubber sleeve to maintain grip on flat surface.

Surface Materials

Flat top hanger

- 0835 Black
- 4750 Champagne

Actual Dimensions

Depth 3"

Width 15¹/₂"

Height 7³/₄"

Weight 1 lb

Pelican Pencil Drawer

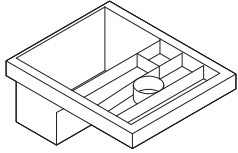

► Specifying, page 37

Product Details

Pelican pencil drawer includes file bars for up to 10" of letter or legal filing.

Pelican pencil drawer combines center drawer capabilities and file storage.

Pelican pencil drawer is available in non-locking or locking.

Tip: For locks to be keyed alike to other Steelcase locks, specify a non-locking drawer and order locking plugs separately (877209201SR). Field installation will be required.

Tip: Non-locking pencil drawer ships with a plastic front plug and an empty lock core. It can be converted to locking in the field.

Pelican pencil drawer requires a 24" unobstructed worksurface depth and 20"W clearance.

Pelican pencil drawer holds a maximum of 75 lb.

Surface Materials

Pelican pencil drawer
• 6000 Black

Actual Dimensions

Depth 23"

Width 19"

Height 2"

Weight 22 lb

Pelican Installation Bar

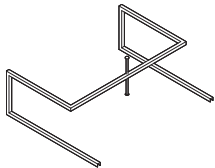

► Specifying, page 37

Product Details

Pelican installation bar holds drawer securely for drilling and fastening.

Pelican installation bar is reusable.

Actual Dimensions

Depth 17"

Width 21½"

Height 7"

Weight 5 lb

Trays

Tip: Trays do not interlock when installed on slatwall.

Standard Includes	Required to Specify
<ul style="list-style-type: none"> ▶ Need help? Product details, page 23 • Tray: plastic 	<ul style="list-style-type: none"> 1 Style number 2 Plastic color number for letter tray: <ul style="list-style-type: none"> 6000 Black 6009 Arctic White 6544 Frost 6546 Rain

Related Products	
<ul style="list-style-type: none"> • Slatwall tiles • SlatRail 	<ul style="list-style-type: none"> ▶ Page 15 ▶ Page 21

Specification Information					
Dimensions			Weight	Style Number	U.S. Price
D	W	H			

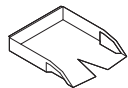

Portrait Letter Tray					
12½"	10 ³ / ₁₆ "	2½"	1.5 lb	WLTS	\$61

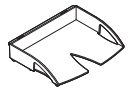

Landscape Letter Tray					
10"	12½"	2½"	1.5 lb	WLT12L	\$61

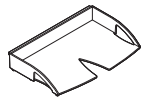

Landscape Legal Tray					
10"	15½"	2½"	1.75 lb	WLG15L	\$61

Binder Holder

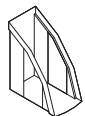

Tip: Binder holder requires 9½"H clearance under bins or shelves.

Standard Includes	Required to Specify
<ul style="list-style-type: none"> ▶ Need help? Product details, page 23 • Binder holder: plastic 	<ul style="list-style-type: none"> 1 Style number 2 Plastic color number for binder holder: <ul style="list-style-type: none"> 6000 Black 6009 Arctic White 6544 Frost 6546 Rain

Related Products	
<ul style="list-style-type: none"> • Slatwall tiles • SlatRail 	<ul style="list-style-type: none"> ▶ Page 15 ▶ Page 21

Specification Information					
Dimensions			Weight	Style Number	U.S. Price
D	W	H			



For Canadian Pricing
 Multiply U.S. Price by the Canadian price factor.
 ▶ See page 1 for details.

9⅛"	4¾"	11 ³ / ₈ "	1.2 lb	WBHS	\$61
-----	-----	----------------------------------	--------	-------------	------

PaperFlo Manager

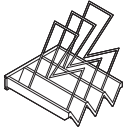

Tip: PaperFlo manager requires 11" clearance under bins.

Standard Includes		Required to Specify
<ul style="list-style-type: none"> ▶ Need help? Product details, page 23 	<ul style="list-style-type: none"> • PaperFlo manager: plastic 	<ul style="list-style-type: none"> 1 Style number 2 Plastic color number for PaperFlo manager: <ul style="list-style-type: none"> 6000 Black 6009 Arctic White 6544 Frost 6546 Rain

Specification Information					
• Dimensions			• Weight	• Style Number	• U.S. Price
D	W	H			
12"	9¾"	9¾"	2 lb	WPFS	\$147

Universal Shelves

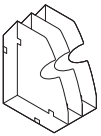

Tip: Universal shelves are not recommended for use on SlatRail.

Tip: Shelves do not interlock when installed on Slatwall.

Standard Includes		Required to Specify
<ul style="list-style-type: none"> ▶ Need help? Product details, page 24 	<ul style="list-style-type: none"> • Shelf: plastic 	<ul style="list-style-type: none"> 1 Style number 2 Plastic color number for shelf: <ul style="list-style-type: none"> 6000 Black 6009 Arctic White 6544 Frost 6546 Rain

Specification Information					
• Dimensions			• Weight	• Style Number	• U.S. Price
D	W	H			

Single Pack

9½"	2¾"	12"	0.5 lb	WUS	\$ 36
-----	-----	-----	--------	------------	-------

Three Pack

9½"	2¾"	12"	1.5 lb	WUS3	\$106
-----	-----	-----	--------	-------------	-------



For Canadian Pricing

Multiply U.S. Price by the Canadian price factor.

▶ See page 1 for details.

Hanging Brackets

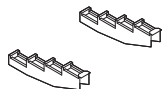

Tip: Hanging brackets require 6" clearance from top step of bracket to access files under bin and a 9" clearance from the bottom step to the top of worksurface to allow files to hang freely.

Tip: Hanging brackets are recommended using in pairs only. Brackets should not be shared when mounting multiple brackets side by side.

Standard Includes

- ▶ Need help? Product details, page 24
- Hanging brackets: plastic

Required to Specify

- 1 Style number
- 2 Plastic color number for hanging brackets:
 - 6000 Black
 - 6009 Arctic White
 - 6544 Frost
 - 6546 Rain

Related Products

- Slatwall tiles ▶ Page 15
- SlatRail ▶ Page 21

Specification Information

• Dimensions			• Weight	• Style Number	• U.S. Price
D	W	H			
9 ³ / ₄ "	1 ¹ / ₂ "	1 ¹ / ₄ "	1 lb	WHB	\$61
⋮	⋮	⋮	⋮	⋮	⋮

Pen/Pencil Cup



Standard Includes

- ▶ Need help? Product details, page 24
- Pen/pencil cup: plastic

Required to Specify

- 1 Style number
- 2 Plastic color number for pen/pencil cup:
 - 6000 Black
 - 6009 Arctic White
 - 6544 Frost
 - 6546 Rain

Related Products

- Slatwall tiles ▶ Page 15
- SlatRail ▶ Page 21

Specification Information

• Dimensions			• Weight	• Style Number	• U.S. Price
D	W	H			
4"	3 ¹ / ₄ "	3 ⁵ / ₈ "	0.5 lb	WPCS	\$61
⋮	⋮	⋮	⋮	⋮	⋮



For Canadian Pricing
Multiply U.S. Price by the Canadian price factor.
▶ See page 1 for details.

Double Square Dish



Standard Includes		Required to Specify
<ul style="list-style-type: none"> ▶ Need help? Product details, page 25 	<ul style="list-style-type: none"> • Double square dish: plastic • Attachment bracket 	<ul style="list-style-type: none"> 1 Style number 2 Plastic color number for square dish: <ul style="list-style-type: none"> 6000 Black 6009 Arctic White 6544 Frost 6546 Rain

Related Products	
<ul style="list-style-type: none"> • Slatwall tiles • SlatRail 	<ul style="list-style-type: none"> ▶ Page 15 ▶ Page 21

Specification Information					
• Dimensions			• Weight	• Style Number	• U.S. Price
D	W	H			
4"	9 ³ / ₄ "	1 ¹ / ₂ "	0.5 lb	WSQS	\$61

Office in a File

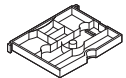

Standard Includes		Required to Specify
<ul style="list-style-type: none"> ▶ Need help? Product details, page 25 	<ul style="list-style-type: none"> • Storage file: plastic • Built-in tape dispenser • Translucent cover 	<ul style="list-style-type: none"> 1 Style number 2 Plastic color number for storage file: <ul style="list-style-type: none"> 6000 Black 6009 Arctic White 6544 Frost 6546 Rain

Specification Information					
• Dimensions			• Weight	• Style Number	• U.S. Price
D	W	H			
9 ⁵ / ₈ "	12 ¹ / ₄ "	1 ³ / ₈ "	1.5 lb	WOFS	\$61



For Canadian Pricing
 Multiply U.S. Price by the Canadian price factor.
 ▶ See page 1 for details.

Mini Shelf



Standard Includes		Required to Specify
▶ Need help? Product details, page 25	• Shelf: plastic	1 Style number 2 Plastic color number for shelf: 6000 Black 6009 Arctic White 6544 Frost 6546 Rain

Related Products	
• Slatwall tiles	▶ Page 15
• SlatRail	▶ Page 21

Specification Information					
• Dimensions			• Weight	• Style	• U.S.
D	W	H		Number	Price
10"	8"	1 7/8"	0.5 lb	KMINI	\$43
:	:	:	:	:	:

Personal Shelf

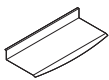

Standard Includes		Required to Specify
▶ Need help? Product details, page 26	• Personal shelf: paint	1 Style number 2 Paint color number for personal shelf: 0835 Black 4750 Champagne 7018 Pewter

Related Products	
• Slatwall tiles	▶ Page 15
• SlatRail	▶ Page 21

Specification Information					
• Dimensions			• Weight	• Style	• U.S.
D	W			Number	Price
5"	13 1/2"		3 lb	WSPS	\$68
:	:	:	:	:	:



For Canadian Pricing
Multiply U.S. Price by the
Canadian price factor.
▶ See page 1 for details.

Telephone Caddy

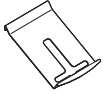

Tip: Telephone caddy is not compatible with Cisco phones.

Tip: 4³/₄" clearance required to install on Slatwall or SlatRail.

Standard Includes		Required to Specify
▶ Need help? Product details, page 26	• Telephone caddy: paint	1 Style number 2 Paint color number for telephone caddy: 0835 Black 4750 Champagne 7018 Pewter

Related Products	
• Slatwall tiles	▶ Page 15
• SlatRail	▶ Page 21

Specification Information					
• Dimensions			• Weight	• Style	• U.S.
D	W	H		Number	Price
2"	8"	11"	6 lb	WTCS	\$148
:	:	:	:	:	:

Tackstrip



Standard Includes		Required to Specify
▶ Need help? Product details, page 26	• Tackstrip: 6000 Black	Style number

Specification Information					
• Dimensions			• Weight	• Style	• U.S.
D	W	H		Number	Price
5/16"	15"	3 1/8"	0.5 lb	WTBS	\$70
:	:	:	:	:	:



For Canadian Pricing
Multiply U.S. Price by the
Canadian price factor.
▶ See page 1 for details.

Work Tags



Tip: Tags are wet-erase and reusable.

Standard Includes	Required to Specify
<ul style="list-style-type: none"> Need help? Product details, page 26 Tags, package of 10: 6544 Frost 	Style number

Specification Information					
Dimensions			Weight	Style Number	U.S. Price
D	W	H			
1 1/2"	2 3/8"	5/16"	1 lb	WWT	\$61

Markerboard

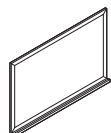

Tip: Not recommended for use on SlatRail.

Standard Includes	Required to Specify
<ul style="list-style-type: none"> Need help? Product details, page 27 Dry-erase markerboard Frame: aluminum Integrated holder for dry-erase markers 	Style number

Specification Information					
Dimensions			Weight	Style Number	U.S. Price
D	W	H			
1"	17 3/4"	11 3/4"	1.75 lb	WMB	\$169

Wastebasket

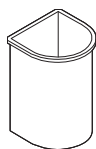

Standard Includes	Required to Specify
<ul style="list-style-type: none"> Need help? Product details, page 27 Wastebasket: 6000 Black 	Style number

Specification Information					
Dimensions			Weight	Style Number	U.S. Price
D	W	H			
10"	10"	15"	5 lb	DWBE	\$68



For Canadian Pricing
Multiply U.S. Price by the
Canadian price factor.
▶ See page 1 for details.

Coat Hook



Tip: Coat hook not recommended for use at end of panel run configurations.

Tip: Maximum weight for coat hook is 10 lb.

Standard Includes		Required to Specify
<ul style="list-style-type: none"> ▶ Need help? Product details, page 27 	<ul style="list-style-type: none"> • Coat hook: paint 	<ul style="list-style-type: none"> 1 Style number 2 Paint color number for coat hook: 0835 Black, 7018 Pewter

Specification Information					
• Dimensions			• Weight	• Style Number	• U.S. Price
D	W	H			
7/8"	2 1/2"	2 1/4"	0.15 lb	WCH	\$27
:	:	:	:	:	:

Flat Top Hanger

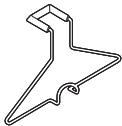

Tip: Maximum weight for hanger is 10 lb.

Standard Includes		Required to Specify
<ul style="list-style-type: none"> ▶ Need help? Product details, page 27 	<ul style="list-style-type: none"> • Hanger: paint • Rubber sleeve 	<ul style="list-style-type: none"> 1 Style number 2 Paint color number for hanger: 0835 Black, 4750 Champagne

Specification Information					
• Dimensions			• Weight	• Style Number	• U.S. Price
D	W	H			
3"	15 1/2"	7 3/4"	1 lb	FTH	\$36
:	:	:	:	:	:



For Canadian Pricing

Multiply U.S. Price by the Canadian price factor.

▶ See page 1 for details.

Pelican Pencil Drawers

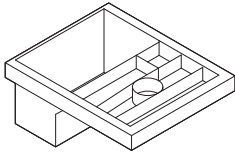

Tip: Drawer requires a 24" unobstructed worksurface depth and 20"W clearance.

Tip: For locks to be keyed alike to other Steelcase locks, specify a non-locking drawer and order locking plugs separately (service part number 877209201SR). Field installation will be required.

Tip: Non-locking pencil drawer ships with a plastic front plug and an empty lock core. It can be converted to locking in the field.

Standard Includes	Required to Specify
<ul style="list-style-type: none"> Need help? Product details, page 28 Pencil drawer: 6000 Black File bars Lock, if selected 	Style number

Specification Information					
Dimensions			Weight	Style Number	U.S. Price
D	W	H			
23"	19"	2"	22 lb	WDPDNL	\$563

Non-Locking Pencil Drawer

23"	19"	2"	22 lb	WDPDNL	\$563
-----	-----	----	-------	--------	-------

Locking Pencil Drawer

23"	19"	2"	22 lb	WDPDL	\$570
-----	-----	----	-------	-------	-------

Pelican Installation Bar

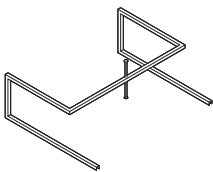

Standard Includes	Required to Specify
<ul style="list-style-type: none"> Need help? Product details, page 28 Installation bar 	Style number

Specification Information					
Dimensions			Weight	Style Number	U.S. Price
D	W	H			
17"	21½"	7"	5 lb	WIB	\$269



For Canadian Pricing
Multiply U.S. Price by the Canadian price factor.
▶ See page 1 for details.

SOTO Worktools

SOTO Rail

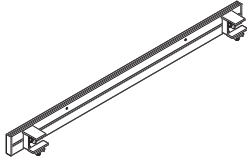

► Specifying, page 44

Product Details

SOTO rail supports several worktool combinations.

SOTO rail provides 1" clearance between worksurface and rail for cable management.

SOTO rail is flush with top of worksurface.

SOTO rail clamps onto worksurfaces or materials up to 2" thick. Each clamp requires 2" footprint above the worksurface. Clamp mounting brackets are included.

SOTO rail clamps are standard with rubber feet to ensure a tight fit without marring worksurface.

SOTO rail requires 18" minimum worksurface depth.

SOTO rail requires 3¼" clearance underneath worksurface to accommodate mounting clamps.

SOTO rails are not for use with glass worksurfaces.

SOTO rail supports a maximum weight of 125 lb.

Surface Materials

SOTO rail

- 4799 Platinum Metallic
 - Accent paints
- See *Surface Materials* on page 264 for accent paint options.

Actual Dimensions

Depth	1"
Width	28", 34", 40", 46", 52", 58", and 64"
Height	3½"
Weight	4.6 lb, 5.2 lb, 5.75 lb, 6.3 lb, 6.9 lb, 7.5 lb, and 8 lb

SOTO Pile Box

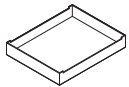

► Specifying, page 44

Product Details

SOTO pile boxes may be used individually, stacked horizontally, or criss-crossed. Boxes interlock when stacked horizontal.

SOTO pile boxes may be used freestanding or on 10" shelf.

SOTO pile boxes accommodate letter size materials.

Surface Materials

SOTO pile box

- 6009 Arctic White
- 6302 Baltic
- 6338 Chili
- 6527 Merle
- 6BE2 Light Peacock
- 6BE3 Cotton Candy

Actual Dimensions

Depth	9⅞"
Width	12¼"
Height	2"
Weight	0.7 lb

SOTO Landscape Letter Box

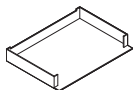

► Specifying, page 45

Product Details

SOTO landscape boxes may be used individually or stacked horizontal. Boxes interlock when stacked horizontal.

SOTO landscape boxes may be used freestanding or on 10" shelf.

SOTO landscape boxes accommodate letter size materials.

SOTO landscape box is standard with open front to allow for easy viewing of materials.

Surface Materials

SOTO landscape box

- 6009 Arctic White
- 6302 Baltic
- 6338 Chili
- 6527 Merle
- 6BE2 Light Peacock
- 6BE3 Cotton Candy

Actual Dimensions

Depth	9⅞"
Width	13¾"
Height	2"
Weight	0.8 lb

SOTO Tool Box



► Specifying, page 45

Product Details

SOTO tool box accommodates pens, pencils, Post-it® notes, and other small office tools.

SOTO tool box is standard with a translucent removable dividing insert to keep items separate.

Surface Materials

- SOTO tool box**
- 6009 Arctic White
 - 6302 Baltic
 - 6338 Chili
 - 6527 Merle
 - 6BE2 Light Peacock
 - 6BE3 Cotton Candy

Actual Dimensions

Depth	3½"
Width	3¼"
Height	3½"
Weight	0.3 lb

SOTO Diagonal File Box

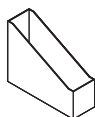

► Specifying, page 7

Product Details

SOTO diagonal file box supports binders and other reference materials.

SOTO diagonal file boxes may be used free-standing or on 10" shelf.

SOTO diagonal file box may be used in tall orientation for most materials or short orientation for larger materials.

Surface Materials

- SOTO diagonal file box**
- 6009 Arctic White
 - 6302 Baltic
 - 6338 Chili
 - 6527 Merle
 - 6BE2 Light Peacock
 - 6BE3 Cotton Candy

Actual Dimensions

Depth	12¼"
Width	4"
Height	9⅞"
Weight	0.5 lb

SOTO Utility Box



► Specifying, page 46

Product Details

SOTO utility box is for use on 3" shelf, inside personal box, or on worksurface.

Surface Materials

- SOTO utility box**
- 6009 Arctic White
 - 6302 Baltic
 - 6338 Chili
 - 6527 Merle
 - 6BE2 Light Peacock
 - 6BE3 Cotton Candy

Actual Dimensions

Depth	3⅞"
Width	9"
Height	1¼"
Weight	0.3 lb

SOTO Personal Box

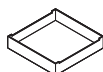

► Specifying, page 46

Product Details

SOTO personal box provides user controlled area for small business or personal items.

SOTO personal boxes may be used freestanding or on 10" shelf.

SOTO personal boxes may be used individually or stacked horizontal. Boxes interlock when stacked horizontal.

Surface Materials

- SOTO personal box**
- 6009 Arctic White
 - 6302 Baltic
 - 6338 Chili
 - 6527 Merle
 - 6BE2 Light Peacock
 - 6BE3 Cotton Candy

Actual Dimensions

Depth	9"
Width	9"
Height	2"
Weight	0.3 lb

SOTO Mobile Caddy

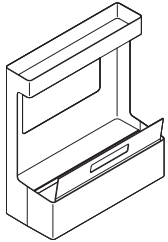

► Specifying, page 48

Product Details

SOTO mobile caddy provides space to stow personal items off floor and out of work chair.

Upper shelf of SOTO mobile caddy houses a fabric pad to hold mobile devices in soft, open environment.

SOTO mobile caddy is standard with in-line casters for ease of pulling out and pushing under worksurface.

SOTO tool box, utility box, and storage boxes fit into the top shelf of caddy.

SOTO mobile caddy is designed to meet C2C Silver Certification and BIFMA Level 1 Certification.

Surface Materials

SOTO mobile caddy

- 6009 Arctic White
- 6527 Merle

Fabric pad

- Dark grey felt (standard)
 - Cogent: Connect (option)
- See Surface Materials, page 264

Actual Dimensions

Depth	21"
Width	9½"
Height	23¾"
Weight	16.8 lb

SOTO Launch Pad

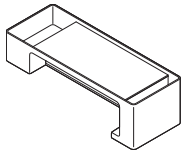

► Specifying, page 48

Product Details

SOTO launch pad provides connectivity for mobile devices at the front of the worksurface.

SOTO launch pad is standard with integrated pockets on each end for storage.

SOTO personal box and utility box fit in top section of launch pad.

Powered SOTO launch pad, if selected, is standard with three outlets on each side, including one for large plugs, and a 9' power cord with cable management clips. Powered SOTO launch pad contains a 15 amp circuit breaker.

SOTO launch pad may be placed inboard or outboard of cantilevers, if placed outboard overhang must be specified.

SOTO launch pad may be clamped on any standard worksurface edge ½" to 1½" thick.

SOTO launch pad may be shared by two users in a bench application.

SOTO launch pad is U.L. and c.U.L. listed and designed to meet BIFMA Level 1 Certification.

Surface Materials

SOTO launch pad

- 6009 Arctic White
- 6527 Merle

Fabric pad

- Dark grey felt (standard)
 - Cogent: Connect (option)
- See Surface Materials, page 264

Actual Dimensions

Depth	24"
Worksurface Depth when installed	21"
Width	9"
Height above worksurface 5"	
Weight	7.75 lb and 10.1 lb

Tip: Steelcase products are designed and tested for code and standard compliance when installed and used as an integrated product solution in accordance with Steelcase application guidelines and installation instructions. However, consult with your local authority having jurisdiction as they have final say if the products as installed are compliant with local code.

SOTO Functional Screen

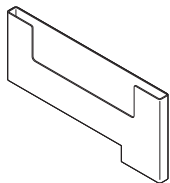

Tip: Functional screen not applicable for use with glass, bullnose, knife-edge, or any other non-standard worksurface edge.

► Specifying, page 49

Product Details

SOTO functional screen combines organization and boundary while providing privacy.

SOTO functional screen has a 1¾" integrated opening to hold frequently accessed documents and materials.

SOTO functional screen may be clamped to any standard worksurface ¾" to 1½" thick. Clamp depth is 2½".

SOTO functional screen is standard with felt liner to dampen noise.

SOTO functional screen is 14" above work-surface when installed.

SOTO functional screen is designed to meet C2C Silver Certification and BIFMA Level 1 Certification.

SOTO functional screen is field changeable from right to left facing. Phillips screwdriver is required.

Surface Materials

SOTO functional screen

- 6009 Arctic White
- 6527 Merle

Actual Dimensions

Overall Depth	28½"
Overall Width	1¾"
Overall Height	14"
Worksurface Installed Depth	21½"
Worksurface Installed Width	1¾"
Worksurface Installed Height	11"
Worksurface Installed Pocket Opening	1⅝"

SOTO Personal Pocket



► Specifying, page 7

Product Details

SOTO personal pocket provides space to store frequently accessed materials.

SOTO personal pocket may be used freestanding in a single unit or ganged to create a desktop organizer.

When used as a single unit, SOTO personal pocket will easily attach to mobile caddy or functional screen.

Ends of SOTO personal pocket are open to accommodate various sizes of materials.

SOTO personal pocket holds a maximum weight of 10 lb.

SOTO personal pocket is designed to meet BIFMA Level 1 Certification.

Surface Materials

SOTO personal pocket

- 6000 Black

Actual Dimensions

Depth	11¾"
Width	2"
Height	5½"
Weight	1.1 lb

SOTO Cable Clip



Tip: Cable clips cannot be used with glass, bullnose, knife edge, or other non-standard worksurface edges.

► Specifying, page 49

Product Details

SOTO cable clip provides cable management.

SOTO cable clip clamps to any worksurface ¾" to 1¼" thick.

Surface Materials

SOTO cable clip

- 6009 Arctic White
- 6059 Sterling Dark Solid

Actual Dimensions

Depth	2"
Width	1"
Height	2"
Weight	0.5 lb

SOTO Personal Hook



Tip: Personal hook not applicable for use with glass, bullnose, knife-edge, or any other non-standard worksurface edge.

► Specifying, page 50

Product Details

SOTO personal hook is designed to hold lightweight bags, keys, umbrella, or other small items.

SOTO personal hook clamps to any worksurface ¾" to 1¼" thick.

SOTO personal hook may not be clamped to the sides of the Migration work-surface due to its cantilevers.

SOTO personal hook holds a maximum weight of 10 lb.

Surface Materials

SOTO personal hook

- 6009 Arctic White
- 6059 Sterling Dark Solid

Actual Dimensions

Depth	2"
Width	¾"
Height	2"
Weight	0.5 lb

Tip: Steelcase products are designed and tested for code and standard compliance when installed and used as an integrated product solution in accordance with Steelcase application guidelines and installation instructions. However, consult with your local authority having jurisdiction as they have final say if the products as installed are compliant with local code.

SOTO Monitor Bridge

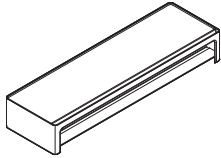

► Specifying, page 50

Product Details

SOTO monitor bridge supports monitor or multiple monitors (depending on size) and one-over-one screen application with laptop.

Optional monitor bridge shelf can support up to three SOTO personal boxes and provide additional storage space for objects or keyboard.

SOTO monitor bridge clears space in front of user for more available worksurface.

SOTO monitor bridge can hold a maximum 50 lb.

Anti-skid pads are standard to help prevent slipping.

The distance between worksurface top and underside of bridge is 3 1/2".

The distance between worksurface top and underside of shelf is 1".

The distance between top of shelf and underside of bridge is 2 1/2".

The distance between bridge stanchions is 27".

Channel opening size is 0.7"D x 29"W x 0.8"H.

Surface Materials

SOTO monitor bridge

- 6009 Arctic White
- 6527 Merle

Fabric pad

- Dark Grey Felt (standard)
- Cogent:Connect (option)

► See Surface Materials, page 264

Actual Dimensions

Depth	9"
Width	29 2/5"
Height	4 1/2"
Bridge weight	4.1 lb
Shelf weight	8.24 lb

Application Topics

SOTO monitor bridge works with SOTO laptop shelf to allow use with laptop as a second screen.
 ► See page 50

SOTO Laptop Shelf

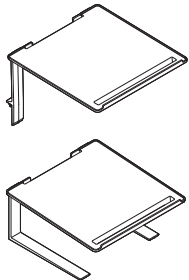

► Specifying, page 51

Product Details

SOTO laptop shelf allows user to utilize an external keyboard and the laptop as a dual screen.

SOTO laptop shelf raises the laptop for better user ergonomics.

Docking station can be rear or side-mounted.

SOTO laptop shelf is available in rail-mounted or freestanding. Both versions can hold a maximum 20 lb.

Allows use of shelf with monitor arms or monitor bridge.

SOTO laptop shelf supports tablet or cell phone in display or video chat angle.

Anti-skid pads are standard to help prevent slipping.

The distance between worksurface top and underside of front is 5 7/8" for rail-mounted shelf and 5 3/8" for freestanding shelf.

The distance between worksurface top and underside of back of shelf is 7 1/4".

The distance between bridge stanchions is 9".

Channel opening size for shelf is 0.6"D x 12"W x 0.6"H.

Foot length of free-standing shelf bracket is 11".

The front of the shelf has a 2/5"H lip.

Surface Materials

SOTO laptop shelf

- 6009 Arctic White
- 4799 Platinum

Actual Dimensions

Depth	14 1/4"
Width	14"
Height of rail-mounted shelf	9 5/8"
Height of freestanding shelf	7"
Weight of rail-mounted shelf	2.7 lb
Weight of freestanding shelf	3 lb

Application Topics

SOTO personal box fits between shelves legs for additional object storage.
 ► See page 46

SOTO Box Application Chart

	Tool Box	Pile Box	Diagonal File Box	Personal Box	Landscape Letter Box	Utility Box
Shelf 10"D and 24½"W	Yes	Yes	Yes (Rotates 90°)	Yes	Yes	Yes
Shelf 6"D x 24½"W	Yes					Yes
Shelf 3"D x 36"W	Yes					Yes
Display Shelf 24½"W and 5"H Stanchions						Yes
Display Shelf 24½"W and 8"H Stanchions						Yes

SOTO Worktool/SOTO Rail Application Chart

	Shelf 10"D x 24½"W	Shelf 6"D x 24½"W	Shelf 3"D x 30"W	Display Shelf Stanchions 24½"W x 5"H	Display Shelf Stanchions 24½"W x 8"H	LED Light Rail Mount	20"L Cableway	30"L Cableway
Rail 28"W	1	1	1 w/overhang	1	1*	1**	1	1 w/overhang
Rail 34"W	1	1	1 w/overhang	1	1*	1**	1	1
Rail 40"W	1	1	1 w/overhang	1	1*	1**	2	1
Rail 46"W	1	1	1 w/overhang	1	1*	1**	2	1
Rail 52"W	2	2	1	2	2*	1**	(1) 20* and (1) 30*	(1) 20* and (1) 30*
Rail 58"W	2	2	1	2	2*	1**	(1) 20* and (1) 30*	(1) 20* and (1) 30*
Rail 64"W	2	2	1	2	2*	1**	(3) 20* or (1) 20* and (1) 30*	(2) 20* or (1) 20* and (1) 30*

* All other shelves can occupy the same space mounted 3" below.

** Able to occupy the same space with 24" and 36" shelves (not display shelves).

SOTO Worktools

SOTO Rails

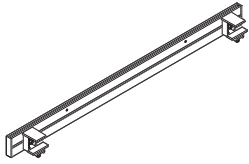

Tip: The colors for plastic end caps are defaulted by bracket color.
 ▶ See page 266, Defaulted Finishes.

Tip: Rails clamp to freestanding worksurfaces or material up to 2" thick. Rails are not applicable for glass surfaces.

Tip: Not applicable on glass surfaces.

Tip: Allow 1" clearance between worksurface and rail for cable management. Allow 2" for rail mount installed behind a worksurface, and 3 3/4" overall to install the rail.

Tip: Maximum weight load for rails is 2 lb per lineal inch.

Tip: Each clamp requires a 2" footprint above the worksurface, and a 3 1/4" clearance below the worksurface.

Tip: Rails require a minimum worksurface depth of 18" for stability.

Standard Includes	Required to Specify
<ul style="list-style-type: none"> ▶ Need help? Product details, page 38 • Rail: 4799 Platinum Metallic • Brackets and stanchions: 4799 Platinum Metallic 	<ul style="list-style-type: none"> 1 Style number 2 Options, if selected (see below) ▶ See <i>Surface Materials</i>, page 264.

Options	U.S. Price	Required to Specify
Surface Materials <ul style="list-style-type: none"> • Rail • Paint price group 3 	+\$38	<ul style="list-style-type: none"> Specify paint color number. ▶ See <i>Surface Materials</i> on page 264 for accent paint options.

Specification Information					
• Dimensions	• Weight			• Style Number	• U.S. Base Price
	D	W	H		
1"	28"	3 1/4"	4.6 lb	DSR28	\$323
1"	34"	3 1/4"	5.2 lb	DSR34	\$340
1"	40"	3 1/4"	5.75 lb	DSR40	\$362
1"	46"	3 1/4"	6.3 lb	DSR46	\$381
1"	52"	3 1/4"	6.9 lb	DSR52	\$401
1"	58"	3 1/4"	7.5 lb	DSR58	\$420
1"	64"	3 1/4"	8 lb	DSR64	\$443

SOTO Pile Box

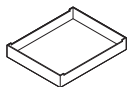

Standard Includes	Required to Specify
<ul style="list-style-type: none"> ▶ Need help? Product details, page 38 • Pile box: plastic 	<ul style="list-style-type: none"> 1 Style number 2 Plastic color number for pile box: <ul style="list-style-type: none"> 6009 Arctic White 6302 Baltic 6338 Chili 6527 Merle 6BE2 Light Peacock 6BE3 Cotton Candy

Specification Information					
• Dimensions	• Weight			• Style Number	• U.S. Price
	D	W	H		
9 7/8"	12 1/4"	2"	0.7 lb	DSSPB	\$63

 **For Canadian Pricing**
 Multiply U.S. Price by the Canadian price factor.
 ▶ See page 1 for details.

SOTO Landscape Letter Box

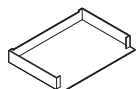

Standard Includes		Required to Specify
<ul style="list-style-type: none"> ▶ Need help? Product details, page 38 	<ul style="list-style-type: none"> • Landscape letter box: plastic 	<ul style="list-style-type: none"> 1 Style number 2 Plastic color number for letter box: <ul style="list-style-type: none"> 6009 Arctic White 6302 Baltic 6338 Chili 6527 Merle 6BE2 Light Peacock 6BE3 Cotton Candy

Specification Information					
• Dimensions			• Weight	• Style Number	• U.S. Price
D	W	H			
9 ⁷ / ₈ "	13 ³ / ₄ "	2"	0.8 lb	DSLLB	\$63

SOTO Tool Box



Tip: Tool box contains removable semi-opaque insert to separate pens from sticky notes.

Standard Includes		Required to Specify
<ul style="list-style-type: none"> ▶ Need help? Product details, page 39 	<ul style="list-style-type: none"> • Tool box: plastic 	<ul style="list-style-type: none"> 1 Style number 2 Plastic color number for tool box: <ul style="list-style-type: none"> 6009 Arctic White 6302 Baltic 6338 Chili 6527 Merle 6BE2 Light Peacock 6BE3 Cotton Candy

Specification Information					
• Dimensions			• Weight	• Style Number	• U.S. Price
D	W	H			
3 ¹ / ₂ "	3 ¹ / ₄ "	3 ¹ / ₂ "	0.3 lb	DSTB	\$56

SOTO Diagonal File Box

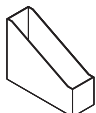

Standard Includes		Required to Specify
<ul style="list-style-type: none"> ▶ Need help? Product details, page 39 	<ul style="list-style-type: none"> • Diagonal file box: plastic 	<ul style="list-style-type: none"> 1 Style number 2 Plastic color number for file box: <ul style="list-style-type: none"> 6009 Arctic White 6302 Baltic 6338 Chili 6527 Merle 6BE2 Light Peacock 6BE3 Cotton Candy

Specification Information					
• Dimensions			• Weight	• Style Number	• U.S. Price
D	W	H			
12 ¹ / ₄ "	4"	9 ⁷ / ₈ "	0.5 lb	DSDFB	\$63

 **For Canadian Pricing**
 Multiply U.S. Price by the Canadian price factor.
 ▶ See page 1 for details.

SOTO Utility Box



Standard Includes				Required to Specify	
▶ Need help? Product details, page 39		• Utility box: plastic		1 Style number	2 Plastic color number for utility box:
				6009 Arctic White	6302 Baltic
				6338 Chili	6527 Merle
				6BE2 Light Peacock	6BE3 Cotton Candy
Specification Information					
• Dimensions			• Weight	• Style	• U.S.
D	W	H		Number	Price
37/8"	9"	1 1/4"	0.3 lb	DSUB	\$56
:	:	:	:	:	:

SOTO Personal Box

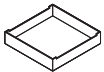

Standard Includes				Required to Specify	
▶ Need help? Product details, page 39		• Personal box: plastic		1 Style number	2 Plastic color number for personal box:
				6009 Arctic White	6302 Baltic
				6338 Chili	6527 Merle
				6BE2 Light Peacock	6BE3 Cotton Candy
Specification Information					
• Dimensions			• Weight	• Style	• U.S.
D	W	H		Number	Price
9"	9"	2"	0.3 lb	DSPB	\$56
:	:	:	:	:	:

SOTO Intro Bundle

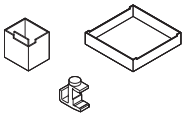

Tip: Intro bundle contains a tool box, personal box, and personal hook.

Standard Includes		Required to Specify	
<ul style="list-style-type: none"> • SOTO tool box: 6009 Arctic White • SOTO personal box: 6009 Arctic White • SOTO personal hook: 6009 Arctic White 		Style number	
Related Products		Required to Specify	
<ul style="list-style-type: none"> • SOTO tool box • SOTO personal box • SOTO personal hook 		<ul style="list-style-type: none"> ▶ Page 45 ▶ See above ▶ Page 50 	
Specification Information			
• Style	• U.S.		
Number	Price		
PCDB1	\$119		
:	:		



For Canadian Pricing
Multiply U.S. Price by the Canadian price factor.
▶ See page 1 for details.

SOTO Box Bundle

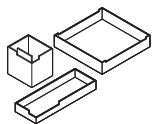

Tip: SOTO box bundle contains a tool box, utility box, and personal box.

Standard Includes	Required to Specify
-------------------	---------------------

- SOTO tool box: plastic price group 1
- SOTO utility box: plastic price group 1
- SOTO personal box: plastic price group 1

- 1 Style number
- 2 Plastic color number for SOTO boxes:
 - 6009 Arctic White
 - 6302 Baltic
 - 6338 Chili
 - 6527 Merle
 - 6BE2 Light Peacock
 - 6BE3 Cotton Candy

Related Products	Required to Specify
------------------	---------------------

- SOTO tool box
- SOTO utility box
- SOTO personal box

- ▶ Page 45
- ▶ Page 46
- ▶ Page 46

Specification Information	
Style Number	U.S. Price

PCDB3	\$141
-------	-------

SOTO Essential Bundle

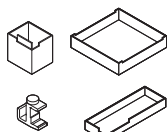

Tip: Essential bundle contains a tool box, utility box, personal box, and personal hook.

Standard Includes	Required to Specify
-------------------	---------------------

- SOTO tool box: plastic
- SOTO utility box: plastic
- SOTO personal box: plastic
- SOTO personal hook: plastic

- 1 Style number
- 2 Plastic color number for SOTO boxes:
 - 6009 Arctic White
 - 6302 Baltic
 - 6338 Chili
 - 6527 Merle
 - 6BE2 Light Peacock
 - 6BE3 Cotton Candy
- 3 Plastic color number for personal hook:
 - 6009 Arctic White
 - 6059 Sterling Dark Solid

Related Products	Required to Specify
------------------	---------------------

- SOTO tool box
- SOTO utility box
- SOTO personal box
- SOTO personal hook

- ▶ Page 45
- ▶ Page 46
- ▶ Page 46
- ▶ Page 50

Specification Information	
Style Number	U.S. Price

PCDB2	\$161
-------	-------



For Canadian Pricing
 Multiply U.S. Price by the Canadian price factor.
 ▶ See page 1 for details.

SOTO Mobile Caddy

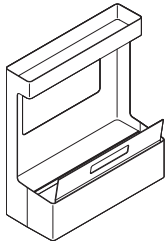

Tip: Height-adjustable work surface controllers and cables must be clear of mobile caddy.

Tip: When positioning work surface in lowest position, mobile caddy must be moved from under work surface.

Standard Includes		Required to Specify
-------------------	--	---------------------

<ul style="list-style-type: none"> ▶ Need help? Product details, page 40 	<ul style="list-style-type: none"> • Mobile caddy: plastic • Fabric covered pad: dark grey felt 	<ul style="list-style-type: none"> 1 Style number 2 Plastic color number for mobile caddy: 6009 Arctic White 6527 Merle 3 Options, if selected (see below) ▶ See <i>Surface Materials</i>, page 264.
-----------------------------------------------------------------------------------------	-------------------------------------------------------------------------------------------------------------------------	------------------------------------------------------------------------------------------------------------------------------------------------------------------------------------------------------------------------------------------------

Options	U.S. Price	Required to Specify
---------	------------	---------------------

Surface Materials <ul style="list-style-type: none"> • Fabric covered pad • Grey felt • Fabric finish set 1 • Fabric finish set 2 	<ul style="list-style-type: none"> No cost +\$ 61 +\$131 	<ul style="list-style-type: none"> Specify grey felt. Specify fabric color number. Specify fabric color number.
------------------------------------------------------------------------------------------------------------------------------------------------------------------------------------	-------------------------------------------------------------------------------------------	--------------------------------------------------------------------------------------------------------------------------------------------------

Specification Information					
Dimensions			Weight	Style Number	U.S. Base Price
D	W	H			

21"	9½"	23¾"	16.8 lb	DSMC	\$697
-----	-----	------	---------	-------------	-------

SOTO Launch Pad

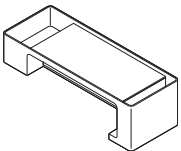

Standard Includes		Required to Specify
-------------------	--	---------------------

<ul style="list-style-type: none"> ▶ Need help? Product details, page 40 	<ul style="list-style-type: none"> • Launch pad: plastic • Fabric pad: grey felt • Powered, if selected: 3 outlets on each side, 9' power cord, cable management clips 	<ul style="list-style-type: none"> 1 Style number 2 Plastic color number for launch pad: 6009 Arctic White 6527 Merle 3 Options, if selected (see below) ▶ See <i>Surface Materials</i>, page 264.
-----------------------------------------------------------------------------------------	---------------------------------------------------------------------------------------------------------------------------------------------------------------------------------------------------------	----------------------------------------------------------------------------------------------------------------------------------------------------------------------------------------------------------------------------------------------

Options	U.S. Price	Required to Specify
---------	------------	---------------------

Surface Materials <ul style="list-style-type: none"> • Fabric covered pad • Grey felt • Fabric finish set 1 • Fabric finish set 2 	<ul style="list-style-type: none"> No cost +\$ 61 +\$131 	<ul style="list-style-type: none"> Specify grey felt. Specify fabric color number. Specify fabric color number.
------------------------------------------------------------------------------------------------------------------------------------------------------------------------------------	-------------------------------------------------------------------------------------------	--------------------------------------------------------------------------------------------------------------------------------------------------

Specification Information					
Dimensions			Weight	Style Number	U.S. Base Price
D	W	H			

24"	9"	5"	7.75 lb	DSLPLNP	\$461
-----	----	----	---------	----------------	-------

Non-Powered Launch Pad

24"	9"	5"	7.75 lb	DSLPLNP	\$461
-----	----	----	---------	----------------	-------

Powered Launch Pad

24"	9"	5"	10.1 lb	DSLPLP	\$697
-----	----	----	---------	---------------	-------

Tip: SOTO powered launch pad contains a 15 amp circuit breaker.



For Canadian Pricing
Multiply U.S. Price by the Canadian price factor.
▶ See page 1 for details.

SOTO Functional Screen

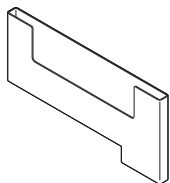

Tip: Screens cannot be used on glass, bullnose, knife edge, or other non-standard worksurface edges.

Tip: All height-adjustable worksurface controllers must be mounted clear of installed screen.

Standard Includes	Required to Specify
<ul style="list-style-type: none"> ▶ Need help? Product details, page 41 • Functional screen: plastic 	<ul style="list-style-type: none"> 1 Style number 2 Plastic color number for functional screen: <ul style="list-style-type: none"> 6009 Arctic White 6527 Merle

Specification Information					
• Dimensions			• Weight	• Style Number	• U.S. Price
D	W	H			
28½"	1¾"	14"	5.1 lb	DSFS	\$420
·	·	·	·	·	·

SOTO Personal Pocket



Tip: Personal pocket fits on mobile caddy and functional screen, or can be ganged together while freestanding.

Standard Includes	Required to Specify
<ul style="list-style-type: none"> ▶ Need help? Product details, page 41 • Personal pocket: 6000 Black 	<ul style="list-style-type: none"> Style number

Specification Information					
• Dimensions			• Weight	• Style Number	• U.S. Price
D	W	H			
11¾"	2"	5½"	1.1 lb	DSPP	\$63
·	·	·	·	·	·

SOTO Cable Clip



Tip: Clips cannot be used with glass, bullnose, knife edge, or other non-standard worksurface edges.

Standard Includes	Required to Specify
<ul style="list-style-type: none"> ▶ Need help? Product details, page 41 • Cable clip: plastic 	<ul style="list-style-type: none"> 1 Style number 2 Plastic color number for cable clip: <ul style="list-style-type: none"> 6009 Arctic White 6059 Sterling Dark Solid

Specification Information					
• Dimensions			• Weight	• Style Number	• U.S. Price
D	W	H			
2"	1"	2"	0.5 lb	DCCLIP	\$38
·	·	·	·	·	·



For Canadian Pricing
 Multiply U.S. Price by the Canadian price factor.
 ▶ See page 1 for details.

SOTO Personal Hook

Tip: Hooks cannot be used with glass, bullnose, knife edge, or other non-standard worksurface edges.

Standard Includes	Required to Specify
-------------------	---------------------

- | | | |
|-----------------------------------------------------------------------------------------|----------------------------------------------------------------------------|--------------------------------------------------------------------------------------------------------------------------------------------------------------------------------------------------------------------------------------------------------|
| <ul style="list-style-type: none"> ▶ Need help? Product details, page 41 | <ul style="list-style-type: none"> • Personal hook: plastic | <ul style="list-style-type: none"> 1 Style number 2 Plastic color number for personal hook: <ul style="list-style-type: none"> 6009 Arctic White 6059 Sterling Dark Solid |
|-----------------------------------------------------------------------------------------|----------------------------------------------------------------------------|--------------------------------------------------------------------------------------------------------------------------------------------------------------------------------------------------------------------------------------------------------|

Specification Information					
• Dimensions			• Weight	• Style	• U.S.
D	W	H		Number	Base Price

2"	3/4"	2"	0.5 lb	DPHOOK	\$38
·	·	·	·	·	·

SOTO Monitor Bridge

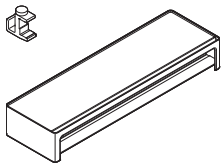

Standard Includes	Required to Specify
-------------------	---------------------

- | | | |
|-----------------------------------------------------------------------------------------|---------------------------------------------------------------------------------------------------------------------------|----------------------------------------------------------------------------------------------------------------------------------------------------------------------------------------------------------------------------------------------------------------------------------------------------------------------------------------------------------------------------------------------------------------|
| <ul style="list-style-type: none"> ▶ Need help? Product details, page 42 | <ul style="list-style-type: none"> • Monitor bridge: plastic • Fabric covered pad: dark grey felt | <ul style="list-style-type: none"> 1 Style number 2 Plastic color number for monitor bridge: <ul style="list-style-type: none"> 6009 Arctic White 6527 Merle 3 Options, if selected (see below) <ul style="list-style-type: none"> ▶ See <i>Surface Materials</i>, page 264. |
|-----------------------------------------------------------------------------------------|---------------------------------------------------------------------------------------------------------------------------|----------------------------------------------------------------------------------------------------------------------------------------------------------------------------------------------------------------------------------------------------------------------------------------------------------------------------------------------------------------------------------------------------------------|

Options	U.S. Price	Required to Specify
---------	------------	---------------------

Surface Materials <ul style="list-style-type: none"> • Merle shelf 	+\$110	Specify <i>with 6527 Merle</i> .		
Fabric covered pad <ul style="list-style-type: none"> • Grey felt • Fabric finish set 1 • Fabric finish set 2 			No cost +\$ 61 +\$131	Specify grey felt. Specify fabric color number. Specify fabric color number.

Specification Information					
• Dimensions			• Weight	• Style	• U.S.
D	W	H		Number	Base Price

9"	29 ² / ₅ "	4 ¹ / ₂ "	4.1 lb	DSMB	\$334
·	·	·	·	·	·



For Canadian Pricing
 Multiply U.S. Price by the Canadian price factor.
 ▶ See page 1 for details.

SOTO Laptop Shelf

Standard Includes	Required to Specify
<ul style="list-style-type: none"> ▶ Need help? Product details, page 42 • Laptop shelf: 6009 Arctic White • Stanchion: 4799 Platinum 	Style number

Specification Information

• Dimensions			• Weight	• Style	• U.S.
D	W	H		Number	Price
⋮	⋮	⋮	⋮	⋮	⋮

Rail-Mounted

14 ³ / ₄ "	14"	9 ⁵ / ₈ "	2.7 lb	DSL SRM	\$246
⋮	⋮	⋮	⋮	⋮	⋮

Freestanding

14 ³ / ₄ "	14"	7"	3 lb	DSL S	\$268
⋮	⋮	⋮	⋮	⋮	⋮

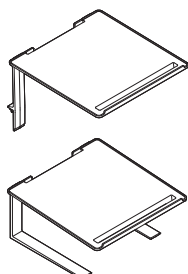

Tip: To prevent tipping with freestanding unit, press only on middle to rear of product.

Tip: Laptop shelf is able to accommodate side or rear mounted docking stations.



For Canadian Pricing
 Multiply U.S. Price by the Canadian price factor.
 ▶ See page 1 for details.



Victor2

	
Statement of Line	54
	
Victor2	
Understanding	56
Specifying	58

Statement of Line

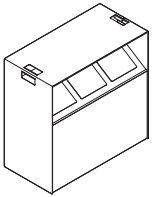

Understanding
▶ Page 56
Specifying
▶ Page 58

Mobile Unit

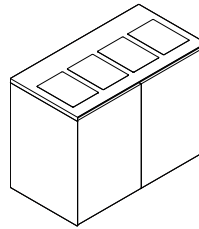

Understanding
▶ Page 56
Specifying
▶ Page 60

Freestanding Unit



Understanding
▶ Page 57
Specifying
▶ Page 62

Tray Shelf



Understanding
▶ Page 57
Specifying
▶ Page 62

Display

Victor2

Victor2 is a recycling solution that is appropriate for supporting larger work groups, conference rooms, and cafés. A mobile unit and two freestanding units are available.
 ▶ Specifying, pages 58

Mobile unit has three openings. Eight insert options are available to pick for the openings. These eight insert options contain English, Spanish, and French.

Receptacles contain features to accommodate oversized bags.

Four non-locking casters are standard. Two casters swivel, and two casters are fixed. Move unit from the swivel casters side. Unit moves from the right in the direction of the swivel casters. Enclosing the unit in too limited of space impedes movement. Unit needs room to swivel, approximately 5" from side of enclosure.

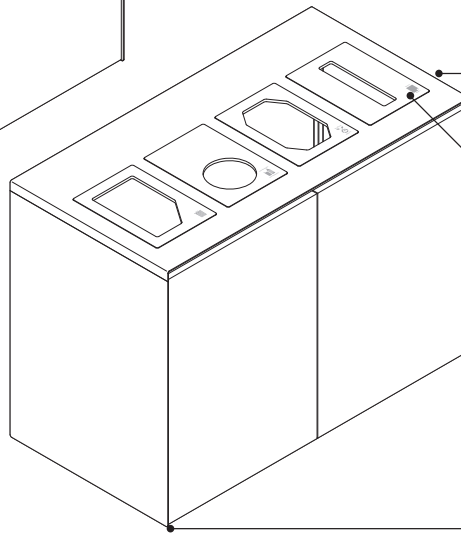
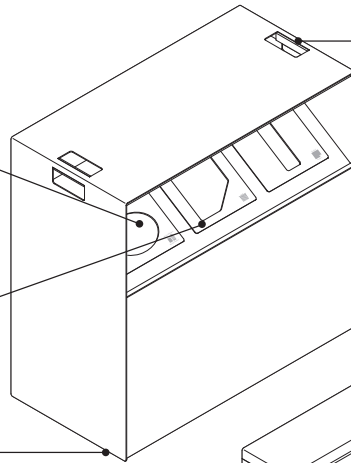

Soft-touch integral handle allows easy movement from one location to another.

Receptacles fit bags from 30 gallon size and larger.

Freestanding unit has four or five openings. Eight insert options are available to pick for the openings. These eight insert options contain English, Spanish and French.

Leveling glides are fully adjustable up to 1½".

Actual Dimensions

	Mobile Unit	Freestanding Unit
Depth	18"	25"
Width	36"	48" or 60"
Height	36"	36"

Product Details

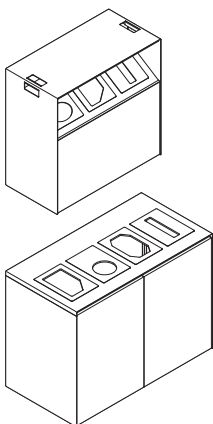

Mobile and freestanding units are standard with a metal case and top. Front and back of unit are available in wood or laminate.

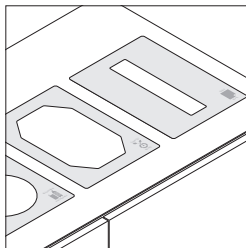

Acrylic inserts etched with recycling icons are standard on mobile and freestanding units. The verbiage for each icon is in English/Spanish/French on the same insert.

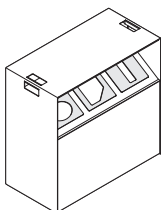

Mobile unit is standard with three openings for inserts and sloped receptacles with built-in bag holding system.

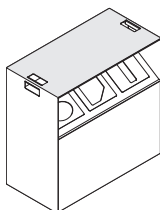

Top on the mobile unit can be used for food service use or tray storage.

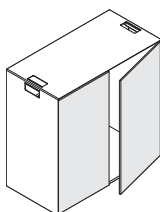

Hinged doors on the back are standard on the mobile unit for easy access to receptacles.

Four non-locking concealed casters, two swivel and two fixed, are standard on the mobile unit. Unit moves from the front right side. It is not recommended to move from the fixed caster side.

Receptacles in mobile unit can accommodate 12 gallons each. Receptacles in freestanding unit can accommodate 30 gallon size and larger.

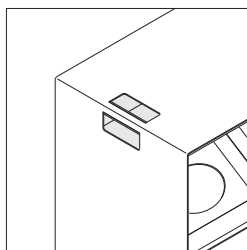

Soft-touch integral handle on mobile unit allows for easy movement from one location to another.

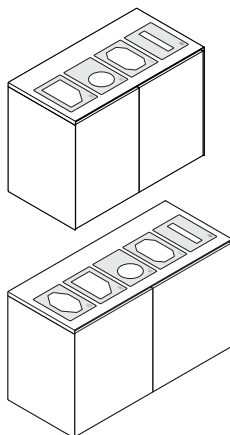

Freestanding unit is standard with either four or five openings for inserts on the top of the unit.

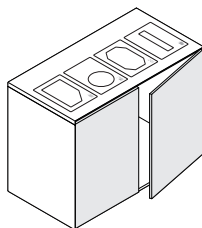

Hinged doors on the front are standard on the freestanding unit for easy access to the receptacles.

Leveling glides on freestanding units are fully adjustable to 1½".

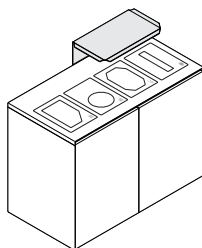

Tray shelf can only be used with the freestanding unit.

Tray shelf fits most trays up to 20¾" x 12".

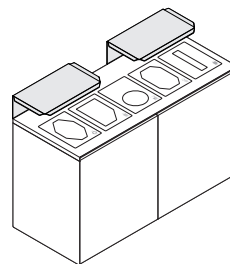

Freestanding four- or five-slot opening will accommodate two tray shelves.
Tip: A gap of 15" will separate the two tray shelves on a five-opening unit.

Maximum capacity of tray is 20 food trays with maximum size of tray 20" x 20".

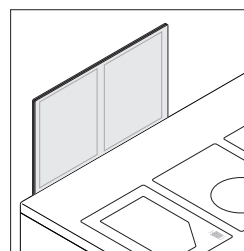

Display holds two 8½" x 11" papers or one 11" x 17" paper.

Tip: Paper will be between two acrylic plates. Paper can easily be replaced without tools.

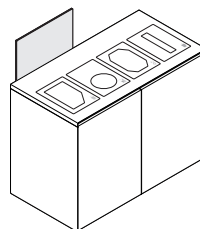

Display can only be used with the freestanding unit.

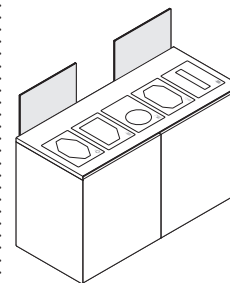

Freestanding four- or five-slot opening will accommodate two displays.
Tip: A gap of 18½" will separate the two displays on a five-opening unit.

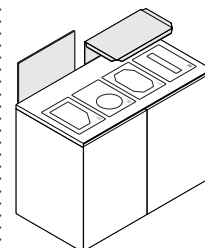

One tray shelf and one display can be used on the freestanding unit.

Surface Materials

Top and sides

- Paint

Back and front

- Wood
- Laminate (HPL)
- Customiz stain (option on wood)

Victor2 Mobile Unit

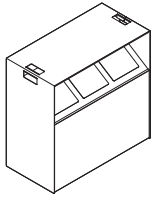

Tip: Acrylic inserts lift out without tools for ease of cleaning and changeability.









Tip: Verbiage on each insert contains English, Spanish, and French.

For laminate price group 2 and 3 pricing, please refer to the electronic catalog or SmartTools.

Tip: Receptacle contains features to accommodate oversized bags.

Tip: Soft-touch integral handle allows easy movement from one location to another.

Standard Includes		Required to Specify
<ul style="list-style-type: none"> ▶ Need help? Product details, page 56 	<ul style="list-style-type: none"> Mobile unit: <ul style="list-style-type: none"> - Front and back: wood group 1 - Sides and top: paint Finished back hinged doors Three slot opening with sloped receptacles and built in bag holding system Acrylic inserts etched with recycling icons and wording Three 100% recycled plastic rigid recycling bins – 12 gallon capacity each Four non-locking black casters: two swivel/two fixed 	<ol style="list-style-type: none"> Style number Wood color number for front and back Paint color number for sides and top (case) Three acrylic inserts (see below under Required Selections) Options, if selected (see below) <p>▶ See <i>Surface Materials Reference Manual</i>.</p>

Required Selections	
Acrylic Inserts (Pick three)	
 Plastic	 Compost
 Mixed	 Waste
 Paper	 Aluminum
 Returns	 Glass

Options	U.S. Price	Required to Specify
Surface Materials <ul style="list-style-type: none"> Wood front and back <ul style="list-style-type: none"> • Wood group 2 +\$111 • Wood group 3 +\$382 • Customiz stain No cost 		Specify wood color number. Specify wood color number. Specify with <i>Customiz stain</i> . ▶ See <i>Surface Materials Reference Manual</i> .
<ul style="list-style-type: none"> Laminate front and back <ul style="list-style-type: none"> • Laminate price group 1 -\$501 • Laminate price group 2 See information at left • Laminate price group 3 See information at left • Open Line Laminate -\$390 plus cost of laminate 		Specify laminate color number. Specify laminate color number. Specify laminate color number. ▶ See <i>Surface Materials Reference Manual</i> .
<ul style="list-style-type: none"> Paint on case <ul style="list-style-type: none"> • Paint price group 1 No cost • Paint price group 2 +\$120 • Paint price group 3 +\$208 		Specify paint color number. Specify paint color number. Specify paint color number.

Specification Information			
Dimensions			U.S. Base Price
D	W	H	Number
18"	36"	36"	AWRM183636
:	:	:	:
:	:	:	:
:	:	:	:

Mobile Unit—3 Openings			
D	W	H	U.S. Base Price
18"	36"	36"	AWRM183636
:	:	:	:
:	:	:	:
:	:	:	:

 **For Canadian Pricing**
 Multiply U.S. Price by the Canadian price factor.
 ▶ See page 1 for details.

Victor2 Freestanding Units

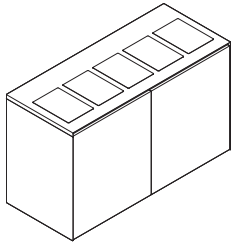
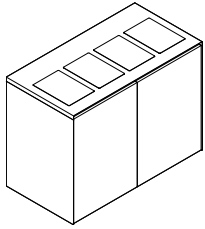

Tip: Tray shelf and display are ordered separately.

Tip: Acrylic inserts lift out without tools for ease of cleaning and changeability.

Tip: Verbiage on each insert contains English, Spanish, and French.

For laminate price group 2 and 3 pricing, please refer to the electronic catalog or SmartTools.

Standard Includes	Required to Specify
<ul style="list-style-type: none"> ▶ Need help? Product details, page 56 • Freestanding unit: <ul style="list-style-type: none"> - Front and back: wood group 1 - Side and top: paint • Finished back • Four or five top slot openings with receptacles • Acrylic inserts etched with recycling icons and wording • Four or five recycling bins (capacity of 23 gallon each receptacle) – fits 30 gallon size bags and larger • Leveling glides: black only 	<ol style="list-style-type: none"> 1 Style number 2 Wood color number for front and back 3 Paint color number for sides and top (case) 4 Four or five acrylic inserts (see below under Required Selections) 5 Options, if selected (see below) <ul style="list-style-type: none"> ▶ See <i>Surface Materials Reference Manual</i>.

Required Selections

Acrylic Inserts (Pick four or five)

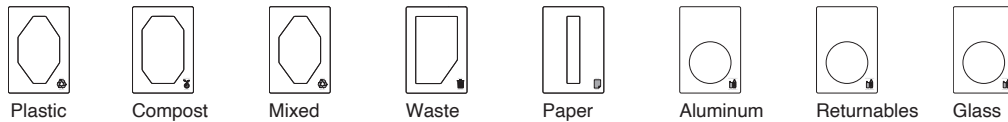

Surface Materials	Options	U.S. Price	Required to Specify
	Wood front and back <ul style="list-style-type: none"> • Wood group 2 • Wood group 3 • Customiz stain 	Prices at right Prices at right No cost	Specify wood color number. Specify wood color number. Specify with <i>Customiz stain</i> . ▶ See <i>Surface Materials Reference Manual</i> .
	Laminate front and back <ul style="list-style-type: none"> • Laminate price group 1 <ul style="list-style-type: none"> – Four opening –\$ 836 – Five opening –\$1168 • Laminate price group 2 <ul style="list-style-type: none"> – Four opening See information at left – Five opening See information at left • Laminate price group 3 <ul style="list-style-type: none"> – Four opening See information at left – Five opening See information at left • Open Line Laminate <ul style="list-style-type: none"> – Four opening –\$ 725 plus cost of laminate – Five opening –\$1057 plus cost of laminate 		Specify laminate color number. Specify laminate color number. Specify laminate color number. Specify laminate color number. Specify laminate color number. ▶ See <i>Surface Materials Reference Manual</i> . ▶ See <i>Surface Materials Reference Manual</i> .
	Paint on case <ul style="list-style-type: none"> • Paint price group 1 • Paint price group 2 • Paint price group 3 	No cost +\$ 120 +\$ 208	Specify paint color number. Specify paint color number. Specify paint color number.

Related Products	<ul style="list-style-type: none"> • Tray Shelf and Display 	▶ Page 62
-------------------------	----------------------------------------------------------------------------	-----------



For Canadian Pricing
 Multiply U.S. Price by the Canadian price factor.
 ▶ See page 1 for details.

Specification Information

Dimensions			Style	U.S.	Options	
D	W	H	Number	Base Price	(Add \$ to Base Price)	
					Premium Wood	
					Wood front and back	
					Wood 2	Wood 3

Freestanding Unit—4 Openings

25"	48"	36"	AWRF254836	\$ 8688	+\$198	+\$693
-----	-----	-----	-------------------	---------	--------	--------

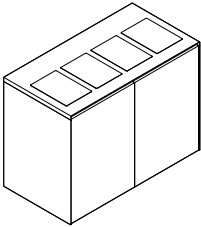

Freestanding Unit—5 Openings

25"	60"	36"	AWRF256036	\$10,948	+\$251	+\$869
-----	-----	-----	-------------------	----------	--------	--------

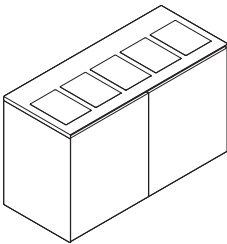

Victor2



For Canadian Pricing
 Multiply U.S. Price by the Canadian price factor.
 ▶ See page 1 for details.

Victor2 Tray Shelf and Display

Tray Shelf



Tip: Tray shelf fits most trays up to 20³/₄" x 12".

Tip: Tray shelf cannot be used with the mobile unit.

Tip: Two tray shelves can be used on the freestanding 4 or 5 slot opening. A 15" gap will separate the two tray shelves if used on the freestanding 5 unit.

Tip: Maximum tray storage is 20 food trays.

Standard Includes		Required to Specify		
▶ Need help? Product details, page 57	• Tray shelf: paint	1 Style number 2 Paint color number for tray 3 Options, if selected (see below) ▶ See <i>Surface Materials</i> , page 264.		
Options		U.S. Price	Required to Specify	
Surface Materials	• Paint price group 1	No cost	Specify paint color number.	
	• Paint price group 2	+\$17	Specify paint color number.	
	• Paint price group 3	+\$37	Specify paint color number.	
Related Products	• Freestanding units		▶ Page 60	
Specification Information				
Dimensions			Style Number	U.S. Base Price
D	W	H		
12 ³ / ₄ "	22 ¹ / ₄ "	9 ¹⁵ / ₁₆ "	AWTS	\$606

Display



Tip: Display holds two 8¹/₂" x 11" papers or one 11" x 17".

Tip: Display cannot be used with the mobile unit.

Tip: Two displays can be used on the freestanding 4 or 5 slot opening. A gap of 18¹/₂" will separate the two displays if used on the Freestanding 5 unit.

Tip: Paper is placed between the two acrylic plates.

Standard Includes		Required to Specify		
▶ Need help? Product details, page 57	• Display • Attachment brackets: paint	1 Style number 2 Paint color number for bracket 3 Options, if selected (see below) ▶ See <i>Surface Materials</i> , page 264.		
Options		U.S. Price	Required to Specify	
Surface Materials	• Paint price group 1	No cost	Specify paint color number.	
	• Paint price group 2	+\$17	Specify paint color number.	
	• Paint price group 3	+\$37	Specify paint color number.	
Related Products	• Freestanding units		▶ Page 60	
Specification Information				
Dimensions			Style Number	U.S. Base Price
D	W	H		
1 ³ / ₁₆ "	20 ³ / ₄ "	15 ¹ / ₂ "	AWDR	\$606



For Canadian Pricing

Multiply U.S. Price by the Canadian price factor.

▶ See page 1 for details.

Lighting



Statement of Line and Comparison	64
dash and dash mini LED Lights	
Understanding	70
Specifying	73
Steelcase Eclipse Light	
Understanding	78
Specifying	81
LED Radial Desktop Lights	
Understanding	82
Specifying	85
LED Linear Desktop Lights	
Understanding	86
Specifying	89
LED Intro Task Lights	
Understanding	90
Specifying	93
LED Shelf Lights	
Understanding	96
Specifying	98
LED Linear Shelf Lights	
Understanding	100
Specifying	104
Standard Shelf Lights	
Understanding	106
Specifying	112
Bottomline Light	
Understanding	108
Specifying	114
Vertical Wire Manager	
Understanding	115
Specifying	116

Statement of Line and Comparison

Task lights offer end users added control and adjustability to place the proper amount of task lighting to create a holistic work setting.

LED Lights

dash and dash mini LED Lights

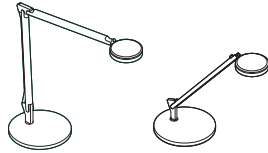

LED Radial and Linear Desktop Lights

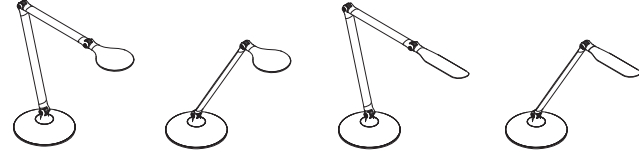

Mounting Options

- Freestanding
- Freestanding with USB
- C-clamp for worksurfaces $\frac{3}{4}$ " to $1\frac{1}{2}$ " thick
- Slatwall
- Panel
- Rails—SOTO, Ology, Elective Elements, FrameOne, Campfire, Answer beam, and Tour

- Freestanding
- Freestanding with USB
- C-clamp for worksurfaces $\frac{7}{8}$ " to $1\frac{7}{8}$ " thick
- Slatwall
- Panel
- Rails—SOTO, Ology, Elective Elements, FrameOne, Campfire, Answer beam, and Tour
- Through mount
- Theft deterrent through-mount

Understanding
 ▶ Page 70
 Specifying
 ▶ Pages 73–76

Understanding
 ▶ Pages 82 and 86
 Specifying
 ▶ Pages 85 and 89

Watts/Lumens/Efficacy	9.3 Watts/570 Lumens/61.3 Efficacy	7.5 Watts/337 Lumens/44.9 Efficacy
Color Rendering Index	94	85
Color Temperature	3500K	3500K
Automatic Turn Off	10 hours	10 hours
Horizontal Arm Range	Standard 0"–37" Mini 0"–24"	Radial Double 8"–20½" Single 0"–13" Linear Double 10"–22½" Single 2"–15"
Vertical Height Adjustment	Standard 2"–25" Mini 0"–20⅜"	Radial Double 6"–21½" Single 13"–16½" Linear Double 6"–21½" Single 13"–16½"
Tilt/Swivel	360° at light head, 160° at freestanding base, and 360° at mounting bracket	90° vertical tilt at head and 320° at base
Replacement Lamp/Bulb	• Not available	• Not available
Average Rated Lamp Life	• 50,000 hrs.	• 50,000 hrs.
Finish Options	• Paint: Arctic White (4231), Low Gloss Black (4710), Platinum Metallic (4799), or accent paint*	• Paint: Arctic White (4231), Low Gloss Black (4710), or Platinum Metallic (4799), or accent paint*
Electronic Dimmer	• 100%–15%	• 100%–15%
Occupancy Sensor	• Available	• Available
USB Ports	• One type-A (2.4A max) • One type-C (60-watt max)	• One type-A (1.2A max)

* For complete listing of accent paints, see *Surface Materials* on page 264.

Task lights offer end users added control and adjustability to place the proper amount of task lighting to create a holistic work setting.

LED Lights

Steelcase Eclipse Light

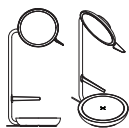

LED Intro Task Light Single Arm



LED Intro Task Light Double Arm

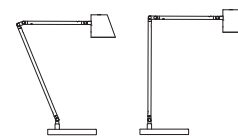

Mounting Options	<ul style="list-style-type: none"> Freestanding Base with Wireless Charging 	<ul style="list-style-type: none"> Freestanding Base 	<ul style="list-style-type: none"> Freestanding Base
	<ul style="list-style-type: none"> Understanding <ul style="list-style-type: none"> ▶ Page 78 Specifying <ul style="list-style-type: none"> ▶ Page 81 	<ul style="list-style-type: none"> Understanding <ul style="list-style-type: none"> ▶ Page 90 Specifying <ul style="list-style-type: none"> ▶ Pages 93 	<ul style="list-style-type: none"> Understanding <ul style="list-style-type: none"> ▶ Page 90 Specifying <ul style="list-style-type: none"> ▶ Pages 93
Watts/Lumens/Efficacy	4.4 Watts/200 Lumens/ 46 Efficacy	7 Watts/400 Lumens/62 Efficacy	7 Watts/400 Lumens/62 Efficacy
Color Rendering Index	96+	90	90
Color Temperature	3500K	3000K	3000K
Horizontal Arm Range	Height: 18" Range: +90° forward or backward	0"-9 ² / ₅ "	3"-19 ¹ / ₄ "
Vertical Height Adjustment	180°	17 ² / ₅ "-18 ⁹ / ₂₀ "	9 ¹ / ₅ "-24 ⁴ / ₅ "
Tilt/Swivel	<ul style="list-style-type: none"> Light head hinge rotation: ± 150° On/Off switch rotation: 0-90° Base hinge rotation: ± 90° 	<ul style="list-style-type: none"> Light head pivot – 180° up/down Swivel – 350° 	<ul style="list-style-type: none"> Light head pivot – 180° up/down Swivel – 350°
Replacement Lamp/Bulb	<ul style="list-style-type: none"> Not available 	<ul style="list-style-type: none"> Not available 	<ul style="list-style-type: none"> Not available
Average Rated Lamp Life	<ul style="list-style-type: none"> 40,000 hrs. 	<ul style="list-style-type: none"> 50,000 hrs. 	<ul style="list-style-type: none"> 50,000 hrs.
Finish Options	<ul style="list-style-type: none"> Paint: Black Matte (4135), Clay (4239) or Pearl Snow (ZW01) 	<ul style="list-style-type: none"> Paint: Black Matte (4135), Platinum Gloss (4142), or White Matte (4143) 	<ul style="list-style-type: none"> Paint: Black Matte (4135), Platinum Gloss (4142), or White Matte (4143)
Electronic Dimmer	<ul style="list-style-type: none"> Continuous 0% to 100% range 	<ul style="list-style-type: none"> Three-step: 10%-50%-100% 	<ul style="list-style-type: none"> Three-step: 10%-50%-100%
Occupancy Sensor	<ul style="list-style-type: none"> Not available 	<ul style="list-style-type: none"> Not available 	<ul style="list-style-type: none"> Not available
Warranty	<ul style="list-style-type: none"> 3 Year warranty 	<ul style="list-style-type: none"> 3 year warranty 	<ul style="list-style-type: none"> 3 year warranty
Power Supply Wattage	<ul style="list-style-type: none"> 12 watts 	<ul style="list-style-type: none"> 12 watts 	<ul style="list-style-type: none"> 12 watts
Power Supply Voltage	<ul style="list-style-type: none"> 24 volts 	<ul style="list-style-type: none"> 24 volts 	<ul style="list-style-type: none"> 24 volts
Cord length	<ul style="list-style-type: none"> 91" (7.58') 	<ul style="list-style-type: none"> 75" (6¹/₄)' 	<ul style="list-style-type: none"> 75" (6¹/₄)'
Cord material	<ul style="list-style-type: none"> Black plastic only 	<ul style="list-style-type: none"> Black plastic only 	<ul style="list-style-type: none"> Black plastic only
Wireless Charging Wattage	<ul style="list-style-type: none"> 15 watts 	<ul style="list-style-type: none"> Not available 	<ul style="list-style-type: none"> Not available

90° mini extension cord can be used with Ology bench, FrameOne, or where power receptacles are located in confined spaces. UL/RoHS certified.
▶ Specifying, page 94

90° Mini Extension Cord



Wire	14/3 SJTOW, Black, 105c, 300V, Cable OD 0.375 +/- 0.010
End 1	Molded NEMA 5-15P Right Angle (South), 125V, 15A
End 2	Molded NEMA 5-15R Connector, 125V, 15A

Statement of Line and Comparison, continued

Shelf lights offer end users added control and adjustability to place the proper amount of shelf lighting to create a holistic work setting. Ideally suited for recessed mount applications to bottom of bin or shelf.

Shelf Lights

Storage-Mounted Lights

LED Shelf Light

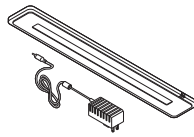

LED Linear Shelf Lights

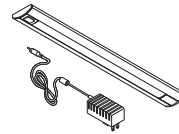

Mounting

- Standard includes magnetic mount for steel bins and shelves. Optional fastener kit for wood shelves are available.

- Standard includes magnetic mount for steel bins and shelves. Each light length comes with set quantity of mounting brackets for both steel and wood applications.

- Understanding
- ▶ Page 96
- Specifying
- ▶ Page 98

- Understanding
- ▶ Page 100
- Specifying
- ▶ Page 104

Depth

2½"

2"

Width

18"

17", 31", 44", or 58"

Number of LEDs

- 102 LEDs

17"W	31"W	44"W	58"W	
24	48	72	96	Standard Output LEDs
47	94	141	188	High Output LEDs

Watts/Lumens/Efficacy

9.6 Watts / 522 Lumens / 54 Efficacy

17"W	31"W	44"W	58"W	
6.7	13.1	19.1	25.3	Standard Output Watts LEDs
9.1	17.6	25.9	33.7	System Wattage
474	970	1447	1942	Lumens
70.0	74.1	75.8	76.8	Efficacy (Lumens/Watts LEDs)

17"W	31"W	44"W	58"W	
9.5	17.1	24.6	32.3	High Output Watts LEDs
10.2	19.7	28.2	38.2	System Wattage
751	1497	2131	2827	Lumens
74.0	76.0	75.5	74.0	Efficacy (Lumens/Watts LEDs)

Color Rendering Index

94

92

Color Temperature

3500K

3500K

Description

An environmentally-friendly light that consumes only 11 watts of power, contains no harmful metals (mercury), and has a useful life of over 50,000 hours. Ideally suited for recessed mount applications to bottom of bin or shelf.

With its low profile and available four widths, the LED linear light will fit in a variety of shelving and overhead storage applications. Beneficial features of this fixture include: energy efficient LEDs, continuous dimming, automatic turn off after 10 hours, and optional occupancy sensor.

Finish Options

- Bottom surface clear anodized aluminum only. Plastic cover Arctic White (6009) or Black (6000).

- 4231 Arctic White body with Arctic White (6009) end caps or 0835 Black body with Black (6000) end caps.

Optics

- Polycarbonate matte film

- Polycarbonate matte film

Ballasts

- Energy saving low-voltage power supply

- Energy saving low-voltage power supply

Electronic Dimmer

- Standard on all lights

- Standard on all lights

Average Rated Lamp Life

- 50,000 hrs.

- 50,000 hrs.

Warranty

- Power supply - 5 years
- Fixture - 12 years

- Power supply - 5 years
- Fixture - 12 years

Shelf lights mount into the recessed bottom of storage shelves and bins to illuminate the worksurface. Five types of shelf lights are available to control the quality of light for specific applications. Each type is compatible with Steelcase systems furniture.

Shelf Lights

Storage-Mounted Lights

Standard Shelf Light

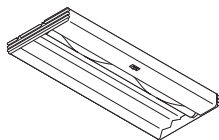

Mounting Options	<ul style="list-style-type: none"> • Universal mounting package (standard) • Flush mount • Competitive mounting package <p>Understanding ▶ Page 106 Specifying ▶ Page 112</p>
Depth	9¼"
Width	25", 37", or 49"
Lamp	• T8 Fluorescent
Watts/Lumens/Efficacy	25"W – 17 Watts/1343 Lumens/79 Efficacy 37"W – 25 Watts/2150 Lumens/86 Efficacy 49"W – 32 Watts/2899 Lumens/90.6 Efficacy
Color Temperature	3500K
Description	The right choice for the majority of people in today's workplace who switch frequently from task to task throughout the day.
Optics	<ul style="list-style-type: none"> • Faceted, white reflector • Contrast sleeve that can be manually rotated to vary light
Ballasts	<ul style="list-style-type: none"> • Electronic ballast • High power factor ballast
Electronic Dimmer	• Not available
Lens Options	• None
Average Rated Lamp Life	• 20,000 hours
Warranty	<ul style="list-style-type: none"> • Ballast—5 years • Fixture—12 years

Statement of Line and Comparison, continued

Shelf lights offer end users added control and adjustability to place the proper amount of shelf lighting to create a holistic work setting. Ideally suited for recessed mount applications to bottom of bin or shelf.

Shelf Lights

Bottomline Light

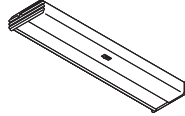

Mounting	<ul style="list-style-type: none"> Standard includes universal spring bracket for recessed mount or screw-in for flush mount (tool free clips for New York applications). <p>Understanding ▶ Page 108 Specifying ▶ Page 114</p>
Depth	4½"
Width	23¼", 35", or 46¾"
Height	1¼"
Weight	4.02 lb, 4.95 lb, or 6.9 lb
Lamp	<ul style="list-style-type: none"> T5 Fluorescent
Watts/Lumens/Efficacy	23¼"W – 14 Watts/1275 Lumens/91 Efficacy 35"W – 21 Watts/2000 Lumens/95 Efficacy 46¾"W – 28 Watts/2697 Lumens/96 Efficacy
Color Temperature	3500K
Description	Designed to be environmentally friendly providing 15% more light with an even distribution of light on the worksurface. Ideally suited for recessed mount applications to bottom of bin or shelf.
Finish Options	<ul style="list-style-type: none"> Paint: Black (0835) or Pewter (7018)
Optics	<ul style="list-style-type: none"> Mylar reflector with batwing lens
Ballasts	<ul style="list-style-type: none"> Energy saving electronic ballast
Electronic Dimmer	<ul style="list-style-type: none"> Not available
Average Rated Lamp Life	<ul style="list-style-type: none"> 20,000 hrs.
Warranty	<ul style="list-style-type: none"> Ballast - 5 years Fixture - 12 years

dash and dash mini LED Lights

dash and dash mini LED lights are available in a variety of mounting applications.

► Specifying, pages 73–76

Vertical height adjustment range of dash light is 2"–25".

Housing is painted steel.

Freestanding bases, if selected, are painted to match housing.

Soft touch switch has continuous range dimming from 100%–15%.

9.3-watt LED, 3500K is standard.

Automatic turn off is standard and is enabled after 10 hours.

Mounting brackets are available for C-clamp for worksurfaces $\frac{3}{4}$ " to $1\frac{1}{2}$ " thick, Slat-wall/SlatRail, panel, and rail applications. Rail applications include SOTO, Ology, Elective Elements, Campfire, Tour, Answer beam, and FrameOne. All mounting brackets are painted to match housing.

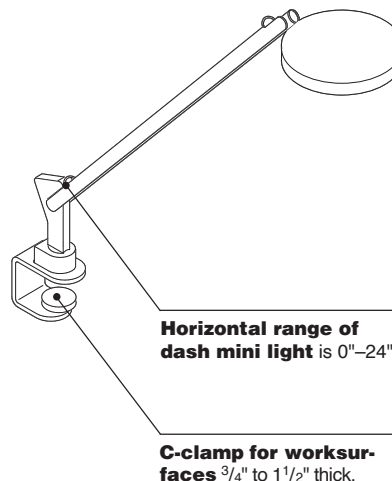
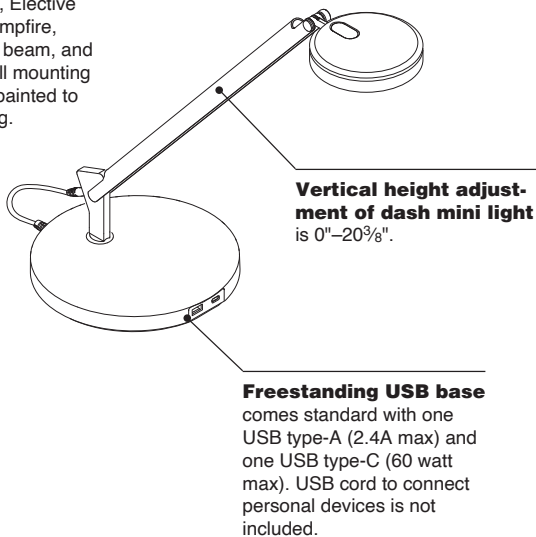
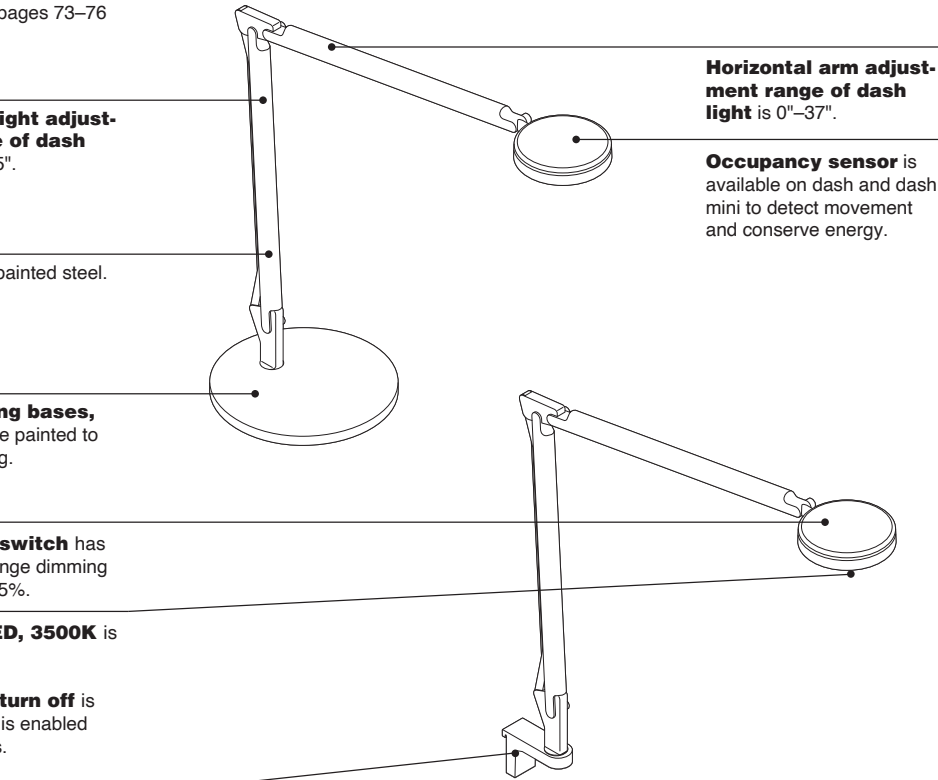

Product Details

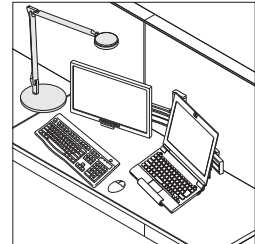

dash LED light is for use with worksurfaces 60"W or greater.

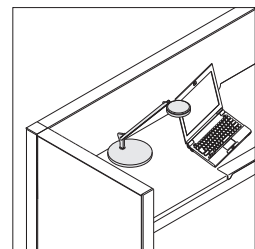

dash mini LED light is for use with worksurfaces 58"W or smaller.

dash and dash mini LED lights are 110 volt, mercury free, and has a color rendering index of 94.

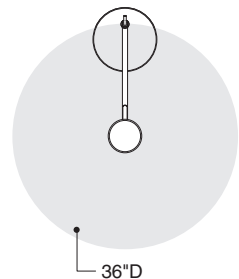

Occupancy sensor utilizes a passive infrared technology to detect the slightest movements by constantly monitoring a 36" diameter zone around the LED light head.

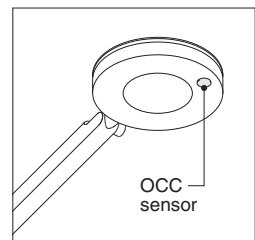

Occupancy sensor is fully integrated into the LED light head and activates in 15 minutes when no movement is detected to conserve energy.

Average rated lamp life of dash and dash mini LED lights is 50,000 hours.

Power supply for all dash lights except with USB base has a 15-watt, 9' cord.

Power supply for dash with USB base has a 60-watt, 11' modular cord with standard two prong plug, an integrated low voltage cord, and a connector to the attached USB base.

Freestanding USB base provides two integrated USB charging ports, type-A and type-C. The USB cord to connect personal devices is not included.

When specified with Height-Adjustable Series Benching or power and data tray, flexible receptacles are recommended.

90° mini extension cord can be used with Ology bench, FrameOne, or where power receptacles are located in confined spaces.
► Specifying, page 94

Head of light rotates 360°.

dash and dash mini LED lights, designed in collaboration with Foster + Partners, is U.L. and c.U.L. listed and BIFMA Level 1 certified.

Connections

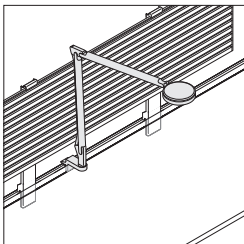

For applications that include an integrated SOTO rail: FrameOne, Ology, Campfire, Tour, or SOTO rail; specify dash rail mount with integrated SOTO bracket. dash can be mounted in front of privacy screens, Slatwall, or FrameOne center screen.

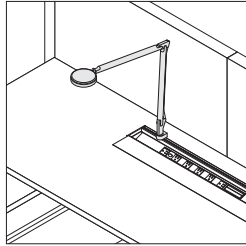

Applications that include a rail mounted dash to Elective Elements Tech Zone will need to choose the optional Elective Elements Tech Zone rail mount bracket. Elective Elements Tech Zone rail mount bracket cannot be used with privacy screens, Slatwall, or FrameOne center screens. The light must be mounted adjacent to the screens or Slatwall.

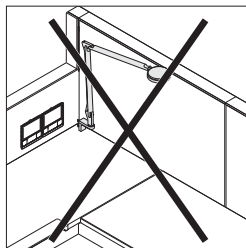

Panel-mount light cannot be used in corner application.

Wiring & Cabling

Electronic dimming control features a soft touch switch, which allows dimming from 100% to 15% light output.

Surface Materials

Housing

- 4231 Arctic White
- 4710 Low Gloss Black
- 4799 Platinum Metallic
- Accent paint

► See *Surface Materials* on page 264 for accent paint options.

Mounting brackets and freestanding bases

- Paint to match housing

Cord

- Black plastic only

Actual Dimensions

dash LED Lights

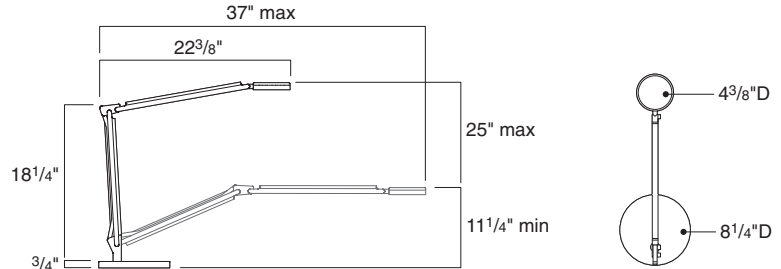

	Freestanding	C-clamp, Slatwall, panel, and rail applications
Depth	37"	37"
Width	8 1/4"	3/4"
Height	25", 25 1/4" (with USB)	24 1/4"
Occupancy sensor monitor radius	36"	36"

dash mini LED Lights

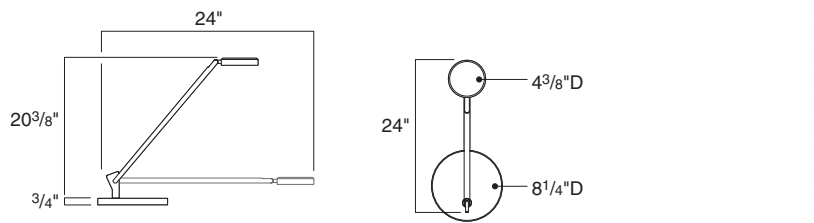

	Freestanding	C-clamp, Slatwall, panel, and rail applications
Depth	24"	24"
Width	8 1/4"	3/4"
Height	21 1/10", 21 7/10" (with USB)	20 3/8"
Occupancy sensor monitor radius	36"	36"

Dash 15"W Power Supply Dimensions

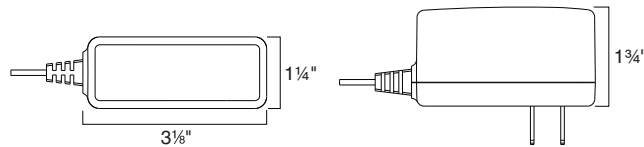

Cord length	9'
-------------	----

Dash USB 60"W Power Supply Dimensions

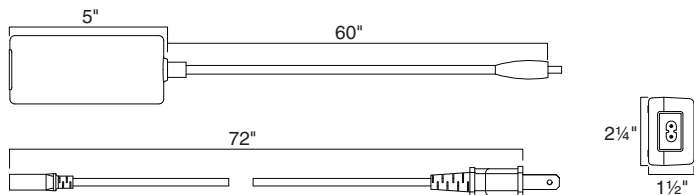

Photometric Data

dash Maximum Illuminance

Worksurface rear

12"	26	36	45	52	55	52	45	36	26
9"	42	49	64	76	80	76	64	49	42
6"	44	63	84	101	109	101	84	63	44
3"	50	74	101	126	136	126	101	74	50
0"	54	78	109	136	146	136	109	78	54
3"	50	74	101	126	136	126	101	74	50
6"	44	63	84	101	109	101	84	63	44
9"	42	49	64	76	80	76	64	49	42
12"	26	36	45	52	55	52	45	36	26

12" 9" 6" 3" CL 3" 6" 9" 12"

Worksurface front

Tip: For applications that include an integrated SOTO rail: Ology, FrameOne, Campfire, Tour, or SOTO rail; specify dash rail mount with integrated SOTO bracket. dash can be mounted in front of privacy screens, Slatwall, or FrameOne center screen.

Tip: 90° mini extension cord can be used with Ology bench, FrameOne, or where power receptacles are located in confined spaces.
▶ Page 94

Tip: For a complete listing of accent paints, see Surface Materials on page 264.

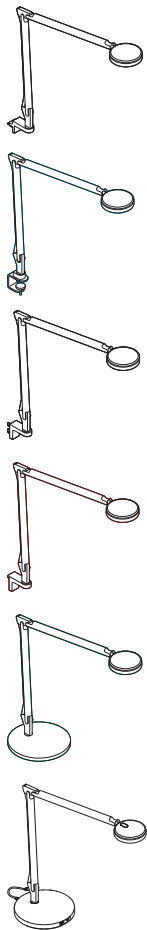

Standard Includes		Required to Specify
▶ Need help? Product details, page 70	<ul style="list-style-type: none"> • Task light and mounting bracket: paint price group 1 • 9.3-watt LED 3500K • Continuous range dimmer • 15-watt, 9' black power supply • 60-watt, 11' black modular power supply, if USB base is selected • Two integrated USB charging ports (type-A and type-C), if freestanding USB is selected • Integrated SOTO rail bracket, if selected 	1 Style number 2 Paint color number for light: 4231 Arctic White 4710 Low Gloss Black 4799 Platinum Metallic 3 Options, if selected (see below) ▶ See <i>Surface Materials</i> , page 264.

Options	U.S. Price	Required to Specify
Surface Materials • Paint price group 3	+\$47	Specify paint color number. ▶ See <i>Surface Materials</i> on page 264 for accent paint options.
Rail Bracket • Elective Elements Tech Zone bracket	No cost	Specify with <i>EE Tech Zone</i> bracket.

Specification Information					
• Dimensions			• Weight	• Style	• U.S.
D	W	H		Number	Base Price

Rail-Mounted					
37"	3/4"	24 1/4"	1.7 lb	LDASHR	\$ 820
:	:	:	:	:	:

C-Clamp Mount					
37"	3/4"	24 1/4"	2.2 lb	LDASHC	\$ 820
:	:	:	:	:	:

Panel-Mounted For Use with Answer, Avenir, and Kick					
37"	3/4"	24 1/4"	2 lb	LDASHP	\$ 820
:	:	:	:	:	:

Slatwall- and SlatRail-Mounted					
37"	3/4"	24 1/4"	2 lb	LDASHS	\$ 820
:	:	:	:	:	:

Freestanding					
37"	8 1/4"	25"	9.65 lb	LDASHF	\$ 820
:	:	:	:	:	:

Freestanding USB					
37"	8 1/4"	25 1/4"	9.65 lb	LDASHU	\$1030
:	:	:	:	:	:

Tip: Applications that include a rail mounted dash to Elective Elements Tech Zone will need to choose the optional Elective Elements Tech Zone rail mount bracket. Elective Elements Tech Zone rail mount bracket cannot be used with privacy screens, Slatwall, or FrameOne center screens. The light must be mounted adjacent to the screens or Slatwall.



dash LED Lights

With Occupancy Sensor

Tip: For applications that include an integrated SOTO rail: Ology, FrameOne, Campfire, Tour, or SOTO rail; specify dash rail mount with integrated SOTO bracket. dash can be mounted in front of privacy screens, Slatwall, or FrameOne center screen.

Tip: 90° mini extension cord can be used with Ology bench, FrameOne, or where power receptacles are located in confined spaces.

▶ Page 94

Tip: For a complete listing of accent paints, see Surface Materials on page 264.

Standard Includes		Required to Specify
▶ Need help? Product details, page 70	<ul style="list-style-type: none"> Task light and mounting bracket: paint price group 1 Occupancy sensor 9.3-watt LED 3500K Continuous range dimmer 15-watt, 9' black power supply 60-watt, 11' black modular power supply, if USB base is selected Two integrated USB charging ports (type-A and type-C), if freestanding USB is selected Integrated SOTO rail bracket, if selected 	1 Style number 2 Paint color number for light: 4231 Arctic White 4710 Low Gloss Black 4799 Platinum Metallic 3 Options, if selected (see below) ▶ See <i>Surface Materials</i> , page 264.

Options	U.S. Price	Required to Specify
Surface Materials • Paint price group 3	+ \$47	Specify paint color number. ▶ See <i>Surface Materials</i> on page 264 for accent paint options.
Rail Bracket • Elective Elements Tech Zone bracket	No cost	Specify with <i>EE Tech Zone</i> bracket.

Specification Information					
Dimensions			Weight	Style Number	U.S. Base Price
D	W	H			

Rail-Mounted					
37"	3/4"	24 1/4"	1.7 lb	LDASHOR	\$ 901
:	:	:	:	:	:

C-Clamp Mount					
37"	3/4"	24 1/4"	2.2 lb	LDASHOC	\$ 901
:	:	:	:	:	:

Panel-Mounted For Use with Answer, Avenir, and Kick					
37"	3/4"	24 1/4"	2 lb	LDASHOP	\$ 901
:	:	:	:	:	:

Slatwall- and SlatRail-Mounted					
37"	3/4"	24 1/4"	2 lb	LDASHOS	\$ 901
:	:	:	:	:	:

Freestanding					
37"	8 1/4"	25"	9.65 lb	LDASHOF	\$ 901
:	:	:	:	:	:

Freestanding USB					
37"	8 1/4"	25 1/4"	9.65 lb	LDASHOU	\$1111
:	:	:	:	:	:

Tip: Applications that include a rail mounted dash to Elective Elements Tech Zone will need to choose the optional Elective Elements Tech Zone rail mount bracket. Elective Elements Tech Zone rail mount bracket cannot be used with privacy screens, Slatwall, or FrameOne center screens. The light must be mounted adjacent to the screens or Slatwall.

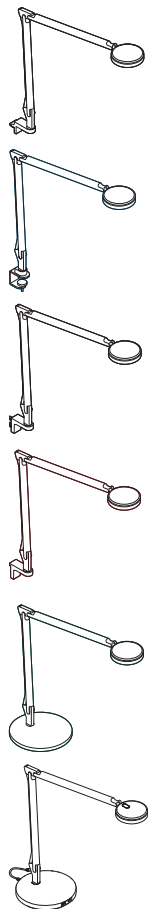

Tip: For applications that include an integrated SOTO rail: Ology, FrameOne, Campfire, Tour, or SOTO rail; specify dash rail mount with integrated SOTO bracket. dash can be mounted in front of privacy screens, Slatwall, or FrameOne center screen.

Tip: 90° mini extension cord can be used with Ology bench, FrameOne, or where power receptacles are located in confined spaces.
▶ Page 94

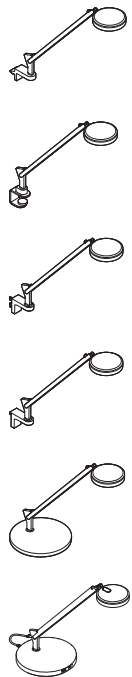

Tip: For a complete listing of accent paints, see Surface Materials on page 264.

For Canadian Pricing
Multiply U.S. Price by the Canadian price factor.
▶ See page 1 for details.

Standard Includes		Required to Specify
▶ Need help? Product details, page 70	<ul style="list-style-type: none"> Task light and mounting bracket: paint price group 1 9.3-watt LED 3500K Continuous range dimmer 15-watt, 9' black power supply 60-watt, 11' black modular power supply, if USB base is selected Two integrated USB charging ports (type-A and type-C), if freestanding USB is selected Integrated SOTO rail bracket, if selected 	1 Style number 2 Paint color number for light: 4231 Arctic White 4710 Low Gloss Black 4799 Platinum Metallic 3 Options, if selected (see below) ▶ See <i>Surface Materials</i> , page 264.

Options	U.S. Price	Required to Specify
Surface Materials • Paint price group 3	+\$47	Specify paint color number. ▶ See <i>Surface Materials</i> on page 264 for accent paint options.
Rail Bracket • Elective Elements Tech Zone bracket	No cost	Specify with <i>EE Tech Zone</i> bracket.

Specification Information

Dimensions	Weight	Style Number	U.S. Base Price
D W H			

Rail-Mounted

24"	3/4"	20 3/8"	1.3 lb	LDASHMINIR	\$673
-----	------	---------	--------	-------------------	-------

C-Clamp Mount

24"	3/4"	20 3/8"	1.8 lb	LDASHMINIC	\$673
-----	------	---------	--------	-------------------	-------

Panel-Mounted For Use with Answer, Avenir, and Kick

24"	3/4"	20 3/8"	1.6 lb	LDASHMINIP	\$673
-----	------	---------	--------	-------------------	-------

Slatwall- and SlatRail-Mounted

24"	3/4"	20 3/8"	1.6 lb	LDASHMINIS	\$673
-----	------	---------	--------	-------------------	-------

Freestanding

24"	8 1/4"	21 1/10"	9.25 lb	LDASHMINIF	\$673
-----	--------	----------	---------	-------------------	-------

Freestanding USB

24"	8 1/4"	21 7/10"	9.25 lb	LDASHMINIU	\$883
-----	--------	----------	---------	-------------------	-------

Tip: Applications that include a rail mounted dash to Elective Elements Tech Zone will need to choose the optional Elective Elements Tech Zone rail mount bracket. Elective Elements Tech Zone rail mount bracket cannot be used with privacy screens, Slatwall, or FrameOne center screens. The light must be mounted adjacent to the screens or Slatwall.

dash mini LED Lights

With Occupancy Sensor

Tip: For applications that include an integrated SOTO rail: Ology, FrameOne, Campfire, Tour, or SOTO rail; specify dash rail mount with integrated SOTO bracket. dash can be mounted in front of privacy screens, Slatwall, or FrameOne center screen.

Tip: 90° mini extension cord can be used with Ology bench, FrameOne, or where power receptacles are located in confined spaces.

▶ Page 94

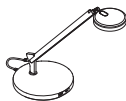

Tip: Applications that include a rail mounted dash to Elective Elements Tech Zone will need to choose the optional Elective Elements Tech Zone rail mount bracket. Elective Elements Tech Zone rail mount bracket cannot be used with privacy screens, Slatwall, or FrameOne center screens. The light must be mounted adjacent to the screens or Slatwall.

Standard Includes		Required to Specify
▶ Need help? Product details, page 70	<ul style="list-style-type: none"> • Task light and mounting bracket: paint price group 1 • 9.3-watt LED 3500K • Continuous range dimmer • 15-watt, 9' black power supply • 60-watt, 11' black modular power supply, if USB base is selected • Two integrated USB charging ports (type-A and type-C), if freestanding USB is selected • Occupancy sensor • Integrated SOTO rail bracket, if selected 	1 Style number 2 Paint color number for light: 4231 Arctic White 4710 Low Gloss Black 4799 Platinum Metallic 3 Options, if selected (see below) ▶ See <i>Surface Materials</i> , page 264.

Options	U.S. Price	Required to Specify
Surface Materials • Paint price group 3	+\$47	Specify paint color number. ▶ See <i>Surface Materials</i> on page 264 for accent paint options.
Rail Bracket • Elective Elements Tech Zone bracket	No cost	Specify with <i>EE Tech Zone</i> bracket.

Specification Information					
• Dimensions			• Weight	• Style	• U.S.
D	W	H		Number	Base Price
:	:	:	:	:	:
:	:	:	:	:	:

Rail-Mounted

24"	3/4"	20 3/8"	1.3 lb	LDASHMINIOR	\$754
-----	------	---------	--------	--------------------	-------

C-Clamp Mount

24"	3/4"	20 3/8"	1.8 lb	LDASHMINIOC	\$754
-----	------	---------	--------	--------------------	-------

Panel-Mounted For Use with Answer, Avenir, and Kick

24"	3/4"	20 3/8"	1.6 lb	LDASHMINIOP	\$754
-----	------	---------	--------	--------------------	-------

Slatwall- and SlatRail-Mounted

24"	3/4"	20 3/8"	1.6 lb	LDASHMINIOS	\$754
-----	------	---------	--------	--------------------	-------

Freestanding

24"	8 1/4"	21 1/10"	9.25 lb	LDASHMINIOF	\$754
-----	--------	----------	---------	--------------------	-------

Freestanding USB

24"	8 1/4"	21 7/10"	9.25 lb	LDASHMINIOU	\$964
-----	--------	----------	---------	--------------------	-------

*Tip: For a complete listing of accent paints, see *Surface Materials* on page 264.*

Steelcase Eclipse Light

Steelcase Eclipse video and task light provides power and performance in one LED light. Energy efficient and innovative, Steelcase eclipse light illuminates residential and commercial environments.
▶ Specifying, page 81

Adjust light head and arm for video-light or task-light mode.

Aluminum extrusion arm with hidden wire.

Arm lower pivot with range of 180° ships flat.

Padded, anti-slip surface holds phone in place without slipping off the base.

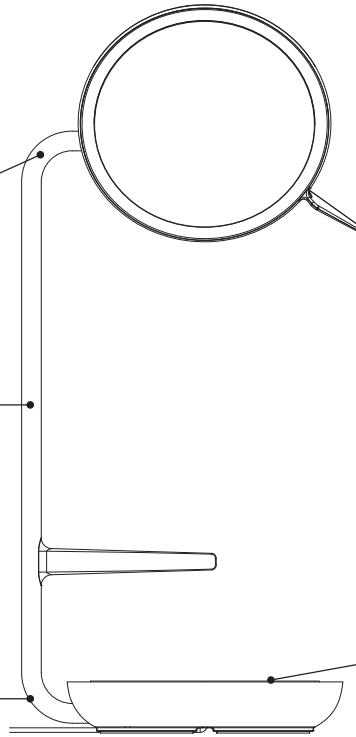

Copper tinted mirror softly diffuses light and improves appearance.

Soft golden reflector.

Slide lever off/on to adjust dimming range from 0% to 100%.

Phone support in both vertical and horizontal positions on kickstand.

Cord egress on bottom of light.

15 watt wireless charger provides power for devices laying flat on base.

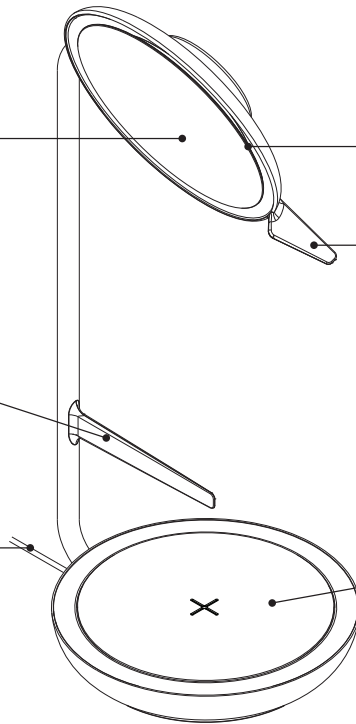

Product Details



LED light performance with a 96+ color rendering index rating and Flicker-Free technology.

Adjustability at the lighthouse and arm directs light where needed.

Color temperature is 3500K.

Color rendering index is 96+.

Copper-tinted mirror in center of light.

15 watt wireless charger provides power for devices laying flat on base.

Connections

Freestanding base

Wiring and Cabling

Light comes standard with sliding lever dimming range 0% to 100%.

Power supply uses a modular cord with standard two prong plug, cord length 91".

Surface Materials

- Paint**
- 4135 Black Matte
 - 4239 Clay
 - ZW01 Pearl Snow

Application Topics

90° mini extension cord can be used with Ology bench, FrameOne, or where power receptacles are located in confined spaces.
▶ See page 94

Power cord length is 91". Consider distance from light to power receptacle, and if surface or under the worksurface power receptacle may be needed.
▶ See pages 197–206

Actual Dimensions

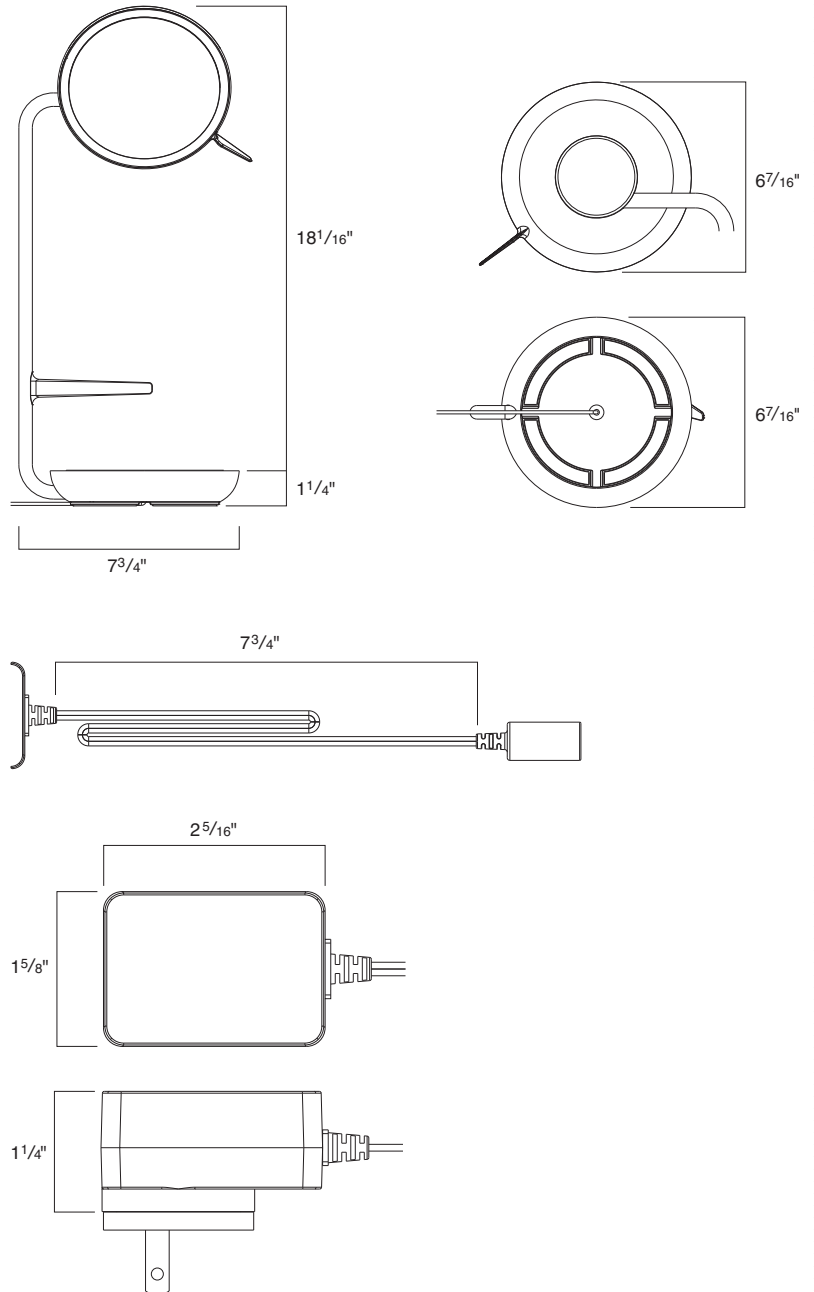

Photometric Data

Steelcase Eclipse Light
Worksurface rear

12"	9	13	18	21	22	22	16	12	7
9"	13	19	19	34	37	26	25	18	11
6"	15	29	41	53	59	54	37	26	16
3"	19	30	53	96	106	96	54	33	19
0"	22	38	44	93	108	100	61	38	22
3"	19	33	57	90	99	92	59	38	23
6"	17	32	48	60	64	61	44	29	17
9"	17	25	34	43	44	37	30	21	12
12"	10	16	19	25	25	23	19	14	8

12" 9" 6" 3" 0" 3" 6" 9" 12"
Worksurface front

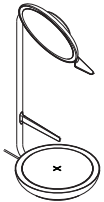
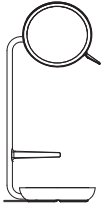

Tip: The Steelcase Eclipse light head disk can be positioned in task light or video light mode. Superior articulation – 90° arm movement 180° tilt, 300° tilt head rotation.

Tip: Power cord length is 91". Consider distance from light to power receptacle. If surface or under the work-surface power receptacle may be needed.

Tip: The 90° mini extension cord can be used with Ology bench, FrameOne, or where power receptacles are located in confined spaces.

Standard Includes		Required to Specify
<ul style="list-style-type: none"> ▶ Need help? Product details, page 78 	<ul style="list-style-type: none"> • Task/video light and freestanding base: paint • 91" cord two-prong power supply • LED ring light source • Full range dimming 0% to 100% • 4.4-watt LED • Color temperature 3500K • Copper tinted mirror • Phone kickstand • 15 watt wireless charger 	<ul style="list-style-type: none"> 1 Style number 2 Paint color number for light: <ul style="list-style-type: none"> 4135 Black Matte 4239 Clay ZW01 Pearl Snow

Related Products	
<ul style="list-style-type: none"> • Powerstrip Intro • Powerstrip Plus • Under worksurface utility power • 90° mini extension cord • Universal cable management kits 	<ul style="list-style-type: none"> ▶ Page 199 ▶ Page 200 ▶ Page 226 ▶ Page 94 ▶ Page 205

Specification Information				
Dimensions			Style Number	U.S. Price
D	W	H		
6 ⁵ / ₈ "	7 ³ / ₄ "	18"	LECLIPSE	\$505



For Canadian Pricing
 Multiply U.S. Price by the Canadian price factor.
 ▶ See page 1 for details.

LED Radial Desktop Lights

LED radial desktop single and double arm lights are available in a variety of mounting applications.

► Specifying, page 85

Rotational base provides 320° of adjustment.

Freestanding base, if selected, is painted to match housing.

Integrated rail-mount bracket used on SOTO rail, FrameOne, Ology, Campfire, and Tour applications can be mounted in front of privacy screens, Slatwall, or FrameOne center screen.

Knuckle tension points are adjustable with a hex wrench.

Panel-mount, if selected, allows single and double arms to mount to Answer, Avenir, and Kick.

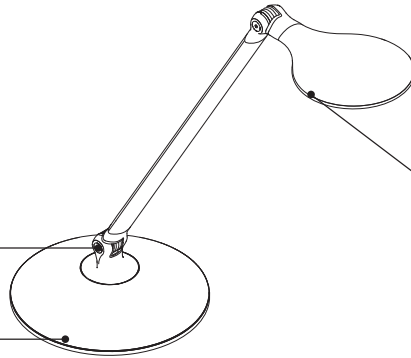

A properly diffused light source under the radial head provides a softly blended light pattern that reduces eye strain.

Optional occupancy sensor turns LEDs off after 30 minutes of inactivity, available on both single and double arm models.

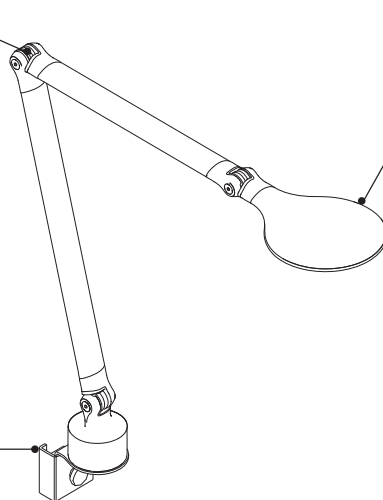

Single touch on/off pad plus touch and hold dimming for easy individual user control.

Continuous dimming from 100% to 15% with last state memory.

Product Details

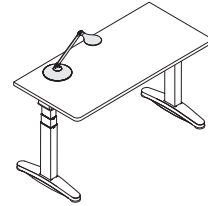

LED radial single arm desktop lights are for use with worksurfaces 58"W or smaller.

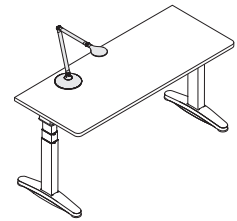

LED radial double arm desktop lights are for use with worksurfaces 60"W or greater.

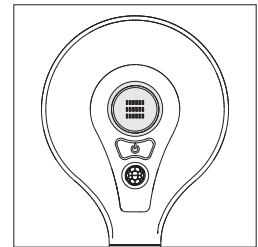

LED radial single and double arm desktop lights come standard with 7.5-watt 18 fractional LEDs with a color temperature of 3500K.

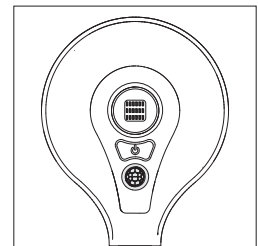

Occupancy sensor is fully integrated into the LED light head and activates in 30 minutes when no movement is detected to conserve energy.

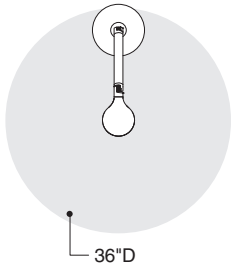

Occupancy sensor utilizes a passive infrared technology to detect the slightest movements by constantly monitoring a 36" diameter zone around the LED light head.

Average rated lamp life of LED radial desktop lights is 50,000 hours.

Color temperature of LEDs is 3500K.

Color rendering index of LEDs is 85.

Automatic turn off after 10 hours (+/- 15 mins.); standard with both models.

Through-mount and theft deterrent through-mount brackets can only be used with worksurfaces that are 1" thick to 1 3/4" thick. They are not for use with Bivi or FrameOne worksurfaces under 1" thick.

Theft deterrent through-mount bracket cannot be retrofitted in the field.

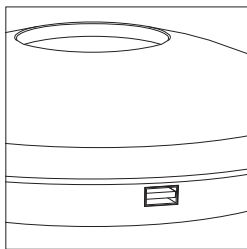

Freestanding base with USB provides an integrated USB charging connection in the base to power up devices such as smart phones (USB cord not included).

Connections

- Freestanding base
- Freestanding base with USB
- Through-mount for worksurfaces 1" to 1 3/4" thick
- C-clamp mount for worksurfaces 7/8" to 1 7/8" thick
- Slatwall-mount
- Panel-mount
- Theft deterrent through-mount for worksurfaces 1" to 1 3/4" thick
- Integrated rail-mount

Optional choice of base/mounting brackets includes: freestanding base, C-clamp mount, Slatwall mount, integrated rail-mount, panel-mount, through-mount, or theft deterrent through-mount.

Wiring & Cabling

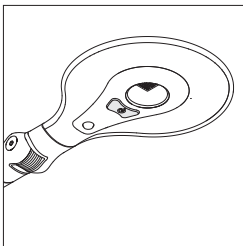

Light is standard with single touch on/off and touch control dimming.

User adjustable touch and hold dimming pad includes continuous dimming range of 100% to 15%.

Power supply uses a modular cord with standard two prong plug, integrated 3' silver cord, and an 18-watt, 9' black cord.

When specified with Height-Adjustable Series Benching or power and data tray, flexible receptacles are recommended.

Surface Materials

Housing

- 4231 Arctic White
 - 4710 Low Gloss Black
 - 4799 Platinum Metallic
 - Accent paint
- ▶ See *Surface Materials* on page 264 for accent paint options.

Mounting brackets

- Paint to match housing

Cord

- Silver

Actual Dimensions

LED Radial Desktop Single Arm Light

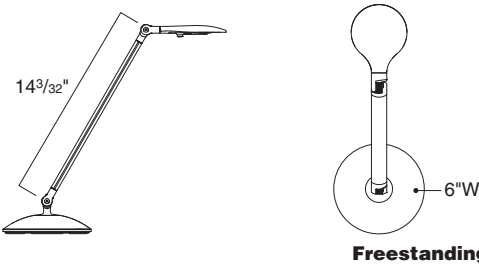

Occupancy sensor monitor radius 36"

LED Radial Desktop Double Arm Light

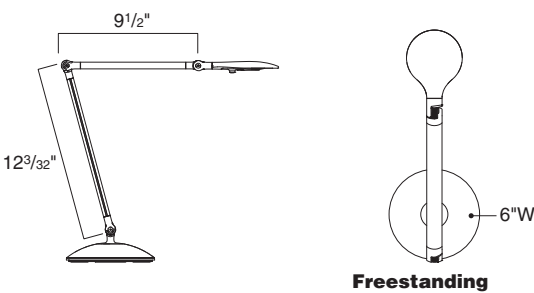

Occupancy sensor monitor radius 36"

LED Radial Desktop Power Supply Dimensions

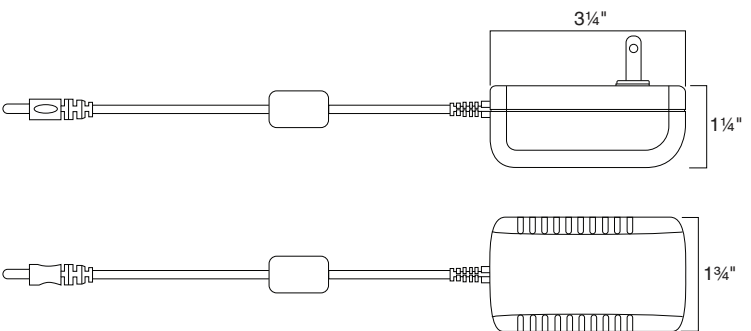

Cord length 9'

LED Radial Desktop Lights, continued

Photometric Data													
LED Radial Desktop Light													
Worksurface rear													
12"	5	6	9	13	18	23	26	24	21	16	11	8	5
9"	6	7	12	19	26	37	41	39	33	24	16	10	6
6"	7	9	15	26	41	56	64	61	48	32	19	12	7
3"	8	10	18	32	53	76	87	79	59	39	23	13	8
CL	5	11	20	35	59	84	95	86	64	40	24	13	8
3"	8	9	18	32	53	74	86	79	60	39	23	13	8
6"	7	9	15	27	43	56	64	59	45	31	18	11	7
9"	6	7	12	20	29	38	42	39	32	23	14	9	6
12"	4	6	9	13	18	23	25	24	20	15	10	7	4
18"	15"	12"	9"	6"	3"	CL	3"	6"	9"	12"	15"	18"	
Worksurface front													

Standard Includes		Required to Specify
<ul style="list-style-type: none"> ▶ Need help? Product details, page 82 	<ul style="list-style-type: none"> • Task light and mounting bracket: paint price group 1 • 18-watt power supply with 9' black cord with 3' silver cord with quick connector • Continuous range dimmer • Automatic turn off program • 7.5-watt LED 3500K 	<ol style="list-style-type: none"> 1 Style number 2 Paint color number for light: <ul style="list-style-type: none"> 4231 Arctic White 4710 Low Gloss Black 4799 Platinum Metallic 3 Options, if selected (see below) <ul style="list-style-type: none"> ▶ See <i>Surface Materials</i>, page 264.

Options	U.S. Price	Required to Specify
Surface Materials	• Paint price group 3 +\$ 47	Specify paint color number. ▶ See <i>Surface Materials</i> on page 264 for accent paint options.
Occupancy Sensor	• With occupancy sensor +\$183	Specify <i>with occupancy sensor</i> .
Base/Mounting Brackets	<ul style="list-style-type: none"> • Freestanding base No cost • C-clamp mount bracket No cost • Slatwall mount bracket No cost • Integrated rail-mount bracket No cost 	Specify <i>with freestanding base</i> . Specify <i>with C-clamp mount bracket</i> . Specify <i>with Slatwall mount bracket</i> . Specify <i>with integrated rail-mount bracket</i> .
	<ul style="list-style-type: none"> • Panel-mount bracket No cost • Through-mount bracket No cost • Theft deterrent through-mount bracket No cost • Freestanding base with USB +\$ 82 	Specify <i>with panel-mount bracket</i> . Specify <i>with through-mount bracket</i> . Specify <i>with theft deterrent through-mount bracket</i> . Specify <i>with freestanding base with USB</i> .

Tip: Through-mount and theft deterrent through-mount brackets can only be used with worksurfaces that are 1" to 1¾" thick. They are not for use with Bivi or FrameOne worksurfaces under 1"D.



Specification Information				
Dimensions			Style	U.S.
D	W	H	Number	Base Price

LED Radial Single Arm Light

13"	6"	16½"	LLRDS	\$544
-----	----	------	-------	-------

LED Radial Double Arm Light

20½"	6"	21½"	LLRDD	\$622
------	----	------	-------	-------

*Tip: For a complete listing of accent paints, see *Surface Materials* on page 264.*



For Canadian Pricing
 Multiply U.S. Price by the Canadian price factor.
 ▶ See page 1 for details.

LED Linear Desktop Lights

LED linear desktop single and double arm lights are available in a variety of mounting applications.

► Specifying, page 89

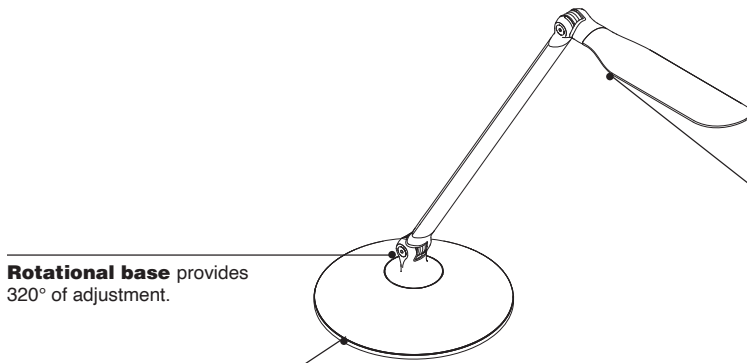

Rotational base provides 320° of adjustment.

Freestanding base, if selected, is painted to match housing.

A properly diffused light source under the linear head provides a softly blended light pattern that reduces eye strain.

Optional occupancy sensor turns LEDs off after 30 minutes of inactivity, available on both single and double arm models.

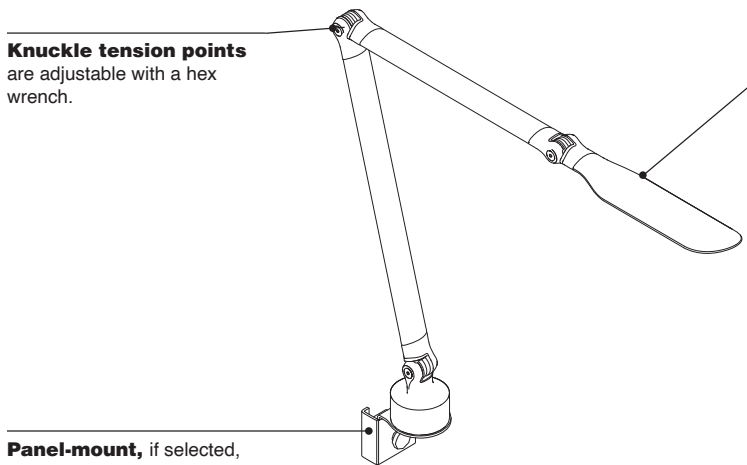

Knuckle tension points are adjustable with a hex wrench.

Panel-mount, if selected, allows single and double arms to mount to Answer, Avenir, and Kick.

Single touch on/off pad plus touch and hold dimming for easy individual user control.

Continuous dimming from 100% to 15% with last state memory.

Integrated rail-mount bracket used on Soto rail, FrameOne, Ology, Campfire, and Tour applications can be mounted in front of privacy screens, Slatwall, or FrameOne center screen.

Product Details

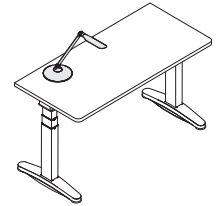

LED linear single arm desktop lights are for use with worksurfaces 58"W or smaller.

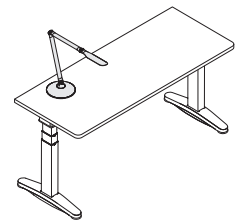

LED linear double arm desktop lights are for use with worksurfaces 60"W or greater.

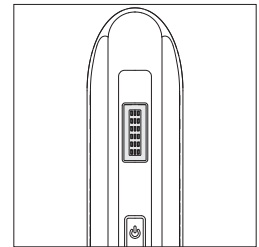

LED linear single and double arm desktop lights come standard with 7.5-watt 18 fractional LEDs with a color temperature of 3500K.

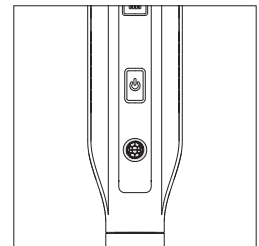

Occupancy sensor is fully integrated into the LED light head and activates in 30 minutes when no movement is detected to conserve energy.

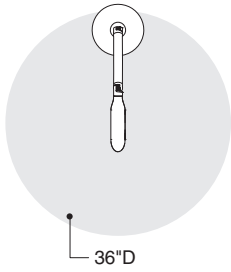

Occupancy sensor utilizes a passive infrared technology to detect the slightest movements by constantly monitoring a 36" diameter zone around the LED light head.

Average rated lamp life of LED linear desktop lights is 50,000 hours.

Color temperature of LEDs is 3500K.

Color rendering index of LEDs is 85.

Automatic turn off after 10 hours (+/- 15 mins.); standard with both models.

Through-mount and theft deterrent through-mount brackets can only be used with worksurfaces that are 1" thick to 1 3/4" thick. They are not for use with Bivi or FrameOne worksurfaces under 1" thick.

Theft deterrent through-mount bracket cannot be retrofitted in the field.

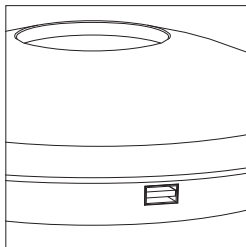

Freestanding base with USB provides an integrated USB charging connection in the base to power up devices such as smart phones (USB cord not included).

Connections

- Freestanding base
- Freestanding base with USB
- Through-mount for worksurfaces 1" to 1 3/4" thick
- C-clamp mount for worksurfaces 7/8" to 1 7/8" thick
- Slatwall-mount
- Panel-mount
- Theft deterrent through-mount for worksurfaces 1" to 1 3/4" thick
- Integrated rail-mount

Optional choice of base/mounting brackets includes: freestanding base, C-clamp mount, Slatwall mount, integrated rail-mount, panel-mount, through-mount, or theft deterrent through-mount.

Wiring & Cabling

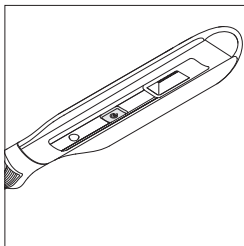

Light is standard with single touch on/off and touch control dimming.

User adjustable touch and hold dimming pad includes continuous dimming range of 100% to 15%.

Power supply uses a modular cord with standard two prong plug, integrated 3' silver cord, and an 18-watt, 9' black cord.

When specified with Height-Adjustable Series Benching or power and data tray, flexible receptacles are recommended.

Surface Materials

Housing

- 4231 Arctic White
- 4710 Low Gloss Black
- 4799 Platinum Metallic
- Accent paint
- ▶ See *Surface Materials* on page 264 for accent paint options.

Mounting brackets

- Paint to match housing

Cord

- Silver

Actual Dimensions

LED Linear Desktop Single Arm Light

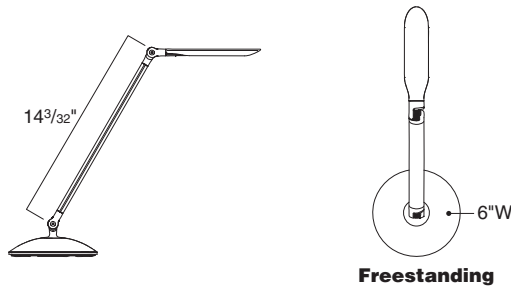

Freestanding

Occupancy sensor monitor radius 36"

LED Linear Desktop Double Arm Light

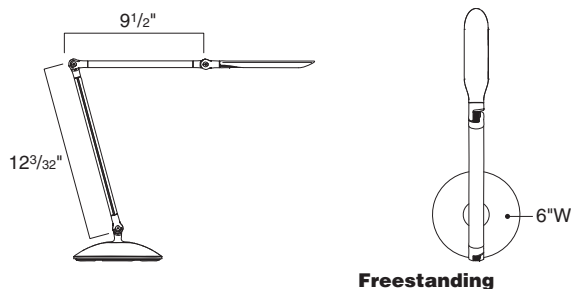

Freestanding

Occupancy sensor monitor radius 36"

LED Linear Desktop Power Supply Dimensions

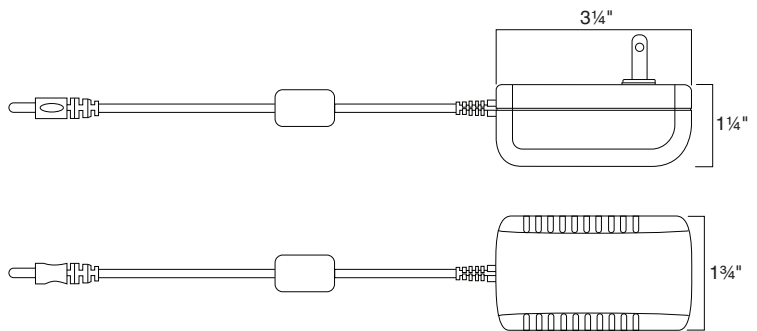

Cord length 9'

LED Linear Desktop Lights, continued

Photometric Data

LED Linear Desktop Light
Worksurface rear

12"	5	6	9	13	18	23	26	24	21	16	11	8	5
9"	6	7	12	19	26	37	41	39	33	24	16	10	6
6"	7	9	15	26	41	56	64	61	48	32	19	12	7
3"	8	10	18	32	53	76	87	79	59	39	23	13	8
CL	5	11	20	35	59	84	95	86	64	40	24	13	8
3"	8	9	18	32	53	74	86	79	60	39	23	13	8
6"	7	9	15	27	43	56	64	59	45	31	18	11	7
9"	6	7	12	20	29	38	42	39	32	23	14	9	6
12"	4	6	9	13	18	23	25	24	20	15	10	7	4
18"	15"	12"	9"	6"	3"	CL	3"	6"	9"	12"	15"	18"	

Worksurface front

Standard Includes		Required to Specify
<ul style="list-style-type: none"> ▶ Need help? Product details, page 86 	<ul style="list-style-type: none"> • Task light and mounting bracket: paint price group 1 • 18-watt power supply with 9' black cord with 3' silver cord with quick connector • Continuous range dimmer • Automatic turn off program • 7.5-watt LED 3500K 	<ol style="list-style-type: none"> 1 Style number 2 Paint color number for light: <ul style="list-style-type: none"> 4231 Arctic White 4710 Low Gloss Black 4799 Platinum Metallic 3 Options, if selected (see below) <ul style="list-style-type: none"> ▶ See <i>Surface Materials</i>, page 264.

Options	U.S. Price	Required to Specify
Surface Materials <ul style="list-style-type: none"> • Paint price group 3 	+\$ 47	Specify paint color number. ▶ See <i>Surface Materials</i> on page 264 for accent paint options.
Occupancy Sensor <ul style="list-style-type: none"> • With occupancy sensor 	+\$183	Specify <i>with occupancy sensor</i> .
Base/Mounting Brackets <ul style="list-style-type: none"> • Freestanding base • C-clamp mount bracket • Slatwall-mount bracket • Integrated rail-mount bracket 	No cost No cost No cost No cost	Specify <i>with freestanding base</i> . Specify <i>with C-clamp mount bracket</i> . Specify <i>with Slatwall-mount bracket</i> . Specify <i>with integrated rail-mount bracket</i> .
<ul style="list-style-type: none"> • Panel-mount bracket • Through-mount bracket • Theft deterrent through-mount bracket • Freestanding base with USB 	No cost No cost No cost +\$ 82	Specify <i>with panel-mount bracket</i> . Specify <i>with through-mount bracket</i> . Specify <i>with theft deterrent through-mount bracket</i> . Specify <i>with freestanding base with USB</i> .

Tip: Through-mount and theft deterrent through-mount brackets can only be used with worksurfaces that are 1" to 1³/₄" thick. They are not for use with Bivi or FrameOne worksurfaces under 1"D.

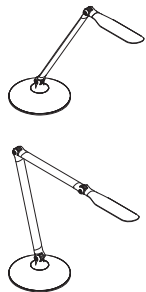

Specification Information		
Dimensions	Style Number	U.S. Base Price
D W H		
15" 6" 16 ¹ / ₂ "	LLLDS	\$544
22 ¹ / ₂ " 6" 21 ¹ / ₂ "	LLLDD	\$622

LED Linear Single Arm Light

15" 6" 16¹/₂" LLLDS \$544

LED Linear Double Arm Light

22¹/₂" 6" 21¹/₂" LLLDD \$622

Tip: For a complete listing of accent paints, see Surface Materials on page 264.

 **For Canadian Pricing**
Multiply U.S. Price by the Canadian price factor.
▶ See page 1 for details.

LED Intro Task Lights

LED intro task lights provides ease of user adjustments to direct light where needed, plus a three-step dimming feature. LED light source for energy efficiency.
▶ Specifying, page 93

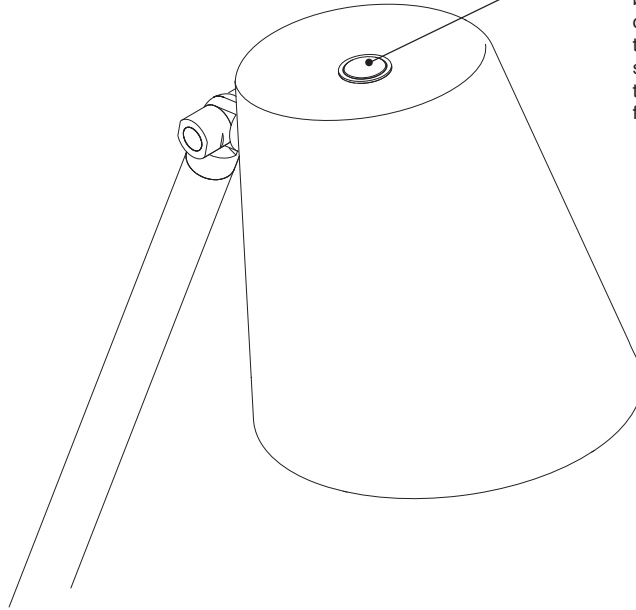

Capacitive touch switch is located on the back of the light source with dimming control. The first touch is 10% illumination, second touch is 50%, third touch is 100%, and the fourth touch turns off.

Light source knuckle and base knuckle provide articulation points for ease of adjustments to where the light is needed.

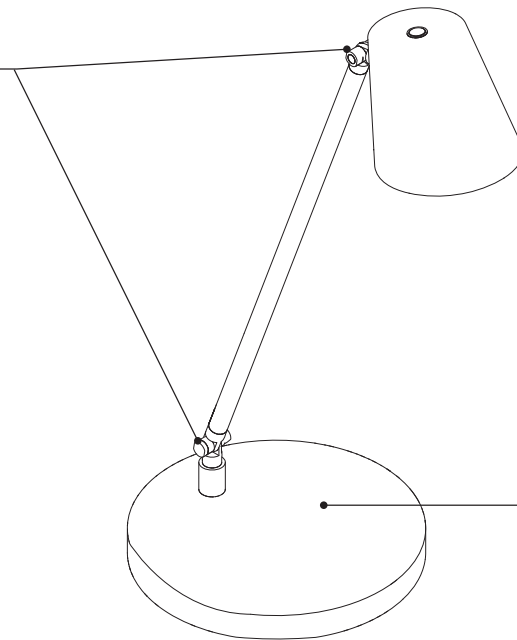

Freestanding base is ideal for placing on desk or table tops. Painted to match the entire light fixture and weighted to prevent tipping.

Product Details

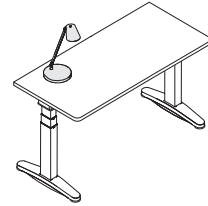

LED intro single-arm lights are for use with worksurfaces 58"W or smaller.

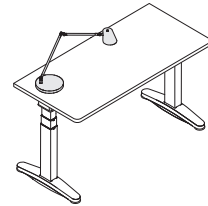

LED intro double-arm lights are for use with worksurfaces 60"W or larger.

LED light performance with 3000K color temperature and a 90 color rendering index rating.

Adjustability at the light source and base directs light where needed.

Examples

- Light head swivels 350° (side to side)

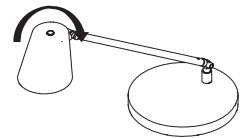

- Light head pivots up and down 180° (up/down)

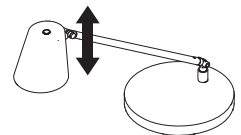

Capacitive touch on/off switch and dimming feature comes standard with three levels: 10%, 50%, and 100%.

Color temperature of LED is 3000K.

Color rendering index (CRI) is 90.

Connections

 Freestanding base

Wiring & Cabling

Light comes standard with single touch on /10%–50%–100% / off.

Power supply uses a modular cord with standard two prong plug, cord length 75".

Surface Materials

Paint

- 4135 Black Matte
- 4142 Platinum Gloss
- 4143 White Matte

Application Topics

90° mini extension cord can be used with Ology bench, FrameOne, or where power receptacles are located in confined spaces.

▶ Page 94

Power cord length is 75". Consider distance from light to power receptacle, and if surface or under the work-surface power receptacle may be needed.

▶ Pages 197–206

Actual Dimensions

Single Arm

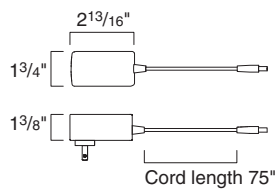
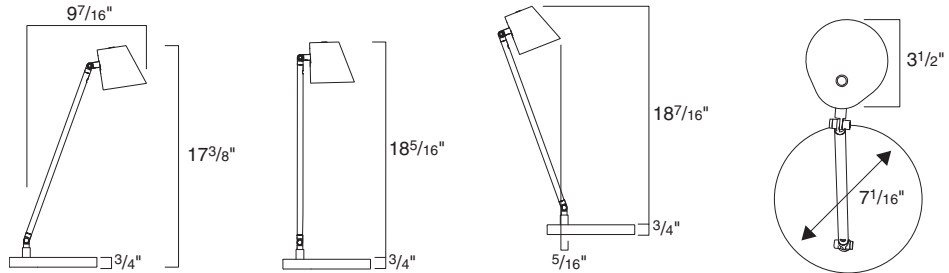

Double Arm

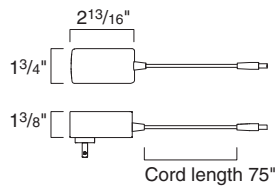
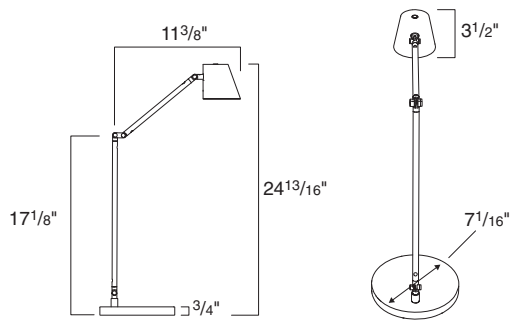
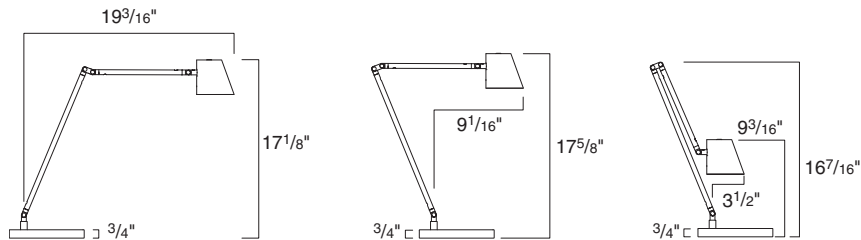

LED Intro Task Lights, continued

Photometric Data

LED Intro Task Light
Worksurface rear

12"	35	76	77	80	85	80	77	76	35
9"	82	92	97	100	109	100	97	92	82
6"	92	108	124	130	141	130	124	108	92
3"	100	120	155	200	207	200	155	120	100
0	106	128	172	225	225	225	172	128	106
3"	100	120	155	200	207	200	155	120	100
6"	92	108	124	130	141	130	124	108	92
9"	82	92	97	100	109	100	97	92	82
12"	35	76	77	80	85	80	77	76	35

12" 9" 6" 3" CL 3" 6" 9" 12"
Worksurface front

Tip: The 90° mini extension cord can be used with Ology bench, FrameOne, or where power receptacles are located in confined spaces.
 ▶ Page 94

Tip: Power cord length is 75". Consider distance from light to power receptacle, and if surface or under the worksurface power receptacle may be needed. Applies to both single-arm and double-arm lights.

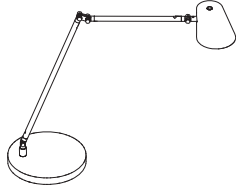
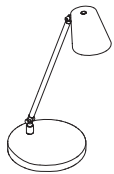

Standard Includes	Required to Specify
<ul style="list-style-type: none"> ▶ Need help? Product details, page 90 • Task light and freestanding base: paint price group 1 • 75" cord two-prong power supply • LED light source • Capacitive switch • Three-step dimming • 7W LED 3000K 	<ul style="list-style-type: none"> 1 Style number 2 Paint color number for light: <ul style="list-style-type: none"> 4135 Black Matte 4142 Platinum Gloss 4143 White Matte

Related Products
<ul style="list-style-type: none"> • Powerstrip plus ▶ Page 200 • 90° mini extension cord ▶ Page 94 • Universal cable management kits ▶ Page 205

Specification Information

Dimensions			Style	U.S.
D	W	H	Number	Price

LED Intro Single-Arm Task Light

7"	7"	18 ³ / ₁₀ "	LSCTSKLIGHT1	\$303
----	----	-----------------------------------	---------------------	-------

LED Intro Double-Arm Task Light

7"	7"	17 ³ / ₄ "	LSCTSKLIGHT2	\$433
----	----	----------------------------------	---------------------	-------



 **For Canadian Pricing**
 Multiply U.S. Price by the Canadian price factor.
 ▶ See page 1 for details.

90° Mini Extension Cord



Tip: 90° mini extension cord can be used with Ology bench, FrameOne, or where power receptacles are located in confined spaces.

Standard Includes	Required to Specify
<ul style="list-style-type: none"> • 10" L molded NEMA mini extension cord 	Style number

Specification Information	
• Style Number	• U.S. Price
LMINICORD	\$62
•	•



For Canadian Pricing
 Multiply U.S. Price by the Canadian price factor.
 ▶ See page 1 for details.

LED Shelf Lights

► Specifying, page 98

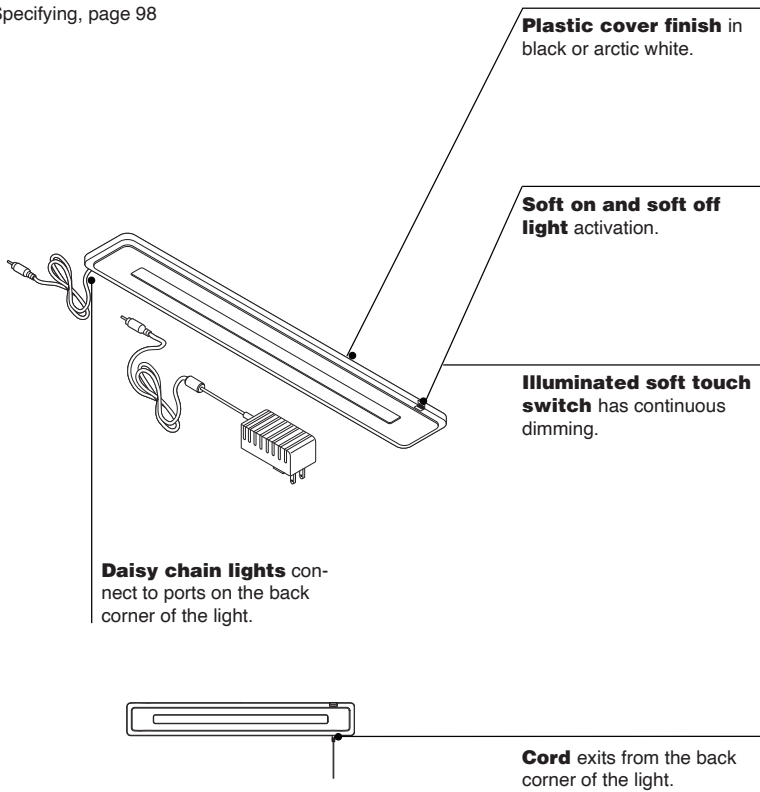

Actual Dimensions

Depth 2⁵/₈"

Width 18¹/₈"

Height 1/2"

- Power Supply 18 Watt Cord
 - 9' with two prong driver plug
- Power Supply 65 Watt Cord Set (11')
 - Line voltage cord: 6'
 - Low voltage cord: 5'

Product Details

Shelf light includes the lamp and power supply with cord set. Daisy chain primary light includes lamp and larger power supply to support up to three lights. Daisy chain secondary light includes lamp and daisy chain cord set.

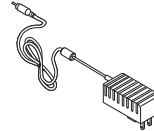

An 18 watt power supply is used on the LED standard light; it is 9' long with a two prong driver plug.
Tip: Energy saving mini-LEDs greatly reduce power use.

LED Shelf Light Power Supply Dimensions

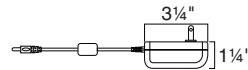

Tip: Cord length is 9'.

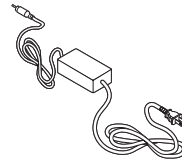

Power supply for LED daisy chain starter light uses an 11' 65 watt modular cord with standard two prong plug, an integrated low voltage cord, and a connector to attach to light.

LED Shelf Light Power Supply Dimensions

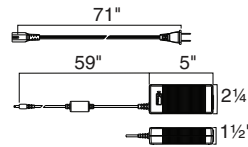

Tip: Applies to daisy chained.

Connections

Shelf light mounts recessed or flush depending on design of overhead storage bin or shelf. Installation is done in the field.

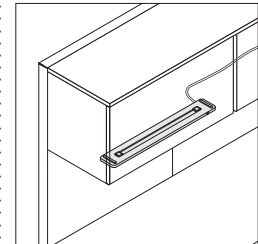
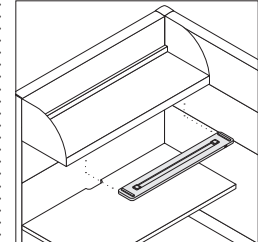

Magnetic mounting allows shelf light to be installed without tools under most metal overhead storage bins and shelves. This mounting allows the light to be mounted to most competitive steel bins and shelves.

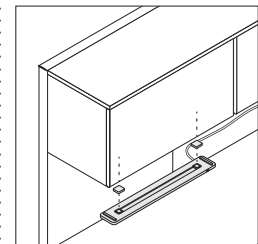

Optional fastener kit allows shelf light to be mounted to wood shelves.

Specify LED shelf light or LED linear shelf light for use under 24" wide bins. Standard and Bottomline 24" wide lights do not fit under 24" wide bins.

Wiring & Cabling

Shelf light includes the lamp and power supply with cord set. Daisy chain starter light includes lamp and larger power supply to support up to three lights. Daisy chain secondary light includes lamp and daisy chain cord set.

Power supply for LED daisy chain starter light uses a 65 watt modular cord with standard two prong plug, an integrated low voltage cord, and a connector to attach to light. An 18 watt power supply is used on the LED standard light, it is 9' long with a two prong driver plug.

Tip: Daisy chain starter light comes with a 65 watt power supply to support up to three lights. Daisy chain secondary lights do not come with a power supply, but instead come with a daisy chain cord set.

Surface Materials

Housing

- 6000 Black
- 6009 Arctic White

Reflector

- Clear anodized aluminum only

Cord

- Black plastic only

Photometric Data

LED Shelf Light

Initial horizontal footcandles for LSL18

Worksurface rear

12"	16	22	29	36	42	47	48	46	40	34	27	20	15
9"	20	28	38	49	59	66	67	64	56	46	35	26	19
6"	24	35	48	62	76	85	87	83	72	58	44	31	22
3"	27	39	55	72	89	101	104	98	85	67	50	35	24
CL	28	41	57	76	94	107	111	104	89	70	52	36	25
3"	26	38	54	71	88	100	103	97	83	66	49	34	24
6"	23	33	50	60	73	83	85	80	69	55	41	30	20
9"	19	26	36	46	55	62	64	61	53	43	33	24	17
12"	15	20	25	32	38	42	44	41	37	30	24	18	13

Worksurface front

18"	15"	12"	9"	6"	3"	CL	3"	6"	9"	12"	15"	18"
-----	-----	-----	----	----	----	----	----	----	----	-----	-----	-----

LED Shelf Lights

Tip: Maximum number of lights that can be daisy chained is three lights.

Standard Includes		Required to Specify
<ul style="list-style-type: none"> ▶ Need help? Product details, page 96 	<ul style="list-style-type: none"> Aluminum extrusion with plastic cover Power supply with cord Soft touch switch Thin profile accommodates recessed and low profile flush mounting Ultra energy efficient LED light source Universal magnetic mounting Polycarbonate matte film diffuser Continuous dimming 	<ul style="list-style-type: none"> 1 Style number 2 Plastic color number for cover: 6000 Black, 6009 Arctic White 3 Options, if selected (see below)

Options	U.S. Price	Required to Specify
Mounting <ul style="list-style-type: none"> Fastener kit for use with wood shelf 	+\$9	Specify <i>with fastener kit</i> .

Specification Information

Dimensions			Lamp Wattage	Style Number	U.S. Base Price
D	W	H			
2 1/2"	18"	1/2"	9.6 watts	LSL18	\$549

LED Standard Light

2 1/2"	18"	1/2"	9.6 watts	LSL18	\$549
--------	-----	------	-----------	--------------	-------

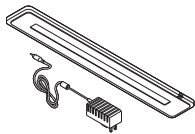

Tip: LED standard light comes with a 9' 18 watt power supply.

LED Daisy Chain Starter Light

2 1/2"	18"	1/2"	9.6 watts	LSL18YA	\$591
--------	-----	------	-----------	----------------	-------

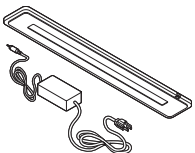

Tip: Daisy chain starter light comes with a 65 watt power supply that will support up to three lights in series (11' cord; 6' from power supply to power outlet, 5' from power supply to fixture). Does not include daisy chain jumper cords.

LED Daisy Chain Secondary Light

2 1/2"	18"	1/2"	9.6 watts	LSL18YB	\$540
--------	-----	------	-----------	----------------	-------

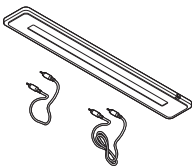

Tip: Daisy chain secondary light does not come with a power supply. Daisy chain cord package (8" and 30") comes standard with each secondary light.

LED Linear Shelf Lights

A properly diffused light source under the linear head provides a softly blended light pattern that reduces eye strain.
 ▶ Specifying, page 104

Optional occupancy sensor turns off after 30 minutes of no activity and will turn back on upon return.

Single touch on/off pad plus touch and hold dimming for easy individual user control.

Continuous dimming from 100% to 15% with last state memory.

Cord exits from either end of the light. When needed, allow 1³/₄" cord bend clearance. With optional occupancy sensor, allow additional 4³/₄" clearance from the light fixture.

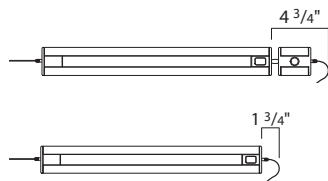

Magnetic mounts and wood mount bracket hardware, both come standard with both LED light and optional occupancy sensor.

Light widths available in 17", 31", 44", and 58".

Product Details

LED linear stand alone and daisy chain starter lights include the lamp, power supply, and both magnetic mounts, and wood bracket hardware with adhesive cord managers.

LED linear daisy chain lights include the lamp, daisy chain cords, and both magnetic mounts, and wood mount bracket hardware with adhesive cord managers.

Optional occupancy sensor is a separate component that connects to the light fixture and activates in 30 minutes when no movement is detected to conserve energy. It will also turn back on upon return.

Average rated lamp life of LED linear shelf lights is 50,000 hours.

Color temperature of LEDs is 3500K.

Color rendering index of LEDs is 92.

Automatic turn off after 10 hours (+/- 15 mins.); standard with both models.

Connections

Lights mount recessed or flush depending on design of overhead storage bin or shelf. Installation is done in the field.

Magnet mounts allow shelf lights to be installed without tools under most metal overhead storage bins or shelves.

Wood mount brackets allow shelf lights to be mounted to wood shelves.

Specify LED shelf light or LED linear shelf light for use under 24" wide bins. Standard and Bottomline 24" wide lights do not fit under 24" wide bins.

Actual Dimensions

	Light	Occupancy Sensor
Depth	2"	2"
Width	17", 31", 44", or 58"	2 ⁹ / ₁₀ "
Height	1/2"	7/10"

Light width	Number of LEDs in Standard Output/ High Output	System Wattage Standard Output/ High Output
17"	24 / 47	9.1 / 10.2
31"	48 / 94	17.6 / 19.7
44"	72 / 141	25.9 / 28.2
58"	96 / 188	33.7 / 38.2

Wiring & Cabling

Light is standard with single touch on/off and touch control dimming.

User adjustable touch and hold dimming pad includes continuous dimming range of 100% to 15%.

Power supply for 17" linear stand alone only uses a straight plug with a 9' 18 watt 24 volt wall transformer.

LED Linear Shelf Light Power Supply Dimensions

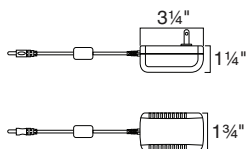

Tip: Cord length is 9'.

Power supply for 31", 44", 58", or 17" starter light; 65 watt compact in-line brick straight plug. The cord is 11', 6' from power supply to power outlet and 5' from power supply to fixture.

LED Linear Shelf Light Power Supply Dimensions

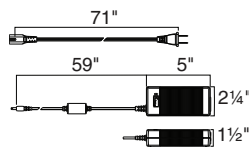

Tip: Applies to 31", 44", 58", and daisy chained.

Tip: Daisy chain starter light comes with a 65 watt power supply to support up to a limited number of lights – refer to chart for daisy chaining fixture. Daisy chain secondary lights do not come with a power supply, but instead come with two daisy chain jumper cords, one 8" and one 30" set.

▶ See page 102.

Surface Materials

- Housing**
- 4321 Arctic White
 - 0835 Black

- Cord**
- Black plastic only

Photometric Data

17"W Standard Output Linear Shelf Light
Worksurface rear

12"	10	18	27	31	27	18	11
6"	15	30	49	59	49	30	15
CL	18	38	64	79	65	38	19
8"	16	32	54	65	64	33	17
12"	12	21	31	37	31	21	12

18" 12" 6" CL 6" 12" 18"

Worksurface front

31"W Standard Output Linear Shelf Light
Worksurface rear

12"	25	38	49	53	50	39	26
6"	41	67	88	95	87	67	42
CL	50	86	114	125	115	87	52
8"	43	73	96	104	97	74	45
12"	29	45	57	62	58	46	30

18" 12" 6" CL 6" 12" 18"

Worksurface front

44"W Standard Output Linear Shelf Light
Worksurface rear

12"	42	54	61	63	61	54	42
6"	73	95	106	109	104	93	72
CL	94	124	138	141	137	122	94
8"	80	105	117	121	117	104	80
12"	50	64	72	75	72	64	50

18" 12" 6" CL 6" 12" 18"

Worksurface front

58"W Standard Output Linear Shelf Light
Worksurface rear

12"	58	65	68	69	68	64	57
6"	101	113	117	118	116	110	98
CL	131	144	150	151	149	143	128
8"	109	122	127	129	127	121	108
12"	67	75	79	80	79	75	67

18" 12" 6" CL 6" 12" 18"

Worksurface front

17"W High Output Linear Shelf Light
Measured from 18" above worksurface
Worksurface rear

12"	17	30	44	51	44	30	18
6"	26	50	82	97	81	51	26
CL	31	63	109	132	109	65	32
8"	28	56	90	108	91	55	29
12"	20	36	53	59	53	36	21

18" 12" 6" CL 6" 12" 18"

Worksurface front

31"W High Output Linear Shelf Light
Worksurface rear

12"	40	61	78	85	79	62	42
6"	64	106	140	152	141	108	67
CL	80	137	183	200	186	141	84
8"	70	116	154	168	156	119	73
12"	47	72	92	99	93	73	49

18" 12" 6" CL 6" 12" 18"

Worksurface front

44"W High Output Linear Shelf Light
Worksurface rear

12"	69	88	100	104	100	89	71
6"	118	155	174	180	174	154	120
CL	151	199	224	232	225	202	155
8"	127	167	188	194	189	168	131
12"	79	102	115	120	115	103	81

18" 12" 6" CL 6" 12" 18"

Worksurface front

58"W High Output Linear Shelf Light
Worksurface rear

12"	93	104	110	110	111	104	95
6"	160	179	187	189	187	178	162
CL	205	228	238	240	239	229	207
8"	172	192	202	204	203	194	176
12"	104	120	126	129	127	121	108

18" 12" 6" CL 6" 12" 18"

Worksurface front

Chart for Daisy Chaining Fixtures

Standard Output Linear Shelf Light											
Light fixture widths	Maximum number of fixtures allowed with daisy chain starter light										
	17"	6	4	3	2	2	1	1	-	-	-
31"	-	1	-	2	-	2	1	3	1	1	-
44"	-	-	1	-	-	-	1	-	1	-	2
58"	-	-	-	-	1	-	-	-	-	1	-

High Output Linear Shelf Light				
Light fixture widths	Maximum number of fixtures allowed with daisy chain starter light			
	17"	4	2	1
31"	-	1	-	2
44"	-	-	1	-

- A 65 watt power supply is required for daisy chaining.
- Total system wattage of all fixtures together cannot meet or exceed 65 watts, see chart.
- Cannot daisy chain standard output and high output together.
- Cannot daisy chain 58" high output fixtures.
- Occupancy sensor must be positioned between the power supply and the first starter fixture.
- Only need one sensor when daisy chaining.

Tip: Each column is the maximum number of fixtures that can be daisy chained together.

Occupancy Sensor

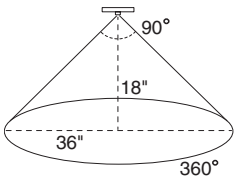

- Turns off after 30 minutes of no activity and will turn back on upon return
- 360° lens view
- 90° outward detection angle
- 30" diameter coverage if mounted 15" above worksurface
- 36" diameter coverage if mounted 18" above worksurface
- Connects to fixture with one end-to-end connector. 8" or 30" jumper cords

LED Linear Shelf Lights

Tip: The power supply for the 17" stand alone only uses a straight plug with a 9' 18 watt 24 volt wall transformer. The power supply for the 31", 44", 58", or 17" starter light uses a 11' 65 watt compact in-line brick with straight plug.

Tip: Cord exists on ends of light fixture. Allow 1³/₄" cord bend radius. With optional occupancy sensor, add 4³/₄".

Tip: The high output option will be culled October 18, 2026.

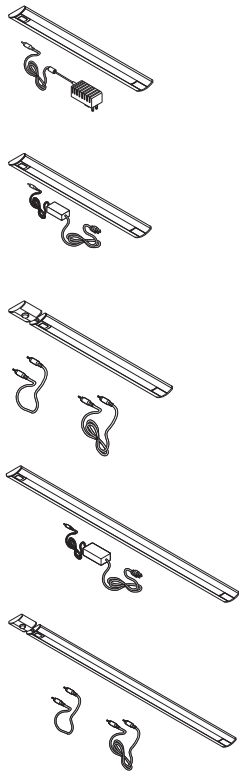

 **For Canadian Pricing**
Multiply U.S. Price by the Canadian price factor.
▶ See page 1 for details.

Standard Includes		Required to Specify
▶ Need help? Product details, page 100	<ul style="list-style-type: none"> Task light and mounting bracket: 4231 Arctic White Power supply with cord: black Soft touch switch Magnetic and wood mounting brackets Continuous range dimmer Automatic turn off program Color temperature 3500K 	1 Style number 2 Options, if selected (see below)

Options	U.S. Price	Required to Specify
Surface Materials • Painted light housing in 0835 Black	+\$ 20	Specify with 0835 Black.
Occupancy Sensor • 17"W, 31"W, 44"W, and 58"W with stand alone or daisy chain starter	+\$203	Specify with occupancy sensor.
High Output  10/26 • 17"W with stand alone, starter, or secondary	+\$128	Specify with high output.
• 31"W, 44"W, and 58"W with stand alone or daisy chain starter, or secondary	+\$218	Specify with high output.

Specification Information			Style Number	U.S. Base Price
Dimensions				
D	W	H		

17" Stand Alone Light				
2"	17"	7/10"	LLL17	\$416
:	:	:	:	:

17" Daisy Chain Starter Light				
2"	17"	7/10"	LLL17YA	\$484
:	:	:	:	:

17" Daisy Chain Secondary Light				
2"	17"	7/10"	LLL17YB	\$362
:	:	:	:	:

31" Stand Alone or Daisy Chain Starter Light				
2"	31"	7/10"	LLL31	\$673
:	:	:	:	:

31" Daisy Chain Secondary Light				
2"	31"	7/10"	LLL31YB	\$557
:	:	:	:	:

▶ **Specification Information, continued on next page**

 10/26 = Last order entry
October 18, 2026

► **Specification Information, continued from previous page**

Specification Information

• Dimensions			• Style • Number	• U.S. • Base • Price
D	W	H		

44" Stand Alone or Daisy Chain Starter Light

2"	44"	7/10"	LLL44	\$ 893
----	-----	-------	--------------	--------

44" Daisy Chain Secondary Light

2"	44"	7/10"	LLL44YB	\$ 748
----	-----	-------	----------------	--------

58" Stand Alone or Daisy Chain Starter Light

2"	58"	7/10"	LLL58	\$1143
----	-----	-------	--------------	--------

58" Daisy Chain Secondary Light

2"	58"	7/10"	LLL58YB	\$ 807
----	-----	-------	----------------	--------

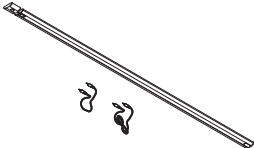
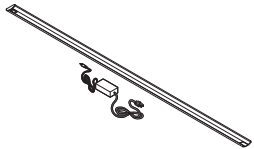
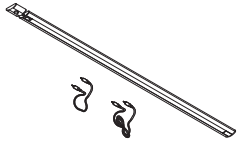
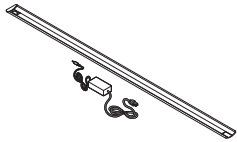

Tip: Cord exists on ends of light fixture. Allow 1 3/4" cord bend radius. With optional occupancy sensor, add 4 3/4".



For Canadian Pricing
 Multiply U.S. Price by the Canadian price factor.
 ► See page 1 for details.

Shelf Lights

Standard

► Specifying, page 112

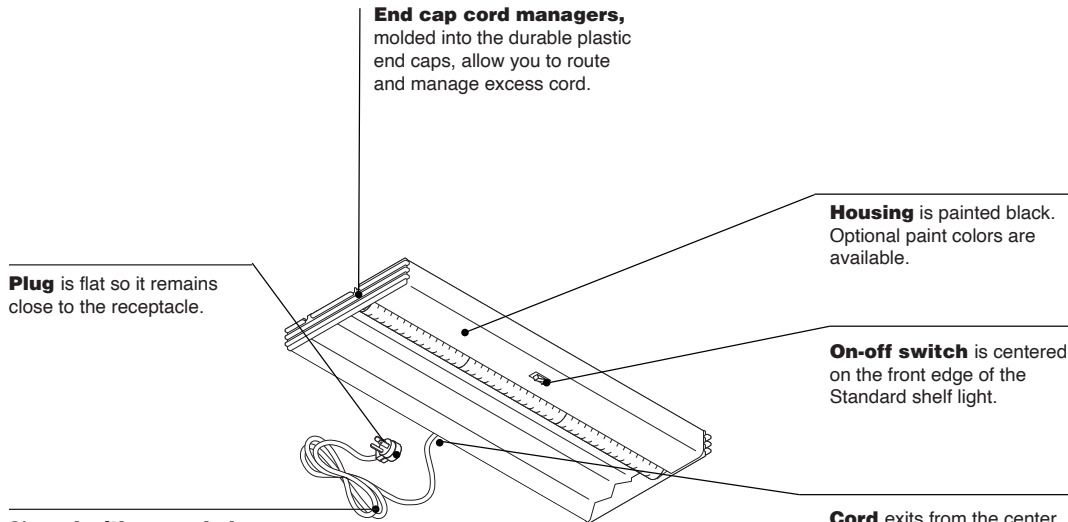

9' cord with grounded plug is factory installed. Length is maximum allowed by U.S. National Electrical Code. Cord with circuit breaker is available to meet the requirements of the Chicago code.

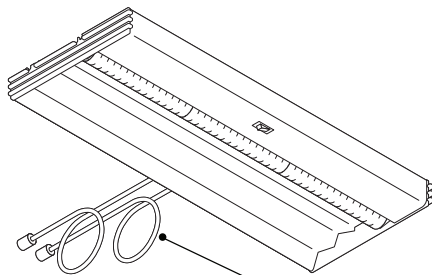

Daisy chain cords have modular connectors to link Standard shelf lights together.

Product Details

Shelf light includes the lamp, ballast, and either a 9' cord with three-prong plug or daisy-chain cords.

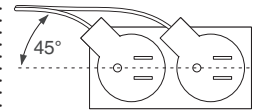

Plug configuration allows two Standard shelf lights to engage adjacent outlets in one receptacle.

Energy-saving T8 lamps have triphosphor coating for balanced color and pleasing light.

Connections

Shelf light mounts recessed or flush depending on design of overhead storage bin or shelf. Installation is done in the field.

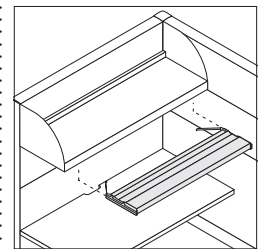

Universal bracket allows shelf light to be installed without tools under most metal overhead storage bins and shelves.

Specify LED shelf light or LED linear shelf light for use under 24" wide bins. Standard and Bottomline 24" wide lights do not fit under 24" wide bins.

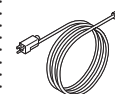

Daisy chain starter cord must be ordered separately when used with Standard shelf lights in a daisy chain application.

Actual Dimensions

Standard

Depth	9 ¹ / ₄ " (235 mm)
Width	24 ⁵ / ₈ ", 36 ⁵ / ₈ ", or 48 ⁵ / ₈ " (625 mm, 930 mm, or 1235 mm)
Height	1 ³ / ₄ " (44 mm)

Width	Lamp width	Lamp wattage	Replacement lamps
24 ⁵ / ₈ "	24"	17 watts	F17T8-TL735
36 ⁵ / ₈ "	36"	25 watts	F25T8-TL735
48 ⁵ / ₈ "	48"	32 watts	F32T8-TL735

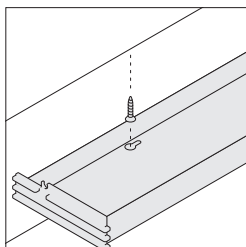

Keyhole slots in housing of fixture allow shelf light to be mounted beneath wood or laminate overhead storage bins and shelves using screws provided. Keyhole slots are also used to mount lights to overhead storage bins and shelves manufactured prior to August 1991.

Standard shelf competitive mounting package provides attachment hardware to mount Steelcase shelf lights on all major competitive furniture lines. Package includes screws and installation instructions.

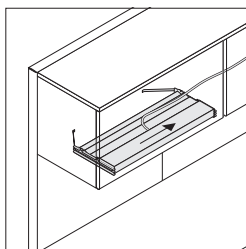

Shelf light can be mounted anywhere from side to side beneath overhead storage bin or shelf. The cord length is the only limitation.

Wiring & Cabling

Power drawn is approximately 1/2 amp.

Daisy chaining permits interconnecting up to six Standard shelf lights from a single power outlet.
▶ Page 110

Starter cord for Standard powers first light in a daisy chain and allows you to convert any daisy chain light for independent operation.

Electronic high-power factor ballast that is roughly 45% more efficient than a normal-power-factor ballast is available on Standard.

Surface Materials

Housing

- Black paint (standard)
- Paint colors (option)

Reflector

- White

Cord

- Black plastic only

End cap cord manager

- Black plastic only

Photometric Data

Standard								
Initial horizontal footcandles for LSM24K								
Worksurface rear								
3"	88	85	78	67	55	42	31	22
6"	93	90	82	70	57	43	31	23
9"	91	88	81	69	56	41	30	21
12"	82	80	72	62	50	38	28	20
15"	69	67	61	53	43	33	24	18
18"	56	55	49	43	36	28	21	16
21"	41	40	37	32	27	22	17	13
24"	29	28	26	23	19	16	13	10
27"	19	19	18	16	14	12	10	8
30"	13	13	12	11	10	9	7	6
CL	3"	6"	9"	12"	15"	18"	21"	
Worksurface front								

Shelf Lights

Bottomline

► Specifying, page 114

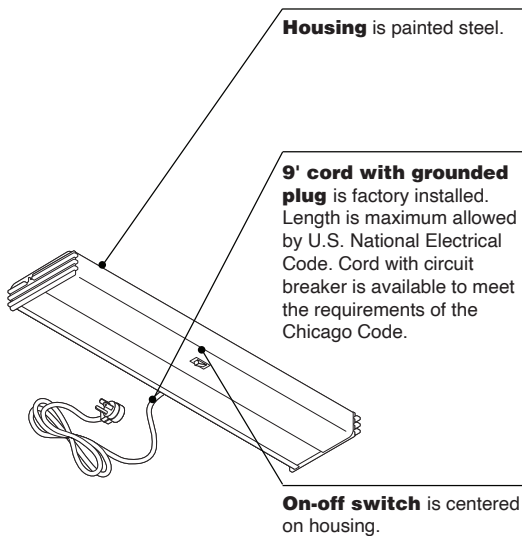

Product Details

Shelf light includes the lamp, ballast, and either a 9' cord with a three-prong plug or a Chicago plug.

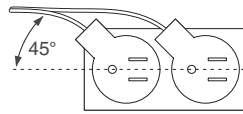

Plug configuration allows two task lights to engage adjacent outlets in one receptacle.

Optics: **Bottomline** includes a batwing lens with mylar reflector that provides low glare and broad distribution of light.

Connections

Shelf light mounts recessed or flush depending on the design of the overhead storage bin or shelf. Standard with universal spring brackets for recessed mount or screw-in for flush mount.

Specify LED shelf light or LED linear shelf light for use under 24" wide bins. Standard and Bottomline 24" wide lights do not fit under 24" wide bins.

Width	Lamp width	Lamp wattage	Replacement lamps
24"	23.3"	14 watts	F14T5-835
36"	35.1"	21 watts	F21T5-835
48"	46.8"	28 watts	F28T5-835

Lamp life of a fluorescent lamp that turns on and off once a day will last longer than a lamp that turns on and off many times a day. Environmental effects can shorten the life of a lamp, such as: moisture or higher humidity, higher or colder than normal temperatures, excessive vibration, and power surges.

Tip: If the light begins to flicker, or shuts down immediately, the sensor is indicating the lamp is at the end of its life and needs to be replaced.

Wiring & Cabling

Power drawn is approximately 1/2 amp.

Daisy chaining is only available on Bottomline shelf lights.

Daisy chaining on Bottomline permits interconnecting up to six shelf lights from a single power outlet.

► Page 110

Daisy chaining on Bottomline allows for independent operation of lights.

Electronic ballast is more energy efficient than T8 electronic ballasts.

Surface Materials

Housing

- Paint
0835 Black
7018 Pewter

Reflector

- Mylar reflector with batwing lens - flat acrylic diffuser

Cord

- Black plastic only

End caps

- Molded to match housing

Actual Dimensions

Depth	4 1/2"
Width	23 1/4", 35", 46 3/4"
Height	1 1/4"
Weight	4.02 lb, 4.95 lb, 6.9 lb

Photometric Data**Bottomline**Initial horizontal footcandles for L52FT
Worksurface rear

3"	52	49	43	37	28	20	15	10
6"	77	72	63	52	39	29	20	14
9"	98	93	80	66	50	36	26	17
12"	114	107	94	77	58	42	30	20
15"	124	117	104	85	63	47	33	22
18"	119	112	99	81	63	46	32	22
21"	98	92	81	68	52	39	28	19
24"	70	68	61	51	40	30	22	16
27"	47	44	40	34	27	22	16	12
30"	29	27	25	23	18	15	12	9

CL	3"	6"	9"	12"	15"	18"	21"
----	----	----	----	-----	-----	-----	-----

Worksurface front

Daisy Chaining

For Standard and Bottomline Lights

Daisy chaining shelf lights together extends power from one fixture to another within workstations to help keep receptacles clear for other uses.

For Standard shelf lights, starter cord is required with daisy chain cords to bring power to the first shelf light in a daisy chain so there's no need to designate where each fixture will be used within the chain.

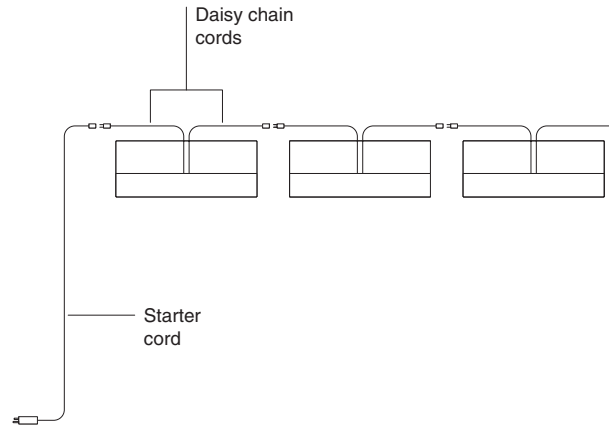

Tip: Daisy chaining is not allowed in Chicago. Local electrical codes vary, so you should consult a qualified electrical contractor or engineer for proper installation of all electrical equipment.

Tip: Overhead cabinets and shelves provide a recessed area for shelf lights. They are not designed to conceal cords when daisy chaining.

Tip: When using upmount brackets with overhead storage and daisy chaining lights, use the open design upmount bracket for better cord management.

Power will not be interrupted in a chain even if one of the shelf lights is turned off or its lamp has burned out. That's because the path of power through the chain doesn't pass through the lamps or switches.

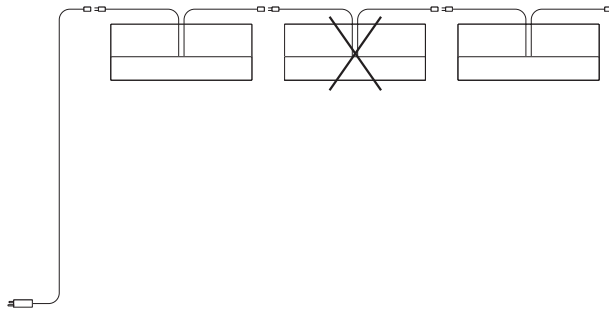

For Bottomline lights, starter light is required with daisy chain lights to bring power to the first light in the daisy chain.

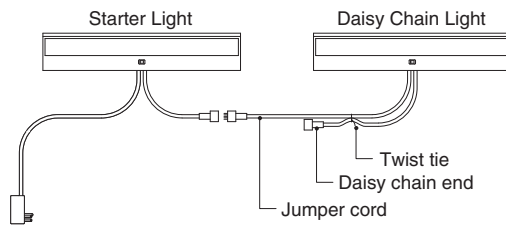

Standard Shelf Lights ❏ 10/26

Tip: Daisy chaining shelf lights together extends power from one fixture to another within workstations to help keep receptacles clear for other uses.
 ▶ See page 110 for more information.

Tip: Daisy chaining is not allowed in Chicago. Local electrical codes vary, so you should consult a qualified electrical contractor or engineer for proper installation of all electrical equipment.

Tip: Because shelf lights are usually recessed, black is the standard paint color. Paint colors other than black have an upcharge.

Tip: If an optional paint color is selected for the housing, the electrical switches and end caps will remain black plastic.

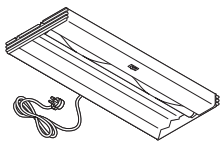

Tip: When ordering with standard power cord or Chicago cord, daisy chaining is not possible.

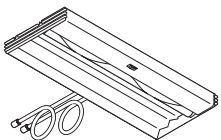

Tip: Remember to order a daisy chain starter cord separately.
 ▶ See Related Products on next page.



For Canadian Pricing
 Multiply U.S. Price by the Canadian price factor.
 ▶ See page 1 for details.

Standard Includes	Required to Specify
<ul style="list-style-type: none"> ▶ Need help? Product details, page 106 • Light housing with centered on-off switch: black paint • End cap cord managers: black plastic only • Cords: <ul style="list-style-type: none"> — Standard and Chicago (including circuit breaker), 9' cord with three-prong plug at 45° angle: black plastic only — Daisy chain, one 78" cord with modular connectors for daisy chaining: black plastic only • Contrast sleeve around lamp • Faceted reflector: white only • T8 3500K lamp • Ballast • Universal mounting hardware package • Daisy chain starter cord, if selected: black plastic only (order separately) 	<ol style="list-style-type: none"> 1 Style number 2 Paint color number, if other than black (see options below) 3 Options, if selected (see below) ▶ See <i>Surface Materials</i> , page 264.

Options	U.S. Price	Required to Specify
Surface Materials <ul style="list-style-type: none"> • Painted light housing other than black 	+\$38	Specify paint color number for housing.
Bracket Option <ul style="list-style-type: none"> • Competitive mounting package • Flush mounting package 	No cost	Specify <i>with competitive mounting package</i> . Specify <i>with flush mounting package</i> and paint color number for end cap covers.

Specification Information			
Dimensions	Lamp Wattage	Style Number	U.S. Base Price
D W H	:	:	:

Electronic High-Power-Factor Ballast

With Standard Power Cord

9 1/4"	25"	1 3/4"	17 watts	LSM24K ❏ 10/26	\$668
9 1/4"	37"	1 3/4"	25 watts	LSM36K ❏ 10/26	\$707
9 1/4"	49"	1 3/4"	32 watts	LSM48K ❏ 10/26	\$765

With Chicago Cord Including Circuit Breaker

9 1/4"	25"	1 3/4"	17 watts	LSM24KC ❏ 10/26	\$771
9 1/4"	37"	1 3/4"	25 watts	LSM36KC ❏ 10/26	\$810
9 1/4"	49"	1 3/4"	32 watts	LSM48KC ❏ 10/26	\$868

With Daisy Chain Cords

9 1/4"	25"	1 3/4"	17 watts	LSM24KD ❏ 10/26	\$727
9 1/4"	37"	1 3/4"	25 watts	LSM36KD ❏ 10/26	\$766
9 1/4"	49"	1 3/4"	32 watts	LSM48KD ❏ 10/26	\$824

▶ **Specification Information, continued on next page**

❏ 10/26 = Last order entry
 October 18, 2026

► **Specification Information, continued from previous page**

Related Products

Quantity in Package	Length	Style Number	U.S. Price
---------------------	--------	--------------	------------

Daisy Chain Starter Cord

1	78"	LS1FSC ✕ 10/26	\$ 92
6	78"	LS6FSC ✕ 10/26	\$552

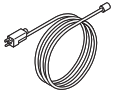

Tip: Use with Standard shelf light with daisy chain cord only.



For Canadian Pricing

Multiply U.S. Price by the Canadian price factor.

► See page 1 for details.

✕ 10/26 = Last order entry
October 18, 2026

Bottomline Shelf Light 10/26

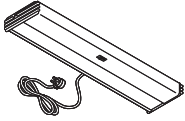

Tip: Daisy chaining shelf lights together extends power from one fixture to another within workstations to help keep receptacles clear for other uses.

▶ See page 110 for more information.













Tip: Daisy chaining is not allowed in Chicago. Local electrical codes vary, so you should consult a qualified electrical contractor or engineer for proper installation of all electrical equipment.

Tip: When ordering with standard power cord or Chicago cord, daisy chaining is not possible.

Tip: When ordering the Bottomline shelf lights with daisy chain starter cord you do NOT need to order a starter cord or jumper cord.

Standard Includes		Required to Specify
▶ Need help? Product details, page 108	<ul style="list-style-type: none"> Steel light housing: paint Mylar reflector Batwing lens Polycarbonate end caps: molded to match housing Cords: <ul style="list-style-type: none"> — Standard and Chicago (including circuit breaker), 9' cord with three-prong plug at 45° angle: black plastic only — Daisy chain, one 56" cord with modular connectors for daisy chaining: black plastic only Energy efficient electronic ballast Energy efficient 3500K T5 fluorescent light Universal spring brackets for recessed mount and screw-in for flush mount Tool free clips for New York application 	<ul style="list-style-type: none"> 1 Style number 2 Paint color number for housing and end caps: <ul style="list-style-type: none"> 0835 Black 7018 Pewter

Specification Information

Dimensions			Lamp	Style	U.S.
D	W	H	Wattage	Number	Price
With Standard Power Cord					
4½"	23¼"	1¼"	14 watts	L52FT 	\$405
4½"	35"	1¼"	21 watts	L53FT 	\$435
4½"	46¾"	1¼"	28 watts	L54FT 	\$468
With Chicago Cord Including Circuit Breaker					
4½"	23¼"	1¼"	14 watts	L52FTCHI 	\$475
4½"	35"	1¼"	21 watts	L53FTCHI 	\$517
4½"	46¾"	1¼"	28 watts	L54FTCHI 	\$552
With Daisy Chain Cord					
4½"	23¼"	1¼"	14 watts	L52FTY 	\$448
4½"	35"	1¼"	21 watts	L53FTY 	\$475
4½"	46¾"	1¼"	28 watts	L54FTY 	\$507
With Daisy Chain Starter Cord					
4½"	23¼"	1¼"	14 watts	L52FTS 	\$448
4½"	35"	1¼"	21 watts	L53FTS 	\$475
4½"	46¾"	1¼"	28 watts	L54FTS 	\$507

Specification Guidelines

Application	Requirement
2 lights	1 starter fixture and 1 daisy chain fixture
3 lights	1 starter fixture and 2 daisy chain fixtures
4 lights	1 starter fixture and 3 daisy chain fixtures
5 lights	1 starter fixture and 4 daisy chain fixtures
6 lights	1 starter fixture and 5 daisy chain fixtures

Note: Daisy chaining minimum of two fixtures; maximum of six fixtures.

 = Last order entry
October 18, 2026

For Canadian Pricing
Multiply U.S. Price by the Canadian price factor.
▶ See page 1 for details.

Vertical wire manager

conceals cords and cables that are routed vertically outside of the panels.

► Specifying, page 116

Cover conceals cords or cables.

Hooks fit into vertical channel at edge of panel.



Actual Dimensions

Depth	1" (25 mm)
Width	1 ⁵ / ₈ " (41 mm)
Height	48" (1219 mm)

Product Details

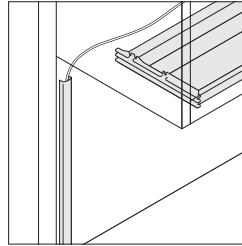

Wire manager is available for use between the bottom of a shelf or overhead storage bin and a worksurface. Wire manager can be cut in the field to suit specific application.

Wire manager can also be used below the worksurface.

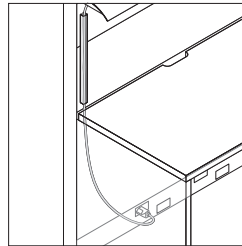

Power cords and cables can be routed from the wire manager and the 1/2" gap along the back edge of the worksurface.

Connections

Snaps into the slotted channel of the junction.

Surface Materials

Cover

- 6000 Black
- 6009 Arctic White
- 6249 Platinum Solid
- 6652 Platinum
- 6654 Sand
- 6697 Fog

Vertical Wire Manager



Tip: Wire manager can be cut in the field to the specific length needed.

Standard Includes	Required to Specify
-------------------	---------------------

- | | |
|------------------------------------------------------------------------------------------|------------------------------------------------------------------------------------|
| <ul style="list-style-type: none"> ▶ Need help? Product details, page 115 | <ul style="list-style-type: none"> • Vertical wire manager: plastic |
|------------------------------------------------------------------------------------------|------------------------------------------------------------------------------------|

- | |
|-----------------------------------------------------------------------------------------------------------------------------------------------------------------------------------------------------------------------------------------------------------------------------------------------------------------|
| <ul style="list-style-type: none"> 1 Style number 2 Plastic color number: <ul style="list-style-type: none"> 6000 Black 6009 Arctic White 6249 Platinum Solid 6652 Titanium 6654 Sand 6697 Fog |
|-----------------------------------------------------------------------------------------------------------------------------------------------------------------------------------------------------------------------------------------------------------------------------------------------------------------|

Specification Information		
Height	Style Number	U.S. Price

48"	TS7PVWM	\$50
-----	----------------	------





For Canadian Pricing

Multiply U.S. Price by the Canadian price factor.

▶ See page 1 for details.

Computer Support Tools

	
Statement of Line	118
	
Basics of Ergonomics Computer Support Tools	121
Basics of Monitor Arm Positioning	122
Keyboard Supports Basics	123
How to Specify a Keyboard Assembly	124
Mechanism and Tracks and Keyboard Platforms	
Understanding	126
Specifying	128
Technology Worktools	
Understanding	130
Specifying	132
Flat Panel Monitor Arms and Supports	135
CF Monitor Arm Collection	
Understanding	136
Specifying	152

Statement of Line

Mechanisms



5" Lift and Lock Mechanism

Understanding

▶ Page 126

Specifying

▶ Page 128



Understanding

▶ Page 126

Specifying

▶ Page 128

Tracks

11"L 17"L 20"L 23"L



Keyboard Platforms



Jules Keyboard Platforms

Understanding

▶ Page 127

Specifying

▶ Page 129

Technology Worktools and Cable Management

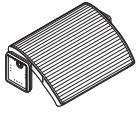

Adjustable Foot Rest

Understanding
 ▶ Page 130
 Specifying
 ▶ Page 132



CPU Cradle for Mini Processors

Understanding
 ▶ Page 130
 Specifying
 ▶ Page 132

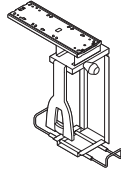

Vertical Locking CPU Cradle

Understanding
 ▶ Page 131
 Specifying
 ▶ Page 133

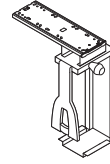

Vertical Non-Locking CPU Cradle

Understanding
 ▶ Page 131
 Specifying
 ▶ Page 133



Vertical Processor Fixed Sling

Understanding
 ▶ Page 131
 Specifying
 ▶ Page 134



CF Technology Cradle

Understanding
 ▶ Page 131
 Specifying
 ▶ Page 134

CF Flat Panel Monitor Arms and Supports

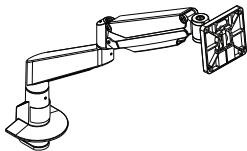

CF Intro Single Monitor Arm

Understanding
 ▶ Page 139
 Specifying
 ▶ Page 152

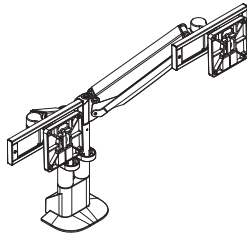

CF Intro Monitor Arm

Understanding
 ▶ Page 139
 Specifying
 ▶ Page 152

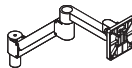

CF Plus

Understanding
 ▶ Page 140
 Specifying
 ▶ Page 153

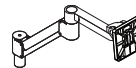

CF Plus HD Monitor Arm

Understanding
 ▶ Page 140
 Specifying
 ▶ Page 154

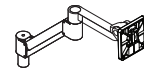

CF Max Monitor Arm

Understanding
 ▶ Page 140
 Specifying
 ▶ Page 158

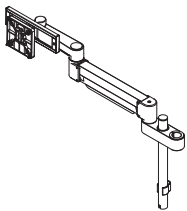

CF Plus Conversion Kit

Understanding
 ▶ Page 140
 Specifying
 ▶ Page 155

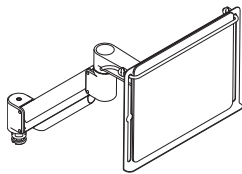

CF Laptop Conversion Kit

Understanding
 ▶ Page 145
 Specifying
 ▶ Page 156

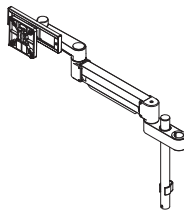

CF Plus HD Conversion Kit

Understanding
 ▶ Page 140
 Specifying
 ▶ Page 156

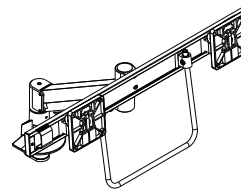

CF Standard Dual Bar Assembly

Understanding
 ▶ Page 145
 Specifying
 ▶ Page 157

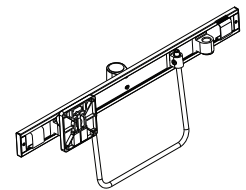

CF Standard Dual Bar Conversion Kit

Understanding
 ▶ Page 145
 Specifying
 ▶ Page 157

CF Flat Panel Monitor Arms and Supports, continued

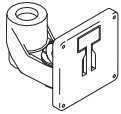

CF Tilt Head and Single Connector
Understanding
▶ Page 136
Specifying
▶ Page 158



CF Arm Bracket Connector
Understanding
▶ Page 136
Specifying
▶ Page 159



CF Dual Hub
Understanding
▶ Page 136
Specifying
▶ Page 159



CF Technology Cradle
Understanding
▶ Page 131
Specifying
▶ Page 160

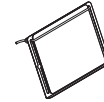

CF Laptop Holder Platform
Understanding
▶ Page 136
Specifying
▶ Page 160



CF C-Clamp
Understanding
▶ Page 136
Specifying
▶ Page 161



CF Through Mount Bracket
Understanding
▶ Page 136
Specifying
▶ Page 161



CF Modular Pole Mount C-Clamp Bracket
Understanding
▶ Page 136
Specifying
▶ Page 162



FrameOne Bracket
Understanding
▶ Page 136
Specifying
▶ Page 162



CF Maximum-Duty Arm Bracket
Understanding
▶ Page 136
Specifying
▶ Page 162



CF Wall/Reverse Wall-Mount Bracket
Understanding
▶ Page 136
Specifying
▶ Page 163



CF Slatwall Bracket
Understanding
▶ Page 136
Specifying
▶ Page 163



CF Heavy-Duty Tilt Head
Understanding
▶ Page 136
Specifying
▶ Page 164

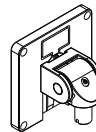

CF Standard Tilt Head with Quick Release
Understanding
▶ Page 136
Specifying
▶ Page 164

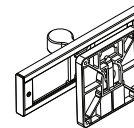

CF Slider Bar Tilt Head
Understanding
▶ Page 136
Specifying
▶ Page 165

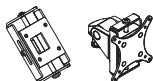

CF Monitor Arm Adapters and Tilt Heads
Understanding
▶ Page 136
Specifying
▶ Page 166



CF Flat Panel Pole Mount without Arm
Understanding
▶ Page 136
Specifying
▶ Page 167



CF Articulating Arm Extensions for Pole Mount Assemblies
Understanding
▶ Page 136
Specifying
▶ Page 167



200x200 VESA Plate
Understanding
▶ Page 136
Specifying
▶ Page 168

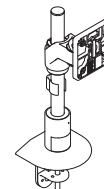

CF Static
Understanding
▶ Page 136
Specifying
▶ Page 169

Basics of Ergonomic Computer Support Tools

Proper ergonomic worktools and seating can help workers perform more efficiently and avoid muscle and eye strain.

Neck is straight or slightly forward.

Shoulders are relaxed so arms hang naturally.

Back has full contact with the backrest (sit all the way back in your chair).

Lower back fits into curved lumbar support.

Tension is adjusted so backrest tilts easily, yet provides smooth, even support.

Elbows and forearms can rest comfortably on the arms of your chair, or on worksurfaces that are used for writing, paperwork, and other tasks.

Screen is 20" to 30" from the eyes.

Top of monitor should be at eye level.

Screen is at eye level slightly lower and directly in front of worker so head is not turned.

Wrists should be straight when keying or mousing, not bent up or down.

When keying or mousing, forearms are parallel to the floor.

Keyboard is at elbow height.

Thighs are parallel to the floor.

Feet are flat on the floor or on a foot rest.

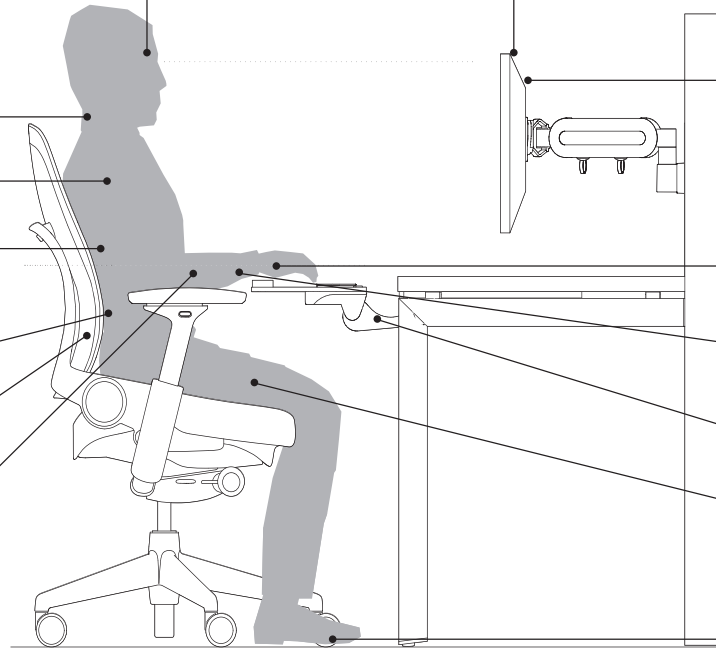

Laptop Support

Frequent or extended use in cramped posture positions increase risk of damage to the spine, neck, shoulders, and legs.

To reduce eyestrain and unhealthy postures when using laptops, an external full-size monitor with external keyboard and mouse is recommended.

Keep frequently viewed objects, such as source documents, at or below the horizontal line of sight. Arrange display screen and documents to be equidistant from your eyes. See Freestanding In-Line Document Support, page 131.

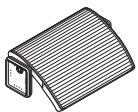

If worksurfaces and keyboard support are not height-adjustable, raise your chair's seat height to achieve the appropriate relationship to your tasks. If this leaves your feet dangling above the floor, use a foot rest.

▶ See page 132

Basics of Monitor Arm Positioning

Monitor arms offer varying levels of adjustability to meet the needs of many types of users. Adjustable arms should be adjusted for best positioning as such.

Top of monitor should be 0° to 20° below horizontal line of sight.

Keying height should have minimal bend at the wrist.

Avoid locking knees to help maintain good posture.

Feet should be flat on the floor or use foot rest or foot pad.

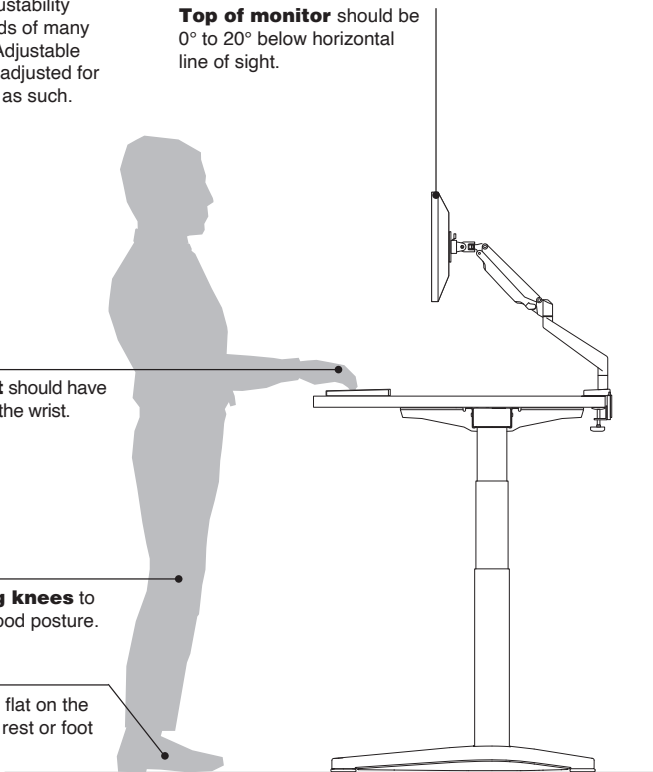

Height

Top of monitor.

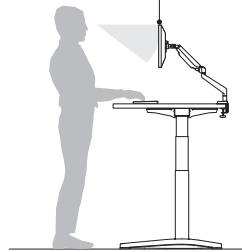

Top of the monitor should be positioned at or slightly below eye level.

Distance

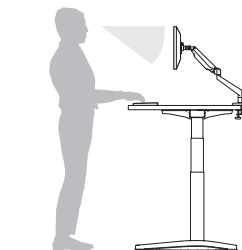

Monitor should be 20" to 30" from the eyes or approximately an arm's length away.

Alignment

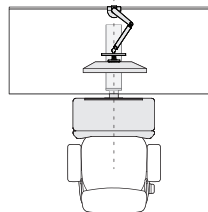

Proper alignment is the key to preventing strain. Computer monitor, keyboard, and mouse should be centered to allow user to see the display without looking downward or to either side. Mouse should be accessible without twisting or reaching. Reference documents should never be flat on desk and should be at the same height as or aligned with the monitor or above keyboard and below the monitor.

Dual Monitor Alignment

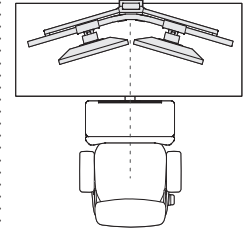

If using two monitors, position the monitor used more often closer. If equally used, center monitors directly in front and angle them in a slight inward "V" shape.

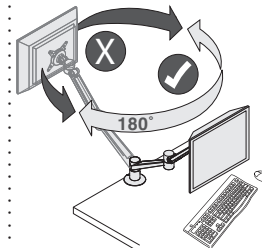

Monitor arms are not intended for use in applications where the monitor extends beyond the perimeter of the worksurface.

Keyboard supports are comprised of a mechanism and track, a keyboard platform that includes a variety of mouse surfaces and palm rests options. The components can be ordered individually. Below are illustrations to guide you in your selection.

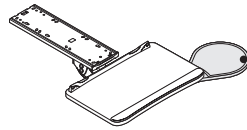

Mouse surfaces are options for all platforms.

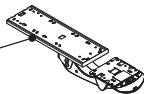

Mechanisms are orderable individually.
▶ See *Mechanisms and Tracks*, page 128.

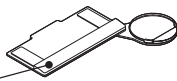

Palm rests can be ordered separately.
▶ See *Keyboard Platforms and Palm Rests*, page 129.

Product Details

Mechanism Key Feature Graphics

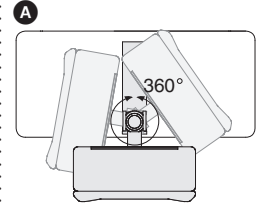

Swivel side to side

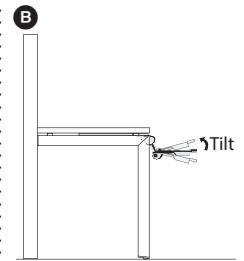

Positive to negative tilt

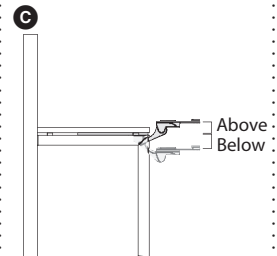

Above track to below

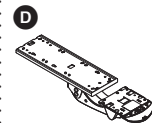

Track length

Standard track lengths are 11", 17", 20", and 23". Shorter tracks may effect ability to stow platform under worksurface.

Features			
Mechanisms	Rear Swivel	Tilt	Minimum Worksurface Depth
5" Lift and Lock	360°	+/-15°	23"

Tip: All mechanisms ship with positive tilt locked out.

How to Specify a Keyboard Assembly

1. Determine workstation configuration—straight, 90°, radius, or diagonal.
2. Measure the depth of clearance on the underside of worksurface or see track specifying guide below.
3. Select platform depending on needs of the keyboard size and mouse location preference.

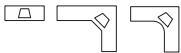
Platforms											
Features	Applications	Required Knee Space Clearance	Palm Rest	Platform			Separate Mouse Surface		Microsoft Natural	Cord Management	Document Slot (20 Sheets)
				D	W	H	D	W			
Jules	Straight, 17" Diagonal, and 12" Radius 	20"W	Without or with standard foam	12"	18 ³ / ₄ "	2 ¹ / ₂ "	8 ¹ / ₂ "	8 ¹ / ₂ "	Order without palm rest	●	N.A.

Tip: For 12" radius corner applications, specify Jules, FrameOne, or 19" platform with 7" Lift and Lock mechanism.

Tip: Minimum worksurface size for keyboard platforms on straight height-adjustable desks is 29"D x 46"W.

Tip: Keyboard platforms are not permitted on two-leg height-adjustable desks with casters or height saver feet.

How to Specify a Keyboard Track on Height-Adjustable Desks

How to Specify a Keyboard Track on Height-Adjustable Desks

Migration SE

Straight

23"D or 24"D—Not available through standard options

28"D—Not available through standard options

29"D, 30"D, 35"D, or 36"D—Specify 11" keyboard track

90°/120° (Mounted on Sides)

23"D or 24"D—Not available through standard options

29"D or 30"D—Specify 11" keyboard track

90°/120° (Mounted on Corner)

23"D or 24"D—Specify 11" keyboard track

29"D or 30"D—Specify 17" keyboard track

Ology

Rectangular or Tapered

23"D or 24"D—Keyboard not allowed

29"D or 30"D and 46"W or wider—Specify 11" keyboard track

35"D or 36"D—Specify up to 17" keyboard track

90°/120° (Mounted on Sides)

23"D—Not allowed

29"D—Specify 11" keyboard track

90° (Mounted on Corner)

23"D to 30"D—Specify up to 20" keyboard track

120° (Mounted on Corner)

23"D to 30"D—Specify up to 17" keyboard track

Mechanism and Tracks and Keyboard Platforms

Keyboard supports

are comprised of a mechanism and track, a keyboard platform that includes a variety of mouse surface and palm rest options. The components can be ordered individually. Below are illustrations to guide you in your selection.

Mechanisms and tracks are orderable individually.

Keyboard platforms are available in a variety of options.

▶ Pages 129

Palm rest are options on all platforms or can be ordered separately.

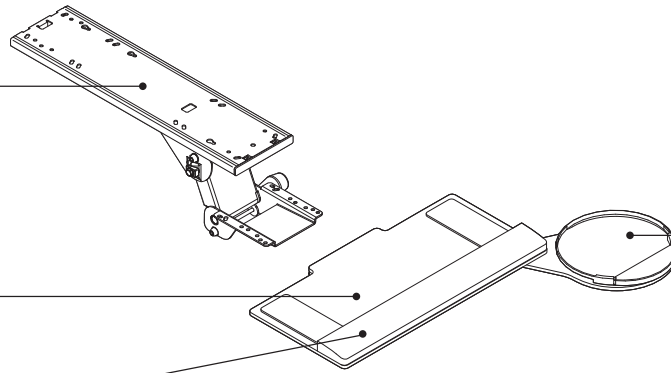

Mouse surfaces are options for all platforms.

Jules Keyboard Platform



▶ See Specifying, page 129.

Product Details

Jules keyboard platforms are available with standard foam palm rest. Palm rest fixed and is 2"D.
Tip: When using MS Natural Keyboard, specify platform without palm rest.

Jules keyboard platforms are standard with mouse surface for either left- or right-hand use and is ideal for multi-user workstation. Jules mousing surface stores beneath platform when not in use.

Jules platforms include integrated cable routing clips for cord management.

Application Topics

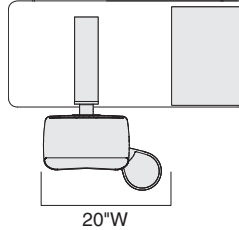

Jules platforms require 20"W of kneespace clearance below worksurface for storage.

12" radius corner applications require an extended mechanism when specifying Jules platform.

Surface Materials

Jules keyboard platforms

- 6288 Charcoal

Actual Dimensions

Depth	12"
Width	19"
Height	2½"

Tip: Jules keyboard platform is 19" wide without the ambidextrous, sliding mouse surface.

Mechanisms and Tracks

5" Lift and Lock Mechanism Only



Tip: Mechanism requires a 23"L track to completely store platform under the worksurface.

Standard Includes	Required to Specify
<ul style="list-style-type: none"> • 5" Lift and Lock mechanism: 0835 Black • Attachment hardware 	Style number

Specification Information		
Weight	Style Number	U.S. Price
8 lb	L5	\$241

Tracks



Tip: Attachment hardware and end cap not included. Order service part 18711701SR, if required.

Tip: 11"L and 17"L tracks are recommended for use with FrameOne 24"D and 30"D worksurfaces.

Standard Includes	Required to Specify
<ul style="list-style-type: none"> • Track: 0835 Black 	Style number

Specification Information			
Dimensions Length	Weight	Style Number	U.S. Price
11"	3.5 lb	Q11T	\$28
17"	3.5 lb	Q17T	\$28
20"	3.5 lb	Q20T	\$28
23"	3.5 lb	Q23T	\$28



For Canadian Pricing
 Multiply U.S. Price by the Canadian price factor.
 ▶ See page 1 for details.

Jules Keyboard Platform



Tip: Jules keyboard platforms are for use in straight, 17" diagonal, and 18" radius applications.

▶ See page 124.

Tip: Extended mechanism required for 12" radius corner applications.

Tip: Jules keyboard platform requires 20"W of kneespace clearance below worksurface.

Tip: Jules keyboard platform is 19" wide without the ambidextrous, sliding mouse surface.

Standard Includes	Required to Specify
<ul style="list-style-type: none"> ▶ Need help? Product details, page 127 • Keyboard platform: 6288 Charcoal plastic • 8½"D x 8½"W ambidextrous, sliding mouse surface • Foam palm rest 	<ul style="list-style-type: none"> Style number

Specification Information					
• Dimensions			• Weight	• Style	• U.S.
D	W	H		Number	Price
12"	19"	2½"	3.08 lb	JP10SF	\$193

With Standard Foam Palm Rest

12"	19"	2½"	3.08 lb	JP10SF	\$193
-----	-----	-----	---------	---------------	-------



For Canadian Pricing

Multiply U.S. Price by the Canadian price factor.

▶ See page 1 for details.

Technology Worktools

Adjustable Foot Rest

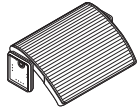

► Specifying, page 132

Product Details

Foot rest features a curved, non-skid surface to provide optimal seat posture and blood circulation.

Foot rest can be set in four height positions from 2" to 6" off floor.

Surface Materials

Foot rest
• 6000 Black

Actual Dimensions

Depth 12"

Width 18"

Height 2"–6"

Weight 8 lb

CPU Cradle for Mini Processors



► Specifying, page 132

Product Details

CPU cradle mounts vertically below worksurface and swivels 360°.

Protective pad is standard with CPU cradle.

CPU cradle supports a maximum weight of 15 lb.

CPU cradle must be mounted inboard of leg on standard Ology worksurfaces.

CPU cradles can be mounted inboard or outboard of leg with 9" overhang on 23"D, 29"D, and 35"D worksurfaces.

CPU cradle may be used with FrameOne applications.

CPU cradle slides on track to allow for access to cables.

Surface Materials

CPU cradle and track
• 0835 Black

Height-adjustable column
• Brushed Aluminum

Actual Dimensions

CPU cradle

Depth 7"

Width 12"

Height 4"

Weight 4 lb

Track

Depth 9⁷/₈"

Width 5³/₄"

Weight 1 lb

Application Topics

CPU cradle holds CPUs with the following dimension ranges:

Depth 17¹/₂"

Width 2¹/₈"–4³/₄"

Height 11"–14⁹/₁₀"

Weight 15 lb

Vertical CPU Cradles

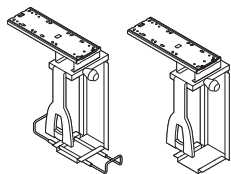

► Specifying, page 133

Product Details

Vertical CPU cradles are available locking or non-locking.

Vertical locking CPU cradle is standard with soft touch knob with key locking system. All locks are keyed alike.

Vertical CPU cradle mounts vertically below worksurface and swivels 360°.

Vertical CPU cradle requires 18"D clearance below worksurface.

Vertical CPU cradle can be fixed- or wall-mounted.

Vertical CPU cradle supports a maximum weight of 85 lb.

Vertical CPU cradle slides on track to allow for access to cables.

CPU cradles must mount outboard of leg with 9" overhang on 23"D and 29"D worksurfaces.

Surface Materials

Vertical CPU cradle
• 0835 Black

Actual Dimensions

Depth 15"–22"

Width 3¹/₂"–9"

Height 12¹/₂"–22¹/₂"

Track Depth with Endcap 17³/₁₀"

Weight

– Non-Locking 12.65 lb

– Locking 14 lb

Vertical Processor Fixed Sling For Use with Ology Desk and FrameOne

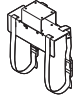

► Specifying, page 134

Product Details

Vertical processor sling stores CPUs vertically and is mounted in a fixed position below worksurface.

Adjustable straps support CPUs with perimeters up to 53".

Vertical processor sling requires 12"D clearance below worksurface.

Vertical processor sling supports a maximum weight of 50 lb.

CPU cradles must mount outboard of leg with 9" overhang on 23"D and 29"D worksurfaces.

Surface Materials

Vertical processor sling

- 0835 Black

Actual Dimensions

Depth	10¾"
Width	3¾"
Height	6"
Weight	5 lb

CF Technology Cradle



► Specifying, page 134

Product Details

Technology cradle stores CPU thin clients and docking stations and is mounted in a fixed position to the back of a monitor, on a CF modular pole, underneath a worksurface, or on a wall.

Technology cradle comes standard with an adjustable strap to securely hold the desired device in place.

Technology cradle maximum load capacity

is 6 lb when mounted to a VESA plate and 11 lb when attached to a CF modular pole, mounted underneath a worksurface, or wall.

Technology cradle is compatible with all 75 mm/100 mm VESA plates.

Surface Materials

Technology cradle

- 0835 Black

Actual Dimensions

Depth	7/8"-2¼"
Width	4"-9"
Height	6¾"
Weight	1 lb

Technology Worktools

Adjustable Foot Rest

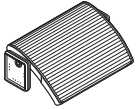

Standard Includes		Required to Specify
<ul style="list-style-type: none"> ▶ Need help? Product details, page 130 	<ul style="list-style-type: none"> • Adjustable foot rest: 6000 Black plastic 	<ul style="list-style-type: none"> Style number

Specification Information				
• Dimensions			• Style	• U.S.
D	W	H	Number	Price
12"	18"	2"-6"	CFTR	\$212

CPU Cradle For Mini Processors



Tip: CPU cradle holds CPUs 2¹/₈"W to 4³/₄"W and 11"H to 14⁹/₁₀"H. Track is 9⁷/₈"D and 5³/₄"W.

Tip: CPU cradle requires 10" clearance under the worksurface.

Standard Includes		Required to Specify
<ul style="list-style-type: none"> ▶ Need help? Product details, page 131 	<ul style="list-style-type: none"> • CPU holder and track: 0835 Black • Height-adjustable column: brushed aluminum 	<ul style="list-style-type: none"> Style number

Specification Information				
• Dimensions			• Style	• U.S.
D	W	H	Number	Price
7"	4"	12"	CPUMINI	\$276



For Canadian Pricing
 Multiply U.S. Price by the Canadian price factor.
 ▶ See page 1 for details.

Vertical Locking CPU Cradle

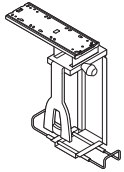

Tip: Vertical CPU cradle supports CPUs 3½"W to 9"W, 15"D to 22"D, 12½"H to 22½"H and up to 85 lb.

Tip: CPU cradle requires 18" clearance under the worksurface.

Standard Includes		Required to Specify
▶ Need help? Product details, page 131	<ul style="list-style-type: none"> • CPU cradle: 0835 Black • Soft touch knob with locking system for side clamp adjustment • 17" track • Lock mechanism 	Style number

Specification Information

Dimensions			Style Number	U.S. Price
D	W	H		
15"	4"	18¼"	CPRCCL	\$338

Vertical Non-Locking CPU Cradle

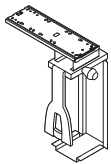

Tip: Vertical CPU cradle supports CPUs 3½"W to 9"W, 15"D to 22"D, 12½"H to 22½"H and up to 85 lb.

Tip: CPU cradle requires 18" clearance under the worksurface.

Standard Includes		Required to Specify
▶ Need help? Product details, page 131	<ul style="list-style-type: none"> • CPU cradle: 0835 Black • Soft touch knob for side clamp adjustment • 17"L track 	Style number

Specification Information

Dimensions			Style Number	U.S. Price
D	W	H		
17"	3½"	18¼"	CPRCCN	\$290



For Canadian Pricing

Multiply U.S. Price by the Canadian price factor.

▶ See page 1 for details.

Vertical Processor Slings

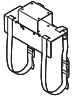

Tip: CPU must be at least 10"D and 3½"W for fixed vertical processor sling.

Tip: Fixed vertical processor sling supports CPUs with perimeters of 53" and 50 lb.

Tip: Fixed vertical processor sling requires 12" clearance under the worksurface.

Tip: Fixed vertical processor sling is mounted in a fixed position.

Standard Includes		Required to Specify
▶ Need help? Product details, page 131	<ul style="list-style-type: none"> Vertical processor sling: 7207 Textured Black 17"L track for standard vertical processor sling, if selected 	Style number

Specification Information				
Dimensions			Style Number	U.S. Price
D	W	H		

Fixed (For Use with FrameOne and Ology Desk)

10¾"	3¾"	6"	CPRSLFO	\$198
------	-----	----	----------------	-------

CF Technology Cradle



Tip: Technology cradle will work with 75 mm/ 100 mm VESA plate of other monitor arms.

Tip: Technology cradle can be mounted to a monitor arm, pole, wall mount, or under the worksurface.

Tip: When mounted between a monitor and tilt head, maximum monitor weight is 15 lb or the rated load of the monitor arm, whichever is lower.

Tip: Technology cradle maximum load capacity is 6 lb when mounted to a VESA plate and 11 lb when attached to a CF modular pole, mounted underneath a worksurface or to a wall.

Standard Includes		Required to Specify
▶ Need help? Product details, page 131	<ul style="list-style-type: none"> Cradle: 0835 Black Technology support strap 	Style number

Specification Information				
Dimensions			Style Number	U.S. Price
D	W	H		

7/8"-2¼"	7"-9"	9¾"	CFTECHCRD	\$76
----------	-------	-----	------------------	------



For Canadian Pricing

Multiply U.S. Price by the Canadian price factor.

▶ See page 1 for details.

Flat panel monitor arms are for use in C-clamp, through-mount, and FrameOne. CF flat panel monitor arms are also for use with Slatwall and SlatRail applications. ▶ See *individual series for application limitations*.

To select appropriate flat panel monitor arm, determine mounting application, number of monitors to be supported, weight of monitors to be supported, and whether a dynamic or static arm movement is preferred.

Tip: All Steelcase monitor arms utilize the VESA hole pattern to connect monitor to arm. Apple monitors do not connect without optional adapter plate. Plate must be acquired through Apple.

Tip: Attaching monitor arms to freestanding tables with casters or glides is not recommended due to tipping hazards.

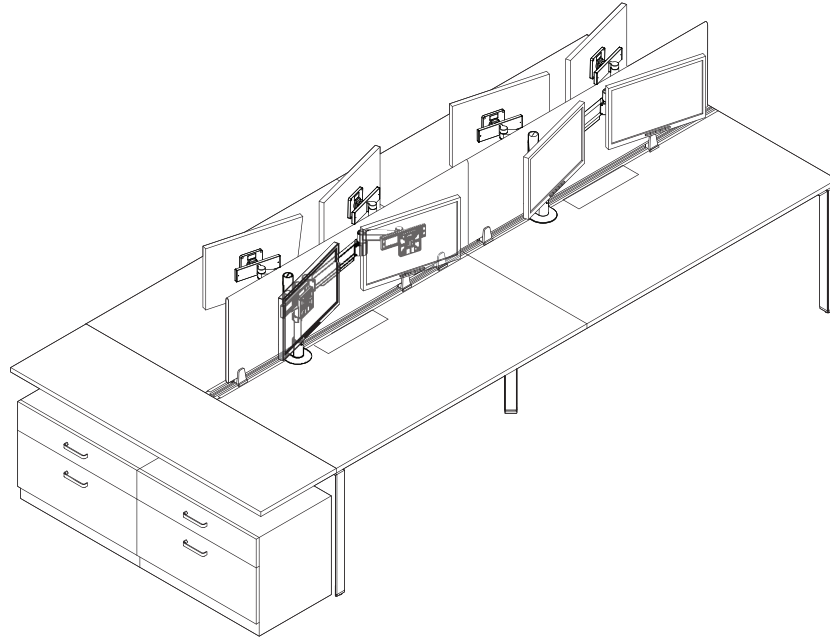

CF Monitor Arm Collection

CFINTRO/CFINTRODSLIDE

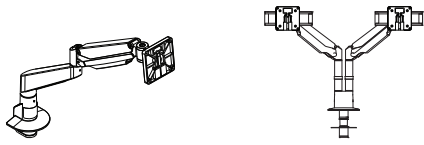

CFPLUS/CFPLUSHD

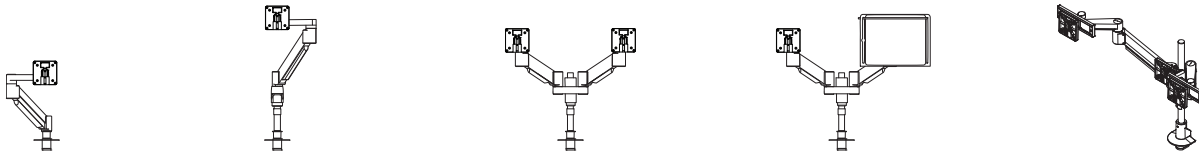

Single arm

Single arm on pole

Dual arm on pole

Dual arm on pole with laptop holder

Triple arm on pole
*Note: Only triple dynamic available on **CFPLUS**.*

CFSTDDUALBAR

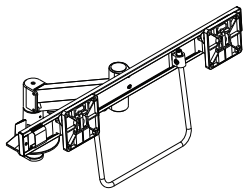

CFMAX

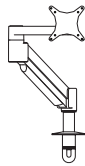

CF Static Products

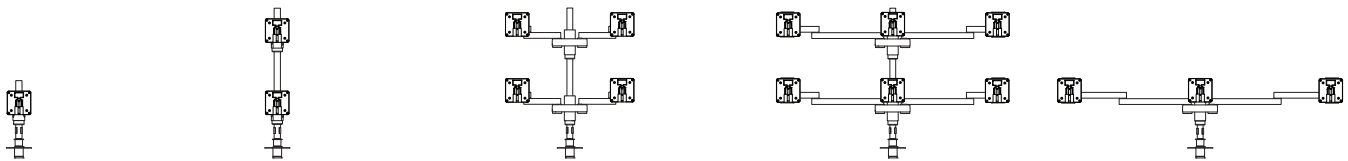

Single static

One over one static

Two over two static

Three over three static

Triple static

Supporting Single, Dual, and Triple Monitor Arm Applications on 2 Leg Height-Adjustable Desks

Supporting Single, Dual, and Triple Monitor Arm Applications on 2 Leg Height-Adjustable Desks

Rules:

- Single monitor arm/monitor requires a minimum worksurface size of 23/24"D x 46"W
- Dual and triple monitor arms/monitors require a minimum worksurface size of 29/30"D x 58"W
- Monitor arms are not permitted on 2 leg desks with casters

Monitor Arm Assemblies	Migration SE T-Leg Only	Migration SE C-Leg Only	Ology	Flex
Single Dynamic/Single Static Monitor Arm	Approved	Approved	Approved	Approved
Dual Dynamic/Dual Static Monitor Arm	Approved	Approved	Approved	Approved
Triple Dynamic/Triple Static Monitor Arm	Approved	Static only	Approved	Static only

Tip: Attached monitor arms on freestanding tables must not extend beyond the perimeter of the desk (this includes the front, sides, and back edge of the worksurface).

Tip: Ology desk or bench with integrated rail, specify CF monitor arm with C-clamp mount. Monitor arm does not mount to integrated rail.

Supporting Tiered Monitor Arm Applications on 2 Leg Height-Adjustable Desks

Rules:

- Minimum worksurface size of 29/30"D x 58"W required for multiple monitors
- Six monitors maximum permitted on 2 leg desk
- 60 lbs total maximum monitor weight per 2 leg desk
- Monitor arm applications are not permitted on 2 legs desks with casters
- When calculating height-adjustable desk lifting capacity, subtract the weight of the worksurface, understructure, options, and add-on products (e.g. flat panel monitor arm, monitors, and CPUs)

Monitor Arm Assemblies	Migration SE C-Leg Only	Migration SE T-Leg Only	Ology	Flex
One over One Static Monitor Arm	Not Approved	Approved	Approved	Not Approved
Two over Two Static/Wide Static Monitor Arm	Not Approved	Approved	Approved	Not Approved
Three over Three Static/Wide Static Monitor Arm	Not Approved	Approved	Approved	Not Approved

Tip: Ology desk or bench with integrated rail, specify CF monitor arm with C-clamp mount. Monitor arm does not mount to integrated rail.

CF Intro Single and Dual

- CF intro single and dual arm brackets available in C-clamp and through-mount bracket options.
- CF intro single and dual arms can support 2.2–20 lbs per arm.

CF Intro Single (CFINTRO)

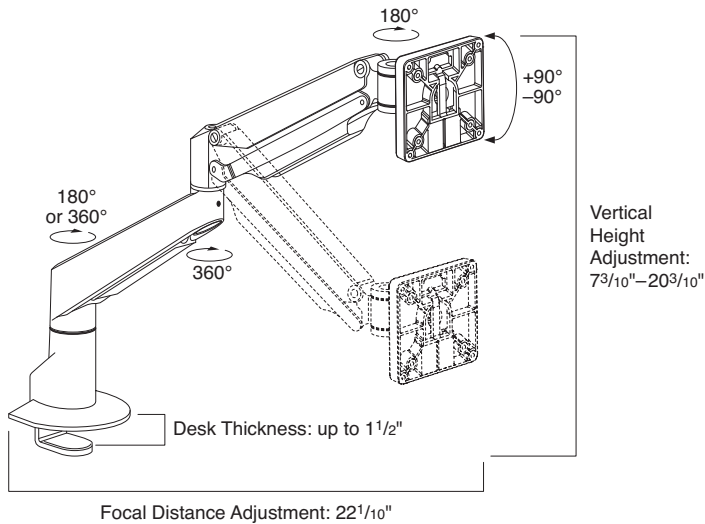

CF Intro Dual (CFINTROSLIDE)

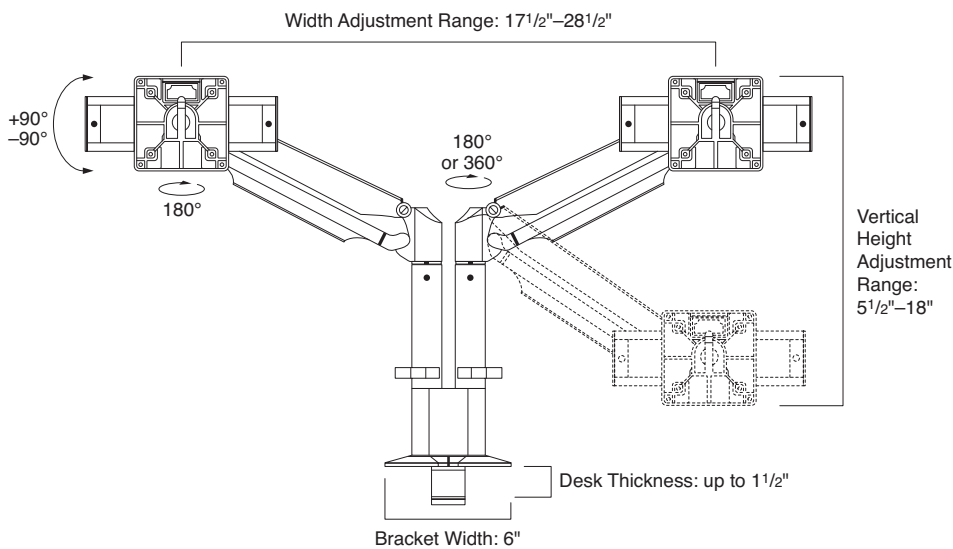

CF Monitor Arm Collection

VESA plates are standard with 100x100 VESA plate hole pattern.

All tilt heads are standard with quick release.

Cable management is included with all CF monitor arm supports.

Tip: All Steelcase monitor arms utilize the VESA hole pattern to connect monitors to arm. Apple monitors do not connect without optional adapter plate. Plate must be acquired through Apple.

All CF monitor arms allow for monitors to rotate portrait to landscape orientation.

Mounting brackets and tilt heads can be optioned in assembly or ordered separately.

When using curved screens greater than 32" use HD tilt head. Heavy-duty tilt heads can be optioned in on CF plus, CF Plus heavy-duty, and CF max. They can also be ordered separately using **CFHDQRTH2**. Heavy-duty tilt heads not compatible with CF Intro.

Monitor arm assemblies with more than two monitors are not allowed on non-tethered desks.

Surface Materials

CF monitor arms and components available in three finishes:

- 0835 Black
- 7018 Pewter
- ZW01 Pearl Snow

CF Plus and CF Plus Heavy Duty

- Dimensions for **CFPLUS** and **CFPLUSHD** are the same. Please refer to weight ranges to determine which arm is the correct fit.
- **CFPLUS** supports monitors ranging from 7–17 lbs.
- **CFPLUSHD** supports monitors ranging from 13–28 lbs.

CF Plus and CF Plus HD Single Arm

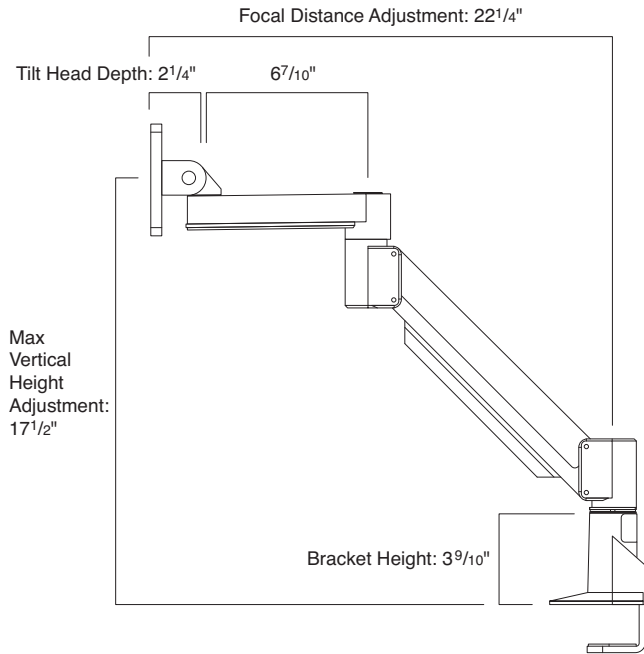

CF Plus and CF Plus HD Dual Arm on Pole

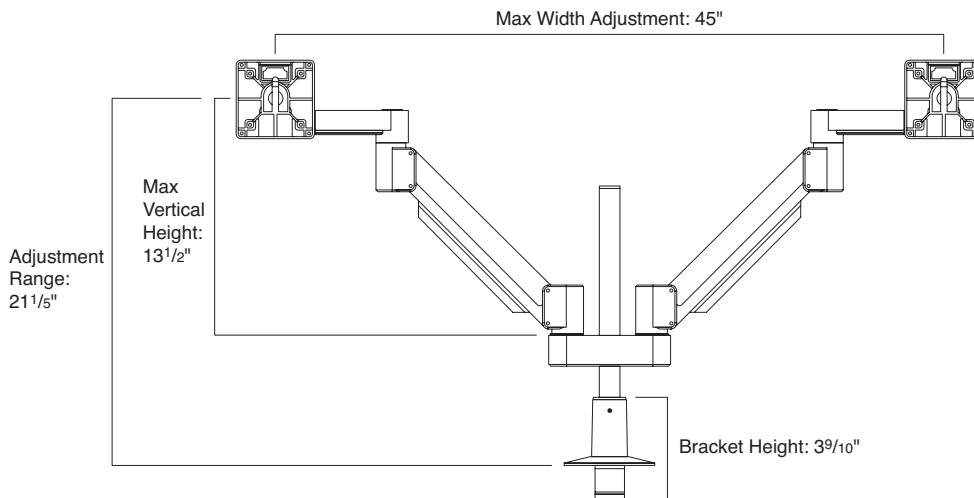

- CF Plus and CF Plus HD have heavy-duty quick release tilt head and slider bar quick release tilt head options available.
- CF Plus and CF Plus HD arms and components are available to allow various configurations to meet user needs.
- Measurements for CF Plus and CF Plus HD are identical, please reference weight range information to identify which monitor arm to use.

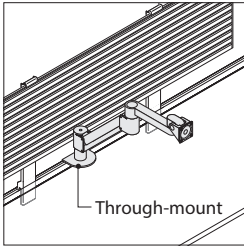

- CF Plus cannot be mounted in front of stanchion mounted Slatwall when using C-clamp bracket. For this application, a through-mount bracket is recommended.
Tip: Double-arm pole is not recommended for use with Slatwall mounting bracket.
- When planning with stand-alone, single-sided FrameOne base units, the worksurface must be 66"W or greater and utilize no more than one single CF monitor arm.
- **CFP28** is not recommended for use with single-sided FrameOne or any freestanding applications.

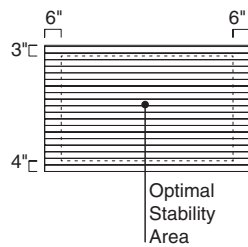
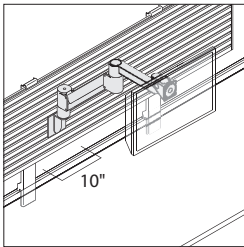

- When mounting CF Plus arms to Slatwall, bracket must be mounted no further than 10" away from Slatwall mounting bracket. If application does not allow bracket to be installed within the 10" range, an additional bracket or brackets should be installed within 10" of desired arm location.
Tip: Slatwall skin brace package is required when mounting a flat panel monitor arm on an Answer slatwall skin.
- Single monitor arm can be mounted on 12"H slatwall skin that has an installed brace package.
- Two single or one dual monitor arm can be mounted on 18"H or 24"H Answer slatwall skin that has an installed brace package. For optimal stability, the monitor arm should be mounted as shown above.

CF Monitor Arm Collection

VESA plates are standard with 100x100 VESA plate hole pattern.

All tilt heads are standard with quick release.

Cable management is included with all CF monitor arm supports.
Tip: All Steelcase monitor arms utilize the VESA hole pattern to connect monitors to arm. Apple monitors do not connect without optional adapter plate. Plate must be acquired through Apple.

All CF monitor arms allow for monitors to rotate portrait to landscape orientation.

Mounting brackets and tilt heads can be optioned in assembly or ordered separately.

When using curved screens greater than 32" use HD tilt head. Heavy-duty tilt heads can be optioned in on CF plus, CF Plus heavy-duty, and CF max. They can also be ordered separately using **CFHDQRTH2**. Heavy-duty tilt heads not compatible with CF Intro.

Monitor arm assemblies with more than two monitors are not allowed on non-tethered desks.

Surface Materials

CF monitor arms and components available in three finishes:

- 0835 Black
- 7018 Pewter
- ZW01 Pearl Snow

CFINTRO and CFINTRODSLIDE Specifications

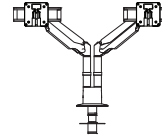
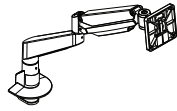

CFINTRO Products (2.2–20 pounds)

	CFINTRO	CFINTRODSLIDE
Max Height	18"	18"
Max Width (Measured Left to Right)	32"	27"
Max Width (Curved)	32"	27"

Tip: When using curved screens greater than 32", specify CF heavy-duty tilt head.

Tip: All measurements are provided under the assumption that the arms are in their lowest position.

Tip: All width measurements are provided in the left to right (edge to edge) measurement, NOT diagonal.

Tip: Maximum monitor size may be impacted by thickness of monitor and location of VESA bracket mount. Dimensions are estimates.

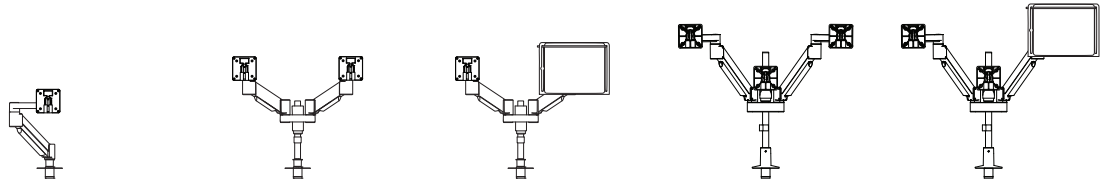

CFPLUS Products (7-17 pounds)					
Arm Configuration	Single (No Pole)	Dual (14" Pole)	Dual (With Laptop Support)	Triple (14" Pole)	Triple (With Laptop Support)
Max Height	18"	18"	18"	18"	18"
Max Width (With Standard Tilt Head/HD Tilt)	32"	44"	44"	21½"	21½"
Max Width (With Universal Slide)	32"	49"	49"	24"	24"
Max Width (With HD Slider)	32"	53½"	53½"	26"	26"

Tip: When using curved screens greater than 32", specify CF heavy-duty tilt head.

Tip: All measurements are provided under the assumption that the arms are in their lowest position.

Tip: All width measurements are provided in the left to right (edge to edge) measurement, NOT diagonal.

Tip: Maximum monitor size may be impacted by thickness of monitor and location of VESA bracket mount. Dimensions are estimates.

Tip: When heavy duty slider bar or universal slider bar are selected, please reduce the monitor arms weight range by 2 pounds.

CFPLUSHD Specifications

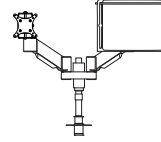
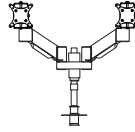
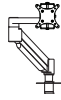

CFPLUSHD Product (13–28 pounds)

Arm Configuration	Single (No Pole)	Dual (14" Pole)	Dual (With Laptop Support)
Max Height	18"	18"	18"
Max Width (With Standard Tilt Head/HD Tilt)	32"	44"	44"
Max Width (With Universal Slide)	32"	49"	49"
Max Width (With HD Slider)	32"	53½"	53½"

Tip: When using curved screens greater than 32", specify CF heavy-duty tilt head.

Tip: All measurements are provided under the assumption that the arms are in their lowest position.

Tip: All width measurements are provided in the left to right (edge to edge) measurement, NOT diagonal.

Tip: Maximum monitor size may be impacted by thickness of monitor and location of VESA bracket mount. Dimensions are estimates.

Tip: When heavy duty slider bar or universal slider bar are selected, please reduce the monitor arms weight range by 2 pounds.

- **CFMAX** supports monitors ranging from 28–40 lbs.
- **CFMAX** can only be used with the maximum duty mounting bracket.

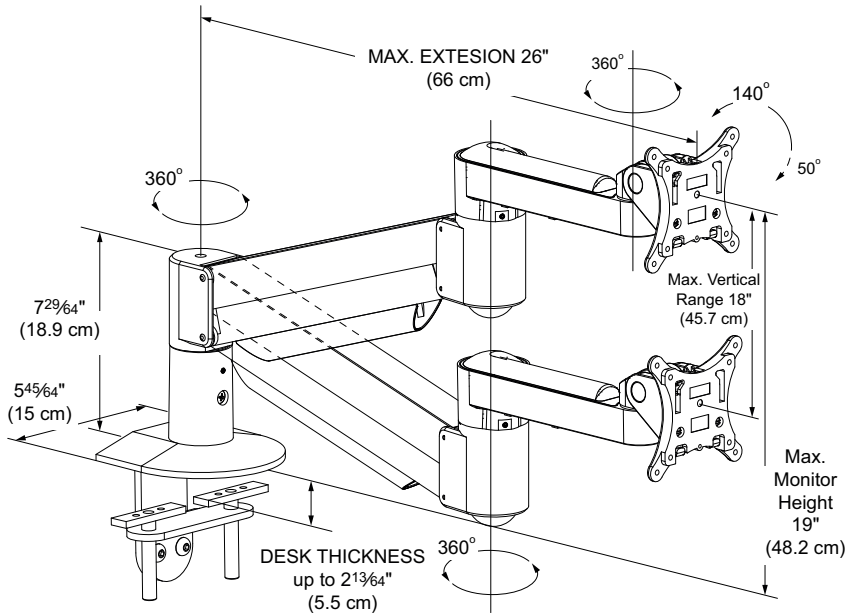

CF Standard Dual Bar

- **CFSTDDUALBAR** supports 11–28 lbs.
- **CFSTDDUALBAR** handle has 6" of vertical height adjustment.

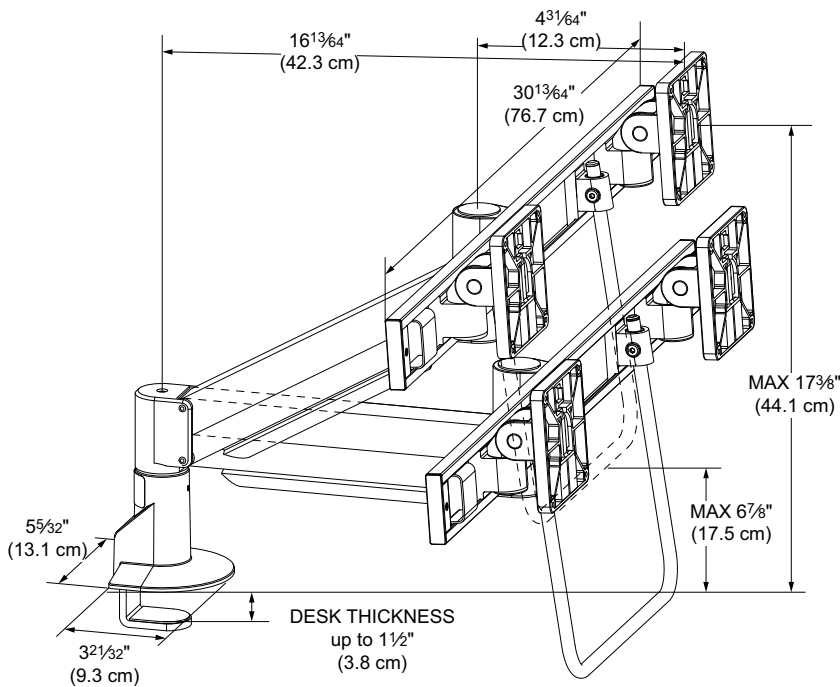

CF Monitor Arm Collection

VESA plates are standard with 100x100 VESA plate hole pattern.

All tilt heads are standard with quick release.

Cable management is included with all CF monitor arm supports.

Tip: All Steelcase monitor arms utilize the VESA hole pattern to connect monitors to arm. Apple monitors do not connect without optional adapter plate. Plate must be acquired through Apple.

All CF monitor arms allow for monitors to rotate portrait to landscape orientation.

Mounting brackets and tilt heads can be optioned in assembly or ordered separately.

When using curved screens greater than 32" use HD tilt head. Heavy-duty tilt heads can be optioned in on CF plus, CF Plus heavy-duty, and CF max. They can also be ordered separately using **CFHDQRTH2**. Heavy-duty tilt heads not compatible with CF Intro.

Monitor arm assemblies with more than two monitors are not allowed on non-tethered desks.

Surface Materials

CF monitor arms and components available in three finishes:

- 0835 Black
- 7018 Pewter
- ZW01 Pearl Snow

CFMAX and CFSTDDUALBAR Specifications

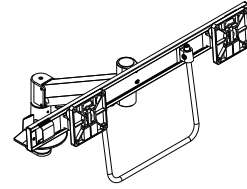
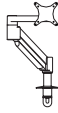

CFMAX Product (28–40 pounds) CFSTDDUALBAR Product (11–28 pounds)		
	CFMAX	CFSTDDUALBAR
Max Height	21"	18"
Max Width (With Standard Tilt Head/HD Tilt)	37"	27"
Max Width (With Universal Slide)	N.A.	N.A.
Max Width (With HD Slider)	32"	N.A.

Tip: When using curved screens greater than 32", specify CF heavy-duty tilt head.

Tip: All measurements are provided under the assumption that the arms are in their lowest position.

Tip: All width measurements are provided in the left to right (edge to edge) measurement, NOT diagonal.

Tip: Maximum monitor size may be impacted by thickness of monitor and location of VESA bracket mount. Dimensions are estimates.

Tip: When heavy duty slider bar or universal slider bar are selected, please reduce the monitor arms weight range by 2 pounds.

- Dimensions and weight ranges for CF Static varies based on the configuration. Please refer to CF Monitor Arm Specification pages 149–151 for more details based on specific configurations.
- When adding static configuration Height-Adjustable desks and benches, please refer to the application guidelines on page 137.

CF Static Single

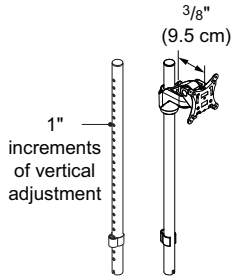

CF Static One over One

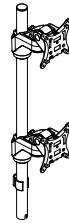

CF Static Two over Two

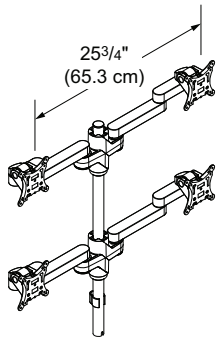

CF Static Two over Two Wide

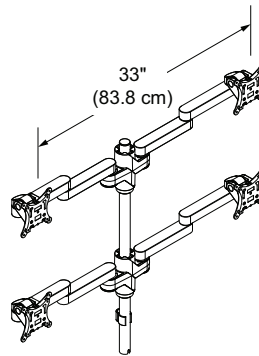

CF Static Three over Three

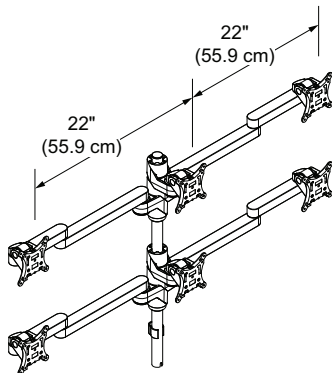

CF Static Three over Three Wide

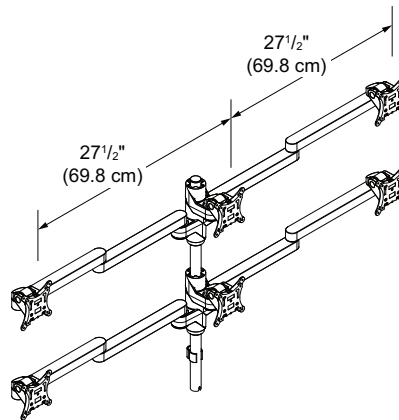

CFSTATIC Specifications

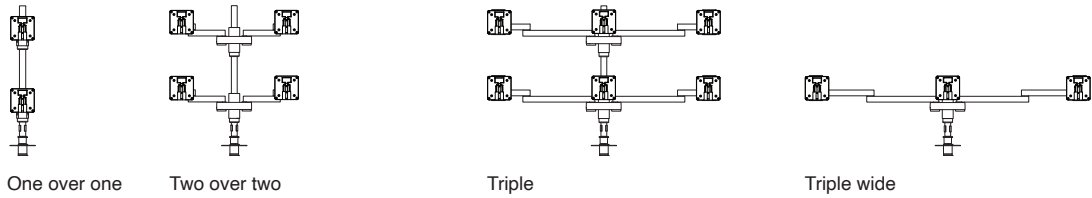

CFSTATIC Product (Weight per arm dependent on configuration)							
Arm Configuration	One over one	Two over two	Two over two wide	Three over three	Three over three wide	Triple	Triple wide
Max Height	18"	18"	18"	15"	15"	18"	18"
Max Width (With Standard Tilt Head/HD Tilt)	32"	25"	32"	21"	26½"	21"	26½"
Max Width (With Universal Slide)	N.A.	30"	37½"	N.A.	N.A.	N.A.	N.A.
Max Width (With HD Slider)	N.A.	34"	41"	N.A.	N.A.	N.A.	N.A.

Tip: When using curved screens greater than 32", specify CF heavy-duty tilt head.

Tip: All measurements are provided under the assumption that the arms are in their lowest position.

Tip: All width measurements are provided in the left to right (edge to edge) measurement, NOT diagonal.

Tip: Maximum monitor size may be impacted by thickness of monitor and location of VESA bracket mount. Dimensions are estimates.

Tip: When heavy duty slider bar or universal slider bar are selected, please reduce the monitor arms weight range by 2 pounds.

Tip: Sliders are not available on one over one or three over three configurations due to utilizing the adjustable monitor adapter to keep the monitor aligned.

CF Monitor Arm Specifications

Dynamic Solutions

CF Monitor Arm
Specifications

Style Number	CFINTRO	CFINTROSLIDE	CFPLUS	CFPLUSHD	CFSTDDUALBAR	CFMAX
Number of Monitors Assembly Supports	1	2	3	2	2	1
Maximum Monitor Weight	2.2–20 lb	2.2–20 lb per monitor	7–17 lb per monitor	13–28 lb Up to 25 lbs per monitor when using FrameOne bracket	11–28 lb	28–40 lb
Functional Focal Length**	23.7"	16"	24"	24"	12"	27"
Vertical Adjustment Range	13.2"	13"	16"	16"	18"	18"
Tilt (forward/backward)	200°	180°	200°	200°	145°	200°
Lower Arm Rotation	200°	180°	200°	200°	180°	200°
Upper Arm Rotation	360°	360°	360°	360°	360°	360°
VESA Plate	75 x 75 mm	100 x 100 mm	100 mm	100 mm	100 mm	100 mm
VESA Plate Bracket Range (side to Side)	180°	180°	180°	180°	180°	180°
Vertical adjustment range on pole mounted options	N.A.	N.A.	1" intervals	1" intervals	N.A.	N.A.

** Maximum monitor size may be impacted by thickness of monitor and location of VESA bracket mount. Dimensions are estimates.

Tip: All Steelcase monitor arms utilize the VESA hole pattern to connect monitor to arm. Apple monitors do not connect without optional adapter plate. Plate must be acquired through Apple.

Tip: When a monitor arm is used with a CF slider bar, reduce monitor weight capacity by 2 lb per monitor.

Tip: When using curved screens greater than 32", specify CF heavy-duty tilt head.

CF Monitor Arm Specifications

Static Solutions—Single Tier

Style Number	Single	Triple	Triple Wide
	CFSTATIC	CFSTATIC	CFSTATIC
Maximum Monitor Weight	up to 30 lb	Up to 15 lb per monitor	Up to 15 lb per monitor
Functional Focal Length**	N.A.	24" monitor 0-1½"	"24" monitors 0-7½" 30" 0-6"
Vertical Adjustment Range	9"	9"	9"
Tilt (forward/backward)	200°	200°	200°
Lower Arm Rotation	N.A.	200°	200°
Upper arm rotation	N.A.	360°	360°
Rotation (portrait to landscape)	Yes	Yes	Yes
VESA Plate	100 mm	100 mm	100 mm
VESA Plate Bracket Range (side to side)	180°	180°	180°
Vertical Adjustment range on pole mounted options	1" intervals	1" intervals	1" intervals

** Maximum monitor size may be impacted by thickness of monitor and location of VESA bracket mount. Dimensions are estimates.

Tip: All Steelcase monitor arms utilize the VESA hole pattern to connect monitor to arm.

Apple monitors do not connect without optional adapter plate. Plate must be acquired through Apple.

Tip: When a monitor arm is used with a CF slider bar, reduce monitor weight capacity by 2 lb per monitor.

Tip: When using curved screens greater than 32", specify CF heavy-duty tilt head.

CF Monitor Arm Specifications

Static Solutions—Two Tier

CF Monitor Arm
Specifications

	One over One	Two over Two	Two over Two Wide	Three over Three	Three over Three Wide
Style Number	CFSTATIC	CFSTATIC	CFSTATIC	CFSTATIC	CFSTATIC
Maximum Monitor Weight	up to 20 lb	Up to 12 lb per monitor	Up to 12 lb per monitor	Up to 10 lb per monitor	Up to 10 lb per monitor
Functional Focal Length**	N.A.	24" monitor 0-6"	24" monitor 0-11" 30" monitor 0-8¾"	24" monitor 0- 1½"	24" monitor 0- 7½" 30" monitor 0-6"
Vertical Adjustment Range	Monitor Dependent	Monitor Dependent	Monitor Dependent	Monitor Dependent	Monitor Dependent
Tilt (forward/backward)	200°	200°	200°	200°	200°
Lower Arm Rotation	N.A.	200°	200°	200°	200°
Upper Arm Rotation	N.A.	360°	360°	360°	360°
Rotation (portrait to landscape)	Yes	Yes	Yes	Yes	Yes
VESA Plate	100 mm	100 mm	100 mm	100 mm	100 mm
VESA Plate Bracket Range (side to side)	180°	180°	180°	180°	180°
Vertical adjustment range on pole mounted options	1" intervals	1" intervals	1" intervals	1" intervals	1" intervals

** Maximum monitor size may be impacted by thickness of monitor and location of VESA bracket mount. Dimensions are estimates.

Tip: All Steelcase monitor arms utilize the VESA hole pattern to connect monitor to arm.

Apple monitors do not connect without optional adapter plate. Plate must be acquired through Apple.

Tip: When a monitor arm is used with a CF slider bar, reduce monitor weight capacity by 2 lb per monitor.

Tip: When using curved screens greater than 32", specify CF heavy-duty tilt head.

CF Dynamic Arms

CF Intro Single

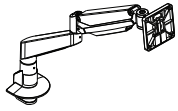

Tip: **CFINTRO** supports 2.2-20 lb. per monitor.

Tip: CF Standard Tilt head and CF Universal Slider bar tilt heads are standard with quick release.

Tip: CF C-clamp uses **CFSERIESCC**.

Standard Includes	Required to Specify
<ul style="list-style-type: none"> Need help? Product details, page 136 Monitor arm: paint Standard tilt head with quick release 	<ol style="list-style-type: none"> Style number Paint color number for monitor arm: <ul style="list-style-type: none"> 0835 Black 7018 Pewter ZW01 Pearl Snow Options, if selected (see below)

Options	U.S. Price	Required to Specify
Tilt head mechanism <ul style="list-style-type: none"> CF standard tilt head CF universal slider bar tilt head 	No cost +\$117	Specify with CF standard tilt head. Specify with CF slider bar tilt head.
Brackets <ul style="list-style-type: none"> No bracket CF C-clamp CF through mount 	No cost +\$ 64 +\$ 64	Specify with no bracket. Specify with CF C-clamp. Specify with CF through mount.

Specification Information		
Weight	Style Number	U.S. Base Price
7.6 lb	CFINTRO	\$285

CF Intro Dual

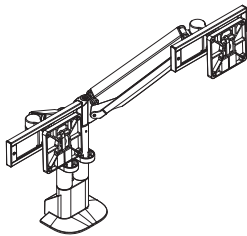

Tip: **CFINTROSLIDE** supports 2.2–20 lb per monitor.

Tip: **CFINTROSLIDE** is standard with two CF standard slider bar tilt heads.

Tip: **CFINTROSLIDE** is not recommended for corner applications.

Standard Includes	Required to Specify
<ul style="list-style-type: none"> Need help? Product details, page 136 Monitor arm: paint CF standard tilt head with quick release 	<ol style="list-style-type: none"> Style number Paint color number for monitor arm: <ul style="list-style-type: none"> 0835 Black 7018 Pewter ZW01 Pearl Snow Options, if selected (see below)

Options	U.S. Price	Required to Specify
Brackets <ul style="list-style-type: none"> CF dual C-clamp CF dual through mount 	+\$85 +\$85	Specify with CF dual C-clamp. Specify with CF dual through mount.

Specification Information		
Weight	Style Number	U.S. Base Price
13.65 lb	CFINTROSLIDE	\$529



For Canadian Pricing
Multiply U.S. Price by the Canadian price factor.

▶ See page 1 for details.

CF Plus

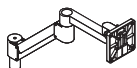

Tip: When pole is specified, select C-clamp, through mount, Bivi pole mount, or FrameOne pole mount brackets.

Tip: When using slider bar tilt heads, reduce monitor weight capacity by 2 lb. per monitor supported by the slider bar tilt head.

Tip: In triple assemblies, the center tilt head will always be a standard or heavy-duty tilt head.

Tip: CF plus triple supports 7–17 lb. per monitor.

Tip: When using curved screens greater than 32", please specify the heavy-duty tilt head option.

Tip: For dual dynamic monitor arm assembly with laptop holder, a slow rise cylinder arm will be designated for laptop holder use. One arm will contain range of 7–17 lb. and the slow rise cylinder arm will support 2–12 lb.

Tip: Laptop holder supports laptops up to 11 lb.

Tip: If monitor requires 75x75 mm VESA hole pattern, specify heavy-duty tilt head or CF heavy-duty slider bar tilt head.

*Tip: **CFPLUS** and **CFPLUSHD** cannot be used with maximum-duty arm bracket **CFSPSGLBASE**.*

Tip: Upcharge for tilt head options represents pricing for one unit. If you select dual it will be double the list upcharge shown.

Tip: Ology desk or bench with integrated rail, specify CF monitor arm with C-clamp mount.

*Tip: Bivi mounting bracket requires additional Bivi brace (**TS8TMBRAC**).*

▶ See Benching Specification Guide.

Standard Includes	Required to Specify
-------------------	---------------------

- | | | |
|------------------------------------------------------------------------------------------|------------------------------------------------------------------------------------------------------------------------------------------|----------------------------------------------------------------------------------------------------------------------------------------------------------------------------------------------------------------------------------------------------------------------------------------------|
| <ul style="list-style-type: none"> ▶ Need help? Product details, page 136 | <ul style="list-style-type: none"> • Monitor arm: paint • 100x100 standard VESA plate • C-clamp bracket | <ul style="list-style-type: none"> 1 Style number 2 Finish color number for arm: <ul style="list-style-type: none"> 0835 Black 7018 Pewter ZW01 Pearl Snow 3 Options, if selected (see below) |
|------------------------------------------------------------------------------------------|------------------------------------------------------------------------------------------------------------------------------------------|----------------------------------------------------------------------------------------------------------------------------------------------------------------------------------------------------------------------------------------------------------------------------------------------|

Options	U.S. Price	Required to Specify
---------	------------	---------------------

Arm Type	<ul style="list-style-type: none"> • Single • Dual • Triple 	<ul style="list-style-type: none"> No cost +\$326 +\$760 	<ul style="list-style-type: none"> Specify with <i>single arm</i>. Specify with <i>dual arm</i>. Specify with <i>triple arm</i>.
Pole Height	<ul style="list-style-type: none"> • No pole • 14" pole • 20" pole 	<ul style="list-style-type: none"> No cost +\$136 +\$184 	<ul style="list-style-type: none"> Specify with <i>no pole</i>. Specify with <i>14" pole</i>. Specify with <i>20" pole</i>.
Tilt Head	<ul style="list-style-type: none"> • CF standard tilt head with quick release • CF standard slider bar tilt head with quick release • CF heavy-duty tilt head with quick release • CF heavy-duty slider bar tilt head with quick release 	<ul style="list-style-type: none"> No cost +\$ 27 per tilt head +\$ 57 per tilt head +\$189 per tilt head 	<ul style="list-style-type: none"> Specify with <i>CF standard tilt head</i>. Specify with <i>CF standard slider bar tilt head</i>. Specify with <i>CF heavy-duty tilt head</i>. Specify with <i>CF heavy-duty slider bar tilt head</i>.
Bracket	<ul style="list-style-type: none"> • No bracket • C-clamp • Wall mount/reverse mount • Slatwall • Bivi • Bivi pole mount • Through mount • FrameOne • FrameOne pole mount 	<ul style="list-style-type: none"> –\$ 88 No cost +\$ 76 +\$ 76 +\$ 76 +\$ 76 +\$ 88 +\$135 +\$135 	<ul style="list-style-type: none"> Specify with <i>no bracket</i>. Specify with <i>C-clamp bracket</i>. Specify with <i>wall mount/reverse mount bracket</i>. Specify with <i>slatwall bracket</i>. Specify with <i>Bivi bracket</i>. Specify with <i>Bivi pole mount bracket</i>. Specify with <i>through mount bracket</i>. Specify with <i>FrameOne bracket</i>. Specify with <i>FrameOne pole mount bracket</i>.
Laptop Support	<ul style="list-style-type: none"> • No laptop support • Laptop support 	<ul style="list-style-type: none"> No cost +\$109 	<ul style="list-style-type: none"> Specify with <i>no laptop support</i>. Specify with <i>laptop support</i>.
Related Products	<ul style="list-style-type: none"> • CF Intro • CF Plus Heavy-Duty 		<ul style="list-style-type: none"> ▶ Page 152 ▶ Page 154

Specification Information	
---------------------------	--

Style Number	U.S. Base Price
--------------	-----------------

CFPLUS	\$461
---------------	-------

CF Plus HD

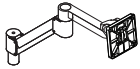

Tip: When using slider bar tilt heads, reduce monitor weight capacity by 2 lb. per monitor supported by the slider bar tilt head.

*Tip: **CFPLUS** and **CFPLUSHD** cannot be used with maximum-duty arm bracket **CFSPSGLBASE**.*

Tip: When using curved screens greater than 32", please specify the heavy-duty tilt head option.

Tip: If monitor requires 75x75 mm VESA hole pattern, specify heavy-duty tilt head or CF heavy-duty slider bar tilt head.

Tip: For dual dynamic monitor arm assembly with laptop holder, a slow rise cylinder arm will be designated for laptop holder use. One arm will contain range of 13–28 lb. and the slow rise cylinder arm will support 2–12 lb.

Tip: Laptop holder supports laptops up to 11 lb.

Tip: When using curved screens greater than 32", specify the heavy-duty tilt head option.

Tip: Upcharge for tilt head options represents pricing for one unit. If you select dual it will be double the list upcharge shown.

Tip: Ology desk or bench with integrated rail, specify CF monitor arm with C-clamp mount.

*Tip: Bivi mounting bracket requires additional Bivi brace (**TS8TMBRAC**).*

▶ See Benching Specification Guide.

Standard Includes		Required to Specify	
▶ Need help? Product details, page 136	<ul style="list-style-type: none"> • Monitor arm: paint • 100x100 standard VESA plate • C-clamp bracket 	1 Style number	2 Finish color number for arm: 0835 Black 7018 Pewter ZW01 Pearl Snow
		3 Options, if selected (see below)	

Options	U.S. Price	Required to Specify
Arm Type	<ul style="list-style-type: none"> • Single No cost • Dual +\$380 	Specify with single arm. Specify with dual arm.
Pole Height	<ul style="list-style-type: none"> • No pole No cost • 14" pole +\$109 • 20" pole +\$156 	Specify with no pole. Specify with 14" pole. Specify with 20" pole.
Tilt Head	<ul style="list-style-type: none"> • CF standard tilt head with quick release No cost • CF standard slider bar tilt head with quick release +\$ 27 per tilt head • CF heavy-duty tilt head with quick release +\$ 57 per tilt head • CF heavy-duty slider bar tilt head with quick release +\$189 per tilt head 	Specify with CF standard tilt head. Specify with CF standard slider bar tilt head. Specify with CF heavy-duty tilt head. Specify with CF heavy-duty slider bar tilt head.
Bracket	<ul style="list-style-type: none"> • No bracket -\$ 88 • C-clamp No cost • Wall mount/reverse mount +\$ 76 • Bivi +\$ 76 • Bivi pole mount +\$ 76 • Through mount +\$ 88 • FrameOne +\$135 • FrameOne pole mount +\$135 	Specify with no bracket. Specify with C-clamp bracket. Specify with wall mount/reverse mount bracket. Specify with Bivi bracket. Specify with Bivi pole mount bracket. Specify with through mount bracket. Specify with FrameOne bracket. Specify with FrameOne pole mount bracket.
Laptop Support	<ul style="list-style-type: none"> • No laptop support No cost • Laptop support +\$109 	Specify with no laptop support. Specify with laptop support.
Related Products	<ul style="list-style-type: none"> • CF Intro • CF Plus 	▶ Page 152 ▶ Page 153

Specification Information

Style Number	U.S. Base Price
CFPLUSHD	\$543

 **For Canadian Pricing**
Multiply U.S. Price by the Canadian price factor.
▶ See page 1 for details.

CF Plus Conversion Kit

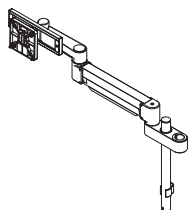

*Tip: Conversion kit will include one single **CFPLUS** arm without a bracket, specified tilthead, specified pole height, and dual hub.*

Tip: All tilt heads are standard with quick release.

Standard Includes		Required to Specify	
-------------------	--	---------------------	--

<ul style="list-style-type: none"> ▶ Need help? Product details, page 136 	<ul style="list-style-type: none"> • Monitor arm: paint • 100x100 standard VESA plate • CF Plus single arm, dual hub, and no bracket 	<ol style="list-style-type: none"> 1 Style number 2 Finish color number for arm: <ul style="list-style-type: none"> 0835 Black 7018 Pewter ZW01 Pearl Snow 3 Options, if selected (see below) 	
------------------------------------------------------------------------------------------	-----------------------------------------------------------------------------------------------------------------------------------------------------------------------	----------------------------------------------------------------------------------------------------------------------------------------------------------------------------------------------------------------------------------------------------------------------------------------------	--

Options	U.S. Price	Required to Specify	
---------	------------	---------------------	--

Pole Height <ul style="list-style-type: none"> • 14" pole • 20" pole 	<ul style="list-style-type: none"> +\$ 33 +\$ 80 	Specify with 14" pole.	Specify with 20" pole.
Tilt Head <ul style="list-style-type: none"> • CF standard slider bar tilt head with quick release • CF heavy-duty slider bar tilt head with quick release 	<ul style="list-style-type: none"> +\$118 +\$189 	Specify with CF standard slider bar tilt head.	Specify with CF heavy-duty slider bar tilt head.

Related Products <ul style="list-style-type: none"> • CF Plus 	▶ Page 153
-------------------------------------------------------------------------------------	------------

Specification Information

Style Number	U.S. Base Price
CFPLUSCK	\$446



For Canadian Pricing

Multiply U.S. Price by the Canadian price factor.

▶ See page 1 for details.

CF Plus HD Conversion Kit

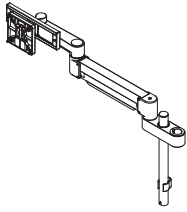

Tip: Conversion kit will include one single **CFPLUSHD** arm without a bracket, specified tilthead, specified pole height, and dual hub.

Tip: All tilt heads are standard with quick release.

Standard Includes		Required to Specify	
<ul style="list-style-type: none"> ▶ Need help? Product details, page 136 	<ul style="list-style-type: none"> • Monitor arm: paint • 100x100 standard VESA plate • CF Plus heavy-duty single arm, dual hub, and no bracket 	<ul style="list-style-type: none"> 1 Style number 2 Finish color number for arm: 0835 Black, 7018 Pewter, ZW01 Pearl Snow 3 Options, if selected (see below) 	
Options		U.S. Price	Required to Specify
Pole Height	<ul style="list-style-type: none"> • 14" pole • 20" pole 	<ul style="list-style-type: none"> +\$ 33 +\$ 80 	<ul style="list-style-type: none"> Specify with 14" pole. Specify with 20" pole.
Tilt Head	<ul style="list-style-type: none"> • CF standard slider bar tilt head with quick release • CF heavy-duty slider bar tilt head with quick release 	<ul style="list-style-type: none"> +\$118 +\$189 	<ul style="list-style-type: none"> Specify with CF standard slider bar tilt head. Specify with CF heavy-duty slider bar tilt head.
Related Products	<ul style="list-style-type: none"> • CF Plus 		▶ Page 153

Specification Information

Style Number	U.S. Base Price
CFPLUSHDCK	\$555

CF Laptop Conversion Kit

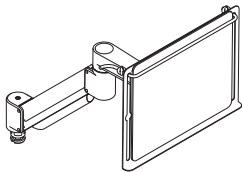

Tip: Laptop conversion kit includes the CF slow rise monitor arm and CF laptop holder.

Standard Includes		Required to Specify	
<ul style="list-style-type: none"> ▶ Need help? Product details, page 136 	<ul style="list-style-type: none"> • Monitor arm: paint • Laptop slow rise monitor arm and laptop holder • Laptop holder finish is black/pewter combination 	<ul style="list-style-type: none"> 1 Style number 2 Finish color number for arm: 0835 Black, 7018 Pewter, ZW01 Pearl Snow 	
Specification Information		U.S. Price	
Style Number			
CFLAPTOPCK		\$597	



For Canadian Pricing
Multiply U.S. Price by the Canadian price factor.
▶ See page 1 for details.

CF Standard Dual Bar Assembly

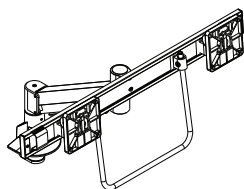

Tip: **CFSTDDUALBAR** supports up 11–28 lb.

Tip: CF standard tilt head is standard with quick release.

Tip: Ology desk or bench with integrated rail, specify CF monitor arm with C-clamp mount.

Tip: Adjustable handle has 6" of vertical height adjustment.

Standard Includes		Required to Specify
<ul style="list-style-type: none"> Need help? Product details, page 136 	<ul style="list-style-type: none"> Monitor arm: paint Dual bar, handle and tilt heads: 0835 Black Standard CF tilt head with 100 x 100 quick release VESA plate Handle No mounting bracket 	<ol style="list-style-type: none"> Style number Paint color number for monitor arm: 0835 Black, 7018 Pewter, ZW01 Pearl Snow Options, if selected (see below)

Options	U.S. Price	Required to Specify
Brackets		
• No bracket	No cost	Specify with <i>no bracket</i> .
• Wall/reverse mount	+\$ 76	Specify with <i>wall/reverse mount</i> .
• Slatwall	+\$ 76	Specify with <i>Slatwall bracket</i> .
• Bivi	+\$ 76	Specify with <i>Bivi bracket</i> .
• CF C-clamp	+\$ 88	Specify with <i>CF C-clamp</i> .
• CF through mount	+\$ 88	Specify with <i>CF through mount</i> .
• FrameOne	+\$134	Specify with <i>FrameOne Bracket</i> .

Specification Information		
Weight	Style Number	U.S. Base Price
15 lb	CFSTDDUALBAR	\$671

CF Standard Dual Bar Conversion Kit

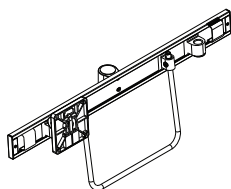

Tip: **CFDUALBARCK** includes one CF standard tilt head, a dual bar, and a handle.

Standard Includes		Required to Specify
<ul style="list-style-type: none"> Need help? Product details, page 136 	<ul style="list-style-type: none"> Tilt head and adapter: paint Dual bar and handle: 0835 Black One standard tilt head with 100 x 100 VESA plate Handle Dual bar 	<ol style="list-style-type: none"> Style number Paint color number for tilt head and adapter: 0835 Black, 7018 Pewter, ZW01 Pearl Snow

Specification Information	
Style Number	U.S. Price
CFDUALBARCK	\$307

 **For Canadian Pricing**
 Multiply U.S. Price by the Canadian price factor.
 ▶ See page 1 for details.

CF Max

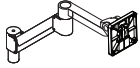

Tip: **CFMAX** can only be used with the maximum-duty arm bracket (**CFSPSGLBASE**).

Tip: All tilt heads are standard with quick release.

Standard Includes		Required to Specify
▶ Need help? Product details, page 136	<ul style="list-style-type: none"> • Monitor arm: paint • 75x75 and 100x100 heavy-duty tilt head/VESA plate • No mounting bracket 	1 Style number 2 Finish color number for arm: 7018 Pewter 0835 Black ZW01 Pearl Snow 3 Options, if selected (see below)

	Options	U.S. Price	Required to Specify
Bracket	<ul style="list-style-type: none"> • No bracket • Maximum duty C-clamp bracket 	No cost +\$92	Specify with <i>no bracket</i> . Specify with <i>maximum duty C-clamp</i> .
Tilt Head	<ul style="list-style-type: none"> • CF heavy-duty tilt head 	+\$57	Specify with <i>CF heavy-duty tilt head</i> .
Related Products	<ul style="list-style-type: none"> • CF Plus • CF Plus heavy-duty 		▶ Page 153 ▶ Page 154

Specification Information	
Style Number	U.S. Base Price
CFMAX	\$666
.	.
.	.

CF Tilt Head and Single Connector

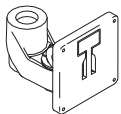

Tip: **CFTHC** is compatible with **CFPLUS** and **CFPLUSHD** pole assemblies.

Tip: All tilt heads are standard with quick release.

Standard Includes		Required to Specify
▶ Need help? Product details, page 136	<ul style="list-style-type: none"> • Monitor arm: paint • 100x100 standard VESA plate • CF Plus single connector 	1 Style number 2 Finish color number for arm: 0835 Black 7018 Pewter ZW01 Pearl Snow 3 Options, if selected (see below)

	Options	U.S. Price	Required to Specify
Tilt Head	<ul style="list-style-type: none"> • CF standard tilt head • CF heavy-duty tilt head 	No cost +\$56	Specify with <i>CF standard tilt head</i> . Specify with <i>CF heavy-duty tilt head</i> .
Related Products	<ul style="list-style-type: none"> • CF Plus • CF Plus HD 		▶ Page 152 ▶ Page 154

Specification Information	
Style Number	U.S. Base Price
CFTHC	\$157
.	.
.	.

 **For Canadian Pricing**
 Multiply U.S. Price by the Canadian price factor.
 ▶ See page 1 for details.

CF Arm Connector



Standard Includes		Required to Specify
<ul style="list-style-type: none"> ▶ Need help? Product details, page 136 	<ul style="list-style-type: none"> • Bracket: paint • Inserts to attach arm extensions and hardware 	<ul style="list-style-type: none"> 1 Style number 2 Paint color number for bracket: <ul style="list-style-type: none"> 0835 Black 7018 Pewter ZW01 Pearl Snow

Specification Information	
Style Number	U.S. Price
CFMSC	\$37

Tip: **CFMSC** connectors are included with **CF Plus** and **Plus HD** when single pole options are specified in assembly.

Tip: **CF Plus** and **Plus** heavy-duty dynamic arms are compatible with **CFMSC**.

CF Dual Hub



Standard Includes		Required to Specify
<ul style="list-style-type: none"> ▶ Need help? Product details, page 136 	<ul style="list-style-type: none"> • Dual hub: paint 	<ul style="list-style-type: none"> 1 Style number 2 Paint color number for bracket: <ul style="list-style-type: none"> 0835 Black 7018 Pewter ZW01 Pearl Snow

Specification Information	
Style Number	U.S. Price
CFDC	\$87

Tip: Compatible with **CFPLUS** and **CFPLUSHD** dual pole mounted assemblies.

Tip: **CFDC** is not compatible with horizontal extenders or tilt heads. To support horizontal extenders and tilt heads, specify **CFMSC**.



For Canadian Pricing

Multiply U.S. Price by the Canadian price factor.

▶ See page 1 for details.

CF Tablet and Laptop Holders

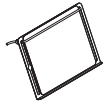

Tip: Laptop holder includes black pad to stop laptop slippage. Security cord secures laptop in place.

Tip: Laptop holder and universal laptop/tablet holder attach to tilt head mechanism (not included).

Tip: The laptop holder platform (CFLHS) can be used on CF monitor arms, as well as most monitor arms with a VESA plate and tilt head that has tilt functionality.

Tip: Please mockup when ordering CF laptop holder to ensure it meets mobility expectations.

Tip: CF slider bar will limit the mobility of the laptop holder to approximately 45 degrees. For best mobility, make sure the attached arm does not have a slide bar.

Standard Includes	Required to Specify
-------------------	---------------------

- | | |
|----------------------------------------------|--------------------------------------------------------------------------------------------------------------------------------------------------------------------|
| ▶ Need help?
Product details,
page 136 | <ul style="list-style-type: none"> Laptop holder, if selected: paint Universal laptop/tablet holder, if selected: black/pewter combination |
|----------------------------------------------|--------------------------------------------------------------------------------------------------------------------------------------------------------------------|

- | |
|------------------------------------------------------------------------------------------------------|
| 1 Style number |
| 2 Paint color number for laptop holder, if selected:
0835 Black
7018 Pewter
ZW01 Pearl Snow |

Specification Information

Dimensions		Style Number	U.S. Price
D	W		
10"	13½"	CFLHS	\$257

CF Technology Cradle



Tip: Technology cradle will work with 75 mm/ 100 mm VESA plate of other monitor arms.

Tip: Technology cradle can be mounted to a monitor arm, pole, wall mount, or under the worksurface.

Tip: When mounted between a monitor and tilt head, maximum monitor weight is 15 lb or the rated load of the monitor arm, whichever is lower.

Standard Includes	Required to Specify
-------------------	---------------------

- | | |
|----------------------------------------------|--------------------------------------------------------------------------------------------------------|
| ▶ Need help?
Product details,
page 132 | <ul style="list-style-type: none"> Cradle: 0835 Black Technology support strap |
|----------------------------------------------|--------------------------------------------------------------------------------------------------------|

- | |
|--------------|
| Style number |
|--------------|

Specification Information

Dimensions			Style Number	U.S. Price
D	W	H		
7/8"-2¼"	7"-9"	9¾"	CFTECHCRD	\$76

Tip: Technology cradle maximum load capacity is 6 lb when mounted to a VESA plate and 11 lb when attached to a CF pole mounted solution, mounted underneath a worksurface or to a wall.

CF Flat Panel Monitor Brackets

Tip: Flat panel monitor arm must be used with flat panel monitor brackets, ordered separately.

Tip: When mounting CF arm brackets to Slatwall, bracket must be mounted no further than 10" away from Slatwall mounting bracket. If application does not allow bracket to be installed within the 10" range, an additional bracket or brackets should be installed within 10" of desired arm location.



Tip: Ology desk or bench with integrated rail, specify CF monitor arm with C-clamp mount.



*Tip: **CFSERIESTM** compatible with **CFINTRO**, **CFPLUS**, **CFPLUSHD** if ordered after April 19, 2021.*

*Tip: **CFSERIESTM** can be used with 14", 20", 28" poles.*

Standard Includes		Required to Specify
▶ Need help? Product details, page 136	• Bracket: paint	1 Style number 2 Paint color number for bracket: 0835 Black 7018 Pewter ZW01 Pearl Snow

Related Products	
• Flat panel monitor pole mounts	▶ Page 167

Specification Information		
Weight	Style Number	U.S. Price

CF C-Clamp

4 lb	CFSERIESCC	\$88
:	:	:

CF Through Mount Bracket

3 lb	CFSERIESTM	\$88
:	:	:



For Canadian Pricing
Multiply U.S. Price by the Canadian price factor.
▶ See page 1 for details.

CF Pole Mount C-Clamp Bracket



Standard Includes	Required to Specify
<ul style="list-style-type: none"> ▶ Need help? Product details, page 136 • Bracket: paint 	<ul style="list-style-type: none"> 1 Style number 2 Paint color number for bracket: <ul style="list-style-type: none"> 0835 Black 7018 Pewter ZW01 Pearl Snow

Related Products
<ul style="list-style-type: none"> • Flat panel monitor pole mounts

▶ Page 167

Specification Information		
Weight	Style Number	U.S. Price
4 lb	CFSPMOD	\$88

Tip: **CFSPMOD** is not compatible with **FLEXDOCK**.

Tip: **CFSPMOD** is recommended for use with CF static assemblies.

Tip: **CFSPMOD** includes the flex mount through mounting hardware.

CF Arm Brackets

Standard Includes	Required to Specify
<ul style="list-style-type: none"> ▶ Need help? Product details, page 136 • Bracket: paint • Inserts to attach arm extensions and hardware 	<ul style="list-style-type: none"> 1 Style number 2 Paint color number for bracket: <ul style="list-style-type: none"> 0835 Black 7018 Pewter ZW01 Pearl Snow

Specification Information	
Style Number	U.S. Price

Frame One Pole-Mount Bracket	
CFSPMODFO	\$159

Bivi Pole-Mount Bracket	
CFSPMODBV	\$104

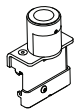

Tip: Bivi mounting bracket requires additional Bivi brace (**TS8TMBRAC**).

▶ See Benching Specification Guide.

CF Brackets

Tip: Flat panel monitor arm must be used with flat panel monitor brackets, ordered separately.

Tip: When mounting CF arm brackets to Slatwall, bracket must be mounted no further than 10" away from Slatwall mounting bracket. If application does not allow bracket to be installed within the 10" range, an additional bracket or brackets should be installed within 10" of desired arm location.



Tip: **CFSPWM** is not recommended for drywall, sheet rock, or plaster surfaces.



Tip: When using **CFSPSW**, limit the CF arm load to 25 lb.

Standard Includes		Required to Specify
▶ Need help? Product details, page 136	• Bracket: paint	1 Style number 2 Paint color number for bracket: 0835 Black 7018 Pewter ZW01 Pearl Snow

Related Products
• Flat panel monitor pole mounts ▶ Page 167

Specification Information		
Weight	Style Number	U.S. Price
:	:	:
:	:	:

Wall/Reverse Wall-Mount Bracket

2.5 lb	CFSPWM	\$76
:	:	:

Slatwall Bracket

3 lb	CFSPSW	\$76
:	:	:

CF Bracket



Tip: **CFMAX** can be used only with maximum-duty arm bracket **CFSPSGLBASE**.

Standard Includes		Required to Specify
▶ Need help? Product details, page 136	• Bracket: paint	1 Style number 2 Paint color number for bracket: 0835 Black 7018 Pewter ZW01 Pearl Snow

Specification Information		
Weight	Style Number	U.S. Price
:	:	:
:	:	:

Maximum-Duty Arm Bracket

4 lb	CFSPSGLBASE	\$92
:	:	:

CF Tilt Heads/Poles/Extenders

Tip: Use the adjustable monitor adapter with standard tilt head mechanism to add more vertical movement on the CF pole system triple assemblies.

Standard Includes	Required to Specify
<ul style="list-style-type: none"> ▶ Need help? Product details, page 136 • Tilt head: paint • Tilt head mechanism with VESA plate, if selected 	<ul style="list-style-type: none"> 1 Style number 2 Paint color number for tilt head: <ul style="list-style-type: none"> 0835 Black 7018 Pewter ZW01 Pearl Snow

Specification Information	
Style Number	U.S. Price

CF Standard Tilt Head with Quick Release

CFSTH	\$141



Tip: **CFSTH** can be used with CF Plus and CF Plus heavy-duty.

Tip: **CFSTH** is standard with 100x100 VESA plate.

Heavy-Duty Tilt Head

CFHDTH	\$219



Heavy-Duty Tilt Head Mechanism with Quick Release

CFHDQRTH2	\$214



Tip: When using curved screens greater than 32" or if your monitor weighs over 30 lb, specify heavy-duty spring tilt head.



For Canadian Pricing

Multiply U.S. Price by the Canadian price factor.

▶ See page 1 for details.

CF Standard Slider Bar Tilt Head

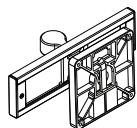

Tip: UNIVERSALSLIDE can be used with the entire CF dynamic portfolio. Single static, one-over-one static, triple assemblies, and three-over-three monitor arm assemblies are not compatible with sliders. Sliders are available options on two-over-two and two-over-two wide static assemblies only.

Tip: When using CF Universal slider bar, reduce monitor weight capacity by 2 lb per monitor supported by the slider bar tilt head.

Tip: UNIVERSALSLIDE adds horizontal range of 5 3/8".

Tip: UNIVERSALSLIDE is standard with quick release.

Tip: UNIVERSALSLIDE includes **CFSTH** tilt head.

Standard Includes	Required to Specify
-------------------	---------------------

- | | |
|----------------------------------------------|---------------------------------------------------------------------------------------------------------|
| ▶ Need help?
Product details,
page 136 | • Tilt head: paint
• Slider bar tilt head with 100x100 VESA plate:
black paint only |
| | 1 Style number
2 Paint color number for monitor arm:
0835 Black
7018 Pewter
ZW01 Pearl Snow |

Specification Information

Style Number	U.S. Price

CF Standard Slider Bar Tilt Head

UNIVERSALSLIDE	\$160
-----------------------	-------

CF Heavy-Duty Slider Bar Tilt Head

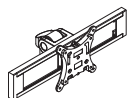

Tip: Sliders add horizontal range of 9".

Tip: CFSLIDETHHD works with all CF arms except CF intro.

Tip: Tilt head on slider bar does not rotate.

Tip: When using CF heavy-duty slider bar, reduce monitor weight capacity by 2 lb per monitor supported by the slider bar tilt head.

Tip: CFSLIDETHHD can be used with the entire CF dynamic portfolio. Single static, one-over-one static, triple assemblies, and three-over-three monitor arm assemblies are not compatible with sliders. Sliders are available options on two-over-two and two-over-two wide static assemblies only.

Standard Includes	Required to Specify
-------------------	---------------------

- | | |
|----------------------------------------------|-------------------------------------------------------------------------------------------------------------------------------------|
| ▶ Need help?
Product details,
page 136 | • Slider bar with quick release tilt head |
| | 1 Style number
2 Paint color number for slider bar with quick release tilt head:
0835 Black
7018 Pewter
ZW01 Pearl Snow |

Specification Information

Style Number	U.S. Price

Slider Bar Heavy-Duty Tilt Head with Quick Release

CFSLIDETHHD	\$268
--------------------	-------

CF Monitor Arm Adapters and Tilt Heads

Tip: Use the adjustable monitor adapter with standard tilt head mechanism to add more vertical movement on the CF pole system triple assemblies.

Tip: **CFTHSLIDEWO** and **CFTHSLIDEHD** can be used with CF pole mounted solutions.

Tip: **CFHDTH** and **CFHDQRTH2** can be used with both CF Plus and CF Plus heavy-duty.



Tip: To adjust the monitor height up and down using a static pole, specify the adjustable monitor arm adapter.

Tip: When using curved screens greater than 32" or if your monitor weighs over 30 lb, use CF heavy-duty tilt head (**CFHDTH** or **CFHDQRTH2**).



	Standard Includes	Required to Specify
▶ Need help? Product details, page 136	<ul style="list-style-type: none"> Tilt head: paint Adjustable monitor adapter without tilt head mechanism: black paint only Tilt head mechanism with VESA plate, if selected 	1 Style number 2 Paint color number for tilt head: 0835 Black 7018 Pewter ZW01 Pearl Snow

Specification Information	
Style Number	U.S. Price

Adjustable Monitor Adapter without Tilt Head Mechanism

CFTHSLIDEWO	\$ 75
:	:

Adjustable Monitor Adapter with Standard Tilt Head Mechanism

CFTHSLIDE	\$167
:	:

Adjustable Monitor Adapter with Heavy-Duty Tilt Head Mechanism

CFTHSLIDEHD	\$202
:	:



For Canadian Pricing

Multiply U.S. Price by the Canadian price factor.

▶ See page 1 for details.

CF Pole Without Arms



Tip: Assemblies using **CFP28** may not exceed 15 lb per monitor.

CFP14, **CFP20**, and **CFP28** can be used with both Plus and CF Plus heavy-duty.

Tip: Ology desk or bench with integrated rail, specify CF monitor arm with C-clamp mount.

Standard Includes	Required to Specify
<ul style="list-style-type: none"> ▶ Need help? Product details, page 136 • Monitor pole mount: paint 	<ul style="list-style-type: none"> 1 Style number 2 Paint color number for pole mount: <ul style="list-style-type: none"> 0835 Black 7018 Pewter ZW01 Pearl Snow

Related Products
<ul style="list-style-type: none"> • Flat panel monitor pole mounts

▶ Page 167

Specification Information			
Dimension H	Weight	Style Number	U.S. Price
14"	2 lb	CFP14	\$184
20"	2.3 lb	CFP20	\$212
28"	3 lb	CFP28	\$242
·	·	·	·

CF Articulating Arm Extensions for Pole Mount Assemblies



Tip: CF arm extensions are interchangeable and retrofitable. Arm extensions support larger monitors.

Tip: Tilt head is not included with the extension arm. Must order tilt heads separately.

Tip: **CFXP4H**, **CFXP8H**, and **CFXP12H** can be used with CF Plus, CF Plus heavy-duty, and static monitor arms.

Tip: Horizontal extenders are not compatible to work directly with **CFDC**.

Standard Includes	Required to Specify
<ul style="list-style-type: none"> ▶ Need help? Product details, page 136 • Articulating extension arm: paint 	<ul style="list-style-type: none"> 1 Style number 2 Paint color number for extender: <ul style="list-style-type: none"> 0835 Black 7018 Pewter ZW01 Pearl Snow

Specification Information		
Weight	Style Number	U.S. Price
0.5 lb	CFXP4H	\$35
0.8 lb	CFXP8H	\$60
1.1 lb	CFXP12H	\$88
·	·	·



For Canadian Pricing
 Multiply U.S. Price by the Canadian price factor.
 ▶ See page 1 for details.

200x200 VESA Plate



Tip: Contains 75x75, 100x100, 100x200, and 200x200 VESA hole patterns.

Standard Includes	Required to Specify
<ul style="list-style-type: none"> ▶ Need help? Product details, page 136 • VESA plate: black 	<ul style="list-style-type: none"> Style number

Specification Information	
Style Number	U.S. Price
VESA200	\$119



For Canadian Pricing
 Multiply U.S. Price by the Canadian price factor.
 ▶ See page 1 for details.

CF Static

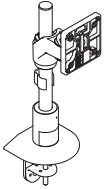

Tip: All tilt head and slider bar tilt head options are standard with quick release.

Tip: 28" pole is a must specify with tiered assemblies.

Tip: If monitor requires 75x75 mm VESA hole pattern, please specify CF heavy-duty tilt head with quick release or CF heavy-duty slider bar tilt head with quick release.

Tip: When using curved screens greater than 32" or if your monitor weighs over 30 lb, specify heavy-duty spring tilt head.

*Tip: When C-clamp selected on **CFSTATIC** assemblies, the undermount clamp is provided.*

*Tip: **FLEXDOCK** does not work with **CFSTATIC**.*

Tip: Triple monitor arm includes two height adjustable adapter tilt head mechanisms.

*Tip: Bivi mounting bracket requires additional Bivi brace (**TS8TMBRAC**). See Benching Specification Guide.*

*Tip: When using **UNIVERSALSLIDE**, reduce monitor weight capacity by 2 lb per monitor supported by the slider bar tilt head.*

Tip: Single static, one-over-one static, triple assemblies, and three-over-three monitor arm assemblies are not compatible with sliders. Sliders are available options on two-over-two and two-over-two wide static assemblies only.

Standard Includes	Required to Specify
<ul style="list-style-type: none"> ▶ Need help? Product details, page 136 • Monitor arm: paint • Standard tilt head with 100x100 VESA plate 	<ol style="list-style-type: none"> 1 Style number 2 Paint color number for monitor arm: 0835 Black, 7018 Pewter, ZW01 Pearl Snow 3 Assembly option (see Required Selections below) 4 Options, if selected (see below)

Required Selections	U.S. Price	Required to Specify
Assembly Option <ul style="list-style-type: none"> • Single • One over one • Triple • Triple wide • Two over two • Two over two wide • Three over three • Three over three wide 	<ul style="list-style-type: none"> +\$ 81 +\$ 359 +\$ 706 +\$ 760 +\$ 977 +\$1194 +\$1465 +\$1574 	Specify with single static assembly. Specify with one over one static assembly. Specify with triple static assembly. Specify with triple wide static assembly. Specify with two over two static assembly. Specify with two over two wide static assembly. Specify with three over three static assembly. Specify with three over three wide static assembly.

Options	U.S. Price	Required to Specify
Pole Height <ul style="list-style-type: none"> • 14" pole • 20" pole • 28" pole 	<ul style="list-style-type: none"> No cost +\$ 80 +\$ 109 	Specify with 14" pole. Specify with 20" pole. Specify with 28" pole.
Tilt Head Mechanism <ul style="list-style-type: none"> • Standard tilt head • Standard slider • Heavy-duty tilt head • Heavy-duty tilt head slider 	<ul style="list-style-type: none"> No cost +\$ 27 per tilt head +\$ 57 per tilt head +\$ 189 per tilt head 	Specify with CF standard tilt head. Specify with CF standard slider bar tilt head. Specify with CF heavy-duty tilt head. Specify with CF heavy-duty slider bar tilt head.
Brackets <ul style="list-style-type: none"> • No bracket • Undermount C-clamp • Undermount through mount • Bivi pole mount • FrameOne pole mount 	<ul style="list-style-type: none"> No cost +\$ 88 +\$ 88 +\$ 104 +\$ 159 	Specify with no bracket. Specify with undermount C-clamp bracket. Specify with undermount through mount bracket. Specify with Bivi pole mount bracket. Specify with FrameOne pole mount bracket.

Specification Information

Style Number	U.S. Base Price
CFSTATIC	\$292

Tip: Upcharge for tilt head options represents pricing for one unit. If you select dual it will be double the list upcharge shown.



Screens



Statement of Line **172**



Divisio Side Screen

Understanding **174**

Specifying **175**

Fixed Personal/Modesty Screens

Understanding **176**

Specifying **178**

Privacy Screens and Modesty Screens

Understanding **179**

Specifying **180**

Statement of Line

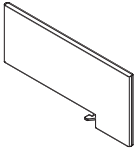

Understanding
 ▶ Page 174
 Specifying
 ▶ Page 175

Divisio Side Screen

29½"D

11⅝"H ●

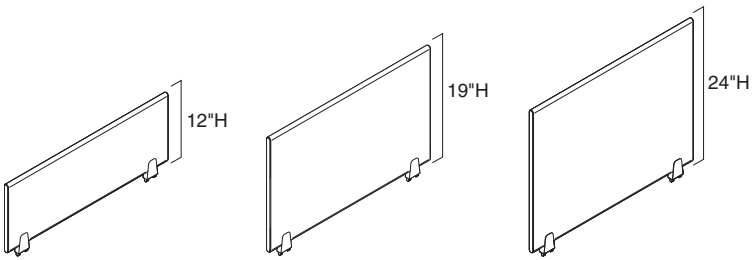

Understanding
 ▶ Page 176
 Specifying
 ▶ Page 178

Fixed Personal/Modesty Screens

	30"W	36"W	42"W	48"W
12"H	●	●	●	●
19"H	●	●	●	●
24"H	●	●	●	●

Privacy Screens and Modesty Screens



Understanding
 ▶ Page 179
 Specifying
 ▶ Page 180

Privacy Screens

	22"W	28"W	34"W	40"W	46"W	52"W	58"W	64"W
22"H	•	•	•	•	•	•	•	•



Understanding
 ▶ Page 179
 Specifying
 ▶ Page 180

Modesty Screens

	22"W	28"W	34"W	40"W	46"W	52"W	58"W	64"W
14"H	•	•	•	•	•	•	•	•

Divisio Side Screen

Divisio side screen is magnetic and provides a territorial boundary between users. The user-movable functionality allows users to decide when and where they need additional privacy. The screens may be used on any $\frac{3}{4}$ "- to $1\frac{1}{2}$ "-thick worksurface.

► Specifying, page 175

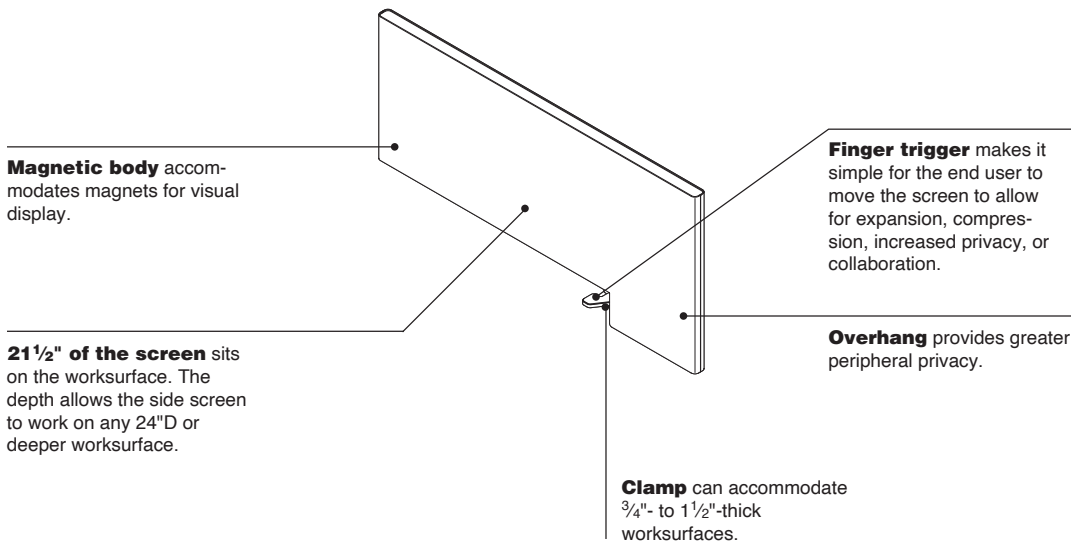

Product Details

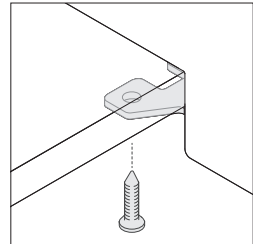

Divisio side screen can be made more permanent by adding two screws through the clamp. For worksurfaces 1" thick or less; FrameOne, Ology, Migration, a #10 x $\frac{3}{4}$ " countersunk wood screw is recommended. For worksurfaces over 1", a #10 x $\frac{7}{8}$ " countersunk wood screw is recommended.

Actual Dimensions

Depth 29 $\frac{1}{2}$ " (total), 21 $\frac{1}{2}$ " (sits on worksurface)

Width 1 $\frac{1}{4}$ "

Height 14 $\frac{1}{4}$ " (total), 11 $\frac{5}{8}$ " (above worksurface)

Divisio Side Screen

Divisio
Side Screen



Tip: The Divisio side screen can be used on any 3/4"- to 1 1/2"-thick worksurface.

Tip: The Divisio side screen has an overhang of 8". This is important when planning for returns or storage.

Tip: The Divisio side screen weighs approximately 14 1/2 lb. Take this into consideration when planning for use on height-adjustable worksurfaces.

Tip: The Divisio side screen is intended for use on the front of a worksurface.

Tip: The Divisio side screen does not work on knife edge profiles.

Standard Includes

- ▶ Need help? Product details, page 174
- Screen: fabric price group A
- Top cap and clamp: 4799 Platinum paint

Required to Specify

- 1 Style number
- 2 Fabric color number
- 3 Options, if selected (see below)
- ▶ See *Surface Materials Reference Manual*.

Options

Surface Materials	Fabric	U.S. Price	Required to Specify
	• Fabric price group A	No cost	Specify fabric color number.
	• Fabric price group 1	No cost	Specify fabric color number.
	• Fabric price group 2	+\$ 23	Specify fabric color number.
	• Fabric price group 3	+\$ 42	Specify fabric color number.
	• Fabric price group 4	+\$ 61	Specify fabric color number.
	• Fabric price group 5	+\$ 94	Specify fabric color number.
	• Fabric price group 6	+\$ 425	Specify fabric color number.
	• Fabric price group 7	+\$ 573	Specify fabric color number.
	• Fabric price group 8	+\$ 730	Specify fabric color number.
	• Fabric price group 9	+\$ 868	Specify fabric color number.
	• Fabric price group 10	+\$1015	Specify fabric color number.
	• Customer's Own Material (COM)	+\$ 25	▶ See <i>Surface Materials Reference Manual</i> .

Specification Information

• Dimensions		• Style	• U.S.
D	H	Number	Base Price
29 1/2"	11 5/8"	DVSS2912	\$552

Screens

 **For Canadian Pricing**
Multiply U.S. Price by the Canadian price factor.
▶ See page 1 for details.

Fixed Personal/Modesty Screens

Personal / modesty screens are tackable and provide variable privacy when and where it is needed. The screens can be used on the beam, on 1½-High low storage with a connect zone, on the back of the desk for visual privacy, or below the desk for modesty. 19½"H and 24"H are not intended for use in modesty position when used with a height-adjustable desk. ▶ Specifying, page 178

Fixed personal/modesty screens are available in three heights, 12", 19½", and 24", and four widths to accommodate varying levels of privacy. Height is measured from the top of the mounting surface to the top of the screen.

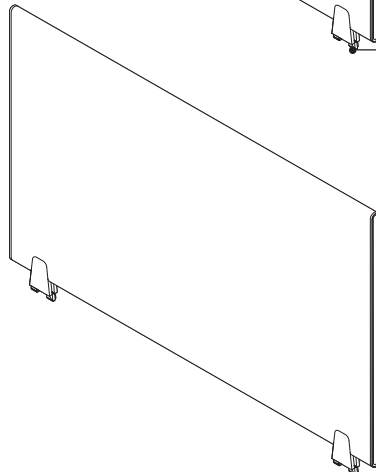
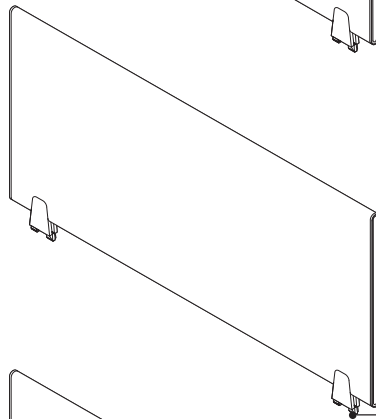
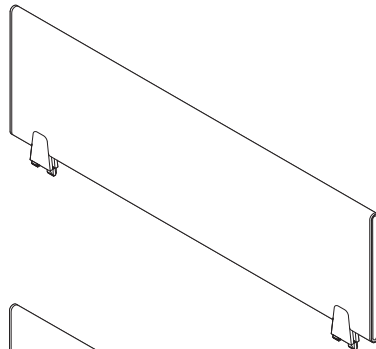

Brackets are attached to the screens.

Actual Dimensions

Width	30", 36", 42", or 48"
Height	11", 18½", or 23"
Overall height	12", 19½", or 24"
Thickness	¾"

Product Details

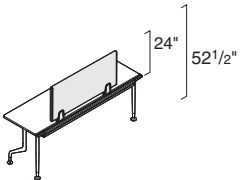
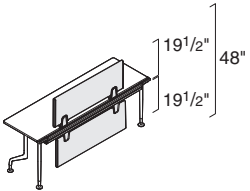
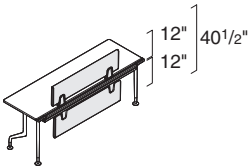

Fixed personal/modesty screens can be mounted on the desk rail. In privacy applications on a 28 1/2"H desk, the 12"H screen has an overall height of 40 1/2" from the floor, a 19 1/2"H screen has an overall height of 48" from the floor, and a 24"H screen has an overall height of 52 1/2" from the floor.

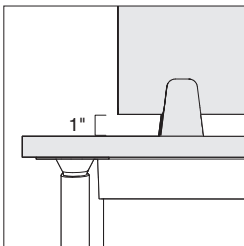

Gap is 1" between personal/modesty screen and mounting surface.

Connections

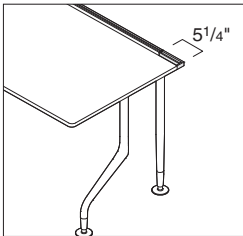

Each end of the top desk rail has a 5 1/4" mounting free zone which prohibits the attachment of personal screens.

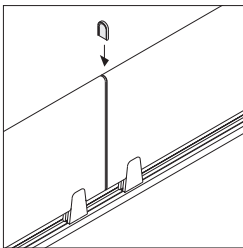

When screens are placed directly adjacent to each other, a small aligner can be placed in between the screens at the top to connect them for planar alignment. Aligners are ordered separately in packages of 10.

Surface Materials

Infill

- Fabric

Brackets

- 4799 Platinum paint

front



back



Fabric without pattern is recommended when using a COM fabric to provide a consistent visual. Fabric with patterns could result in the above visual.

Application Topics

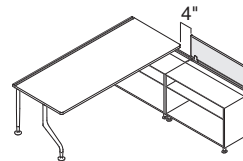

Screen width needs to allow 4" clearance from front edge of desk to allow desk surface to slide forward.

Fixed Personal/Modesty Screens

Standard Includes		Required to Specify
<ul style="list-style-type: none"> ▶ Need help? Product details, page 176 	<ul style="list-style-type: none"> • Personal/modesty screens: fabric price group 1 • Brackets: 4799 Platinum 	<ul style="list-style-type: none"> 1 Style number 2 Fabric color number for screen 3 Options, if selected (see below) ▶ See <i>Surface Materials</i>, page 264.

Surface Materials	Options	U.S. Price			Required to Specify
	Fabric	12"H	19½"H	24"H	
	• Fabric price group 1	No cost	No cost	No cost	Specify fabric color number.
	• Fabric price group 2	+\$ 39	+\$ 53	+\$ 63	Specify fabric color number.
	• Fabric price group 3	+\$104	+\$142	+\$178	Specify fabric color number.
	• Fabric price group 4	+\$135	+\$178	+\$220	Specify fabric color number.
	• Customer's Own Material (COM)	+\$ 25	+\$ 25	+\$ 25	▶ See <i>Surface Materials Reference Manual</i> .

Tip: When using COM fabric, it is recommended that non-patterned fabric be used to provide a consistent visual between adjacent screens, and from one side to the other.

Specification Information		
Width	Style Number	U.S. Base Price
...

12"H Screens

30"	CQSF3012	\$282
36"	CQSF3612	\$331
42"	CQSF4212	\$370
48"	CQSF4812	\$419
...

19½"H Screens

30"	CQSF3019	\$435
36"	CQSF3619	\$483
42"	CQSF4219	\$530
48"	CQSF4819	\$571
...

24"H Screens

30"	CQSF3024	\$584
36"	CQSF3624	\$635
42"	CQSF4224	\$680
48"	CQSF4824	\$725
...

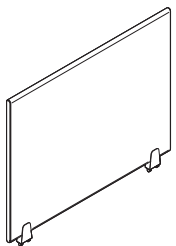
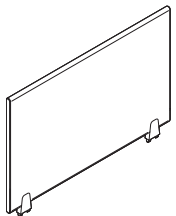
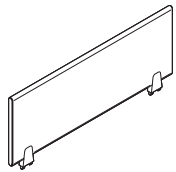

Tip: 19½"H and 24"H screens are not intended for use in the modesty position when used with a height-adjustable desk.



For Canadian Pricing
Multiply U.S. Price by the Canadian price factor.
▶ See page 1 for details.

Privacy Screens and Modesty Screens

Privacy Screens and Modesty Screens

Privacy Screens



► Specifying, page 180

Tip: Screen may need to be shorter than worksurface width. To determine screen and height-adjustable worksurface compatibility, see Worktools Compatibility Charts, in the Height-Adjustable Desks Specification Guide.

Product Details

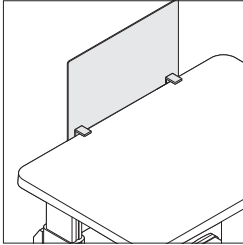

Privacy screen provides lightweight space division above worksurface.

Privacy screen top is a fixed height 19" above worksurface.

Privacy screen can be used in combination with modesty screen.

Privacy screen ships with Universal clamps for field installation.

Application Topics

Screen Width	SlatRail Width					
	24"	30"	36"	42"	48"	60"
22"	Dark Gray	Dark Gray	Dark Gray	Dark Gray	Dark Gray	Dark Gray
25"/28"	Black	Dark Gray	Dark Gray	Dark Gray	Dark Gray	Dark Gray
31"/34"	Dark Gray	Black	Dark Gray	Dark Gray	Dark Gray	Dark Gray
37"/40"	Dark Gray	Dark Gray	Black	Dark Gray	Dark Gray	Dark Gray
43"/46"	Dark Gray	Dark Gray	Dark Gray	Black	Dark Gray	Dark Gray
49"/52"	Dark Gray	Dark Gray	Dark Gray	Dark Gray	Black	Dark Gray
55"/58"	Dark Gray	Dark Gray	Dark Gray	Dark Gray	Dark Gray	Black
61"/64"	Dark Gray	Dark Gray	Dark Gray	Dark Gray	Dark Gray	Black

- SlatRail stanchions mount on the outside of the screen
- SlatRail stanchions will not work with the screen
- SlatRail stanchions mount on the inside of the screen

Tip: SlatRail does not overhang the SlatRail stanchions; therefore, it is important to order the appropriate SlatRail size when used in combination with screens.

Surface Materials

Screen
• 6544 Frost only

Universal clamp
• 0835 Black
• 4799 Platinum

Actual Dimensions

Depth 1/4"
Width 22", 28", 34", 40", 46", 52", 58", and 64"
Height 22"

Modesty Screens



► Specifying, page 180

Tip: Screen may need to be shorter than worksurface width. To determine screen and height-adjustable worksurface compatibility, see Worktools Compatibility Charts, in the Height-Adjustable Desks Specification Guide.

Product Details

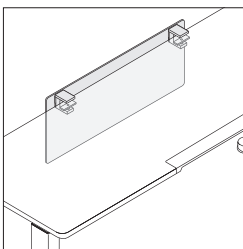

Modesty screen provides below worksurface modesty.

Gap between worksurface and screen is 1" to allow for cable feed through.

Modesty screen top is a fixed height 1/4" above and 12 1/2" below worksurface.

Modesty screen can be used in combination with privacy screen.

Modesty screen ships with Universal clamps for field installation.

Application Topics

Screen Width	SlatRail Width					
	24"	30"	36"	42"	48"	60"
22"	Dark Gray	Dark Gray	Dark Gray	Dark Gray	Dark Gray	Dark Gray
25"/28"	Black	Dark Gray	Dark Gray	Dark Gray	Dark Gray	Dark Gray
31"/34"	Dark Gray	Black	Dark Gray	Dark Gray	Dark Gray	Dark Gray
37"/40"	Dark Gray	Dark Gray	Black	Dark Gray	Dark Gray	Dark Gray
43"/46"	Dark Gray	Dark Gray	Dark Gray	Black	Dark Gray	Dark Gray
49"/52"	Dark Gray	Dark Gray	Dark Gray	Dark Gray	Black	Dark Gray
55"/58"	Dark Gray	Dark Gray	Dark Gray	Dark Gray	Dark Gray	Black
61"/64"	Dark Gray	Dark Gray	Dark Gray	Dark Gray	Dark Gray	Black

- SlatRail stanchions mount on the outside of the screen
- SlatRail stanchions will not work with the screen
- SlatRail stanchions mount on the inside of the screen

Tip: SlatRail does not overhang the SlatRail stanchions; therefore, it is important to order the appropriate SlatRail size when used in combination with screens.

Surface Materials

Screen
• 6544 Frost only

Universal clamp
• 0835 Black
• 4799 Platinum

Actual Dimensions

Depth 1/4"
Width 22", 28", 34", 40", 46", 52", 58", and 64"
Height 14"

Screens

Tip: Screen may need to be shorter than worksurface width. To determine screen and height adjustable worksurface compatibility, see Worktools Compatibility Charts, in the Height-Adjustable Desks Specification Guide.



Tip: 58"W and 64"W screens are not recommended for use with 22 1/4"D rectangular Airtouch worksurfaces.

Tip: 58"W and 64"W screens ship with three Universal clamps. All other screen widths ship with two Universal clamps.

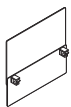

 **For Canadian Pricing**
Multiply U.S. Price by the Canadian price factor.
▶ See page 1 for details.

Standard Includes		Required to Specify
▶ Need help? Product details, page 179	<ul style="list-style-type: none"> • Screen: 6544 Frost only • Universal clamps: paint 	1 Style number 2 Paint color number for Universal clamp: 0835 Black 4799 Platinum

Specification Information

Screen Width	Weight	Style Number	U.S. Price
--------------	--------	--------------	------------

Privacy Screens Only

22"	5.67 lb	AP22	\$ 543
28"	5.77 lb	AP28	\$ 569
34"	6.17 lb	AP34	\$ 601
40"	6.57 lb	AP40	\$ 629
46"	6.77 lb	AP46	\$ 663
52"	6.97 lb	AP52	\$ 693
58"	7.27 lb	AP58	\$ 775
64"	7.77 lb	AP64	\$ 803
:	:	:	:

Modesty Screens Only

22"	4.27 lb	AM22	\$ 495
28"	4.57 lb	AM28	\$ 528
34"	4.87 lb	AM34	\$ 556
40"	5.17 lb	AM40	\$ 583
46"	5.52 lb	AM46	\$ 616
52"	5.77 lb	AM52	\$ 646
58"	5.97 lb	AM58	\$ 726
64"	6.27 lb	AM64	\$ 749
:	:	:	:

Modesty and Privacy Screens

22"	8.07 lb	AMP22	\$ 884
28"	8.57 lb	AMP28	\$ 946
34"	9.27 lb	AMP34	\$1002
40"	9.97 lb	AMP40	\$1064
46"	10.52 lb	AMP46	\$1128
52"	10.97 lb	AMP52	\$1189
58"	11.47 lb	AMP58	\$1296
64"	12.27 lb	AMP64	\$1355
:	:	:	:

Power and Cable Management



Statement of Line **182**



High-Capacity Cable Riser

Understanding	184
Specifying	197

Vertical Cable Carrier

Understanding	185
Specifying	197

6"D Wire Managers

Understanding	185
Specifying	198

1¾"D Wire Managers

Understanding	185
Specifying	198

Powerstrip Intro

Understanding	186
Specifying	199

Powerstrip Plus

Understanding	190
Specifying	200

Pop Up Powerstrip

Understanding	190
Specifying	202

Under Worksurface Utility Power

Understanding	194
Specifying	204

Universal Cable Management Kits

Understanding	196
Specifying	205

Statement of Line

Power and Cable Management

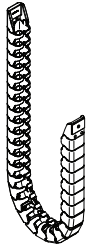

High-Capacity Cable Riser
 Understanding
 ▶ Page 184
 Specifying
 ▶ Page 197



Vertical Cable Carrier
 Understanding
 ▶ Page 185
 Specifying
 ▶ Page 197

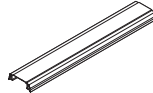

6\"D Wire Managers
 Understanding
 ▶ Page 185
 Specifying
 ▶ Page 198

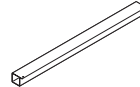

1 3/4\"D Wire Managers
 Understanding
 ▶ Page 185
 Specifying
 ▶ Page 198

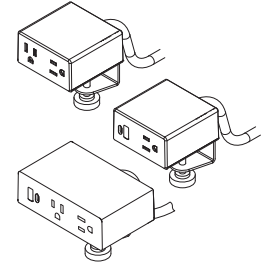

Powerstrip Intro
 Understanding
 ▶ Page 186
 Specifying
 ▶ Page 199



Powerstrip Plus
 Understanding
 ▶ Page 190
 Specifying
 ▶ Page 200



Powerstrip Plus Front Edge Mount
 Understanding
 ▶ Page 190
 Specifying
 ▶ Page 200

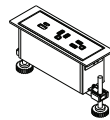

Powerstrip Plus Flush Mount
 Understanding
 ▶ Page 190
 Specifying
 ▶ Page 200

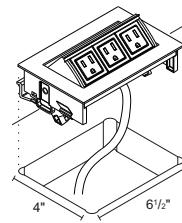

Pop Up Powerstrip
 Understanding
 ▶ Page 190
 Specifying
 ▶ Page 202

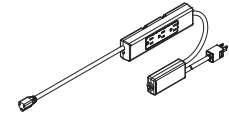

Under Worksurface Utility Power
 Understanding
 ▶ Page 194
 Specifying
 ▶ Page 204

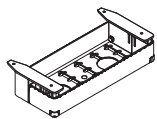

Universal Cable Management Kit, Small
 Understanding
 ▶ Page 196
 Specifying
 ▶ Page 205

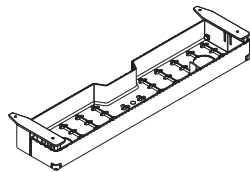

Universal Cable Management Kit, Large
 Understanding
 ▶ Page 196
 Specifying
 ▶ Page 205

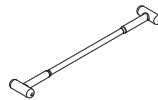

Smart Straps Bulk Pack
 Specifying
 ▶ Page 206

Power and Cable Management

High-Capacity Cable Riser

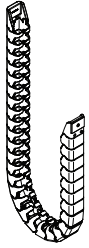

► Specifying, page 197

Product Details

High-capacity cable riser provides vertical cable management for multiple, heavy gauge cords; recommended for height-adjustable workspaces to a magnetic metal surface connection.

Easy cord installation and disassembly with a robust hold to keep cords in place.

Each link lays flat against the other to form a concealed front to hide cords and provide a clean aesthetic.

Links will move uniformly together keeping cables aligned and well managed.

Universal fit for most applications.

Application

Recommended for height-adjustable workspaces.

Attaches to the underside of the top along the back edge to route cords and cables from top to power source.

Tip: Do not use with standard integrated storage or within enclosed areas that would restrict the movement of the cable riser's links.

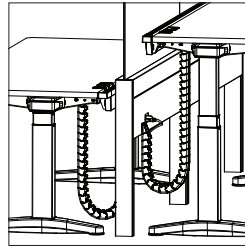

Top bracket can pivot to 90 degrees and attaches directly underneath the worksurface with screws.

Bottom bracket attaches to magnetic metal surfaces near a power receptacle via a rubber-coated magnet to avoid scratching.

Ideal for use with height-adjustable desks paired with Answer fence, beam, panel system, Bivi Slim Leg application, and benching applications.

Top bracket footprint needed: 2¹/₂"D by 2"W.

Top thickness – 1" plus with hardware included. If installing on less than 1" thick surface, shorter screw lengths must be obtained.
Tip: For Bivi with a 1/2" thick surface, a shorter screw length is needed.

Screw length – 7/8"

Links can be rotated 180° degrees for customization.

Minimum bend radius is 1³/₁₆".

Surface Materials

Two choices for blending in with the furniture's palette aesthetic.

Cable Riser

- 6053 Seagull
- 6527 Merle

Actual Dimensions

Cable Riser Assembly

Depth 17/16"

Width 13¹/₃₂"

Length 41⁵/₁₆" (including brackets and links)

Internal Cavity

Depth 11/4"

Width 17/16"

Cable riser weight is 1.2 pounds (without cords).

Vertical Cable Carrier



Product Details

Vertical cable carrier has a 52" flexible spine with two management channels to manage cords from below worksurface to the floor.

Vertical cable carrier bracket attaches to the underside of the worksurface and weighted base sits on floor.

Surface Materials

Vertical cable carrier
• 6688 Steel

Actual Dimensions

Width	2½"
Height	52"
Weight	1 lb

► Specifying, page 197

6"D Wire Managers



Product Details

Wire manager is flexible to manage cords underneath the worksurface.

PVC-free ABX material is resistant to fatigue and recyclable.

Surface Materials

Wire manager
• 6000 Black
• 6249 Platinum

Actual Dimensions

Depth	6"
Width	30", 36", 42", 48", 54", and 60"
Height	2"

► Specifying, page 197

1¾"D Wire Managers

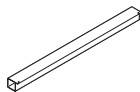

Product Details

Wire manager is flexible to manage cords underneath the worksurface.

PVC-free polypropylene material is resistant to fatigue and recyclable.

Surface Materials

Wire manager
• 6000 Black

Actual Dimensions

Depth	1¾"
Width	6", 12", 18", 23¼", 30", 35", 42", and 48"
Height	1¾"

► Specifying, page 198

Powerstrip Intro

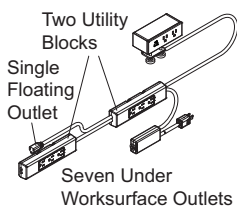
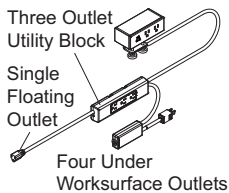
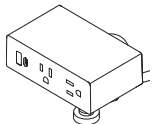
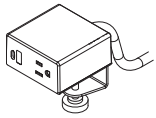
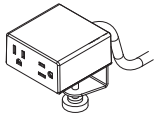

► Specifying, page 199
 Tip: Desktop modules without under worksurface utility power are tamper resistant.

Tip: Under worksurface utility power outlets are not tamper resistant.

Product Details

Powerstrip intro offers desktop C-clamped powerstrips with combinations of power outlets, USB A+C 20W, and optional under worksurface utility power 4 or 7 power outlets.

Desktop power configuration options and specifications include:

- Two power-A
- One power and USB A+C 20W
- Two power and one USB-A+C 20W
- Power outlet is 15A, 120V, 60Hz
- Tamper resistant power outlets on desktop module only. Optional under worksurface utility power outlets are not tamper resistant.

Meets spill test criteria.

Powerstrips with 20 watt intelligent USB A+C:

- If only USB-C in use: delivers what the device needs up to 20 watts
- If only USB-A in use, up to 10 watts
- If both USB A+C in use, USB-A delivers up to 10 watts and 10 watts to USB-C. If USB-A device needs less than 10W, the remainder up to 20 watts goes to the USB-C device

C-clamp is designed to accommodate worksurfaces up to 1½" thick.

USB A+C 20W



Powerstrip intro USB ports are recommended for charging: cell phones, tablets, headphones, wearable fitness trackers, or other small electronic devices. Not recommended for devices needing higher output, more than 20-watts, like laptops. See Powerstrip Plus for higher output USB options.

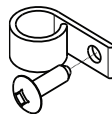
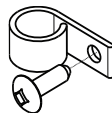

Cable management clips, 2-pack, comes standard with each powerstrip. Mounts under the worksurface to manage cords.

Tip: Cord clip screw length for minimum worksurface thickness of ¾".

Tip: For Bivi with a ½" thick surface, a shorter screw length is needed.

Powerstrip intro without optional under worksurface utility power includes a 9-foot standard smooth cord with a diameter of ⅜" or 163" curly cord.

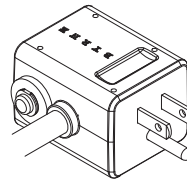

Powerstrip intro includes a standard straight 3-prong plug. An overcurrent protection (OCP) 90° plug is also an option. Check with your local authorities having jurisdiction to see if overcurrent protection is required.
 Tip: When using thread monument, specify standard straight plug head.

Optional Under Worksurface Utility Power

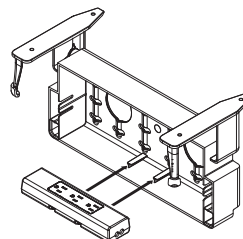
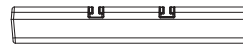
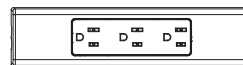

The bottom of each utility powerstrip block has slots. The slots allow the block to slide onto raised bars in the universal cable management trays, sold separately. These help keep the powerstrip in place when the tray is opened or closed.

Optional under worksurface utility power blocks do not ship with independent mounting hardware. They are designed to mount into the universal cable management kit without additional hardware. Kit sold separately.

Universal cable management tray - small tray, **DSTRAYS**M, holds four outlets and large tray, **DSTRAY**LG, holds seven outlets under worksurface utility power.

Overcurrent protection, OCP, via a circuit breaker prevents one powerstrip intro assembly from drawing more than 15 amps of power.

Overcurrent protection is included as standard with powerstrip intro configurations with more than three outlets and is an option on configurations with less than four outlets. Check with your local authorities having jurisdiction to see if overcurrent protection is required for assemblies with less than four outlets.

Overcurrent protection (OCP) includes a circuit breaker rated for 15 amps.

Powerstrip intro with optional under worksurface utility power comes standard with OCP inline box and optional 6-foot or 8-foot standard smooth power cord with a diameter of ⅜" or 163" curly cord. Choice of standard straight or 90° NEMA 5-15 3-prong plug.

NRTL listed industry safety standard UL962A furniture power distribution unit.

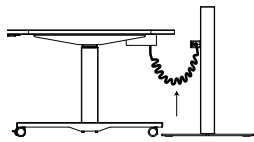

Optional 163" curly cord provides extra power cord length to reposition desk without unplugging.

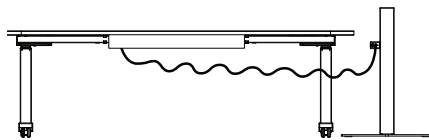

Shown repositioned desk at 90°.

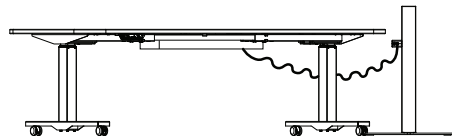

Shown repositioned desk at 180°.

Surface Materials

Housing

- 6009 Arctic White
- 6527 Merle

Tip: Arctic white housing will have white cord and merle housing will have black cord.

Utility power blocks

- 6527 Merle

Actual Dimensions

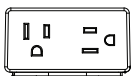

2 Ports

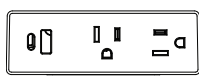

3 Ports

	2 Ports	3 Ports
D	3 ¹ / ₁₆ "	3 ⁷ / ₁₆ "
W	3 ¹ / ₁₆ "	4 ¹ / ₁₆ "
H	1 ⁵ / ₈ "	1 ⁵ / ₈ "

Underwriters Laboratory (UL) Listed. These products have been designed to meet U.S. and Canadian national electrical and energy codes and most local building codes. Local electrical codes vary, so consult with your local authority having jurisdiction as they have final say if the products as installed are compliant with local code.

Certifications include:

- cULus



Power cord length

Nema 5-15 3 prong plug options

Overcurrent Protection (OCP)



	Without under worksurface utility power	With under worksurface utility power
Power cord length	9' or 163" curly cord	6' and 8' options or 163" curly cord
Nema 5-15 3 prong plug options	Standard Straight 1 ³ / ₈ " x 1" x 7/ ₈ "	Standard Straight
Overcurrent Protection (OCP)	90° with Overcurrent Protection (OCP) in plug 2 ¹ / ₁₆ " x 1 ⁵ / ₈ " x 1 ⁷ / ₁₆ "	Standard 90°
	90° OCP plug	Included with utility power as an inline box

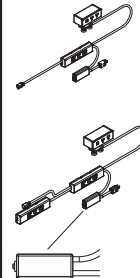

Tip: When optioning the under worksurface utility power and a height adjustable desk, specify the 8' power cord option for better reach to building outlet.

Standard 3-Prong Plug

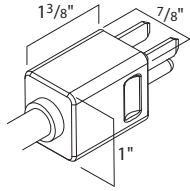

3-Prong Plus 90° Plug

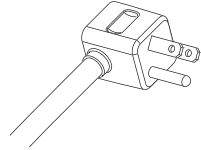

Overcurrent Protection (OCP) 90° Plug

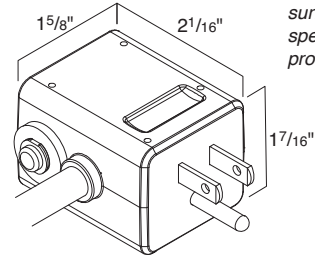

Tip: When no under work surface utility power is specified this plug will be provided.

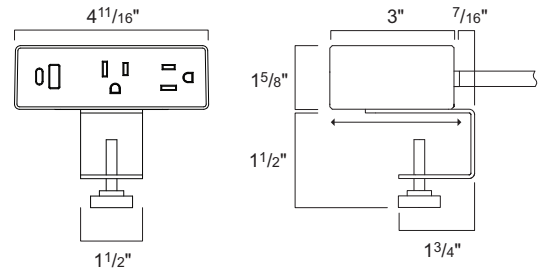
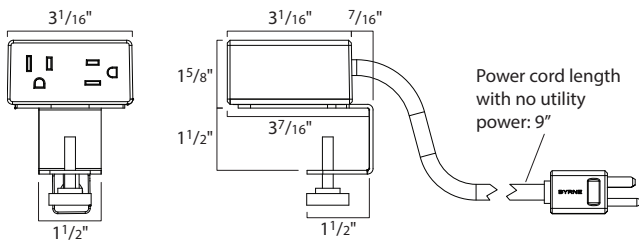

Optional Under Worksurface Utility Power

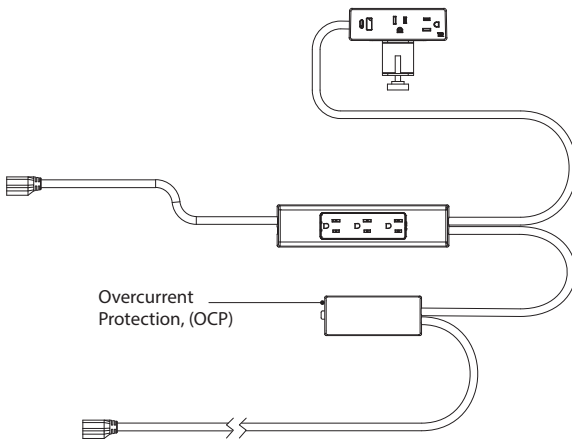

Cord from desktop power to under worksurface utility power is a preset length 48"

Cord between the two under worksurface utility powerstrips is preset at 24"

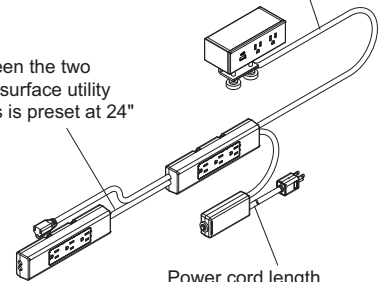

Power cord length with optional utility power: 6 ft, 8 ft, or 10 ft standard or braided. 8 ft or 163 inch curly cord.

Powerstrip Intro vs. Powerstrip Plus

Product Name	Powerstrip Intro	Powerstrip Plus	Pop Up
Number of Worksurfaces Power Configurations	3 Combination of Power outlets, USB A+C 20W	14 Combination of Power outlets, USB A+C 20W, USB-C 45W, and USB-C 100W and Data	4 Combination of Power outlets, USB A+C 20W and data
20W USB A+C	Yes	Yes	Yes
USB C-45W (Compact laptops) and 100W (Medium and large laptops)	No	Yes	Yes
Mounting Options	C-Clamp	C-Clamp, Rail, Front Edge, or Flush Mount	Flush Mount
Under Worksurface Utility Power Options	4 Outlets or 7 Outlets	4 Outlets 7 Outlets or 9 Outlets	4 Outlets, 7 Outlets, or 9 Outlets
Overcurrent Protection (OCP)	Optional with no utility power Standard with more than three power outlets Standard with utility power	Optional with no utility power Standard with more than three power outlets Standard with utility power	Optional with no utility power Standard with more than three power outlets Standard with utility power
Cord Options	Standard and Curly	Standard, Braided or Curly	Standard, Braided or Curly
Plug Options	Desktop powerstrip Standard NEMA 90° NEMA with overcurrent protection Desktop powerstrip with optional under worksurface utility powerstrip Standard NEMA 90° NEMA <i>Tip: Both plug options include overcurrent protection inline box with utility power, see illustration below.</i>	Standard NEMA 90° NEMA Thread Low Profile (with standard or braided cord only)	Standard NEMA 90 Degree NEMA Thread Low Profile (with standard or braided cord only)

Overcurrent protection inline box

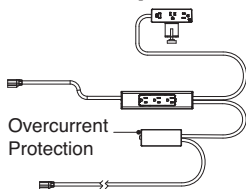

Powerstrip Plus and Pop Up Powerstrip

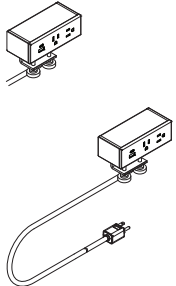

Without overcurrent protection

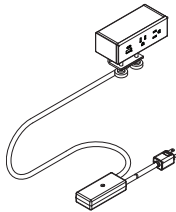

With overcurrent protection

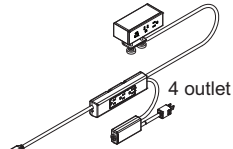

4 outlet

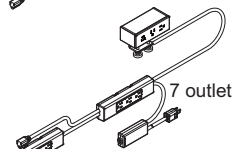

7 outlet

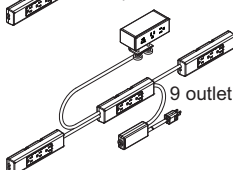

9 outlet

► Specifying, page 200

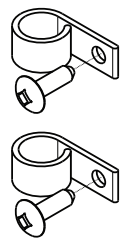
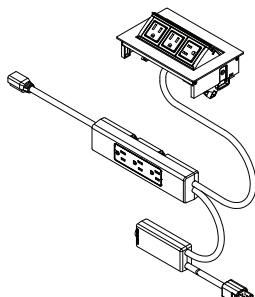

Cable management kit comes standard with each powerstrip. Mounts under the worksurface to manage cords.

Tip: Cord clip screw length for minimum worksurface thickness of 3/4".

Tip: For Bivi with a 1/2" thick surface, a shorter screw length is needed.

Pop up powerstrip is available with or without overcurrent protection, as well as four, seven, or nine outlet utility power.

► Specifying, page 202

Product Details

Desktop power offers multiple power, USB, and data options; and can be specified with a C-clamp, rail mount, front edge mount, or flush mount. Meets spill test criteria.

C-clamp is designed to accommodate worksurfaces between 1/2" and 1 3/8" thick. Also available with rail mount, front edge mount, or flush mount.

Flush mount and pop up powerstrips require the top's surface to be cut in the field. See assembly directions for details.

Front edge mount bracket attaches under the top's surface with four #10 x 7/16" screws.

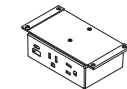

Under worksurface optional utility power blocks do not ship with independent mounting hardware. They are designed to mount into the Universal cable management kit without additional hardware. Kit sold separately.

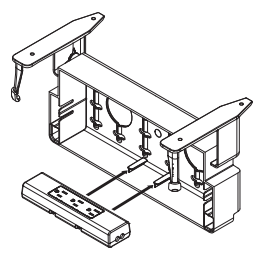
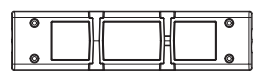
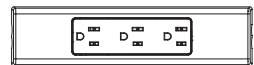

The bottom of each utility powerstrip block has slots. The slots allow the block to slide onto raised bars in the universal cable management kit. These help keep the powerstrip in place when the tray is opened or closed. Universal cable management kit sold separately.

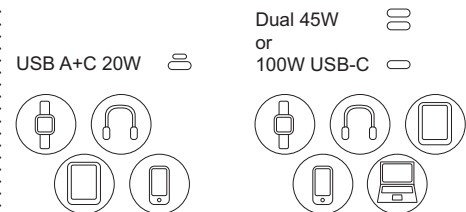

Powerstrip Plus's USB A+C 20W recommended for charging: cell phones, tablets, headphones, wearable fitness trackers, or other small electronic devices.

USB-C 45W recommended for all of the above and compact laptops.

Dual USB-C 45W, if one USB-C device is charging then full 45W is utilized. If two USB-C devices are charging, then 45W is split between each device.

USB-C 100W recommended for all of the above and medium to large size laptops.

Tip: For USB-C 100W port, use USB-C charging cable rated for 100W use for full charging benefits. Charging cables not included.

Overcurrent protection via a circuit breaker prevents one powerstrip plus assembly from drawing more than 15 amps of power.

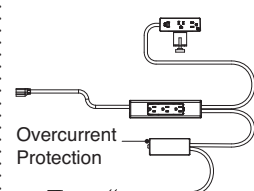

Overcurrent protection is included as standard with powerstrip plus configurations with more than three outlets and is an option on configurations with less than four outlets. Check with your local authorities having jurisdiction to see if overcurrent protection is required for assemblies with less than four outlets.

- Power plug options:**
- Standard NEMA 5-15 3 prong
 - 90° NEMA 5-15 3 prong
 - Thread low profile plug

NRTL listed industry safety standard UL962A furniture power distribution unit.

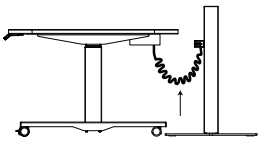

Optional 163" curly cord provides extra power cord length to reposition desk without unplugging.

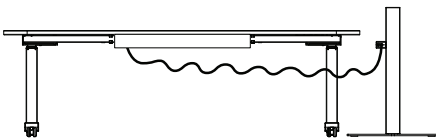

Shown repositioned desk at 90°.

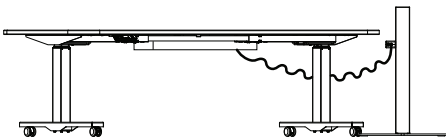

Shown repositioned desk at 180°.

Surface Materials

Desktop power

- 6000 Black
- 6009 Arctic White
- 6053 Seagull
- 6302 Baltic
- 6338 Chili
- 6527 Merle
- 6BD1 Aubergine
- 6BD2 Peacock
- 6BD5 Honey
- 6BD6 Lagoon
- 6BD7 Saffron
- 6BE2 Light Peacock

Flush mount frame and faceplate

- 6000 Black
- 6009 Arctic White
- 6053 Seagull
- 6527 Merle

Pop up powerstrip frame/lid and faceplate

- 0835 Black
- 4799 Platinum Metallic
- 7241 Arctic White
- 7243 Seagull
- 7360 Merle

Tip: When selecting 4799 Platinum Metallic on the pop up powerstrip the faceplate will be merle.

Utility power blocks

- 6527 Merle

Power cord options and lengths:

- Smooth straight 6', 8', or 10': Black or White
- Braided 6', 8', or 10': Black or Seagull
- Curly cord 8' or 163": Black or White

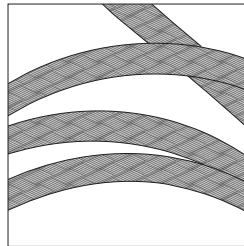

Braided cord

- 9009 Black
- 9011 Seagull

Actual Dimensions

Diameter of Powerstrip Plus power cords:

Standard	1/3"
Braided	2/5"
Curly	1/3"

(coiled area 1 1/2" diameter)

Underwriters Laboratory (UL) Listed. These products have been designed to meet U.S. and Canadian national electrical and energy codes and most local building codes. Local electrical codes vary, so consult with your local authority having jurisdiction as they have final say if the products as installed are compliant with local code.

Power configurations options guide

Hedberg Option Code	Power Outlet	Number per Powerstrip		Data
		USB A+C/ Low Wattage	USB-C/ High Wattage	
3P	3			
2P1AC20	2	1 – 20W		
2P1AC1D	2	1 – 20W		1
2P1C100	2		1 – 100W	
3P1AC	3	1 – 20W		
1P1AC1C100	1	1 – 20W	1 – 100W	
2P1AC1C100	2	1 – 20W	1 – 100W	
2P2AC	2	2 – 20W		
3P2AC20	3	2 – 20W		
3P1AC201D	3	1 – 20W		1
2P1ACC100D	2	1 – 20W	1 – 100W	1
2P2C45	2		2-45W	
2P1D (Flush mount and Pop Up only)	2			1
1P1C100 (Flush mount and Pop Up only)	1		1 – 100W	

Tip: For USB-C 100W port, use USB-C charging cable rated for 100W use for full charging benefits. Charging cables not included.

Optional data port adapter information chart. (Coupler/jack not included)

Note: Please verify fit of jack in adapter before ordering large quantities as manufacturer designs may change without notice.

Adapter	Manufacturer
BBB	L-Com Keystone Modular
BBB	NETCONNECT, and 110 Connect Series Modular Jack
BBB	Siemon ZMAX Style
BBB	Allen Tel Versa Tap Series
BBB	Leviton Quick Port Series
BBB	Belden REVConnect
BBB	HDMI Adapter Cable
CCC	Hubbell Nextspeed Keystone Series
CCC	ADC Truenet series
DDD	Blank (no coupler/jack)
EEE	Ortronics TracJack Series
FFF	Panduit Mini-Com Series
HHH	Video Monitor Jack/DB-15, panel mount solder style

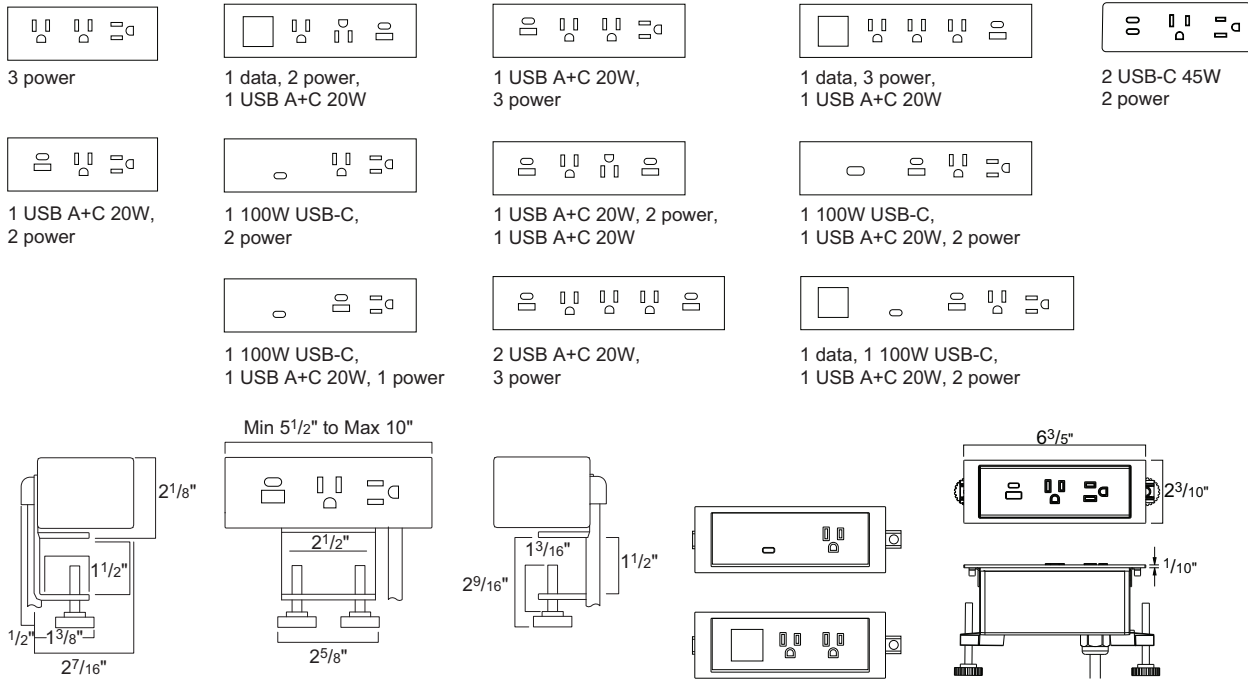

Flush Mount / Pop Up options only:

- 3 power (used on all mounting brackets)
- 1 USB A+C 20W, 2 power (used on all mounting brackets)
- 1 data, 2 power (only available with flush mount and pop up, shown above)
- 1 USB-C 100W, 1 power (only available with flush mount and pop up, shown above)

Optional Under Worksurface Utility Power Dimensions

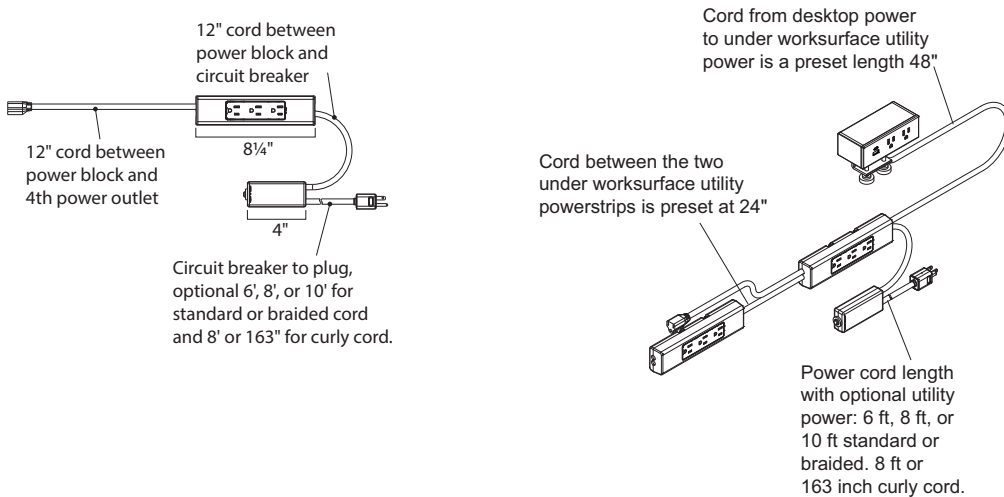

Under Worksurface Utility Power

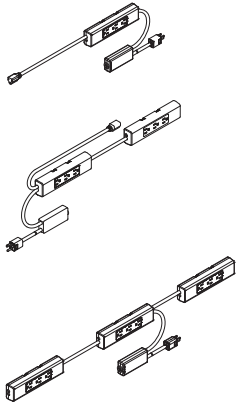

► Specifying, page 204

Product Details

Under worksurface utility power provides multiple power outlets for plugging in a height adjustable desk, computer, and desktop necessities with a one cord out solution.

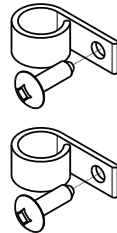

Cable management kit comes standard and mounts under the worksurface to manage cords.

Tip: Cord clip screw length for minimum worksurface thickness of 3/4".

Tip: For Bivi with a 1/2" thick surface, a shorter screw length is needed.

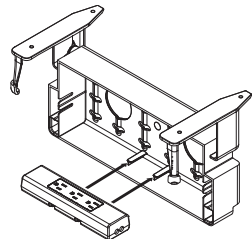

Under worksurface utility power does not ship with independent mounting hardware. The blocks are designed to mount into the universal cable management kit without additional hardware. Kit sold separately.

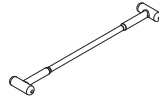
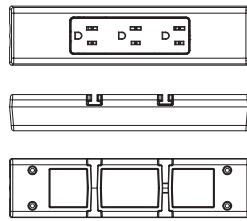

The bottom of each utility powerstrip block has slots. The slots allow the block to slide onto raised bars in the universal cable management kit trays. This design helps keep the powerstrip in place when the tray is opened or closed. Universal cable management kit's smart straps, if selected, are used to hold the power cord in place. ► See page 205 for universal cable management kit understanding content.

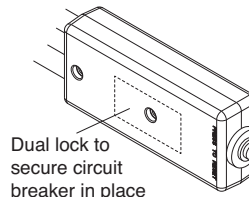
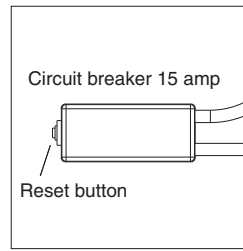

Overcurrent protection is required by UL on these products.

NRTL Listed: Utility power block outlets are hardwired together in a complete, NRTL listed assembly. *Tip: Nationally recognized testing laboratory (NRTL) listed. These products have been designed to meet U.S. and Canadian national electrical and energy codes and most local building codes. Local electrical codes vary, so consult with your local authority having jurisdiction as they have final say if the products as installed are compliant with local code.*

NRTL listed industry safety standard UL962A furniture power distribution unit.

- Power plug options:**
- Standard NEMA 5-15 3 prong
 - 90° NEMA 5-15 3 prong
 - Thread low profile plug

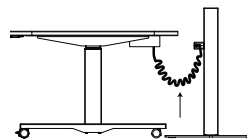

Optional 163" curly cord provides extra power cord length to reposition desk without unplugging.

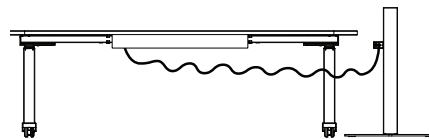

Shown repositioned desk at 90°.

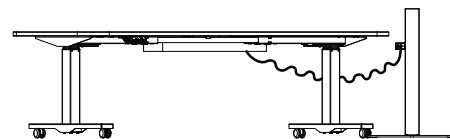

Shown repositioned desk at 180°.

Four outlets total – One utility block, with three outlets each and one floating female outlet

Seven outlets total – Two utility block, with three outlets each and one floating female outlet

Nine outlets total – Three utility block, with three outlets each.

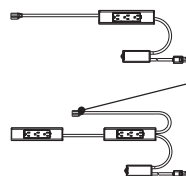

Floating female outlet for oversized plugs or power supplies.



Optional standard NEMA 3-prong plug, 90° or thread low profile plug.

Surface Materials

Power cord options and lengths:

- Smooth straight 6', 8', or 10': black or white
- Braided 6', 8', or 10': black or seagull
- Curly cord 8' or 163": back or white

Utility power blocks

- 6527 Merle

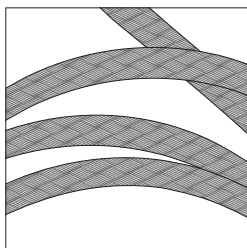

Braided cord

- 9009 Black
- 9011 Seagull

Actual Dimensions

Power blocks

Depth	2"
Width	8¼"
Thickness	1"

Dimensions

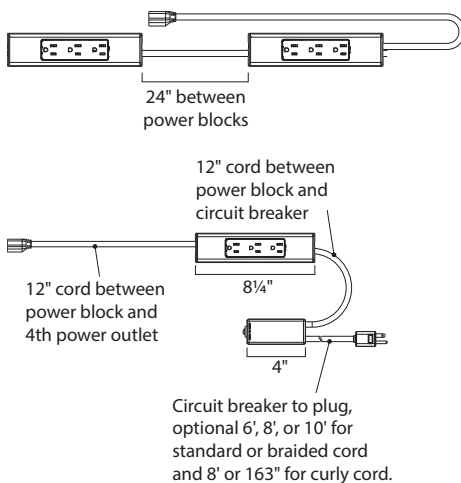

Optional under worksurface utility power available with:

- NEMA 90°
- Standard NEMA 5-15 3-prong
- Thread low profile plug

Universal Cable Management Kits

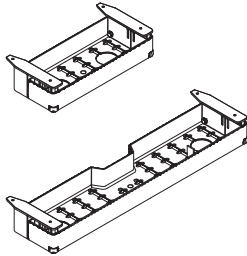

► Specifying, page 205

Product Details

Universal cable management kit provides easy management and access to cords, cables, and power blocks under a workstation.

Optional smart straps allow for easy management of cables and cords in the cable management tray. Straps are 5³/₄" long.

Cable management tray is designed to fit behind the stretcher bar and under-structure of most Steelcase height-adjustable tables. *Tip: Exceptions are Ology desks with integrated rail or modesty panel.*

Cable management tray provides tool-free and hardware-free mounting of under worksurface utility power.

Cable management tray allows for a 1/8" gap around all four sides between the tray and the worksurface when mounted to allow for cable egress.

The small 15¹/₂" cable management tray is designed to hold one, 4 outlet, utility powerstrip.

The tray does not have the capacity to hold more than one utility powerstrip. *Tip: When specifying for Flex personal spaces 120° height-adjustable desks, only small cable management kit will fit.*

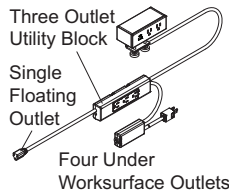
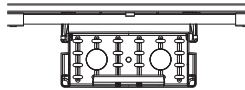

The large 30" cable management tray holds two utility powerstrips in the raised bars section. There is capacity to add three utility powerstrips, two in the raised bar area and one more in the tray, strapped down.

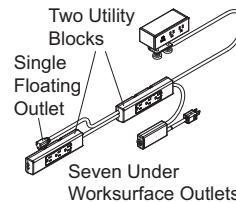
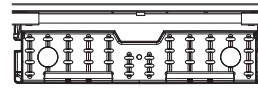

Consider ordering one small and one large tray when specifying nine under worksurface outlets, for additional storage.

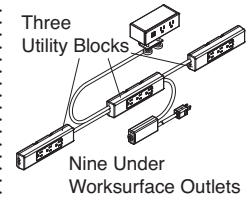

Surface Materials

Cable tray
• 6205 Black

Actual Dimensions

Depth 6⁵/₁₆"
(7⁴/₈" with bracket)

Width 15¹/₂", 30"

Height 2⁵/₈"
(3¹/₂" when installed)

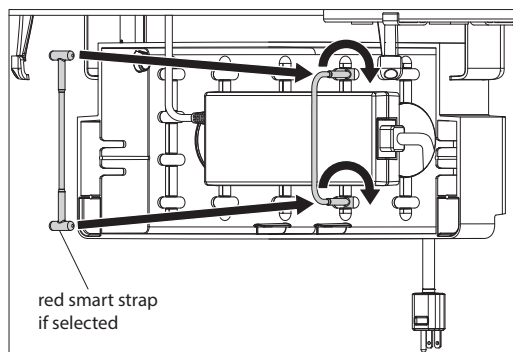
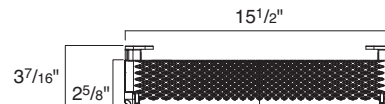
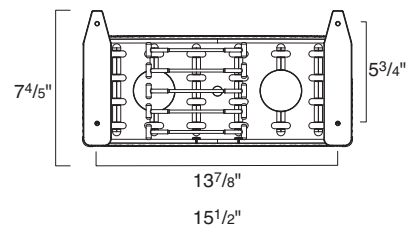
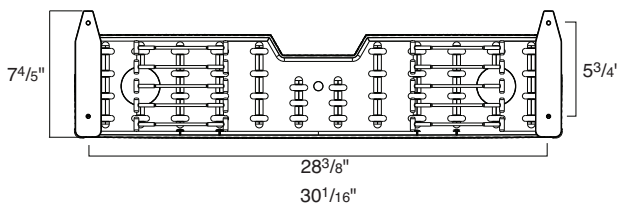

High-Capacity Cable Riser

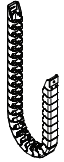

Tip: Screw attachment to the underside of the mounting surface.

Tip: Magnetic bottom bracket attaches to metal magnetic surface.

Tip: Do not use with integrated storage.

Tip: Do not use within an enclosed area that would restrict the movement of the cable riser's links.

Tip: Total weight is 1.2 pounds (without cords).

Standard Includes		Required to Specify
▶ Need help? Product details, page 184	<ul style="list-style-type: none"> High capacity vertical cable riser: plastic Attachment hardware for top bracket Magnetic bottom bracket 	1 Style number 2 Plastic color number for cable riser: 6053 Seagull 6527 Merle

Related Products	
<ul style="list-style-type: none"> Powerstrip Intro Powerstrip Plus Pop Up Powerstrip 	<ul style="list-style-type: none"> ▶ Page 199 ▶ Page 200 ▶ Page 202

Specification Information				
Dimensions			Style Number	U.S. Price
D	W	L		
17/16"	131/32"	415/16"	DSVCMHC	\$215

Tip: Top thickness minimum of 1" with hardware included. If top is less than 1" thick, shorter screws will be needed.

Tip: For Bivi with a 1/2" thick surface, a shorter screw length is needed.

Vertical Cable Carrier



Tip: Vertical cable carrier is recommended for use with height-adjustable work surfaces.

Tip: Vertical cable carrier affixes under the work surface and has a weighted base to hold it in place.

Standard Includes		Required to Specify
▶ Need help? Product details, page 185	<ul style="list-style-type: none"> Cable carrier: 6688 Steel Attachment hardware 	Style number

Specification Information			
Dimensions		Style Number	U.S. Price
W	H		
21/2"	52"	AHCC	\$251

 **For Canadian Pricing**
 Multiply U.S. Price by the Canadian price factor.
 ▶ See page 1 for details.

6"D Wire Managers

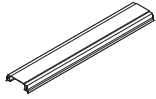

Tip: Wire manager attaches to a clip that is affixed to the underside of a worksurface.

Tip: Top thickness minimum of 1" with hardware included. If top is less than 1" thick, shorter screws will be needed.

Standard Includes		Required to Specify
▶ Need help? Product details, page 185	<ul style="list-style-type: none"> • Wire manager: 6000 Black or 6249 Platinum • Attachment hardware 	1 Style number 2 Plastic color number for wire manager

Specification Information					
• Dimensions			• Weight	• Style Number	• U.S. Price
D	W	H			
6"	30½"	2"	0.13 lb	AWMXL30	\$110
6"	36½"	2"	0.24 lb	AWMXL36	\$126
6"	42½"	2"	0.34 lb	AWMXL42	\$143
6"	48½"	2"	0.44 lb	AWMXL48	\$156
6"	54½"	2"	0.56 lb	AWMXL54	\$175
6"	60½"	2"	0.65 lb	AWMXL60	\$194

1¾"D Wire Managers

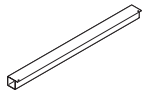

*Tip: Actual width of **AWM23** is 23¼".*

Tip: Top thickness minimum of 1" with hardware included. If top is less than 1" thick, shorter screws will be needed.

Standard Includes		Required to Specify
▶ Need help? Product details, page 185	<ul style="list-style-type: none"> • Wire manager: 6000 Black • Attachment hardware, includes four #10 x 7/16" screws 	Style number

Specification Information					
• Dimensions			• Weight	• Style Number	• U.S. Price
D	W	H			
1¾"	6"	1¾"	0.13 lb	AWM06	\$ 38
1¾"	12"	1¾"	0.24 lb	AWM12	\$ 50
1¾"	18"	1¾"	0.34 lb	AWM18	\$ 57
1¾"	23"	1¾"	0.44 lb	AWM23	\$ 65
1¾"	30"	1¾"	0.56 lb	AWM30	\$ 76
1¾"	35"	1¾"	0.65 lb	AWM35	\$ 83
1¾"	42"	1¾"	0.77 lb	AWM42	\$ 92
1¾"	48"	1¾"	0.88 lb	AWM48	\$104



For Canadian Pricing
 Multiply U.S. Price by the Canadian price factor.
 ▶ See page 1 for details.

Powerstrip Intro

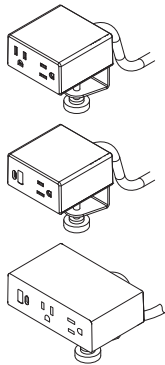

Tip: C-clamp is designed to accommodate workspaces up to 1 1/2" thick.

Tip: Overcurrent protection includes a 15 amp circuit breaker.

Tip: USB A+C 20W for charging cell phones, tablets, headphones, wearable fitness trackers, or other small electronic devices.

Tip: Optional under worksurface utility power blocks do not ship with independent mounting hardware. Designed to be used with the universal cable management kits. Kit sold separately.

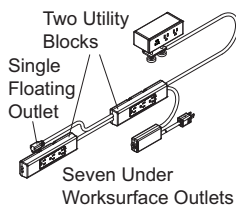
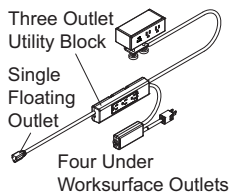

Standard Includes		Required to Specify
▶ Need help? Product details, page 186	<ul style="list-style-type: none"> • Powerstrip intro: plastic • Straight 3-prong plug • C-clamp mount • Cord managers • NRTL listed 	<ol style="list-style-type: none"> 1 Style number 2 Desktop power configuration (see below under Required Selections) 3 Plastic color number for housing: 6009 Arctic White, 6527 Merle 4 Options, (if selected) see below

	Required Selections	U.S. Price	Required to Specify
Desktop Power Configuration	<ul style="list-style-type: none"> • Two power outlets • One power outlet with one USB A+C 20W • Two power outlets with one USB A+C 20W 	No cost +\$ 43 +\$132	Specify with two power outlets. Specify with one power outlet with one USB A+C 20W. Specify with two power outlets with one USB A+C 20W.

	Options	U.S. Price	Required to Specify
Power Plug Type	<ul style="list-style-type: none"> • Standard NEMA 3-prong • 90° NEMA with overcurrent protection (OCP, used when desktop power only is specified, no utility power) • 90° NEMA (No OCP, used when utility power option is specified) 	No cost +\$ 56 +\$ 39	Specify with standard NEMA plug. Specify with 90° NEMA plug with overcurrent protection (OCP). Specify with 90° NEMA (no OCP).

Under Worksurface Utility Power Configuration	<ul style="list-style-type: none"> • Four outlets total—one utility block, with three outlets each, and one floating female outlet • Seven outlets total—two utility blocks, with three outlets each, and one floating female outlet 	+\$139 +\$277	Specify with one utility and one female plug. Specify with two utility and one female plug.
------------------------------------------------------	--------------------------------------------------------------------------------------------------------------------------------------------------------------------------------------------------------------------------------------------------------------	------------------	------------------------------------------------------------------------------------------------

Power Cord Lengths Without Under Worksurface Utility Power	<ul style="list-style-type: none"> • 9' standard • 163" curly cord 	No cost +\$314	Specify with 9' standard cord. Specify with 163" curly cord.
-------------------------------------------------------------------	--------------------------------------------------------------------------------------------	-------------------	-----------------------------------------------------------------

Power Cord Lengths With Under Worksurface Utility Power	<ul style="list-style-type: none"> • 6' standard • 8' standard • 163" curly cord 	No cost +\$ 22 +\$314	Specify with 6' standard cord. Specify with 8' standard cord. Specify with 163" curly cord.
----------------------------------------------------------------	-------------------------------------------------------------------------------------------------------------------	-----------------------------	---------------------------------------------------------------------------------------------------

Specification Information				
• Dimensions			• Style	• U.S. Base
D	W	H	Number	Price
3"	3"	3 1/8"	DSPINTRO	\$222

Tip: Specify 163" curly cord and 90° NEMA plug together and add additional cord management near the plug for a more secure power connection during desk movement.

Tip: Check top surface thickness and cord manager length to determine if shorter screws are needed.

Tip: Cord clip screw length for minimum worksurface thickness of 3/4".



For Canadian Pricing

Multiply U.S. Price by the Canadian price factor.

▶ See page 1 for details.

Powerstrip Plus



C-clamp

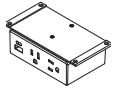

Front edge mount

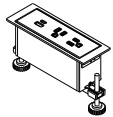

Flush mount

Tip: C-clamp is designed to accommodate worksurfaces between 1/2" and 1 3/8" thick.

Tip: Desktop power cord exit extends 1/2" off of the back of the worksurface when C-clamped.

Tip: 20-watt USB-C provides wattage to charge cell phones and tablets. 45-watt and 100-watt USB-C is needed to charge larger devices like compact laptops.

Tip: Cord length between desktop power and under worksurface power is 48" and length between under worksurface blocks is 24".

Tip: Power cord 8' or 163" curly cannot be specified with power plug type thread low profile.

Tip: Cord clip screw length for minimum worksurface thickness of 3/4".

Tip: Flush mount requires top surface to be field cut. See assembly directions for details.

Tip: Flush mount faceplate mounts flat just above worksurface.

Tip: For USB-C 100W port, use USB-C charging cable rated for 100W use for full charging benefits. Charging cables not included.

	Standard Includes	Required to Specify
▶ Need help? Product details, page 190	<ul style="list-style-type: none"> • Powerstrip plus: plastic price group 1 and group 2 • 8' standard power cord: black or white • C-clamp mount • Cord managers • NRTL listed 	<ol style="list-style-type: none"> 1 Style number 2 Desktop power mount (see below under Required Selections) 3 Desktop power configuration (see below under Required Selections) 4 Plastic color number for powerstrip 5 Plastic color number for power cord 6 Options, (if selected) see below <p>▶ Surface Materials, see page 264.</p>

	Required Selections	U.S. Price	Required to Specify
Desktop Power Mount	<ul style="list-style-type: none"> • C-clamp • Front edge under mount • Rail mount • Flush mount 	<p>No cost</p> <p>+\$ 22</p> <p>+\$ 35</p> <p>No cost</p>	<p>Specify with C-clamp power mount.</p> <p>Specify with front-edge under mount.</p> <p>Specify with rail power mount.</p> <p>Specify with flush mount.</p>
Desktop Power Configuration	<ul style="list-style-type: none"> • Three power outlets • Two power outlets with USB A+C 20-watt • Two power outlets with USB A+C 20W and open data port • Three power outlets with USB A+C 20W • Three power with dual USB A+C 20-watt and open data port • Two power outlets with dual 45-watt USB-C • Three power with two dual USB A+C 20-watt • Two power with dual USB A+C 20W • Two power outlets with 100-watt USB-C • One power outlet with USB A+C 20W and 100-watt USB-C • Two power outlets with USB A+C 20W and 100-watt USB-C • Two power outlets with USB A+C 20W, 100-watt USB-C, and open data port 	<p>No cost</p> <p>+\$ 69</p> <p>+\$104</p> <p>+\$104</p> <p>+\$139</p> <p>+\$161</p> <p>+\$277</p> <p>+\$347</p> <p>+\$347</p> <p>+\$484</p> <p>+\$555</p> <p>+\$622</p>	<p>Specify with three power outlets.</p> <p>Specify with two power outlets with USB A+C 20-watt.</p> <p>Specify with two power outlets with USB A+C 20W and open data port.</p> <p>Specify with three power outlets with USB A+C 20W</p> <p>Specify with three power with dual USB A+C 20-watt and open data port.</p> <p>Specify with two power outlets with dual 45-watt USB-C.</p> <p>Specify with three power with two dual USB A+C 20-watt.</p> <p>Specify with two power with dual USB A+C 20W.</p> <p>Specify with two power outlets with 100-watt USB-C.</p> <p>Specify with one power outlet with USB A+C 20W and 100-watt USB-C.</p> <p>Specify with two power outlets with USB A+C 20W and 100-watt USB-C.</p> <p>Specify with two power outlets with dual USB A+C 20W, 100-watt USB-C, and open data port.</p>
Flush mount only	<ul style="list-style-type: none"> • Two power outlets and open data port • One power outlet with 100-watt USB-C 	<p>No cost</p> <p>+\$269</p>	<p>Specify with two power outlets and open data port.</p> <p>Specify with one power outlet 100-watt USB-C.</p>

▶ Options, continued on next page

Tip: For Bivi with a 1/2" thick top surface, a shorter screw length is needed.

Tip: Under worksurface power blocks do not ship with independent mounting hardware. They are designed to mount into the Universal cable management kit without additional hardware. Kit sold separately.

Tip: Overcurrent protection includes a 15 amp circuit breaker.

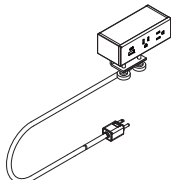

Without overcurrent protection

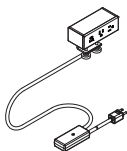

With overcurrent protection

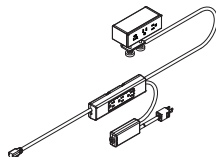

with optional under worksurface utility power with 4 outlets

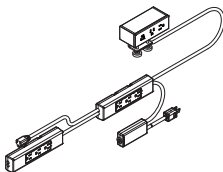

with optional under worksurface utility power with 7 outlets

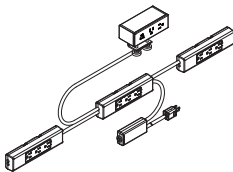

with optional under worksurface utility power with 9 outlets



For Canadian Pricing
Multiply U.S. Price by the Canadian price factor.
▶ See page 1 for details.

► Options, continued from previous page

Options	U.S. Price	Required to Specify
Surface Materials	• Plastic price groups 1 and 2 No cost	Specify plastic color number.
Under Worksurface (Utility) Power Configuration	• No under worksurface power No cost • No under worksurface with overcurrent protection +\$ 56 • Four outlets total—one utility block, with three outlets each, and one floating female outlet +\$139 • Seven outlets total—two utility blocks, with three outlets each, and one floating female outlet +\$277 • Nine outlets total—three utility blocks, with three outlets each +\$417	Specify with no utility. Specify with no utility and with overcurrent protection. Specify with one utility and one female plug. Specify with two utility and one female plug. Specify with three utility.
Power Cord	• 6' standard cord -\$ 22 • 8' standard cord No cost • 10' standard cord No cost • 6' braided cord +\$ 74 • 8' braided cord +\$222 • 10' braided cord +\$222 • 8' curly cord +\$277 • 163" curly cord +\$314	Specify with 6' standard cord. Specify with 8' standard cord. Specify with 10' standard cord. Specify with 6' braided cord. Specify with 8' braided cord. Specify with 10' braided cord. Specify with 8' curly cord. Specify with 163" curly cord.
Power Cord Color	Standard and curly cord • Black No cost • White No cost	Specify with black cord. Specify with white cord.
	Braided cord • Black No cost • Seagull No cost	Specify with black braided cord. Specify with seagull braided cord.
Power Plug Type	• Standard NEMA 3-prong No cost • 90° NEMA +\$ 39 • Thread low profile +\$ 43	Specify with standard NEMA plug. Specify with 90° NEMA plug. Specify with Thread low profile plug.

Specification Information

Style Number	U.S. Base Price
DSPower	\$431

Tip: Configurations with outlets under the worksurface are standard with overcurrent protection.

Tip: Local electrical codes vary, so consult with your local authority having jurisdiction as they have final say if the products as installed are compliant with local code.

Tip: Height-adjustable desks can be plugged into powerstrip's utility power for a one cord down solution.

Tip: When using powerstrip plus with nine outlets under worksurface utility power, specify one large and one small universal cable management kit.

Tip: Do not use a vertical cable manager with a curly cord or braided cord.

Tip: Curly power cord cannot be used with power plug type thread.

Tip: Specify 163" curly cord and 90° NEMA plug together and add additional cord management near the plug for a more secure power connection during desk movement.

Pop Up Powerstrip

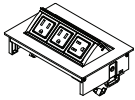

Tip: Illustration above includes the four outlet under worksurface utility power option.

Tip: Pop up powerstrips require the top's surface to be cut in the field. See assembly directions for further details.

Tip: For USB-C 100W port, use USB-C charging cable rated for 100W use for full charging benefits. Charging cables not included.

Tip: Optional data port adapter, coupler/jack not included. Verify fit of jack in adapter before ordering large quantities as manufacturer designs may change without notice.

Tip: Cord clip screw length for minimum worksurface thickness of 3/4".

Tip: Power cord 8' curly or 163" curly cannot be specified with power plug type thread.

Tip: Under worksurface power blocks do not ship with independent mounting hardware. They are designed to mount into the universal cable management kit without additional hardware. Kit sold separately.

Tip: When selecting 4799 Platinum Metallic on the pop up powerstrip the faceplate will be merle.

Tip: Do not use a vertical cable manager with a curly cord or braided cord.

Tip: For Bivi with a 1/2" thick top surface, a shorter screw length is needed.



For Canadian Pricing

Multiply U.S. Price by the Canadian price factor.

▶ See page 1 for details.

	Standard Includes	Required to Specify
▶ Need help? Product details, page 190	<ul style="list-style-type: none"> • Desktop module, with one touch open and close hinged door; anodized aluminum with painted steel • 8' standard power cord: black or white • Cord managers • Faceplate keystone provided when data is specified • NRTL Listed 	<ol style="list-style-type: none"> 1 Style number 2 Paint color number for powerstrip: <ul style="list-style-type: none"> 0835 Black 4799 Platinum Metallic 7241 Arctic White 7243 Seagull 7360 Merle 3 Power configuration (see below under Required Selections) 4 Options, if selected (see below)

	Required Selections	U.S. Price	Required to Specify
Power Configuration	<ul style="list-style-type: none"> • Three power outlets • Two power, one data • Two power, one USB A+C 20W • One power, one USB-C 100W 	<ul style="list-style-type: none"> No cost No cost +\$ 69 +\$269 	<ul style="list-style-type: none"> Specify with three power outlets. Specify with two power, one data. Specify with two power, one USB A+C 20W. Specify with one power, one USB-C 100W.

	Options	U.S. Price	Required to Specify
Under Worksurface Utility Power Configuration	<ul style="list-style-type: none"> • No under worksurface power • No under worksurface with overcurrent protection • Four outlets total – one utility block, with 3 outlets each and one floating female outlet • Seven outlets total – two utility blocks, with 3 outlets each and one floating female outlet • Nine outlets total – three utility blocks, with 3 outlets each 	<ul style="list-style-type: none"> No cost +\$ 56 +\$139 +\$277 +\$417 	<ul style="list-style-type: none"> Specify with no utility. Specify with no utility and with overcurrent protection. Specify with one utility and one female plug. Specify with two utility and one female plug. Specify with three utility.

		U.S. Price	Required to Specify
Power Cord	<ul style="list-style-type: none"> • 6' standard cord • 8' standard cord • 10' standard cord • 6' braided cord • 8' braided cord • 10' braided cord • 8' curly cord • 163" curly cord 	<ul style="list-style-type: none"> -\$ 22 No cost No cost +\$ 74 +\$222 +\$222 +\$277 +\$314 	<ul style="list-style-type: none"> Specify with 6' standard cord. Specify with 8' standard cord. Specify with 10' standard cord. Specify with 6' braided cord. Specify with 8' braided cord. Specify with 10' braided cord. Specify with 8' curly cord. Specify with 163" curly cord.

	Standard and curly cord	U.S. Price	Required to Specify
Power Cord Color	<ul style="list-style-type: none"> • Black • White 	<ul style="list-style-type: none"> No cost No cost 	<ul style="list-style-type: none"> Specify with black cord. Specify with white cord.
	Braided cord		
	<ul style="list-style-type: none"> • Black • Seagull 	<ul style="list-style-type: none"> No cost No cost 	<ul style="list-style-type: none"> Specify with black braided cord. Specify with seagull braided cord.

▶ Options, continued on next page

► Options, continued from previous page

Options	U.S. Price	Required to Specify
Power Plug Type	<ul style="list-style-type: none"> Standard NEMA 3-prong 90° NEMA Thread low profile 	<ul style="list-style-type: none"> No cost +\$39 +\$43
Related Products	<ul style="list-style-type: none"> Universal cable management kits 	► Page 205

Tip: Local electrical codes vary, so consult with your local authority having jurisdiction as they have final say if the products as installed are compliant with local code.

Tip: Height-adjustable desks can be plugged into power-strip's utility power for a one cord down solution.

Specification Information		
Dimensions	Style	U.S.
D W H	Number	Base Price
·	·	·
·	·	·
·	·	·

Powerstrip Pop Up

4½"	6¾"	2⅓"	DSPOP	\$431
·	·	·	·	·

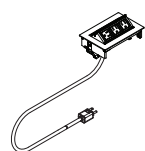

Without overcurrent protection

Tip: Illustration above includes the four outlet under worksurface utility power option.

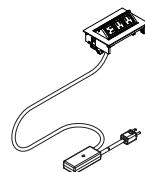

With overcurrent protection

Tip: When using power-strip pop up with nine utility power outlets, specify one large and one small universal cable management kit.

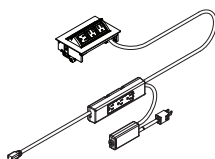

With optional under worksurface utility power with 4 outlets

Tip: Specify 163" curly cord and 90° NEMA plug together and add additional cord management near the plug for a more secure power connection during desk movement.

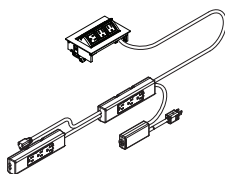

With optional under worksurface utility power with 7 outlets

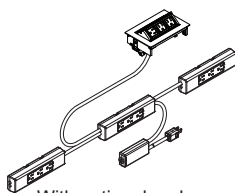

With optional under worksurface utility power with 9 outlets

Under Worksurface Utility Power

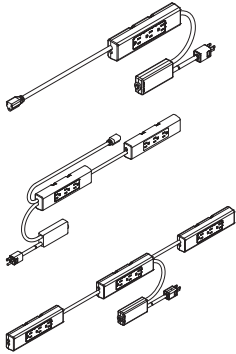

Tip: Under worksurface power blocks do not ship with independent mounting hardware. They are designed to mount into the universal cable management kit without additional hardware. Kit sold separately.

Tip: Overcurrent protection includes a 15 amp circuit breaker.

Tip: Do not use a vertical cable manager with a curly cord or braided cord.

Tip: Cord length between blocks is 24", if applicable.

Tip: Never plug a powerstrip into another powerstrip.

Tip: 4 outlet utility block fits in the small tray universal cable management kit, 7 outlet utility block fits in large tray universal cable management kit, and 9 outlets with three utility blocks, specify one large and one small universal cable management kit. Kit sold separately.

Tip: Power cord 8' curly cannot be specified with power plug type thread low profile.

Tip: Cord clip screw length for minimum worksurface thickness of 3/4".

Tip: Specify 163" curly cord and 90° NEMA plug together and add additional cord management near the plug for a more secure power connection during desk movement.

Standard Includes	Required to Specify
<ul style="list-style-type: none"> ▶ Need help? Product details, page 190 • Under worksurface utility power: 4 outlets • 8' standard cord: plastic • Circuit breaker • Cord managers • Power blocks in merle finish • NRTL listed 	<ol style="list-style-type: none"> 1 Style number 2 Under worksurface utility power configuration (see below under Required Selections) 3 Options, (if selected) see below

	Required Selections	U.S. Price	Required to Specify
Under Worksurface Utility Power Configuration	• Four outlets total – one utility block, with three outlets each and one floating female outlet	No cost	Specify with one utility and one female plug.
	• Seven outlets total – two utility blocks, with three outlets each and one floating female outlet	+\$132	Specify with two utility and one female plug.
	• Nine outlets total – three utility blocks, with three outlets each	+\$264	Specify with three utility.

	Options	U.S. Price	Required to Specify
Power Cord	• 6' standard cord	–\$ 22	Specify with 6' standard cord.
	• 8' standard cord	No cost	Specify with 8' standard cord.
	• 10' standard cord	No cost	Specify with 10' standard cord.
	• 6' braided cord	+\$ 74	Specify with 6' braided cord.
	• 8' braided cord	+\$222	Specify with 8' braided cord.
	• 10' braided cord	+\$222	Specify with 10' braided cord.
	• 8' curly cord	+\$277	Specify with 8' curly cord.
	• 163" curly cord	+\$314	Specify with 163" curly cord.
Power Cord Color	Standard and curly cord		
	• Black	No cost	Specify with black cord.
	• White	No cost	Specify with white cord.
Power Plug Type	Braided cord		
	• Black	No cost	Specify with black braided cord.
	• Seagull	No cost	Specify with seagull braided cord.
	• Standard NEMA 3-prong	No cost	Specify with standard NEMA plug.
	• 90° NEMA	+\$ 39	Specify with 90° NEMA plug.
	• Thread low profile	+\$ 43	Specify with Thread low profile plug.

Related Products • Universal cable management kits ▶ Page 205

Specification Information

Style Number	U.S. Base Price
DSUP	\$198

Tip: For Bivi with a 1/2" or shorter thick top surface, a shorter screw length is needed for cord manager.

Universal Cable Management Kits

Standard Includes		Required to Specify
▶ Need help? Product details, page 196	<ul style="list-style-type: none"> Cable management tray: 6205 Black Attachment hardware 	1 Style number 2 Options, if selected (see below)

Options	U.S. Price	Required to Specify
Strap • Smart straps	No cost	Specify with <i>smart straps</i> .

Tip: The weight limit of the 15½" tray is five pounds, while the weight limit of the 30" tray is 10 pounds.

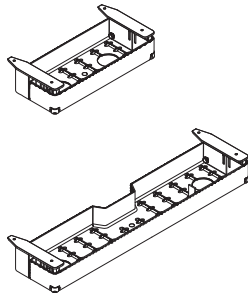

Tip: When installed, tray provides ¼" of clearance on all sides to allow for cable egress between the underside of the worksurface and the top of the tray.

Tip: Tray attachment hardware accommodates work-surfaces more than ¾" in thickness. Screws may pop through thinner work-surfaces.

Tip: Cord clip screw length for minimum worksurface thickness of ¾".

Tip: For Bivi with a ½" thick top surface, a shorter screw length is needed.

Tip: Does not fit behind stretcher bar on Ology desk with integrated rail or modesty panel.

Specification Information				
Dimensions			Style	U.S.
D	W	H	Number	Price

Small Cable Management Kit

7½"	15½"	3½"	DSTRAYSM	\$104
-----	------	-----	-----------------	-------

Large Cable Management Kit

7½"	30"	3½"	DSTRAYLG	\$139
-----	-----	-----	-----------------	-------

 **For Canadian Pricing**
 Multiply U.S. Price by the Canadian price factor.
 ▶ See page 1 for details.

Smart Straps Bulk Pack

For Use with Universal Cable Management Kit

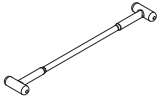

Tip: A pack of five smart straps is available as a service part.

Standard Includes	Required to Specify
<ul style="list-style-type: none"> • 100 red rubber: smart straps • 5½" in length 	Style number

Specification Information	
Style Number	U.S. Price
DSBULKSTRP	\$139



For Canadian Pricing

Multiply U.S. Price by the Canadian price factor.

▶ See page 1 for details.

Modular Power Systems

Modular Power Comparison	208
How to Calculate Power Needs	209
Universal Modular Power System	211
Relay Modular Power System	239

Modular Power Comparisons

Universal Modular Power System and Relay Modular Power System

	Universal Modular Power System	Relay Modular Power System
Single circuit – 15 amps**	Yes	Yes
Electrician needed	No	No
Plugs into building receptacle	Yes	Yes
Hardwired	No	No
Reconfigurable by facilities	Yes	Yes
One direction	Yes	Yes
Splits power in two directions	Yes	No
Linear same height furniture, lounge, or flip top training tables	Yes	Yes
Height-adjustable furniture	Yes	No
Monthly reconfiguring of furniture	Yes	Yes
Training tables/weekly reconfiguring frequently	Not recommended if reconfiguring weekly	Yes push button disconnect
Furniture required to be ganged together	No	Yes
Max powerstrips/connections	20	8
Max simplex per powerstrip	8	3
Powerstrip with option 4 power outlet under worksurface utility power	Yes	No
Country availability*	U.S. & Canada	U.S. & Canada
Overall lengths	50' (Chicago 30')	40'
Warranty	Same	Same
NRTL listed industry safety standard UL962A furniture power distribution unit	Yes	Yes

Tip: Bolded text indicates product differentiation between Universal and Relay Modular Power System.

**Always check first with local authorities having jurisdiction for any restrictions.*

***Review customer power usage needs and reference How to Calculate Power Needs for creating the best experience.*

How to Calculate Power Needs

Use This to Determine How Many Power-Ins You'll Need

How to Calculate
Power Needs

When planning a modular power network, you must calculate the amperage requirements of all your electrical components so you can provide sufficient electricity to power them.

If your usage is known in advance:

Add up the amperage used by each piece of equipment in the workstation. Whenever you reach 15 amps per circuit from items that are likely to be used at the same time, you have reached the limit for a single power-in. Specify another power-in and continue until all equipment is powered.

If the circuits will normally be subject to a continuous load (three or more hours of continuous use, such as lights or computers), the NEC requires that circuit capacity be "de-rated" by 20 percent. Therefore, treat circuits used for continuous loads as if they were rated at 12 amps instead of the regular 15 amps.

Try to anticipate future increases in power requirements and build some excess capacity into your plan.

▶ See table at right for typical and actual amperage usages for components.

To calculate amperage when the wattage of a device is known, divide watts by 120.

Some appliances, such as large copiers, coffee makers, or space heaters may require most of the current available on a 15 amp circuit. It is recommended that such devices be supplied with their own receptacle/circuit, directly from the building. This leaves the capacity of the furniture circuits available for the more dynamic requirements of the office equipment.

Local electrical codes vary. Consult a qualified electrical contractor or engineer for the proper planning of electrical circuits in your locale.

Approximate power consumption for common devices

• Device	• Amperage
Laptop	0.8
CPU/Desktop Computer	1.1
Monitor	0.5
Desktop Task Light	0.2
Cell Phone Charger in use	2
High Power Tablet (e.g. Surface Pro)	0.4
Low Power Tablet (e.g. iPad Air)	0.1
Height-Adjustable Desks:	
Ology, Flex	
2 columns in motion	2.5
*Standby mode	0.0008
3 columns in motion	3.75
*Standby mode	0.0008
Height-Adjustable Desks:	
Migration SE	
2 columns in motion	5
*Standby mode	0.0025
Bluetooth Speaker	0.1
Desktop Printer	0.4
42" LCD Screen	1.9
DVD Player	0.2
Projector	1.6
Large Printer/Copier (high)	17.3
Large Printer/Copier (low)	7.7
Paper Shredder	3.3
Desktop Fan	0.2
Standing Fan	1.6
Coffee Maker (high)	10.9
Coffee Maker (low)	5.5
Microwave (high)	13.6
Microwave (low)	5.5
Refrigerator (high)	3.6
Refrigerator (low)	1.4
Vacuum (high)	13.6
Vacuum (low)	1.8
Space Heater (high)	13.6
Space Heater (low)	6.8

Tip: These calculations are estimations and are meant solely for informational purposes. It is important to conduct proper power planning for each installation to prevent overloading a circuit.



Universal Modular Power System

			
Statement of Line	212	Modular Power—Jumper Cord—Straight	
		Understanding	216
		Specifying	234
		Modular Power—Jumper Cord—Curly	
Steelcase Universal Modular Power System Overview—Desking	213	Understanding	216
Steelcase Universal Modular Power System Overview—Conference Table	214	Specifying	235
Steelcase Universal Modular Power System Overview—Power infeed entering from center, Splitting power in two directions	215	Modular Power—Power Distribution Block	
Modular Power—Under Worksurface Utility Power—Four outlets		Understanding	216
Understanding	216	Specifying	236
Specifying	226	Modular Power—Infeed Power Splitter Distribution Block	
Modular Power—Powerstrip with Edge Mount		Understanding	216
Understanding	216	Specifying	237
Specifying	227	Modular Power—Cord Management Clips—Two Pack	
Modular Power—Powerstrip with C-Clamp		Understanding	216
Understanding	216	Specifying	238
Specifying	228	Modular Power—Cord Management Clips—Six Pack	
Modular Power—Pop Up Powerstrip		Understanding	216
Understanding	216	Specifying	238
Specifying	229		
Modular Power—Flush Mount Powerstrip			
Understanding	216		
Specifying	230		
Modular Power—Pyramid Powerstrip			
Understanding	216		
Specifying	231		
Modular Power—Power Infeed—Straight Cord			
Understanding	216		
Specifying	232		
Modular Power—Power Infeed—Curly Cord			
Understanding	216		
Specifying	233		

Statement of Line

Universal Modular Power System

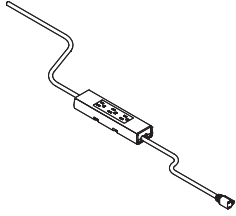

Under Worksurface Utility Power - Four Outlets
 Understanding
 ▶ Page 216
 Specifying
 ▶ Page 226

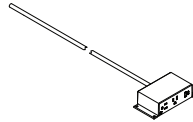

Powerstrip with Edge Mount
 Understanding
 ▶ Page 216
 Specifying
 ▶ Page 227

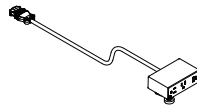

Powerstrip with C-Clamp
 Understanding
 ▶ Page 216
 Specifying
 ▶ Page 228

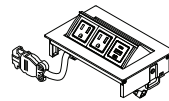

Pop Up Powerstrip
 Understanding
 ▶ Page 216
 Specifying
 ▶ Page 229

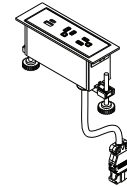

Flush Mount Powerstrip
 Understanding
 ▶ Page 216
 Specifying
 ▶ Page 230

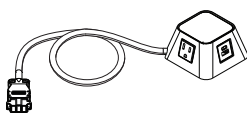

Pyramid Powerstrip
 Understanding
 ▶ Page 216
 Specifying
 ▶ Page 231

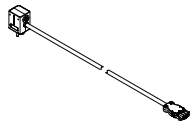

Power Infeed—Straight Cord
 Understanding
 ▶ Page 216
 Specifying
 ▶ Page 232

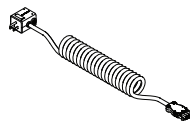

Power Infeed—Curly Cord
 Understanding
 ▶ Page 216
 Specifying
 ▶ Page 233

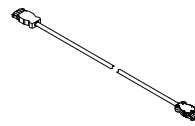

Jumper Cord - Straight
 Understanding
 ▶ Page 216
 Specifying
 ▶ Page 234

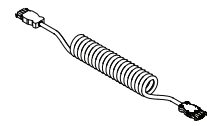

Jumper Cord - Curly
 Understanding
 ▶ Page 216
 Specifying
 ▶ Page 235



Power Distribution Block—Grey
 Understanding
 ▶ Page 216
 Specifying
 ▶ Page 236

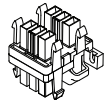

Infeed Power Splitter Distribution Block—Black
 Understanding
 ▶ Page 216
 Specifying
 ▶ Page 237



Cord Management P-Clips—Two Pack
 Understanding
 ▶ Page 218
 Specifying
 ▶ Page 238



Cord Management P-Clips—Six Pack
 Understanding
 ▶ Page 218
 Specifying
 ▶ Page 238

Steelcase Universal Modular Power System Overview—Desking

Steelcase Universal Modular
Power System Overview
—Desking

Power distribution block, Grey, connects power infeed cord and/or jumper cord to powerstrip.

Powerstrips C-clamp

Cord management clips (2 pack) for cord routing

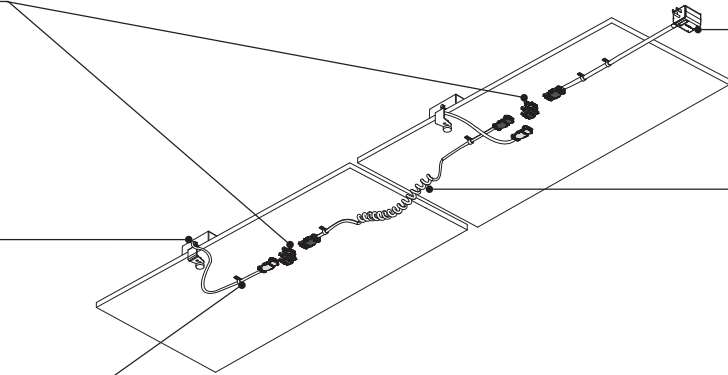

Power infeed cord with 15A overcurrent protection plug, single circuit. Connects to the building's power outlet.

Jumper cord connects to power distribution block, grey when connecting to powerstrip.

Straight cord for linear, same height furniture, lounge, or conference tables.

Curly cord (shown) for height-adjustable desking.

Steelcase Universal Modular Power System Overview— Conference Table

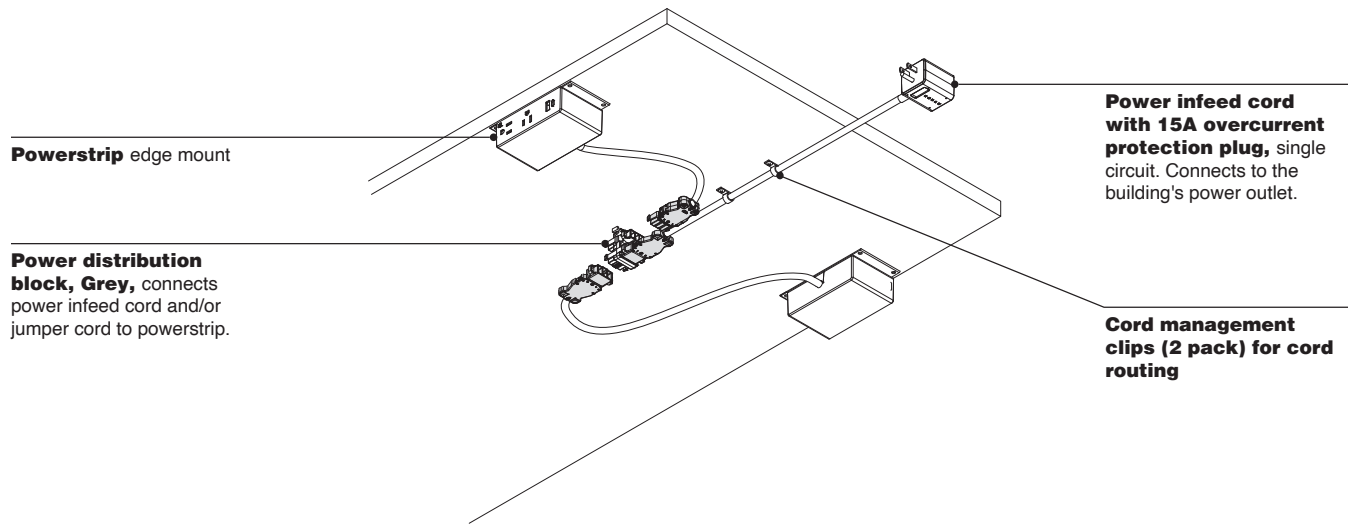

Steelcase Universal Modular Power System Overview— Power infeed entering from center, Splitting power in two directions

Steelcase Universal Modular
Power System Overview
—Power infeed entering
from center, Splitting power
in two directions

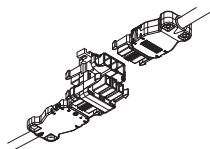
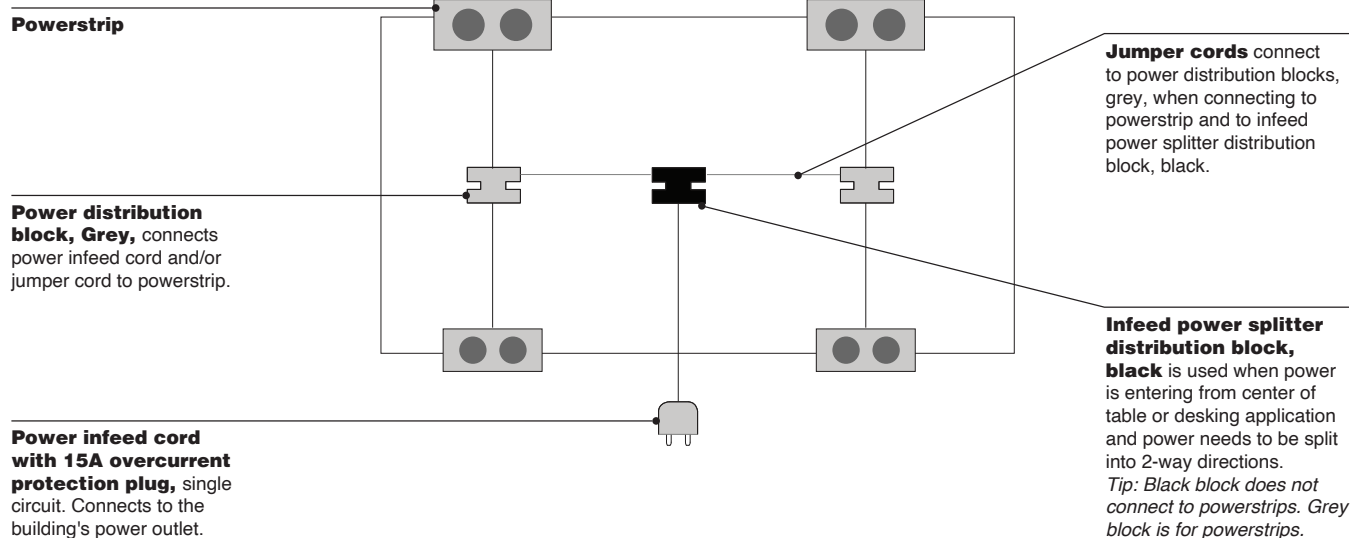

Tip: Connectors are tightly fitted together and do not dislodge easily. If used on training tables, it is recommended if the need to reconfigure is less than once a month.

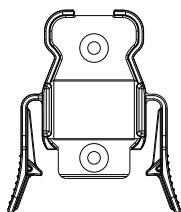

Tip: To help with disconnecting connectors to blocks, see assembly directions for details.

Universal Modular Power System

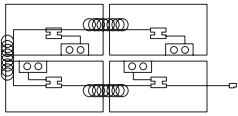

Universal modular power system provides a NRTL listed system that distributes power from one power receptacle to a group of fixed or height-adjustable desks or a conference table, that gives each individual access to user power for their worktools and devices. Ideal for workspaces with basic energy needs, nomadic workspaces, lower investment space creation, or areas with limited power receptacles.

► Specifying, page 226

Powerstrip Accessory Options

Two power outlets with intelligent USB A+C 20W:

- If only USB-C in use, delivers what the device needs up to 20 watts
- If only USB-A in use, up to 10 watts
- If both USB A+C in use, USB-A delivers up to 10 watts and 10 watts to USB-C. If USB-A device needs less than 10W, the remainder, up to 20 watts, goes to the USB-C device

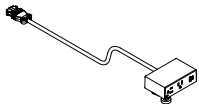

Desktop power, two power outlets, one USB A+C 20W, C-clamp

- C-clamp bracket
- Straight cord lengths: 24", 36", 48", 60", and curly cord 163"
- Modular power connector

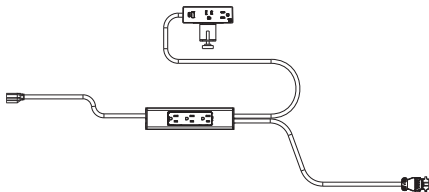

Desktop power, two power outlets, one USB A+C 20W, C-clamp with four outlets under the worksurface utility power

- Straight cord lengths: 24", 36", 48", 60", and curly cord length 163"
- Modular power connector

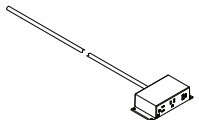

Desktop power, two power outlets, one USB A+C 20W, edge mount

- Edge mount bracket, for use with conference and collaborative tables
- Straight cord lengths: 24", 36", 48", and 60"
- Modular power connector

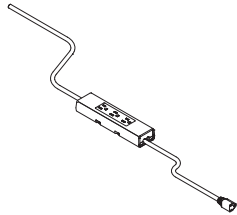

Under worksurface utility power four outlets

- Straight cord lengths: 24", 36", 48", 60", and curly cord length 163"

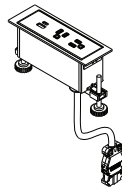

Flush mount powerstrip, flush mounted into the top's surface. Top surface requires field cut-out.

- Two power outlets, One USB A+C 20W.
- Straight cord lengths: 24", 36", 48", 60", and 163" curly cord
- Modular power connector
- Optional tamper resistant



Flush mount powerstrip with four outlets

includes under worksurface utility power. Flush mounted into the top's surface. Top surface requires field cut-out.

- Two power outlets, One USB A+C 20W.
- Straight cord lengths: 24", 36", 48", 60", and 163" curly cord
- Modular power connector
- No tamper resistant with optional utility power

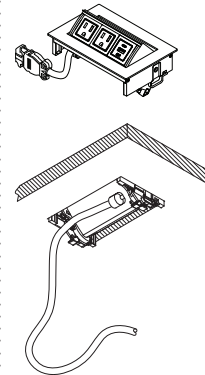

Pop up powerstrip mounted into the top's surface. Top surface requires field cut-out.

- Two power outlets, One USB A+C 20W.
- Straight cord lengths: 24", 36", 48", 60", and 163" curly cord
- Modular power connector
- Optional tamper resistant

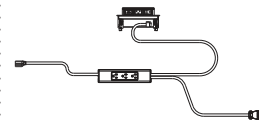

Pop up powerstrip with four outlets

includes under worksurface utility power. Top surface requires field cut-out.

- Two power outlets, One USB A+C 20W.
- Straight cord lengths: 24", 36", 48", 60", and 163" curly cord
- Modular power connector

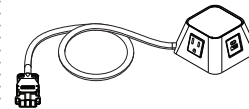

Pyramid powerstrip, freestanding base.

- Two optional power configurations
- Four power outlets
- Two power outlets, 1 USB A+C 20W intelligence
- Straight cord lengths: 72" and 120"
- Modular power connector

Powerstrip Cord Options

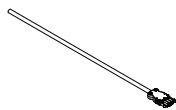

Straight cord and modular power connector are available on all powerstrips.

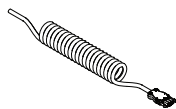

Curly cord and modular power connector are available on powerstrip C-clamp, C-clamp with option utility power, and under worksurface utility power.

Distribution Block Options

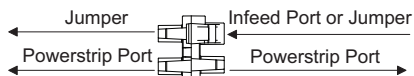
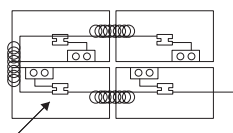

Power distribution block grey for connecting power infeed, jumper, and user power (powerstrip/ accessory).

Tip: Cord clip screw length for minimum worksurface thickness of 1".



3 Way Splitter
Distribution Block (Black)

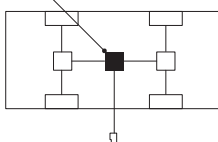

Infeed power splitter distribution block black for splitting infeed power in two directions when needed.

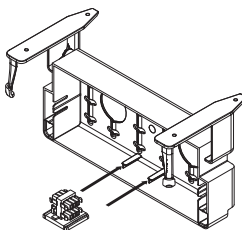
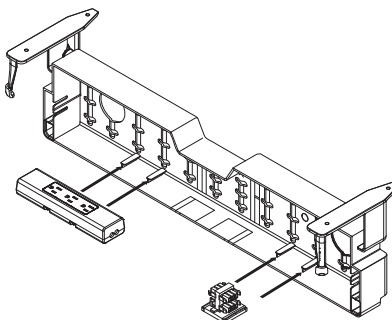
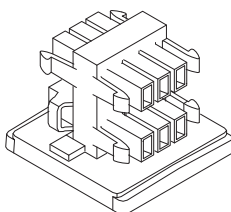

When universal modular power is specified with universal cable management tray, select option with tray mount.

Tip: Cord clip screw length for minimum worksurface thickness of 3/4".

Power Infeed Options

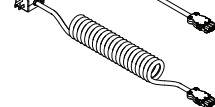
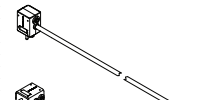
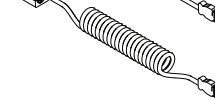
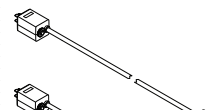

Power infeed is available in straight cord lengths of 72", 108", 120", or curly cord length of 163". Straight cord or curly cord with 15A overcurrent protection, (OCP), plug. Plug options come either straight or 90°. Cords and plugs finishes come in black.

*Check first with authority having jurisdiction, AHJ, for Chicago installs as the power infeed is limited to 9 feet or 108".

*Disconnect assist hardware included.

Jumper Cord Options

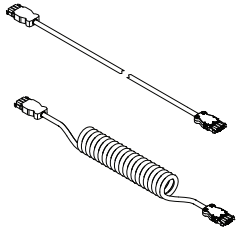

Curly Cord Jumper

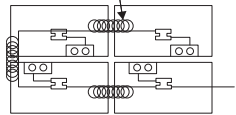

Straight Cord Jumper

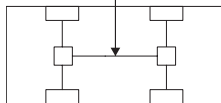

Jumper cords are available in straight cord lengths of 48", 60", 72", 84", 96", 108", and curly cord length 163".

Minimum cord bend radius is 2⁹/₃₂".

Curly jumper cord is recommended for height adjustable desk.

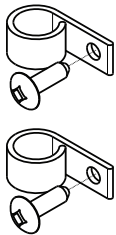

Cord management P-clips attach to the underside of the top to assist cord routing.

Tip: Cord clip screw length for minimum work surface thickness of 3/4".

Connections

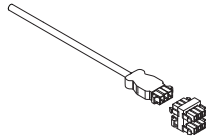

Powerstrip modular power connector to power distribution block grey

Insert the plug end into the bottom part of a grey distribution block. Top ports next to screw holes for power infeed and jumpers. Bottom port, at opposite end of screw holes is for powerstrip. Press until tabs lock into place.

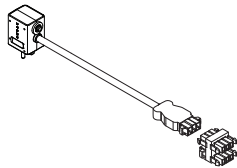

Power infeed connector to power distribution block grey for one way power direction

Insert the infeed cord into the infeed port of the first distribution block. Press until tabs lock into place.

Power Distribution Block to Powerstrip - Grey

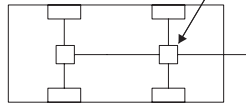

Infeed Power Splitter Distribution Block - Black

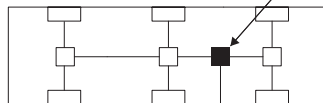

Power Infeed Cord

Power infeed connector to infeed power splitter distribution block black for two-way power direction

Use black power distribution block when power needs to be split, infeed power and jumper cords only.

Surface Materials

Power distribution block to powerstrip, grey

- Grey plastic

Infeed power splitter distribution block, black

- Black plastic

Power infeed cords and connectors

- Black

Jumper cords, straight or curly

- Black

Powerstrip, desktop

- Arctic white
- Merle

Powerstrip, 4 outlet utility power block

- Merle

Application Topics

Modular power system cannot exceed a maximum of 15A of current draw.

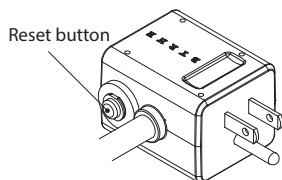

Single circuit system, up to 15A. See *How to Calculate Power Needs* on page 209 and approximate power consumption for common devices before space planning. More than 15A power draw will trip the overcurrent protector, OCP. For safety, all power accessories on the circuit will turn off. Once the power consumption is under 15A, the OCP can be reset.

Tip: When using with thread monument, specify standard straight plug head.

Dependent upon user power consumption and the total power infeed and jumper cord lengths limits:

- Height-adjustable desks with modular power, up to six desks back-to-back and up to four desks side by side, due to max cord length limits
- Eight NEMA outlets per desk limit with modular power

Tip: Local electrical codes vary, so consult with your local code authority, as they have final say if the products as installed are compliant with local code.

Universal modular power system is Nationally Recognized Testing Laboratory (NRTL) listed, UL962A.

A maximum of 10 distribution blocks (total of grey and black), and 50 feet including the power infeed cord, all jumper cord lengths to the farthest distribution block are permitted, in a single direction:

- If power infeed cord is split with the black infeed power splitter distribution block, then 50 feet in both directions or a total of 100 feet
- Powerstrip/accessory cords do not count toward 50 feet maximum limit
- Jumper curly cords are 163" or 14 feet. Three curly cords total 41 feet, power infeed cannot exceed 108" or nine feet, total 50 feet maximum

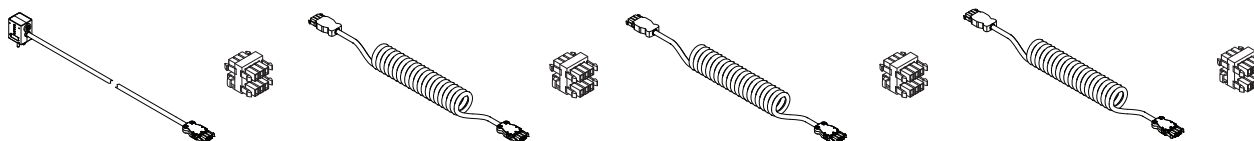

Power Infeed Length	+	Jumper Cord	+	Jumper Cord	+	Jumper Cord
Example: 108"	+	163"	+	163"	+	163" = 597" or 49.75 ft.
						(max. limit = 50 ft)

New York City—Furniture Power Distribution Units, FPDUs, can be used in New York City, per the official NYC Electrical Code. Check first with local authority having jurisdiction, AHJ.

Chicago - FPDUs, can be used on Listed freestanding furnishings in Chicago, limitations apply. Check first with local AHJ.

Chicago installations:

- Nine feet maximum length power infeed cord
- 30 feet maximum between all jumper cords and the farthest distribution block permitted, 39 feet total including power infeed cord. Use of the infeed power splitter distribution block, black is limited to 39 feet total in Chicago
- System must be attached to a Listed table or product
- Must be mounted on a portable furnishing (movable by one person)

Notice: A Furniture Power Distribution Unit (FPDU) is not for permanent installation as part of the building structure and not for mounting in a permanently installed furnishing such as a fixed countertop.

This FPDU is required to be plugged into a building receptacle, do not plug one powerstrip into another or into an extension cord.

Tip: Local electrical codes vary, so consult with your local code authority, as they have final say if the products as installed are compliant with local code.

Cords must be accessible for visual inspection.

Power distribution block must be mounted inboard to be fully contained under worksurface and account for minimum bend radius. Minimum cord bend radius is 2¼".

Maximum of eight NEMA 5-15 receptacles (power outlets) permitted per workstation.

Tip: USB power is not included in eight receptacle count.

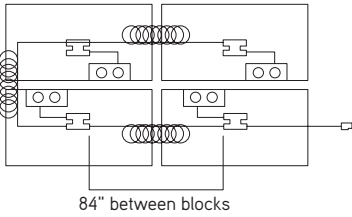

Spacing between distribution blocks maximum length is 84" when using the 163" curly cord. Take into consideration anything that may obstruct the cord while desk is operating.

Cord management clip usage is recommended to route cords underneath the desktop and eliminate trip hazards and avoid aisle ways.

Straight cord jumpers between desks need to be carefully managed to avoid any type of collision or entanglement. Not recommended in any traffic areas, due to tripping hazard.

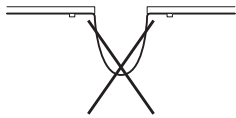

Curly cord jumpers are recommended with height-adjustable desk.

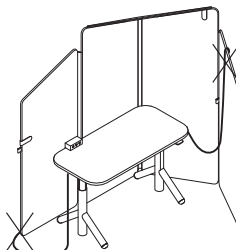

Do not route cords over barriers or objects that may cause dislodgement or stress on cords or connections. Cords are not intended to be routed through walls, windows, ceilings, floors or similar openings of buildings.

Actual Dimensions

Powerstrip with C-clamp (DSMPSC)

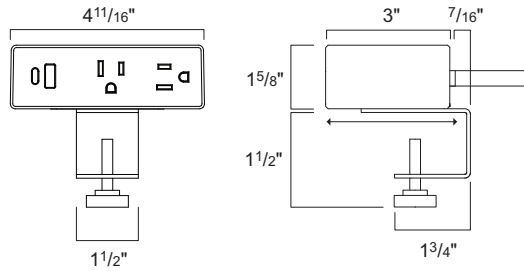

Powerstrip, C-clamp with optional under worksurface utility power (DSMPSC)

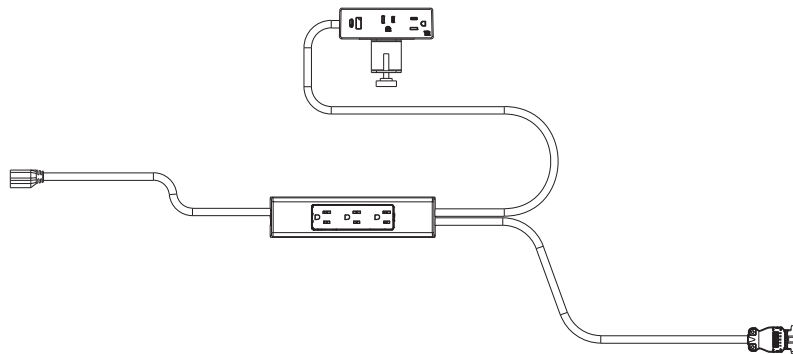

Under worksurface utility powerstrip, 4 power outlets (DSMPUP)

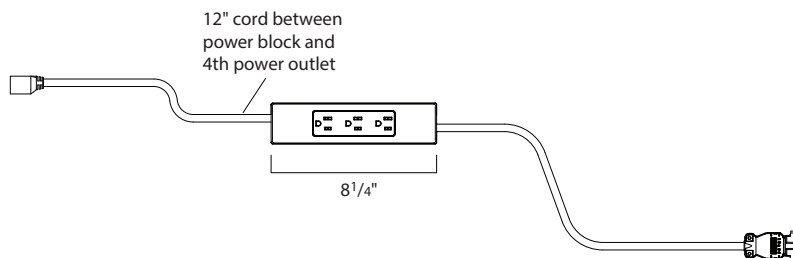

Overcurrent protection plug

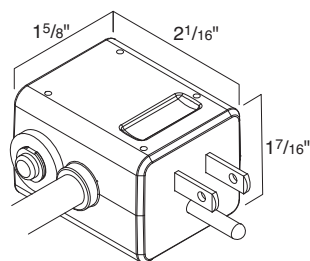

Powerstrip with front edge mount (DSMPPSE)

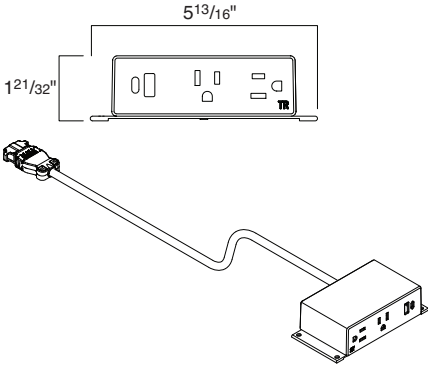

Pop up powerstrip with four outlets under worksurface utility power

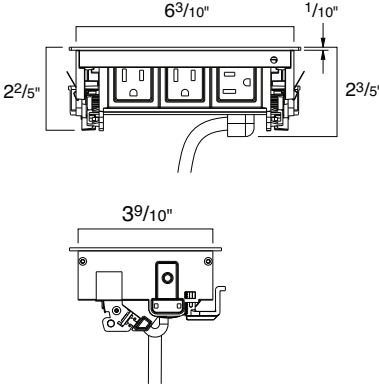

Flush mount powerstrip with four outlets under worksurface utility power

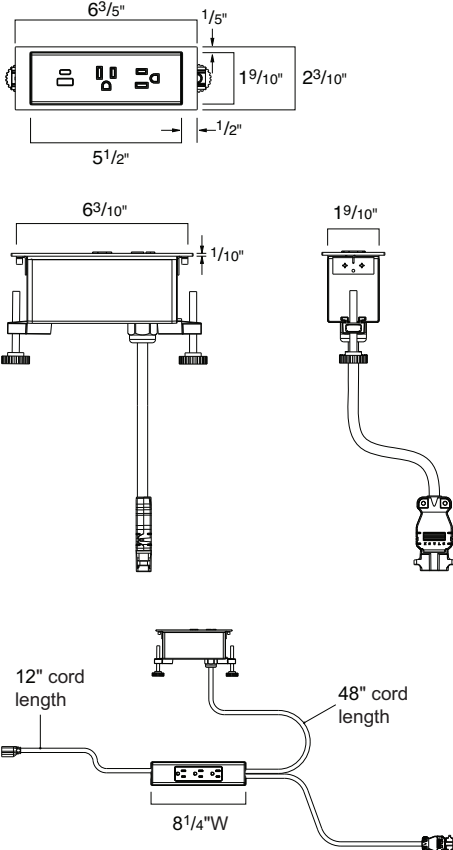

Pyramid powerstrip (DSMPPSPYR)

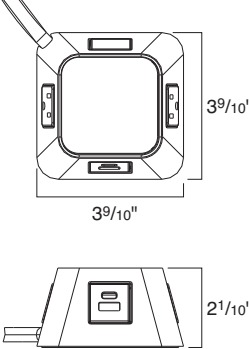

Furniture Applications Examples

Fixed-Height Desks

*Reminder, 50 feet maximum includes power infeed cord and all jumper cord lengths to the farthest distribution block, in a single direction, 15A maximum power draw.

Fixed-Height Desks—Side-by-Side Two-, Four-, or Six-Packs

Example of two-pack components:

Quantity, description, style number

One power infeed (72", 108", 120", or 163"), DSMPINFEED or DSMPINFEEDC

Two power distribution blocks to powerstrip—grey, DSMPDB

One jumper cord, straight (48", 60", 72", 84", 96", or 108"), DSMPJS

Two powerstrips (cord lengths: 24", 36", 48", or 60"), DSMPPSC, DSMPPSE, DSMPPUP, DSMPPSP, DSMPPSF, or DSMPPSPYR

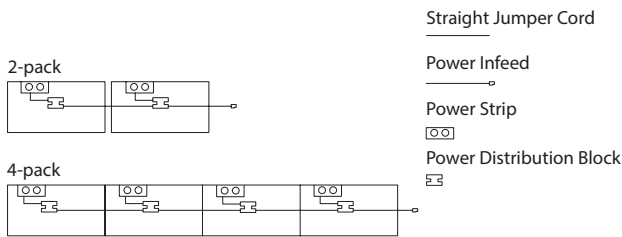

6-pack

Example of six-pack components:

Quantity, description, style number

One power infeed (72", 108", or 120"), DSMPINFEED

Six power distribution blocks to powerstrip - grey, DSMPDB

Five jumper cords, straight (48", 60", 72", 84", or 96"), DSMPJS

Six powerstrips (cord lengths: 24", 36", 48", or 60"), DSMPPSC, DSMPPSE, DSMPPUP, DSMPPSP, DSMPPSF, or DSMPPSPYR

Tip: Power infeed and jumper cord lengths can vary if the total lengths all together are no more than 50 feet.

Fixed-Height Desks—Back-to-Back Two-, Four-, or Six-Packs

2-pack

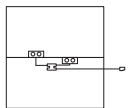

4-pack

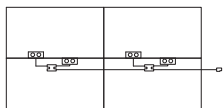

6-pack

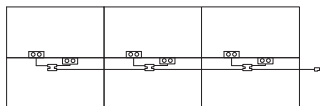

Example of six-pack components:

Quantity, description, style number

One power infeed (72", 108", 120", or 163"), DSMPINFEED or DSMPINFEEDC

Three power distribution blocks to powerstrip—grey, DSMPDB

Two jumper cords, straight (48", 60", 72", 84", 96", or 108"), DSMPJS

Six powerstrips (straight cord lengths: 24", 36", 48", or 60"), DSMPPSC, DSMPPSE, DSMPPUP, DSMPPSP, DSMPPSF, or DSMPPSPYR

Height-Adjustable Desks

*Reminder: 15A maximum power draw per power infeed. Under one power infeed system, multiple users adjusting desk height **at the same time** may cause the overcurrent protector to shut down all power, depending on total power draw from desk, worktools, and devices.

Items and Amp(s)	Ology Height Adjustable Desks 2 columns		
	Quantity	Constant Power (amps)	Peak Power (amps)
Desk in <i>Standby Mode</i>	1	0.0008	
Desk being <i>Adjusted</i>			2.5
Laptop	1	0.8	0.8
Monitor Screen x 1	1	0.5	0.5
Task light LED Intro 7W	1	0.06	0.06
Cell Phone Charger	1	0	2
Total Amps Individual		1	6
2 Pack		3	12
4 Pack		5	23*
6 Pack		8	35*

*If all desks are adjusting and phones charging at once, the circuit breaker will trip at 15A.

Height-Adjustable Desks—Side-by-Side—Up to four-pack only with curly cord jumpers, due to 50 foot maximum

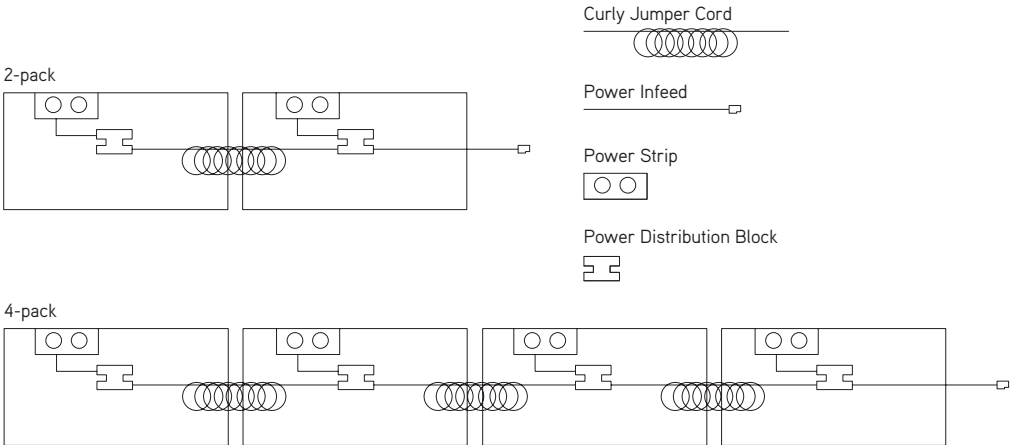

- Example of four-pack components:
 Quantity, description, style number
 One power infeed (72" or 108"), DSMPINFEED
 Four power distribution blocks to powerstrip—grey, DSMPDB
 Three jumper cords, curly 163", DSMPJC
 Four powerstrips (straight cord lengths: 24", 36", 48", or 60"), DSMPPSC, DSMPPSE, DSMPPUP, DSMPPSP, or DSMPPSF

Height-Adjustable Desks, continued

Height-Adjustable Desks—Back-to-Back Two-, Four-, or Six-Packs

2-pack

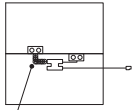

Powerstrip with curly cord option

Example of two-pack components:

Quantity, description, style number

One power infeed (72", 108", 120", or 163"), DSMPINFEED or DSMPINFEEDC

One power distribution block to powerstrip, grey, DSMPDB

One powerstrip (straight cord lengths 24", 36", 48", or 60"), DSMPPSC, DSMPPSE, DSMPUP, DSMPPSP, or DSMPPSF

One powerstrip 163" curly cord, DSMPPSC, DSMPPSE, or DSMPUP

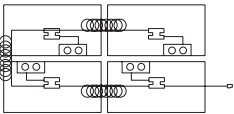

Example of four-pack components:

Quantity, description, style number

One power infeed (72" or 108"), DSMPINFEED

Four power distribution blocks to powerstrip—grey, DSMPDB

Three jumper cords, curly 163", DSMPJC

Four powerstrips (straight cord lengths: 24", 36", 48", or 60"), DSMPPSC, DSMPPSE, DSMPUP, DSMPPSP, or DSMPPSF

4-pack pinwheel

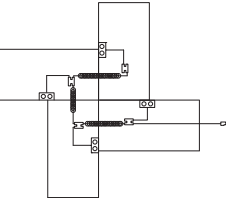

Example of four-pack pinwheel (components same as back-to-back):

Quantity, description, style number

One power infeed (72" or 108"), DSMPINFEED

Four power distribution blocks to powerstrip - grey, DSMPDB

Three jumper cords, curly 163", DSMPJC

Four powerstrips (straight cord lengths: 24", 36", 48", or 60"), DSMPPSC, DSMPPSE, DSMPUP, DSMPPSP, or DSMPPSF

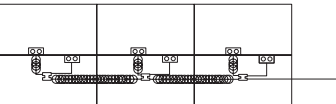

Example of six-pack (not supported in SmartTools):

Quantity, description, style number

One power infeed (72", 108", 120", or 163"), DSMPINFEED or DSMPINFEEDC

Three power distribution blocks to powerstrip - grey, DSMPDB

Two jumper cords, curly 163", DSMPJC

Three powerstrips (straight cord lengths: 24", 36", 48", or 60"), DSMPPSC, DSMPPSE, DSMPUP, DSMPPSP, or DSMPPSF

Three powerstrips 163" curly cord, DSMPPSC, DSMPPSE, or DSMPUP

Conference/Collaborative Tables

Conference/Collaborative Tables—Four to Eight Seats

Edge power infeed

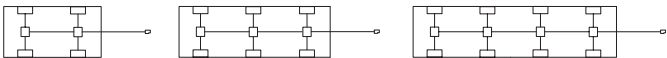

- Power infeed cord (72", 108", 120", or 163"), DSMPINFEED or DSMPINFEEDC
- Power distribution block(s) to powerstrip - Grey (two, three, or four), DSMPDB
- Jumper cord(s), straight (48", 60", 72", 84", 96", or 108" lengths), DSMPJS
- Powerstrip, edge mount (cord lengths 24", 36", 48", or 60"), DSMPPSE

Center power infeed

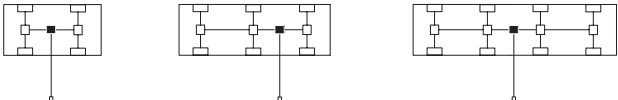

- Power infeed cord (72", 108", 120", or 163"), DSMPINFEED or DSMPINFEEDC
- Infeed power splitter distribution block - Black (one), DSMPSPB
- Power distribution block(s) to powerstrip - Grey (two, three, or four), DSMPDB
- Jumper cord(s), straight (48", 60", 72", 84", 96", or 108" lengths), DSMPJS
- Powerstrip, edge mount (cord lengths: 24", 36", 48", or 60"), DSMPPSE

Universal Modular Power—Under Worksurface Utility Power Four Outlets

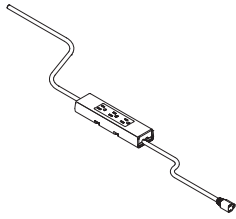

Tip: Under worksurface utility power block does not ship with independent mounting hardware. Designed to be used with the Universal cable management kits.

Tip: Do not use a vertical cable manager with a curly cord.

Tip: Height-adjustable desks can be plugged into utility power for a 'one cord down' solution.

Tip: When specifying under worksurface utility power and power distribution block or power splitter block with tray mount, a large universal cable management kit (DSTRAYLG) is required.

Standard Includes	Required to Specify
<ul style="list-style-type: none"> ▶ Need help? Product details, page 216 • Under worksurface utility power: four outlets – one utility power block with three outlets each, and one floating female outlet • Powerstrip finish, 6527 Merle • Power cord finish, black • Modular power connector • NRTL listed 	<ul style="list-style-type: none"> 1 Style number 2 Power cord (see below under Required Selections)

Power Cord	Required Selections	U.S. Price	Required to Specify
	• 24" standard cord	No cost	Specify with 24" standard cord.
	• 36" standard cord	+\$ 14	Specify with 36" standard cord.
	• 48" standard cord	+\$ 31	Specify with 48" standard cord.
	• 60" standard cord	+\$ 44	Specify with 60" standard cord.
	• 163" curly cord	+\$314	Specify with 163" curly cord.

Related Products		
• Universal cable management kits	▶	Page 205
• Universal modular power system power infeed	▶	Page 232
• Universal modular power system power distribution block to powerstrip, grey	▶	Page 236
• Universal modular power system cord management clips	▶	Page 238

Specification Information				
• Dimensions			• Style	• U.S.
D	W	H	Number	Base Price
2"	8 1/4"	1"	DSMPUP	\$226
:	:	:	:	:
:	:	:	:	:

 **For Canadian Pricing**
 Multiply U.S. Price by the Canadian price factor.
 ▶ See page 1 for details.

Universal Modular Power— Powerstrip with Edge Mount

Universal Modular Power—
Powerstrip with Edge Mount

Universal Modular
Power System

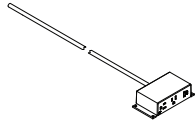

Tip: Edge mount for conference/collaborative tables mounts under the worksurface, front user edge.

Tip: Hardware included is for 1" plus thick surface. If installing on less than 1" thick surface, shorter length screws must be obtained.

Standard Includes	Required to Specify
<ul style="list-style-type: none"> ▶ Need help? Product details, page 216 • Powerstrip, two power, one USB A+C 20W • Power cord finish, black • Modular power connector • Edge mount bracket • Hardware pack • NRTL listed 	<ul style="list-style-type: none"> 1 Style number 2 Plastic color number for housing: 6009 Arctic White 6527 Merle 3 Power cord (see below under Required Selections)

Required Selections	U.S. Price	Required to Specify
Power Cord <ul style="list-style-type: none"> • 24" standard cord • 36" standard cord • 48" standard cord • 60" standard cord 	<ul style="list-style-type: none"> No cost +\$14 +\$31 +\$44 	<ul style="list-style-type: none"> Specify with 24" standard cord. Specify with 36" standard cord. Specify with 48" standard cord. Specify with 60" standard cord.

Related Products <ul style="list-style-type: none"> • Universal modular power system power infeed • Universal modular power system power distribution block to powerstrip, grey • Universal modular power system cord management clips 	<ul style="list-style-type: none"> ▶ Page 232 ▶ Page 236 ▶ Page 238
--------------------------------------------------------------------------------------------------------------------------------------------------------------------------------------------------------------------------------------------------------------------------------	------------------------------------------------------------------------------------------------------

Specification Information				
Dimensions			Style	U.S.
D	W	H	Number	Base Price
3"	3"	3 1/8"	DSMPPSE	\$401
.

 **For Canadian Pricing**
Multiply U.S. Price by the Canadian price factor.
▶ See page 1 for details.

Universal Modular Power— Powerstrip with C-Clamp

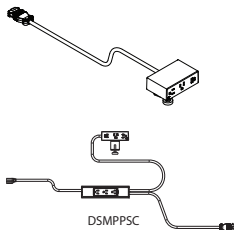

Tip: The second illustration above includes the four outlet under worksurface utility power option.

Tip: C-clamp is designed to accommodate worksurfaces up to 1½" thick.

Tip: Optional under worksurface four outlet utility power block does not ship with independent mounting hardware. Designed to be used with the Universal cable management kits.

Tip: Do not use a vertical cable manager with a curly cord.

Tip: Height-adjustable desks can be plugged into powerstrip's utility power for a 'one cord down' solution.

Tip: When specifying under worksurface utility power and power distribution block or power splitter block with tray mount, a large universal cable management kit (**DSTRAYLG**) is required.

Standard Includes		Required to Specify
▶ Need help? Product details, page 216	<ul style="list-style-type: none"> • Powerstrip, two power, one USB A+C 20W • Power cord finish, black • Modular power connector • C-clamp mount • NRTL listed 	<ol style="list-style-type: none"> 1 Style number 2 Plastic color number for housing: 6009 Arctic White 6527 Merle 3 Power cord (see below under Required Selections) 4 Options, if selected (see below)

Power Cord	Required Selections	U.S. Price	Required to Specify
	• 24" standard cord	No cost	Specify with 24" standard cord.
	• 36" standard cord	+\$ 14	Specify with 36" standard cord.
	• 48" standard cord	+\$ 31	Specify with 48" standard cord.
	• 60" standard cord	+\$ 44	Specify with 60" standard cord.
	• 163" curly cord	+\$314	Specify with 163" curly cord.

Under Worksurface Utility Power Configuration	Options	U.S. Price	Required to Specify
	• Four outlets total - one utility block, with three outlets, and one floating female outlet	+\$139	Specify with one utility and one female plug.

Related Products		
	• Universal cable management kits	▶ Page 205
	• Universal modular power system power infeed	▶ Page 232
	• Universal modular power system power distribution block to powerstrip, grey	▶ Page 236
	• Universal modular power system cord management clips	▶ Page 238

Specification Information				
Dimensions			Style Number	U.S. Base Price
D	W	H		
3"	3"	3 1/8"	DSMPPSC	\$379



For Canadian Pricing
Multiply U.S. Price by the Canadian price factor.
▶ See page 1 for details.

Universal Modular Power— Pop Up Powerstrip

Universal Modular Power—
Pop Up Powerstrip

Universal Modular
Power System

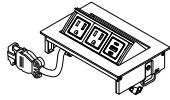

Tip: Pop up powerstrips require the top's surface to be cut in the field. See assembly directions for further details.

Tip: Optional under worksurface four outlet utility power block does not ship with independent mounting hardware. Designed to be used with the universal cable management kits, sold separately.

Tip: Local electrical codes vary, so consult with your local authority having jurisdiction as they have final say if the products as installed are compliant with local code.

Tip: Do not use a vertical cable manager with a curly cord.

Tip: Height-adjustable desks can be plugged into powerstrip's utility power for a one cord down solution.

*Tip: When specifying under worksurface utility power and power distribution block or power splitter block with tray mount a large universal cable management kit (**DSTRAYLG**) will be needed.*

Tip: Tamper resistance not available with optional under worksurface utility power.

Tip: When selecting 4799 Platinum Metallic on the pop up powerstrip the faceplate will be merle.

Standard Includes	Required to Specify
<ul style="list-style-type: none"> ▶ Need help? Product details, page 216 • Powerstrip, two power outlets, one USB A+C 20W • Power cord: black • NRTL listed 	<ol style="list-style-type: none"> 1 Style number 2 Paint color number for powerstrip: <ul style="list-style-type: none"> 0835 Black 4799 Platinum Metallic 7241 Arctic White 7243 Seagull 7360 Merle 3 Power cord (see below under Required Selections) 4 Options, if selected (see below)

	Required Selections	U.S. Price	Required to Specify
Power Cord	<ul style="list-style-type: none"> • 24" standard cord • 36" standard cord • 48" standard cord • 60" standard cord • 163" curly cord 	<ul style="list-style-type: none"> No cost +\$ 14 +\$ 31 +\$ 44 +\$314 	<ul style="list-style-type: none"> Specify with 24" standard cord. Specify with 36" standard cord. Specify with 48" standard cord. Specify with 60" standard cord. Specify with 163" curly cord.

	Options	U.S. Price	Required to Specify
Under Worksurface Utility Power Configuration	<ul style="list-style-type: none"> • No utility • Four outlets total— one utility block, with three outlets and one floating female outlet 	<ul style="list-style-type: none"> No cost +\$139 	<ul style="list-style-type: none"> Specify with no utility. Specify with one utility and one female plug.
Tamper Resistance Power Outlets	<ul style="list-style-type: none"> • No tamper resistance • With tamper resistance 	<ul style="list-style-type: none"> No cost +\$ 49 	<ul style="list-style-type: none"> Specify with no tamper resistance. Specify with tamper resistance.

Related Products	
<ul style="list-style-type: none"> • Universal cable management kits • Universal modular power system power infeed • Universal modular power system power distribution block to powerstrip, grey • Universal modular power system cord management clips 	<ul style="list-style-type: none"> ▶ Page 205 ▶ Page 232 ▶ Page 236 ▶ Page 238

Specification Information				
Dimensions			Style Number	U.S. Base Price
D	W	H		
4 1/2"	6 3/4"	2 1/2"	DSMPSP	\$548



For Canadian Pricing

Multiply U.S. Price by the Canadian price factor.

▶ See page 1 for details.

Universal Modular Power— Flush Mount Powerstrip

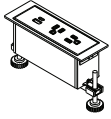

Tip: Flush mount and pop up powerstrips require the top's surface to be cut in the field. See assembly directions for futher details.

Tip: Optional under work-surface four outlet utility power block does not ship with independent mounting hardware. Designed to be used with the universal cable management kits, sold separately.

Tip: Do not use a vertical cable manager with a curly cord.

Tip: Height-adjustable desks can be plugged into power-strip's utility power for a one cord down solution.

*Tip: When specifying under worksurface utility power and power distribution block or power splitter block with tray mount, need large universal cable management kit, **DSTRAYLG**.*

Tip: Faceplate mounts flat just above the worksurface.

Tip: Tamper resistance not available with optional under worksurface utility power.

Standard Includes		Required to Specify
▶ Need help? Product details, page 216	<ul style="list-style-type: none"> Powerstrip, two power outlets, one USB A+C 20W Power cord: black NRTL listed 	<ol style="list-style-type: none"> Style number Plastic color number for powerstrip: 6000 Black 6009 Arctic White 6053 Seagull 6527 Merle Power cord (see below under Required Selections) Options, if selected (see below)

Required Selections	U.S. Price	Required to Specify
Power Cord	<ul style="list-style-type: none"> 24" standard cord: No cost 36" standard cord: +\$ 14 48" standard cord: +\$ 31 60" standard cord: +\$ 44 163" curly cord: +\$314 	<ul style="list-style-type: none"> Specify with 24" standard cord. Specify with 36" standard cord. Specify with 48" standard cord. Specify with 60" standard cord. Specify with 163" curly cord.

Options	U.S. Price	Required to Specify
Under Worksurface Utility Power Configuration	<ul style="list-style-type: none"> No utility: No cost Four outlets total— one utility block with three outlets and one floating female outlet: +\$139 	<ul style="list-style-type: none"> Specify with no utility. Specify with one utility and one female plug.
Tamper Resistance Power Outlets	<ul style="list-style-type: none"> No tamper resistance: No cost With tamper resistance: +\$ 49 	<ul style="list-style-type: none"> Specify with no tamper resistance. Specify with tamper resistance.
Related Products	<ul style="list-style-type: none"> Universal cable management kits Universal modular power system power infeed Universal modular power system power distribution block to powerstrip, grey Universal modular power system cord management clips 	<ul style="list-style-type: none"> ▶ Page 205 ▶ Page 232 ▶ Page 236 ▶ Page 238

Specification Information				
Dimensions			Style Number	U.S. Base Price
D	W	H		
2 ³ / ₁₀ "	6 ⁵ / ₈ "	2 ⁴ / ₅ "	DSMPPSF	\$521



For Canadian Pricing

Multiply U.S. Price by the Canadian price factor.

▶ See page 1 for details.

Universal Modular Power— Pyramid Powerstrip Freestanding

Universal Modular Power—
Pyramid Powerstrip
Freestanding

Universal Modular
Power System

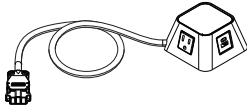

Standard Includes	Required to Specify
<ul style="list-style-type: none"> ▶ Need help? Product details, page 216 • Desktop powerstrip module • Freestanding base • Universal modular power connector • Power cord: black • NRTL listed 	<ol style="list-style-type: none"> 1 Style number 2 Plastic color number for pyramid: <ul style="list-style-type: none"> 6205 Black 6276 Storm 6BD8 Snow 3 Power configuration (see below under Required Selections) 4 Power cord (see below under Required Selections)

	Required Selections	U.S. Price	Required to Specify
Power Configuration	<ul style="list-style-type: none"> • Four power outlets • Two power, one USB A+C 20W 	No cost +\$69	Specify with <i>four power outlets</i> . Specify with <i>two power, one USB A+C 20W</i> .
Power Cord	<ul style="list-style-type: none"> • 72" standard cord • 120" standard cord 	No cost +\$22	Specify with <i>72" standard cord</i> . Specify with <i>120" standard cord</i> .
Related Products	<ul style="list-style-type: none"> • Universal modular power system power infeed • Universal modular power system power distribution block to powerstrip, grey • Universal modular power system cord management clips 		<ul style="list-style-type: none"> ▶ Page 232 ▶ Page 236 ▶ Page 238

Tip: Local electrical codes vary, so consult with your local authority having jurisdiction as they have final say if the products as installed are compliant with local code.

Tip: Black is the standard cord color.

Specification Information			
Dimensions	Style	U.S.	
D	W	Base	Price
:	:	:	:
:	:	:	:
2 ¹ / ₁₀ "	3 ⁹ / ₁₀ "	DSMPPSPYR	\$462
:	:	:	:
:	:	:	:



For Canadian Pricing
Multiply U.S. Price by the Canadian price factor.
▶ See page 1 for details.

Universal Modular Power— Power Infeed, Straight Cord

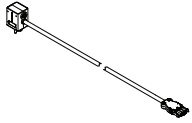

Tip: Local electrical codes vary, so consult with your local authority having jurisdiction as they have final say if the products as installed are compliant with local code.

Tip: Power infeed cord length must be included in the total modular power system length's maximum calculation.

Tip: For Chicago installs, consult with your local authority having jurisdiction, as the power infeed is limited to nine feet.

Tip: Cord clip screw length for minimum worksurface thickness of 3/4".

Tip: Disconnect implement to help with connector to block detachment. See assembly directions for details.

Tip: Minimum cord bend radius: 2 1/4".

Tip: When using with thread monument, specify standard straight plug head.

Standard Includes		Required to Specify
▶ Need help? Product details, page 216	<ul style="list-style-type: none"> Power infeed, straight cord Power plug with 15A overcurrent protection, OCP Cord, black Modular power connector Cord management P-clips, 2 pack 	<ol style="list-style-type: none"> Style number Power plug type (see below under Required Selections) Cord length (see below under Required Selections)

	Required Selections	U.S. Price	Required to Specify
Power Plug Type	• NEMA 5-15 3-prong OCP, straight	No cost	Specify with NEMA 5-15 3-prong OCP, straight.
	• NEMA 5-15 3-prong OCP, 90°	No cost	Specify with NEMA 5-15 3-prong OCP, 90°.
Cord Length	• 72" cord length	No cost	Specify with 72" cord length.
	• 108" cord length	+\$22	Specify with 108" cord length.
	• 120" cord length	+\$22	Specify with 120" cord length.
Related Products	• Universal modular power system power infeed		▶ Page 232
	• Universal modular power system power distribution block to powerstrip, grey		▶ Page 236
	• Universal modular power system Infeed power splitter distribution block, black		▶ Page 237
	• Universal modular power system cord management clips		▶ Page 238
	• Universal cable management kits		▶ Page 205

Specification Information	
Style Number	U.S. Base Price
DSMPINFEED	\$440

 **For Canadian Pricing**
Multiply U.S. Price by the Canadian price factor.
▶ See page 1 for details.

Universal Modular Power— Power Infeed, Curly Cord

Universal Modular Power—
Power Infeed, Curly Cord

Universal Modular
Power System

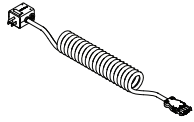

Tip: Do not use a vertical cable manager with a curly cord.

Tip: Local electrical codes vary, so consult with your local code authority, as they have final say if the products as installed are compliant with local code.

Tip: Power infeed cord length must be included in the total modular power system maximum length calculation.

Tip: For Chicago installs, consult with your local authority having jurisdiction, as the power infeed is limited to nine feet. The power infeed curly cord is 163" or 13.6'.

Tip: Minimum cord bend radius: 2.28" to be maintained near connection points.

Tip: Cord clip screw length for minimum worksurface thickness of 3/4".

Tip: When using with thread monument, specify standard straight plug head.

	Standard Includes	Required to Specify
▶ Need help? Product details, page 216	<ul style="list-style-type: none"> Power infeed, curly cord Power plug with 15A overcurrent protection, OCP Cord finish, black Modular power connector Cord management P-clips, 2 pack 	1 Style number 2 Power plug type (see below under Required Selections)

	Required Selections	U.S. Price	Required to Specify
Power Plug Type	<ul style="list-style-type: none"> NEMA 5-15 3-prong OCP, straight NEMA 5-15 3-prong OCP, 90° 	No cost No cost	Specify with NEMA 5-15 3-prong OCP, straight. Specify with NEMA 5-15 3-prong OCP, 90°.
Related Products	<ul style="list-style-type: none"> Universal modular power system power infeed Universal modular power system power distribution block to powerstrip, grey Universal modular power system Infeed power splitter distribution block, black Universal modular power system cord management clips Universal cable management kits 		▶ Page 232 ▶ Page 236 ▶ Page 237 ▶ Page 238 ▶ Page 205

Specification Information	
Style Number	U.S. Price
DSMPINFEDC	\$693

 **For Canadian Pricing**
 Multiply U.S. Price by the Canadian price factor.
 ▶ See page 1 for details.

Universal Modular Power— Jumper Cord, Straight

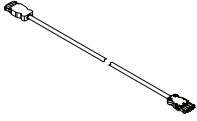

Tip: Jumper cord length must be included in the 50' modular power system maximum calculation. Chicago 30' maximum.

Tip: Minimum cord bend radius: 2.28".

Tip: Cord clip screw length for minimum worksurface thickness of 3/4".

Standard Includes		Required to Specify
▶ Need help? Product details, page 216	<ul style="list-style-type: none"> • Jumper cord, straight • Cord, black • Modular power connector • Cord management P-clips, 2 pack 	1 Style number 2 Power cord (see below under Required Selections)

	Required Selections	U.S. Price	Required to Specify
Power Cord	<ul style="list-style-type: none"> • 48" standard cord • 60" standard cord • 72" standard cord • 84" standard cord • 96" standard cord • 108" standard cord 	No cost +\$14 +\$28 +\$43 +\$59 +\$74	Specify with 48" standard cord. Specify with 60" standard cord. Specify with 72" standard cord. Specify with 84" standard cord. Specify with 96" standard cord. Specify with 108" standard cord.

Related Products		
• Universal modular power system power infeed	▶	Page 232
• Universal modular power system power distribution block to powerstrip, grey	▶	Page 236
• Universal modular power system Infeed power splitter distribution block, black	▶	Page 237
• Universal modular power system cord management clips	▶	Page 238
• Universal cable management kits	▶	Page 205

Specification Information	
• Style Number	• U.S. Base Price
DSMPJS	\$188



For Canadian Pricing
 Multiply U.S. Price by the Canadian price factor.
 ▶ See page 1 for details.

Universal Modular Power— Jumper Cord, Curly

Universal Modular Power
—Jumper Cord, Curly

Universal Modular
Power System

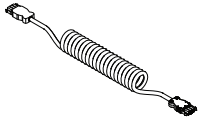

Tip: Do not use a vertical cable manager with a curly cord.

Tip: Jumper cord length must be included in the 50' modular power system maximum calculation. Chicago 30' maximum.

Tip: Minimum cord bend radius: 2.28".

Tip: Cord clip screw length for minimum worksurface thickness of 3/4".

Standard Includes	Required to Specify
<ul style="list-style-type: none"> ▶ Need help? Product details, page 216 • Jumper cord, curly • Cord, black • Modular power connector • Cord management P-clips, 2 pack 	<ul style="list-style-type: none"> Style number

Related Products	
• Universal modular power system power infeed	▶ Page 232
• Universal modular power system power distribution block to powerstrip, grey	▶ Page 236
• Universal modular power system Infeed power splitter distribution block, black	▶ Page 237
• Universal modular power system cord management clips	▶ Page 238
• Universal cable management kits	▶ Page 205

Specification Information	
• Style Number	• U.S. Price
DSMPJC	\$347
.	.
.	.

 **For Canadian Pricing**
Multiply U.S. Price by the Canadian price factor.
▶ See page 1 for details.

Universal Modular Power—Power Distribution Block to Powerstrip, Grey



Tip: Optional tray mount does not ship with independent mounting hardware. Designed to be used with the Universal cable management kits.

Tip: When specifying under worksurface utility power and power distribution block or power splitter block with tray mount, a large universal cable management kit (DSTRAYLG) is required.

Tip: If specified with no tray mount, hardware included is for 1" plus thick surface. If installing on less than 1" thick surface, shorter length screws must be obtained.

Tip: Hardware included with tray mount option.

Standard Includes		Required to Specify
▶ Need help? Product details, page 216	<ul style="list-style-type: none"> Power distribution block to powerstrip, grey Hardware pack 	1 Style number 2 Tray mount application (see below under Required Selections)

	Required Selections	U.S. Price	Required to Specify
Tray Mount Application	<ul style="list-style-type: none"> With tray mount No tray mount 	No cost No cost	Specify <i>with tray mount</i> . Specify <i>with no tray mount</i> .
Related Products	<ul style="list-style-type: none"> Universal cable management kits Universal modular power system power infeed Universal modular power powerstrip with C-clamp Universal modular power powerstrip with edge mount block to powerstrip, grey Universal modular power under worksurface utility power four outlets 		▶ Page 205 ▶ Page 232 ▶ Page 228 ▶ Page 236 ▶ Page 238

Specification Information				
Dimensions			Style Number	U.S. Price
D	W	H		
1 ¹¹ / ₁₆ "	1 ¹⁵ / ₁₆ "	1 ⁵ / ₈ "	DSMPDB	\$75



For Canadian Pricing

Multiply U.S. Price by the Canadian price factor.

▶ See page 1 for details.

Universal Modular Power—Infeed Power Splitter Distribution Block, Black

Universal Modular Power—
Infeed Power Splitter
Distribution Block, Black

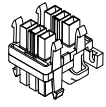

Tip: Optional tray mount does not ship with independent mounting hardware. Designed to be used with the Universal cable management kits.

Tip: Infeed power splitter distribution block when power source needs to split in two directions.

Tip: Infeed power splitter distribution block used for jumper power cords and infeed power only; no powerstrip connection.

*Tip: When specifying under worksurface utility power and power distribution block or power splitter block with tray mount, a large universal cable management kit (**DSTRAYLG**) is required.*

Tip: If specified with no tray mount, hardware included is for 1" plus thick surface. If installing on less than 1" thick surface, shorter length screws must be obtained.

Tip: Hardware included with tray mount option.

Standard Includes		Required to Specify
▶ Need help? Product details, page 216	<ul style="list-style-type: none"> Infeed power splitter distribution block, black Hardware pack 	1 Style number 2 Tray mount application (see below under Required Selections)

	Required Selections	U.S. Price	Required to Specify
Tray Mount Application	<ul style="list-style-type: none"> With tray mount No tray mount 	No cost No cost	Specify <i>with tray mount</i> . Specify <i>with no tray mount</i> .
Related Products	<ul style="list-style-type: none"> Universal cable management kits Universal modular power system power infeed Universal modular power jumper, straight cord Universal modular power, power distribution block to powerstrip, grey 		<ul style="list-style-type: none"> ▶ Page 205 ▶ Page 232 ▶ Page 228 ▶ Page 236

Specification Information				
Dimensions			Style Number	U.S. Price
D	W	H		
1 ¹¹ / ₁₆ "	1 ¹⁵ / ₁₆ "	1 ⁵ / ₈ "	DSMPSB	\$75



For Canadian Pricing

Multiply U.S. Price by the Canadian price factor.

▶ See page 1 for details.

Cord Management P-Clips

Standard Includes	Required to Specify
<ul style="list-style-type: none"> ▶ Need help? Product details, page 218 	<ul style="list-style-type: none"> • Cord management P-clips and screws
	Style number

Tip: Two cord management P-clips come standard with power infeed and jumper cord style numbers.

Tip: Use with modular power powerstrips, jumper cords, power infeed cords to keep cords managed.

Tip: Cord clip screw length for minimum worksurface thickness of 3/4".

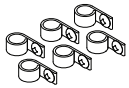

Related Products	
<ul style="list-style-type: none"> • Universal modular power system power infeed • Universal modular power system jumper cord, straight • Universal modular power system jumper cord, curly • Universal modular power powerstrip with C-clamp • Universal modular power powerstrip with edge mount • Universal modular power under worksurface utility power four outlets • Universal cable management kits 	<ul style="list-style-type: none"> ▶ Page 232 ▶ Page 234 ▶ Page 235 ▶ Page 228 ▶ Page 227 ▶ Page 238 ▶ Page 205

Specification Information		
Quantity	Style Number	U.S. Price

Cord Management P-Clips—Two-Pack

2	DSPCLIP2	\$ 8



Cord Management P-Clips—Six-Pack

6	DSPCLIP6	\$20



For Canadian Pricing
 Multiply U.S. Price by the Canadian price factor.
 ▶ See page 1 for details.

Relay Modular Power System

	
Statement of Line	240
	
Relay Modular Power System Overview	241
Relay Power—Pop Up Powerstrip	
Understanding	246
Specifying	249
Relay Power—Flush Mount Powerstrip	
Understanding	246
Specifying	250
Relay Power—C-Clamp	
Understanding	246
Specifying	251
Relay Power—Front Edge Mount Powerstrip	
Understanding	246
Specifying	252
Relay Power—Infeed and Control Box	
Understanding	246
Specifying	253
Relay Power—Jumper Cord	
Understanding	246
Specifying	254
Relay Power—Cord Management Six Pack	
Understanding	246
Specifying	255

Statement of Line

Relay Modular Power System

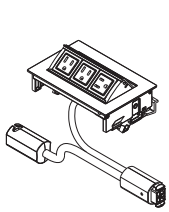

Pop Up Powerstrip
Understanding
▶ Page 246
Specifying
▶ Page 249

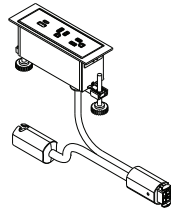

Flush Mount Powerstrip
Understanding
▶ Page 246
Specifying
▶ Page 250

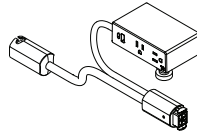

Powerstrip with C-Clamp
Understanding
▶ Page 246
Specifying
▶ Page 251

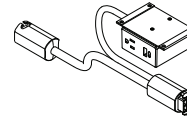

Powerstrip Front Edge Mount
Understanding
▶ Page 246
Specifying
▶ Page 252

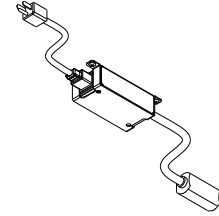

Power Infeed and Control Box
Understanding
▶ Page 246
Specifying
▶ Page 253

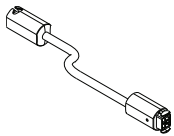

Jumper Cord
Understanding
▶ Page 246
Specifying
▶ Page 254

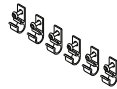

Cord Management J-Clips—Six Pack
Understanding
▶ Page 246
Specifying
▶ Page 255



Cord Management P-Clips—Two Pack
Understanding
▶ Page 246
Specifying
▶ Page 238

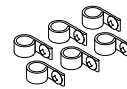

Cord Management P-Clips—Six Pack
Understanding
▶ Page 246
Specifying
▶ Page 238

Relay Modular Power System Overview

When multiple workstations, tables, or lounge furniture need to be connected to one another, providing power to the entire series, Relay Modular Power can be specified to enhance existing furniture settings with power access.

Relay modular power system provides a NRTL listed solution of continuous power to a group of furniture or lounge settings. Plug and play NEMA plug connects to the building's outlet, no hardwiring, and no electrician is needed.

Add Relay to existing, non-powered furniture/lounge, when multiple powerstrips must be connected by one power infeed.

- Used on linear, fixed height tables, flip top training tables, or lounge furniture.
- One direction, non-sequential, modular power system.
- Push button, quick release connector; designed for easy and frequent reconfiguring and connecting of furniture applications.
- One power infeed control box allows up to 15-amp max.
- One power infeed and control box can have up to eight total connections and extend up to 40 feet, from plug to last connection.
- One connection is either a powerstrip or jumper cord.
- Relay modular power system is NRTL listed, industry safety standard UL962A furniture power distribution unit.

The installation of the Relay modular power system must be performed in accordance with all assembly directions. Improper usage could result in risk of fire or electric shock. Only connect to products with Relay modular power system connectors. For use in indoor, dry locations only. Always check first with authorities having jurisdiction.

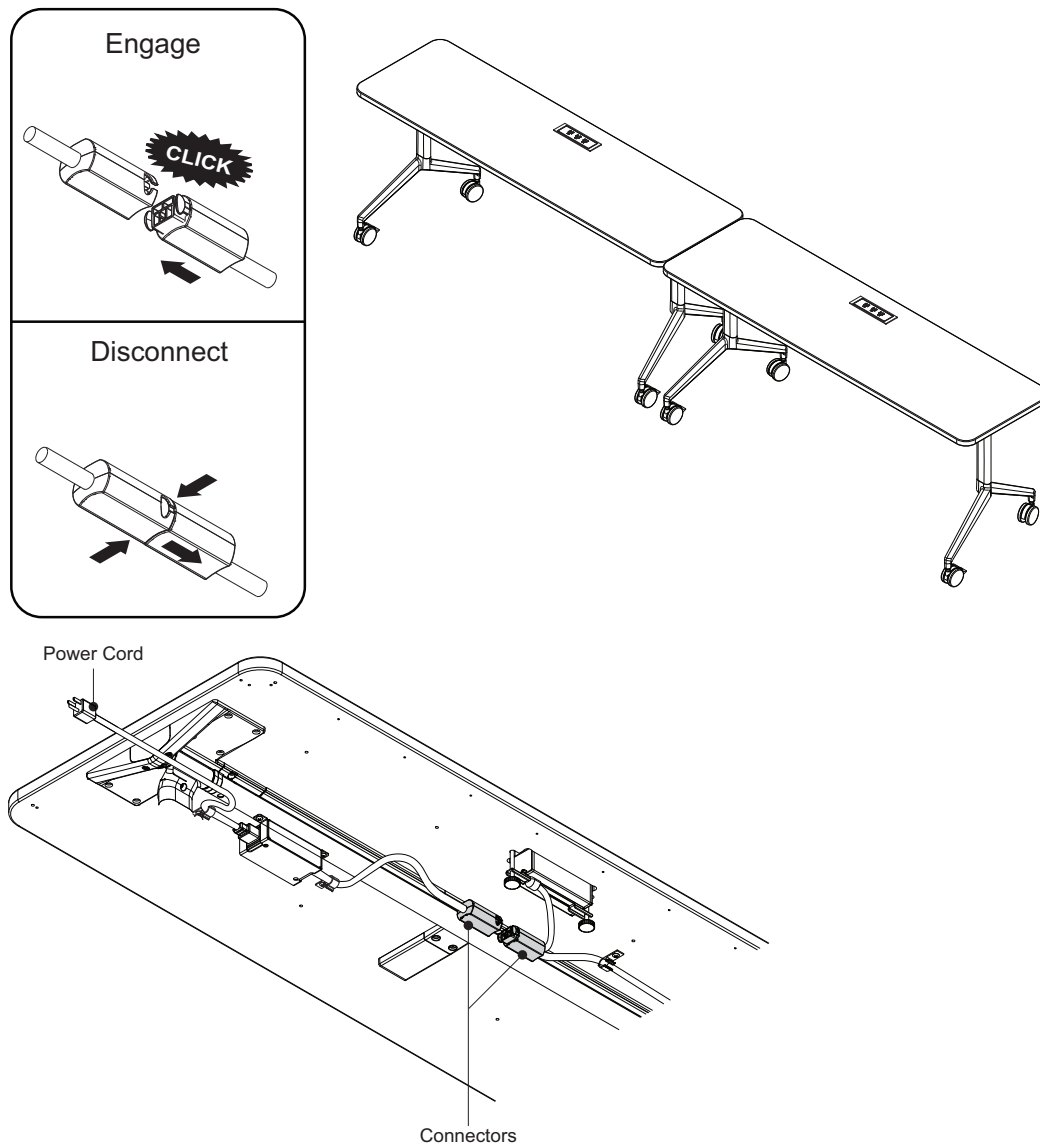

Relay Modular Power System Overview— Table Power

Power infeed and control box powerstrip cord management clips with NEMA plugs.

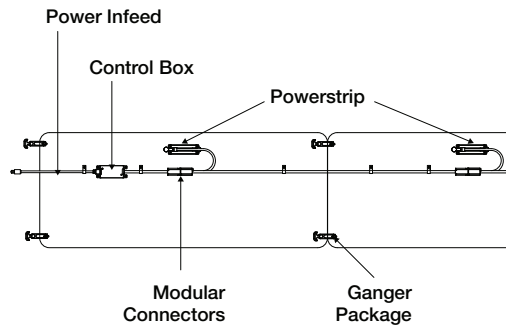
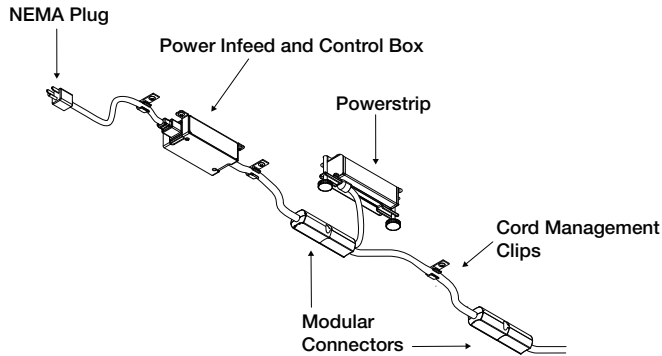

Example of tables that connected with Relay modular power and flex ganger:

***Per UL 962, D4.1.3** When two or more tables are capable of being used in combination, a mechanical means of securement between tables shall be provided. See Section D7, Mechanical Assembly.

If connecting two or more furniture pieces and there is no mechanical securement hardware, flex ganger package is available and sold separately, style **TS4FG**.

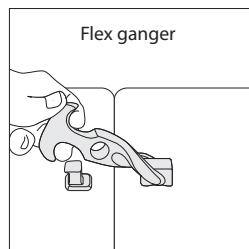

Examples of existing tables that can be retrofitted with the Relay Modular Power System.

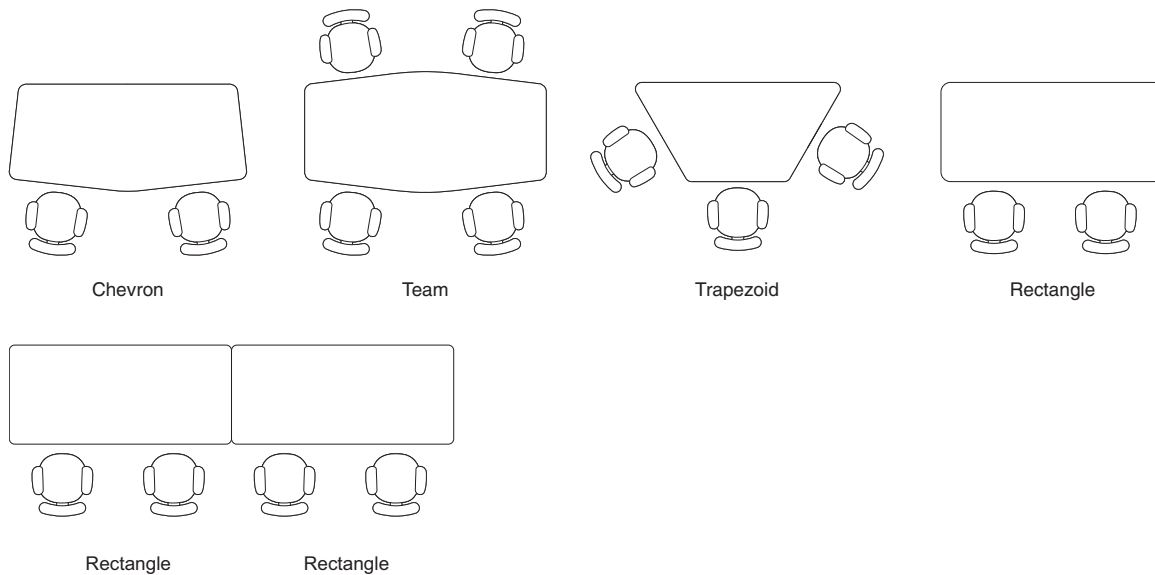

Examples of Table Configurations

Examples of Table Configurations

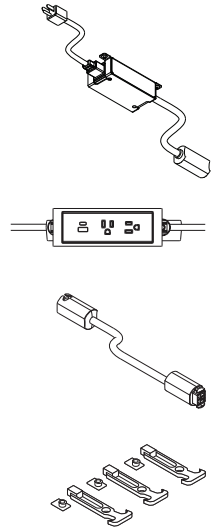
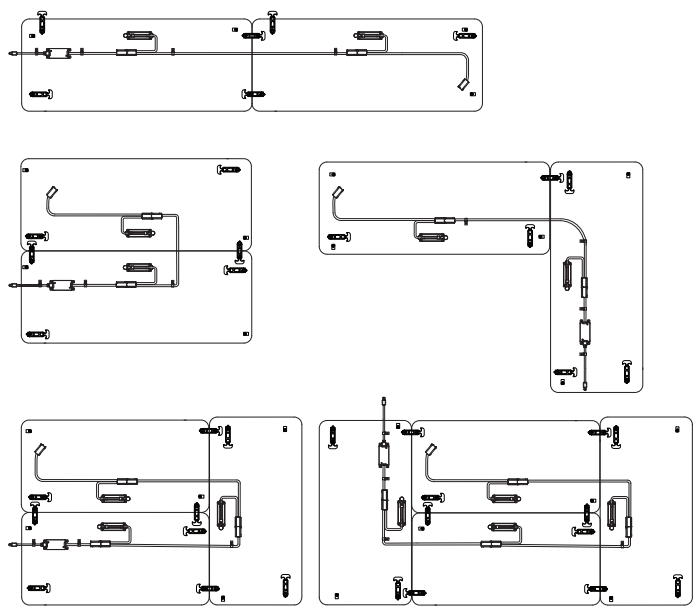

Power Infeed with Control Box

Powerstrip

Jumper Cord

Flex Gangers (TS4FG)
 ▶ See Conference and Collaborative Tables Specification Guide

Tables 36"W to 60"W—
no jumper required

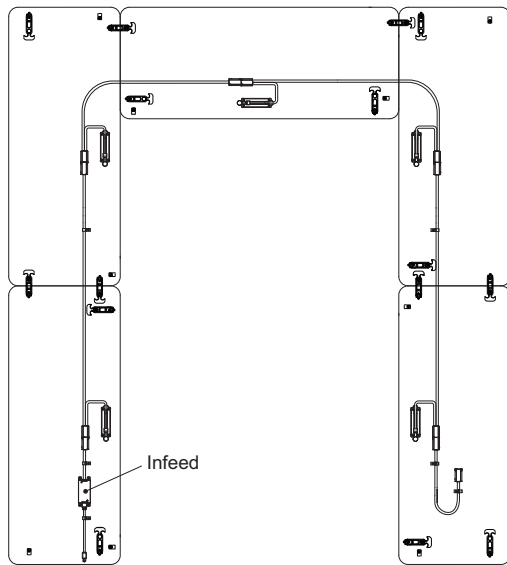

Tables 60 1/16"W to 84"W—
jumper required

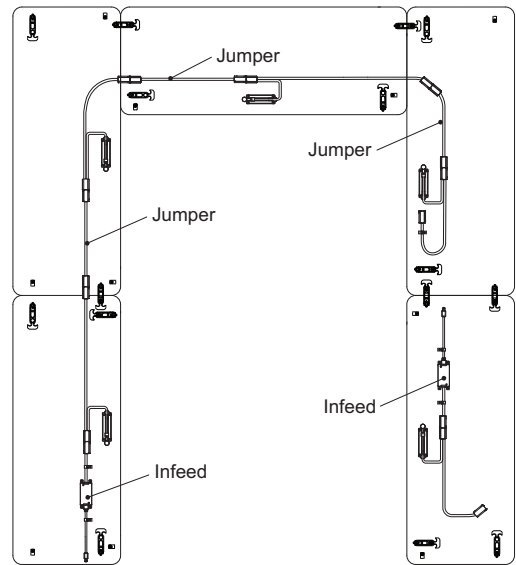

Tip: Jumper cords are not required on tables 60"W or less.

Table Power Cutout Specifications

Prior to making the cutout for powerstrips with flush or pop up mount, evaluate what other items will be added to the worksurface, such as modesty panel. Ensure the power unit will not interfere with those items, nor the understructure.

Cutouts must be a minimum of 2.5" from edge of worksurface (dimension A). Novell

Rectangular Worksurfaces Center Power Position

Size	B	Size	B
19"x48"	20.75"	30"x36"	14.75"
19"x60"	26.75"	30"x42"	17.75"
19"x66"	29.75"	30"x48"	20.75"
19"x72"	32.75"	30"x60"	26.75"
19"x84"	38.75"	30"x66"	29.75"
24"x36"	14.75"	30"x72"	32.75"
24"x42"	17.75"	30"x84"	38.75"
24"x48"	20.75"		
24"x60"	26.75"		
24"x66"	29.75"		
24"x72"	32.75"		
24"x84"	38.75"		

Rectangular Worksurfaces Left-Right Power Position

Size	B
19"x72"	14.75"
19"x84"	17.75"
24"x72"	14.75"
24"x84"	17.75"
30"x72"	14.75"
30"x84"	17.75"

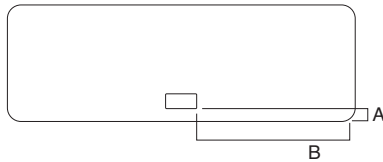

Center Power Position

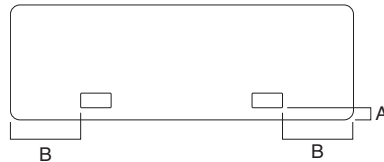

Left - Right Power Position

Team Table Worksurfaces Center Power Position

Size	A		B
	Nonflip	Flip	
36"x60"	16"	11.44"	26.75"
36"x66"	16"	11.44"	29.75"
36"x72"	16"	11.44"	32.75"
36"x84"	16"	11.44"	38.75"

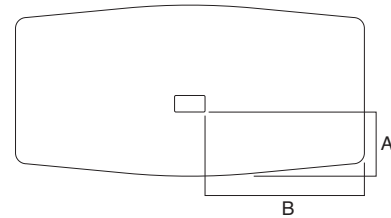

Center Power Position

Team Table Worksurfaces Left-Right Power Position

Size	A		B
	Nonflip	Flip	
36"x72"	16"	18.32"	14.75"
36"x84"	16"	18.32"	17.75"

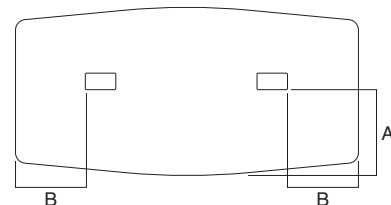

Left - Right Power Position

Relay Modular Power System Overview— Lounge Power

Examples of Relay modular power system being applied to existing lounge furniture pieces.

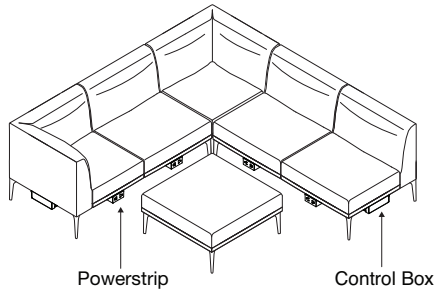

Relay modular power system allows power to be run across multiple ganged lounge units without requiring an electrician.

Tip: Relay components attach with screws, ideal for attaching to wood frame applications.

Product Details

Power Infeed and Control Box

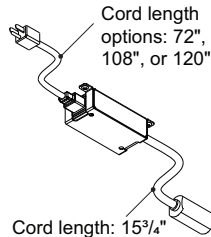

Power Infeed and Control Box:

- 15A max.
- Eight connections max, one connection is either a powerstrip or jumper cord or a max of eight power strips and jumper cords can be connected to one power infeed and control box.
- 40 feet max from plug to last connector.
- Control box monitors the number of connections. When powered, a green light appears. If more than eight connections are detected, light turns red, indicating it has exceeded the number of connections. Reset by disconnecting extra connections and unplug power for 15 seconds. Reconnect power to the control box and indicator light will turn green.
- Control box bracket with screws included, attaches to a surface with a minimum thickness of 3/4".

Power cord length options:

options: 72", 108", 120"
Tip: Chicago 108" maximum cord length.

Power plug options:

- Standard NEMA 5-15 3-prong plug
- 90° NEMA 5-15 3-prong plug
- Thread low-profile plug
Finish: black

Jumper Cord with Modular Power Connector

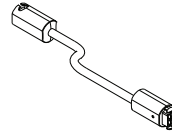

For use to span ganging furniture or provide extra length between powerstrips. Optional 15" and 30".

Jumper cord connects two powerstrips together for additional length when needed, in lounge settings or on furniture 60¹/₁₆"W up to 84"W.

Powerstrip with cord lengths

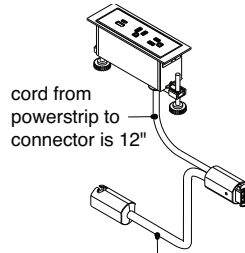

Powerstrip Options: Powerstrips with USB A+C 20W Intelligence

- If only USB-C in use, delivers what the device needs up to 20 watts.
- If only USB-A in use, up to 10 watts.
- If both USC A+C in use, USB-A delivers up to 10 watts and 10 watts to USB-C. If USB-A device needs less than 10W, the remainder, up to 20 watts, goes to USB-C device.

Powerstrip C-Clamp, 2 power outlets, 1 USB A+C 20W intelligence

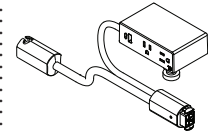

- Tamper resistant power outlets.
- Control box bracket with screws included, minimum worksurface thickness 3/4" permitted.

Power cord lengths with modular connectors:

- 40"
- 50"
- 60"

Finishes:

- 6009 Arctic White
- 6527 Merle

Powerstrip Front Edge Mount, with 1 power outlet, 1 USB A+C 20W intelligence

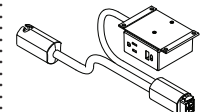

- Tamper resistant power outlet
- Footprint needed for installation

Power cord lengths with modular connectors:

- 40"
- 50"
- 60"

Finishes:

- 6009 Arctic White
- 6527 Merle

Powerstrip Flush Mount

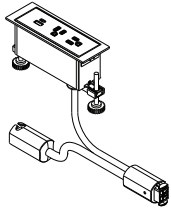

Power configurations:

- 3 power outlets
- 2 power outlets, 1 USB A+C 20W intelligence
- 2 power outlets, 1 data post
- 1 power outlet, 1 USB-C 100W
- Optional tamper resistant power outlets available.
- Faceplate keystone provided when data is specified. Coupler/jack not included
- Verify fit of jack in adapter before ordering large quantities as manufacturer designs may change without notice

Power cord lengths with modular connectors, black finish:

- 40"
- 50"
- 60"

Finishes:

- 6000 Black
- 6009 Arctic White
- 6053 Seagull
- 6527 Merle

Flush mount powerstrip requires the worksurface to be cut in the field. See assembly directions for details.

Pop Up Powerstrip

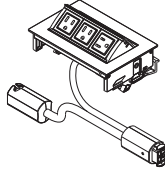

Power configurations:

- 3 power outlets
- 2 power outlets, 1 USB A+C 20W intelligence
- 2 power outlets, 1 data post
- 1 power outlet, 1 USB-C 100W
- Optional tamper resistant power outlets available.
- Faceplate keystone provided when data is specified. Coupler/jack not included
- Verify fit of jack in adapter before ordering large quantities as manufacturer designs may change without notice

Power cord lengths with modular connectors, black finish:

- 40"
- 50"
- 60"

Finishes:

- 4799 Platinum Metallic
- 6000 Black
- 6009 Arctic White
- 6053 Seagull
- 6527 Merle

Pop up powerstrip

requires the top's surface to be cut in the field. See assembly direction for details.

Tip: When selecting 4799 Platinum Metallic on the pop up powerstrip the faceplate will be merle.

Flush Mount and Pop Up Power Configurations

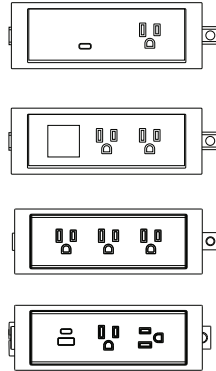

Actual Dimensions

Pop Up Power

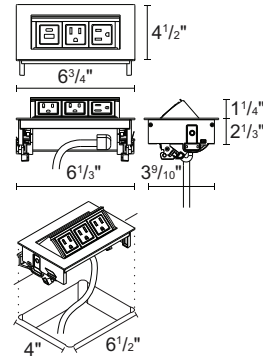

Flush Power

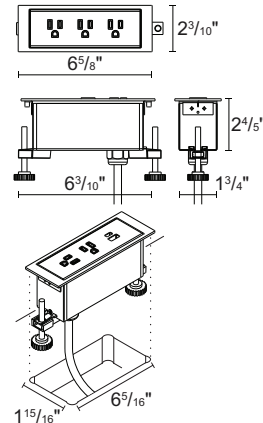

Powerstrip C-Clamp

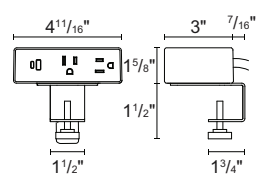

Powerstrip Front Edge Mount

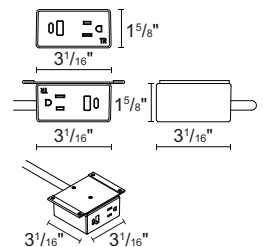

Wiring & Cabling

Cord Management P-clips

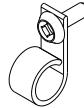

P-clips cord management clips attach to the underside of the top to assist cord routing. Used as accessory and where infrequently moving power unit. Cords must be managed 24 inches max from the connection point and cannot hang below worksurface more than six inches. Powerstrip includes 5 P-clips and 3 J-clips.

Tip: Cord clip screw length for minimum worksurface thickness of 3/4".

J-Clip Cord Management

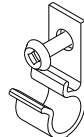

J-clip cord manager attaches to the underside of the top to assist cord routing. Included with powerstrips, infeed power, and jumpers. Install J-clips near cord end where connection and disconnection occurs between tables, so cords are well managed when not in use. Cords must be supported no more than 24 inches from connector edge and cannot hang below worksurface more than six inches.

- Powerstrip includes 5 P-clips and 3 J-clips.
- Power infeed includes 3 J-clips.
- Jumper cord includes 3 J-clips.

Tip: Cord clip screw length for minimum worksurface thickness of 3/4".

Connections

Supports for mechanical means of securement between two or more tables.

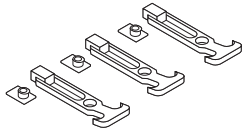

Flex Ganger Package	Style Number
Flex Ganger	TS4FG

Flex ganger packages are available and are installed on-site. They are useful in situations when tables will frequently be reconfigured and reganged. Specify one package for each table.

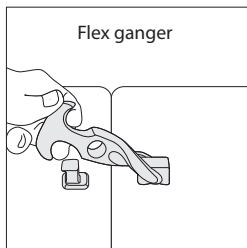

Flex gangers can be used to easily link adjacent tables in multiple configurations. Flex gangers use a flexible loop that engages a hook to hold two adjacent table tops in place. No tools are required to stretch the loop across the seam between two table edges and to connect it to the hook on the adjacent table.

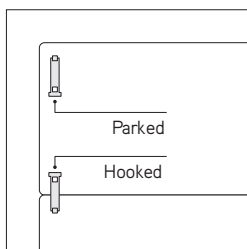

Flex gangers that are not in use can be folded back into the parked position.

Rectangle Tables Flex Ganger Locations

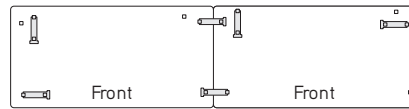

End-to-end

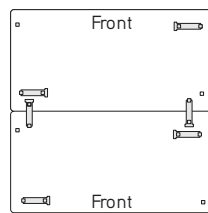

Back-to-back

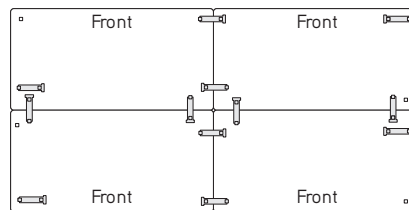

End-and-back

Team Tables Flex Ganger Locations

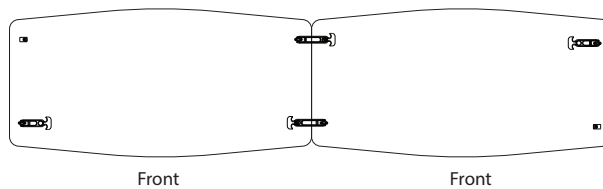

Relay Modular Power System— Pop Up Powerstrip

Relay Modular Power
System—Pop Up Powerstrip

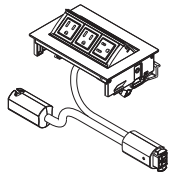

▶ Need help?
Product details,
page 246

Standard Includes

- Desktop module, with one touch open and close hinged door; anodized aluminum with painted steel
- Relay modular power connector
- Power cord: black
- Cord manager, 5 P-clips and 3 J-clips
- NRTL Listed

Required to Specify

- 1 Style number
- 2 Paint color number for powerstrip:
 - 0835 Black
 - 4799 Platinum Metallic
 - 7241 Arctic White
 - 7243 Seagull
 - 7360 Merle
- 3 Power configuration (see below under Required Selections)
- 4 Power cord (see below under Required Selections)
- 5 Options, if selected (see below)

Tip: Flush mount and pop up powerstrips require the top's surface to be cut in the field. See assembly directions for further details.

Tip: For USB-C 100W port, use USB-C charging cable rated for 100W use for full charging benefits. Charging cables not included.

Tip: Local electrical codes vary, so consult with your local authority having jurisdiction as they have final say if the products as installed are compliant with local code.

Tip: Optional data port adapter, coupler/jack not included. Verify fit of jack in adapter before ordering large quantities as manufacturer designs may change without notice.

Tip: Faceplate keystone provided when data is specified.

Tip: When selecting 4799 Platinum Metallic on the pop up powerstrip the faceplate will be merle.

	Required Selections	U.S. Price	Required to Specify
Power Configuration	<ul style="list-style-type: none"> • Three power outlets • Two power, one data • Two power, one USB A+C 20W • One power, one USB-C 100W 	No cost No cost +\$ 69 +\$269	Specify with three power outlets. Specify with two power, one data. Specify with two power, one USB A+C 20W. Specify with one power, one USB-C 100W.

Power Cord	<ul style="list-style-type: none"> • 40" standard cord • 50" standard cord • 60" standard cord 	No cost +\$ 38 +\$ 44	Specify with 40" standard cord. Specify with 50" standard cord. Specify with 60" standard cord.
-------------------	---------------------------------------------------------------------------------------------------------------------------------	-----------------------------	-------------------------------------------------------------------------------------------------------

	Options	U.S. Price	Required to Specify
Tamper Resistance Power Outlets	<ul style="list-style-type: none"> • No tamper resistance • With tamper resistance 	No cost +\$ 49	Specify with no tamper resistance. Specify with tamper resistance.

Related Products	<ul style="list-style-type: none"> • Relay modular power system power infeed and control box • Relay modular power system power jumper cord • Relay modular power system cord management clips and J-clips • Relay modular power system flush mount powerstrip • Relay modular power system powerstrip C-clamp • Relay modular power system powerstrip front edge mount 	▶ Page 253 ▶ Page 254 ▶ Pages 238 and 255 ▶ Page 250 ▶ Page 251 ▶ Page 252	
-------------------------	-------------------------------------------------------------------------------------------------------------------------------------------------------------------------------------------------------------------------------------------------------------------------------------------------------------------------------------------------------------------------------------------------------------------------------------	-------------------------------------------------------------------------------------------	--

Specification Information				
Dimensions			Style	U.S.
D	W	H	Number	Base Price
4 1/2"	6 3/4"	2 1/8"	DSMPQPSP	\$417



For Canadian Pricing

Multiply U.S. Price by the Canadian price factor.

▶ See page 1 for details.

Relay Modular Power System— Flush Mount Powerstrip

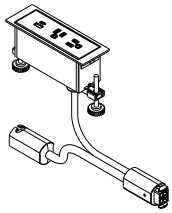

Tip: Flush mount and pop up powerstrips require the top's surface to be cut in the field. See assembly directions for further details.

Tip: For USB-C 100W port, use USB-C charging cable rated for 100W use for full charging benefits. Charging cables not included.

Tip: Local electrical codes vary, so consult with your local authority having jurisdiction as they have final say if the products as installed are compliant with local code.

Tip: Optional data port adapter, coupler/jack not included. Verify fit of jack in adapter before ordering large quantities as manufacturer designs may change without notice.

Tip: Faceplate mounts flat just above the worksurface top.

Tip: Faceplate keystone provided when data is specified.

Standard Includes		Required to Specify
<ul style="list-style-type: none"> ▶ Need help? Product details, page 246 	<ul style="list-style-type: none"> • Desktop module: plastic • Requires field top cut out • Relay modular power connector • Power cord: black • Cord manager, 5 P-clips and 3 J-clips • NRTL Listed 	<ol style="list-style-type: none"> 1 Style number 2 Plastic color number for powerstrip: 6000 Black, 6009 Arctic White, 6053 Seagull, 6527 Merle 3 Power configuration (see below under Required Selections) 4 Power cord (see below under Required Selections) 5 Options, if selected (see below)

	Required Selections	U.S. Price	Required to Specify
Power Configuration	<ul style="list-style-type: none"> • Three power outlets • Two power, one data • Two power, one USB A+C 20W • One power, one USB-C 100W 	<ul style="list-style-type: none"> No cost No cost +\$ 69 +\$269 	<ul style="list-style-type: none"> Specify with three power outlets. Specify with two power, one data. Specify with two power, one USB A+C 20W. Specify with one power, one USB-C 100W.
Power Cord	<ul style="list-style-type: none"> • 40" standard cord • 50" standard cord • 60" standard cord 	<ul style="list-style-type: none"> No cost +\$ 38 +\$ 44 	<ul style="list-style-type: none"> Specify with 40" standard cord. Specify with 50" standard cord. Specify with 60" standard cord.

	Options	U.S. Price	Required to Specify
Tamper Resistance Power Outlets	<ul style="list-style-type: none"> • No tamper resistance • With tamper resistance 	<ul style="list-style-type: none"> No cost +\$ 49 	<ul style="list-style-type: none"> Specify with no tamper resistance. Specify with tamper resistance.
Related Products	<ul style="list-style-type: none"> • Relay modular power system power infeed and control box • Relay modular power system power jumper cord • Relay modular power system cord management clips and J-clips • Relay modular power system powerstrip C-clamp • Relay modular power system powerstrip front edge mount 	<ul style="list-style-type: none"> ▶ Page 253 ▶ Page 254 ▶ Pages 238 and 255 ▶ Page 251 ▶ Page 252 	

Specification Information				
Dimensions			Style	U.S.
D	W	H	Number	Base Price
4 ³ / ₁₀ "	6 ⁵ / ₈ "	2 ⁴ / ₅ "	DSMPQPSF	\$417



For Canadian Pricing

Multiply U.S. Price by the Canadian price factor.

▶ See page 1 for details.

Relay Modular Power System— Powerstrip C-Clamp

Relay Modular Power
System—Powerstrip
C-Clamp

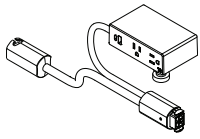

▶ Need help?
Product details,
page 246

Standard Includes

- Desktop module: plastic
- Powerstrip, two power, one USB A+C 20W
- Powerstrip with tamper resistance
- C-clamp mount
- Relay modular power connector
- Power cord: black
- Cord manager, 5 P-clips and 3 J-clips
- NRTL Listed

Required to Specify

- 1 Style number
- 2 Plastic color number for powerstrip:
6009 Arctic White
6527 Merle
- 3 Power cord (see below under Required
Selections)

*Tip: C-clamp is designed to
accommodate worksurfaces
up to 1 1/2" thick.*

*Tip: Local electrical codes
vary, so consult with your
local authority having jurisdic-
tion as they have final say if
the products as installed are
compliant with local code.*

	Required Selections	U.S. Price	Required to Specify
Power Cord	<ul style="list-style-type: none"> • 40" standard cord • 50" standard cord • 60" standard cord 	<ul style="list-style-type: none"> No cost +\$38 +\$44 	<ul style="list-style-type: none"> Specify with 40" standard cord. Specify with 50" standard cord. Specify with 60" standard cord.

Related Products

- Relay modular power system power infeed and control box ▶ Page 253
- Relay modular power system power jumper cord ▶ Page 254
- Relay modular power system cord management clips and J-clips ▶ Pages 238 and 255
- Relay modular power system flush mount powerstrip ▶ Page 250
- Relay modular power system powerstrip front edge mount ▶ Page 252

Specification Information

Dimensions			Style	U.S.
D	W	H	Number	Base Price
3"	3"	3 1/8"	DSMPQPSC	\$419

Relay Modular
Power System



For Canadian Pricing

Multiply U.S. Price by the
Canadian price factor.

▶ See page 1 for details.

Relay Modular Power System— Powerstrip Front Edge Mount

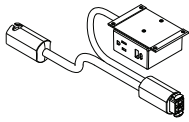

Standard Includes		Required to Specify
<ul style="list-style-type: none"> ▶ Need help? Product details, page 246 	<ul style="list-style-type: none"> • Module: plastic • Powerstrip, one power, one USB A+C 20W • Powerstrip with tamper resistance • Front edge mount • Relay modular power connector • Power cord: black • Cord manager, 5 P-clips and 3 J-clips • NRTL Listed 	<ol style="list-style-type: none"> 1 Style number 2 Plastic color number for powerstrip: 6009 Arctic White 6527 Merle 3 Power cord (see below under Required Selections)

Tip: Local electrical codes vary, so consult with your local authority having jurisdiction as they have final say if the products as installed are compliant with local code.

Tip: Edge mount for lounge conference/collaborative tables, mounts under the lounge frame or worksurface, front user edge for ease of access.

Tip: Hardware included is for 1" plus thick surfaces. If installing on less than 1" thick surfaces, shorter length screws must be obtained.

Tip: Edge mount bracket requires under the worksurface footprint of 4" depth (includes cord radius) and 4 1/8" width.

Required Selections	U.S. Price	Required to Specify
Power Cord		
• 40" standard cord	No cost	Specify with 40" standard cord.
• 50" standard cord	+\$38	Specify with 50" standard cord.
• 60" standard cord	+\$44	Specify with 60" standard cord.

Related Products	
• Relay modular power system power infeed and control box	▶ Page 253
• Relay modular power system power jumper cord	▶ Page 254
• Relay modular power system cord management clips and J-clips	▶ Pages 238 and 255
• Relay modular power system flush mount powerstrip	▶ Page 250
• Relay modular power system powerstrip front edge mount	▶ Page 252

Specification Information				
Dimensions			Style Number	U.S. Base Price
D	W	H		
47/10"	3"	1 3/5"	DSMPQPSE	\$301



For Canadian Pricing
Multiply U.S. Price by the Canadian price factor.
▶ See page 1 for details.

Relay Modular Power System— Power Infeed and Control Box

Relay Modular Power
System—Power Infeed and
Control Box

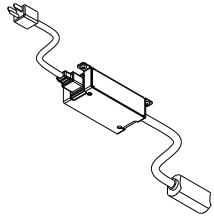

Tip: Local electrical codes vary, so consult with your local authority having jurisdiction as they have final say if the products as installed are compliant with local code.

Tip: Control box bracket with screws. Minimum worksurface thickness 3/4" permitted.

Tip: A maximum of eight connections. A total of 8 jumper cords and powerstrips can be connected to one power infeed and control box.

Tip: Control box light indicator with proper connections illuminates green. If connections exceed the maximum of eight, the light indicator will illuminate red. To reset, disconnect extra connections and unplug control box from power for 15 seconds. Reconnect power to the control box and the light indicator will illuminate green.

Tip: Connector to control box cord length is 15 3/4". Cord length from control box to plug options are 72", 108", or 120".

Standard Includes		Required to Specify
▶ Need help? Product details, page 246	<ul style="list-style-type: none"> • Power infeed with control box • Control box mounting bracket • Power cord: black • Cord management, 3 J-clips • NRTL Listed 	1 Style number 2 Power cord (see below under Required Selections) 3 Options, if selected (see below)

Required Selections	U.S. Price	Required to Specify
Power Cord		
• 72" standard cord	No cost	Specify with 72" standard cord.
• 108" standard cord	+\$22	Specify with 108" standard cord.
• 120" standard cord	+\$22	Specify with 120" standard cord.

Options	U.S. Price	Required to Specify
Power Plug		
• Standard NEMA 5-15 3-prong	No cost	Specify with standard NEMA 5-15 3-prong plug.
• 90° NEMA 5-15 3-prong	+\$39	Specify with 90° NEMA 5-15 3-prong plug.
• Thread low profile plug	+\$43	Specify with thread low profile plug.

Related Products		
• Relay modular power system power jumper cord		▶ Page 254
• Relay modular power system cord management clips and J-clips		▶ Pages 238 and 255
• Relay modular power system flush mount powerstrip		▶ Page 250
• Relay modular power system powerstrip C-clamp		▶ Page 251
• Relay modular power system powerstrip front edge mount		▶ Page 252

Specification Information	
Style Number	U.S. Base Price
DSMPQINFEEED	\$591

Relay Modular
Power System

 **For Canadian Pricing**
Multiply U.S. Price by the Canadian price factor.
▶ See page 1 for details.

Relay Modular Power System— Jumper Cord

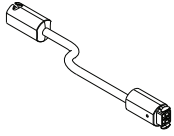

Tip: Local electrical codes vary, so consult with your local authority having jurisdiction as they have final say if the products as installed are compliant with local code.

Tip: A maximum of eight jumper cords and powerstrips can be connected to one power infeed and control box.

Tip: Jumper cord can be used to span ganging furniture or provide extra length between powerstrips, or for tables 60¹/₁₆"W and greater.

Standard Includes		Required to Specify
▶ Need help? Product details, page 246	<ul style="list-style-type: none"> • Jumper cord with relay modular power connector • Power cord: black • Cord manager, 3 J-clips • NRTL Listed 	1 Style number 2 Power cord (see below under Required Selections)

Power Cord	Required Selections	U.S. Price	Required to Specify
	• 15" standard cord	No cost	Specify with 15" standard cord.
	• 30" standard cord	+\$11	Specify with 30" standard cord.

Related Products		
Related Products	<ul style="list-style-type: none"> • Relay modular power system power infeed and control box • Relay modular power system cord management clips and J-clips • Relay modular power system flush mount powerstrip • Relay modular power system powerstrip C-clamp • Relay modular power system powerstrip front edge mount 	▶ Page 253 ▶ Pages 238 and 255 ▶ Page 250 ▶ Page 251 ▶ Page 252

Specification Information	
Style Number	U.S. Base Price
DSMPQJUMP	\$123



For Canadian Pricing
 Multiply U.S. Price by the Canadian price factor.
 ▶ See page 1 for details.

Relay Modular Power System— J-Clips Cord Management

Relay Modular Power
System—J-Clips Cord
Management

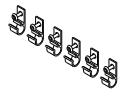

Tip: Use with modular power powerstrip cords, jumper cords, power infeed cords for proper cord management.

Tip: Cord clip screw length requires a minimum work-surface thickness of 3/4".

Standard Includes	Required to Specify
<ul style="list-style-type: none"> ▶ Need help? Product details, page 246 	<ul style="list-style-type: none"> • J-clip cord management six pack • Includes six screws • Clip: black
	<ul style="list-style-type: none"> ▶ Style number

Related Products	
• Relay modular power system power infeed and control box	▶ Page 253
• Relay modular power system power jumper cord	▶ Page 254
• Relay modular power system flush mount powerstrip	▶ Page 250
• Relay modular power system powerstrip C-clamp	▶ Page 251
• Relay modular power system powerstrip front edge mount	▶ Page 252

Specification Information	
• Style Number	• U.S. Price
DSMPQCLIP6	\$41

Relay Modular Power System

 **For Canadian Pricing**
Multiply U.S. Price by the Canadian price factor.
▶ See page 1 for details.



Steelcase Flex Collection

	
Statement of Line	258

Steelcase Flex Mobile Power

Understanding	259
Specifying	260

Steelcase Flex Mobile Power Charging Cart

Understanding	261
Specifying	262

Statement of Line

Flex Mobile Power

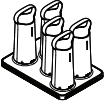

- Understanding
 - ▶ Page 259
- Specifying
 - ▶ Page 260

Flex Mobile Power Charging Cart

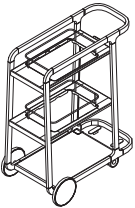

- Understanding
 - ▶ Page 261
- Specifying
 - ▶ Page 262

Steelcase Flex Mobile Power

Steelcase Flex
Mobile Power

Steelcase Flex mobile power is a sleek, smart mobile power solution that gives teams and individuals the freedom to work anywhere they want.
▶ Specifying, page 260

Steelcase Flex mobile power is ordered and shipped as a kit of five mobile power units and one mobile power charging tray.

With bumper is an option on mobile power charging tray. Specify with bumper for freestanding applications.
Tip: Bumper can be added or uninstalled in the field.

No bumper is an option for mobile power integrated into the Steelcase Flex mobile power charging cart.

Mobile power charging tray can charge five mobile power units simultaneously in approximately five hours.

USB-C ports can charge a single 100W laptop or up to two 60W laptops simultaneously. USB-C charging cable rated to 100W for full charging benefits. Charging cables not included.

USB-A port can provide up to 18W, ideal for devices like earbuds, phones, and tablets.

Total wattage of all three ports cannot exceed 120W. See user guide for more details.

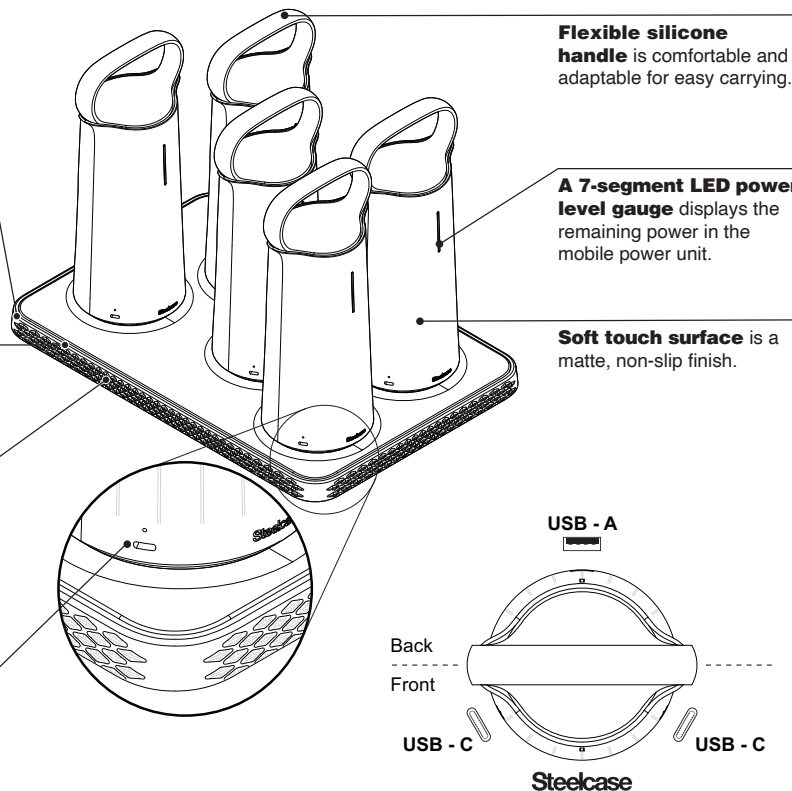

Product Details

Steelcase Flex mobile power units have a capacity of 154-watt hours each and can provide up to 120-watts of power simultaneously to up to three devices; two USB-C and one USB-A devices.

Battery chemistry utilizes cobalt-free Lithium Iron Phosphate battery cells designed to maintain 80% of their capacity after 2,000 cycles.

Mobile power charging tray can be specified as standalone freestanding tray, with a bumper on the outside with rubber feet, or without the bumper so it can be integrated into the Steelcase Flex mobile power-charging cart.
▶ Specifying, page 262

Mobile power charging tray ships with a freestanding 200-watt power supply.

Place the batteries and charging tray in an open, well-ventilated area.

Product Performance

Mobile power can only charge laptops that receive power via a USB-C port. Use of adapters or converters from USB-C to legacy barrel jack connectors may void Steelcase and laptop warranty.

Surface Materials

Flex mobile power kit
• 6000 Black

Steelcase
Flex Collection

Actual Dimensions

	Mobile power unit	Mobile power charging tray
Depth	4 ¹ / ₅ "	1 ¹ / ₅ "
Width	5"	11 ² / ₅ "
Length	11 ³ / ₁₀ "	16 ⁷ / ₁₀ "

Steelcase Flex Mobile Power

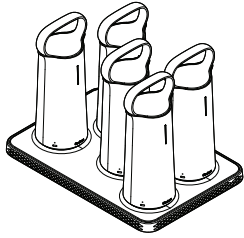

Tip: Mobile power and tray ship separately via FedEx ground due to lithium ion battery regulations.

Tip: With bumper has a total charging cord length of 113.3" or 9.4 feet.

Tip: No bumper has a total charging cord length of 83.7" or 7 feet.

Tip: Order no bumper option when using Flex mobile power charging cart, (cart sold separately).

Tip: Order with bumper for freestanding use.

Tip: USB-C charging cable rated to 100W for full charging benefits. Charging cables not included.

Tip: Flex Mobile power can only charge laptops that receive power via a UCB-C port. Use of adapters or converters from USB-C to legacy barrel jack connectors may void laptop warranty.

Standard Includes	Required to Specify
<ul style="list-style-type: none"> ▶ Need help? Product details, page 259 • Five mobile power units • One mobile power charging tray • One power supply with standard NEMA plug • Battery and tray: 6000 Black 	<ul style="list-style-type: none"> 1 Style number 2 Options, if selected (see below)

Options	U.S. Price	Required to Specify
Bumper <ul style="list-style-type: none"> • No bumper • With bumper 	<ul style="list-style-type: none"> No cost No cost 	<ul style="list-style-type: none"> Specify <i>with no bumper</i>. Specify <i>with bumper</i>.

Specification Information	
Style Number	U.S. Price
FLXMBATPKG2AM	\$6074



For Canadian Pricing

Multiply U.S. Price by the Canadian price factor.

▶ See page 1 for details.

Steelcase Flex Mobile Power Charging Cart

Steelcase Flex Mobile
Power Charging Cart

Steelcase Flex mobile power charging cart allows for convenient charging for up to 10 mobile power units with one cord to connect to an outlet.

► Specifying, page 262

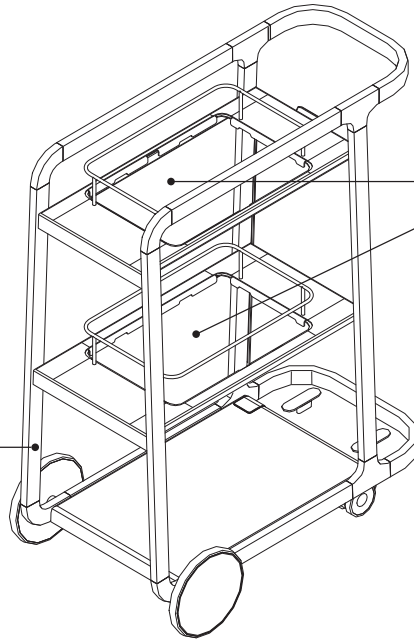

Flex mobile power charging cart is shipped with cable management clips and routing for power cords that come from trays. These will match the frame color that is specified.

Two charging shelves always ship with cutout and railing to accommodate two mobile power charging trays. Mobile power kit ordered separately, see page 268

Product Details

Top and middle shelves are painted black to match the charging tray and batteries.

Frame and bottom shelf sections will always match.

Mobile power charging cart does not accommodate clips or hooks for hanging accessories or markerboards.

Mobile power charging cart is available with either a standard three prong NEMA plug for use with standard receptacles or with Steelcase's proprietary thread low-profile plug.

Surface Materials

Frame and bottom shelf

- Paint

Top and middle shelves

- 7207 Black

Wheels and casters

- 6053 Seagull with sterling dark solid tread
- 6527 Merle with Merle tread

Steelcase
Flex Collection

Actual Dimensions

Depth	13"
Width	32"
Height	41 ³ / ₈ "

Steelcase Flex Mobile Power Charging Cart

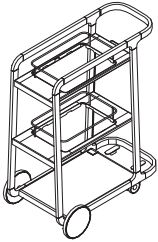

Tip: Cart is standard with shelves and cable routing for two mobile power kits (FLXMBATPKG2AM, ordered separately).

	Standard Includes	Required to Specify
▶ Need help? Product details, page 261	<ul style="list-style-type: none"> • Frame: paint price group 1 • One perforated bottom shelf: paint matches frame • Top and middle shelves for mobile power charging tray integration: 7207 Black • Casters: <ul style="list-style-type: none"> – 6053 Seagull – 6527 Merle • Power routing clips and cable management tray for underside of cart • Power tap for plugging in mobile power charging tray power supplies • 9' cord 	<ol style="list-style-type: none"> 1 Style number 2 Paint color number for frame 3 Plastic color number for casters 4 Options, if selected (see below) <p>▶ See Surface Materials, page 264.</p>

	Options	U.S. Price	Required to Specify
Surface Materials	Frame <ul style="list-style-type: none"> • Paint price group 1 • Paint price group 2 • Paint price group 3 	No cost +\$ 52 +\$104	Specify paint color number. Specify paint color number. Specify paint color number.
Power Plug Type	<ul style="list-style-type: none"> • Standard NEMA 5–15 3-prong • Thread low profile plug 	No cost +\$ 43	Specify with <i>standard NEMA 5–15 3-prong plug.</i> Specify with <i>thread low profile plug.</i>

Specification Information				
Dimensions			Style Number	U.S. Base Price
D	W	H		
13"	32"	41 ³ / ₈ "	FLXBCTBAT	\$3647



For Canadian Pricing
 Multiply U.S. Price by the Canadian price factor.
 ▶ See page 1 for details.

Surface Materials

Surface Materials	264
Defaulted Finishes	266

Surface Materials

This listing includes all the surface material choices that are available for the products in this specification guide.

Resources

For more information about surface materials, refer to the following resources:

- Steelcase Surface Materials Reference Manual
- Steelcase Wood Finish Swatch Card
- www.steelcase.com

Additional surface materials specification tools are available to assist you in the specification process—the Surface Materials Binders.

Surface Materials Binders

- include:
- A complete set of swatch cards for hard surfaces, vertical surface fabrics, and seating upholstery

Paint

► See Surface Materials Reference Manual for a listing of available paints for Victor2.

Tip: All products may not be available in all colors listed below.

Applies to:

- Lighting
 - Computer support tools
 - Organizational worktools
 - Flat panel arm
- 0835 Black
4140 Arctic White
4231 Arctic White Gloss
4710 Low Gloss Black
4750 Champagne
4799 Platinum Metallic
7018 Pewter
7360 Merle
ZW01 Pearl Snow

Applies to:

- Flex mobile power charging cart
- 4140 Arctic White Gloss
4144 Black Gloss
4238 Mocha
4239 Clay
4240 Chalk
4242 Milk
4710 Low Gloss Black
4728 Nickel Metallic **E**
4750 Champagne Metallic
4798 Sterling Metallic **E**
4799 Platinum Metallic
4803 Near Black Metallic
4990 Perfect Match
7207 Black
7225 Sand
7237 Slate
7238 Fieldstone
7239 Midnight **E**
7241 Arctic White
7243 Seagull
7250 Sterling Dark Solid
7278 Dark Bronze
7360 Merle
1ATG Rose Quartz
4AV3 Blue Jay
4AV4 Baltic
4AX1 Citron
4AY2 Chili
4AZ5 Marlin
4B20 Obsidian
4B22 Matte Brass
4B23 Burnished Bronze
4B24 Night Bronze
4B25 Matte Copper
4B26 Smoked Mica
4B29 Cast Iron
4CL1 Dark Olivine
4CL2 Ice Blue
4CL3 Aura
4CL4 Sea Glass
4CL5 Light Matcha
4CL6 Terra
4CL7 Sandstone
4CL8 Smokey Plum
4CZ5 Honey
4CZ6 Lagoon

Applies to:

- dash LED light
 - dash mini LED light
 - LED radial desktop lights
 - LED linear desktop lights
 - SOTO rails
- See page 266 for SOTO rails defaulted finishes.

Price Group 3

Applies to:

- dash lights
- LED radial desktop lights
- LED linear desktop lights

Accent Paint

- 1ATG Rose Quartz
4AV3 Blue Jay
4AV4 Baltic
4AX1 Citron
4AY2 Chili
4AZ5 Marlin
4CL1 Dark Olivine
4CL2 Ice Blue
4CL3 Aura
4CL4 Sea Glass
4CL5 Light Matcha
4CL6 Terra
4CL7 Sandstone
4CL8 Smokey Plum
4CZ5 Honey
4CZ6 Lagoon

Custom Surfaces

Price Group 3

PerfectMatch

PerfectMatch is a service that allows you to create your own paint color. Refer to the Surface Materials Reference Manual for more information about this program.

Laminate

► See Surface Materials Reference Manual for a listing of available laminates for Victor2.

Wood

► See Surface Materials Reference Manual for a listing of available wood for Victor2.

Plastic

- 6000 Black
6009 Arctic White
6059 Sterling Dark Solid
6288 Charcoal
6527 Merle
6544 Frost
6546 Rain
- Tip: Light color plastic edges are susceptible to degradation due to normal wear and tear. Staining (e.g., ball point pen or clothing dyes such as blue jeans) and dirt effects are more pronounced in light colors and are not considered defects.*

Applies to:

- SOTO storage
- 6009 Arctic White
6302 Baltic
6338 Chili
6527 Merle
6BE2 Light Peacock
6BE3 Cotton Candy

Applies to:

- SOTO functional screen
 - SOTO mobile caddy
 - SOTO launch pad
 - SOTO monitor bridge
- 6009 Arctic White
6527 Merle

Applies to:

- Powerstrip Plus
- 6000 Black
6009 Arctic White
6053 Seagull
6302 Baltic
6338 Chili
6527 Merle
6BD1 Aubergine
6BD2 Peacock
6BD5 Honey
6BD6 Lagoon
6BD7 Saffron
6BE2 Light Peacock

Acrylic

Applies to:

- Modesty and privacy screens
- 6544A Acrylic Frost

SOTO Fabric Pads

Applies to:

- SOTO mobile caddy
- SOTO launch pad
- SOTO monitor bridge

Standard Fabric Pad

Dark grey felt

Cogent: Connect Fabric Set 1

- 5S17 Tangerine
5S18 Scarlet
5S21 Blue Jay
5S23 Wasabi
5S25 Graphite
5S27 Malt

Cogent: Connect Fabric Set 2

- 5S15 Coconut
5S16 Turmeric/Honey
5S19 Concord
5S24 Nickel
5S26 Licorice
5S28 Root Beer
5S93 Indigo/Blueprint
5S94 Lizard/Jungle
5S95 Sailor
5S96 Quicksilver
5S99 Lipstick/Merlot
5SD0 Royal Blue
5SD1 Aubergine
5SD2 Peacock
5SD3 Lagoon
5SD4 Saffron

E = Excluded

Select Surfaces

For information on products within Select Surfaces, including accent paints and fabrics from Designtex, Gabriel, Kvadrat, and Pollack, please refer to the *Surface Materials Reference Manual* or visit steelcase.com/surface-materials under the Select Surfaces section.

Custom Surfaces

Price Group COM (Customer's Own Material)

Fabric Approval and Yardage

To confirm whether a particular COM material has already been tested for use on a specific Steelcase product or to determine actual yardage requirements:

- Visit www.steelcase.com

Fabric

- Applies to:
- Divisio side screen
 - Fixed personal/modesty screens

Price Group 2

Dovetail by Designtex

- 5H39 Light Mocha
- 5H40 Pebble
- 5H41 Warm White
- 5H42 Sandstone
- 5H43 Honeycomb
- 5H44 Terra
- 5H45 Honeydew
- 5H46 Denim
- 5H47 Storm
- 5H48 Ice Blue
- 5H49 Aura
- 5H50 Darkest Grey

SoftNext

- 5H27 Obsidian
- 5H28 Foggy Night
- 5H29 Greystone
- 5H30 Mocha
- 5H31 Clay
- 5H32 Sandstone
- 5H33 Chalk
- 5H34 Midnight
- 5H35 Blue Mica
- 5H36 Jade
- 5H37 Burnt Umber
- 5H38 Cinnabar

Defaulted Finishes

SOTO Rails

Rails	Brackets and Stanchions	Plastic Components*
4799 Platinum Metallic	4799 Platinum Metallic	6278 Felt
4AV4 Baltic, 4AY2 Chili	4799 Platinum Metallic	6278 Felt
	7360 Merle	6527 Merle

**Plastic components are defaulted by bracket and stanchion color.*

Resources

Style Number Index

268

Style Number Index

Style Number	Page	Description
AHCC	197	Vertical Cable Carrier
AM22	180	22" Modesty Screen
AM28	180	28" Modesty Screen
AM34	180	34" Modesty Screen
AM40	180	40" Modesty Screen
AM46	180	46" Modesty Screen
AM52	180	52" Modesty Screen
AM58	180	58" Modesty Screen
AM64	180	64" Modesty Screen
AMP22	180	22" Modesty and Privacy Screen
AMP28	180	28" Modesty and Privacy Screen
AMP34	180	34" Modesty and Privacy Screen
AMP40	180	40" Modesty and Privacy Screen
AMP46	180	46" Modesty and Privacy Screen
AMP52	180	52" Modesty and Privacy Screen
AMP58	180	58" Modesty and Privacy Screen
AMP64	180	64" Modesty and Privacy Screen
AP22	180	22" Privacy Screen
AP28	180	28" Privacy Screen
AP34	180	34" Privacy Screen
AP40	180	40" Privacy Screen
AP46	180	46" Privacy Screen
AP52	180	52" Privacy Screen
AP58	180	58" Privacy Screen
AP64	180	64" Privacy Screen
AWDR	62	Victor2 Display
AWM06	198	6" Wire Manager
AWM12	198	12" Wire Manager
AWM18	198	18" Wire Manager
AWM23	198	23" Wire Manager
AWM30	198	30" Wire Manager
AWM35	198	35" Wire Manager
AWM42	198	42" Wire Manager
AWM48	198	48" Wire Manager
AWMXL30	198	6"D Wire Manager
AWMXL36	198	6"D Wire Manager
AWMXL42	198	6"D Wire Manager
AWMXL48	198	6"D Wire Manager
AWMXL54	198	6"D Wire Manager
AWMXL60	198	6"D Wire Manager
AWRF254836	61	Victor2 Freestanding Unit
AWRF256036	61	Victor2 Freestanding Unit
AWRM183636	58	Victor2 Mobile Unit
AWTS	62	Victor2 Tray Shelf
CFDC	159	CF Dual Hub
CFDUALBARCK	157	CF Ser Std Dual Bar Assy Conv Kit
CFHDQRTH2	164	Heavy-Duty Tilt Head Mechanism
CFHDTH	164	CF Heavy-Dt Tilt Head
CFINTRO	152	CF Intro Single
CFINTROSLIDE	152	CF Intro Dual with sliders
CFLAPTOPCK	156	CF Laptop Conversion Kit
CFLHS	160	CF Laptop Holder Tray Platform
CFMAX	158	CF Max
CFMSC	159	CF Single Connector Monitor Bracket
CFP14	167	CF Flat Panel Pole No Arm

Style Number	Page	Description
CFP20	167	CF Flat Panel Pole
CFP28	167	CF Flat Panel Pole No Arm
CFPLUS	153	CF Plus
CFPLUSCK	155	CF Plus Conversion Kit
CFPLUSHD	154	CF Plus Heavy-Duty
CFPLUSHDCK	156	CF Plus HD Conversion Kit
CFSERIESCC	161	CF C-Clamp
CFSERIESTM	161	CF Flat Panel Monitor Bracket
CFSLIDETHHD	165	CF Slider Bar Tilt Head
CFSPMOD	162	CF Modular Pole
CFSPMODBV	162	CF Modular Pole Mount Bivi Brkt
CFSPMODFO	162	CF Modular Pole Mount FrameOne Brkt
CFSPSGLBASE	163	CF Max-Duty Arm Brkt
CFSPSW	163	CF Flat Pnl Monitor Brkt
CFSPWM	163	CF Flat Pnl Monitor Brkt
CFSTATIC	169	CF Static
CFSTDDUALBAR	157	CF Ser Std Dual Bar Assy
CFSTH	164	CF Flat Pnl Monitor Arms and Supt
CFTECHCRD	134, 160	CF Technology Cradle
CFTHC	158	CF Conversion Kit
CFTHSLIDE	166	CF Adjustable Monitor Adapter
CFTHSLIDEHD	166	CF Adjustable Monitor Adapter
CFTHSLIDEWO	166	CF Adjustable Monitor Adapter
CFTR	132	Adjustable Foot Rest
CFXP12H	167	CF Arm Extensions for Pole Mount
CFXP4H	167	CF Arm Extensions for Pole Mount
CFXP8H	167	CF Arm Extensions for Pole Mount
CPRCCL	133	Vertical Locking CPU Cradle
CPRCCN	133	Vertical Non-Locking CPU Cradle
CPRSLFO	134	Vert Processor Sling, Fixed
CPUMINI	132	CPU Cradle For Mini Processors
CQSF3012	178	12"H Fixed Personal/Modesty Screen
CQSF3019	178	19"H Fixed Personal/Modesty Screen
CQSF3024	178	24"H Fixed Personal/Modesty Screen
CQSF3612	178	12"H Fixed Personal/Modesty Screen
CQSF3619	178	19"H Fixed Personal/Modesty Screen
CQSF3624	178	24"H Fixed Personal/Modesty Screen
CQSF4212	178	12"H Fixed Personal/Modesty Screen
CQSF4219	178	19"H Fixed Personal/Modesty Screen
CQSF4224	178	24"H Fixed Personal/Modesty Screen
CQSF4812	178	12"H Fixed Personal/Modesty Screen
CQSF4819	178	19"H Fixed Personal/Modesty Screen
CQSF4824	178	24"H Fixed Personal/Modesty Screen
DCCLIP	49	SOTO Cable Clip
DPHOOK	50	SOTO Personal Hook
DSBULKSTRP	206	Smart Straps Bulk Pack
DSDFB	45	SOTO Diag File Box
DSFS	49	SOTO Functional Screen
DSLLB	45	SOTO Lndscp Ltr Box
DSLPLNP	48	SOTO Launch Pad
DSLPLP	48	SOTO Launch Pad
DSLS	51	SOTO Freestand Laptop Shelf
DSLSRM	51	SOTO Rail-Mount Laptop Shelf
DSMB	50	SOTO Monitor Bridge
DSMC	48	SOTO Mobile Caddy

Style Number	Page	Description	Style Number	Page	Description
DSMPDB	236	Univ Mod Pwr Sys Pwr Dist Blk to Pwrstrip	L53FTY	114	Bottomline
DSMPINFEED	232	Univ Mod Pwr Sys Pwr Infeed	L54FT	114	Bottomline
DSMPINFEEDC	233	Univ Mod Pwr Sys Pwr Infeed	L54FTCHI	114	Bottomline
DSMPJC	235	Univ Mod Pwr Sys Jumper Cord	L54FTS	114	Bottomline
DSMPJS	234	Univ Mod Pwr Sys Jumper Cord	L54FTY	114	Bottomline
DSMPSPC	228	Univ Mod Pwr Sys Pwrstrip w/C-Clamp	LDASHC	73	dash LED Light, C-clamp Mount
DSMPSPSE	227	Univ Mod Pwr Sys Pwrstrip w/Edge Mount	LDASHF	73	dash LED Light, Freestanding
DSMPSPSF	230	Univ Mod Power—Powerstrip w/Flush Mount	LDASHMINIC	75	dash mini LED Light, C-clamp Mount
DSMPSPSP	229	Univ Mod Power—Powerstrip Pop-Up	LDASHMINIF	75	dash mini LED Light, Freestanding
DSMPSPSPYR	231	Power Pyramid Modular	LDASHMINIOC	76	dash mini LED Light, C-clamp Mount
DSMPQCLIP6	255	Relay Mod Power Syst—J Clips Cord Mgmt	LDASHMINIOF	76	dash mini LED Light, Freestanding
DSMPQINFEED	253	Relay Mod Pwr Sys—Pwr Infeed and Ctrl Box	LDASHMINIOP	76	dash mini LED Light, Pnl-Mount
DSMPQJUMP	254	Relay Mod Power Sys—Jumper Cord	LDASHMINIOR	76	dash mini LED Light, Rail-Mount
DSMPQPSC	251	Relay Mod Power Sys—Powerstrip C-Clamp	LDASHMINIOS	76	dash mini LED Light, Slatwall/SlatRail Mount
DSMPQPSE	252	Relay Mod Pwr Sys—Pwrstrip Front Edge Mnt	LDASHMINIOU	76	dash mini LED Light, Free USB, Occ Snrs
DSMPQPSPF	250	Relay Mod Power Sys—Pwrstrip Flush Mount	LDASHMINIP	75	dash mini LED Light, Pnl-Mount
DSMPQPSPSP	249	Relay Mod Power Syst—Powerstrip Pop-Up	LDASHMINIR	75	dash mini LED Light, Rail-Mount
DSMPSPB	237	Univ Mod Pwr Sys Infeed Pwr Splitter Dist Blk	LDASHMINIS	75	dash mini LED Light, Slatwall/SlatRail Mount
DSMPUP	226	Univ Mod Pwr Sys Und Wksf Utility Pwr 4 Out	LDASHMINIU	75	dash mini LED Light, Freestanding USB
DSPB	46	SOTO Personal Box	LDASHOC	74	dash LED Light, C-clamp Mount
DSPCLIP2	238	Univ Mod Pwr Sys Cord Mgmt Clip	LDASHOF	74	dash LED Light, Freestanding
DSPCLIP6	238	Univ Mod Pwr Sys Cord Mgmt Clip	LDASHOP	74	dash LED Light, Pnl-Mount
DSPINTRO	199	Powerstrip Intro	LDASHOR	74	dash LED Light, Rail-Mount
DSPOP	203	Univ Mod Power - Powerstrip Pop-Up	LDASHOS	74	dash LED Light, Slatwall/SlatRail Mount
DSPPOWER	201	Desktop Powerstrip Plus USB/Data	LDASHOU	74	dash LED Light, Freestanding USB, Occ Snrs
DSPPP	49	SOTO Personal Pocket	LDASHOU	73	dash LED Light, Pnl-Mount
DSR28	44	28" SOTO Rail	LDASHR	73	dash LED Light, Rail-Mount
DSR34	44	34" SOTO Rail	LDASHS	73	dash LED Light, Slatwall/SlatRail Mount
DSR40	44	40" SOTO Rail	LDASHU	73	dash LED Light, Freestanding USB
DSR46	44	46" SOTO Rail	LECLIPSE	81	Steelcase Eclipse Light
DSR52	44	52" SOTO Rail	LLL17	104	LED Linear Shelf Light
DSR58	44	58" SOTO Rail	LLL17YA	104	LED Linear Shelf Light
DSR64	44	64" SOTO Rail	LLL17YB	104	LED Linear Shelf Light
DSSPB	44	SOTO Pile Box	LLL31	104	LED Linear Shelf Light
DSTB	45	SOTO Tool Box	LLL31YB	104	LED Linear Shelf Light
DSTRAYLG	205	Universal Cable Management Kit Large	LLL44	105	LED Linear Shelf Light
DSTRAYSM	205	Universal Cable Management Kit Small	LLL44YB	105	LED Linear Shelf Light
DSUB	46	SOTO Utility Box	LLL58	105	LED Linear Shelf Light
DSUP	204	Under Worksurface Utility Power	LLL58YB	105	LED Linear Shelf Light
DSVCMHC	197	High-Capacity Cable Riser	LLLDD	89	LED Linear Desktop Light
DVSS2912	175	Divisio Side Screen	LLLDS	89	LED Linear Desktop Light
DWBE	35	Wastebasket	LLRDD	85	LED Radial Desktop Light
FLXBCTBAT	262	Flex, Mobile Power Charging Cart	LLRDS	85	LED Radial Desktop Light
FLXMBATPKG2AM	260	Flex Mobile Power	LMINICORD	94	Mini Extension Cord
FTH	36	Flat Top Hanger	LS1FSC	113	Daisy Chain Cord
JP10SF	129	Jules Keyboard Pltfrm	LS6FSC	113	Daisy Chain Cord
KMINI	33	Mini Shelf	LSCTSKLIGHT1	93	LED Intro Task Light
L5	128	5" Lift & Lock Mechanism	LSCTSKLIGHT2	93	LED Intro Task Light
L52FT	114	Bottomline	LSL18	98	LED Light
L52FTCHI	114	Bottomline	LSL18YA	98	LED Light
L52FTS	114	Bottomline	LSL18YB	98	LED Light
L52FTY	114	Bottomline	LSM24K	112	Standard Light
L53FT	114	Bottomline	LSM24KC	112	Standard Light
L53FTCHI	114	Bottomline	LSM24KD	112	Standard Light
L53FTS	114	Bottomline	LSM36K	112	Standard Light

Style Number Index, continued

Style Number	Page	Description
LSM36KC	112	Standard Light
LSM36KD	112	Standard Light
LSM48K	112	Standard Light
LSM48KC	112	Standard Light
LSM48KD	112	Standard Light
PCDB1	46	SOTO Intro Bundle
PCDB2	47	SOTO Essential Bundle
PCDB3	47	SOTO Box Bundle
Q11T	128	11" Track
Q17T	128	17" Track
Q20T	128	20" Track
Q23T	128	23" Track
TS4FG	248	Flex Ganger Package
TS7PVWM	116	Vertical Wire Mgr
UNIVERSALSLIDE	165	CF Universal Slider Bar Tilt Head
VESA200	168	200 x 200 VESA Plate
WBHS	29	Binder Holder
WCH	36	Coat Hook
WDPDL	37	Pelican Pencil Drawer, Locking
WDPDNL	37	Pelican Pencil Drawer, Non-Locking
WFCS	14	Freestanding Slatwall Stanchions
WHB	31	Hanging Brackets
WIB	37	Pelican Installation Bar
WLG15L	29	Landscape Legal Tray
WLT12L	29	Landscape Letter Tray
WLTS	29	Portrait Letter Tray
WMB	35	Markerboard
WOFS	32	Office in a File
WPCS	31	Pen/Pencil Cup
WPFS	30	PaperFlo Manager
WS24	15	12"H Slatwall Tile
WS2418H	15	18"H Slatwall Tile
WS30	15	12"H Slatwall Tile
WS3018H	15	18"H Slatwall Tile
WS36	15	12"H Slatwall Tile
WS3618H	15	18"H Slatwall Tile
WS42	15	12"H Slatwall Tile
WS4218H	15	18"H Slatwall Tile
WS45	15	12"H Slatwall Tile
WS4518H	15	18"H Slatwall Tile
WS48	15	12"H Slatwall Tile
WS4818H	15	18"H Slatwall Tile
WS60	15	12"H Slatwall Tile
WS6018H	15	18"H Slatwall Tile
WSPS	33	Personal Shelf
WSQS	32	Double Square Dish
WSR24	21	24" SlatRail
WSR30	21	30" SlatRail
WSR36	21	36" SlatRail
WSR42	21	42" SlatRail
WSR48	21	48" SlatRail
WSR60	21	60" SlatRail
WSRFS	20	Freestanding SlatRail Stanchions
WSRU1	22	SlatRail Pnl-Mount Brkts
WSW42AN	16	Slatwall Brkt, 12"H Pnl-Mount

Style Number	Page	Description
WSWANS	16	Slatwall Brkt, 12"H Pnl-Mount
WSWANS18	16	Slatwall Brkt, 18"H Pnl-Mount
WSWM	16	Slatwall Brkt, 12"H Wall-Mount
WSWM18	16	Slatwall Brkt, 18"H Wall-Mount
WSWUSA	16	Slatwall Brkt, 12"H Pnl-Mount
WSWUSA18	16	Slatwall Brkt, 18"H Pnl-Mount
WTBS	34	Tackstrip
WTCS	34	Telephone Caddy
WUS	30	Universal Shelf, Single
WUS3	30	Universal Shelves, 3-Pack
WWT	35	Work Tags

Trademark List

™/® The following is a non-exhaustive list of trademarks and registered trademarks for products of Steelcase Inc. or one of its related corporate entities: Agree, Airtouch, Aisla, Alight, Amia, Answer, Apprise, Aspekt, Avenir, Await, B-Free, Ballet, Bassline, Bindu, Bivi, Bix, Bottomline, Brody, Buoy, Cachet, Campfire, Capa, CF Series, CG_1, Chord, Circa, Clipper, Cobi, Collaboration, Convene, Coupe, Cura, Currency, dash, Divisio, Duo, E-Table 2, Edge Series, Elbrook, Elective Elements, Embold, Empath, Everwall, Exponents, Folio, FrameOne, Gesture, Groupwork, Host, Hosu, i2i, Jenny, Kart, Kathryn, Kick, Lagunitas, Leap, Leela, LessThanFive, LiveBack, LiveSeat, Mackinac, Marien152, Max-Stacker, media:scape, Migration, Millbrae, Mineral, Mitra, Montage, Montara650, MoreThanFive, Move, Node, Ocular, Ology, Opus, Paperflo, Passerelle, Player, Pocket, Potrero415, QiVi, Radia, Regard, Relay, Reply, Ripple, Roam, Sarto, Scoop, Sebastopol, Senti Series, Senza, Shortcut, Sidewalk, Siento, Sieste, SILQ, Soffio, Sorrel, SOTO, Steelcase Eclipse, Steelcase Flex, Steelcase Karman, Steelcase Relay, Steelcase Rise, Steelcase Series, Surround, SW_1, Switch, Sync, Tava, Tenor, Think, Thoughtful, Thread, Together, Train, Trees, Turnstone, Umami, Underscore, V.I.A., Verb, Verge, Verlay, Victor2, Visalia, WorkValet, and X-tenz.

™/® The following are trademarks or registered trademarks of AMQ Solutions, LLC: 3F, Activ, Amobi, Bixby, Bodi, Cluvo, Concur, Embank, FL-X, Iline, Jaku, Kinex, Personality Plus, Revi, S-Series, Siya, Tektis, Tizu, Uptake, and Zilo.

™/® The following are trademarks or registered trademarks of Orangebox Ltd., Cardiff, UK: Air3, Aspect, Avi, Away from the Desk, Border, Campers & Dens, Coppice, Cubb, Kirm, On the QT, Ramsey, Skomer, Sully, Track-B, and Vale.

™/® The following are trademarks or registered trademarks of Viccarbe Habitat, S.L.: Aleta, Cambio, Designed in The Sun, Foro, Funda, Holy Day, Kelly, Last Minute, Noha, Savina, Sistema, Sistema, Viable, and Wrapp.

® The following are registered brands of Steelcase Inc. and its family of companies: Steelcase, AMQ, Coalesse, Designtex, Halcon, Orangebox, Smith System, and Viccarbe.

® The following registered trademarks are under license from AWI Licensing Company, Dover, DE: SoundScapes, DuraBrite, BioBlock, and Armstrong.

® The following registered trademarks are under license from Byrne Electrical, Rockford, MI: Interport, Mini-Port, Axil Z, and Ellora.

® The following is a registered trademark of DuPont, Wilmington, DE: Corian.

® The following is a registered trademark of Genlyte Thomas Company, Louisville, KY: Lightolier.

® The following is a registered trademark of Hilti Corporation, FL-9494 Schaan, Principality of Liechtenstein: Hilti.

® The following is a registered trademark of Leviton Manufacturing Company, Little Neck, NY: Decora.

® The following is a registered trademark of Mechanical Plastics Corp, Elmsford, NY: Toggler.

® The following is a registered trademark of Microsoft Corporation, Redmond, WA: Microsoft.

® The following are registered trademarks of Orangebox Ltd., Cardiff, UK: Orangebox.

® The following is a registered trademark of Panduit Corporation, Lockport, IL: Panduit.

® The following is a registered trademark of Trav (Press), Cuneo, Italy: Assisa.

® The following is a registered trademark of Virtual Ink, Boston, MA: mimioActive.

® The following registered trademarks are under license from Wilkhahn Furniture Products: Avera, Senzo, Versal, and Wilkhahn FS.

® The following are registered trademarks of Polyvision Corp: Flow, Motif, Polyvision, Sans, and Serif.

® The following is a registered trademark of Wilsonart International, Temple, TX: Chemsurf.

® The following is a registered trademark of Wiremold, West Hartford, CT: Wiremold.

® The following is a registered trademark of EMU Group S.P.A., Perugia, Italy: EMU.

® The following is a registered trademark of Security People, Inc.: Digilock.

® The following are registered trademarks of Natural Capital Partners Europe Limited: CarbonNeutral and the CarbonNeutral Certified logo.

™ The following is a trademark of Microsoft Corporation, Redmond, WA: Windows.

™ The following is a trademark of Rodman Industries, Inc., Oconomowoc, WI: ResinCore1.

™ The following is a trademark of Ultrafabrics, LLC, Elmsford, NY: Ultraleather.

™ The following trademarks are under license from Wilkhahn Furniture products: Cana, Linus, Logon, Picto, Range, Stitz, Thema, Timetable, and Tubis.

™ The following trademarks are under license from Walter Knoll: Andoo, Bob, Lazlo, Lox, Ribbon, and Together.

™ The following trademarks are under license from PP Mobler: Bar and Flag Halyard.

™ The following trademarks are under license from Carl Hansen: Elbow, Paddle, Shell, Wing, and Wishbone.

™ The following trademarks are under license from Cambridge Sound Management, LLC Cambridge, MA: QtPro Soundmasking, Qt Quiet Technology, and Sonet Qt.

™ The following is a trademark of Electri-Cable Assemblies, Shelton, CT: Interact.

™ The following is a trademark of Clestra Hauserman: IRYS.

™ The following is a trademark of Wiesner-Hager Möbel GmbH: Nooi.

™ The following are trademarks of Polyvision: Accord, a3, e3, Boundri, and Nota.

™ The following is a trademark of Bostock Company, Inc: SnapCab.

™ The following is a trademark of Williams-Sonoma, Inc: West Elm.

™ The following is a trademark of Elena Marquina Testor: nanimarquina.

™ The following is a trademark of Forbo International SA: Forbo.

Trademarks used herein are the property of Steelcase Inc. or their respective owners.