



West Elm Work Collection Specification Guide

Availability

Electronic price list updated with release 204.C (U.S.) and 158.C (Canada), dated June 15, 2026.

All specifications subject to change without notice. Reference the electronic catalog/Hedberg for current pricing.

Transitional products in this specification guide are **maintained for existing customers only** and are likely to be phased out over time. These products are indicated with a . Products that are scheduled to be culled are indicated with an , followed by the last order entry date.

Surface Materials

The surface materials team has announced the launch of the Finish Library, found at www.steelcase.com/finishlibrary/.

► For a list of all trademarks, refer to the last page of this specification guide. © 2026 Steelcase Inc.



For Canadian Pricing

Canadian factor can be found at www.steelcase.com/CADpricing/.

Calculate in the following order to avoid rounding errors:

- Multiply the base price and each option by the Canadian factor.
- Round each to the nearest dollar.
- Add base and options for total list price.

Additional Resources

2



Statement of Line

4

West Elm – Steelcase

Seating

Belle	16
Boardwalk	20
Brighton	24
Mesa	28
Willow	32
Slope	34
Sterling	38
Kent	42
Lucas	46
Fulton	48

Furniture

Greenpoint	51
Sutton	76

West Elm – Licensed

Seating

Nimbus	81
Slope	82

Furniture

Lily Pad	86
Linear	87
Maisie	88
Mesa	89

Specifying

West Elm – Steelcase	91
West Elm – Licensed	231

Resources and Surface Materials

241

Additional Resources

The West Elm Work Collection is supported with an array of informational materials, tools, and software to help you plan and install efficiently.

Surface Materials

West Elm Work Collection Materials Swatches Individual swatches, larger memo samples, and family group swatch cards are available by contacting Ad Stock at 1.800.784.0358 or by ordering electronically at village.steelcase.com.

Computer Tools

Digital Publications You can access these digital publications at www.steelcase.com or village.steelcase.com.

Electronic Catalog

Accurate sales quotations and purchase orders for West Elm products are created with specification software that uses West Elm Electronic Catalog data. Use the data to specify and price style numbers and options for every West Elm product. The data is updated bimonthly by Steelcase and provided to software programs like the Hedberg Business System, 20-20 CAP Studio.

Furniture Symbol Graphic Data

Steelcase creates 2D and 3D furniture symbols (with attributes) for planning and initially specifying Steelcase products. This data is incorporated into several add-on software packages that work in either a Microstation or an AutoCAD drafting environment.

For more information about these and other software tools to help you plan effective work environments, please email fsl@steelcase.com.

Support

Steelcase Capabilities

Steelcase products are distributed, installed, and serviced through a network of more than 600 dealers worldwide. Steelcase is also represented with offices and corporate showrooms in 26 U.S. cities, 4 Canadian cities, and in France, Germany, Great Britain, and Japan. Every Steelcase product meets our exceptionally high standards of quality and durability and comes with the Steelcase assurance of excellence in service.

For ordering or product assistance,

call your local dealer, the Steelcase Solutions Resource Team, or the Steelcase Solutions Fulfillment Team at 1.888.STEELCASE or send an e-mail to lineone@steelcase.com.

Call the Steelcase Solutions Resource Team prior to placing an order, when working on a bid, or when you need information about product applications and specifications.

Call the Steelcase Solutions Fulfillment Team if you have submitted an order to Steelcase and you need to speak to your Solutions Fulfillment Team Representative about the order. Also call if you have any post-shipment quality concerns or service parts questions.

For warranty information, please go to <http://www.steelcase.com/warranty/>.

Outside the U.S.A., Canada, Mexico, Puerto Rico, and the U.S. Virgin Islands, call 1.616.247.2500.

Statement of Line

West Elm – Steelcase

Seating

Belle

Lounge Seating

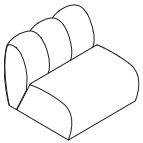

Belle One-Seat Lounge

Understanding
▶ Page 16
Specifying
▶ Page 92

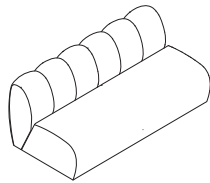

Belle Two-Seat Lounge

Understanding
▶ Page 16
Specifying
▶ Page 94

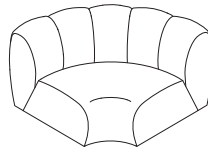

Belle Corner Lounge

Understanding
▶ Page 16
Specifying
▶ Page 96

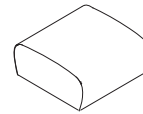

Belle Ottoman

Understanding
▶ Page 16
Specifying
▶ Page 98

Boardwalk

Lounge Seating

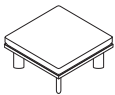

Boardwalk One-Seat Lounge

Understanding
▶ Page 20
Specifying
▶ Page 100

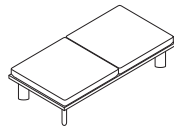

Boardwalk Two-Seat Lounge

Understanding
▶ Page 20
Specifying
▶ Page 102

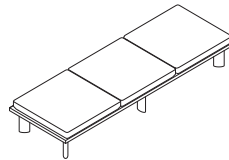

Boardwalk Three-Seat Lounge

Understanding
▶ Page 20
Specifying
▶ Page 104

Occasional Tables

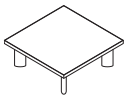

Boardwalk 30\"/>

Understanding
▶ Page 20
Specifying
▶ Page 107

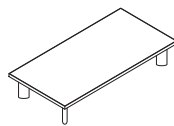

Boardwalk 30\"/>

Understanding
▶ Page 20
Specifying
▶ Page 108

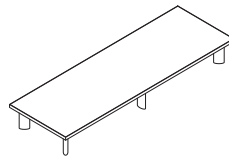

Boardwalk 30\"/>

Understanding
▶ Page 20
Specifying
▶ Page 109

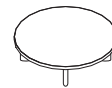

Boardwalk 40\"/>

Understanding
▶ Page 20
Specifying
▶ Page 110

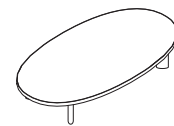

Boardwalk 35\"/>

Understanding
▶ Page 20
Specifying
▶ Page 111

Accessories

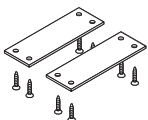

Ganging Kit

Understanding
▶ Page 21
Specifying
▶ Page 112

Seating, continued

Brighton

Lounge Seating



Brighton One-Seat Lounge
Understanding
▶ Page 24
Specifying
▶ Page 114

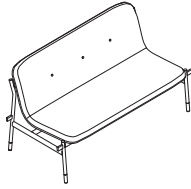

Brighton Two-Seat Lounge
Understanding
▶ Page 24
Specifying
▶ Page 116



Brighton Ottoman
Understanding
▶ Page 24
Specifying
▶ Page 118

Occasional Tables



Brighton 60° Ganging Table
Understanding
▶ Page 24
Specifying
▶ Page 119



Brighton 90° Ganging Table
Understanding
▶ Page 24
Specifying
▶ Page 120



Brighton Straight Ganging Table
Understanding
▶ Page 24
Specifying
▶ Page 121



Brighton End Table
Understanding
▶ Page 24
Specifying
▶ Page 122



Brighton Square Table
Understanding
▶ Page 24
Specifying
▶ Page 123



Brighton Rectangle Table
Understanding
▶ Page 24
Specifying
▶ Page 124

Accessories

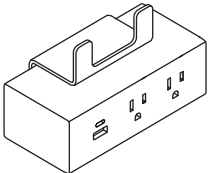

Brighton Module Power
Specifying
▶ Page 125

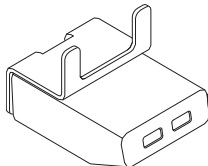

Brighton USB Power
Specifying
▶ Page 125

Seating, continued

Mesa

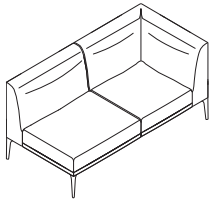

Mesa Left-Hand Chaise Lounge
Understanding
▶ Page 28
Specifying
▶ Page 126

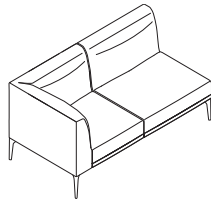

Mesa Right-Hand Chaise Lounge
Understanding
▶ Page 28
Specifying
▶ Page 127

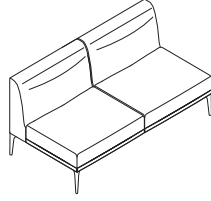

Mesa Two-Seat Lounge
Understanding
▶ Page 28
Specifying
▶ Page 128

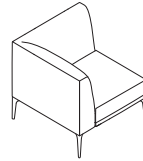

Mesa Corner Lounge
Understanding
▶ Page 28
Specifying
▶ Page 129

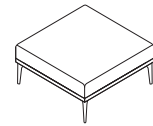

Ottoman
Understanding
▶ Page 28
Specifying
▶ Page 130

Willow

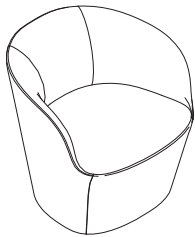

Willow Fixed Base Lounge
Understanding
▶ Page 32
Specifying
▶ Page 132

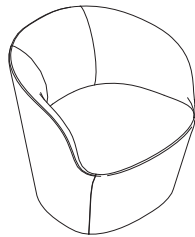

Willow Swivel Base Lounge
Understanding
▶ Page 32
Specifying
▶ Page 134

Slope

Guest Chairs and Stools



Slope Guest Chair
Understanding
▶ Page 34
Specifying
▶ Page 136



Slope Lounge Chair
Understanding
▶ Page 34
Specifying
▶ Page 137

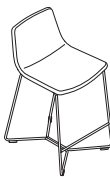

Slope Counter-Height Stool
Understanding
▶ Page 34
Specifying
▶ Page 138



Slope Bar-Height Stool
Understanding
▶ Page 34
Specifying
▶ Page 139



Slope Stacking Chair
Understanding
▶ Page 34
Specifying
▶ Page 141



Seating, continued

Conference Chairs



Slope Conference Chair
 Understanding
 ▶ Page 34
 Specifying
 ▶ Page 140

Sterling

Guest Chairs and Stools

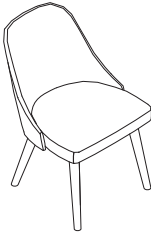

Sterling Guest Chair-Armless
 Understanding
 ▶ Page 38
 Specifying
 ▶ Page 142

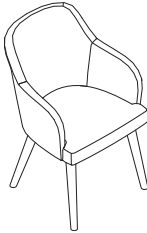

Sterling Guest Chair
 Understanding
 ▶ Page 38
 Specifying
 ▶ Page 143



Sterling Counter Height Stool
 Understanding
 ▶ Page 39
 Specifying
 ▶ Page 144



Sterling Bar Height Stool
 Understanding
 ▶ Page 39
 Specifying
 ▶ Page 145

Conference Chairs



Sterling Conference Chair-Five-Star Armless
 Understanding
 ▶ Page 38
 Specifying
 ▶ Page 146



Sterling Conference Chair-Five-Star with Arms
 Understanding
 ▶ Page 38
 Specifying
 ▶ Page 147



Sterling Conference Chair-Four-Star Armless
 Understanding
 ▶ Page 39
 Specifying
 ▶ Page 148



Sterling Conference Chair-Four-Star with Arms
 Understanding
 ▶ Page 38
 Specifying
 ▶ Page 149

Seating, continued

Sterling, continued

Lounge

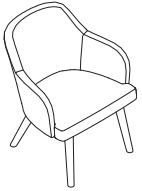

Sterling Lounge
Understanding
▶ Page 39
Specifying
▶ Page 150



Sterling Health Guest Chairs
Specifying
▶ Page 151

Kent

Conference Chairs



Kent Conference Chair—Five-Star with Arms
Understanding
▶ Page 42
Specifying
▶ Page 153



Kent Conference Chair—Five-Star Armless
Understanding
▶ Page 42
Specifying
▶ Page 154



Kent Conference Chair—Four-Star with Arms
Understanding
▶ Page 42
Specifying
▶ Page 155



Kent Conference Chair—Four-Star Armless
Understanding
▶ Page 42
Specifying
▶ Page 156

Guest Chairs

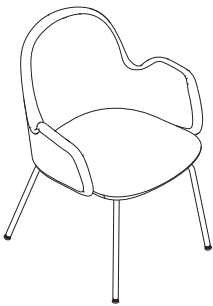

Kent Guest Chair Four Legs with Arms
Understanding
▶ Page 42
Specifying
▶ Page 157



Kent Guest Chair Four Legs Armless
Understanding
▶ Page 42
Specifying
▶ Page 158

Conference Stools

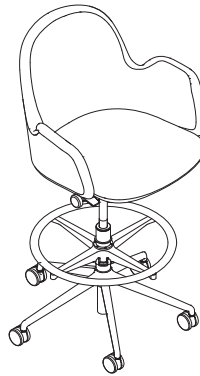

Kent Conference Stool—Five-Star with Arms
Understanding
▶ Page 42
Specifying
▶ Page 159

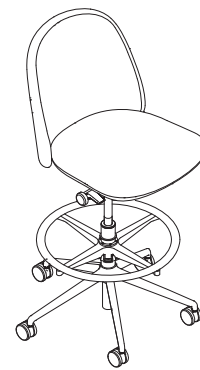

Kent Conference Stool—Five-Star Armless
Understanding
▶ Page 42
Specifying
▶ Page 160

Seating, continued

Lucas

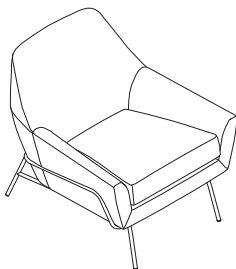

Lucas Wire Chair

Understanding
▶ Page 46
Specifying
▶ Page 161

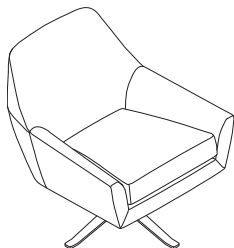

Lucas Swivel Chair

Understanding
▶ Page 46
Specifying
▶ Page 162

Fulton



Fulton Guest Chair

Understanding
▶ Page 48
Specifying
▶ Page 163

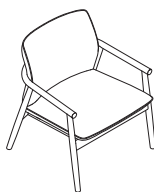

Fulton Lounge Chair

Understanding
▶ Page 48
Specifying
▶ Page 164

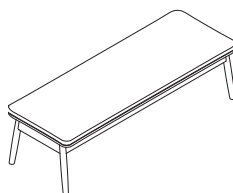

Fulton Bench

Understanding
▶ Page 48
Specifying
▶ Page 165

Furniture

Greenpoint Private Office

Desks and Returns

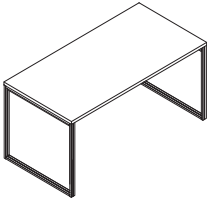

Private Desk
Understanding
▶ Page 52
Specifying
▶ Page 166

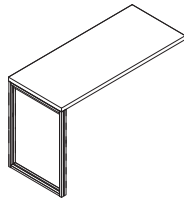

Desk Return with Leg
Understanding
▶ Page 52
Specifying
▶ Page 167

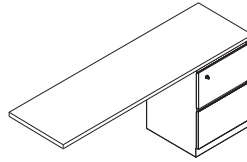

Desk Return with Pedestal
Understanding
▶ Page 52
Specifying
▶ Page 168

Modesty Panel

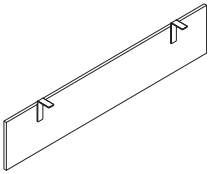

Understanding
▶ Page 52
Specifying
▶ Page 170

Credenzas

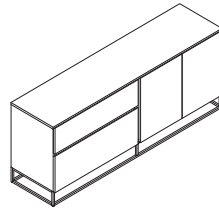

Filing Credenza
Understanding
▶ Page 53
Specifying
▶ Page 171

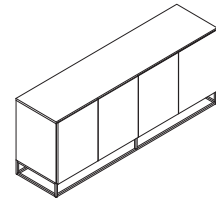

Storage Credenza
Understanding
▶ Page 53
Specifying
▶ Page 172

Wood Lateral File

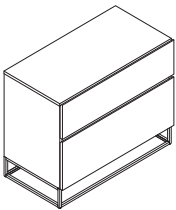

Understanding
▶ Page 53
Specifying
▶ Page 173

Furniture, continued

Greenpoint Private Office, continued

Bookcases

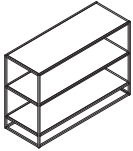

**Open Bookcase—
Low**
Understanding
▶ Page 54
Specifying
▶ Page 174



**Open Bookcase—
Narrow**
Understanding
▶ Page 54
Specifying
▶ Page 175



**Open Bookcase—
Tall**
Understanding
▶ Page 54
Specifying
▶ Page 176



Storage Bookcase
Understanding
▶ Page 54
Specifying
▶ Page 177

Metal Mobile Pedestal

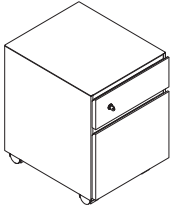

Understanding
▶ Page 54
Specifying
▶ Page 178

Basic Cushion Enhanced

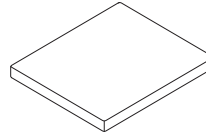

Understanding
▶ Page 54
Specifying
▶ Page 179

Wire Managers



Wire Clip
Specifying
▶ Page 180



2½" Round Grommet
Specifying
▶ Page 180

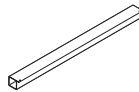

Wire Manager
Specifying
▶ Page 180

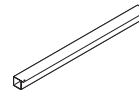

1¾"D Wire Managers
Specifying
▶ Page 181

Power and Data

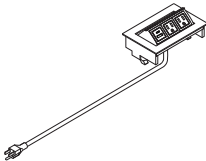

**Greenpoint
Desk Power Unit**
Specifying
▶ Page 182



**Greenpoint
Round/Square
Power Unit**
Specifying
▶ Page 183

Furniture, continued

Greenpoint Benching

Worksurfaces and Returns

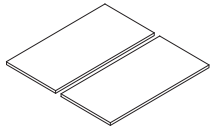

Dual-Sided

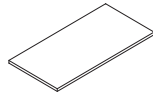

Single-Sided

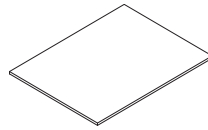

Continuous Top

Understanding
 ▶ Page 60
 Specifying
 ▶ Pages 184-192

Greenpoint 24"D or 30"D Worksurfaces

	Dual-Sided Leg/Leg	Dual-Sided Leg/Credenza*	Dual-Sided Credenza/Credenza*	Single-Sided Leg/Leg	Single-Sided Leg/Credenza*	Single-Sided Credenza/Credenza*	Continuous Top Leg/Leg	Continuous Top Leg/Credenza	Continuous Top Credenza/Credenza
48"W	●	●	●	●	●	●	●	●	●
54"W	●	●	●	●	●	●	●	●	●
60"W	●	●	●	●	●	●	●	●	●
66"W	●	●	●	●	●	●	●	●	●
72"W	●	●	●	●	●	●	●	●	●
78"W	●	●	●	●	●	●	●	●	●

*Add 3"W to the leg/credenza work surface and 6"W to the credenza/credenza work surface.

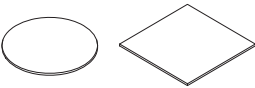

Understanding
 ▶ Page 62
 Specifying
 ▶ Pages 193–194



Understanding
 ▶ Page 62
 Specifying
 ▶ Page 195

Round and Square

	48"W	60"W
48"D/Dia.	●	
60"D/Dia.		●

Half-Round

	48"W	60"W
24"D	●	
30"D		●

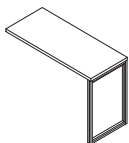

Understanding
 ▶ Page 64
 Specifying
 ▶ Page 196

Greenpoint Bench Returns

	42"W	48"W	54"W	60"W
18"D	●	●	●	●
24"D	●	●	●	●

Furniture, continued

Greenpoint Benching, continued

Legs

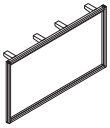
**Greenpoint Dual-Sided End Leg**

Understanding
 ▶ Page 63
 Specifying
 ▶ Page 197

**Greenpoint Single-Sided End Leg**

Understanding
 ▶ Page 63
 Specifying
 ▶ Page 198

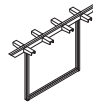
**Greenpoint Dual-Sided Intermediate Leg**

Understanding
 ▶ Page 63
 Specifying
 ▶ Page 199

**Greenpoint Single-Sided Intermediate Leg**

Understanding
 ▶ Page 63
 Specifying
 ▶ Page 200

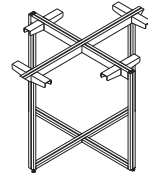
**Greenpoint Round and Square Top, X-Leg**

Understanding
 ▶ Page 63
 Specifying
 ▶ Page 201

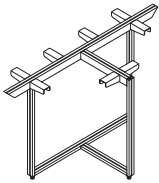
**Greenpoint Half-Round Top, T-Leg**

Understanding
 ▶ Page 63
 Specifying
 ▶ Page 202

Credenzas

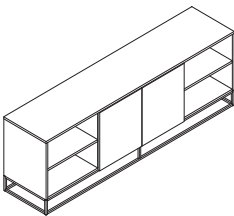
**Greenpoint End Credenza**

Understanding
 ▶ Page 64
 Specifying
 ▶ Page 203

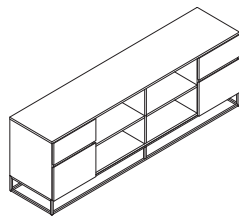
**Greenpoint Personal Credenza**

Understanding
 ▶ Page 64
 Specifying
 ▶ Page 204

Center Screens

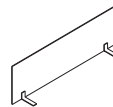
**Greenpoint Glass Center Screen**

Understanding
 ▶ Page 64
 Specifying
 ▶ Page 205

Furniture, continued

Greenpoint Benching, continued

Power and Data

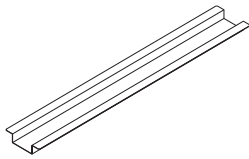

Greenpoint Dual-Sided Power Support
Understanding
▶ Page 65
Specifying
▶ Page 206

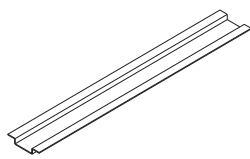

Greenpoint Single-Sided Power Support
Understanding
▶ Page 65
Specifying
▶ Page 206

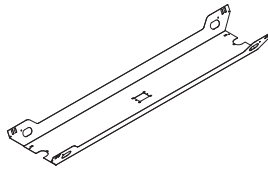

Greenpoint Dual-Sided Tray
Understanding
▶ Page 65
Specifying
▶ Page 207

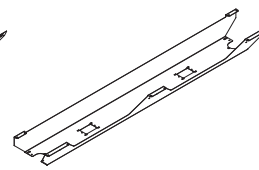

Greenpoint Single-Sided Tray
Understanding
▶ Page 65
Specifying
▶ Page 207

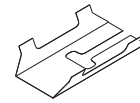

Greenpoint Dual-Sided Extension Tray
Understanding
▶ Page 65
Specifying
▶ Page 208

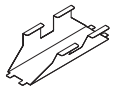

Greenpoint Single-Sided Extension Tray
Understanding
▶ Page 65
Specifying
▶ Page 208

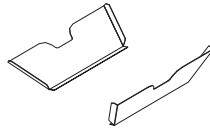

Greenpoint Dual-Sided End Cap Tray
Understanding
▶ Page 65
Specifying
▶ Page 208

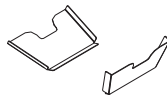

Greenpoint Single-Sided End Cap Tray
Understanding
▶ Page 65
Specifying
▶ Page 208

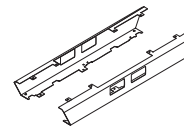

Greenpoint Dual-Sided Power Cover
Understanding
▶ Page 65
Specifying
▶ Page 209

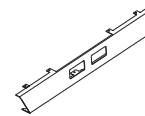

Greenpoint Single-Sided Power Cover
Understanding
▶ Page 65
Specifying
▶ Page 209

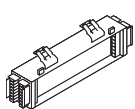

Modular Power Block—Standard-Capacity
Specifying
▶ Page 210

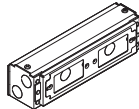

Chicago Hardwire Power Kit
Specifying
▶ Page 211



Duplex Receptacle
Specifying
▶ Page 212



USB Receptacle
Specifying
▶ Page 213



Filler Package—Power/Data
Specifying
▶ Page 213

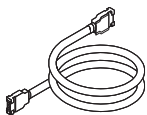

Modular Harnesses
Specifying
▶ Page 214

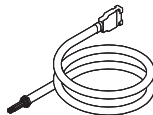

Hardwire-to-Modular Power Infeed
Specifying
▶ Page 215

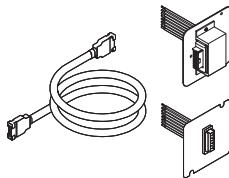

Modular-to-Modular Power Infeed
Specifying
▶ Page 215

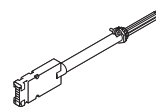

San Francisco Power Infeed
Specifying
▶ Page 216

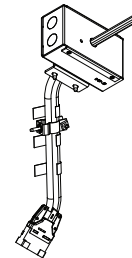

New York City Power Infeed
Specifying
▶ Page 216

Furniture, continued

Greenpoint Benching, continued

Power and Data, continued

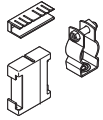

Bracket Kit Power
Specifying
▶ Page 217



Vertebral Cable Riser
Specifying
▶ Page 218



Extension Vertebral Cable Riser
Specifying
▶ Page 218

Sutton

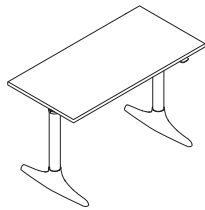

Understanding
▶ Page 76
Specifying
▶ Page 220–222

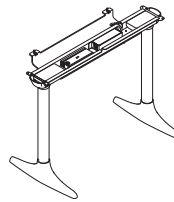

Understanding
▶ Page 76
Specifying
▶ Pages 224–226

Rectangle Height-Adjustable Desks

	46"W	52"W	58"W	64"W	70"W
23"D	●	●	●	●	●
29"D	●	●	●	●	●

Tip: Widths are parametric to 1/16" from 46"–72".

Rectangle Height-Adjustable Bases

	46"W	52"W	58"W	64"W	70"W
23"D	●	●	●	●	●
29"D	●	●	●	●	●

Tip: Widths are parametric to 1/16" from 46"–72".

Accessories

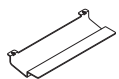

Cable Tray
Understanding
▶ Page 77
Specifying
▶ Page 228

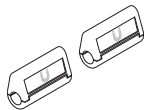

Magnetic Cable Clips
Understanding
▶ Page 77
Specifying
▶ Page 228

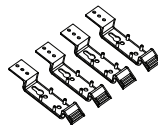

Cable Brackets
Understanding
▶ Page 77
Specifying
▶ Page 229

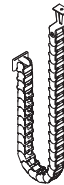

Cable Riser
Understanding
▶ Page 77
Specifying
▶ Page 229

Belle Lounge Seating

Belle lounge features deco inspired tufted forms and soft curves that have been expertly tailored to create an inviting venue for solo work and coworker congregations alike. Each modular piece has been thoughtfully designed to function either freestanding or connected, setting the stage for applications that are both expressive and memorable. Generous corners and versatile ottomans allow limitless flexibility in planning, where Belle's curves can be appreciated from any angle.

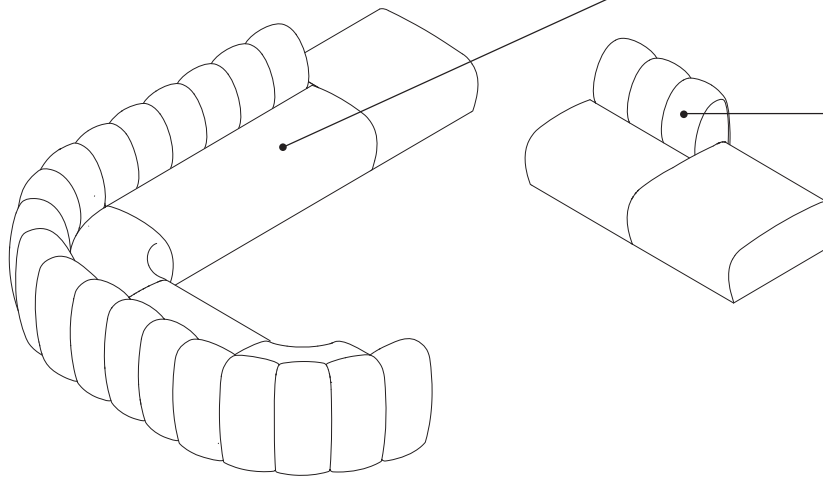

Lounge units are available in one-seat lounge, two-seat lounge, and corner lounge.

Lounge units can be connected together to create a wide range of configurations.

Upholstered seat and back cushions are attached.

Integrated ganging brackets are included.

Glides are not adjustable.

Product Details

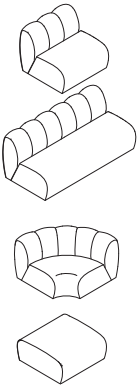

Lounge seating features four fully upholstered, complementary models: one-seat lounge, two-seat lounge, corner lounge, and ottoman. Legs are concealed for a streamlined profile.

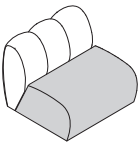

Lounges are available in contrasting seat and back fabrics. Seat and back fabrics do not have to be in the same fabric family.

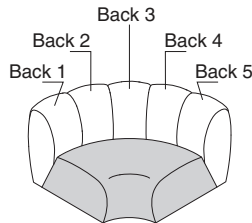
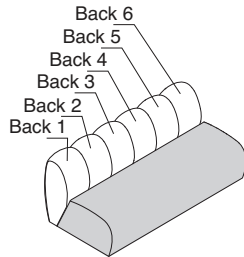
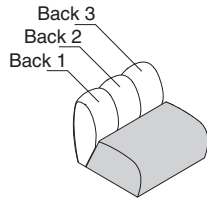

Contrasting all option is available on the one-seat lounge, two-seat lounge, and corner lounge. Back channels and seat can be specified separately.
Tip: Contrasting back channels must be in the same fabric family.

Contrasting fabrics are specified from the right handed seated position.

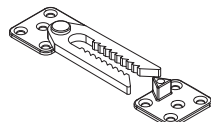

Integrated ganging device is included and keeps units aligned.

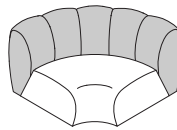
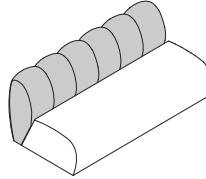
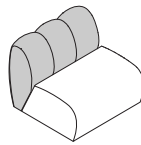

Crown of back channels may vary depending on stiffness of fabric. It is recommended to use the same back fabric when connecting multiple pieces.

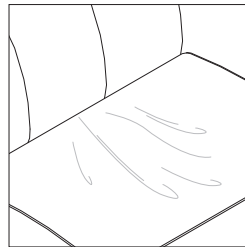

Comfort wrinkles are expected to occur over time. Smooth the cushion fabric with a sweeping/wiping motion to reduce the definition.

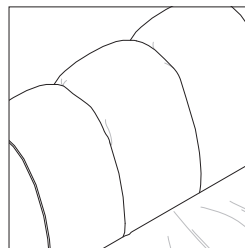

Tufted seams can loosen over time or during installation and may require occasional manual adjustment by pushing fabric into seams.

Surface Materials

Upholstery

- Fabric
- ▶ See *Surface Materials*, page 242 for specific availability, or refer to the *Surface Materials Reference Manual* for further information.

Visit <https://srh.steelcase.com/comcalculator.aspx> for Steelcase Textile calculator.

Dimensions

- ▶ Page 18

Dimensions

Belle Lounge Seating

<ul style="list-style-type: none"> • Features • • • • 	<ul style="list-style-type: none"> • Overall • Depth • Width • Height • •
--	---

Belle

Lounge Seating

One-Seat	36"	36"	32"
Two-Seat	36"	72"	32"
Corner	45"	45"	32"
Ottoman	35"	35"	17"

Boardwalk Lounge Seating and Occasional Tables

East meets west in the design of our modular Boardwalk system. Pillow-like cushions inspired by Japanese "zaisu" are lifted off the ground by a simple modular platform with natural wood detailing—a nod to California-cool residential design. In a celebration of minimalism, Boardwalk offers a respite within an office landscape and configures to provide seating, table surfaces, and power access.

Boardwalk lounge system is based on a 30"D x 30"W planning module with platforms available in 30"D x 30"W, 30"D x 60"W, and 30"D x 90"W sizes.

Cushions or open table positions can be specified in each 30" module. Cushions can be specified as single seat only, mid back, left corner, or right corner.

Edge finish has an edge band that is defaulted to match the laminate surface, or can be specified in another color.

Mounting holes for cushions are symmetrical, allowing for them to be positioned facing any direction.

Lounge units can be connected together to create a variety of configurations.

Connector brackets are not included with lounge units but can be ordered separately as style number: **TS31410**.

When a module is specified with no cushion, that module is left open as a table position. It will have a surface in the finish specified for the rest of the platform with no holes or cutouts for mounting cushions. Cushions are not retro-fittable.

Cushions are bolted to the seating platform. They are not retro-fittable to open table positions. Legs, platform, and cushions ship separately and require assembly.

Legs are hardwood oak and available in several hardwood finishes that complement platform finishes.

Units specified with seat cushions can be used to create ottomans or benches.

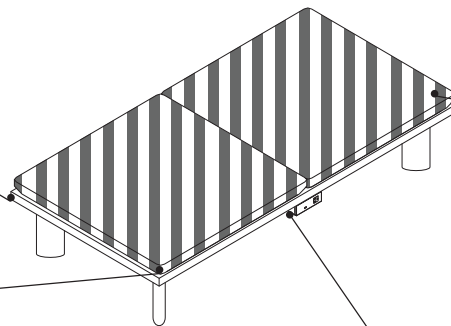
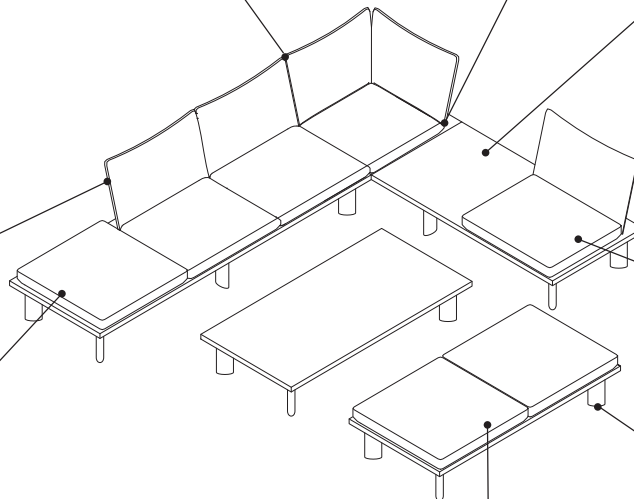

Cushion orientation can be changed or determined in the field. However, specifiers should be mindful of fabric direction when using directional or patterned fabrics on adjacent cushions.

Power units can be installed beneath lounges and tables. All lounge and table platforms are shipped with inserts on the underside for power units to be mounted. Power style number (**COSISPWR**) must be ordered separately. ▶ See *Coalesse Seating Specification Guide*.

Product Details



Single Seat



Mid Back Seat



Corner Seat

Cushions can be specified as seat only, mid back, left corner, and right corner. Lounge styles must have at least one cushion specified.



Single Platform

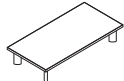

Double Platform

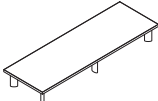

Triple Platform

Platforms and tables come in three sizes: 30" x 30", 30" x 60", and 30" x 90". Platforms are 11"H with a seat height of 16³/₄", when a cushion is specified. Tables are available in 11"H or 15"H. The same platform is used in both the seating and the 11"H table applications.

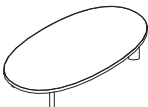

Tables are also available in a 40" round and 65" x 35" oval version.

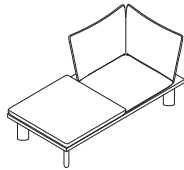

Left Corner

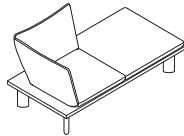

Right Corner

Corner cushions can be specified as left or right. Orientation is determined in the seated position. Corners are symmetrical; however, the fabric direction for the seat is determined by left or right specification.

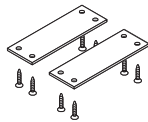

Ganging plate (TS31410) can be ordered separately to permanently gang units.

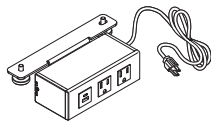

Power block style number (COSISPWR) can be mounted to any platform.
▶ See *Coalesse Seating Specification Guide*.

Power blocks can be specified with either two power, one USB A+C 20W port or one power, or one USB C single 60"W.

Surface Materials

Upholstery

- Fabric
- Leather
- Vinyl

Tip: Contrasting fabric is not an option.

▶ See *Surface Materials*, page 242 for specific availability, or refer to the *Surface Materials Reference Manual* for further information.

Visit <https://srh.steelcase.com/comcalculator.aspx> for Steelcase Textile calculator.

Platform

- High-Pressure Laminate
 - Veneer
- ▶ See *Surface Materials*, page 242

Edge

- Plastic

Tip: Edge finish has an edge band that is defaulted to match the laminate surface, or can be specified in another color.

Leg

- Customiz stain
- VP01 Oak Light
- VP03 Black Oak
- VP05 White Oak

Leg Bracket

- 0835 Black

Dimensions

▶ Page 22

Dimensions

Boardwalk Lounge Seating

Features	Overall Depth	Width	Height	Functional Seat Depth	Seat Width	Seat Height from Floor	Back Width	Back Height from Seat
Boardwalk								
Lounge Seating								
One-Seat Platform	30"	30"	11"	N.A.	N.A.	N.A.	N.A.	N.A.
Two-Seat Platform	30"	60"	11"	N.A.	N.A.	N.A.	N.A.	N.A.
Three-Seat Platform	30"	90"	11"	N.A.	N.A.	N.A.	N.A.	N.A.
Seat Cushion	30"	30"	16¾"	30"	30"	16¾"	30"	N.A.
Mid Back	30"	30"	31"	22½"	30"	16¾"	30"	20"
Corner Cushion	30"	30"	31"	22½"	22½"	16¾"	30"	20"
Occasional Tables								
Square Table	30"	30"	11" or 15"	N.A.	N.A.	N.A.	N.A.	N.A.
Rectangle Table	30"	60"	11" or 15"	N.A.	N.A.	N.A.	N.A.	N.A.
Rectangle Table	30"	90"	11" or 15"	N.A.	N.A.	N.A.	N.A.	N.A.
Round Table	N.A.	40" Dia.	11" or 15"	N.A.	N.A.	N.A.	N.A.	N.A.
Oval Table	35"	65"	11" or 15"	N.A.	N.A.	N.A.	N.A.	N.A.

Tip: Height and seat height dimensions are included for cushion mounted to platform.

Brighton Lounge Seating

Inspired by the traditional wood frame joinery of mid-century design, Brighton lounge seating offers an updated take with sleek metal construction while optional brass accents add a deco-friendly spark. It's configurability allows Brighton to arrange into infinite formations, while freestanding lounge and table options create even more choice.

One and two seat lounges can be specified with ganging hardware for attached table.

Lounge seat and backs are fully upholstered. Back shells can be specified with contrasting fabric.

Frame caps can be specified to match or contrast the frame. Caps are offered in a range of powder coat finishes, antique brass, and brushed nickel.

Arms are available on lounge units. Arm caps are solid oak and can be specified in a range of finishes.

Frames are offered in a range of powder coat finishes.

Tables are available in laminate and veneer. Frames are offered in a range of powder coat finishes.

Frame foot can be specified to match or contrast the frame. Feet are offered in a range of powder coat finishes, antique brass, and brushed nickel.

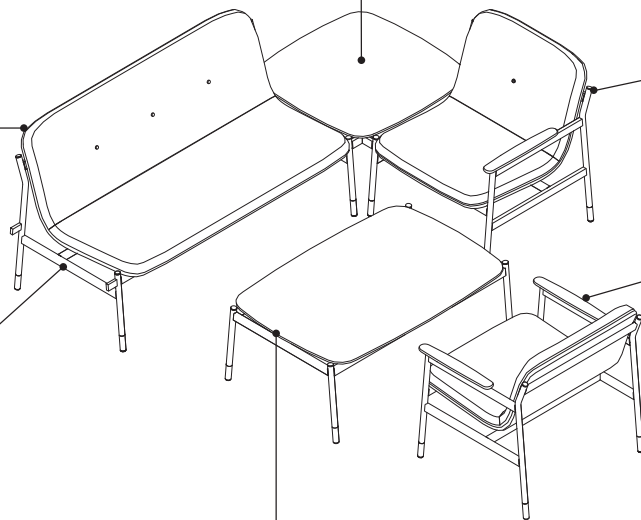

Product Details

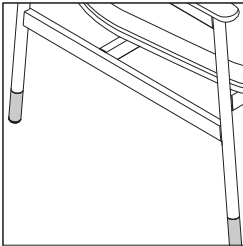

Frame feet can be specified to match or contrast the frame. Feet are offered in a range of powder coat finishes, antique brass, and brushed nickel.

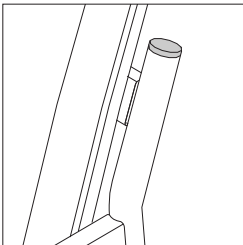

Frame caps can be specified to match or contrast the frame. Caps are offered in a range of powder coat finishes, antique brass, and brushed nickel.

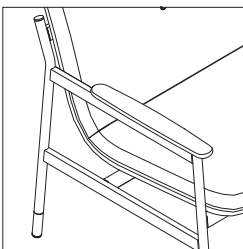

Armcaps are solid oak wood and are available on both one- and two-seat lounges in a range of wood finishes.

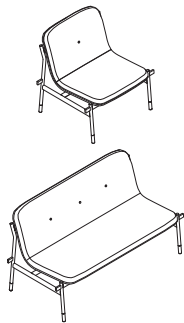

Button tufting is standard on all lounges that are upholstered in fabric, vinyl, and faux-leather. One-seat lounges come standard with one button, two-seat lounges come with three buttons. There will be no button tufting when leather upholstery is specified.

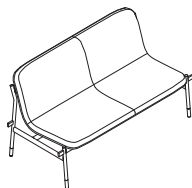

When leather is specified on the two-seat lounge, there will be an additional seam down the center of the seat and back.

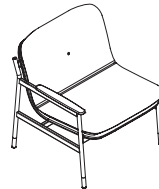
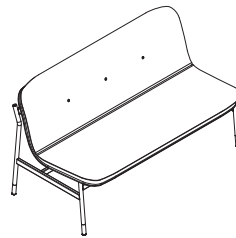

Arm Right



Arm Left

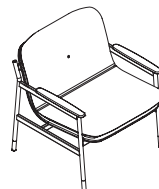

One- and two-seat lounges are available with and without arms and can be specified with ganging hardware or as freestanding.

Lounges must be specified with ganging hardware when used with end or ganging tables. Ganging hardware and arms cannot be specified on the same side of a lounge unit.

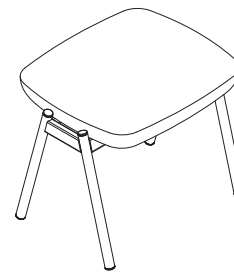

Ottoman is upholstered with a metal frame that is available in a range of powder coat finishes. Contrasting frame caps are optional.

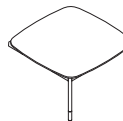

Ganging tables are available in three options: 60°, 90° and straight. Tables can be attached facing either direction and must be attached between lounge units.



End table is available in one size 28" square and can be added to either side of a lounge unit.

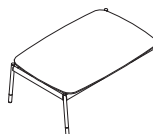

Freestanding tables are available in 28" square and 28"D x 42"W rectangle.

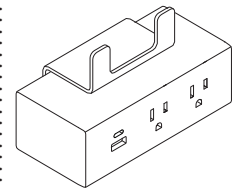

Power module has a 9' cord.

Surface Materials

Upholstery

(available in contrasting front and back)

- Fabric
- Leather
- Vinyl

▶ See *Surface Materials*, page 242 for specific availability, or refer to the *Surface Materials Reference Manual* for further information.

Visit <https://srh.steelcase.com/comcalculator.aspx> for Steelcase Textile calculator.

Table tops

- High-Pressure Laminate
 - Veneer
- ▶ See *Surface Materials*, page 242

Frames

- Paint
- Accent paint
- Lux Coatings

▶ See *Surface Materials*, page 242

Feet and caps

- Paint
- Accent paint
- Lux Coatings
- WE03 Antique Brass
- WE04 Brushed Nickel

Arms

- Customiz stain
- VP01 Light Oak
- VP03 Black Oak
- VP04 Gray Oak
- VP05 White Oak

Power

- 6000 Black
- 6052 Milk

Dimensions

▶ Page 26

Dimensions

Brighton Lounge Seating

Features	Overall Depth	Width	Height	Functional Seat Depth	Seat Width	Seat Height from Floor
----------	---------------	-------	--------	-----------------------	------------	------------------------

Brighton

Lounge Seating

One-Seat Lounge	29 ³ / ₄ "	29 ⁷ / ₈ "	33 ¹ / ₁₆ "	19 ⁷ / ₁₆ "	26 ¹ / ₄ "	17 ⁷ / ₁₆ "
Two-Seat Lounge	29 ³ / ₄ "	57 ⁹ / ₁₆ "	33 ¹ / ₁₆ "	19 ⁷ / ₁₆ "	54"	17 ⁷ / ₁₆ "
Ottoman	16 ³¹ / ₃₂ "	19 ¹⁵ / ₃₂ "	16 ²³ / ₃₂ "	N.A.	N.A.	N.A.
60° Ganging Table	28 ¹ / ₄ "	37 ³ / ₄ "	15 ¹¹ / ₁₆ "	N.A.	N.A.	N.A.
90° Ganging Table	29"	29"	15 ¹¹ / ₁₆ "	N.A.	N.A.	N.A.
End Table	28 ¹ / ₂ "	28 ¹ / ₄ "	15 ¹¹ / ₁₆ "	N.A.	N.A.	N.A.
Square Table	28 ¹ / ₂ "	28 ¹ / ₄ "	15 ¹¹ / ₁₆ "	N.A.	N.A.	N.A.
Rectangle Table	28 ¹ / ₂ "	42"	15 ¹¹ / ₁₆ "	N.A.	N.A.	N.A.

Mesa Lounge Seating

Mesa lounge seating adds style to any workspace with its modern form and tapered legs. Modular pieces can easily create common areas of any size.

Connector brackets are standard with all lounges and ottomans.

Lounge units can be connected together to create an L- or U-configuration. Two corners can be used together for a two-seat sofa.

Lounge units are available in two-seat lounge, right- and left-hand chaise lounge, and corner lounge.

Upholstered seat and back cushions are attached.

Frame is a unibody construction with finger jointed plywood.

Tapered legs are cast aluminum and coated in WE01 Antique Bronze.

Ottoman can be freestanding or connected to other lounge units.

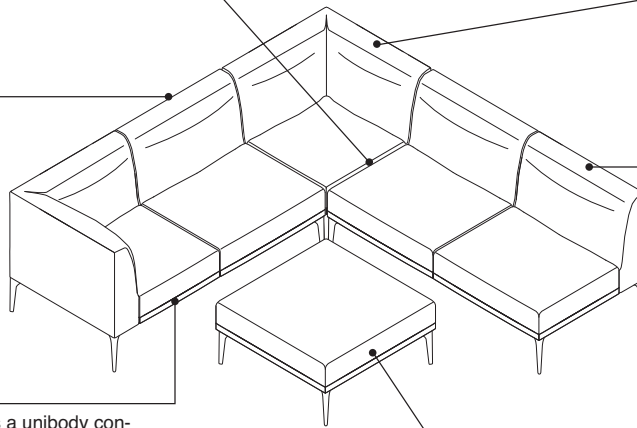

Product Details

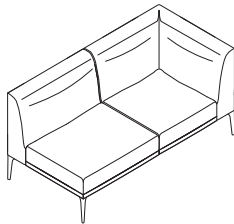
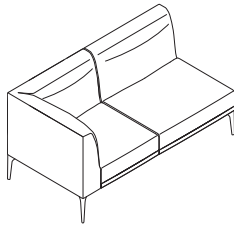
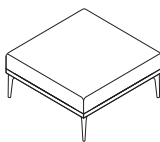
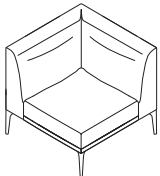
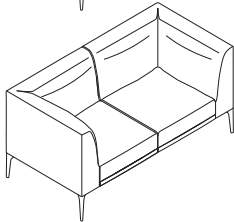
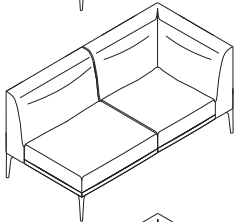
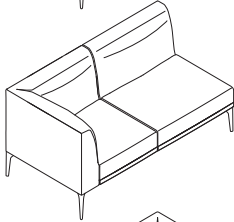
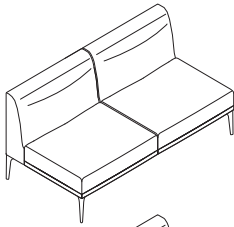

Chaise lounge can be specified in a right- or left-hand configuration.
Tip: Handedness is determined while in the seated position.

The corner unit is not handed and can be connected on either side with other units. Avoid using directional fabrics as it may not align with adjacent pieces.

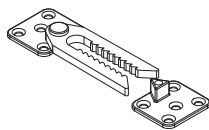

Integrated ganging device is included and keeps units aligned.

Lounge seating features five fully upholstered, complementary models: two-seat lounge, right-hand chaise lounge, left-hand chaise lounge, corner lounge, and ottoman. All models feature a four-leg, cast aluminum base with a powder coat painted finish.

Surface Materials

Upholstery

► See *Surface Materials*, page 242 for specific availability, or refer to the *Surface Materials Reference Manual* for further information.

Visit <https://srh.steelcase.com/comcalculator.aspx> for Steelcase Textile calculator.

Legs

• WE01 Antique Bronze
Tip: Contrasting fabric is not available on Mesa.

Dimensions

► Page 30

Dimensions

Mesa Lounge Seating

• Features	• Overall Depth	Width	Height	• Functional Seat Depth	• Seat Width	• Seat Height from Floor
Mesa						
Lounge Seating						
Two-Seat	32 ¹ / ₄ "	64 ¹ / ₄ "	28 ³ / ₄ "	22 ³ / ₄ "	64 ¹ / ₄ "	18 ³ / ₄ "
Chaise	32 ¹ / ₄ "	64 ¹ / ₄ "	28 ³ / ₄ "	22 ³ / ₄ "	55"	18 ³ / ₄ "
Corner	32 ¹ / ₄ "	32 ¹ / ₄ "	28 ³ / ₄ "	22 ³ / ₄ "	22 ³ / ₄ "	18 ³ / ₄ "
Ottoman	32 ¹ / ₄ "	32 ¹ / ₄ "	18 ³ / ₄ "	N.A.	N.A.	N.A.
:	:	:	:	:	:	:

Willow Seating

Willow is a fresh take on the classic club chair. Sporting either a smooth upholstered interior for a clean and versatile look or soft upholstery treatment that's casual and elevated, Willow can blend in or stand out.

Willow comes in either a fixed or 360 swivel base.

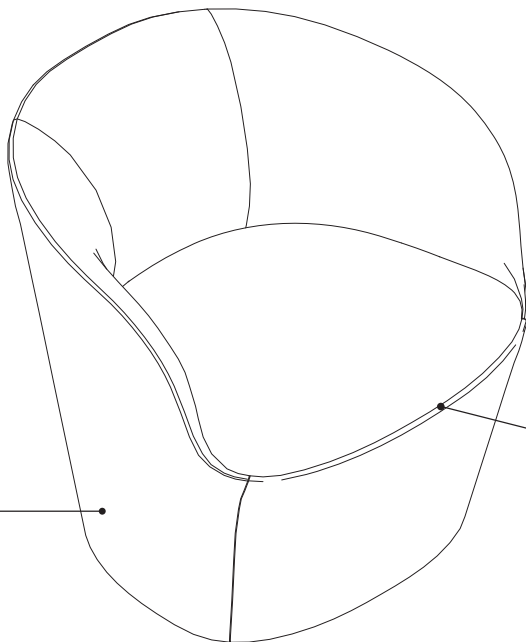

Seat height is 19" from the ground.

Upholstery treatment is available in smooth or soft and refers to the inside of the back of the chair.

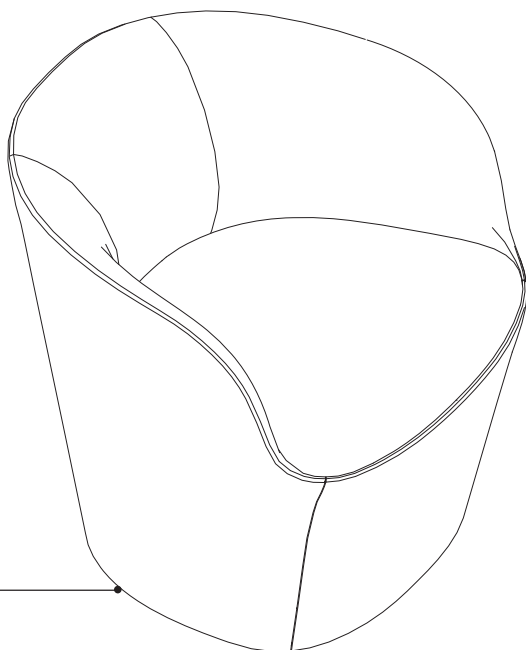

The base of the chair has 1 1/2" of clearance for both the fixed and swivel bases.

Fabric is applied in vertical direction. Optional contrasting fabric is available between the seat interior and outer shell.

Product Details

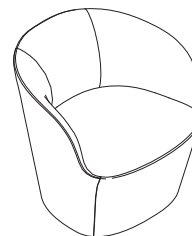

An optional 360° swivel base is available.

All product in the Willow product line ships fully assembled in one package.

Surface Materials

See surface materials matrix on page 256 for upholstery options.

Optional contrasting fabric is available between the seat interior and outer shell.

Visit <https://srh.steelcase.com/comcalculator.aspx> for Steelcase Textile calculator.

Dimensions

► Page 33

Dimensions

Willow Seating

Features	Base Depth	Width	Overall Height	Seat Height	Weight (lb)
Willow Seating					
Fixed Base Lounge					
	30"	31 ⁹ / ₁₀ "	29 ¹ / ₂ "	19"	58 lb
Swivel Base Lounge					
	30"	31 ⁹ / ₁₀ "	29 ¹ / ₂ "	19"	78 lb

Slope Seating

Simple yet timeless design allows the Slope family of seating to blend seamlessly into the modern office. A wide range of paint colors and upholstery options ranging from muted to playful add personality.

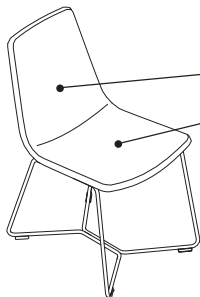

Seat and back are always fully upholstered.

The double-needle stitch down the center of the slope seat and back is an iconic detail of the slope chair. As an option, slope upholstery can be specified with this seam.

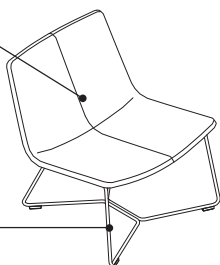

Wire frame base is painted and available in a range of standard, accent and Lux Coatings.

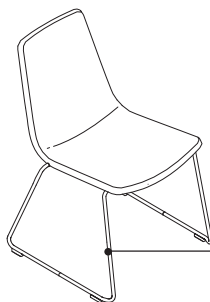

Stackable base configuration allows for easier storage and cleaning. Stacking chairs can be stacked up to five high.

Seat height adjusts 4", from 17½"H to 20½"H, with a pneumatic adjustment mechanism.

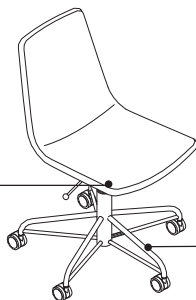

Glides are polyethylene for superior durability on carpeted and hard floors. Glides are available in milk or black.

Five-star base is available in hot rolled steel finish only.

Product Details



Guest chair



Stacking chair



Lounge chair



Counter-height stool



Conference chair



Bar-height stool

Five-star and wire-frame bases are available for guest chair and stool.

Slope wire frame stool is available in two heights to pair with counter and bar height tables.

360° adjustable height swivel mechanism is standard on five-star base models.

Slope ships knocked down and the seat must be assembled to the frame on site, with the exception of the stacker with arms and the guest chair with arms which ship fully assembled. All slope styles come in a single carton.

Arms are available as an option for guest, stacking, and conference chair.

Slope stacking chairs can be stacked up to five chairs high.

	Made-to-order	Stocked
Guest Chair	WESSLPCG	WEM1
Stacking Chair	WESSLPCS	N.A.
Lounge Chair	WESSLPCL	WEM2
Conference Chair	WESSLPCC	WEM3
Counter Stool	WESSLPSC	WEM50
Bar Stool	WESSLPSB	WEM66
Height-Adjustable Bar Stool	N.A.	WEM67

Tip: Slope is available made-to-order in a broad selection of frame colors and upholstery options. Slope is also available stocked in West Elm leather and a single frame color. Stocked styles are shipped with a rapid 2-week lead time and have specific style numbers. Please refer to the table above for the made-to-order and stocked style numbers.

Adjustment Features

Adjustability instructions are included with every swivel-base chair. Instructions can also be found at www.steelcase.com.

Seat Adjustments

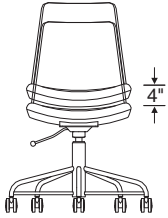

Conference Chair

Seat height adjusts

pneumatically. To lower, pull lever up while seated. To raise, pull lever up and keep your weight off the chair.

Other features

Soft wheel casters for hard floors on five-star base models are available for specific applications.

Surface Materials

Stocked Slope chairs are only available in pre-configured base color and leather combinations. When Saddle or Fog leather are specified, the base will be Hot Rolled Steel. When Aegean leather is specified, the base will be Antique Brass.

Seat and back upholstery

▶ See *Surface Materials*, page 242 for specific availability, or refer to the *Surface Materials Reference Manual* for further information.

Visit <https://srh.steelcase.com/comcalculator.aspx> for Steelcase Textile calculator.

Wire frame base

- Paint
- Accent paint
- Lux Coatings
- ▶ See *Surface Materials*, page 242

Five-star base

- Hot-rolled steel

Casters

- 6205 Black

Glides

- 6205 Black
- 6052 Milk

Tip: 6052 Milk glides are available on 4242 Milk wire frame painted bases only, all other colors will have black glides.

All Steelcase seating with standard upholstery fabrics complies with requirements of the State of California Technical Bulletin 117-2013. All standard seating is labeled to be in compliance with California 117-2013.

Dimensions

▶ Page 36

Dimensions

Slope Seating

• Features	• Overall Depth	Width	Height	• Functional Seat Depth	• Seat Width	• Seat Height from Floor	• Back Width	• Back Height from Seat	• Weight
Slope Seating									
Guest Chair									
	21½"	19¼"	33¼"	17¾"	17¾"	18¾"	16¾"	18¾"	33.15 lb
Stacking Chair									
	21½"	19¼"	33¼"	17¾"	17¾"	18¾"	16¾"	18¾"	N.A.
Lounge Chair									
	26½"	26½"	28"	21¾"	26½"	15¾"	25¾"	19¼"	28 lb
Counter Stool									
	21½"	19"	35¾"	17¾"	17¾"	25¼"	16¾"	13"	35.75 lb
Bar Stool									
	21½"	19¼"	40"	17¾"	17¾"	29½"	14¼"	13"	40 lb
Conference Chair									
	21½"	19¼"	32" – 36"	17¾"	17¾"	17½" – 20½"	16¾"	18¾"	28.25 lb

* Overall width does not include the base.

Tip: The diameter of the chair with the five-arm base is 25".

Sterling Seating

Sterling is a family of seating inspired by classic mid-century design. The style and generous sit brings retro-inspired comfort to the office. Hardwood legs or a classic aluminum base and arm options make the Sterling collection relevant across the floor plan.

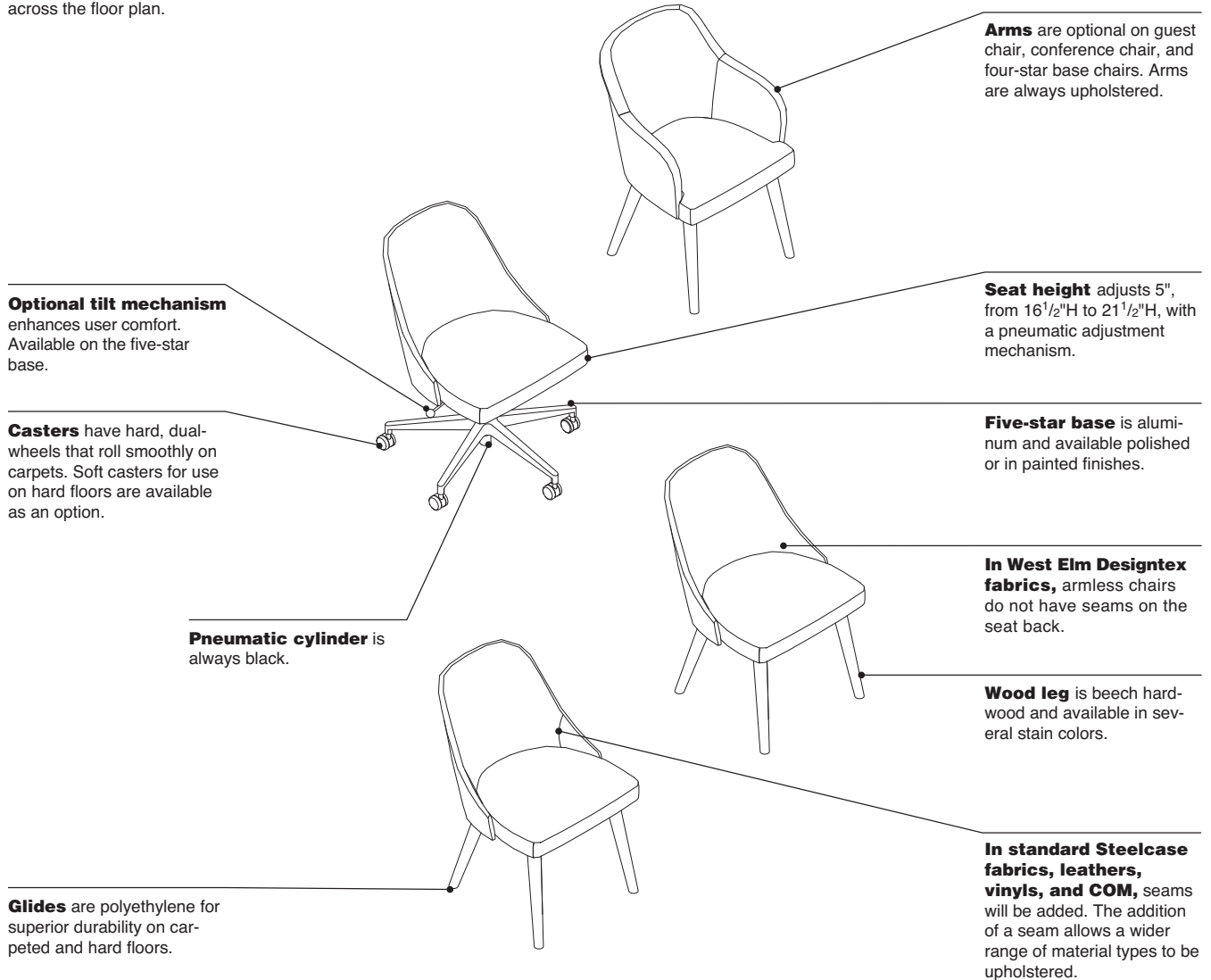

Sterling stools have a 360° swivel feature that comes standard and does not have auto-return feature.

Sterling stools include footrest for added comfort.
Tip: The footrest is 8½" from the ground on the counter-height stool and 14¼" on the bar-height stool.

Glides are polyethylene for superior durability on carpeted and hard floors.

Sterling lounge is available with arms only.

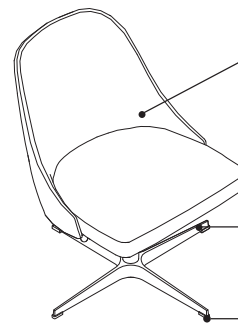
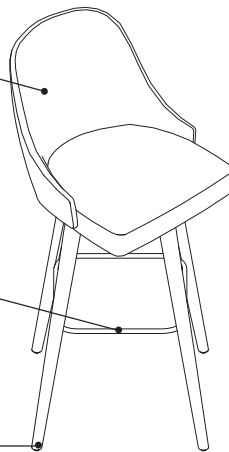

Sterling four-star chair comes with 360° swivel and height adjustable mechanism. It does not have an auto-return feature or tilt option.

Four-star base is available in polished aluminum only.

Glides are polyethylene for superior durability on carpeted and hard floors. Casters are not available.

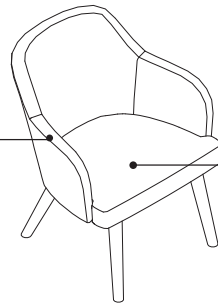

Sterling lounge has a seat height of 17¼" and more reclined seat and back to encourage a more relaxed posture.

Product Details



Five-star, four-star, and four-leg chairs are available with and without arms.

Optional tilt mechanism is available on five-star chairs and has 10° rearward and 2° forward tilt range. The seat and back always remain in a fixed position relative to each other (i.e. no recline).

360° adjustable height swivel mechanism is standard on five-star and four-star base models.

Adjustment Features

Adjustability instructions are included with every swivel-base chair. Instructions can also be found at www.steelcase.com.

Seat Adjustments

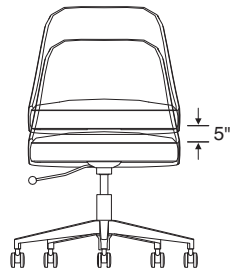

Seat height adjusts pneumatically. To lower, pull lever up while seated. To raise, pull lever up and keep your weight off the chair.

Other features

Soft wheel casters for hard floors on five-star base models are available for specific applications.

Surface Materials

Upholstery

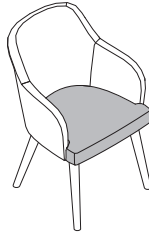

Optional contrasting fabric is available between the seat and back/arms.

- Fabric
- Leather
- Vinyl

▶ See *Surface Materials*, page 242 for specific availability, or refer to the *Surface Materials Reference Manual* for further information.

Customer's Own Material (COM)

Four-leg and stool base

- Customiz stain
- VP01 Light Oak
- VP03 Black Oak
- VP04 Grey Oak
- VP05 White Oak

Five-star base

- 0835 Black
- 4242 Milk
- 4B22 Matte Brass
- 4B24 Night Bronze
- 7278 Dark Bronze
- 8046 Polished Aluminum

Four-star base

- 8046 Polished Aluminum

Casters and glides

- 6205 Black

All Steelcase seating with standard upholstery fabrics complies with requirements of the State of California Technical Bulletin 117-2013. All standard seating is labeled to be in compliance with California 117-2013.

Dimensions

▶ Page 41

Dimensions

Sterling Seating

Dimensions

Features	Overall Depth	Width	Height	Functional Seat Depth	Seat Width	Seat Height from Floor	Back Width	Back Height from Seat	Arm Height from Floor
West Elm Work Sterling									
Guest Chairs									
	25 ¹ / ₈ "	26 ³ / ₄ "	32 ⁵ / ₈ "	18 ⁵ / ₈ "	22"	18 ¹ / ₂ "	21"	15 ¹ / ₂ "	26 ¹ / ₂ "
Guest Chairs—Armless									
	24 ¹ / ₂ "	23 ¹ / ₂ "	32 ⁵ / ₈ "	18 ⁵ / ₈ "	22"	18 ¹ / ₂ "	21"	15 ¹ / ₂ "	N.A.
Conference Chairs—Five-Star with Arms									
	25 ¹ / ₈ "	26 ³ / ₄ "	31 ³ / ₄ "—36 ³ / ₄ "	18 ⁵ / ₈ "	22"	16 ¹ / ₂ "—21 ¹ / ₂ "	21"	15 ¹ / ₂ "	25 ¹ / ₂ "—30 ¹ / ₂ "
Conference Chairs—Five-Star Armless									
	24 ¹ / ₂ "	23 ¹ / ₂ "	31 ³ / ₄ "—36 ³ / ₄ "	18 ⁵ / ₈ "	22"	16 ¹ / ₂ "—21 ¹ / ₂ "	21"	15 ¹ / ₂ "	N.A.
Counter Height Stool									
	26 ¹ / ₄ "	26 ¹ / ₄ "	38"	17"	17 ¹ / ₂ "	26"	19 ¹ / ₄ "	12 ³ / ₈ "	N.A.
Bar Height Stool									
	26 ¹ / ₄ "	26 ¹ / ₄ "	44"	17"	17 ¹ / ₂ "	32"	19 ¹ / ₄ "	12 ³ / ₈ "	N.A.
Conference Chairs—Four-Star with Arms									
	25 ¹ / ₈ "	26 ³ / ₄ "	30"—35"	18 ⁵ / ₈ "	22"	15 ³ / ₁₆ "—20 ³ / ₁₆ "	21"	15 ¹ / ₂ "	23 ¹ / ₂ "—28 ¹ / ₂ "
Conference Chairs—Four-Star Armless									
	24 ¹ / ₂ "	23 ¹ / ₂ "	30"—35"	18 ⁵ / ₈ "	22"	15 ³ / ₁₆ "—20 ³ / ₁₆ "	21"	15 ¹ / ₂ "	N.A.
Lounge									
	25 ¹ / ₄ "	26 ³ / ₄ "	30"	18 ⁵ / ₈ "	22"	17 ¹ / ₄ "	21"	15 ¹ / ₂ "	24"

*Overall width does not include the base.

The diameter of the chair with the five-star base is 26".

The diameter of the chair with the four-star base is 26¹/₂".

Kent Seating

Soft, modern minimalism meets the performance and comfort needed for today's collaborative workplace with West Elm Work Kent seating. The broad collection offers a range of application possibilities – from meeting rooms to the private office.

Kent is available in five base options and three seat backs. Base options are five-star, four-star (with glides or casters), guest chair (four-leg), or stool. Seat back options are armless, with arms, and high-back with arms.

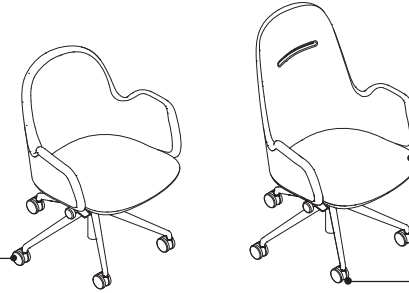

Five-star seat height adjusts 5" from 17¹/₄" to 22¹/₄".

Hard, dual wheeled casters are standard for use on carpets. Soft, roll-control, dual-wheel casters are available for use on hard floors or chair mats. Casters are 2¹/₂" diameter.

Tip: Do not roll the chair across asphalt during installation as this may damage the casters.

Five-star base is only available with casters.

The five-star base includes tilt and lock features on the standard application.



Four-star base swivels and is not height adjustable. It is available with casters or glides.

Stool seat height adjusts 7", from 25" to 32".

Stools cannot be specified with a high-back.

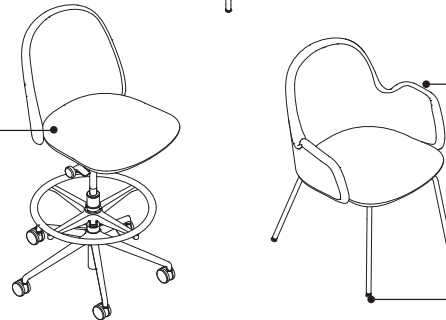

If arms are specified, they are always upholstered.

Glides come standard in black.

Product Details

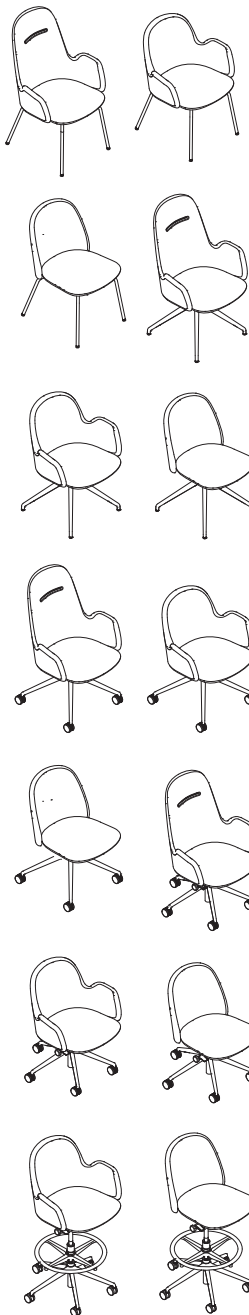

All products in the Kent product line ship in one package. The four-leg guest chair ships fully assembled. Four-star, five-star, and stools ship knocked down and feature a tool-less assembly.

Adjustment Features

Adjustability instructions are included with every swivel-base chair. Instructions can also be found at www.steelcase.com.

Seat Adjustments

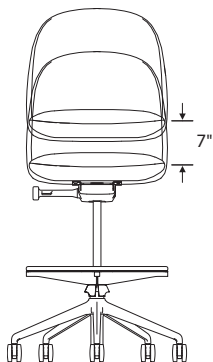
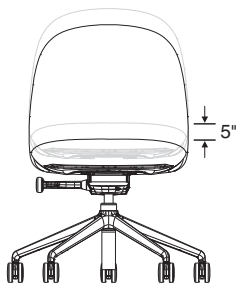

Seat height adjusts pneumatically. To lower, pull lever up while seated. To raise, pull lever up and keep your weight off the chair.

Surface Materials

Upholstery

► See *Surface Materials*, page 256 for upholstery options.

Visit <https://srh.steelcase.com/comcalculator.aspx> for Steelcase Textile calculator.



Fabric is applied in the vertical direction. Optional contrasting fabric is available between the seat and back/arms.

Five-star, four-star, and stool bases are available to be painted or in 8046 Polished Aluminum.

Guest (four-leg) bases are available to be painted or in 9201 Chrome.

Pneumatic cylinders

- 6205 Black

Foot ring

- 6205 Black

Dimensions

► Page 44

Dimensions

Kent Seating

Features Base	Depth	Width	Seat Height	Arm Height	Overall Height	Weight (lb)
Kent						
Conference Chairs—Five-Star with Arms						
	27"	25 ³ / ₁₆ "	17 ⁵ / ₁₆ " – 22 ³ / ₁₆ "	25 ¹ / ₂ "	31 ⁵ / ₈ " – 36 ¹ / ₂ "	29 lb
Conference Chairs—Five-Star High Back with Arms						
	27"	25 ³ / ₁₆ "	17 ⁵ / ₁₆ " – 22 ³ / ₁₆ "	25 ¹ / ₂ "	38 ¹ / ₂ " – 43 ⁵ / ₁₆ "	30 lb
Conference Chairs—Five-Star Armless						
	27"	25 ³ / ₁₆ "	17 ⁵ / ₁₆ " – 22 ³ / ₁₆ "		31 ⁵ / ₈ " – 36 ¹ / ₂ "	28 lb
Conference Chairs—Four-Star with Arms						
	24 ⁵ / ₁₆ "	24 ¹¹ / ₁₆ "	19"	25 ¹ / ₂ "	33 ⁵ / ₁₆ "	29 lb
Conference Chairs—Four-Star High Back with Arms						
	24 ⁵ / ₁₆ "	24 ¹¹ / ₁₆ "	19"	25 ¹ / ₂ "	40 ³ / ₁₆ "	30 lb
Conference Chairs—Four-Star Armless						
	24 ⁵ / ₁₆ "	19 ¹³ / ₁₆ "	19"		33 ⁵ / ₁₆ "	28 lb
Guest Chairs—Four-Legs with Arms						
	23 ⁷ / ₈ "	25 ³ / ₁₆ "	19"	25 ¹ / ₂ "	33 ⁵ / ₁₆ "	29 lb
Guest Chairs—Four-Legs High Back with Arms						
	23 ⁷ / ₈ "	25 ³ / ₁₆ "	19"	25 ¹ / ₂ "	40 ³ / ₁₆ "	30 lb
Guest Chairs—Four-Legs Armless						
	23 ⁷ / ₈ "	19 ¹³ / ₁₆ "	19"		33 ⁵ / ₁₆ "	28 lb
Conference Stools—Five-Star with Arms						
	27"	25 ³ / ₁₆ "	25" – 32"	25 ¹ / ₂ "	38 ⁵ / ₁₆ " – 45 ¹³ / ₁₆ "	29 lb
Conference Stools—Five-Star Armless						
	27"	25 ³ / ₁₆ "	25" – 32"		38 ⁵ / ₁₆ " – 45 ¹³ / ₁₆ "	28 lb

*Overall width does not include the base.
 The diameter of the chair with the five-star base is 26".
 The diameter of the chair with the four-star base is 26¹/₂".

Lucas Seating

Modern lines give Lucas a streamlined look, while a wide seat and reclined pitch make it a comfortable spot to sit during long meetings and busy days.

Lucas comes standard with arms at a height of 20½".

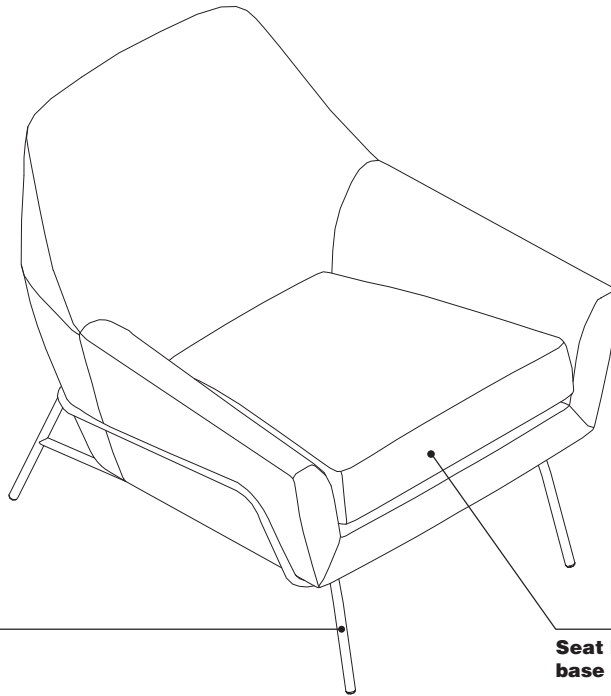

The wire base comes standard in West Elm WE05 Burnished Bronze with black glides.

Seat height on wire base chair is fixed at 18½".

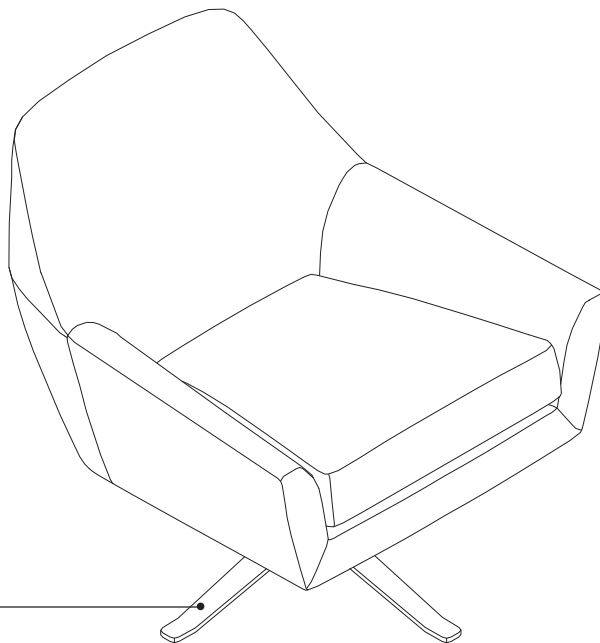

Swivel base comes standard in 8046 Polished Aluminum. Swivel is a full 360° without an automatic return.

Product Details

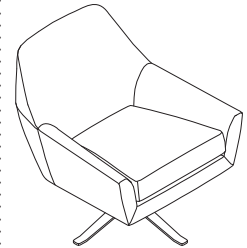

Cushion is detachable.

All product in the Lucas product line ships fully assembled.

Surface Materials

Swivel base is 8046 Polished Aluminum. The base of the Lucas swivel chair will match the previous style number **WEM3598978**.

Wire base is WE05 West Elm Burnished Bronze. The base of the Lucas wire base will match the previous style number **WEM3406073**.

Contrasting fabric is not available.

Visit <https://srh.steelcase.com/comcalculator.aspx> for Steelcase Textile calculator.

Dimensions

Dimensions

Lucas Seating

Features	Overall Depth	Width	Height	Seat Depth	Seat Width	Seat Height	Arm Height	Weight
Lucas Seating								
Wire Base Chair								
	32"	30½"	31"	21"	22"	18½"	20½"	53.7 lb
Swivel Base Chair								
	32"	30½"	31"	21"	22"	20¾"	20½"	60.1 lb

Seating

Fulton Seating

Fulton is a timeless wood-frame collection of a guest chair, lounge chair, and bench; great for shared spaces and private offices.

Upholstery treatment is available in contrasting or non-contrasting cord, which wraps around the perimeter of the seat and back cushions. Cord wraps around seat cushion of the bench.

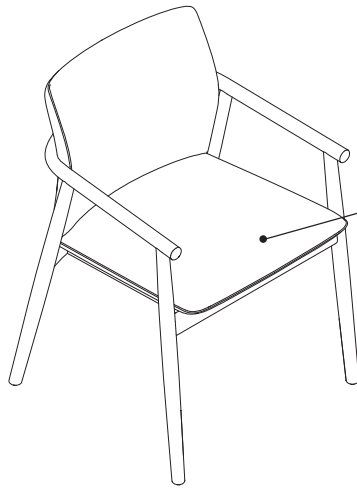

Seat height for the guest chair is 18³/₄"H.

Product Details

All products include plastic glides.

All product in the Fulton product line ships fully assembled in one package.

Surface Materials

Optional contrasting cord is available on the perimeter of the seat and back.

Visit <https://srh.steelcase.com/comcalculator.aspx> for Steelcase Textile calculator.

See surface materials matrix on page 256 for upholstery options.

The frame of the guest chair, lounge chair, and bench comes in stained ash.

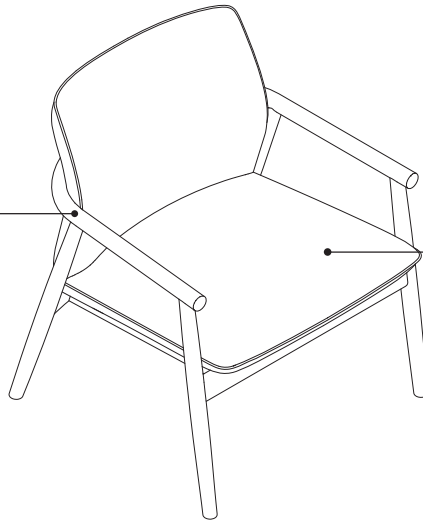

Seat height for the lounge chair is 17¹/₄"H.

Seat height for the bench is 17³/₄".

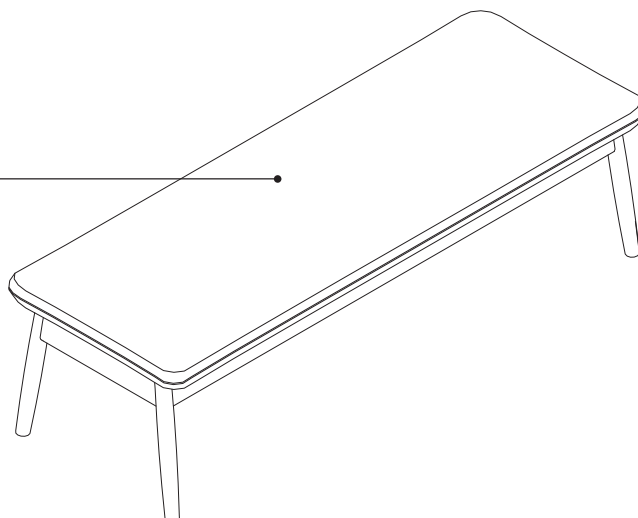

Dimensions

Fulton Seating

Features	Depth	Width	Overall Height	Seat Height	Arm Height at Front	Seat Depth
Fulton Seating						
Guest Chair						
	22"	22 ¹ / ₄ "	32"	18 ³ / ₄ "	24 ³ / ₄ "	18 ¹ / ₄ "
Lounge Chair						
	28 ³ / ₄ "	27 ³ / ₄ "	30 ³ / ₄ "	17 ¹ / ₄ "	21 ¹ / ₂ "	20 ¹ / ₂ "
Bench						
	22"	58 ¹ / ₂ "	17 ³ / ₄ "	17 ³ / ₄ "	N.A.	N.A.



Understanding Greenpoint

Private Office	52
Storage Capacities	58
Benching	60
Storage Capacities	66
Universal Tackable Center Screens	67
Power Routing Harness Chart	68
Distribution and Access	70
Building Interface	72
Stability Guidelines	74
Directional Laminate and Edge Profile Detail	75

Greenpoint Private Office

Greenpoint private office

offers a contemporary take on the private office with its distinct visual language and fresh material options.

A power cutout can be specified in the center, the left, or the right side of the desk worksurface. The desk power unit is ordered separately.

*Tip: The style number for desk power unit is **WESINDPWR**.*

A modesty panel is available and ordered separately, in widths from 48" to 78". They can be specified in either wood veneer or High-Pressure Laminate. Modesty panels are specified one size smaller than the desk to allow for 3" clearance on both ends to accommodate the legs. Modesty panel can be mounted flush or inset.

Leveling glides provide 1½" adjustment.

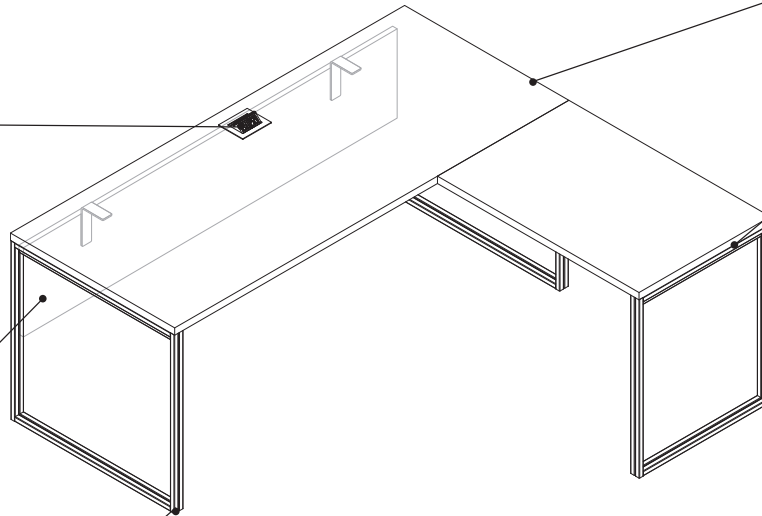

Private desk work-surfaces are 1⅛" thick. They can be specified with either wood veneer or High-Pressure Laminate. Height of the private desk is 29½".

Desk returns are available for private desks and can be specified with a leg or pedestal support.

Product Details

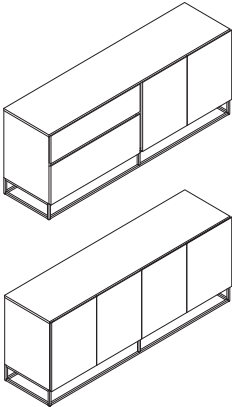

Credenzas come in two non-locking configurations—storage and filing. Storage credenzas have two sets of doors with adjustable shelves. Filing credenzas have two drawers and a set of doors with adjustable shelves. Back panels are finished. Leveling glides provide 1½" adjustment.

Counterweights are included with filing credenza.

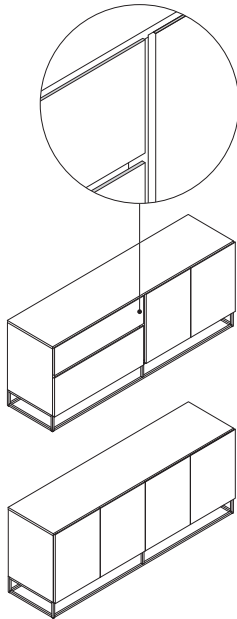

Door and drawer fronts on credenzas, lateral files, and pedestals that are specified in High-Pressure Laminate have a corresponding painted top edge. For more information, see the matrix in *Surface Materials* section.

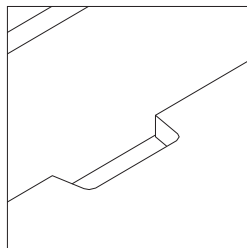

Cutout in lower cabinet shelf is standard on all credenzas to allow cord pass-through.

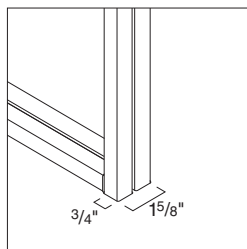

Legs are welded metal.

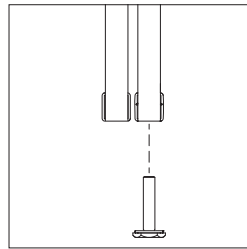

Glides are adjustable and provide 1½" adjustment.

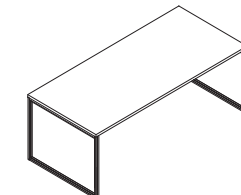
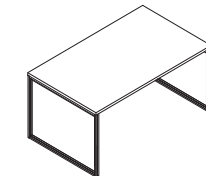
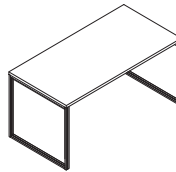

Private desks are available in a range of sizes and come standard with two legs. Desk returns and modesty panels are also available. Power cutouts are available in center, left, and right.

▶ See wiring on cabling, page 56.

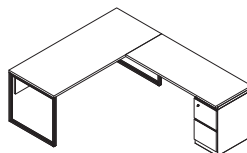
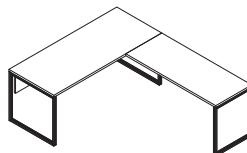

Desk returns are used with private desks to form L-shape configurations, where everything is in reach. Specify with leg or pedestal support.

Modesty panels cannot be used on the return side of this configuration.

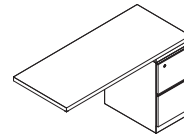

File/file

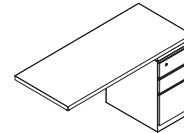

Box/box/file

Under-worksurface pedestals are available 18"D and 24"D for desk returns. Pedestals are available in file/file or box/box/file configurations.

Lock comes standard on pedestals.

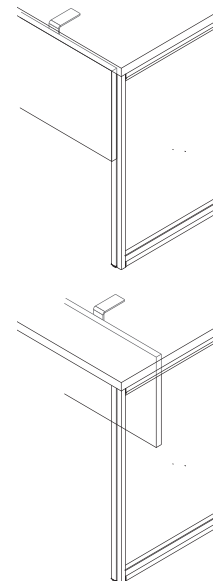

Modesty panel can be mounted flush or inset. Height can be adjusted to provide cord pass-through.

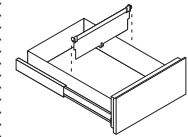

Box drawers are a welded steel construction and available with wide integral pull fronts. One divider is included with each box drawer.

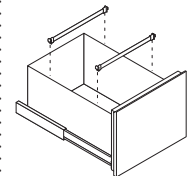

File drawers are a welded steel construction and available with wide integral pull fronts. Drawer body sides are full height and accommodate front-to-back filing of hanging letter-size file folders.

Optional rails accommodate side-to-side filing of letter-, A4-, and legal-size hanging folders. *Exception: Legal-size file folders cannot be filed in 17½"D or 18¾"D pedestals.*

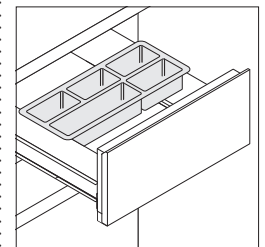

Pencil tray to hold small office supplies comes standard with each box/box/file and mobile pedestal, but can be excluded in the basic drawer option.

Optional basic drawer interior allows box/box/file pedestals to be ordered without rails, box drawer dividers, or pencil trays.

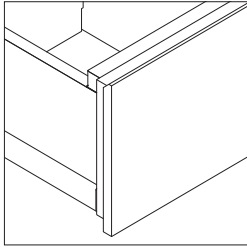

Pull on drawer and door fronts is full width and integral.

Drawer and door fronts are available in wood veneer or High-Pressure Laminate.

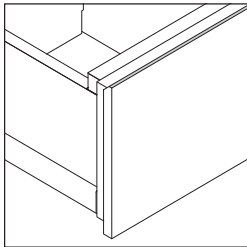

Door and drawer fronts on credenzas, lateral files, and pedestals

that are specified in High-Pressure Laminate have a corresponding painted top edge. For more information, see the table *High-Pressure Laminate Top Edge* from the next page.

3"H base is integral to pedestal and lateral cases.

Leveling glides adjust to install under-worksurface pedestals and lateral files on uneven floors.

Lateral files are ideal for high-density paper storage.

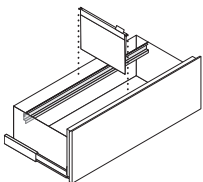

Hanging folder bar accommodates side-to-side filing of letter-, A4 international-, and legal-size hanging folders.

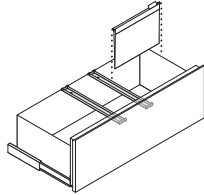

Rails accommodate front-to-back filing of letter-, A4 international-, and legal-size hanging folders. Rail packages accommodate two rows of letter-size files in 30"W and 36"W drawers.

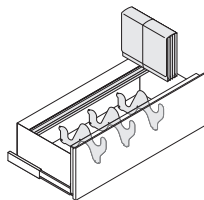

Dividers accommodate side-to-side filing of expandable folders and other objects. Divider packages include three dividers and one hanging folder bar per drawer.

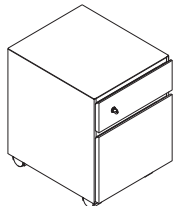

Metal lateral files and mobile pedestals have limited finishes.

Metal mobile pedestals are 18"D. Clearance from the ground to the bottom of the pedestal is 2 1/2".

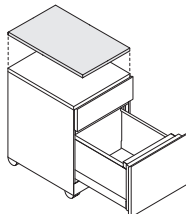

Basic cushion enhanced is ordered separately for use on mobile pedestals. Basic cushion enhanced is field-installed and attaches to the existing top with hook and loop fastener.

Counterweight packages are required to ensure product stability and are ordered as an option or separately.

Four casters are hard composition and non-locking, with a full-rotation swivel mechanism. Casters are exposed at the base of box/file pedestals.

Bookcases offer convenient storage for binders, books, and other objects.



Tall Open

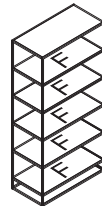

Low Open

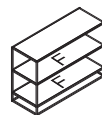

Narrow Open

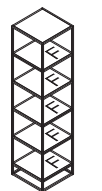

Narrow Open

F - Fixed shelf

Bookcases, are available in several different configurations and ship fully assembled. Shelf inside storage bookcase is adjustable. Shelves are standard 1/2" thick and can carry a load of 100 pounds. Back panels are finished. Shelf inside storage bookcase is adjustable.

Bookcases and lateral files cannot be used to support worksurfaces.

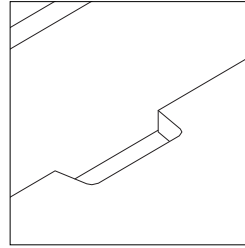

Cutout in lower cabinet shelf is standard on storage bookcase to allow cord pass-through.

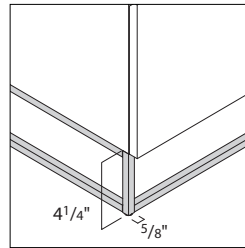

Metal bases are standard on all credenzas, bookcases, and wood lateral files. Leveling glides provide 1 1/2" adjustment.

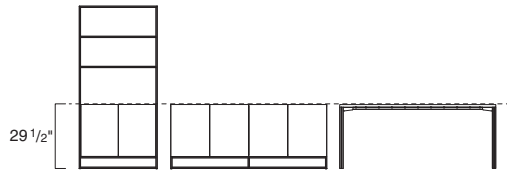

Storage bookcases align with private desks and storage or filing credenzas.

High-Pressure Laminate Top Edge

Door and Drawer Front HPL Finish	Top Edge Corresponding Paint Color	Door and Drawer Front HPL Finish	Top Edge Corresponding Paint Color
2406 Clear Cherry	CLRF Clear	2HAA Persian Salt	CLRF Clear
2409 Clear Maple	4700 Warm White	2HAB Rose	CLRF Clear
2410 Graphite Walnut	4238 Mocha	2HAC Indigo	CLRF Clear
2412 Natural Cherry	CLRF Clear	2HAD Green Citrine	CLRF Clear
2422 Medium Cherry	7278 Dark Bronze	2HAE Dark Olivine	CLRF Clear
24H4 Satin Mocha	CLRF Clear	2HAF Cloudy	CLRF Clear
2511 Winter on Maple	4700 Warm White	2HAK Clear Oak	4242 Milk
2535 Virginia Walnut	7225 Sand	2HAN Ash Noce	4242 Milk
2536 Blackwood	4B24 Night Bronze	2HAT Acacia	4700 Warm White
2538 Clear Walnut	7278 Dark Bronze	2HAW Ash Wenge	4242 Milk
2592 Blonde on Maple	4700 Warm White	2HBN Bisque Noce	4242 Milk
2612 Marbled Maple	4700 Warm White	2HBW Bisque Wenge	4242 Milk
2614 Chocolate Walnut	7278 Dark Bronze	2HCN Clay Noce	4242 Milk
2615 Marbled Cherry V2	4700 Warm White	2HCW Clay Wenge	4242 Milk
2714 Natural Walnut	7278 Dark Bronze	2HMG Merle	7360 Merle
2722 Cream	4700 Warm White	2HSN Storm Noce	7360 Merle
2730 Arctic White	4231 Arctic White	2HSW Storm Wenge	7360 Merle
2746 Black	0835 Black	2HWB Planked Walnut	7278 Dark Bronze
2759 Warm White	4700 Warm White	2TH2 Fawn Cypress	4700 Warm White
2811 Mist	7243 Seagull	2TH4 Saddle Oak	7207 Black
2820 Coffee Speckle	4700 Warm White	2TH5 Veranda Teak	7225 Sand
2823 Driftwood Speckle	4700 Warm White	2TH7 Walnut Heights	4239 Clay
2824 Smoke Speckle	7243 Seagull	2UH1 Reclaimed Aggregate	4242 Milk
2825 Vanadium Speckle	4242 Milk	2UH2 Reclaimed Gravel	7360 Merle
2850 Vanadium Fiber	4231 Arctic White	2UH4 Cement	4242 Milk
2852 Tungsten Fiber	7243 Seagull	2UH6 Sheetrock	4242 Milk
2854 Vellum Fiber	4700 Warm White	WE40 Natural Oak	CLRF Clear
2860 Granite Fiber	7360 Merle	WE41 Black Walnut	7238 Fieldstone
2862 Stucco Fiber	7243 Seagull	WE42 Gray Ash	4B24 Night Bronze
2870 Blonde Bronze Patina	4700 Warm White		
2873 Instant Iron Patina	7360 Merle		
2883 Seagull	7243 Seagull		
2884 Milk	4242 Milk		
2885 Dune	4242 Milk		
2897 Desert Oak	4700 Warm White		
2920 Marl Micro	7243 Seagull		
2921 Gypsum Micro	4242 Milk		
2922 Clay Micro	4700 Warm White		

Lock and Keying

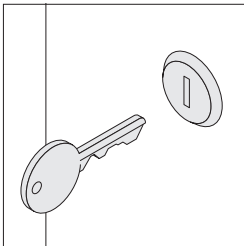

Locks are available field-installed. Field-installed locks are available with consecutive, specific, and random keying options. Master-keyed locks are also available. Lock cylinders must be specified separately.

Locks are standard on under-worksurface pedestals, metal pedestals, and metal lateral files. Lock is located in the top drawer. Key will lock both drawers if applicable. Locks are standard factory installed, keyed random.

▶ *Lock and Keying*, page 258

Wiring and Cabling



Field-installed 2 1/2" grommet, ordered separately, provides wire and cable management for workspaces.

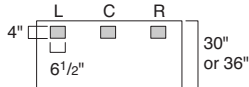

Worksurface power modules are available on executive and private desks. Cutouts can be specified for left, center, and right locations.

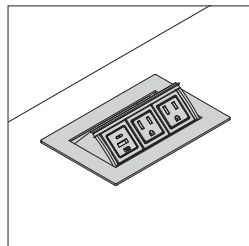
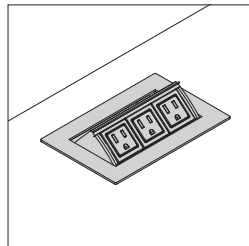

Power modules are available in three simplex and two simplex/USB A+C 20W configurations. The one-touch retractable door allows easy access.

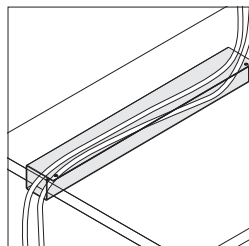

Cable tray is available to keep cords and cables out of the way.

Application Topics

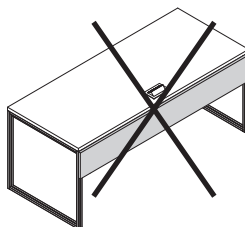
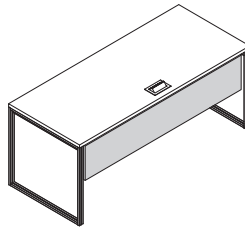

Modesty panels are specified one size smaller than the desk to allow for 3" clearance on both ends to accommodate the legs.

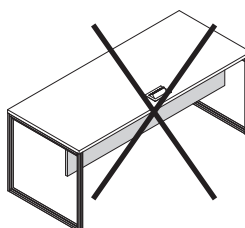
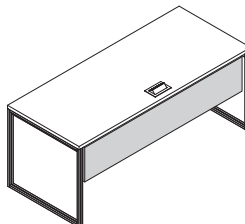

When a power cutout has been specified, modesty panel must be mounted flush to front of desk.

Storage Capacities and Dimensions

▶ Page 58

Surface Materials

Private desk and personal desk worksurface

- High-Pressure Laminate
- Wood veneer

Desk return with pedestal

- Drawer fronts are available in limited High-Pressure Laminate and veneer finishes.

Drawer and door fronts

- High-Pressure Laminate
- Wood veneer

Modesty panels

- High-Pressure Laminate
- Wood veneer

Credenzas, bookcases, and lateral files

- High-Pressure Laminate
- Wood veneer

Metal lateral files, and metal mobile pedestal

Drawer fronts are available in limited High-Pressure Laminate and veneer finishes:

- 2884 Milk
- 2HAN Ash Noce
- 2HMG Merle
- 36A2 Volcanic Oak
- 37A2 Thunder Walnut
- WE20 Natural Oak
- WE40 Natural Oak
- WE41 Gray Ash
- WE42 Black Walnut

Metal storage cases and metal bases

- 0835 Black
- 4B22 Matte Brass
- 4B24 Night Brass
- 4242 Milk
- 7278 Dark Bronze

Basic cushion enhanced

- Fabric

Lock

- 9201 Polished Chrome
- 9250 Ember Chrome

Desk power unit

- 6000 Black
- 6052 Milk

2 1/2" round grommet



- 0835 Black
- 4799 Platinum Metallic
- 7241 Arctic White
- 7278 Dark Bronze
- 9201 Polished Chrome
- 9211 Nickel

Tip: When selecting a Steelcase top surface finish, a corresponding Steelcase edge finish must be selected. When selecting West Elm top surface finish, a corresponding West Elm edge finish must be selected.

Greenpoint Private Office

Storage Capacities

Greenpoint Storage

Box Drawer	Size/Type	Inside Dimensions		
		D	W	H
	• Return pedestal	15 1/8"	12"	4 1/4" (includes drawer front) 2 3/4" (box drawer body only)
File Drawer	Size/Type	Inside Dimensions		
		D	W	H
	• Return pedestals	15 1/8"	12"	10 1/2" (includes drawer front)
	• Mobile pedestals	15 1/8"	12"	9 1/4" (file drawer body only)
Wood Lateral File Drawer	Size/Type	Inside Dimensions		
		D	W	H
	• Wood lateral	13"	32"	8 1/10" (includes drawer front)

Tip: When specified in High-Pressure Laminate, the drawer fronts will be painted according to the matrix in the Surface Materials section.

Tip: Drawer fronts on pedestal and metal lateral files are available in limited High-Pressure Laminate and veneer finishes. See Surface Materials section for more information.

Greenpoint Storage, continued

Filing Credenza

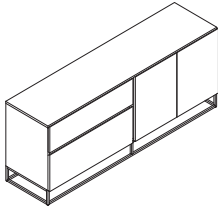

Size/Type

- Top drawer
- Bottom drawer
- Storage cabinet

Inside Dimensions

D	W	H
13"	31½"	8 ¹ / ₁₀ " (includes drawer front)
13"	31½"	11 ³ / ₈ " (file drawer body only)
17 ³ / ₁₆ "	34"	22½"

*Five holes for adjustable shelf
1½" apart—first hole from top and
bottom = 8¼".

Outside Dimensions

D	W	H
18¾"	72"	29½"

Storage Credenza

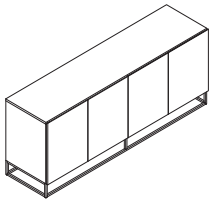

Size/Type

- Storage cabinet

Inside Dimensions

D	W	H
17 ³ / ₁₆ "	34"	22½" (per opening)

*Five holes for adjustable shelf
1½" apart—first hole from top and
bottom = 8¼".

Outside Dimensions

D	W	H
18¾"	72"	29½"

Bookcase Storage

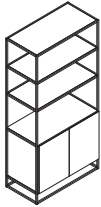

Size/Type

- Open shelf
- Storage cabinet

Inside Dimensions

D	W	H
18"	36"	75"
17"	32¼"	22¼" (1 shelf at ¾" = 22 ³ / ₈ ")

*Five holes for adjustable shelf
1½" apart—first hole from top and
bottom = 8¼".

Bookcases

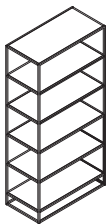

Size/Type

- Storage
- Tall open
- Low open
- Narrow open

Outside Dimensions

D	W	H
18"	36"	75"
18"	36"	75"
18"	48"	33"
18"	18"	75"

Lateral File

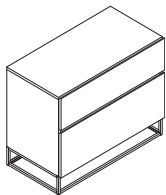

Outside Dimensions

D	W	H
18¾"	36"	29½"

Greenpoint Benching

Greenpoint benching

is designed to keep things simple while providing a rich range of design options that blends performance with a light and airy appeal.

Privacy screens provide privacy and are available for single- or dual-sided applications. Available in tackable fabric and glass. Glass options include clear or fluted.

A 2 1/2" gap between worksurfaces accommodates screens, worktools, and cords.

Credenzas can be used to support worksurfaces and provide storage. All brackets and mounting hardware are included.

Optional center power cutout is available. Power units are specified separately.

End legs are available on dual-sided units in 48" and 60" widths. End legs are designed to be flush with the corners of the worksurface and include all brackets and mounting hardware. Leveling glides provide 1 1/2" adjustment. Legs are fixed height with top of surface at 28 1/2"H.

Dual-sided worksurfaces are available in overall depths of 24" and 30". Worksurfaces are 1 1/8" thick and can be supported by legs or credenzas. Widths range from 48" to 78".

Intermediate legs are used to connect dual-sided units. Intermediate legs are 30"W for 48"W and 60"W dual-sided worksurfaces and include all brackets and mounting hardware. Leveling glides provide 1 1/2" adjustment. Legs are fixed height with top of surface at 28 1/2"H.

End legs are available on single-sided units in 24" and 30" depths. End legs are designed to be flush with the corners of the worksurface and include all brackets and mounting hardware. Leveling glides provide 1 1/2" adjustment. Legs are fixed height with top of surface at 28 1/2"H.

A modesty panel is available and ordered separately, in widths from 48" to 78". They can be specified in either wood veneer or High-Pressure Laminate. Modesty panels are specified one size smaller than the desk to allow for 3" clearance on both ends to accommodate the legs. Modesty panel can be mounted flush or inset.

Intermediate legs are used to connect single-sided units. Intermediate legs are available in 24" and 30" depths to match the depth of the worksurface and include all brackets and mounting hardware. Leveling glides provide 1 1/2" adjustment. Legs are fixed height with top of surface at 28 1/2"H.

Leveling glides provide 1 1/2" adjustment.

Bench returns offer additional worksurface space and are available in depths of 18" or 24" and widths of 42", 48", 54", and 60" for single- and dual-sided applications.

Continuous tops are available in a depth of 48". Worksurfaces are 1¹/₈" thick and can be supported by legs or credenzas. Widths range from 48" to 78".

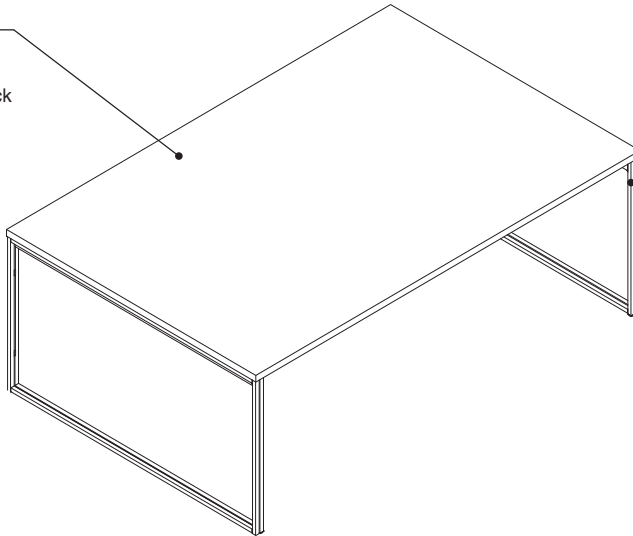

End legs are designed to be flush with the corners of the worksurface and include all brackets and mounting hardware. Leveling glides provide 1¹/₂" adjustment. Legs are fixed height with top of surface at 28¹/₂"H.

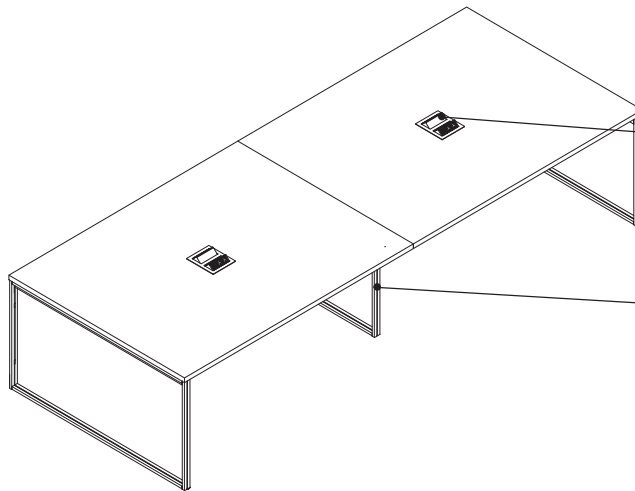

Optional center power cutout is available. Power units are specified separately.

Intermediate legs are used to connect continuous tops. Intermediate legs are 30"W for the 48"D continuous top worksurface and include all brackets and mounting hardware. Leveling glides provide 1¹/₂" adjustment. Legs are fixed height with top of surface at 28¹/₂"H.

Greenpoint Benching

Round, Square, and Half-Round Tables

Round tops are available in 48" or 60" diameters. The worksurface is 1 1/8" thick.

Square tops are available in 48" x 48" or 60" x 60". The worksurface is 1 1/8" thick.

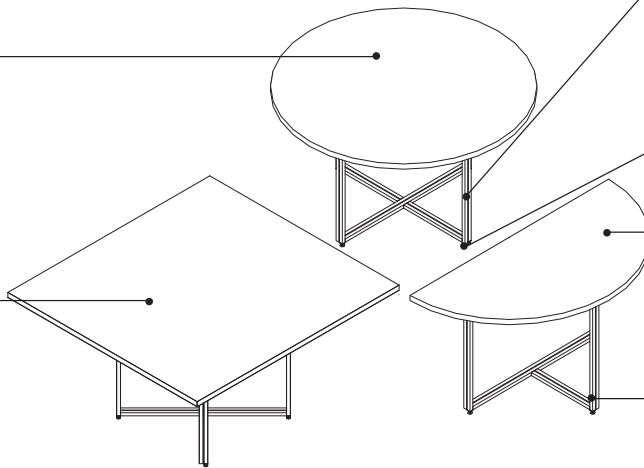

Legs for both the 48" round and square tops are inset by 4 3/4" and 7 1/2" from the edge of the worksurface. Legs for both the 60" round and square tops are inset by 5 7/8" and 9 1/8" from the edge of the worksurface.

Leveling glides provide 1 1/2" adjustment. Legs are fixed height with top surface at 28 1/2"H.

Half-round tops are available in 48" or 60" diameters.

Half-round tops must attach to a continuous top or dual-sided bench of the same dimension.

Legs for the half-round tops are inset by 8 7/8" for the 48"W and 10 3/8" for the 60"W from the edge of the worksurface.

Half-round legs include all brackets and hardware to attach a half-round top to either a continuous top or dual-sided bench.

Actual Dimensions

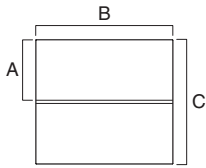

Dual-Sided

A	24" or 30"
B	48", 54", 60", 66", 72", 78"
C	50 1/2" or 62 1/5"

Thickness 1 1/8"

*78"W not available in credenza/credenza application.

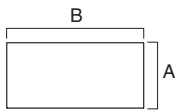

Single-Sided

A	24" or 30"
B	48", 54", 60", 66", 72", 78"

Thickness 1 1/8"

*78"W not available in credenza/credenza application.

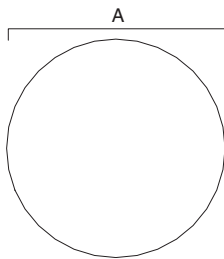

Round

A	48" or 60"
---	------------

Thickness 1 1/8"

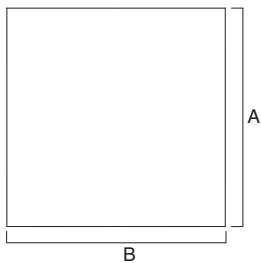

Square

A	48" or 60"
B	48" or 60"

Thickness 1 1/8"

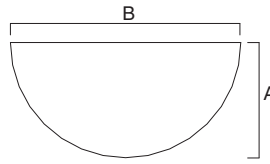

Half-Round

A	24" or 30"
---	------------

B	48" or 60"
---	------------

Thickness 1 1/8"

Product Details

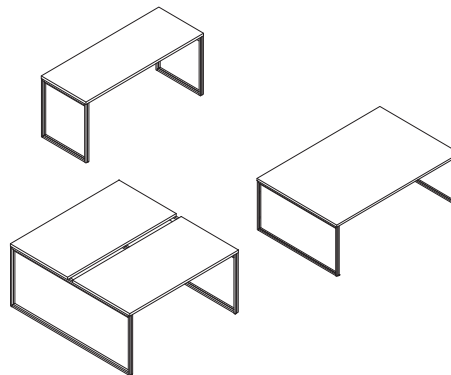

Worksurfaces are available for single-, dual-sided, or continuous top applications in depths of 24" or 30" for single- and dual-sided, and 48" for continuous top, and widths of 48", 54", 60", 66", 72", and 78". Leg and credenza supports are sold separately.

Tip: 78"W not available in credenza/credenza application.

Half-round worksurfaces must attach to a continuous top or dual-sided bench of the same dimension.

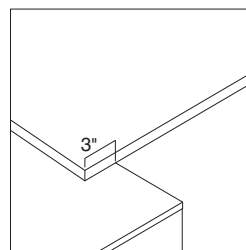

Worksurfaces using one credenza support are 3" wider than those used between leg supports. Worksurfaces used with credenza supports on both ends are 6" wider. Mounting hardware is included with credenzas for applications with credenza support.

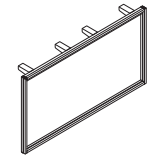

Dual Sided End Leg

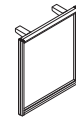

Single Sided End Leg

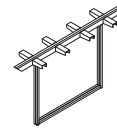

Dual Sided Intermediate Leg

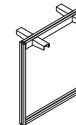

Single Sided Intermediate Leg

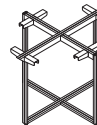

X-Leg

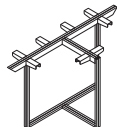

T-Leg

Leg support single- and dual-sided applications used to support worksurfaces at the end-of-run or intermediately.

24"W or 30"W single-sided end legs are to be used with 24"W or 30"W single-sided worksurfaces.

48"W or 60"W dual-sided end legs are to be used with 48"W or 60"W dual-sided worksurfaces.

Round and square worksurfaces must be specified with round/square legs. Half-round worksurfaces must be specified with half-round legs and be adjacent to a continuous top or dual-sided bench.

Intermediate legs are to be used between a run of worksurfaces. Dual-sided intermediate legs are 30"D and work for both 48"D and 60"D worksurfaces. Single-sided intermediate legs are available in 24"D and 30"D.

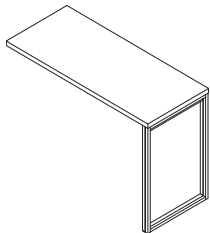

Bench returns are available on dual- and single-sided applications in depths of 18" or 24" and widths of 42", 48", 54", and 60".

Bench returns include return worksurface, leg support, all brackets, and mounting hardware.

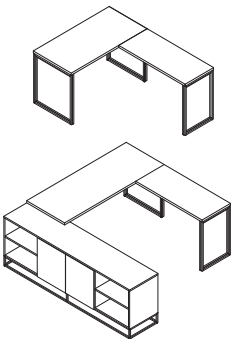

Bench returns can be used with a leg-leg worksurface or leg-credenza worksurface.

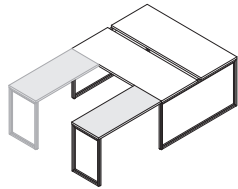

Returns must be placed flush to either end of the worksurface.

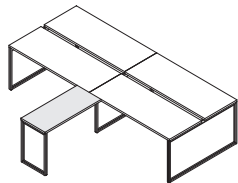

Returns can span equally across adjoining worksurfaces.

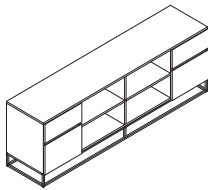

Personal credenza

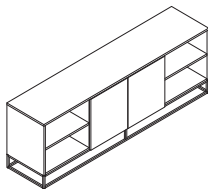

End credenza

Credenzas are available in two configurations – personal and end. The case can be specified as an inward or outward orientation, and single or dual-sided application, resulting in the correct hardware. If specifying as a stand-alone credenza, the orientation and application do not matter.

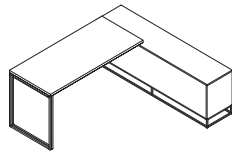
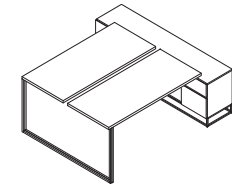

Personal credenzas can be used facing inwards or outwards in dual-sided applications. Specify with 24"D worksurfaces when orienting towards the user to allow easier access to storage drawers. In single-sided applications, the credenza must face outward.

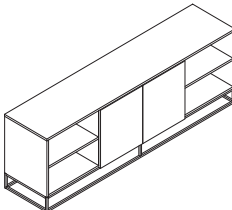

End credenzas can face inward or outward in 24"D single-sided applications. When 30" single-sided is specified, inward facing end credenza is not allowed. In dual-sided applications, credenza must face outward. Both open and closed sections come with adjustable shelves.

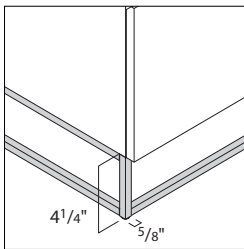

Steel bases are standard on credenzas.

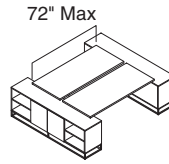

Dual- and single-sided worksurfaces using credenza/credenza support cannot exceed 72"W.

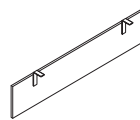

A modesty panel is available and ordered separately, in widths from 48" to 78". They can be specified in either wood veneer or High-Pressure Laminate. Modesty panels are specified one size smaller than the desk to allow for 3" clearance on both ends to accommodate the legs. Modesty panel can be mounted flush or inset.

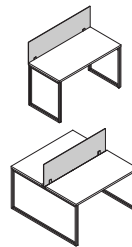

Glass screens are available for single- or dual-sided applications. Worksurface mounting brackets are included. Screens align with a 42"H datum from the floor.

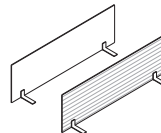

Glass screens are available in clear or fluted glass.

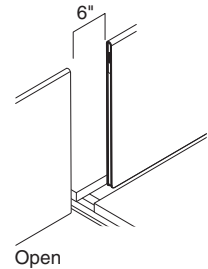

Open

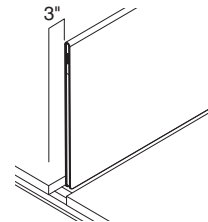

Full

Universal screens will have a 3" gap to the end of a bench run and 6" gap between screens. Screens do not run full worksurface width.

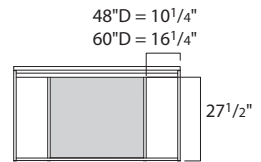

48"D desks have 10 1/4" clearance to intermediate leg. 60"D desks have 16 1/4" clearance.

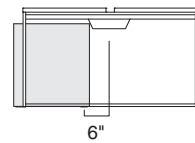

Storage must be at least 6" from centerline when trays are used.

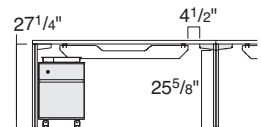

Storage can nest under the bench. The clearance is 27 1/4" except when within 4 1/2" of an intermediate leg, the clearance is 25 5/8".

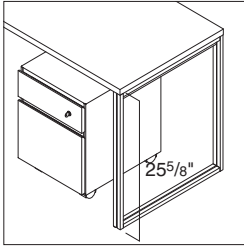

Storage can nest under the return. The clearance is 25⁵/₈".

Wiring and Cabling

Modular power cannot be routed through personal and end credenzas in any configuration.



Worksurface power modules are available on dual- and single-sided bench units. Cutouts are centered on the worksurface.

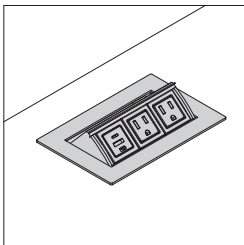
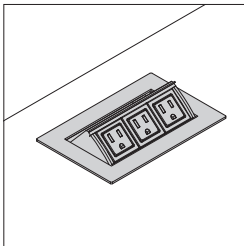

Power modules are available in three simplex and two simplex/USB A+C 20W configurations. The one-touch retractable door allows easy access.

Tip: When using modular power under the worksurface, specify 18" L cord length.

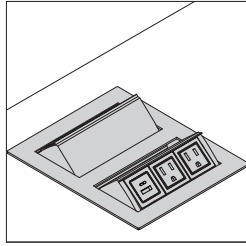

Continuous top power modules are available in six simplex and four simplex/USB A+C 20W configurations. The one-touch retractable door allows easy access.

Tip: When using modular power under the worksurface, specify 18" L cord length.

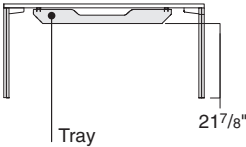

Power trays are optional and provide under the surface cord management and accommodate standard capacity power only. Power trays include all brackets and mounting hardware.

Power trays work with single-sided and dual-sided benches as well as continuous tops.

If center cutout is specified on single-sided worksurfaces, specify either left-hand or right-hand power tray.

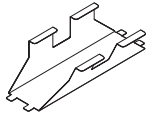

Single-sided tray extension

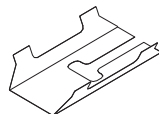

Dual-sided tray extension

Extension trays conceal conduit or wires between sections using power trays. They also allow for wires or conduit to be brought up through the bottom.

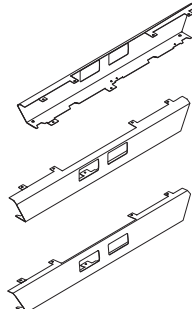

Power covers can be added to provide decorative trim around receptacles. Power covers are available for dual- and single-sided applications.

If power covers are not selected, any connection points on modular power blocks not being used by a harness, infeed, or connector must be filled with dust covers. Order style number **(FMVBK)** separately.

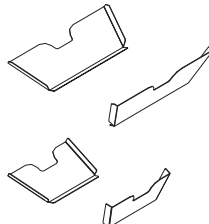

End caps can be added to power trays and are sold in pairs. End caps are painted metal.

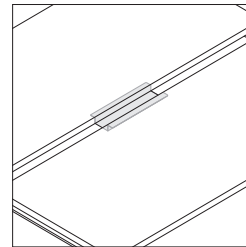
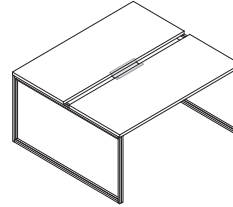

Power support is required when using modular power and provides an attachment location for a modular power block. Location is centered between worksurfaces for dual-sided applications and off-center for single-sided applications.

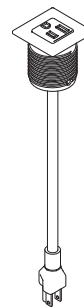
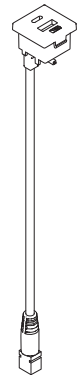

Round and square worksurfaces can be specified with a power cutout. Round/square power comes in configurations of 1 power or USB A+C 20W and has a 72" cord length.

Related Products

The following monitor arms work with the Greenpoint bench dual- and single-sided worksurfaces: **CFINTRO** and **CFINTROSLIDE**, with c-clamp mounting bracket. For more information, see *Worktools Specification Guide*.

Tip: Dual monitor mounts are not approved on 24" D worksurface applications.

Surface Materials

Worksurfaces and returns

- High-Pressure Laminate
- Wood veneer

Modesty panels

- High-Pressure Laminate
- Wood veneer

Credenzas

- High-Pressure Laminate
- Wood veneer

Tip: Credenzas specified in High-Pressure Laminate, will have a corresponding painted pull, according to the matrix in the Surface Materials section.

Legs, trays, extensions, end caps, and covers

- Paint

Desk power unit

- 6000 Black
- 6052 Milk

Glass screen

- 6500 Clear Glass
- WE80 Fluted Glass

Tip: When selecting a Steelcase top surface finish, a corresponding Steelcase edge finish must be selected. When selecting West Elm top surface finish, a corresponding West Elm edge finish must be selected.

Greenpoint Benching

Storage Capacities

Greenpoint Storage

End Credenza

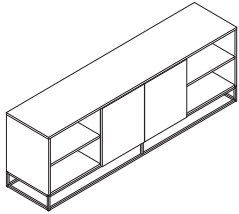

Size/Type

- Storage cabinet
- Open section
- Closed section

Inside Dimensions

D	W	H
18"	80"	27 ¹ / ₄ "
17 ¹ / ₈ "	17 ¹ / ₄ "	20 ¹ / ₄ "
17 ¹ / ₈ "	34 ¹ / ₂ "	20 ¹ / ₄ "

Outside Dimensions

D	W	H
18"	80"	27 ¹ / ₄ "

Personal Credenza

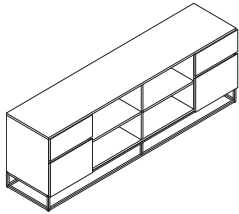

Size/Type

- Storage cabinet
- Top drawer
- Bottom drawer

Inside Dimensions

D	W	H
18"	80"	27 ¹ / ₄ "

Outside Dimensions

D	W	H
18"	80"	27 ¹ / ₄ "

Universal Tackable Center Screens

For Use with Greenpoint

Universal Tackable Center Screens

Universal tackable center screens provide a boundary element along the bench. They are available in two heights to accommodate varying levels of privacy.

► Specifying, page 205

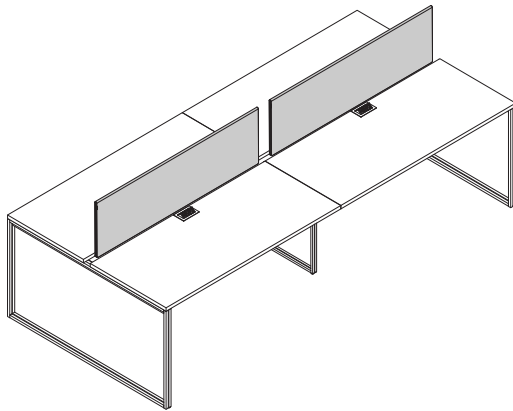

Product Details

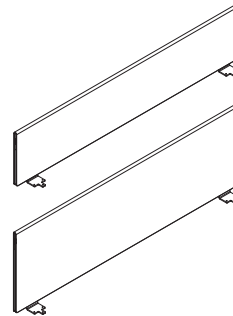

Universal tackable center screens are tackable and available in 13½"H and 19½"H. These screens are available in widths from 48"W-78"W.

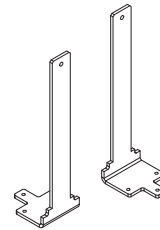

Brackets are included with screens. Two brackets are used on all screens.

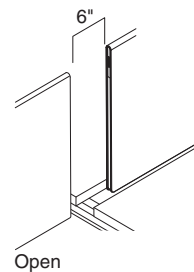

Open

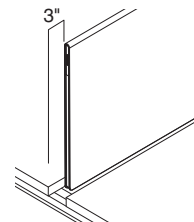

Full

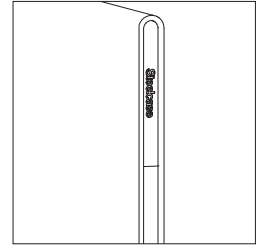

The edge of the screen is comprised of two different materials. The upper segment is merle plastic. The lower portion is PET which can be specified in medium heather grey to provide contrast or dark heather grey for a uniform visual.

Surface Materials

Fabric

► See *Surface Materials*, page 242

Edge

- P630 Medium Heather Grey PET
- P631 Dark Heather Grey PET

Brackets

► See *Surface Materials*, page 242

Front



Back



All fabrics are wrapped over the top of the screen. Approved fabrics are non-directional, and non-patterned.

Actual Dimensions

	13½" Screen	19½" Screen
Height	12½"	18½"
Thickness	¾"	¾"
Width	48", 54", 60", 66", 72", or 78"	48", 54", 60", 66", 72", or 78"

Tip: 13½"H screen aligns with a 40½"H datum from the floor. 19½"H screen aligns with a 46½"H datum from the floor.

Tip: Screens will have a 3" gap to the end of a bench run and a 6" gap between screens. Screens do not run full worksurface width.

Greenpoint Benching

Power Routing Harness Chart

Dual-Sided Benches

Bench A

Bench B	Bench A					
	48	54	60	66	72	78
48	45	48	51	54	57	60
54	48	51	54	57	60	63
60	51	54	57	60	63	66
66	54	57	60	63	66	69
72	57	60	63	66	69	72
78	60	63	66	69	72	75

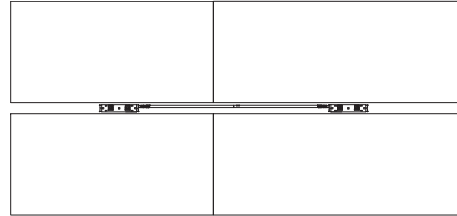

Single-Sided Benches, Left to Left or Right to Right

Bench A

Bench B	Bench A					
	48	54	60	66	72	78
48	45	48	51	54	57	60
54	48	51	54	57	60	63
60	51	54	57	60	63	66
66	54	57	60	63	66	69
72	57	60	63	66	69	72
78	60	63	66	69	72	75



Single-Sided Benches, Right to Left

Bench A

Bench B	Bench A					
	48	54	60	66	72	78
48	27	30	33	36	39	42
54	30	33	36	39	42	45
60	33	36	39	42	45	48
66	36	39	42	45	48	51
72	39	42	45	48	51	54
78	42	45	48	51	54	57

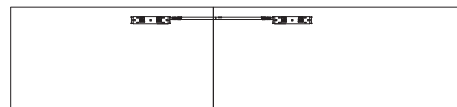

Tip: When skipping over a bench, add the width of the bench to the calculations above.

Tip: Power module is always mounted in the center for dual-sided benches.

Tip: Power modules are mounted off-center for single-sided benches.

Single-Sided Benches, Left to Right

Bench A

		48	54	60	66	72	78
Bench B	48	66	69	72	75	78	
	54	69	72	75	78		
	60	72	75	78			
	66	75	78				
	72	78					
	78						

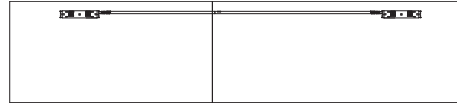

- Tip: When skipping over a bench, add the width of the bench to the calculations above.*
- Tip: Power module is always mounted in the center for dual-sided benches.*
- Tip: Power modules are mounted off-center for single-sided benches.*

Greenpoint Benching

Distribution and Access

Power blocks can be attached to power supports that are mounted to the underside of the worksurface. The location is centered on dual-sided application and off-center on single-sided applications.

Because single-sided application is off-centered, the power tray (**WESINDPTSS**) is either left- or right-handed.

Standard-capacity power includes one power block, provides back-to-back power, and accepts two receptacles per side.

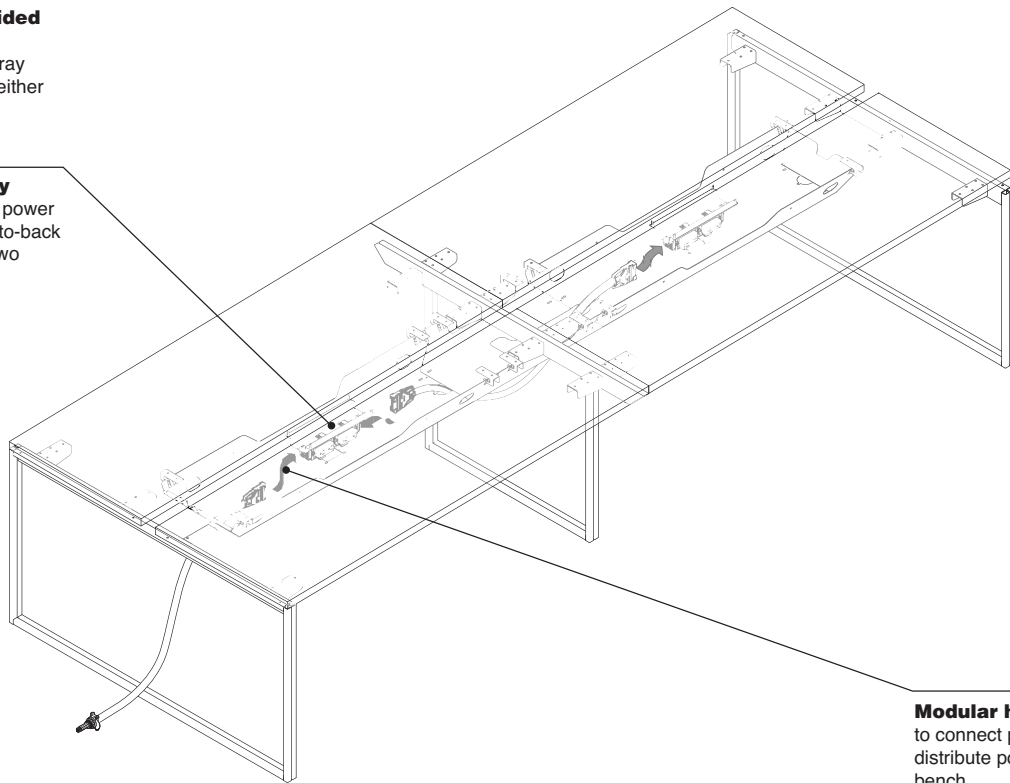

Modular harness is used to connect power blocks and distribute power through the bench.

Wiring and Cabling

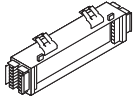

Standard-capacity power includes one power block, provides back-to-back power, and accepts two receptacles per side.

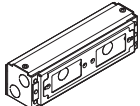

Chicago hardwire box is available. It accommodates two receptacles per side.



Duplex receptacles are available in 15- and 20-amps, isolated or system ground, with multiple line options. Receptacles have two outlets and are ordered separately.



USB receptacles are available in three wiring schematics with multiple line options. USB receptacles offer easy access to two charging ports. Each port provides 1 ampere of output. USB receptacles conveniently charge a wide range of electronic devices. Some devices may not be compatible.

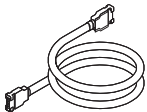

Modular harnesses are used to connect power blocks.

► See *Power Routing Harness Chart*, page 68, to determine lengths needed.

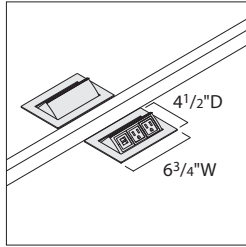

Power unit can be added when a worksurface cutout is specified. It is centered on the surface and provides user access to power.

If power unit and cutout is not specified, power and data is accessible under the worksurface. Dual-sided power trays can be removed without tools to provide additional clearance to plug in devices if needed. Single-sided power trays require tools to remove.

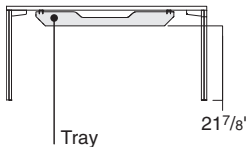

Power trays are available on dual- and single-sided units. Power trays hang from the underside of the worksurface and include all brackets and mounting hardware to provide cord management and conceal the standard capacity power blocks and conduit.

Modular power in a dual-sided base or extension unit, without trays, must be secured with a strain relief bracket. Order style number (**FMBVK**) for each unit.

Power infeed on single- and dual-sided applications must be secured with a strain relief bracket. To order one, use style number (**FMBVK**) for each unit.

Filler packages are available to fill unused power or data options. Order separately in packages of 20.

Three wiring schematics are available—3+1, 2+2, and three circuits with separate neutrals (3SN). All the components in an electrical distribution system must use the same wiring schematic. For safety, the components are keyed, labeled, and color-coded to make it impossible to connect mismatched parts.

All electrical components are cULus listed to the appropriate industry standards in accordance with the National and Canadian Electrical code.

Local electrical codes vary, so consult with your local authority having jurisdiction as they have final say if the products as installed are compliant with local code. Consult a qualified electrical contractor or engineer for the proper installation of all electrical components.

Greenpoint Benching

Building Interface

Building power and data can interface with the bench from floor or wall. Both modular and hardwire infeeds are available.

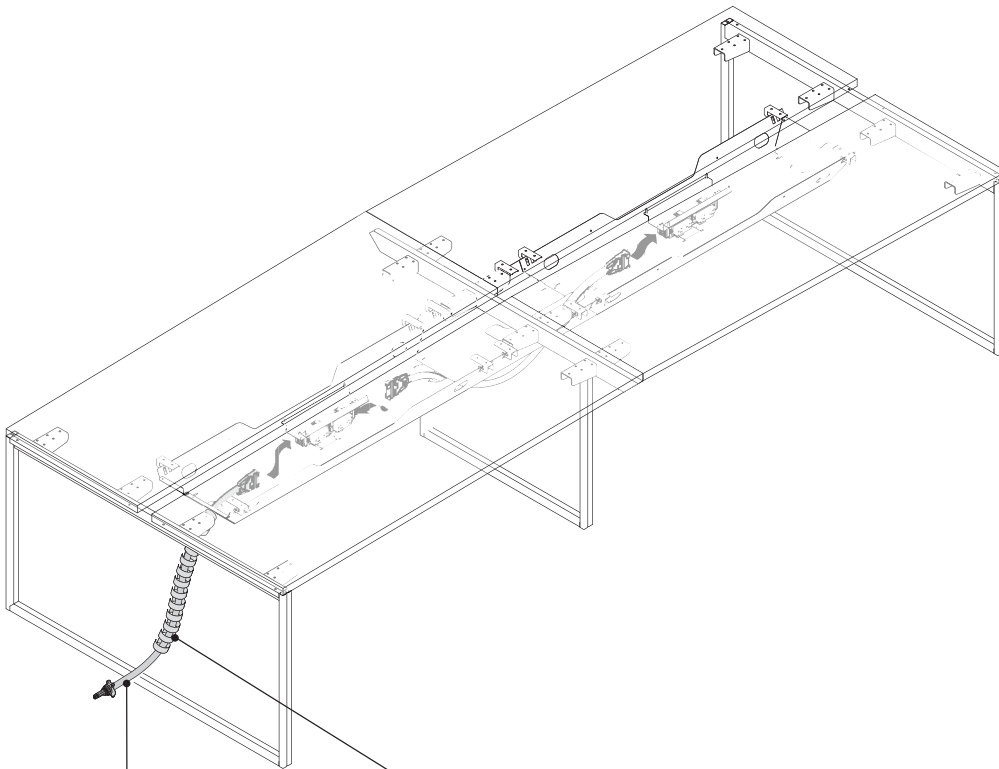

Infeeds can enter anywhere along the bench. If power trays are being used, infeeds can enter approximately 18" from either end of the bench section.

A vertebral riser is available to conceal the power and data.

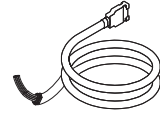

Hardwire-to-modular power infeed is available in 6, 12, and 24 foot lengths. If a shorter harness is needed, it can be cut by the electrician. The hard-wired end is connected by an electrician to a junction box wherever it is located in the building. The harness is routed into the bench and connected to a power block. Non-PVC is standard. PVC version can be optioned.

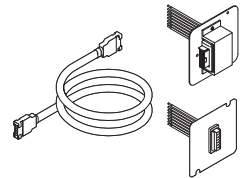

Modular-to-modular power infeed is available in 6, 12, and 24 foot lengths. A straight/flush modular junction box faceplate cover is standard and is wired to a 4¹/₁₆" square junction box located in the building. The harness is then routed into the bench and connected to a power block. A 90° junction box faceplate can be optioned and is recommended for use at a wall or column. The straight/flush is generally used in the floor. Non-PVC is standard. PVC version can be optioned.

Straight/
Flush

90°

Modular junction box faceplate can be ordered separately and used with any modular harness length when 12 and 24 foot lengths are not appropriate. Straight/flush and 90° faceplates are available. A 90° junction box faceplate is recommended for use at a wall or column. Non-PVC is standard. PVC version can be optioned.

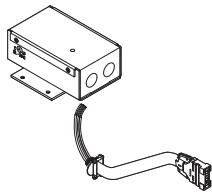

New York power infeeds are available. The junction box is mounted to the underside of the desk. A 50" harness is included to reach the first power block in the bench. If a shorter harness is needed, it can be cut by the electrician. Non-PVC is standard. PVC version can be optioned. Hardwire-to-modular infeeds can also be used.

Hardwired/Chicago power infeeds are supplied by the electrician.

San Francisco can use hardwire or modular infeeds. When infeed is coming from floor or wall, liquid tight metallic conduit may be required. In this case, order infeed specific to San Francisco.

Base power infeeds are not available.

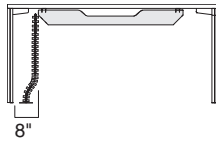

Vertebral riser can attach to the lower tray or simple tray. Its position is approximately 18" from either end of the desk unit. Length is 30".



Extension vertebral riser can be used to conceal conduit and cables along the floor. Length is 15". Risers can be linked to each other for longer length requirements.

Power and data can enter the bench through the end of the power tray. The opening is approximately 14" from the end of the desk.

Three wiring schematics are available—3+1, 2+2, and three circuits with separate neutrals (3SN). All the components in an electrical distribution system must use the same wiring schematic. For safety, the components are keyed, labeled, and color-coded to make it impossible to connect mismatched parts.

Non-PVC modular electrical components are the standard offering with the option to order PVC on some components. For those trying to gain the LEED Innovation and Design credit, non-PVC should be selected.

All electrical components are cULus listed to the appropriate industry standards in accordance with the National and Canadian Electrical code.

Local electrical codes vary, so consult with your local authority having jurisdiction as they have final say if the products as installed are compliant with local code. Consult a qualified electrical contractor or engineer for the proper installation of all electrical components.

Greenpoint Benching

Stability Guidelines

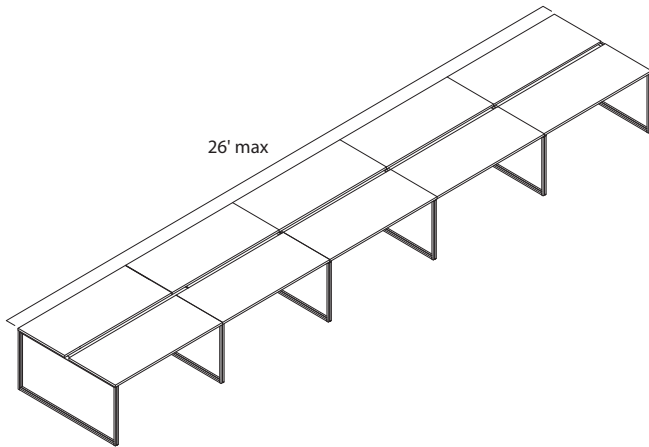

Maximum run on dual-sided and extension is 26'.

▶ See the *Steelcase Worktools Specification Guide* for approved monitor arm on dual-sided worksurfaces.

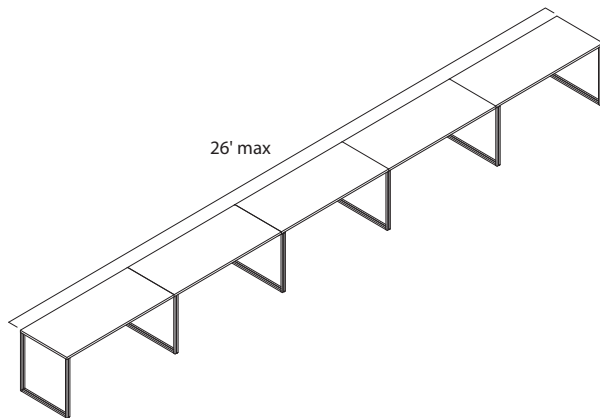

Maximum run on single-sided and extension is 26'.

▶ See the *Steelcase Worktools Specification Guide* for approved monitor arm on dual-sided worksurfaces.

Greenpoint Benching

Directional Laminate and Edge Profile Detail

The appearance of laminate may change slightly depending on the angle from which it is viewed. This natural phenomenon is called polarization, and it can be seen on natural veneer, and to a lesser extent on composite veneer. Polarization is often noticed on worksurfaces installed at a 90° angle with each other. Please refer to the following illustrations for an understanding of grain direction on your installation.

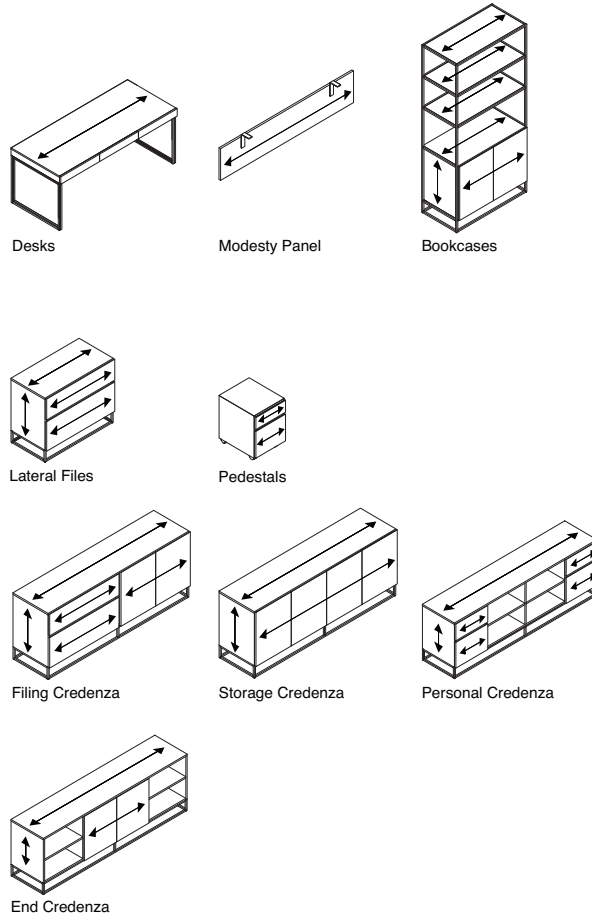

Product Details



3 mm radius front edge profile
(1 1/8" thick)

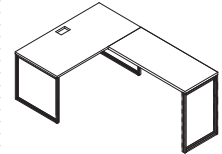

3 mm edge profile is on all four worksurface sides.

Sutton

Rectangle Height-Adjustable Desks and Bases

Rectangle height-adjustable desks bring mobility and wellbeing, allowing users to change posture and location to suit their work needs. Optional integrated power includes a single power cord that comes out of the desk for ease of movement.
▶ Specifying pages 232-236

Desk has a wood core with a High-Pressure Laminate or wood veneer surface, and is 1" thick.

Radius corners are available with a square edge profile. Corners feature a 2" radius.

Square edge is available in 3 mm edge profile, when High-Pressure Laminate or wood veneer is selected.

Basic height-adjustable base adjusts from 27³/₈"H–46⁷/₁₀"H in any increment.

Square corners are available with a square edge or blade edge.

Extended height-adjustable base adjusts from 22³/₈"H to 48⁷/₁₀"H in any increment.

Leveling glides adjust 1/2" to install desk on uneven floors. Glides are black.

Push button simple touch controller adjusts height at a rate of 1 1/2" per second.

Base supports a maximum distributed weight load of 360 pounds (2-leg).
Tip: When calculating lifting capacity, subtract the weight of the worksurface, understructure, and options selected.
▶ See page 80 for worksurface weights.

Active touch controller is Bluetooth-enabled; is standard and includes digital display, two preset buttons, double-tap automatic drive, and active motion posture reminders.
Tip: Steelcase Rise mobile app is available that pairs with any active touch controller to support preferences, presets, and activity tracking.

Lifting column is controlled by central control box for synchronization. Columns are precision surface balanced to minimize surface vibrations.

Blade edge is available on the front user edge when square corners are selected.

Product Details

Radius corners have rounded 2" corners on all four sides with a continuous user edge. Radius corners eliminate sharp edges and are appropriate for free-standing furniture. Radius corners are not available in combination with a blade edge profile.

Square corners have a 90 degree corner on all four sides.

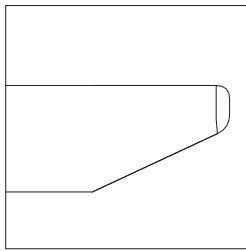

Blade edge profile is available on the front user edge with a clear coat over MDF. It is not available on desks with radius corners.

Desk overhang is not available. Distance from edge of worksurface to lift column is 4.96".

High-Pressure Laminate Desks

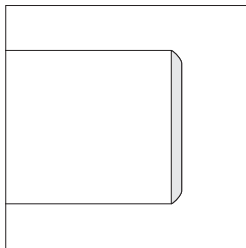

Edge profile is available in 3 mm edge profile for desks with radius corners and square corners. Blade edge profile is not available on desks with radius corner profile.

PVC-free, 3 mm edge profiles are proprietary polyolefin blend for all solid colors and woodgrain finishes.

Edge profile finishes are specified separately from laminate color.

Wood Veneer Desks

Edge profile is available in 3 mm edge profile for desks with radius corners and square corners. Blade edge profile is not available on desks with radius corner profile.

Simple touch controller is available as an option and easily adjusts height of desk, at a rate of 1 1/2" per second, by lifting or pressing down on the controller.

Active touch controller is Bluetooth-enabled; is standard and includes digital display, two preset buttons, double-tap automatic drive, and active motion posture reminders.
Tip: Mobile app is available that pairs with any active touch controller to support preferences, presets, and activity tracking.

Obstruction sensing technology is standard with all desks. The worksurface will backtrack when it makes contact with an object.

The overall depth of the worksurface is 23"D or 29"D.

Extended height desks and bases adjust 22 3/8"H to 48 7/10"H in any increment.

Basic height-adjustable desks and bases adjust from 27 3/8"H to 46 9/10"H in any increment.

Desk sizes are listed in actual dimensions to allow for 1" gap to adjacent furniture, eliminating any pinch points.

Wiring and Cabling

Low surge electric motor with quiet operation adjusts at 1 1/2" per second. Motor is 110V and includes a 10' power cord. Motor has 0.1W standby power.

Chicago requires that desks shipping into Illinois ship with a 9' power cord.

Sutton desks and bases are listed by ETL.

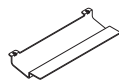

Cable trays are available as an option or can be ordered separately. 46"W–57 15/16"W desks use the 28" cable tray. 58"W–72"W desks use the 40"W cable tray.

Integrated power is optional and is located in the understructure of a desk. Integrated power consolidates technology to provide one cord out of the desk for convenience to the user. Two versions are available: underworksurface only and underworksurface plus worksurface clamp on convenience power. Worksurface power has two power outlet options, either USB A+C 20W or USB-C. Desks 57 15/16"W and under receive three power outlets in the understructure and desks 58"W and above receive five power outlets. Over-current power protection is standard on the integrated power option. If the over-current protection trips, reset by pushing the button located on the face of the understructure.

Integrated power is standard with a 10' standard black power cord. A 20' cord option is available if additional length is needed. For extra color, braided cord option is available.

Integrated power is available with either a standard three prong NEMA plug for use with standard receptacles or with Steelcase's proprietary thread low-profile plug for use with one-door and two-door low-profile connectors.

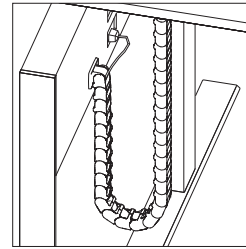

Cable riser, with fence connection, inside dimensions are 1"D x 1"W to accommodate a variety of cord sizes. Overall depth is 2". Order style number **OLCR** separately.

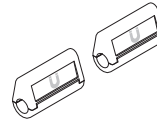

Magnetic cable clips are optimized for the braided one-cord out solution. However, the magnetic cable clips will work on Sutton, Ology, Migration SE, and the standard Flex power cords. The clips are used to manage power cords out of the users way. Order style numbers **FLXMCC2** or **FLXMCC10** separately.

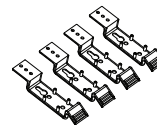

Cable brackets, ordered separately, support horizontal cable management below the worksurface. Order style number **FLXCBK4** separately.

Inside dimensions of cable brackets are 6"D x 2 1/4"W x 1/16"H.

Surface Materials

High-Pressure Laminate Desk

- Laminate
- ▶ See *Surface Materials Reference Manual*.
- Open Line laminate (option)
A program including non-Steelcase laminates which are suitable for use on Steelcase products.
- ▶ See *Surface Materials Reference Manual*.

3 mm edge profile

- Plastic

Blade edge profile

- Clear coat

Wood Veneer Desk

- Wood veneer (standard)
- Customiz stain (option)

Square 3 mm edge profile

- Wood veneer to match desk

Blade edge profile

- Clear coat

Height-adjustable base

- 4799 Platinum Metallic
- 7207 Black
- 7243 Seagull
- 7360 Merle

Foot

- Paint
- Accent paint
- Lux Coatings

Ring

- Paint
- Accent paint
- Lux Coatings
- WE04 Brushed Nickel
- WE06 Smooth Brass
- 9201 Polished Chrome

Braided Cord Color Matrix

Braided cord samples are not available to order. Use matrix below that compares the braided cord finish to the nearest Steelcase finish color for color reference purposes.
Tip: Braided cord color is defaulted to 9007 Sterling.

Finish	Similar Steelcase Color
9003 Fuchsia	4BQ7 Fuchsia
9004 Marlin	4AZ5 Marlin
9006 Chili	6338 Chili
9007 Sterling*	6059 Sterling Dark Solid
9008 Honey	4CZ5 Honey
9009 Black	0835 Black
9010 Light Peacock	4CZ8 Light Peacock
9011 Seagull	4858 Seagull

*Default finish on integrated power.

Application Topics

Moving desks can collide with other components. Do not install overhead storage, desk-height power, or desk accessories in the path of height-adjustable desks.

Universal boundary screens are not permitted on height-adjustable desks, as they do not pass minimum safety requirements which could result in the desk tipping over.

Sarto screens are recommended to be used with Sutton height-adjustable desks. Universal and Soffio screens are also compatible.

On extended height desks, any storage higher than 19" will impede the height range of the desk. On basic height desks, any storage higher than 23⁷/₁₀" will impede the height range of the desk.
Tip: Do not place storage underneath controller.

CPU holders are not allowed for use on Sutton. There is no overhang option available to support CPU holders.

All assemblies meet or exceed ANSI/BIFMA standards.

WARNING

Read base only warranty limitations.

Keyboard assemblies are not allowed for use on height-adjustable desks. They do not meet minimum safety requirements.

A modesty panel is available and ordered separately, in widths from 48" to 78". They can be specified in either wood veneer or High-Pressure Laminate. Modesty panels are specified one size smaller than the desk to allow for 2" clearance on both ends to accommodate the legs. Modesty panel can be mounted flush or inset.

Modesty panels may be inset from the back edge of the worksurface to allow for worktool clamps.

For monitor arms, only single and dual flat panel monitor arm applications are permitted for use with height adjustable desks. For further information, see the *Steelcase Worktools Specification Guide*.

Dual monitor arms are not allowed on 23"D worksurfaces.

Height-Adjustable Desks Comparison Chart

Rectangle Height-Adjustable Desks

Basic Height

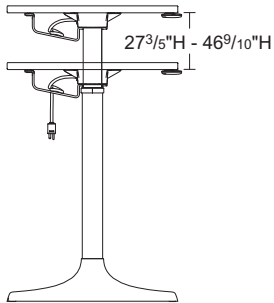

Extended Height

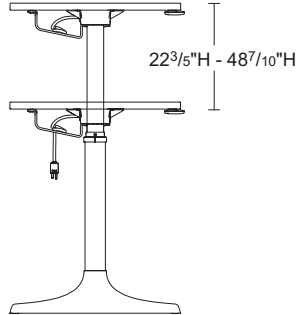

Enhanced sit-to-stand height-adjustability

A push button delivers electric adjustability up to 1 1/2" per second. Includes two controller options:

- Simple touch
- Active touch

	Weight Capacity
Sutton Desk	360 lb

Tip: When calculating lifting capacity, subtract the weight of the worksurface, understructure, and options selected.

Adjustables Comparison Chart

	Sutton Desk Sit-to-Stand
Range of Adjustment	Extended height: 22 ³ / ₅ " – 48 ⁷ / ₁₀ " Basic height: 27 ³ / ₅ " – 46 ⁹ / ₁₀ "
Type of Adjustment	Electric
Distributed Weight Capacity	360 lb
Worksurface Weight	See page 80 for worksurface weights
Worksurface Thickness	1"
Controller	Simple touch, Active touch
Integrated Rail	No
Integrated Soft Edge	No
Integrated Power	Yes
Motor	Enclosed
Decibel Rating	< 45 dBA
Volts	120v AC
Input Amps	2.5A
Watts	300W
Standby Power	0.1W
Frequency and Phase	60 Hz Single Phase
Adjustability Speed	1 1/2" per second
Stretcher or Understructure Design	Fixed
Base Only Availability	Yes
ANSI/BIFMA (29"D Knee depth requirement for worksurface)	Meet or Exceed

Sutton, Height-Adjustable Desks Comparison Chart, continued

Installation

Desks ship with pre-drilled holes for mounting bases.

Height-adjustable base requires attachment to the worksurface.

Base supports a maximum distributed weight capacity of 360 pounds.

Tip: When calculating lifting capacity, subtract the weight of the worksurface, understructure, and options.

Tip: A label applied to the underside of the worksurface will include the load-capacity for each desk.

Worksurface Weight

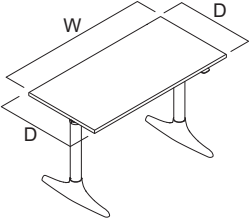
Worksurface Shape	W	D	Worksurface Weight	Understructure Weight	Leg Clearance (A)	Options
						Integrated Power Weight
	46"	23"	27 lb	7.1 lb	9 ¹ / ₂ "	5.0 lb
	58"	23"	35 lb	9.4 lb	9 ¹ / ₂ "	5.0 lb
	70"	23"	42 lb	11.7 lb	9 ¹ / ₂ "	5.0 lb
	46"	29"	34 lb	7.1 lb	12 ¹ / ₂ "	5.0 lb
	58"	29"	43 lb	9.4 lb	12 ¹ / ₂ "	5.0 lb
	70"	29"	52 lb	11.7 lb	12 ¹ / ₂ "	5.0 lb

Nimbus has a soft, inviting profile making it a comfortable conference seating option.

The Nimbus conference chair has a product height of 31.5" with an adjustable base.



The Nimbus conference chair has a width of 26" and depth of 24.4".

Product Details

Nimbus has an adjustable base height.

Seat includes a foam base for a comfortable sit.

Ships in one box, knocked down.

Assembly directions included in the box.

Surface Materials

Chair

- Platinum upholstered fabric

Base

- Antique bronze

Slope Guest (Licensed)

Slope has a sloped seat for added comfortability and metal base style.



The Slope guest chair has a depth of 21.5" and width of 19.25".

Product Details

Limited finishes offered.

Surface Materials

Chair

Aniline-dyed leather:

- Saddle
- Fog

Frame

- Hot-rolled steel

Slope Conference Chair (Licensed)

Slope Conference Chair
(Licensed)

Slope has a sloped seat for added comfortability and sleek 5-star base.

Product Details

Adjustable 5-star base.

Surface Materials

Chair

Aniline-dyed leather:
• Saddle

The Slope conference chair has a depth of 21.5" and width of 19.25".



Slope Stools (Licensed)

The Slope bar stool has a depth of 21.5" and width of 19.25". The product height is 40" and a seat height of 29.5".



The Slope counter stool has a depth of 21.5" and width of 19". The product height is 35.75" and a seat height of 25.25".



The Slope height adjustable stool has a depth of 21.5" and width of 19". The product height is 40.25" with adjustable base.

Product Details

Three different bases are offered for versatility.

Surface Materials

Stool

Available in
Aniline-dyed leather:
• Saddle

Base

• Hot-rolled steel

Slope Lounge (Licensed)

Slope Lounge (Licensed)

Slope has a sloped seat for added comfortability and metal base style.

The Slope lounge has a product height of 31.5" and seat height of 15.75".

The Slope lounge has a depth of 24.4" and width of 26".



Product Details

Limited finishes offered.

Surface Materials

Seat

Available in Aniline-dyed leather:

- Saddle

Lily Pad Nesting Tables (Licensed)

Lily Pad tables are offered in three heights.

The Lily Pad nesting tables have a depth of 25" and width of 30" for all height options.

The Lily Pad nesting tables have heights of 16", 18", and 20".



Product Details

Three available heights to mix and match.

Surface Materials

Table top

- Walnut veneer
- White marble

Base

- Antique brass

Linear C Table (Licensed)

Linear C Table
(Licensed)

Linear C table is a mobile, makeshift workplace that fits under chairs and sofas.

The **Linear C table** has a depth of 13.5", width of 24", and 26.5" height.



Product Details

A steel and natural oak mobile laptop table.

Surface Materials

Top
• Natural oak

Base
• Hot-rolled steel powder coated charcoal

Maisie Side Table (Licensed)

Maisie side table is offered in two heights.

The Maisie short side table has a diameter of 18" and height of 22".



The Maisie tall side table has a diameter of 18" and height of 25".



Product Details

Available in two heights.

Surface Materials

Top

- Walnut
- White marble

Base

- Antique brass

Mesa Coffee Table (Licensed)

Mesa Coffee Table
(Licensed)

Mesa coffee table is designed for any common area.

The Mesa coffee table has a depth of 32" and width of 32". With a height of 12".



Product Details

Table comes with black marble tabletop and burnished bronze legs.

Surface Materials

Top

- Black marble

Legs

- Burnished bronze

Maise Side Table



West Elm—Steelcase

Specifying

Seating

Belle

Lounge Seating **92**

Boardwalk

Lounge Seating **100**

Occasional Tables **107**

Accessories **112**

Brighton

Lounge Seating **114**

Occasional Tables **119**

Power **125**

Mesa

Lounge Seating **126**

Willow

Lounge Seating **132**

Slope

Guest Chairs and Stools **136**

Conference Chair **140**

Stacking Chair **141**

Sterling

Guest Chairs and Stools **142**

Conference Chairs **146**

Lounge **150**

Sterling Health

Guest Chairs **151**

Kent

Conference Chairs **153**

Guest Chairs **157**

Stools **159**

Lucas

Lounge **161**

Fulton

Guest Chair **163**

Lounge Chair **164**

Bench **165**

Furniture

Greenpoint Private Office

Desks and Returns **166**

Modesty Panels **170**

Credenzas **171**

Wood Lateral File **173**

Bookcases **174**

Metal Mobile Pedestal **178**

Basic Cushions Enhanced **179**

Accessories **180**

Power Units **182**

Greenpoint Bench

Worksurfaces and Returns **184**

Legs **197**

Credenzas **203**

Center Screens **205**

Power and Data

Power Supports **206**

Power Trays **208**

Power Covers **209**

Modular Power Blocks **210**

Chicago Hardwire Box **211**

Power and Data Receptacles and Filler Package **212**

Modular Harnesses **214**

Power Infeeds **215**

Bracket Kit **217**

Vertabral Risers **218**

Sutton

Desks **220**

Bases **224**

Accessories **228**

Belle One Seat Lounge

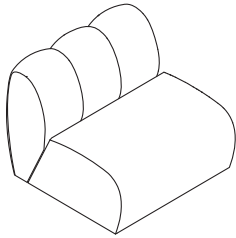

Tip: Contrasting back channels can have contrasting color within the same fabric family. (For example, 59DB Birdseye specified on back channel 1 and 59DB Birdseye specified on back channel 2; both are Birdseye by Designtex.)

Tip: Contrasting seat and back can be from two different fabric families.

Tip: Contrasting back channel fabrics are specified from the right handed seated position.

Standard Includes		Required to Specify	
<ul style="list-style-type: none"> ▶ Need help? Product details, page 16 	<ul style="list-style-type: none"> Fully upholstered non-contrasting lounge: fabric price group 1 Plastic ganging brackets Glides 	<ul style="list-style-type: none"> 1 Style number 2 Fabric color number for lounge 3 Options, if selected (see below) ▶ See <i>Surface Materials</i>, page 242. 	
Color Scheme	Options	U.S. Price	Required to Specify
	<ul style="list-style-type: none"> Non contrasting Contrasting seat and back Contrasting all surfaces 	<ul style="list-style-type: none"> No cost +\$ 181 +\$ 326 	<ul style="list-style-type: none"> Specify <i>with non contrasting</i>. Specify <i>with contrasting seat and back</i>. Specify <i>with contrasting all channels</i>.
Surface Materials	Seat		
	<ul style="list-style-type: none"> Customer's Own Material (COM) Fabric price group 1 Fabric price group 2 Fabric price group 3 Fabric price group 4 Fabric price group 5 Fabric price group 6 Fabric price group 7 Fabric price group 8 Fabric price group 9 Fabric price group 10 	<ul style="list-style-type: none"> No cost No cost +\$ 12 +\$ 65 +\$ 123 +\$ 223 +\$ 330 +\$ 460 +\$ 597 +\$ 735 +\$ 867 	<ul style="list-style-type: none"> ▶ See <i>Surface Materials Reference Manual</i>. Specify fabric color number. Specify fabric color number. Specify fabric color number. Specify fabric color number. Specify fabric color number. Specify fabric color number. Specify fabric color number. Specify fabric color number. Specify fabric color number. Specify fabric color number.
	Back		
	<ul style="list-style-type: none"> Customer's Own Material (COM) Fabric price group 1 Fabric price group 2 Fabric price group 3 Fabric price group 4 Fabric price group 5 Fabric price group 6 Fabric price group 7 Fabric price group 8 Fabric price group 9 Fabric price group 10 	<ul style="list-style-type: none"> No cost No cost +\$ 12 +\$ 102 +\$ 198 +\$ 351 +\$ 522 +\$ 732 +\$ 942 +\$1167 +\$1383 	<ul style="list-style-type: none"> ▶ See <i>Surface Materials Reference Manual</i>. Specify fabric color number. Specify fabric color number. Specify fabric color number. Specify fabric color number. Specify fabric color number. Specify fabric color number. Specify fabric color number. Specify fabric color number. Specify fabric color number. Specify fabric color number.
	Back channel 1		
	<ul style="list-style-type: none"> Customer's Own Material (COM) Fabric price group 1 Fabric price group 2 Fabric price group 3 Fabric price group 4 Fabric price group 5 Fabric price group 6 Fabric price group 7 Fabric price group 8 Fabric price group 9 Fabric price group 10 	<ul style="list-style-type: none"> No cost No cost +\$ 4 +\$ 34 +\$ 66 +\$ 117 +\$ 174 +\$ 244 +\$ 314 +\$ 389 +\$ 461 	<ul style="list-style-type: none"> ▶ See <i>Surface Materials Reference Manual</i>. Specify fabric color number. Specify fabric color number. Specify fabric color number. Specify fabric color number. Specify fabric color number. Specify fabric color number. Specify fabric color number. Specify fabric color number. Specify fabric color number. Specify fabric color number.
	Back channel 2		
	<ul style="list-style-type: none"> Customer's Own Material (COM) Fabric price group 1 Fabric price group 2 Fabric price group 3 Fabric price group 4 Fabric price group 5 Fabric price group 6 Fabric price group 7 Fabric price group 8 Fabric price group 9 Fabric price group 10 	<ul style="list-style-type: none"> No cost No cost +\$ 4 +\$ 34 +\$ 66 +\$ 117 +\$ 174 +\$ 244 +\$ 314 +\$ 389 +\$ 461 	<ul style="list-style-type: none"> ▶ See <i>Surface Materials Reference Manual</i>. Specify fabric color number. Specify fabric color number. Specify fabric color number. Specify fabric color number. Specify fabric color number. Specify fabric color number. Specify fabric color number. Specify fabric color number. Specify fabric color number. Specify fabric color number.

▶ Options, continued on next page



For Canadian Pricing

Multiply U.S. Price by the Canadian price factor.

▶ See page 1 for details.

► Options, continued from previous page

Options	U.S. Price	Required to Specify
Surface Materials, continued		
Back channel 3		► See <i>Surface Materials Reference Manual</i> .
• Customer's Own Material (COM)	No cost	Specify fabric color number.
• Fabric price group 1	No cost	Specify fabric color number.
• Fabric price group 2	+\$ 4	Specify fabric color number.
• Fabric price group 3	+\$ 34	Specify fabric color number.
• Fabric price group 4	+\$ 66	Specify fabric color number.
• Fabric price group 5	+\$117	Specify fabric color number.
• Fabric price group 6	+\$174	Specify fabric color number.
• Fabric price group 7	+\$244	Specify fabric color number.
• Fabric price group 8	+\$314	Specify fabric color number.
• Fabric price group 9	+\$389	Specify fabric color number.
• Fabric price group 10	+\$461	Specify fabric color number.

Specification Information

Style Number	U.S. Base Price
WESBELLNG1	\$3559

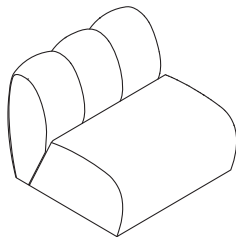

 **For Canadian Pricing**
 Multiply U.S. Price by the Canadian price factor.
 ► See page 1 for details.

Belle Two Seat Lounge

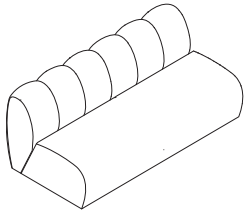

Tip: Contrasting back channels can have contrasting color within the same fabric family. (For example, 59DB Birdseye specified on back channel 1 and 59DB Birdseye specified on back channel 2; both are Birdseye by Designtex.)

Tip: Contrasting seat and back can be from two different fabric families.

Tip: Contrasting back channel fabrics are specified from the right handed seated position.

Standard Includes		Required to Specify	
<ul style="list-style-type: none"> ▶ Need help? Product details, page 16 	<ul style="list-style-type: none"> Fully upholstered non-contrasting lounge: fabric price group 1 Plastic ganging brackets Glides 	<ul style="list-style-type: none"> 1 Style number 2 Fabric color number for lounge 3 Options, if selected (see below) ▶ See <i>Surface Materials</i>, page 242. 	
Options		U.S. Price	Required to Specify
Color Scheme	<ul style="list-style-type: none"> Non contrasting Contrasting seat and back Contrasting all surfaces 	<ul style="list-style-type: none"> No cost +\$ 181 +\$ 919 	<ul style="list-style-type: none"> Specify <i>with non contrasting</i>. Specify <i>with contrasting seat and back</i>. Specify <i>with contrasting all channels</i>.
Surface Materials	Seat	<ul style="list-style-type: none"> Customer's Own Material (COM) No cost Fabric price group 1 No cost Fabric price group 2 +\$ 22 Fabric price group 3 +\$ 95 Fabric price group 4 +\$ 187 Fabric price group 5 +\$ 338 Fabric price group 6 +\$ 495 Fabric price group 7 +\$ 691 Fabric price group 8 +\$ 896 Fabric price group 9 +\$1105 Fabric price group 10 +\$1304 	<ul style="list-style-type: none"> ▶ See <i>Surface Materials Reference Manual</i>. Specify fabric color number. Specify fabric color number. Specify fabric color number. Specify fabric color number. Specify fabric color number. Specify fabric color number. Specify fabric color number. Specify fabric color number. Specify fabric color number. Specify fabric color number.
	Back	<ul style="list-style-type: none"> Customer's Own Material (COM) No cost Fabric price group 1 No cost Fabric price group 2 +\$ 24 Fabric price group 3 +\$ 204 Fabric price group 4 +\$ 396 Fabric price group 5 +\$ 702 Fabric price group 6 +\$1044 Fabric price group 7 +\$1464 Fabric price group 8 +\$1884 Fabric price group 9 +\$2334 Fabric price group 10 +\$2766 	<ul style="list-style-type: none"> ▶ See <i>Surface Materials Reference Manual</i>. Specify fabric color number. Specify fabric color number. Specify fabric color number. Specify fabric color number. Specify fabric color number. Specify fabric color number. Specify fabric color number. Specify fabric color number. Specify fabric color number. Specify fabric color number.
	Back channel 1	<ul style="list-style-type: none"> Customer's Own Material (COM) No cost Fabric price group 1 No cost Fabric price group 2 +\$ 4 Fabric price group 3 +\$ 34 Fabric price group 4 +\$ 66 Fabric price group 5 +\$ 117 Fabric price group 6 +\$ 174 Fabric price group 7 +\$ 244 Fabric price group 8 +\$ 314 Fabric price group 9 +\$ 389 Fabric price group 10 +\$ 461 	<ul style="list-style-type: none"> ▶ See <i>Surface Materials Reference Manual</i>. Specify fabric color number. Specify fabric color number. Specify fabric color number. Specify fabric color number. Specify fabric color number. Specify fabric color number. Specify fabric color number. Specify fabric color number. Specify fabric color number. Specify fabric color number.
	Back channel 2	<ul style="list-style-type: none"> Customer's Own Material (COM) No cost Fabric price group 1 No cost Fabric price group 2 +\$ 4 Fabric price group 3 +\$ 34 Fabric price group 4 +\$ 66 Fabric price group 5 +\$ 117 Fabric price group 6 +\$ 174 Fabric price group 7 +\$ 244 Fabric price group 8 +\$ 314 Fabric price group 9 +\$ 389 Fabric price group 10 +\$ 461 	<ul style="list-style-type: none"> ▶ See <i>Surface Materials Reference Manual</i>. Specify fabric color number. Specify fabric color number. Specify fabric color number. Specify fabric color number. Specify fabric color number. Specify fabric color number. Specify fabric color number. Specify fabric color number. Specify fabric color number. Specify fabric color number.

▶ Options, continued on next page



For Canadian Pricing

Multiply U.S. Price by the Canadian price factor.

▶ See page 1 for details.

► Options, continued from previous page

Options	U.S. Price	Required to Specify
Surface Materials, continued		
Back channel 3		
• Customer's Own Material (COM)	No cost	► See <i>Surface Materials Reference Manual</i> . Specify fabric color number.
• Fabric price group 1	No cost	
• Fabric price group 2	+\$ 4	
• Fabric price group 3	+\$ 34	
• Fabric price group 4	+\$ 66	
• Fabric price group 5	+\$117	
• Fabric price group 6	+\$174	
• Fabric price group 7	+\$244	
• Fabric price group 8	+\$314	
• Fabric price group 9	+\$389	
• Fabric price group 10	+\$461	
Back channel 4		
• Customer's Own Material (COM)	No cost	► See <i>Surface Materials Reference Manual</i> . Specify fabric color number.
• Fabric price group 1	No cost	
• Fabric price group 2	+\$ 4	
• Fabric price group 3	+\$ 34	
• Fabric price group 4	+\$ 66	
• Fabric price group 5	+\$117	
• Fabric price group 6	+\$174	
• Fabric price group 7	+\$244	
• Fabric price group 8	+\$314	
• Fabric price group 9	+\$389	
• Fabric price group 10	+\$461	
Back channel 5		
• Customer's Own Material (COM)	No cost	► See <i>Surface Materials Reference Manual</i> . Specify fabric color number.
• Fabric price group 1	No cost	
• Fabric price group 2	+\$ 4	
• Fabric price group 3	+\$ 34	
• Fabric price group 4	+\$ 66	
• Fabric price group 5	+\$117	
• Fabric price group 6	+\$174	
• Fabric price group 7	+\$244	
• Fabric price group 8	+\$314	
• Fabric price group 9	+\$389	
• Fabric price group 10	+\$461	
Back channel 6		
• Customer's Own Material (COM)	No cost	► See <i>Surface Materials Reference Manual</i> . Specify fabric color number.
• Fabric price group 1	No cost	
• Fabric price group 2	+\$ 4	
• Fabric price group 3	+\$ 34	
• Fabric price group 4	+\$ 66	
• Fabric price group 5	+\$117	
• Fabric price group 6	+\$174	
• Fabric price group 7	+\$244	
• Fabric price group 8	+\$314	
• Fabric price group 9	+\$389	
• Fabric price group 10	+\$461	



Specification Information

Style Number	U.S. Base Price
WESBELLNG2	\$6234

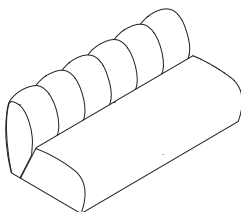

Belle Corner Lounge

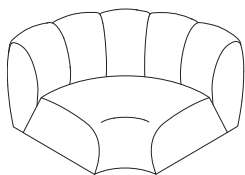

Tip: Contrasting back channels can have contrasting color within the same fabric family. (For example, 59DB Birdseye specified on back channel 1 and 59DB Birdseye specified on back channel 2; both are Birdseye by DesignTex.)

Tip: Contrasting seat and back can be from two different fabric families.

Tip: Contrasting back channel fabrics are specified from the right handed seated position.

Standard Includes		Required to Specify
▶ Need help? Product details, page 16	<ul style="list-style-type: none"> Fully upholstered non-contrasting lounge: fabric price group 1 Plastic ganging brackets Glides 	1 Style number 2 Fabric color number for lounge 3 Options, if selected (see below) ▶ See <i>Surface Materials</i> , page 242.

Options	U.S. Price	Required to Specify																										
Color Scheme	<ul style="list-style-type: none"> Non contrasting No cost Contrasting seat and back +\$ 181 Contrasting all surfaces +\$ 592 	Specify <i>with non contrasting</i> . Specify <i>with contrasting seat and back</i> . Specify <i>with contrasting all channels</i> .																										
Surface Materials	<table border="0"> <tr> <td>Seat</td> <td></td> <td></td> </tr> <tr> <td>• Customer's Own Material (COM)</td> <td>No cost</td> <td rowspan="10">▶ See <i>Surface Materials Reference Manual</i>. Specify fabric color number.</td> </tr> <tr> <td>• Fabric price group 1</td> <td>No cost</td> </tr> <tr> <td>• Fabric price group 2</td> <td>+\$ 13</td> </tr> <tr> <td>• Fabric price group 3</td> <td>+\$ 75</td> </tr> <tr> <td>• Fabric price group 4</td> <td>+\$ 145</td> </tr> <tr> <td>• Fabric price group 5</td> <td>+\$ 257</td> </tr> <tr> <td>• Fabric price group 6</td> <td>+\$ 381</td> </tr> <tr> <td>• Fabric price group 7</td> <td>+\$ 528</td> </tr> <tr> <td>• Fabric price group 8</td> <td>+\$ 687</td> </tr> <tr> <td>• Fabric price group 9</td> <td>+\$ 848</td> </tr> <tr> <td>• Fabric price group 10</td> <td>+\$ 999</td> </tr> </table>	Seat			• Customer's Own Material (COM)	No cost	▶ See <i>Surface Materials Reference Manual</i> . Specify fabric color number.	• Fabric price group 1	No cost	• Fabric price group 2	+\$ 13	• Fabric price group 3	+\$ 75	• Fabric price group 4	+\$ 145	• Fabric price group 5	+\$ 257	• Fabric price group 6	+\$ 381	• Fabric price group 7	+\$ 528	• Fabric price group 8	+\$ 687	• Fabric price group 9	+\$ 848	• Fabric price group 10	+\$ 999	
Seat																												
• Customer's Own Material (COM)	No cost	▶ See <i>Surface Materials Reference Manual</i> . Specify fabric color number.																										
• Fabric price group 1	No cost																											
• Fabric price group 2	+\$ 13																											
• Fabric price group 3	+\$ 75																											
• Fabric price group 4	+\$ 145																											
• Fabric price group 5	+\$ 257																											
• Fabric price group 6	+\$ 381																											
• Fabric price group 7	+\$ 528																											
• Fabric price group 8	+\$ 687																											
• Fabric price group 9	+\$ 848																											
• Fabric price group 10	+\$ 999																											
	<table border="0"> <tr> <td>Back</td> <td></td> <td></td> </tr> <tr> <td>• Customer's Own Material (COM)</td> <td>No cost</td> <td rowspan="10">▶ See <i>Surface Materials Reference Manual</i>. Specify fabric color number.</td> </tr> <tr> <td>• Fabric price group 1</td> <td>No cost</td> </tr> <tr> <td>• Fabric price group 2</td> <td>+\$ 20</td> </tr> <tr> <td>• Fabric price group 3</td> <td>+\$ 170</td> </tr> <tr> <td>• Fabric price group 4</td> <td>+\$ 330</td> </tr> <tr> <td>• Fabric price group 5</td> <td>+\$ 585</td> </tr> <tr> <td>• Fabric price group 6</td> <td>+\$ 870</td> </tr> <tr> <td>• Fabric price group 7</td> <td>+\$1220</td> </tr> <tr> <td>• Fabric price group 8</td> <td>+\$1570</td> </tr> <tr> <td>• Fabric price group 9</td> <td>+\$1945</td> </tr> <tr> <td>• Fabric price group 10</td> <td>+\$2305</td> </tr> </table>	Back			• Customer's Own Material (COM)	No cost	▶ See <i>Surface Materials Reference Manual</i> . Specify fabric color number.	• Fabric price group 1	No cost	• Fabric price group 2	+\$ 20	• Fabric price group 3	+\$ 170	• Fabric price group 4	+\$ 330	• Fabric price group 5	+\$ 585	• Fabric price group 6	+\$ 870	• Fabric price group 7	+\$1220	• Fabric price group 8	+\$1570	• Fabric price group 9	+\$1945	• Fabric price group 10	+\$2305	
Back																												
• Customer's Own Material (COM)	No cost	▶ See <i>Surface Materials Reference Manual</i> . Specify fabric color number.																										
• Fabric price group 1	No cost																											
• Fabric price group 2	+\$ 20																											
• Fabric price group 3	+\$ 170																											
• Fabric price group 4	+\$ 330																											
• Fabric price group 5	+\$ 585																											
• Fabric price group 6	+\$ 870																											
• Fabric price group 7	+\$1220																											
• Fabric price group 8	+\$1570																											
• Fabric price group 9	+\$1945																											
• Fabric price group 10	+\$2305																											
	<table border="0"> <tr> <td>Back channel 1</td> <td></td> <td></td> </tr> <tr> <td>• Customer's Own Material (COM)</td> <td>No cost</td> <td rowspan="10">▶ See <i>Surface Materials Reference Manual</i>. Specify fabric color number.</td> </tr> <tr> <td>• Fabric price group 1</td> <td>No cost</td> </tr> <tr> <td>• Fabric price group 2</td> <td>+\$ 4</td> </tr> <tr> <td>• Fabric price group 3</td> <td>+\$ 34</td> </tr> <tr> <td>• Fabric price group 4</td> <td>+\$ 66</td> </tr> <tr> <td>• Fabric price group 5</td> <td>+\$ 117</td> </tr> <tr> <td>• Fabric price group 6</td> <td>+\$ 174</td> </tr> <tr> <td>• Fabric price group 7</td> <td>+\$ 244</td> </tr> <tr> <td>• Fabric price group 8</td> <td>+\$ 314</td> </tr> <tr> <td>• Fabric price group 9</td> <td>+\$ 389</td> </tr> <tr> <td>• Fabric price group 10</td> <td>+\$ 461</td> </tr> </table>	Back channel 1			• Customer's Own Material (COM)	No cost	▶ See <i>Surface Materials Reference Manual</i> . Specify fabric color number.	• Fabric price group 1	No cost	• Fabric price group 2	+\$ 4	• Fabric price group 3	+\$ 34	• Fabric price group 4	+\$ 66	• Fabric price group 5	+\$ 117	• Fabric price group 6	+\$ 174	• Fabric price group 7	+\$ 244	• Fabric price group 8	+\$ 314	• Fabric price group 9	+\$ 389	• Fabric price group 10	+\$ 461	
Back channel 1																												
• Customer's Own Material (COM)	No cost	▶ See <i>Surface Materials Reference Manual</i> . Specify fabric color number.																										
• Fabric price group 1	No cost																											
• Fabric price group 2	+\$ 4																											
• Fabric price group 3	+\$ 34																											
• Fabric price group 4	+\$ 66																											
• Fabric price group 5	+\$ 117																											
• Fabric price group 6	+\$ 174																											
• Fabric price group 7	+\$ 244																											
• Fabric price group 8	+\$ 314																											
• Fabric price group 9	+\$ 389																											
• Fabric price group 10	+\$ 461																											
	<table border="0"> <tr> <td>Back channel 2</td> <td></td> <td></td> </tr> <tr> <td>• Customer's Own Material (COM)</td> <td>No cost</td> <td rowspan="10">▶ See <i>Surface Materials Reference Manual</i>. Specify fabric color number.</td> </tr> <tr> <td>• Fabric price group 1</td> <td>No cost</td> </tr> <tr> <td>• Fabric price group 2</td> <td>+\$ 4</td> </tr> <tr> <td>• Fabric price group 3</td> <td>+\$ 34</td> </tr> <tr> <td>• Fabric price group 4</td> <td>+\$ 66</td> </tr> <tr> <td>• Fabric price group 5</td> <td>+\$ 117</td> </tr> <tr> <td>• Fabric price group 6</td> <td>+\$ 174</td> </tr> <tr> <td>• Fabric price group 7</td> <td>+\$ 244</td> </tr> <tr> <td>• Fabric price group 8</td> <td>+\$ 314</td> </tr> <tr> <td>• Fabric price group 9</td> <td>+\$ 389</td> </tr> <tr> <td>• Fabric price group 10</td> <td>+\$ 461</td> </tr> </table>	Back channel 2			• Customer's Own Material (COM)	No cost	▶ See <i>Surface Materials Reference Manual</i> . Specify fabric color number.	• Fabric price group 1	No cost	• Fabric price group 2	+\$ 4	• Fabric price group 3	+\$ 34	• Fabric price group 4	+\$ 66	• Fabric price group 5	+\$ 117	• Fabric price group 6	+\$ 174	• Fabric price group 7	+\$ 244	• Fabric price group 8	+\$ 314	• Fabric price group 9	+\$ 389	• Fabric price group 10	+\$ 461	
Back channel 2																												
• Customer's Own Material (COM)	No cost	▶ See <i>Surface Materials Reference Manual</i> . Specify fabric color number.																										
• Fabric price group 1	No cost																											
• Fabric price group 2	+\$ 4																											
• Fabric price group 3	+\$ 34																											
• Fabric price group 4	+\$ 66																											
• Fabric price group 5	+\$ 117																											
• Fabric price group 6	+\$ 174																											
• Fabric price group 7	+\$ 244																											
• Fabric price group 8	+\$ 314																											
• Fabric price group 9	+\$ 389																											
• Fabric price group 10	+\$ 461																											

▶ Options, continued on next page



For Canadian Pricing

Multiply U.S. Price by the Canadian price factor.

▶ See page 1 for details.

► Options, continued from previous page

	Options	U.S. Price	Required to Specify
Surface Materials, continued	Back channel 3		
	• Customer's Own Material (COM)	No cost	► See <i>Surface Materials Reference Manual</i> . Specify fabric color number.
	• Fabric price group 1	No cost	Specify fabric color number.
	• Fabric price group 2	+\$ 4	Specify fabric color number.
	• Fabric price group 3	+\$ 34	Specify fabric color number.
	• Fabric price group 4	+\$ 66	Specify fabric color number.
	• Fabric price group 5	+\$117	Specify fabric color number.
	• Fabric price group 6	+\$174	Specify fabric color number.
	• Fabric price group 7	+\$244	Specify fabric color number.
	• Fabric price group 8	+\$314	Specify fabric color number.
	• Fabric price group 9	+\$389	Specify fabric color number.
• Fabric price group 10	+\$461	Specify fabric color number.	
	Back channel 4		
	• Customer's Own Material (COM)	No cost	► See <i>Surface Materials Reference Manual</i> . Specify fabric color number.
	• Fabric price group 1	No cost	Specify fabric color number.
	• Fabric price group 2	+\$ 4	Specify fabric color number.
	• Fabric price group 3	+\$ 34	Specify fabric color number.
	• Fabric price group 4	+\$ 66	Specify fabric color number.
	• Fabric price group 5	+\$117	Specify fabric color number.
	• Fabric price group 6	+\$174	Specify fabric color number.
	• Fabric price group 7	+\$244	Specify fabric color number.
	• Fabric price group 8	+\$314	Specify fabric color number.
	• Fabric price group 9	+\$389	Specify fabric color number.
• Fabric price group 10	+\$461	Specify fabric color number.	
	Back channel 5		
	• Customer's Own Material (COM)	No cost	► See <i>Surface Materials Reference Manual</i> . Specify fabric color number.
	• Fabric price group 1	No cost	Specify fabric color number.
	• Fabric price group 2	+\$ 4	Specify fabric color number.
	• Fabric price group 3	+\$ 34	Specify fabric color number.
	• Fabric price group 4	+\$ 66	Specify fabric color number.
	• Fabric price group 5	+\$117	Specify fabric color number.
	• Fabric price group 6	+\$174	Specify fabric color number.
	• Fabric price group 7	+\$244	Specify fabric color number.
	• Fabric price group 8	+\$314	Specify fabric color number.
	• Fabric price group 9	+\$389	Specify fabric color number.
• Fabric price group 10	+\$461	Specify fabric color number.	

Specification Information

• Style Number	• U.S. Base Price
WESBELC	\$4809

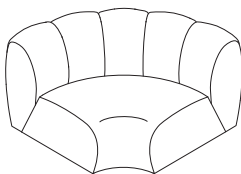

 **For Canadian Pricing**
Multiply U.S. Price by the Canadian price factor.
► See page 1 for details.

Belle Ottoman

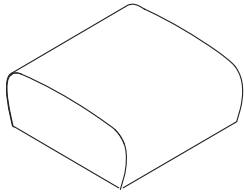

	Standard Includes	Required to Specify
▶ Need help? Product details, page 16	<ul style="list-style-type: none"> Fully upholstered ottoman: fabric price group 1 Plastic ganging brackets Glides 	1 Style number 2 Fabric color number for ottoman 3 Options, if selected (see below) ▶ See <i>Surface Materials</i> , page 242.

	Options	U.S. Price	Required to Specify
Surface Materials	<ul style="list-style-type: none"> Customer's Own Material (COM) Fabric price group 1 Fabric price group 2 Fabric price group 3 Fabric price group 4 Fabric price group 5 Fabric price group 6 Fabric price group 7 Fabric price group 8 Fabric price group 9 Fabric price group 10 	No cost No cost +\$ 24 +\$ 104 +\$ 202 +\$ 359 +\$ 528 +\$ 737 +\$ 955 +\$1175 +\$1389	▶ See <i>Surface Materials Reference Manual</i> . Specify fabric color number. Specify fabric color number. Specify fabric color number. Specify fabric color number. Specify fabric color number. Specify fabric color number. Specify fabric color number. Specify fabric color number. Specify fabric color number.

Specification Information	
• Style Number	• U.S. Base Price
WESBELO	\$2076
.	.
.	.



For Canadian Pricing
 Multiply U.S. Price by the Canadian price factor.
 ▶ See page 1 for details.



Boardwalk One Seat Lounge

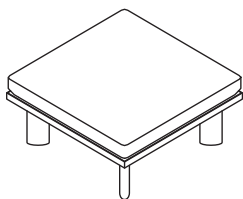

Tip: To gang Boardwalk lounge seating order gang-ing kit **TS31410**.

Standard Includes	Required to Specify
<ul style="list-style-type: none"> ▶ Need help? Product details, page 20 • Modular platform: High-Pressure Laminate price group 1 with 3 mm plastic edge • Fully upholstered cushion, if selected: fabric price group 1 • Legs: veneer price group 1 • Leg brackets: paint • Requires assembly 	<ol style="list-style-type: none"> 1 Style number 2 High-Pressure Laminate color number for platform 3 Veneer color number for legs 4 Plastic color number for edge 5 Paint color number for leg brackets 6 Fabric color number for cushion, if selected 7 Options, if selected (see below) <p>▶ See <i>Surface Materials</i>, page 242.</p>

Options	U.S. Price	Required to Specify
Cushion		
• Seat	+\$ 744	Specify <i>with seat cushion</i> .
• Mid back	+\$1412	Specify <i>with mid back cushion</i> .
• Left corner	+\$1926	Specify <i>with left corner cushion</i> .
• Right corner	+\$1926	Specify <i>with right corner cushion</i> .
Surface Materials		
Platform		
• High-Pressure Laminate price group 1	No cost	Specify laminate color number.
• Customiz stain	No cost	Specify <i>with Customiz stain</i> . ▶ See <i>Surface Materials Reference Manual</i> .
• High-Pressure Laminate price group 2	+\$ 165	Specify laminate color number.
• Composite veneer price group 1	+\$ 651	Specify wood color number.
• Composite veneer price group 2	+\$ 787	Specify wood color number.
• Veneer price group 1	+\$ 716	Specify wood color number.
• Open Line laminate	+\$ 111 plus cost of laminate	▶ See <i>Surface Materials Reference Manual</i> .
Leg		
• Customiz stain	No cost	Specify <i>with Customiz stain</i> . ▶ See <i>Surface Materials Reference Manual</i> .
• Veneer price group 1	No cost	Specify wood color number.

Cushion

	Options (Add \$ to Base Price)		
	Seat	Mid Back	Left or Right Corner
Fabric Price Group 1	No cost	No cost	No cost
Fabric Price Group 2	+\$ 8	+\$ 17	+\$ 22
Vinyl Price Group 2	+\$ 8	+\$ 17	+\$ 22
Fabric Price Group 3	+\$ 50	+\$ 81	+\$ 95
Fabric Price Group 4	+\$ 94	+\$ 156	+\$ 187
Fabric Price Group 5	+\$211	+\$ 346	+\$ 417
Fabric Price Group 6	+\$250	+\$ 411	+\$ 495
Fabric Price Group 7	+\$345	+\$ 575	+\$ 691
Fabric Price Group 8	+\$448	+\$ 747	+\$ 896
Fabric Price Group 9	+\$532	+\$ 887	+\$1062
Fabric Price Group 10	+\$650	+\$1083	+\$1304
COM	No cost	No cost	No cost
COL	+\$214	+\$ 214	+\$ 214
Leather Price Group 1	+\$712	+\$1187	+\$1519
Leather Price Group 2	+\$878	+\$1459	+\$1869



For Canadian Pricing
Multiply U.S. Price by the Canadian price factor.
▶ See page 1 for details.

Specification Information

Style Number	U.S. Base Price
WESHTSLNG1	\$1340

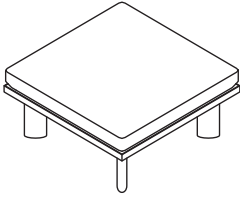

For Canadian Pricing

Multiply U.S. Price by the Canadian price factor.

▶ See page 1 for details.

Boardwalk Two Seat Lounge

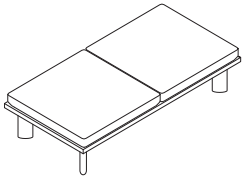

Tip: To gang Boardwalk lounge seating order ganging kit **TS31410**.

Standard Includes		Required to Specify
<ul style="list-style-type: none"> ▶ Need help? Product details, page 20 	<ul style="list-style-type: none"> • Modular platform: High-Pressure Laminate price group 1 with 3 mm plastic edge • Fully upholstered cushion, if selected: fabric price group 1 • Legs: veneer price group 1 • Leg brackets: paint • Requires assembly 	<ol style="list-style-type: none"> 1 Style number 2 High-Pressure Laminate color number for platform 3 Veneer color number for legs 4 Plastic color number for edge 5 Paint color number for leg brackets 6 Fabric color number for cushion, if selected 7 Options, if selected (see below) <p>▶ See <i>Surface Materials</i>, page 242.</p>

Options	U.S. Price	Required to Specify	
Right Position <ul style="list-style-type: none"> • No cushion • Seat • Mid back • Left corner • Right corner 	<ul style="list-style-type: none"> No cost +\$ 744 +\$1412 +\$1926 +\$1926 	<ul style="list-style-type: none"> Specify <i>with no cushion</i>. Specify <i>with seat cushion</i>. Specify <i>with mid back cushion</i>. Specify <i>with left corner cushion</i>. Specify <i>with right corner cushion</i>. 	
Left Position <ul style="list-style-type: none"> • No cushion • Seat • Mid back • Left corner • Right corner 	<ul style="list-style-type: none"> No cost +\$ 744 +\$1412 +\$1926 +\$1926 	<ul style="list-style-type: none"> Specify <i>with no cushion</i>. Specify <i>with seat cushion</i>. Specify <i>with mid back cushion</i>. Specify <i>with left corner cushion</i>. Specify <i>with right corner cushion</i>. 	
Surface Materials	Platform <ul style="list-style-type: none"> • High-Pressure Laminate price group 1 • Customiz stain • High-Pressure Laminate price group 2 • Composite veneer price group 1 • Composite veneer price group 2 • Veneer price group 1 • Open Line laminate 	<ul style="list-style-type: none"> No cost No cost +\$ 178 +\$ 781 +\$ 956 +\$ 859 +\$ 111 plus cost of laminate 	<ul style="list-style-type: none"> Specify laminate color number. Specify <i>with Customiz stain</i>. ▶ See <i>Surface Materials Reference Manual</i>. Specify laminate color number. Specify wood color number. Specify wood color number. Specify wood color number. ▶ See <i>Surface Materials Reference Manual</i>.
	Leg <ul style="list-style-type: none"> • Customiz stain • Veneer price group 1 	<ul style="list-style-type: none"> No cost No cost 	<ul style="list-style-type: none"> Specify <i>with Customiz stain</i>. ▶ See <i>Surface Materials Reference Manual</i>. Specify wood color number.

▶ Options, continued on next page



For Canadian Pricing

Multiply U.S. Price by the Canadian price factor.

▶ See page 1 for details.

► Options, continued from previous page

Cushion—Right Position

	Options (Add \$ to Base Price)		
	Seat	Mid Back	Left or Right Corner
Fabric Price Group 1	No cost	No cost	No cost
Fabric Price Group 2	+\$ 8	+\$ 17	+\$ 22
Vinyl Price Group 2	+\$ 8	+\$ 17	+\$ 22
Fabric Price Group 3	+\$ 50	+\$ 81	+\$ 95
Fabric Price Group 4	+\$ 94	+\$ 156	+\$ 187
Fabric Price Group 5	+\$211	+\$ 346	+\$ 417
Fabric Price Group 6	+\$250	+\$ 411	+\$ 495
Fabric Price Group 7	+\$345	+\$ 575	+\$ 691
Fabric Price Group 8	+\$448	+\$ 747	+\$ 896
Fabric Price Group 9	+\$532	+\$ 887	+\$1062
Fabric Price Group 10	+\$650	+\$1083	+\$1304
COM	No cost	No cost	No cost
COL	+\$214	+\$ 214	+\$ 214
Leather Price Group 1	+\$712	+\$1187	+\$1519
Leather Price Group 2	+\$878	+\$1459	+\$1869

Cushion—Left Position

Fabric Price Group 1	No cost	No cost	No cost
Fabric Price Group 2	+\$ 8	+\$ 17	+\$ 22
Vinyl Price Group 2	+\$ 8	+\$ 17	+\$ 22
Fabric Price Group 3	+\$ 50	+\$ 81	+\$ 95
Fabric Price Group 4	+\$ 94	+\$ 156	+\$ 187
Fabric Price Group 5	+\$211	+\$ 346	+\$ 417
Fabric Price Group 6	+\$250	+\$ 411	+\$ 495
Fabric Price Group 7	+\$345	+\$ 575	+\$ 691
Fabric Price Group 8	+\$448	+\$ 747	+\$ 896
Fabric Price Group 9	+\$532	+\$ 887	+\$1062
Fabric Price Group 10	+\$650	+\$1083	+\$1304
COM	No cost	No cost	No cost
COL	+\$214	+\$ 214	+\$ 214
Leather Price Group 1	+\$712	+\$1187	+\$1519
Leather Price Group 2	+\$878	+\$1459	+\$1869

Specification Information

• Style Number	• U.S. Base Price
WESHTSLNG2	\$1842

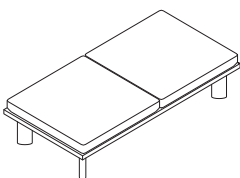

Boardwalk Three Seat Lounge

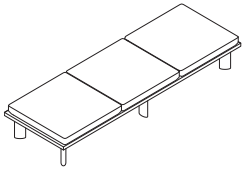

Tip: To gang Boardwalk lounge seating order ganging kit **TS31410**.

	Standard Includes	Required to Specify
▶ Need help? Product details, page 20	<ul style="list-style-type: none"> Modular platform: High-Pressure Laminate price group 1 with 3 mm plastic edge Fully upholstered cushion, if selected: fabric price group 1 Legs: veneer price group 1 Leg brackets: paint Requires assembly 	<ol style="list-style-type: none"> Style number High-Pressure Laminate color number for platform Veneer color number for legs Plastic color number for edge Paint color number for leg brackets Fabric color number for cushion, if selected Options, if selected (see below) <p>▶ See <i>Surface Materials</i>, page 242.</p>

	Options	U.S. Price	Required to Specify
Right Position	<ul style="list-style-type: none"> No cushion Seat Mid back Left corner Right corner 	<ul style="list-style-type: none"> No cost +\$ 744 +\$1412 +\$1926 +\$1926 	<ul style="list-style-type: none"> Specify <i>with no cushion</i>. Specify <i>with seat cushion</i>. Specify <i>with mid back cushion</i>. Specify <i>with left corner cushion</i>. Specify <i>with right corner cushion</i>.
Center Position	<ul style="list-style-type: none"> No cushion Seat Mid back Left corner Right corner 	<ul style="list-style-type: none"> No cost +\$ 744 +\$1412 +\$1926 +\$1926 	<ul style="list-style-type: none"> Specify <i>with no cushion</i>. Specify <i>with seat cushion</i>. Specify <i>with mid back cushion</i>. Specify <i>with left corner cushion</i>. Specify <i>with right corner cushion</i>.
Left Position	<ul style="list-style-type: none"> No cushion Seat Mid back Left corner Right corner 	<ul style="list-style-type: none"> No cost +\$ 744 +\$1412 +\$1926 +\$1926 	<ul style="list-style-type: none"> Specify <i>with no cushion</i>. Specify <i>with seat cushion</i>. Specify <i>with mid back cushion</i>. Specify <i>with left corner cushion</i>. Specify <i>with right corner cushion</i>.
Surface Materials	<p>Platform</p> <ul style="list-style-type: none"> High-Pressure Laminate price group 1 Customiz stain High-Pressure Laminate price group 2 Composite veneer price group 1 Composite veneer price group 2 Veneer price group 1 Open Line laminate <p>Leg</p> <ul style="list-style-type: none"> Customiz stain Veneer price group 1 	<ul style="list-style-type: none"> No cost No cost +\$ 195 +\$ 976 +\$1189 +\$1074 +\$ 111 plus cost of laminate No cost No cost 	<ul style="list-style-type: none"> Specify laminate color number. Specify <i>with Customiz stain</i>. ▶ See <i>Surface Materials Reference Manual</i>. Specify laminate color number. Specify wood color number. Specify wood color number. Specify wood color number. ▶ See <i>Surface Materials Reference Manual</i>. Specify <i>with Customiz stain</i>. ▶ See <i>Surface Materials Reference Manual</i>. Specify wood color number.

▶ Options, continued on next page



For Canadian Pricing

Multiply U.S. Price by the Canadian price factor.

▶ See page 1 for details.

► Options, continued from previous page

Cushion—Right Position

	Options (Add \$ to Base Price)		
	Seat	Mid Back	Left or Right Corner
Fabric Price Group 1	No cost	No cost	No cost
Fabric Price Group 2	+\$ 8	+\$ 17	+\$ 22
Vinyl Price Group 2	+\$ 8	+\$ 17	+\$ 22
Fabric Price Group 3	+\$ 50	+\$ 81	+\$ 95
Fabric Price Group 4	+\$ 94	+\$ 156	+\$ 187
Fabric Price Group 5	+\$211	+\$ 346	+\$ 417
Fabric Price Group 6	+\$250	+\$ 411	+\$ 495
Fabric Price Group 7	+\$345	+\$ 575	+\$ 691
Fabric Price Group 8	+\$448	+\$ 747	+\$ 896
Fabric Price Group 9	+\$532	+\$ 887	+\$1062
Fabric Price Group 10	+\$650	+\$1083	+\$1304
COM	No cost	No cost	No cost
COL	+\$214	+\$ 214	+\$ 214
Leather Price Group 1	+\$712	+\$1187	+\$1519
Leather Price Group 2	+\$878	+\$1459	+\$1869

Cushion—Center Position

Fabric Price Group 1	No cost	No cost	No cost
Fabric Price Group 2	+\$ 8	+\$ 17	+\$ 22
Vinyl Price Group 2	+\$ 8	+\$ 17	+\$ 22
Fabric Price Group 3	+\$ 50	+\$ 81	+\$ 95
Fabric Price Group 4	+\$ 94	+\$ 156	+\$ 187
Fabric Price Group 5	+\$211	+\$ 346	+\$ 417
Fabric Price Group 6	+\$250	+\$ 411	+\$ 495
Fabric Price Group 7	+\$345	+\$ 575	+\$ 691
Fabric Price Group 8	+\$448	+\$ 747	+\$ 896
Fabric Price Group 9	+\$532	+\$ 887	+\$1062
Fabric Price Group 10	+\$650	+\$1083	+\$1304
COM	No cost	No cost	No cost
COL	+\$214	+\$ 214	+\$ 214
Leather Price Group 1	+\$712	+\$1187	+\$1519
Leather Price Group 2	+\$878	+\$1459	+\$1869

► Options, continued on next page

**For Canadian Pricing**

Multiply U.S. Price by the
Canadian price factor.

► See page 1 for details.

► **Options, continued from previous page**

Cushion—Left Position

	Options (Add \$ to Base Price)		
	Seat	Mid Back	Left or Right Corner
Fabric Price Group 1	No cost	No cost	No cost
Fabric Price Group 2	+\$ 8	+\$ 17	+\$ 22
Vinyl Price Group 2	+\$ 8	+\$ 17	+\$ 22
Fabric Price Group 3	+\$ 50	+\$ 81	+\$ 95
Fabric Price Group 4	+\$ 94	+\$ 156	+\$ 187
Fabric Price Group 5	+\$211	+\$ 346	+\$ 417
Fabric Price Group 6	+\$250	+\$ 411	+\$ 495
Fabric Price Group 7	+\$345	+\$ 575	+\$ 691
Fabric Price Group 8	+\$448	+\$ 747	+\$ 896
Fabric Price Group 9	+\$532	+\$ 887	+\$1062
Fabric Price Group 10	+\$650	+\$1083	+\$1304
COM	No cost	No cost	No cost
COL	+\$214	+\$ 214	+\$ 214
Leather Price Group 1	+\$712	+\$1187	+\$1519
Leather Price Group 2	+\$878	+\$1459	+\$1869

Specification Information

Style Number	U.S. Base Price
WESHTSLNG3	\$2343

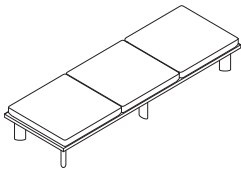

For Canadian Pricing
 Multiply U.S. Price by the
 Canadian price factor.
 ► See page 1 for details.

Boardwalk 30"D x 30"W Square Table

Boardwalk 30"D x 30"W
Square Table

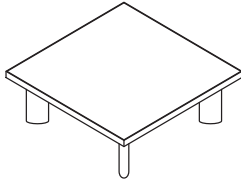

Tip: To gang Boardwalk lounge seating order ganging kit **TS31410**.

Standard Includes		Required to Specify
<ul style="list-style-type: none"> ▶ Need help? Product details, page 20 	<ul style="list-style-type: none"> • Table: High-Pressure Laminate price group 1 with 3 mm plastic edge • Legs: veneer price group 1 • Leg brackets: paint • Requires assembly 	<ol style="list-style-type: none"> 1 Style number 2 High-Pressure Laminate color number for platform 3 Veneer color number for legs 4 Plastic color number for edge 5 Paint color number for leg brackets 6 Options, if selected (see below) <ul style="list-style-type: none"> ▶ See <i>Surface Materials</i>, page 242.

Options	U.S. Price	Required to Specify
Table Height	<ul style="list-style-type: none"> • 11" No cost • 15" +\$ 56 	<ul style="list-style-type: none"> Specify with 11"H table. Specify with 15"H table.
Surface Materials	<p>Platform</p> <ul style="list-style-type: none"> • High-Pressure Laminate price group 1 No cost • Customiz stain No cost • High-Pressure Laminate price group 2 +\$165 • Composite veneer price group 1 +\$651 • Composite veneer price group 2 +\$787 • Veneer price group 1 +\$716 • Open Line laminate +\$111 plus cost of laminate <p>Leg</p> <ul style="list-style-type: none"> • Customiz stain No cost • Veneer price group 1 No cost 	<ul style="list-style-type: none"> Specify laminate color number. Specify with Customiz stain. ▶ See <i>Surface Materials Reference Manual</i>. Specify laminate color number. Specify wood color number. Specify wood color number. Specify wood color number. ▶ See <i>Surface Materials Reference Manual</i>. Specify with Customiz stain. ▶ See <i>Surface Materials Reference Manual</i>. Specify wood color number.

Specification Information	
Style Number	U.S. Base Price
WESHTSTBL30	\$1649

Boardwalk

 **For Canadian Pricing**
Multiply U.S. Price by the Canadian price factor.
▶ See page 1 for details.

Boardwalk Boardwalk 30"D x 60"W Rectangle Table

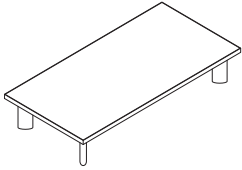

Tip: To gang Boardwalk lounge seating order ganging kit **TS31410**.

	Standard Includes	Required to Specify
▶ Need help? Product details, page 20	<ul style="list-style-type: none"> Table: High-Pressure Laminate price group 1 with 3 mm plastic edge Legs: veneer price group 1 Leg brackets: paint Requires assembly 	<ol style="list-style-type: none"> Style number High-Pressure Laminate color number for platform Veneer color number for legs Plastic color number for edge Paint color number for leg brackets Options, if selected (see below) <p>▶ See <i>Surface Materials</i>, page 242.</p>

	Options	U.S. Price	Required to Specify
Table Height	<ul style="list-style-type: none"> 11" 15" 	<p>No cost</p> <p>+\$ 56</p>	<p>Specify with 11"H table.</p> <p>Specify with 15"H table.</p>
Surface Materials	<p>Platform</p> <ul style="list-style-type: none"> High-Pressure Laminate price group 1 Customiz stain <p>High-Pressure Laminate price group 2</p> <ul style="list-style-type: none"> Composite veneer price group 1 Composite veneer price group 2 Veneer price group 1 Open Line laminate 	<p>No cost</p> <p>No cost</p> <p>+\$178</p> <p>+\$781</p> <p>+\$956</p> <p>+\$859</p> <p>+\$111 plus cost of laminate</p>	<p>Specify laminate color number.</p> <p>Specify with <i>Customiz stain</i>.</p> <p>▶ See <i>Surface Materials Reference Manual</i>. Specify laminate color number.</p> <p>Specify wood color number.</p> <p>Specify wood color number.</p> <p>Specify wood color number.</p> <p>▶ See <i>Surface Materials Reference Manual</i>.</p>
	<p>Leg</p> <ul style="list-style-type: none"> Customiz stain Veneer price group 1 	<p>No cost</p> <p>No cost</p>	<p>Specify with <i>Customiz stain</i>.</p> <p>▶ See <i>Surface Materials Reference Manual</i>. Specify wood color number.</p>

Specification Information	
Style Number	U.S. Base Price
WESHTSTBL60	\$1891



For Canadian Pricing
 Multiply U.S. Price by the Canadian price factor.
 ▶ See page 1 for details.

Boardwalk 30"D x 90"W Rectangle Table

Boardwalk 30"D x 90"W
Rectangle Table

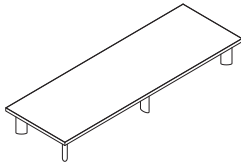

Tip: To gang Boardwalk lounge seating order ganging kit **TS31410**.

Standard Includes	Required to Specify
<ul style="list-style-type: none"> ▶ Need help? Product details, page 20 • Table: High-Pressure Laminate price group 1 with 3 mm plastic edge • Legs: veneer price group 1 • Leg brackets: paint • Requires assembly 	<ol style="list-style-type: none"> 1 Style number 2 High-Pressure Laminate color number for platform 3 Veneer color number for legs 4 Plastic color number for edge 5 Paint color number for leg brackets 6 Options, if selected (see below) <p>▶ See <i>Surface Materials</i>, page 242.</p>

Options	U.S. Price	Required to Specify
Table Height <ul style="list-style-type: none"> • 11" • 15" 	<ul style="list-style-type: none"> No cost +\$ 88 	<ul style="list-style-type: none"> Specify with 11"H table. Specify with 15"H table.
Surface Materials <ul style="list-style-type: none"> • Platform • High-Pressure Laminate price group 1 • Customiz stain • High-Pressure Laminate price group 2 • Composite veneer price group 1 • Composite veneer price group 2 • Veneer price group 1 • Open Line laminate 	<ul style="list-style-type: none"> No cost No cost +\$ 195 +\$ 976 +\$1189 +\$1074 +\$ 111 plus cost of laminate 	<ul style="list-style-type: none"> Specify laminate color number. Specify with <i>Customiz stain</i>. ▶ See <i>Surface Materials Reference Manual</i>. Specify laminate color number. Specify wood color number. Specify wood color number. Specify wood color number. ▶ See <i>Surface Materials Reference Manual</i>.
Leg <ul style="list-style-type: none"> • Customiz stain • Veneer price group 1 	<ul style="list-style-type: none"> No cost No cost 	<ul style="list-style-type: none"> Specify with <i>Customiz stain</i>. ▶ See <i>Surface Materials Reference Manual</i>. Specify wood color number.

Specification Information	
Style Number	U.S. Base Price
WESHTSTBL90	\$2723

Boardwalk

 **For Canadian Pricing**
Multiply U.S. Price by the Canadian price factor.
▶ See page 1 for details.

Boardwalk 40"D Round Table

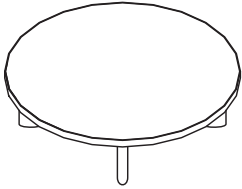

Tip: To gang Boardwalk lounge seating order ganging kit **TS31410**.

Standard Includes	Required to Specify
<ul style="list-style-type: none"> ▶ Need help? Product details, page 20 • Table: High-Pressure Laminate price group 1 with 3 mm plastic edge • Legs: veneer price group 1 • Leg brackets: paint • Requires assembly 	<ol style="list-style-type: none"> 1 Style number 2 High-Pressure Laminate color number for platform 3 Veneer color number for legs 4 Plastic color number for edge 5 Paint color number for leg brackets 6 Options, if selected (see below) <p>▶ See <i>Surface Materials</i>, page 242.</p>

Options	U.S. Price	Required to Specify
Table Height <ul style="list-style-type: none"> • 11" • 15" 	<ul style="list-style-type: none"> No cost +\$ 56 	<ul style="list-style-type: none"> Specify with 11"H table. Specify with 15"H table.
Surface Materials <ul style="list-style-type: none"> • Platform <ul style="list-style-type: none"> • High-Pressure Laminate price group 1 • Customiz stain • High-Pressure Laminate price group 2 • Composite veneer price group 1 • Composite veneer price group 2 • Veneer price group 1 • Open Line laminate 	<ul style="list-style-type: none"> No cost No cost +\$178 +\$710 +\$897 +\$781 +\$111 plus cost of laminate 	<ul style="list-style-type: none"> Specify laminate color number. Specify with <i>Customiz stain</i>. ▶ See <i>Surface Materials Reference Manual</i>. Specify laminate color number. Specify wood color number. Specify wood color number. Specify wood color number. ▶ See <i>Surface Materials Reference Manual</i>.
<ul style="list-style-type: none"> • Leg <ul style="list-style-type: none"> • Customiz stain • Veneer price group 1 	<ul style="list-style-type: none"> No cost No cost 	<ul style="list-style-type: none"> Specify with <i>Customiz stain</i>. ▶ See <i>Surface Materials Reference Manual</i>. Specify wood color number.

Specification Information	
• Style Number	• U.S. Base Price
WESHTSTBLRD40	\$1849
:	:
:	:



For Canadian Pricing
 Multiply U.S. Price by the Canadian price factor.
 ▶ See page 1 for details.

Boardwalk 35"D x 65"D Oval Table

Boardwalk 35"D x 65"D Oval Table

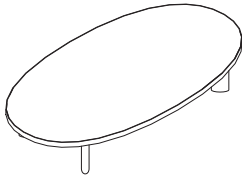

Tip: To gang Boardwalk lounge seating order ganging kit **TS31410**.

Standard Includes		Required to Specify
<ul style="list-style-type: none"> ▶ Need help? Product details, page 20 	<ul style="list-style-type: none"> • Table: High-Pressure Laminate price group 1 with 3 mm plastic edge • Legs: veneer price group 1 • Leg brackets: paint • Requires assembly 	<ol style="list-style-type: none"> 1 Style number 2 High-Pressure Laminate color number for platform 3 Veneer color number for legs 4 Plastic color number for edge 5 Paint color number for leg brackets 6 Options, if selected (see below) <ul style="list-style-type: none"> ▶ See <i>Surface Materials</i>, page 242.

Options	U.S. Price	Required to Specify
Table Height <ul style="list-style-type: none"> • 11" • 15" 	No cost +\$ 56	Specify with 11"H table. Specify with 15"H table.
Surface Materials <ul style="list-style-type: none"> • High-Pressure Laminate price group 1 • Customiz stain • High-Pressure Laminate price group 2 • Composite veneer price group 1 • Composite veneer price group 2 • Veneer price group 1 • Open Line laminate 	No cost No cost +\$ 178 +\$ 841 +\$1062 +\$ 925 +\$ 111 plus cost of laminate	Specify laminate color number. Specify with Customiz stain. ▶ See <i>Surface Materials Reference Manual</i> . Specify laminate color number. Specify wood color number. Specify wood color number. Specify wood color number. ▶ See <i>Surface Materials Reference Manual</i> .
Leg <ul style="list-style-type: none"> • Customiz stain • Veneer price group 1 	No cost No cost	Specify with Customiz stain. ▶ See <i>Surface Materials Reference Manual</i> . Specify wood color number.

Specification Information	
Style Number	U.S. Base Price
WESHTSTBLOV65	\$2048

Boardwalk

 **For Canadian Pricing**
 Multiply U.S. Price by the Canadian price factor.
 ▶ See page 1 for details.

Boardwalk Ganging Kit

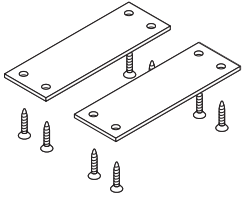

Standard Includes		Required to Specify
<ul style="list-style-type: none"> ▶ Need help? Product details, page 20 	<ul style="list-style-type: none"> • Ganging kit • Two plates • Attachment hardware 	<ul style="list-style-type: none"> Style number
Specification Information		
• Style Number	• U.S. Price	
TS31410	\$47	



For Canadian Pricing
 Multiply U.S. Price by the Canadian price factor.
 ▶ See page 1 for details.

Brighton One Seat Lounge Chair

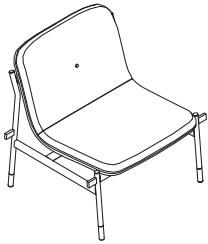

	Standard Includes	Required to Specify
▶ Need help? Product details, page 24	<ul style="list-style-type: none"> Fully upholstered lounge chair: fabric price group 1 Frame: paint price group 1 Frame caps: paint price group 1 Frame feet: paint price group 1 Arms, if selected: veneer price group 1 	<ol style="list-style-type: none"> Style number Fabric color number for chair Paint color number for frame Paint color number for frame caps Paint color number for frame feet Wood color number for arms, if selected Options, if selected (see below) <p>▶ See <i>Surface Materials</i>, page 242.</p>

	Options	U.S. Price	Required to Specify
Color Scheme	<ul style="list-style-type: none"> Non contrasting Contrasting 	<p>No cost</p> <p>+\$180</p>	<p>Specify with <i>non contrasting</i>.</p> <p>Specify with <i>contrasting</i>.</p>
Surface Materials	<p>Inner</p> <ul style="list-style-type: none"> Customer's Own Material (COM) Fabric price group 1 Fabric price group 2 Vinyl price group 2 Fabric price group 3 Fabric price group 4 Customer's Own Leather (COL) Fabric price group 5 Fabric price group 6 Fabric price group 7 Fabric price group 8 Fabric price group 9 Fabric price group 10 Leather price group 1 Leather price group 2 <p>Outer</p> <ul style="list-style-type: none"> Customer's Own Material (COM) Fabric price group 1 Fabric price group 2 Vinyl price group 2 Fabric price group 3 Fabric price group 4 Customer's Own Leather (COL) Fabric price group 5 Fabric price group 6 Fabric price group 7 Fabric price group 8 Fabric price group 9 Fabric price group 10 Leather price group 1 Leather price group 2 <p>Frame</p> <ul style="list-style-type: none"> Paint price group 1 Paint price group 2 Paint price group 3 <p>Arms</p> <ul style="list-style-type: none"> Customiz stain Veneer price group 1 Veneer price group 2 <p>Foot</p> <ul style="list-style-type: none"> Paint price group 1 Paint price group 2 Paint price group 3 <p>Cap</p> <ul style="list-style-type: none"> Paint price group 1 Paint price group 2 Paint price group 3 	<p>No cost</p> <p>No cost</p> <p>+\$ 5</p> <p>+\$ 5</p> <p>+\$ 34</p> <p>+\$ 63</p> <p>+\$109</p> <p>+\$113</p> <p>+\$166</p> <p>+\$231</p> <p>+\$300</p> <p>+\$369</p> <p>+\$435</p> <p>+\$474</p> <p>+\$586</p> <p>No cost</p> <p>No cost</p> <p>+\$ 5</p> <p>+\$ 5</p> <p>+\$ 34</p> <p>+\$ 63</p> <p>+\$109</p> <p>+\$113</p> <p>+\$166</p> <p>+\$231</p> <p>+\$300</p> <p>+\$369</p> <p>+\$435</p> <p>+\$474</p> <p>+\$586</p> <p>No cost</p> <p>+\$ 84</p> <p>+\$178</p> <p>No cost</p> <p>No cost</p> <p>+\$ 30</p> <p>No cost</p> <p>+\$ 9</p> <p>+\$ 24</p> <p>No cost</p> <p>+\$ 3</p> <p>+\$ 5</p>	<p>▶ See <i>Surface Materials Reference Manual</i>. Specify fabric color number. Specify fabric color number. Specify vinyl color number. Specify fabric color number. Specify fabric color number.</p> <p>▶ See <i>Surface Materials Reference Manual</i>. Specify fabric color number. Specify fabric color number. Specify fabric color number. Specify fabric color number. Specify fabric color number. Specify fabric color number. Specify fabric color number. Specify fabric color number. Specify leather color number. Specify leather color number.</p> <p>▶ See <i>Surface Materials Reference Manual</i>. Specify fabric color number. Specify fabric color number. Specify vinyl color number. Specify fabric color number. Specify fabric color number.</p> <p>▶ See <i>Surface Materials Reference Manual</i>. Specify fabric color number. Specify fabric color number. Specify fabric color number. Specify fabric color number. Specify fabric color number. Specify fabric color number. Specify fabric color number. Specify fabric color number. Specify leather color number. Specify leather color number.</p> <p>Specify paint color number. Specify paint color number. Specify paint color number.</p> <p>Specify with <i>Customiz stain</i>.</p> <p>▶ See <i>Surface Materials Reference Manual</i>. Specify wood color number. Specify wood color number.</p> <p>Specify paint color number. Specify paint color number. Specify paint color number.</p> <p>Specify paint color number. Specify paint color number. Specify paint color number.</p>

▶ Options, continued on next page

 **For Canadian Pricing**
Multiply U.S. Price by the Canadian price factor.
▶ See page 1 for details.

► Options, continued from previous page

	Options	U.S. Price	Required to Specify
Arm Position	• No arms	No cost	Specify with <i>no arms</i> .
	• Arm left	+\$260	Specify with <i>left-hand arm</i> .
	• Arm right	+\$260	Specify with <i>right-hand arm</i> .
	• Arms—left and right	+\$519	Specify with <i>arms left and right</i> .
Ganging	• Not ganging	No cost	Specify with <i>no ganging</i> .
	• Left	+\$ 61	Specify with <i>ganging left</i> .
	• Right	+\$ 61	Specify with <i>ganging right</i> .
	• Left and right	+\$122	Specify with <i>ganging left and right</i> .

Tip: Handedness is determined while in the seated position.

Specification Information

Style Number	U.S. Base Price
WESARYLNG1	\$2412

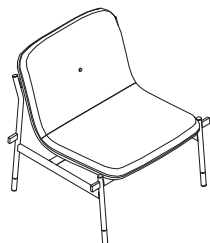

 **For Canadian Pricing**
Multiply U.S. Price by the Canadian price factor.
► See page 1 for details.

Brighton Two Seat Lounge Chair

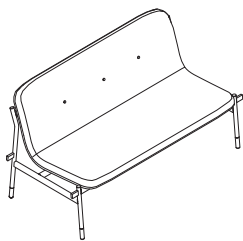

▶ Need help?
Product details,
page 24

Standard Includes

- Fully upholstered lounge chair: fabric price group 1
- Frame: paint price group 1
- Frame caps: paint price group 1
- Frame feet: paint price group 1
- Arms, if selected: veneer price group 1

Required to Specify

- 1 Style number
 - 2 Fabric color number for chair
 - 3 Paint color number for frame
 - 4 Paint color number for frame caps
 - 5 Paint color number for frame feet
 - 6 Wood color number for arms, if selected
 - 7 Options, if selected (see below)
- ▶ See *Surface Materials*, page 242.

	Options	U.S. Price	Required to Specify
Color Scheme	<ul style="list-style-type: none"> • Non contrasting • Contrasting 	<ul style="list-style-type: none"> No cost +\$ 180 	<ul style="list-style-type: none"> Specify with <i>non contrasting</i>. Specify with <i>contrasting</i>.
Surface Materials	<p>Inner</p> <ul style="list-style-type: none"> • Customer's Own Material (COM) • Fabric price group 1 • Fabric price group 2 • Vinyl price group 2 • Fabric price group 3 • Customer's Own Leather (COL) • Fabric price group 4 • Fabric price group 5 • Fabric price group 6 • Fabric price group 7 • Fabric price group 8 • Fabric price group 9 • Fabric price group 10 • Leather price group 1 • Leather price group 2 <p>Outer</p> <ul style="list-style-type: none"> • Customer's Own Material (COM) • Fabric price group 1 • Fabric price group 2 • Vinyl price group 2 • Fabric price group 3 • Customer's Own Leather (COL) • Fabric price group 4 • Fabric price group 5 • Fabric price group 6 • Fabric price group 7 • Fabric price group 8 • Fabric price group 9 • Fabric price group 10 • Leather price group 1 • Leather price group 2 <p>Frame</p> <ul style="list-style-type: none"> • Paint price group 1 • Paint price group 2 • Paint price group 3 <p>Arms</p> <ul style="list-style-type: none"> • Customiz stain • Veneer price group 1 • Veneer price group 2 <p>Foot</p> <ul style="list-style-type: none"> • Paint price group 1 • Paint price group 2 • Paint price group 3 <p>Cap</p> <ul style="list-style-type: none"> • Paint price group 1 • Paint price group 2 • Paint price group 3 	<ul style="list-style-type: none"> No cost No cost +\$ 12 +\$ 12 +\$ 65 +\$ 109 +\$ 127 +\$ 224 +\$ 331 +\$ 461 +\$ 601 +\$ 737 +\$ 867 +\$ 947 +\$1168 No cost No cost +\$ 12 +\$ 12 +\$ 65 +\$ 109 +\$ 127 +\$ 224 +\$ 331 +\$ 461 +\$ 601 +\$ 737 +\$ 867 +\$ 947 +\$1168 No cost +\$ 111 +\$ 247 No cost No cost +\$ 30 No cost +\$ 9 +\$ 24 No cost +\$ 3 +\$ 5 	<ul style="list-style-type: none"> ▶ See <i>Surface Materials Reference Manual</i>. Specify fabric color number. Specify fabric color number. Specify vinyl color number. Specify fabric color number. ▶ See <i>Surface Materials Reference Manual</i>. Specify fabric color number. Specify fabric color number. Specify fabric color number. Specify fabric color number. Specify fabric color number. Specify fabric color number. Specify fabric color number. Specify fabric color number. Specify fabric color number. Specify leather color number. Specify leather color number. ▶ See <i>Surface Materials Reference Manual</i>. Specify fabric color number. Specify fabric color number. Specify vinyl color number. Specify fabric color number. ▶ See <i>Surface Materials Reference Manual</i>. Specify fabric color number. Specify fabric color number. Specify fabric color number. Specify fabric color number. Specify fabric color number. Specify fabric color number. Specify fabric color number. Specify leather color number. Specify leather color number. Specify paint color number. Specify paint color number. Specify paint color number. Specify with <i>Customiz stain</i>. ▶ See <i>Surface Materials Reference Manual</i>. Specify wood color number. Specify wood color number. Specify paint color number. Specify paint color number. Specify paint color number. Specify paint color number. Specify paint color number. Specify paint color number.

▶ Options, continued on next page

 **For Canadian Pricing**
Multiply U.S. Price by the
Canadian price factor.
▶ See page 1 for details.

► Options, continued from previous page

Tip: Handedness is determined while in the seated position.

	Options	U.S. Price	Required to Specify
Arm Position	• No arms	No cost	Specify with <i>no arms</i> .
	• Arm left	+\$260	Specify with <i>left-hand arm</i> .
	• Arm right	+\$260	Specify with <i>right-hand arm</i> .
	• Arms—left and right	+\$519	Specify with <i>arms left and right</i> .
Ganging	• Not ganging	No cost	Specify with <i>no ganging</i> .
	• Left	+\$ 61	Specify with <i>ganging left</i> .
	• Right	+\$ 61	Specify with <i>ganging right</i> .
	• Left and right	+\$122	Specify with <i>ganging left and right</i> .

Specification Information

Style Number	U.S. Base Price
WESARYLNG2	\$3598

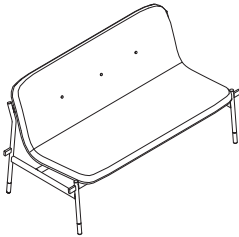

For Canadian Pricing
Multiply U.S. Price by the Canadian price factor.
► See page 1 for details.

Brighton Ottoman



Standard Includes		Required to Specify
▶ Need help? Product details, page 24	<ul style="list-style-type: none"> Fully upholstered ottoman: fabric price group 1 Frame: paint price group 1 Frame caps: paint price group 1 	1 Style number 2 Fabric color number for ottoman 3 Paint color number for frame 4 Paint color number for frame caps 5 Options, if selected (see below) ▶ See <i>Surface Materials</i> , page 242.

Options	U.S. Price	Required to Specify
Surface Materials		
Upholstery		
• Customer's Own Material (COM)	No cost	▶ See <i>Surface Materials Reference Manual</i> . Specify fabric color number.
• Fabric price group 1	No cost	Specify fabric color number.
• Fabric price group 2	+\$ 1	Specify vinyl color number.
• Vinyl price group 2	+\$ 1	Specify fabric color number.
• Fabric price group 3	+\$ 5	Specify fabric color number.
• Fabric price group 4	+\$ 13	Specify fabric color number.
• Fabric price group 5	+\$ 27	Specify fabric color number.
• Fabric price group 6	+\$ 39	Specify fabric color number.
• Fabric price group 7	+\$ 57	Specify fabric color number.
• Fabric price group 8	+\$ 75	Specify fabric color number.
• Fabric price group 9	+\$ 91	Specify fabric color number.
• Fabric price group 10	+\$110	Specify fabric color number.
• Leather price group 1	+\$117	Specify leather color number.
• Leather price group 2	+\$146	Specify leather color number.
• Customer's Own Leather (COL)	+\$214	▶ See <i>Surface Materials Reference Manual</i> .
Frame		
• Paint price group 1	No cost	Specify paint color number.
• Paint price group 2	+\$ 36	Specify paint color number.
• Paint price group 3	+\$ 68	Specify paint color number.
Cap		
• Paint price group 1	No cost	Specify paint color number.
• Paint price group 2	+\$ 3	Specify paint color number.
• Paint price group 3	+\$ 5	Specify paint color number.

Specification Information	
• Style Number	• U.S. Base Price
WESARYO	\$759



For Canadian Pricing
 Multiply U.S. Price by the
 Canadian price factor.
 ▶ See page 1 for details.

Brighton 60° Ganging Table

Brighton 60° Ganging Table

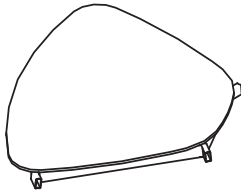

Tip: Ganging tables or end table must be used when specifying ganging hardware on lounge units. Ganging hardware and arms cannot be specified on the same side of a lounge unit.

Standard Includes	Required to Specify
<ul style="list-style-type: none"> ▶ Need help? Product details, page 24 • Table: High-Pressure Laminate price group 1 with 3 mm plastic edge • Frame: paint price group 1 • Plastic ganging brackets 	<ol style="list-style-type: none"> 1 Style number 2 High-Pressure Laminate color number for table 3 Plastic color number for edge 4 Paint color number for frame 5 Options, if selected (see below) <p>▶ See <i>Surface Materials</i>, page 242.</p>

Surface Materials	Options	U.S. Price	Required to Specify
	Frame		
	<ul style="list-style-type: none"> • Paint price group 1 • Paint price group 2 • Paint price group 3 	<p>No cost</p> <p>+\$ 34</p> <p>+\$ 59</p>	<p>Specify paint color number.</p> <p>Specify paint color number.</p> <p>Specify paint color number.</p>
	Top		
	<ul style="list-style-type: none"> • High-Pressure Laminate price group 1 • Customiz stain • High-Pressure Laminate price group 2 • Composite veneer price group 1 • Composite veneer price group 2 • Veneer price group 1 • Veneer price group 3 • Open Line laminate 	<p>No cost</p> <p>No cost</p> <p>+\$ 104</p> <p>+\$ 608</p> <p>+\$ 730</p> <p>+\$ 669</p> <p>+\$1338</p> <p>+\$ 111 plus cost of laminate</p>	<p>Specify laminate color number.</p> <p>Specify <i>with Customiz stain</i>.</p> <p>▶ See <i>Surface Materials Reference Manual</i>. Specify laminate color number.</p> <p>Specify wood color number.</p> <p>Specify wood color number.</p> <p>Specify wood color number.</p> <p>Specify wood color number.</p> <p>▶ See <i>Surface Materials Reference Manual</i>.</p>

Specification Information	
• Style Number	• U.S. Base Price
WESARYTBL60	\$1263
.	.



 **For Canadian Pricing**
 Multiply U.S. Price by the Canadian price factor.
 ▶ See page 1 for details.

Brighton 90° Ganging Table

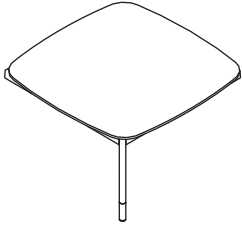

Tip: Ganging tables or end table must be used when specifying ganging hardware on lounge units. Ganging hardware and arms cannot be specified on the same side of a lounge unit.

Standard Includes	Required to Specify
<ul style="list-style-type: none"> ▶ Need help? Product details, page 24 • Table: High-Pressure Laminate price group 1 with 3 mm plastic edge • Frame: paint price group 1 • Frame feet: paint price group 1 • Plastic ganging brackets 	<ol style="list-style-type: none"> 1 Style number 2 High-Pressure Laminate color number for table 3 Plastic color number for edge 4 Paint color number for frame 5 Paint color number for feet 6 Options, if selected (see below) <p>▶ See <i>Surface Materials</i>, page 242.</p>

Surface Materials	Options	U.S. Price	Required to Specify
	Frame		
	<ul style="list-style-type: none"> • Paint price group 1 • Paint price group 2 • Paint price group 3 	<ul style="list-style-type: none"> No cost +\$ 39 +\$ 78 	<ul style="list-style-type: none"> Specify paint color number. Specify paint color number. Specify paint color number.
	Top		
	<ul style="list-style-type: none"> • High-Pressure Laminate price group 1 • Customiz stain 	<ul style="list-style-type: none"> No cost No cost 	<ul style="list-style-type: none"> Specify laminate color number. Specify <i>with Customiz stain</i>. ▶ See <i>Surface Materials Reference Manual</i>. Specify laminate color number.
	<ul style="list-style-type: none"> • High-Pressure Laminate price group 2 • Composite veneer price group 1 • Composite veneer price group 2 • Veneer price group 1 • Veneer price group 3 • Open Line laminate 	<ul style="list-style-type: none"> +\$ 118 +\$ 622 +\$ 745 +\$ 685 +\$1369 +\$ 111 plus cost of laminate 	<ul style="list-style-type: none"> Specify wood color number. Specify wood color number. Specify wood color number. Specify wood color number. ▶ See <i>Surface Materials Reference Manual</i>.
	Foot		
	<ul style="list-style-type: none"> • Paint price group 1 • Paint price group 2 • Paint price group 3 	<ul style="list-style-type: none"> No cost +\$ 9 +\$ 24 	<ul style="list-style-type: none"> Specify paint color number. Specify paint color number. Specify paint color number.

Specification Information	
• Style Number	• U.S. Base Price
WESARYTBL90	\$1337



For Canadian Pricing
 Multiply U.S. Price by the Canadian price factor.
 ▶ See page 1 for details.

Brighton Straight Ganging Table

Brighton Straight Ganging Table

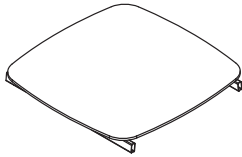

Tip: Ganging tables or end table must be used when specifying ganging hardware on lounge units. Ganging hardware and arms cannot be specified on the same side of a lounge unit.

Standard Includes	Required to Specify
<ul style="list-style-type: none"> ▶ Need help? Product details, page 24 • Table: High-Pressure Laminate price group 1 with 3 mm plastic edge • Frame: paint price group 1 • Plastic ganging brackets 	<ol style="list-style-type: none"> 1 Style number 2 High-Pressure Laminate color number for table 3 Plastic color number for edge 4 Paint color number for frame 5 Options, if selected (see below) <p>▶ See <i>Surface Materials</i>, page 242.</p>

Surface Materials	Options	U.S. Price	Required to Specify
	Frame		
	<ul style="list-style-type: none"> • Paint price group 1 • Paint price group 2 • Paint price group 3 	<p>No cost</p> <p>+\$ 39</p> <p>+\$ 78</p>	<p>Specify paint color number.</p> <p>Specify paint color number.</p> <p>Specify paint color number.</p>
	Top		
	<ul style="list-style-type: none"> • High-Pressure Laminate price group 1 • Customiz stain • High-Pressure Laminate price group 2 • Composite veneer price group 1 • Composite veneer price group 2 • Veneer price group 1 • Veneer price group 3 • Open Line laminate 	<p>No cost</p> <p>No cost</p> <p>+\$ 118</p> <p>+\$ 622</p> <p>+\$ 745</p> <p>+\$ 685</p> <p>+\$1369</p> <p>+\$ 111 plus cost of laminate</p>	<p>Specify laminate color number.</p> <p>Specify <i>with Customiz stain</i>.</p> <p>▶ See <i>Surface Materials Reference Manual</i>. Specify laminate color number.</p> <p>Specify wood color number.</p> <p>Specify wood color number.</p> <p>Specify wood color number.</p> <p>Specify wood color number.</p> <p>▶ See <i>Surface Materials Reference Manual</i>.</p>

Specification Information	
• Style Number	• U.S. Base Price
WESARYTBLSG	\$1263
.	.



 **For Canadian Pricing**
 Multiply U.S. Price by the Canadian price factor.
 ▶ See page 1 for details.

Brighton End Table

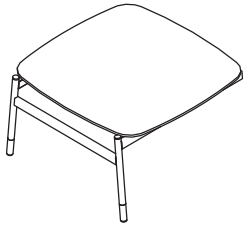

► Need help?
Product details,
page 24

Standard Includes

- Table: High-Pressure Laminate price group 1 with 3 mm plastic edge
- Frame: paint price group 1
- Frame feet: paint price group 1
- Frame caps: paint price group 1
- Plastic ganging brackets

Required to Specify

- 1 Style number
 - 2 High-Pressure Laminate color number for table
 - 3 Plastic color number for edge
 - 4 Paint color number for frame
 - 5 Paint color number for frame feet
 - 6 Paint color number for frame caps
 - 7 Options, if selected (see below)
- See *Surface Materials*, page 242.

	Options	U.S. Price	Required to Specify
Surface Materials	Frame		
	• Paint price group 1	No cost	Specify paint color number.
	• Paint price group 2	+\$ 44	Specify paint color number.
	• Paint price group 3	+\$ 83	Specify paint color number.
	Top		
	• High-Pressure Laminate price group 1	No cost	Specify laminate color number.
	• Customiz stain	No cost	Specify <i>with Customiz stain</i> .
	• High-Pressure Laminate price group 2	+\$ 118	► See <i>Surface Materials Reference Manual</i> . Specify laminate color number.
	• Composite veneer price group 1	+\$ 622	Specify wood color number.
	• Composite veneer price group 2	+\$ 745	Specify wood color number.
	• Veneer price group 1	+\$ 685	Specify wood color number.
	• Veneer price group 3	+\$1369	Specify wood color number.
	• Open Line laminate	+\$ 111 plus cost of laminate	► See <i>Surface Materials Reference Manual</i> .
	Foot		
	• Paint price group 1	No cost	Specify paint color number.
	• Paint price group 2	+\$ 9	Specify paint color number.
	• Paint price group 3	+\$ 24	Specify paint color number.
	Cap		
	• Paint price group 1	No cost	Specify paint color number.
	• Paint price group 2	+\$ 3	Specify paint color number.
	• Paint price group 3	+\$ 5	Specify paint color number.
Ganging	• Left	No cost	Specify <i>with ganging left</i> .
	• Right	No cost	Specify <i>with ganging right</i> .

Tip: Ganging tables or end table must be used when specifying ganging hardware on lounge units. Ganging hardware and arms cannot be specified on the same side of a lounge unit.

Specification Information

• Style Number	• U.S. Base Price
WESARYTBLED	\$1403



For Canadian Pricing

Multiply U.S. Price by the Canadian price factor.

► See page 1 for details.

Brighton Square Table

Brighton Square Table

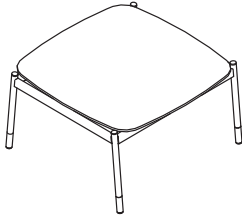

► Need help?
Product details,
page 24

Standard Includes

- Table: High-Pressure Laminate price group 1 with 3 mm plastic edge
- Frame: paint price group 1
- Frame feet: paint price group 1
- Frame caps: paint price group 1

Required to Specify

- 1 Style number
 - 2 High-Pressure Laminate color number for table
 - 3 Plastic color number for edge
 - 4 Paint color number for frame
 - 5 Paint color number for frame feet
 - 6 Paint color number for frame caps
 - 7 Options, if selected (see below)
- See *Surface Materials*, page 242.

	Options	U.S. Price	Required to Specify
Surface Materials	Frame		
	• Paint price group 1	No cost	Specify paint color number.
	• Paint price group 2	+\$ 52	Specify paint color number.
	• Paint price group 3	+\$ 95	Specify paint color number.
	Top		
	• High-Pressure Laminate price group 1	No cost	Specify laminate color number.
	• Customiz stain	No cost	Specify with <i>Customiz stain</i> . ► See <i>Surface Materials Reference Manual</i> . Specify laminate color number.
	• High-Pressure Laminate price group 2	+\$ 118	
	• Composite veneer price group 1	+\$ 622	Specify wood color number.
	• Composite veneer price group 2	+\$ 745	Specify wood color number.
	• Veneer price group 1	+\$ 685	Specify wood color number.
	• Veneer price group 3	+\$1369	Specify wood color number.
	• Open Line laminate	+\$ 111 plus cost of laminate	► See <i>Surface Materials Reference Manual</i> .
Foot			
• Paint price group 1	No cost	Specify paint color number.	
• Paint price group 2	+\$ 9	Specify paint color number.	
• Paint price group 3	+\$ 24	Specify paint color number.	
Cap			
• Paint price group 1	No cost	Specify paint color number.	
• Paint price group 2	+\$ 3	Specify paint color number.	
• Paint price group 3	+\$ 5	Specify paint color number.	

Specification Information

Style Number	U.S. Base Price
WESARYTBSQ	\$1547

Brighton



For Canadian Pricing

Multiply U.S. Price by the Canadian price factor.

► See page 1 for details.

Brighton Rectangle Table

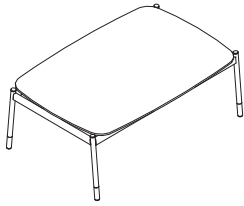

► Need help?
Product details,
page 24

Standard Includes

- Table: High-Pressure Laminate price group 1 with 3 mm plastic edge
- Frame: paint price group 1
- Frame feet: paint price group 1
- Frame caps: paint price group 1

Required to Specify

- 1 Style number
 - 2 High-Pressure Laminate color number for table
 - 3 Plastic color number for edge
 - 4 Paint color number for frame
 - 5 Paint color number for frame feet
 - 6 Paint color number for frame caps
 - 7 Options, if selected (see below)
- See *Surface Materials*, page 242.

	Options	U.S. Price	Required to Specify
Surface Materials	Frame		
	• Paint price group 1	No cost	Specify paint color number.
	• Paint price group 2	+\$ 59	Specify paint color number.
	• Paint price group 3	+\$ 104	Specify paint color number.
	Top		
	• High-Pressure Laminate price group 1	No cost	Specify laminate color number.
	• Customiz stain	No cost	Specify <i>with Customiz stain</i> . ► See <i>Surface Materials Reference Manual</i> . Specify laminate color number.
	• High-Pressure Laminate price group 2	+\$ 134	
	• Composite veneer price group 1	+\$ 739	Specify wood color number.
	• Composite veneer price group 2	+\$ 885	Specify wood color number.
• Veneer price group 1	+\$ 812	Specify wood color number.	
• Veneer price group 3	+\$1623	Specify wood color number.	
• Open Line laminate	+\$ 111 plus cost of laminate	► See <i>Surface Materials Reference Manual</i> .	
Foot			
• Paint price group 1	No cost	Specify paint color number.	
• Paint price group 2	+\$ 9	Specify paint color number.	
• Paint price group 3	+\$ 24	Specify paint color number.	
Cap			
• Paint price group 1	No cost	Specify paint color number.	
• Paint price group 2	+\$ 3	Specify paint color number.	
• Paint price group 3	+\$ 5	Specify paint color number.	

Specification Information

• Style Number	• U.S. Base Price
WESARYTBLRT	\$1758



For Canadian Pricing

Multiply U.S. Price by the Canadian price factor.

► See page 1 for details.

Brighton Module Power

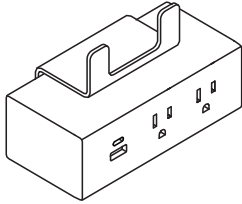

Standard Includes	Required to Specify
<ul style="list-style-type: none"> ▶ Need help? Product details, page 25 • Power module: <ul style="list-style-type: none"> – 6000 Black – 6052 Milk • 9' cord with three-prong plug: black plastic only 	<ul style="list-style-type: none"> 1 Style number 2 Plastic color number for power module 3 Options, if selected (see below)

Options	U.S. Price	Required to Specify
Power Configuration <ul style="list-style-type: none"> • 2 power 1 USB A+C 20W • 1 power 1 USBC 	No cost +\$133	Specify with 2 power 1 USB A+C 20W. Specify with 1 power 1 USBC.

Specification Information	
• Style Number	• U.S. Base Price
WESARYPWR	\$460

Brighton USB Power

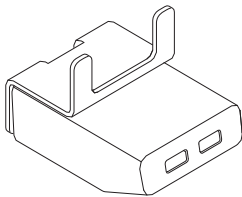

Standard Includes	Required to Specify
<ul style="list-style-type: none"> ▶ Need help? Product details, page 25 • Power module: <ul style="list-style-type: none"> – 6000 Black – 6052 Milk • 9' cord with three-prong plug: black plastic only 	<ul style="list-style-type: none"> 1 Style number 2 Plastic color number for power

Specification Information	
• Style Number	• U.S. Price
WESARYUSB	\$304

Brighton

For Canadian Pricing
 Multiply U.S. Price by the Canadian price factor.
 ▶ See page 1 for details.

Mesa Chaise Lounge—Left Hand

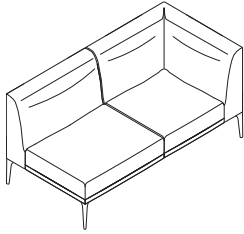

Tip: Contrasting fabric is not available on Mesa lounge seating.

Tip: Handedness is determined while in the seated position.

Standard Includes		Required to Specify
▶ Need help? Product details, page 28	<ul style="list-style-type: none"> Fully upholstered non-contrasting lounge: fabric price group 1 Four leg cast aluminum base: WE01 Antique Bronze Plastic ganging brackets 	<ol style="list-style-type: none"> Style number Fabric color number for lounge Options, if selected (see below) <p>▶ See <i>Surface Materials</i>, page 242.</p>

Options	U.S. Price	Required to Specify
Surface Materials		
Inner		
• Customer's Own Material (COM)	No cost	▶ See <i>Surface Materials Reference Manual</i> .
• Fabric price group 1	No cost	Specify fabric color number.
• Fabric price group 2	+\$ 34	Specify fabric color number.
• Customer's Own Leather (COL)	+\$ 109	▶ See <i>Surface Materials Reference Manual</i> .
• Fabric price group 3	+\$ 155	Specify fabric color number.
• Fabric price group 4	+\$ 301	Specify fabric color number.
• Fabric price group 5	+\$ 535	Specify fabric color number.
• Fabric price group 6	+\$ 791	Specify fabric color number.
• Fabric price group 7	+\$1105	Specify fabric color number.
• Fabric price group 8	+\$1432	Specify fabric color number.
• Fabric price group 9	+\$1769	Specify fabric color number.
• Fabric price group 10	+\$2082	Specify fabric color number.
• Leather price group 1	+\$2278	Specify leather color number.
• Leather price group 2	+\$2806	Specify leather color number.
Outer		
• Customer's Own Material (COM)	No cost	▶ See <i>Surface Materials Reference Manual</i> .
• Fabric price group 1	No cost	Specify fabric color number.
• Fabric price group 2	+\$ 8	Specify fabric color number.
• Fabric price group 3	+\$ 51	Specify fabric color number.
• Fabric price group 4	+\$ 101	Specify fabric color number.
• Customer's Own Leather (COL)	+\$ 109	▶ See <i>Surface Materials Reference Manual</i> .
• Fabric price group 5	+\$ 178	Specify fabric color number.
• Fabric price group 6	+\$ 265	Specify fabric color number.
• Fabric price group 7	+\$ 369	Specify fabric color number.
• Fabric price group 8	+\$ 479	Specify fabric color number.
• Fabric price group 9	+\$ 590	Specify fabric color number.
• Fabric price group 10	+\$ 694	Specify fabric color number.
• Leather price group 1	+\$ 760	Specify leather color number.
• Leather price group 2	+\$ 936	Specify leather color number.

Specification Information	
Style Number	U.S. Base Price
WESMESCHLH	\$5650



For Canadian Pricing
Multiply U.S. Price by the Canadian price factor.
▶ See page 1 for details.

Mesa Chaise Lounge—Right Hand

Mesa Chaise Lounge—
Right Hand

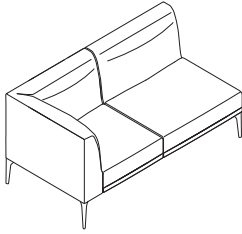

Tip: Contrasting fabric is not available on Mesa lounge seating.

Tip: Handedness is determined while in the seated position.

Standard Includes		Required to Specify
<ul style="list-style-type: none"> ▶ Need help? Product details, page 28 	<ul style="list-style-type: none"> Fully upholstered non-contrasting lounge: fabric price group 1 Four leg cast aluminum base: WE01 Antique Bronze Plastic ganging brackets 	<ol style="list-style-type: none"> Style number Fabric color number for lounge Options, if selected (see below) <ul style="list-style-type: none"> ▶ See <i>Surface Materials</i>, page 242.

Options	U.S. Price	Required to Specify
Surface Materials		
Inner		
• Customer's Own Material (COM)	No cost	▶ See <i>Surface Materials Reference Manual</i> . Specify fabric color number.
• Fabric price group 1	No cost	Specify fabric color number.
• Fabric price group 2	+\$ 34	Specify fabric color number.
• Customer's Own Leather (COL)	+\$ 109	▶ See <i>Surface Materials Reference Manual</i> . Specify fabric color number.
• Fabric price group 3	+\$ 155	Specify fabric color number.
• Fabric price group 4	+\$ 301	Specify fabric color number.
• Fabric price group 5	+\$ 535	Specify fabric color number.
• Fabric price group 6	+\$ 791	Specify fabric color number.
• Fabric price group 7	+\$1105	Specify fabric color number.
• Fabric price group 8	+\$1432	Specify fabric color number.
• Fabric price group 9	+\$1769	Specify fabric color number.
• Fabric price group 10	+\$2082	Specify fabric color number.
• Leather price group 1	+\$2278	Specify leather color number.
• Leather price group 2	+\$2806	Specify leather color number.

Outer

• Customer's Own Material (COM)	No cost	▶ See <i>Surface Materials Reference Manual</i> . Specify fabric color number.
• Fabric price group 1	No cost	Specify fabric color number.
• Fabric price group 2	+\$ 8	Specify fabric color number.
• Fabric price group 3	+\$ 51	Specify fabric color number.
• Fabric price group 4	+\$ 101	Specify fabric color number.
• Customer's Own Leather (COL)	+\$ 109	▶ See <i>Surface Materials Reference Manual</i> . Specify fabric color number.
• Fabric price group 5	+\$ 178	Specify fabric color number.
• Fabric price group 6	+\$ 265	Specify fabric color number.
• Fabric price group 7	+\$ 369	Specify fabric color number.
• Fabric price group 8	+\$ 479	Specify fabric color number.
• Fabric price group 9	+\$ 590	Specify fabric color number.
• Fabric price group 10	+\$ 694	Specify fabric color number.
• Leather price group 1	+\$ 760	Specify leather color number.
• Leather price group 2	+\$ 936	Specify leather color number.

Specification Information

Style Number	U.S. Base Price
WESMESCHRH	\$5650

Mesa



For Canadian Pricing

Multiply U.S. Price by the Canadian price factor.

▶ See page 1 for details.

Mesa Armless Lounge

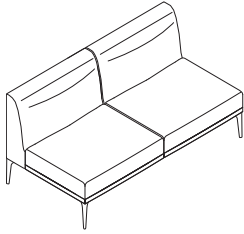

Tip: Contrasting fabric is not available on Mesa lounge seating.

Standard Includes		Required to Specify
<ul style="list-style-type: none"> ▶ Need help? Product details, page 28 	<ul style="list-style-type: none"> Fully upholstered non-contrasting lounge: fabric price group 1 Four leg cast aluminum base: WE01 Antique Bronze Plastic ganging brackets 	<ol style="list-style-type: none"> Style number Fabric color number for lounge Options, if selected (see below) <ul style="list-style-type: none"> ▶ See <i>Surface Materials</i>, page 242.

Options	U.S. Price	Required to Specify
Surface Materials		
Inner <ul style="list-style-type: none"> Customer's Own Material (COM) No cost Fabric price group 1 No cost Fabric price group 2 +\$ 30 Customer's Own Leather (COL) +\$ 109 Fabric price group 3 +\$ 143 Fabric price group 4 +\$ 275 Fabric price group 5 +\$ 495 Fabric price group 6 +\$ 731 Fabric price group 7 +\$1019 Fabric price group 8 +\$1321 Fabric price group 9 +\$1628 Fabric price group 10 +\$1921 Leather price group 1 +\$2098 Leather price group 2 +\$2584 		<ul style="list-style-type: none"> ▶ See <i>Surface Materials Reference Manual</i>. Specify fabric color number. Specify fabric color number. ▶ See <i>Surface Materials Reference Manual</i>. Specify fabric color number. Specify fabric color number. Specify fabric color number. Specify fabric color number. Specify fabric color number. Specify fabric color number. Specify fabric color number. Specify fabric color number. Specify leather color number. Specify leather color number.
Outer <ul style="list-style-type: none"> Customer's Own Material (COM) No cost Fabric price group 1 No cost Fabric price group 2 +\$ 8 Fabric price group 3 +\$ 49 Fabric price group 4 +\$ 91 Customer's Own Leather (COL) +\$ 109 Fabric price group 5 +\$ 166 Fabric price group 6 +\$ 244 Fabric price group 7 +\$ 341 Fabric price group 8 +\$ 440 Fabric price group 9 +\$ 543 Fabric price group 10 +\$ 641 Leather price group 1 +\$ 698 Leather price group 2 +\$ 863 		<ul style="list-style-type: none"> ▶ See <i>Surface Materials Reference Manual</i>. Specify fabric color number. Specify fabric color number. Specify fabric color number. Specify fabric color number. ▶ See <i>Surface Materials Reference Manual</i>. Specify fabric color number. Specify fabric color number. Specify fabric color number. Specify fabric color number. Specify fabric color number. Specify fabric color number. Specify leather color number. Specify leather color number.

Specification Information	
Style Number	U.S. Base Price
WESMES2SEAT	\$5128



For Canadian Pricing
 Multiply U.S. Price by the Canadian price factor.
 ▶ See page 1 for details.

Mesa Corner Lounge Unit

Mesa Corner Lounge Unit

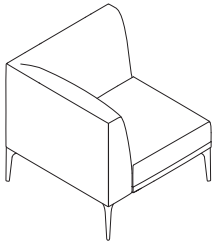

Tip: Contrasting fabric is not available on Mesa lounge seating.

Tip: The corner unit is not handed and can be connected on either side with other units. Avoid using directional fabrics as it may not align with adjacent pieces.

Standard Includes		Required to Specify
<ul style="list-style-type: none"> ▶ Need help? Product details, page 28 	<ul style="list-style-type: none"> Fully upholstered non-contrasting lounge: fabric price group 1 Four leg cast aluminum base: WE01 Antique Bronze Plastic ganging brackets 	<ol style="list-style-type: none"> Style number Fabric color number for lounge Options, if selected (see below) <ul style="list-style-type: none"> ▶ See <i>Surface Materials</i>, page 242.

Options	U.S. Price	Required to Specify
Surface Materials		
Inner		
• Customer's Own Material (COM)	No cost	<ul style="list-style-type: none"> ▶ See <i>Surface Materials Reference Manual</i>. Specify fabric color number. ▶ See <i>Surface Materials Reference Manual</i>. Specify fabric color number. ▶ See <i>Surface Materials Reference Manual</i>. Specify fabric color number. ▶ See <i>Surface Materials Reference Manual</i>. Specify fabric color number. ▶ See <i>Surface Materials Reference Manual</i>. Specify fabric color number. ▶ See <i>Surface Materials Reference Manual</i>. Specify fabric color number. ▶ See <i>Surface Materials Reference Manual</i>. Specify fabric color number. ▶ See <i>Surface Materials Reference Manual</i>. Specify fabric color number. ▶ See <i>Surface Materials Reference Manual</i>. Specify fabric color number. ▶ See <i>Surface Materials Reference Manual</i>. Specify fabric color number.
• Fabric price group 1	No cost	
• Fabric price group 2	+\$ 18	
• Fabric price group 3	+\$ 89	
• Customer's Own Leather (COL)	+\$ 109	
• Fabric price group 4	+\$ 174	
• Fabric price group 5	+\$ 309	
• Fabric price group 6	+\$ 460	
• Fabric price group 7	+\$ 638	
• Fabric price group 8	+\$ 827	
• Fabric price group 9	+\$1021	
• Fabric price group 10	+\$1203	
• Leather price group 1	+\$1315	
• Leather price group 2	+\$1623	
Outer		
• Customer's Own Material (COM)	No cost	<ul style="list-style-type: none"> ▶ See <i>Surface Materials Reference Manual</i>. Specify fabric color number. ▶ See <i>Surface Materials Reference Manual</i>. Specify fabric color number. ▶ See <i>Surface Materials Reference Manual</i>. Specify fabric color number. ▶ See <i>Surface Materials Reference Manual</i>. Specify fabric color number. ▶ See <i>Surface Materials Reference Manual</i>. Specify fabric color number. ▶ See <i>Surface Materials Reference Manual</i>. Specify fabric color number. ▶ See <i>Surface Materials Reference Manual</i>. Specify fabric color number. ▶ See <i>Surface Materials Reference Manual</i>. Specify fabric color number. ▶ See <i>Surface Materials Reference Manual</i>. Specify fabric color number. ▶ See <i>Surface Materials Reference Manual</i>. Specify fabric color number. ▶ See <i>Surface Materials Reference Manual</i>. Specify fabric color number. ▶ See <i>Surface Materials Reference Manual</i>. Specify fabric color number. ▶ See <i>Surface Materials Reference Manual</i>. Specify fabric color number. ▶ See <i>Surface Materials Reference Manual</i>. Specify fabric color number. ▶ See <i>Surface Materials Reference Manual</i>. Specify fabric color number. ▶ See <i>Surface Materials Reference Manual</i>. Specify fabric color number.
• Fabric price group 1	No cost	
• Fabric price group 2	+\$ 4	
• Fabric price group 3	+\$ 30	
• Fabric price group 4	+\$ 59	
• Fabric price group 5	+\$ 104	
• Customer's Own Leather (COL)	+\$ 109	
• Fabric price group 6	+\$ 153	
• Fabric price group 7	+\$ 213	
• Fabric price group 8	+\$ 275	
• Fabric price group 9	+\$ 341	
• Fabric price group 10	+\$ 402	
• Leather price group 1	+\$ 438	
• Leather price group 2	+\$ 538	

Specification Information	
Style Number	U.S. Base Price
WESMESC	\$3334

For Canadian Pricing
 Multiply U.S. Price by the Canadian price factor.
 ▶ See page 1 for details.



Mesa Ottoman

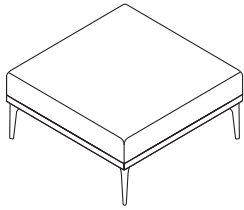

Standard Includes		Required to Specify
<ul style="list-style-type: none"> ▶ Need help? Product details, page 28 	<ul style="list-style-type: none"> Fully upholstered ottoman: fabric price group 1 Four leg cast aluminum base: WE01 Antique Bronze Plastic ganging brackets 	<ul style="list-style-type: none"> 1 Style number 2 Fabric color number for ottoman 3 Options, if selected (see below) ▶ See <i>Surface Materials</i>, page 242.

Options	U.S. Price	Required to Specify
Upholstery		
• Customer's Own Material (COM)	No cost	▶ See <i>Surface Materials Reference Manual</i> .
• Fabric price group 1	No cost	Specify fabric color number.
• Fabric price group 2	+\$ 13	Specify fabric color number.
• Fabric price group 3	+\$ 75	Specify fabric color number.
• Fabric price group 4	+\$ 145	Specify fabric color number.
• Customer's Own Leather (COL)	+\$ 214	▶ See <i>Surface Materials Reference Manual</i> .
• Fabric price group 5	+\$ 257	Specify fabric color number.
• Fabric price group 6	+\$ 381	Specify fabric color number.
• Fabric price group 7	+\$ 528	Specify fabric color number.
• Fabric price group 8	+\$ 687	Specify fabric color number.
• Fabric price group 9	+\$ 848	Specify fabric color number.
• Fabric price group 10	+\$ 999	Specify fabric color number.
• Leather price group 1	+\$1090	Specify leather color number.
• Leather price group 2	+\$1344	Specify leather color number.

Specification Information	
• Style Number	• U.S. Base Price
WESMESO	\$2279



For Canadian Pricing
 Multiply U.S. Price by the Canadian price factor.
 ▶ See page 1 for details.

Willow Fixed Base Lounge

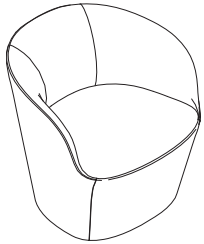

Standard Includes		Required to Specify	
<ul style="list-style-type: none"> ▶ Need help? Product details, page 32 	<ul style="list-style-type: none"> Fully upholstered non-contrasting seat with back: fabric price group 1 Back detail: smooth Glides 	<ul style="list-style-type: none"> 1 Style number 2 Fabric color number for chair 3 Options, if selected (see below) ▶ See <i>Surface Materials</i>, page 242. 	
Color Scheme	Options	U.S. Price	Required to Specify
	<ul style="list-style-type: none"> Non contrasting Contrasting inner and outer 	<ul style="list-style-type: none"> No cost +\$ 140 	<ul style="list-style-type: none"> Specify <i>with non contrasting</i>. Specify <i>with contrasting</i>.
Surface Materials	Upholstery		
	<ul style="list-style-type: none"> Customer's Own Material (COM) Fabric price group 1 Fabric price group 2 Vinyl price group 2 Fabric price group 3 Customer's Own Leather (COL) Fabric price group 4 Fabric price group 5 Fabric price group 6 Fabric price group 7 Fabric price group 8 Fabric price group 9 Fabric price group 10 Leather price group 1 Leather price group 2 	<ul style="list-style-type: none"> No cost No cost +\$ 61 +\$ 61 +\$ 145 +\$ 195 +\$ 292 +\$ 418 +\$ 686 +\$ 812 +\$1123 +\$1332 +\$1518 +\$1869 +\$2185 	<ul style="list-style-type: none"> ▶ See <i>Surface Materials Reference Manual</i>. Specify fabric color number. Specify fabric color number. Specify vinyl color number. Specify fabric color number. ▶ See <i>Surface Materials Reference Manual</i>. Specify fabric color number. Specify fabric color number. Specify fabric color number. Specify fabric color number. Specify fabric color number. Specify fabric color number. Specify fabric color number. Specify fabric color number. Specify leather color number. Specify leather color number.
	Inner		
	<ul style="list-style-type: none"> Customer's Own Material (COM) Fabric price group 1 Fabric price group 2 Vinyl price group 2 Fabric price group 3 Fabric price group 4 Customer's Own Leather (COL) Fabric price group 5 Fabric price group 6 Fabric price group 7 Fabric price group 8 Fabric price group 9 Fabric price group 10 Leather price group 1 Leather price group 2 	<ul style="list-style-type: none"> No cost No cost +\$ 31 +\$ 31 +\$ 73 +\$ 146 +\$ 195 +\$ 209 +\$ 343 +\$ 405 +\$ 561 +\$ 666 +\$ 760 +\$ 936 +\$1092 	<ul style="list-style-type: none"> ▶ See <i>Surface Materials Reference Manual</i>. Specify fabric color number. Specify fabric color number. Specify vinyl color number. Specify fabric color number. Specify fabric color number. ▶ See <i>Surface Materials Reference Manual</i>. Specify fabric color number. Specify fabric color number. Specify fabric color number. Specify fabric color number. Specify fabric color number. Specify fabric color number. Specify fabric color number. Specify leather color number. Specify leather color number.
	Outer		
	<ul style="list-style-type: none"> Customer's Own Material (COM) Fabric price group 1 Fabric price group 2 Vinyl price group 2 Fabric price group 3 Fabric price group 4 Customer's Own Leather (COL) Fabric price group 5 Fabric price group 6 Fabric price group 7 Fabric price group 8 Fabric price group 9 Fabric price group 10 Leather price group 1 Leather price group 2 	<ul style="list-style-type: none"> No cost No cost +\$ 32 +\$ 32 +\$ 73 +\$ 146 +\$ 195 +\$ 209 +\$ 343 +\$ 406 +\$ 561 +\$ 666 +\$ 760 +\$ 937 +\$1092 	<ul style="list-style-type: none"> ▶ See <i>Surface Materials Reference Manual</i>. Specify fabric color number. Specify fabric color number. Specify vinyl color number. Specify fabric color number. Specify fabric color number. ▶ See <i>Surface Materials Reference Manual</i>. Specify fabric color number. Specify fabric color number. Specify fabric color number. Specify fabric color number. Specify fabric color number. Specify fabric color number. Specify fabric color number. Specify leather color number. Specify leather color number.
Back Detail	<ul style="list-style-type: none"> Smooth Soft 	<ul style="list-style-type: none"> No cost +\$ 217 	<ul style="list-style-type: none"> Specify <i>with smooth back detail</i>. Specify <i>with soft back detail</i>.



For Canadian Pricing
 Multiply U.S. Price by the Canadian price factor.
 ▶ See page 1 for details.

Specification Information

Style Number	U.S. Base Price
WESWL0LNGF	\$2717

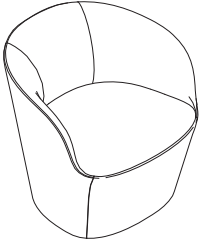

For Canadian Pricing
Multiply U.S. Price by the
Canadian price factor.
▶ See page 1 for details.

Willow Swivel Base Lounge

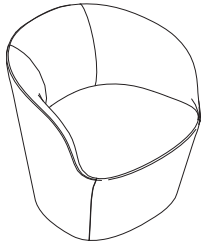

Standard Includes		Required to Specify	
<ul style="list-style-type: none"> ▶ Need help? Product details, page 32 	<ul style="list-style-type: none"> Fully upholstered non-contrasting seat with back: fabric price group 1 Back detail: smooth Swivel base 	<ul style="list-style-type: none"> 1 Style number 2 Fabric color number for chair 3 Options, if selected (see below) ▶ See <i>Surface Materials</i>, page 242. 	
Color Scheme	Options	U.S. Price	Required to Specify
	<ul style="list-style-type: none"> Non contrasting Contrasting inner and outer 	<ul style="list-style-type: none"> No cost +\$ 140 	<ul style="list-style-type: none"> Specify <i>with non contrasting</i>. Specify <i>with contrasting</i>.
Surface Materials	Upholstery		
	<ul style="list-style-type: none"> Customer's Own Material (COM) Fabric price group 1 Fabric price group 2 Vinyl price group 2 Fabric price group 3 Customer's Own Leather (COL) Fabric price group 4 Fabric price group 5 Fabric price group 6 Fabric price group 7 Fabric price group 8 Fabric price group 9 Fabric price group 10 Leather price group 1 Leather price group 2 	<ul style="list-style-type: none"> No cost No cost +\$ 61 +\$ 61 +\$ 145 +\$ 195 +\$ 292 +\$ 418 +\$ 686 +\$ 812 +\$1123 +\$1332 +\$1518 +\$1869 +\$2185 	<ul style="list-style-type: none"> ▶ See <i>Surface Materials Reference Manual</i>. Specify fabric color number. Specify fabric color number. Specify vinyl color number. Specify fabric color number. ▶ See <i>Surface Materials Reference Manual</i>. Specify fabric color number. Specify fabric color number. Specify fabric color number. Specify fabric color number. Specify fabric color number. Specify fabric color number. Specify fabric color number. Specify fabric color number. Specify leather color number. Specify leather color number.
	Inner		
	<ul style="list-style-type: none"> Customer's Own Material (COM) Fabric price group 1 Fabric price group 2 Vinyl price group 2 Fabric price group 3 Fabric price group 4 Customer's Own Leather (COL) Fabric price group 5 Fabric price group 6 Fabric price group 7 Fabric price group 8 Fabric price group 9 Fabric price group 10 Leather price group 1 Leather price group 2 	<ul style="list-style-type: none"> No cost No cost +\$ 31 +\$ 31 +\$ 73 +\$ 146 +\$ 195 +\$ 209 +\$ 343 +\$ 405 +\$ 561 +\$ 666 +\$ 760 +\$ 936 +\$1092 	<ul style="list-style-type: none"> ▶ See <i>Surface Materials Reference Manual</i>. Specify fabric color number. Specify fabric color number. Specify vinyl color number. Specify fabric color number. Specify fabric color number. ▶ See <i>Surface Materials Reference Manual</i>. Specify fabric color number. Specify fabric color number. Specify fabric color number. Specify fabric color number. Specify fabric color number. Specify fabric color number. Specify fabric color number. Specify leather color number. Specify leather color number.
	Outer		
	<ul style="list-style-type: none"> Customer's Own Material (COM) Fabric price group 1 Fabric price group 2 Vinyl price group 2 Fabric price group 3 Fabric price group 4 Customer's Own Leather (COL) Fabric price group 5 Fabric price group 6 Fabric price group 7 Fabric price group 8 Fabric price group 9 Fabric price group 10 Leather price group 1 Leather price group 2 	<ul style="list-style-type: none"> No cost No cost +\$ 32 +\$ 32 +\$ 73 +\$ 146 +\$ 195 +\$ 209 +\$ 343 +\$ 406 +\$ 561 +\$ 666 +\$ 760 +\$ 937 +\$1092 	<ul style="list-style-type: none"> ▶ See <i>Surface Materials Reference Manual</i>. Specify fabric color number. Specify fabric color number. Specify vinyl color number. Specify fabric color number. Specify fabric color number. ▶ See <i>Surface Materials Reference Manual</i>. Specify fabric color number. Specify fabric color number. Specify fabric color number. Specify fabric color number. Specify fabric color number. Specify fabric color number. Specify fabric color number. Specify leather color number. Specify leather color number.
Back Detail	<ul style="list-style-type: none"> Smooth Soft 	<ul style="list-style-type: none"> No cost +\$ 217 	<ul style="list-style-type: none"> Specify <i>with smooth back detail</i>. Specify <i>with soft back detail</i>.



For Canadian Pricing
 Multiply U.S. Price by the Canadian price factor.
 ▶ See page 1 for details.

Specification Information

Style Number	U.S. Base Price
WESWL0LNGS	\$3103

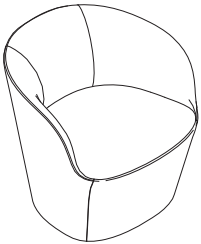



For Canadian Pricing
Multiply U.S. Price by the
Canadian price factor.
▶ See page 1 for details.

Slope Lounge Chair

Slope Lounge Chair

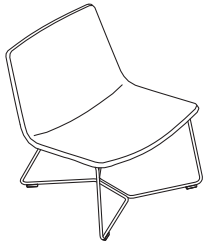
Slope



Tip: Upholstery and paint available on Steelcase Slope. Licensed Slope (stocked) lounge chair only available in saddle and fog with hot rolled steel frame.

Standard Includes		Required to Specify
<ul style="list-style-type: none"> ▶ Need help? Product details, page 34 	<ul style="list-style-type: none"> Fully upholstered seat with back: fabric price group 1 Wire frame base: paint price group 1 Glides: <ul style="list-style-type: none"> – Natural – Black Requires assembly 	<ol style="list-style-type: none"> Style number Fabric color number for chair Paint color number for base Color color number for glides Options, if selected (see below) <ul style="list-style-type: none"> ▶ See <i>Surface Materials</i>, page 242.

Options	U.S. Price	Required to Specify
Surface Materials	Upholstery	
	<ul style="list-style-type: none"> Customer's Own Material (COM) No cost Fabric price group 1 No cost Fabric price group 2 +\$ 8 Fabric price group 3 +\$ 50 Fabric price group 4 +\$ 94 Fabric price group 5 +\$211 Customer's Own Leather (COL) +\$214 Fabric price group 6 +\$250 Fabric price group 7 +\$345 Fabric price group 8 +\$448 Fabric price group 9 +\$532 Fabric price group 10 +\$650 Leather price group 1 +\$742 Leather price group 2 +\$906 	<ul style="list-style-type: none"> ▶ See <i>Surface Materials Reference Manual</i>. Specify fabric color number. Specify fabric color number. Specify fabric color number. Specify fabric color number. Specify fabric color number. ▶ See <i>Surface Materials Reference Manual</i>. Specify fabric color number. Specify fabric color number. Specify fabric color number. Specify fabric color number. Specify fabric color number. Specify leather color number. Specify leather color number.
	Base	
	<ul style="list-style-type: none"> Paint price group 1 No cost Paint price group 2 +\$ 44 Paint price group 3 +\$ 90 	<ul style="list-style-type: none"> Specify paint color number. Specify paint color number. Specify paint color number.
Vertical Seam	<ul style="list-style-type: none"> Without seam No cost With seam +\$ 12 	<ul style="list-style-type: none"> Specify <i>without seam</i>. Specify <i>with seam</i>.

Specification Information	
Style Number	U.S. Base Price
WESSLPCL	\$1315

 **For Canadian Pricing**
 Multiply U.S. Price by the Canadian price factor.
 ▶ See page 1 for details.

Slope Counter-Height Stool

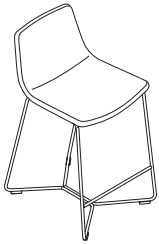

Tip: Upholstery and paint available on Steelcase Slope. Licensed Slope (stocked) counter height stool only available in saddle with hot rolled steel frame.

Standard Includes		Required to Specify
<ul style="list-style-type: none"> ▶ Need help? Product details, page 34 	<ul style="list-style-type: none"> Fully upholstered seat with back: fabric price group 1 Wire frame base: paint price group 1 Glides: <ul style="list-style-type: none"> – Natural – Black Requires assembly 	<ol style="list-style-type: none"> 1 Style number 2 Fabric color number for stool 3 Paint color number for base 4 Color number for glides 5 Options, if selected (see below) <ul style="list-style-type: none"> ▶ See <i>Surface Materials</i>, page 242.

Options	U.S. Price	Required to Specify
Surface Materials	Upholstery	
	<ul style="list-style-type: none"> Customer's Own Material (COM) No cost Fabric price group 1 No cost Fabric price group 2 +\$ 5 Fabric price group 3 +\$ 34 Fabric price group 4 +\$ 63 Fabric price group 5 +\$140 Fabric price group 6 +\$166 Customer's Own Leather (COL) +\$214 Fabric price group 7 +\$231 Fabric price group 8 +\$300 Fabric price group 9 +\$354 Fabric price group 10 +\$435 Leather price group 1 +\$476 Leather price group 2 +\$587 	<ul style="list-style-type: none"> ▶ See <i>Surface Materials Reference Manual</i>. Specify fabric color number. Specify fabric color number. Specify fabric color number. Specify fabric color number. Specify fabric color number. Specify fabric color number. ▶ See <i>Surface Materials Reference Manual</i>. Specify fabric color number. Specify fabric color number. Specify fabric color number. Specify fabric color number. Specify leather color number. Specify leather color number.
	Base	
	<ul style="list-style-type: none"> Paint price group 1 No cost Paint price group 2 +\$ 44 Paint price group 3 +\$ 90 	<ul style="list-style-type: none"> Specify paint color number. Specify paint color number. Specify paint color number.
Vertical Seam	<ul style="list-style-type: none"> Without seam No cost With seam +\$ 12 	<ul style="list-style-type: none"> Specify <i>without seam</i>. Specify <i>with seam</i>.

Specification Information	
Style Number	U.S. Base Price
WESSLPSC	\$1187

 **For Canadian Pricing**
 Multiply U.S. Price by the Canadian price factor.
 ▶ See page 1 for details.

Slope Bar-Height Stool

Slope Bar-Height Stool

Slope

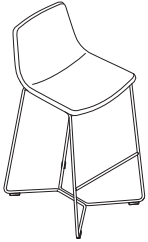

Tip: Upholstery and paint available on Steelcase Slope. Licensed Slope (stocked) bar height stool is only available in saddle with hot rolled steel frame.

Standard Includes	Required to Specify
<ul style="list-style-type: none"> ▶ Need help? Product details, page 34 Fully upholstered seat with back: fabric price group 1 Wire frame base: paint price group 1 Glides: <ul style="list-style-type: none"> – Natural – Black Requires assembly 	<ol style="list-style-type: none"> Style number Fabric color number for stool Paint color number for base Color number for glides Options, if selected (see below) <ul style="list-style-type: none"> ▶ See <i>Surface Materials</i>, page 242.

Options	U.S. Price	Required to Specify
Surface Materials	Upholstery	
	<ul style="list-style-type: none"> Customer's Own Material (COM) No cost Fabric price group 1 No cost Fabric price group 2 +\$ 5 Fabric price group 3 +\$ 34 Fabric price group 4 +\$ 63 Fabric price group 5 +\$140 Fabric price group 6 +\$166 Customer's Own Leather (COL) +\$214 Fabric price group 7 +\$231 Fabric price group 8 +\$300 Fabric price group 9 +\$354 Fabric price group 10 +\$435 Leather price group 1 +\$476 Leather price group 2 +\$587 	<ul style="list-style-type: none"> ▶ See <i>Surface Materials Reference Manual</i>. Specify fabric color number. Specify fabric color number. Specify fabric color number. Specify fabric color number. Specify fabric color number. Specify fabric color number. ▶ See <i>Surface Materials Reference Manual</i>. Specify fabric color number. Specify fabric color number. Specify fabric color number. Specify fabric color number. Specify leather color number. Specify leather color number.
	Base	
	<ul style="list-style-type: none"> Paint price group 1 No cost Paint price group 2 +\$ 44 Paint price group 3 +\$ 90 	<ul style="list-style-type: none"> Specify paint color number. Specify paint color number. Specify paint color number.
Vertical Seam	<ul style="list-style-type: none"> Without seam No cost With seam +\$ 12 	<ul style="list-style-type: none"> Specify <i>without seam</i>. Specify <i>with seam</i>.

Specification Information	
Style Number	U.S. Base Price
WESSLPSB	\$1242

 **For Canadian Pricing**
 Multiply U.S. Price by the Canadian price factor.
 ▶ See page 1 for details.

Slope Height-Adjustable Conference Chair



Tip: Upholstery and paint available on Steelcase Slope. Licensed Slope (stocked) conference chair only available in saddle and fog with hot rolled steel frame.

Standard Includes		Required to Specify
<ul style="list-style-type: none"> ▶ Need help? Product details, page 34 	<ul style="list-style-type: none"> • Fully upholstered seat with back: fabric price group 1 • Five-star adjustable base: hot-rolled steel finish • Hard casters: 6205 Black • Requires assembly 	<ol style="list-style-type: none"> 1 Style number 2 Fabric color number for chair 3 Options, if selected (see below) <ul style="list-style-type: none"> ▶ See <i>Surface Materials</i>, page 242.

Options	U.S. Price	Required to Specify
Surface Materials	Upholstery <ul style="list-style-type: none"> • Customer's Own Material (COM) No cost • Fabric price group 1 No cost • Fabric price group 2 +\$ 5 • Fabric price group 3 +\$ 34 • Fabric price group 4 +\$ 63 • Fabric price group 5 +\$140 • Fabric price group 6 +\$166 • Customer's Own Leather (COL) +\$214 • Fabric price group 7 +\$231 • Fabric price group 8 +\$300 • Fabric price group 9 +\$354 • Fabric price group 10 +\$435 • Leather price group 1 +\$476 • Leather price group 2 +\$587 	<ul style="list-style-type: none"> ▶ See <i>Surface Materials Reference Manual</i>. Specify fabric color number. Specify fabric color number. Specify fabric color number. Specify fabric color number. Specify fabric color number. Specify fabric color number. ▶ See <i>Surface Materials Reference Manual</i>. Specify fabric color number. Specify fabric color number. Specify fabric color number. Specify fabric color number. Specify leather color number. Specify leather color number.
Vertical Seam <ul style="list-style-type: none"> • Without seam • With seam 	<ul style="list-style-type: none"> No cost +\$ 12 	<ul style="list-style-type: none"> Specify <i>without seam</i>. Specify <i>with seam</i>.
Arm Type <ul style="list-style-type: none"> • Without arm • With arm 	<ul style="list-style-type: none"> No cost +\$173 	<ul style="list-style-type: none"> Specify <i>without arm</i>. Specify <i>with arm</i>.
Caster <ul style="list-style-type: none"> • Hard casters • Soft casters 	<ul style="list-style-type: none"> No cost +\$ 38 	<ul style="list-style-type: none"> Specify <i>with hard casters</i>. Specify <i>with soft casters</i>.

Specification Information	
Style Number	U.S. Base Price
WESSLPCC	\$1300

 **For Canadian Pricing**
 Multiply U.S. Price by the Canadian price factor.
 ▶ See page 1 for details.

Slope Stacking Chair

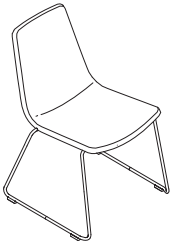

Tip: Slope stacking chair with arms is shipped fully assembled; without arms will require assembly.

Standard Includes		Required to Specify
▶ Need help? Product details, page 34	<ul style="list-style-type: none"> Fully upholstered seat with back: fabric price group 1 Wire frame base: paint price group 1 Glides: <ul style="list-style-type: none"> Natural Black 	<ol style="list-style-type: none"> Style number Fabric color number for chair Paint color number for base Color number for glides Options, if selected (see below) <p>▶ See <i>Surface Materials</i>, page 242.</p>

Options	U.S. Price	Required to Specify
Surface Materials		
Upholstery		
• Customer's Own Material (COM)	No cost	▶ See <i>Surface Materials Reference Manual</i> .
• Fabric price group 1	No cost	Specify fabric color number.
• Fabric price group 2	+\$ 5	Specify fabric color number.
• Fabric price group 3	+\$ 34	Specify fabric color number.
• Fabric price group 4	+\$ 63	Specify fabric color number.
• Fabric price group 5	+\$140	Specify fabric color number.
• Fabric price group 6	+\$166	Specify fabric color number.
• Customer's Own Leather (COL)	+\$214	▶ See <i>Surface Materials Reference Manual</i> .
• Fabric price group 7	+\$231	Specify fabric color number.
• Fabric price group 8	+\$300	Specify fabric color number.
• Fabric price group 9	+\$354	Specify fabric color number.
• Fabric price group 10	+\$435	Specify fabric color number.
• Leather price group 1	+\$476	Specify leather color number.
• Leather price group 2	+\$587	Specify leather color number.
Base		
• Paint price group 1	No cost	Specify paint color number.
• Paint price group 2	+\$ 44	Specify paint color number.
• Paint price group 3	+\$ 90	Specify paint color number.
Vertical Seam		
• Without seam	No cost	Specify <i>without seam</i> .
• With seam	+\$ 12	Specify <i>with seam</i> .
Arm Type		
• Without arm	No cost	Specify <i>without arm</i> .
• With arm	+\$173	Specify <i>with arm</i> .

Specification Information	
Style Number	U.S. Base Price
WESSLPCS	\$965

 **For Canadian Pricing**
 Multiply U.S. Price by the Canadian price factor.
 ▶ See page 1 for details.

Sterling 4-Legs Armless Guest Chair

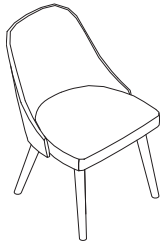

Standard Includes		Required to Specify
<ul style="list-style-type: none"> ▶ Need help? Product details, page 38 	<ul style="list-style-type: none"> Fully upholstered non-contrasting seat with back: fabric price group 1 Legs (base): veneer price group 1 Glides: plastic 	<ol style="list-style-type: none"> 1 Style number 2 Fabric color number for chair 3 Wood color number for legs (base) 4 Plastic color number for glides 5 Options, if selected (see below) <ul style="list-style-type: none"> ▶ See <i>Surface Materials</i>, page 242.

Options	U.S. Price	Required to Specify
Color Scheme		
<ul style="list-style-type: none"> Non contrasting Contrasting 	<ul style="list-style-type: none"> No cost +\$191 	<ul style="list-style-type: none"> Specify <i>with non contrasting</i>. Specify <i>with contrasting</i>.
Surface Materials		
Back		
<ul style="list-style-type: none"> Customer's Own Material (COM) Fabric price group 1 Fabric price group 2 Vinyl price group 2 Fabric price group 3 Fabric price group 4 Customer's Own Leather (COL) Fabric price group 5 Fabric price group 6 Fabric price group 7 Fabric price group 8 Fabric price group 9 Fabric price group 10 Leather price group 1 Leather price group 2 	<ul style="list-style-type: none"> No cost No cost +\$ 5 +\$ 5 +\$ 39 +\$ 80 +\$109 +\$173 +\$206 +\$287 +\$372 +\$442 +\$543 +\$592 +\$730 	<ul style="list-style-type: none"> ▶ See <i>Surface Materials Reference Manual</i>. Specify fabric color number. Specify fabric color number. Specify vinyl color number. Specify fabric color number. Specify fabric color number. ▶ See <i>Surface Materials Reference Manual</i>. Specify fabric color number. Specify fabric color number. Specify fabric color number. Specify fabric color number. Specify fabric color number. Specify fabric color number. Specify fabric color number. Specify leather color number. Specify leather color number.
Seat		
<ul style="list-style-type: none"> Customer's Own Material (COM) Fabric price group 1 Fabric price group 2 Vinyl price group 2 Fabric price group 3 Fabric price group 4 Customer's Own Leather (COL) Fabric price group 5 Fabric price group 6 Fabric price group 7 Fabric price group 8 Fabric price group 9 Fabric price group 10 Leather price group 1 Leather price group 2 	<ul style="list-style-type: none"> No cost No cost +\$ 5 +\$ 5 +\$ 34 +\$ 63 +\$109 +\$140 +\$166 +\$231 +\$300 +\$354 +\$435 +\$476 +\$587 	<ul style="list-style-type: none"> ▶ See <i>Surface Materials Reference Manual</i>. Specify fabric color number. Specify fabric color number. Specify vinyl color number. Specify fabric color number. Specify fabric color number. ▶ See <i>Surface Materials Reference Manual</i>. Specify fabric color number. Specify fabric color number. Specify fabric color number. Specify fabric color number. Specify fabric color number. Specify fabric color number. Specify fabric color number. Specify leather color number. Specify leather color number.
Base		
<ul style="list-style-type: none"> Customiz stain Veneer price group 1 Veneer price group 2 	<ul style="list-style-type: none"> No cost No cost +\$ 44 	<ul style="list-style-type: none"> Specify <i>with Customiz stain</i>. ▶ See <i>Surface Materials Reference Manual</i>. Specify wood color number. Specify wood color number.

Specification Information	
Style Number	U.S. Base Price
WESMDC4NA	\$1197

 **For Canadian Pricing**
 Multiply U.S. Price by the Canadian price factor.
 ▶ See page 1 for details.

Sterling 4-Legs with Arms Guest Chair

Sterling 4-Legs with Arms
Guest Chair

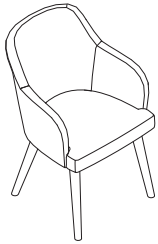

Standard Includes		Required to Specify
<ul style="list-style-type: none"> ▶ Need help? Product details, page 38 	<ul style="list-style-type: none"> Fully upholstered non-contrasting seat with back: fabric price group 1 Legs (base): veneer price group 1 Glides: plastic 	<ol style="list-style-type: none"> Style number Fabric color number for chair Wood color number for legs (base) Plastic color number for glides Options, if selected (see below) <ul style="list-style-type: none"> ▶ See <i>Surface Materials</i>, page 242.

Options	U.S. Price	Required to Specify
Color Scheme		
<ul style="list-style-type: none"> Non contrasting Contrasting 	<p>No cost</p> <p>+\$191</p>	<p>Specify <i>with non contrasting</i>.</p> <p>Specify <i>with contrasting</i>.</p>
Surface Materials		
Back		
<ul style="list-style-type: none"> Customer's Own Material (COM) Fabric price group 1 Fabric price group 2 Vinyl price group 2 Fabric price group 3 Fabric price group 4 Customer's Own Leather (COL) Fabric price group 5 Fabric price group 6 Fabric price group 7 Fabric price group 8 Fabric price group 9 Fabric price group 10 Leather price group 1 Leather price group 2 	<p>No cost</p> <p>No cost</p> <p>+\$ 8</p> <p>+\$ 8</p> <p>+\$ 50</p> <p>+\$ 94</p> <p>+\$109</p> <p>+\$211</p> <p>+\$250</p> <p>+\$345</p> <p>+\$448</p> <p>+\$532</p> <p>+\$650</p> <p>+\$712</p> <p>+\$878</p>	<ul style="list-style-type: none"> ▶ See <i>Surface Materials Reference Manual</i>. Specify fabric color number. Specify fabric color number. Specify vinyl color number. Specify fabric color number. Specify fabric color number. ▶ See <i>Surface Materials Reference Manual</i>. Specify fabric color number. Specify fabric color number. Specify fabric color number. Specify fabric color number. Specify fabric color number. Specify fabric color number. Specify fabric color number. Specify leather color number. Specify leather color number.
Seat		
<ul style="list-style-type: none"> Customer's Own Material (COM) Fabric price group 1 Fabric price group 2 Vinyl price group 2 Fabric price group 3 Fabric price group 4 Customer's Own Leather (COL) Fabric price group 5 Fabric price group 6 Fabric price group 7 Fabric price group 8 Fabric price group 9 Fabric price group 10 Leather price group 1 Leather price group 2 	<p>No cost</p> <p>No cost</p> <p>+\$ 5</p> <p>+\$ 5</p> <p>+\$ 34</p> <p>+\$ 63</p> <p>+\$109</p> <p>+\$140</p> <p>+\$166</p> <p>+\$231</p> <p>+\$300</p> <p>+\$354</p> <p>+\$435</p> <p>+\$476</p> <p>+\$587</p>	<ul style="list-style-type: none"> ▶ See <i>Surface Materials Reference Manual</i>. Specify fabric color number. Specify fabric color number. Specify vinyl color number. Specify fabric color number. Specify fabric color number. ▶ See <i>Surface Materials Reference Manual</i>. Specify fabric color number. Specify fabric color number. Specify fabric color number. Specify fabric color number. Specify fabric color number. Specify fabric color number. Specify fabric color number. Specify leather color number. Specify leather color number.
Base		
<ul style="list-style-type: none"> Customiz stain Veneer price group 1 Veneer price group 2 	<p>No cost</p> <p>No cost</p> <p>+\$ 44</p>	<p>Specify <i>with Customiz stain</i>.</p> <ul style="list-style-type: none"> ▶ See <i>Surface Materials Reference Manual</i>. Specify wood color number. Specify wood color number.

Specification Information	
Style Number	U.S. Base Price
WESMDC4WA	\$1337

 **For Canadian Pricing**
Multiply U.S. Price by the Canadian price factor.
▶ See page 1 for details.

Sterling

Sterling Armless Counter-Height Stool



Standard Includes		Required to Specify
<ul style="list-style-type: none"> ▶ Need help? Product details, page 38 	<ul style="list-style-type: none"> Fully upholstered non-contrasting seat with back: fabric price group 1 Legs (base): veneer price group 1 Glides: plastic 	<ol style="list-style-type: none"> Style number Fabric color number for chair Wood color number for legs (base) Plastic color number for glides Options, if selected (see below) <ul style="list-style-type: none"> ▶ See <i>Surface Materials</i>, page 242.

Options	U.S. Price	Required to Specify
Color Scheme		
<ul style="list-style-type: none"> Non contrasting Contrasting 	<ul style="list-style-type: none"> No cost +\$191 	<ul style="list-style-type: none"> Specify <i>with non contrasting</i>. Specify <i>with contrasting</i>.
Surface Materials		
Back		
<ul style="list-style-type: none"> Customer's Own Material (COM) Fabric price group 1 Fabric price group 2 Vinyl price group 2 Fabric price group 3 Fabric price group 4 Customer's Own Leather (COL) Fabric price group 5 Fabric price group 6 Fabric price group 7 Fabric price group 8 Fabric price group 9 Fabric price group 10 Leather price group 1 Leather price group 2 	<ul style="list-style-type: none"> No cost No cost +\$ 5 +\$ 5 +\$ 39 +\$ 80 +\$109 +\$173 +\$206 +\$287 +\$372 +\$442 +\$543 +\$592 +\$730 	<ul style="list-style-type: none"> ▶ See <i>Surface Materials Reference Manual</i>. Specify fabric color number. Specify fabric color number. Specify vinyl color number. Specify fabric color number. Specify fabric color number. ▶ See <i>Surface Materials Reference Manual</i>. Specify fabric color number. Specify fabric color number. Specify fabric color number. Specify fabric color number. Specify fabric color number. Specify fabric color number. Specify fabric color number. Specify leather color number. Specify leather color number.
Seat		
<ul style="list-style-type: none"> Customer's Own Material (COM) Fabric price group 1 Fabric price group 2 Vinyl price group 2 Fabric price group 3 Fabric price group 4 Customer's Own Leather (COL) Fabric price group 5 Fabric price group 6 Fabric price group 7 Fabric price group 8 Fabric price group 9 Fabric price group 10 Leather price group 1 Leather price group 2 	<ul style="list-style-type: none"> No cost No cost +\$ 5 +\$ 5 +\$ 34 +\$ 63 +\$109 +\$140 +\$166 +\$231 +\$300 +\$354 +\$435 +\$476 +\$587 	<ul style="list-style-type: none"> ▶ See <i>Surface Materials Reference Manual</i>. Specify fabric color number. Specify fabric color number. Specify vinyl color number. Specify fabric color number. Specify fabric color number. ▶ See <i>Surface Materials Reference Manual</i>. Specify fabric color number. Specify fabric color number. Specify fabric color number. Specify fabric color number. Specify fabric color number. Specify fabric color number. Specify fabric color number. Specify leather color number. Specify leather color number.
Base		
<ul style="list-style-type: none"> Customiz stain Veneer price group 1 Veneer price group 2 	<ul style="list-style-type: none"> No cost No cost +\$ 63 	<ul style="list-style-type: none"> Specify <i>with Customiz stain</i>. ▶ See <i>Surface Materials Reference Manual</i>. Specify wood color number. Specify wood color number.

Specification Information	
Style Number	U.S. Base Price
WESMDCSCHNA	\$1422

 **For Canadian Pricing**
 Multiply U.S. Price by the Canadian price factor.
 ▶ See page 1 for details.

Sterling Armless Bar-Height Stool

Sterling Armless Bar-Height Stool



Standard Includes		Required to Specify
▶ Need help? Product details, page 38	<ul style="list-style-type: none"> Fully upholstered non-contrasting seat with back: fabric price group 1 Legs (base): veneer price group 1 Glides: plastic 	<ol style="list-style-type: none"> Style number Fabric color number for chair Wood color number for legs (base) Plastic color number for glides Options, if selected (see below) <p>▶ See <i>Surface Materials</i>, page 242.</p>

Options	U.S. Price	Required to Specify											
Color Scheme	<ul style="list-style-type: none"> Non contrasting Contrasting+\$191 	No cost Specify with <i>non contrasting</i> . Specify with <i>contrasting</i> .											
Surface Materials	<table border="0"> <tr> <td>Back</td> <td> <ul style="list-style-type: none"> Customer's Own Material (COM) Fabric price group 1 Fabric price group 2 Vinyl price group 2 Fabric price group 3 Fabric price group 4 Customer's Own Leather (COL) Fabric price group 5 Fabric price group 6 Fabric price group 7 Fabric price group 8 Fabric price group 9 Fabric price group 10 Leather price group 1 Leather price group 2 </td> <td> No cost No cost +\$ 5 +\$ 5 +\$ 39 +\$ 80 +\$109 +\$173 +\$206 +\$287 +\$372 +\$442 +\$543 +\$592 +\$730 </td> <td> ▶ See <i>Surface Materials Reference Manual</i>. Specify fabric color number. Specify fabric color number. Specify vinyl color number. Specify fabric color number. Specify fabric color number. ▶ See <i>Surface Materials Reference Manual</i>. Specify fabric color number. Specify fabric color number. Specify fabric color number. Specify fabric color number. Specify fabric color number. Specify fabric color number. Specify fabric color number. Specify leather color number. Specify leather color number. </td> </tr> <tr> <td>Seat</td> <td> <ul style="list-style-type: none"> Customer's Own Material (COM) Fabric price group 1 Fabric price group 2 Vinyl price group 2 Fabric price group 3 Fabric price group 4 Customer's Own Leather (COL) Fabric price group 5 Fabric price group 6 Fabric price group 7 Fabric price group 8 Fabric price group 9 Fabric price group 10 Leather price group 1 Leather price group 2 </td> <td> No cost No cost +\$ 5 +\$ 5 +\$ 34 +\$ 63 +\$109 +\$140 +\$166 +\$231 +\$300 +\$354 +\$435 +\$476 +\$587 </td> <td> ▶ See <i>Surface Materials Reference Manual</i>. Specify fabric color number. Specify fabric color number. Specify vinyl color number. Specify fabric color number. Specify fabric color number. ▶ See <i>Surface Materials Reference Manual</i>. Specify fabric color number. Specify fabric color number. Specify fabric color number. Specify fabric color number. Specify fabric color number. Specify fabric color number. Specify fabric color number. Specify leather color number. Specify leather color number. </td> </tr> <tr> <td>Base</td> <td> <ul style="list-style-type: none"> Customiz stain Veneer price group 1 Veneer price group 2 </td> <td> No cost No cost +\$ 63 </td> <td> Specify with <i>Customiz stain</i>. ▶ See <i>Surface Materials Reference Manual</i>. Specify wood color number. Specify wood color number. </td> </tr> </table>	Back	<ul style="list-style-type: none"> Customer's Own Material (COM) Fabric price group 1 Fabric price group 2 Vinyl price group 2 Fabric price group 3 Fabric price group 4 Customer's Own Leather (COL) Fabric price group 5 Fabric price group 6 Fabric price group 7 Fabric price group 8 Fabric price group 9 Fabric price group 10 Leather price group 1 Leather price group 2 	No cost No cost +\$ 5 +\$ 5 +\$ 39 +\$ 80 +\$109 +\$173 +\$206 +\$287 +\$372 +\$442 +\$543 +\$592 +\$730	▶ See <i>Surface Materials Reference Manual</i> . Specify fabric color number. Specify fabric color number. Specify vinyl color number. Specify fabric color number. Specify fabric color number. ▶ See <i>Surface Materials Reference Manual</i> . Specify fabric color number. Specify fabric color number. Specify fabric color number. Specify fabric color number. Specify fabric color number. Specify fabric color number. Specify fabric color number. Specify leather color number. Specify leather color number.	Seat	<ul style="list-style-type: none"> Customer's Own Material (COM) Fabric price group 1 Fabric price group 2 Vinyl price group 2 Fabric price group 3 Fabric price group 4 Customer's Own Leather (COL) Fabric price group 5 Fabric price group 6 Fabric price group 7 Fabric price group 8 Fabric price group 9 Fabric price group 10 Leather price group 1 Leather price group 2 	No cost No cost +\$ 5 +\$ 5 +\$ 34 +\$ 63 +\$109 +\$140 +\$166 +\$231 +\$300 +\$354 +\$435 +\$476 +\$587	▶ See <i>Surface Materials Reference Manual</i> . Specify fabric color number. Specify fabric color number. Specify vinyl color number. Specify fabric color number. Specify fabric color number. ▶ See <i>Surface Materials Reference Manual</i> . Specify fabric color number. Specify fabric color number. Specify fabric color number. Specify fabric color number. Specify fabric color number. Specify fabric color number. Specify fabric color number. Specify leather color number. Specify leather color number.	Base	<ul style="list-style-type: none"> Customiz stain Veneer price group 1 Veneer price group 2 	No cost No cost +\$ 63	Specify with <i>Customiz stain</i> . ▶ See <i>Surface Materials Reference Manual</i> . Specify wood color number. Specify wood color number.
Back	<ul style="list-style-type: none"> Customer's Own Material (COM) Fabric price group 1 Fabric price group 2 Vinyl price group 2 Fabric price group 3 Fabric price group 4 Customer's Own Leather (COL) Fabric price group 5 Fabric price group 6 Fabric price group 7 Fabric price group 8 Fabric price group 9 Fabric price group 10 Leather price group 1 Leather price group 2 	No cost No cost +\$ 5 +\$ 5 +\$ 39 +\$ 80 +\$109 +\$173 +\$206 +\$287 +\$372 +\$442 +\$543 +\$592 +\$730	▶ See <i>Surface Materials Reference Manual</i> . Specify fabric color number. Specify fabric color number. Specify vinyl color number. Specify fabric color number. Specify fabric color number. ▶ See <i>Surface Materials Reference Manual</i> . Specify fabric color number. Specify fabric color number. Specify fabric color number. Specify fabric color number. Specify fabric color number. Specify fabric color number. Specify fabric color number. Specify leather color number. Specify leather color number.										
Seat	<ul style="list-style-type: none"> Customer's Own Material (COM) Fabric price group 1 Fabric price group 2 Vinyl price group 2 Fabric price group 3 Fabric price group 4 Customer's Own Leather (COL) Fabric price group 5 Fabric price group 6 Fabric price group 7 Fabric price group 8 Fabric price group 9 Fabric price group 10 Leather price group 1 Leather price group 2 	No cost No cost +\$ 5 +\$ 5 +\$ 34 +\$ 63 +\$109 +\$140 +\$166 +\$231 +\$300 +\$354 +\$435 +\$476 +\$587	▶ See <i>Surface Materials Reference Manual</i> . Specify fabric color number. Specify fabric color number. Specify vinyl color number. Specify fabric color number. Specify fabric color number. ▶ See <i>Surface Materials Reference Manual</i> . Specify fabric color number. Specify fabric color number. Specify fabric color number. Specify fabric color number. Specify fabric color number. Specify fabric color number. Specify fabric color number. Specify leather color number. Specify leather color number.										
Base	<ul style="list-style-type: none"> Customiz stain Veneer price group 1 Veneer price group 2 	No cost No cost +\$ 63	Specify with <i>Customiz stain</i> . ▶ See <i>Surface Materials Reference Manual</i> . Specify wood color number. Specify wood color number.										

Specification Information	
Style Number	U.S. Base Price
WESMDCSBHNA	\$1547

 **For Canadian Pricing**
 Multiply U.S. Price by the Canadian price factor.
 ▶ See page 1 for details.

Sterling

Sterling Armless 5-Star Conference Chair



Standard Includes		Required to Specify
<ul style="list-style-type: none"> ▶ Need help? Product details, page 38 	<ul style="list-style-type: none"> Fully upholstered seat with back: fabric price group 1 Five-star adjustable base: hot-rolled steel finish Hard casters: 6205 Black 	<ol style="list-style-type: none"> Style number Fabric color number for chair Paint color number for base Options, if selected (see below) <ul style="list-style-type: none"> ▶ See <i>Surface Materials</i>, page 242.

Options	U.S. Price	Required to Specify
Color Scheme		
<ul style="list-style-type: none"> Non contrasting Contrasting 	<ul style="list-style-type: none"> No cost +\$191 	<ul style="list-style-type: none"> Specify <i>with non contrasting</i>. Specify <i>with contrasting</i>.

Surface Materials	Back	U.S. Price	Required to Specify
	<ul style="list-style-type: none"> Customer's Own Material (COM) Fabric price group 1 Fabric price group 2 Vinyl price group 2 Fabric price group 3 Fabric price group 4 Customer's Own Leather (COL) Fabric price group 5 Fabric price group 6 Fabric price group 7 Fabric price group 8 Fabric price group 9 Fabric price group 10 Leather price group 1 Leather price group 2 	<ul style="list-style-type: none"> No cost No cost +\$ 5 +\$ 5 +\$ 39 +\$ 80 +\$109 +\$173 +\$206 +\$287 +\$372 +\$442 +\$543 +\$592 +\$730 	<ul style="list-style-type: none"> ▶ See <i>Surface Materials Reference Manual</i>. Specify fabric color number. Specify fabric color number. Specify vinyl color number. Specify fabric color number. Specify fabric color number. ▶ See <i>Surface Materials Reference Manual</i>. Specify fabric color number. Specify fabric color number. Specify fabric color number. Specify fabric color number. Specify fabric color number. Specify fabric color number. Specify fabric color number. Specify leather color number. Specify leather color number.

Seat	U.S. Price	Required to Specify
<ul style="list-style-type: none"> Customer's Own Material (COM) Fabric price group 1 Fabric price group 2 Vinyl price group 2 Fabric price group 3 Fabric price group 4 Customer's Own Leather (COL) Fabric price group 5 Fabric price group 6 Fabric price group 7 Fabric price group 8 Fabric price group 9 Fabric price group 10 Leather price group 1 Leather price group 2 	<ul style="list-style-type: none"> No cost No cost +\$ 5 +\$ 5 +\$ 34 +\$ 63 +\$109 +\$140 +\$166 +\$231 +\$300 +\$354 +\$435 +\$476 +\$587 	<ul style="list-style-type: none"> ▶ See <i>Surface Materials Reference Manual</i>. Specify fabric color number. Specify fabric color number. Specify vinyl color number. Specify fabric color number. Specify fabric color number. ▶ See <i>Surface Materials Reference Manual</i>. Specify fabric color number. Specify fabric color number. Specify fabric color number. Specify fabric color number. Specify fabric color number. Specify fabric color number. Specify leather color number. Specify leather color number.

Base	U.S. Price	Required to Specify
<ul style="list-style-type: none"> Paint price group 1 Paint price group 2 Paint price group 3 Polished aluminum 	<ul style="list-style-type: none"> No cost +\$ 44 +\$ 90 +\$136 	<ul style="list-style-type: none"> Specify paint color number. Specify paint color number. Specify paint color number. Specify <i>with polished aluminum</i>.

Caster	U.S. Price	Required to Specify
<ul style="list-style-type: none"> Hard casters Soft casters 	<ul style="list-style-type: none"> No cost +\$ 38 	<ul style="list-style-type: none"> Specify <i>with hard casters</i>. Specify <i>with soft casters</i>.

Tilt Mechanism	U.S. Price	Required to Specify
<ul style="list-style-type: none"> Without tilt With tilt 	<ul style="list-style-type: none"> No cost +\$106 	<ul style="list-style-type: none"> Specify <i>without tilt</i>. Specify <i>with tilt</i>.

Specification Information	
Style Number	U.S. Base Price
WESMDC5NA	\$1349

 **For Canadian Pricing**
 Multiply U.S. Price by the Canadian price factor.
 ▶ See page 1 for details.

Sterling 5-Star Conference Chair With Arms

Sterling 5-Star Conference
Chair With Arms



Standard Includes		Required to Specify
<ul style="list-style-type: none"> ▶ Need help? Product details, page 38 	<ul style="list-style-type: none"> Fully upholstered seat with back: fabric price group 1 Five-star adjustable base: hot-rolled steel finish Hard casters: 6205 Black 	<ol style="list-style-type: none"> Style number Fabric color number for chair Paint color number for base Options, if selected (see below) <ul style="list-style-type: none"> ▶ See <i>Surface Materials</i>, page 242.

	Options	U.S. Price	Required to Specify
Color Scheme	<ul style="list-style-type: none"> Non contrasting Contrasting 	<ul style="list-style-type: none"> No cost +\$191 	<ul style="list-style-type: none"> Specify <i>with non contrasting</i>. Specify <i>with contrasting</i>.
Surface Materials	Back	<ul style="list-style-type: none"> Customer's Own Material (COM) No cost Fabric price group 1 No cost Fabric price group 2 +\$ 8 Vinyl price group 2 +\$ 8 Fabric price group 3 +\$ 50 Fabric price group 4 +\$ 94 Customer's Own Leather (COL) +\$109 Fabric price group 5 +\$211 Fabric price group 6 +\$250 Fabric price group 7 +\$345 Fabric price group 8 +\$448 Fabric price group 9 +\$532 Fabric price group 10 +\$650 Leather price group 1 +\$712 Leather price group 2 +\$878 	<ul style="list-style-type: none"> ▶ See <i>Surface Materials Reference Manual</i>. Specify fabric color number. Specify fabric color number. Specify vinyl color number. Specify fabric color number. Specify fabric color number. ▶ See <i>Surface Materials Reference Manual</i>. Specify fabric color number. Specify fabric color number. Specify fabric color number. Specify fabric color number. Specify fabric color number. Specify fabric color number. Specify fabric color number. Specify leather color number. Specify leather color number.
	Seat	<ul style="list-style-type: none"> Customer's Own Material (COM) No cost Fabric price group 1 No cost Fabric price group 2 +\$ 5 Vinyl price group 2 +\$ 5 Fabric price group 3 +\$ 34 Fabric price group 4 +\$ 63 Customer's Own Leather (COL) +\$109 Fabric price group 5 +\$140 Fabric price group 6 +\$166 Fabric price group 7 +\$231 Fabric price group 8 +\$300 Fabric price group 9 +\$354 Fabric price group 10 +\$435 Leather price group 1 +\$476 Leather price group 2 +\$587 	<ul style="list-style-type: none"> ▶ See <i>Surface Materials Reference Manual</i>. Specify fabric color number. Specify fabric color number. Specify vinyl color number. Specify fabric color number. Specify fabric color number. ▶ See <i>Surface Materials Reference Manual</i>. Specify fabric color number. Specify fabric color number. Specify fabric color number. Specify fabric color number. Specify fabric color number. Specify fabric color number. Specify leather color number. Specify leather color number.
	Base	<ul style="list-style-type: none"> Paint price group 1 No cost Paint price group 2 +\$ 44 Paint price group 3 +\$ 90 Polished aluminum +\$136 	<ul style="list-style-type: none"> Specify paint color number. Specify paint color number. Specify paint color number. Specify <i>with polished aluminum</i>.
Caster	<ul style="list-style-type: none"> Hard casters Soft casters 	<ul style="list-style-type: none"> No cost +\$ 38 	<ul style="list-style-type: none"> Specify <i>with hard casters</i>. Specify <i>with soft casters</i>.
Tilt Mechanism	<ul style="list-style-type: none"> Without tilt With tilt 	<ul style="list-style-type: none"> No cost +\$106 	<ul style="list-style-type: none"> Specify <i>without tilt</i>. Specify <i>with tilt</i>.

Specification Information	
Style Number	U.S. Base Price
WESMDC5WA	\$1473

 **For Canadian Pricing**
Multiply U.S. Price by the Canadian price factor.
▶ See page 1 for details.

Sterling

Sterling 4-Star Armless Conference Chair



Standard Includes		Required to Specify
<ul style="list-style-type: none"> ▶ Need help? Product details, page 38 	<ul style="list-style-type: none"> Fully upholstered seat with back: fabric price group 1 Four-star base: 8046 Polished aluminum Glides: plastic 	<ol style="list-style-type: none"> Style number Fabric color number for chair Plastic color number for glides Options, if selected (see below) <ul style="list-style-type: none"> ▶ See <i>Surface Materials</i>, page 242.

Options	U.S. Price	Required to Specify
Color Scheme <ul style="list-style-type: none"> Non contrasting Contrasting 	No cost +\$191	Specify <i>with non contrasting</i> . Specify <i>with contrasting</i> .

Surface Materials	Back	U.S. Price	Required to Specify
	<ul style="list-style-type: none"> Customer's Own Material (COM) Fabric price group 1 Fabric price group 2 Vinyl price group 2 Fabric price group 3 Fabric price group 4 Customer's Own Leather (COL) Fabric price group 5 Fabric price group 6 Fabric price group 7 Fabric price group 8 Fabric price group 9 Fabric price group 10 Leather price group 1 Leather price group 2 	No cost No cost +\$ 5 +\$ 5 +\$ 39 +\$ 80 +\$109 +\$173 +\$206 +\$287 +\$372 +\$442 +\$543 +\$592 +\$730	<ul style="list-style-type: none"> ▶ See <i>Surface Materials Reference Manual</i>. Specify fabric color number. Specify fabric color number. Specify vinyl color number. Specify fabric color number. Specify fabric color number. ▶ See <i>Surface Materials Reference Manual</i>. Specify fabric color number. Specify fabric color number. Specify fabric color number. Specify fabric color number. Specify fabric color number. Specify fabric color number. Specify fabric color number. Specify leather color number. Specify leather color number.

Surface Materials	Seat	U.S. Price	Required to Specify
	<ul style="list-style-type: none"> Customer's Own Material (COM) Fabric price group 1 Fabric price group 2 Vinyl price group 2 Fabric price group 3 Fabric price group 4 Customer's Own Leather (COL) Fabric price group 5 Fabric price group 6 Fabric price group 7 Fabric price group 8 Fabric price group 9 Fabric price group 10 Leather price group 1 Leather price group 2 	No cost No cost +\$ 5 +\$ 5 +\$ 34 +\$ 63 +\$109 +\$140 +\$166 +\$231 +\$300 +\$354 +\$435 +\$476 +\$587	<ul style="list-style-type: none"> ▶ See <i>Surface Materials Reference Manual</i>. Specify fabric color number. Specify fabric color number. Specify vinyl color number. Specify fabric color number. Specify fabric color number. ▶ See <i>Surface Materials Reference Manual</i>. Specify fabric color number. Specify fabric color number. Specify fabric color number. Specify fabric color number. Specify fabric color number. Specify fabric color number. Specify fabric color number. Specify leather color number. Specify leather color number.

Specification Information	
Style Number	U.S. Base Price
WESMDC4CNFNA	\$1126

For Canadian Pricing
 Multiply U.S. Price by the Canadian price factor.
 ▶ See page 1 for details.

Sterling 4-Star Conference Chair with Arms

Sterling 4-Star Conference
Chair with Arms



Standard Includes		Required to Specify
<ul style="list-style-type: none"> ▶ Need help? Product details, page 38 	<ul style="list-style-type: none"> Fully upholstered seat with back: fabric price group 1 Four-star base: 8046 Polished aluminum Glides: plastic 	<ol style="list-style-type: none"> Style number Fabric color number for chair Plastic color number for glides Options, if selected (see below) <ul style="list-style-type: none"> ▶ See <i>Surface Materials</i>, page 242.

Options	U.S. Price	Required to Specify
Color Scheme		
<ul style="list-style-type: none"> Non contrasting Contrasting 	<p>No cost</p> <p>+\$191</p>	<p>Specify <i>with non contrasting</i>.</p> <p>Specify <i>with contrasting</i>.</p>
Surface Materials		
Back		
<ul style="list-style-type: none"> Customer's Own Material (COM) Fabric price group 1 Fabric price group 2 Vinyl price group 2 Fabric price group 3 Fabric price group 4 Customer's Own Leather (COL) Fabric price group 5 Fabric price group 6 Fabric price group 7 Fabric price group 8 Fabric price group 9 Fabric price group 10 Leather price group 1 Leather price group 2 	<p>No cost</p> <p>No cost</p> <p>+\$ 8</p> <p>+\$ 8</p> <p>+\$ 50</p> <p>+\$ 94</p> <p>+\$109</p> <p>+\$211</p> <p>+\$250</p> <p>+\$345</p> <p>+\$448</p> <p>+\$532</p> <p>+\$650</p> <p>+\$712</p> <p>+\$878</p>	<ul style="list-style-type: none"> ▶ See <i>Surface Materials Reference Manual</i>. Specify fabric color number. Specify fabric color number. Specify vinyl color number. Specify fabric color number. Specify fabric color number. ▶ See <i>Surface Materials Reference Manual</i>. Specify fabric color number. Specify fabric color number. Specify fabric color number. Specify fabric color number. Specify fabric color number. Specify fabric color number. Specify fabric color number. Specify leather color number. Specify leather color number.
Seat		
<ul style="list-style-type: none"> Customer's Own Material (COM) Fabric price group 1 Fabric price group 2 Vinyl price group 2 Fabric price group 3 Fabric price group 4 Customer's Own Leather (COL) Fabric price group 5 Fabric price group 6 Fabric price group 7 Fabric price group 8 Fabric price group 9 Fabric price group 10 Leather price group 1 Leather price group 2 	<p>No cost</p> <p>No cost</p> <p>+\$ 5</p> <p>+\$ 5</p> <p>+\$ 34</p> <p>+\$ 63</p> <p>+\$109</p> <p>+\$140</p> <p>+\$166</p> <p>+\$231</p> <p>+\$300</p> <p>+\$354</p> <p>+\$435</p> <p>+\$476</p> <p>+\$587</p>	<ul style="list-style-type: none"> ▶ See <i>Surface Materials Reference Manual</i>. Specify fabric color number. Specify fabric color number. Specify vinyl color number. Specify fabric color number. Specify fabric color number. ▶ See <i>Surface Materials Reference Manual</i>. Specify fabric color number. Specify fabric color number. Specify fabric color number. Specify fabric color number. Specify fabric color number. Specify fabric color number. Specify fabric color number. Specify leather color number. Specify leather color number.

Specification Information	
Style Number	U.S. Base Price
WESMDC4CNFWA	\$1240

 **For Canadian Pricing**
Multiply U.S. Price by the Canadian price factor.
▶ See page 1 for details.

Sterling Lounge

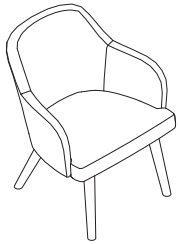

Standard Includes		Required to Specify
<ul style="list-style-type: none"> ▶ Need help? Product details, page 38 	<ul style="list-style-type: none"> Fully upholstered seat with back: fabric price group 1 Legs (base): veneer price group 1 Glides: plastic 	<ol style="list-style-type: none"> Style number Fabric color number for chair Wood color number for legs (base) Plastic color number for glides Options, if selected (see below) <ul style="list-style-type: none"> ▶ See <i>Surface Materials</i>, page 242.

Options	U.S. Price	Required to Specify
Color Scheme		
<ul style="list-style-type: none"> Non contrasting Contrasting 	<ul style="list-style-type: none"> No cost +\$191 	<ul style="list-style-type: none"> Specify <i>with non contrasting</i>. Specify <i>with contrasting</i>.
Surface Materials		
Back		
<ul style="list-style-type: none"> Customer's Own Material (COM) Fabric price group 1 Fabric price group 2 Vinyl price group 2 Fabric price group 3 Fabric price group 4 Customer's Own Leather (COL) Fabric price group 5 Fabric price group 6 Fabric price group 7 Fabric price group 8 Fabric price group 9 Fabric price group 10 Leather price group 1 Leather price group 2 	<ul style="list-style-type: none"> No cost No cost +\$ 8 +\$ 8 +\$ 50 +\$ 94 +\$109 +\$211 +\$250 +\$345 +\$448 +\$532 +\$650 +\$712 +\$878 	<ul style="list-style-type: none"> ▶ See <i>Surface Materials Reference Manual</i>. Specify fabric color number. Specify fabric color number. Specify vinyl color number. Specify fabric color number. Specify fabric color number. ▶ See <i>Surface Materials Reference Manual</i>. Specify fabric color number. Specify fabric color number. Specify fabric color number. Specify fabric color number. Specify fabric color number. Specify fabric color number. Specify fabric color number. Specify leather color number. Specify leather color number.
Seat		
<ul style="list-style-type: none"> Customer's Own Material (COM) Fabric price group 1 Fabric price group 2 Vinyl price group 2 Fabric price group 3 Fabric price group 4 Customer's Own Leather (COL) Fabric price group 5 Fabric price group 6 Fabric price group 7 Fabric price group 8 Fabric price group 9 Fabric price group 10 Leather price group 1 Leather price group 2 	<ul style="list-style-type: none"> No cost No cost +\$ 5 +\$ 5 +\$ 34 +\$ 63 +\$109 +\$140 +\$166 +\$231 +\$300 +\$354 +\$435 +\$476 +\$587 	<ul style="list-style-type: none"> ▶ See <i>Surface Materials Reference Manual</i>. Specify fabric color number. Specify fabric color number. Specify vinyl color number. Specify fabric color number. Specify fabric color number. ▶ See <i>Surface Materials Reference Manual</i>. Specify fabric color number. Specify fabric color number. Specify fabric color number. Specify fabric color number. Specify fabric color number. Specify fabric color number. Specify fabric color number. Specify leather color number. Specify leather color number.
Base		
<ul style="list-style-type: none"> Customiz stain Veneer price group 1 Veneer price group 2 	<ul style="list-style-type: none"> No cost No cost +\$ 44 	<ul style="list-style-type: none"> Specify <i>with Customiz stain</i>. ▶ See <i>Surface Materials Reference Manual</i>. Specify wood color number. Specify wood color number.

Specification Information	
Style Number	U.S. Base Price
WESMDC4LNG	\$1335

 **For Canadian Pricing**
 Multiply U.S. Price by the Canadian price factor.
 ▶ See page 1 for details.

Sterling Health—Armless Guest Chair with Metal Leg

Sterling Health—Armless Guest Chair with Metal Leg



Standard Includes		Required to Specify
<ul style="list-style-type: none"> ▶ Need help? Product details, page 38 	<ul style="list-style-type: none"> Fully upholstered non-contrasting chair: fabric price group 1 Legs (base): paint price group 1 Glides: plastic 	<ol style="list-style-type: none"> Style number Fabric color number for chair Paint color number for legs (base) Plastic color number for glides Options, if selected (see below) <ul style="list-style-type: none"> ▶ See <i>Surface Materials</i>, page 242.

Options	U.S. Price	Required to Specify
Color Scheme		
<ul style="list-style-type: none"> Non contrasting Contrasting 	<p>No cost</p> <p>+\$191</p>	<p>Specify with <i>non contrasting</i>.</p> <p>Specify with <i>contrasting</i>.</p>
Surface Materials		
Back		
<ul style="list-style-type: none"> Customer's Own Material (COM) Fabric price group 1 Fabric price group 2 Vinyl price group 2 Fabric price group 3 Fabric price group 4 Customer's Own Leather (COL) Fabric price group 5 Fabric price group 6 Fabric price group 7 Fabric price group 8 Fabric price group 9 Fabric price group 10 Leather price group 1 Leather price group 2 	<p>No cost</p> <p>No cost</p> <p>+\$ 5</p> <p>+\$ 5</p> <p>+\$ 39</p> <p>+\$ 80</p> <p>+\$109</p> <p>+\$173</p> <p>+\$206</p> <p>+\$287</p> <p>+\$372</p> <p>+\$442</p> <p>+\$543</p> <p>+\$592</p> <p>+\$730</p>	<ul style="list-style-type: none"> ▶ See <i>Surface Materials Reference Manual</i>. Specify fabric color number. Specify fabric color number. Specify vinyl color number. Specify fabric color number. Specify fabric color number. ▶ See <i>Surface Materials Reference Manual</i>. Specify fabric color number. Specify fabric color number. Specify fabric color number. Specify fabric color number. Specify fabric color number. Specify fabric color number. Specify fabric color number. Specify fabric color number. Specify leather color number. Specify leather color number.
Seat		
<ul style="list-style-type: none"> Customer's Own Material (COM) Fabric price group 1 Fabric price group 2 Vinyl price group 2 Fabric price group 3 Fabric price group 4 Customer's Own Leather (COL) Fabric price group 5 Fabric price group 6 Fabric price group 7 Fabric price group 8 Fabric price group 9 Fabric price group 10 Leather price group 1 Leather price group 2 	<p>No cost</p> <p>No cost</p> <p>+\$ 5</p> <p>+\$ 5</p> <p>+\$ 34</p> <p>+\$ 63</p> <p>+\$109</p> <p>+\$140</p> <p>+\$166</p> <p>+\$231</p> <p>+\$300</p> <p>+\$354</p> <p>+\$435</p> <p>+\$476</p> <p>+\$587</p>	<ul style="list-style-type: none"> ▶ See <i>Surface Materials Reference Manual</i>. Specify fabric color number. Specify fabric color number. Specify vinyl color number. Specify fabric color number. Specify fabric color number. ▶ See <i>Surface Materials Reference Manual</i>. Specify fabric color number. Specify fabric color number. Specify fabric color number. Specify fabric color number. Specify fabric color number. Specify fabric color number. Specify fabric color number. Specify fabric color number. Specify leather color number. Specify leather color number.
Base		
<ul style="list-style-type: none"> Paint price group 1 Paint price group 2 Paint price group 3 	<p>No cost</p> <p>+\$ 44</p> <p>+\$ 90</p>	<p>Specify paint color number.</p> <p>Specify paint color number.</p> <p>Specify paint color number.</p>

Specification Information	
Style Number	U.S. Base Price
WEHMDC4MNA	\$1613

 **For Canadian Pricing**
 Multiply U.S. Price by the Canadian price factor.
 ▶ See page 1 for details.



Sterling Health—Guest Chair with Arms and Metal Legs



Standard Includes		Required to Specify
<ul style="list-style-type: none"> ▶ Need help? Product details, page 38 	<ul style="list-style-type: none"> Fully upholstered non-contrasting chair: fabric price group 1 Legs (base): paint price group 1 Glides: plastic 	<ol style="list-style-type: none"> Style number Fabric color number for chair Paint color number for legs (base) Plastic color number for glides Options, if selected (see below) <ul style="list-style-type: none"> ▶ See <i>Surface Materials</i>, page 242.

Options	U.S. Price	Required to Specify
Color Scheme		
<ul style="list-style-type: none"> Non contrasting Contrasting 	No cost +\$191	Specify <i>with non contrasting</i> . Specify <i>with contrasting</i> .
Surface Materials		
Back		
<ul style="list-style-type: none"> Customer's Own Material (COM) Fabric price group 1 Fabric price group 2 Vinyl price group 2 Fabric price group 3 Fabric price group 4 Customer's Own Leather (COL) Fabric price group 5 Fabric price group 6 Fabric price group 7 Fabric price group 8 Fabric price group 9 Fabric price group 10 Leather price group 1 Leather price group 2 	No cost No cost +\$ 8 +\$ 8 +\$ 50 +\$ 94 +\$109 +\$211 +\$250 +\$345 +\$448 +\$532 +\$650 +\$712 +\$878	<ul style="list-style-type: none"> ▶ See <i>Surface Materials Reference Manual</i>. Specify fabric color number. Specify fabric color number. Specify vinyl color number. Specify fabric color number. Specify fabric color number. ▶ See <i>Surface Materials Reference Manual</i>. Specify fabric color number. Specify fabric color number. Specify fabric color number. Specify fabric color number. Specify fabric color number. Specify fabric color number. Specify fabric color number. Specify leather color number. Specify leather color number.
Seat		
<ul style="list-style-type: none"> Customer's Own Material (COM) Fabric price group 1 Fabric price group 2 Vinyl price group 2 Fabric price group 3 Fabric price group 4 Customer's Own Leather (COL) Fabric price group 5 Fabric price group 6 Fabric price group 7 Fabric price group 8 Fabric price group 9 Fabric price group 10 Leather price group 1 Leather price group 2 	No cost No cost +\$ 5 +\$ 5 +\$ 34 +\$ 63 +\$109 +\$140 +\$166 +\$231 +\$300 +\$354 +\$435 +\$476 +\$587	<ul style="list-style-type: none"> ▶ See <i>Surface Materials Reference Manual</i>. Specify fabric color number. Specify fabric color number. Specify vinyl color number. Specify fabric color number. Specify fabric color number. ▶ See <i>Surface Materials Reference Manual</i>. Specify fabric color number. Specify fabric color number. Specify fabric color number. Specify fabric color number. Specify fabric color number. Specify fabric color number. Specify fabric color number. Specify leather color number. Specify leather color number.
Base		
<ul style="list-style-type: none"> Paint price group 1 Paint price group 2 Paint price group 3 	No cost +\$ 44 +\$ 90	Specify paint color number. Specify paint color number. Specify paint color number.

Specification Information	
Style Number	U.S. Base Price
WEHMDC4MWA	\$1752

 **For Canadian Pricing**
 Multiply U.S. Price by the Canadian price factor.
 ▶ See page 1 for details.

Kent 5-Star Conference Chair with Arms

Kent 5-Star Conference
Chair with Arms



Standard Includes		Required to Specify	
<ul style="list-style-type: none"> ▶ Need help? Product details, page 42 	<ul style="list-style-type: none"> Fully upholstered non-contrasting seat with back: fabric price group 1 Five-star adjustable base: paint price group 1 Hard casters: 6205 Black Requires assembly 	<ol style="list-style-type: none"> Style number Fabric color number for chair Paint color number for base Options, if selected (see below) 	<ul style="list-style-type: none"> ▶ See <i>Surface Materials</i>, page 242.
Options		U.S. Price	Required to Specify
Color Scheme	<ul style="list-style-type: none"> Non contrasting Contrasting 	No cost +\$166	Specify <i>with non contrasting</i> . Specify <i>with contrasting</i> .
Back	<ul style="list-style-type: none"> Low back High back 	No cost +\$377	Specify <i>with low back</i> . Specify <i>with high back</i> .
Surface Materials	<p>Back</p> <ul style="list-style-type: none"> Customer's Own Material (COM) Fabric price group 1 Fabric price group 2 Vinyl price group 2 Fabric price group 3 Customer's Own Leather (COL) Fabric price group 4 Fabric price group 5 Fabric price group 6 Fabric price group 7 Fabric price group 8 Leather price group 1 Fabric price group 9 Leather price group 2 Fabric price group 10 <p>Seat</p> <ul style="list-style-type: none"> Customer's Own Material (COM) Fabric price group 1 Fabric price group 2 Vinyl price group 2 Fabric price group 3 Fabric price group 4 Customer's Own Leather (COL) Fabric price group 5 Fabric price group 6 Fabric price group 7 Fabric price group 8 Fabric price group 9 Leather price group 1 Fabric price group 10 Leather price group 2 <p>Base</p> <ul style="list-style-type: none"> Paint price group 1 Paint price group 2 Paint price group 3 Polished aluminum 	No cost No cost +\$ 22 +\$ 22 +\$ 52 +\$ 95 +\$118 +\$193 +\$358 +\$488 +\$630 +\$679 +\$753 +\$836 +\$884 No cost No cost +\$ 9 +\$ 9 +\$ 28 +\$ 65 +\$ 95 +\$104 +\$195 +\$266 +\$342 +\$409 +\$455 +\$482 +\$553 No cost +\$ 44 +\$ 87 +\$131	<ul style="list-style-type: none"> ▶ See <i>Surface Materials Reference Manual</i>. Specify fabric color number. Specify fabric color number. Specify vinyl color number. Specify fabric color number. ▶ See <i>Surface Materials Reference Manual</i>. Specify fabric color number. Specify fabric color number. Specify fabric color number. Specify fabric color number. Specify fabric color number. Specify leather color number. Specify fabric color number. Specify leather color number. Specify fabric color number. Specify fabric color number. ▶ See <i>Surface Materials Reference Manual</i>. Specify fabric color number. Specify fabric color number. Specify vinyl color number. Specify fabric color number. Specify fabric color number. Specify leather color number. Specify fabric color number. Specify leather color number. Specify fabric color number. Specify paint color number. Specify paint color number. Specify paint color number. Specify <i>with polished aluminum</i>. Specify <i>with hard casters</i>. Specify <i>with soft casters</i>.
Caster	<ul style="list-style-type: none"> Hard casters Soft casters 	No cost +\$ 35	Specify <i>with hard casters</i> . Specify <i>with soft casters</i> .

Specification Information	
Style Number	U.S. Base Price
WESKNT5CWA	\$1794

 **For Canadian Pricing**
Multiply U.S. Price by the Canadian price factor.
▶ See page 1 for details.

Kent

Kent 5-Star Armless Conference Chair



Standard Includes		Required to Specify	
<ul style="list-style-type: none"> ▶ Need help? Product details, page 42 	<ul style="list-style-type: none"> Fully upholstered non-contrasting seat with back: fabric price group 1 Five-star adjustable base: paint price group 1 Hard casters: 6205 Black Requires assembly 	<ol style="list-style-type: none"> Style number Fabric color number for chair Paint color number for base Options, if selected (see below) 	<ul style="list-style-type: none"> ▶ See <i>Surface Materials</i>, page 242.
Options		U.S. Price	Required to Specify
Color Scheme	<ul style="list-style-type: none"> Non contrasting Contrasting 	No cost +\$166	Specify <i>with non contrasting</i> . Specify <i>with contrasting</i> .
Surface Materials	<p>Back</p> <ul style="list-style-type: none"> Customer's Own Material (COM) No cost Fabric price group 1 No cost Fabric price group 2 +\$ 9 Vinyl price group 2 +\$ 9 Fabric price group 3 +\$ 28 Fabric price group 4 +\$ 65 Customer's Own Leather (COL) +\$ 95 Fabric price group 5 +\$104 Fabric price group 6 +\$195 Fabric price group 7 +\$266 Fabric price group 8 +\$342 Fabric price group 9 +\$409 Leather price group 1 +\$455 Fabric price group 10 +\$482 Leather price group 2 +\$553 <p>Seat</p> <ul style="list-style-type: none"> Customer's Own Material (COM) No cost Fabric price group 1 No cost Fabric price group 2 +\$ 9 Vinyl price group 2 +\$ 9 Fabric price group 3 +\$ 28 Fabric price group 4 +\$ 65 Customer's Own Leather (COL) +\$ 95 Fabric price group 5 +\$104 Fabric price group 6 +\$195 Fabric price group 7 +\$266 Fabric price group 8 +\$342 Fabric price group 9 +\$409 Leather price group 1 +\$455 Fabric price group 10 +\$482 Leather price group 2 +\$553 <p>Base</p> <ul style="list-style-type: none"> Paint price group 1 No cost Paint price group 2 +\$ 44 Paint price group 3 +\$ 87 Polished aluminum +\$131 	No cost No cost +\$ 9 +\$ 9 +\$ 28 +\$ 65 +\$ 95 +\$104 +\$195 +\$266 +\$342 +\$409 +\$455 +\$482 +\$553	<ul style="list-style-type: none"> ▶ See <i>Surface Materials Reference Manual</i>. Specify fabric color number. Specify fabric color number. Specify vinyl color number. Specify fabric color number. Specify fabric color number. ▶ See <i>Surface Materials Reference Manual</i>. Specify fabric color number. Specify fabric color number. Specify fabric color number. Specify fabric color number. Specify fabric color number. Specify fabric color number. Specify leather color number. Specify fabric color number. Specify leather color number.
Caster	<ul style="list-style-type: none"> Hard casters Soft casters 	No cost +\$ 35	Specify <i>with hard casters</i> . Specify <i>with soft casters</i> .

Specification Information

Style Number	U.S. Base Price
WESKNT5CNA	\$1629



For Canadian Pricing
 Multiply U.S. Price by the Canadian price factor.
 ▶ See page 1 for details.

Kent 4-Star Conference Chair with Arms

Kent 4-Star Conference
Chair with Arms



Standard Includes		Required to Specify
<ul style="list-style-type: none"> ▶ Need help? Product details, page 42 	<ul style="list-style-type: none"> Fully upholstered non-contrasting seat with back: fabric price group 1 Four-star adjustable base: paint price group 1 Hard casters: 6205 Black Requires assembly 	<ol style="list-style-type: none"> Style number Fabric color number for chair Paint color number for base Options, if selected (see below) <ul style="list-style-type: none"> ▶ See <i>Surface Materials</i>, page 242.

Options	U.S. Price	Required to Specify
Color Scheme		
<ul style="list-style-type: none"> Non contrasting Contrasting 	<ul style="list-style-type: none"> No cost +\$166 	<ul style="list-style-type: none"> Specify <i>with non contrasting</i>. Specify <i>with contrasting</i>.
Back		
<ul style="list-style-type: none"> Low back High back 	<ul style="list-style-type: none"> No cost +\$377 	<ul style="list-style-type: none"> Specify <i>with low back</i>. Specify <i>with high back</i>.

Surface Materials	Back	U.S. Price	Required to Specify
	<ul style="list-style-type: none"> Customer's Own Material (COM) Fabric price group 1 Fabric price group 2 Vinyl price group 2 Fabric price group 3 Customer's Own Leather (COL) Fabric price group 4 Fabric price group 5 Fabric price group 6 Fabric price group 7 Fabric price group 8 Leather price group 1 Fabric price group 9 Leather price group 2 Fabric price group 10 	<ul style="list-style-type: none"> No cost No cost +\$ 22 +\$ 22 +\$ 52 +\$ 95 +\$118 +\$193 +\$358 +\$488 +\$630 +\$679 +\$753 +\$836 +\$884 	<ul style="list-style-type: none"> ▶ See <i>Surface Materials Reference Manual</i>. Specify fabric color number. Specify fabric color number. Specify vinyl color number. Specify fabric color number. ▶ See <i>Surface Materials Reference Manual</i>. Specify fabric color number. Specify fabric color number. Specify fabric color number. Specify fabric color number. Specify fabric color number. Specify fabric color number. Specify leather color number. Specify fabric color number. Specify leather color number. Specify fabric color number.

Seat	U.S. Price	Required to Specify
<ul style="list-style-type: none"> Customer's Own Material (COM) Fabric price group 1 Fabric price group 2 Vinyl price group 2 Fabric price group 3 Fabric price group 4 Customer's Own Leather (COL) Fabric price group 5 Fabric price group 6 Fabric price group 7 Fabric price group 8 Fabric price group 9 Leather price group 1 Fabric price group 10 Leather price group 2 	<ul style="list-style-type: none"> No cost No cost +\$ 9 +\$ 9 +\$ 28 +\$ 65 +\$ 95 +\$104 +\$195 +\$266 +\$342 +\$409 +\$455 +\$482 +\$553 	<ul style="list-style-type: none"> ▶ See <i>Surface Materials Reference Manual</i>. Specify fabric color number. Specify fabric color number. Specify vinyl color number. Specify fabric color number. Specify fabric color number. ▶ See <i>Surface Materials Reference Manual</i>. Specify fabric color number. Specify fabric color number. Specify fabric color number. Specify fabric color number. Specify fabric color number. Specify leather color number. Specify fabric color number. Specify leather color number.

Base	U.S. Price	Required to Specify
<ul style="list-style-type: none"> Paint price group 1 Paint price group 2 Paint price group 3 Polished aluminum 	<ul style="list-style-type: none"> No cost +\$ 44 +\$ 87 +\$131 	<ul style="list-style-type: none"> Specify paint color number. Specify paint color number. Specify paint color number. Specify <i>with polished aluminum</i>.

Caster	U.S. Price	Required to Specify
<ul style="list-style-type: none"> Hard casters Soft casters 	<ul style="list-style-type: none"> No cost +\$ 35 	<ul style="list-style-type: none"> Specify <i>with hard casters</i>. Specify <i>with soft casters</i>.

Specification Information	
Style Number	U.S. Base Price
WESKNT4CWA	\$1794

 **For Canadian Pricing**
Multiply U.S. Price by the Canadian price factor.
▶ See page 1 for details.

Kent 4-Star Armless Conference Chair



Standard Includes		Required to Specify	
<ul style="list-style-type: none"> ▶ Need help? Product details, page 42 	<ul style="list-style-type: none"> Fully upholstered non-contrasting seat with back: fabric price group 1 Four-star base: paint price group 1 Hard casters: 6205 Black Requires assembly 	<ol style="list-style-type: none"> Style number Fabric color number for chair Paint color number for base Options, if selected (see below) <ul style="list-style-type: none"> ▶ See <i>Surface Materials</i>, page 242. 	
Options		U.S. Price	Required to Specify
Color Scheme	<ul style="list-style-type: none"> Non contrasting Contrasting 	No cost +\$166	Specify <i>with non contrasting</i> . Specify <i>with contrasting</i> .
Surface Materials	<p>Back</p> <ul style="list-style-type: none"> Customer's Own Material (COM) No cost Fabric price group 1 No cost Fabric price group 2 +\$ 9 Vinyl price group 2 +\$ 9 Fabric price group 3 +\$ 28 Fabric price group 4 +\$ 65 Customer's Own Leather (COL) +\$ 95 Fabric price group 5 +\$104 Fabric price group 6 +\$195 Fabric price group 7 +\$266 Fabric price group 8 +\$342 Fabric price group 9 +\$409 Leather price group 1 +\$455 Fabric price group 10 +\$482 Leather price group 2 +\$553 <p>Seat</p> <ul style="list-style-type: none"> Customer's Own Material (COM) No cost Fabric price group 1 No cost Fabric price group 2 +\$ 9 Vinyl price group 2 +\$ 9 Fabric price group 3 +\$ 28 Fabric price group 4 +\$ 65 Customer's Own Leather (COL) +\$ 95 Fabric price group 5 +\$104 Fabric price group 6 +\$195 Fabric price group 7 +\$266 Fabric price group 8 +\$342 Fabric price group 9 +\$409 Leather price group 1 +\$455 Fabric price group 10 +\$482 Leather price group 2 +\$553 <p>Base</p> <ul style="list-style-type: none"> Paint price group 1 No cost Paint price group 2 +\$ 44 Paint price group 3 +\$ 87 Polished aluminum +\$131 		<ul style="list-style-type: none"> ▶ See <i>Surface Materials Reference Manual</i>. Specify fabric color number. Specify fabric color number. Specify vinyl color number. Specify fabric color number. Specify fabric color number. ▶ See <i>Surface Materials Reference Manual</i>. Specify fabric color number. Specify fabric color number. Specify fabric color number. Specify fabric color number. Specify fabric color number. Specify leather color number. Specify fabric color number. Specify leather color number. <ul style="list-style-type: none"> ▶ See <i>Surface Materials Reference Manual</i>. Specify fabric color number. Specify fabric color number. Specify vinyl color number. Specify fabric color number. Specify fabric color number. ▶ See <i>Surface Materials Reference Manual</i>. Specify fabric color number. Specify fabric color number. Specify fabric color number. Specify fabric color number. Specify fabric color number. Specify leather color number. Specify fabric color number. Specify leather color number.
Caster	<ul style="list-style-type: none"> Hard casters Soft casters 	No cost +\$ 35	Specify <i>with hard casters</i> . Specify <i>with soft casters</i> .

Specification Information

Style Number	U.S. Base Price
WESKNT4CNA	\$1629



For Canadian Pricing
 Multiply U.S. Price by the Canadian price factor.
 ▶ See page 1 for details.

Kent 4-Leg Guest Chair with Arms

Kent 4-Leg Guest
Chair with Arms



Standard Includes		Required to Specify
<ul style="list-style-type: none"> ▶ Need help? Product details, page 42 	<ul style="list-style-type: none"> Fully upholstered non-contrasting seat with back: fabric price group 1 Legs (base): paint price group 1 Glides: plastic 	<ol style="list-style-type: none"> Style number Fabric color number for chair Paint color number for base Plastic color number for glides Options, if selected (see below) <ul style="list-style-type: none"> ▶ See <i>Surface Materials</i>, page 242.

Options	U.S. Price	Required to Specify
Color Scheme		
<ul style="list-style-type: none"> Non contrasting Contrasting 	<p>No cost</p> <p>+\$166</p>	<p>Specify <i>with non contrasting</i>.</p> <p>Specify <i>with contrasting</i>.</p>
Back		
<ul style="list-style-type: none"> Low back High back 	<p>No cost</p> <p>+\$229</p>	<p>Specify <i>with low back</i>.</p> <p>Specify <i>with high back</i>.</p>
Surface Materials		
Back		
<ul style="list-style-type: none"> Customer's Own Material (COM) Fabric price group 1 Fabric price group 2 Vinyl price group 2 Fabric price group 3 Customer's Own Leather (COL) Fabric price group 4 Fabric price group 5 Fabric price group 6 Fabric price group 7 Fabric price group 8 Leather price group 1 Fabric price group 9 Leather price group 2 Fabric price group 10 	<p>No cost</p> <p>No cost</p> <p>+\$ 22</p> <p>+\$ 22</p> <p>+\$ 52</p> <p>+\$ 95</p> <p>+\$118</p> <p>+\$193</p> <p>+\$358</p> <p>+\$488</p> <p>+\$630</p> <p>+\$679</p> <p>+\$753</p> <p>+\$836</p> <p>+\$884</p>	<ul style="list-style-type: none"> ▶ See <i>Surface Materials Reference Manual</i>. Specify fabric color number. Specify fabric color number. Specify vinyl color number. Specify fabric color number. ▶ See <i>Surface Materials Reference Manual</i>. Specify fabric color number. Specify fabric color number. Specify fabric color number. Specify fabric color number. Specify fabric color number. Specify fabric color number. Specify leather color number. Specify fabric color number. Specify leather color number. Specify fabric color number.
Seat		
<ul style="list-style-type: none"> Customer's Own Material (COM) Fabric price group 1 Fabric price group 2 Vinyl price group 2 Fabric price group 3 Fabric price group 4 Customer's Own Leather (COL) Fabric price group 5 Fabric price group 6 Fabric price group 7 Fabric price group 8 Fabric price group 9 Leather price group 1 Fabric price group 10 Leather price group 2 	<p>No cost</p> <p>No cost</p> <p>+\$ 9</p> <p>+\$ 9</p> <p>+\$ 28</p> <p>+\$ 65</p> <p>+\$ 95</p> <p>+\$104</p> <p>+\$195</p> <p>+\$266</p> <p>+\$342</p> <p>+\$409</p> <p>+\$455</p> <p>+\$482</p> <p>+\$553</p>	<ul style="list-style-type: none"> ▶ See <i>Surface Materials Reference Manual</i>. Specify fabric color number. Specify fabric color number. Specify vinyl color number. Specify fabric color number. Specify fabric color number. ▶ See <i>Surface Materials Reference Manual</i>. Specify fabric color number. Specify fabric color number. Specify fabric color number. Specify fabric color number. Specify fabric color number. Specify leather color number. Specify fabric color number. Specify leather color number.
Base		
<ul style="list-style-type: none"> Paint price group 1 Paint price group 2 Paint price group 3 Polished chrome 	<p>No cost</p> <p>+\$ 44</p> <p>+\$ 87</p> <p>+\$131</p>	<p>Specify paint color number.</p> <p>Specify paint color number.</p> <p>Specify paint color number.</p> <p>Specify <i>with polished chrome</i>.</p>

Specification Information	
Style Number	U.S. Base Price
WESKNT4LWA	\$1545

 **For Canadian Pricing**
Multiply U.S. Price by the Canadian price factor.
▶ See page 1 for details.



Kent 4-Leg Armless Guest Chair



Standard Includes		Required to Specify
<ul style="list-style-type: none"> ▶ Need help? Product details, page 42 	<ul style="list-style-type: none"> Fully upholstered non-contrasting seat with back: fabric price group 1 Legs (base): paint price group 1 Glides: plastic 	<ol style="list-style-type: none"> Style number Fabric color number for chair Paint color number for base Plastic color number for glides Options, if selected (see below) <ul style="list-style-type: none"> ▶ See <i>Surface Materials</i>, page 242.

Options	U.S. Price	Required to Specify
Color Scheme		
<ul style="list-style-type: none"> Non contrasting Contrasting 	<ul style="list-style-type: none"> No cost +\$166 	<ul style="list-style-type: none"> Specify <i>with non contrasting</i>. Specify <i>with contrasting</i>.
Surface Materials		
Back		
<ul style="list-style-type: none"> Customer's Own Material (COM) Fabric price group 1 Fabric price group 2 Vinyl price group 2 Fabric price group 3 Fabric price group 4 Customer's Own Leather (COL) Fabric price group 5 Fabric price group 6 Fabric price group 7 Fabric price group 8 Fabric price group 9 Leather price group 1 Fabric price group 10 Leather price group 2 	<ul style="list-style-type: none"> No cost No cost +\$ 9 +\$ 9 +\$ 28 +\$ 65 +\$ 95 +\$104 +\$195 +\$266 +\$342 +\$409 +\$455 +\$482 +\$553 	<ul style="list-style-type: none"> ▶ See <i>Surface Materials Reference Manual</i>. Specify fabric color number. Specify fabric color number. Specify vinyl color number. Specify fabric color number. Specify fabric color number. ▶ See <i>Surface Materials Reference Manual</i>. Specify fabric color number. Specify fabric color number. Specify fabric color number. Specify fabric color number. Specify fabric color number. Specify fabric color number. Specify leather color number. Specify fabric color number. Specify leather color number.
Seat		
<ul style="list-style-type: none"> Customer's Own Material (COM) Fabric price group 1 Fabric price group 2 Vinyl price group 2 Fabric price group 3 Fabric price group 4 Customer's Own Leather (COL) Fabric price group 5 Fabric price group 6 Fabric price group 7 Fabric price group 8 Fabric price group 9 Leather price group 1 Fabric price group 10 Leather price group 2 	<ul style="list-style-type: none"> No cost No cost +\$ 9 +\$ 9 +\$ 28 +\$ 65 +\$ 95 +\$104 +\$195 +\$266 +\$342 +\$409 +\$455 +\$482 +\$553 	<ul style="list-style-type: none"> ▶ See <i>Surface Materials Reference Manual</i>. Specify fabric color number. Specify fabric color number. Specify vinyl color number. Specify fabric color number. Specify fabric color number. ▶ See <i>Surface Materials Reference Manual</i>. Specify fabric color number. Specify fabric color number. Specify fabric color number. Specify fabric color number. Specify fabric color number. Specify fabric color number. Specify leather color number. Specify fabric color number. Specify leather color number.
Base		
<ul style="list-style-type: none"> Paint price group 1 Paint price group 2 Paint price group 3 Polished chrome 	<ul style="list-style-type: none"> No cost +\$ 44 +\$ 87 +\$131 	<ul style="list-style-type: none"> Specify paint color number. Specify paint color number. Specify paint color number. Specify <i>with polished chrome</i>.

Specification Information	
Style Number	U.S. Base Price
WESKNT4LNA	\$1377

 **For Canadian Pricing**
 Multiply U.S. Price by the Canadian price factor.
 ▶ See page 1 for details.

Kent 5-Star Conference Stool with Arms

Kent 5-Star Conference Stool with Arms

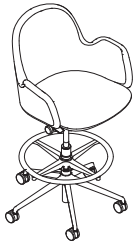

Standard Includes		Required to Specify
<ul style="list-style-type: none"> ▶ Need help? Product details, page 42 	<ul style="list-style-type: none"> Fully upholstered non-contrasting seat with back: fabric price group 1 Five-star adjustable base with stool ring: paint price group 1 Hard casters: 6205 Black Requires assembly 	<ol style="list-style-type: none"> Style number Fabric color number for stool Paint color number for base Options, if selected (see below) <ul style="list-style-type: none"> ▶ See <i>Surface Materials</i>, page 242.

Options	U.S. Price	Required to Specify
Color Scheme		
<ul style="list-style-type: none"> Non contrasting Contrasting 	No cost +\$166	Specify <i>with non contrasting</i> . Specify <i>with contrasting</i> .
Surface Materials		
Back		
<ul style="list-style-type: none"> Customer's Own Material (COM) Fabric price group 1 Fabric price group 2 Vinyl price group 2 Fabric price group 3 Customer's Own Leather (COL) Fabric price group 4 Fabric price group 5 Fabric price group 6 Fabric price group 7 Fabric price group 8 Leather price group 1 Fabric price group 9 Fabric price group 10 Leather price group 2 	No cost No cost +\$ 20 +\$ 20 +\$ 49 +\$ 95 +\$109 +\$175 +\$326 +\$445 +\$572 +\$679 +\$685 +\$803 +\$836	<ul style="list-style-type: none"> ▶ See <i>Surface Materials Reference Manual</i>. Specify fabric color number. Specify fabric color number. Specify vinyl color number. Specify fabric color number. ▶ See <i>Surface Materials Reference Manual</i>. Specify fabric color number. Specify fabric color number. Specify fabric color number. Specify fabric color number. Specify fabric color number. Specify fabric color number. Specify leather color number. Specify fabric color number. Specify fabric color number. Specify leather color number.
Seat		
<ul style="list-style-type: none"> Customer's Own Material (COM) Fabric price group 1 Fabric price group 2 Vinyl price group 2 Fabric price group 3 Fabric price group 4 Customer's Own Leather (COL) Fabric price group 5 Fabric price group 6 Fabric price group 7 Fabric price group 8 Fabric price group 9 Leather price group 1 Fabric price group 10 Leather price group 2 	No cost No cost +\$ 9 +\$ 9 +\$ 28 +\$ 65 +\$ 95 +\$104 +\$195 +\$266 +\$342 +\$409 +\$455 +\$482 +\$553	<ul style="list-style-type: none"> ▶ See <i>Surface Materials Reference Manual</i>. Specify fabric color number. Specify fabric color number. Specify vinyl color number. Specify fabric color number. Specify fabric color number. ▶ See <i>Surface Materials Reference Manual</i>. Specify fabric color number. Specify fabric color number. Specify fabric color number. Specify fabric color number. Specify fabric color number. Specify leather color number. Specify fabric color number. Specify leather color number.
Base		
<ul style="list-style-type: none"> Paint price group 1 Paint price group 2 Paint price group 3 Polished aluminum 	No cost +\$ 44 +\$ 87 +\$131	Specify paint color number. Specify paint color number. Specify paint color number. Specify <i>with polished aluminum</i> .
Caster		
<ul style="list-style-type: none"> Hard casters Soft casters 	No cost +\$ 35	Specify <i>with hard casters</i> . Specify <i>with soft casters</i> .

Specification Information	
Style Number	U.S. Base Price
WESKNT5SWA	\$2334

 **For Canadian Pricing**
 Multiply U.S. Price by the Canadian price factor.
 ▶ See page 1 for details.

Kent

Kent 5-Star Armless Conference Stool

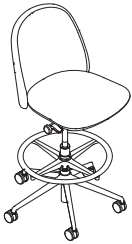

Standard Includes		Required to Specify
<ul style="list-style-type: none"> ▶ Need help? Product details, page 42 	<ul style="list-style-type: none"> Fully upholstered non-contrasting seat with back: fabric price group 1 Five-star adjustable base with stool ring: paint price group 1 Hard casters: 6205 Black Requires assembly 	<ol style="list-style-type: none"> Style number Fabric color number for stool Paint color number for base Options, if selected (see below) <ul style="list-style-type: none"> ▶ See <i>Surface Materials</i>, page 242.

Options	U.S. Price	Required to Specify
Color Scheme		
<ul style="list-style-type: none"> Non contrasting Contrasting 	<ul style="list-style-type: none"> No cost +\$166 	<ul style="list-style-type: none"> Specify <i>with non contrasting</i>. Specify <i>with contrasting</i>.
Surface Materials		
Back		
<ul style="list-style-type: none"> Customer's Own Material (COM) Fabric price group 1 Fabric price group 2 Vinyl price group 2 Fabric price group 3 Fabric price group 4 Customer's Own Leather (COL) Fabric price group 5 Fabric price group 6 Fabric price group 7 Fabric price group 8 Fabric price group 9 Leather price group 1 Fabric price group 10 Leather price group 2 	<ul style="list-style-type: none"> No cost No cost +\$ 9 +\$ 9 +\$ 28 +\$ 65 +\$ 95 +\$104 +\$195 +\$266 +\$342 +\$409 +\$455 +\$482 +\$553 	<ul style="list-style-type: none"> ▶ See <i>Surface Materials Reference Manual</i>. Specify fabric color number. Specify fabric color number. Specify vinyl color number. Specify fabric color number. Specify fabric color number. ▶ See <i>Surface Materials Reference Manual</i>. Specify fabric color number. Specify fabric color number. Specify fabric color number. Specify fabric color number. Specify fabric color number. Specify fabric color number. Specify leather color number. Specify fabric color number. Specify leather color number.
Seat		
<ul style="list-style-type: none"> Customer's Own Material (COM) Fabric price group 1 Fabric price group 2 Vinyl price group 2 Fabric price group 3 Fabric price group 4 Customer's Own Leather (COL) Fabric price group 5 Fabric price group 6 Fabric price group 7 Fabric price group 8 Fabric price group 9 Leather price group 1 Fabric price group 10 Leather price group 2 	<ul style="list-style-type: none"> No cost No cost +\$ 9 +\$ 9 +\$ 28 +\$ 65 +\$ 95 +\$104 +\$195 +\$266 +\$342 +\$409 +\$455 +\$482 +\$553 	<ul style="list-style-type: none"> ▶ See <i>Surface Materials Reference Manual</i>. Specify fabric color number. Specify fabric color number. Specify vinyl color number. Specify fabric color number. Specify fabric color number. ▶ See <i>Surface Materials Reference Manual</i>. Specify fabric color number. Specify fabric color number. Specify fabric color number. Specify fabric color number. Specify fabric color number. Specify fabric color number. Specify leather color number. Specify fabric color number. Specify leather color number.
Base		
<ul style="list-style-type: none"> Paint price group 1 Paint price group 2 Paint price group 3 Polished aluminum 	<ul style="list-style-type: none"> No cost +\$ 44 +\$ 87 +\$131 	<ul style="list-style-type: none"> Specify paint color number. Specify paint color number. Specify paint color number. Specify <i>with polished aluminum</i>.
Caster		
<ul style="list-style-type: none"> Hard casters Soft casters 	<ul style="list-style-type: none"> No cost +\$ 35 	<ul style="list-style-type: none"> Specify <i>with hard casters</i>. Specify <i>with soft casters</i>.

Specification Information	
Style Number	U.S. Base Price
WESKNT5SNA	\$2165

 **For Canadian Pricing**
 Multiply U.S. Price by the Canadian price factor.
 ▶ See page 1 for details.

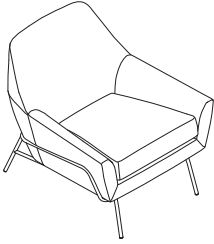

Standard Includes		Required to Specify
<ul style="list-style-type: none"> ▶ Need help? Product details, page 46 	<ul style="list-style-type: none"> Fully upholstered seat with back: fabric price group 1 Wire frame base: WE05 West Elm Burnished Bronze 	<ul style="list-style-type: none"> 1 Style number 2 Fabric color number for chair 3 Options, if selected (see below) ▶ See <i>Surface Materials</i>, page 242.

Options	U.S. Price	Required to Specify
Upholstery		
• Customer's Own Material (COM)	No cost	▶ See <i>Surface Materials Reference Manual</i> . Specify fabric color number.
• Fabric price group 1	No cost	Specify vinyl color number.
• Vinyl price group 2	+\$ 68	Specify fabric color number.
• Fabric price group 2	+\$ 68	Specify fabric color number.
• Fabric price group 3	+\$ 158	Specify fabric color number.
• Customer's Own Leather (COL)	+\$ 195	▶ See <i>Surface Materials Reference Manual</i> . Specify fabric color number.
• Fabric price group 4	+\$ 318	Specify fabric color number.
• Fabric price group 5	+\$ 456	Specify fabric color number.
• Fabric price group 6	+\$ 747	Specify fabric color number.
• Fabric price group 7	+\$ 885	Specify fabric color number.
• Fabric price group 8	+\$1223	Specify fabric color number.
• Fabric price group 9	+\$1453	Specify fabric color number.
• Fabric price group 10	+\$1654	Specify fabric color number.
• Leather price group 1	+\$2222	Specify leather color number.
• Leather price group 2	+\$2595	Specify leather color number.

Specification Information	
Style Number	U.S. Base Price
WESLUCW	\$2892



For Canadian Pricing
 Multiply U.S. Price by the Canadian price factor.
 ▶ See page 1 for details.

Lucas Swivel Chair

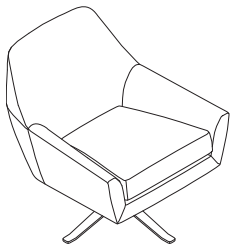

Standard Includes		Required to Specify
▶ Need help? Product details, page 46	<ul style="list-style-type: none"> Fully upholstered seat with back: fabric price group 1 Swivel base: 8046 Polished Aluminum 	1 Style number 2 Fabric color number for chair 3 Options, if selected (see below) ▶ See <i>Surface Materials</i> , page 242.

Options	U.S. Price	Required to Specify
Upholstery		
• Customer's Own Material (COM)	No cost	▶ See <i>Surface Materials Reference Manual</i> .
• Fabric price group 1	No cost	Specify fabric color number.
• Vinyl price group 2	+\$ 68	Specify vinyl color number.
• Fabric price group 2	+\$ 68	Specify fabric color number.
• Fabric price group 3	+\$ 158	Specify fabric color number.
• Customer's Own Leather (COL)	+\$ 195	▶ See <i>Surface Materials Reference Manual</i> .
• Fabric price group 4	+\$ 318	Specify fabric color number.
• Fabric price group 5	+\$ 456	Specify fabric color number.
• Fabric price group 6	+\$ 747	Specify fabric color number.
• Fabric price group 7	+\$ 885	Specify fabric color number.
• Fabric price group 8	+\$1223	Specify fabric color number.
• Fabric price group 9	+\$1453	Specify fabric color number.
• Fabric price group 10	+\$1654	Specify fabric color number.
• Leather price group 1	+\$2222	Specify leather color number.
• Leather price group 2	+\$2595	Specify leather color number.

Specification Information	
• Style Number	• U.S. Base Price
WESLUCS	\$3111

 **For Canadian Pricing**
 Multiply U.S. Price by the Canadian price factor.
 ▶ See page 1 for details.

Fulton Guest Chair

Fulton Guest Chair

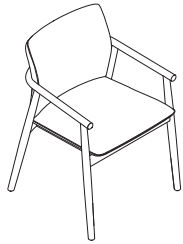

Standard Includes		Required to Specify
<ul style="list-style-type: none"> ▶ Need help? Product details, page 48 	<ul style="list-style-type: none"> Fully upholstered non-contrasting seat with back: fabric price group 1 Frame: veneer price group 1 Glides 	<ol style="list-style-type: none"> Style number Fabric color number for chair Wood color number for frame Options, if selected (see below) <ul style="list-style-type: none"> ▶ See <i>Surface Materials</i>, page 242.

Options	U.S. Price	Required to Specify
Surface Materials		
Upholstery		
• Customer's Own Material (COM)	No cost	<ul style="list-style-type: none"> ▶ See <i>Surface Materials Reference Manual</i>. Specify fabric color number. Specify vinyl color number. Specify fabric color number. Specify fabric color number. ▶ See <i>Surface Materials Reference Manual</i>. Specify fabric color number. Specify fabric color number. Specify fabric color number. Specify fabric color number. Specify fabric color number. Specify fabric color number. Specify fabric color number. Specify leather color number. Specify leather color number.
• Fabric price group 1	No cost	
• Vinyl price group 2	+\$ 19	
• Fabric price group 2	+\$ 19	
• Fabric price group 3	+\$ 65	
• Customer's Own Leather (COL)	+\$ 109	
• Fabric price group 4	+\$ 137	
• Fabric price group 5	+\$ 257	
• Fabric price group 6	+\$ 333	
• Fabric price group 7	+\$ 429	
• Fabric price group 8	+\$ 516	
• Fabric price group 9	+\$ 591	
• Fabric price group 10	+\$ 688	
• Leather price group 1	+\$1162	
• Leather price group 2	+\$1426	
Frame		
• Customiz stain	No cost	Specify <i>with Customiz stain</i> .
• Veneer price group 1	No cost	<ul style="list-style-type: none"> ▶ See <i>Surface Materials Reference Manual</i>. Specify wood color number. Specify wood color number.
• Veneer price group 2	+\$ 62	
Color cord		
• Non contrasting	No cost	Specify <i>with non contrasting</i> .
• Contrasting	+\$ 32	Specify <i>with contrasting</i> .
Cord		
• Customer's Own Material (COM)	No cost	<ul style="list-style-type: none"> ▶ See <i>Surface Materials Reference Manual</i>. Specify fabric color number. Specify vinyl color number. Specify fabric color number. Specify fabric color number. ▶ See <i>Surface Materials Reference Manual</i>. Specify fabric color number. Specify fabric color number. Specify fabric color number. Specify fabric color number. Specify fabric color number. Specify fabric color number. Specify leather color number. Specify leather color number.
• Fabric price group 1	No cost	
• Vinyl price group 2	+\$ 5	
• Fabric price group 2	+\$ 5	
• Fabric price group 3	+\$ 16	
• Customer's Own Leather (COL)	+\$ 16	
• Fabric price group 4	+\$ 35	
• Fabric price group 5	+\$ 65	
• Fabric price group 6	+\$ 83	
• Fabric price group 7	+\$ 107	
• Fabric price group 8	+\$ 129	
• Fabric price group 9	+\$ 148	
• Fabric price group 10	+\$ 172	
• Leather price group 1	+\$ 291	
• Leather price group 2	+\$ 357	

Specification Information	
Style Number	U.S. Base Price
WESFTNCG	\$1942

 **For Canadian Pricing**
 Multiply U.S. Price by the Canadian price factor.
 ▶ See page 1 for details.



Fulton Lounge Chair

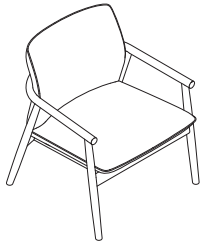

Standard Includes		Required to Specify
<ul style="list-style-type: none"> ▶ Need help? Product details, page 48 	<ul style="list-style-type: none"> Fully upholstered non-contrasting seat with back: fabric price group 1 Frame: veneer price group 1 Glides 	<ol style="list-style-type: none"> 1 Style number 2 Fabric color number for chair 3 Wood color number for frame 4 Options, if selected (see below) <ul style="list-style-type: none"> ▶ See <i>Surface Materials</i>, page 242.

Options	U.S. Price	Required to Specify	
Surface Materials			
Upholstery			
• Customer's Own Material (COM)	No cost	▶ See <i>Surface Materials Reference Manual</i> . Specify fabric color number.	
• Fabric price group 1	No cost		
• Vinyl price group 2	+\$ 26		
• Fabric price group 2	+\$ 26		
• Fabric price group 3	+\$ 87		
• Customer's Own Leather (COL)	+\$ 109		
• Fabric price group 4	+\$ 183		
• Fabric price group 5	+\$ 343		
• Fabric price group 6	+\$ 444		
• Fabric price group 7	+\$ 572		
• Fabric price group 8	+\$ 688	▶ See <i>Surface Materials Reference Manual</i> . Specify fabric color number.	
• Fabric price group 9	+\$ 787		
• Fabric price group 10	+\$ 916		
• Leather price group 1	+\$1549		
• Leather price group 2	+\$1902		
Frame			
• Customiz stain	No cost		Specify with <i>Customiz stain</i> .
▶ See <i>Surface Materials Reference Manual</i> .			
• Veneer price group 1	No cost		Specify wood color number.
• Veneer price group 2	+\$ 62		Specify wood color number.
Color cord			
• Non contrasting	No cost	Specify with <i>non contrasting</i> .	
• Contrasting	+\$ 32	Specify with <i>contrasting</i> .	
Cord			
• Customer's Own Material (COM)	No cost	▶ See <i>Surface Materials Reference Manual</i> . Specify fabric color number.	
• Fabric price group 1	No cost		
• Vinyl price group 2	+\$ 6		
• Fabric price group 2	+\$ 6		
• Fabric price group 3	+\$ 22		
• Customer's Own Leather (COL)	+\$ 22		
• Fabric price group 4	+\$ 45		
• Fabric price group 5	+\$ 85		
• Fabric price group 6	+\$ 112		
• Fabric price group 7	+\$ 142		
• Fabric price group 8	+\$ 172	▶ See <i>Surface Materials Reference Manual</i> . Specify fabric color number.	
• Fabric price group 9	+\$ 197		
• Fabric price group 10	+\$ 229		
• Leather price group 1	+\$ 387		
• Leather price group 2	+\$ 476		

Specification Information	
• Style Number	• U.S. Base Price
WESFTNCL	\$2776



For Canadian Pricing
 Multiply U.S. Price by the Canadian price factor.
 ▶ See page 1 for details.

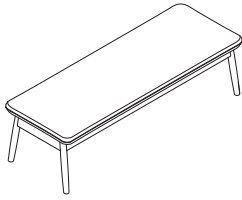

Standard Includes	Required to Specify
<ul style="list-style-type: none"> Need help? Product details, page 48 Fully upholstered non-contrasting seat: fabric price group 1 Frame: veneer price group 1 Glides 	<ol style="list-style-type: none"> Style number Fabric color number for bench Wood color number for frame Options, if selected (see below) <p>▶ See <i>Surface Materials</i>, page 242.</p>

Options	U.S. Price	Required to Specify
<p>Surface Materials</p> <ul style="list-style-type: none"> Customer's Own Material (COM) Fabric price group 1 Vinyl price group 2 Fabric price group 2 Fabric price group 3 Customer's Own Leather (COL) Fabric price group 4 Fabric price group 5 Fabric price group 6 Fabric price group 7 Fabric price group 8 Fabric price group 9 Fabric price group 10 Leather price group 1 Leather price group 2 	<ul style="list-style-type: none"> No cost No cost +\$ 26 +\$ 26 +\$ 87 +\$ 109 +\$ 183 +\$ 343 +\$ 444 +\$ 572 +\$ 688 +\$ 787 +\$ 917 +\$1549 +\$1902 	<p>▶ See <i>Surface Materials Reference Manual</i>. Specify fabric color number. Specify vinyl color number. Specify fabric color number. Specify fabric color number.</p> <p>▶ See <i>Surface Materials Reference Manual</i>. Specify fabric color number. Specify fabric color number. Specify fabric color number. Specify fabric color number. Specify fabric color number. Specify fabric color number. Specify fabric color number. Specify fabric color number. Specify fabric color number. Specify leather color number. Specify leather color number.</p>
<p>Upholstery</p> <ul style="list-style-type: none"> Customer's Own Material (COM) Fabric price group 1 Vinyl price group 2 Fabric price group 2 Fabric price group 3 Customer's Own Leather (COL) Fabric price group 4 Fabric price group 5 Fabric price group 6 Fabric price group 7 Fabric price group 8 Fabric price group 9 Fabric price group 10 Leather price group 1 Leather price group 2 	<ul style="list-style-type: none"> No cost No cost +\$ 26 +\$ 26 +\$ 87 +\$ 109 +\$ 183 +\$ 343 +\$ 444 +\$ 572 +\$ 688 +\$ 787 +\$ 917 +\$1549 +\$1902 	<p>▶ See <i>Surface Materials Reference Manual</i>. Specify fabric color number. Specify vinyl color number. Specify fabric color number. Specify fabric color number.</p> <p>▶ See <i>Surface Materials Reference Manual</i>. Specify fabric color number. Specify fabric color number. Specify fabric color number. Specify fabric color number. Specify fabric color number. Specify fabric color number. Specify fabric color number. Specify fabric color number. Specify fabric color number. Specify leather color number. Specify leather color number.</p>
<p>Frame</p> <ul style="list-style-type: none"> Customiz stain Veneer price group 1 Veneer price group 2 	<ul style="list-style-type: none"> No cost No cost +\$ 62 	<p>Specify with <i>Customiz stain</i>.</p> <p>▶ See <i>Surface Materials Reference Manual</i>. Specify wood color number. Specify wood color number.</p>
<p>Color cord</p> <ul style="list-style-type: none"> Non contrasting Contrasting 	<ul style="list-style-type: none"> No cost +\$ 32 	<p>Specify with <i>non contrasting</i>.</p> <p>Specify with <i>contrasting</i>.</p>
<p>Cord</p> <ul style="list-style-type: none"> Customer's Own Material (COM) Fabric price group 1 Vinyl price group 2 Fabric price group 2 Fabric price group 2 Fabric price group 3 Customer's Own Leather (COL) Fabric price group 4 Fabric price group 5 Fabric price group 6 Fabric price group 7 Fabric price group 8 Fabric price group 9 Fabric price group 10 Leather price group 1 Leather price group 2 	<ul style="list-style-type: none"> No cost No cost +\$ 6 +\$ 6 +\$ 22 +\$ 22 +\$ 45 +\$ 85 +\$ 112 +\$ 142 +\$ 172 +\$ 197 +\$ 229 +\$ 387 +\$ 476 	<p>▶ See <i>Surface Materials Reference Manual</i>. Specify fabric color number. Specify vinyl color number. Specify fabric color number. Specify fabric color number.</p> <p>▶ See <i>Surface Materials Reference Manual</i>. Specify fabric color number. Specify fabric color number. Specify fabric color number. Specify fabric color number. Specify fabric color number. Specify fabric color number. Specify fabric color number. Specify fabric color number. Specify fabric color number. Specify leather color number. Specify leather color number.</p>

Specification Information	
Style Number	U.S. Base Price
WESFTNBH	\$2220

For Canadian Pricing
 Multiply U.S. Price by the Canadian price factor.
 ▶ See page 1 for details.



Greenpoint Private Office Desk

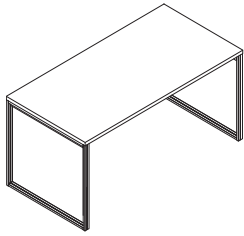

Tip: Edge will be matching veneer flat profile on side and back edges when wood top surface is selected, or 3 mm plastic edge when laminate top surface is selected.

Standard Includes		Required to Specify
<ul style="list-style-type: none"> ▶ Need help? Product details, page 52 	<ul style="list-style-type: none"> • Desk worksurface: High-Pressure Laminate price group 1 • Square tube legs (frame): paint price group 1 • 1½" leveling glides 	<ol style="list-style-type: none"> 1 Style number 2 Specify depth 3 Specify width 4 Laminate color number for worksurface 5 Paint color number for legs (frame) 6 Options, if selected (see below) <ul style="list-style-type: none"> ▶ See <i>Surface Materials</i>, page 242.

	Options	U.S. Price	Required to Specify
Depth	<ul style="list-style-type: none"> • 30" • 36" 	Prices below Prices below	Select 30" depth. Select 36" depth.
Width	<ul style="list-style-type: none"> • 60" • 66" • 72" 	Prices below Prices below Prices below	Select 60" width. Select 66" width. Select 72" width.
Surface Materials	<p>Top</p> <ul style="list-style-type: none"> • High-Pressure Laminate price group 1 • High-Pressure Laminate price group 2 • Veneer price group 1 • West Elm veneer <p>Frame</p> <ul style="list-style-type: none"> • Paint price group 1 • Paint price group 2 <ul style="list-style-type: none"> – 30"D – 36"D • Paint price group 3 <ul style="list-style-type: none"> – 30"D – 36"D 	Prices below Prices below Prices below Prices below No cost +\$ 44 +\$ 52 +\$ 90 +\$104	Specify laminate color number. Specify laminate color number. Specify wood color number. Specify West Elm wood color number. Specify paint color number. Specify paint color number. Specify paint color number. Specify paint color number.
Cutout Type	<ul style="list-style-type: none"> • No cutout • Cutout center • Cutout left • Cutout right 	No cost +\$ 75 +\$ 75 +\$ 75	Specify <i>with no cutout</i> . Specify <i>with center cutout</i> . Specify <i>with left cutout</i> . Specify <i>with right cutout</i> .

Specification Information

• Style Number	• Depth	• U.S. Base Prices		
		60"W	66"W	72"W
:	:	:	:	:

High-Pressure Laminate Price Group 1

WESINDPD	Depth	60"W	66"W	72"W
	30"	\$2326	\$2392	\$2460
	36"	N.A.	N.A.	\$2593

High-Pressure Laminate Price Group 2

WESINDPD	Depth	60"W	66"W	72"W
	30"	\$2497	\$2565	\$2630
	36"	N.A.	N.A.	\$2764

West Elm Veneer

WESINDPD	Depth	60"W	66"W	72"W
	30"	\$2771	\$2839	\$2905
	36"	N.A.	N.A.	\$3037

Veneer Price Group 1

WESINDPD	Depth	60"W	66"W	72"W
	30"	\$3201	\$3306	\$3407
	36"	N.A.	N.A.	\$3615

 **For Canadian Pricing**
Multiply U.S. Price by the Canadian price factor.
▶ See page 1 for details.

Greenpoint Private Office Desk Return with Leg

Greenpoint Private Office
Desk Return with Leg

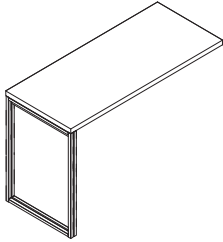

Tip: Edge will be matching veneer flat profile on side and back edges when wood top surface is selected, or 3 mm plastic edge when laminate top surface is selected.

Standard Includes		Required to Specify
<ul style="list-style-type: none"> ▶ Need help? Product details, page 52 	<ul style="list-style-type: none"> • Desk worksurface: High-Pressure Laminate price group 1 • Square tube legs (frame): paint price group 1 • 1½" leveling glides 	<ol style="list-style-type: none"> 1 Style number 2 Specify depth 3 Specify width 4 Laminate color number for worksurface 5 Paint color number for legs (frame) 6 Options, if selected (see below) <ul style="list-style-type: none"> ▶ See <i>Surface Materials</i>, page 242.

	Options	U.S. Price	Required to Specify
Depth	<ul style="list-style-type: none"> • 18" • 24" 	Prices below Prices below	Select 18" depth. Select 24" depth.
Width	<ul style="list-style-type: none"> • 42" • 48" • 54" • 60" 	Prices below Prices below Prices below Prices below	Select 42" width. Select 48" width. Select 54" width. Select 60" width.
Surface Materials	<p>Top</p> <ul style="list-style-type: none"> • High-Pressure Laminate price group 1 • High-Pressure Laminate price group 2 • Veneer price group 1 • West Elm veneer <p>Frame</p> <ul style="list-style-type: none"> • Paint price group 1 • Paint price group 2 <ul style="list-style-type: none"> – 18"D – 24"D • Paint price group 3 <ul style="list-style-type: none"> – 18"D – 24"D 	Prices below Prices below Prices below Prices below No cost +\$16 +\$20 +\$30 +\$37	Specify laminate color number. Specify laminate color number. Specify wood color number. Specify West Elm wood color number. Specify paint color number. Specify paint color number. Specify paint color number. Specify paint color number.

Specification Information

• Style Number	• Depth	• U.S. Base Prices			
		• 42"W	• 48"W	• 54"W	• 60"W
•	•	•	•	•	•

High-Pressure Laminate Price Group 1

WESINDRL	18"	24"	42"W	48"W	54"W	60"W
	\$1207	\$1285	\$1273	\$1349	\$1341	\$1409

High-Pressure Laminate Price Group 2

WESINDRL	18"	24"	42"W	48"W	54"W	60"W
	\$1335	\$1409	\$1402	\$1474	\$1467	\$1609

West Elm Veneer

WESINDRL	18"	24"	42"W	48"W	54"W	60"W
	\$1490	\$1563	\$1556	\$1628	\$1623	\$1762

Veneer Price Group 1

WESINDRL	18"	24"	42"W	48"W	54"W	60"W
	\$1662	\$1779	\$1727	\$1845	\$1839	\$2030

 **For Canadian Pricing**
Multiply U.S. Price by the Canadian price factor.
▶ See page 1 for details.

Greenpoint
Private Office

Greenpoint Private Office Desk Return with Pedestal

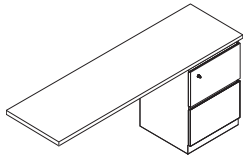

► Need help? Product details, page 52

Standard Includes

- Desk worksurface: High-Pressure Laminate price group 1
- Under worksurface file/file pedestal case: paint price group 1
- Under worksurface file/file pedestal front: High-Pressure Laminate price group 1
- Basic pedestal configuration
- Lock on pedestal
- 1½" leveling glides

Required to Specify

- 1 Style number
 - 2 Specify depth
 - 3 Specify width
 - 4 Laminate color number for worksurface
 - 5 Paint color number for pedestal case
 - 6 Laminate color number for pedestal front
 - 7 Options, if selected (see below)
- See *Surface Materials*, page 242.

Tip: Edge will be matching veneer flat profile on side and back edges when wood top surface is selected, or 3 mm plastic edge when laminate top surface is selected.

*Tip: When specified in High-Pressure Laminate, the pull of the drawer will be painted according to the matrix in the *Surface Materials* section.*

*Tip: Drawer fronts on pedestal are available in limited High-Pressure Laminate and veneer finishes. See *Surface Materials* section for more information.*

	Options	U.S. Price	Required to Specify
Depth	<ul style="list-style-type: none"> • 18" • 24" 	Prices at right Prices at right	Specify 18" depth. Specify 24" depth.
Width	<ul style="list-style-type: none"> • 42" • 48" • 54" • 60" 	Prices at right Prices at right Prices at right Prices at right	Specify 42" width. Specify 48" width. Specify 54" width. Specify 60" width.
Surface Materials	<p>Top</p> <ul style="list-style-type: none"> • High-Pressure Laminate price group 1 • High-Pressure Laminate price group 2 • Veneer price group 1 • West Elm veneer <p>Case</p> <ul style="list-style-type: none"> • Paint price group 1 • Paint price group 2 • Paint price group 3 <p>Front</p> <ul style="list-style-type: none"> • Wood veneer • West Elm open pore • High-Pressure Laminate price group 1 • High-Pressure Laminate price group 2 <p>Lock</p> <ul style="list-style-type: none"> • Ember chrome • Polished chrome 	Prices at right Prices at right Prices at right Prices at right No cost +\$ 44 +\$ 81 No cost No cost No cost No cost No cost No cost	Specify laminate color number. Specify laminate color number. Specify wood color number. Specify West Elm wood color number. Specify paint color number. Specify paint color number. Specify paint color number. Specify wood color number. Specify West Elm wood color number. Specify laminate color number. Specify laminate color number. Specify with 9250 Ember Chrome lock. Specify with 9201 Polished Chrome lock.
Lock and Keying	<ul style="list-style-type: none"> • Keying 	No cost	► See <i>Lock and Keying</i>
Drawer Configuration	<ul style="list-style-type: none"> • File/file • Box/box/file 	No cost +\$174	Specify with <i>file/file pedestal</i> . Specify with <i>box/box/file pedestal</i> .
Drawer Interior	<ul style="list-style-type: none"> • Basic drawer • Full drawer 	No cost +\$ 75	Specify with <i>basic drawer</i> . Specify with <i>full drawer</i> .
Drawer Accessories	<ul style="list-style-type: none"> • No rail • With rail 	No cost No cost	Specify with <i>no rail</i> . Specify with <i>with rail</i> .



For Canadian Pricing

Multiply U.S. Price by the Canadian price factor.

► See page 1 for details.

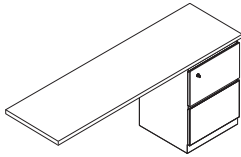

Specification Information

• Style Number	• Depth	• U.S. Base Prices			
		42"W	48"W	54"W	60"W

High-Pressure Laminate Price Group 1

WESINDRP	Depth	42"W	48"W	54"W	60"W
	18"	\$2130	\$2196	\$2264	\$2332
	24"	\$2213	\$2278	\$2345	\$2414

High-Pressure Laminate Price Group 2

WESINDRP	Depth	42"W	48"W	54"W	60"W
	18"	\$2258	\$2325	\$2390	\$2459
	24"	\$2339	\$2405	\$2473	\$2538

West Elm Veneer

WESINDRP	Depth	42"W	48"W	54"W	60"W
	18"	\$2413	\$2479	\$2546	\$2612
	24"	\$2493	\$2559	\$2626	\$2692

Veneer Price Group 1

WESINDRP	Depth	42"W	48"W	54"W	60"W
	18"	\$2626	\$2692	\$2803	\$2872
	24"	\$2752	\$2821	\$2938	\$3005

 **For Canadian Pricing**
Multiply U.S. Price by the Canadian price factor.
▶ See page 1 for details.

Greenpoint Private Office Modesty Panel

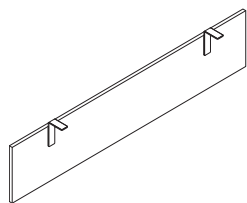

Tip: A modesty panel is available and ordered separately, in widths from 48" to 78". They can be specified in either wood veneer or High-Pressure Laminate. Modesty panels are specified one size smaller than the desk to allow for 3" clearance on both ends to accommodate the legs. Modesty panel can be mounted flush or inset with the edge of the worksurface. Modesty panel allows for 1" cord gap between the surface.

Standard Includes		Required to Specify
▶ Need help? Product details, page 52	<ul style="list-style-type: none"> Modesty panel: High-Pressure Laminate price group 1 Mounting brackets: black paint 	1 Style number 2 Laminate color number for modesty panel 3 Options, if selected (see below) ▶ See <i>Surface Materials</i> , page 242.

Options	U.S. Price	Required to Specify
Width		
• 42"	Prices below	Specify 42" width.
• 48"	Prices below	Specify 48" width.
• 54"	Prices below	Specify 54" width.
• 60"	Prices below	Specify 60" width.
• 72"	Prices below	Specify 72" width.
• 78"	Prices below	Specify 78" width.
Surface Materials		
• High-Pressure Laminate price group 1	Prices below	Specify laminate color number.
• High-Pressure Laminate price group 2	Prices below	Specify laminate color number.
• Veneer price group 1	Prices below	Specify wood color number.
• West Elm veneer	Prices below	Specify West Elm wood color number.

Specification Information

Style Number	Depth	U.S. Base Prices					
		42"W	48"W	54"W	60"W	72"W	78"W
•	•	•	•	•	•	•	•
•	•	•	•	•	•	•	•

High-Pressure Laminate Price Group 1

WESINDMP	12 1/2"	\$487	\$517	\$546	\$577	\$ 605	\$ 635
•	•	•	•	•	•	•	•

High-Pressure Laminate Price Group 2

WESINDMP	12 1/2"	\$582	\$615	\$643	\$673	\$ 702	\$ 733
•	•	•	•	•	•	•	•

West Elm Veneer

WESINDMP	12 1/2"	\$745	\$775	\$804	\$836	\$ 865	\$ 894
•	•	•	•	•	•	•	•

Veneer Price Group 1

WESINDMP	12 1/2"	\$857	\$887	\$932	\$961	\$1079	\$1109
•	•	•	•	•	•	•	•

 **For Canadian Pricing**
 Multiply U.S. Price by the Canadian price factor.
 ▶ See page 1 for details.

Greenpoint Private Office Filing Credenza

Greenpoint Private Office
Filing Credenza

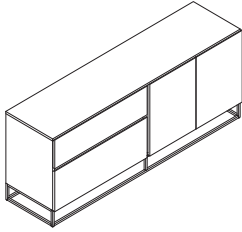

Tip: When specified in High-Pressure Laminate, the pull of the drawer will be painted according to the matrix in the Surface Materials section.

Standard Includes	Required to Specify
<ul style="list-style-type: none"> ▶ Need help? Product details, page 52 • Credenza: High-Pressure Laminate price group 1 • Square tube legs (frame): paint price group 1 • 1½" leveling glides 	<ul style="list-style-type: none"> 1 Style number 2 Laminate color number for modesty panel 3 Paint color number for legs (frame) 4 Options, if selected (see below) ▶ See <i>Surface Materials</i>, page 242.

Options	U.S. Price	Required to Specify
Surface Materials <ul style="list-style-type: none"> • High-Pressure Laminate price group 1 • High-Pressure Laminate price group 2 • West Elm veneer • Veneer price group 1 	<ul style="list-style-type: none"> No cost +\$ 970 +\$1430 +\$6291 	<ul style="list-style-type: none"> Specify laminate color number. Specify laminate color number. Specify West Elm wood color number. Specify wood color number.
Frame <ul style="list-style-type: none"> • Paint price group 1 • Paint price group 2 • Paint price group 3 	<ul style="list-style-type: none"> No cost +\$ 44 +\$ 78 	<ul style="list-style-type: none"> Specify paint color number. Specify paint color number. Specify paint color number.

Specification Information	
Style Number	U.S. Base Price
WESINDFC	\$5658

For Canadian Pricing
Multiply U.S. Price by the Canadian price factor.
▶ See page 1 for details.

Greenpoint
Private Office

Greenpoint Private Office Storage Credenza

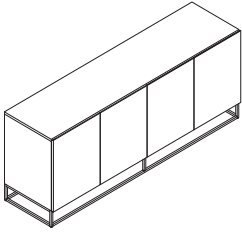

Tip: When specified in High-Pressure Laminate, the pull of the drawer will be painted according to the matrix in the Surface Materials section.

Standard Includes		Required to Specify
<ul style="list-style-type: none"> ▶ Need help? Product details, page 52 	<ul style="list-style-type: none"> • Credenza: High-Pressure Laminate price group 1 • Square tube legs (frame): paint price group 1 • 1½" leveling glides 	<ol style="list-style-type: none"> 1 Style number 2 High-Pressure Laminate color number for credenza 3 Paint color number for legs (frame) 4 Options, if selected (see below) <ul style="list-style-type: none"> ▶ See <i>Surface Materials</i>, page 242.

Options	U.S. Price	Required to Specify
Surface Materials		
Case <ul style="list-style-type: none"> • High-Pressure Laminate price group 1 • High-Pressure Laminate price group 2 • West Elm veneer • Veneer price group 1 	No cost +\$1110 +\$1423 +\$6122	Specify laminate color number. Specify laminate color number. Specify West Elm wood color number. Specify wood color number.
Frame <ul style="list-style-type: none"> • Paint price group 1 • Paint price group 2 • Paint price group 3 	No cost +\$ 44 +\$ 78	Specify paint color number. Specify paint color number. Specify paint color number.

Specification Information	
• Style Number	• U.S. Base Price
WESINDSC	\$4924



For Canadian Pricing
 Multiply U.S. Price by the Canadian price factor.
 ▶ See page 1 for details.

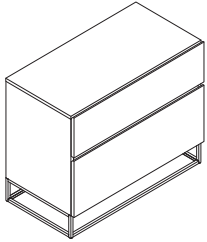

Tip: When specified in High-Pressure Laminate, the pull of the drawer will be painted according to the matrix in the Surface Materials section.

Standard Includes	Required to Specify
<ul style="list-style-type: none"> ▶ Need help? Product details, page 52 • Lateral file: High-Pressure Laminate price group 1 • Square tube legs (frame): paint price group 1 • 1½" leveling glides 	<ul style="list-style-type: none"> 1 Style number 2 High-Pressure Laminate color number for credenza 3 Paint color number for legs (frame) 4 Options, if selected (see below) ▶ See <i>Surface Materials</i>, page 242.

Options	U.S. Price	Required to Specify
Surface Materials <ul style="list-style-type: none"> • High-Pressure Laminate price group 1 • High-Pressure Laminate price group 2 • West Elm veneer • Veneer price group 1 	<ul style="list-style-type: none"> No cost +\$ 535 +\$ 896 +\$3319 	<ul style="list-style-type: none"> Specify laminate color number. Specify laminate color number. Specify West Elm wood color number. Specify wood color number.
Frame <ul style="list-style-type: none"> • Paint price group 1 • Paint price group 2 • Paint price group 3 	<ul style="list-style-type: none"> No cost +\$ 24 +\$ 37 	<ul style="list-style-type: none"> Specify paint color number. Specify paint color number. Specify paint color number.

Specification Information	
Style Number	U.S. Base Price
WESINDLF	\$3782

 **For Canadian Pricing**
Multiply U.S. Price by the Canadian price factor.
▶ See page 1 for details.

Greenpoint Private Office Low Open Bookcase

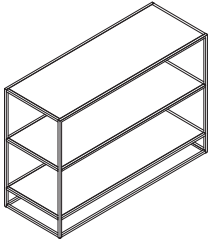

Standard Includes		Required to Specify
<ul style="list-style-type: none"> ▶ Need help? Product details, page 52 	<ul style="list-style-type: none"> • Bookcase shelf: High-Pressure Laminate price group 1 • Square tube legs (frame): paint price group 1 • 1½" leveling glides 	<ul style="list-style-type: none"> 1 Style number 2 High-Pressure Laminate color number for bookcase shelf 3 Paint color number for legs (frame) 4 Options, if selected (see below) ▶ See <i>Surface Materials</i>, page 242.

Options	U.S. Price	Required to Specify
Surface Materials Shelf <ul style="list-style-type: none"> • High-Pressure Laminate price group 1 • High-Pressure Laminate price group 2 • West Elm veneer • Veneer price group 1 	<ul style="list-style-type: none"> No cost +\$224 +\$224 +\$757 	<ul style="list-style-type: none"> Specify laminate color number. Specify laminate color number. Specify West Elm wood color number. Specify wood color number.
Frame <ul style="list-style-type: none"> • Paint price group 1 • Paint price group 2 • Paint price group 3 	<ul style="list-style-type: none"> No cost +\$ 44 +\$ 90 	<ul style="list-style-type: none"> Specify paint color number. Specify paint color number. Specify paint color number.

Specification Information	
• Style Number	• U.S. Base Price
WESINDLOB	\$2716



For Canadian Pricing
 Multiply U.S. Price by the Canadian price factor.
 ▶ See page 1 for details.

Greenpoint Private Office Narrow Open Bookcase

Greenpoint Private Office
Narrow Open Bookcase

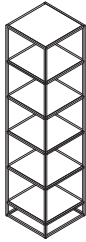

Standard Includes	Required to Specify
<ul style="list-style-type: none"> ▶ Need help? Product details, page 52 • Bookcase shelf: High-Pressure Laminate price group 1 • Square tube legs (frame): paint price group 1 • 1½" leveling glides 	<ul style="list-style-type: none"> 1 Style number 2 High-Pressure Laminate color number for bookcase shelf 3 Paint color number for legs (frame) 4 Options, if selected (see below) ▶ See <i>Surface Materials</i>, page 242.

Options	U.S. Price	Required to Specify
Surface Materials <ul style="list-style-type: none"> • High-Pressure Laminate price group 1 • High-Pressure Laminate price group 2 • West Elm veneer • Veneer price group 1 	<ul style="list-style-type: none"> No cost +\$224 +\$224 +\$455 	<ul style="list-style-type: none"> Specify laminate color number. Specify laminate color number. Specify West Elm wood color number. Specify wood color number.
Frame <ul style="list-style-type: none"> • Paint price group 1 • Paint price group 2 • Paint price group 3 	<ul style="list-style-type: none"> No cost +\$ 39 +\$ 78 	<ul style="list-style-type: none"> Specify paint color number. Specify paint color number. Specify paint color number.

Specification Information	
Style Number	U.S. Base Price
WESINDNOB	\$3010

 **For Canadian Pricing**
Multiply U.S. Price by the Canadian price factor.
▶ See page 1 for details.

Greenpoint
Private Office

Greenpoint Private Office Tall Open Bookcase

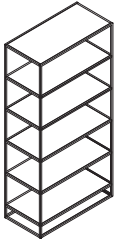

Standard Includes		Required to Specify
<ul style="list-style-type: none"> ▶ Need help? Product details, page 52 	<ul style="list-style-type: none"> • Bookcase shelf: High-Pressure Laminate price group 1 • Square tube legs (frame): paint price group 1 • 1½" leveling glides 	<ul style="list-style-type: none"> 1 Style number 2 High-Pressure Laminate color number for bookcase shelf 3 Paint color number for legs (frame) 4 Options, if selected (see below) ▶ See <i>Surface Materials</i>, page 242.

Options	U.S. Price	Required to Specify
Surface Materials		
Shelf <ul style="list-style-type: none"> • High-Pressure Laminate price group 1 • High-Pressure Laminate price group 2 • West Elm veneer • Veneer price group 1 	<ul style="list-style-type: none"> No cost +\$ 260 +\$ 260 +\$1571 	<ul style="list-style-type: none"> Specify laminate color number. Specify laminate color number. Specify West Elm wood color number. Specify wood color number.
Frame <ul style="list-style-type: none"> • Paint price group 1 • Paint price group 2 • Paint price group 3 	<ul style="list-style-type: none"> No cost +\$ 71 +\$ 149 	<ul style="list-style-type: none"> Specify paint color number. Specify paint color number. Specify paint color number.

Specification Information	
Style Number	U.S. Base Price
WESINDOB	\$3764



For Canadian Pricing
 Multiply U.S. Price by the Canadian price factor.
 ▶ See page 1 for details.

Greenpoint Private Office Storage Bookcase

Greenpoint Private Office
Storage Bookcase

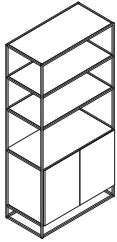

Standard Includes	Required to Specify
<ul style="list-style-type: none"> ▶ Need help? Product details, page 52 • Bookcase shelf: High-Pressure Laminate price group 1 • Square tube legs (frame): paint price group 1 • 1½" leveling glides 	<ol style="list-style-type: none"> 1 Style number 2 High-Pressure Laminate color number for bookcase shelf 3 Paint color number for legs (frame) 4 Options, if selected (see below) <p>▶ See <i>Surface Materials</i>, page 242.</p>

Options	U.S. Price	Required to Specify
Surface Materials		
Shelf		
• High-Pressure Laminate price group 1	No cost	Specify laminate color number.
• High-Pressure Laminate price group 2	+\$ 372	Specify laminate color number.
• West Elm veneer	+\$ 372	Specify West Elm wood color number.
• Veneer price group 1	+\$3001	Specify wood color number.
Frame		
• Paint price group 1	No cost	Specify paint color number.
• Paint price group 2	+\$ 71	Specify paint color number.
• Paint price group 3	+\$ 149	Specify paint color number.

Specification Information	
Style Number	U.S. Base Price
WESINDSB	\$5121

 **For Canadian Pricing**
Multiply U.S. Price by the Canadian price factor.
▶ See page 1 for details.

**Greenpoint
Private Office**

Greenpoint Private Office Metal Mobile Box/File Pedestal

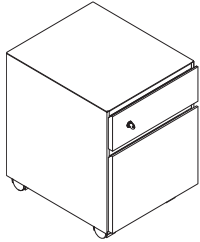

Tip: Drawer fronts on pedestal are available in limited High-Pressure Laminate and veneer finishes. See Surface Materials section for more information.

Tip: When specified in High-Pressure Laminate, the pull of the drawer will be painted according to the matrix in the Surface Materials section.

Standard Includes		Required to Specify
<ul style="list-style-type: none"> ▶ Need help? Product details, page 52 	<ul style="list-style-type: none"> • 18"D X 15"W mobile pedestal: paint price group 1 • Box/file configuration with full drawer • Lock • Casters: black plastic 	<ul style="list-style-type: none"> 1 Style number 2 Paint color number for pedestal case 3 Options, if selected (see below) ▶ See <i>Surface Materials</i>, page 242.

	Options	U.S. Price	Required to Specify
Surface Materials	Case		
	• Paint price group 1	No cost	Specify paint color number.
	• Paint price group 2	+\$ 26	Specify paint color number.
	• Paint price group 3	+\$ 44	Specify paint color number.
	Front		
	• Solid High-Pressure Laminate	No cost	Specify laminate color number.
	• Woodgrain High-Pressure Laminate price group 1	No cost	Specify laminate color number.
	• Woodgrain High-Pressure Laminate price group 2	+\$ 44	Specify laminate color number.
	• West Elm open pore	+\$148	Specify West Elm wood color number.
	• Natural veneer	+\$193	Specify wood color number.
	Lock		
	• Ember chrome	No cost	Specify with 9250 Ember Chrome lock.
	• Polished chrome	No cost	Specify with 9201 Polished Chrome lock.
Lock and Keying	• Keying	No cost	▶ See <i>Lock and Keying</i> .
Drawer Interior	• Full drawer	No cost	Specify with full drawer.
	• Basic drawer	-\$ 76	Specify with basic drawer.
Drawer Accessories	• No rail	No cost	Specify with no rail.
	• With rail	No cost	Specify with rail.

Specification Information	
• Style Number	• U.S. Base Price
WESINDMPM	\$1334



For Canadian Pricing
Multiply U.S. Price by the Canadian price factor.
▶ See page 1 for details.

Greenpoint Private Office Basic Cushions Enhanced

Greenpoint Private Office
Basic Cushions Enhanced

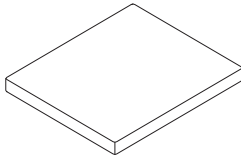

Tip: Basic cushion enhanced is field-installed and supplies to attach are included.

Tip: Basic cushion enhanced is constructed with a thin solid base.

Tip: For both cushion top and basic cushion enhanced: fabric patterns with a linear design will always be applied from the front to back of the unit (depth of the unit).

Tip: For both cushion top and basic cushion enhanced: pattern matching will not be done on COM.

Tip: Support brace is for 30"W and 36" steel laterals with an open configuration.

Standard Includes	Required to Specify
<ul style="list-style-type: none"> ▶ Need help? Product details, page 52 • Enhanced cushion top: fabric price group 1 • Attachment supplies: hook and loop fastener 	<ol style="list-style-type: none"> 1 Style number 2 Fabric color number for enhanced cushion 3 Options, if selected (see below) <ul style="list-style-type: none"> ▶ See <i>Surface Materials</i>, page 242.

Options	U.S. Price	Required to Specify
Surface Materials <ul style="list-style-type: none"> • Fabric price group 1 • Fabric price group 2 • Customer's Own Material (COM) • Fabric price group 3 • Fabric price group 4 • Fabric price group 5 • Fabric price group 6 • Fabric price group 7 • Fabric price group 8 • Fabric price group 9 • Fabric price group 10 	<ul style="list-style-type: none"> No cost +\$ 13 +\$ 25 +\$ 63 +\$ 79 +\$ 99 +\$139 +\$167 +\$242 +\$309 +\$377 	<ul style="list-style-type: none"> Specify fabric color number. Specify fabric color number. ▶ See <i>Surface Materials Reference Manual</i>. Specify fabric color number. Specify fabric color number. Specify fabric color number. Specify fabric color number. Specify fabric color number. Specify fabric color number. Specify fabric color number. Specify fabric color number.
Storage Bracing <ul style="list-style-type: none"> • Bracing for 30"W storage • Bracing for 36"W storage 	<ul style="list-style-type: none"> +\$ 83 +\$ 83 	<ul style="list-style-type: none"> Specify <i>with bracing for 30"W storage</i>. Specify <i>with bracing for 36"W storage</i>.

Specification Information				
Dimensions			Style Number	U.S. Base Price
D	W	H		
17½"	15"	1½"	RCHE1715	\$299
18"	30"	1½"	RCHE1830	\$405
18"	36"	1½"	RCHE1836	\$430
:	:	:	:	:

 **For Canadian Pricing**
Multiply U.S. Price by the Canadian price factor.
▶ See page 1 for details.

Greenpoint
Private Office

Greenpoint Private Office

Accessories

Wire Clip



Standard Includes	Required to Specify
<ul style="list-style-type: none"> ▶ Need help? Product details, page 52 • Carton of six wire clips: black plastic only • Foam tape • Mounting screws 	<ul style="list-style-type: none"> Style number

Specification Information	
Style Number	U.S. Price

Wire Clip, Package of 6

999CHT	\$118

2½" Round Grommet



Tip: Grommet **AWAG2** is for use on worksurfaces only.

Standard Includes	Required to Specify
<ul style="list-style-type: none"> ▶ Need help? Product details, page 52 • Grommet: paint or metal • Installation instructions 	<ul style="list-style-type: none"> 1 Style number 2 Color number for grommet ▶ See <i>Surface Materials</i>, page 242.

Specification Information	
Style Number	U.S. Price

AWAG2	\$110

Wire Manager

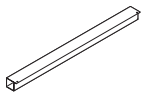

Standard Includes	Required to Specify
<ul style="list-style-type: none"> ▶ Need help? Product details, page 52 • 25" wire manager with double-sided tape: black plastic • Attachment hardware 	<ul style="list-style-type: none"> Style number

Specification Information	
Style Number	U.S. Price

AWVW	\$24



For Canadian Pricing
 Multiply U.S. Price by the Canadian price factor.
 ▶ See page 1 for details.

1 3/4"D Wire Managers

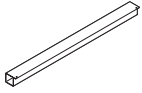

Standard Includes		Required to Specify
<ul style="list-style-type: none"> ▶ Need help? Product details, page 52 	<ul style="list-style-type: none"> • Wire manager: 6000 Black • Attachment hardware 	Style number

Specification Information					
Dimensions			Weight	Style Number	U.S. Price
D	W	H			
1 3/4"	12"	1 3/4"	0.24 lb	AWM12	\$50
1 3/4"	18"	1 3/4"	0.34 lb	AWM18	\$57
1 3/4"	23"	1 3/4"	0.44 lb	AWM23	\$65
1 3/4"	30"	1 3/4"	0.56 lb	AWM30	\$76
1 3/4"	35"	1 3/4"	0.65 lb	AWM35	\$83
1 3/4"	42"	1 3/4"	0.77 lb	AWM42	\$92
:	:	:	:	:	:

 **For Canadian Pricing**
 Multiply U.S. Price by the Canadian price factor.
 ▶ See page 1 for details.

Greenpoint Private Office

Power Units

Greenpoint Power Unit

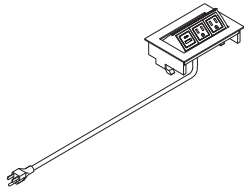

Tip: When using modular power under the worksurface specify 18" L cord length.

Standard Includes		Required to Specify	
-------------------	--	---------------------	--

- | | | |
|---|---|--|
| <ul style="list-style-type: none"> ▶ Need help? Product details, page 52 | <ul style="list-style-type: none"> • Power unit: paint • 18" cord | <ul style="list-style-type: none"> 1 Style number 2 Paint color number for power unit 3 Options, if selected (see below) ▶ See <i>Surface Materials</i>, page 242. |
|---|---|--|

	Options	U.S. Price	Required to Specify
--	---------	------------	---------------------

- | | | | |
|----------------------------|--|---|--|
| Power Configuration | <ul style="list-style-type: none"> • 3 power • 2 power 1 USB A+C 20W | <ul style="list-style-type: none"> No cost +\$146 | <ul style="list-style-type: none"> Specify with 3 power. Specify with 2 power 1 USB A+C 20W. |
| Cord Length | <ul style="list-style-type: none"> • 18" • 108" | <ul style="list-style-type: none"> No cost +\$ 13 | <ul style="list-style-type: none"> Specify with 18" cord. Specify with 108" cord. |

Specification Information

Style Number	U.S. Base Price
WESINDPWR	\$436

Greenpoint Power Unit for Use with Continuous Top

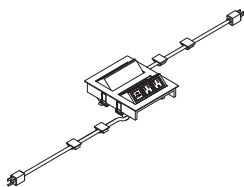

Standard Includes		Required to Specify	
-------------------	--	---------------------	--

- | | | |
|---|---|--|
| <ul style="list-style-type: none"> ▶ Need help? Product details, page 52 | <ul style="list-style-type: none"> • Power unit: paint • 18" cord | <ul style="list-style-type: none"> 1 Style number 2 Paint color number for power unit 3 Options, if selected (see below) ▶ See <i>Surface Materials</i>, page 242. |
|---|---|--|

	Options	U.S. Price	Required to Specify
--	---------	------------	---------------------

- | | | | |
|----------------------------|--|---|--|
| Power Configuration | <ul style="list-style-type: none"> • 6 power • 4 power 1 USB A+C 20W | <ul style="list-style-type: none"> No cost +\$291 | <ul style="list-style-type: none"> Specify with 6 power. Specify with 4 power 1 USB A+C 20W. |
| Cord Length | <ul style="list-style-type: none"> • 18" • 108" | <ul style="list-style-type: none"> No cost +\$ 28 | <ul style="list-style-type: none"> Specify with 18" cord. Specify with 108" cord. |

Specification Information

Style Number	U.S. Base Price
WESINDPWRCT	\$734



For Canadian Pricing

Multiply U.S. Price by the Canadian price factor.

▶ See page 1 for details.

Greenpoint Round/Square Power Unit

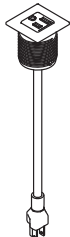

Standard Includes		Required to Specify	
-------------------	--	---------------------	--

- | | | | |
|---|---|--|--|
| <ul style="list-style-type: none"> ▶ Need help? Product details, page 52 | <ul style="list-style-type: none"> • Power unit: plastic | <ul style="list-style-type: none"> 1 Style number 2 Plastic color number for power unit 3 Options, if selected (see below) ▶ See <i>Surface Materials</i>, page 242. | |
|---|---|--|--|

Options		U.S. Price	Required to Specify
---------	--	------------	---------------------

- | | | | |
|--|--|---|--|
| <ul style="list-style-type: none"> Power Configuration | <ul style="list-style-type: none"> • 1 power • 1 USB A+C | <ul style="list-style-type: none"> No cost +\$107 | <ul style="list-style-type: none"> Specify with 1 power. Specify with 1 USB A+C. |
|--|--|---|--|

Specification Information	
---------------------------	--

Style Number	U.S. Base Price
WESINDPWRFR	\$140

 **For Canadian Pricing**
 Multiply U.S. Price by the Canadian price factor.
 ▶ See page 1 for details.

Greenpoint Bench Dual Sided Worksurface— Leg/Leg Application

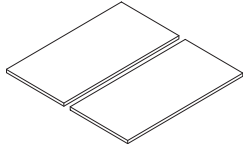

Tip: Edge will be matching veneer flat profile on side and back edges when wood top surface is selected, or 3 mm plastic edge when laminate top surface is selected.

	Standard Includes	Required to Specify
▶ Need help? Product details, page 60	<ul style="list-style-type: none"> Worksurface: High-Pressure Laminate price group 1 with 3 mm plastic edge 	<ol style="list-style-type: none"> Style number Select depth Select width Laminate color number for worksurface Options, if selected (see below) <p>▶ See <i>Surface Materials</i>, page 242.</p>

	Options	U.S. Price	Required to Specify
Depth	<ul style="list-style-type: none"> 24" 30" 	Prices below Prices below	Select 24" depth. Select 30" depth.
Width	<ul style="list-style-type: none"> 48" 54" 60" 66" 72" 78" 	Prices below Prices below Prices below Prices below Prices below Prices below	Select 48" width. Select 54" width. Select 60" width. Select 66" width. Select 72" width. Select 78" width.
Surface Materials	Top <ul style="list-style-type: none"> High-Pressure Laminate price group 1 High-Pressure Laminate price group 2 Veneer price group 1 West Elm veneer 	Prices below Prices below Prices below Prices below	Specify laminate color number. Specify laminate color number. Specify wood color number. Specify West Elm wood color number.
Cutout Type	<ul style="list-style-type: none"> Cutout center No cutout 	No cost No cost	Specify <i>with center cutout</i> . Specify <i>with no cutout</i> .

Specification Information		U.S. Base Prices					
Style Number	Depth	48"W	54"W	60"W	66"W	72"W	78"W
:	:	:	:	:	:	:	:

High-Pressure Laminate Price Group 1

WESINDWLLDS	Depth	48"W	54"W	60"W	66"W	72"W	78"W
	24"	\$1320	\$1452	\$1588	\$1724	\$1854	\$1996
	30"	\$1604	\$1738	\$1870	\$2006	\$2136	\$2274

High-Pressure Laminate Price Group 2

WESINDWLLDS	Depth	48"W	54"W	60"W	66"W	72"W	78"W
	24"	\$1662	\$1798	\$1928	\$2064	\$2196	\$2330
	30"	\$1942	\$2082	\$2212	\$2348	\$2482	\$2614

West Elm Veneer

WESINDWLLDS	Depth	48"W	54"W	60"W	66"W	72"W	78"W
	24"	\$2210	\$2346	\$2478	\$2610	\$2742	\$2876
	30"	\$2494	\$2622	\$2760	\$2890	\$3024	\$3158

Veneer Price Group 1

WESINDWLLDS	Depth	48"W	54"W	60"W	66"W	72"W	78"W
	24"	\$2804	\$2996	\$3188	\$3382	\$3576	\$3770
	30"	\$3230	\$3424	\$3616	\$3814	\$4002	\$4194



For Canadian Pricing
 Multiply U.S. Price by the Canadian price factor.
 ▶ See page 1 for details.

Greenpoint Bench Dual Sided Worksurface— Leg/Credenza Application

Greenpoint Bench Dual
Sided Worksurface—Leg/
Credenza Application

Greenpoint
Bench

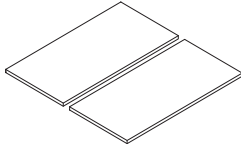

Standard Includes		Required to Specify
▶ Need help? Product details, page 60	<ul style="list-style-type: none"> Worksurface: High-Pressure Laminate price group 1 with 3 mm plastic edge 	1 Style number 2 Select depth 3 Select width 4 Laminate color number for worksurface 5 Options, if selected (see below) ▶ See <i>Surface Materials</i> , page 242.

Tip: Edge will be matching veneer flat profile on side and back edges when wood top surface is selected, or 3 mm plastic edge when laminate top surface is selected.

	Options	U.S. Price	Required to Specify
Depth	<ul style="list-style-type: none"> 24" 30" 	Prices below Prices below	Select 24" depth. Select 30" depth.
Width	<ul style="list-style-type: none"> 48" 54" 60" 66" 72" 78" 	Prices below Prices below Prices below Prices below Prices below Prices below	Select 48" width. Select 54" width. Select 60" width. Select 66" width. Select 72" width. Select 78" width.
Surface Materials	Top <ul style="list-style-type: none"> High-Pressure Laminate price group 1 High-Pressure Laminate price group 2 Veneer price group 1 West Elm veneer 	Prices below Prices below Prices below Prices below	Specify laminate color number. Specify laminate color number. Specify wood color number. Specify West Elm wood color number.
Cutout Type	<ul style="list-style-type: none"> Cutout center No cutout 	No cost No cost	Specify <i>with center cutout</i> . Specify <i>with no cutout</i> .

Specification Information		U.S. Base Prices					
Style Number	Depth	48"W	54"W	60"W	66"W	72"W	78"W
:	:	:	:	:	:	:	:
:	:	:	:	:	:	:	:

High-Pressure Laminate Price Group 1

WESINDWLCDS	Depth	48"W	54"W	60"W	66"W	72"W	78"W
	24"	\$1394	\$1526	\$1662	\$1798	\$1928	\$2070
	30"	\$1678	\$1812	\$1944	\$2080	\$2210	\$2348

High-Pressure Laminate Price Group 2

WESINDWLCDS	Depth	48"W	54"W	60"W	66"W	72"W	78"W
	24"	\$1736	\$1872	\$2002	\$2138	\$2270	\$2404
	30"	\$2017	\$2156	\$2287	\$2422	\$2557	\$2688

West Elm Veneer

WESINDWLCDS	Depth	48"W	54"W	60"W	66"W	72"W	78"W
	24"	\$2284	\$2420	\$2552	\$2684	\$2816	\$2950
	30"	\$2568	\$2696	\$2834	\$2964	\$3098	\$3232

Veneer Price Group 1

WESINDWLCDS	Depth	48"W	54"W	60"W	66"W	72"W	78"W
	24"	\$2878	\$3070	\$3262	\$3456	\$3650	\$3844
	30"	\$3304	\$3498	\$3690	\$3888	\$4076	\$4268



For Canadian Pricing
 Multiply U.S. Price by the
 Canadian price factor.
 ▶ See page 1 for details.

Greenpoint Bench Dual Sided Worksurface— Credenza/Credenza Application

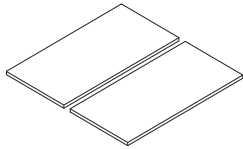

Tip: Edge will be matching veneer flat profile on side and back edges when wood top surface is selected, or 3 mm plastic edge when laminate top surface is selected.

	Standard Includes	Required to Specify
▶ Need help? Product details, page 60	• Worksurface: High-Pressure Laminate price group 1 with 3 mm plastic edge	1 Style number 2 Select depth 3 Select width 4 Laminate color number for worksurface 5 Options, if selected (see below) ▶ See <i>Surface Materials</i> , page 242.

	Options	U.S. Price	Required to Specify
Depth	• 24" • 30"	Prices below Prices below	Select 24" depth. Select 30" depth.
Width	• 48" • 54" • 60" • 66" • 72"	Prices below Prices below Prices below Prices below Prices below	Select 48" width. Select 54" width. Select 60" width. Select 66" width. Select 72" width.
Surface Materials	Top • High-Pressure Laminate price group 1 • High-Pressure Laminate price group 2 • Veneer price group 1 • West Elm veneer	Prices below Prices below Prices below Prices below	Specify laminate color number. Specify laminate color number. Specify wood color number. Specify West Elm wood color number.
Cutout Type	• Cutout center • No cutout	No cost No cost	Specify <i>with center cutout</i> . Specify <i>with no cutout</i> .

Specification Information						
Style Number	Depth	U.S. Base Prices				
		48"W	54"W	60"W	66"W	72"W
•	•	•	•	•	•	•
•	•	•	•	•	•	•

High-Pressure Laminate Price Group 1

WESINDWCCDS	Depth	48"W	54"W	60"W	66"W	72"W
	24"	\$1454	\$1586	\$1722	\$1858	\$1988
	30"	\$1738	\$1872	\$2004	\$2140	\$2270

High-Pressure Laminate Price Group 2

WESINDWCCDS	Depth	48"W	54"W	60"W	66"W	72"W
	24"	\$1796	\$1932	\$2062	\$2198	\$2330
	30"	\$2076	\$2216	\$2346	\$2482	\$2616

West Elm Veneer

WESINDWCCDS	Depth	48"W	54"W	60"W	66"W	72"W
	24"	\$2344	\$2480	\$2612	\$2744	\$2876
	30"	\$2628	\$2756	\$2894	\$3024	\$3158

Veneer Price Group 1

WESINDWCCDS	Depth	48"W	54"W	60"W	66"W	72"W
	24"	\$2938	\$3130	\$3322	\$3516	\$3710
	30"	\$3364	\$3558	\$3750	\$3948	\$4136



For Canadian Pricing
Multiply U.S. Price by the Canadian price factor.
▶ See page 1 for details.

Greenpoint Bench Single Sided Worksurface— Leg/Leg Application

Greenpoint Bench Single
Sided Worksurface—Leg/
Leg Application

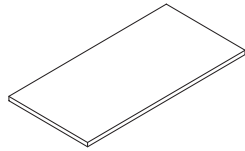

Tip: Edge will be matching veneer flat profile on side and back edges when wood top surface is selected, or 3 mm plastic edge when laminate top surface is selected.

Standard Includes	Required to Specify
<ul style="list-style-type: none"> ▶ Need help? Product details, page 60 • Worksurface: High-Pressure Laminate price group 1 with 3 mm plastic edge 	<ol style="list-style-type: none"> 1 Style number 2 Select depth 3 Select width 4 Laminate color number for worksurface 5 Options, if selected (see below) <p>▶ See <i>Surface Materials</i>, page 242.</p>

Options	U.S. Price	Required to Specify
Depth <ul style="list-style-type: none"> • 24" • 30" 	Prices below Prices below	Select 24" depth. Select 30" depth.
Width <ul style="list-style-type: none"> • 42" • 48" • 54" • 60" • 66" • 72" • 78" 	Prices below Prices below Prices below Prices below Prices below Prices below Prices below	Select 42" width. Select 48" width. Select 54" width. Select 60" width. Select 66" width. Select 72" width. Select 78" width.
Surface Materials <ul style="list-style-type: none"> • Top • High-Pressure Laminate price group 1 • High-Pressure Laminate price group 2 • Veneer price group 1 • West Elm veneer 	Prices below Prices below Prices below Prices below	Specify laminate color number. Specify laminate color number. Specify wood color number. Specify West Elm wood color number.
Cutout Type <ul style="list-style-type: none"> • Cutout center • No cutout 	No cost No cost	Specify <i>with center cutout</i> . Specify <i>with no cutout</i> .

Specification Information		U.S. Base Prices						
Style Number	Depth	42"W	48"W	54"W	60"W	66"W	72"W	78"W
•	•	•	•	•	•	•	•	•

High-Pressure Laminate Price Group 1

WESINDWLLSS	Depth	42"W	48"W	54"W	60"W	66"W	72"W	78"W
	24"	\$ 499	\$ 664	\$ 731	\$ 798	\$ 864	\$ 932	\$ 998
	30"	\$ 738	\$ 803	\$ 871	\$ 937	\$1004	\$1074	\$1140

High-Pressure Laminate Price Group 2

WESINDWLLSS	Depth	42"W	48"W	54"W	60"W	66"W	72"W	78"W
	24"	\$ 670	\$ 837	\$ 901	\$ 968	\$1034	\$1104	\$1170
	30"	\$ 907	\$ 976	\$1044	\$1110	\$1176	\$1244	\$1309

West Elm Veneer

WESINDWLLSS	Depth	42"W	48"W	54"W	60"W	66"W	72"W	78"W
	24"	\$1040	\$1107	\$1172	\$1241	\$1307	\$1374	\$1440
	30"	\$1182	\$1248	\$1315	\$1381	\$1446	\$1516	\$1580

Veneer Price Group 1

WESINDWLLSS	Depth	42"W	48"W	54"W	60"W	66"W	72"W	78"W
	24"	\$1337	\$1402	\$1499	\$1597	\$1692	\$1788	\$1884
	30"	\$1521	\$1619	\$1716	\$1810	\$1908	\$2003	\$2100

 **For Canadian Pricing**
Multiply U.S. Price by the Canadian price factor.
▶ See page 1 for details.

Greenpoint Bench Single Sided Worksurface— Leg/Credenza Application

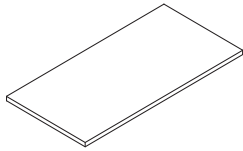

Tip: Edge will be matching veneer flat profile on side and back edges when wood top surface is selected, or 3 mm plastic edge when laminate top surface is selected.

	Standard Includes	Required to Specify
▶ Need help? Product details, page 60	<ul style="list-style-type: none"> Worksurface: High-Pressure Laminate price group 1 with 3 mm plastic edge 	<ol style="list-style-type: none"> Style number Select depth Select width Laminate color number for worksurface Options, if selected (see below) <p>▶ See <i>Surface Materials</i>, page 242.</p>

	Options	U.S. Price	Required to Specify
Depth	<ul style="list-style-type: none"> 24" 30" 	Prices below Prices below	Select 24" depth. Select 30" depth.
Width	<ul style="list-style-type: none"> 48" 54" 60" 66" 72" 78" 	Prices below Prices below Prices below Prices below Prices below Prices below	Select 48" width. Select 54" width. Select 60" width. Select 66" width. Select 72" width. Select 78" width.
Surface Materials	Top <ul style="list-style-type: none"> High-Pressure Laminate price group 1 High-Pressure Laminate price group 2 Veneer price group 1 West Elm veneer 	Prices below Prices below Prices below Prices below	Specify laminate color number. Specify laminate color number. Specify wood color number. Specify West Elm wood color number.
Cutout Type	<ul style="list-style-type: none"> Cutout center No cutout 	No cost No cost	Specify <i>with center cutout</i> . Specify <i>with no cutout</i> .

Specification Information		U.S. Base Prices					
Style Number	Depth	48"W	54"W	60"W	66"W	72"W	78"W
.....

High-Pressure Laminate Price Group 1

WESINDWLCSS	Depth	48"W	54"W	60"W	66"W	72"W	78"W
	24"	\$ 697	\$ 763	\$ 831	\$ 899	\$ 964	\$1035
	30"	\$ 839	\$ 906	\$ 972	\$1040	\$1105	\$1174

High-Pressure Laminate Price Group 2

WESINDWLCSS	Depth	48"W	54"W	60"W	66"W	72"W	78"W
	24"	\$ 868	\$ 936	\$1001	\$1069	\$1135	\$1202
	30"	\$1008	\$1078	\$1143	\$1211	\$1278	\$1344

West Elm Veneer

WESINDWLCSS	Depth	48"W	54"W	60"W	66"W	72"W	78"W
	24"	\$1142	\$1210	\$1276	\$1342	\$1408	\$1475
	30"	\$1284	\$1348	\$1417	\$1482	\$1549	\$1616

Veneer Price Group 1

WESINDWLCSS	Depth	48"W	54"W	60"W	66"W	72"W	78"W
	24"	\$1439	\$1535	\$1631	\$1728	\$1825	\$1922
	30"	\$1652	\$1749	\$1845	\$1944	\$2038	\$2134



For Canadian Pricing
 Multiply U.S. Price by the Canadian price factor.
 ▶ See page 1 for details.

Greenpoint Bench Single Sided Worksurface— Credenza/Credenza Application

Greenpoint Bench Single
Sided Worksurface—
Credenza/Credenza
Application

Greenpoint
Bench

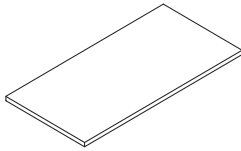

Standard Includes	Required to Specify
<ul style="list-style-type: none"> ▶ Need help? Product details, page 60 • Worksurface: High-Pressure Laminate price group 1 with 3 mm plastic edge 	<ol style="list-style-type: none"> 1 Style number 2 Select depth 3 Select width 4 Laminate color number for worksurface 5 Options, if selected (see below) <ul style="list-style-type: none"> ▶ See <i>Surface Materials</i>, page 242.

Tip: Edge will be matching veneer flat profile on side and back edges when wood top surface is selected, or 3 mm plastic edge when laminate top surface is selected.

	Options	U.S. Price	Required to Specify
Depth	<ul style="list-style-type: none"> • 24" • 30" 	Prices below Prices below	Select 24" depth. Select 30" depth.
Width	<ul style="list-style-type: none"> • 48" • 54" • 60" • 66" • 72" 	Prices below Prices below Prices below Prices below Prices below	Select 48" width. Select 54" width. Select 60" width. Select 66" width. Select 72" width.
Surface Materials	<p>Top</p> <ul style="list-style-type: none"> • High-Pressure Laminate price group 1 • High-Pressure Laminate price group 2 • Veneer price group 1 • West Elm veneer 	Prices below Prices below Prices below Prices below	Specify laminate color number. Specify laminate color number. Specify wood color number. Specify West Elm wood color number.
Cutout Type	<ul style="list-style-type: none"> • Cutout center • No cutout 	No cost No cost	Specify <i>with center cutout</i> . Specify <i>with no cutout</i> .

Specification Information						
Style Number	Depth	U.S. Base Prices				
		48"W	54"W	60"W	66"W	72"W
•	•	•	•	•	•	•
•	•	•	•	•	•	•
•	•	•	•	•	•	•

High-Pressure Laminate Price Group 1

WESINDWCCSS	Depth	48"W	54"W	60"W	66"W	72"W
	24"	\$ 727	\$ 793	\$ 861	\$ 929	\$ 994
	30"	\$ 869	\$ 936	\$1002	\$1070	\$1135

High-Pressure Laminate Price Group 2

WESINDWCCSS	Depth	48"W	54"W	60"W	66"W	72"W
	24"	\$ 898	\$ 966	\$1031	\$1099	\$1165
	30"	\$1038	\$1108	\$1173	\$1241	\$1308

West Elm Veneer

WESINDWCCSS	Depth	48"W	54"W	60"W	66"W	72"W
	24"	\$1172	\$1240	\$1306	\$1372	\$1438
	30"	\$1314	\$1378	\$1447	\$1512	\$1579

Veneer Price Group 1

WESINDWCCSS	Depth	48"W	54"W	60"W	66"W	72"W
	24"	\$1469	\$1565	\$1661	\$1758	\$1855
	30"	\$1682	\$1779	\$1875	\$1974	\$2068



For Canadian Pricing
Multiply U.S. Price by the
Canadian price factor.
▶ See page 1 for details.

Greenpoint Bench Continuous Worksurface— Leg/Leg Application

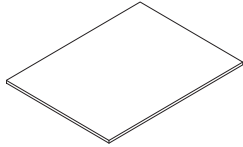

Tip: Edge will be matching veneer flat profile on side and back edges when wood top surface is selected, or 3 mm plastic edge when laminate top surface is selected.

Standard Includes	Required to Specify
<ul style="list-style-type: none"> ▶ Need help? Product details, page 62 • 48"D worksurface: High-Pressure Laminate price group 1 with 3 mm plastic edge 	<ol style="list-style-type: none"> 1 Style number 2 Select width 3 Laminate color number for worksurface 4 Options, if selected (see below) <ul style="list-style-type: none"> ▶ See <i>Surface Materials</i>, page 242.

Options	U.S. Price	Required to Specify
Width <ul style="list-style-type: none"> • 48" • 54" • 60" • 66" • 72" • 78" 	<ul style="list-style-type: none"> Prices below Prices below Prices below Prices below Prices below Prices below 	<ul style="list-style-type: none"> Select 48" width. Select 54" width. Select 60" width. Select 66" width. Select 72" width. Select 78" width.
Surface Materials <ul style="list-style-type: none"> • Top • High-Pressure Laminate price group 1 • High-Pressure Laminate price group 2 • Veneer price group 1 	<ul style="list-style-type: none"> Prices below Prices below Prices below 	<ul style="list-style-type: none"> Specify laminate color number. Specify laminate color number. Specify wood color number.
Cutout Type <ul style="list-style-type: none"> • Cutout center • No cutout 	<ul style="list-style-type: none"> No cost No cost 	<ul style="list-style-type: none"> Specify <i>with center cutout</i>. Specify <i>with no cutout</i>.

Specification Information

• Style Number	• Depth	• U.S. Base Prices					
		• 48"W	• 54"W	• 60"W	• 66"W	• 72"W	• 78"W
•	•	•	•	•	•	•	•

High-Pressure Laminate Price Group 1

WESINDWLLCT	48"	\$ 882	\$1016	\$1149	\$1284	\$1417	\$1553
•	•	•	•	•	•	•	•

High-Pressure Laminate Price Group 2

WESINDWLLCT	48"	\$1225	\$1359	\$1493	\$1627	\$1762	\$1894
•	•	•	•	•	•	•	•

Veneer Price Group 1

WESINDWLLCT	48"	\$1920	\$2052	\$2187	\$2319	\$2453	\$2586
•	•	•	•	•	•	•	•



For Canadian Pricing
Multiply U.S. Price by the Canadian price factor.
▶ See page 1 for details.

Greenpoint Bench Continuous Worksurface— Leg/Credenza Application

Greenpoint Bench
Continuous Worksurface—
Leg/Credenza Application

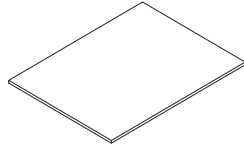

Tip: Edge will be matching veneer flat profile on side and back edges when wood top surface is selected, or 3 mm plastic edge when laminate top surface is selected.

Standard Includes	Required to Specify
<ul style="list-style-type: none"> ▶ Need help? Product details, page 62 • 48"D worksurface: High-Pressure Laminate price group 1 with 3 mm plastic edge 	<ol style="list-style-type: none"> 1 Style number 2 Select width 3 Laminate color number for worksurface 4 Options, if selected (see below) <ul style="list-style-type: none"> ▶ See <i>Surface Materials</i>, page 242.

Options	U.S. Price	Required to Specify
Width		
• 48"	Prices below	Select 48" width.
• 54"	Prices below	Select 54" width.
• 60"	Prices below	Select 60" width.
• 66"	Prices below	Select 66" width.
• 72"	Prices below	Select 72" width.
• 78"	Prices below	Select 78" width.
Surface Materials	Top	
	• High-Pressure Laminate price group 1	Specify laminate color number.
	• High-Pressure Laminate price group 2	Specify laminate color number.
	• Veneer price group 1	Specify wood color number.
Cutout Type		
• Cutout center	No cost	Specify <i>with center cutout</i> .
• No cutout	No cost	Specify <i>with no cutout</i> .

Specification Information

Style Number	Depth	U.S. Base Prices					
		48"W	54"W	60"W	66"W	72"W	78"W
:	:	:	:	:	:	:	:
:	:	:	:	:	:	:	:

High-Pressure Laminate Price Group 1

WESINDWLCCT	48"	\$ 917	\$1051	\$1184	\$1319	\$1452	\$1588
:	:	:	:	:	:	:	:

High-Pressure Laminate Price Group 2

WESINDWLCCT	48"	\$1260	\$1394	\$1528	\$1662	\$1797	\$1929
:	:	:	:	:	:	:	:

Veneer Price Group 1

WESINDWLCCT	48"	\$1955	\$2087	\$2222	\$2354	\$2488	\$2621
:	:	:	:	:	:	:	:

 **For Canadian Pricing**
Multiply U.S. Price by the Canadian price factor.
▶ See page 1 for details.

Greenpoint Bench Continuous Worksurface— Credenza/Credenza Application

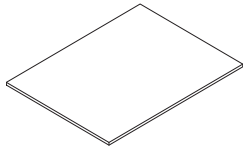

Tip: Edge will be matching veneer flat profile on side and back edges when wood top surface is selected, or 3 mm plastic edge when laminate top surface is selected.

Standard Includes	Required to Specify
<ul style="list-style-type: none"> ▶ Need help? Product details, page 62 • 48"D worksurface: High-Pressure Laminate price group 1 with 3 mm plastic edge 	<ol style="list-style-type: none"> 1 Style number 2 Select width 3 Laminate color number for worksurface 4 Options, if selected (see below) <ul style="list-style-type: none"> ▶ See <i>Surface Materials</i>, page 242.

Options	U.S. Price	Required to Specify
Width <ul style="list-style-type: none"> • 48" • 54" • 60" • 66" • 72" • 78" 	Prices below Prices below Prices below Prices below Prices below Prices below	Select 48" width. Select 54" width. Select 60" width. Select 66" width. Select 72" width. Select 78" width.
Surface Materials <ul style="list-style-type: none"> • Top • High-Pressure Laminate price group 1 • High-Pressure Laminate price group 2 • Veneer price group 1 	Prices below Prices below Prices below	Specify laminate color number. Specify laminate color number. Specify wood color number.
Cutout Type <ul style="list-style-type: none"> • Cutout center • No cutout 	No cost No cost	Specify <i>with center cutout</i> . Specify <i>with no cutout</i> .

Specification Information

• Style Number	• Depth	• U.S. Base Prices					
		• 48"W	• 54"W	• 60"W	• 66"W	• 72"W	• 78"W
•	•	•	•	•	•	•	•

High-Pressure Laminate Price Group 1

WESINDWCCCT	48"	\$ 945	\$1079	\$1212	\$1347	\$1480	\$1616
•	•	•	•	•	•	•	•

High-Pressure Laminate Price Group 2

WESINDWCCCT	48"	\$1288	\$1422	\$1556	\$1690	\$1825	\$1957
•	•	•	•	•	•	•	•

Veneer Price Group 1

WESINDWCCCT	48"	\$1983	\$2115	\$2250	\$2382	\$2516	\$2649
•	•	•	•	•	•	•	•



For Canadian Pricing
 Multiply U.S. Price by the Canadian price factor.
 ▶ See page 1 for details.

Greenpoint Bench Round Worksurface

Greenpoint Bench Round
Worksurface

Greenpoint
Bench

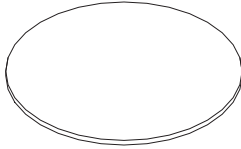

Standard Includes	Required to Specify
<ul style="list-style-type: none"> ▶ Need help? Product details, page 62 • Worksurface: High-Pressure Laminate price group 1 with 3 mm plastic edge 	<ol style="list-style-type: none"> 1 Style number 2 Select diameter 3 Laminate color number for worksurface 4 Options, if selected (see below) <ul style="list-style-type: none"> ▶ See <i>Surface Materials</i>, page 242.

Options	U.S. Price	Required to Specify
Diameter <ul style="list-style-type: none"> • 48" • 60" 	Prices below Prices below	Select 48" diameter. Select 60" diameter.
Surface Materials <ul style="list-style-type: none"> • Top • High-Pressure Laminate price group 1 • High-Pressure Laminate price group 2 • Veneer price group 1 	Prices below Prices below Prices below	Specify laminate color number. Specify laminate color number. Specify wood color number.
Cutout Type <ul style="list-style-type: none"> • Cutout center • No cutout 	No cost No cost	Specify <i>with center cutout</i> . Specify <i>with no cutout</i> .

Specification Information

Style Number	Diameter	U.S. Base Price
•	•	•
:	:	:
:	:	:

High-Pressure Laminate Price Group 1

WESINDWFR	Diameter	U.S. Price
	48"	\$ 863
	60"	\$1507
:	:	:

High-Pressure Laminate Price Group 2

WESINDWFR	Diameter	U.S. Price
	48"	\$1192
	60"	\$1835
:	:	:

Veneer Price Group 1

WESINDWFR	Diameter	U.S. Price
	48"	\$1863
	60"	\$2508
:	:	:

For Canadian Pricing
 Multiply U.S. Price by the Canadian price factor.
 ▶ See page 1 for details.

Greenpoint Bench Square Worksurface

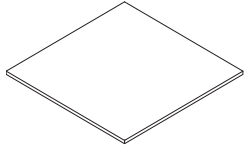

	Standard Includes	Required to Specify
▶ Need help? Product details, page 62	<ul style="list-style-type: none"> • Worksurface: High-Pressure Laminate price group 1 with 3 mm plastic edge 	<ol style="list-style-type: none"> 1 Style number 2 Select depth and width 3 Laminate color number for worksurface 4 Options, if selected (see below) <p>▶ See <i>Surface Materials</i>, page 242.</p>

	Options	U.S. Price	Required to Specify
Depth and Width	<ul style="list-style-type: none"> • 48" • 60" 	<p>Prices below</p> <p>Prices below</p>	<p>Select 48".</p> <p>Select 60".</p>
Surface Materials	<p>Top</p> <ul style="list-style-type: none"> • High-Pressure Laminate price group 1 • High-Pressure Laminate price group 2 • Veneer price group 1 	<p>Prices below</p> <p>Prices below</p> <p>Prices below</p>	<p>Specify laminate color number.</p> <p>Specify laminate color number.</p> <p>Specify wood color number.</p>
Cutout Type	<ul style="list-style-type: none"> • Cutout center • No cutout 	<p>No cost</p> <p>No cost</p>	<p>Specify <i>with center cutout</i>.</p> <p>Specify <i>with no cutout</i>.</p>

Specification Information

• Style Number	• Dimensions	• U.S. Base Price
•	•	•
•	•	•
•	•	•

High-Pressure Laminate Price Group 1

WESINDWSQ		
	48"	\$ 863
	60"	\$1507
•	•	•

High-Pressure Laminate Price Group 2

WESINDWSQ		
	48"	\$1192
	60"	\$1835
•	•	•

Veneer Price Group 1

WESINDWSQ		
	48"	\$1863
	60"	\$2508
•	•	•



For Canadian Pricing
 Multiply U.S. Price by the Canadian price factor.
 ▶ See page 1 for details.

Greenpoint Bench Half-Round Worksurface

Greenpoint Bench Half-Round Worksurface

Greenpoint
Bench

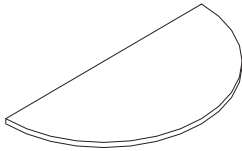

Standard Includes		Required to Specify
<ul style="list-style-type: none"> ▶ Need help? Product details, page 62 	<ul style="list-style-type: none"> • Worksurface: High-Pressure Laminate price group 1 with 3 mm plastic edge 	<ul style="list-style-type: none"> 1 Style number 2 Select width 3 Laminate color number for worksurface 4 Options, if selected (see below) ▶ See <i>Surface Materials</i>, page 242.

Options	U.S. Price	Required to Specify
Width <ul style="list-style-type: none"> • 48" • 60" 	Prices below Prices below	Select 48" width. Select 60" width.
Surface Materials <ul style="list-style-type: none"> • Top • High-Pressure Laminate price group 1 • High-Pressure Laminate price group 2 • Veneer price group 1 	Prices below Prices below Prices below	Specify laminate color number. Specify laminate color number. Specify wood color number.

Specification Information

Style Number	Width	U.S. Base Price
•	•	•
:	:	:
:	:	:

High-Pressure Laminate Price Group 1

WESINDWHR	Width	U.S. Price
	48"	\$ 682
	60"	\$ 946
:	:	:

High-Pressure Laminate Price Group 2

WESINDWHR	Width	U.S. Price
	48"	\$ 848
	60"	\$1111
:	:	:

Veneer Price Group 1

WESINDWHR	Width	U.S. Price
	48"	\$1217
	60"	\$1483
:	:	:



For Canadian Pricing
 Multiply U.S. Price by the Canadian price factor.
 ▶ See page 1 for details.

Greenpoint Bench Worksurface—Return

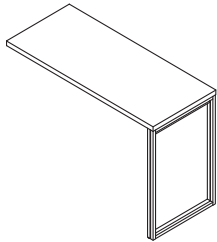

Tip: Edge will be matching veneer flat profile on side and back edges when wood top surface is selected, or 3 mm plastic edge when laminate top surface is selected.

Standard Includes		Required to Specify
<ul style="list-style-type: none"> ▶ Need help? Product details, page 62 	<ul style="list-style-type: none"> • Worksurface: High-Pressure Laminate price group 1 with 3 mm plastic edge • Square tube leg (frame): paint price group 1 • Height: 28½"H 	<ol style="list-style-type: none"> 1 Style number 2 Select depth 3 Select width 4 Laminate color number for worksurface 5 Paint color number for leg (frame) 6 Options, if selected (see below) <ul style="list-style-type: none"> ▶ See <i>Surface Materials</i>, page 242.

	Options	U.S. Price	Required to Specify
Depth	<ul style="list-style-type: none"> • 18" • 24" 	Prices below Prices below	Select 18" depth. Select 24" depth.
Width	<ul style="list-style-type: none"> • 42" • 48" • 54" • 60" 	Prices below Prices below Prices below Prices below	Select 42" width. Select 48" width. Select 54" width. Select 60" width.
Surface Materials	Top <ul style="list-style-type: none"> • High-Pressure Laminate price group 1 • High-Pressure Laminate price group 2 • Veneer price group 1 • West Elm veneer 	Prices below Prices below Prices below Prices below	Specify laminate color number. Specify laminate color number. Specify wood color number. Specify West Elm wood color number.
Frame	<ul style="list-style-type: none"> • Paint price group 1 • Paint price group 2 <ul style="list-style-type: none"> – 18"D – 24"D • Paint price group 3 <ul style="list-style-type: none"> – 18"D – 24"D 	No cost +\$16 +\$20 +\$30 +\$37	Specify paint color number. Specify paint color number. Specify paint color number. Specify paint color number. Specify paint color number.

Specification Information

• Style Number	• Depth	• U.S. Base Prices			
		• 42"W	• 48"W	• 54"W	• 60"W
•	•	•	•	•	•
•	•	•	•	•	•

High-Pressure Laminate Price Group 1

WESINDRB	18"	24"	42"W	48"W	54"W	60"W
	\$1220	\$1298	\$1286	\$1362	\$1354	\$1422
•	•	•	•	•	•	•

High-Pressure Laminate Price Group 2

WESINDRB	18"	24"	42"W	48"W	54"W	60"W
	\$1348	\$1422	\$1415	\$1487	\$1480	\$1549
•	•	•	•	•	•	•

West Elm Veneer

WESINDRB	18"	24"	42"W	48"W	54"W	60"W
	\$1503	\$1576	\$1569	\$1641	\$1636	\$1702
•	•	•	•	•	•	•

Veneer Price Group 1

WESINDRB	18"	24"	42"W	48"W	54"W	60"W
	\$1675	\$1792	\$1740	\$1858	\$1852	\$1916
•	•	•	•	•	•	•



For Canadian Pricing
 Multiply U.S. Price by the Canadian price factor.
 ▶ See page 1 for details.

Greenpoint Bench Dual Leg

Greenpoint Bench Dual Leg

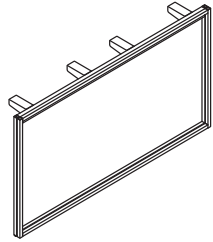

Greenpoint Bench

Standard Includes		Required to Specify
<ul style="list-style-type: none"> ▶ Need help? Product details, page 62 	<ul style="list-style-type: none"> • Square tube leg (frame): paint price group 1 • 1½"H leveling glides 	<ol style="list-style-type: none"> 1 Style number 2 Select depth 3 Paint color number for leg (frame) 4 Options, if selected (see below) <ul style="list-style-type: none"> ▶ See <i>Surface Materials</i>, page 242.

Options	U.S. Price	Required to Specify
Depth <ul style="list-style-type: none"> • 48" • 60" 	Prices below Prices below	Select 48" depth. Select 60" depth.
Surface Materials	Frame <ul style="list-style-type: none"> • Paint price group 1 • Paint price group 2 <ul style="list-style-type: none"> – 48"D +\$39 – 60"D +\$44 • Paint price group 3 <ul style="list-style-type: none"> – 48"D +\$78 – 60"D +\$90 	No cost Specify paint color number. Specify paint color number. Specify paint color number.

Specification Information		
Style Number	Depth	U.S. Base Price
WESINDELDS	48"	\$727
	60"	\$844

 **For Canadian Pricing**
 Multiply U.S. Price by the Canadian price factor.
 ▶ See page 1 for details.

Greenpoint Bench Single Sided End Leg

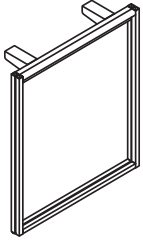

Standard Includes		Required to Specify
<ul style="list-style-type: none"> ▶ Need help? Product details, page 62 	<ul style="list-style-type: none"> • Square tube leg (frame): paint price group 1 • 1½"H leveling glides 	<ol style="list-style-type: none"> 1 Style number 2 Select depth 3 Paint color number for leg (frame) 4 Options, if selected (see below) <ul style="list-style-type: none"> ▶ See <i>Surface Materials</i>, page 242.

Options	U.S. Price	Required to Specify
Depth <ul style="list-style-type: none"> • 24" • 30" 	Prices below Prices below	Select 24" depth. Select 30" depth.
Surface Materials	Frame <ul style="list-style-type: none"> • Paint price group 1 • Paint price group 2 <ul style="list-style-type: none"> – 24"D +\$20 – 30"D +\$24 • Paint price group 3 <ul style="list-style-type: none"> – 24"D +\$37 – 30"D +\$44 	No cost Specify paint color number. Specify paint color number. Specify paint color number. Specify paint color number. Specify paint color number.

Specification Information		
Style Number	Depth	U.S. Base Price
WESINDELSS	24"	\$551
	30"	\$587



For Canadian Pricing
 Multiply U.S. Price by the Canadian price factor.
 ▶ See page 1 for details.

Greenpoint Bench Single Sided End Leg

Greenpoint Bench Single
Sided End Leg

Greenpoint
Bench

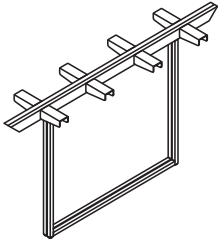

Standard Includes		Required to Specify
<ul style="list-style-type: none"> ▶ Need help? Product details, page 62 	<ul style="list-style-type: none"> • Square tube leg (frame): paint price group 1 • 1½"H leveling glides 	<ul style="list-style-type: none"> 1 Style number 2 Paint color number for leg (frame) 3 Options, if selected (see below) ▶ See <i>Surface Materials</i>, page 242.

Options	U.S. Price	Required to Specify
Surface Materials <ul style="list-style-type: none"> • Paint price group 1 • Paint price group 2 • Paint price group 3 	Frame <ul style="list-style-type: none"> No cost +\$39 +\$78 	<ul style="list-style-type: none"> Specify paint color number. Specify paint color number. Specify paint color number.

Specification Information	
Style Number	U.S. Base Price
WESINDILDS	\$622

 **For Canadian Pricing**
Multiply U.S. Price by the Canadian price factor.
▶ See page 1 for details.

Greenpoint Bench Intermediate Single Leg

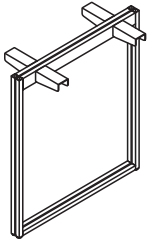

Standard Includes		Required to Specify
<ul style="list-style-type: none"> ▶ Need help? Product details, page 62 	<ul style="list-style-type: none"> • Square tube leg (frame): paint price group 1 • 1½"H leveling glides 	<ol style="list-style-type: none"> 1 Style number 2 Select depth 3 Paint color number for leg (frame) 4 Options, if selected (see below) <ul style="list-style-type: none"> ▶ See <i>Surface Materials</i>, page 242.

Options	U.S. Price	Required to Specify
Depth <ul style="list-style-type: none"> • 24" • 30" 	Prices below Prices below	Select 24" depth. Select 30" depth.
Surface Materials	Frame <ul style="list-style-type: none"> • Paint price group 1 • Paint price group 2 <ul style="list-style-type: none"> – 24"D +\$20 – 30"D +\$24 • Paint price group 3 <ul style="list-style-type: none"> – 24"D +\$37 – 30"D +\$44 	No cost Specify paint color number. Specify paint color number. Specify paint color number. Specify paint color number. Specify paint color number.

Specification Information		
Style Number	Depth	U.S. Base Price
WESINDILSS	24"	\$515
	30"	\$551



For Canadian Pricing
 Multiply U.S. Price by the Canadian price factor.
 ▶ See page 1 for details.

Greenpoint Bench Round/Square Leg

Greenpoint Bench Round/
Square Leg

Greenpoint
Bench

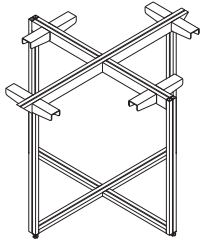

Standard Includes		Required to Specify
<ul style="list-style-type: none"> ▶ Need help? Product details, page 62 	<ul style="list-style-type: none"> • Square tube leg (frame): paint price group 1 • 1½"H leveling glides • Height: 28½"H 	<ol style="list-style-type: none"> 1 Style number 2 Select depth 3 Paint color number for leg (frame) 4 Options, if selected (see below) <ul style="list-style-type: none"> ▶ See <i>Surface Materials</i>, page 242.

Options	U.S. Price	Required to Specify
Depth <ul style="list-style-type: none"> • 48" • 60" 	Prices below Prices below	Select 48" depth. Select 60" depth.
Surface Materials	Frame <ul style="list-style-type: none"> • Paint price group 1 • Paint price group 2 <ul style="list-style-type: none"> – 48"D +\$ 59 – 60"D +\$ 65 • Paint price group 3 <ul style="list-style-type: none"> – 48"D +\$115 – 60"D +\$129 	No cost Specify paint color number. Specify paint color number. Specify paint color number. Specify paint color number.

Specification Information		
Style Number	Depth	U.S. Base Price
WESINDLFR	48"	\$1357
	60"	\$1453

 **For Canadian Pricing**
 Multiply U.S. Price by the Canadian price factor.
 ▶ See page 1 for details.

Greenpoint Bench Intermediate Single Leg

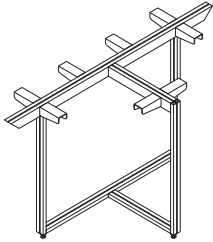

Standard Includes		Required to Specify
<ul style="list-style-type: none"> ▶ Need help? Product details, page 62 	<ul style="list-style-type: none"> • Square tube leg (frame): paint price group 1 • 1½"H leveling glides • Height: 28½"H 	<ol style="list-style-type: none"> 1 Style number 2 Select depth 3 Paint color number for leg (frame) 4 Options, if selected (see below) <ul style="list-style-type: none"> ▶ See <i>Surface Materials</i>, page 242.

Options	U.S. Price	Required to Specify
Depth <ul style="list-style-type: none"> • 48" • 60" 	Prices below Prices below	Select 48" depth. Select 60" depth.
Surface Materials <ul style="list-style-type: none"> • Paint price group 1 • Paint price group 2 <ul style="list-style-type: none"> – 48"D – 60"D • Paint price group 3 <ul style="list-style-type: none"> – 48"D – 60"D 	Frame <ul style="list-style-type: none"> • No cost • +\$ 59 • +\$ 65 • +\$115 • +\$129 	Specify paint color number. Specify paint color number. Specify paint color number. Specify paint color number. Specify paint color number.

Specification Information		
• Style Number	• Depth	• U.S. Base Price
WESINDLHR	48"	\$1018
	60"	\$1092



For Canadian Pricing
 Multiply U.S. Price by the Canadian price factor.
 ▶ See page 1 for details.

Greenpoint Bench End Credenza

Greenpoint Bench
End Credenza

Greenpoint
Bench

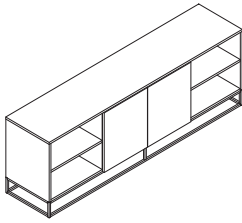

Tip: When specified in High-Pressure Laminate, the pull of the drawer will be painted according to the matrix in the Surface Materials section.

Standard Includes	Required to Specify
<ul style="list-style-type: none"> ▶ Need help? Product details, page 66 • Credenza: High-Pressure Laminate price group 1 • Square tube leg (frame): paint price group 1 • 1½"H leveling glides 	<ul style="list-style-type: none"> 1 Style number 2 Laminate color number for case 3 Paint color number for leg (frame) 4 Options, if selected (see below) ▶ See <i>Surface Materials</i>, page 242.

Options	U.S. Price	Required to Specify
Surface Materials <ul style="list-style-type: none"> • Case • High-Pressure Laminate price group 1 • High-Pressure Laminate price group 2 • West Elm veneer • Veneer price group 1 	<ul style="list-style-type: none"> No cost +\$ 737 +\$1052 +\$6649 	<ul style="list-style-type: none"> Specify laminate color number. Specify laminate color number. Specify West Elm wood color number. Specify wood color number.
<ul style="list-style-type: none"> • Frame • Paint price group 1 • Paint price group 2 • Paint price group 3 	<ul style="list-style-type: none"> No cost +\$ 39 +\$ 78 	<ul style="list-style-type: none"> Specify paint color number. Specify paint color number. Specify paint color number.
Case Orientation <ul style="list-style-type: none"> • Inward • Outward 	<ul style="list-style-type: none"> No cost No cost 	<ul style="list-style-type: none"> Specify <i>with inward orientation</i>. Specify <i>with outward orientation</i>.
Application <ul style="list-style-type: none"> • Dual sided • Single sided 	<ul style="list-style-type: none"> No cost No cost 	<ul style="list-style-type: none"> Specify <i>with dual-sided application</i>. Specify <i>with single-sided application</i>.

Specification Information	
• Style Number	• U.S. Base Price
WESINDEC	\$4924

 **For Canadian Pricing**
Multiply U.S. Price by the Canadian price factor.
▶ See page 1 for details.

Greenpoint Bench Personal Credenza

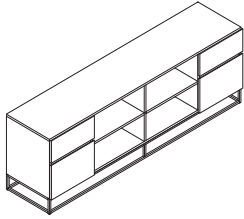

Tip: When specified in High-Pressure Laminate, the pull of the drawer will be painted according to the matrix in the Surface Materials section.

Standard Includes	Required to Specify
<ul style="list-style-type: none"> ▶ Need help? Product details, page 66 • Credenza: High-Pressure Laminate price group 1 • Square tube leg (frame): paint price group 1 • 1½"H leveling glides 	<ul style="list-style-type: none"> 1 Style number 2 Laminate color number for case 3 Paint color number for leg (frame) 4 Options, if selected (see below) ▶ See <i>Surface Materials</i>, page 242.

Options	U.S. Price	Required to Specify
Surface Materials <ul style="list-style-type: none"> • Case • High-Pressure Laminate price group 1 • High-Pressure Laminate price group 2 • West Elm veneer • Veneer price group 1 	<ul style="list-style-type: none"> No cost +\$1079 +\$1437 +\$7129 	<ul style="list-style-type: none"> Specify laminate color number. Specify laminate color number. Specify West Elm wood color number. Specify wood color number.
<ul style="list-style-type: none"> • Frame • Paint price group 1 • Paint price group 2 • Paint price group 3 	<ul style="list-style-type: none"> No cost +\$ 39 +\$ 78 	<ul style="list-style-type: none"> Specify paint color number. Specify paint color number. Specify paint color number.
Case Orientation <ul style="list-style-type: none"> • Inward • Outward 	<ul style="list-style-type: none"> No cost No cost 	<ul style="list-style-type: none"> Specify <i>with inward orientation</i>. Specify <i>with outward orientation</i>.
Application <ul style="list-style-type: none"> • Dual sided • Single sided 	<ul style="list-style-type: none"> No cost No cost 	<ul style="list-style-type: none"> Specify <i>with dual-sided application</i>. Specify <i>with single-sided application</i>.

Specification Information	
• Style Number	• U.S. Base Price
WESINDPC	\$5716
•	•
•	•



For Canadian Pricing
 Multiply U.S. Price by the Canadian price factor.
 ▶ See page 1 for details.

Greenpoint Bench Glass Screen

Greenpoint Bench Glass
Screen

Greenpoint
Bench

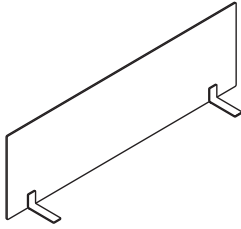

Standard Includes	Required to Specify
<ul style="list-style-type: none"> ▶ Need help? Product details, page 67 • Screen: glass price group 1 • Brackets: paint price group 1 	<ol style="list-style-type: none"> 1 Style number 2 Specify width 3 Glass color number for screen 4 Paint color number for brackets 5 Options, if selected (see below) <p>▶ See <i>Surface Materials</i>, page 242.</p>

Options	U.S. Price	Required to Specify	
Width <ul style="list-style-type: none"> • 48" • 54" • 60" • 66" • 72" • 78" 	<ul style="list-style-type: none"> No cost +\$ 36 +\$ 75 +\$111 +\$147 +\$183 	<ul style="list-style-type: none"> Select 48" width. Select 54" width. Select 60" width. Select 66" width. Select 72" width. Select 78" width. 	
Surface Materials	Glass <ul style="list-style-type: none"> • Glass price group 1 • Glass price group 2 	<ul style="list-style-type: none"> No cost +\$370 	<ul style="list-style-type: none"> Specify glass color number. Specify glass color number.
	Bracket <ul style="list-style-type: none"> • Paint price group 1 • Paint price group 2 • Paint price group 3 	<ul style="list-style-type: none"> No cost +\$ 20 +\$ 44 	<ul style="list-style-type: none"> Specify paint color number. Specify paint color number. Specify paint color number.

Specification Information	
Style Number	U.S. Base Price
WESINDCSG	\$778
.	.
.	.

 **For Canadian Pricing**
Multiply U.S. Price by the Canadian price factor.
▶ See page 1 for details.

Power and Data

Standard Includes	Required to Specify
<ul style="list-style-type: none"> ▶ Need help? Product details, page 70 • Power support: black paint • Attachment hardware 	Style number

Specification Information	
• Style Number	• U.S. Price

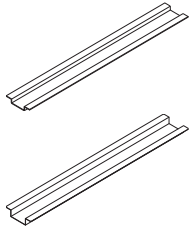

Greenpoint Single Sided Power Support	
WESINDPSSS	\$64

Greenpoint Dual Sided Power Support	
WESINDPSDS	\$64



For Canadian Pricing
 Multiply U.S. Price by the Canadian price factor.
 ▶ See page 1 for details.

Greenpoint Dual-Sided Power Cover

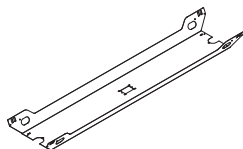

	Standard Includes	Required to Specify
▶ Need help? Product details, page 70	<ul style="list-style-type: none"> Power tray: black paint Attachment hardware 	1 Style number 2 Specify width 3 Options, if selected (see below)

	Options	U.S. Price	Required to Specify
Width	<ul style="list-style-type: none"> 48" 54" 60" 66" 72" 78" 	No cost +\$ 5 +\$13 +\$23 +\$28 +\$36	Select 48" width. Select 54" width. Select 60" width. Select 66" width. Select 72" width. Select 78" width.

Specification Information	
Style Number	U.S. Base Price
WESINDPTDS	\$206

Power and Data

Greenpoint Single-Sided Power Cover

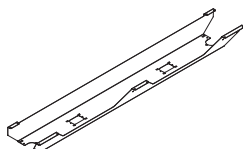

	Standard Includes	Required to Specify
▶ Need help? Product details, page 70	<ul style="list-style-type: none"> Power tray: black paint Attachment hardware 	1 Style number 2 Specify width 3 Options, if selected (see below)

	Options	U.S. Price	Required to Specify
Width	<ul style="list-style-type: none"> 48" 54" 60" 66" 72" 78" 	No cost +\$ 5 +\$13 +\$23 +\$28 +\$36	Select 48" width. Select 54" width. Select 60" width. Select 66" width. Select 72" width. Select 78" width.
Handedness	<ul style="list-style-type: none"> Left hand Right hand 	No cost No cost	Specify <i>with left hand</i> . Specify <i>with right hand</i> .

Specification Information	
Style Number	U.S. Base Price
WESINDPTSS	\$183

 **For Canadian Pricing**
 Multiply U.S. Price by the Canadian price factor.
 ▶ See page 1 for details.

Power and Data

Power Trays

Standard Includes	Required to Specify
<ul style="list-style-type: none"> ▶ Need help? Product details, page 70 	<ul style="list-style-type: none"> • Tray end cap or extension: black paint • Attachment hardware

Specification Information	
• Style Number	• U.S. Price

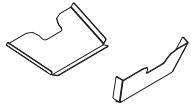

Greenpoint Single Sided Tray End Cap

WESINDCTSS \$42

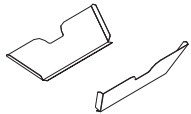

Greenpoint Dual Sided Tray End Cap

WESINDCTDS \$42

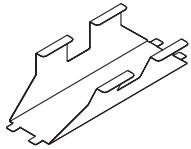

Greenpoint Single Sided Tray Extension

WESINDETSS \$75

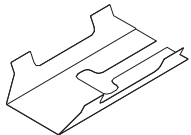

Greenpoint Dual Sided Tray Extension

WESINDETDS \$75



For Canadian Pricing

Multiply U.S. Price by the Canadian price factor.

▶ See page 1 for details.

Power Covers

*Tip: If power covers are not selected, any connection points on modular power blocks not being used by a harness, infeed, or connector must be filled with dust covers. Order style number **FMVBK** separately.*

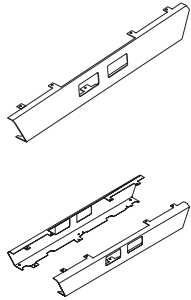

Standard Includes		Required to Specify
▶ Need help? Product details, page 70	<ul style="list-style-type: none"> • Power cover: black paint • Attachment hardware 	Style number

Specification Information	
• Style Number	• U.S. Price

Greenpoint Single Sided Power Cover

WESINDPCSS	\$51
:	:
:	:

Greenpoint Dual Sided Power Cover

WESINDPCDS	\$51
:	:
:	:



For Canadian Pricing

Multiply U.S. Price by the Canadian price factor.

▶ See page 1 for details.

Power and Data Power Block—Standard Capacity

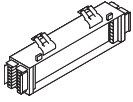

Standard Includes		Required to Specify
▶ Need help? Product details, page 70	• Non-PVC power block	1 Style number 2 Options, if selected (see below)

Options	U.S. Price	Required to Specify
Power	• 2+2	No cost
Schematic	• 3+1	No cost
	• 3SN	No cost

Specification Information	
Style Number	U.S. Price
FMVPBS	\$273
.	.



For Canadian Pricing
 Multiply U.S. Price by the
 Canadian price factor.
 ▶ See page 1 for details.

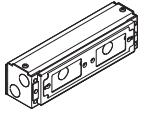

Standard Includes	Required to Specify
<ul style="list-style-type: none"> ▶ Need help? Product details, page 70 • Hardwire box: black 	<ul style="list-style-type: none"> Style number

Specification Information	
<ul style="list-style-type: none"> • Style Number 	<ul style="list-style-type: none"> • U.S. Price

Power Kit—Chicago Hardwire	
<ul style="list-style-type: none"> FMVCP 	<ul style="list-style-type: none"> \$403

Power and Data



For Canadian Pricing
Multiply U.S. Price by the Canadian price factor.
▶ See page 1 for details.

Power and Data

Power and Data Receptacles and Filler Package

Receptacle—Duplex



Tip: For designation of controlled receptacles, order permanent ink stamp with controlled icon; service part **1063909001SR**. It includes a pair of stamps, one white and one black. Appropriate receptacles can be stamped at the job site during installation.

Standard Includes		Required to Specify
<ul style="list-style-type: none"> ▶ Need help? Product details, page 70 	<ul style="list-style-type: none"> • 15-amp, system ground duplex receptacle: <ul style="list-style-type: none"> – 6000 Black – 6009 Arctic White – 6527 Merle – 6899 Platinum Metallic 	<ul style="list-style-type: none"> 1 Style number 2 Plastic color number for receptacle 3 Options, if selected (see below)

	Options	U.S. Price	Required to Specify
3+1 Power	<ul style="list-style-type: none"> • Line 1 • Line 2 • Line 3 • Line 4 	<ul style="list-style-type: none"> No cost No cost No cost No cost 	<ul style="list-style-type: none"> Specify with line 1 3+1 power. Specify with line 2 3+1 power. Specify with line 3 3+1 power. Specify with line 4 3+1 power.
2+2 Power	<ul style="list-style-type: none"> • Line 1 • Line 2 • Line 3 • Line 4 	<ul style="list-style-type: none"> No cost No cost No cost No cost 	<ul style="list-style-type: none"> Specify with line 1 2+2 power. Specify with line 2 2+2 power. Specify with line 3 2+2 power. Specify with line 4 2+2 power.
3SN Power	<ul style="list-style-type: none"> • Line 1 • Line 2 • Line 3 	<ul style="list-style-type: none"> No cost No cost No cost 	<ul style="list-style-type: none"> Specify with line 1 3SN power. Specify with line 2 3SN power. Specify with line 3 3SN power.
Amperage	<ul style="list-style-type: none"> • 15 amp • 20 amp 	<ul style="list-style-type: none"> No cost +\$37 	<ul style="list-style-type: none"> Specify with 15 amp. Specify with 20 amp.
Ground Type	<ul style="list-style-type: none"> • System • Isolated 	<ul style="list-style-type: none"> No cost +\$21 	<ul style="list-style-type: none"> Specify with system ground. Specify with isolated ground.
Controlled Stamp	<ul style="list-style-type: none"> • No stamp • With controlled stamp 	<ul style="list-style-type: none"> No cost +\$ 5 	<ul style="list-style-type: none"> Specify with no stamp. Specify with controlled stamp.

Specification Information	
• Style Number	• U.S. Base Price
FMVRD	\$52



For Canadian Pricing

Multiply U.S. Price by the Canadian price factor.

▶ See page 1 for details.

Receptacle—USB



Standard Includes		Required to Specify
<ul style="list-style-type: none"> ▶ Need help? Product details, page 70 	<ul style="list-style-type: none"> • USB receptacle: <ul style="list-style-type: none"> – 6000 Black – 6009 Arctic White – 6527 Merle – 6899 Platinum Metallic 	<ul style="list-style-type: none"> 1 Style number 2 Plastic color number for receptacle 3 Options, if selected (see below)

	Options	U.S. Price	Required to Specify
3+1 Power	<ul style="list-style-type: none"> • Line 1 • Line 2 • Line 3 • Line 4 	<ul style="list-style-type: none"> No cost No cost No cost No cost 	<ul style="list-style-type: none"> Specify with line 1 3+1 power. Specify with line 2 3+1 power. Specify with line 3 3+1 power. Specify with line 4 3+1 power.
2+2 Power	<ul style="list-style-type: none"> • Line 1 • Line 2 • Line 3 • Line 4 	<ul style="list-style-type: none"> No cost No cost No cost No cost 	<ul style="list-style-type: none"> Specify with line 1 2+2 power. Specify with line 2 2+2 power. Specify with line 3 2+2 power. Specify with line 4 2+2 power.
3SN Power	<ul style="list-style-type: none"> • Line 1 • Line 2 • Line 3 	<ul style="list-style-type: none"> No cost No cost No cost 	<ul style="list-style-type: none"> Specify with line 1 3SN power. Specify with line 2 3SN power. Specify with line 3 3SN power.

Specification Information	
Style Number	U.S. Price
FMVRUSB	\$122

Filler Package



Standard Includes		Required to Specify
<ul style="list-style-type: none"> ▶ Need help? Product details, page 70 	<ul style="list-style-type: none"> • Package of 20 fillers: <ul style="list-style-type: none"> – 6000 Black – 6009 Arctic White – 6527 Merle – 6899 Platinum Metallic 	<ul style="list-style-type: none"> 1 Style number 2 Plastic color number for filler

Specification Information	
Style Number	U.S. Price
FMVF	\$55

 **For Canadian Pricing**
 Multiply U.S. Price by the Canadian price factor.
 ▶ See page 1 for details.

Power and Data

Modular Harnesses

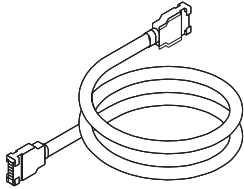

Tip: Refer to Power Routing Harness Chart for recommended harness lengths.

	Standard Includes	Required to Specify
▶ Need help? Product details, page 72	<ul style="list-style-type: none"> Non-PVC modular harness 	1 Style number 2 Options, if selected (see below)

	Options	U.S. Price	Required to Specify
Power Schematic	<ul style="list-style-type: none"> 2+2 3+1 3SN 	No cost No cost No cost	Specify with 2+2 power. Specify with 3+1 power. Specify with 3SN power.
PVC	<ul style="list-style-type: none"> With PVC Non PVC 	-\$13 No cost	Specify with PVC. Specify with non PVC.

Specification Information		
Length	Style Number	U.S. Base Price
24"	FMVH24	\$189
27"	FMVH27	\$189
30"	FMVH30	\$189
33"	FMVH33	\$189
36"	FMVH36	\$189
39"	FMVH39	\$189
42"	FMVH42	\$189
45"	FMVH45	\$209
48"	FMVH48	\$209
51"	FMVH51	\$209
54"	FMVH54	\$209
57"	FMVH57	\$209
60"	FMVH60	\$239
63"	FMVH63	\$239
66"	FMVH66	\$239
69"	FMVH69	\$239
72"	FMVH72	\$263
:	:	:



For Canadian Pricing

Multiply U.S. Price by the Canadian price factor.

▶ See page 1 for details.

Power Infeeds, Hardwire to Modular

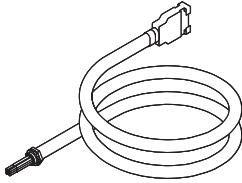

Standard Includes		Required to Specify
<ul style="list-style-type: none"> Need help? Product details, page 72 	<ul style="list-style-type: none"> Non-PVC infeed harness 	<ul style="list-style-type: none"> 1 Style number 2 Options, if selected (see below)

Options	U.S. Price	Required to Specify
Power Schematic <ul style="list-style-type: none"> 2+2 3+1 3SN 	<ul style="list-style-type: none"> No cost No cost No cost 	<ul style="list-style-type: none"> Specify with 2+2 power. Specify with 3+1 power. Specify with 3SN power.
PVC <ul style="list-style-type: none"> With PVC Non PVC 	<ul style="list-style-type: none"> -\$13 No cost 	<ul style="list-style-type: none"> Specify with PVC. Specify with non PVC.

Specification Information		
Length	Style Number	U.S. Base Price
6"	FMVI6H	\$301
12"	FMVI12H	\$386
24"	FMVI24H	\$557
:	:	:

Power and Data

Power Infeeds, Modular to Modular

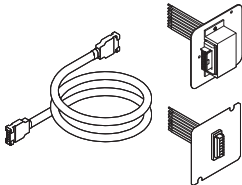

Standard Includes		Required to Specify
<ul style="list-style-type: none"> Need help? Product details, page 72 	<ul style="list-style-type: none"> Non-PVC infeed harness Straight/flush junction box faceplate 	<ul style="list-style-type: none"> 1 Style number 2 Options, if selected (see below)

Options	U.S. Price	Required to Specify
Power Schematic <ul style="list-style-type: none"> 2+2 3+1 3SN 	<ul style="list-style-type: none"> No cost No cost No cost 	<ul style="list-style-type: none"> Specify with 2+2 power. Specify with 3+1 power. Specify with 3SN power.
Plate Type <ul style="list-style-type: none"> Straight/flush faceplate 90° faceplate 	<ul style="list-style-type: none"> No cost +\$66 	<ul style="list-style-type: none"> Specify with straight/flush faceplate. Specify with 90° faceplate.
PVC <ul style="list-style-type: none"> With PVC Non PVC 	<ul style="list-style-type: none"> -\$13 No cost 	<ul style="list-style-type: none"> Specify with PVC. Specify with non PVC.

Specification Information		
Length	Style Number	U.S. Base Price
6"	FMVI6M	\$408
12"	FMVI12M	\$509
24"	FMVI24M	\$680
:	:	:

 **For Canadian Pricing**
 Multiply U.S. Price by the Canadian price factor.
 ▶ See page 1 for details.

Power Infeed—San Francisco

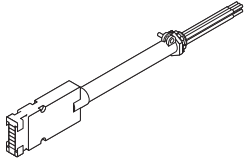

	Standard Includes	Required to Specify
▶ Need help? Product details, page 72	<ul style="list-style-type: none"> • 12' PVC infeed harness with liquid tight metallic conduit 	1 Style number 2 Options, if selected (see below)

	Options	U.S. Price	Required to Specify
Power Schematic	<ul style="list-style-type: none"> • 2+2 • 3+1 • 3SN 	No cost No cost No cost	Specify with 2+2 power. Specify with 3+1 power. Specify with 3SN power.

Specification Information	
Style Number	U.S. Price
FMVISS	\$483
.	.

Ology Infeed—New York

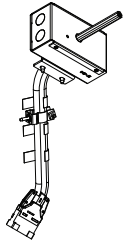

	Standard Includes	Required to Specify
▶ Need help? Product details, page 72	<ul style="list-style-type: none"> • 50" non-PVC infeed harness • Junction box • Strain relief brackets 	1 Style number 2 Options, if selected (see below)

	Options	U.S. Price	Required to Specify
Wiring Schematic	<ul style="list-style-type: none"> • 2+2 • 3 separate neutrals • 3+1 	No cost No cost No cost	Specify with 2+2 power. Specify with 3 separate neutrals. Specify with 3+1 power.
PVC	<ul style="list-style-type: none"> • With PVC 	-\$13	Specify with PVC.

Specification Information	
Style Number	U.S. Base Price
OLBVINN	\$306
.	.



For Canadian Pricing
 Multiply U.S. Price by the Canadian price factor.
 ▶ See page 1 for details.

Bracket Kit

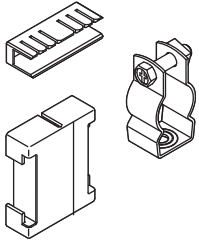

Standard Includes	Required to Specify
-------------------	---------------------

- | | |
|---|--|
| <ul style="list-style-type: none"> ▶ Need help? Product details, page 70 | <ul style="list-style-type: none"> • Brackets and dust covers |
| | <ul style="list-style-type: none"> Style number |

Specification Information	
---------------------------	--

Style Number	U.S. Price
FMVBK	\$60



For Canadian Pricing

Multiply U.S. Price by the Canadian price factor.

▶ See page 1 for details.

Power and Data

Vertabral Risers

Wire Manager Assembly—Vertabral

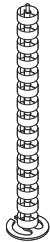

Standard Includes		Required to Specify
<ul style="list-style-type: none"> ▶ Need help? Product details, page 72 	<ul style="list-style-type: none"> • Wire manager 	Style number
Specification Information		
• Style Number	• U.S. Price	
FMVC	\$261	
•	•	

Wire Manager Assembly—Vertabral Extension



Standard Includes		Required to Specify
<ul style="list-style-type: none"> ▶ Need help? Product details, page 72 	<ul style="list-style-type: none"> • Wire manager 	Style number
Specification Information		
• Style Number	• U.S. Price	
FMVCE	\$76	
•	•	



For Canadian Pricing

Multiply U.S. Price by the Canadian price factor.

▶ See page 1 for details.

Sutton Basic Height-Adjustable Desks

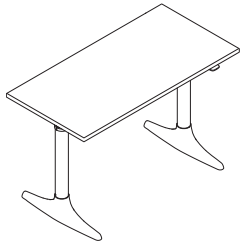

► Need help?
Product details,
page 76

Standard Includes

- Basic height-adjustable desk
- Worksurface:
 - High-Pressure Laminate price group 1 with 3 mm plastic edge
 - Wood group 1 veneer with matching 3 mm square edge, if selected
- Electric height-adjustable sit-to-stand base: paint price group 1
- Simple touch controller
- Foot: paint price group 1
- Leg ring: paint price group 1
- Modular widths: 46", 52", 58", 64", or 70"
- Attachment hardware
- Power cord: 10' with standard plug

Required to Specify

- 1 Style number
 - 2 High-Pressure Laminate or wood color number for worksurface
 - 3 Paint color number for base
 - 4 Paint color number for foot
 - 5 Paint color number for leg ring
 - 6 Options, if selected (see below)
- See *Surface Materials*, page 242.

	Options	U.S. Price	Required to Specify
Size	<ul style="list-style-type: none"> • Modular • Parametric 	No cost No cost	Specify modular. Specify parametric.
Surface Materials	<p>Top</p> <ul style="list-style-type: none"> • Customiz stain • High-Pressure Laminate price group 1 • High-Pressure Laminate price group 2 <ul style="list-style-type: none"> – 46"W–54"W – 54¹/₁₆"W–66"W – 66¹/₁₆"W–72"W • High-Pressure Laminate price group 3 <ul style="list-style-type: none"> – 46"W–54"W – 54¹/₁₆"W–66"W – 66¹/₁₆"W–72"W • Composite veneer price group 1 • Composite veneer price group 2 • Veneer price group 1 • Veneer price group 3 • West Elm veneer • Open Line laminate <p>Foot</p> <ul style="list-style-type: none"> • Paint price group 1 • Paint price group 2 • Paint price group 3 • Polished aluminum <p>Base</p> <ul style="list-style-type: none"> • Paint price group 1 • Paint price group 2 <p>Leg ring</p> <ul style="list-style-type: none"> • Paint price group 1 • Paint price group 2 • Paint price group 3 • Polished chrome 	No cost Prices at right +\$ 27 +\$ 36 +\$ 44 +\$ 53 +\$ 71 +\$ 89 Prices at right +\$108 Prices at right +\$417 +\$478 +\$111 plus cost of laminate No cost +\$ 24 +\$ 44 +\$ 44 No cost +\$ 24 No cost +\$ 5 +\$ 16 +\$ 22 No cost No cost +\$349 No cost +\$ 99	Specify <i>with Customiz stain</i> . ► See <i>Surface Materials Reference Manual</i> . Specify laminate color number. Specify laminate color number. Specify laminate color number. Specify laminate color number. Specify laminate color number. Specify laminate color number. Specify laminate color number. Specify composite veneer color number. Specify composite veneer color number. Specify veneer color number. Specify veneer color number. Specify West Elm veneer color number. ► See <i>Surface Materials Reference Manual</i> . Specify paint color number. Specify paint color number. Specify paint color number. Specify <i>with polished aluminum</i> . Specify paint color number. Specify paint color number. Specify paint color number. Specify paint color number. Specify paint color number. Specify paint color number. Specify <i>with 3 mm plastic edge</i> and select plastic color number. Specify <i>with 3 mm wood edge</i> . Specify <i>with blade edge</i> . Specify <i>with square corner</i> . Specify <i>with radius corner</i> .
Edge Type	<ul style="list-style-type: none"> • 3 mm plastic edge • 3 mm wood edge • Blade edge 	No cost No cost +\$349	Specify <i>with 3 mm plastic edge</i> and select plastic color number. Specify <i>with 3 mm wood edge</i> . Specify <i>with blade edge</i> .
Corner	<ul style="list-style-type: none"> • Square corner • Radius corner 	No cost +\$ 99	Specify <i>with square corner</i> . Specify <i>with radius corner</i> .

► Options, continued on next page

 **For Canadian Pricing**
Multiply U.S. Price by the Canadian price factor.
► See page 1 for details.

► Options, continued from previous page

Options	U.S. Price	Required to Specify
Cable Tray	<ul style="list-style-type: none"> No cable tray With cable tray 	No cost Prices below Specify with no cable tray. Specify with cable tray.
Controller	<ul style="list-style-type: none"> Simple touch controller Active touch controller 	No cost +\$ 79 Specify with simple touch controller. Specify with active touch controller.
Power Configuration	<ul style="list-style-type: none"> No under worksurface power Under worksurface clamp with USB A+C <ul style="list-style-type: none"> – 46"W–57¹/₁₆"W – 58"W–72"W Under worksurface clamp with USB-C <ul style="list-style-type: none"> – 46"W–57¹/₁₆"W – 58"W–72"W Under worksurface only <ul style="list-style-type: none"> – 46"W–57¹/₁₆"W – 58"W–72"W 	No cost +\$ 853 +\$ 888 +\$1195 +\$1229 +\$ 507 +\$ 541 Specify with no under worksurface power. Specify with under worksurface clamp with USB A+C. Specify with under worksurface clamp with USB A+C. Specify with under worksurface clamp with USB-C. Specify with under worksurface clamp with USB-C. Specify with under worksurface power. Specify with under worksurface power.
Power Cord	<ul style="list-style-type: none"> 10' standard cord 9' standard cord 10' braided cord 20' standard cord 20' braided cord 8' curly cord 	No cost No cost +\$ 79 +\$ 79 +\$ 234 +\$ 340 Specify with 10' standard cord. Specify with 9' standard cord. Specify with 10' braided cord and select finish. Specify with 20' standard cord. Specify with 20' braided cord and select finish. Specify with 8' curly cord.
Power Plug Type	<ul style="list-style-type: none"> Standard NEMA 5-15 3-prong Thread low profile plug 	No cost +\$ 43 Specify with standard NEMA 5-15 3-prong. Specify with thread low profile plug.
PVC	<ul style="list-style-type: none"> With PVC Non PVC 	No cost +\$ 36 Specify with PVC. Specify with non PVC.

Tip: Plastic selection will be required if clamp is selected.

Sutton

Specification Information

Style Number	Depth	U.S. Base Prices						Option (Add \$ to Base Price) Cable Tray
		Modular 46"W	52"W	58"W	64"W	70"W	76"W	
		46"W	48 ¹ / ₁₆ "W	54 ¹ / ₁₆ "W	60 ¹ / ₁₆ "W	66 ¹ / ₁₆ "W		
		48"W	54"W	60"W	66"W	72"W		

High-Pressure Laminate Price Group 1

WESSUTSRQ	Depth	46"W	52"W	58"W	64"W	70"W	Option
	23"	\$2304	\$2375	\$2449	\$2523	\$2597	+\$195
	29"	\$2588	\$2669	\$2751	\$2834	\$2918	+\$218

Composite Veneer Price Group 1

WESSUTSRQ	Depth	46"W	52"W	58"W	64"W	70"W	Option
	23"	\$3057	\$3151	\$3249	\$3347	\$3446	+\$195
	29"	\$3362	\$3468	\$3574	\$3681	\$3790	+\$218

Veneer Price Group 1

WESSUTSRQ	Depth	46"W	52"W	58"W	64"W	70"W	Option
	23"	\$3132	\$3230	\$3329	\$3429	\$3532	+\$195
	29"	\$3439	\$3548	\$3656	\$3766	\$3878	+\$218

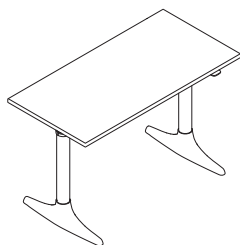

For Canadian Pricing
 Multiply U.S. Price by the Canadian price factor.
 ► See page 1 for details.

Sutton Extended Height-Adjustable Desks

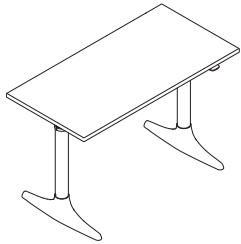

► Need help?
Product details,
page 76

Standard Includes

- Extended height-adjustable desk
- Worksurface:
 - High-Pressure Laminate price group 1 with 3 mm plastic edge
 - Wood group 1 veneer with matching 3 mm square edge, if selected
- Electric height-adjustable sit-to-stand base: paint price group 1
- Simple touch controller
- Foot: paint price group 1
- Leg ring: paint price group 1
- Modular widths: 46", 52", 58", 64", or 70"
- Attachment hardware
- Power cord: 10' with standard plug

Required to Specify

- 1 Style number
 - 2 High-Pressure Laminate or wood color number for worksurface
 - 3 Paint color number for base
 - 4 Paint color number for foot
 - 5 Paint color number for leg ring
 - 6 Options, if selected (see below)
- See *Surface Materials*, page 242.

	Options	U.S. Price	Required to Specify
Size	<ul style="list-style-type: none"> • Modular • Parametric 	No cost No cost	Specify modular. Specify parametric.
Surface Materials	<p>Top</p> <ul style="list-style-type: none"> • Customiz stain • High-Pressure Laminate price group 1 • High-Pressure Laminate price group 2 <ul style="list-style-type: none"> – 46"W–54"W – 54¹/₁₆"W–66"W – 66¹/₁₆"W–72"W • High-Pressure Laminate price group 3 <ul style="list-style-type: none"> – 46"W–54"W – 54¹/₁₆"W–66"W – 66¹/₁₆"W–72"W • Composite veneer price group 1 • Composite veneer price group 2 • Veneer price group 1 • Veneer price group 3 • West Elm veneer • Open Line laminate <p>Foot</p> <ul style="list-style-type: none"> • Paint price group 1 • Paint price group 2 • Paint price group 3 • Polished aluminum <p>Base</p> <ul style="list-style-type: none"> • Paint price group 1 • Paint price group 2 <p>Leg ring</p> <ul style="list-style-type: none"> • Paint price group 1 • Paint price group 2 • Paint price group 3 • Polished chrome 	No cost Prices at right +\$ 27 +\$ 36 +\$ 44 +\$ 53 +\$ 71 +\$ 89 Prices at right +\$108 Prices at right +\$417 +\$478 +\$111 plus cost of laminate No cost +\$ 24 +\$ 44 +\$ 44 No cost +\$ 24 No cost +\$ 5 +\$ 16 +\$ 22	Specify <i>with Customiz stain</i> . ► See <i>Surface Materials Reference Manual</i> . Specify laminate color number. Specify laminate color number. Specify laminate color number. Specify laminate color number. Specify laminate color number. Specify laminate color number. Specify laminate color number. Specify composite veneer color number. Specify composite veneer color number. Specify veneer color number. Specify veneer color number. Specify West Elm veneer color number. ► See <i>Surface Materials Reference Manual</i> . Specify paint color number. Specify paint color number. Specify paint color number. Specify <i>with polished aluminum</i> . Specify paint color number. Specify paint color number. Specify paint color number. Specify paint color number. Specify paint color number. Specify paint color number. Specify <i>with 3 mm plastic edge</i> and select plastic color number. Specify <i>with 3 mm wood edge</i> . Specify <i>with blade edge</i> . Specify <i>with square corner</i> . Specify <i>with radius corner</i> .
Edge Type	<ul style="list-style-type: none"> • 3 mm plastic edge • 3 mm wood edge • Blade edge 	No cost No cost +\$349	Specify <i>with 3 mm plastic edge</i> and select plastic color number. Specify <i>with 3 mm wood edge</i> . Specify <i>with blade edge</i> .
Corner	<ul style="list-style-type: none"> • Square corner • Radius corner 	No cost +\$ 99	Specify <i>with square corner</i> . Specify <i>with radius corner</i> .

► Options, continued on next page

 **For Canadian Pricing**
Multiply U.S. Price by the Canadian price factor.
► See page 1 for details.

► Options, continued from previous page

Options	U.S. Price	Required to Specify
Cable Tray	<ul style="list-style-type: none"> No cable tray With cable tray 	No cost Prices below Specify with no cable tray. Specify with cable tray.
Controller	<ul style="list-style-type: none"> Simple touch controller Active touch controller 	No cost +\$ 79 Specify with simple touch controller. Specify with active touch controller.
Power Configuration	<ul style="list-style-type: none"> No under worksurface power Under worksurface clamp with USB A+C <ul style="list-style-type: none"> – 46"W–57¹/₁₆"W – 58"W–72"W Under worksurface clamp with USB-C <ul style="list-style-type: none"> – 46"W–57¹/₁₆"W – 58"W–72"W Under worksurface only <ul style="list-style-type: none"> – 46"W–57¹/₁₆"W – 58"W–72"W 	No cost +\$ 853 +\$ 888 +\$1195 +\$1229 +\$ 507 +\$ 541 Specify with no under worksurface power. Specify with under worksurface clamp with USB A+C. Specify with under worksurface clamp with USB A+C. Specify with under worksurface clamp with USB-C. Specify with under worksurface clamp with USB-C. Specify with under worksurface power. Specify with under worksurface power.
Power Cord	<ul style="list-style-type: none"> 10' standard cord 9' standard cord 10' braided cord 20' standard cord 20' braided cord 8' curly cord 	No cost No cost +\$ 79 +\$ 79 +\$ 234 +\$ 340 Specify with 10' standard cord. Specify with 9' standard cord. Specify with 10' braided cord and select finish. Specify with 20' standard cord. Specify with 20' braided cord and select finish. Specify with 8' curly cord.
Power Plug Type	<ul style="list-style-type: none"> Standard NEMA 5-15 3-prong Thread low profile plug 	No cost +\$ 43 Specify with standard NEMA 5-15 3-prong. Specify with thread low profile plug.
PVC	<ul style="list-style-type: none"> With PVC Non PVC 	No cost +\$ 36 Specify with PVC. Specify with non PVC.



Specification Information

Style Number	Depth	U.S. Base Prices						Option (Add \$ to Base Price) Cable Tray
		Modular 46"W	52"W	58"W	64"W	70"W	76"W	
		46"W	48 ¹ / ₁₆ "W	54 ¹ / ₁₆ "W	60 ¹ / ₁₆ "W	66 ¹ / ₁₆ "W	72"W	
		48"W	54"W	60"W	66"W	72"W		

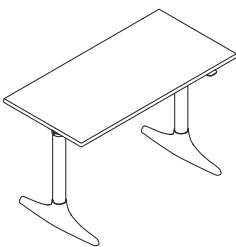

High-Pressure Laminate Price Group 1

WEISSUTERQ	23"	29"	35"	41"	47"	53"	Option
	\$2512	\$2589	\$2669	\$2749	\$2832	+\$195	
	\$2821	\$2909	\$2998	\$3089	\$3182	+\$218	

Composite Veneer Price Group 1

WEISSUTERQ	23"	29"	35"	41"	47"	53"	Option
	\$3265	\$3365	\$3469	\$3573	\$3681	+\$195	
	\$3595	\$3708	\$3821	\$3936	\$4054	+\$218	

Veneer Price Group 1

WEISSUTERQ	23"	29"	35"	41"	47"	53"	Option
	\$3340	\$3444	\$3549	\$3655	\$3767	+\$195	
	\$3672	\$3788	\$3903	\$4021	\$4142	+\$218	

For Canadian Pricing
 Multiply U.S. Price by the Canadian price factor.
 ► See page 1 for details.

Sutton Basic Height-Adjustable Bases

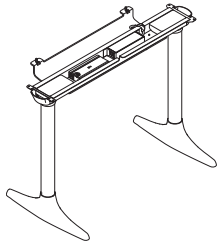

► Need help?
Product details,
page 76

Standard Includes

- Basic height-adjustable base
- Electric height-adjustable sit-to-stand base: paint price group 1
- Foot: paint price group 1
- Leg ring: paint price group 1
- Simple touch controller
- Modular widths: 46", 52", 58", 64", or 70"
- Attachment hardware
- Power cord: 10' with standard plug

Required to Specify

- 1 Style number
 - 2 Paint color number for base
 - 3 Paint color number for foot
 - 4 Paint color number for leg ring
 - 5 Options, if selected (see below)
- See *Surface Materials*, page 242.

	Options	U.S. Price	Required to Specify
Size	<ul style="list-style-type: none"> • Modular • Parametric 	No cost No cost	Specify modular. Specify parametric.
Surface Materials	<p>Foot</p> <ul style="list-style-type: none"> • Paint price group 1 • Paint price group 2 • Paint price group 3 • Polished aluminum <p>Base</p> <ul style="list-style-type: none"> • Paint price group 1 • Paint price group 2 <p>Leg ring</p> <ul style="list-style-type: none"> • Paint price group 1 • Paint price group 2 • Paint price group 3 • Polished chrome 	No cost +\$ 24 +\$ 44 +\$ 44 No cost +\$ 24 No cost +\$ 5 +\$ 16 +\$ 22	Specify paint color number. Specify paint color number. Specify paint color number. Specify <i>with polished aluminum</i> . Specify paint color number. Specify paint color number. Specify paint color number. Specify <i>with polished aluminum</i> .
Cable Tray	<ul style="list-style-type: none"> • No cable tray • With cable tray 	No cost Prices at right	Specify <i>with no cable tray</i> . Specify <i>with cable tray</i> .
Controller	<ul style="list-style-type: none"> • Simple touch controller • Active touch controller 	No cost +\$ 79	Specify <i>with simple touch controller</i> . Specify <i>with active touch controller</i> .
Power Configuration	<ul style="list-style-type: none"> • No under worksurface power • Under worksurface clamp with USB A+C <ul style="list-style-type: none"> – 46"W–57¹/₁₆"W – 58"W–72"W • Under worksurface clamp with USB-C <ul style="list-style-type: none"> – 46"W–57¹/₁₆"W – 58"W–72"W • Under worksurface only <ul style="list-style-type: none"> – 46"W–57¹/₁₆"W – 58"W–72"W 	No cost +\$ 853 +\$ 888 +\$1195 +\$1229 +\$ 507 +\$ 541	Specify <i>with no under worksurface power</i> . Specify <i>with under worksurface clamp with USB A+C</i> . Specify <i>with under worksurface clamp with USB A+C</i> . Specify <i>with under worksurface clamp with USB-C</i> . Specify <i>with under worksurface clamp with USB-C</i> . Specify <i>with under worksurface power</i> . Specify <i>with under worksurface power</i> .
Power Cord	<ul style="list-style-type: none"> • 10' standard cord • 9' standard cord • 10' braided cord • 20' standard cord • 20' braided cord • 8' curly cord 	No cost No cost +\$ 79 +\$ 79 +\$ 234 +\$ 340	Specify <i>with 10' standard cord</i> . Specify <i>with 9' standard cord</i> . Specify <i>with 10' braided cord</i> and select finish. Specify <i>with 20' standard cord</i> . Specify <i>with 20' braided cord</i> and select finish. Specify <i>with 8' curly cord</i> .
Power Plug Type	<ul style="list-style-type: none"> • Standard NEMA 5-15 3-prong • Thread low profile plug 	No cost +\$ 43	Specify <i>with standard NEMA 5-15 3-prong</i> . Specify <i>with thread low profile plug</i> .
PVC	<ul style="list-style-type: none"> • With PVC • Non PVC 	No cost +\$ 36	Specify <i>with PVC</i> . Specify <i>with non PVC</i> .



For Canadian Pricing
Multiply U.S. Price by the
Canadian price factor.
► See page 1 for details.

Specification Information

• Style Number	• Depth	• U.S. Base Prices					• Option (Add \$ to Base Price) Cable Tray	
		Modular	46"W	52"W	58"W	64"W		70"W
		Parametric	46"W-48"W	48 1/16"W-54"W	54 1/16"W-60"W	60 1/16"W-66"W	66 1/16"W-72"W	
WESSUTSRQB	23"		\$2110	\$2153	\$2247	\$2318	\$2389	+\$195
	29"		\$2380	\$2456	\$2479	\$2529	\$2548	+\$218

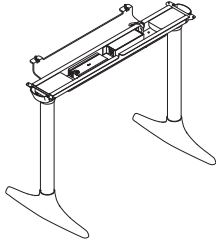

 **For Canadian Pricing**
 Multiply U.S. Price by the Canadian price factor.
 ▶ See page 1 for details.

Sutton Extended Height-Adjustable Bases

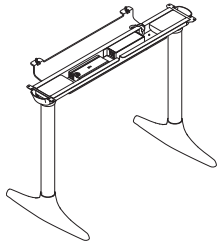

► Need help?
Product details,
page 76

Standard Includes

- Extended height-adjustable base
- Electric height-adjustable sit-to-stand base: paint price group 1
- Foot: paint price group 1
- Leg ring: paint price group 1
- Simple touch controller
- Modular widths: 46", 52", 58", 64", or 70"
- Attachment hardware
- Power cord: 10' with standard plug

Required to Specify

- 1 Style number
 - 2 Paint color number for base
 - 3 Paint color number for foot
 - 4 Paint color number for leg ring
 - 5 Options, if selected (see below)
- See *Surface Materials*, page 242.

	Options	U.S. Price	Required to Specify
Size	<ul style="list-style-type: none"> • Modular • Parametric 	No cost No cost	Specify modular. Specify parametric.
Surface Materials	<p>Foot</p> <ul style="list-style-type: none"> • Paint price group 1 • Paint price group 2 • Paint price group 3 • Polished aluminum <p>Base</p> <ul style="list-style-type: none"> • Paint price group 1 • Paint price group 2 <p>Leg ring</p> <ul style="list-style-type: none"> • Paint price group 1 • Paint price group 2 • Paint price group 3 • Polished chrome 	No cost +\$ 24 +\$ 44 +\$ 44 No cost +\$ 24 No cost +\$ 5 +\$ 16 +\$ 22	Specify paint color number. Specify paint color number. Specify paint color number. Specify with polished aluminum. Specify paint color number. Specify paint color number. Specify paint color number. Specify paint color number. Specify paint color number. Specify with polished aluminum.
Cable Tray	<ul style="list-style-type: none"> • No cable tray • With cable tray 	No cost Prices at right	Specify with no cable tray. Specify with cable tray.
Controller	<ul style="list-style-type: none"> • Simple touch controller • Active touch controller 	No cost +\$ 79	Specify with simple touch controller. Specify with active touch controller.
Power Configuration	<ul style="list-style-type: none"> • No under worksurface power • Under worksurface clamp with USB A+C <ul style="list-style-type: none"> – 46"W–57¹/₁₆"W – 58"W–72"W • Under worksurface clamp with USB-C <ul style="list-style-type: none"> – 46"W–57¹/₁₆"W – 58"W–72"W • Under worksurface only <ul style="list-style-type: none"> – 46"W–57¹/₁₆"W – 58"W–72"W 	No cost +\$ 853 +\$ 888 +\$1195 +\$1229 +\$ 507 +\$ 541	Specify with no under worksurface power. Specify with under worksurface clamp with USB A+C. Specify with under worksurface clamp with USB A+C. Specify with under worksurface clamp with USB-C. Specify with under worksurface clamp with USB-C. Specify with under worksurface power. Specify with under worksurface power.
Power Cord	<ul style="list-style-type: none"> • 10' standard cord • 9' standard cord • 10' braided cord • 20' standard cord • 20' braided cord • 8' curly cord 	No cost No cost +\$ 79 +\$ 79 +\$ 234 +\$ 340	Specify with 10' standard cord. Specify with 9' standard cord. Specify with 10' braided cord and select finish. Specify with 20' standard cord. Specify with 20' braided cord and select finish. Specify with 8' curly cord.
Power Plug Type	<ul style="list-style-type: none"> • Standard NEMA 5-15 3-prong • Thread low profile plug 	No cost +\$ 43	Specify with standard NEMA 5-15 3-prong. Specify with thread low profile plug.
PVC	<ul style="list-style-type: none"> • With PVC • Non PVC 	No cost +\$ 36	Specify with PVC. Specify with non PVC.



For Canadian Pricing
Multiply U.S. Price by the
Canadian price factor.
► See page 1 for details.

Specification Information

• Style Number	• Depth	• U.S. Base Prices					• Option (Add \$ to Base Price) Cable Tray	
		Modular	46"W	52"W	58"W	64"W		70"W
		Parametric	46"W-48"W	48 1/16"W-54"W	54 1/16"W-60"W	60 1/16"W-66"W	66 1/16"W-72"W	
WESSUTERQB	23"		\$2281	\$2355	\$2431	\$2533	\$2611	+\$195
	29"		\$2602	\$2684	\$2709	\$2763	\$2784	+\$218

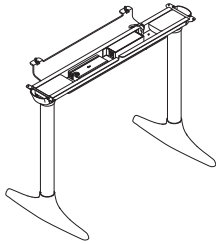

 **For Canadian Pricing**
 Multiply U.S. Price by the Canadian price factor.
 ▶ See page 1 for details.

Cable Tray

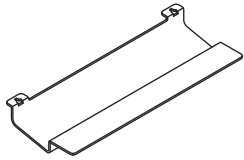

Standard Includes	Required to Specify
<ul style="list-style-type: none"> ▶ Need help? Product details, page 76 • Cable tray: P631 Dark Heather Grey molded PET felt • Attachment hardware • 28"W cable tray, if 46"W–57¹⁵/₁₆"W worksurface selected • 40"W cable tray, if 58"W–72"W worksurface selected 	<ul style="list-style-type: none"> 1 Style number 2 Select worksurface depth 3 Select worksurface width

Specification Information			
• Style Number	• Worksurface Width	• U.S. Prices • Worksurface Depth	
WESSUTCT	46"–72"	\$195	\$218

Magnetic Cable Clips

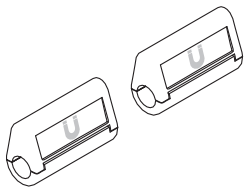

Standard Includes	Required to Specify
<ul style="list-style-type: none"> ▶ Need help? Product details, page 76 • Magnetic clips: 6053 Seagull 	<ul style="list-style-type: none"> Style number

Specification Information	
• Style Number	• U.S. Price
Quantity 2	
FLXMCC2	\$106
Quantity 10	
FLXMCC10	\$418

 **For Canadian Pricing**
Multiply U.S. Price by the Canadian price factor.
▶ See page 1 for details.

Cable Brackets

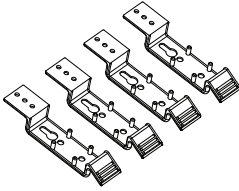

	Standard Includes	Required to Specify
▶ Need help? Product details, page 76	• Cable brackets, quantity of four: 6527 Merle	Style number

Specification Information

Style Number	U.S. Price
FLXCBK4	\$51

Sutton

Cable Riser

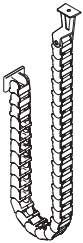

	Standard Includes	Required to Specify
▶ Need help? Product details, page 76	• Cable riser with fence connection: 7360 Merle paint • Attachment hardware	1 Style number 2 Options, if selected (see below)

Options	U.S. Price	Required to Specify
Connection Type		
• Fence connection	No cost	Specify with fence connection.
• Leg connection	+\$165	Specify with leg connection.

Specification Information

Style Number	U.S. Base Price
OLCR	\$113



For Canadian Pricing
Multiply U.S. Price by the Canadian price factor.
▶ See page 1 for details.



West Elm—Licensed Specifying

Seating

Nimbus

Conference Chair **232**

Slope

Guest Chairs and Stools **233**

Conference Chair **236**

Furniture

Lily Pad

Occasional Tables **237**

Linear

Occasional Tables **238**

Maisie

Occasional Tables **239**

Mesa

Coffee Table **240**

Nimbus

Conference Chair



	Standard Includes	Required to Specify
▶ Need help? Product details, page 81	<ul style="list-style-type: none"> • Chair: platinum • Depth 24.4" • Width 26" • Height 31.5" • Weight 40 lbs • Warranty 5 years • Certification BIFMA compliant 	Style number

Specification Information	
Style Number	U.S. Price
WEM70	\$1187



For Canadian Pricing
 Multiply U.S. Price by the Canadian price factor.
 ▶ See page 1 for details.

Slope

Guest Chairs and Stools

Slope Lounge Chair



Standard Includes	Required to Specify
<ul style="list-style-type: none"> ▶ Need help? Product details, page 85 • Chair: saddle • Depth 24.4" • Width 26" • Height 31.5" • Weight 40 lbs • 5 years warranty • Certification: BIFMA compliant 	Style number

Specification Information	
• Style Number	• U.S. Price
WEM2	\$1293

Slope Bar Stool



Standard Includes	Required to Specify
<ul style="list-style-type: none"> ▶ Need help? Product details, page 84 • Stool: saddle • Depth 21.5" • Width 19.25" • Height 40" • Weight 29 lbs • 5 years warranty • Certification: BIFMA compliant 	Style number

Specification Information	
• Style Number	• U.S. Price
WEM66	\$1113

West Elm—Licensed

For Canadian Pricing
 Multiply U.S. Price by the Canadian price factor.
 ▶ See page 1 for details.

Slope Counter Stool



	Standard Includes	Required to Specify
▶ Need help? Product details, page 84	<ul style="list-style-type: none"> • Stool: saddle • Depth 21.5" • Width 19" • Height 35.75" • Weight 28 lbs • 5 years warranty • Certification: BIFMA compliant 	Style number

Specification Information	
• Style Number	• U.S. Price
WEM50	\$1113
•	•

Slope Guest Chair



	Standard Includes	Required to Specify
▶ Need help? Product details, page 82	<ul style="list-style-type: none"> • Chair: fog or saddle • Depth 21.5" • Width 19.25" • Height 33.25" • Weight 27 lbs • 5 years warranty • Certification: BIFMA compliant 	1 Style number 2 Color number for chair

Specification Information	
• Style Number	• U.S. Price
WEM1	\$1022
•	•



For Canadian Pricing
 Multiply U.S. Price by the Canadian price factor.
 ▶ See page 1 for details.

Slope Height Adjustable Bar Stool



	Standard Includes	Required to Specify
▶ Need help? Product details, page 84	<ul style="list-style-type: none"> • Stool: saddle • Depth 21.5" • Width 19" • Height 34.25"–40.25" • Weight 41 lbs • 5 years warranty • Certification: BIFMA compliant 	Style number

Specification Information	
• Style Number	• U.S. Price
WEM67	\$1369

 **For Canadian Pricing**
 Multiply U.S. Price by the
 Canadian price factor.
 ▶ See page 1 for details.

Slope

Conference Chair



	Standard Includes	Required to Specify
▶ Need help? Product details, page 83	<ul style="list-style-type: none"> • Chair: saddle • Depth 21.5" • Width 19.25" • Height 32"–36" • Weight 38 lbs • Warranty 5 years • Certification BIFMA compliant 	Style number

Specification Information	
Style Number	U.S. Price
WEM3	\$1293



For Canadian Pricing
 Multiply U.S. Price by the
 Canadian price factor.
 ▶ See page 1 for details.

Lily Pad

Occasional Tables

16" Lily Pad Nesting Table



Standard Includes		Required to Specify
<ul style="list-style-type: none"> ▶ Need help? Product details, page 86 	<ul style="list-style-type: none"> • Depth 25" • Width 30" • Height 16" • Weight 16 lbs • 5 years warranty • Certification: BIFMA compliant 	<ul style="list-style-type: none"> 1 Style number 2 Color number for table 3 Options, if selected (see below)

Options	U.S. Price	Required to Specify
Color <ul style="list-style-type: none"> • Walnut • White marble 	No cost +\$530	Select walnut. Select white marble.

Specification Information	
Style Number	U.S. Base Price
WEM7	\$1132

18" Lily Pad Nesting Table



Standard Includes		Required to Specify
<ul style="list-style-type: none"> ▶ Need help? Product details, page 86 	<ul style="list-style-type: none"> • Depth 25" • Width 30" • Height 18" • Weight 18 lbs • 5 years warranty • Certification: BIFMA compliant 	<ul style="list-style-type: none"> 1 Style number 2 Color number for table 3 Options, if selected (see below)

Options	U.S. Price	Required to Specify
Color <ul style="list-style-type: none"> • Walnut • White marble 	No cost +\$529	Select walnut. Select white marble.

Specification Information	
Style Number	U.S. Base Price
WEM59	\$1176

West Elm—Licensed

 **For Canadian Pricing**
 Multiply U.S. Price by the Canadian price factor.
 ▶ See page 1 for details.

Lily Pad, Occasional Tables, continued

20" Lily Pad Nesting Table



Standard Includes		Required to Specify
<ul style="list-style-type: none"> ▶ Need help? Product details, page 86 	<ul style="list-style-type: none"> • Depth 25" • Width 30" • Height 20" • Weight 20 lbs • 5 years warranty • Certification: BIFMA compliant 	<ul style="list-style-type: none"> 1 Style number 2 Color number for table 3 Options, if selected (see below)

Options	U.S. Price	Required to Specify
Color <ul style="list-style-type: none"> • Walnut • White marble 	<ul style="list-style-type: none"> No cost +\$530 	<ul style="list-style-type: none"> Select walnut. Select white marble.

Specification Information	
Style Number	U.S. Base Price
WEM60	\$1219

Linear C Table



Standard Includes		Required to Specify
<ul style="list-style-type: none"> ▶ Need help? Product details, page 87 	<ul style="list-style-type: none"> • Table: natural oak • Depth 13.5" • Width 24" • Height 26.5" • Weight 38 lbs • 5 years warranty • Certification: BIFMA compliant 	<ul style="list-style-type: none"> Style number

Specification Information	
Style Number	U.S. Price
WEM8	\$728



For Canadian Pricing
 Multiply U.S. Price by the Canadian price factor.
 ▶ See page 1 for details.

Maisie

Occasional Tables

22" Maisie Side Table



Standard Includes		Required to Specify
<ul style="list-style-type: none"> ▶ Need help? Product details, page 88 	<ul style="list-style-type: none"> • Table: walnut • Diameter 18" • Height 22" • Weight 35 lbs • 5 years warranty • Certification: BIFMA compliant ISCS Indoor Advantage 	<ul style="list-style-type: none"> 1 Style number 2 Color number for table 3 Options, if selected (see below)

Options	U.S. Price	Required to Specify
Color		
<ul style="list-style-type: none"> • Walnut • Marble 	No cost +\$241	Specify walnut. Specify marble.

Specification Information	
Style Number	U.S. Base Price
WEM11	\$920

25" Maisie Side Table



Standard Includes		Required to Specify
<ul style="list-style-type: none"> ▶ Need help? Product details, page 88 	<ul style="list-style-type: none"> • Table: walnut • Diameter 18" • Height 25" • Weight 35 lbs • 5 years warranty • Certification: BIFMA compliant 	<ul style="list-style-type: none"> 1 Style number 2 Color number for table 3 Options, if selected (see below)

Options	U.S. Price	Required to Specify
Color		
<ul style="list-style-type: none"> • Walnut • Marble 	No cost +\$248	Specify walnut. Specify marble.

Specification Information	
Style Number	U.S. Base Price
WEM4	\$956

West Elm—Licensed

 **For Canadian Pricing**
 Multiply U.S. Price by the Canadian price factor.
 ▶ See page 1 for details.

Mesa

Coffee Table



Standard Includes		Required to Specify
<ul style="list-style-type: none"> ▶ Need help? Product details, page 89 	<ul style="list-style-type: none"> • Table: black • Depth 32" • Width 32" • Height 12" • Weight 20 lbs • Limited lifetime warranty • Certification: BIFMA compliant 	<ul style="list-style-type: none"> • Style number

Specification Information	
• Style Number	• U.S. Price
WEM68	\$1757



For Canadian Pricing
 Multiply U.S. Price by the Canadian price factor.
 ▶ See page 1 for details.

Resources and Surface Materials

Surface Materials	242
Color Availability Matrix	
Plastic, Metal, and Paint Availability Matrix	244
Laminate Availability Matrix	248
Wood Availability Matrix	252
Upholstery Matrix	256
Lock and Keying Options	258
Style Number Index	260

Surface Materials

Wood

Tip: Known for its uniqueness, planked veneer has intentional and natural variations that include, but are not limited to: character marks, grain pattern, color, and natural color aging.

Select Surfaces

For information on products within Select Surfaces, including accent paints and fabrics from Designtex, Gabriel, Kvadrat, and Pollack, please refer to the *Surface Materials Reference Manual* or visit steelcase.com/surface-materials under the Select Surfaces section.

Composite Veneer

Composite veneers are an engineered wood intended to create specific grain patterns and characteristics. They are pre-stained and finished with Steelcase's Clarity water-borne UV topcoat, which protects the environment while providing durability and clarity. Only open-pore finishes are available on composite wood. Composite veneers with natural solid nosings because composite and natural wood grain and color matching are rarely compatible. Composite veneers are Select Surfaces and available as Wood Group 1 pricing.

Upholstery

Select Surfaces Program: Upholstery

Applies to:

- Belle
- Boardwalk
- Brighton
- Mesa
- Willow
- Slope
- Sterling

A collection of textiles

are available as part of a Select Surfaces Program. The collection from the leading suppliers in the market consists of high-performance textiles.

To order these fabrics, enter the finish code which corresponds with the fabric price group.

Price Group	Finish Code
1	59DA
2	59DB
3	59DC
4	59DD
5	59DE
6	59DF
7	59DG
8	59DH
9	59DJ
10	59DK

Then enter the fabric information in the Special Fabric Information pop up window.

Custom Surfaces

Price Group COM (Customer's Own Material)

Fabric Approval and Yardage To confirm whether a particular COM material has already been tested for use on a specific Steelcase product or to determine actual yardage requirements:

- Visit www.steelcase.com

Visit <https://srh.steelcase.com/comcalculator.aspx> for Steelcase Textile calculator.

For additional information regarding Customer's Own Material, call

1.888.STEELCASE (1.888.783.3522) or send an e-mail to lineone@steelcase.com.

Laminate

Tip: When selecting a Steelcase top surface finish, a corresponding Steelcase edge finish must be selected. When selecting West Elm top surface finish, a corresponding West Elm edge finish must be selected.

Color Availability Matrix

Plastic, Metal, and Paint Availability Matrix

Legend

- = Not available
- = Available
- = Available with exceptions
- ⓪ = Excluded
- ▶ See specification pages for details.

		Plastic Price Group 1		Paint Price Group 1 (Accessory)		Paint Price Group 1 (Smooth)		Paint Price Group 1 (Textured)														
		6000 Black	6052 Milk	4140 Arctic White Gloss	4144 Black Gloss	4238 Mocha	4239 Clay	4240 Chalk	4242 Milk	4710 Low Gloss Black	WE00 Hot Rolled Steel	WE01 Antique Bronze	7207 Black	7225 Sand	7237 Slate	7238 Fieldstone	7239 Midnight ⓪	7241 Arctic White	7243 Seagull	7250 Sterling Dark Solid		
Boardwalk	Platform	•	•	•	•	•	•	•	•	•	•	•	•	•	•	•	•	•	•	•	•	
	Legs	•	•	•	•	•	•	•	•	•	•	•	•	•	•	•	•	•	•	•	•	
Brighton	Table top	•	•	•	•	•	•	•	•	•	•	•	•	•	•	•	•	•	•	•	•	
	Frame	•	•	■	■	■	■	■	■	■	■	■	■	■	■	■	■	■	■	■	■	
	Foot and frame caps	•	•	■	■	■	■	■	■	■	■	■	■	■	■	■	■	■	■	■	■	
	Hardwood arms	•	•	•	•	•	•	•	•	•	•	•	•	•	•	•	•	•	•	•	•	
	Power	■	■	•	•	•	•	•	•	•	•	•	•	•	•	•	•	•	•	•	•	
Mesa	Feet	•	•	•	•	•	•	•	•	•	•	■	•	•	•	•	•	•	•	•	•	
Willow	Fixed base	•	•	•	•	•	•	•	•	•	•	•	•	•	•	•	•	•	•	•	•	
	Swivel base	•	•	•	•	•	•	•	•	•	•	•	•	•	•	•	•	•	•	•	•	
Slope*	Wire frame base	•	•	■	■	■	■	■	■	■	■	■	■	■	■	■	■	■	■	■	■	
	Five-star base	•	•	•	•	•	•	•	•	•	■	•	•	•	•	•	•	•	•	•	•	
Sterling	Five-star base	•	•	•	•	•	•	•	•	■	■	•	•	•	•	•	•	•	•	•	•	
	Four-star base	•	•	•	•	•	•	•	•	•	•	•	•	•	•	•	•	•	•	•	•	
	Hardwood legs	•	•	•	•	•	•	•	•	•	•	•	•	•	•	•	•	•	•	•	•	
Kent	Five-star base	•	•	■	■	■	■	■	■	■	■	■	■	■	■	■	■	■	■	■	■	
	Four-star base	•	•	■	■	■	■	■	■	■	■	■	■	■	■	■	■	■	■	■	■	
	Four-leg base	•	•	■	■	■	■	■	■	■	■	■	■	■	■	■	■	■	■	■	■	
	Stool	•	•	■	■	■	■	■	■	■	■	■	■	■	■	■	■	■	■	■	■	
Greenpoint	Desk and bench frames	•	•	■	■	■	■	■	■	■	■	■	■	■	■	■	■	■	■	■	■	
	Desk and bench worksurfaces	•	•	•	•	•	•	•	•	•	•	•	•	•	•	•	•	•	•	•	•	
	Storage frames and metal bodies	•	•	■	■	■	■	■	■	■	■	■	■	■	■	■	■	■	■	■	■	
	Wood storage—bodies, faces, and shelves	•	•	•	•	•	•	•	•	•	•	•	•	•	•	•	•	•	•	•	•	
	Metal storage—faces and shelves	•	•	•	•	•	•	•	•	•	•	•	•	•	•	•	•	•	•	•	•	
	Power	•	•	•	■	■	■	■	■	■	■	■	■	■	■	■	■	■	■	■	■	■
	Brackets	•	•	■	■	■	■	■	■	■	■	■	■	■	■	■	■	■	■	■	■	■
Sutton HAD	Top	•	•	•	•	•	•	•	•	•	•	•	•	•	•	•	•	•	•	•	•	
	Foot	•	•	•	•	•	•	•	•	•	•	•	•	•	•	•	•	•	•	•	•	
	Base	•	•	•	•	•	•	•	•	•	•	•	■	•	•	•	•	•	■	•	•	
	Leg Ring	•	•	■	■	■	■	■	■	■	■	■	■	■	■	■	■	■	■	■	■	■

* Paint options available on Steelcase Slope shown. Licensed Slope (stocked) frame will be defaulted to WE00 Hot Rolled Steel.
 Exception: Aegean leather Slope (stocked) frame is defaulted to Antique Brass.

Plastic, Metal, and Paint Availability Matrix, continued

Legend

- = Not available
- = Available
- = Available with exceptions
- ▶ See specification pages for details.

		Paint Price Group 3 (Accent)								Paint Price Group 3 (Smooth)	Paint Price Group 3 (Coatings)	Paint Price Group 3 (Lux Coatings)																													
		1ATG	Rose Quartz	4AV3	Blue Jay	4AV4	Baltic	4AX1	Citron	4AY2	Chili	4AZ5	Marlin	4CZ5	Honey	4CZ6	Lagoon	4CZ8	Light Peacock	WE03	Antique Brass	1ATT	Cast Shadow	4B20	Obsidian	4B22	Matte Brass	4B23	Burnished Bronze	4B24	Night Bronze	4B25	Matte Copper	4B26	Smoked Mica	4B29	Cast Iron				
Boardwalk	Platform	•	•	•	•	•	•	•	•	•	•	•	•	•	•	•	•	•	•	•	•	•	•	•	•	•	•	•	•	•	•	•	•	•	•	•	•	•			
	Legs	•	•	•	•	•	•	•	•	•	•	•	•	•	•	•	•	•	•	•	•	•	•	•	•	•	•	•	•	•	•	•	•	•	•	•	•	•	•		
Brighton	Table top	•	•	•	•	•	•	•	•	•	•	•	•	•	•	•	•	•	•	•	•	•	•	•	•	•	•	•	•	•	•	•	•	•	•	•	•	•	•		
	Frame	■	■	■	■	■	■	■	■	■	■	■	■	■	■	■	■	■	■	■	■	■	■	■	■	■	■	■	■	■	■	■	■	■	■	■	■	■	■	■	
	Foot and frame caps	■	■	■	■	■	■	■	■	■	■	■	■	■	■	■	■	■	■	■	■	■	■	■	■	■	■	■	■	■	■	■	■	■	■	■	■	■	■	■	
	Hardwood arms	•	•	•	•	•	•	•	•	•	•	•	•	•	•	•	•	•	•	•	•	•	•	•	•	•	•	•	•	•	•	•	•	•	•	•	•	•	•	•	
	Power	•	•	•	•	•	•	•	•	•	•	•	•	•	•	•	•	•	•	•	•	•	•	•	•	•	•	•	•	•	•	•	•	•	•	•	•	•	•	•	
	Mesa	Feet	•	•	•	•	•	•	•	•	•	•	•	•	•	•	•	•	•	•	•	•	•	•	•	•	•	•	•	•	•	•	•	•	•	•	•	•	•	•	
Willow	Fixed base	•	•	•	•	•	•	•	•	•	•	•	•	•	•	•	•	•	•	•	•	•	•	•	•	•	•	•	•	•	•	•	•	•	•	•	•	•	•		
	Swivel base	•	•	•	•	•	•	•	•	•	•	•	•	•	•	•	•	•	•	•	•	•	•	•	•	•	•	•	•	•	•	•	•	•	•	•	•	•	•	•	
Slope*	Wire frame base	■	■	■	■	■	■	■	■	■	■	■	■	■	■	■	■	■	■	•	■	■	■	■	■	■	■	■	■	■	■	■	■	■	■	■	■	■	■	■	
	Five-star base	•	•	•	•	•	•	•	•	•	•	•	•	•	•	•	•	•	•	•	•	•	•	•	•	•	•	•	•	•	•	•	•	•	•	•	•	•	•	•	
Sterling	Five-star base	•	•	•	•	•	•	•	•	•	•	•	•	•	•	•	•	•	•	•	•	•	•	•	•	■	•	■	•	■	•	■	•	■	•	■	•	■	•	■	
	Four-star base	•	•	•	•	•	•	•	•	•	•	•	•	•	•	•	•	•	•	•	•	•	•	•	•	•	•	•	•	•	•	•	•	•	•	•	•	•	•	•	
	Hardwood legs	•	•	•	•	•	•	•	•	•	•	•	•	•	•	•	•	•	•	•	•	•	•	•	•	•	•	•	•	•	•	•	•	•	•	•	•	•	•	•	
Kent	Five-star base	■	■	■	■	■	■	■	■	■	■	■	■	■	■	■	■	■	■	•	■	■	■	■	■	■	■	■	■	■	■	■	■	■	■	■	■	■	■	■	■
	Four-star base	■	■	■	■	■	■	■	■	■	■	■	■	■	■	■	■	■	■	•	■	■	■	■	■	■	■	■	■	■	■	■	■	■	■	■	■	■	■	■	■
	Four-leg base	■	■	■	■	■	■	■	■	■	■	■	■	■	■	■	■	■	■	•	■	■	■	■	■	■	■	■	■	■	■	■	■	■	■	■	■	■	■	■	■
	Stool	■	■	■	■	■	■	■	■	■	■	■	■	■	■	■	■	■	■	•	■	■	■	■	■	■	■	■	■	■	■	■	■	■	■	■	■	■	■	■	■
Greenpoint	Desk and bench frames	■	■	■	■	■	■	■	■	■	■	■	■	■	■	■	■	■	■	■	■	■	■	■	■	■	■	■	■	■	■	■	■	■	■	■	■	■	■	■	
	Desk and bench worksurfaces	•	•	•	•	•	•	•	•	•	•	•	•	•	•	•	•	•	•	•	•	•	•	•	•	•	•	•	•	•	•	•	•	•	•	•	•	•	•	•	
	Storage frames and metal bodies	■	■	■	■	■	■	■	■	■	■	■	■	■	■	■	■	■	■	■	■	■	■	■	■	■	■	■	■	■	■	■	■	■	■	■	■	■	■	■	■
	Wood storage—bodies, faces, and shelves	•	•	•	•	•	•	•	•	•	•	•	•	•	•	•	•	•	•	•	•	•	•	•	•	•	•	•	•	•	•	•	•	•	•	•	•	•	•	•	
	Metal storage—faces and shelves	•	•	•	•	•	•	•	•	•	•	•	•	•	•	•	•	•	•	•	•	•	•	•	•	•	•	•	•	•	•	•	•	•	•	•	•	•	•	•	
	Power	•	•	•	•	•	•	•	•	•	•	•	•	•	•	•	•	•	•	•	•	•	•	•	•	•	•	•	•	•	•	•	•	•	•	•	•	•	•	•	
Sutton HAD	Brackets	■	■	■	■	■	■	■	■	■	■	■	■	■	■	■	■	■	■	•	■	■	■	■	■	■	■	■	■	■	■	■	■	■	■	■	■	■	■	■	■
Sutton HAD	Top	•	•	•	•	•	•	•	•	•	•	•	•	•	•	•	•	•	•	•	•	•	•	•	•	•	•	•	•	•	•	•	•	•	•	•	•	•	•	•	
	Foot	■	■	■	■	■	■	■	■	■	■	■	■	■	■	■	■	■	■	■	■	■	■	■	■	■	■	■	■	■	■	■	■	■	■	■	■	■	■	■	■
	Base	□	□	□	□	□	□	□	□	□	□	□	□	□	□	□	□	□	□	□	□	□	□	□	■	■	■	■	■	■	■	■	■	■	■	■	■	■	■	■	■
	Leg Ring	■	■	■	■	■	■	■	■	■	■	■	■	■	■	■	■	■	■	■	•	■	■	■	■	■	■	■	■	■	■	■	■	■	■	■	■	■	■	■	■

* Paint options available on Steelcase Slope shown. Licensed Slope (stocked) frame will be defaulted to WE00 Hot Rolled Steel. Exception: Aegean leather Slope (stocked) frame is defaulted to Antique Brass.

Laminate Availability Matrix

Legend

- = Not available
- = Available
- = Available with exceptions
- ⊖ = Excluded
- ▶ See specification pages for details.

		HPL Price Group 1 (Woodgrain)	2406 Clear Cherry ⊖	2409 Clear Maple	2410 Graphite Walnut	2412 Natural Cherry	2422 Medium Cherry ⊖	2503 Brushed Silver	2511 Winter on Maple ⊖	2535 Virginia Walnut	2536 Blackwood	2538 Clear Walnut	2539 Warm Oak	2592 Blonde on Maple ⊖	2614 Chocolate Walnut	2615 Marbled Cherry V2	2714 Natural Walnut ⊖	2759 Warm White	2772 Medium Mahogany on Walnut	2822 Woodrose Speckle	2851 Rhyme Fiber	2923 Shadow Micro	2HAK Clear Oak	2HAN Ash Noce
Boardwalk	Platform	■	■	■	■	■	■	■	■	■	■	■	■	■	■	■	■	■	■	■	■	■	■	■
	Legs	•	•	•	•	•	•	•	•	•	•	•	•	•	•	•	•	•	•	•	•	•	•	•
Brighton	Table top	■	■	■	■	■	•	■	■	■	■	■	■	■	■	■	■	•	■	•	•	•	■	■
	Frame	•	•	•	•	•	•	•	•	•	•	•	•	•	•	•	•	•	•	•	•	•	•	•
	Foot and frame caps	•	•	•	•	•	•	•	•	•	•	•	•	•	•	•	•	•	•	•	•	•	•	•
	Hardwood arms	•	•	•	•	•	•	•	•	•	•	•	•	•	•	•	•	•	•	•	•	•	•	•
	Power	•	•	•	•	•	•	•	•	•	•	•	•	•	•	•	•	•	•	•	•	•	•	•
Mesa	Feet	•	•	•	•	•	•	•	•	•	•	•	•	•	•	•	•	•	•	•	•	•	•	•
Willow	Fixed base	•	•	•	•	•	•	•	•	•	•	•	•	•	•	•	•	•	•	•	•	•	•	•
	Swivel base	•	•	•	•	•	•	•	•	•	•	•	•	•	•	•	•	•	•	•	•	•	•	•
Slope	Wire frame base	•	•	•	•	•	•	•	•	•	•	•	•	•	•	•	•	•	•	•	•	•	•	•
	Five-star base	•	•	•	•	•	•	•	•	•	•	•	•	•	•	•	•	•	•	•	•	•	•	•
Sterling	Five-star base	•	•	•	•	•	•	•	•	•	•	•	•	•	•	•	•	•	•	•	•	•	•	•
	Four-star base	•	•	•	•	•	•	•	•	•	•	•	•	•	•	•	•	•	•	•	•	•	•	•
	Hardwood legs	•	•	•	•	•	•	•	•	•	•	•	•	•	•	•	•	•	•	•	•	•	•	•
Kent	Five-star base	•	•	•	•	•	•	•	•	•	•	•	•	•	•	•	•	•	•	•	•	•	•	•
	Four-star base	•	•	•	•	•	•	•	•	•	•	•	•	•	•	•	•	•	•	•	•	•	•	•
	Four-leg base	•	•	•	•	•	•	•	•	•	•	•	•	•	•	•	•	•	•	•	•	•	•	•
	Stool	•	•	•	•	•	•	•	•	•	•	•	•	•	•	•	•	•	•	•	•	•	•	•
Greenpoint	Desk and bench frames	•	•	•	•	•	•	•	•	•	•	•	•	•	•	•	•	•	•	•	•	•	•	•
	Desk and bench worksurfaces	■	■	■	■	■	•	■	■	■	■	■	■	■	■	■	■	•	■	•	•	•	■	■
	Storage frames and metal bodies	•	•	•	•	•	•	•	•	•	•	•	•	•	•	•	•	•	•	•	•	•	•	•
	Wood storage—bodies, faces, and shelves	□	□	□	□	□	•	□	□	□	□	□	□	□	□	□	□	•	□	•	•	•	□	■
	Metal storage—faces and shelves	•	•	•	•	•	•	•	•	•	•	•	•	•	•	•	•	•	•	•	•	•	•	■
Power	•	•	•	•	•	•	•	•	•	•	•	•	•	•	•	•	•	•	•	•	•	•	•	
Sutton HAD	Top	■	■	■	■	■	■	•	•	•	•	■	•	■	■	•	•	■	■	■	■	■	•	•
	Foot	■	■	■	■	■	■	■	■	■	■	■	■	■	■	■	■	■	■	■	■	■	■	■
	Base	■	■	■	■	■	■	■	■	■	■	■	■	■	■	■	■	■	■	■	■	■	■	■
	Leg Ring	■	■	■	■	■	■	■	■	■	■	■	■	■	■	■	■	■	■	■	■	■	■	■

Laminate Availability Matrix, continued

Legend

- = Not available
- = Available
- = Available with exceptions
- ⓔ = Excluded
- ▶ See specification pages for details.

		HPL Price Group 1 (Patina)			HPL Price Group 1 (Solid)			HPL Price Group 1 (Speckle)			HPL Price Group 2 (Textured)												
		2870	2871	2873	2722	2730	2746	2759	2811	2883	2884	2885	2HMG	2820	2823	2824	2825	2TH2	2TH4	2TH5	2TH7	2UH1	
		Blonde Bronze Patina	Blackened Bronze Patina	Instant Iron Patina	Cream ⓔ	Arctic White	Black	Warm White	Mist ⓔ	Seagull	Milk	Dune	Merle	Coffee Speckle ⓔ	Driftwood Speckle	Smoke Speckle	Vanadium Speckle	Fawn Cypress	Saddle Oak	Veranda Teak	Walnut Heights	Reclaimed Aggregate	
Boardwalk	Platform	■	■	■	■	■	■	■	■	■	■	■	■	■	■	■	■	■	■	■	■	■	■
	Legs	•	•	•	•	•	•	•	•	•	•	•	•	•	•	•	•	•	•	•	•	•	•
Brighton	Table top	■	■	■	■	■	■	■	■	■	■	■	■	■	■	■	■	■	■	■	■	■	■
	Frame	•	•	•	•	•	•	•	•	•	•	•	•	•	•	•	•	•	•	•	•	•	•
	Foot and frame caps	•	•	•	•	•	•	•	•	•	•	•	•	•	•	•	•	•	•	•	•	•	•
	Hardwood arms	•	•	•	•	•	•	•	•	•	•	•	•	•	•	•	•	•	•	•	•	•	•
	Power	•	•	•	•	•	•	•	•	•	•	•	•	•	•	•	•	•	•	•	•	•	•
Mesa	Feet	•	•	•	•	•	•	•	•	•	•	•	•	•	•	•	•	•	•	•	•	•	•
Willow	Fixed base	•	•	•	•	•	•	•	•	•	•	•	•	•	•	•	•	•	•	•	•	•	•
	Swivel base	•	•	•	•	•	•	•	•	•	•	•	•	•	•	•	•	•	•	•	•	•	•
Slope	Wire frame base	•	•	•	•	•	•	•	•	•	•	•	•	•	•	•	•	•	•	•	•	•	•
	Five-star base	•	•	•	•	•	•	•	•	•	•	•	•	•	•	•	•	•	•	•	•	•	•
Sterling	Five-star base	•	•	•	•	•	•	•	•	•	•	•	•	•	•	•	•	•	•	•	•	•	•
	Four-star base	•	•	•	•	•	•	•	•	•	•	•	•	•	•	•	•	•	•	•	•	•	•
	Hardwood legs	•	•	•	•	•	•	•	•	•	•	•	•	•	•	•	•	•	•	•	•	•	•
Kent	Five-star base	•	•	•	•	•	•	•	•	•	•	•	•	•	•	•	•	•	•	•	•	•	•
	Four-star base	•	•	•	•	•	•	•	•	•	•	•	•	•	•	•	•	•	•	•	•	•	•
	Four-leg base	•	•	•	•	•	•	•	•	•	•	•	•	•	•	•	•	•	•	•	•	•	•
	Stool	•	•	•	•	•	•	•	•	•	•	•	•	•	•	•	•	•	•	•	•	•	•
Greenpoint	Desk and bench frames	•	•	•	•	•	•	•	•	•	•	•	•	•	•	•	•	•	•	•	•	•	•
	Desk and bench worksurfaces	■	■	■	■	■	■	■	■	■	■	■	■	■	■	■	■	■	■	■	■	■	■
	Storage frames and metal bodies	•	•	•	•	•	•	•	•	•	•	•	•	•	•	•	•	•	•	•	•	•	•
	Wood storage—bodies, faces, and shelves	□	□	□	□	□	□	□	□	□	□	□	■	□	□	□	□	□	□	□	□	□	□
	Metal storage—faces and shelves	•	•	•	•	•	•	•	•	•	•	■	■	•	•	•	•	•	•	•	•	•	•
Power	•	•	•	•	•	•	•	•	•	•	•	•	•	•	•	•	•	•	•	•	•	•	
Sutton HAD	Top	■	•	■	•	•	•	•	•	•	•	•	•	•	•	•	•	•	•	•	•	•	•
	Foot	■	■	■	■	■	■	■	■	■	■	■	■	■	■	■	■	■	■	■	■	■	■
	Base	■	■	■	■	■	■	■	■	■	■	■	■	■	■	■	■	■	■	■	■	■	■
	Leg Ring	■	■	■	■	■	■	■	■	■	■	■	■	■	■	■	■	■	■	■	■	■	■

	2UH2 Recycled Gravel	2UH4 Cement	2UH6 Sheetrock
	■	■	■
	•	•	•
	■	■	■
	•	•	•
	•	•	•
	•	•	•
	•	•	•
	•	•	•
	•	•	•
	•	•	•
	•	•	•
	•	•	•
	•	•	•
	•	•	•
	•	•	•
	•	•	•
	•	•	•
	•	•	•
	•	•	•
	•	•	•
	•	•	•
	•	•	•
	■	■	■
	•	•	•
	□	□	□
	•	•	•
	•	•	•
	•	•	•
	•	•	■
	■	■	■
	■	■	■
	■	■	■

Wood Availability Matrix

Legend

- = Not available
- = Available
- = Available with exceptions
- Ⓢ = Excluded
- ▶ See specification pages for details.

		Wood	Price Group 1 (Flat Cut)																		
			Cherry			Maple			Walnut												
			3402	3412	3422	V1AC	V1CC	3522	35A2	V1AM	3062	3082	3342	3702	3712	3752	3762	3772	37A2	V1EW	
			FC/OP Clear Cherry (Aged)	FC/OP Natural Cherry Ⓢ	FC/OP Medium Cherry	FC/OP Natural Cherry	FC/OP Medium Amber Cherry	FC/OP Clear Maple	FC/OP Blanch Maple	FC/OP Clear Maple	FC/OP Graphite Walnut	FC/OP Washed Walnut	FC/OP Black Walnut	FC/OP Clear Walnut	FC/OP Natural Walnut	FC/OP Medium Walnut Ⓢ	FC/OP Dark Walnut	FC/OP Medium Mahogany on Walnut	FC/OP Thunder Walnut	FC/OP Dark Walnut	
Boardwalk	Platform		•	•	•	•	•	•	•	•	•	•	•	•	•	•	•	•	•	•	•
	Legs		•	•	•	•	•	•	•	•	•	•	•	•	•	•	•	•	•	•	•
Brighton	Table top		■	■	■	■	■	■	■	■	■	■	■	■	■	■	■	■	■	■	■
	Frame		•	•	•	•	•	•	•	•	•	•	•	•	•	•	•	•	•	•	•
	Foot and frame caps		•	•	•	•	•	•	•	•	•	•	•	•	•	•	•	•	•	•	•
	Hardwood arms		•	•	•	•	•	•	•	•	•	•	•	•	•	•	•	•	•	•	•
	Power		•	•	•	•	•	•	•	•	•	•	•	•	•	•	•	•	•	•	•
Mesa	Feet		•	•	•	•	•	•	•	•	•	•	•	•	•	•	•	•	•	•	•
Willow	Fixed base		•	•	•	•	•	•	•	•	•	•	•	•	•	•	•	•	•	•	•
	Swivel base		•	•	•	•	•	•	•	•	•	•	•	•	•	•	•	•	•	•	•
Slope	Wire frame base		•	•	•	•	•	•	•	•	•	•	•	•	•	•	•	•	•	•	•
	Five-star base		•	•	•	•	•	•	•	•	•	•	•	•	•	•	•	•	•	•	•
Sterling	Five-star base		•	•	•	•	•	•	•	•	•	•	•	•	•	•	•	•	•	•	•
	Four-star base		•	•	•	•	•	•	•	•	•	•	•	•	•	•	•	•	•	•	•
	Hardwood legs		•	•	•	•	•	•	•	•	•	•	•	•	•	•	•	•	•	•	•
Kent	Five-star base		•	•	•	•	•	•	•	•	•	•	•	•	•	•	•	•	•	•	•
	Four-star base		•	•	•	•	•	•	•	•	•	•	•	•	•	•	•	•	•	•	•
	Four-leg base		•	•	•	•	•	•	•	•	•	•	•	•	•	•	•	•	•	•	•
	Stool		•	•	•	•	•	•	•	•	•	•	•	•	•	•	•	•	•	•	•
Greenpoint	Desk and bench frames		•	•	•	•	•	•	•	•	•	•	•	•	•	•	•	•	•	•	•
	Desk and bench worksurfaces		■	■	■	•	•	■	■	•	■	•	■	■	■	■	■	■	■	■	•
	Storage frames and metal bodies		•	•	•	•	•	•	•	•	•	•	•	•	•	•	•	•	•	•	•
	Wood storage—bodies, faces, and shelves		□	□	□	•	•	□	□	•	□	•	□	□	□	□	□	□	□	■	•
	Metal storage—faces and shelves		•	•	•	•	•	•	•	•	•	•	•	•	•	•	•	•	•	■	•
Power		•	•	•	•	•	•	•	•	•	•	•	•	•	•	•	•	•	•	•	•
Sutton HAD	Top		•	•	•	■	■	•	•	■	•	•	•	•	•	•	•	•	•	•	■
	Foot		■	■	■	■	■	■	■	■	■	■	■	■	■	■	■	■	■	■	■
	Base		■	■	■	■	■	■	■	■	■	■	■	■	■	■	■	■	■	■	■
	Leg Ring		■	■	■	■	■	■	■	■	■	■	■	■	■	■	■	■	■	■	■

Wood Availability Matrix, continued

Legend

- = Not available
- = Available
- = Available with exceptions
- ⊖ = Excluded
- ▶ See specification pages for details.

		Wood, continued				Price Group 1 (Planked)					Price Group 1 (Hardwood)				
		Price Group 1 (Rift Cut)				Cherry	Maple	Oak	Walnut	Oak					
		3602	3611	3612	36A2	3P41	3P51	3P61	3VFX	WE20	3P71	VP01	VP03	VP04	VP05
		RC/OP Desert Oak	RC/OP Natural Oak	RC/OP Warm Oak	RC/OP Volcanic Oak	OP Planked Cherry	OP Planked Maple	OP Planked Oak	OP Natural Recon	OP Natural Oak	OP Planked Walnut	RC/LS Light Oak	RC/LS Black Oak	RC/LS Gray Oak	RC/LS White Oak
Boardwalk	Platform	■	■	■	■	•	•	■	■	•	•	•	•	•	•
	Legs	•	•	•	•	•	•	•	•	•	•	■	■	•	■
Brighton	Table top	■	■	■	■	■	■	■	■	•	■	•	•	•	•
	Frame	•	•	•	•	•	•	•	•	•	•	•	•	•	•
	Foot and frame caps	•	•	•	•	•	•	•	•	•	•	•	•	•	•
	Hardwood arms	•	•	•	•	•	•	•	•	•	•	■	■	■	■
	Power	•	•	•	•	•	•	•	•	•	•	•	•	•	•
Mesa	Feet	•	•	•	•	•	•	•	•	•	•	•	•	•	•
Willow	Fixed base	•	•	•	•	•	•	•	•	•	•	•	•	•	•
	Swivel base	•	•	•	•	•	•	•	•	•	•	•	•	•	•
Slope	Wire frame base	•	•	•	•	•	•	•	•	•	•	•	•	•	•
	Five-star base	•	•	•	•	•	•	•	•	•	•	•	•	•	•
Sterling	Five-star base	•	•	•	•	•	•	•	•	•	•	•	•	•	•
	Four-star base	•	•	•	•	•	•	•	•	•	•	■	■	■	■
	Hardwood legs	•	•	•	•	•	•	•	•	•	•	■	■	■	■
Kent	Five-star base	•	•	•	•	•	•	•	•	•	•	•	•	•	•
	Four-star base	•	•	•	•	•	•	•	•	•	•	•	•	•	•
	Four-leg base	•	•	•	•	•	•	•	•	•	•	•	•	•	•
	Stool	•	•	•	•	•	•	•	•	•	•	•	•	•	•
Greenpoint	Desk and bench frames	•	•	•	•	•	•	•	•	•	•	•	•	•	•
	Desk and bench worksurfaces	■	•	•	■	■	■	■	■	■	■	•	•	•	•
	Storage frames and metal bodies	•	•	•	•	•	•	•	•	•	•	•	•	•	•
	Wood storage—bodies, faces, and shelves	□	•	•	■	□	□	□	□	■	□	•	•	•	•
	Metal storage—faces and shelves	•	•	•	■	•	•	•	•	■	•	•	•	•	•
Power	•	•	•	•	•	•	•	•	•	•	•	•	•	•	
Sutton HAD	Top	•	•	•	•	•	•	•	•	•	•	•	•	•	•

Upholstery Matrix

Legend

- = Available in the default direction
- V = Only available in the vertical direction
- H = Only available in the horizontal direction
- = Not available

	Price Group	Belle	Boardwalk	Brighton	Kent	Lucas Wire and Swivel	Mesa	Slope	Sterling	Willow
3014 Speckle Boucle	6	•	■	H	■	■	■	•	■	■
3018 Cube Geo	6	V	■	H	■	•	•	•	■	•
3019 Boucle Houndstooth	6	V	■	H	■	■	■	H	■	■
3020 Plush Grid	6	•	■	•	■	•	•	•	•	•
3063 Cozy Texture	4	V	•	H	•	•	■	H	■	•
3064 Tweedy Twill	4	V	■	H	■	■	■	H	■	■
3170 Corded	7	•	•	H	•	■	■	•	■	■
3171 Boucle Melange	7	V	■	H	■	■	■	•	■	■
3172 Chunky Tweed	7	•	•	H	•	■	■	H	■	■
3173 Chenille Chevron	7	•	•	H	•	•	•	■	■	•
3722 Tweed Multi	3	V	■	■	■	■	■	■	■	■
3741 Tiny Herringbone	6	V	■	■	■	■	•	■	■	•
3746 Bark Cloth	6	V	■	■	■	■	■	■	■	■
3747 Reppweave	5	V	■	H	■	■	■	•	■	■
3748 Starburst	7	V	■	•	■	•	•	•	■	•
3749 Tack Cloth	6	V	■	•	■	•	•	■	■	•
3752 Hem Stitch	5	V	■	■	■	■	■	•	■	■
3761 Hatchmark	8	V	■	■	■	■	•	■	■	•
3762 Crossweave	4	V	■	■	■	■	■	■	■	■
3797 Brushed Flannel	4	V	■	■	■	■	■	■	■	■
3815 Big Texture	7	V	■	■	■	■	■	■	■	■
3928 Linen Like	5	V	■	■	•	•	■	■	■	•
3931 Fomo	5	V	■	■	■	■	■	V	■	■
3935 Distressed Texture	7	V	■	■	•	•	■	■	■	•
4142 Birdseye	2	V	■	■	■	■	■	•	■	■
4144 Cloud Velvet	4	V	■	■	■	■	■	■	■	■
Mont Blanc - Moore & Giles	L	•	■	H	■	■	■	•	■	■

* Upholstery available on Steelcase Slope shown.
 Licensed slope available only in saddle, fog, and aegean leather.

Legend

- = Not available
- = Available
- = Available with exceptions
- Ⓢ = Excluded
- ▶ See specification pages for details.

Steelcase

Price Group 1

	Belle	Boardwalk	Brighton	Fulton	Kent	Mesa	Willow	Slope*	Sterling
Buzz2	■	■	■	■	■	■	■	■	■
Era	■	■	■	■	■	■	■	■	■
Foundation	•	■	■	■	■	•	■	•	■
Jacks Ⓢ	■	■	■	■	■	■	•	■	■
Link	•	■	■	■	■	■	■	■	■
New Black: Henry and Bruce	■	■	■	■	■	■	■	■	■

Price Group 2

Chainmail	■	■	■	■	■	■	■	■	■
Cogent: Connect	■	■	■	■	■	■	■	■	■
Dovetail by Designtex	■	■	■	■	■	■	■	■	■
New Black: James, Harley, Jack	■	■	■	■	■	■	■	■	■
Nitelights	■	■	■	■	■	■	■	■	■
SoftNext	■	■	■	■	■	■	■	■	■
Spyder	•	■	■	•	■	■	•	•	■
Stand In	•	•	■	■	■	•	■	•	•

Price Group 3

Billiard Multi-Use by Designtex	■	■	■	■	■	■	■	■	■
Gaja	■	■	■	■	■	■	■	■	■
Redeem	■	■	■	■	■	■	■	■	■
Retrieve	■	■	■	■	■	■	■	■	■
Tweed Multi by Designtex**	•	•	•	■	■	•	■	•	•

Price Group 4

Cloud Velvet by Designtex***	•	•	•	■	■	•	■	•	•
------------------------------	---	---	---	---	---	---	---	---	---

Price Group 5

Bo Peep	•	■	■	■	■	■	■	■	■
Remix	■	■	■	■	■	■	■	■	■
Silk	■	■	■	■	■	■	■	■	■

Price Group 6

Brisa	•	■	■	■	■	■	■	■	■
-------	---	---	---	---	---	---	---	---	---

Price Group 7

Steelcut Trio	•	■	■	■	■	■	■	■	■
---------------	---	---	---	---	---	---	---	---	---

Leather Price Group 1

Cafe	•	■	■	■	■	■	•	•	■
Steelcase Leather Ⓢ	•	■	■	■	■	■	•	•	■

Leather Price Group 2

Elmosoft	•	■	■	■	■	■	■	■	■
----------	---	---	---	---	---	---	---	---	---

* Upholstery available on Steelcase Slope shown. Licensed Slope available only in saddle, fog, and aegean leather.

** Tweed Multi available in medium grey, medium blue, light grey, and all other finishes are available as graded-in.

*** Cloud Velvet available in light mocha, black indigo, slate, and all other finishes are available as graded-in.

Lock and Keying Options

Greenpoint Pedestals and Greenpoint Lateral Files

All locking products are standard with factory-installed, keyed-random locks. Consecutive, specific, and random keying are available as field-installed options.

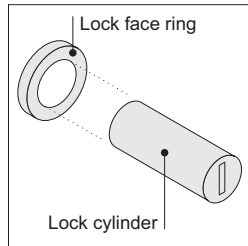

Locks consist of a field-installed lock cylinder and a factory-installed lock face ring.

Two types of locks are available — the standard keying system (FR series) and the master keying system (XF series). All the locks in the XF series can be opened with a single master key.

Field-Installed Keying

Field-installed locks are only available on products that include factory-installed lock mechanisms.

Specify "plug" when specifying furniture, and the product will ship with a plastic plug in place of the lock cylinder.

Tip: For products with optional lock colors, make sure to specify the color for both the lock and lock face ring.

Front-removable lock cylinders must be specified separately. You must also order a special lock tool to install or remove lock cylinders in the field.

Tip: Lock tools are reusable. You do not need to order additional lock tools with every furniture order.

Lock cylinders will be shipped separately so that you can install the locks when you are ready.

Three keying choices are available for field installation—random (standard), specific, and consecutive. All three are also available with master keying, which means that all locks can be opened with a single master key.

Key random means that the locks will be assigned arbitrarily at the factory with key numbers ranging from FR305 to FR999 (Master keying numbers: XF1001 to XF3000).

Tip: Random keying can mean that different furniture units will have the same key number. If you must have all locks keyed differently, you should specify key specific or key consecutive lock cylinders.

Key specific means that you can specify any key number from FR305 to FR999 (Master keying numbers: XF1001 to XF3000). This option can be used to key all the furniture units in a workstation or department the same.

Tip: Designate the quantity per key number in your specification.



▶ See below.

Key consecutive means that you can specify lock numbers in a consecutive order to ensure that no two locks have the same key number until the key sequence repeats. You must select a beginning key number from FR305 to FR999 (Master keying numbers: XF1001 to XF3000).



Example of a typical lock cylinder specification is shown below:

10	LOCKFR FR320
5	LOCKFR FR350
15	LOCKXF XF1100
<hr/>	
30	Total
1	877102003SR standard lock tool
1	877102002SR master lock tool



Key Random

 FR305
 FR421
 FR305



or

 XF1011 }
 XF1042 } XF Master Key
 XF1011 }



Key Specific

 FR350
 FR350
 FR350



or

 XF1020 }
 XF1020 } XF Master Key
 XF1020 }

Key Consecutive

 FR350
 FR351
 FR352

or

 XF1020 }
 XF1021 } XF Master Key
 XF1022 }

Lock Cylinders

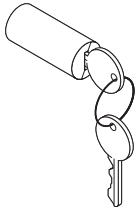

Tip: Lock price is included in price of furniture with locks.

Tip: For replacement lock cylinders, refer to Service Parts.

Tip: You can change lock cylinders in the field by using the appropriate lock tool.

Standard Includes	Required to Specify
<ul style="list-style-type: none"> Lock cylinder, keyed random Two keys 	1 Style number 2 Lock finish 9201 Polished Chrome 9250 Ember Chrome 3 Options, if selected (see below)

Options	Price	Required to Specify
Key specific	No cost	Select key number from FR305–FR999.
Key consecutive	No cost	Specify <i>key consecutive</i> and must select beginning key number from FR305–FR999.
Master key random	+\$39 each	Specify master key random.
Master key specific	+\$39 each	Specify key number from XF1001–XF3000.
Master key consecutive	+\$39 each	Specify <i>master key consecutive</i> and must select beginning key number from XF1001–XF3000.

Specification Information	
Style Number	Base Price

FR Series (Standard Keying System)—Lock Cylinder

LOCKFR	No cost
---------------	---------

Standard Lock Tool

877102003SR	\$39
--------------------	------

XF Series (Master Keying System)—Lock Cylinder

LOCKXF	No additional cost. Price included in price of furniture with master-keyed locks.
---------------	---

Master Lock Tool

877102002SR	\$39
--------------------	------

 **For Canadian Pricing**
 Multiply U.S. Price by the Canadian price factor.
 ▶ See page 1 for details.

Style Number Index

Style Number	Page	Description
877102002SR	259	Master Lock Tool
877102003SR	259	Standard Lock Tool
999CHT	180	Wire Clips
AWAG2	180	2½" Round Grommet
AWM12	181	12" Wire Manager
AWM18	181	18" Wire Manager
AWM23	181	23" Wire Manager
AWM30	181	30" Wire Manager
AWM35	181	35" Wire Manager
AWM42	181	42" Wire Manager
AWVW	180	Wire Mgr
FLXCBK4	229	Cable Brackets
FLXMCC10	228	Magnetic Cable Clips
FLXMCC2	228	Magnetic Cable Clips
FMVBK	217	Brckt Kit for Dsk w/Pwer and No Power Tray
FMVC	218	Vertebral Riser
FMVCE	218	Vertebral Riser
FMVCP	211	Chicago Hardwire Box
FMVF	213	Filler Pkg Pwr/Data
FMVH24	214	Modular Harness
FMVH27	214	Modular Harness
FMVH30	214	Modular Harness
FMVH33	214	Modular Harness
FMVH36	214	Modular Harness
FMVH39	214	Modular Harness
FMVH42	214	Modular Harness
FMVH45	214	Modular Harness
FMVH48	214	Modular Harness
FMVH51	214	Modular Harness
FMVH54	214	Modular Harness
FMVH57	214	Modular Harness
FMVH60	214	Modular Harness
FMVH63	214	Modular Harness
FMVH66	214	Modular Harness
FMVH69	214	Modular Harness
FMVH72	214	Modular Harness
FMVI12H	215	Hardwire-to-Modular Power Infeed
FMVI12M	215	Modular-to-Modular Power Infeed
FMVI24H	215	Hardwire-to-Modular Power Infeed
FMVI24M	215	Modular-to-Modular Power Infeed
FMVI6H	215	Hardwire-to-Modular Power Infeed
FMVI6M	215	Modular-to-Modular Power Infeed
FMVISS	216	San Francisco Power Infeed
FMVPBS	210	Modular Power Block—Standard-Capacity
FMVRD	212	Duplex Receptacle
FMVRUSB	213	USB Receptacle
LOCKFR	259	Lock Cylinder
LOCKXF	259	Lock Cylinder
OLBVINN	216	New York Power Infeed
OLCR	229	Cable Riser
RCHE1715	179	Bsc Cushion E
RCHE1830	179	Bsc Cushion E
RCHE1836	179	Bsc Cushion E
TS31410	112	Alight Ganging Kit
WEHMDC4MNA	151	Sterling—Health Guest Chair
WEHMDC4MWA	152	Sterling—Health Guest Chair
WEM1	234	Slope Guest Chair
WEM11	239	Maisie Side Table
WEM2	233	Slope Lounge Chair
WEM3	236	Slope Conference Chair
WEM4	239	Maisie Side Table

Style Number	Page	Description
WEM50	234	Slope Counter Stool
WEM59	237	Lily Pad Nesting Table
WEM60	238	Lily Pad Nesting Table
WEM66	233	Slope Bar Stool
WEM67	235	Slope Bar Stool
WEM68	240	Mesa Sectional Coffee Table
WEM7	237	Lily Pad Nesting Table
WEM70	232	Nimbus Conference Chair
WEM8	238	Linear C Table
WESARYLNG1	115	Brighton One Seat
WESARYLNG2	117	Brighton Two Seat
WESARYO	118	Brighton Ottoman
WESARYPWR	125	Brighton Module Power
WESARYTBL60	119	Brighton Ganging Table
WESARYTBL90	120	Brighton Ganging Table
WESARYTBLED	122	Brighton End Table
WESARYTBLRT	124	Brighton Rectangle Table
WESARYTBLSG	121	Brighton Occasional Tables
WESARYTBLSQ	123	Brighton Square Table
WESARYUSB	125	Brighton USB Power
WESBELC	97	Belle Corner Lounge
WESBELLNG1	93	Belle One-Seat Lounge
WESBELLNG2	95	Belle Two-Seat Lounge
WESBELO	98	Belle Ottoman
WESFTNBH	165	Fulton Bench
WESFTNCG	163	Fulton Guest Chair
WESFTNCL	164	Fulton Lounge Chair
WESHTSLNG1	101	Boardwalk One-Seat Lounge
WESHTSLNG2	103	Boardwalk Two-Seat Lounge
WESHTSLNG3	106	Boardwalk Three Seat
WESHTSTBL30	107	Boardwalk Square Table
WESHTSTBL60	108	Boardwalk Rectangle Table
WESHTSTBL90	109	Boardwalk Rectangle Table
WESHTSTBLOV65	111	Boardwalk Oval Table
WESHTSTBLRD40	110	Boardwalk Round Table
WESINDCSG	205	Greenpoint Glass Screen
WESINDCTDS	208	Greenpoint Tray End
WESINDCTSS	208	Greenpoint Tray End
WESINDEC	203	Greenpoint End Credenza
WESINDELDS	197	Greenpoint Leg
WESINDELSS	198	Greenpoint Leg
WESINDETDS	208	Greenpoint Tray Extension
WESINDETSS	208	Greenpoint Tray Extension
WESINDFC	171	Greenpoint Filing Credenza
WESINDILDS	199	Greenpoint Leg
WESINDILSS	200	Greenpoint Leg
WESINDLF	173	Greenpoint Lateral File
WESINDLFR	201	Greenpoint Leg Round/Square
WESINDLHR	202	Greenpoint Leg Half Round
WESINDLOB	174	Greenpoint Bookcase
WESINDMP	170	Greenpoint Modesty Panel
WESINDMPM	178	Greenpoint Mobile Ped
WESINDNOB	175	Greenpoint Bookcase
WESINDOB	176	Greenpoint Bookcase
WESINDPC	204	Greenpoint Personal Credenza
WESINDPCDS	209	Greenpoint Power Cover
WESINDPCSS	209	Greenpoint Power Cover
WESINDPD	166	Greenpoint Private Desk
WESINDPSDS	206	Greenpoint Power Support
WESINDPSSS	206	Greenpoint Power Support
WESINDPTDS	207	Greenpoint Tray

Style Number	Page	Description
WESINDPTSS	207	Greenpoint Tray
WESINDPWR	182	Greenpoint Power Unit
WESINDPWRCT	182	Greenpoint Continuous Top Power
WESINDPWRFR	183	Greenpoint Round/Square Power Unit
WESINDRB	196	Greenpoint Bench Return
WESINDRL	167	Greenpoint Desk Return
WESINDRP	169	Greenpoint Desk Return
WESINDSB	177	Greenpoint Bookcase
WESINDSC	172	Greenpoint Credenza
WESINDWCCCT	192	Greenpoint Continuous Top, Cred/Cred
WESINDWCCDS	186	Greenpoint Worksurface
WESINDWCCSS	189	Greenpoint Worksurface
WESINDWFR	193	Greenpoint Worksurface Round
WESINDWHR	195	Greenpoint Worksurface Round
WESINDWLCCT	191	Greenpoint Continuous Top, Leg/Cred
WESINDWLCDS	185	Greenpoint Worksurface
WESINDWLCSS	188	Greenpoint Worksurface
WESINDWLLCT	190	Greenpoint Continuous Top, Leg/Leg
WESINDWLLDS	184	Greenpoint Worksurface
WESINDWLLSS	187	Greenpoint Worksurface
WESINDWSQ	194	Greenpoint Worksurface Square
WESKNT4CNA	156	Kent Conference Chair
WESKNT4CWA	155	Kent Conference Chair
WESKNT4LNA	158	Kent Guest Chair
WESKNT4LWA	157	Kent Guest Chair
WESKNT5CNA	154	Kent Conference Chair
WESKNT5CWA	153	Kent Conference Chair
WESKNT5SNA	160	Kent Conference Stool
WESKNT5SWA	159	Kent Conference Stool
WESLUCS	162	Lucas Swivel Chair
WESLUCW	161	Lucas Wire Chair
WESMDC4CNFNA	148	Sterling Conference Chair
WESMDC4CNFWA	149	Sterling Conference Chair
WESMDC4LNG	150	Sterling Lounge Chair
WESMDC4NA	142	Sterling Guest Chair
WESMDC4WA	143	Sterling Guest Chair
WESMDC5NA	146	Sterling Conference Chair
WESMDC5WA	147	Sterling Conference Chair
WESMDCSBHNA	145	Sterling Guest Stool
WESMDCSCHNA	144	Sterling Guest Stool
WESMES2SEAT	128	Mesa Two-Seat Lounge
WESMESC	129	Mesa Corner Lounge
WESMESCHLH	126	Mesa Two Seat Chaise
WESMESCHRH	127	Mesa Two-Seat Chaise
WESMESO	130	Mesa Ottoman
WESSLPCC	140	Slope Conference Chair
WESSLPCG	136	Slope Guest Chair
WESSLPCL	137	Slope Lounge Chair
WESSLPCS	141	Slope Stacking Chair
WESSLPSB	139	Slope Bar Stool
WESSLPSC	138	Slope Counter Stool
WESSUTCT	228	Sutton Cable Tray
WESSUTERQ	223	Sutton Extended Height-Adjustable Desk
WESSUTERQB	227	Sutton Extended Height-Adjustable Base
WESSUTSRQ	221	Sutton Basic Height-Adjustable Desk
WESSUTSRQB	225	Sutton Basic Height-Adjustable Base
WESWLONLGF	133	Willow Lounge Seating
WESWLONLGS	135	Willow Lounge Seating

Trademark List

™/® The following is a non-exhaustive list of trademarks and registered trademarks for products of Steelcase Inc. or one of its related corporate entities: Agree, Airtouch, Aisla, Alight, Amia, Answer, Apprise, Aspekt, Avenir, Await, B-Free, Ballet, Bassline, Bindu, Bivi, Bix, Bottomline, Brody, Buoy, Cachet, Campfire, Capa, CF Series, CG_1, Chord, Circa, Clipper, Cobi, Collaboration, Convene, Coupe, Cura, Currency, dash, Divisio, Duo, E-Table 2, Edge Series, Elbrook, Elective Elements, Embold, Empath, Everwall, Exponents, Folio, FrameOne, Gesture, Groupwork, Host, Hosu, i2i, Jenny, Kart, Kathryn, Kick, Lagunitas, Leap, Leela, LessThanFive, LiveBack, LiveSeat, Mackinac, Marien152, Max-Stacker, media:scape, Migration, Millbrae, Mineral, Mitra, Montage, Montara650, MoreThanFive, Move, Node, Ocular, Ology, Opus, Paperflo, Passerelle, Player, Pocket, Potrero415, QiVi, Radia, Regard, Relay, Reply, Ripple, Roam, Sarto, Scoop, Sebastopol, Senti Series, Senza, Shortcut, Sidewalk, Siento, Sieste, SILQ, Soffio, Sorrel, SOTO, Steelcase Eclipse, Steelcase Flex, Steelcase Karman, Steelcase Relay, Steelcase Rise, Steelcase Series, Surround, SW_1, Switch, Sync, Tava, Tenor, Think, Thoughtful, Thread, Together, Train, Trees, Turnstone, Umami, Underscore, V.I.A., Verb, Verge, Verlay, Victor2, Visalia, WorkValet, and X-tenz.

™/® The following are trademarks or registered trademarks of AMQ Solutions, LLC: 3F, Activ, Amobi, Bixby, Bodi, Cluvo, Concur, Embank, FL-X, Iline, Jaku, Kinex, Personality Plus, Revi, S-Series, Siya, Tektis, Tizu, Uptake, and Zilo.

™/® The following are trademarks or registered trademarks of Orangebox Ltd., Cardiff, UK: Air3, Aspect, Avi, Away from the Desk, Border, Campers & Dens, Coppice, Cubb, Kirm, On the QT, Ramsey, Skomer, Sully, Track-B, and Vale.

™/® The following are trademarks or registered trademarks of Viccarbe Habitat, S.L.: Aleta, Cambio, Designed in The Sun, Foro, Funda, Holy Day, Kelly, Last Minute, Noha, Savina, Sistema, Sistema, Viable, and Wrapp.

® The following are registered brands of Steelcase Inc. and its family of companies: Steelcase, AMQ, Coalesse, Designtex, Halcon, Orangebox, Smith System, and Viccarbe.

® The following registered trademarks are under license from AWI Licensing Company, Dover, DE: SoundScapes, DuraBrite, BioBlock, and Armstrong.

® The following registered trademarks are under license from Byrne Electrical, Rockford, MI: Interport, Mini-Port, Axil Z, and Ellora.

® The following is a registered trademark of DuPont, Wilmington, DE: Corian.

® The following is a registered trademark of Genlyte Thomas Company, Louisville, KY: Lightolier.

® The following is a registered trademark of Hilti Corporation, FL-9494 Schaan, Principality of Liechtenstein: Hilti.

® The following is a registered trademark of Leviton Manufacturing Company, Little Neck, NY: Decora.

® The following is a registered trademark of Mechanical Plastics Corp, Elmsford, NY: Toggler.

® The following is a registered trademark of Microsoft Corporation, Redmond, WA: Microsoft.

® The following are registered trademarks of Orangebox Ltd., Cardiff, UK: Orangebox.

® The following is a registered trademark of Panduit Corporation, Lockport, IL: Panduit.

® The following is a registered trademark of Trav (Press), Cuneo, Italy: Assisa.

® The following is a registered trademark of Virtual Ink, Boston, MA: mimioActive.

® The following registered trademarks are under license from Wilkhahn Furniture Products: Avera, Senzo, Versal, and Wilkhahn FS.

® The following are registered trademarks of Polyvision Corp: Flow, Motif, Polyvision, Sans, and Serif.

® The following is a registered trademark of Wilsonart International, Temple, TX: Chemsurf.

® The following is a registered trademark of Wiremold, West Hartford, CT: Wiremold.

® The following is a registered trademark of EMU Group S.P.A., Perugia, Italy: EMU.

® The following is a registered trademark of Security People, Inc.: Digilock.

® The following are registered trademarks of Natural Capital Partners Europe Limited: CarbonNeutral and the CarbonNeutral Certified logo.

™ The following is a trademark of Microsoft Corporation, Redmond, WA: Windows.

™ The following is a trademark of Rodman Industries, Inc., Oconomowoc, WI: ResinCore1.

™ The following is a trademark of Ultrafabrics, LLC, Elmsford, NY: Ultraleather.

™ The following trademarks are under license from Wilkhahn Furniture products: Cana, Linus, Logon, Picto, Range, Stitz, Thema, Timetable, and Tubis.

™ The following trademarks are under license from Walter Knoll: Andoo, Bob, Lazlo, Lox, Ribbon, and Together.

™ The following trademarks are under license from PP Mobler: Bar and Flag Halyard.

™ The following trademarks are under license from Carl Hansen: Elbow, Paddle, Shell, Wing, and Wishbone.

™ The following trademarks are under license from Cambridge Sound Management, LLC Cambridge, MA: QtPro Soundmasking, Qt Quiet Technology, and Sonet Qt.

™ The following is a trademark of Electri-Cable Assemblies, Shelton, CT: Interact.

™ The following is a trademark of Clestra Hauserman: IRYS.

™ The following is a trademark of Wiesner-Hager Möbel GmbH: Nooi.

™ The following are trademarks of Polyvision: Accord, a3, e3, Boundri, and Nota.

™ The following is a trademark of Bostock Company, Inc: SnapCab.

™ The following is a trademark of Williams-Sonoma, Inc: West Elm.

™ The following is a trademark of Elena Marquina Testor: nanimarquina.

™ The following is a trademark of Forbo International SA: Forbo.

Trademarks used herein are the property of Steelcase Inc. or their respective owners.