



V.I.A. Specification Guide

Availability

Electronic price list updated with release 204.C (U.S.) and 158.C (Canada), dated June 15, 2026.

All specifications subject to change without notice. Reference the electronic catalog/Hedberg for current pricing.

Transitional products in this specification guide are **maintained for existing customers only** and are likely to be phased out over time. These products are indicated with a . Products that are scheduled to be culled are indicated with an , followed by the last order entry date.

Surface Materials

The surface materials team has announced the launch of the Finish Library, found at www.steelcase.com/finishlibrary/.

► For a list of all trademarks, refer to the last page of this specification guide. © 2026 Steelcase Inc.



For Canadian Pricing

Canadian factor can be found at www.steelcase.com/CADpricing/. Calculate in the following order to avoid rounding errors:

- Multiply the base price and each option by the Canadian factor.
- Round each to the nearest dollar.
- Add base and options for total list price.

Working With This Specification Guide

Ten Tips: How to Get the Most Out of This Book	2
Additional Resources	4



Statement of Line 6

Understanding

Structural Frame Components	24
Cornice Application	30
Captured Glass Frames	36
Skins	40
Reversible Swing Doors	46
Slider Doors	52
Intersections—Junctions and Adapters	68
Mini Ends	74
Cutable Ends	76
Electrical Components	78
Electrical Wiring Schematics	84
How to Calculate Power Needs	85
Technology Components	86
Hang-On Components	94
V.I.A. Planning Dimensions	103
Planning with Landscape Oriented Components	104
Acoustic Planning Considerations	110

Specifying

Structural Frame Components	113
Cornice Application	127
Captured Glass Frames	133
Skins	145
Reversible Swing Doors	153
Slider Doors	171
Intersections—Junctions and Adapters	181
Mini Ends	197
Cutable Ends	201
Electrical Components	205
Technology Components	215
Hang-On Components	219

Surface Materials

Resources	229
------------------	------------

Ten Tips: How to Get the Most Out of This Book

Tip 1

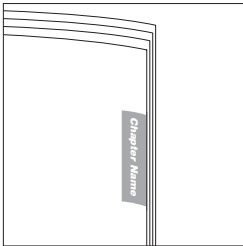

Watch the tabs on the right-hand edges of the pages. They'll always indicate which chapter you are in.

Tip 2

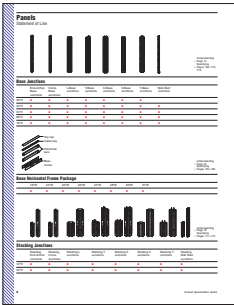

Use the Statement of Line pages for an overview of the available components, their sizes, and page references for additional information. Each *Understanding* chapter includes a statement of line after the table of contents.

Tip 3



Find cross references by looking for page numbers flagged with an arrow.

Tip 4

Study the product detail pages in the *Understanding* section to learn everything an expert knows about specific products. Each product detail page in this section contains the following features, where applicable:

- Product Drawing
- Actual Dimensions
- Product Details
- Connections
- Wiring and Cabling
- Surface Materials
- Application Topics

Product Drawing shows you what the product looks like and points out important features.

Product Details gives specific information on the product and how it is used.

Connections describes how the product is assembled or how it attaches to another product.

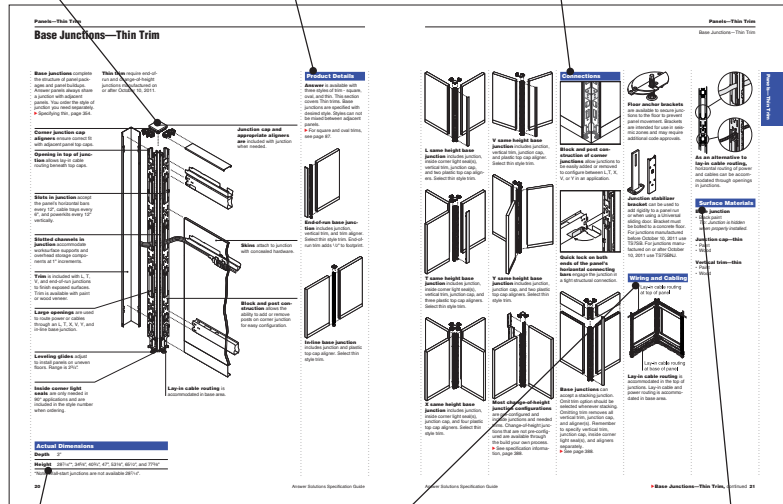

Actual Dimensions table lists the dimensions of the product.

Wiring and Cabling details the power and cable-management and cable routing capabilities of the product.

Surface Materials lists what material is used for each part of the product.

Tip 5

Refer to the specifying pages for all the information needed to order a product. Each product specifying page contains a variety of elements to help you complete a specification:

- Product Drawing
- Standard Includes
- Required to Specify
- Options
- Related Products
- Specification Information
- Dimensions
- Style Number
- Price

Standard Includes (under the red or dark grey band) provides a list of what comes standard with the product.

Required to Specify (under the red or dark grey band) itemizes the information that you must provide to order the standard product and the preferred sequence for specification.

Specification Information (under the teal or light grey band) provides product dimensions, style numbers, and prices for the standard product and any surface material choices that are available.

Product Drawing shows you what the product looks like.

Standard Includes

- Standard length (1000, 1200, 1500, 1800, 2400, 3000, 3600, 4200, 4800, 5400, 6000, 6600, 7200, 7800, 8400, 9000, 9600, 10200, 10800, 11400, 12000, 12600, 13200, 13800, 14400, 15000, 15600, 16200, 16800, 17400, 18000, 18600, 19200, 19800, 20400, 21000, 21600, 22200, 22800, 23400, 24000, 24600, 25200, 25800, 26400, 27000, 27600, 28200, 28800, 29400, 30000, 30600, 31200, 31800, 32400, 33000, 33600, 34200, 34800, 35400, 36000, 36600, 37200, 37800, 38400, 39000, 39600, 40200, 40800, 41400, 42000, 42600, 43200, 43800, 44400, 45000, 45600, 46200, 46800, 47400, 48000, 48600, 49200, 49800, 50400, 51000, 51600, 52200, 52800, 53400, 54000, 54600, 55200, 55800, 56400, 57000, 57600, 58200, 58800, 59400, 60000, 60600, 61200, 61800, 62400, 63000, 63600, 64200, 64800, 65400, 66000, 66600, 67200, 67800, 68400, 69000, 69600, 70200, 70800, 71400, 72000, 72600, 73200, 73800, 74400, 75000, 75600, 76200, 76800, 77400, 78000, 78600, 79200, 79800, 80400, 81000, 81600, 82200, 82800, 83400, 84000, 84600, 85200, 85800, 86400, 87000, 87600, 88200, 88800, 89400, 90000, 90600, 91200, 91800, 92400, 93000, 93600, 94200, 94800, 95400, 96000, 96600, 97200, 97800, 98400, 99000, 99600, 100200, 100800, 101400, 102000, 102600, 103200, 103800, 104400, 105000, 105600, 106200, 106800, 107400, 108000, 108600, 109200, 109800, 110400, 111000, 111600, 112200, 112800, 113400, 114000, 114600, 115200, 115800, 116400, 117000, 117600, 118200, 118800, 119400, 120000, 120600, 121200, 121800, 122400, 123000, 123600, 124200, 124800, 125400, 126000, 126600, 127200, 127800, 128400, 129000, 129600, 130200, 130800, 131400, 132000, 132600, 133200, 133800, 134400, 135000, 135600, 136200, 136800, 137400, 138000, 138600, 139200, 139800, 140400, 141000, 141600, 142200, 142800, 143400, 144000, 144600, 145200, 145800, 146400, 147000, 147600, 148200, 148800, 149400, 150000, 150600, 151200, 151800, 152400, 153000, 153600, 154200, 154800, 155400, 156000, 156600, 157200, 157800, 158400, 159000, 159600, 160200, 160800, 161400, 162000, 162600, 163200, 163800, 164400, 165000, 165600, 166200, 166800, 167400, 168000, 168600, 169200, 169800, 170400, 171000, 171600, 172200, 172800, 173400, 174000, 174600, 175200, 175800, 176400, 177000, 177600, 178200, 178800, 179400, 180000, 180600, 181200, 181800, 182400, 183000, 183600, 184200, 184800, 185400, 186000, 186600, 187200, 187800, 188400, 189000, 189600, 190200, 190800, 191400, 192000, 192600, 193200, 193800, 194400, 195000, 195600, 196200, 196800, 197400, 198000, 198600, 199200, 199800, 200400, 201000, 201600, 202200, 202800, 203400, 204000, 204600, 205200, 205800, 206400, 207000, 207600, 208200, 208800, 209400, 210000, 210600, 211200, 211800, 212400, 213000, 213600, 214200, 214800, 215400, 216000, 216600, 217200, 217800, 218400, 219000, 219600, 220200, 220800, 221400, 222000, 222600, 223200, 223800, 224400, 225000, 225600, 226200, 226800, 227400, 228000, 228600, 229200, 229800, 230400, 231000, 231600, 232200, 232800, 233400, 234000, 234600, 235200, 235800, 236400, 237000, 237600, 238200, 238800, 239400, 240000, 240600, 241200, 241800, 242400, 243000, 243600, 244200, 244800, 245400, 246000, 246600, 247200, 247800, 248400, 249000, 249600, 250200, 250800, 251400, 252000, 252600, 253200, 253800, 254400, 255000, 255600, 256200, 256800, 257400, 258000, 258600, 259200, 259800, 260400, 261000, 261600, 262200, 262800, 263400, 264000, 264600, 265200, 265800, 266400, 267000, 267600, 268200, 268800, 269400, 270000, 270600, 271200, 271800, 272400, 273000, 273600, 274200, 274800, 275400, 276000, 276600, 277200, 277800, 278400, 279000, 279600, 280200, 280800, 281400, 282000, 282600, 283200, 283800, 284400, 285000, 285600, 286200, 286800, 287400, 288000, 288600, 289200, 289800, 290400, 291000, 291600, 292200, 292800, 293400, 294000, 294600, 295200, 295800, 296400, 297000, 297600, 298200, 298800, 299400, 300000, 300600, 301200, 301800, 302400, 303000, 303600, 304200, 304800, 305400, 306000, 306600, 307200, 307800, 308400, 309000, 309600, 310200, 310800, 311400, 312000, 312600, 313200, 313800, 314400, 315000, 315600, 316200, 316800, 317400, 318000, 318600, 319200, 319800, 320400, 321000, 321600, 322200, 322800, 323400, 324000, 324600, 325200, 325800, 326400, 327000, 327600, 328200, 328800, 329400, 330000, 330600, 331200, 331800, 332400, 333000, 333600, 334200, 334800, 335400, 336000, 336600, 337200, 337800, 338400, 339000, 339600, 340200, 340800, 341400, 342000, 342600, 343200, 343800, 344400, 345000, 345600, 346200, 346800, 347400, 348000, 348600, 349200, 349800, 350400, 351000, 351600, 352200, 352800, 353400, 354000, 354600, 355200, 355800, 356400, 357000, 357600, 358200, 358800, 359400, 360000, 360600, 361200, 361800, 362400, 363000, 363600, 364200, 364800, 365400, 366000, 366600, 367200, 367800, 368400, 369000, 369600, 370200, 370800, 371400, 372000, 372600, 373200, 373800, 374400, 375000, 375600, 376200, 376800, 377400, 378000, 378600, 379200, 379800, 380400, 381000, 381600, 382200, 382800, 383400, 384000, 384600, 385200, 385800, 386400, 387000, 387600, 388200, 388800, 389400, 390000, 390600, 391200, 391800, 392400, 393000, 393600, 394200, 394800, 395400, 396000, 396600, 397200, 397800, 398400, 399000, 399600, 400200, 400800, 401400, 402000, 402600, 403200, 403800, 404400, 405000, 405600, 406200, 406800, 407400, 408000, 408600, 409200, 409800, 410400, 411000, 411600, 412200, 412800, 413400, 414000, 414600, 415200, 415800, 416400, 417000, 417600, 418200, 418800, 419400, 420000, 420600, 421200, 421800, 422400, 423000, 423600, 424200, 424800, 425400, 426000, 426600, 427200, 427800, 428400, 429000, 429600, 430200, 430800, 431400, 432000, 432600, 433200, 433800, 434400, 435000, 435600, 436200, 436800, 437400, 438000, 438600, 439200, 439800, 440400, 441000, 441600, 442200, 442800, 443400, 444000, 444600, 445200, 445800, 446400, 447000, 447600, 448200, 448800, 449400, 450000, 450600, 451200, 451800, 452400, 453000, 453600, 454200, 454800, 455400, 456000, 456600, 457200, 457800, 458400, 459000, 459600, 460200, 460800, 461400, 462000, 462600, 463200, 463800, 464400, 465000, 465600, 466200, 466800, 467400, 468000, 468600, 469200, 469800, 470400, 471000, 471600, 472200, 472800, 473400, 474000, 474600, 475200, 475800, 476400, 477000, 477600, 478200, 478800, 479400, 480000, 480600, 481200, 481800, 482400, 483000, 483600, 484200, 484800, 485400, 486000, 486600, 487200, 487800, 488400, 489000, 489600, 490200, 490800, 491400, 492000, 492600, 493200, 493800, 494400, 495000, 495600, 496200, 496800, 497400, 498000, 498600, 499200, 499800, 500400, 501000, 501600, 502200, 502800, 503400, 504000, 504600, 505200, 505800, 506400, 507000, 507600, 508200, 508800, 509400, 510000, 510600, 511200, 511800, 512400, 513000, 513600, 514200, 514800, 515400, 516000, 516600, 517200, 517800, 518400, 519000, 519600, 520200, 520800, 521400, 522000, 522600, 523200, 523800, 524400, 525000, 525600, 526200, 526800, 527400, 528000, 528600, 529200, 529800, 530400, 531000, 531600, 532200, 532800, 533400, 534000, 534600, 535200, 535800, 536400, 537000, 537600, 538200, 538800, 539400, 540000, 540600, 541200, 541800, 542400, 543000, 543600, 544200, 544800, 545400, 546000, 546600, 547200, 547800, 548400, 549000, 549600, 550200, 550800, 551400, 552000, 552600, 553200, 553800, 554400, 555000, 555600, 556200, 556800, 557400, 558000, 558600, 559200, 559800, 560400, 561000, 561600, 562200, 562800, 563400, 564000, 564600, 565200, 565800, 566400, 567000, 567600, 568200, 568800, 569400, 570000, 570600, 571200, 571800, 572400, 573000, 573600, 574200, 574800, 575400, 576000, 576600, 577200, 577800, 578400, 579000, 579600, 580200, 580800, 581400, 582000, 582600, 583200, 583800, 584400, 585000, 585600, 586200, 586800, 587400, 588000, 588600, 589200, 589800, 590400, 591000, 591600, 592200, 592800, 593400, 594000, 594600, 595200, 595800, 596400, 597000, 597600, 598200, 598800, 599400, 600000, 600600, 601200, 601800, 602400, 603000, 603600, 604200, 604800, 605400, 606000, 606600, 607200, 607800, 608400, 609000, 609600, 610200, 610800, 611400, 612000, 612600, 613200, 613800, 614400, 615000, 615600, 616200, 616800, 617400, 618000, 618600, 619200, 619800, 620400, 621000, 621600, 622200, 622800, 623400, 624000, 624600, 625200, 625800, 626400, 627000, 627600, 628200, 628800, 629400, 630000, 630600, 631200, 631800, 632400, 633000, 633600, 634200, 634800, 635400, 636000, 636600, 637200, 637800, 638400, 639000, 639600, 640200, 640800, 641400, 642000, 642600, 643200, 643800, 644400, 645000, 645600, 646200, 646800, 647400, 648000, 648600, 649200, 649800, 650400, 651000, 651600, 652200, 652800, 653400, 654000, 654600, 655200, 655800, 656400, 657000, 657600, 658200, 658800, 659400, 660000, 660600, 661200, 661800, 662400, 663000, 663600, 664200, 664800, 665400, 666000, 666600, 667200, 667800, 668400, 669000, 669600, 670200, 670800, 671400, 672000, 672600, 673200, 673800, 674400, 675000, 675600, 676200, 676800, 677400, 678000, 678600, 679200, 679800, 680400, 681000, 681600, 682200, 682800, 683400, 684000, 684600, 685200, 685800, 686400, 687000, 687600, 688200, 688800, 689400, 690000, 690600, 691200, 691800, 692400, 693000, 693600, 694200, 694800, 695400, 696000, 696600, 697200, 697800, 698400, 699000, 699600, 700200, 700800, 701400, 702000, 702600, 703200, 703800, 704400, 705000, 705600, 706200, 706800, 707400, 708000, 708600, 709200, 709800, 710400, 711000, 711600, 712200, 712800, 713400, 714000, 714600, 715200, 715800, 716400, 717000, 717600, 718200, 718800, 719400, 720000, 720600, 721200, 721800, 722400, 723000, 723600, 724200, 724800, 725400, 726000, 726600, 727200, 727800, 728400, 729000, 729600, 730200, 730800, 731400, 732000, 732600, 733200, 733800, 734400, 735000, 735600, 736200, 736800, 737400, 738000, 738600, 739200, 739800, 740400, 741000, 741600, 742200, 742800, 743400, 744000, 744600, 745200, 745800, 746400, 747000, 747600, 748200, 748800, 749400, 750000, 750600, 751200, 751800, 752400, 753000, 753600, 754200, 754800, 755400, 756000, 756600, 757200, 757800, 758400, 759000, 759600, 760200, 760800, 761400, 762000, 762600, 763200, 763800, 764400, 765000, 765600, 766200, 766800, 767400, 768000, 768600, 769200, 769800, 770400, 771000, 771600, 772200, 772800, 773400, 774000, 774600, 775200, 775800, 776400, 777000, 777600, 778200, 778800, 779400, 780000, 780600, 781200, 781800, 782400, 783000, 783600, 784200, 784800, 785400, 786000, 786600, 787200, 787800, 788400, 789000, 789600, 790200, 790800, 791400, 792000, 792600, 793200, 793800, 794400, 795000, 795600, 796200, 796800, 797400, 798000, 798600, 799200, 799800, 800400, 801000, 801600, 802200, 802800, 803400, 804000, 804600, 805200, 805800, 806400, 807000, 807600, 808200, 808800, 809400, 810000, 810600, 811200, 811800, 812400, 813000, 813600, 814200, 814800, 815400, 816000, 816600, 817200, 817800, 818400, 819000, 819600, 820200, 820800, 821400, 822000, 822600, 823200, 823800, 824400, 825000, 825600, 826200, 826800, 827400, 828000, 828600, 829200, 829800, 830400, 831000, 831600, 832200, 832800, 833400, 834000, 834600, 835200, 835800, 836400, 837000, 837600, 838200, 838800, 839400, 840000, 840600, 841200, 841800, 842400, 843000, 843600, 844200, 844800, 845400, 846000, 846600, 847200, 847800, 848400, 849000, 849600, 850200, 850800, 851400, 852000, 852600, 853200, 853800, 854400, 855000, 855600, 856200, 856800, 857400, 858000, 858600, 859200, 859800, 860400, 861000, 861600, 862200, 862800, 863400, 864000, 864600, 865200, 865800, 866400, 867000, 867600, 868200, 868800, 869400, 870000, 870600, 871200, 871800, 872400, 873000, 873600, 874200, 874800, 875400, 876000, 876600, 877200, 877800, 878400, 879000, 879600, 880200, 880800, 881400, 882000, 882600, 883200, 883800, 884400, 885000, 885600, 886200, 886800, 887400, 888000, 888600, 889200, 889800, 890400, 891000, 891600, 892200, 892800, 893400,

Additional Resources

V.I.A. is supported with informational materials, tools, and software to help you plan, specify, and order an installation efficiently.

Product brochures and planning tools can be ordered through your Steelcase area office by calling 1.800.784.0358 or through Marketing Resources web site at village.steelcase.com.

Printed Materials

Surface Materials Reference Manual

This publication provides:

- An explanation of the surface materials
- "Available on" matrices
- Vertical surface fabric and seating upholstery selection listing
- Technical data for surface materials
- Surface material care and cleaning instructions

Computer Tools

SmartTools

V.I.A. is designed and structured to offer the designer a broad range of dimensional and planning choices. By leveraging the parametric and functional options to best suit a given solution, a V.I.A. application can be as simple or intricate as the design criteria demands.

To help speed the product application process and ensure that product interfaces have been properly planned, all V.I.A. projects will be drawn using SmartTools in order to create a bill of material and then link to Hedberg.

All of the product logic and parametric values that are contained within this specification guide have been incorporated into SmartTools planning logic. This content is important in understanding overall product capabilities and performance. However, a full understanding is not required for planning with V.I.A., as SmartTools will assist by offering the appropriate feedback and preventing any applications that don't comply with product logic.

Electronic Catalog

Accurate sales quotations and purchase orders for Steelcase products are created with specification software that uses Steelcase Electronic Catalog data. Use the data to specify and price style numbers and options for every Steelcase product. The data is updated bimonthly by Steelcase and provided to software programs including: the Hedberg Business System, SmartTools—Steelcase's design and specification software (for more information on SmartTools, please email SmartTools@steelcase.com), the ProjectMatrix ProjectSymbols libraries.

Digital Publications

You can access these digital publications at www.steelcase.com or village.steelcase.com.

V.I.A. Product Training

Basic training for the products included in the V.I.A. product portfolio is available on the Steelcase University website at village.steelcase.com.

Four modules are web-based, interactive courses filled with pictures, detailed positioning, statement of line, and feature benefit information, as well as practice exercises designed to build knowledge of the products. The online courses also provide printable job aids of all content covered in the courses to serve as on going performance support. The available courses are:

- What is V.I.A.—SAL461
- Selling V.I.A.—SAL462
- Managing V.I.A. Installation—SAL466
- V.I.A. Order Fulfillment—SAL467 (Winter 2014)

SAL461 and SAL462 provide the foundation of knowledge for working with V.I.A. and are pre-requisites for taking any of the other V.I.A. courses.

Instructor led courses for V.I.A. are:

- V.I.A. Sales Simulation Workshop—SAL463
- Installing V.I.A.—SAL464
- V.I.A. Application and Specification Using Smart Tools—SAL465

Additionally, there are two courses available to address the positioning of Architectural Solutions in general:

- Architectural Solutions—SAL242
- The AS Value Proposition—SAL258

Support

Steelcase Capabilities

Steelcase products are distributed, installed, and serviced through a network of more than 600 dealers worldwide. Steelcase is also represented with offices and corporate showrooms in 26 U.S. cities, 4 Canadian cities, and in France, Germany, Great Britain, and Japan. Every Steelcase product meets our exceptionally high standards of quality and durability and comes with the Steelcase assurance of excellence in service.

For ordering or product assistance,

please call line one at 1.888.STEELCASE (1.888.783.3522) or send an e-mail to lineone@steelcase.com for product application and specification assistance or contact your regional Architectural Dealer Sales Consultant.

Call the Steelcase Solutions Resource Team for assistance prior to placing an order or when working on a bid.

Call the Steelcase Solutions Fulfillment Team if you have submitted an order to Steelcase and you need to speak to your Solutions Fulfillment Team Representative about the order. Also call if you have any post shipment quality concerns or service parts questions.

For warranty information, please go to <http://www.steelcase.com/warranty/>.

Outside the U.S.A., Canada, Mexico, Puerto Rico, and the U.S. Virgin Islands, call 1.616.247.2500.

For information about Steelcase, the name of your nearest Steelcase dealer, or for product literature, call 1.800.333.9939, or visit our Web site: www.steelcase.com.

Sustainability

At Steelcase, we believe business can be a force for good. We create long-lasting products that are better for people and better for the planet. Our products and operations use life cycle thinking to meet our commitment to reducing climate change. This commitment is reinforced by practices such as designing to minimize global warming and other life cycle impacts, ensuring material health, and enabling end-of-use strategies.

To learn more at a corporate level, visit: <https://www.steelcase.com/discover/steelcase/esg-overview/environmental/>

Product Environmental Profiles, which provide key environmental attributes such as recycled content, embodied carbon and recyclability, as well as product certifications can be found by searching for Steelcase at Origin.build.

Statement of Line

Structural Frame Components



Understanding
 ▶ Page 24
 Specifying
 ▶ Page 114

Post

15"–144"

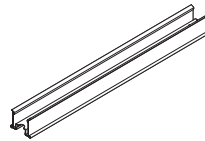

Understanding
 ▶ Page 24
 Specifying
 ▶ Page 115

Structural Horizontal

6"–120"

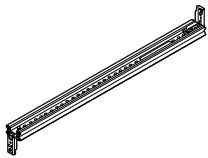

Understanding
 ▶ Page 24
 Specifying
 ▶ Page 115

Intermediate Horizontal

6"–120"

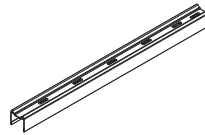

Understanding
 ▶ Page 24
 Specifying
 ▶ Page 116

Straight Ceiling Track

120' 144'

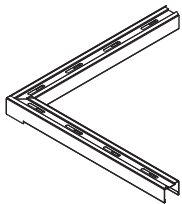

Understanding
 ▶ Page 24
 Specifying
 ▶ Page 116

Corner Fixed Angle Ceiling Track

90° 120° 135°

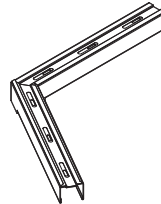

Understanding
 ▶ Page 24
 Specifying
 ▶ Page 117

Corner Variable Angle Ceiling Track

91°–179°



Structural Frame Components, continued



Understanding
 ▶ Page 24
 Specifying
 ▶ Page 118

T/X Ceiling Track Bracket

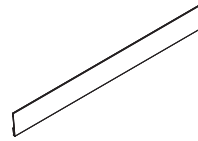

Understanding
 ▶ Page 24
 Specifying
 ▶ Page 119

Straight Base Trim

120" 144"

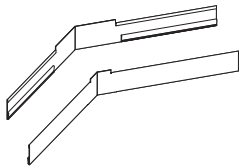

Understanding
 ▶ Page 24
 Specifying
 ▶ Page 119

Corner Fixed Angle Base Trim

90° 120° 135°

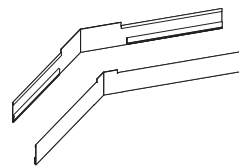

Understanding
 ▶ Page 24
 Specifying
 ▶ Page 120

Corner Variable Angle Base Trim

91°–179°

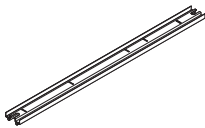

Understanding
 ▶ Page 24
 Specifying
 ▶ Page 121

Floor Track

6"–120"



Understanding
 ▶ Page 24
 Specifying
 ▶ Page 121

Floor Track Spring

Structural Frame Components, continued

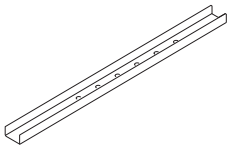

Understanding
▶ Page 24
Specifying
▶ Page 122



Understanding
▶ Page 24
Specifying
▶ Page 123

Floor Guide



Understanding
▶ Page 24
Specifying
▶ Page 124

Short Post Leveler Bracket

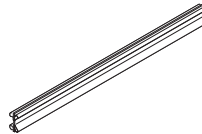

Understanding
▶ Page 24
Specifying
▶ Page 124

Post Acoustic Seal Packages

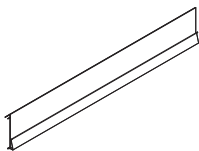

Understanding
▶ Page 24
Specifying
▶ Page 124

Intermediate Horizontal Acoustic Seals



Understanding
▶ Page 24
Specifying
▶ Page 125

Structural Horizontal Acoustic Seals

Structural Beam

12"–120"W



Cornice Application

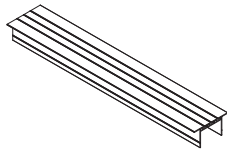

Understanding
 ▶ Page 30
 Specifying
 ▶ Page 128

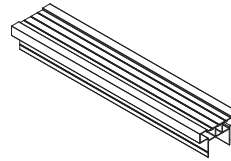

Understanding
 ▶ Page 30
 Specifying
 ▶ Page 128

Cornice Track Deck

130"



Cornice Track Beam

130"

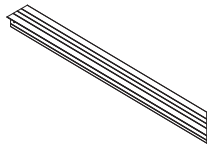

Understanding
 ▶ Page 30
 Specifying
 ▶ Page 128

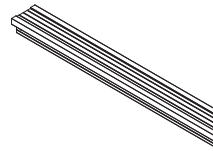

Understanding
 ▶ Page 30
 Specifying
 ▶ Page 128

Cornice Track Deck Corner

36" x 36"



Cornice Track Beam Corner

36" x 36"

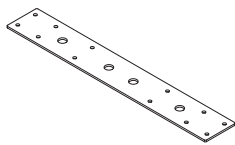

Understanding
 ▶ Page 30
 Specifying
 ▶ Page 129

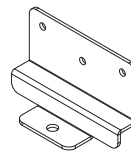

Understanding
 ▶ Page 30
 Specifying
 ▶ Page 129

Cornice Bracket

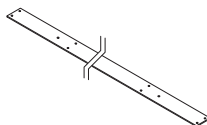

Understanding
 ▶ Page 34
 Specifying
 ▶ Page 130

Cornice Skin Structural Bracket

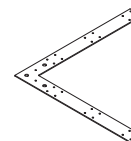

Understanding
 ▶ Page 34
 Specifying
 ▶ Page 130

Cornice Seismic Reinforcing Track – Straight

Cornice Seismic Reinforcing Track – Corner

Captured Glass Frames

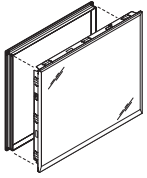

Understanding
▶ Page 36
Specifying
▶ Page 134

Single Glazed Captured Glass Frame

12"—141.71654"H x 12"—120"W

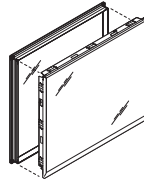

Understanding
▶ Page 36
Specifying
▶ Page 136

Double Glazed Captured Glass Frame

12"—141.71654"H x 12"—120"W

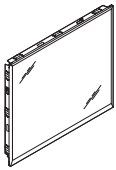

Understanding
▶ Page 36
Specifying
▶ Page 138

Single Side Captured Glass Frame—Side A and Side C

12"—141.71654"H x 12"—120"W

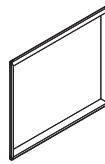

Understanding
▶ Page 36
Specifying
▶ Page 140

Single Side Captured Glass Frame—Side B

12"—141.71654"H x 12"—120"W

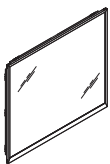

Understanding
▶ Page 36
Specifying
▶ Page 141

Single Side Captured Glass Frame—Side D (Back-Painted Glass)

12"—120"H x 12"—120"W

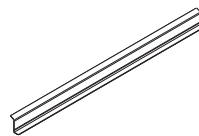

Understanding
▶ Page 36
Specifying
▶ Page 142

Acoustic Seal for Captured Glass

24"W 48"W 72"W 96"W 120"W



Brackets and T Nuts

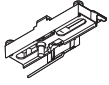

Locking Bracket
 Specifying
 ▶ Page 143

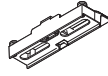

Non-Locking Bracket
 Specifying
 ▶ Page 143



Load Bracket
 Specifying
 ▶ Page 143



T Nuts
 Specifying
 ▶ Page 143

Skins

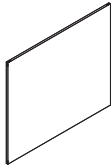

Understanding
 ▶ Page 40
 Specifying
 ▶ Page 146

Solid Steel Skin

6"–141.71654"H x 6"–120"W

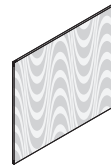

Understanding
 ▶ Page 40
 Specifying
 ▶ Page 147

Solid Veneer Skin

6"–120"H x 6"–120"W

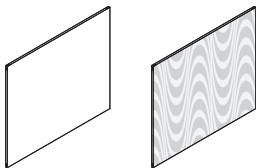

Understanding
 ▶ Page 40
 Specifying
 ▶ Page 148

Solid Laminate Skin

6"–120"H x 6"–120"W

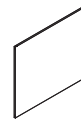

Understanding
 ▶ Page 40
 Specifying
 ▶ Page 149

Ceramic Skin

24"–120"H x 24"–120"W



Skins, continued



Understanding
▶ Page 40
Specifying
▶ Page 150

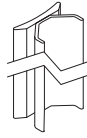

Understanding
▶ Page 40
Specifying
▶ Page 150

Flush Skin Seal

90° Inside Corner Flush Skin Seal

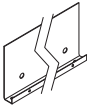

Understanding
▶ Page 40
Specifying
▶ Page 150



Understanding
▶ Page 40
Specifying
▶ Page 151

Cove Base Trim - Straight

Junction Cover Retention Clip

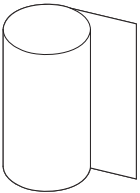

Understanding
▶ Page 40
Specifying
▶ Page 152

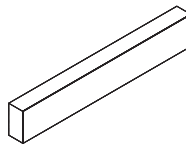

Understanding
▶ Page 40
Specifying
▶ Page 152

Acoustic Insulation

Acoustic Skin Seal

Reversible Swing Doors



Understanding
 ▶ Page 46
 Specifying
 ▶ Page 154

Single Reversible Swing Door Frame

82.44100"–123.71627"H x 28–44.445"



Understanding
 ▶ Page 46
 Specifying
 ▶ Page 156

Single Reversible Solid Swing Door Leaf

82.44100"–123.71627"H x 28–44.445"



Understanding
 ▶ Page 46
 Specifying
 ▶ Page 158

Single Reversible Polished Edge Swing Door Leaf

82.44100"–123.71627"H x 28–44.445"



Understanding
 ▶ Page 46
 Specifying
 ▶ Page 160

Pair of Reversible Swing Door Frames

82.44100"–123.71627"H x 48"–80"

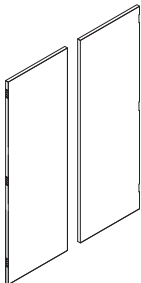

Understanding
 ▶ Page 46
 Specifying
 ▶ Page 162

Pair of Reversible Solid Swing Door Leaves

82.44100"–123.71627"H x 48"–80"

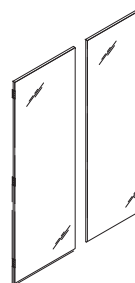

Understanding
 ▶ Page 46
 Specifying
 ▶ Page 164

Pair of Reversible Polished Edge Swing Door Leaves

82.44100"–123.71627"H x 48"–80"



Door Hardware

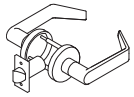

Cylindrical Latch Set
Specifying
▶ Page 165

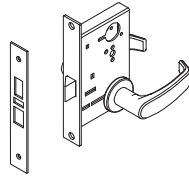

Mortise Latch Set
Specifying
▶ Page 166

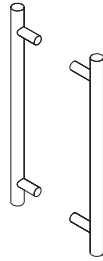

Push/Pull Handle
Specifying
▶ Page 166

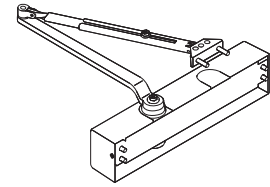

Door Closer
Specifying
▶ Page 166



Roller Latch
Specifying
▶ Page 167

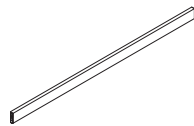

Door Drop Seal
Specifying
▶ Page 168



Electric Hinge
Specifying
▶ Page 168

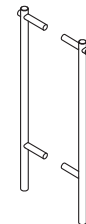

Ladder Pull, Aligned
Specifying
▶ Page 169

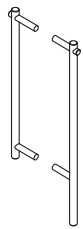

Ladder Pull, Offset
Specifying
▶ Page 169

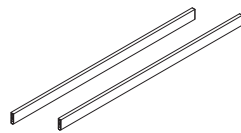

Door Drop Seals
Specifying
▶ Page 170



Flush Bolts
Specifying
▶ Page 170

Slider Doors



Understanding
 ▶ Page 52
 Specifying
 ▶ Page 172

Single Surface Mounted Slider Door Frame

80.984"–120"H x 38–48"W



Understanding
 ▶ Page 52
 Specifying
 ▶ Page 173

Single Surface Mounted Polished Edge Slider Door Leaf

80.984"–120"H x 38–48"W

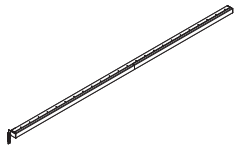

Understanding
 ▶ Page 52
 Specifying
 ▶ Page 174

Basic Single Surface Mounted Slider Door Track

6"–144"W

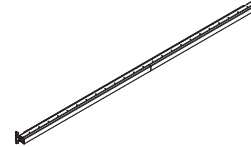

Understanding
 ▶ Page 52
 Specifying
 ▶ Page 176

Reinforced Single Surface Mounted Slider Door Track

98.00001"–168"W

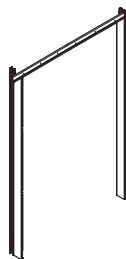

Understanding
 ▶ Page 52
 Specifying
 ▶ Page 177

Frame for Pair of Surface Mounted Slider Doors

80.984"–120"W

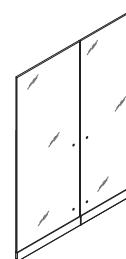

Understanding
 ▶ Page 52
 Specifying
 ▶ Page 178

Pair of Surface Mounted Polished Edge Slider Door Leaves

80.984"–120"W



Slider Doors, continued

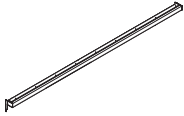

Understanding
▶ Page 52
Specifying
▶ Page 179

Reinforced Track for Pair of Surface Mounted Slider Doors

106.874"—288"W



Intersections—Junctions and Adapters



Understanding
▶ Page 69
Specifying
▶ Page 182



Understanding
▶ Page 69
Specifying
▶ Page 183

Two-Way Fixed Angle Junction Assembly

80"—144"H	90°	120°	135°	180°
	●	●	●	●

Two-Way Variable Angle Junction Assembly

80"—144"H	91°–179°
	●



Understanding
▶ Page 69
Specifying
▶ Page 184



Understanding
▶ Page 69
Specifying
▶ Page 185

Three-Way Junction Assembly

80"—144"H	90°	120°	135°
	●	●	●

Four-Way Junction Assembly

80"—144"H
●

Intersections—Junctions and Adapters, continued



Understanding
 ▶ Page 68
 Specifying
 ▶ Page 187

Inner Junction Cover

77.71654"—141.71654"H	120°	135°
	●	●



Understanding
 ▶ Page 68
 Specifying
 ▶ Page 187

Variable Angle Inner Junction Cover

77.71654"—141.71654"H	91°–179°
	●



Understanding
 ▶ Page 68
 Specifying
 ▶ Page 188

90° Inner Junction Trim

77.71654"—141.71654"H	90°
	●



Understanding
 ▶ Page 68
 Specifying
 ▶ Page 189

Outer Junction Cover

77.71654"—141.71654"H	90°	120°	135°	180°
	●	●	●	●



Understanding
 ▶ Page 68
 Specifying
 ▶ Page 190

Variable Angle Outer Junction Cover

77.71654"—141.71654"H	91°–179°
	●



Understanding
 ▶ Page 72
 Specifying
 ▶ Page 190

Bypass Outer Junction Cover

77.71654"—141.71654"H
●

Intersections—Junctions and Adapters, continued



Understanding
 ▶ Page 68
 Specifying
 ▶ Page 195

90° T/X Adapter

77.71654"–141.71654"H



Understanding
 ▶ Page 68
 Specifying
 ▶ Page 196

Finished End

77.71654"–141.71654"H



Mini Ends



Understanding
 ▶ Page 74
 Specifying
 ▶ Page 198

90° Adjustable Mini End

80"–144"H Small Medium Large
 (2 1/4"– < 3"W) (3"– < 4 1/2"W) (4 1/2"–6 3/4"W)



Understanding
 ▶ Page 74
 Specifying
 ▶ Page 199

Mini End Cover

77.71654"–141.71654"H Small Medium Large
 (2 1/4"– < 3"W) (3"– < 4 1/2"W) (4 1/2"–6 3/4"W)



Cutable Ends

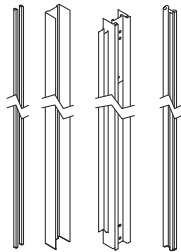

Understanding
 ▶ Page 76
 Specifying
 ▶ Page 202



Understanding
 ▶ Page 76
 Specifying
 ▶ Page 202

90° Cutable End Assembly

80"–144"H



90° Cutable End Inner Channel

48"L 120"L 144"L



Understanding
 ▶ Page 76
 Specifying
 ▶ Page 203



Understanding
 ▶ Page 76
 Specifying
 ▶ Page 203

90° Cutable End Outer Channel

48"L 120"L 144"L



Cutable End Capture Trim

12.1"–144"H



Understanding
 ▶ Page 76
 Specifying
 ▶ Page 204



Understanding
 ▶ Page 76
 Specifying
 ▶ Page 204

Cutable End Corner Angle

Cutable End Elbow

Electrical Components

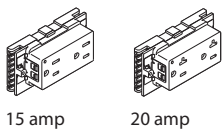

Receptacle
Understanding
▶ Page 80
Specifying
▶ Page 206



USB Receptacle
Understanding
▶ Page 80
Specifying
▶ Page 207

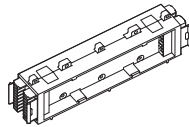

Power Block
Understanding
▶ Page 80
Specifying
▶ Page 207



Power/Communication Receptacle Trim
Understanding
▶ Page 80
Specifying
▶ Page 208

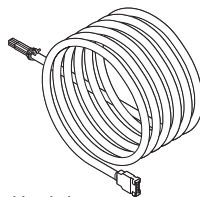

Hardwire

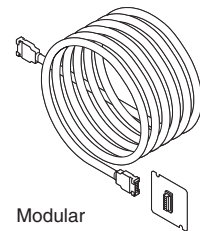

Modular



Blank Cut-Out Cover
Understanding
▶ Page 80
Specifying
▶ Page 208

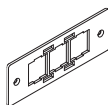

Modular Communication Faceplate
Understanding
▶ Page 78
Specifying
▶ Page 209

Multipurpose Infeed
Understanding
▶ Page 79
Specifying
▶ Page 210



Power Block Connector
Understanding
▶ Page 80
Specifying
▶ Page 210

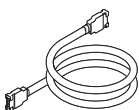

Modular Harness
Understanding
▶ Page 78
Specifying
▶ Page 211



Harness-to-Harness Branching Connector
Understanding
▶ Page 80
Specifying
▶ Page 211

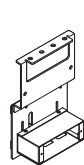

Data

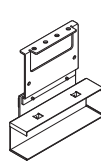

Modular

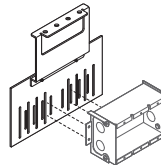

Hardwire

Electrical Mounting Bracket-Skin
Understanding
▶ Page 78
Specifying
▶ Page 212

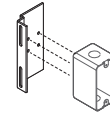

Hardwire box

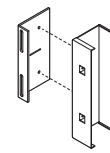

Modular power block

Electrical Mounting Bracket-Utility Panel
Understanding
▶ Page 78
Specifying
▶ Page 212

Electrical Components, continued

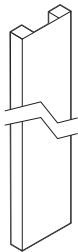

Understanding
▶ Page 81
Specifying
▶ Page 213

Utility Panel Cover

77.71654"–141.71654"H



Technology Components

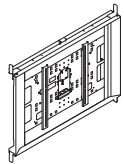

Understanding
▶ Page 86
Specifying
▶ Page 216

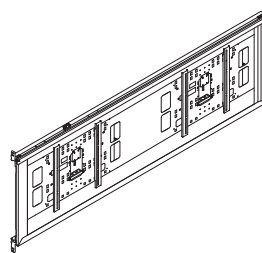

Understanding
▶ Page 86
Specifying
▶ Page 217

Single Monitor Shroud

42"W 48"W 54"W 60"W



Double Monitor Shroud

96"W



Understanding
▶ Page 86
Specifying
▶ Page 218

Camera Shelf for Monitor Shroud

Hang-On Components

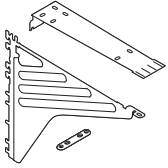

Understanding
▶ Page 97
Specifying
▶ Page 220



Understanding
▶ Page 97
Specifying
▶ Page 220

On-Module Cantilever

Side Support Brackets

Structural Frame Components

► Specifying, page 113

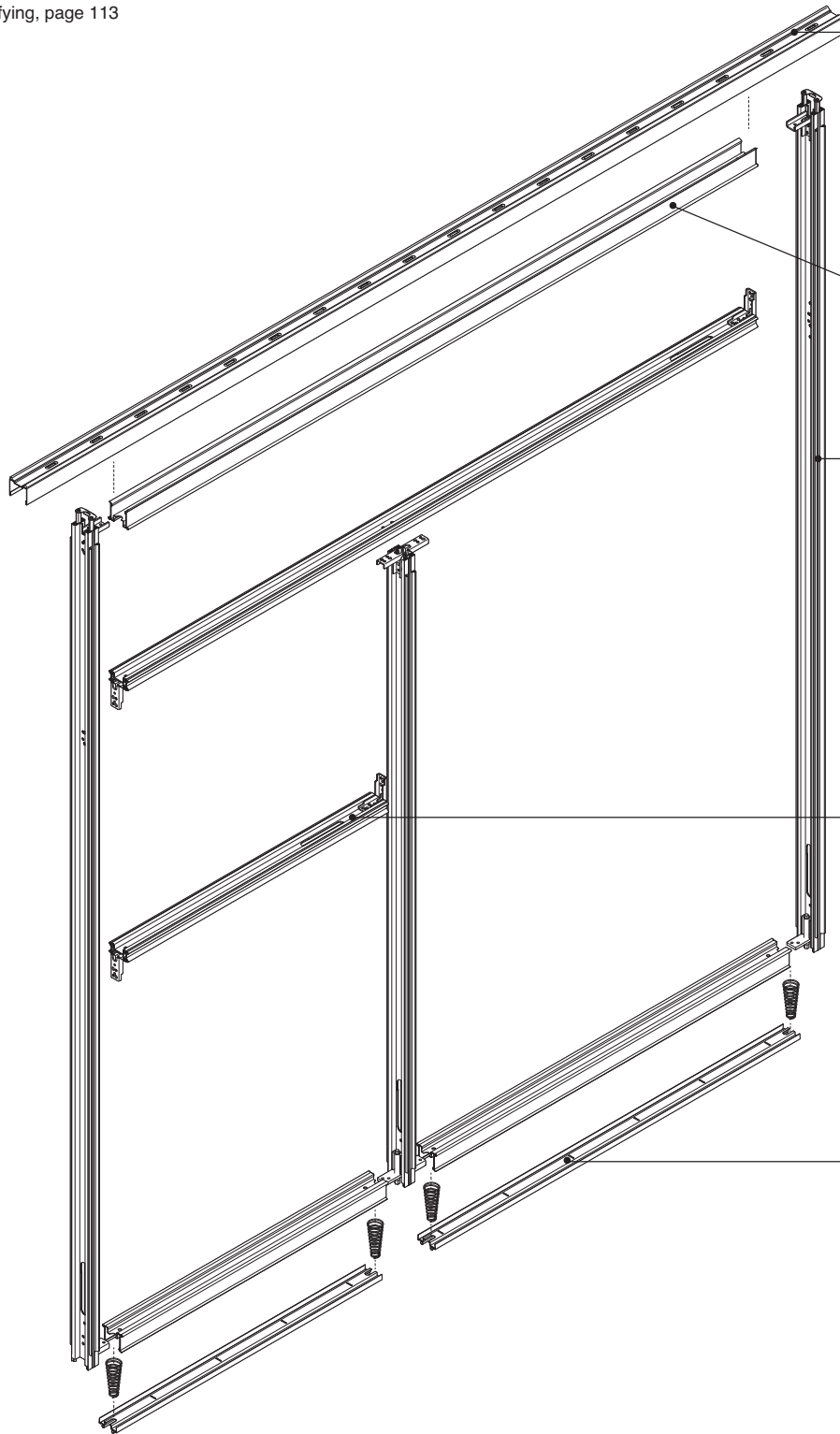

Ceiling track secures the top of the V.I.A. wall to the suspended ceiling grid. There are three types of ceiling track: straight, corner fixed angle, and corner variable angle.

Structural horizontals provide structural connection from post to post at the top and bottom of the wall.

Posts provide vertical support, include threaded levers for adjustment at the floor, and contain slots for hang-on components.

Intermediate horizontals are mounted between the floor and ceiling to support skin segmentation and electrical components.

Floor track is set between posts to receive base trim and provide visual and acoustic separation at the floor.

Tip: When installing on low-profile floor, specify floor guide.

Product Details

► See *V.I.A. Planning Dimensions*, page 103, for important information regarding dimensional references for all V.I.A. components.

V.I.A. structural frames

provide the structure for floor-to-ceiling walls to the exact dimensions and configuration of the wall as defined by the planner. The walls can carry power and data, accommodate technology, and may be relocated as needs change.

Base trim is cut on site and applied to the floor track to provide visual and acoustic separation.

Power and communication mounting brackets are attached to structural and intermediate horizontals for positioning modular and hardware electrical components.

► See *Electrical Components*, page 78

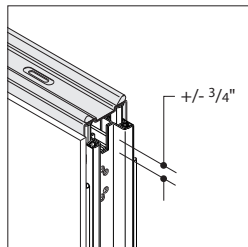

Ceiling track comes in 120" and 144" lengths; can be field cut on site. Allows 3/4" of vertical adjustment to accommodate ceiling variation.

There are two corner options: Fixed angle corners: 90°, 120°, and 135°. Variable angle corners: 91°–119°, 121°–134°, and 136°–179° in 1° increments.

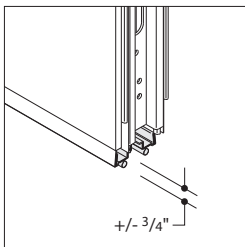

Floor track fits between vertical posts, junctions, or adapters. Allows 3/4" of vertical adjustment to accommodate variations at the base of the wall. Floor track is available from 6" to 120"W to fit V.I.A. wall module width.

Springs are inserted between the floor track and structural horizontals to ensure continuous contact of the floor track with the floor. ► See *SmartTools*, page 4.

Floor track sections that are 12"W or wider include cut-outs for routing cable through the floor.

In most cases, floor track will not be visible. In cases where extreme floor deviation occurs, a small portion of the track may be visible. The floor track should be painted to match the base trim.

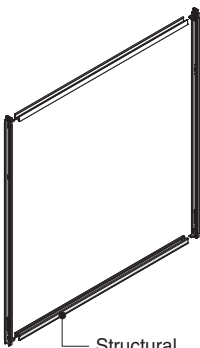

Structural horizontals provide structural connection from post to post at the top and bottom of the wall.

Structural horizontals are manufactured to match the module planning width.

The minimum length of structural horizontal is 6"L and the maximum length is 120"W. Structural horizontals include cut-outs for routing cable through the floor or ceiling.

Horizontals that are less than 16"W will not include factory cutouts for cabling. Additional cutouts for cable routing can be drilled during installation.

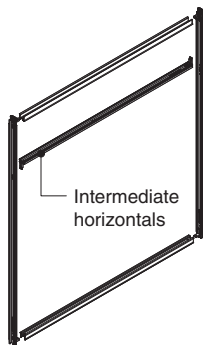

Intermediate horizontals are positioned between posts to accommodate desired skin or glass segmentation.

Intermediate horizontals are positioned between transom height door frames and the component above (skin or captured glass frame).

Intermediate horizontals are positioned as needed to support mounting brackets for electrical components.

Intermediate horizontals accommodate power and cable at user defined heights as low as ADA.

One cable access hole per intermediate horizontal allows for routing of power and communications cabling.

Skins can span across intermediate horizontals.

Posts provide vertical support and are positioned between skins, captured glass frames, and door frames. Post minimum is 15" planning height and maximum is 144" ceiling height.

When the ceiling height exceeds 10'-0", posts cannot be spaced more than 48" apart.

Posts include threaded levers for adjustment at the floor. Posts always extend to the floor.

The top of a post can be specified to connect to the ceiling track or an intermediate horizontal.

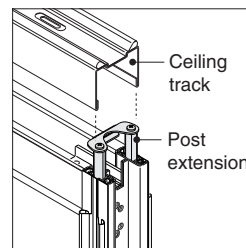

When connecting at the ceiling track, the post includes a post extension to accommodate for variation at the ceiling.

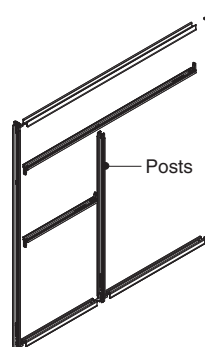

Posts are factory prepared to receive intermediate horizontals at specified heights.

Where posts and horizontals intersect, the post will be continuous, and will separate the horizontals. ► See *SmartTools*, page 4

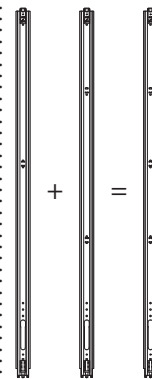

Posts can be configured to receive up to 11 intermediate horizontals. Positions are optimized so that multiple segmentation configurations can be applied to every post to create a universal post as appropriate for a specific project. ► See *SmartTools*, page 4

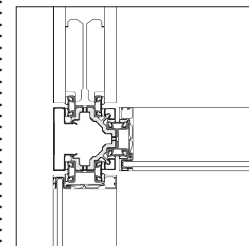

Multiple posts are joined together at intersections to create junctions. ► See page 68

A cable access hole at the bottom of each post allows for routing of power and communications cabling.

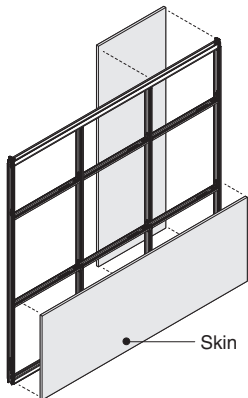

Skins can span across posts.

When two or more door frames connect at a single junction, a short leveler bracket is installed at the bottom of the post within that junction.

▶ See page 123

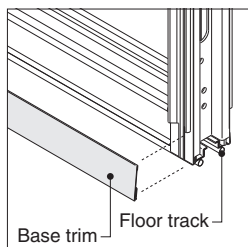

Base trim fits into position at the bottom of the wall over the floor track. Two sizes are available: 10' and 12'L. Base trim is cut to length during installation. 12' lengths can be used over larger spans to minimize the number of seams.

Base trim corner options are:

- Fixed angle corners: 90°, 120°, and 135°.
- Variable angle corners: 91° to 119°; 121° to 134°; and, 136° to 179° in 1° increments.

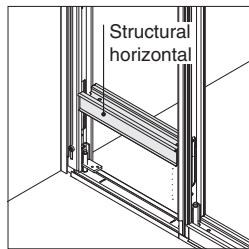

Structural horizontals that are positioned adjacent to cuttable ends will be modified to ensure that cable cut-outs do not interfere with the bracket connection. These horizontals will receive one cut-out only when 22.61" long or greater. Structural horizontals that are less than 22.61" will not have any cable cut-outs.

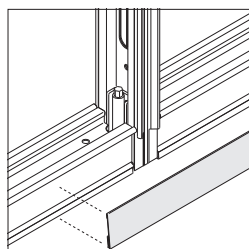

Base trim spans posts, junctions, utility panel, and cut wall panels.

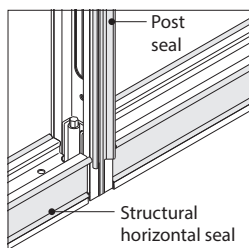

Posts, structural horizontals, and intermediate horizontals include two factory applied seals that minimize sound transmission.

Tip: Seals can also be ordered as a Service Part.

ADA height mounting brackets can be mounted to the bottom structural horizontal which will position power and communication receptacles at an ADA compliant height.

Connections

Ceiling track brackets connect sections of straight ceiling track at all T and X intersections.

- T = one bracket
- X = two brackets

Ceiling track fasteners secure the track to the suspended ceiling grid. Seven standard styles:

- 1"W exposed T
- 9/16"W exposed T
- 1/4" Donn fineline
- 1/8" Donn fineline
- 1" fluted runner 1/4-20
- 1"W T for tegular ceiling tiles
- 9/16"W T for tegular ceiling tiles

Spacers are included with fasteners for tegular ceiling tiles that allow adjustment for different tile edge depths.

Fasteners for other types of ceilings are purchased locally.

▶ See page 28

The building's designated design professional (architect or engineer) must verify that the ceiling grid is adequate to support the lateral loads imposed by V.I.A. Local codes may require independent bracing.

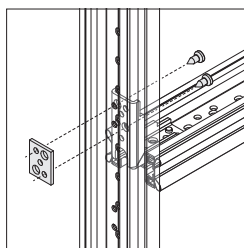

Nut plates attach intermediate horizontals to posts at two-way (fixed or variable angle) junctions, three-way junctions, four-way junctions, utility panels, and mini ends.

Screws affix structural and intermediate horizontals to posts.

Floor guides are positioned under posts, and are required when installing V.I.A. on Low Profile Floor. They include material for gripping to hard surfaces and carpet.

Floor guides can also be specified for use in seismic design applications. Additional mechanical fasteners (not included with the floor guide) may be required as specified by the structural engineer.

▶ See page 122

When planning with V.I.A. on Low Profile Floor, do not position the wall directly above the edge trim as this will create an unstable condition.

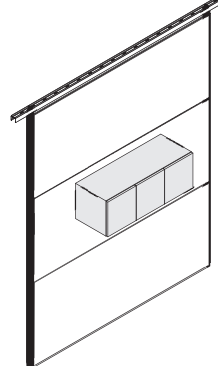
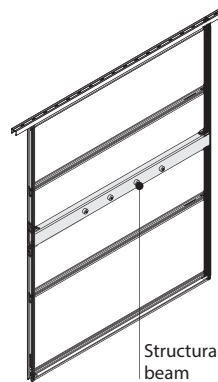

Structural beams are used to provide internal reinforcement in those applications where surface mounted storage is desired.

▶ See Structural Beam, in *Hang-On Components Understanding*, page 96

Wiring & Cabling

Power and data components are ordered separately. Standard access openings are available in the framing components. There is adequate space within the walls to feed the wires and cable needed for either modular or hardwire power and communication. ADA and desk height are the most common placements for power and communication. However, the parametric approach used by V.I.A. can allow for almost any positioning of electrical components.

Surface Materials

Ceiling track

- Paint

Floor track

- Paint

Base trim

- Paint

Seals

- Plastic

Acoustic seals

- Plastic

Application Topics

V.I.A. Planning Dimension

▶ See page 103

Electrical Components

▶ See page 78

Acoustic Planning

Considerations

▶ See page 110

Planning with Solid Skins

and Landscape Oriented

Components

▶ See page 104

Hang-On Components

▶ See page 94

Ceiling Clip Application

Tip: All planning and application guidelines contained in this section of the specification guide are based on the requirement that ceiling track is connected to a ceiling in order to properly install and align the wall components as shown. When any partition is fastened to a suspended ceiling grid, it may be necessary for an architect or engineer to verify that the grid can adequately support the partition. Local codes may require additional bracing.

T Grid Ceiling Fastener Kits

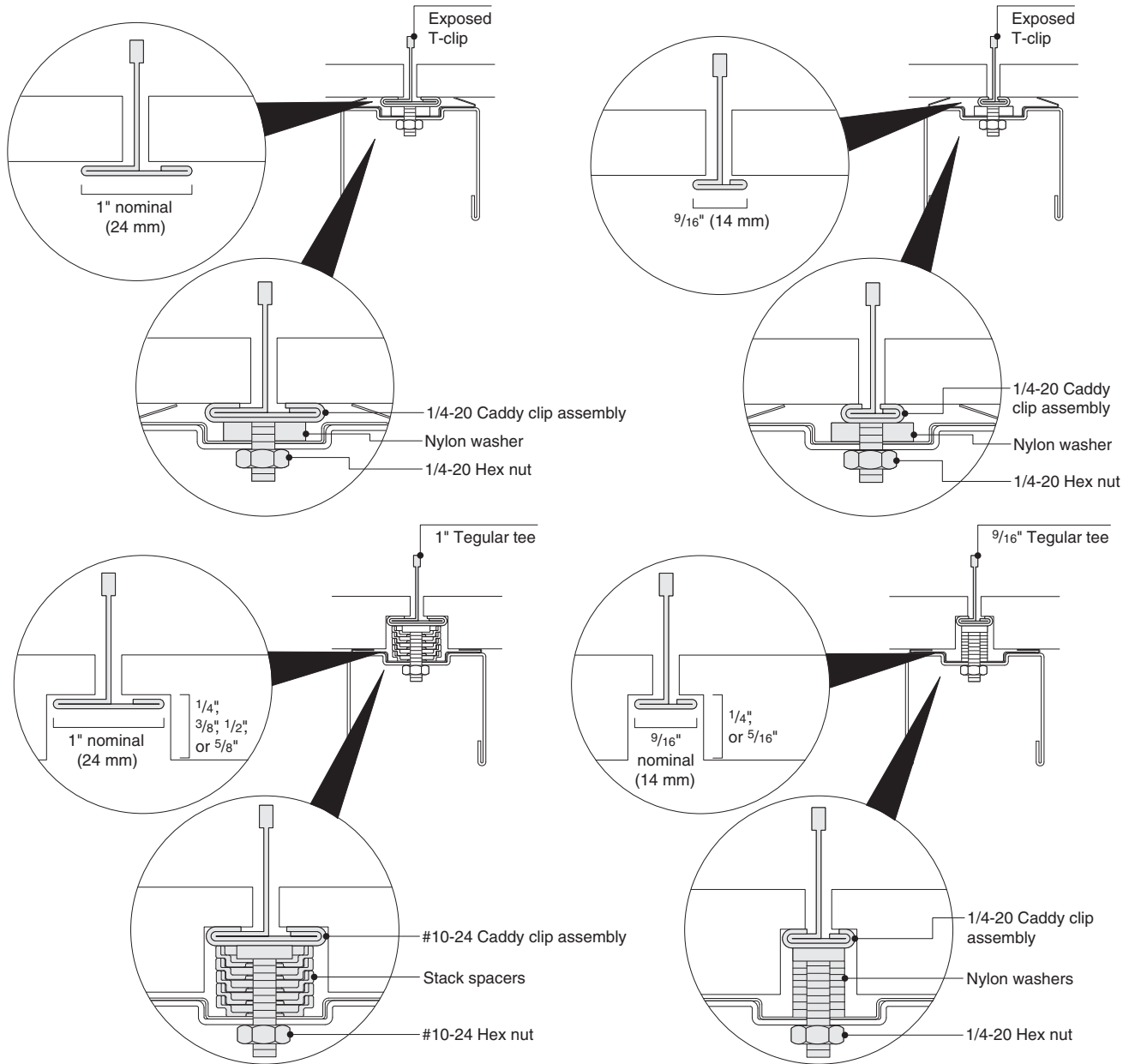

Bolt Slot Grids Ceiling Fastener Kits

Ceiling clips support the most common types of ceiling systems.

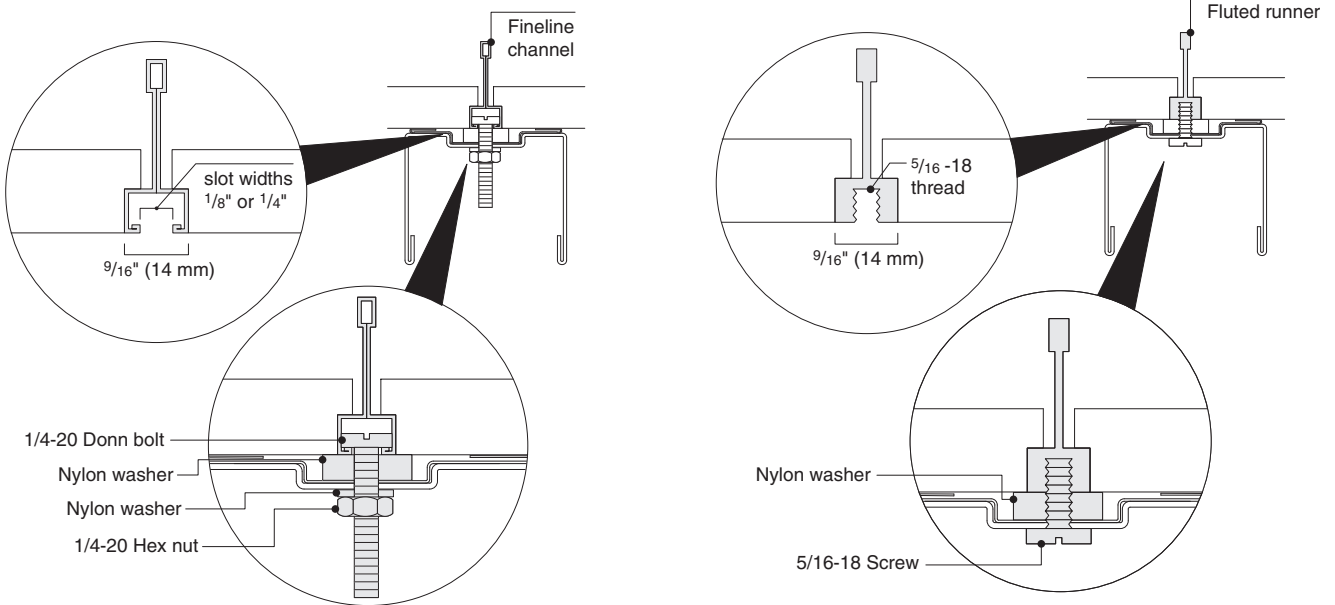

Concealed Grids – Field-Purchased Generic Fasteners

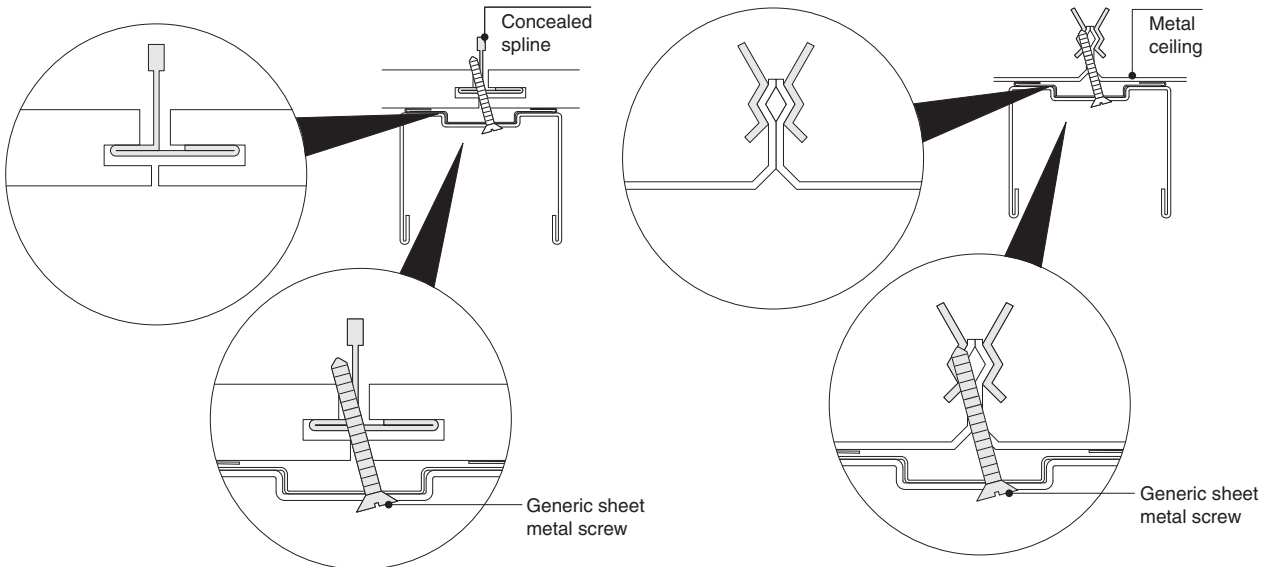

For these and other types of ceilings, the following fasteners can be sourced locally by the installer:

Concealed spline	#7 – 17 x 1 ⁵ / ₈ " Bugle Head Self-Drilling Screws
Drywall	#14 – 1" Phillips Head SMS with plastic anchor
Plaster	1/4 – 20 Toggle Bolt
Concrete	Tapcon Anchor x 2"
Metal Pan	#7 – 17 x 1" Bugle Head Self-Drilling Screws

Cornice Application

In some cases, it may be desirable to install V.I.A. in an application where there is no ceiling. In these types of applications, it is necessary to follow the panel stability guidelines for cornice application in order to provide an acceptable level of stability and rigidity. Also, cornice track is inserted into the top of the walls in place of ceiling track.

► Specifying, page 127

The maximum recommended length of a cornice height wall without a door is 12'.

The maximum allowable length of a cornice height wall without a door is 16'.

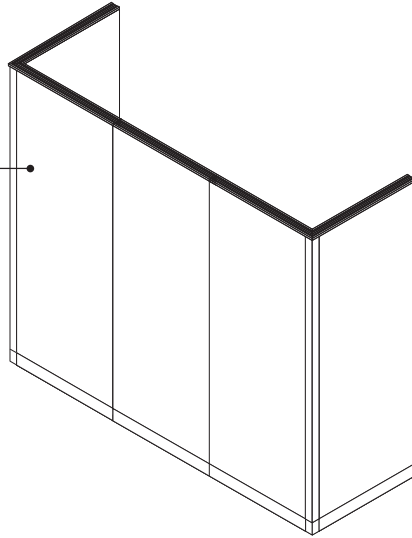

The maximum allowable length of a cornice height wall with a door is 12', which includes the door dimension. Any wall with a door must be configured with a structural condition at both ends.

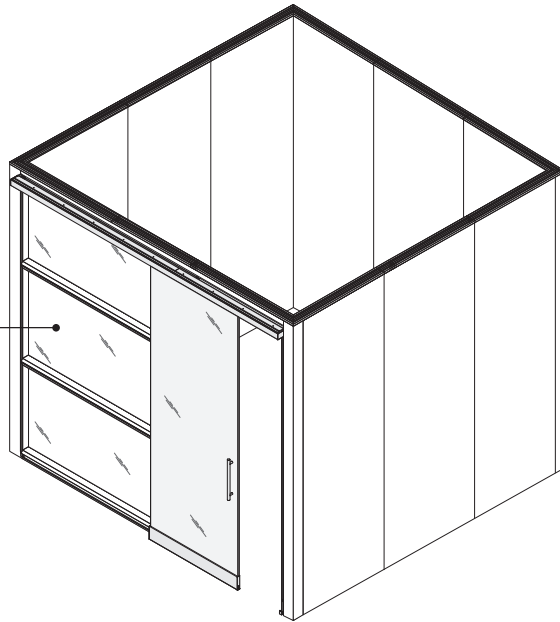

Product Details

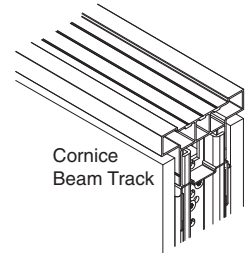

Cornice Beam Track

When applied as free-standing wall without a lid structure, V.I.A. walls are installed with the cornice beam track to provide a finished top trim.

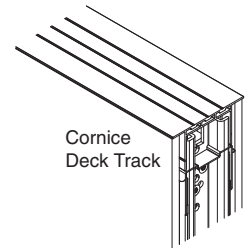

Cornice Deck Track

When applied with a wall supported lid assembly, V.I.A. walls are installed with the cornice deck track to provide a support surface for the lid structure.

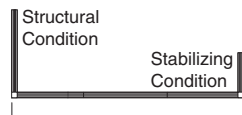

16'0" Maximum allowable
12'0" Maximum recommended

The maximum recommended length of a cornice height wall without a door is 12'.

The maximum allowable length of a cornice height wall without a door is 16'.

Any wall greater than 5' long must be configured with at least a structural condition at one end and a stabilizing condition at the other. Structural conditions at both ends is also acceptable.

Any wall greater than 16' long must have the appropriate structural and stabilizing conditions met at a minimum of every 16'.

A wall of 5' or less must be configured with at least a structural connection at one end only. No additional end condition is required.

Walls can be made up of captured glass or solid skins in any configuration without effecting rigidity.

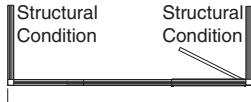

12'0" Maximum allowable

The maximum allowable length of a cornice height wall with a door is 12'.

Any wall with a door must be configured to structural conditions at both ends.

Tip: See page 32 for structural conditions.

Tip: See page 33 for stabilizing conditions.

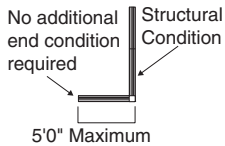

5'0" Maximum

A wall of 5' or less must be configured with at least a structural connection at one end only. No additional end condition is required.

Cornice track is used in place of ceiling track when installing V.I.A. walls in cornice applications.

Cornice track is provided in 130" lengths and cut to length as part of the installation process.

Cornice track is field cut to create intersections as required.

Screws for cornice track are provided and shipped separately.

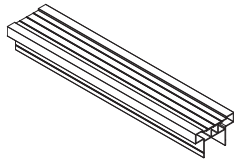

Beam track is used as a finished top trim when walls are applied without a lid assembly. Beam track can be painted or anodized finish.

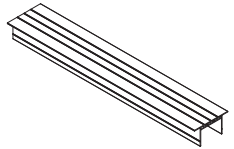

Deck track is used when a wall supported lid assembly is installed. Lid track is available in painted finishes only.

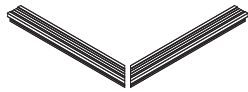

Cornice corner track is specified at L corners for both beam and deck tracks. Corners are factory-mitered and assembled as part of the installation process.

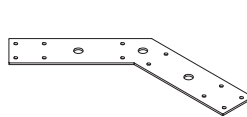
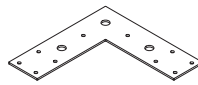
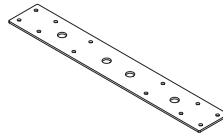

Cornice brackets are provided to join cornice sections at 90°, 135°, and 180° connections.

Screws for cornice brackets are provided and shipped separately.

3-Way 135° intersections can be created by using a 135° cornice bracket to join two of the three walls. Cornice track is cut during installation to accommodate the Y configuration.

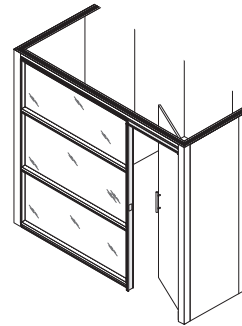
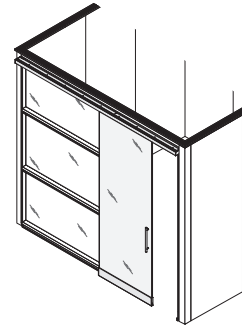

Cornice height walls can be used with slider doors or reversible swing doors, in both single and pair configuration, as well as full height or transom height.

The maximum length of a cornice height wall with a door is 12'.

Cornice height walls cannot support wall-mounted furniture.

Monitor shrouds and surface mounted monitors can be used with cornice height walls.

Standard guidelines for power and data apply. Power infeeds must be routed from the floor to adjacent wall.

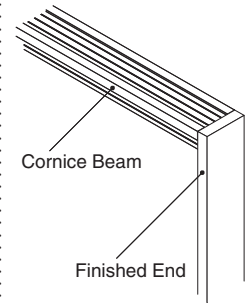

When applied in cornice applications, finished ends should be ordered and specified at a taller height in order to conceal the end of the cornice beam. Planning height = ceiling height minus 0.90551".

Structural Conditions

Examples

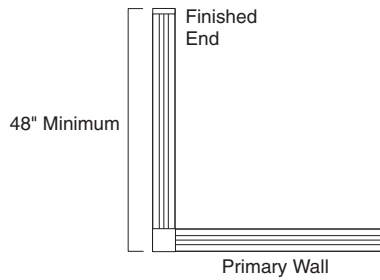
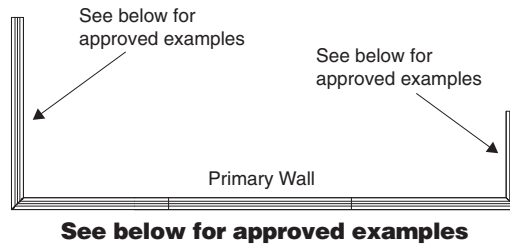

L-wing wall with finished end 48" minimum.

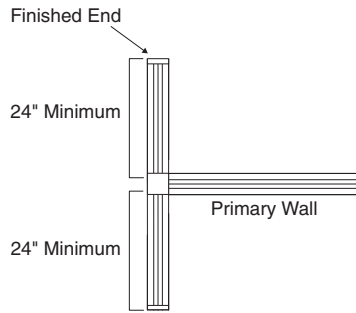

T-wing wall with finished ends 24" minimum.

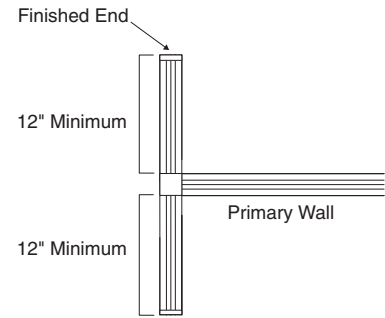

T-wing wall with finished ends 12" minimum with seismic floor guide.

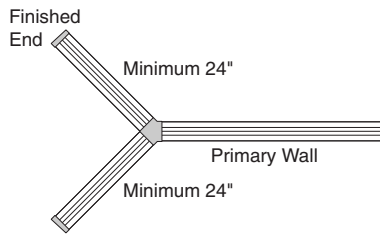

Y-wing walls with finished ends 24" minimum.



Mini-end anchored to fixed wall.

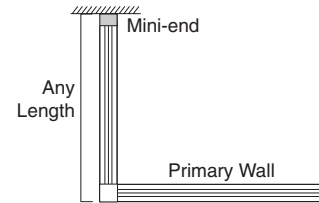

L-wing with mini-end anchored to fixed wall.

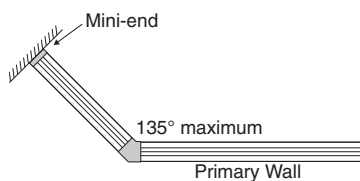

V-wing wall with mini-end anchored to fixed wall.

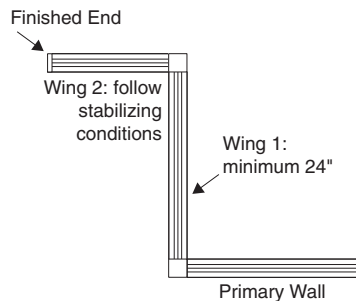

Offset wing walls with finished end. Total length of wing 1 and wing 2 must be greater than 48".

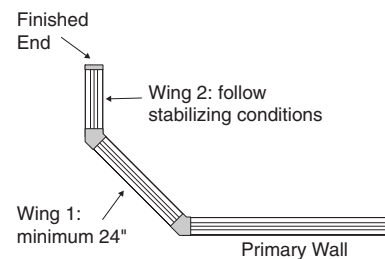

Offset wing walls with finished end. Total length of wing 1 and wing 2 must be greater than 48".

Examples

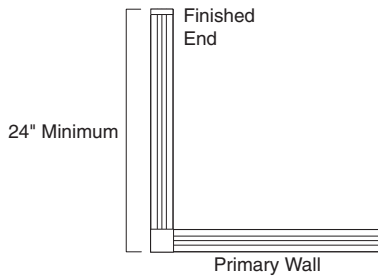
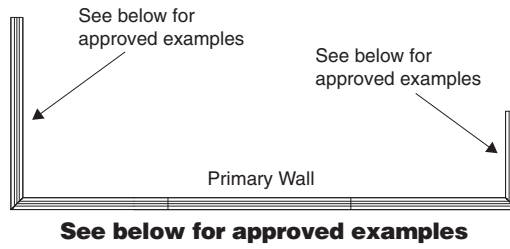

L-wing wall with finished end 24" minimum.

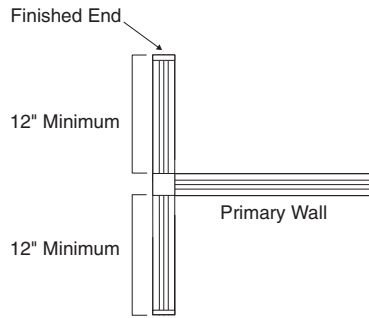

T-wing wall with finished ends 12" minimum.

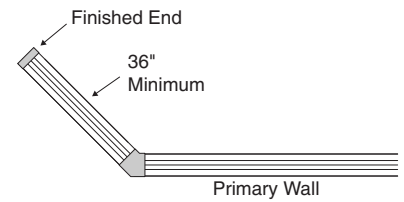

V-wing with finished end 36" minimum.

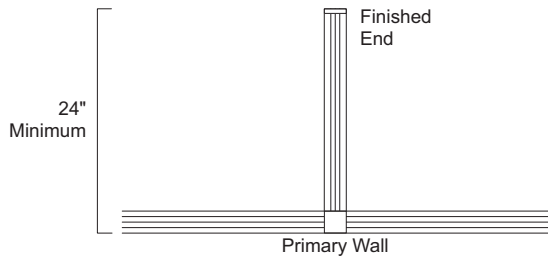

T-wing wall with finished end 24" minimum.

Tip: Any wall greater than 16' long must have the appropriate structural and stabilizing conditions met at a minimum of every 16'.

Cornice Seismic Planning Guidelines

When planning with V.I.A. cornice applications that require a seismic design criteria, additional bracing to the building structure may be required.

Seismic bracing may be avoided by using the following seismic planning guidelines for V.I.A. cornice height applications. Steelcase can provide a generic engineering report to confirm that these configurations will meet seismic structural performance requirements.

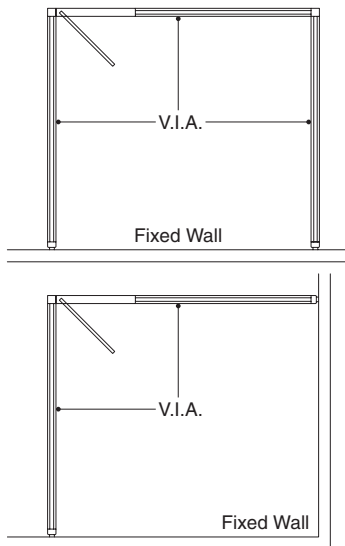

This seismic report applies to four-sided room configurations. The rooms can be planned using all V.I.A. walls, or a combination of V.I.A. walls and fixed construction walls that are adequately braced for seismic applications.

In order to comply with this report, spacing between posts cannot exceed 48". If post spacing exceeds 48", additional bracing to structure may be required.

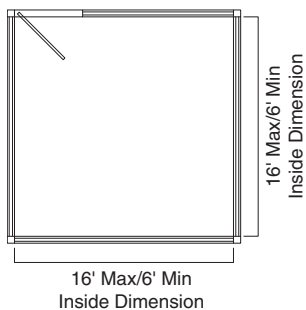

Maximum room size is 16'0" x 16'0". Neither wall can be less than 6'0". In seismic applications, wall lengths are defined by the distance between junctions or mini-ends.

This seismic report does not include lid applications. Cornice height applications with lids will require review by your local engineer.

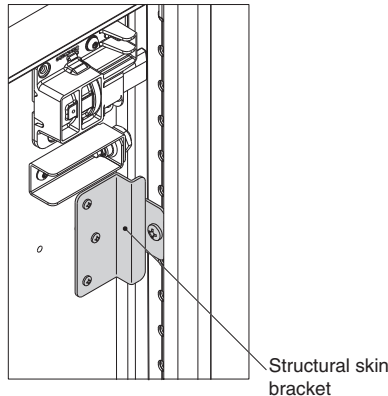

Structural skin brackets are installed on one side of wall and applied to the back face of solid skins when applied in seismic applications (four brackets per skin).

Seismic floor guides are also specified for use in seismic applications. Additional mechanical fasteners (not included with the floor guide) may be required as specified by the structural engineer.

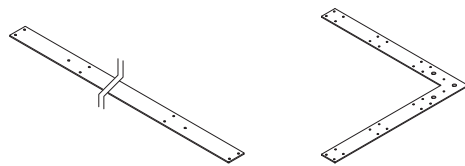

112" Long straight reinforcing track

Corner reinforcing track

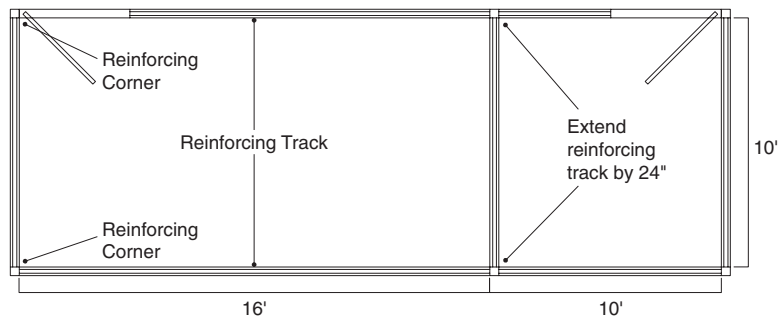
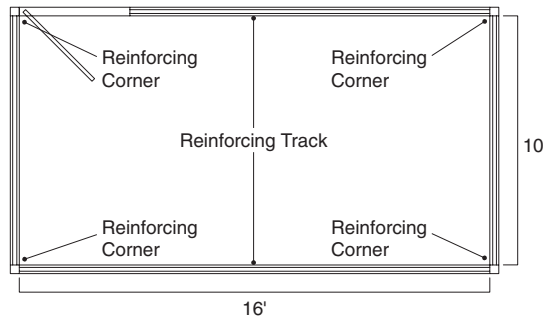

In seismic applications, when a wall is greater than 12'0" in length, that wall must be installed with straight seismic reinforcing and corner reinforcing tracks at the adjacent L corners.

Combining cornice height rooms into groups may require additional review and considerations by the structural engineer.

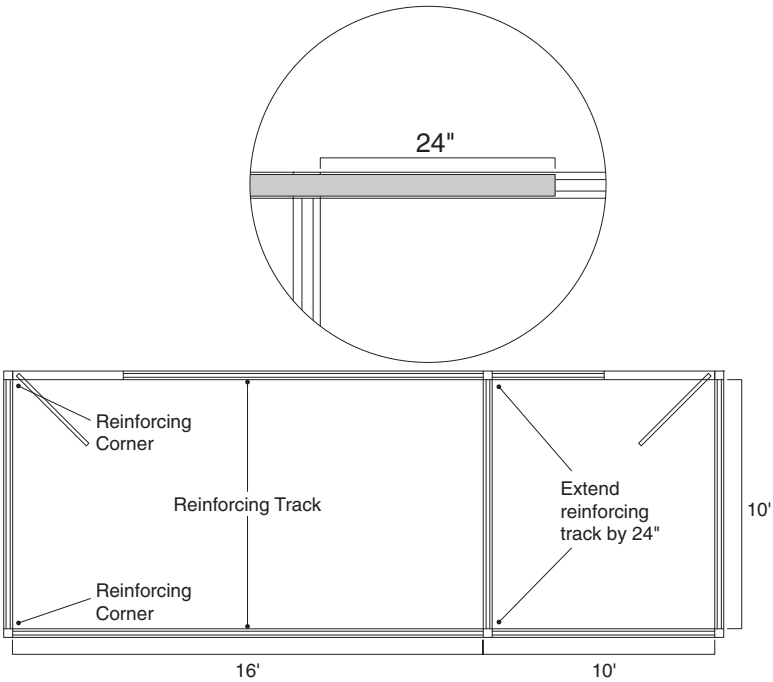

Reinforcing tracks are installed using bracket fasteners. Each straight seismic reinforcing track requires two sets of bracket fasteners. Each seismic reinforcing track corner requires three sets of bracket fasteners.

Captured Glass Frames

V.I.A. captured glass frames are pre-glazed and factory assembled to specified dimensions and orientation. They are mounted into structural frames along with solid skins and door units to provide the appropriate levels of privacy, interaction, and shared light. ▶ Specifying, page 133

Captured glass frames can be combined in virtually any combination of size and orientation to create unique configurations and wide expanses of glass.

Captured glass frames can be either single or double glazed.

Captured glass frames can be combined with solid skins to create clerestory applications.

Single glazed frames are flush glazed, with planar alignment along one surface of the wall.

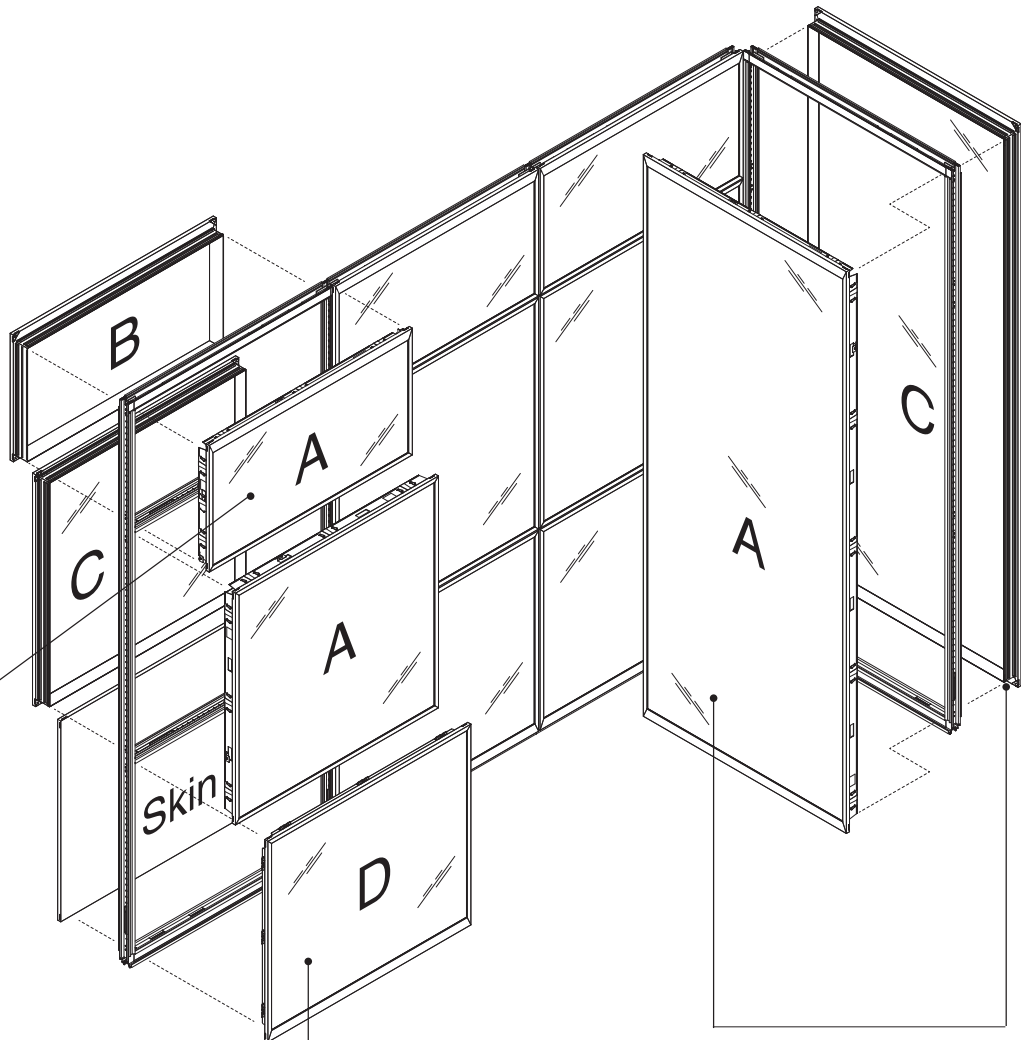

Back-painted glass frames allow the user to design with opaque painted glass as a solid skin, introducing visual accents and employing the functionality of a marker surface.

Double glazed frames are flush on both faces, and provide enhanced level of acoustic separation for superior speech privacy.

Product Details

► See *V.I.A. Planning Dimensions*, page 103, for important information regarding dimensional references for all V.I.A. components.

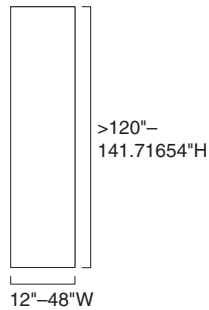
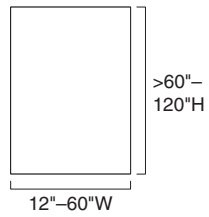
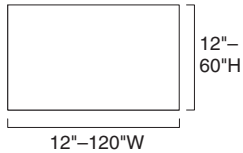

Captured glass frames maximum height is 141.71654"H and maximum width is 120". Minimum height and width is 12".

Glass frames can be specified to the following overall dimensions:

- If 12" to 60"H, then width can be 12"- 120"W.
- If greater than 60" to 120"H, then width can be 12" to 60"W.
- If greater than 120" to 141.71654"H, then width can be 12" to 48"W.

Minimum frame height in the bottom position is 15".

Minimum frame height in the top position is 12".

When the ceiling height exceeds 10'-0", posts cannot be spaced more than 48" apart.

Glass frames can accommodate glass thickness from 1/4" to 3/8". Back-painted glass is available as 1/4" only.

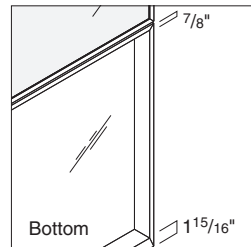
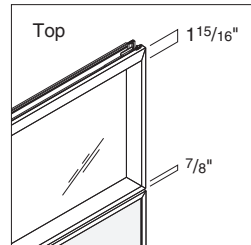

When segmented, top position frames are specifically configured to interface with the ceiling track. Bottom position frames are specifically configured to interface with the floor track. Intermediate frames can be installed in any intermediate position.

Captured glass frames are interchangeable with solid skins of the same size and orientation.

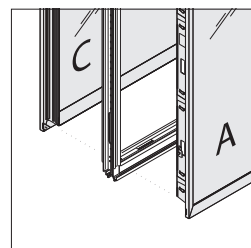

Captured glass frames consist of two sub-assemblies that engage with one another to create a finished frame.

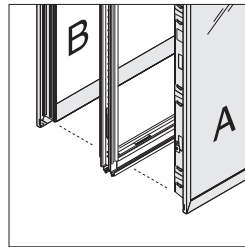

Single glazed frames are designed with a flush glazed side (side A) and a sill side (side B) to finish out the opening.

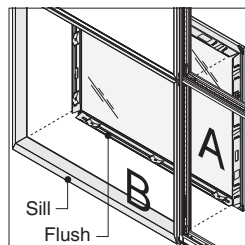
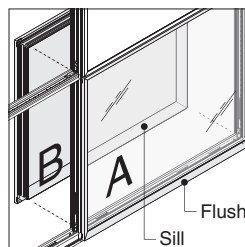

The flush side of a glass frame can be oriented to either face of the wall, without regard for other adjacent components.

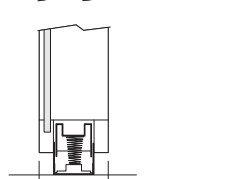
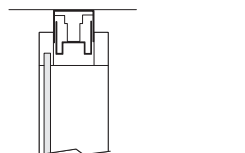

The overall wall thickness is 3 15/16".

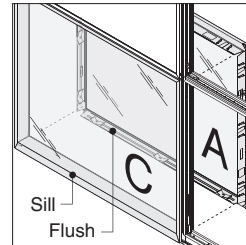
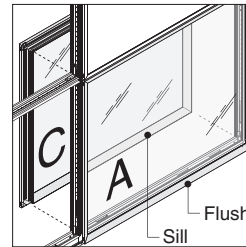

Double glazed frames are designed with two flush glazed sides. Side A is the same configuration as side A used in a single glazed frame. The other glazed side (side C) engages with side A to create a finished assembly.

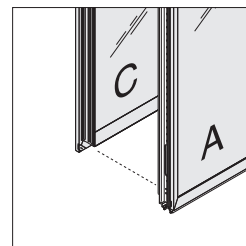
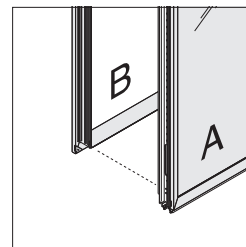

Single glazed frames can be retrofit double glazed by exchanging side B for side C, and vice-versa.

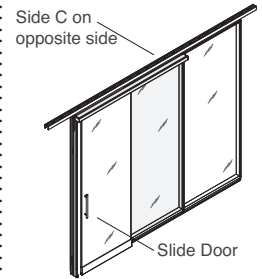

When planning with double glazed frames and slider doors, in order to simplify installation, it is recommended to position the side C frame on the opposite side of the wall from the door.

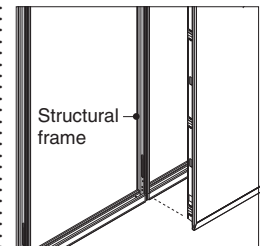

Each vertical edge of a glass frame must have a structural frame support to the floor.

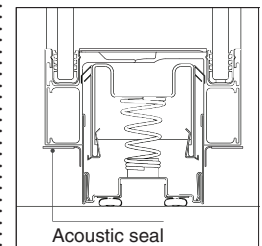
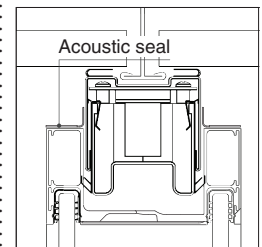

Double glazed glass frames provide better reduction of sound transmission than single glazed frames.

Glass frame acoustic seals are specified at the top and/or bottom of a double glazed frame, where it comes into contact with the ceiling track or base trim.

Acoustic seals are applied during the installation process.

Seals are not visible, due to their position at the top and bottom edges of the glass frame.

Different types and thicknesses of glass may change the overall acoustic performance of a glass wall.

► See page 112 for more information about captured glass frames, acoustic planning considerations, and STC performance ratings.

Certain etched or pattern glass types are polished on one face, and rough (etched or pattern) on the other. When defining the surface orientation of a glass frame, it is also important to consider the surface orientation of these types of glass. When planning with etched glass, the polished face of the glass is most often oriented to the corridor side of the wall to minimize the buildup of dirt on the etched face. Pattern glass is most often positioned with the patterned face oriented to the corridor, as the pattern face of the glass is considered the more attractive surface. Although these are the most common preferences for surface orientation, V.I.A. will allow for any relative position and orientation.

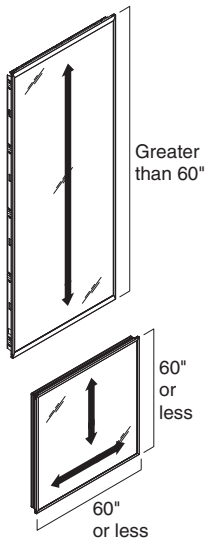

Certain glass patterns have a linear pattern. When one of the glass frame dimensions is greater than 60", the linear direction will run parallel to the long dimension. When both frame dimensions are less than 60", the user can specify if the pattern is to run vertically or horizontally.
Tip: The frame on side A (outside edge) and side B (inside room) can be different finishes.

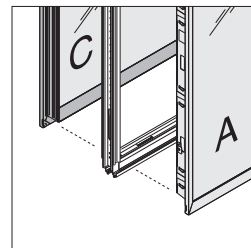

Captured glass frames can be different finishes from one side to the other (side A and C).

Glass in side A and side C can be different glasses.

To change from single-glazed to double-glazed or vice versa, individual captured glass frames can be ordered (sides A, B, or C).

Captured glass frames include glazing strips which are platinum in color.

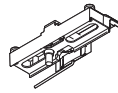

Locking bracket

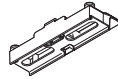

Non-Locking bracket

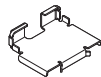

Load bracket



T-Nut

Brackets and hardware for assembling glass frames (sides A, B, and C) into the structural frame are specified separately. These include locking brackets, non-locking brackets, load brackets, and T-nuts.

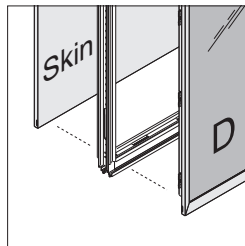

Back-painted glass frames are fully opaque, and allow the user to apply them like solid skins rather than glass. For more information related to back-painted glass, see page 43.

Mounting brackets and hardware are included with back-painted glass frames.

Wiring and Cabling

Captured glass frames do not accommodate power or communication cabling.

Utility panels can be positioned adjacent to glass frames to facilitate cable routing and to introduce outlets, switches, and other electrical devices.

Surface Materials

Glass Lite

- Glass
- Customer specified glass

Glass frames

- Paint
- 8043 Clear Anodized Aluminum

Back-painted glass frames

- Back-painted glass
- Paint
- 8043 Clear Anodized Aluminum



Skins

► Specifying, page 145

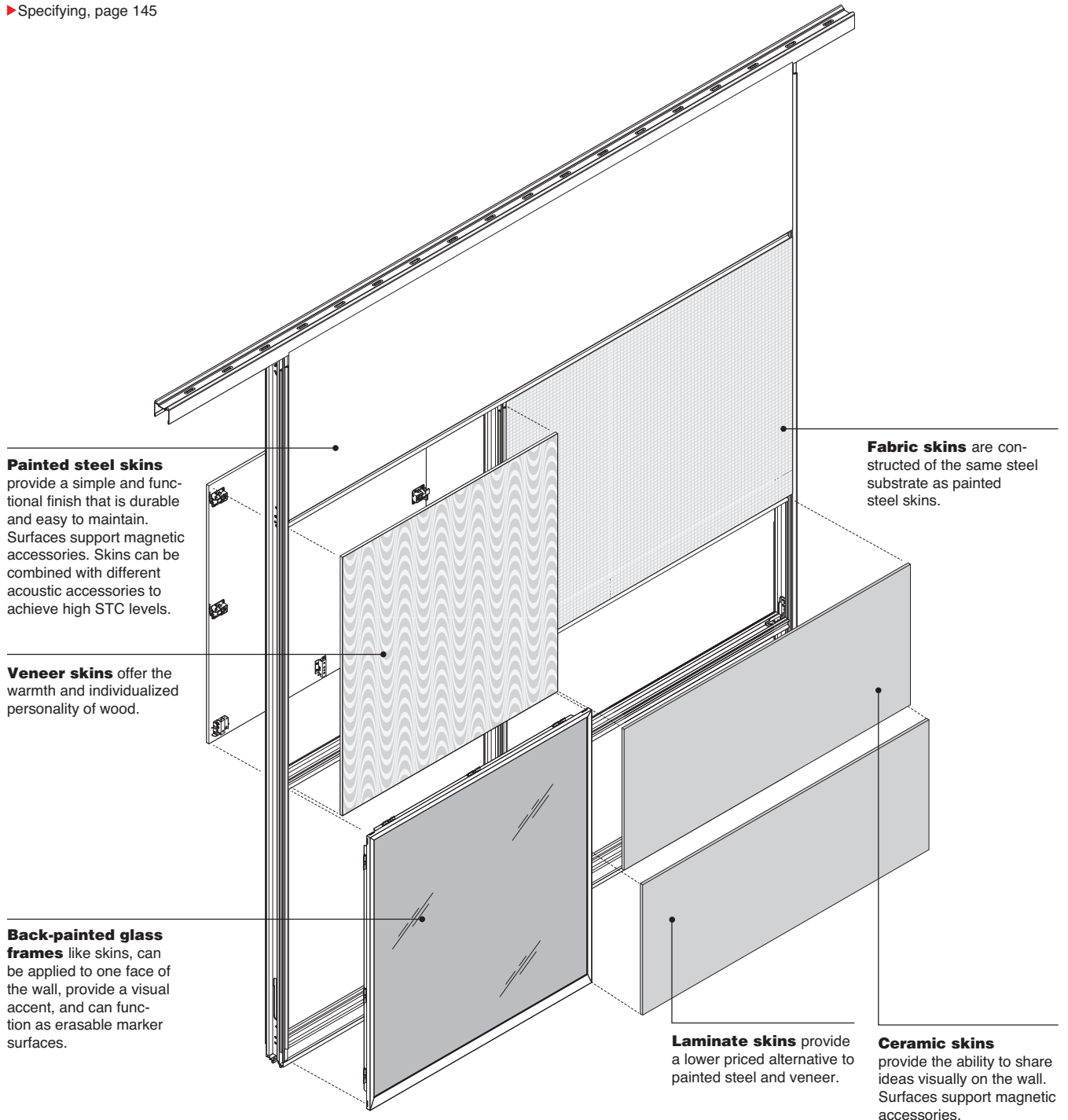

Painted steel skins provide a simple and functional finish that is durable and easy to maintain. Surfaces support magnetic accessories. Skins can be combined with different acoustic accessories to achieve high STC levels.

Veneer skins offer the warmth and individualized personality of wood.

Back-painted glass frames like skins, can be applied to one face of the wall, provide a visual accent, and can function as erasable marker surfaces.

Fabric skins are constructed of the same steel substrate as painted steel skins.

Laminate skins provide a lower priced alternative to painted steel and veneer.

Ceramic skins provide the ability to share ideas visually on the wall. Surfaces support magnetic accessories.

Product Details

► See *V.I.A. Planning Dimensions*, page 103, for important information regarding dimensional references for all V.I.A. components.

Solid skins, available with steel, veneer and laminate surfaces, form the visual and functional surface of the vertical plane that creates the desired environment and facilitates future change.

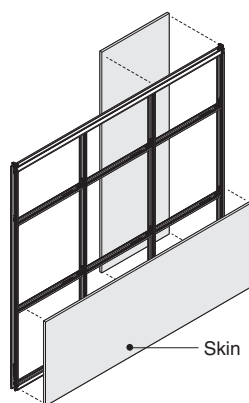

Skins can span structural framing elements, allowing for different skin geometry on opposite sides of a wall.

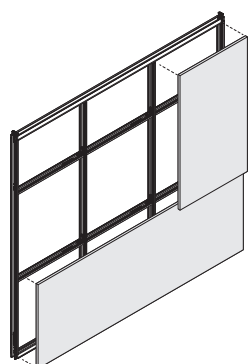

Skins can be oriented horizontally or vertically on the wall.

Solid skins include brackets for mounting to the structural frame.

Skin brackets are positioned for mounting specifically in top, bottom, or intermediate positions.

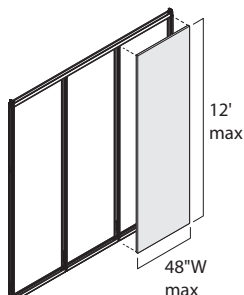
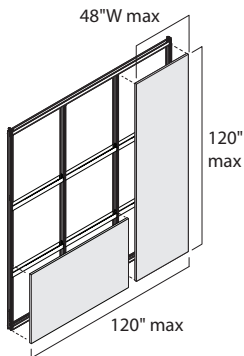

Steel portrait oriented skins can be specified in ceiling heights from 6'-8" to 12'-0". Maximum skin planning width is 60"W up to 10'-0" ceiling height and 48"W up to 12'-0" ceiling height.

Laminate portrait oriented skins can be specified in ceiling heights from 6'-8" to 10'-0". Maximum skin planning width is 60"W.

When orienting skins horizontally, the minimum dimension is 6"H x 15"W. The maximum dimension is 60"H x 120"W.

When orienting steel skins vertically, the minimum dimension is 6"W x 15"H, and the maximum dimension is 48"W x 144"H. (Skins that are 120"H or less can be 60"W maximum).

When the width or height of the skin exceeds 60", the fabric warp direction will run parallel to the long dimension.

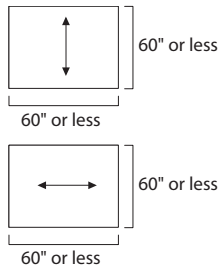

When the skin size is 60" or less in width and height, the fabric warp direction can be specified to run vertically or horizontally.

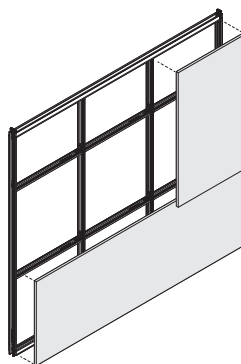

Skins can span across posts and intermediate horizontals.

Height can be specified from 6"-141.71654" to accommodate different ceiling heights. See how the height parameters vary by skin type below.
► See *V.I.A. Planning Dimensions*, Page 103.

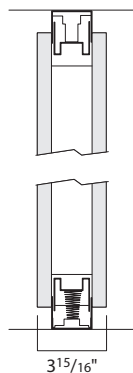

The overall wall thickness is 3¹⁵/₁₆".

Steel Skins

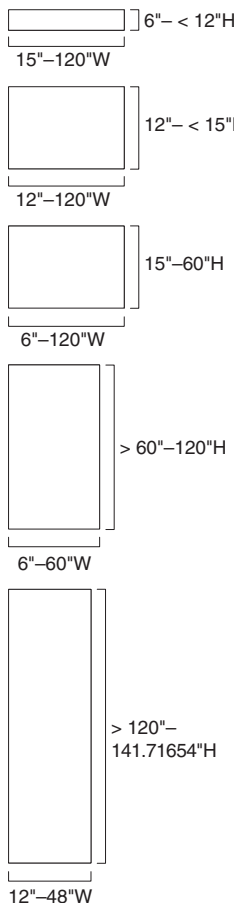

Steel skins height range:

- If 6" to less than 12"H, then 15" to 120"W
- If 12" to less than 15"H, then 12" to 120"W
- If 15" to 60"H, then 6" to 120"W
- If greater than 60" to 120"H, then 6" to 60"W
- If greater than 120" to 141.71654"H, then 12" to 48"W

Width range is 6" to 120"W, depending on height rules above.

Minimum skin size is 6"W x 15"H or 15"W x 6"H. One dimension must equal 15".

The minimum height of a skin in the top position of a wall is 12".

The minimum height of a skin in the bottom position of a wall is 15".

Maximum number of electrical cut-outs, in steel and laminate skins, is nine (if skin is large enough).

Veneer and Laminate Skins

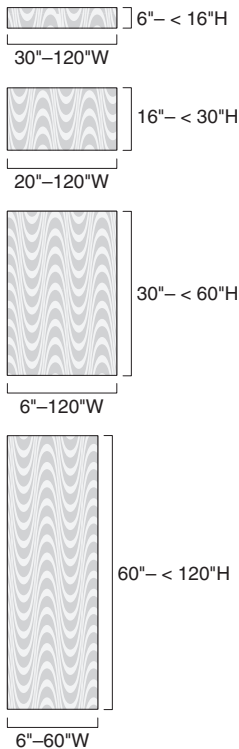

Veneer and laminate skins height range:

- If 6" to less than 16"H, then 30" to 120"W
- If 16" to less than 30"H, then 20" to 120"W
- If 30" to less than 60"H, then 6" to 120"W
- If 60" to less than 120"H, then 6" to 60"W

Width range is 6" to 120"W, depending on height rules above.

Minimum skin size is 6"W x 30"H or 30"W x 6"H.

Minimum skin dimension for laminate HPL skins is 8". The minimum dimensions for laminate LPL skins is 6".

If mounting in the bottom position, then the veneer skin must be at least 15"H.

Maximum number of cut-outs is nine (if skin is large enough).

When the width or height of a veneer or wood grain plastic laminate skin exceeds 60", the grain pattern will run parallel to the long dimension.

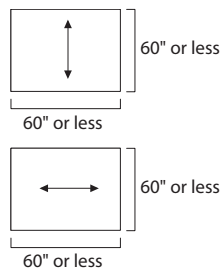

When the skin size is 60" or less in width and height, the grain pattern can be specified to run vertically or horizontally.

To help minimize the potential visual differences in grain pattern when applying veneer skins, Steelcase uses a randomly matched veneer configuration known as pleasing match.

▶ See *Pleasing Match—Veneer*, page 226

High-Pressure Laminate skins are not available for use in Canada.

Ceramic Skins

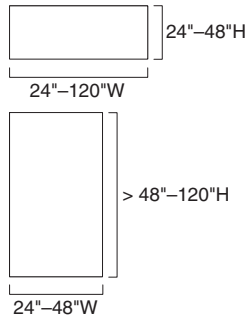

Ceramic skins height range:

- If 24" to 48"H, then 24" to 120"W
- If greater than 48" to 120"H, then 24" to 48"W

Width range is 24" to 120"W, depending on height rules above.

Ceramic skins can be mounted in top, bottom, and intermediate positions. There are no restrictions with the opposite side of the wall when using a ceramic skin.

V.I.A. ceramic skins incorporate the e³ environmental CeramicSteel surface.

Ceramic skins do not accommodate electrical cutouts.

Healthcare Settings

In applications that require flush vertical surfaces to support infection prevention and improved cleanliness, supplemental trims can be specified at skins and base trim.

High-Pressure Laminate skins or painted steel skins are recommended for use in healthcare settings. Low-Pressure Laminates are not ideal for these high impact locations.

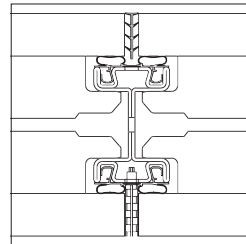

Flush skin seal

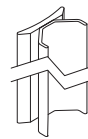

Flush skin seals are available in a translucent finish.

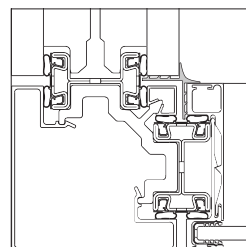

90° inside corner flush skin seal

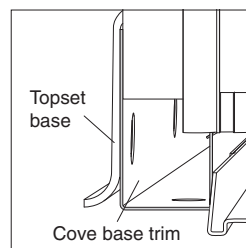

Cove base trim

In applications that require flush vertical surfaces to support infection prevention and improved cleanliness, supplemental trims can be specified at skins and base trim.

Flush skin seals are inserted into the reveals between skins as part of the installation process. They are provided in 120" lengths, and cut to size by the installer. Two seals can be joined together for use when ceiling heights exceed 122".

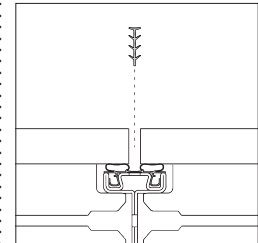

Where vertical reveals run from top to bottom of wall, vertical seals are intended to be continuous, while the seals at the horizontal reveals are installed between the vertical seals.

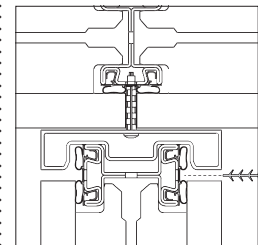

Flush skin seals are positioned at inside corner reveals with 90°, 120°, and 135° junctions. They cannot be used at T adapters or variable angle junctions.

Flush skin seals are pressure fit, and can be easily removed for access to wall cavity.

Flush skin seals are intended for use with paint, laminate, and ceramic skins. They are also inserted between skins and junction covers, or mini-ends and door frames. If desired, flush seals can also be used at fabric skins and captured glass frames.

When used with hang-on components, flush skin seals will be field notched to allow clearance for mounting brackets.

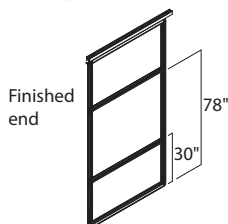
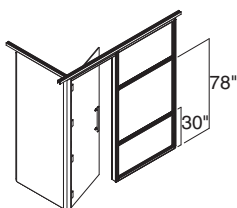

When flush seals are installed in skins adjacent to reversible door frames or finished ends, at least one intermediate horizontal should be positioned in the wall between 30" and 78" (on lock side of door frame).

Additional base trim components can be specified for use with surface applied cove base. These additional V.I.A. base components are not the finished base material, but serve as surface to receive the adhesive for installation of the topset base material, as manufactured by commercial wall base suppliers. The same base trim components can also be used with applied cove flooring applications.

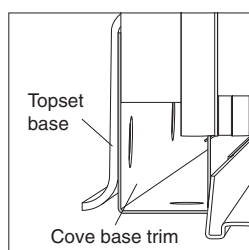

Cove base trims are provided in straight lengths, and cut to size by the installer. *Tip: When using surface applied base, skins are not removed and accessed as easily.*

Tip: When using cove base, the bottom portion of the wall must be a solid skin.

Tip: Topset base is glued to cove base trim. It is not glued to skin.

Seals are not to be used beside any variable angle outside covers or other fixed angle outer covers (120° and 135°). Clips are not required for the 180° outside cover.

When vertical flush skin seals are present on 90° outer corners, add junction retention clips to prevent outer junction covers from coming loose.

Three junction retention clips should be used for ceiling heights of 120" or less, and four clips for ceiling heights greater than 120". Seals are not reusable.

Back-Painted Glass Frames

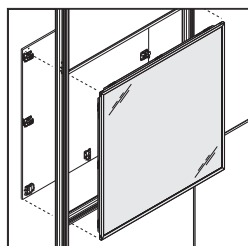

Back-painted glass frames are fully opaque, and allow the user to apply them like solid skins rather than glass.

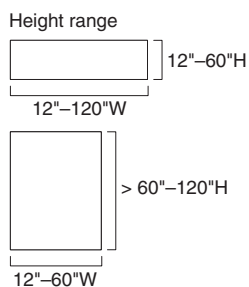

Back-painted glass height range:

- If 12" to 60"H, then 12" to 120"W.
- If greater than 60" to 120"H, then 12" to 60"W.

Width range is 12" to 120"W, depending on height rules above.

Minimum skin size is 12"W x 12"H.

Back-painted glass is referred to as side D in all documentation.

Back-painted glass frames are configured to allow placement of solid skins on the opposite face of the wall.

Back-painted glass frames can mount in top, bottom, and intermediate positions.

Restrictions:

- Must have a skin, other than glass on opposite side of wall.
- Can be back-to-back with slatwall, if both skins are the same size.
- Cannot be back-to-back with monitor skins.
- Back-painted glass frames cannot span posts or horizontals.
- Cannot route power harnesses or infeeds vertically or horizontally behind double back-painted glass frames.

Acoustic Performance

The STC performance can be improved by adding insulation to the wall cavity between the skins, and by adding supplemental acoustic seals to the skins along the top and bottom structural horizontal.

▶ See *Acoustic Planning Considerations*, page 110

Insulation is provided in rolls that are 48"W x 174 feet long x 1" thick.

▶ See *Acoustic Planning Considerations*, page 96

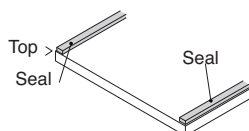

Skin acoustic seals are shipped in 120" lengths and cut to size during the installation process.

Wiring & Cabling

Solid skins can be specified with electrical cut-outs to accommodate modular power, communications, and hardwire devices.

Electrical cut-outs can also be cut on site during installation.

ADA and desk height are the most common placements for power and communication. However, cut-out locations are not pre-designated, and can be positioned along the face of the skin as required.

Receptacles in walls

can be specified in any combination of ADA, desk height, or other positions.

Hardwired switches and other electrical devices can also be located in the wall.

Electrical devices can be specified on either side or both sides of the wall. Components cannot be positioned back-to-back.

Surface Materials

Steel skins

- Fabric
- Paint

Tip: Metallic paint size restrictions = 36"W maximum width and 24 square feet.

Veneer skins

- Wood
- Customiz stain

Ceramic skins

- e³ environmental CeramicSteel

Laminate skins

- High-Pressure Laminate
- Low-Pressure Laminate
- Open Line laminate

Open Line Laminate (OLL)

This service allows you to order non-standard laminate at an additional processing fee, plus the cost of the laminate. When processing orders for Open Line laminate on V.I.A. skins, specify 2900 in the laminate finish field and enter the OLL manufacturer information. Enter the required edge finish as you would a standard laminate.

High-Pressure Laminate pricing does not include premium or digitally printed patterns from any suppliers. Laminate cost may also vary for basic or standard laminates from other suppliers. Please contact the OLL consultant at 616.475.2426 for pricing. The cost of the laminate will be added to your invoice as a separate line on the acknowledgement.

Laminate Approval and Material Requirements

To confirm whether a particular laminate has already been tested for use on a specific Steelcase product or to determine material square foot requirements visit www.steelcase.com or srh.steelcase.com.

For additional information, refer to the *Steelcase Surface Materials Reference Manual*.

OLLs are available for High-Pressure Laminate surfaces only.

If directional, the specifier must designate the application direction as part of the material setup process within SmartTools:

- No direction – material has no direction
- Vertical – material has direction and will be oriented vertically on the skin
- Horizontal – material has direction and will be oriented horizontally on the skin

Steelcase will confirm if the laminate is directional as part of the OLL approval process.

Planner must identify the maximum OLL sheet size as defined by the manufacturer, which will limit the maximum skin sizes that will receive these laminates.

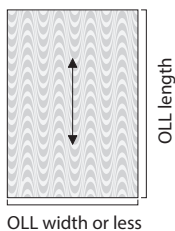
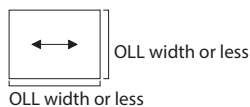
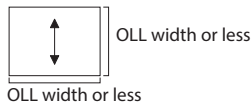

When both skin dimensions are less than the OLL sheet size width, the laminate direction can be specified as either horizontal or vertical. When one dimension is greater than the OLL sheet size width, the pattern will be oriented along the longer dimension.

Application Topics

V.I.A. Planning Dimensions
▶ See page 103

Electrical Components
▶ See page 78

Hang-On Components
▶ See page 94

Reversible Swing Doors

V.I.A. reversible swing door units offer superior acoustic control at door openings, and are available with options to accommodate specific functional requirements.

► Specifying, page 153

Doors and frames are available for either full height or transom height applications.

Door leaves accommodate latch sets or door pulls and are available in solid or polished edge glass.

Door frame and door are factory prepared for reversible hinges. Hinges are included as part of the door frame assembly.

Structural framing elements are ordered separately.

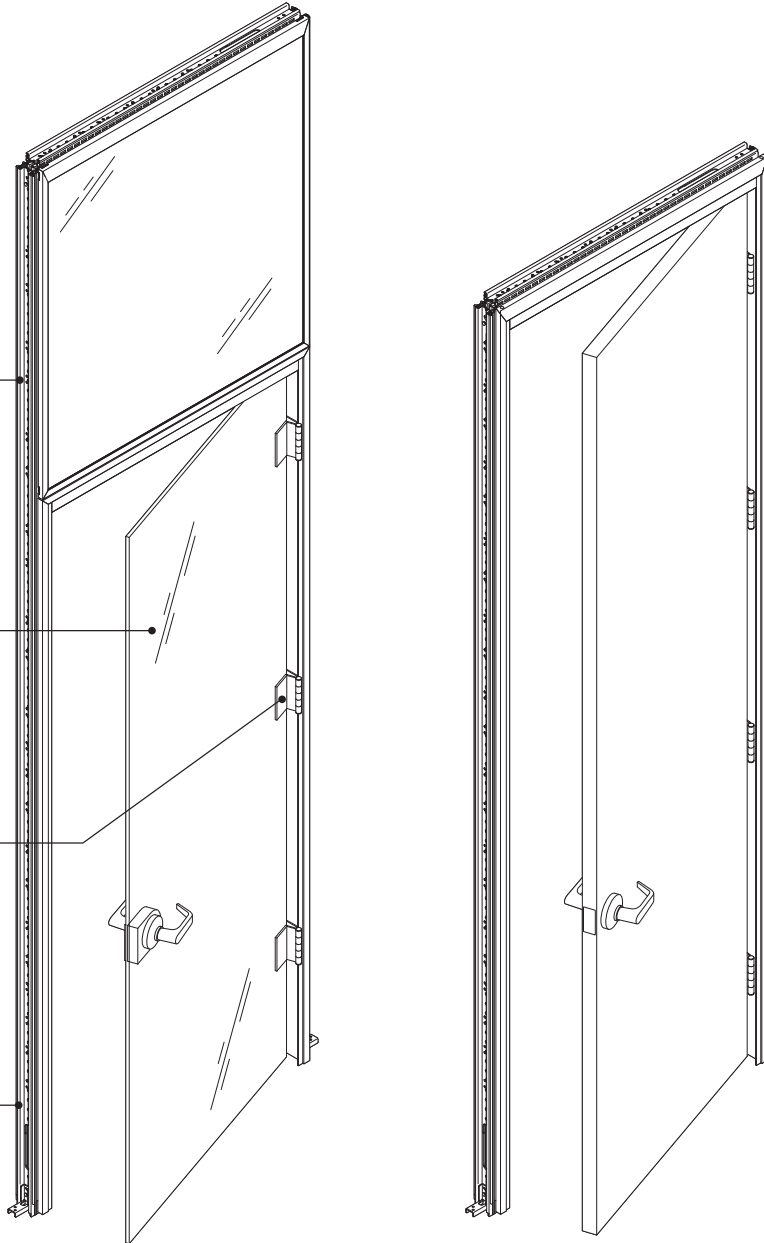

Product Details

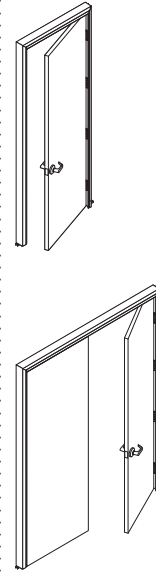

Single and pair versions of doors and door frames are available.

► See *V.I.A. Planning Dimensions*, page 103, for important information regarding dimensional references for all V.I.A. components.

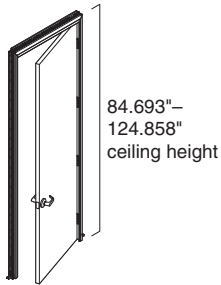

Full height

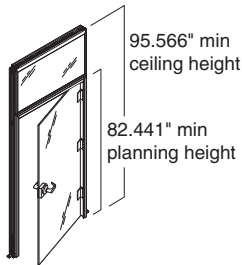

Transom height minimum

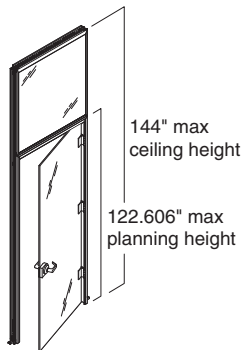

Transom height maximum

Door frames are available in full height and transom height configurations, and are parametric.

Height range:

- Full height = 84.693" to 124.858" ceiling height.
- Transom height range = 82.441" min to 122.606" max planning height.

Tip: Use transom height door units when ceiling height exceeds 124".

Tip: The minimum designated heights will deliver a clear opening height of 80", which is a minimum requirement by code in most areas.

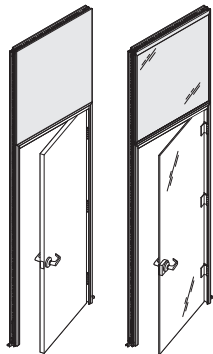

Transom height door frames can be combined with glass frames or solid skins.

Door swing orientation can be altered during the installation process.

Tip: Some door frame components are handed during the factory assembly process to simplify packaging and handling. These can be changed during the installation process. Door frame handing is specified when ordered to align with initial installation.

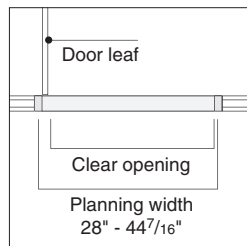

Single door frame

width is parametric, and can vary from 28" to 44⁷/₁₆" planning width. Planning width is measured as centerline of post to centerline of post. Steelcase recommends using a 40" wide door frame to maximize accessibility, maintain visual continuity, and simplify the planning process during reconfigurations. Clear opening dimension equals planning width minus 5⁵/₈".

Polished edge doors are 1/2" thick.

Solid doors are 1³/₄" thick.

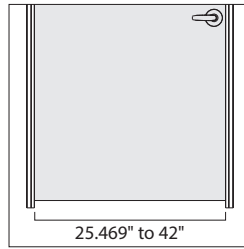

The single door leaf width is also parametric, and can vary from 25.469" to 42".

Single solid door width = planning width minus 2.445".

Single polished glass door width = planning width minus 2.531".

Tip: The minimum door width is not ADA compliant, but may be desired for storage or closet applications.

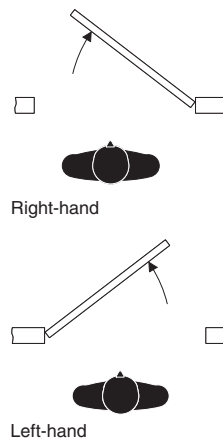

To determine door swing orientation: facing the door, so that the door swings away from you, the side that the hinges are on defines the handing of the door.

Hardware locations for polished edge doors are parametric, and can be changed through the Alternate Pull Manager in SmartTools as part of the design/planning process.

▶ See *SmartTools*, page 4

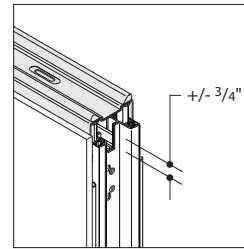

Ceiling track allows 1/2" of vertical adjustment (plus/minus 3/4"), to accommodate ceiling variation.

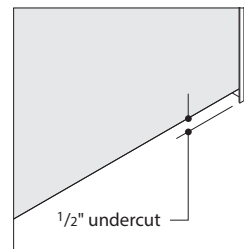

The door frame assembly is designed to allow for 1 1/2" of adjustment at the floor (plus/minus 3/4"), while maintaining a consistent 1/2" undercut between the bottom of the door and the floor. This adjustment comes from the slip fit assembly at the top of the door frame.

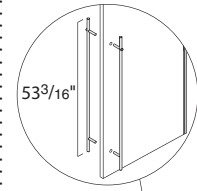
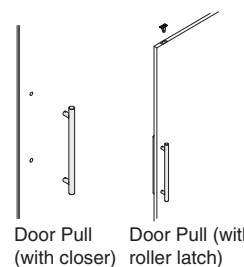
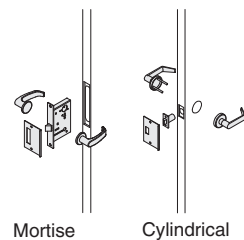

Aligned Pull

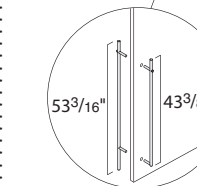
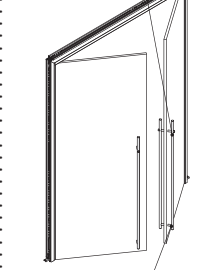

Offset Pull

Doors and frames can be provided with mortise or cylindrical latch sets (either passage or locking) or door pull.

Tip: When using mortise latch sets, once a wood door or a glass door lock housing has been face drilled, it will not be reversible.

Latch sets can be either mortise or cylindrical types. *Tip: Doors that are specified with hardware prep for mortise locks will not have faces drilled for levers or cylinders, etc. All necessary holes in the face of the door must be drilled by the installer.*

Mortise:

- Random key with standard cylinder
- No cylinder (to allow customer to provide cylinders to specific keying requirements)

Cylindrical:

- Random key with standard core
- No core (to allow customer to provide cores to specific keying requirements)

For customers who require specific keying configurations and/or master key coordination, it is recommended to order V.I.A. locks without cylinders or cores. This will allow the customer to manage their keying requirements locally by securing cylinders or cores through their preferred security hardware provider.

The cylindrical lockset for reversible doors can be specified in one of two ways:

1. With a random keyed, standard core (non-removable)
2. Without a core, configured for a small format interchangeable core (SFIC)

V.I.A. cylindrical locksets are compatible with six or seven pin cores (SFIC) as manufactured for Sargent, Best, or Schlage.

The mortise lockset for reversible doors can be specified in one of two ways:

1. With a random keyed lock cylinder
2. Without a cylinder

When ordering cylinders from other suppliers for use with the V.I.A. mortise locks, cylinders must be specified with a cam configuration that is compatible with a Sargent 8200 series lockset.

Locking ladder pulls are equipped with a random keyed, small format interchangeable core. For customers with specific keying requirements, the core can be removed and replaced with customer's locally secured cores.

Locking ladder pulls can accommodate SFIC cores (6 pin) as manufactured by Sargent, Schlage, Best, Medeco, Arrow, Yale, and Falcon.

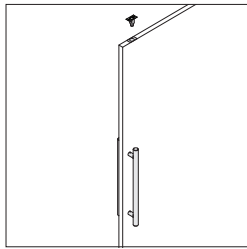

When specifying a door with push/pull handle or ladder pull, either a roller latch or closer must be selected.

Using the following types of hardware will limit the reversible nature of the door opening, as the required hardware preparation will hand the door and/or frame:

- Mortise lock*
- Roller latch
- Closer

*A mortise lock will hand a solid door and the lock body for a polished glass door. The polished glass door leaf itself will not be handed.

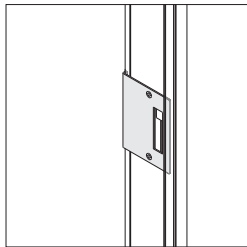

When specifying single door frames for use with mortise locks, the strike plate can be specified in either of two configurations. Strike plate type 1 is compatible with the standard V.I.A. lock, as well as Sargent, Corbin, Russwin, and Yale locks. Strike plate type 2 is compatible with mortise locks manufactured by Schlage and Lawrence.

Tip: If using mortise locks by other manufacturers, check with the specials team for strike plate compatibility.

Tip: Doors that are specified with hardware prep for mortise locks will not have faces drilled for levers, cylinders, etc. All necessary holes in the face of the door must be drilled by the installer.

Tip: Reversible door frames are not compatible with deadbolt locks.

Tip: Strike plates for latch sets and roller latches are part of the door frame assembly.

Hinges ship as part of the door frame. Doors that are 90"H or less will be equipped with three hinges. Doors that are greater than 90"H will be equipped with four.

When an electric hinge is required at a door opening, one less hinge will be provided with the door frame.

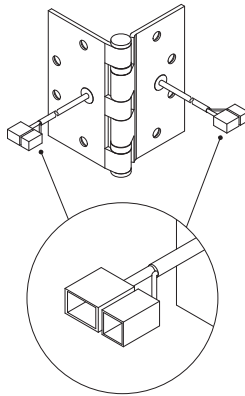

Electric hinge is equipped with 8-pin and 4-pin modular Molex connectors for connection to electric lock.

The electric hinge includes a 48" lead for connection to electric lock, and a separate 132" long lead for connection to building source.

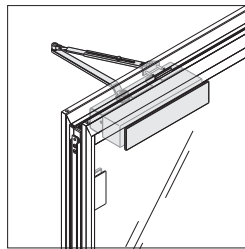

Door closers are available for use on solid and glass doors when the door must close automatically for safety and security reasons.

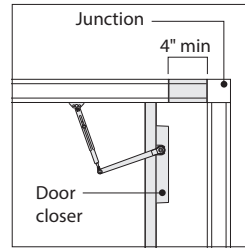

When mounting a closer on a door, and positioning the door at an inside corner, the door frame must be spaced at least 4" away from the adjacent surface.

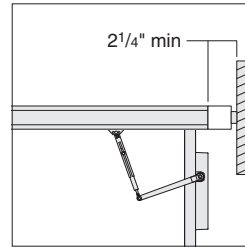

When mounting a closer on a door and positioning the door at a mini-end, the door frame must be spaced at least 2 1/4" away from the adjacent surface.

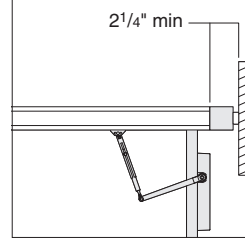

When mounting a closer on a door and positioning the door at a mini-end, the door frame must be spaced at least 2 1/4" away from the adjacent surface.

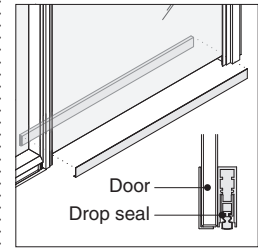

To enhance acoustical performance, an optional drop seal can be specified in the bottom of the door. The drop seal automatically deploys to block the gap under the door when the door is closed and retracts when the door is open.

Tip: Drop seals in a pair of doors application utilize a different style number than single doors.

Tip: Polished glass doors with drop seals are compliant with ADA and California Title 24 guidelines.

Tip: Dome stops and base stops are not recommended when using polished glass doors with drop seals.

Veneer doors use a pleasing match veneer layout technique, similar to veneer skins.
 ▶ See *Pleasing Match—Veneer*, page 226

Reversible pairs of doors can be specified for spaces that require wider door openings for egress, or to provide greater access for storage.



Two Active

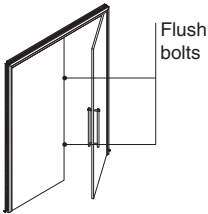

Active/Inactive **Pairs of doors** can be configured as two active doors or as one active with one inactive door (active/inactive).

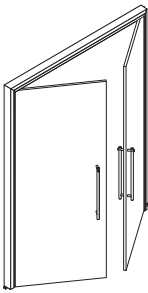

Two Active

Two active doors can be specified for door openings that require frequent use and higher volume of traffic. Active/inactive pairs can be specified for door openings that occasionally require a wider clearance dimension for larger furnishings or equipment. The inactive door is fixed in place by flush bolts and unlatched as needed. While the inactive door is latched in place, the active door will function as a typical single door.

Door and door frame appearance for pairs of doors match the single reversible door assemblies. Inactive doors and frames for inactive doors are not reversible.

Both doors in a pair must be the same material.

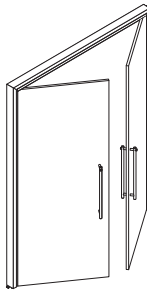

Two Active

When configured as two active doors: Both doors are the same size. Doors can be equipped with either a push/pull handle or a ladder pull. Doors can be equipped with an optional drop seal. Doors can be equipped with an optional vertical seal between doors. Doors must be equipped with either closers or roller latches to retain doors in the closed position. The only available locking hardware option is locking ladder pulls. Mortise and cylindrical latchsets are not available on two active door configurations. Polished edge doors are available only as two active pairs.

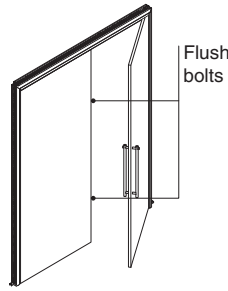

Active/Inactive

When configured as one active and one inactive: Only solid doors are available only as active/inactive. The active door can be a different width than the inactive door. The inactive door leaf is equipped with flush bolts to fix the door in place. The active door can be equipped with either a mortise latch set or ladder pull (locking or non-locking). There is no push/pull or latch handle on the inactive door. Doors include an astragal and seal to be mounted on the inactive leaf. Solid doors can be configured for an electric strike in the inactive leaf or an electric lock in the active leaf. Integral drop seals are not available. Surface mounted drop seals can be provided locally. *Tip: When electric strike is specified, the inactive door leaf is prepared for an HES 1006 electric strike.*

Tip: When configured as one active and one inactive, doors are not reversible.

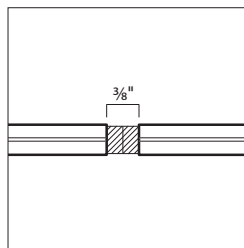

Pairs of polished glass doors include seals.

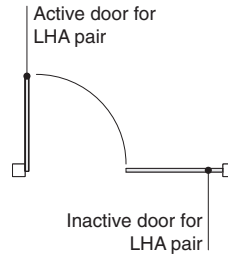

Active door for LHA pair
Inactive door for LHA pair

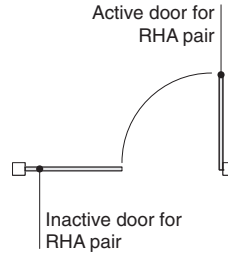

The handing of an active/inactive pair of doors is determined by the door swing orientation of the active door. *Tip: Active/active pairs are not handed.*

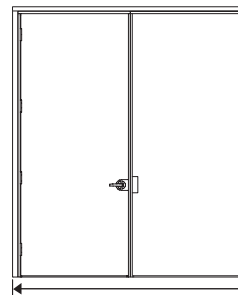

Door frame planning width 48"-80"

Door frame width is parametric, and can vary from 48" to 80" planning width. Planning width is measured as centerline of post to centerline of post. Steelcase recommends using a 80" wide door frame to maximize accessibility, maintain visual continuity, and simplify the planning process during reconfigurations.

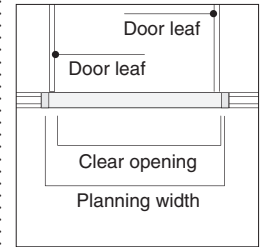

Clear opening dimension equals planning width minus 9".

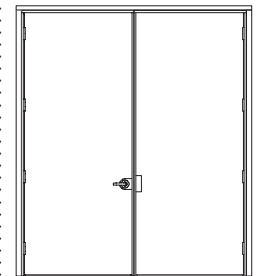

Active door planning width 22 1/2"-42"
Inactive door planning width 8"-37 1/2"

The door leaf widths are also parametric, and can vary in width depending on active versus inactive configurations.

An active door width can vary from 22 1/2" to 42" planning width. When both doors are active, the maximum planning width is 40". An inactive door width can vary from 8" to 37 1/2".

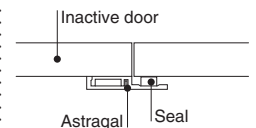

Active/inactive pairs of doors include an astragal with seal. The astragal is finished to match the door frame.

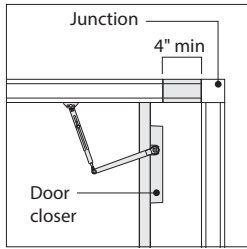

When mounting a closer on a door, and positioning the door at an inside corner, the door frame must be spaced at least 4" away from the adjacent surface.

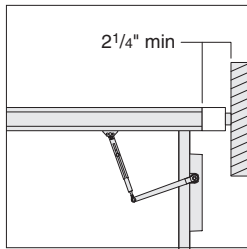

When mounting a closer on a door and positioning the door at a mini-end, the door frame must be spaced at least 2 1/4" away from the adjacent surface.

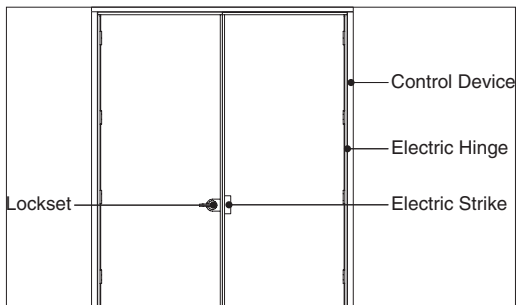
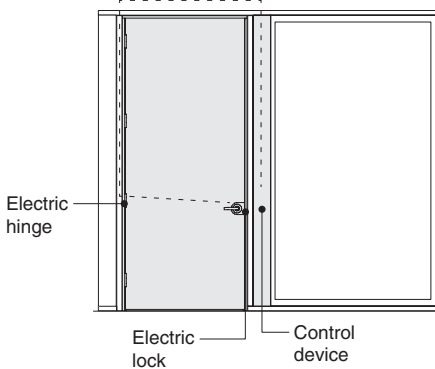

When door openings require an electronic security feature, solid doors can be equipped with an electric hinge. The electric hinge includes wire conductors that link an electric lock to the control device (card reader or keypad). When specified, the solid door is constructed with an internal wireway to manage the wires from the hinge to the electric lock or electric strike. Wires are routed from the hinge to the control device through the vertical door jamb as part of the installation process. The wire conductors are 28 gauge and are suitable for low voltage current only (24 volt maximum). The lengths of the wires is 48" long (through the door) and 120" long (through the door jamb). The electric lock and the control device are not provided by Steelcase.

Door openings that require electronic security are typically equipped with closers in order to help maintain a secure opening. When mounting a closer on a door and positioning the door at an inside corner or mini end, the door frame must be spaced at least 4" away from the adjacent surface.

Utility panels can be positioned adjacent to door frames to act as a mounting point for the control device. Electric hinges cannot be used with polished glass doors.

Door stops can be ordered for use with doors. *Tip: Dome stops and base stops are not recommended when using polished glass doors with drop seals.*

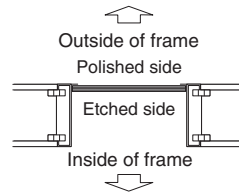

Door in closed position

Polished to Outside

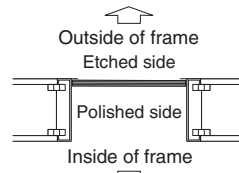

Door in closed position

Polished to Inside

When specifying doors with etched glass, the etched surface can be oriented to either side of the wall, regardless of handing or on which side of the wall the door is mounted.

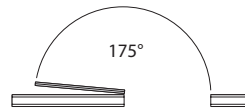

A reversible door can swing open to a maximum of 175°.

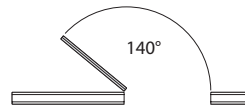

When equipped with a closer, a reversible door can swing open to a maximum of 140°.

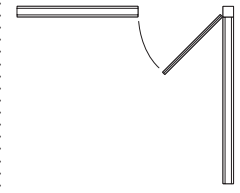

Hinge jamb at two-way 90° junction
Acceptable

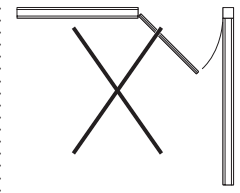

Strike jamb at two-way 90° junction
Swing to inside of junction
Not Acceptable

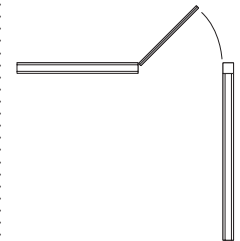

Strike jamb at two-way 90° junction
Swing to outside of junction
Acceptable

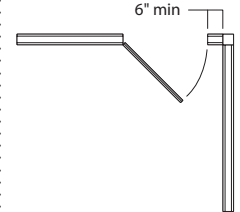

Strike jamb at two-way 90° junction
Minimum 6" from junction
Acceptable

When positioning a door frame with the strike jamb at a two-way 90° junction, the door placement and relative door swing must follow the above guidelines.

Connections

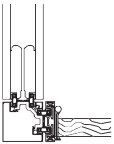

Two-Way 90°

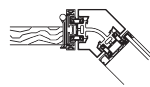

Two-Way 135°

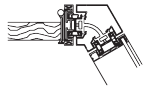

Two-Way 120°

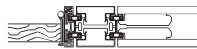

Two-Way 180°

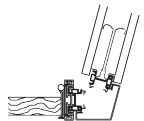

Two-Way variable
91° - 94°

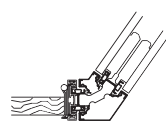

Two-Way variable
95° and greater

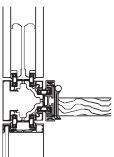

Three-Way 90°

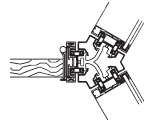

Three-Way 120°

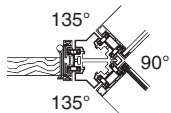

Three-Way 135°

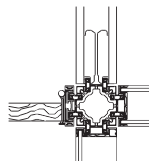

Four-Way

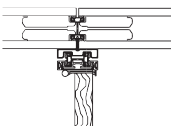

Adapter T on module

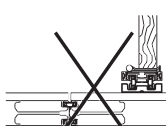

Adapter T off module

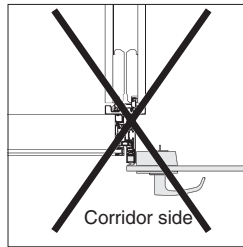

Door frames cannot be positioned adjacent to a T adapter as shown.

Junctions join a door frame to a V.I.A. wall in an L-, T-, X-, V-, or Y-configuration.

Adapters (on module) connect a door frame to a V.I.A. wall in a T- or X-configuration.

Door frames cannot be positioned adjacent to an off-module adapter.

Mini ends connect a door frame to perpendicular building wall.

▶ See page 198

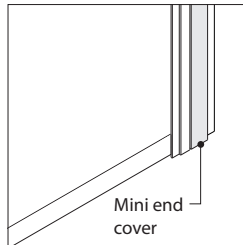

When positioned next to a door frame, the mini end cover will be specified with the to floor option and will be field cut by the installer to final length.

Tip: When door frames are placed adjacent to mini ends, additional mini end connection hardware is specified.

Plinths can be ordered at the bottom of the door jamb when repositioning door frames during wall reconfigurations.

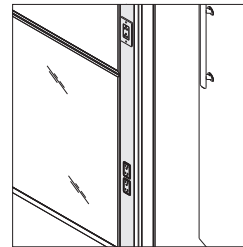

Utility panels can be positioned next to a door frame to accommodate lighting control devices, thermostats, and other technology devices.

▶ See page 81

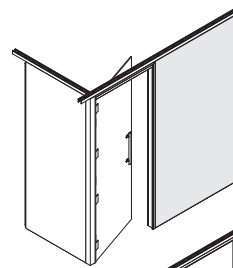

Intermediate horizontal

When a solid, portrait oriented skin is positioned directly adjacent to the latch side of a single door frame, an intermediate horizontal must be installed behind the skin for added stability. This is not required when there is a junction, utility panel, or glass frame directly adjacent to the door frame.

Surface Materials

Door frame

- 8043 Clear Anodized Aluminum
- Paint

Solid door leaf

- Paint
- Wood veneer

Polished glass door

- Glass

Latch set

- 9200 Satin Chrome
- 9201 Polished Chrome

Hinges

- 4710 Low Gloss Black
- 8031 Brushed Stainless
- 9201 Polished Chrome

Door pull (Push/pull handle)

- 4710 Low Gloss Black
- 8031 Satin Stainless

Door closer

- 4710 Low Gloss Black
- 4799 Platinum

Roller latch

- 8031 Brushed Stainless

Tip: Finishes for door hardware can vary slightly from one component to another depending on base metal materiality and finishing processes. When hardware is specified for common assemblies, all hardware components may not match exactly, but are designed to be compatible within a common door opening.

Slider Doors

V.I.A. slider door assemblies offer security and space savings at door openings, and are available with options to accommodate specific functional and aesthetic requirements.

V.I.A. slider doors include door frame, slider track, slider door, and hardware.
► Specifying, page 171

Sliders can be positioned adjacent to any type or configuration of wall module, either vertical or landscape, solid or glass.

Doors and track can be positioned on either face of the wall.

Door frames are available in either full or transom heights.

Slider door and frame can accommodate a pull or lockset.

Basic slider track is used when spanning an adjacent module that is 60"W or less.

Reinforced slider track is used when spanning an adjacent module that is greater than 60"W.

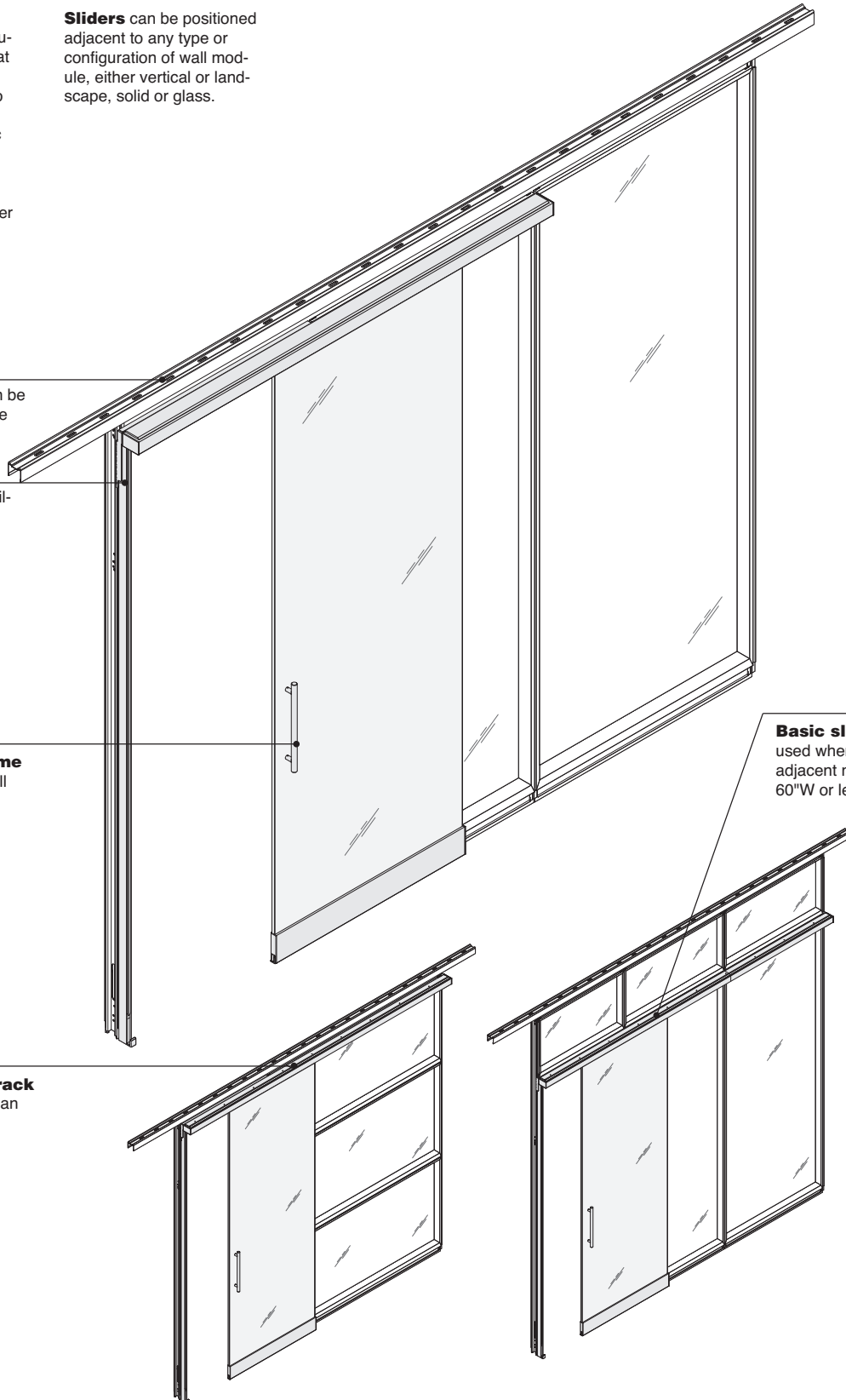

Product Details

► See *V.I.A. Planning Dimensions*, page 103, for important information regarding dimensional references for all V.I.A. components.

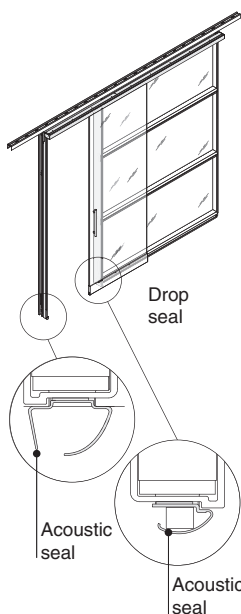

Slider doors are available with static and drop seals to make doorways as acoustically effective as possible.

Door frame seals are platinum in color. Drop seals are housed within the door bottom trim and are not visible.

Frames are available in full height and transom height configurations, and are parametric.

Heights range:

- Full height = 83.188" minimum to 122" maximum ceiling height.
- Transom height range = 80.984" minimum to 120" maximum planning height.

Tip: Must use transom height door units when ceiling height exceeds 122".

Tip: The minimum designated heights will deliver a clear opening height of 80", which is a minimum requirement by code in most areas.

Ceiling track allows 1½" of vertical adjustment (plus/minus ¾"), to accommodate ceiling variation.

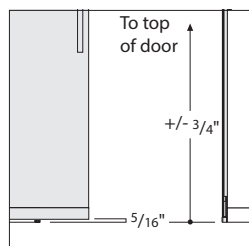

The door frame assembly is designed to allow for 1½" of adjustment at the floor (plus/minus ¾"), while maintaining a consistent 5/16" undercut between the bottom of the door and the floor.

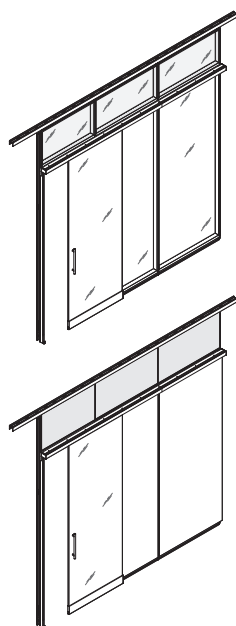

Transom height door frames can be combined with glass frames or solid skins.

Doors can be oriented to either face of the wall to position the door on either the interior or exterior of a room.

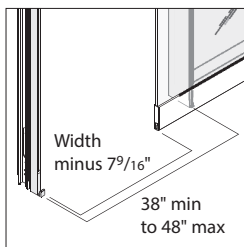

Single door frame width is parametric, and can vary from 38" to 48" planning width. Steelcase recommends using a 40" wide door frame to maximize accessibility, maintain visual continuity, and simplify the planning process during reconfigurations. Clear opening width equals the planning width minus 7 9/16". *Tip: Door frames that are less than 39 7/16" planning width will not meet ADA guidelines for minimum clear opening (32").*

The maximum door frame planning width will vary according to door height.

► See page 59

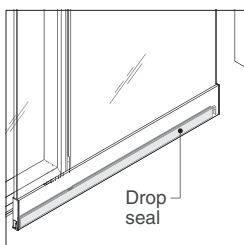

To enhance acoustical performance, an optional drop seal can be specified in the bottom of the door. The drop seal automatically deploys to block the gap under the door when the door is closed, and retracts when the door is open.

Hardware locations for polished edge doors are parametric, and can be changed through the Alternate Pull Manager in SmartTools as part of the design/planning process. ► See *SmartTools*, page 4

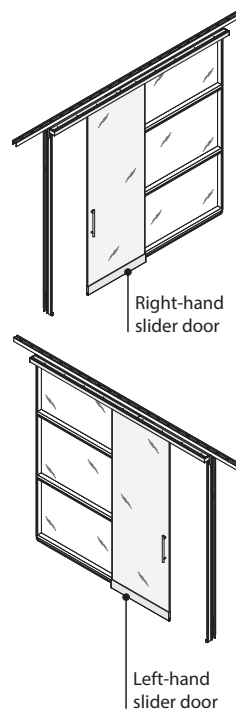

Door handing is determined by the direction in which the door travels when opening, as viewed from the face of the wall on which the door is mounted.

Certain etched or pattern glass types are polished on one face, and rough (etched or pattern) on the other. When defining the surface orientation of a glass frame, it is also important to consider the surface orientation of these types of glass. When planning with etched glass, the polished face of the glass is most often oriented to the corridor side of the wall to minimize the buildup of dirt on the etched face. Pattern glass is most often positioned with the patterned face oriented to the corridor, as the pattern face of the glass is considered the more attractive surface. Although these are the most common preferences for surface orientation, V.I.A. will allow for any relative position and orientation.

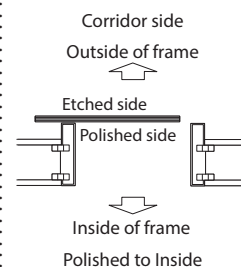
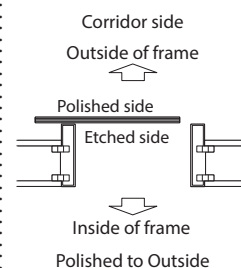
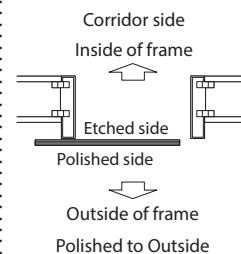
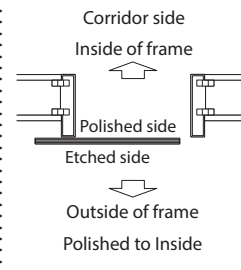

When specifying doors with etched glass, the etched surface can be oriented to either side of the wall, regardless of handing or on which side of the wall the door is mounted.

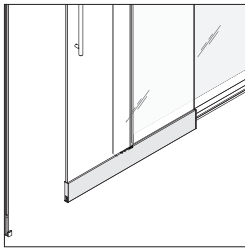

The polished edge door includes an adjustable aluminum bottom trim, which can be adjusted during installation to ensure a minimal and consistent clearance at the bottom of the door.

Slider track is parametric, and spans the door frame and the adjacent wall module(s).

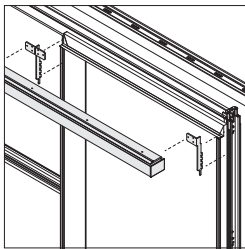

Slider track is mounted to structural posts using support brackets, which are specified in either a left, right, or T-configuration. The track is pre-drilled to fasten to the support brackets in the appropriate positions.

Slider track brackets are parametric in order to engage in post slots and set the slider track at the correct height.

Slider track brackets are painted, and can be specified to match adjacent door frames, glass frames, and skins.

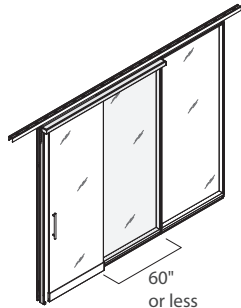

The basic slider track is used with vertically oriented wall modules, where planning widths do not exceed 60".

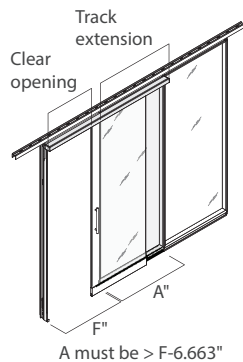

The modules adjacent to the single door frame on which the track is mounted must be at least as wide as the door frame minus 6.663" to allow for the door to travel the required distance to meet clear opening requirements.

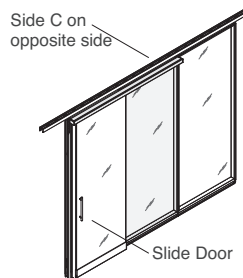

When planning with double glazed frames and slider doors, in order to simplify installation, it is recommended to position the side C frame on the opposite side of the wall from the door.

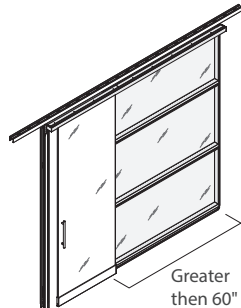

The reinforced slider track is used with landscape oriented wall modules, where planning widths are greater than 60".

▶ See V.I.A. Planning Dimensions, page 103

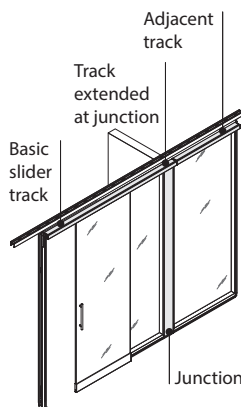

If visual continuity is desired along room exteriors, basic slider track width can be extended to span junctions, adapters, and mini ends. *Tip: When spanning a mini end, the track length allows for an additional 8", and is cut to the exact length by the installer.*

The posts at both ends of the slider track must extend to the ceiling track.

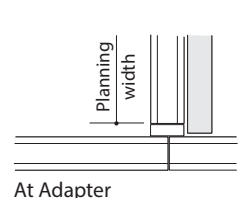
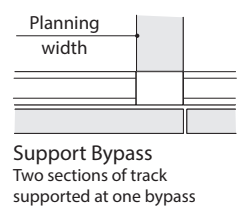
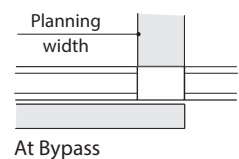
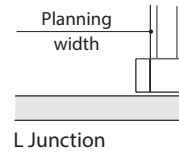
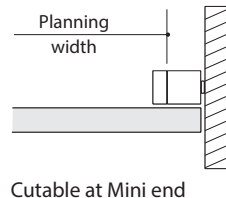
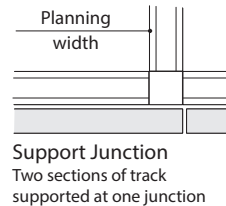
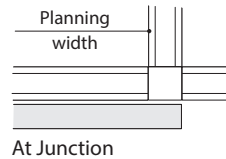
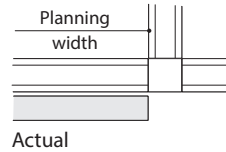

Slider track ends are cut to the correct length as dictated by the plan, with the appropriate hole position for track brackets.

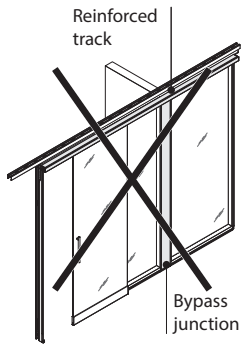

Reinforced track cannot extend over junctions and mini ends.

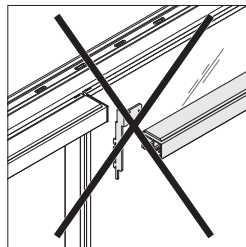

Reinforced track cannot butt to other sections of track.

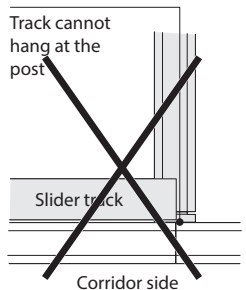

Track cannot hang at the post.

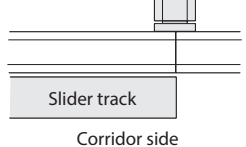

Corridor side

When planning with T-adapters, slider doors must be oriented to the corridor side of the wall.

The basic slider track can span multiple wall modules. A single section of track cannot exceed 144".

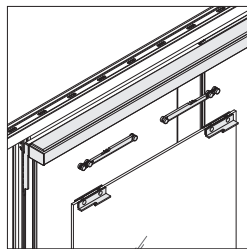

Basic slider track can be ordered with all required hardware, including carriers and soft-close braking mechanisms.

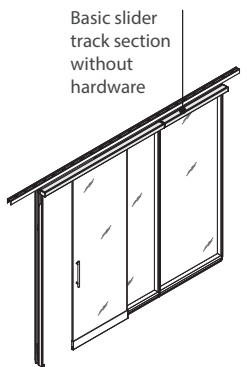

Sections of basic slider track can be specified without hardware and installed adjacent to other sections of track for visual continuity.

Adjacent sections of slider track must meet at a post.

When the end of a basic slider track is not directly adjacent to another section of the track, the end is notched to receive an end cap.

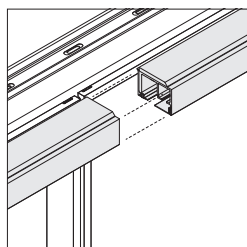

When the end of a basic slider track butts to another section of the track, the end is not notched.

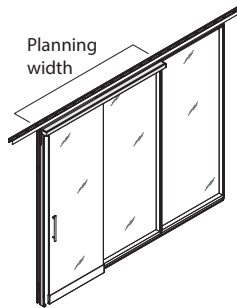

The slider track planning width is door frame width plus adjacent wall module(s).

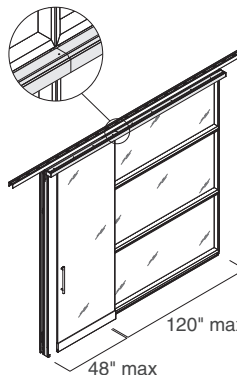

The reinforced slider track will be made up of two sections of track that will span a maximum door frame width of 48", and a maximum adjacent module of 120".

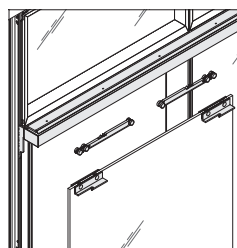

Reinforced slider track will always include the required hardware, including carriers and soft-close braking mechanisms.

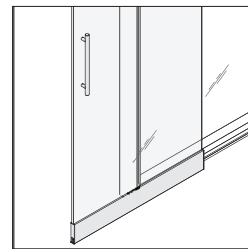

Non-locking doors are equipped with a tubular pull.

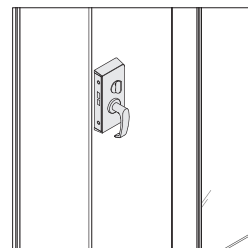

Lever locksets are available as an option on single doors, and are equipped with an ADA compliant single action lock feature, allowing for the door to be unlocked and opened in a single motion.

Locksets can be provided in one of two configurations:

- Random key with standard cylinder
- No cylinder (to allow customer to provide cylinders to specific keying requirements)

Lever locksets are provided with a standard lever handle. Locksets can be provided without handles to allow for an easy substitution of another style of lever.

Slider locksets are compatible with levers as manufactured by Schlage, Dorma, and Lawrence.

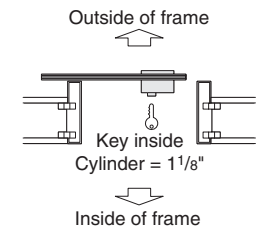
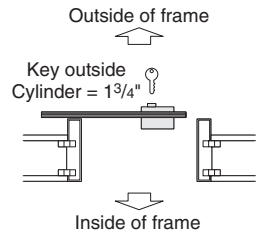

When ordering cylinders from other suppliers for use with the V.I.A. slider lever locksets, cylinders must be specified with a Schlage L cam configuration. When keyway and cylinder are oriented to the outside of the door frame, specify a 1 3/4" cylinder with a 7/16" trim ring. When keyway and cylinder are oriented to the inside of the door frame, specify a 1 1/8" cylinder with a 9/16" trim ring.

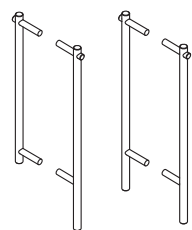

Locking ladder pulls are equipped with a random keyed, small format interchangeable core. For customers with specific keying requirements, the core can be removed and replaced with customer's locally secured cores.

Locking ladder pulls can accommodate SFIC cores (6 pin) as manufactured by Sargent, Schlage, Best, Medeco, Arrow, Yale, and Falcon.

Slider Doors, continued

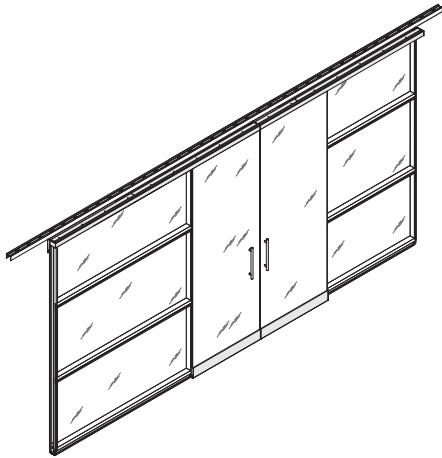

Biparting pairs of slider doors can be specified for spaces that require wider door openings for egress. Pairs of doors are available in full height and transom height configurations.

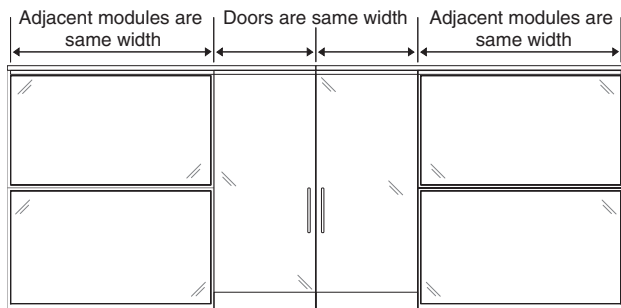

Biparting slider doors are symmetrical. Both doors are the same size, and both adjacent modules are the same size.

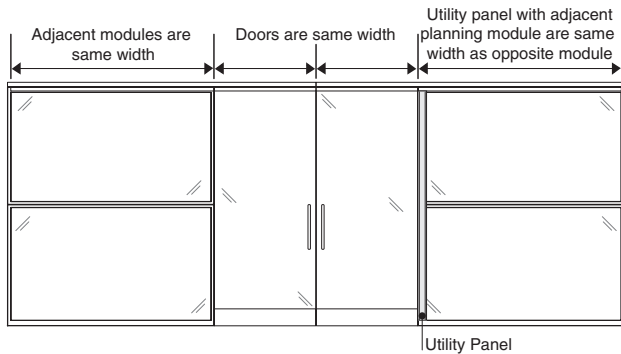

A utility panel can be positioned adjacent to a door frame for pair of doors. The combined width of the utility panel and its adjacent module must be the same as the opposite planning module.

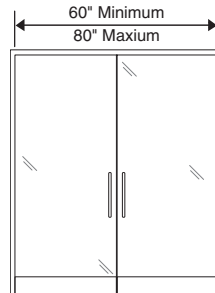

Door frame width is parametric, and can vary from 60" to 80" planning width. Planning width is measured as centerline of post to centerline of post.

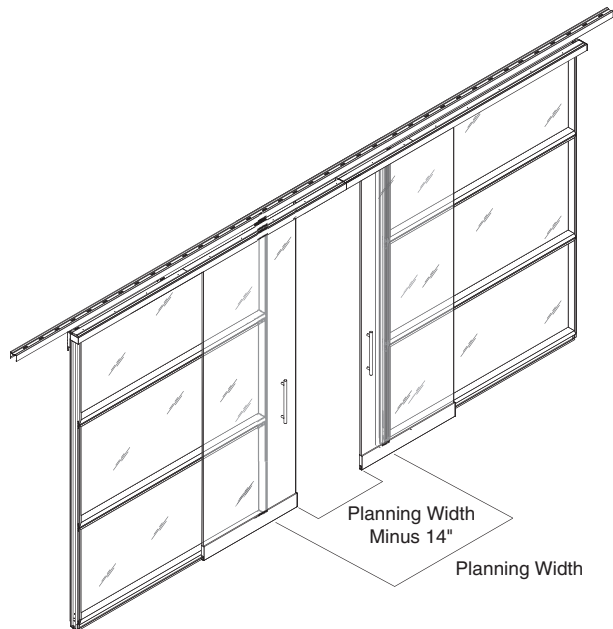

The clear opening dimension is planning width minus 14".

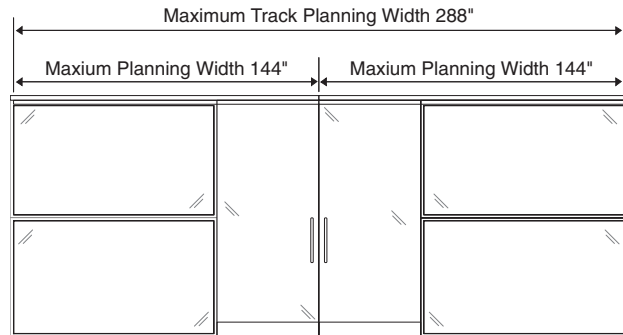

The maximum track length is 288", which is symmetrical to the center of the door frame. Both modules on either side of the door frame must be the same width.

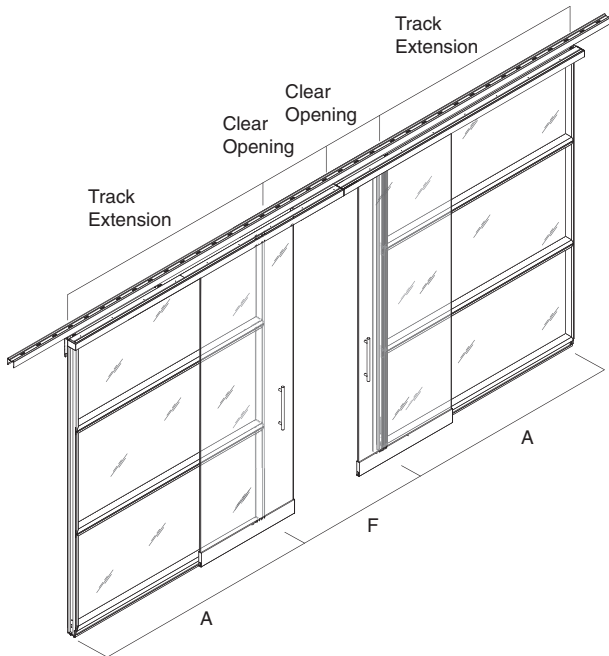

The modules adjacent to the door frame [A] on which the track is mounted must be a minimum width as calculated below:
 Minimum [A] Dimension = Door frame planning width $([F] \times \frac{1}{2}) - 6.5$.

The planning width for a pair of slider door track is the door frame width plus the adjacent modules. The track for a pair of doors is a reinforced track.
 Minimum [A] Dimension = Door frame planning width $([F] \times \frac{1}{2}) - 6.5$.

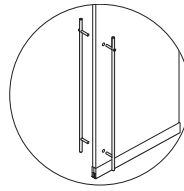

Aligned Pull

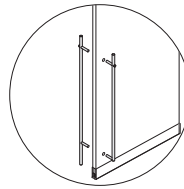
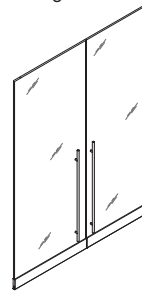

Offset Pull

Pairs of slider doors can be specified with push/pulls x 18", or ladder pulls (aligned or offset).

Pairs of slider doors cannot be equipped with drop seals.

Pairs of slider doors are non-handed.

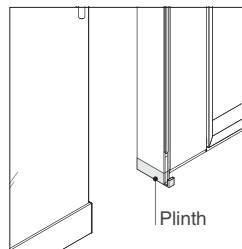

Plinths (ordered as a service part) can be used at the bottom of the door jamb to adapt to potential floor height changes when repositioning door frames during wall reconfigurations.

Connections

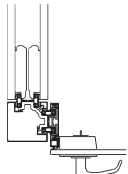

Two-Way 90°

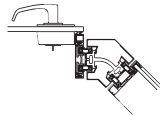

Two-Way 135°

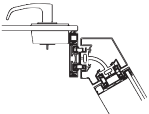

Two-Way 120°

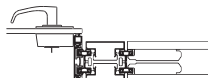

Two-Way 180°

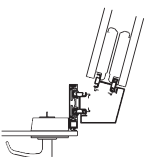

Two-Way variable
91° - 94°

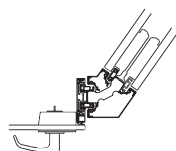

Two-Way variable
95° and greater

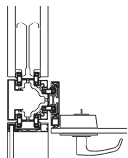

Three-Way 90°

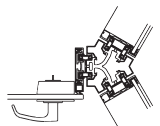

Three-Way 120°

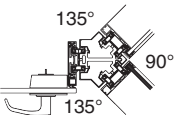

Three-Way 135°

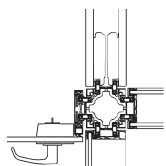

Four-Way

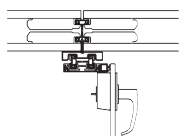

Adapter T on module

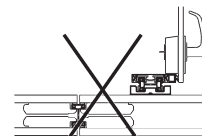

Adapter T off module

Junctions join a door frame to a V.I.A. wall in an L-, T-, X-, V-, or Y- configuration.

Adapters (on module) connect a door frame to a V.I.A. wall in a T- or X- configuration.

▶ See adapters, page 70

Door frames cannot be positioned adjacent to an off-module adapter.

Mini ends connect a door frame to perpendicular building wall.

▶ See page 74

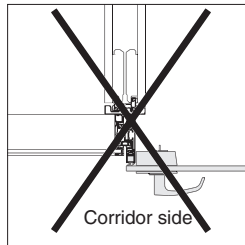

Door frames cannot be oriented at a T adapter as shown.

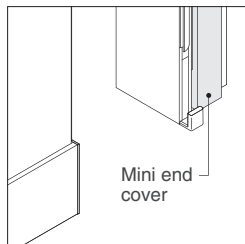

When positioned next to a door frame, the mini end cover will be specified to floor, and will be field cut by the installer to final length.

Utility panels can be positioned next to a door frame to accommodate lighting control devices, thermostats, and other technology devices.

▶ See page 81

In most municipalities, slider doors are not considered code compliant for use in rooms where planned occupancy is greater than ten people.

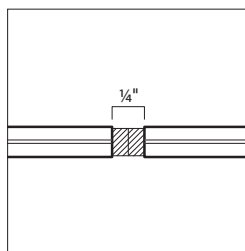

Brush seals are provided for slider door pairs.

Surface Materials

Door frame

- 8043 Clear Anodized Aluminum
- Paint

Polished glass door

- Tempered glass

Polished glass bottom trim

- 8043 Clear Anodized Aluminum
- Paint

Slider track

- 8043 Clear Anodized Aluminum
- Paint

Lockset

- 9200 Satin Chrome

Door pull

- 8031 Brushed Stainless

Slider track bracket

- Paint

Tip: Finishes for door hardware can vary slightly from one component to another depending on base metal materiality and finishing processes. When hardware is specified for common assemblies, all hardware components may not match exactly, but are designed to be compatible within a common door opening.

Maximum Door Planning Widths Based on Height

Maximum Door Planning Widths Based on Height

V.I.A.

Ceiling Height	Full Height Slider		Transom Height Slider	
	Planning Height	Maximum Planning Width	Planning Height	Maximum Planning Width
122"	N.A.	N.A.	120"	40"
121"	119.875"	40"	119"	42"
120"	118.875"	42"	118"	42"
119"	117.875"	42"	117"	42"
118"	116.875"	42"	116"	42"
117"	115.875"	42"	115"	42"
116"	114.875"	42"	114"	42"
115"	113.875"	42"	113"	42"
114"	112.875"	42"	112"	43"
113"	111.875"	42"	111"	43"
112"	110.875"	43"	110"	43"
111"	109.875"	43"	109"	44"
110"	108.875"	44"	108"	44"
109"	107.875"	44"	107"	45"
108"	106.875"	46"	106"	45"
107"	105.875"	46"	105"	46"
106"	104.875"	46"	104"	46"
105"	103.875"	46"	103"	46"
104"	102.875"	46"	102"	47"
103"	101.875"	47"	101"	47"
102"	100.875"	47"	100"	48"
101"	99.875"	48"	99"	48"
100"	98.875"	48"	98"	48"
99"	97.875"	48"	97"	48"
98"	96.875"	48"	96"	48"
97"	95.875"	48"	95"	48"
96"	94.875"	48"	94"	48"
95"	93.875"	48"	93"	48"
94"	92.875"	48"	92"	48"
93"	91.875"	48"	91"	48"
92"	90.875"	48"	90"	48"
91"	89.875"	48"	89"	48"
90"	88.875"	48"	88"	48"
89"	87.875"	48"	87"	48"
88"	86.875"	48"	86"	48"
87"	85.875"	48"	85"	48"
86"	84.875"	48"	84"	48"
85"	83.875"	48"	83"	48"
84"	82.875"	48"	82"	48"
83"	81.875"	48"	N.A.	N.A.

Basic Track Versus Reinforced Track

Slider Door Configurations - Advanced Planning

Basic track is an aluminum extrusion which can be used when the module adjacent to the door opening is less than or equal to 60".

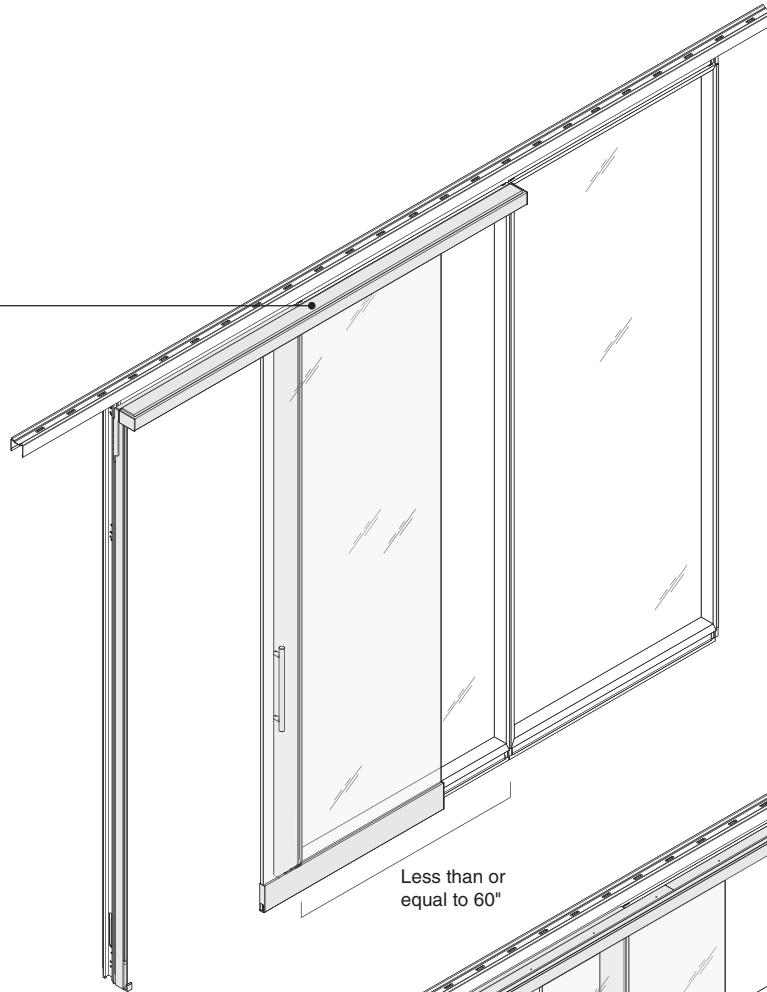

Reinforced track is an aluminum extrusion that is structurally reinforced with a steel angle to span longer lengths. Reinforced track is required when the module adjacent to the door opening is greater than 60". Reinforced track is made up of two lengths of track. Overall length cannot exceed 168".

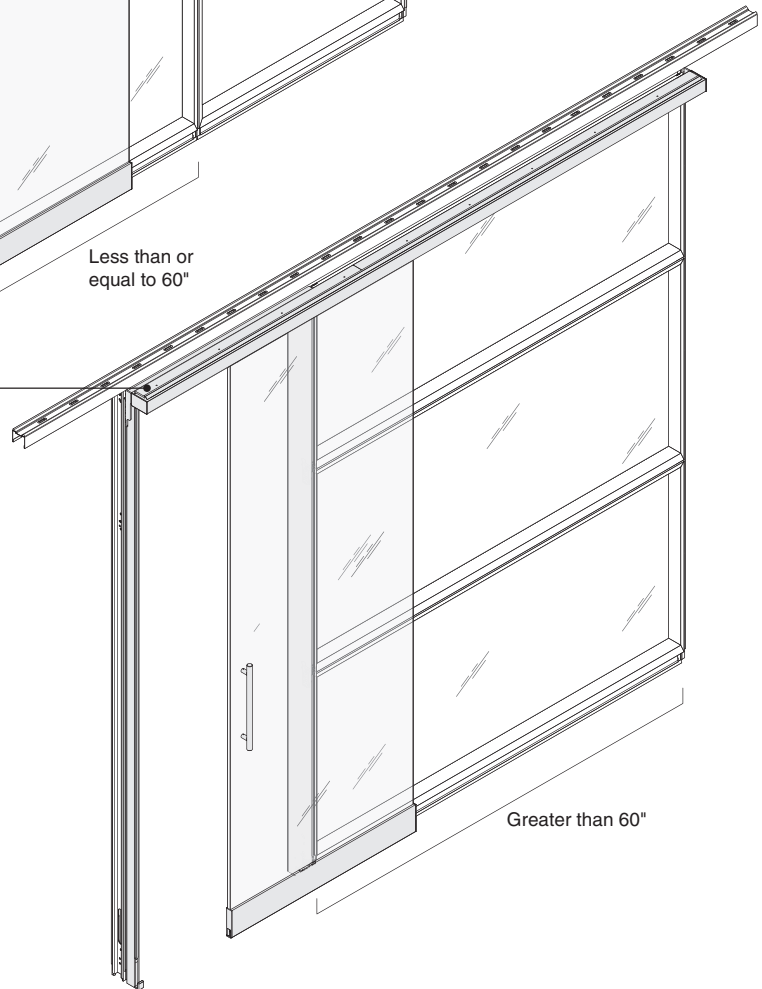

Basic Track Examples

Slider Door Configurations—Advanced Planning

Slider Door and Single Adjacent Module

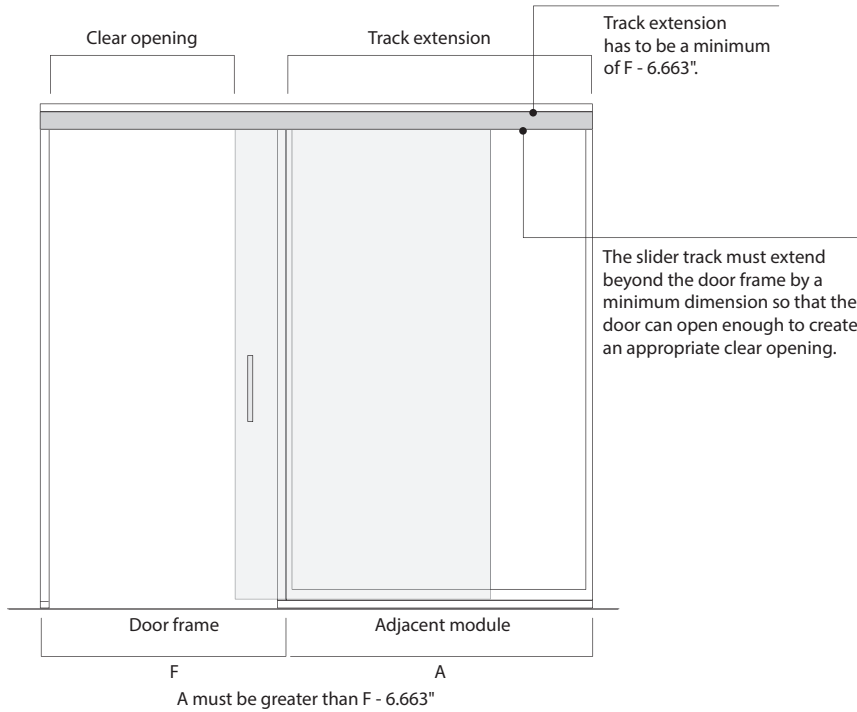

Slider Door and Multiple Adjacent Modules

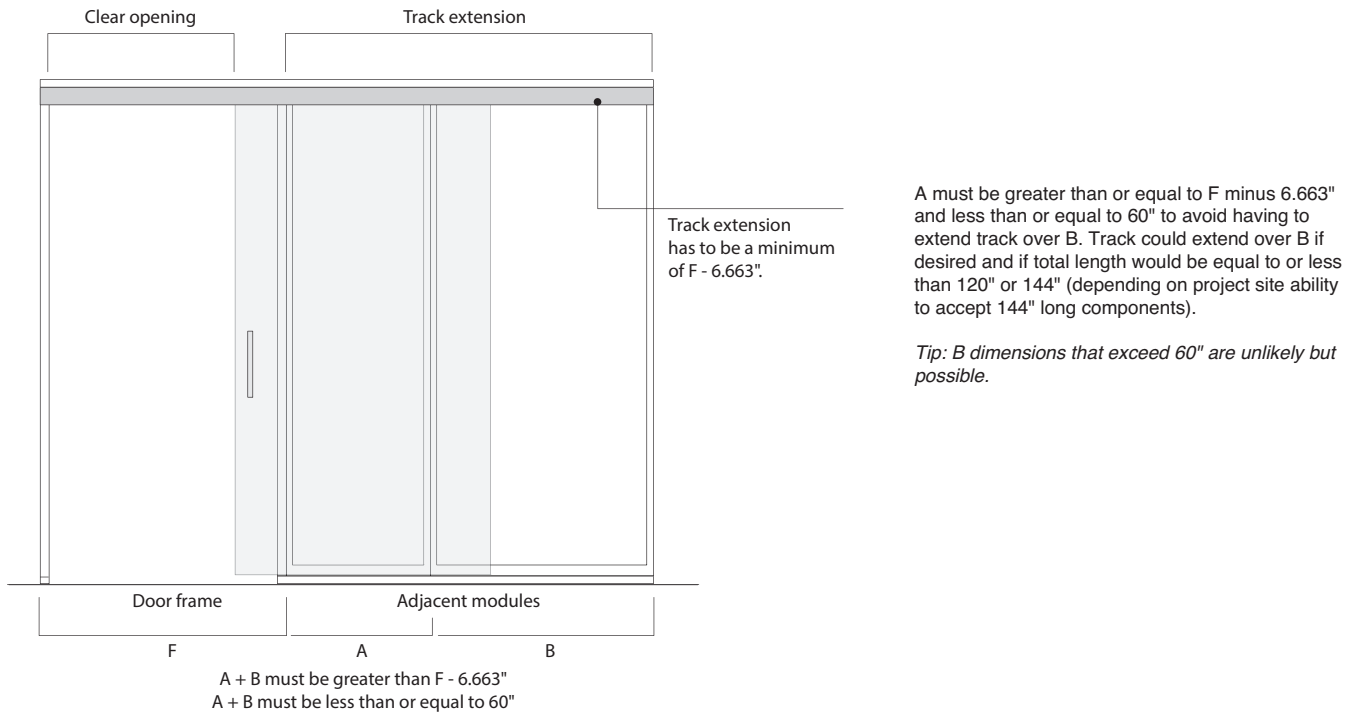

► See *SmartTools*, Page 4

Slider Door and Multiple Adjacent Modules, continued

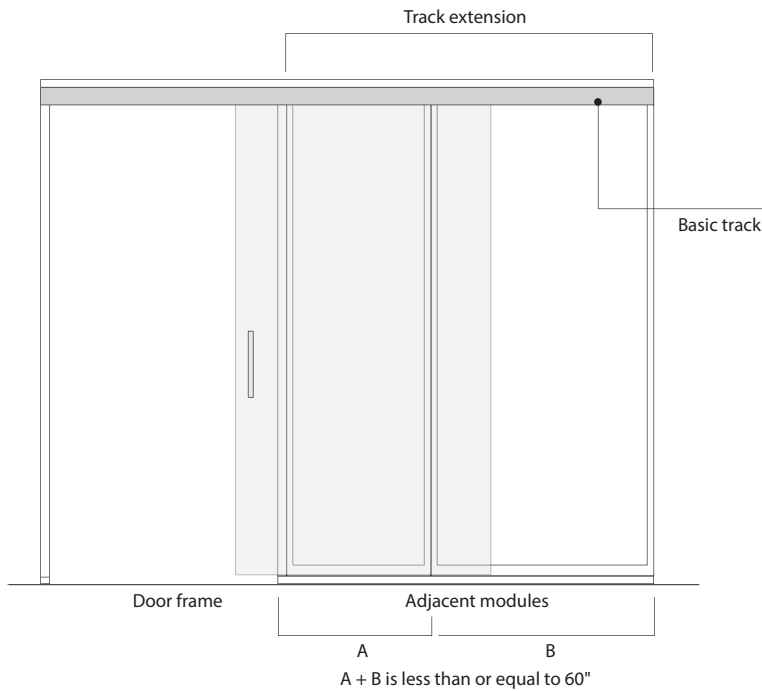

As long as A and B are each less than or equal to 60", basic track can be used. Track does not have to extend over B, but can if continuous visual is desirable.

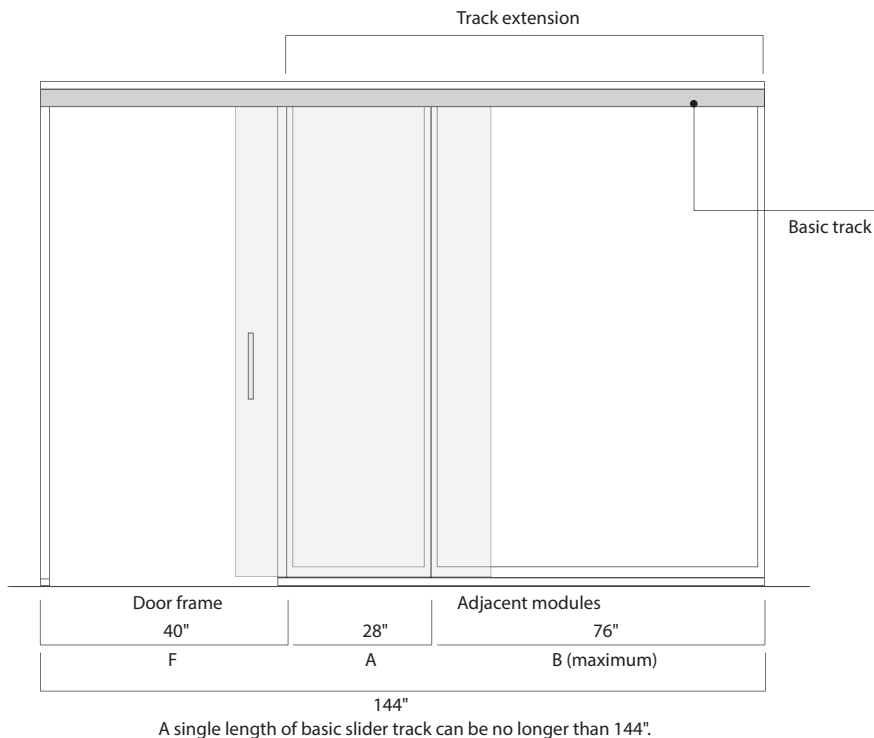

If A is greater than or equal to F minus 12" and less than or equal to 60", then B can be any width using basic track (up to maximum allowable track length minus A minus F). In the example above A equals F minus 12". In this case, the track must extend over B since A is not greater than F minus 6.663".

► See *SmartTools*, Page 4

Slider Door and Multiple Adjacent Modules, continued

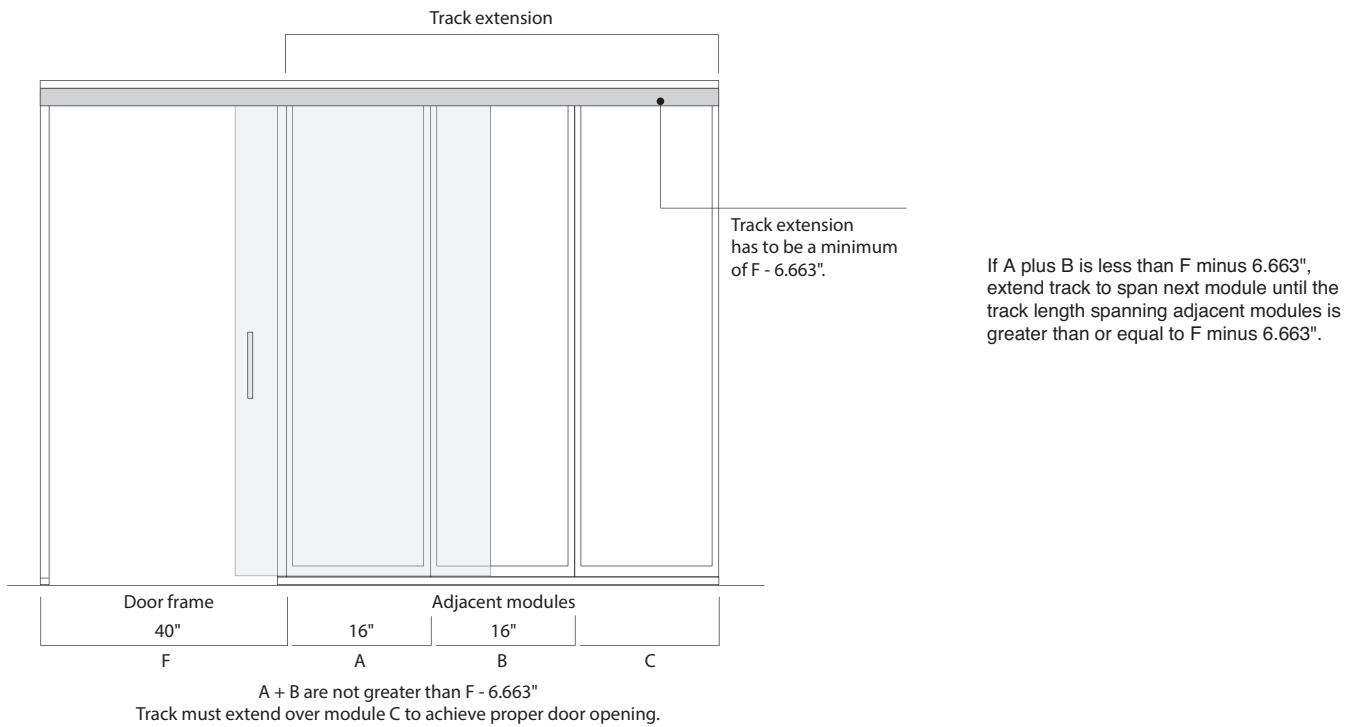

▶ See *SmartTools*, Page 4

Reinforced Track Examples

Slider Door Configurations—Advanced Planning

Slider Door and Multiple Adjacent Modules

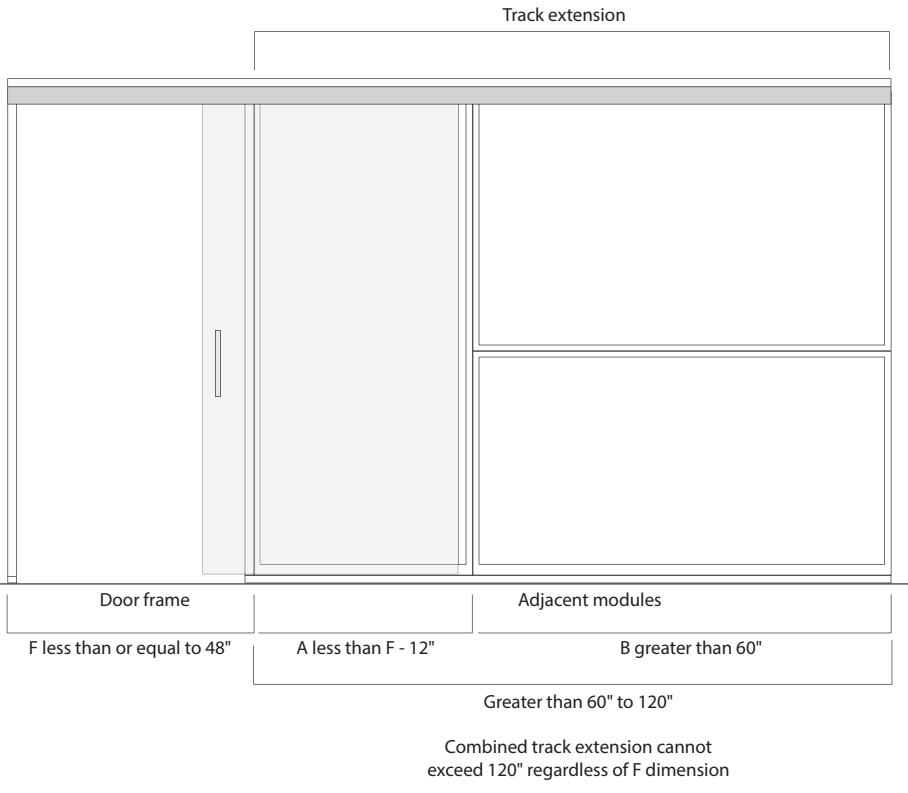

When adjacent module A is greater than F minus 12", reinforced track is required to span modules A and B. Combined adjacent modules cannot exceed 120" regardless of F dimension.

Tip: If A is greater than or equal to F minus 12" and less than 60", this could be a basic track as long as it is less than 120".

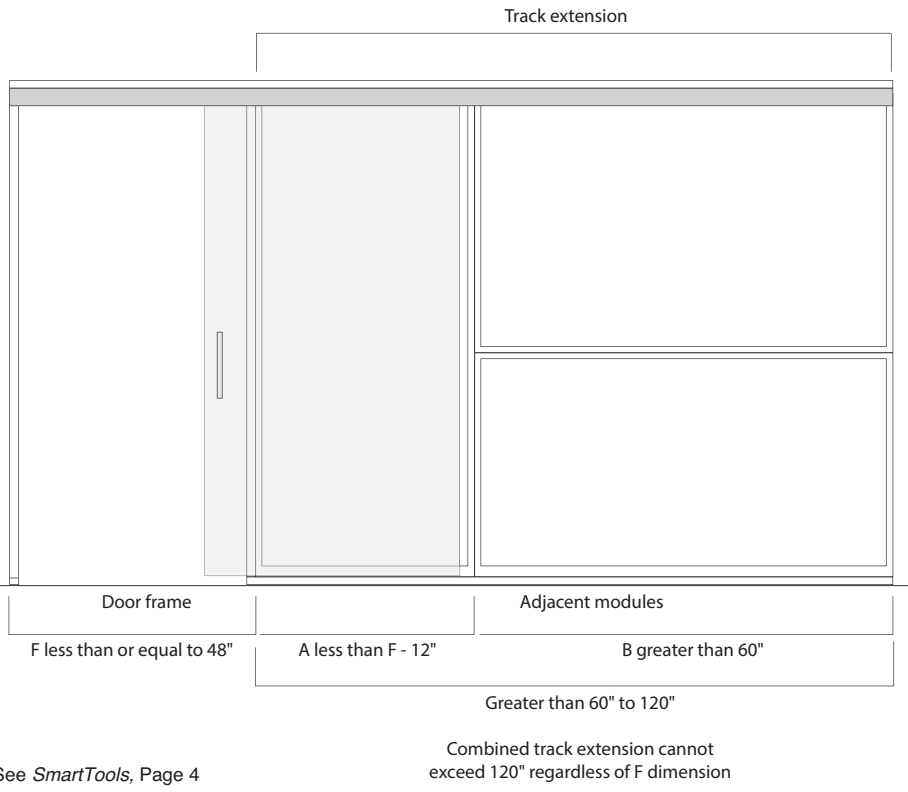

When B is greater than 60" and A is less than F minus 12", reinforced track must be specified.

► See *SmartTools*, Page 4

Basic Track, Reinforced Tracks, and Utility Panel

Slider Door Configurations—Advanced Planning

Utility panel width does not need to be included when calculating the overall span of the track.

In these three examples, the span of the track is allowed to increase by 4" to allow for the utility panel.

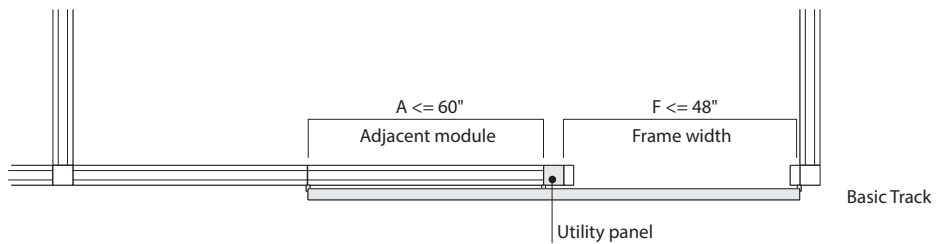
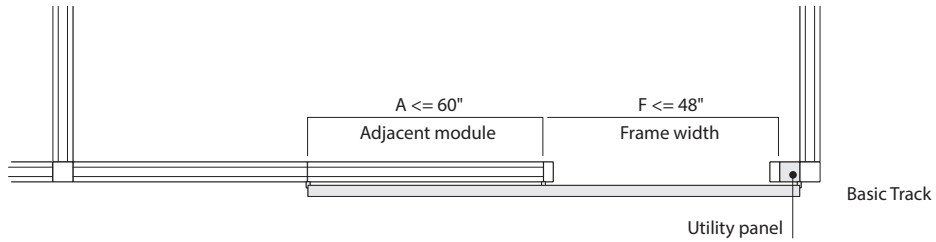
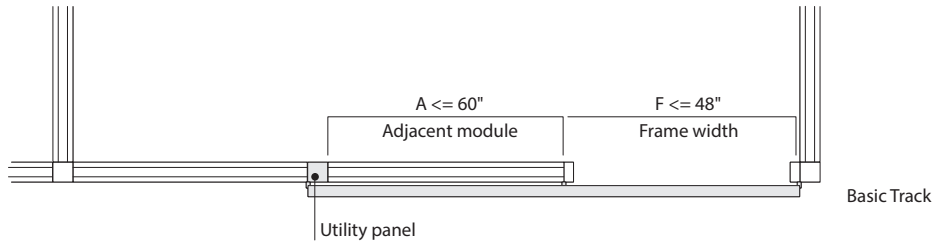

When a utility panel is between an adjacent module and a door frame, the adjacent (landscape) module can still be up to 120".

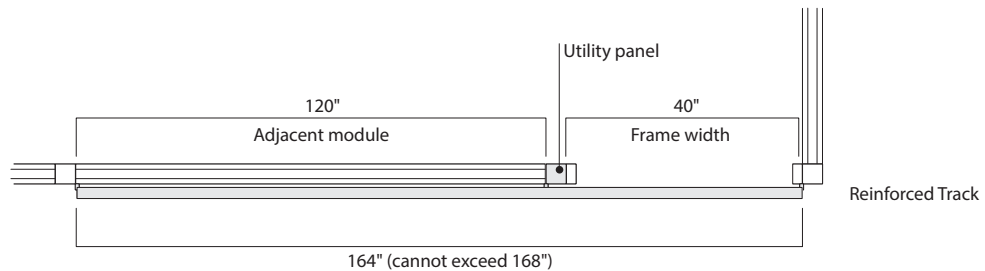

▶ See *SmartTools*, Page 4

Bridging Door Tracks

Slider Door Configurations

If desired, additional lengths of door track can be added (bridged) adjacent to lengths of functioning basic track to create a consistent visual line.

Bridging track can be no longer than 144".

Bridging track is specified without hardware – no trolleys or braking mechanisms are included.

Bridging track can span junctions, mini ends, etc.

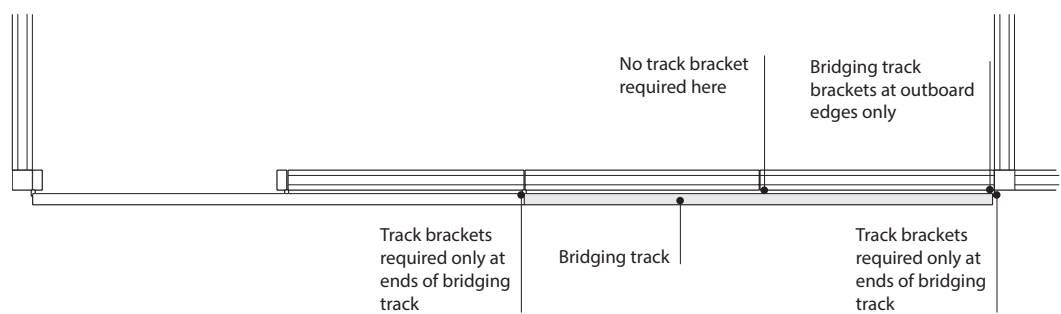
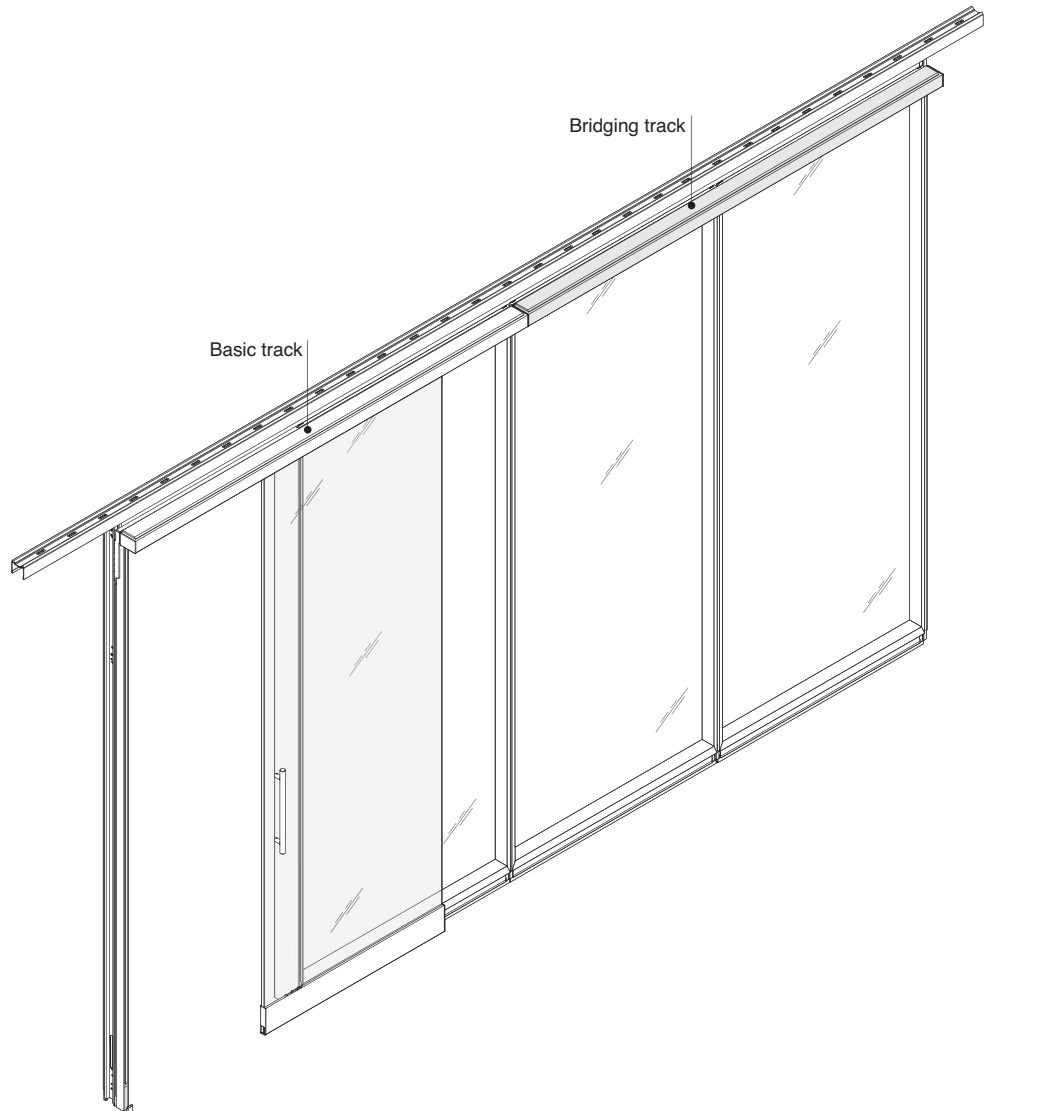

▶ See *SmartTools*, Page 4

Intersections—Junctions and Adapters

V.I.A. junctions are used where two or more walls join together at an angle. They are available at pre-set angles or specifiable angles at 1° intervals.
 ▶ Specifying, page 181

Seals are included at the top and bottom of each junction cover and in the bottom of the junction to control sound transmission.

Junction covers (inner and outer) are applied to visually finish the junction assemblies. Surfaces of junction covers are steel or aluminum, and can be painted or anodized.

Junction blocks and related hardware can be ordered separately for on-site assembly with posts to create junction assemblies.

Base trim is ordered pre-cut to the matching angle.

Ceiling track is ordered pre-cut to the matching angle.

Junctions are made up of two or more posts joined together with junction blocks at specific angles.

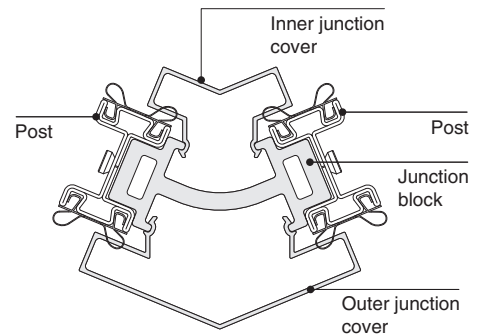
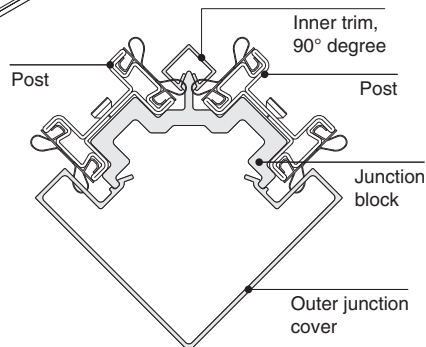
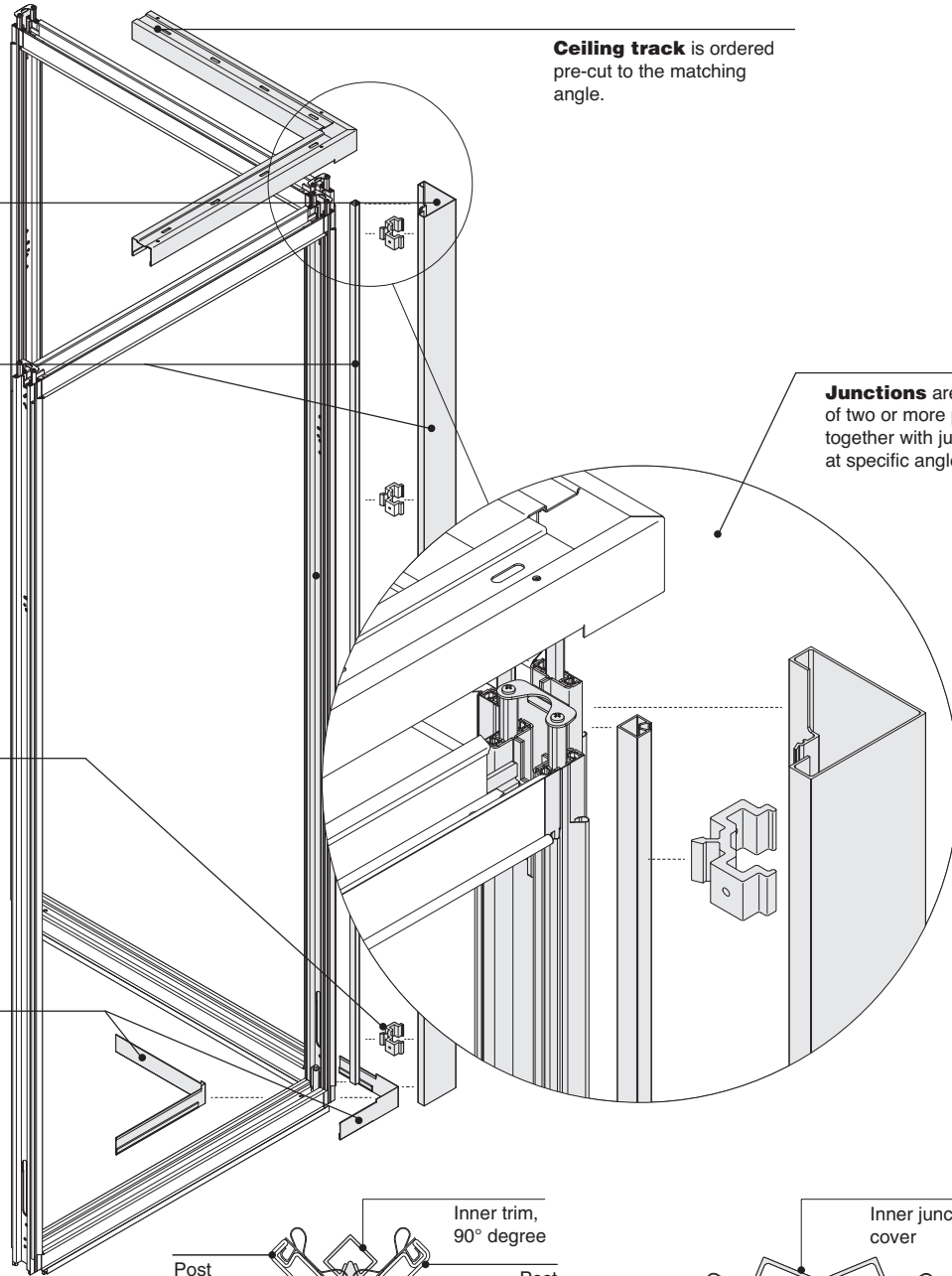

Product Details

► See *V.I.A. Planning Dimensions*, page 103, for important information regarding dimensional references for all V.I.A. components.

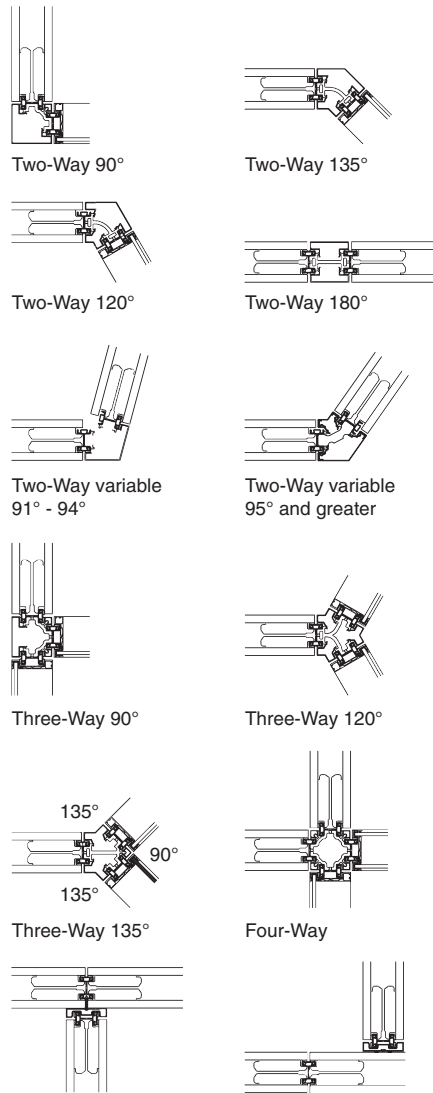

Two-Way 90°

Two-Way 135°

Two-Way 120°

Two-Way 180°

Two-Way variable 91° - 94°

Two-Way variable 95° and greater

Three-Way 90°

Three-Way 120°

135°
90°
135°

Four-Way

Three-Way 135°

Four-Way

Adapter T on module

Adapter T off module

Junctions and adapters join walls in various configurations.

Fixed angle two-way junction assemblies are available in 90°, 120°, 135°, and 180° configurations.

Height can be specified in planning heights from 80"–144" ceiling height.

When creating angles other than 180°, junction assemblies must extend to the ceiling track.

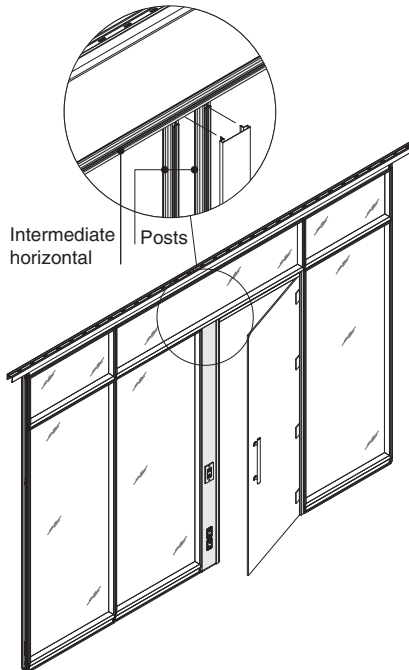
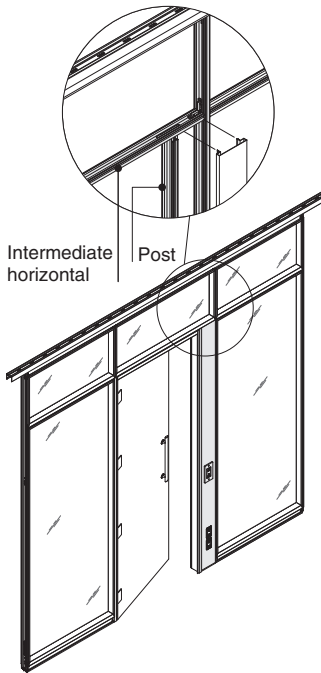

When used in conjunction with utility panels, the top of 180° two way junctions can connect to an intermediate horizontal (either one post or both posts) or the ceiling track.

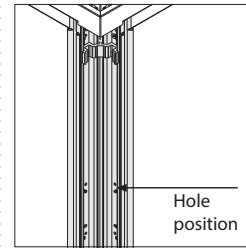

Like posts, junctions can have up to 11 hole positions for intermediate horizontals. The hole pattern will match on all posts within a junction.

When wall geometry does not allow for all posts within a junction to be optimized, the junction will be shipped unassembled.

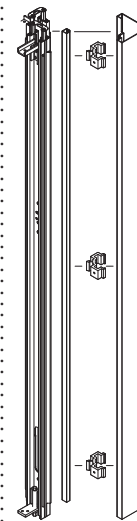

Junctions can be ordered as an assembly from the factory, or as components to be assembled onsite.

Tip: When using existing posts to create a junction, order junction hardware for field assembly.



Two-Way 90°



Two-Way 120°



Two-Way 135°



Two-Way 180°



Two-Way variable small



Three-Way 90°



Three-Way 120°



Three-Way 135°



Four-Way

Junction hardware kits include the necessary junction blocks and fasteners to join posts together to create a junction assembly.

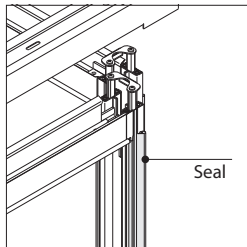

Factory applied seals on structural posts minimize sound transmission. Only one seal color is specifiable per junction assembly.

Tip: If multiple seal colors are required, order additional seals and replace on site.

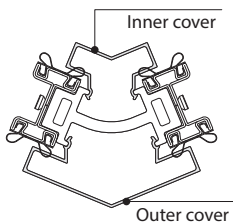

Junction covers, inner and outer, conceal and finish the junction assembly.

Junction covers for fixed angle junctions are aluminum, and can be specified in anodized or painted finishes.

Variable angle two-way junction assemblies are available in all other angles between 90° and 180°, excluding 120° and 135°, which are orderable as fixed angle junctions.

Junction covers for variable angle junctions are steel, and can be specified in painted finishes.

Inner junction trim is specified at 90° angles.

Inner variable angle junction covers are specified for the intersection of two walls at angles between 91° and 179°.

Outer variable angle junction covers are specified for the intersection of two walls between 90° and 180°, excluding 120° and 135°, which are orderable as fixed angle junctions.

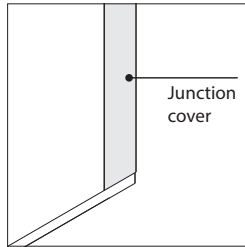

When positioned adjacent to a solid skin or glass frame, the bottom edge of the junction cover will align with the bottom edge of the skin or frame.

When positioned between two door frames or between a mini end and a door frame, the bottom edge of the junction cover will extend to the floor.

180° junction assemblies can be combined with utility panels to house power receptacles, data, switches, and other devices.
▶ See page 81

Any skin type, glass frame, or door frame, can be connected to a junction.

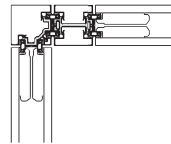
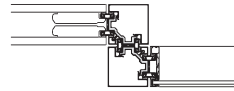

Two junctions can be positioned adjacent to one another.

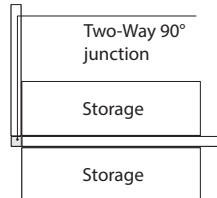

Junctions allow access to slots for hang-on components.

The junction bottom seal is positioned in the base cavity of the junction to minimize sound transfer.

A junction cover seal is installed in each end of the junction cover to minimize sound transfer.

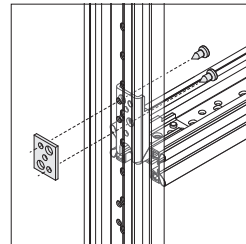

Nut plates are provided at all junctions, other than 90° two-way, to simplify the connection of intermediate horizontals to the posts.

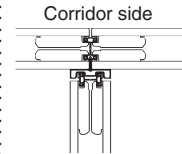

Adapter T on module

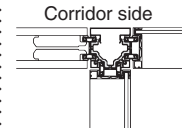

Three-Way junction 90°

Adapters can be used to create a T or X intersection.

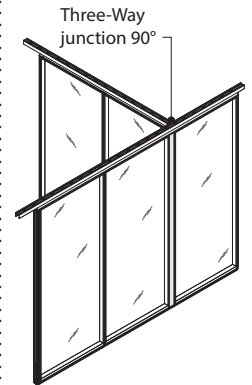
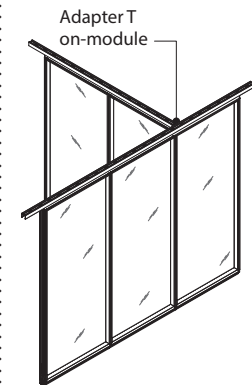

Adapters may be preferable to junctions as they create a smaller profile along the corridor side of a wall.

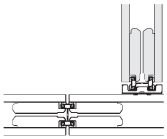

Off-module adapters can be positioned at a solid skin surface (away from a vertical reveal).

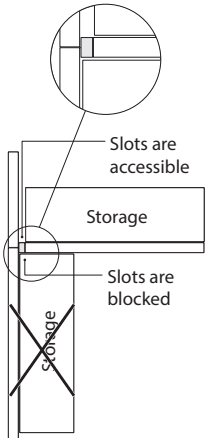

Adapters will block the slots on the intersecting wall.

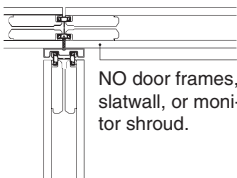

Adapters can be used with any skin type or glass frame, but may be limited to use with door frames, slatwall, or monitor shrouds.

Base and ceiling track are specified in corresponding angled configurations.
▶ See page 24

Do not use off-module adapters when ceiling heights are greater than 10'0".

Wiring and Cabling

Junctions can be used to route power and cable infeeds down from the ceiling and up from the floor.
▶ See *Electrical Components*, page 78

A junction can accommodate four hardwire infeeds and eight Cat 6 cables or two modular infeeds and twelve Cat 6 cables.

Surface Materials

90°, 120°, 135°, and 180° angle junction covers

- 8043 Clear Anodized Aluminum
- Paint

Variable angle junction covers

- Paint

Seals

- Plastic

Application Topics

V.I.A. Planning Dimensions
▶ See page 103

Bypass Junction Assembly

When applying V.I.A. glass fronts with conventional fixed cross walls, it may be desirable to create an interface condition where the V.I.A. wall conceals the cross wall. The bypass assembly is designed so that it can be installed as a complete assembly and create an uninterrupted visual along a corridor.

► Specifying, page 181

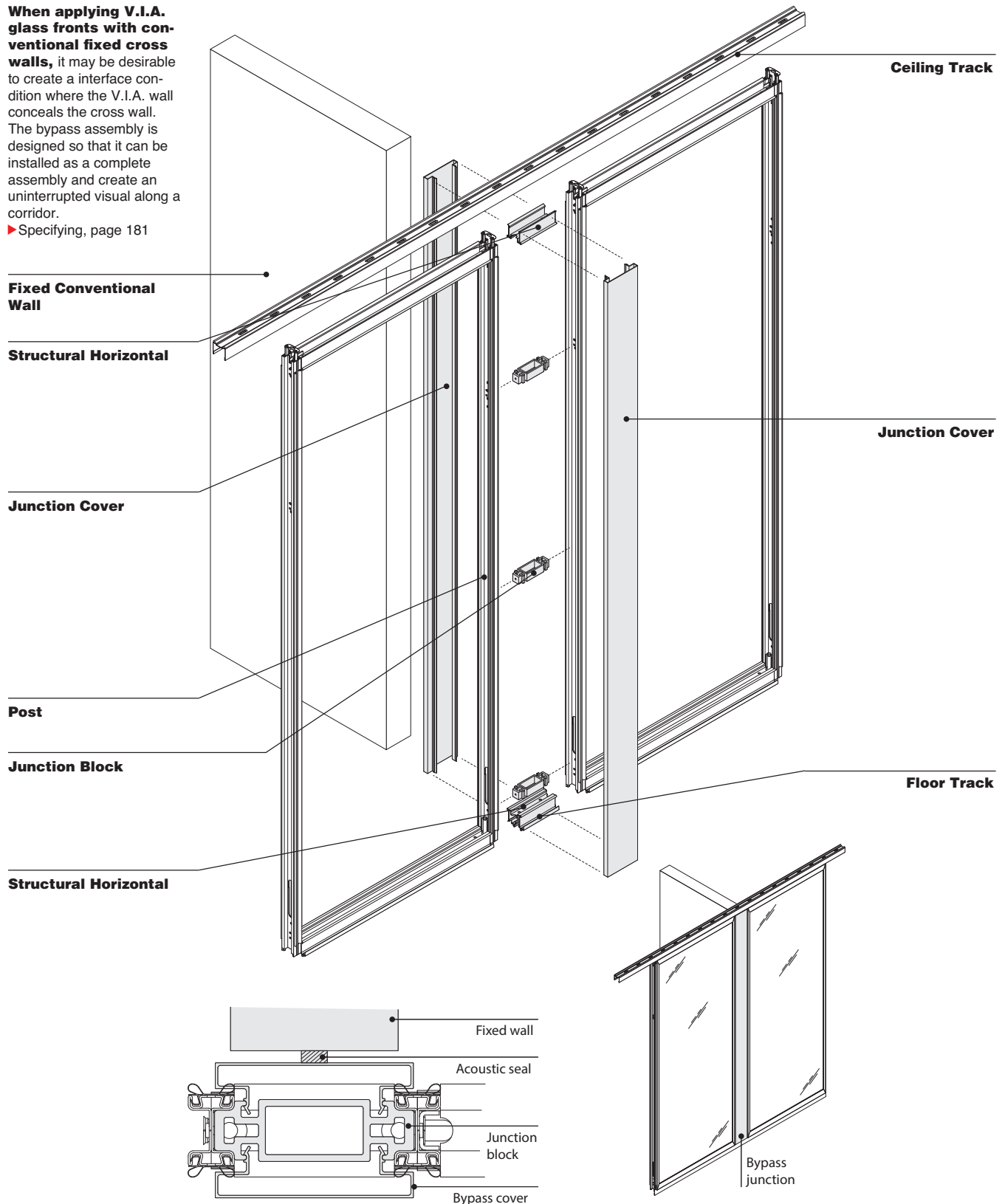

Product Details

► See *V.I.A. Planning Dimensions*, page 103, for important information regarding dimensional references for all V.I.A. components.

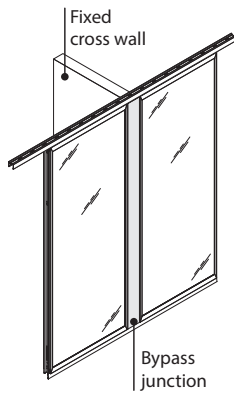

When applying V.I.A. glass fronts with conventional fixed cross walls, it may be desirable to create an interface condition where the V.I.A. wall conceals the cross wall. The bypass assembly is designed so that it can be installed as a complete assembly and create an uninterrupted visual along a corridor.

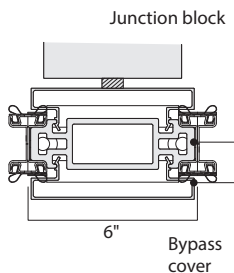

The planning width for a bypass assembly is 6\".

The bypass junction assembly is assembled on site, and includes junction blocks, structural horizontals, and floor track.

Bypass junction covers are aluminum, and can be anodized or painted.

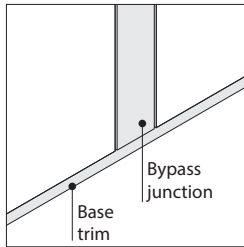

Bypass assemblies are designed to be used with base trim along the corridor side of the wall.

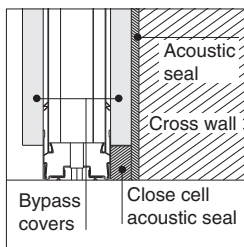

A close cell acoustic seal is included to close any gaps between the end of the cross wall and the face of the bypass cover.

Surface Materials

Bypass outer junction cover

- 8043 Clear Anodized Aluminum
- Paint

Mini Ends

V.I.A. mini ends create a perpendicular connection between V.I.A. wall modules, and other types of walls or building components. Mini ends may be positioned adjacent to solid skins, captured glass frames, or door frames.

► Specifying, page 197

The inner channel of the mini end is designed to connect to a post. Wall slots in the post remain accessible to support wall-mounted furniture.

Mini end consists of three components – the inner channel, the outer channel, and two covers.

The inner and outer channels create a telescoping connection to allow adjustability to fit final field measurements. The inner and outer channels align with the top of the adjacent component and extend to the floor.

Polypropylene seals provide light and sound seal between the mini end and the building wall.

Outer channel has a flat surface to fit flush against vertical surface of the building wall.

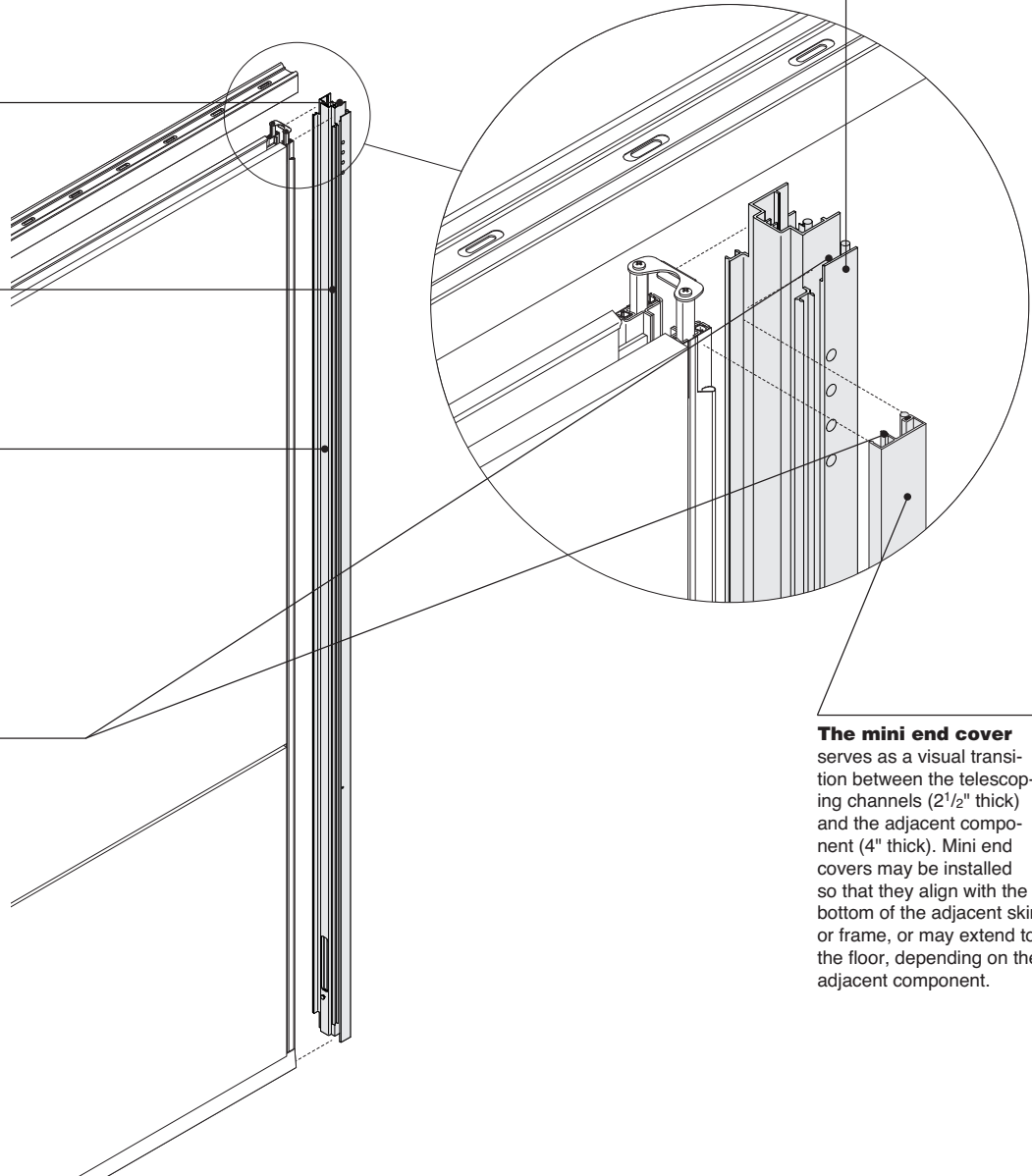

The mini end cover serves as a visual transition between the telescoping channels (2 1/2" thick) and the adjacent component (4" thick). Mini end covers may be installed so that they align with the bottom of the adjacent skin or frame, or may extend to the floor, depending on the adjacent component.

Product Details

► See *V.I.A. Planning Dimensions*, page 103, for important information regarding dimensional references for all V.I.A. components.

Height of the mini end

is specified to the same height as the adjacent wall. Mini ends are available in ceiling heights of 80"-144". The outer channel spans to the floor and is cut on site by the installer.

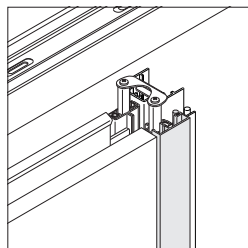

The top of the mini end cover aligns with the top of the adjacent component.

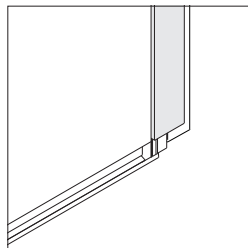

The bottom of the mini end cover can align with the bottom of the adjacent skin or frame, or can extend to the floor when adjacent to a door frame.

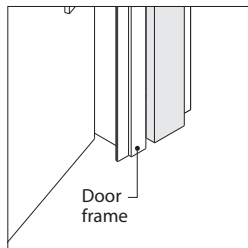

When positioned next to a door frame, the mini end cover should be specified with the to the floor option and will be field-cut by the installer to final length.

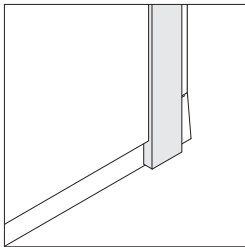

When positioned adjacent to a junction or T-adapter, the bottom of the mini end cover will extend to the floor, and will be field cut by the installer to final length.

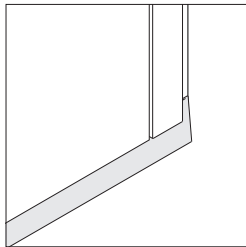

When positioned next to a solid skin or glass frame, the base trim extends under the mini end cover.

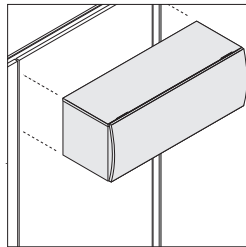

Vertical post adjacent to mini end can support hang-on storage.

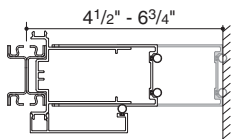
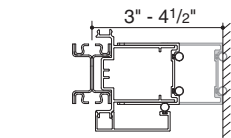
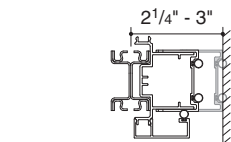

Three sizes of mini ends are available. Each telescopes to a different range of dimensions.
Small: 2 1/4" min - < 3" max
Medium: 3" min - < 4 1/2" max
Large: 4 1/2" min - 6 3/4" max

Mini ends that are planned to allow for less than 1/4" of adjustment require careful coordination to confirm exact site dimensions and plumbness of adjacent fixed walls.

For ceiling heights greater than 10'-0", it is advisable to use medium or large mini ends, and to plan for the placement at the mini end mid point to allow for maximum adjustment.

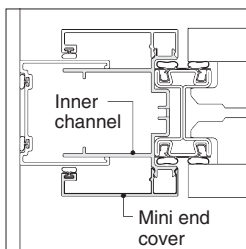

Mini end cover snaps onto the inner channel.

All wall types and door frames can connect to a mini end.

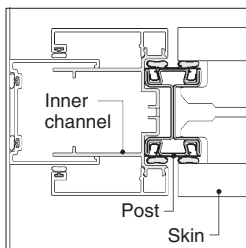

Mini end inner channel shares a post with the adjacent skins, frames, or door frames. The adjacent components can be a combination of different skin types and glass frames.

A screw connection to the building is not typically required. Mini end fits tightly against the building wall, and the contact points are sealed with a continuous polypropylene seal.

A screw connection may be required with mini end at a door frame.

A screw connection is recommended for ceiling heights that are greater than 10'0".

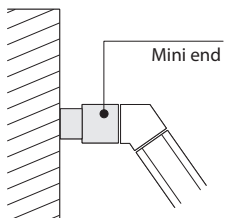

Mini ends can be positioned adjacent to an angled junction to create an angled wall termination.

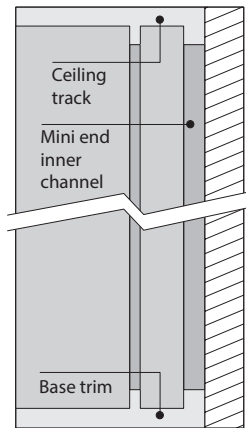

When making paint color selections, it is recommended to use one color for ceiling track, base trim, post seals, and mini end inner channel.

Wiring & Cabling

Wire and cable routing vertically through a mini end is possible. Mini ends are often used to route power around a glass frame.

Surface Materials

Surfaces of mini ends can be painted or 8043 Clear Anodized Aluminum.

Mini end covers are ordered individually, allowing for different finishes on opposite sides of the wall (painted or anodized aluminum).

The outer channel is the same finish on all sides. The inner channel is not visible.

Cutable Ends

Cutable ends can be field cut around irregular building surfaces.

► Specifying, page 201

Cutable ends can be used with a cut skin at a single flush cut.

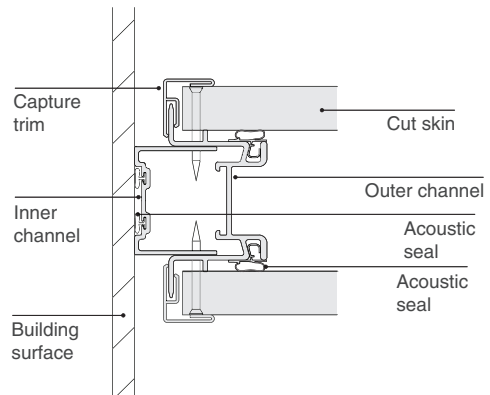
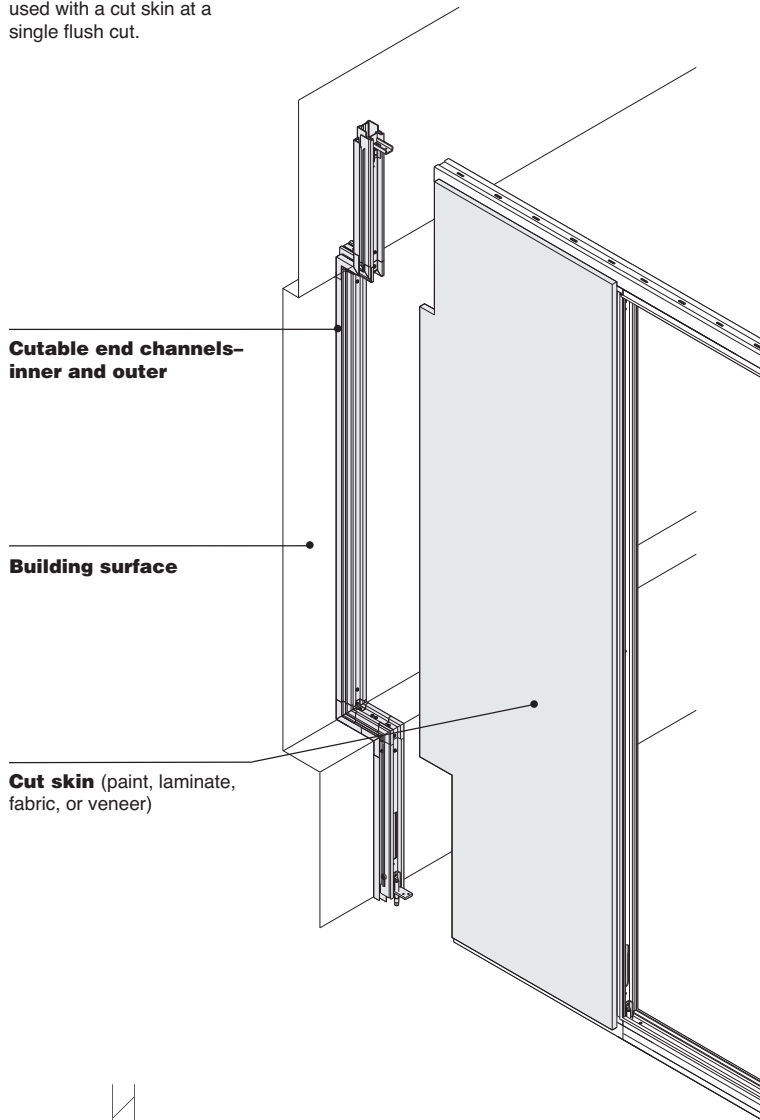

Cutable ends can be used at straight cuts to adapt to site conditions or dimensional changes.

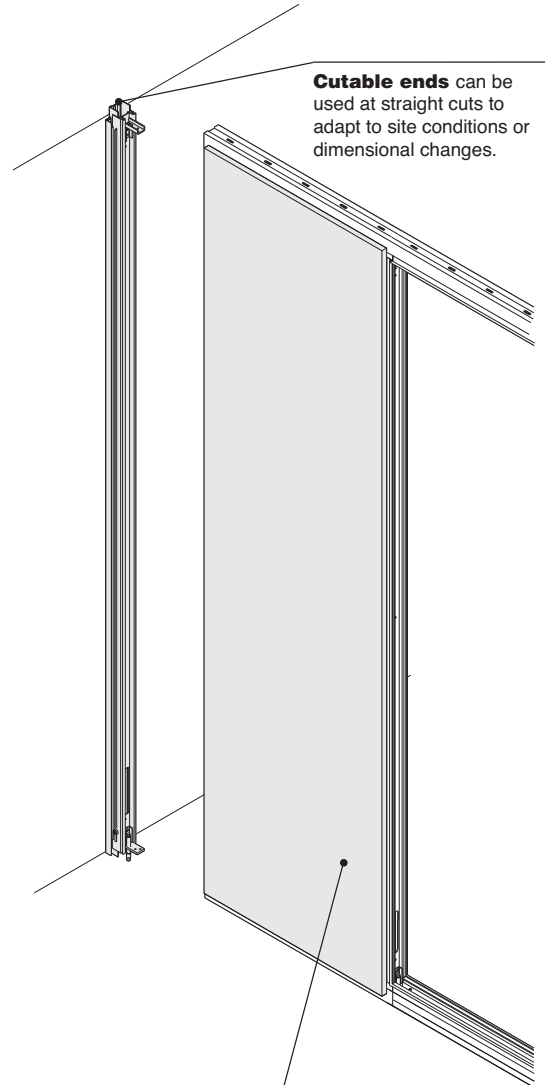

Cut skin (paint, laminate, fabric, or veneer)

Product Details

► See *V.I.A. Planning Dimensions*, page 103, for important information regarding dimensional references for all V.I.A. components.

Cutable ends are sometimes necessary for a field cut at a wall termination – either to allow for unknown dimension, or to trim around irregular building conditions.

Cutable ends are used with monolithic solid skins – paint, laminate, fabric, or veneer.

Special skins are not required for field cutting.

Cutable ends are fastened to the adjacent building surface.

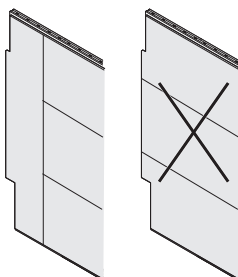

Cutable end assemblies do not accommodate intermediate horizontals or segmentation.

Cutable ends are not used with slatwall, ceramic skins, or monitor shrouds.

Electrical devices cannot be positioned in a cut skin.

Infeeds and cables can be routed behind a cut skin.

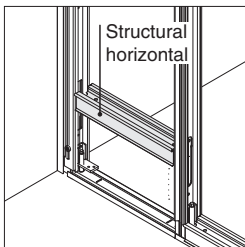

Structural horizontals that are positioned adjacent to cutable ends will be modified to ensure that cable cut-outs do not interfere with the bracket connection. These horizontals will receive one cut-out only when 22.61" long or greater. Structural horizontals that are less than 22.61" will not have any cable cut-outs.

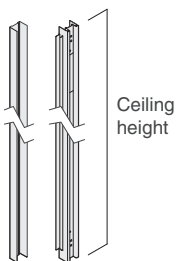

When intended for use with a single vertical cut, the inner and outer channel are ordered in lengths that correspond to ceiling height.

When intended for use with a single vertical cut, the inner and outer channel are combined into a single assembly.

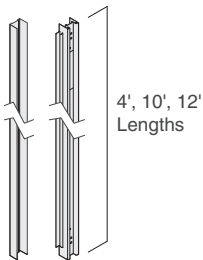

When intended for use with multiple cuts around sills and soffits, channel lengths can be specified in different lengths to minimize scrap.

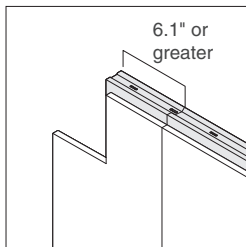

A skin cannot be cut to a dimension less than 6.1" (face of skin to centerline of post).

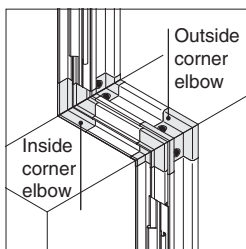

Cutable end assemblies can be combined with corner angles and elbows (inside and outside corner) to allow the installer to trim around unique end configurations.

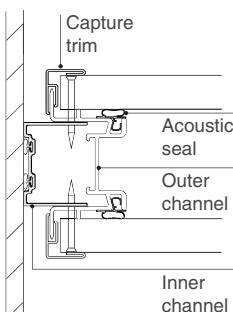

Inner channel can be specified in a different color than capture trim.

In some configurations, the outer channel seal may be visible and should be specified to be color matched to acoustic seals on adjacent posts and horizontals.

Capture trim paint color can differ from one side of wall to the other.

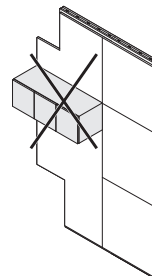

Cutable ends do not accommodate hang-on components.

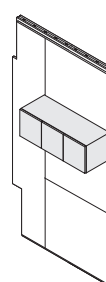

Hang-on storage components can be positioned adjacent to a cut condition.

Surface Materials

90° Cutable end assembly

- Paint (cutable end assembly)
- Plastic (seal)

90° Cutable end inner channel

- Paint (cutable end assembly)
- Plastic (seal)

Cutable end capture trim

- Paint

Electrical Components

Field-installed electrical components are available to provide power, data, or other types of devices. Power options include modular power or conventional hardwired devices.
▶ Specifying, page 205

Communication cabling is field installed.

Modular power components utilize modular connections to simplify power distribution and speed installation.

Electrical mounting brackets are supported by structural or intermediate horizontals, and allow for either modular or hardwired components.

Framing components are pre-punched for cable routing.

Hardwire (power or communications)

Electrical locations are parametric.

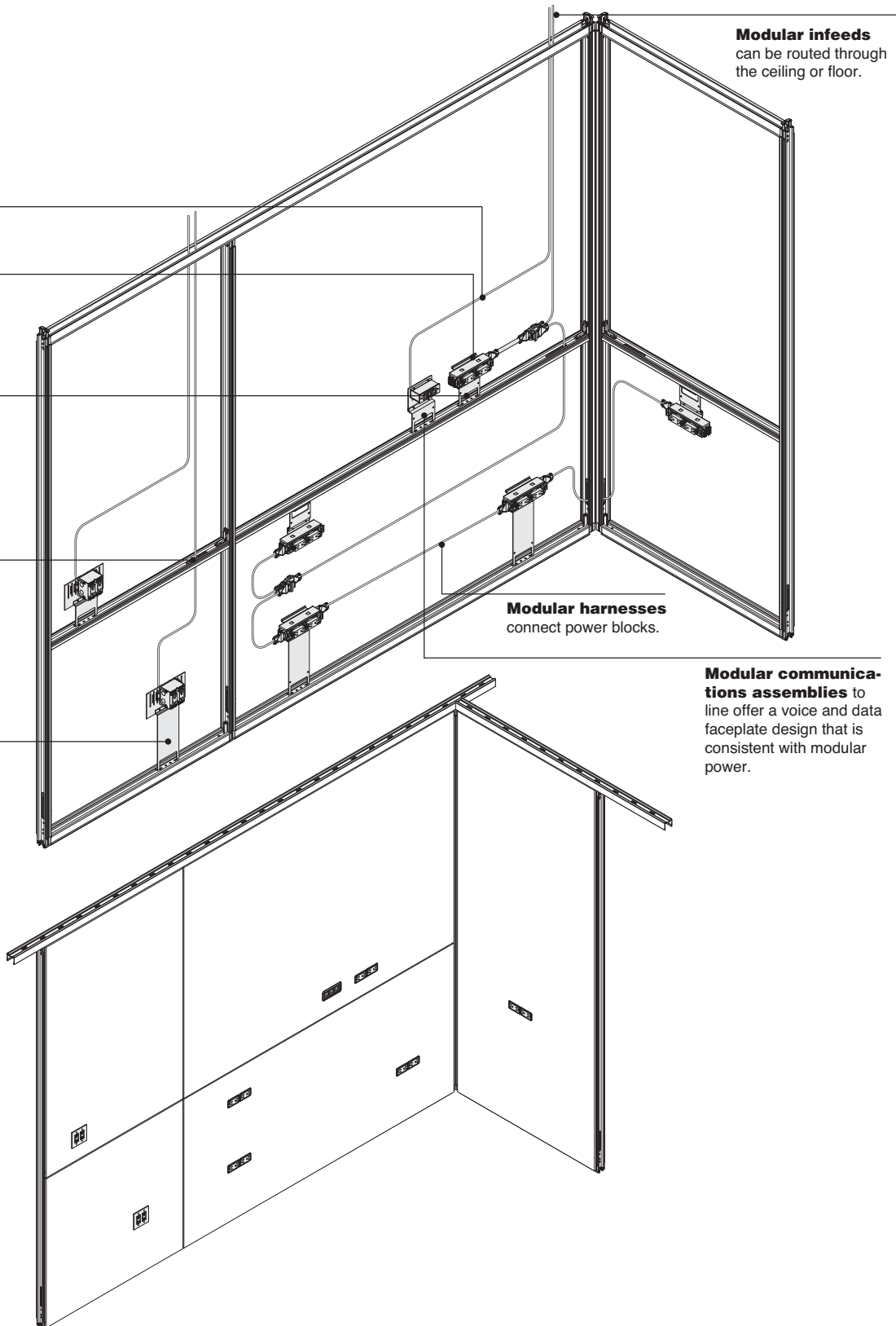

Electrical mounting brackets support hard-wired or modular power.

Utility panels are factory cut for modular or hardwired power.

Multipurpose infeed feeds from floor or ceiling.

Utility panel houses electrical devices when cut-outs in skins are not available or desired.

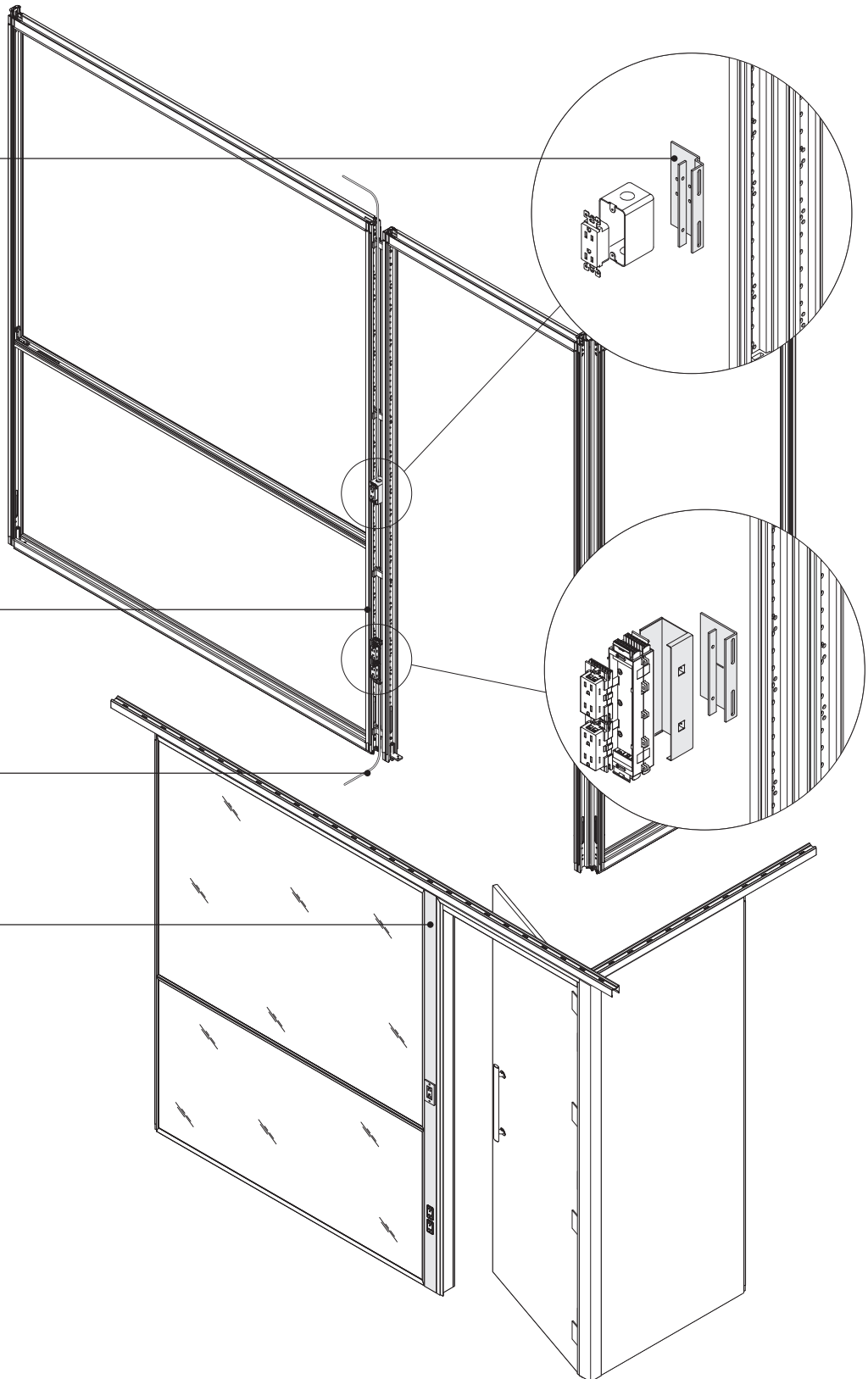

Product Details

▶ See *V.I.A. Planning Dimensions*, page 103, for important information regarding dimensional references for all V.I.A. components.

Electrical devices can be positioned in solid skins or in utility panels.

▶ See *Utility Panels*, page 81

Modular power or hardwired electrical devices can be accommodated. Both types can be combined in the same application.

Cut-out locations are parametric, and are positioned as part of the design/planning process.

▶ See *SmartTools*, page 4

The maximum number of cut-outs per skin will vary depending on the size of the skin and overall skin geometry. The largest skin will allow for nine cut-outs. Electrical cut-outs can be specified for factory cutting, or can be cut on site.

A maximum of three devices can be located in a single utility panel.

▶ See *Utility Panels*, page 81

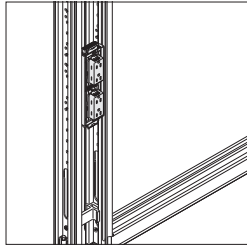
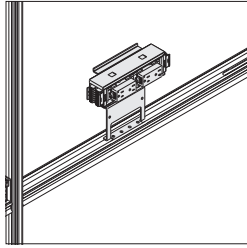

Electrical devices are held in place with mounting brackets, which are fastened to structural frame components.

Electrical or communication devices cannot be positioned in the base assembly.

Each structural post and intermediate horizontal includes a cut-out for cabling routing. If required, additional cable routing holes can be cut during installation.

Modular Power in Skins

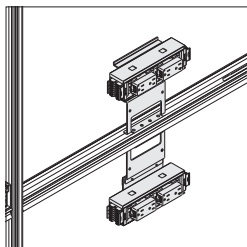

Modular power blocks are held in place with mounting brackets, which are fastened to structural frame components.

A multipurpose infeed brings power from the ceiling or floor to a power block in the wall.

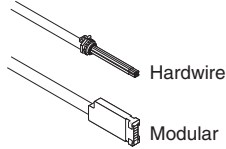

End of the power infeed can be hardwire or modular. Hardwire allows the electrician to make a conventional connection to the building's power inside a junction box. Modular allows the infeed to connect to any corresponding modular infeed cover. This is the same modular connector used by Answer, Montage, and Architectural Solutions modular power system.

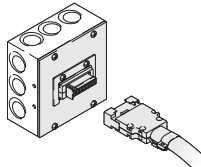

Modular infeed cover is included with modular multipurpose infeed to hardwire to a junction box. It allows modular connector on the infeed to snap easily into position. This allows infeeds to be quickly disconnected, moved, and reconnected later.

Power blocks can accommodate receptacles on one side of the wall.

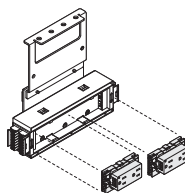

Receptacles are ordered separately and field installed in power blocks. Separate duplex receptacles are available to engage each of the different circuits that are possible in the electrical system. Receptacles are coded to indicate which circuit and type of ground they engage.

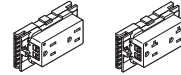

15 amp 20 amp
Receptacles can be specified as 15 amp or 20 amp rated.

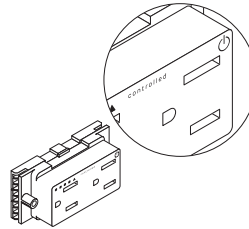

Controlled receptacle must be indicated when tying into the building management system. Duplex receptacles have an option for a factory permanent, pad stamp power icon symbol with the word controlled per compliance with the Energy Code.

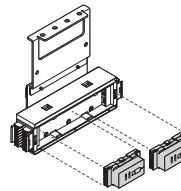

USB receptacles are available in three wiring schematics with multiple line options. USB receptacles offer easy access to two changing ports. Each port provides one amperage of output. USB receptacles conveniently charge a wide range of electronic devices. Some devices may not be compatible.

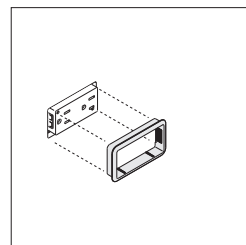

Receptacle trim is used with each receptacle to cover edge of the cut-out and create a precise transition between the cut-out and the receptacle.

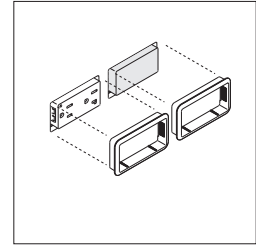

When a single duplex receptacle is needed, use a blank cut-out cover over the unused cut-out.

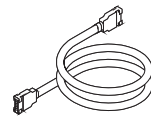

Modular harnesses connect power from one power block to another. Harnesses are available in lengths of 36", 72", and 144".

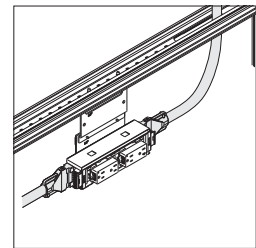

Each power block can receive a single harness at either end.

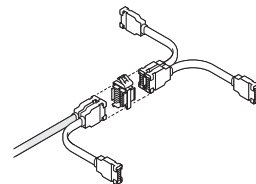

Harness-to-harness branching connector link harnesses. This allows multiple harnesses to connect at a single point to allow power networks to branch.

Harnesses cannot be routed in the base cavity, door frames, behind slatwall skins, or between back-to-back back-painted glass.

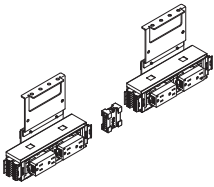

Power block connectors join two power blocks directly adjacent to one another.

Power harnesses can be routed behind solid skins or within junctions and mini ends.

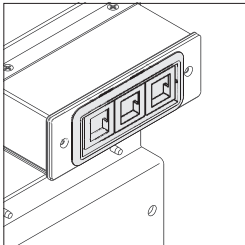

A modular communication faceplate can be used to create voice and data terminations using a design that is consistent with modular power receptacles.

In some cities, like New York and Chicago, local electrical codes will not allow the use of modular power components in full height walls. When planning for power in these areas, use hardwire power components.

Hardwire in Skins

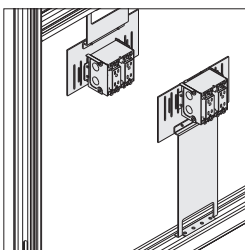

Junction boxes are held in place with mounting brackets, which are in turn fastened to structural frame components.

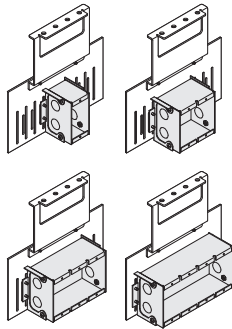

Mounting brackets can accommodate single gang, two gang, three gang, or four gang junction boxes.

Mounting brackets are designed for use with 2 1/2" deep junction boxes as manufactured by Appleton. Single Gang – M1-250 Two Gang – M2-250 Three Gang – M3-250 Four Gang- M4-250 Partition – LVP250 Skins can be factory cut for any of these four sizes.

Junction boxes (and associated devices) and cover plates are purchased locally and are not part of the V.I.A. statement of line.

Conduit cannot be routed in the base cavity, door frames, behind slatwall skins, or between back-to-back back-painted glass.

Utility Panel

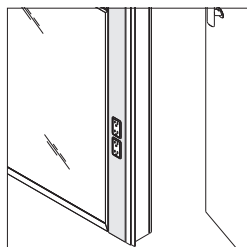

Utility panels are used to house electrical devices when solid skins are not available, or skin cut-outs are not desired.

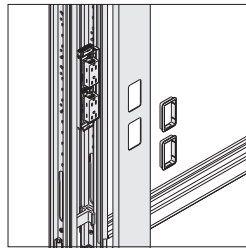

Utility panels are made up of 180° junction assemblies with factory cut covers.

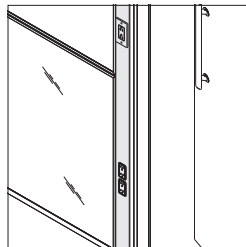

Utility panels can include as many as three electrical devices. One of these can be a modular power block. The three cut-outs can be located in one cover, or can be distributed over both (i.e. two cut-outs in one cover, one cut-out in the other). Utility panel covers can be ordered with factory cut-outs.

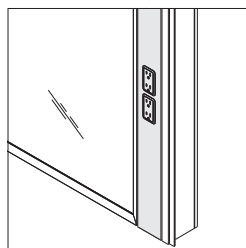

Modular power blocks are oriented vertically in the utility panel.

Utility panels can accommodate hardwired single gang 2" x 4" electrical boxes – either 2 1/2" deep or 1 7/8" deep (shallow box).

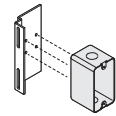

Hardwire box

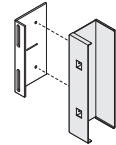

Modular power block

Utility panel mounting brackets are designed for use with hardwired junction boxes as manufactured by Appleton. 2 1/2" deep: 4SSL-1/2" 1 7/8" deep: 4CS-1 1/2"

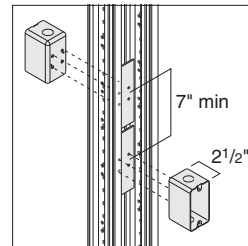

When hardwired devices using a 2 1/2" deep box are cut into both sides of the utility panel, they must be offset by a minimum of 7" (center to center).

There are three types of mounting brackets:

- hardwired 2 1/2" deep box
- hardwired 1 7/8" deep box back-to-back
- Modular power block

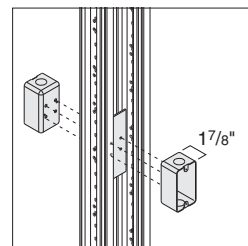

When hardwired devices using a 1 7/8" deep box are cut into both sides of the utility panel, they can be positioned in a back-to-back configuration.

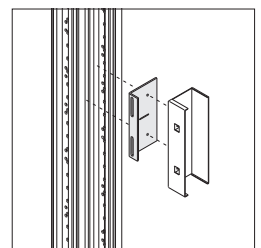
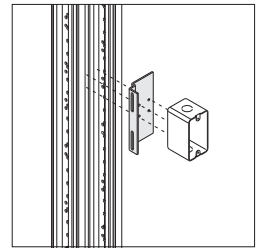

Electrical devices are held in place with mounting brackets, which are in turn fastened to a structural post.

When a modular or hardwired 2 1/2" deep box is specified in a utility panel, one cover is cut-out for the box and the opposing cover is notched to allow the necessary clearance for the mounting bracket.

Modular communication covers cannot be located in a utility panel. Use industry standard communication faceplates.

Junction boxes (and associated devices) and cover plates are purchased locally and are not part of the V.I.A. statement of line.

Modular power cut-outs can be placed on one side only.

Communications

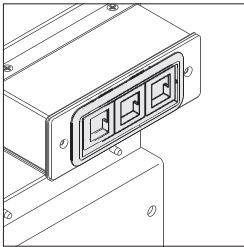

A modular communication faceplate can be used to create voice and data terminations using a design that is consistent with modular power receptacles.

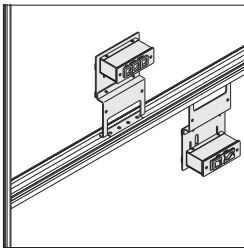

The modular communication faceplate is held in place with mounting brackets, which are fastened to structural frame components.

The modular communication faceplate can be specified for either three RJ45 connections or a combination of one RJ45 and a VGA connection.

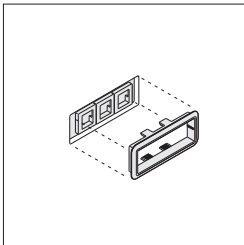

Communications receptacle trim is used with each receptacle to cover the edge of the cut-out and create a precise transition between the cut-out and the faceplate.

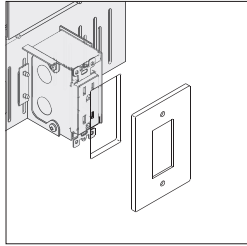

Conventional communication faceplates can be used with an electrical box, which is held in place with electrical mounting brackets.

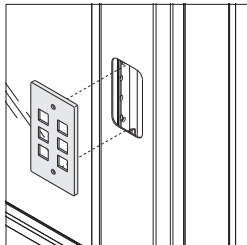
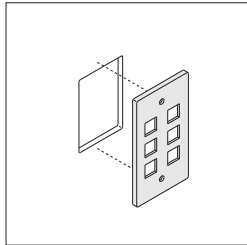

When an electrical box is not desired, communication faceplates can be fastened to the surface of the skin or utility panel.

Cut-Outs

Cut-out locations are parametric, and are positioned as part of the design/planning process.

Electrical cut-outs can be specified for factory cutting or can be cut on site.

The maximum number of cut-outs per skin will vary depending on the size of the skin. The largest skin will allow for nine cut-outs.

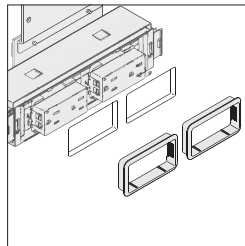

Modular Double (two cut-outs for two receptacles)

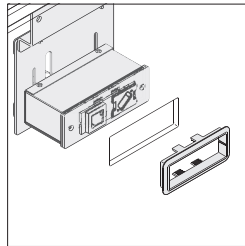

Modular Communications

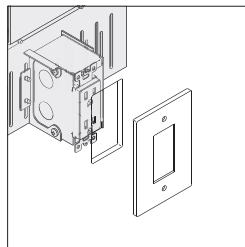

Hardware Single

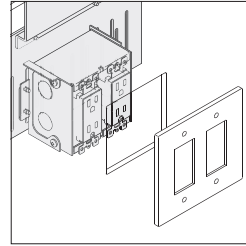

Hardware Double

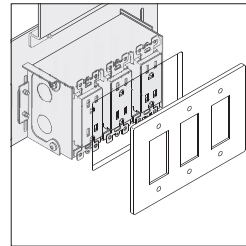

Hardware Triple

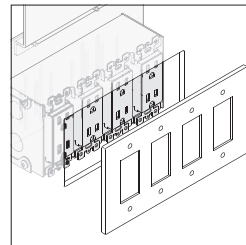

Hardware Fourplex

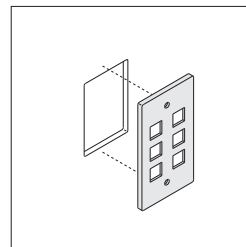

Communications - No Junction Box

Electrical cut-outs in skins are available in seven different configurations.

Brackets

Electrical mounting brackets for skins will fasten to intermediate or structural horizontals. They are available in six types:

- Modular power
- Modular communications
- Modular power at ADA
- Modular communications at ADA
- Hardwire
- Hardwire at ADA

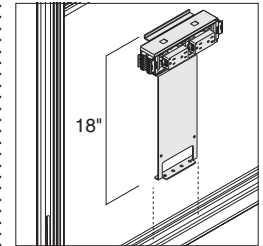

ADA mounting brackets are 18"H, and will position electrical devices at ADA compliant height when fastened to the bottom structural horizontal.

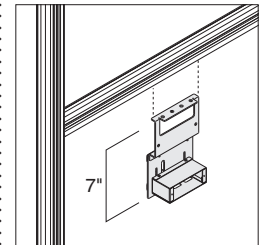

Other mounting brackets are 7" tall.

Mounting brackets for modular power and communication include an acoustical back box to minimize sound transfer.

Three types of mounting brackets for utility panels:

- Hardwire 2 1/2" deep box
- Hardwire 1 7/8" shallow box back-to-back
- Modular power block

All V.I.A. electrical components are listed by Underwriters Laboratory (UL) and certified by the Canadian Standards Association (CSA).

All Steelcase electrical systems are designed in compliance with the National Electrical Code (NEC) and Canadian Electrical Code (CEC) to function as a multi-wire branch circuit. Installations should be made in accordance with the NEC or CEC provisions for multi-wire branch circuits.

Local electrical codes vary. Consult a qualified electrical contractor or engineer for the proper installation of electrical equipment.

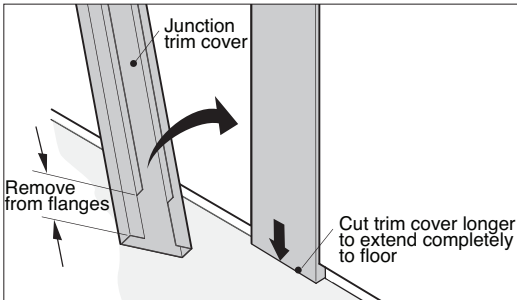
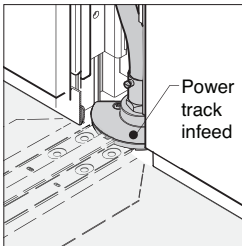

Thread infeed from V.I.A. wall system:

- When routing a thread infeed within a V.I.A. wall, connect thread floor system to the building power source only, not to V.I.A. power.
- When routing a thread infeed within a V.I.A. wall, the thread floor system installation must be completed prior to the V.I.A. installation. The connection of building power source to the thread system must be carefully planned and coordinated.
- When infeeding power, internally, from a V.I.A. wall into a thread power system, the entry point must be from an 180° 2-way V.I.A. junction that is not adjacent to a door frame, a corner, or a finished end. This junction cover needs to be specified with a “to floor” option to conceal connections at the base cavity. It is important to avoid any door clearance issues when planning the thread layout.
- A 180° 2-way junction cannot accommodate a thread infeed along with any other electrical devices or conduit.
- Refer to the *Architectural Solutions Specification Guide* for more information on the thread power system.

Surface Materials

Receptacle

- Plastic

Power/communication receptacle trim

- Plastic

Blank cut-out cover

- Plastic

Modular communication faceplate

- Plastic

Utility panel cover

- 8043 Clear Anodized Aluminum
- Paint

Electrical Wiring Schematics

Details for the Electrician

V.I.A. modular power components are offered in three different wiring schematics to allow you to match your specific wiring strategy to any typical building wiring plan.

Tip: All the components in an electrical system must use the same wiring schematic. The components are color coded and keyed to make it impossible to connect mismatched parts.

- Black = Four-circuit, 3+1
- Brown = Four-circuit, 2+2
- Rust = Three-circuit, separate neutrals
- Shared neutral conductors = 10 gauge
- Separate neutral conductors = 12 gauge
- Hot conductors = 12 gauge
- Grounding conductors = 12 gauge

Four-Circuit, 3+1

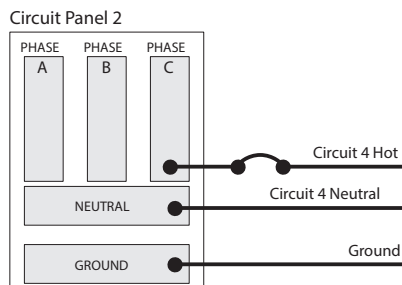
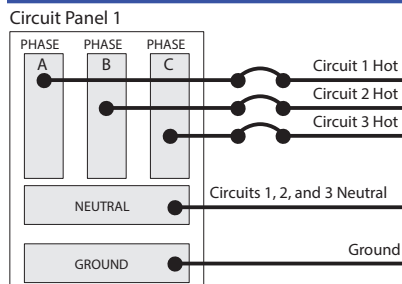

In the four-circuit 3+1 schematic, circuits 1, 2, and 3 are distributed from the first circuit panel and are supported with one shared neutral and one shared ground. Circuit 4 is distributed from a second circuit panel and is supported with a separate neutral and ground.

Single 3-Phase Circuit Panel

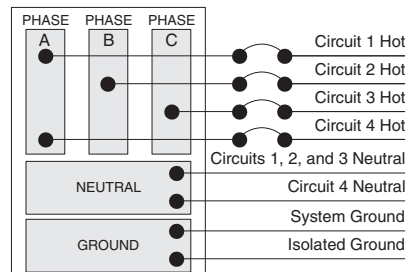

On a single 3-phase circuit panel, all four circuits are distributed as shown.

Four-Circuit, 2+2

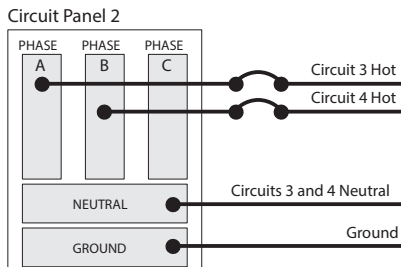
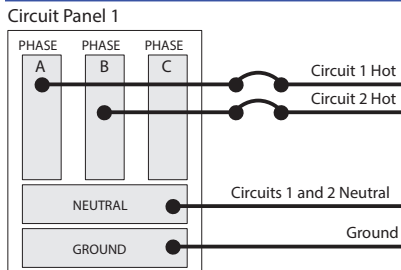

In the four-circuit 2+2 schematic, circuits 1 and 2 are distributed from two different phases from the first circuit panel and are supported with one shared neutral and one shared ground. Circuits 3 and 4 are distributed from a second circuit panel and supported by their own shared neutral and ground.

Single 3-Phase Circuit Panel

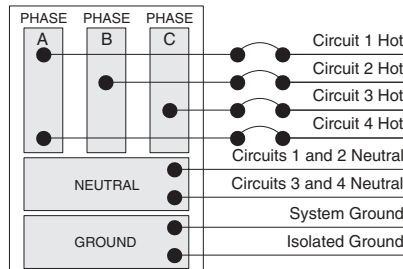

On a single 3-phase circuit panel, all four circuits are distributed as shown.

Split-Phase Circuit Panel

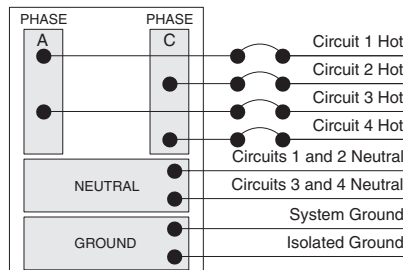

On a split-phase circuit panel, all four circuits are distributed as shown.

Three-Circuit, Separate Neutrals

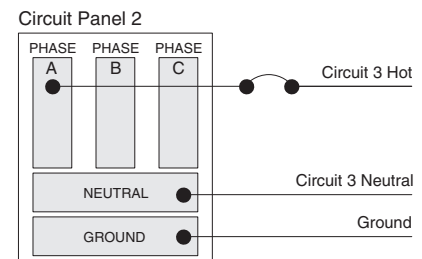
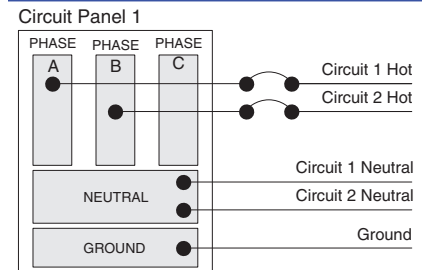

In the three-circuit, separate neutral schematic, circuits 1 and 2 are distributed from two different phases from the first circuit panel. Each circuit is supported with its own neutral and a common ground. Circuit 3 is distributed from the second circuit panel and is supported by its own neutral and ground.

Single 3-Phase Circuit Panel

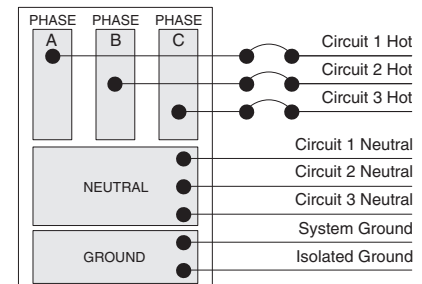

On a single 3-phase circuit panel, three circuits are distributed as shown.

Split-Phase Circuit Panel

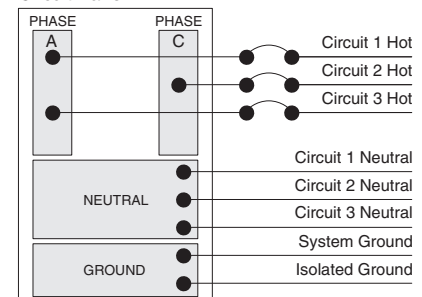

On a split-phase circuit panel, three circuits are distributed as shown.

How to Calculate Power Needs

Use This to Determine How Many Power-Ins You'll Need

When planning a power network, you must calculate the amperage requirements of all your electrical components so you can provide sufficient electricity to power them.

If your usage is not known in advance:

The National Electrical Code (NEC) allows a maximum of 13 receptacles on each 20-amp circuit. This provides up to 30 receptacles for each 3-circuit power-in.

If your usage is known in advance:

Add up the amperage used by each piece of equipment in the workstation. Whenever you reach 60 amps (20 amps times 3 circuits) from items that are likely to be used at the same time, you have reached the limit for a single power-in. Specify another power-in and continue until all equipment is powered.

If the circuits will normally be subject to a continuous load (three or more hours of continuous use, such as lights or computers), the NEC requires that circuit capacity be "de-rated" by 20 percent. Therefore, treat circuits used for continuous loads as if they were rated at 16 amps instead of the regular 20 amps.

Try to anticipate future increases in power requirements and build some excess capacity into your plan.

▶ See table at right for typical and actual amperage usages for components.

To calculate amperage when the wattage of a device is known, divide watts by 120.

Some appliances, such as large copiers, coffee makers, or space heaters require most of the current available on a 20-amp circuit. It is recommended that such devices be supplied with their own receptacle/circuit, directly from the building. This leaves the capacity of the furniture circuits available for the more dynamic requirements of the office equipment.

Local electrical codes vary. Consult a qualified electrical contractor or engineer for the proper planning of electrical circuits in your locale.

Approximate power consumption for common devices

• Device	• Wattage	• Amperage	• Voltage	• Number of Devices Supported on Single 20 Amp Circuit
Laptop (Low)	30	0.25	120	64
Laptop (High)	100	0.83	120	19
CPU/Desktop Computer (Low)	65	0.54	120	30
CPU/Desktop Computer (High)	150	1.25	120	13
Monitor (Low)	15	0.13	120	128
Monitor (High)	80	0.67	120	24
Phone	5	0.04	120	384
High Power Tablet	10	0.08	120	192
Lower Power Tablet	45	0.38	120	43
Desktop Printer	40	0.33	120	48
42" LCD Screen	120	1.00	120	16
Projector (Small)	50	0.42	120	38
Projector (Medium)	250	2.08	120	8
Projector (Large)	800	6.67	120	2
Desktop Lamp	20	0.17	120	96
Large Printer/Copier	1600	13.33	120	1
Small Printer/Copier	800	6.67	120	2
Paper Shredder (Small)	250	2.08	120	8
Paper Shredder (Large)	800	6.67	120	2
Desktop Fan	25	0.21	120	77
Standing Fan	125	1.04	120	15
Coffee Maker (Low)	500	4.17	120	4
Coffee Maker (High)	1500	12.50	120	1
Microwave (Low)	600	5.00	120	3
Microwave (High)	1000	8.33	120	2
Refrigerator (Low)	200	1.67	120	10
Refrigerator (High)	1500	12.50	120	1
Vacuum (Low)	200	1.67	120	10
Vacuum (High)	1500	12.50	120	1
Space Heater (Low)	400	3.33	120	5
Space Heater (High)	1500	12.50	120	1
Height-Adjustable Desk (Low Power Consumption)*	200	1.67	120	10
Height-Adjustable Desk (High Power Consumption)*	550	4.58	120	3

Tip: These calculations are estimations and are meant solely for informational purposes. It is important to conduct proper power planning for each installation to prevent overloading a circuit.

** Refer to the Height-Adjustable Desks Specification Guide for specific product information.*

Technology Components

► Specifying, pages 216–218

Monitor shroud power assembly with infeed

Monitor shrouds can be used in combination with media:scape components.

Monitor shrouds allow for the integration of display monitors within the face of a wall.

Optional camera shelf can be mounted above or below the monitor.

Product Details

► See *V.I.A. Planning Dimensions*, page 103, for important information regarding dimensional references for all V.I.A. components.

Monitor Shrouds

Monitor shrouds are available in a variety of sizes to accommodate different monitor sizes.

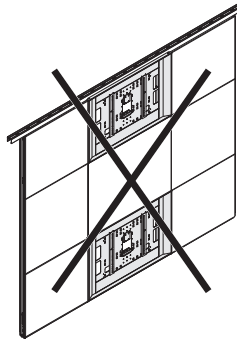

The monitor shroud cannot be positioned at the top or bottom position of the wall, for example, adjacent to the top or bottom structural horizontal.

A minimum 6" skin or 12" glass frame must be above a shroud.

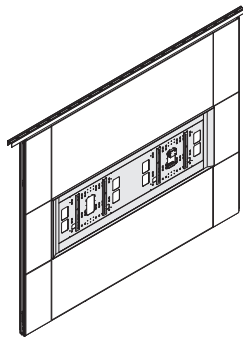

A double monitor shroud accommodates two monitors in a single shroud.

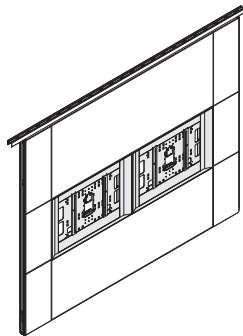

Single shrouds can be placed directly adjacent to one another.

Intermediate horizontals are included as part of the shroud assembly. Each horizontal has two cable routing holes.

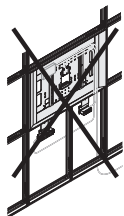

A post cannot be positioned under a shroud.

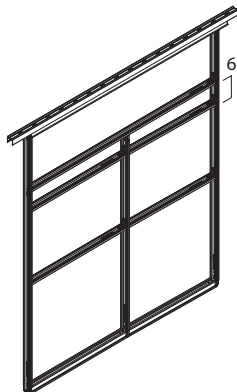

Posts on either side of a monitor shroud must extend above the top of the shroud by at least 6".

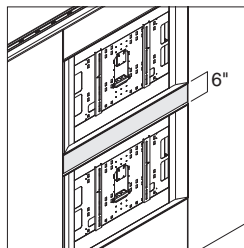

Shrouds can be placed above one another as long as they are separated by a 6"H (minimum) skin.

A shroud cannot be positioned back-to-back with another shroud.

Monitor Shroud Planning Dimensions		Single/Double	Monitor Diagonal Size Class	Monitor Width Minimum	Monitor Width Maximum	Monitor Height Minimum	Monitor Height Maximum
Width	Height						
34.5"	21.651"	Single	32"	25.26"	29.66"	12.90"	19.15"
42"	27.500"	Single	40-42"	32.76"	36.51"	18.79"	25"
48"	30.500"	Single	46"	38.76"	42.51"	21.79"	28"
54"	33.500"	Single	50-55"	44.76"	48.51"	24.79"	31"
60"	37.000"	Single	55-60"	50.76"	54.51"	28.29"	34.5"
63.5"	39.178"	Single	65"	54.26"	58.66"	30.42"	36.67"
70"	41.240"	Single	75"	60.76"	65.16"	32.49"	38.74"
80"	47.426"	Single	84"	70.76"	75.16"	38.68"	44.93"
89"	53.612"	Single	90"	79.76"	84.16"	44.86"	51.11"
96"	30.500"	Double	46-50"	86.76"	90.51"	21.79"	28.00"
103"	34.023"	Double	50-55"	46.88"	49.08"	25.27"	31.52"
120"	39.178"	Double	60-65"	55.38"	57.58"	30.42"	36.67"

Tip: The monitor diagonal size is for reference only. Refer to the actual monitor height and width dimensions to confirm compatibility.

Monitor mounting brackets are included with the monitor shroud. The mounting brackets are compatible with the VESA (Video Electronics Standards Association) mounting interface standards, and will accommodate monitor hole patterns that follow this standard in the following sizes:

- 200 mm x 200 mm
- 200 mm x 400 mm
- 400 mm x 400 mm
- 200 mm x 600 mm
- 600 mm x 600 mm

Shrouds cannot be placed back-to-back with slatwall or back-painted glass.

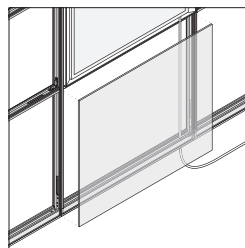

At least one of the modules surrounding a shroud should be solid to allow for cable routing.

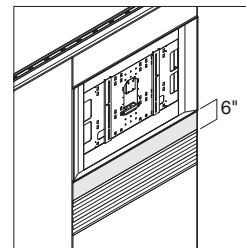

Monitor shrouds can be placed directly above or below a slatwall skin, as long as they are separated by a 6" minimum high skin.

The monitor shroud is designed to support a maximum weight of 200 pounds.

The optimal mounting height for a monitor will depend on:

- the size of the monitor
- the proper viewing distance from the user (1½" – 3 times the monitor size)
- table height where users are seated
- if there is an "outfield"

In general, the following mounting heights are recommended for these settings:

- Lounge-height: 31" AFF (Above Finished Floor) minimum
- Desk-height: 34" AFF (Above Finished Floor) minimum
- Stool-height: 43" AFF (Above Finished Floor) minimum

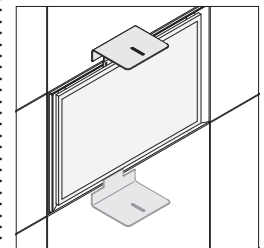

Optional camera shelf can be mounted above or below the monitor. *Tip: The recommended weight capacity of a camera shelf is 25 pounds.*

Display monitors can be surface mounted to steel skins.

► See *Hang-On Components*, page 94, for more information.

The camera shelf can be position anywhere along the top and bottom horizontal edge of the shroud.

Wiring and Cabling

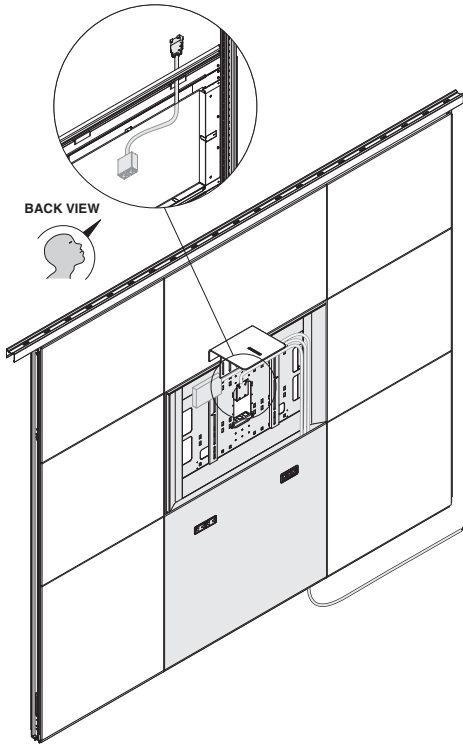

Power and communication cabling is housed within the shroud. Cabling can be routed from the ceiling or the floor.

The shroud includes a power assembly with two simplex receptacles.

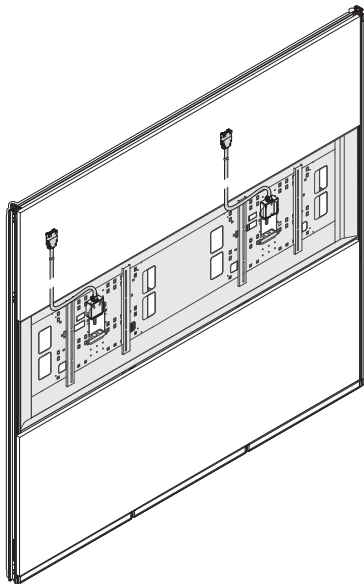

When specifying a double monitor shroud, a second power assembly should be specified to accommodate a camera (when a camera shelf is specified).

The power assembly can be electrified by using a modular power connector or a hardwire connection.

The infeed conduit on the power assembly is 12' long (for both modular and hardwire).

The modular power assembly is rated for 20 amps, and can be configured in any of three wiring schematics:

- 4 circuit 3+1
- 4 circuit 2+2
- 3-circuit separate neutrals

The power assembly connector is configured to connect to circuit 1.

If extra power receptacles are needed, an additional power assembly can be installed in a shroud by field drilling additional mounting holes.

The shroud assembly will include knockouts and data adaptors for three internal data jacks.

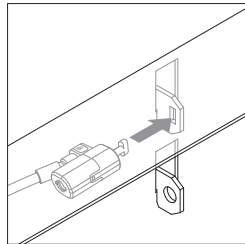

Kensington Lock
or

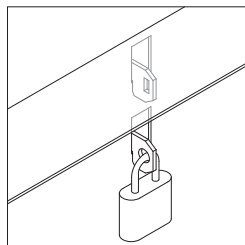

Padlock

The shroud assembly will include fittings for security locks.

Surface Materials

Monitor shroud

- 8043 Clear Anodized Aluminum
- Paint

V.I.A. and Roam Single Wall Mount for Microsoft Surface Hub 2

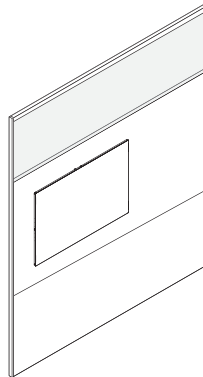

Surface Hub 2, ordered separately, is surface mounted to solid skins of variable sizes and configurations.

▶ See www.steelcase.com

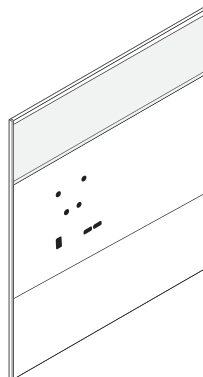

Solid skins can be specified with cutouts as required to support the application of the Surface Hub 2.

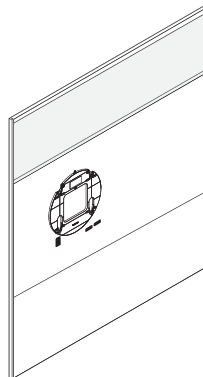

Skin cutouts include holes for installation of the Roam wall mount (ordered separately).

Solid skins can be specified with cutouts as needed to serve the application of the Surface Hub 2. Cutouts will include fastening holes for the mounting disk as well as cutouts for power and communication.

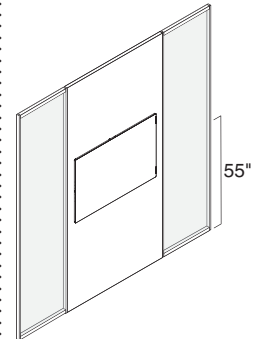

The recommended mounting height for the Surface Hub 2 is 55" to center.

Surface Hub 2 can be applied to portrait or landscape oriented skins.

The Surface Hub 2 can be surface mounted to V.I.A. solid skins (steel, veneer, and laminate). Cutouts are not available on ceramic skins.

The weight of the Surface Hub 2 is supported by the skins. No additional internal structure is required (unless needed to facilitate electrical brackets).

Surface Hub 2 cable management cut-out will embed the four fastening holes for the Roam single wall mount. Other cutouts for power and communication will be positioned to remain hidden behind the Surface Hub 2 monitor using planning guides for electrical components.

▶ See page 89

Surface Hub 2 cannot be mounted in a position that extends beyond the edge of the skin.

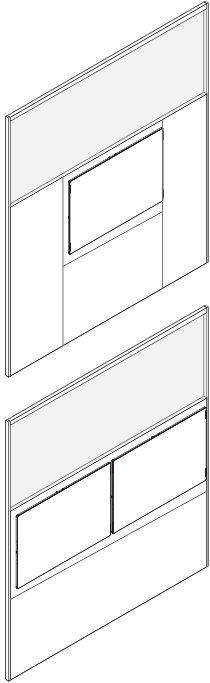

The Surface Hub 2 can be placed in a single application as well as a side by side configuration on a single, landscape oriented skin.

A single skin can be configured with up to two sets of Surface Hub 2 cutouts (in landscape orientation), depending on the skin width.

The Roam single wall mount for Surface Hub 2 is only orderable through your A/V partner, not through Steelcase.
 ▶ See www.steelcase.com

The Surface Hub 2 is not compatible with V.I.A. monitor shrouds.

When mounted on V.I.A., the Surface Hub 2 does not project more than 4" from the surface of the wall, complying with building code guidelines for protrusion into the circulation path.

Existing skins can be field cut to retrofit a Surface Hub 2. New intermediate horizontals may be required for power and data cutouts.
 Tip: See configuration matrix for minimum skin sizes.

Cutouts for Surface Hub 2 can be specified in four different configurations depending on wall planning requirements and power and data needs for the specific Surface Hub 2 application.

Power and data cutouts are positioned to be hidden by the Surface Hub 2.

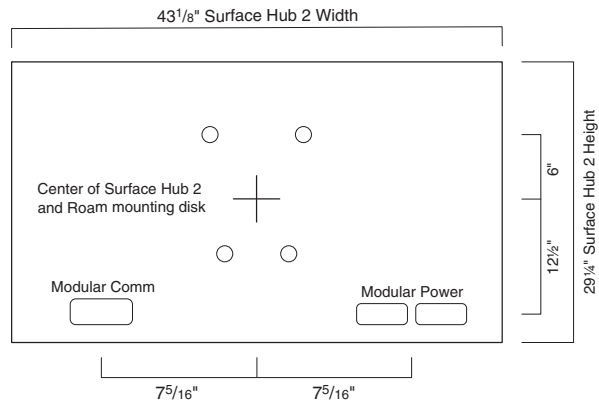

Modular power and modular data

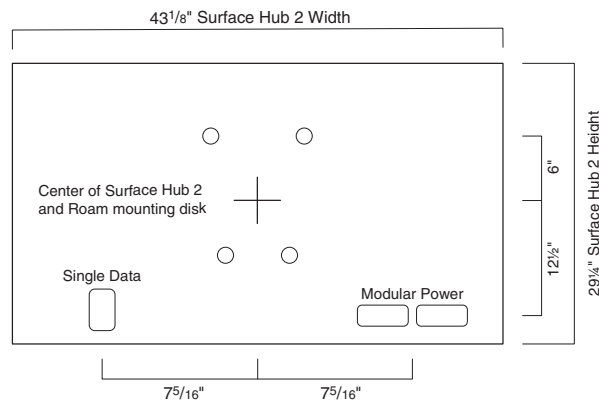

Modular power and single data - no box

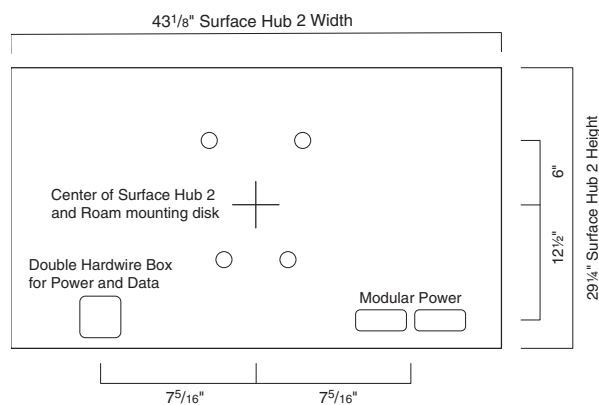

Modular power and double hardwire box

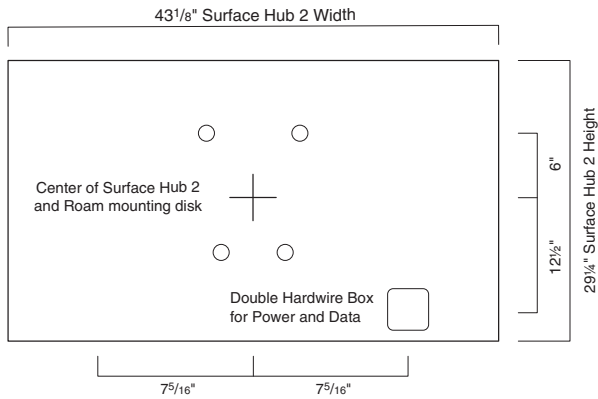

Double hardwire box for shared power and data

The centerline of the Roam single wall mount fastening holes aligns with the centerline of the Surface Hub 2.

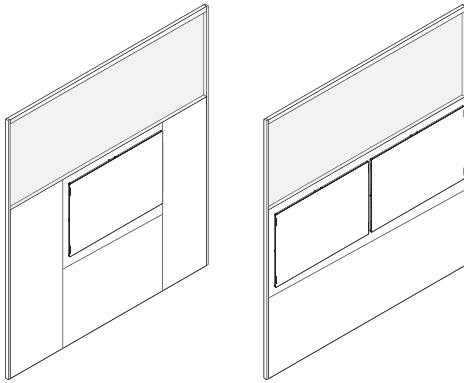

The minimum planning dimensions for skins with Surface Hub 2 cutouts vary based on skin type and Surface Hub 2 configuration.

Skin Type	Surface Hub 2 Configuration	Minimum Plan Width	Minimum Plan Height
Steel and Laminate	Single	46"	36"
Veneer	Single	51"	42"
Steel and Laminate	Side by Side	89"	36"
Veneer	Side by Side	94"	42"

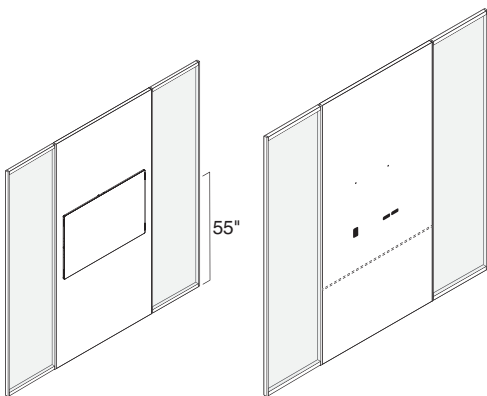

Intermediate horizontals are added as needed to accommodate electrical cutouts.

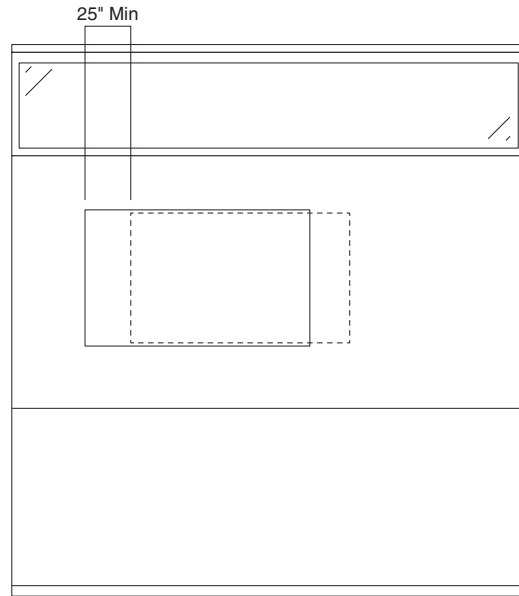

When positioning two of the Surface Hub 2 products with modular power on opposing sides of a wall, they must be offset by at least 25".

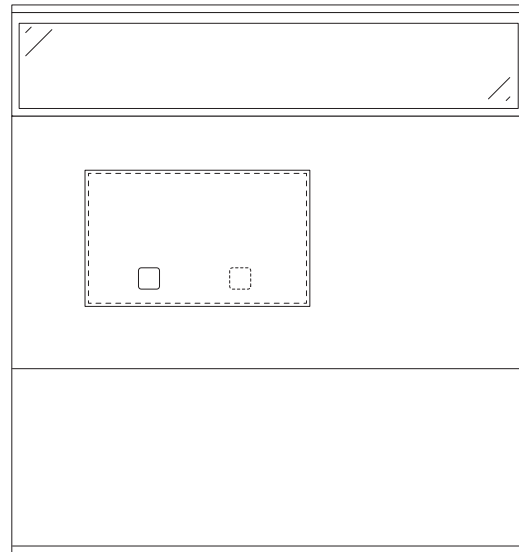

When using a double box for shared power and data, two Surface Hub 2 products can directly align in back to back applications.

85" Microsoft Surface Hub 2 can be mounted to V.I.A. solid wall using the Roam floor supported wall mount.

Mounting hardware can be fastened directly to solid skins.

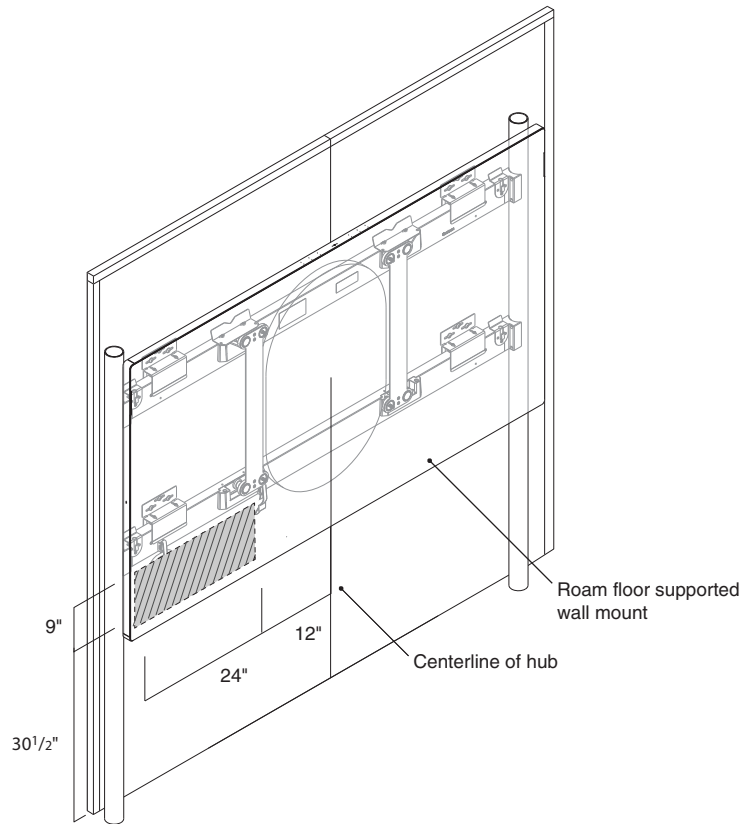

It is recommended to place power receptacles in this 24"W x 9"H high zone as shown above.

Roam floor supported wall mount is available through Microsoft authorized device resellers.

V.I.A. and media:scape Tables—Wiring and Cabling

Internal clearance for media:scape scaler behind monitor shroud

Internal power assembly behind shroud for powering monitor and camera

Data connector/coupler from media:scape scaler to communication faceplate

Modular communication faceplate or NEMA faceplate with hardwire box for HDMI cable from media:scape scaler

Modular power for media:scape scaler.

CODEC, if required, is installed in ceiling or switch closet.

Power assembly infeed for monitor shroud

Scaler, CODEC, and all other media:scape components are not included with the monitor shroud.

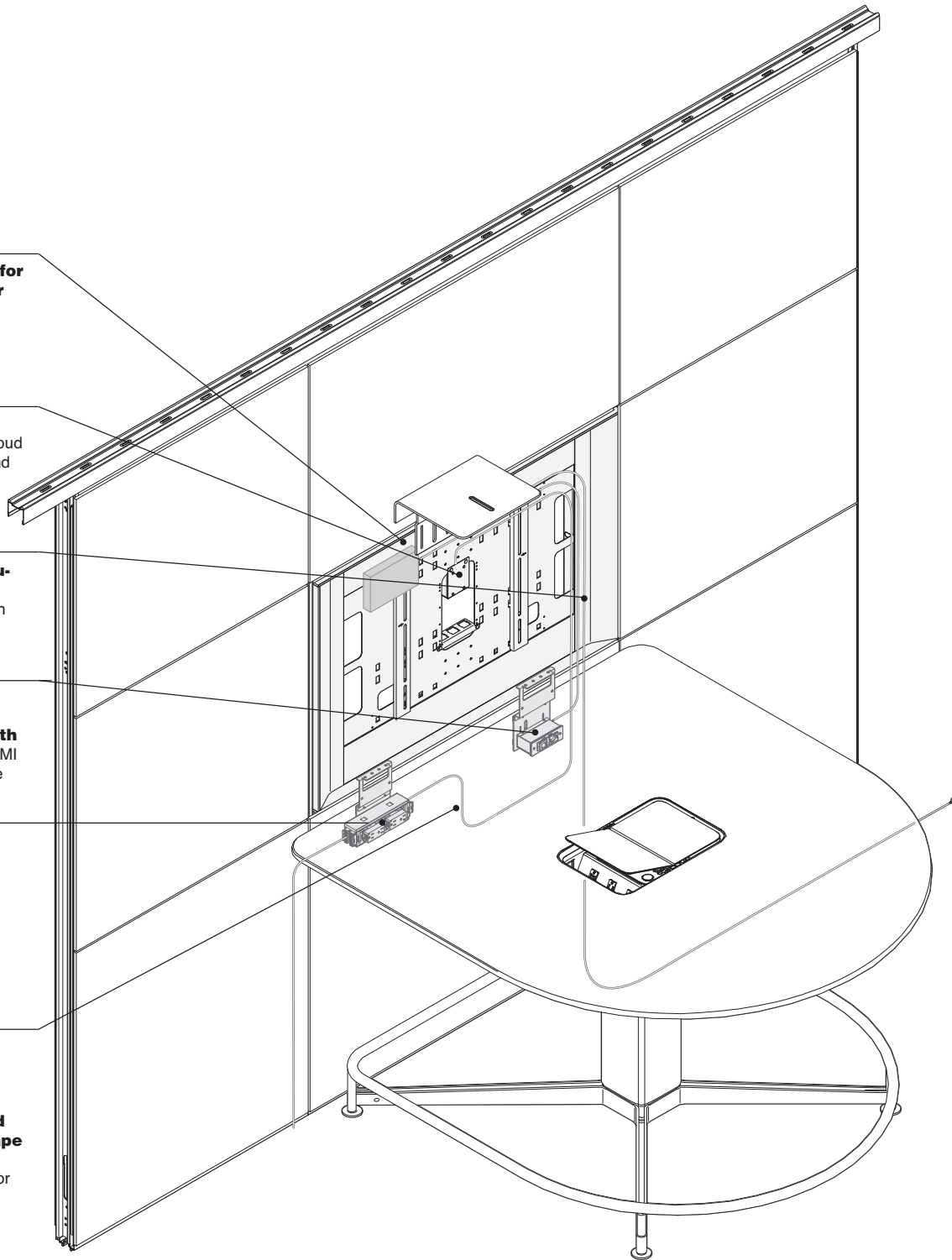

Hang-On Components

V.I.A. is designed to support Steelcase worksurfaces and hang-on storage components.

Posts that support hang-on components must extend to the ceiling.

All structural posts are slotted and configured for Steelcase hang-on mounting brackets and worksurface support brackets.

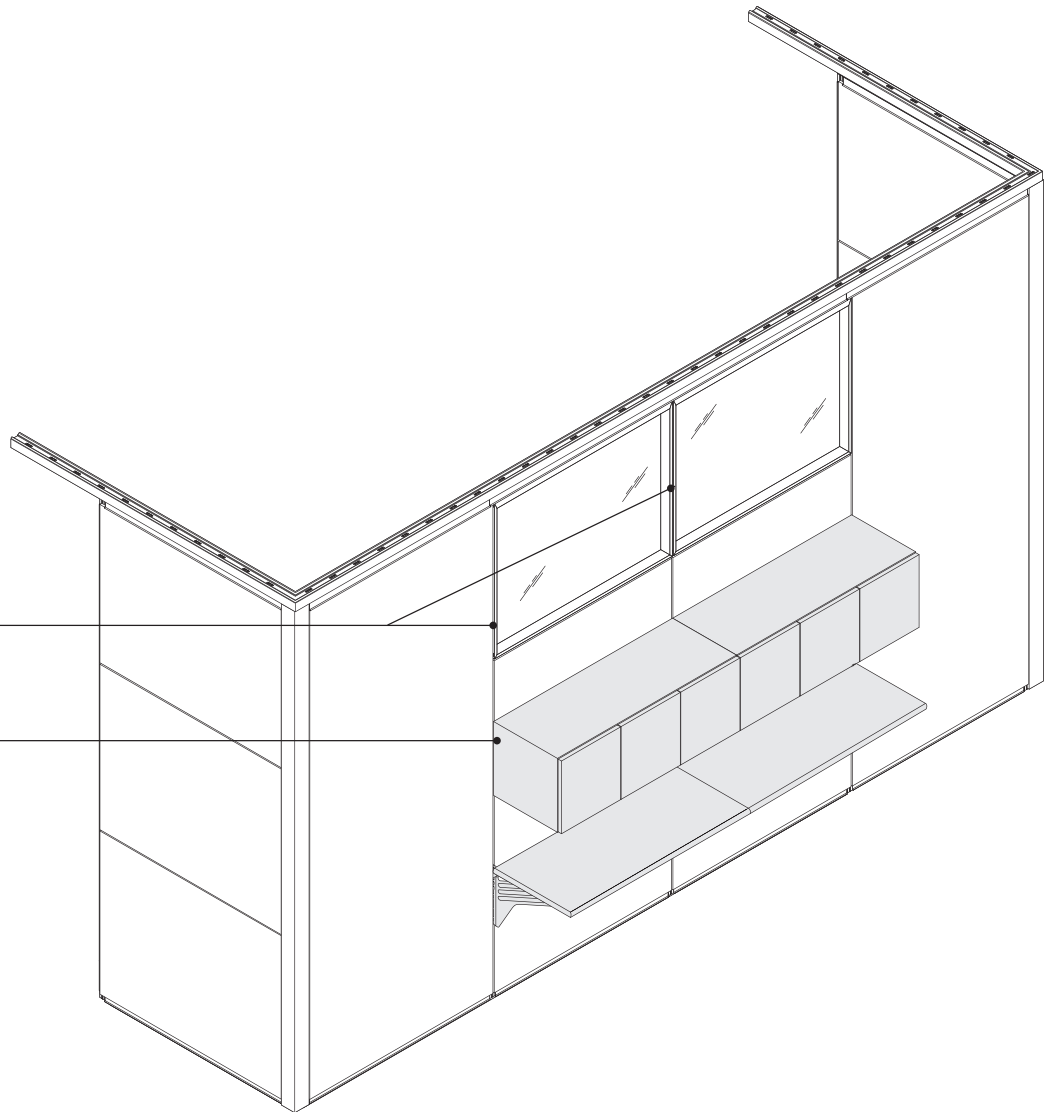

Product Details

► See *V.I.A. Planning Dimensions*, page 103, for important information regarding dimensional references for all V.I.A. components.

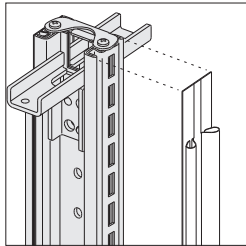

V.I.A. posts are slotted to receive brackets for hang-on storage components.

When planning with furniture to be mounted to slots, V.I.A. wall modules should be configured to the same width as the furniture.

Tip: Off-module brackets can be used to mount bins and shelves to wall modules that are no more than 12" smaller than the bin.

► See *Storage Specification Guide* understanding pages for more information.

A single post can support up to ten hang on components.

A maximum of five components can be loaded per side of each module.

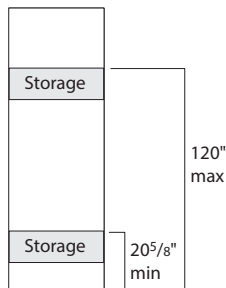

Components can be mounted at any vertical position on the wall between 120" and 12³/₈" AFF (Above Finished Floor), at increments of 1.03". The minimum height will depend on the height of the cabinet.

Minimum Mounting Height

Universal Sliding Door Bins	19 ¹¹ / ₁₆ "
Universal Over the Case Bins	19 ¹¹ / ₁₆ "
Universal In the Case Bins	19 ¹¹ / ₁₆ "
Universal Curved Front Bins	18 ¹¹ / ₁₆ "
Universal L-Shelves	18 ¹¹ / ₁₆ "
Elective Elements - Single-High Overhead Cabinets	18 ¹¹ / ₁₆ "
Elective Elements - Organizer	11 ¹ / ₈ "

When planning with V.I.A. on low profile floor, wall-mounted components cannot be mounted on the wall due to load limitations on the floor.

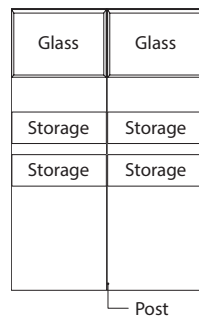

Posts that support hang-on components must extend to the ceiling.

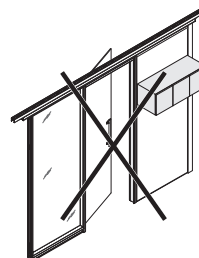

Hang-on storage components should not be mounted in a wall directly adjacent to a door frame (reversible or sliding).

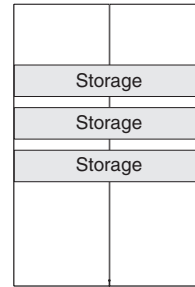

Vertical reveal

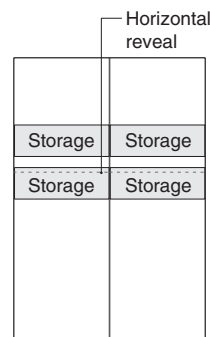

Horizontal reveal

Hang-on components, except for Elective Elements, can span vertical reveals. All components can span horizontal reveals.

Tip: When planning for Elective Elements hang-on components, the skin width should be the same dimension as the component width.

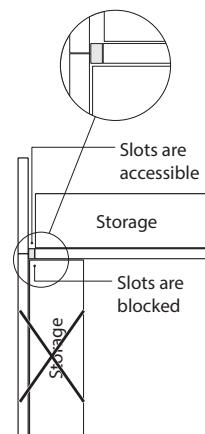

Hang-on components cannot be mounted at an inside corner when using a T adapter, as slots are not accessible.

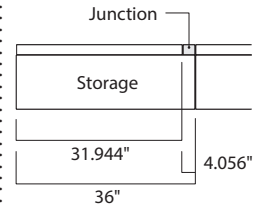

Hang-on components can span junctions. Allow for 4.056" when planning for the adjacent skin width.

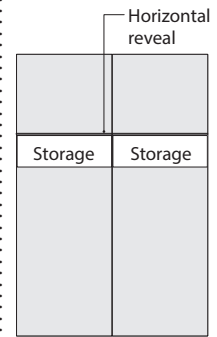

When using segmented skin configurations, skins can be planned so that the reveals will orient to the top of the hang-on unit.

When mounting two or more cabinets side by side, ganging straps are required.

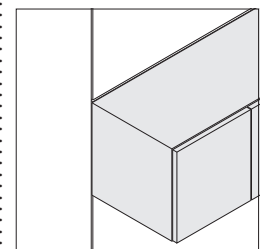

Universal Sliding Door Bins with sliders, Over the Case Bins, In the Case Bins, and Elective Elements bins will align exactly with the top of the skin. Other components will be offset slightly.

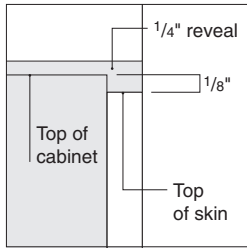

Universal Curved Front Bin

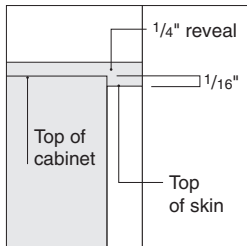

Universal L-Shelf

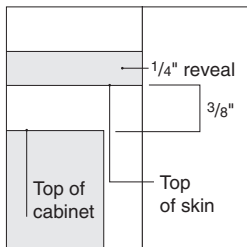

Elective Elements organizer and Open Shelf

The use of hang-on storage has no negative effect on acoustic performance.

Hang-on components can be mounted adjacent to mini ends and door frames, providing they do not interfere with the operation of the door.

Since most hang-ons are not designed to be viewed from the back, it is not recommended to mount hang-ons over glass frames, except for back-painted glass.

Pattern and etched glass may obscure the backs of the cabinets, but may still allow visible shadows.

When planning in a seismically active areas, consult with a structural engineer before considering the use of V.I.A. mounted hang-ons.

Hang-on components that are designed with V.I.A. compatible brackets include:

- Universal Sliding Door Bin
 - Universal Sliding Door Bin —Wood
 - Universal Over the Case Bin, Flat
 - Universal Over the Case Bin, Radius
 - Universal In the Case Bin, Flat
 - Universal In the Case Bin, Flat —Wood
 - Universal Curved Front Bins with Steel and Wood Doors
 - Universal Vertical Off-Module Bracket
 - Elective Elements Single-High Overhead Cabinets with Hinged Doors (15" deep)
 - Elective Elements Single-High Overhead Cabinets with Sliding Doors (15" deep)
 - Elective Elements Single-High Overhead Cabinets—Open (15" deep)
 - Elective Elements Organizer Shelves with Dividers (15" deep)
 - Elective Elements Open Shelves (15" deep)
 - Wall-Mounted Folio
- ▶ See corresponding specification guides for further information.

Convey wall suspended cabinets can be hung on V.I.A. walls using structural beams. Maximum post spacing when mounting Convey is 48".

▶ See *Steelcase Health Specification Guide Volume 2*.

Structural Beam

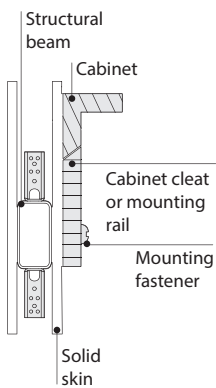
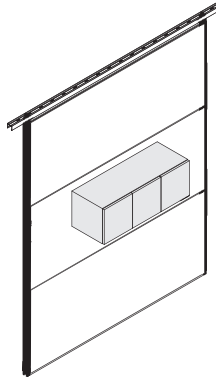

Structural beams are used to provide internal reinforcement in those applications where surface mounted storage is desired.
▶ Specifying, page 125

In some cases the preferred technique for mounting furniture is by fastening through a solid skin. In those cases, a structural beam is specified to provide internal reinforcement to support the weight of the cabinet.

Structural beams are used when mounting Convey suspended cabinets.
▶ See *Steelcase Health Specification Guide Volume 2*.

The weight of the cabinet is entirely supported by the structural beam and the adjacent structural framing components. There is no weight applied to the skin itself.

The structural beam provides the necessary reinforcement to receive fasteners as recommended by the cabinet manufacturer. All required holes are drilled into the skin and beam by the installer, as defined by the cabinet manufacturer.

Structural beams are parametric in width, with a minimum planning width of 12", and a maximum planning width of 120". The structural beam height is 4".

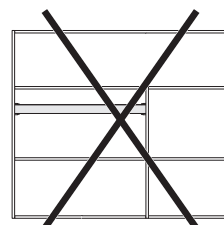
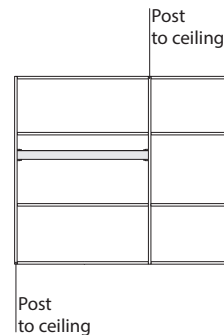

Posts that support a structural beam must extend to the ceiling.

Structural beams can be used to mount onto steel, laminate, or veneer skins.

Structural beams can only be placed behind solid skins on both faces. They cannot be placed adjacent to slatwall or backpainted glass.

No power can be routed vertically through a structural beam.

The mounting height of the structural beam is determined by the relative height of the mounting rail and the cabinet.

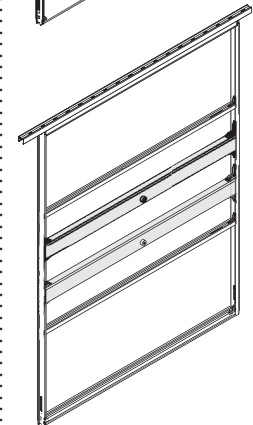
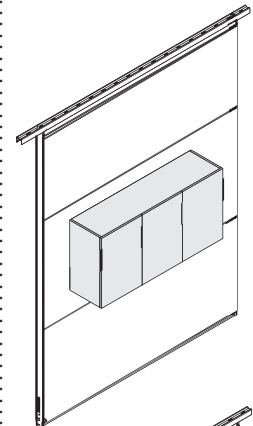

When the cabinet requires two mounting rails, two structural beams must be used accordingly.

Structural beam is positioned in 1.23" increments above the floor.

Cabinets can be mounted from both faces of a structural beam.

Structural beams can be mounted adjacent to one another, sharing the same post.

Structural beam can be no closer to the ceiling than 13.5" (to centerline of beam).

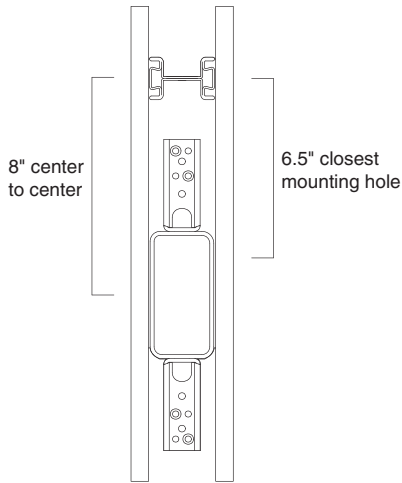

Structural beam must be positioned at least 8" away from an intermediate horizontal (center to center). The fastening points for the mounting rail can be no closer than 6.5".

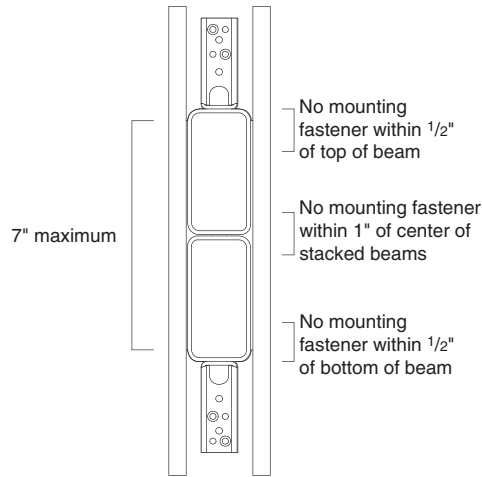

Two structural beams can be stacked together prior to mounting, creating an 8" high beam. If vertical distance between two fastening points is between 3"-7", use two stacked beams.

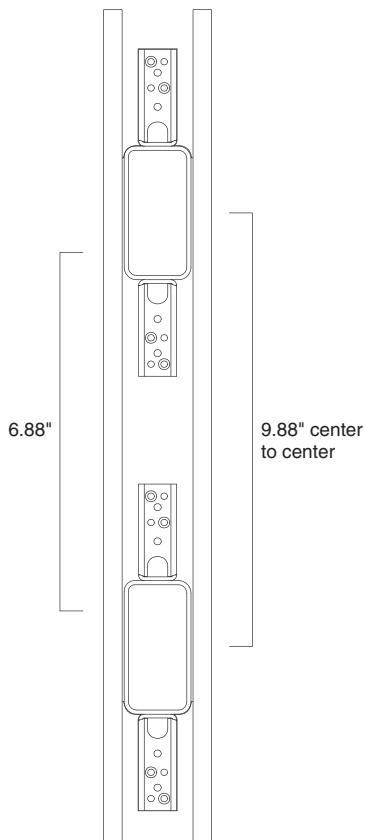

When mounted individually, two structural beams can be positioned no closer than 9.88" to one another (center to center). The fastening points for the mounting rail can be no closer than 6.88".

Universal Systems Worksurface Supports

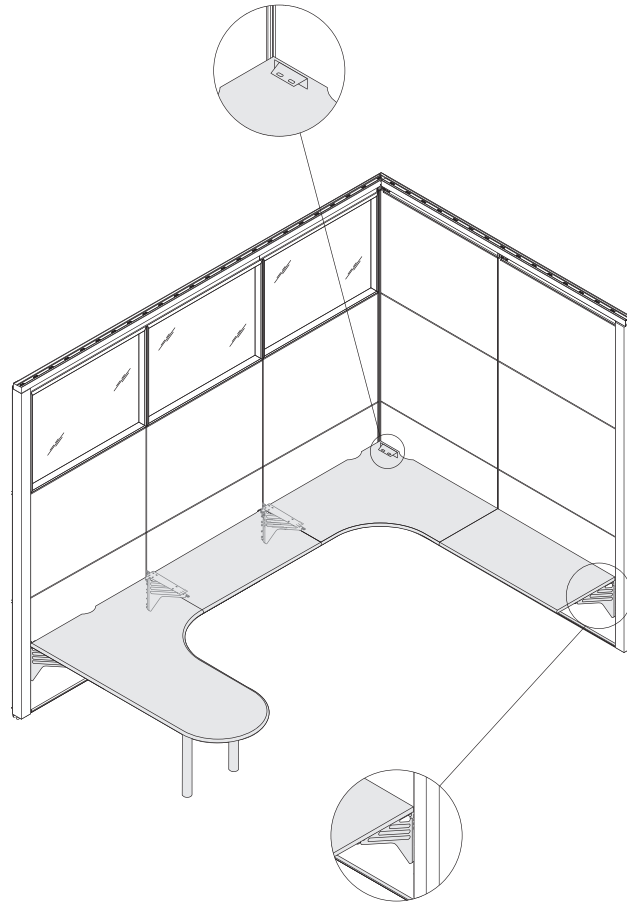

V.I.A. compatible cantilever brackets (VUCANT) and side support brackets (VUSSBR) are specifically designed to integrate with V.I.A.'s post and reveal. Universal worksurfaces can be mounted to V.I.A. walls using these supports.

► See the *Answer Solutions Specification Guide* for a full listing of available worksurfaces.

Universal worksur-
faces are not parametric. When applying worksurfaces to V.I.A., wall module sizes should be planned to correspond to the worksurface width.

V.I.A. walls do not require the use of return panels to properly support wall mounted worksurfaces.

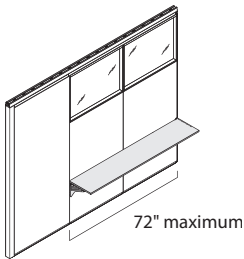
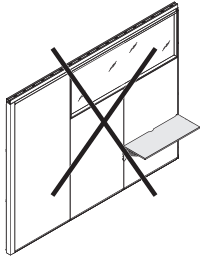
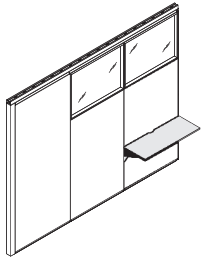

V.I.A. posts which support worksurface brackets must extend to the ceiling.

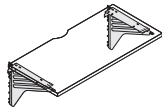

24" deep worksurfaces: Can be properly supported by cantilever brackets alone, or a combination of cantilever and side support brackets, pedestals, legs (post, open loop, or closed loop), and 1.5H storage with intermediate support.

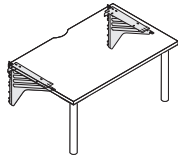

30" deep worksurfaces: In addition to cantilevers, straight and transition worksurfaces require additional floor support along the front edge at each end, such as side support brackets, pedestal, or post leg.

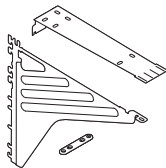

Cantilevers support worksurfaces at any height in 1" increments. Cantilever is non-handed and can be used to support either end of a worksurface, or shared to support two worksurfaces at the same height simultaneously. One tie plate ships with each cantilever.



Side support brackets support worksurfaces at any height in 1" increments. Brackets ship as a left-hand and right-hand pair and are ordered separately.

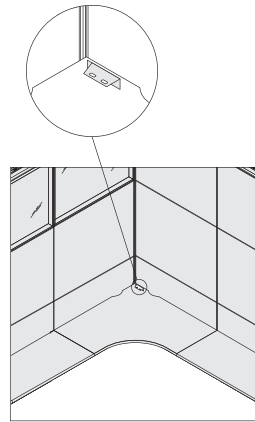
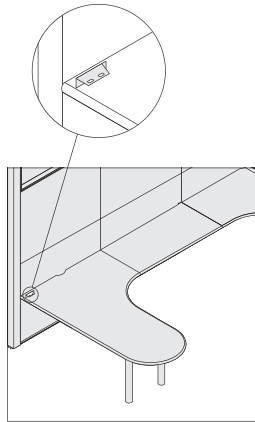

Single side support brackets can be used to support the user's side rear corner of bullet peninsula, or the rear corner of a corner worksurface.

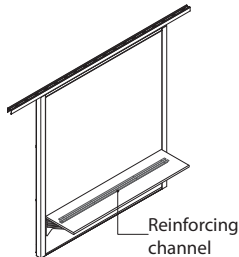

Long worksurface spans must be supported with cantilevers, pedestals, legs, or other supports at least every 54". Reinforcing channel (TS7WKSPPT) allows the distance between supports to be increased to 60" for worksurfaces that will be heavily loaded, or up to 72" for worksurfaces with lighter expected loads. Reinforcing channel must be specified separately.

▶ See the *Answer Solutions Specification Guide*.

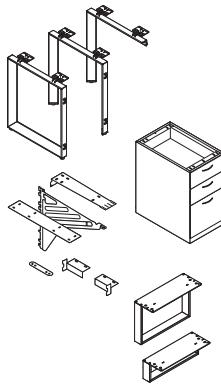

In addition to wall supported applications with cantilevers and side supports, worksurfaces can also be positioned adjacent to V.I.A. walls by specifying other components such as:

- Closed loop
- Open loop
- Half loop
- Intermediate support
- Support plate
- Columns or legs
- Pedestals without fillers

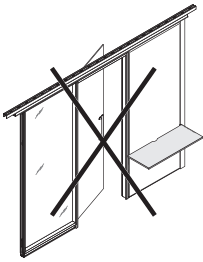

Cantilevered work-surfaces should not be mounted in a wall with a door frame (reversible or sliding).

In certain sizes and configurations, display monitors can be surface mounted to solid skins (steel, laminate, or veneer) without the need for internal reinforcement. The following guidelines are based on an overall monitor projection of 4" or less.

Surface mounting in this manner will result in holes in the skin. Monitor shrouds are recommended as the primary means of monitor integration whenever possible.

Monitor Maximum Weight			
Skin Height	Skin Width Restriction	Maximum Monitor Weight	Classification of Monitor Mounting Brackets
6"-17.99"	N.A.	N.A.	N.A.
18"-35.99"	Must be > 12"	50 lb	50 lb or less
36"-120"	36"-120"	150 lb	150 lb or less

Surface mount monitors to solid skins (steel, laminate, or veneer) (maximum 4" projection).

Mounting bracket should not be positioned closer than 6" to edge of skin.

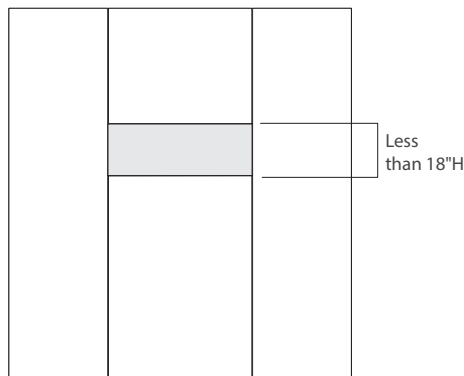

If skin height is less than 18"H, no surface mounting is allowed.

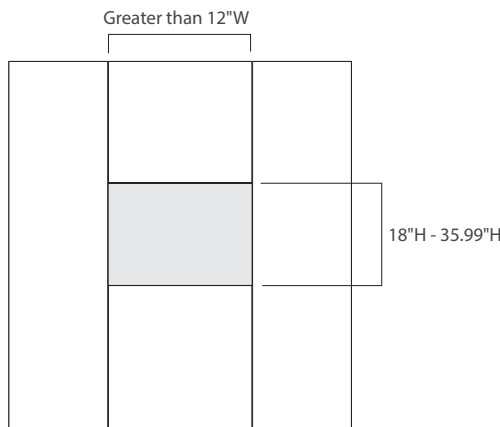

If skin height is 18"H-35.99"H and width is greater than 12"W, surface mounting is allowed up to 50 pounds.

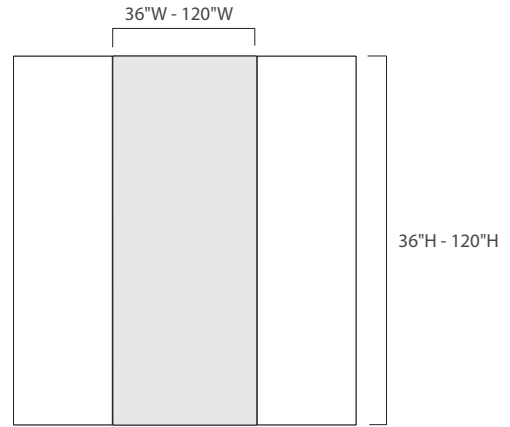

Shown Vertically

If skin height is 36"H-120"H and width is 36"W-120"W, surface mounting is allowed up to 150 pounds.

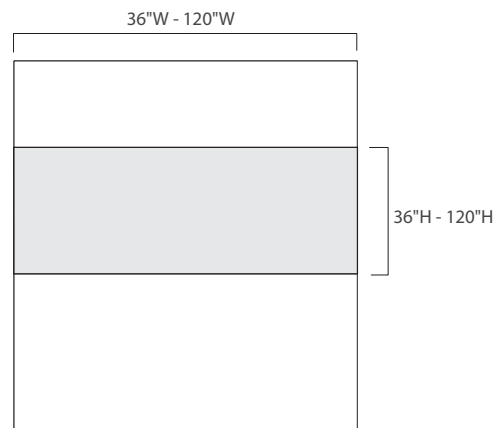

Shown As Landscape

If skin height is 36"H-120"H and width is 36"W-120"W, surface mounting is allowed up to 150 pounds.

Loading and Stability Guidelines

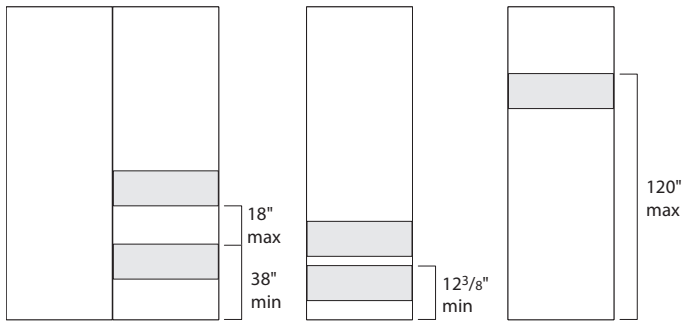

A cabinet cannot be positioned below 38" unless there is a cabinet above it within 18".

Minimum mounting height is dependent on cabinet type.

▶ See *Hang-On Components*, page 80

Tip: No more than ten components, storage or worksurfaces, can be loaded on a single post.

Example 1:

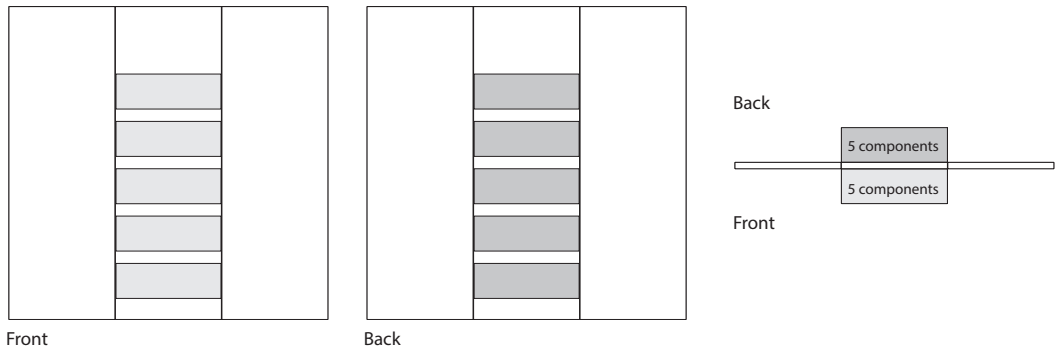

Example 2:

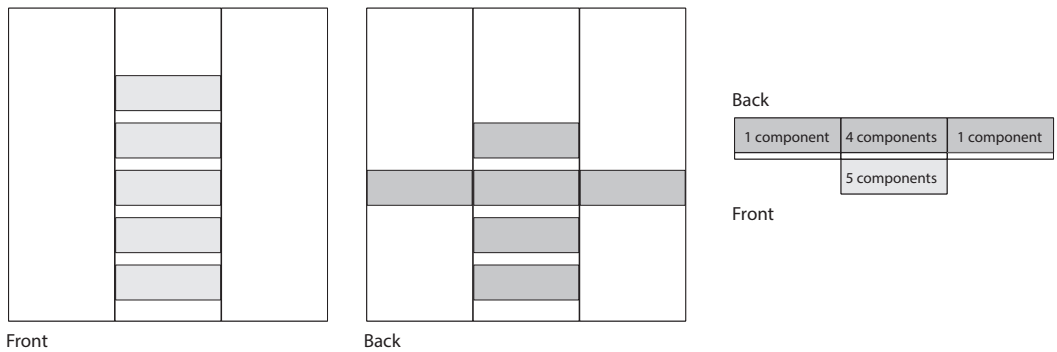

Example 3:

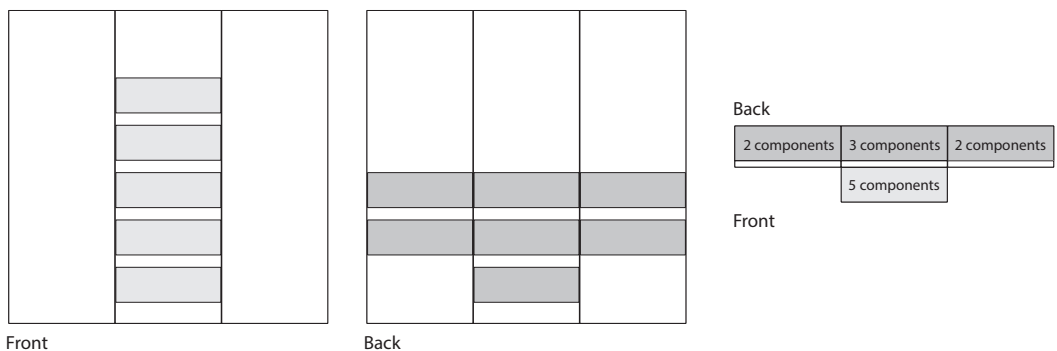

Tip: The maximum hang-on capacity on a given wall can be increased by using 180° junctions between modules to reduce the load on each post.

Example 1:

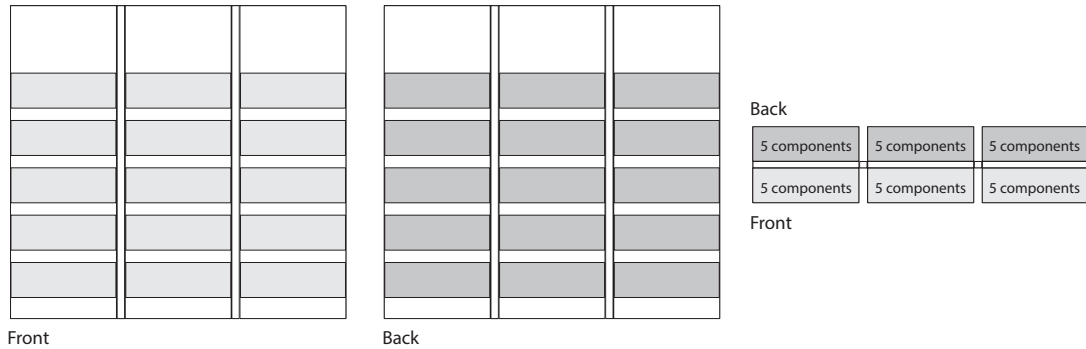

Tip: Components must be mounted in a manner where the load difference per module from one side of the wall to the other does not exceed three components.

Example 1:

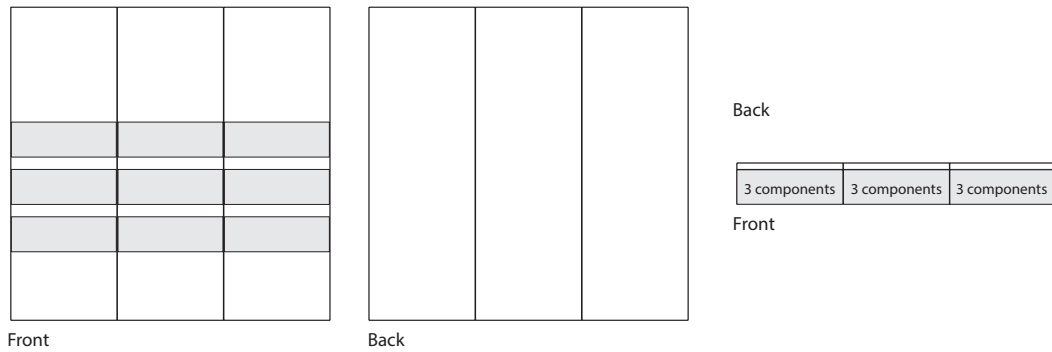

Example 2:

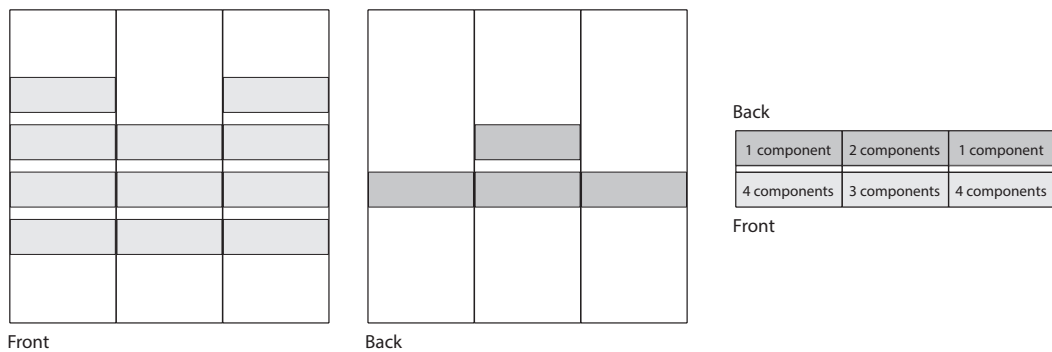

Example 3:

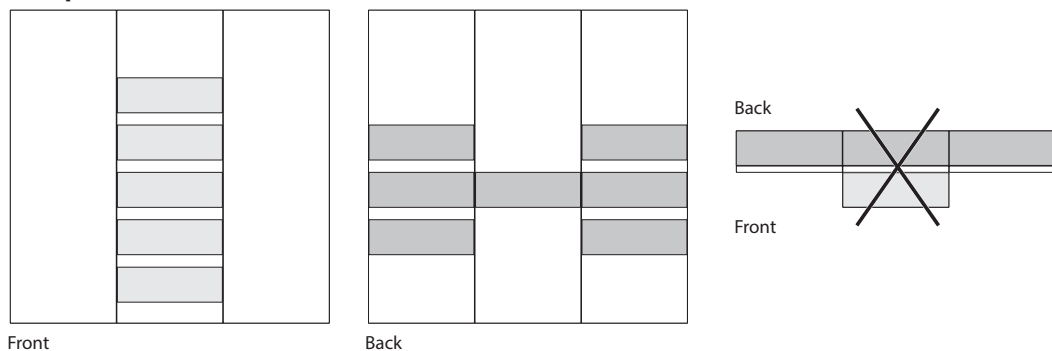

Loading and Stability Guidelines, continued

Example 4:

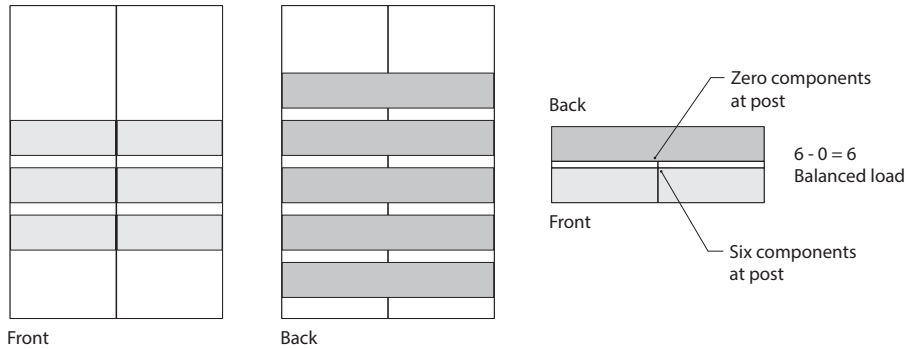

Example 5:

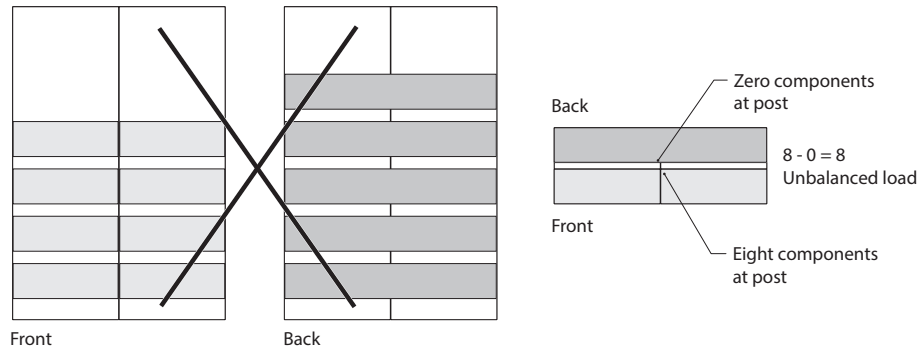

Tip: Posts that support hang-on components must extend to the ceiling.

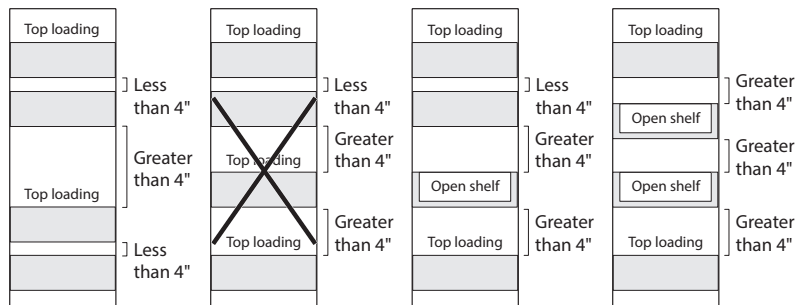
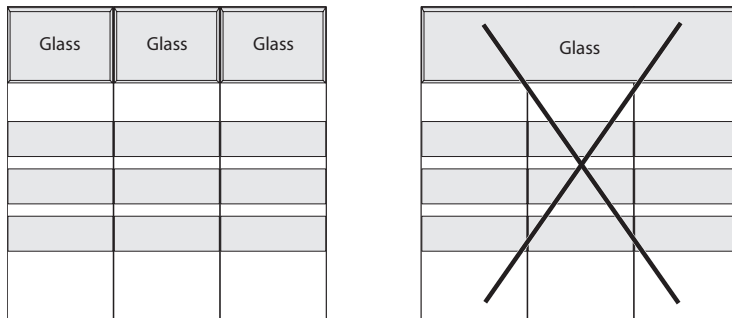

When planning for hanging cabinets with closed tops, no more than two cabinets can be positioned to allow for top loading. Cabinets must be within 4" of each other to limit top loading.

Many of the dimensional planning references for V.I.A. are established based on the position of the skin and frame reveals. To help define component dimensions in this frame of reference, V.I.A. components are specified in the context of planning dimensions, which often use virtual centerlines as a reference point. These planning dimensions are referenced in acknowledgements and other order management documents. The drawing below shows the relationship between planning dimensions, the actual component size, and the correlation to floor and ceiling.

V.I.A.

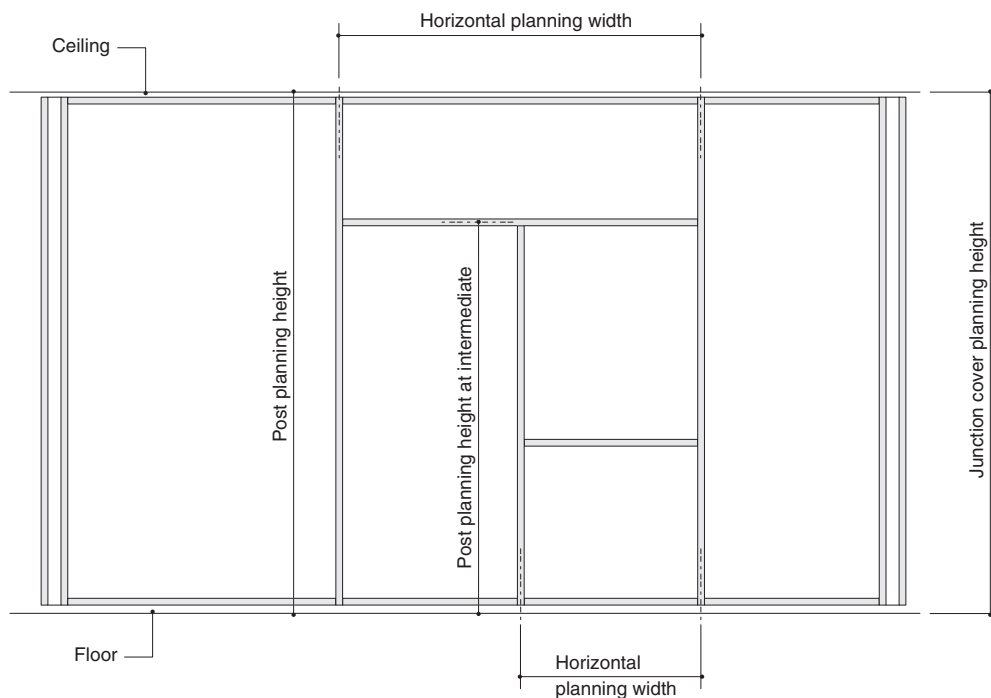
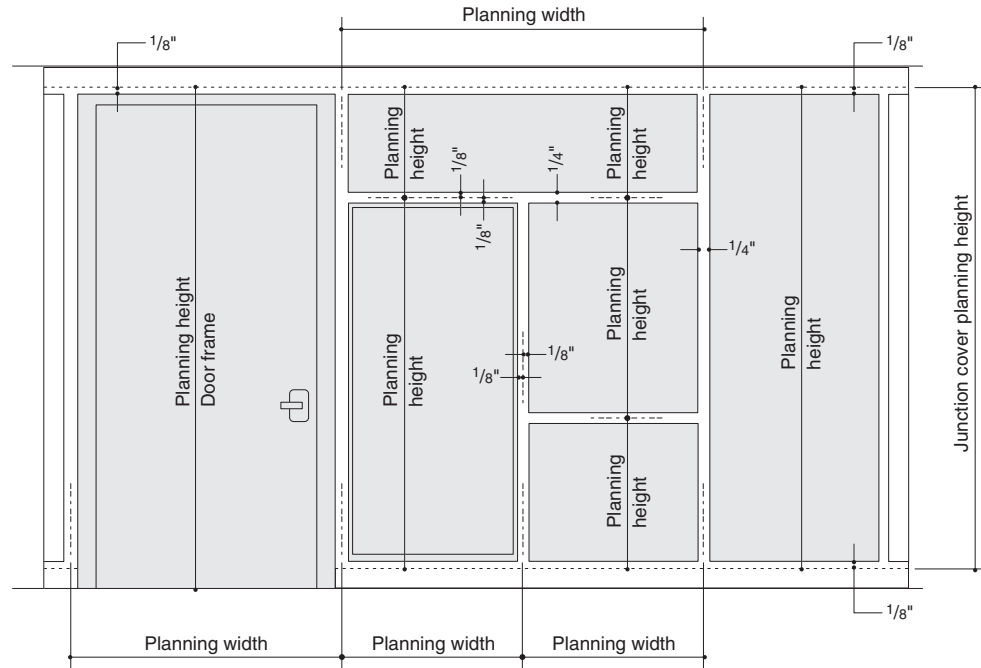

Planning with Landscape Oriented Components

When skins or captured glass frames are more than 60" wide, they are considered to be in landscape orientation.

As part of a landscape oriented wall application, planning modules with posts that are positioned no more than 75" apart can be applied without any limitation consideration as related to the need for primary structural assemblies or wall length.

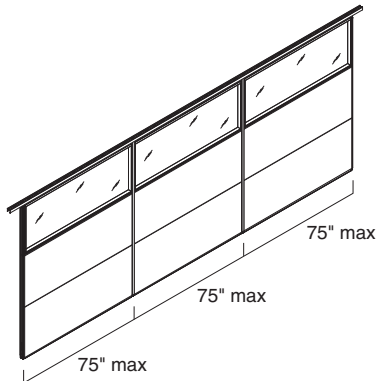

Once the post spacing exceeds 75", additional planning elements such as primary structural assemblies and/or portrait oriented modules are required.

The maximum width of a landscape oriented skin or captured glass frame, and the manner in which it can be configured with other components within a wall assembly, are influenced by:

- The ceiling height
- The positioning of intermediate horizontals
- The adjacent components

Tip: The additive elements and respective maximum dimensions are defined in the Landscape Planning Matrices on page 109.

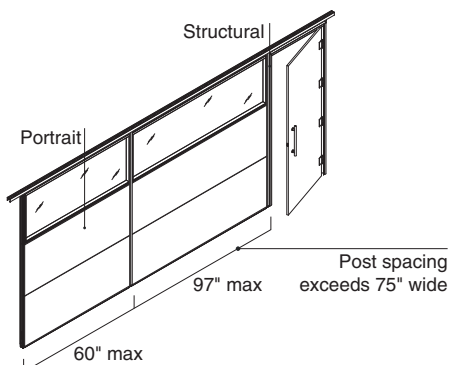

A portrait oriented module includes posts that are spaced no more than 60" apart.

Primary structural assembly can be any of the following:

- Junction (angle or 180°)
- Adapter
- Bypass
- Door frame (reversible or slider, full height or transom height)
- Mini end (anchored)
- Finished end

Posts that are intermediate height (top mount is not at the ceiling) do not provide support as applied to landscape planning guidelines.

Tip: When the ceiling height exceeds 10'-0", posts cannot be spaced more than 48" apart.

When skins or captured glass frames are more than 60" wide, they are considered to be in landscape orientation.

The maximum width of a landscape oriented skin or captured glass frame, and the manner in which it can be configured with other components within a wall assembly, are influenced by:

- The ceiling height
- The positioning of intermediate horizontals
- The adjacent components

Maximum allowable planning width increases as ceiling heights decrease.

These two examples show how the maximum allowable planning width will increase as the ceiling height decreases from 10'-0" to 8'-0".

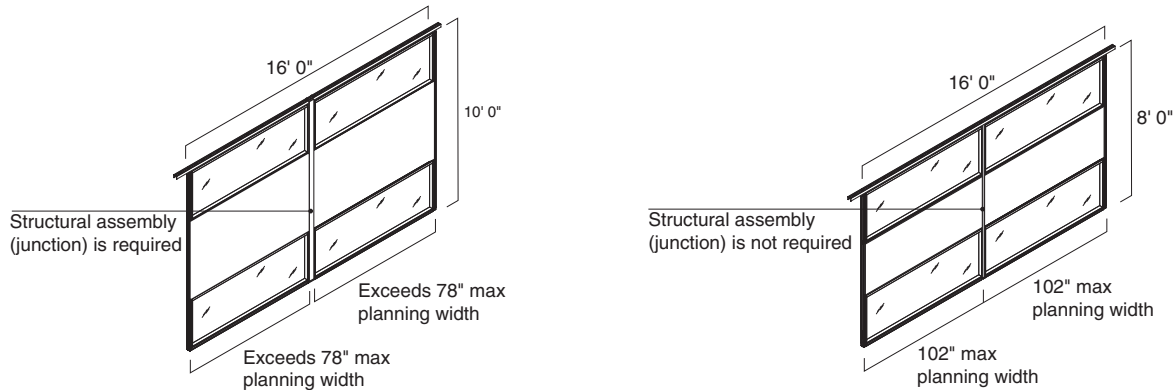

Maximum allowable planning width decreases if intermediate horizontals are positioned within 12" of the centerline of the wall.

These two examples show how the maximum allowable planning width will increase as intermediate horizontals change position.

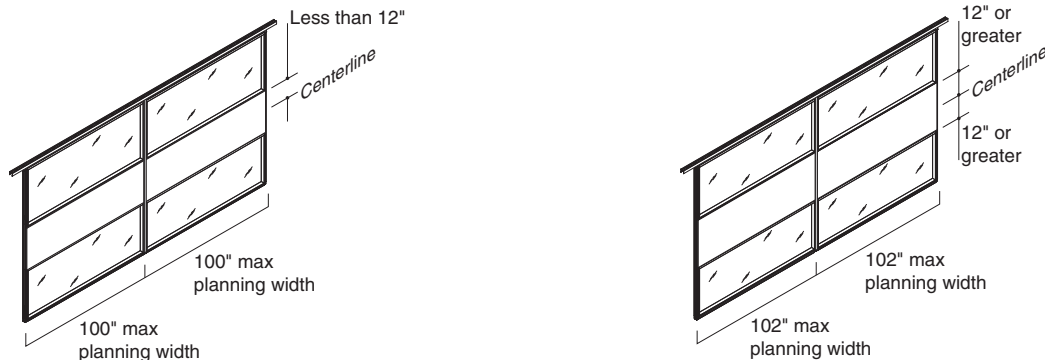

Maximum allowable planning width increases if both adjacent modules are either portrait oriented (60" or less between posts) or are a primary structural assembly. Adding a landscape module at either edge limits the maximum planning width.

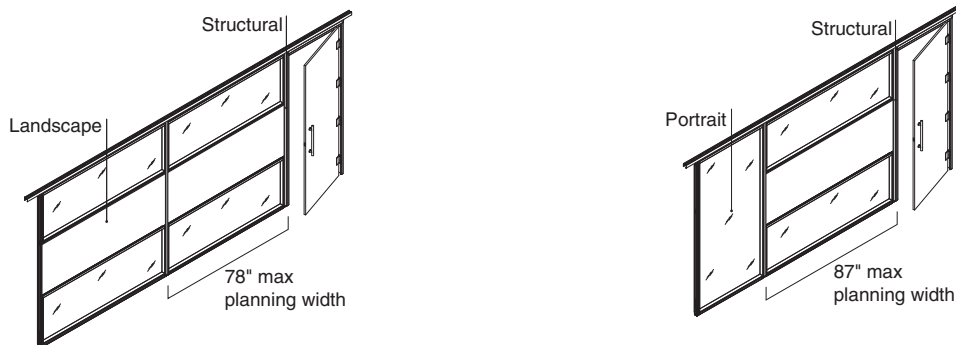

Planning with Landscape Oriented Components, continued

When two posts are more than 75" apart, they must fall within the landscape planning guidelines as outlined below.

Planning Within Spans No Greater Than 120" Wide

Regardless of ceiling height or position of horizontals, a landscape module can be any width up to 120", as long as it falls within a span of primary structural assemblies that are no more than 120 inches apart.

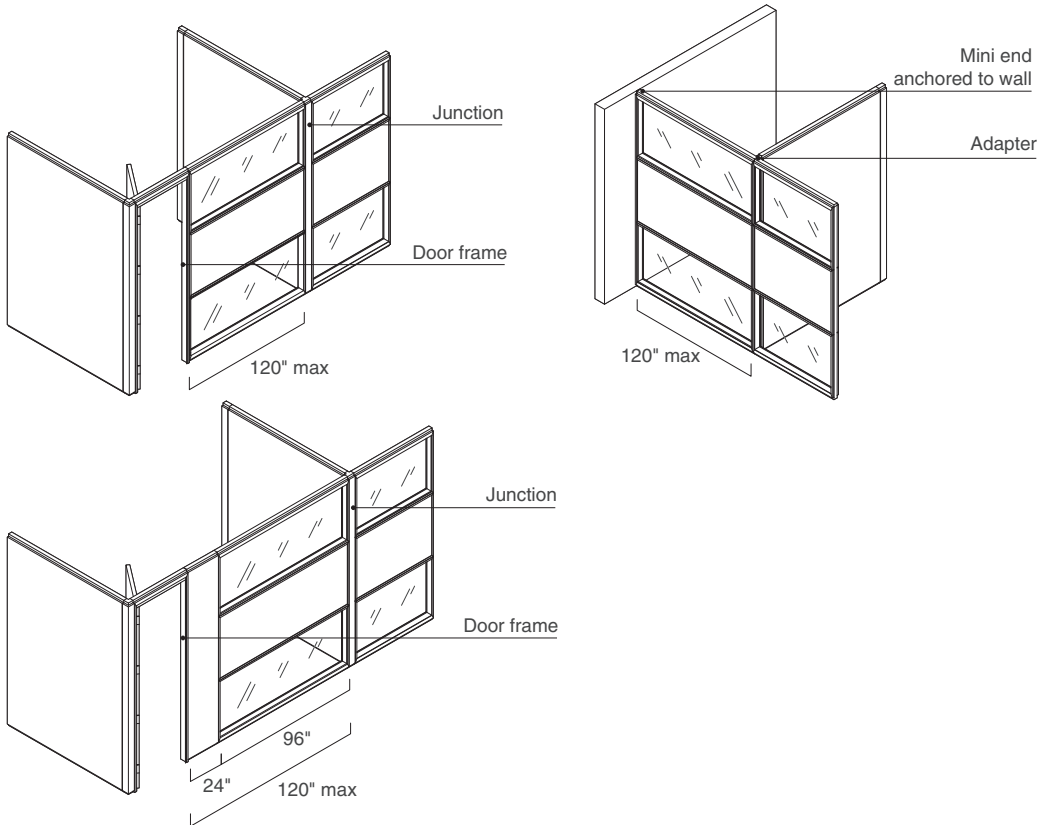

Landscape modules can be placed within spans where primary structural assemblies are greater than 120" apart if they are configured as shown below, with maximum planning widths as defined in the *Landscape Planning Matrices*, see page 109.

Portrait and/or Primary Structural Assembly at Each Edge

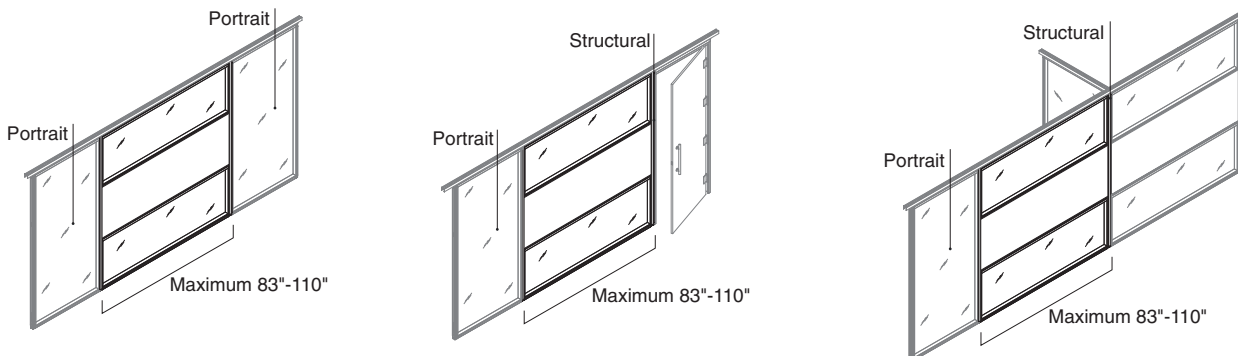

Landscape Module at Either or Both Edges

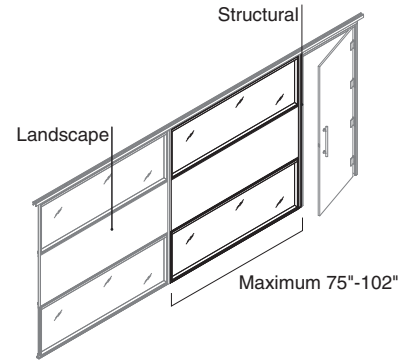
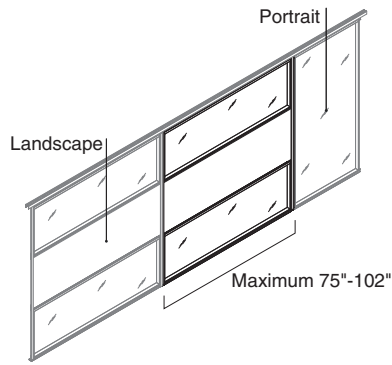
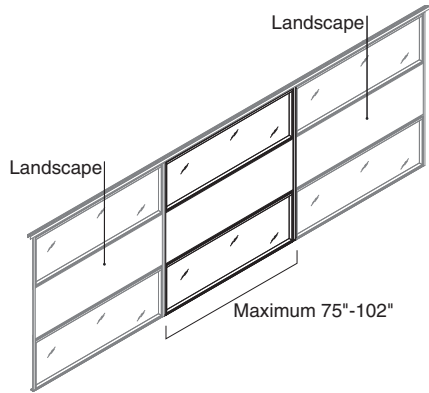

Primary structural assembly:

- Junction (angle or 180°)
- Adapter
- Bypass
- Door frame (reversible or slider, full height or transom height)
- Mini end (anchored)
- Finished end

Posts that are intermediate height (top mount is not at the ceiling) do not factor in to landscape planning guidelines.

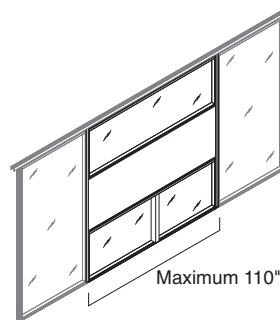
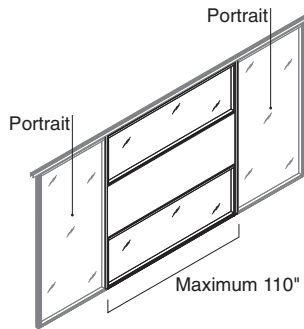

Tip: Adding an intermediate height post does not increase the maximum width of the landscape frame.

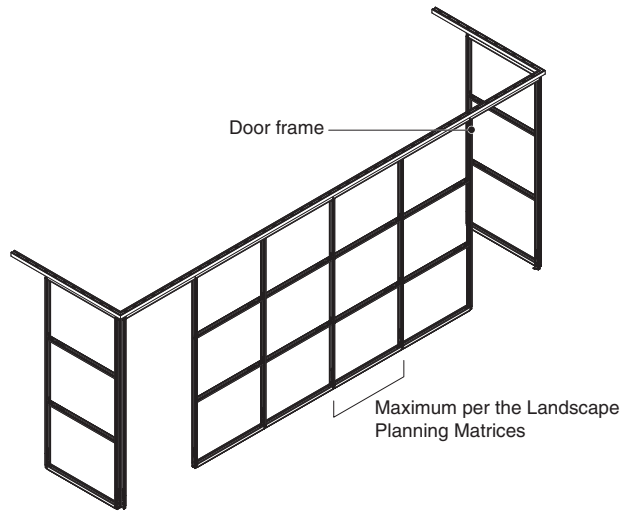
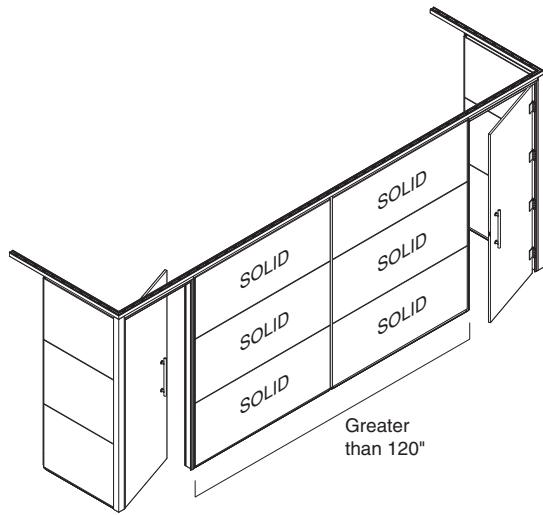
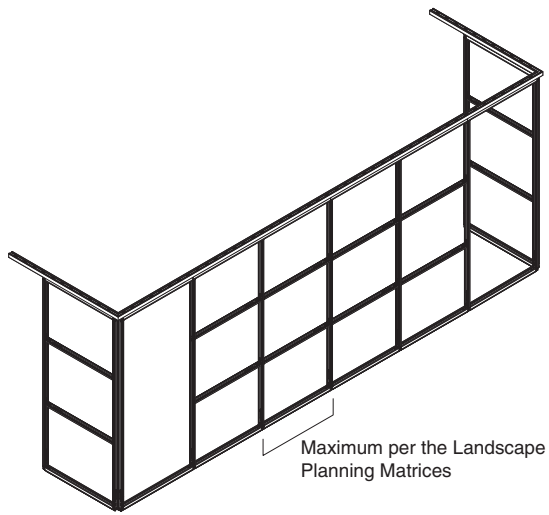
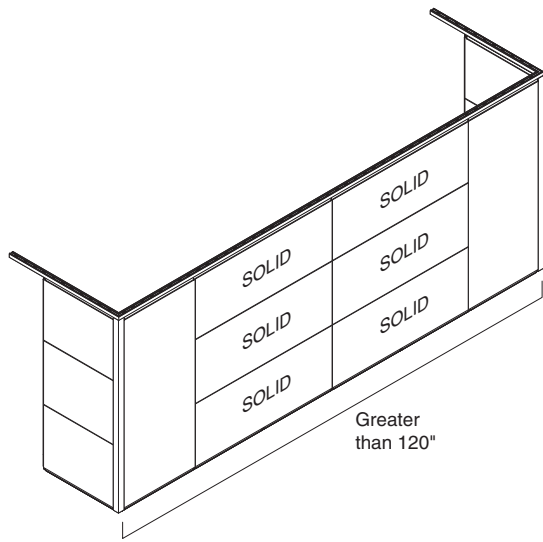

Planning per these guidelines ensures that solid walls will meet IBC structural criteria for transverse loads per ASTM E72.

Either or Both Adjacent Modules Are Landscape

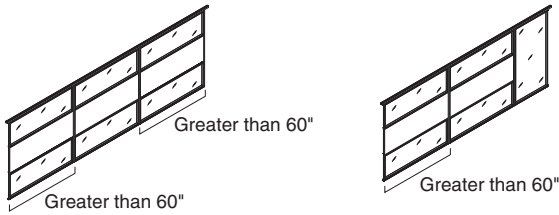

Intermediate Horizontal:

Any horizontal is closer than 12" to centerline

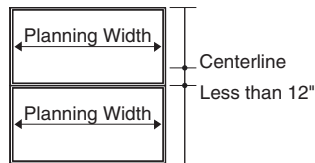

Intermediate Horizontal:

No horizontal is closer than 12" to centerline

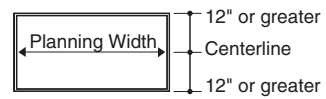

Ceiling Height	Maximum Planning Width	Maximum Planning Width
96"	100"	102"
102"	94"	99"
108"	88"	92"
114"	82"	85"
120"	75"	78"

Both Adjacent Modules Are Either Portrait Oriented Primary Structural Elements

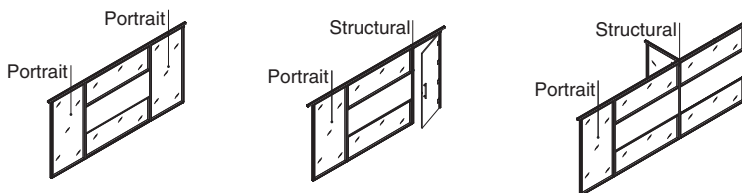

Intermediate Horizontal:

Any horizontal is closer than 12" to centerline

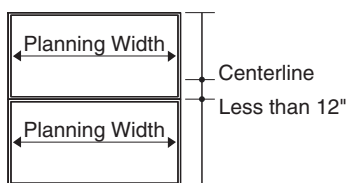

Intermediate Horizontal:

No horizontal is closer than 12" to centerline

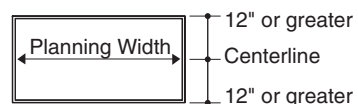

Ceiling Height	Maximum Planning Width	Maximum Planning Width
96"	108"	110"
102"	103"	108"
108"	97"	103"
114"	91"	94"
120"	83"	87"

Tip: When the ceiling height exceeds 10'-0", posts cannot be spaced more than 48" apart. Regardless of ceiling height or position of horizontals, a landscape module can be any width up to 120", as long as it falls within a span of primary structural assemblies that are no more than 120 inches apart.

▶ See Page 106

Acoustic Planning Considerations

Overall acoustic performance related to sound transmission

can be managed by varying the wall configuration, skin materials, and internal composition.

The internal composition can vary in three ways:

1. The wall cavity is untreated. No additional components are used.
2. Internal horizontal seals are added to the back of the skins at the top and bottom structural horizontals. One seal (FESSA2) is applied at each position.
3. Internal seals are added per the above, plus the wall cavity is filled with acoustic insulation (FESIA). Post are also enhanced by vertically positioning the post seal to fully engage with the bottom structural horizontal, and by adding an additional section of post seal to fully engage with the top structural horizontal.

► See *Understanding Skins*, page 40, for more information about acoustic related components and planning guidelines for different skin configurations.

Adding insulation to mini-end assemblies does not improve acoustic performance.



Sound transmission performance at door openings (slider and reversible) can be improved by adding drop seals to the doors.

Mounting hang-on furniture does not negatively effect acoustic performance.

When considering markerboard solutions, keep in mind that ceramic skins will provide better STC performance than back-painted glass.

STC Performance—Solid Walls

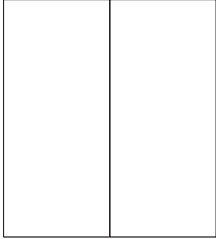
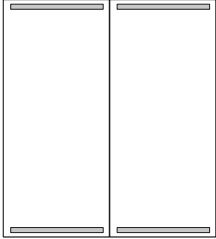
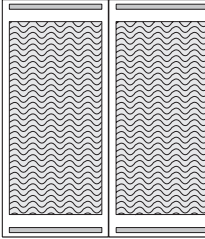
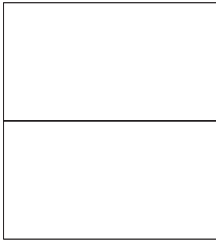
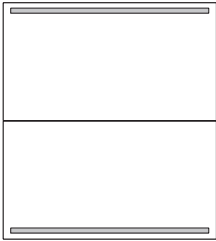
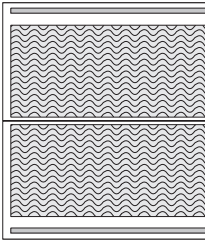
Steel Skins (paint, fabric, and ceramic)

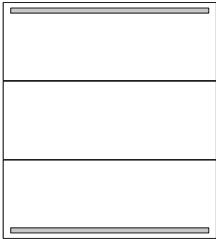
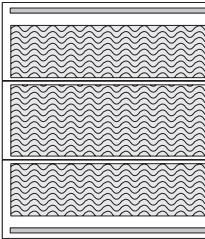
	Untreated	Internal Skin Seals	Internal Skin Seals Full Insulation Extended Post Seal
Steel Skins Portrait Oriented	 44 STC	 47 STC	 50 STC
Steel Skins Landscape 2 Segments	 44 STC	 48 STC	 53 STC
Steel Skins Landscape 3 Segments	 45 STC	 48 STC	 53 STC

**STC Performance—
Solid Walls**

Veneer Skins and Laminate

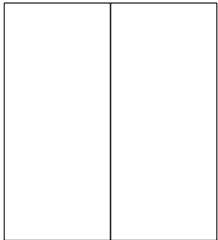
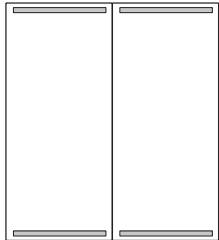
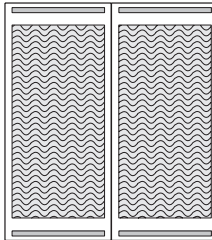
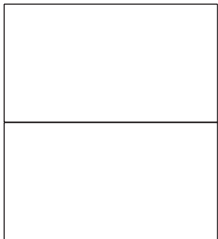
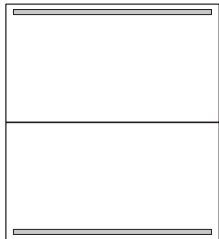
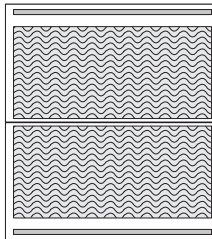
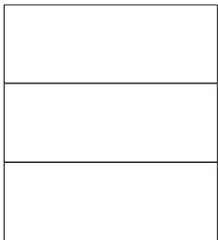
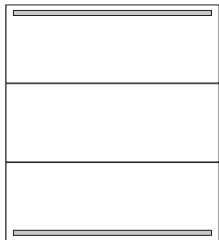
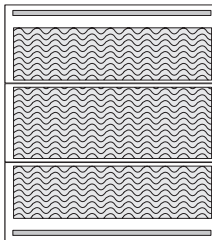
	Untreated	Internal Skin Seals	Internal Skin Seals Full Insulation Extended Post Seal
Veneer and Laminate Skins Portrait Oriented	 37 STC	 39 STC	 42 STC
Veneer and Laminate Skins Landscape 2 Segments	 37 STC	 39 STC	 43 STC
Veneer and Laminate Skins Landscape 3 Segments	 37 STC	 40 STC	 46 STC

Combining steel and veneer skins on opposite sides of the same wall will improve these veneer results by two to four STC points depending on configuration.

Tip: Adding insulation to mini-ends does not improve acoustic performance.

Acoustic Planning Considerations, continued

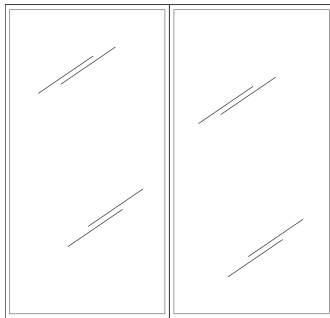

Portrait

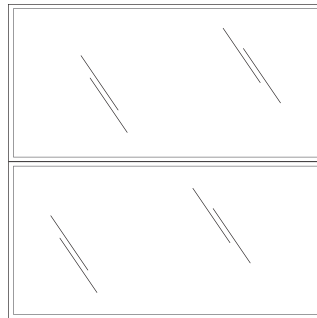

Landscape

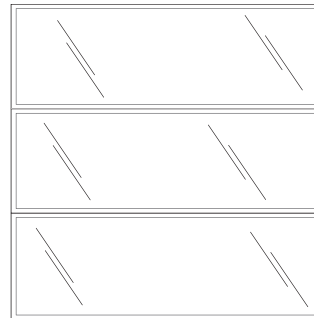

Landscape

STC performance does not vary between portrait and landscape frame configurations.

Double Glazed

1/4" thick tempered + 1/4" thick tempered glass: 42 STC

3/8" thick tempered + 1/4" thick tempered glass: 44 STC

When double glazed frames are positioned at the top and/or bottom of the wall, acoustic glass frame seals (FEFRCGSA) will be applied on both sides of the wall.

Using laminated glass in a double glazed frame does not improve STC performance.

Using 3/8" thick glass in both sides of the frame does not improve STC performance.

Single Glazed

1/4" thick tempered glass: 30 STC

3/8" thick tempered glass: 31 STC

1/4" thick laminated glass: 31 STC

3/8" thick laminated glass: 33 STC

Using acoustic glass frame seals (FEFRCGSA) on single glazed frames will not improve STC performance.

STC = Sound Transmission Coefficient

Specifying Structural Frame Components

Post	114
Structural Horizontal and Intermediate Horizontal	115
Ceiling Tracks	116
Ceiling Fastener and T/X Ceiling Track Bracket	118
Base Trims	119
Floor Track and Floor Track Spring	121
Floor Guide	122
Short Post Leveler Bracket	123
Acoustic Seals	124
Structural Beam	125

Post



Standard Includes		Required to Specify
<ul style="list-style-type: none"> ▶ Need help? Product details, page 24 	<ul style="list-style-type: none"> • Post • Height: 15"–144" • Seal: plastic 	<ol style="list-style-type: none"> 1 Style number 2 Height 3 Plastic color number for seal 4 Top mount type (see below under Required Selections) 5 Horizontal hole count (see below under Required Selections) <ul style="list-style-type: none"> ▶ See <i>Surface Materials</i>, page 222.

	Required Selections	U.S. Price	Required to Specify
Top Mount Type	<ul style="list-style-type: none"> • Ceiling • Intermediate 	No cost No cost	Specify with <i>ceiling mount</i> . Specify with <i>intermediate mount</i> .
Horizontal Hole Count	<p>Horizontal holes</p> <ul style="list-style-type: none"> • No holes • Hole 1 location • Hole 2 location • Hole 3 location • Hole 4 location • Hole 5 location • Hole 6 location • Hole 7 location • Hole 8 location • Hole 9 location • Hole 10 location • Hole 11 location 	No cost No cost No cost No cost No cost No cost No cost No cost No cost No cost No cost No cost	Specify with <i>no holes</i> . Specify <i>Y dimension for hole 1</i> . Specify <i>Y dimension for hole 2</i> . Specify <i>Y dimension for hole 3</i> . Specify <i>Y dimension for hole 4</i> . Specify <i>Y dimension for hole 5</i> . Specify <i>Y dimension for hole 6</i> . Specify <i>Y dimension for hole 7</i> . Specify <i>Y dimension for hole 8</i> . Specify <i>Y dimension for hole 9</i> . Specify <i>Y dimension for hole 10</i> . Specify <i>Y dimension for hole 11</i> .

Specification Information			
• Style Number	• Height	• U.S. Base Price	
		• Per Post	• Per Inch
FEPVS	15"–48"	\$390.12	+\$0.37
	48.00001"–120"	\$403.93	+\$0.35
	120.00001"–144"	\$430.38	+\$0.84
:	:	:	:



For Canadian Pricing
Multiply U.S. Price by the Canadian price factor.
▶ See page 1 for details.

Structural Horizontal

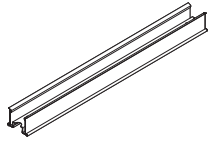

Standard Includes		Required to Specify
<ul style="list-style-type: none"> ▶ Need help? Product details, page 24 	<ul style="list-style-type: none"> • Post • Width: 6"–120" • Seal: plastic 	<ol style="list-style-type: none"> 1 Style number 2 Width 3 Plastic color number for seal 4 Cut-out configuration (see below under Required Selections) <ul style="list-style-type: none"> ▶ See <i>Surface Materials</i>, page 222.

Required Selections	U.S. Price	Required to Specify
Cut-out Configuration <ul style="list-style-type: none"> • Cutable • Non-cut 	No cost No cost	Specify with <i>cutable</i> . Specify with <i>non-cut</i> .

Specification Information			
Style Number	Width	U.S. Base Price	
		Per Horizontal	Per Inch
FERHS	6"–48"	\$ 63.65	+\$0.69
	48.00001"–96"	\$ 95.21	+\$1.23
	96.00001"–120"	\$158.86	+\$0.41

Intermediate Horizontal

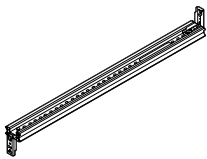

Standard Includes		Required to Specify
<ul style="list-style-type: none"> ▶ Need help? Product details, page 24 	<ul style="list-style-type: none"> • Horizontal • Width: 6"–120" • Seal: plastic 	<ol style="list-style-type: none"> 1 Style number 2 Width 3 Plastic color number for seal 4 Vertical hole count (see below under Required Selections) <ul style="list-style-type: none"> ▶ See <i>Surface Materials</i>, page 222.

Required Selections	U.S. Price	Required to Specify
Vertical Hole Count <ul style="list-style-type: none"> • No holes • Hole 1 location • Hole 2 location • Hole 3 location • Hole 4 location • Hole 5 location • Hole 6 location • Hole 7 location • Hole 8 location • Hole 9 location • Hole 10 location • Hole 11 location 	No cost No cost No cost No cost No cost No cost No cost No cost No cost No cost No cost No cost	Specify with <i>no holes</i> . Specify <i>X dimension for hole 1</i> . Specify <i>X dimension for hole 2</i> . Specify <i>X dimension for hole 3</i> . Specify <i>X dimension for hole 4</i> . Specify <i>X dimension for hole 5</i> . Specify <i>X dimension for hole 6</i> . Specify <i>X dimension for hole 7</i> . Specify <i>X dimension for hole 8</i> . Specify <i>X dimension for hole 9</i> . Specify <i>X dimension for hole 10</i> . Specify <i>X dimension for hole 11</i> .

Specification Information			
Style Number	Width	U.S. Base Price	
		Per Horizontal	Per Inch
FERHI	6"–60"	\$ 95.21	+\$1.75
	60.00001"–96"	\$136.04	+\$2.09
	96.00001"–120"	\$284.11	+\$0.78

 **For Canadian Pricing**
Multiply U.S. Price by the Canadian price factor.
▶ See page 1 for details.

Ceiling Tracks

Straight Ceiling Track

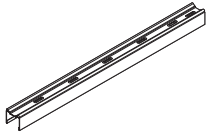

	Standard Includes	Required to Specify
▶ Need help? Product details, page 24	<ul style="list-style-type: none"> Ceiling track: paint Seal to match paint color, when applicable: <ul style="list-style-type: none"> - 7190 Platinum Solid paint will default 6249 Platinum Solid plastic - 7241 Arctic White paint will default 6009 Arctic White plastic - 7360 Merle paint will receive 6527 Merle plastic - All other paint selections require a plastic to be specified 	<ol style="list-style-type: none"> Style number Paint color number for ceiling track Plastic color number for seal, if required Length (see below under Required Selections) Options, if selected (see below) <p>▶ See <i>Surface Materials</i>, page 222.</p>

	Required Selections	U.S. Price	Required to Specify
Length	<ul style="list-style-type: none"> 120" 144" 	<ul style="list-style-type: none"> No cost +\$ 9.91 	<ul style="list-style-type: none"> Specify 120". Specify 144".

	Options	U.S. Price	Required to Specify
Surface Materials	<ul style="list-style-type: none"> Paint price group 1 Paint price group 2 Paint price group 3 	<ul style="list-style-type: none"> No cost +\$24.93 +\$37.57 	<ul style="list-style-type: none"> Specify paint color number. Specify paint color number. Specify paint color number.

Specification Information	
Style Number	U.S. Base Price
FECTS	\$149.60

Corner Fixed Angle Ceiling Track

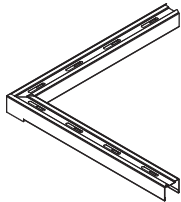

	Standard Includes	Required to Specify
▶ Need help? Product details, page 24	<ul style="list-style-type: none"> Ceiling track: paint Seal to match paint color, when applicable: <ul style="list-style-type: none"> - 7190 Platinum Solid paint will default 6249 Platinum Solid plastic - 7241 Arctic White paint will default 6009 Arctic White plastic - 7360 Merle paint will receive 6527 Merle plastic - All other paint selections require a plastic to be specified 	<ol style="list-style-type: none"> Style number Paint color number for ceiling track Plastic color number for seal, if required Angle (see below under Required Selections) Options, if selected (see below) <p>▶ See <i>Surface Materials</i>, page 222.</p>

	Required Selections	U.S. Price	Required to Specify
Fixed Angles	<ul style="list-style-type: none"> 90° 120° 135° 	<ul style="list-style-type: none"> No cost No cost No cost 	<ul style="list-style-type: none"> Specify with 90° angle. Specify with 120° angle. Specify with 135° angle.

	Options	U.S. Price	Required to Specify
Surface Materials	<ul style="list-style-type: none"> Paint price group 1 Paint price group 2 Paint price group 3 	<ul style="list-style-type: none"> No cost +\$24.93 +\$37.57 	<ul style="list-style-type: none"> Specify paint color number. Specify paint color number. Specify paint color number.

Specification Information	
Style Number	U.S. Base Price
FECTF	\$159.48



For Canadian Pricing
Multiply U.S. Price by the Canadian price factor.
▶ See page 1 for details.

Corner Variable Angle Ceiling Track

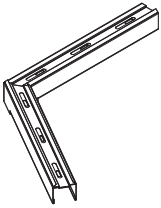

Standard Includes		Required to Specify
-------------------	--	---------------------

<ul style="list-style-type: none"> ▶ Need help? Product details, page 24 	<ul style="list-style-type: none"> Ceiling track: paint Seal to match paint color, when applicable: <ul style="list-style-type: none"> - 7190 Platinum Solid paint will default 6249 Platinum Solid plastic - 7241 Arctic White paint will default 6009 Arctic White plastic - 7360 Merle paint will receive 6527 Merle plastic - All other paint selections require a plastic to be specified 	<ol style="list-style-type: none"> Style number Paint color number for ceiling track Plastic color number for seal, if required Angle (see below under Required Selections) Options, if selected (see below) <ul style="list-style-type: none"> ▶ See <i>Surface Materials</i>, page 222.
---	---	--

Required Selections	U.S. Price	Required to Specify
---------------------	------------	---------------------

Angle	<ul style="list-style-type: none"> 91°–119° 121°–134° 136°–179° 	<ul style="list-style-type: none"> No cost No cost No cost 	<ul style="list-style-type: none"> Specify angle in 1° increment. Specify angle in 1° increment. Specify angle in 1° increment.
--------------	--	---	--

Options	U.S. Price	Required to Specify
---------	------------	---------------------

Surface Materials	<ul style="list-style-type: none"> Paint price group 1 Paint price group 2 Paint price group 3 	<ul style="list-style-type: none"> No cost +\$ 7.91 +\$17.00 	<ul style="list-style-type: none"> Specify paint color number. Specify paint color number. Specify paint color number.
--------------------------	---	---	---

Specification Information

Style Number	U.S. Base Price
FECTV	\$212.69
.	.
.	.

 **For Canadian Pricing**
 Multiply U.S. Price by the Canadian price factor.
 ▶ See page 1 for details.

Ceiling Fastener and T/X Ceiling Track Bracket

Ceiling Fastener



Tip: Order one ceiling fastener package per 10' of ceiling track.

Tip: Spacers are included with fasteners for regular ceiling tiles that allow adjustment for different tile edge depths.

Standard Includes		Required to Specify
▶ Need help? Product details, page 24	• Fastener package	1 Style number 2 Fastener type (see below under Required Selections)

Fastener Type	Required Selections	U.S. Price	Required to Specify
	• 1"W exposed T	No cost	Specify with 1"W exposed T.
	• 9/16"W exposed T	No cost	Specify with 9/16"W exposed T.
	• 1/4"W Donn Finline	No cost	Specify with 1/4"W Donn Finline.
	• 1/8"W Donn Finline	No cost	Specify with 1/8"W Donn Finline.
	• 1"W fluted runner 1/4–20	No cost	Specify with 1"W fluted runner 1/4–20.
	• 1"W tegular	No cost	Specify with 1" tegular.
	• 9/16" tegular	No cost	Specify with 9/16" tegular.

Specification Information	
• Style Number	• U.S. Price
FECF	\$22.84
:	:

T/X Ceiling Track Bracket



Tip: For T application specify one bracket. For X application, specify two brackets.

Standard Includes		Required to Specify
▶ Need help? Product details, page 24	• Bracket	Style number

Specification Information	
• Style Number	• U.S. Price
FACTB	\$17.02
:	:



For Canadian Pricing

Multiply U.S. Price by the Canadian price factor.

▶ See page 1 for details.

Straight Base Trim

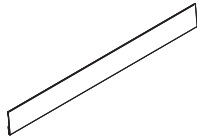

Standard Includes		Required to Specify	
<ul style="list-style-type: none"> ▶ Need help? Product details, page 24 	<ul style="list-style-type: none"> • Base trim: paint 	<ol style="list-style-type: none"> 1 Style number 2 Paint color number for trim 3 Length (see below under Required Selections) 4 Options, if selected (see below) <ul style="list-style-type: none"> ▶ See <i>Surface Materials</i>, page 222. 	
Required Selections		U.S. Price	Required to Specify
Length	<ul style="list-style-type: none"> • 120" • 144" 	No cost +\$12.62	Specify 120". Specify 144".
Options		U.S. Price	Required to Specify
Surface Materials	<ul style="list-style-type: none"> • Paint price group 1 • Paint price group 2 • Paint price group 3 	No cost +\$24.93 +\$37.57	Specify paint color number. Specify paint color number. Specify paint color number.
Specification Information			
Style Number	U.S. Base Price		
FEBTS	\$61.87		

Corner Fixed Angle Base Trim

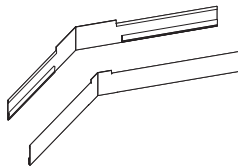

Standard Includes		Required to Specify	
<ul style="list-style-type: none"> ▶ Need help? Product details, page 24 	<ul style="list-style-type: none"> • Base trim: paint 	<ol style="list-style-type: none"> 1 Style number 2 Paint color number for trim 3 Angle (see below under Required Selections) 4 Corner type (see below under Required Selections) 5 Options, if selected (see below) <ul style="list-style-type: none"> ▶ See <i>Surface Materials</i>, page 222. 	
Required Selections		U.S. Price	Required to Specify
Fixed Angles	<ul style="list-style-type: none"> • 90° • 120° • 135° 	No cost No cost No cost	Specify <i>with 90° angle.</i> Specify <i>with 120° angle.</i> Specify <i>with 135° angle.</i>
Corner Type	<ul style="list-style-type: none"> • Inner • Outer 	No cost No cost	Specify <i>with inner corner.</i> Specify <i>with outer corner.</i>
Options		U.S. Price	Required to Specify
Surface Materials	<ul style="list-style-type: none"> • Paint price group 1 • Paint price group 2 • Paint price group 3 	No cost +\$24.93 +\$37.57	Specify paint color number. Specify paint color number. Specify paint color number.
Specification Information			
Style Number	U.S. Base Price		
FEBTF	\$82.61		

 **For Canadian Pricing**
Multiply U.S. Price by the Canadian price factor.
▶ See page 1 for details.

Corner Variable Angle Base Trim

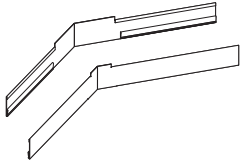

▶ Need help?
Product details,
page 24

Standard Includes

- Base trim: paint

Required to Specify

- 1 Style number
 - 2 Paint color number for trim
 - 3 Angle (see below under Required Selections)
 - 4 Corner type (see below under Required Selections)
 - 5 Options, if selected (see below)
- ▶ See *Surface Materials*, page 222.

	Required Selections	U.S. Price	Required to Specify
Angle	<ul style="list-style-type: none"> • 91°–119° • 121°–134° • 136°–179° 	No cost No cost No cost	Specify angle in 1° increment. Specify angle in 1° increment. Specify angle in 1° increment.

Corner Type	<ul style="list-style-type: none"> • Inner • Outer 	No cost No cost	Specify <i>with inner corner</i> . Specify <i>with outer corner</i> .
--------------------	--	--------------------	--

	Options	U.S. Price	Required to Specify
Surface Materials	<ul style="list-style-type: none"> • Paint price group 1 • Paint price group 2 • Paint price group 3 	No cost +\$ 7.91 +\$17.00	Specify paint color number. Specify paint color number. Specify paint color number.

Specification Information

Style Number	U.S. Base Price
FEBTV	\$97.00



For Canadian Pricing

Multiply U.S. Price by the Canadian price factor.

▶ See page 1 for details.

Floor Track and Floor Track Spring

Floor Track and Floor Track Spring

Floor Track

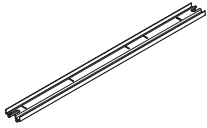

Standard Includes		Required to Specify
-------------------	--	---------------------

- | | | |
|---|--|--|
| <ul style="list-style-type: none"> ▶ Need help? Product details, page 24 | <ul style="list-style-type: none"> • Floor track: paint • Width: 6"–120" | <ul style="list-style-type: none"> 1 Style number 2 Paint color number for floor track 3 Width 4 Options, if selected (see below) ▶ See <i>Surface Materials</i>, page 222. |
|---|--|--|

Options	U.S. Price	Required to Specify
---------	------------	---------------------

- | | | |
|--|---|---|
| Surface Materials <ul style="list-style-type: none"> • Paint price group 1 • Paint price group 2 • Paint price group 3 | <ul style="list-style-type: none"> No cost +\$24.93 +\$37.57 | <ul style="list-style-type: none"> Specify paint color number. Specify paint color number. Specify paint color number. |
|--|---|---|

Specification Information

Style Number	Length	U.S. Base Price	
		Per Track	Per Inch
FEFT	6"–96"	\$37.86	+\$0.37
	96.00001"–120"	\$90.14	+\$0.13

Structural Frame Components

Floor Track Spring



Standard Includes		Required to Specify
-------------------	--	---------------------

- | | | |
|---|--|--|
| <ul style="list-style-type: none"> ▶ Need help? Product details, page 24 | <ul style="list-style-type: none"> • Floor track spring | <ul style="list-style-type: none"> Style number |
|---|--|--|

Specification Information

Style Number	U.S. Price
FEFTS	\$14.43

 **For Canadian Pricing**
 Multiply U.S. Price by the Canadian price factor.
 ▶ See page 1 for details.

Floor Guide

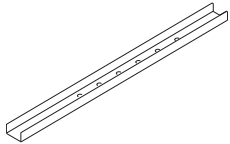

Standard Includes		Required to Specify
▶ Need help? Product details, page 24	• Floor guide	1 Style number 2 Gripper type (see below under Required Selections)

Required Selections	U.S. Price	Required to Specify
Gripper		
• Simple	No cost	Specify <i>with simple</i> .
• Seismic	+\$22.84	Specify <i>with seismic</i> .

Specification Information	
• Style Number	• U.S. Base Price
FEFG	\$44.45
:	:
:	:



For Canadian Pricing
Multiply U.S. Price by the Canadian price factor.
▶ See page 1 for details.



Standard Includes		Required to Specify
▶ Need help? Product details, page 24	• Bracket	Style number

Specification Information	
• Style • Number	• U.S. • Price
FEPLBS	\$28.27
.	.

Structural Frame
Components

 **For Canadian Pricing**
Multiply U.S. Price by the
Canadian price factor.
▶ See page 1 for details.

Acoustic Seals

Tip: When different seal colors are desired on opposite sides of a wall, order additional seals in the appropriate colors for field retrofit.

Standard Includes	Required to Specify
<ul style="list-style-type: none"> ▶ Need help? Product details, page 24 • Acoustic seal: plastic 	<ol style="list-style-type: none"> 1 Style number 2 Plastic color number for seal 3 Height (see below under Required Selections) 4 Width (see below under Required Selections) <ul style="list-style-type: none"> ▶ See <i>Surface Materials</i>, page 222.

	Required Selections	U.S. Price	Required to Specify
Height	For post acoustic seal packages		
	• 72.5"	No cost	Specify height.
	• 145"	+\$13.00	Specify height.
Width	For horizontal acoustic seals		
	• 24"	No cost	Specify width.
	• 48"	+\$ 5.75	Specify width.
	• 72"	+\$11.54	Specify width.
	• 96"	+\$18.50	Specify width.
	• 120"	+\$24.28	Specify width.

Specification Information			
Description	Style Number	For Use With	U.S. Base Price



Post Acoustic Seal Packages

Description	Style Number	For Use With	U.S. Base Price
145"H full-height post package or 72½"H partial-height post package	FEPVSS	FEPVS	\$51.10

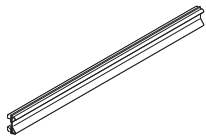

Intermediate Horizontal Acoustic Seals

Description	Style Number	For Use With	U.S. Base Price
24"W, 48"W, 72"W, 96"W, or 120"W	FERHIS	FERHI	\$30.05

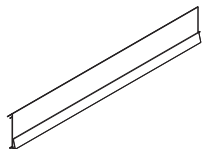

Structural Horizontal Acoustic Seals

Description	Style Number	For Use With	U.S. Base Price
24"W, 48"W, 72"W, 96"W, or 120"W	FERHSS	FERHS	\$30.05



For Canadian Pricing
Multiply U.S. Price by the Canadian price factor.
▶ See page 1 for details.



Standard Includes	Required to Specify
<ul style="list-style-type: none"> ▶ Need help? Product details, page 96 • Beam • Width: 12" – 120" 	<ul style="list-style-type: none"> 1 Style number 2 Width

Specification Information

• Style Number	• Length	• U.S. Base Price	
.....	Per Track	Per Inch
FEBSTR	12"-120"	\$331.57	+\$5.18
.....

Structural Frame Components



For Canadian Pricing
 Multiply U.S. Price by the Canadian price factor.
 ▶ See page 1 for details.



Specifying Cornice Application

Cornice Track and Beam	128
Cornice Brackets and Reinforcing Tracks	129
Cornice Accessories	131

Cornice Track and Beam

Standard Includes		Required to Specify
<ul style="list-style-type: none"> ▶ Need help? Product details, page 30 	<ul style="list-style-type: none"> • Cornice track and beam: paint 	<ul style="list-style-type: none"> 1 Style number 2 Paint color number for cornice track and beam 3 Options, if selected (see below) ▶ See <i>Surface Materials</i>, page 222.

Options	U.S. Price	Required to Specify
Surface Materials <ul style="list-style-type: none"> • Anodized for beams only • Paint price group 1 • Paint price group 2 • Paint price group 3 	No cost No cost +\$28.21 +\$41.02	Specify <i>with anodized for beams only</i> . Specify paint color number. Specify paint color number. Specify paint color number.

Specification Information		
Length	Style Number	U.S. Base Price

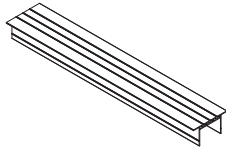

Cornice Track Deck

130"	FECTD	\$422.59
:	:	:

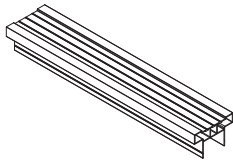

Cornice Track Beam

130"	FECTBE	\$564.27
:	:	:



Cornice Track Deck Corner

36" x 36"	FECTDC	\$282.12
:	:	:



Cornice Track Beam Corner

36" x 36"	FECTBEC	\$314.90
:	:	:



For Canadian Pricing
 Multiply U.S. Price by the Canadian price factor.
 ▶ See page 1 for details.

Cornice Bracket

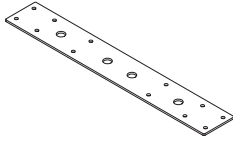

Standard Includes		Required to Specify
<ul style="list-style-type: none"> ▶ Need help? Product details, page 30 	<ul style="list-style-type: none"> • Cornice bracket: paint 	<ol style="list-style-type: none"> 1 Style number 2 Paint color number for cornice bracket 3 Angle (see below under Required Selections) 4 Options, if selected (see below) <ul style="list-style-type: none"> ▶ See <i>Surface Materials</i>, page 222.

Required Selections	U.S. Price	Required to Specify
Angle	<ul style="list-style-type: none"> • 90° No cost • 135° No cost • 180° No cost 	<ul style="list-style-type: none"> Specify with 90° angle. Specify with 135° angle. Specify with 180° angle.

Options	U.S. Price	Required to Specify
Surface Materials	<ul style="list-style-type: none"> • Paint price group 1 No cost • Paint price group 2 +\$7.11 • Paint price group 3 +\$9.97 	<ul style="list-style-type: none"> Specify paint color number. Specify paint color number. Specify paint color number.

Specification Information	
Style Number	U.S. Base Price
FECB	\$84.01
.	.
.	.

Cornice Application

Cornice Skin Structural Brackets

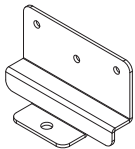

Standard Includes		Required to Specify
<ul style="list-style-type: none"> ▶ Need help? Product details, page 30 	<ul style="list-style-type: none"> • Cornice bracket; quantity four 	<ul style="list-style-type: none"> Style number

Specification Information	
Style Number	U.S. Price
FESSB	\$208.68
.	.
.	.



For Canadian Pricing
Multiply U.S. Price by the Canadian price factor.
▶ See page 1 for details.

Cornice Reinforcing Tracks

Standard Includes	Required to Specify
<ul style="list-style-type: none"> ▶ Need help? Product details, page 34 • Cornice reinforcing track: paint 	<ul style="list-style-type: none"> 1 Style number 2 Paint color number for reinforcing track 3 Options, if selected (see below) ▶ See <i>Surface Materials</i>, page 222.

Options	U.S. Price	Required to Specify
Surface Materials <ul style="list-style-type: none"> • Paint price group 1 • Paint price group 2 • Paint price group 3 	<ul style="list-style-type: none"> No cost +\$28.21 +\$41.02 	<ul style="list-style-type: none"> Specify paint color number. Specify paint color number. Specify paint color number.

Specification Information		
Dimensions	Style	U.S. Base Price
Length	Number	Per Track

Cornice Seismic Reinforcing Track – Straight

112"	FECTSRS	\$254.09
:	:	:

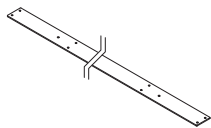

Tip: Specify cornice screw package bracket separately - two sets required for straight track.

Cornice Seismic Reinforcing Track – Corner

24" x 24"	FECTSRC	\$179.19
:	:	:

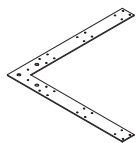

Tip: Specify cornice screw package bracket separately - three sets required for corner track.



For Canadian Pricing

Multiply U.S. Price by the Canadian price factor.

▶ See page 1 for details.

Cornice Screw Package—Track

Standard Includes	Required to Specify
• Screw package: quantity 18	Style number

Specification Information	
Style Number	U.S. Price
FECSPT	\$21.73

Cornice Screw Package—Bracket

Standard Includes	Required to Specify
• Screw package: quantity 12	Style number

Specification Information	
Style Number	U.S. Price
FECSPB	\$21.73

Cornice Application



For Canadian Pricing
 Multiply U.S. Price by the Canadian price factor.
 ▶ See page 1 for details.



Specifying Captured Glass Frames

Single Glazed Captured Glass Frame	134
Double Glazed Captured Glass Frame	136
Single Side Captured Glass Frames—Side A and Side C	138
Single Side Captured Glass Frames—Side B and Side D	140
Acoustic Seal for Captured Glass	142
Brackets and T Nuts	143

Single Glazed Captured Glass Frame

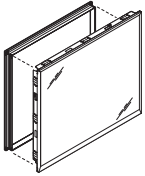

Standard Includes		Required to Specify
<ul style="list-style-type: none"> ▶ Need help? Product details, page 36 	<ul style="list-style-type: none"> • Frame: paint or 8043 Clear Anodized Aluminum • Height: 12"–141.71654" • Width: 12"–120" • Glass: 1/4" thick • Glazing strips: platinum 	<ol style="list-style-type: none"> 1 Style number 2 Height 3 Width 4 Paint or anodized aluminum color number for frame side A 5 Paint or anodized aluminum color number for frame side B 6 Glass color number 7 Glass linear orientation (see below under Required Selections) 8 Glass thickness (see below under Required Selections) 9 Glass surface orientation, if 6542 Satin selected (see below under Required Selections) 10 Top mount type (see below under Required Selections) 11 Bottom mount type (see below under Required Selections) 12 Options, if selected (see below) <ul style="list-style-type: none"> ▶ See <i>Surface Materials</i>, page 222.

Required Selections		U.S. Price		Required to Specify
		Per Frame	Per Sq/Ft	
Glass Thickness (3/8" thick glass)	• Glass price group 1	N.A.	+\$ 24.88	Specify glass color number.
	• Glass price group 2	N.A.	+\$ 7.57	Specify glass color number.
	• Glass price group 3	N.A.	+\$ 31.37	Specify glass color number.
	• Glass price group 4	N.A.	+\$ 25.95	Specify glass color number.
	• Glass price group 6	N.A.	+\$ 25.95	Specify glass color number.
	• Glass price group 7	N.A.	+\$ 25.95	Specify glass color number.
(Note: 1/4" thick glass = No cost)				
Glass Linear Orientation	• Horizontal	No cost	N.A.	Specify <i>with horizontal orientation</i> .
	• Vertical	No cost	N.A.	Specify <i>with vertical orientation</i> .
Glass Surface Orientation	• Polished to flush	No cost	N.A.	Specify <i>with polished to flush</i> .
	• Polished to sill	No cost	N.A.	Specify <i>with polished to sill</i> .
Top Mount Type	• Ceiling	No cost	N.A.	Specify <i>with ceiling mount</i> .
	• Intermediate	No cost	N.A.	Specify <i>with intermediate mount</i> .
Bottom Mount Type	• Floor	No cost	N.A.	Specify <i>with floor mount</i> .
	• Intermediate	No cost	N.A.	Specify <i>with intermediate mount</i> .

Tip: Glass surface orientation only required when 6542 Satin is selected.

Options		U.S. Price		Required to Specify
		Per Frame	Per Sq/Ft	
Surface Materials	Frames			
	• Anodized	No cost	+\$ 0.99	Specify <i>with anodized</i> .
	• Paint price group 1	No cost	No cost	Specify paint color number.
	• Paint price group 2	No cost	+\$ 1.18	Specify paint color number.
	• Paint price group 3	No cost	+\$ 2.10	Specify paint color number.
	• Glass price group 1	No cost	No cost	Specify glass color number.
	• Glass price group 2	No cost	+\$ 30.39	Specify glass color number.
	• Glass price group 3	No cost	+\$ 36.22	Specify glass color number.
	• Glass price group 4	No cost	+\$ 59.64	Specify glass color number.
	• Glass price group 6	No cost	+\$117.88	Specify glass color number.
	• Glass price group 7	No cost	+\$140.09	Specify glass color number.



For Canadian Pricing
Multiply U.S. Price by the Canadian price factor.
▶ See page 1 for details.

Specification Information

Style Number	Square Foot (Sq/Ft)	U.S. Base Price	
		Per Frame	Per Sq/Ft
FEFRCGS	1.00000"-12.00000"	\$351.07	+\$115.86
	12.00001"-30.00000"	\$903.47	+\$ 31.88
	30.00001"-50.00000"	\$401.05	+\$ 53.67

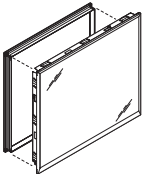

 **For Canadian Pricing**
Multiply U.S. Price by the Canadian price factor.
▶ See page 1 for details.

Double Glazed Captured Glass Frame

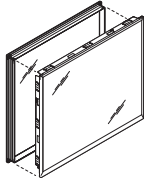

Standard Includes		Required to Specify
<ul style="list-style-type: none"> ▶ Need help? Product details, page 36 	<ul style="list-style-type: none"> • Frame: paint or 8043 Clear Anodized Aluminum • Height: 12"–141.71654" • Width: 12"–120" • Glass: 1/4" thick • Glazing strips: platinum 	<ol style="list-style-type: none"> 1 Style number 2 Height 3 Width 4 Paint or anodized aluminum color number for frame side A 5 Paint or anodized aluminum color number for frame side C 6 Glass color number for side A 7 Glass color number for side C 8 Glass linear orientation for side A (see below under Required Selections) 9 Glass linear orientation for side C (see below under Required Selections) 10 Glass thickness for side A (see below under Required Selections) 11 Glass thickness for side C (see below under Required Selections) 12 Glass surface orientation for side A, if 6542 Satin selected (see below under Required Selections) 13 Glass surface orientation for side C, if 6542 Satin selected (see below under Required Selections) 14 Top mount type (see below under Required Selections) 15 Bottom mount type (see below under Required Selections) 16 Options, if selected (see below) <p>▶ See <i>Surface Materials</i>, page 222.</p>

Required Selections	U.S. Price	Required to Specify
Glass Thickness (3/8" thick glass) (Side A) <ul style="list-style-type: none"> • Glass price group 1 • Glass price group 2 • Glass price group 3 • Glass price group 4 • Glass price group 6 • Glass price group 7 (Note: 1/4" thick glass = No cost)	Per Frame Per Sq/Ft N.A. +\$24.88 N.A. +\$ 7.57 N.A. +\$31.37 N.A. +\$25.95 N.A. +\$25.95 N.A. +\$25.95	Specify glass color number. Specify glass color number. Specify glass color number. Specify glass color number. Specify glass color number. Specify glass color number.
Glass Thickness (3/8" thick glass) (Side C) <ul style="list-style-type: none"> • Glass price group 1 • Glass price group 2 • Glass price group 3 • Glass price group 4 • Glass price group 6 (Note: 1/4" thick glass = No cost)	Per Frame Per Sq/Ft N.A. +\$24.88 N.A. +\$ 7.57 N.A. +\$31.37 N.A. +\$25.95 N.A. +\$25.95	Specify glass color number. Specify glass color number. Specify glass color number. Specify glass color number. Specify glass color number.
Glass Linear Orientation (Side A) <ul style="list-style-type: none"> • Horizontal • Vertical 	No cost No cost	N.A. N.A. Specify <i>with horizontal orientation</i> . Specify <i>with vertical orientation</i> .
Glass Linear Orientation (Side C) <ul style="list-style-type: none"> • Horizontal • Vertical 	No cost No cost	N.A. N.A. Specify <i>with horizontal orientation</i> . Specify <i>with vertical orientation</i> .
Glass Surface Orientation (Side A) <ul style="list-style-type: none"> • Polished to flush • Polished to sill 	No cost No cost	N.A. N.A. Specify <i>with polished to flush orientation</i> . Specify <i>with polished to sill orientation</i> .
Glass Surface Orientation (Side C) <ul style="list-style-type: none"> • Polished to flush • Polished to sill 	No cost No cost	N.A. N.A. Specify <i>with polished to flush orientation</i> . Specify <i>with polished to sill orientation</i> .
Top Mount Type <ul style="list-style-type: none"> • Ceiling • Intermediate 	No cost No cost	N.A. N.A. Specify <i>with ceiling mount</i> . Specify <i>with intermediate mount</i> .
Bottom Mount Type <ul style="list-style-type: none"> • Floor • Intermediate 	No cost No cost	N.A. N.A. Specify <i>with floor mount</i> . Specify <i>with intermediate mount</i> .

Tip: Glass surface orientation only required when 6542 Satin is selected.

 **For Canadian Pricing**
 Multiply U.S. Price by the Canadian price factor.
 ▶ See page 1 for details.

Options		U.S. Price		Required to Specify
Surface Materials	Frames	Per Frame	Per Sq/Ft	
	• Anodized	No cost	+\$ 0.99	Specify <i>with anodized</i> .
	• Paint price group 1	No cost	No cost	Specify paint color number.
	• Paint price group 2	No cost	+\$ 1.18	Specify paint color number.
	• Paint price group 3	No cost	+\$ 2.10	Specify paint color number.
	• Glass price group 1	No cost	No cost	Specify glass color number.
	• Glass price group 2	No cost	+\$ 30.39	Specify glass color number.
	• Glass price group 3	No cost	+\$ 36.22	Specify glass color number.
	• Glass price group 4	No cost	+\$ 59.64	Specify glass color number.
	• Glass price group 6	No cost	+\$117.88	Specify glass color number.
• Glass price group 7	No cost	+\$140.09	Specify glass color number.	

Specification Information			
Style Number	Square Foot (Sq/Ft)	U.S. Base Price	
		Per Frame	Per Sq/Ft
FEFRCGD	1.00000"—12.00000"	\$1173.24	+\$58.84
	12.00001"—30.00000"	\$1311.85	+\$41.12
	30.00001"—50.00000"	\$ 681.19	+\$79.41

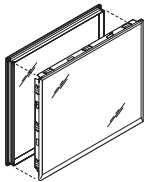

 **For Canadian Pricing**
Multiply U.S. Price by the
Canadian price factor.
▶ See page 1 for details.

Single Side Captured Glass Frames—Side A and Side C

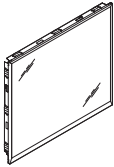

Standard Includes		Required to Specify
<ul style="list-style-type: none"> ▶ Need help? Product details, page 36 	<ul style="list-style-type: none"> • Frame: paint or 8043 Clear Anodized Aluminum • Height: 12"–141.71654" • Width: 12"–120" • Glass: 1/4" thick • Glazing strips: platinum 	<ol style="list-style-type: none"> 1 Style number 2 Height 3 Width 4 Paint or anodized aluminum color number for frame 5 Glass color number 6 Glass thickness (see below under Required Selections) 7 Glass linear orientation (see below under Required Selections) 8 Glass surface orientation, if 6542 Satin selected (see below under Required Selections) 9 Top mount type (see below under Required Selections) 10 Bottom mount type (see below under Required Selections) 11 Options, if selected (see below) <ul style="list-style-type: none"> ▶ See <i>Surface Materials</i>, page 222.

Required Selections	U.S. Price	Required to Specify
Glass Thickness (3/8" thick glass) <ul style="list-style-type: none"> • Glass price group 1 • Glass price group 2 • Glass price group 3 • Glass price group 4 • Glass price group 6 • Glass price group 7 (Note: 1/4" thick glass = No cost)	Per Frame Per Sq/Ft N.A. +\$ 24.88 N.A. +\$ 7.57 N.A. +\$ 31.37 N.A. +\$ 25.95 N.A. +\$ 25.95 N.A. +\$ 25.95	Specify glass color number. Specify glass color number. Specify glass color number. Specify glass color number. Specify glass color number. Specify glass color number.
Glass Linear Orientation <ul style="list-style-type: none"> • Horizontal • Vertical 	No cost N.A. No cost N.A.	Specify <i>with horizontal orientation</i> . Specify <i>with vertical orientation</i> .
Glass Surface Orientation <ul style="list-style-type: none"> • Polished to flush • Polished to sill 	No cost N.A. No cost N.A.	Specify <i>with polished to flush orientation</i> . Specify <i>with polished to sill orientation</i> .
Top Mount Type <ul style="list-style-type: none"> • Ceiling • Intermediate 	No cost N.A. No cost N.A.	Specify <i>with ceiling mount</i> . Specify <i>with intermediate mount</i> .
Bottom Mount Type <ul style="list-style-type: none"> • Floor • Intermediate 	No cost N.A. No cost N.A.	Specify <i>with floor mount</i> . Specify <i>with intermediate mount</i> .

Tip: Glass surface orientation only required when 6542 Satin is selected.

Options	U.S. Price	Required to Specify
Surface Materials <ul style="list-style-type: none"> • Anodized • Paint price group 1 • Paint price group 2 • Paint price group 3 • Glass price group 1 • Glass price group 2 • Glass price group 3 • Glass price group 4 • Glass price group 6 • Glass price group 7 	Per Frame Per Sq/Ft No cost +\$ 0.99 No cost No cost No cost +\$ 1.18 No cost +\$ 2.10 No cost No cost No cost +\$ 30.39 No cost +\$ 36.22 No cost +\$ 59.64 No cost +\$117.88 No cost +\$140.09	Specify <i>with anodized</i> . Specify paint color number. Specify paint color number. Specify paint color number. Specify glass color number. Specify glass color number. Specify glass color number. Specify glass color number. Specify glass color number. Specify glass color number.



For Canadian Pricing
 Multiply U.S. Price by the Canadian price factor.
 ▶ See page 1 for details.

Specification Information

Style Number	Square Foot (Sq/Ft)	U.S. Base Price	
		Per Frame	Per Sq/Ft

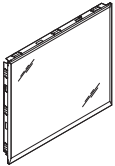

Side A Single Captured Glass Frame

FEFRCGA	1.00000"–12.00000"	\$219.53	+\$62.08
	12.00001"–30.00000"	\$599.16	+\$18.16
	30.00001"–50.00000"	\$271.66	+\$34.61

Side C Single Captured Glass Frame

FEFRCGC	1.00000"–12.00000"	\$844.05	+\$12.15
	12.00001"–30.00000"	\$711.48	+\$26.49
	30.00001"–50.00000"	\$408.40	+\$40.06

Captured Glass
Frames



For Canadian Pricing
Multiply U.S. Price by the
Canadian price factor.
▶ See page 1 for details.

Single Side Captured Glass Frames—Side B and Side D

Single Side Captured Glass Frame—Side B

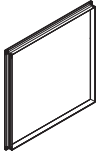

	Standard Includes	Required to Specify
▶ Need help? Product details, page 36	<ul style="list-style-type: none"> • Frame: paint or 8043 Clear Anodized Aluminum • Height: 12"–141.71654" • Width: 12"–120" 	<ol style="list-style-type: none"> 1 Style number 2 Height 3 Width 4 Paint or anodized aluminum color number for frame 5 Top mount type (see below under Required Selections) 6 Bottom mount type (see below under Required Selections) 7 Options, if selected (see below) <p>▶ See <i>Surface Materials</i>, page 222.</p>

	Required Selections	U.S. Price	Required to Specify
Top Mount Type	<ul style="list-style-type: none"> • Ceiling • Intermediate 	No cost No cost	Specify <i>with ceiling mount</i> . Specify <i>with intermediate mount</i> .
Bottom Mount Type	<ul style="list-style-type: none"> • Floor • Intermediate 	No cost No cost	Specify <i>with floor mount</i> . Specify <i>with intermediate mount</i> .

	Options	U.S. Price	Required to Specify
Surface Materials	Frames <ul style="list-style-type: none"> • Anodized • Paint price group 1 • Paint price group 2 • Paint price group 3 	Per Sq/Ft +\$1.14 No cost +\$1.34 +\$2.42	Specify <i>with anodized</i> . Specify paint color number. Specify paint color number. Specify paint color number.

Specification Information			
Style Number	Square Foot (Sq/Ft)	U.S. Base Price	
			Per Frame : Per Sq/Ft
FEFRGGB	1.00000"–12.00000"	\$126.41	+\$49.88
	12.00001"–30.00000"	\$599.56	+\$16.35
	30.00001"–50.00000"	\$128.25	+\$18.45



For Canadian Pricing
 Multiply U.S. Price by the Canadian price factor.
 ▶ See page 1 for details.

Single Side Captured Glass Frame—Side D (Back-Painted Glass)

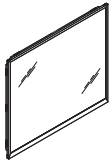

	Standard Includes	Required to Specify
▶ Need help? Product details, page 36	<ul style="list-style-type: none"> • Frame: paint or 8043 Clear Anodized Aluminum • Back-painted glass • Height: 12"–120" • Width: 12"–120" • Glass: 1/4" thick • Glazing strips: platinum 	<ol style="list-style-type: none"> 1 Style number 2 Height 3 Width 4 Paint or anodized aluminum color number for frame 5 Back-painted glass color number 6 Top mount type (see below under Required Selections) 7 Bottom mount type (see below under Required Selections) 8 Options, if selected (see below) <p>▶ See <i>Surface Materials</i>, page 222.</p>

	Required Selections	U.S. Price	Required to Specify
Top Mount Type	<ul style="list-style-type: none"> • Ceiling • Intermediate 	No cost No cost	Specify with <i>ceiling mount</i> . Specify with <i>intermediate mount</i> .
Bottom Mount Type	<ul style="list-style-type: none"> • Floor • Intermediate 	No cost No cost	Specify with <i>floor mount</i> . Specify with <i>intermediate mount</i> .

	Options	U.S. Price	Required to Specify
Surface Materials	Frames <ul style="list-style-type: none"> • Anodized • Paint price group 1 • Paint price group 2 • Paint price group 3 	Per Sq/Ft +\$1.14 No cost +\$1.34 +\$2.42	Specify with <i>anodized</i> . Specify paint color number. Specify paint color number. Specify paint color number.

Specification Information			
Style Number	Square Foot (Sq/Ft)	U.S. Base Price	
		Per Frame	Per Sq/Ft
FEFRGDBP	1.00000" – 12.00000"	\$147.53	+\$229.16
	12.00001"–30.00000"	\$493.93	+\$174.36
	30.00001"–50.00000"	\$206.26	+\$182.64

Captured Glass Frames

 **For Canadian Pricing**
Multiply U.S. Price by the Canadian price factor.
▶ See page 1 for details.

Acoustic Seal for Captured Glass

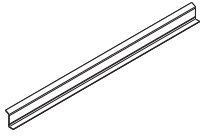

Tip: Seals are ordered to the next largest size depending on frame width, and cut to exact length during installation.

Standard Includes		Required to Specify
▶ Need help? Product details, page 36	• Seal	1 Style number 2 Seal length (see below under Required Selections)

Required Selections	U.S. Price	Required to Specify
Seal Length		
• 24" long seal	No cost	Specify 24" seal.
• 48" long seal	+\$30.05	Specify 48" seal.
• 72" long seal	+\$33.64	Specify 72" seal.
• 96" long seal	+\$54.70	Specify 96" seal.
• 120" long seal	+\$68.76	Specify 120" seal.

Specification Information	
Style Number	U.S. Base Price
FEFRCGSA	\$30.05



For Canadian Pricing
Multiply U.S. Price by the Canadian price factor.
▶ See page 1 for details.

Brackets and T Nuts

For Use with Captured Glass Frames

Locking Bracket

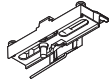

Standard Includes		Required to Specify
<ul style="list-style-type: none"> Locking bracket 		Style number
Specification Information		
Style Number	U.S. Price	
FEFHCGL	\$37.27	

Non-Locking Bracket

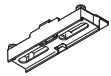

Standard Includes		Required to Specify
<ul style="list-style-type: none"> Non-locking bracket 		Style number
Specification Information		
Style Number	U.S. Price	
FEFHCGI	\$31.85	

Load Bracket



Standard Includes		Required to Specify
<ul style="list-style-type: none"> Load bracket 		Style number
Specification Information		
Style Number	U.S. Price	
FEFHGLB	\$10.83	

T Nuts



Standard Includes		Required to Specify
<ul style="list-style-type: none"> T nuts: package of 25 		Style number
Specification Information		
Style Number	U.S. Price	
FEFHCGT	\$46.26	

 **For Canadian Pricing**
 Multiply U.S. Price by the Canadian price factor.
 ▶ See page 1 for details.



Specifying Skins

Solid Steel Skin	146
Solid Veneer Skin	147
Solid Laminate Skin	148
Ceramic Skin	149
Hardware	150
Acoustic Products	152

Solid Steel Skin

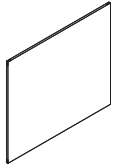

Standard Includes		Required to Specify
<ul style="list-style-type: none"> ▶ Need help? Product details, page 40 	<ul style="list-style-type: none"> • Height: 6"-141.71654" • Width: 6"-120" • Skin: paint or fabric 	<ol style="list-style-type: none"> 1 Style number 2 Height 3 Width 4 Paint or fabric color number for skin 5 Fabric direction (see below under Required Selections) 6 Top mount type (see below under Required Selections) 7 Bottom mount type (see below under Required Selections) 8 Cable management cut-out and cut-out type (see below under Required Selections) 9 Options, if selected (see below) <p>▶ See <i>Surface Materials</i>, page 222.</p>

Required Selections		U.S. Price		Required to Specify
Fabric Direction	Fabric skins	Per Frame	Per Sq/Ft	
	<ul style="list-style-type: none"> • Horizontal • Vertical 	No cost	N.A.	Specify with <i>horizontal application</i> .
		No cost	N.A.	Specify with <i>vertical application</i> .
Top Mount Type	<ul style="list-style-type: none"> • Ceiling • Intermediate 	No cost	N.A.	Specify with <i>ceiling top mount</i> .
		No cost	N.A.	Specify with <i>intermediate top mount</i> .
Bottom Mount Type	<ul style="list-style-type: none"> • Floor • Intermediate 	No cost	N.A.	Specify with <i>floor bottom mount</i> .
		No cost	N.A.	Specify with <i>intermediate bottom mount</i> .
Cable Management	Cut-out			
	• Hardwire single	+\$11.44 per cutout		Specify with <i>hardwire single</i> .
	• Hardwire double	+\$11.44 per cutout		Specify with <i>hardwire double</i> .
	• Hardwire triple	+\$11.44 per cutout		Specify with <i>hardwire triple</i> .
	• Hardwire fourplex	+\$11.44 per cutout		Specify with <i>hardwire fourplex</i> .
	• Modular double	+\$24.11 per cutout		Specify with <i>modular double</i> .
	• Comm only - modular	+\$11.44 per cutout		Specify with <i>comm only - modular</i> .
	• Comm only - no box	+\$11.44 per cutout		Specify with <i>comm only - no box</i> .
	• Surface Hub 2	+\$11.44 per cutout		Specify with <i>surface hub 2</i> .

Options		U.S. Price		Required to Specify
Surface Materials	Frames	Per Skin	Per Sq/Ft	
	• Paint price group 1	No cost	No cost	Specify paint color number.
	• Paint price group 2	+\$ 1.66	+\$ 1.31	Specify paint color number.
	• Paint price group 3	+\$ 1.66	+\$ 2.60	Specify paint color number.
	• Fabric price group 1	+\$47.38	+\$ 7.60	Specify fabric color number.
	• Fabric price group 2	+\$47.38	+\$ 9.06	Specify fabric color number.
	• Fabric price group 3	+\$47.38	+\$10.77	Specify fabric color number.
	• Fabric price group 4	+\$47.38	+\$11.70	Specify fabric color number.
	• Fabric price group 5	+\$47.38	+\$12.65	Specify fabric color number.
	• Fabric price group 6	+\$47.38	+\$16.97	Specify fabric color number.
	• Fabric price group 7	+\$47.38	+\$21.90	Specify fabric color number.
	• Fabric price group 8	+\$47.38	+\$27.16	Specify fabric color number.
	• Fabric price group 9	+\$47.38	+\$31.79	Specify fabric color number.
	• Fabric price group 10	+\$47.38	+\$36.72	Specify fabric color number.

Specification Information			
Style Number	Square Foot (Sq/Ft)	U.S. Base Price	
		Per Skin	Per Sq/Ft
FESSS	0.50000"-12.00000"	\$247.77	+\$60.96
	12.00001"-24.00000"	\$ 52.40	+\$59.31
	24.00001"-50.00000"	\$ 40.10	+\$52.58

 **For Canadian Pricing**
 Multiply U.S. Price by the Canadian price factor.
 ▶ See page 1 for details.

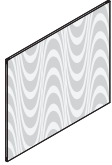

Standard Includes		Required to Specify
<ul style="list-style-type: none"> ▶ Need help? Product details, page 40 	<ul style="list-style-type: none"> • Height: 6"–120" • Width: 6"–120" • Skin: wood veneer 	<ol style="list-style-type: none"> 1 Style number 2 Height 3 Width 4 Wood veneer color number for skin 5 Wood grain direction for skins (see below under Required Selections) 6 Top mount type (see below under Required Selections) 7 Bottom mount type (see below under Required Selections) 8 Cable management cut-out type and location, if selected (see below under Required Selections) 9 Options, if selected (see below) <p>▶ See <i>Surface Materials</i>, page 222.</p>

	Required Selections	U.S. Price		Required to Specify
Wood Grain Direction	Skins	Per Frame	Per Sq/Ft	
	<ul style="list-style-type: none"> • Horizontal application • Vertical application 	No cost	N.A.	Specify with <i>horizontal application</i> .
		No cost	N.A.	Specify with <i>vertical application</i> .
Top Mount Type	<ul style="list-style-type: none"> • Ceiling • Intermediate 	No cost	N.A.	Specify with <i>ceiling top mount</i> .
		No cost	N.A.	Specify with <i>intermediate top mount</i> .
Bottom Mount Type	<ul style="list-style-type: none"> • Floor • Intermediate 	No cost	N.A.	Specify with <i>floor bottom mount</i> .
		No cost	N.A.	Specify with <i>intermediate bottom mount</i> .
Cable Management	Cut-out			
	• Hardwire single	+\$11.44 per cutout		Specify with <i>hardwire single</i> .
	• Hardwire double	+\$11.44 per cutout		Specify with <i>hardwire double</i> .
	• Hardwire triple	+\$11.44 per cutout		Specify with <i>hardwire triple</i> .
	• Hardwire fourplex	+\$11.44 per cutout		Specify with <i>hardwire fourplex</i> .
	• Modular double	+\$24.11 per cutout		Specify with <i>modular double</i> .
	• Comm only - modular	+\$11.44 per cutout		Specify with <i>comm only - modular</i> .
	• Comm only - no box	+\$11.44 per cutout		Specify with <i>comm only - no box</i> .
	• Surface Hub 2	+\$11.44 per cutout		Specify with <i>surface hub 2</i> .

	Options	U.S. Price		Required to Specify
Surface Materials	Frames	Per Skin	Per Sq/Ft	
	• Composite veneer price group 1	No cost	No cost	Specify composite veneer color number.
	• Composite veneer price group 2	+\$ 1.76	+\$14.00	Specify composite veneer color number.
	• Wood group 1	No cost	No cost	Specify wood color number.
	• Wood group 2	+\$ 1.94	+\$15.40	Specify wood color number.
	• Wood group 3	+\$ 1.94	+\$56.40	Specify wood color number.
	• Customiz stain	No cost	No cost	Specify with <i>customiz stain</i> .

Specification Information			
Style Number	Square Foot (Sq/Ft)	U.S. Base Price	
		Per Skin	Per Sq/Ft
FESSV	1.25000"–6.00000"	\$1000.60	+\$131.25
	6.00001"–20.00000"	\$ 940.82	+\$ 72.13
	20.00001"–50.00000"	\$ 901.79	+\$ 71.11

 **For Canadian Pricing**
 Multiply U.S. Price by the Canadian price factor.
 ▶ See page 1 for details.

Solid Laminate Skin

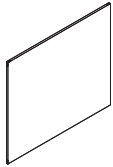

Tip: High-Pressure Laminate skins are not available for use in Canada.

Standard Includes		Required to Specify
<ul style="list-style-type: none"> ▶ Need help? Product details, page 40 	<ul style="list-style-type: none"> • Height: 6"–120" • Width: 6"–120" • Skin: Low-Pressure Laminate (LPL) or High-Pressure Laminate (HPL) price group 1 	<ol style="list-style-type: none"> 1 Style number 2 Height 3 Width 4 Laminate color number for skin 5 Wood grain direction (see below under Required Selections) 6 Top mount type (see below under Required Selections) 7 Bottom mount type (see below under Required Selections) 8 Cable management cut-out and cut-out type (see below under Required Selections) 9 Options, if selected (see below) <ul style="list-style-type: none"> ▶ See <i>Surface Materials</i>, page 222.

	Required Selections	U.S. Price		Required to Specify
		Per Frame	Per Sq/Ft	
Wood Grain Direction	Skins <ul style="list-style-type: none"> • Horizontal application • Vertical application 	No cost	N.A.	Specify with horizontal application.
		No cost	N.A.	Specify with vertical application.
Top Mount Type	<ul style="list-style-type: none"> • Ceiling • Intermediate 	No cost	N.A.	Specify with ceiling top mount.
		No cost	N.A.	Specify with intermediate top mount.
Bottom Mount Type	<ul style="list-style-type: none"> • Floor • Intermediate 	No cost	N.A.	Specify with floor bottom mount.
		No cost	N.A.	Specify with intermediate bottom mount.
Cable Management	Cut-out <ul style="list-style-type: none"> • Hardwire single • Hardwire double • Hardwire triple • Hardwire fourplex • Modular double • Comm only - modular • Comm only - no box • Surface Hub 2 	+\$11.44 per cutout +\$11.44 per cutout +\$11.44 per cutout +\$11.44 per cutout +\$24.11 per cutout +\$11.44 per cutout +\$11.44 per cutout +\$11.44 per cutout		Specify with hardwire single. Specify with hardwire double. Specify with hardwire triple. Specify with hardwire fourplex. Specify with modular double. Specify with comm only - modular. Specify with comm only - no box. Specify with surface hub 2.

	Options	U.S. Price		Required to Specify
		Per Skin	Per Sq/Ft	
Surface Materials	Frames <ul style="list-style-type: none"> • Laminate price group 1 – Low-Pressure • Laminate price group 1 – High-Pressure • Laminate price group 2 – High-Pressure • Laminate price group 3 – High-Pressure • Open Line laminate 	No cost	No cost	Specify laminate color number.
		No cost	+\$11.87	Specify laminate color number.
		No cost	+\$23.29	Specify laminate color number.
		No cost	+\$29.26	Specify laminate color number.
		No cost	+\$11.87	▶ See <i>Surface Materials Reference Manual</i> .

Specification Information			
Style Number	Square Foot (Sq/Ft)	U.S. Base Price	
			Per Skin Per Sq/Ft
FESSL	0.50000"–12.00000"	\$178.85	+\$44.38
	12.00001"–24.00000"	\$ 39.06	+\$44.80
	24.00001"–50.00000"	\$ 31.51	+\$40.34

 **For Canadian Pricing**
 Multiply U.S. Price by the Canadian price factor.
 ▶ See page 1 for details.

Ceramic Skin

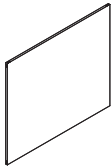

Standard Includes	Required to Specify
<ul style="list-style-type: none"> ▶ Need help? Product details, page 40 • Height: 24"–120" • Width: 24"–120" • Skin with ceramic markerboard surface • Trim: 4145 Milk Gloss paint only 	<ol style="list-style-type: none"> 1 Style number 2 Height 3 Width 4 Top mount type (see below under Required Selections) 5 Bottom mount type (see below under Required Selections)

Required Selections	U.S. Price	Required to Specify
Top Mount Type <ul style="list-style-type: none"> • Ceiling • Intermediate 	No cost No cost	Specify with <i>ceiling top mount</i> . Specify with <i>intermediate top mount</i> .
Bottom Mount Type <ul style="list-style-type: none"> • Floor • Intermediate 	No cost No cost	Specify with <i>floor bottom mount</i> . Specify with <i>intermediate bottom mount</i> .

Specification Information			
Style Number	Square Foot (Sq/Ft)	U.S. Base Price	
:	:	Per Skin	Per Sq/Ft
FESC	4.00000"–12.00000"	\$144.39	+\$77.76
:	12.00001"–40.00000"	\$ 48.81	+\$92.26
:	:	:	:



For Canadian Pricing
 Multiply U.S. Price by the Canadian price factor.
 ▶ See page 1 for details.

Hardware

Flush Skin Seal



Standard Includes		Required to Specify
▶ Need help? Product details, page 40	<ul style="list-style-type: none"> Flush skin seal: clear plastic Length: 120" 	Style number

Specification Information		
Style Number	Length	U.S. Price
FESSF	120"	\$73.67
:	:	:

90° Inside Corner Flush Skin Seal

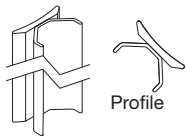

Standard Includes		Required to Specify
▶ Need help? Product details, page 42	<ul style="list-style-type: none"> Flush skin seal: clear plastic Length: 120" 	Style number

Specification Information		
Style Number	Length	U.S. Price
FESSFIC90	120"	\$137.14
:	:	:

Cove Base Trim—Straight

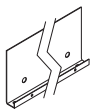

Standard Includes		Required to Specify
▶ Need help? Product details, page 42	<ul style="list-style-type: none"> Cove base trim Length: 75" 	Style number

Specification Information		
Style Number	Length	U.S. Price
FEBTSC	75"	\$142.70
:	:	:



For Canadian Pricing
Multiply U.S. Price by the
Canadian price factor.
▶ See page 1 for details.

Junction Cover Retention Clip



Standard Includes	Required to Specify
<ul style="list-style-type: none"> ▶ Need help? Product details, page 43 • Single clip: steel 	<ul style="list-style-type: none"> Style number

Specification Information

• Style Number	• U.S. Price
FEIJRC	\$70.57

Tip: Three clips required for 90° outside corners 120" tall or less. Four clips required for corners over 120".

Tip: For use on 90° outside corners only when using flush skin seals and 90° inside corner flush skin seals.



 **For Canadian Pricing**
 Multiply U.S. Price by the Canadian price factor.
 ▶ See page 1 for details.

Acoustic Products

Acoustic Insulation

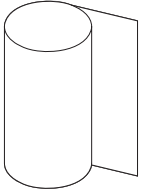

Standard Includes	Required to Specify
<ul style="list-style-type: none"> ▶ Need help? Product details, page 43 • One roll – 48" wide x 87 feet long x 2 layers (696 square feet) 	Style number

Specification Information

• Style Number	• U.S. Price
FESIA	\$860.11

Acoustic Skin Seal

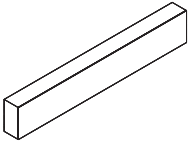

Tip: Horizontal acoustic seals are cut to length during installation.

Standard Includes	Required to Specify
<ul style="list-style-type: none"> ▶ Need help? Product details, page 40 • 120"W seal 	Style number

Specification Information

• Style Number	• U.S. Price
FESSA2	\$38.39



For Canadian Pricing
 Multiply U.S. Price by the Canadian price factor.
 ▶ See page 1 for details.

Specifying Reversible Swing Doors

Single Reversible Swing Door Frame	154
Single Reversible Solid Swing Door Leaf	156
Single Reversible Polished Edge Swing Door Leaf	158
Pair of Reversible Swing Door Frames	160
Pair of Reversible Solid Swing Door Leaves	162
Pair of Reversible Polished Edge Swing Door Leaves	164
Door Hardware	165

Single Reversible Swing Door Frame



Standard Includes		Required to Specify
<ul style="list-style-type: none"> ▶ Need help? Product details, page 46 	<ul style="list-style-type: none"> • Door frame: paint or 8043 Clear Anodized Aluminum • Height: 82.44100"—123.71627" • Width: 28"—44.445" • Hinges: metal • Strike plate: 9200 Satin Chrome or 9201 Polished Chrome 	<ol style="list-style-type: none"> 1 Style number 2 Height 3 Width 4 Paint or anodized aluminum or paint color number for frame 5 Brushed stainless, polished chrome, or black for hinges 6 Top mount type (see below under Required Selections) 7 Handedness (see below under Required Selections) 8 Door type (see below under Required Selections) 9 Latch prep (see below under Required Selections) 10 Roller latch (see below under Required Selections) 11 Door hardware (see below under Required Selections) 12 Strike plate (see below under Required Selections) 13 Electrification (see below under Required Selections) 14 Options, if selected (see below) <ul style="list-style-type: none"> ▶ See <i>Surface Materials</i>, page 222.

Tip: When the black finish is specified, the strike plate will default to the satin chrome finish.

Tip: The roller latch plate is not available in 9201 Polished Chrome, therefore, 9200 Satin Chrome will be defaulted when the hardware finish selected is either 9201 Polished Chrome or 9200 Satin Chrome.

Tip: Finishes for door hardware can vary slightly from one component to another depending on base metal materiality and finishing processes. When hardware is specified for common assemblies, all hardware components may not match exactly, but are designed to be compatible within a common door opening.

Tip: Electrification option is only available when cylindrical or mortise latch prep is selected. Electrification is not available when push/pull handles are selected.

	Required Selections	U.S. Price	Required to Specify
Top Mount Type	<ul style="list-style-type: none"> • Ceiling • Intermediate 	No cost No cost	Specify with <i>ceiling mount</i> . Specify with <i>intermediate mount</i> .
Handedness	<ul style="list-style-type: none"> • Right hand • Left hand 	No cost No cost	Specify with <i>right hand</i> . Specify with <i>left hand</i> .
Door Type	<ul style="list-style-type: none"> • Solid • Polished edge (<=84") • Polished edge (>84") 	No cost +\$191.04 +\$254.72	Specify with <i>solid door</i> . Specify with <i>polished edge door</i> . Specify with <i>polished edge door</i> .
Latch Prep	<ul style="list-style-type: none"> • Cylindrical • Ladder aligned • Ladder offset • Mortise • Push/pull handle 	No cost No cost No cost No cost No cost	Specify with <i>cylindrical latch prep</i> . Specify with <i>ladder aligned latch prep</i> . Specify with <i>ladder offset latch prep</i> . Specify with <i>mortise latch prep</i> . Specify with <i>push/pull handle latch prep</i> .
Roller Latch (only if push/pull handles)	<ul style="list-style-type: none"> • No roller latch • Top roller latch 	No cost No cost	Specify with <i>no roller latch</i> . Specify with <i>roller latch</i> .
Door Hardware (only if cylindrical or mortise)	<ul style="list-style-type: none"> • Satin chrome • Polished chrome (3 hinges) • Polished chrome (4 hinges) • Low gloss black (3 hinges) • Low gloss black (4 hinges) 	No cost +\$109.56 +\$146.08 +\$692.38 +\$923.16	Specify with <i>satin chrome</i> . Specify with <i>polished chrome</i> . Specify with <i>polished chrome</i> . Specify with <i>low gloss black</i> . Specify with <i>low gloss black</i> .
Strike Plate (if latch prep is mortise)	<ul style="list-style-type: none"> • Type 1 • Type 2 • No strike plate 	No cost No cost -\$ 84.05	Specify with <i>type 1 strike plate</i> . Specify with <i>type 2 strike plate</i> . Specify with <i>no strike plate</i> .
Electrification	<ul style="list-style-type: none"> • No electrification • With electrification 	No cost -\$216.11	Specify with <i>no electrification</i> . Specify with <i>electrification</i> .

	Options	U.S. Price	Required to Specify
Surface Materials	Frames	Per Sq/Ft	
	<ul style="list-style-type: none"> • Paint price group 1 • Paint price group 2 • Paint price group 3 • Anodized 	No cost +\$ 1.30 +\$ 2.30 +\$ 1.09	Specify paint color number. Specify paint color number. Specify paint color number. Specify with <i>anodized</i> .

 **For Canadian Pricing**
Multiply U.S. Price by the Canadian price factor.
▶ See page 1 for details.

Specification Information

•Style •Number	•U.S. •Base •Price	: Add per inch : height of frame	: Add per frame : when frame is : not equal to 40"	: Add per frame for 4th hinge : when ceiling height : and height > 93.71700" : or when intermediate height : and height > 92.60600"
FEDFSWR	\$3850.48	+\$3.23	+\$93.75	+\$262.02 (for solid door) +\$508.33 (for polished edge door)
:	:	:	:	:

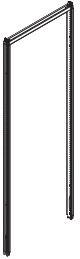

 **For Canadian Pricing**
Multiply U.S. Price by the
Canadian price factor.
▶ See page 1 for details.

Single Reversible Solid Swing Door Leaf



Standard Includes		Required to Specify
<ul style="list-style-type: none"> ▶ Need help? Product details, page 46 	<ul style="list-style-type: none"> • Door leaf: paint or veneer • Height: 82.44100"–123.71627" • Width: 28"–44.445" 	<ol style="list-style-type: none"> 1 Style number 2 Height 3 Width 4 Paint or veneer color number for door leaf 5 Acoustic seal (see below under Required Selections) 6 Top mount type (see below under Required Selections) 7 Latch prep (see below under Required Selections) 8 Roller latch (see below under Required Selections) 9 Door closer (see below under Required Selections) 10 Electrification (see below under Required Selections) 11 Options, if selected (see below) <ul style="list-style-type: none"> ▶ See <i>Surface Materials</i>, page 222.

	Required Selections	U.S. Price	Required to Specify
Acoustic Seal	<ul style="list-style-type: none"> • No seal • Drop seal 	<ul style="list-style-type: none"> No cost +\$ 73.42 	<ul style="list-style-type: none"> Specify <i>with no drop seal</i>. Specify <i>with drop seal</i>.
Top Mount Type	<ul style="list-style-type: none"> • Ceiling • Intermediate 	<ul style="list-style-type: none"> No cost No cost 	<ul style="list-style-type: none"> Specify <i>with ceiling mount</i>. Specify <i>with intermediate mount</i>.
Latch Prep	<ul style="list-style-type: none"> • Cylindrical • Ladder aligned • Ladder offset • Mortise • Push/pull handles 	<ul style="list-style-type: none"> No cost No cost No cost +\$ 31.25 No cost 	<ul style="list-style-type: none"> Specify <i>with cylindrical</i>. Specify <i>with ladder aligned</i>. Specify <i>with ladder offset</i>. Specify <i>with mortise</i>. Specify <i>with push/pull handles</i>.
Roller Latch (only if push/pull handles)	<ul style="list-style-type: none"> • No roller latch • Top roller latch 	<ul style="list-style-type: none"> No cost +\$ 31.25 	<ul style="list-style-type: none"> Specify <i>with no roller latch</i>. Specify <i>with roller latch</i>.
Door Closer (only if mortise or cylindrical)	<ul style="list-style-type: none"> • No door closer • Surface mounted door closer 	<ul style="list-style-type: none"> No cost No cost 	<ul style="list-style-type: none"> Specify <i>with no door closer</i>. Specify <i>with surface mounted door closer</i>.
Electrification	<ul style="list-style-type: none"> • No electrification • With electrification 	<ul style="list-style-type: none"> No cost +\$ 173.05 	<ul style="list-style-type: none"> Specify <i>with no electrification</i>. Specify <i>with electrification</i>.

Tip: Electrification option is only available when cylindrical or mortise latch prep is selected. Electrification is not available when push/pull handles are selected.

	Options	U.S. Price	Required to Specify
Surface Materials	<ul style="list-style-type: none"> • Paint price group 1 • Paint price group 3 • Composite veneer price group 1 • Composite veneer price group 2 • Flat-cut wood veneer • Quarter-cut/rift-cut wood veneer • Wood group 2 • Wood group 3 • Customiz stain 	<ul style="list-style-type: none"> No cost +\$ 169.83 +\$ 94.38 +\$ 467.54 +\$ 103.82 +\$ 296.34 +\$ 514.30 +\$1797.29 +\$ 103.82 	<ul style="list-style-type: none"> Specify paint color number. Specify paint color number. Specify composite veneer color number. Specify composite veneer color number. Specify flat-cut wood color number. Specify quarter-cut/rift-cut wood color number. Specify wood color number. Specify wood color number. Specify <i>with customiz stain</i>.



For Canadian Pricing
 Multiply U.S. Price by the Canadian price factor.
 ▶ See page 1 for details.

Specification Information

Style Number	U.S. Base Price	Add per inch height of door when height > 82.44100"	Add per door when door width is not equal to 40"	Add per door for 4th hinge when ceiling height and height > 93.71700" or when intermediate height and height > 92.60600"
FEDLSWSSR	\$2525.78	+\$20.16	+\$92.02	+\$49.84



 **For Canadian Pricing**
Multiply U.S. Price by the
Canadian price factor.
▶ See page 1 for details.

Single Reversible Polished Edge Swing Door Leaf



Standard Includes		Required to Specify
▶ Need help? Product details, page 46	<ul style="list-style-type: none"> • Door leaf: polished edge glass • Height: 82.44100"–123.71627" • Width: 28"–44.445" • Housing for latch set or roller latch, if selected 	<ol style="list-style-type: none"> 1 Style number 2 Height 3 Width 4 Glass number for door leaf 5 Glass orientation (see below under Required Selections) 6 Top mount type (see below under Required Selections) 7 Handedness (see below under Required Selections) 8 Latch prep (see below under Required Selections) 9 Frame prep (see below under Required Selections) 10 Door closer (see below under Required Selections) 11 Door hardware (see below under Required Selections) 12 Options, if selected (see below) <p>▶ See <i>Surface Materials</i>, page 222.</p>

Tip: Glass orientation applies only when 6542 Satin or 6588 Bamboo glass finishes specified.

Tip: The roller latch housing is not available in 9201 Polished Chrome, therefore, 9200 Satin Chrome will be defaulted when the hardware finish selected is either 9201 Polished Chrome or 9200 Satin Chrome.

Tip: Finishes for door hardware can vary slightly from one component to another depending on base metal materiality and finishing processes. When hardware is specified for common assemblies, all hardware components may not match exactly, but are designed to be compatible within a common door opening.

	Required Selections	U.S. Price	Required to Specify
Glass Orientation	<ul style="list-style-type: none"> • Polished to inside • Polished to outside 	No cost No cost	Specify with <i>polished to inside</i> . Specify with <i>polished to outside</i> .
Top Mount Type	<ul style="list-style-type: none"> • Ceiling • Intermediate 	No cost No cost	Specify with <i>ceiling mount</i> . Specify with <i>intermediate mount</i> .
Handedness	<ul style="list-style-type: none"> • Right hand • Left hand 	No cost No cost	Specify with <i>right hand</i> . Specify with <i>left hand</i> .
Latch Prep	<ul style="list-style-type: none"> • Cylindrical • Ladder aligned • Ladder offset • Mortise • Push/pull handles 	No cost No cost No cost +\$748.91 –\$205.74	Specify with <i>cylindrical latch prep</i> . Specify with <i>ladder aligned latch prep</i> . Specify with <i>ladder offset latch prep</i> . Specify with <i>mortise latch prep</i> . Specify with <i>push/pull handles latch prep</i> .
Frame Prep (only if push/pull handles)	<ul style="list-style-type: none"> • No roller latch • Top roller latch 	No cost +\$709.10	Specify with <i>no roller latch</i> . Specify with <i>roller latch</i> .
Door Closer (only if mortise or cylindrical)	<ul style="list-style-type: none"> • No door closer • Surface mounted door closer 	No cost +\$187.30	Specify with <i>no door closer</i> . Specify with <i>surface mounted door closer</i> .
Door Hardware (only if mortise or, cylindrical or roller latch)	<ul style="list-style-type: none"> • 4710 Low Gloss Black • 9200 Satin Chrome • 9201 Polished Chrome 	No cost +\$ 56.15 +\$220.85	Specify with <i>low gloss black</i> . Specify with <i>satin chrome</i> . Specify with <i>polished chrome</i> .

	Options	U.S. Price	Required to Specify
Surface Materials	Glass (per square foot of door) <ul style="list-style-type: none"> • Glass price group 1 • Glass price group 3 • COG (Customer's Own Glass) 	No cost +\$ 32.69 –\$ 6.33	Specify paint color number. Specify paint color number. Specify paint color number.



For Canadian Pricing
Multiply U.S. Price by the Canadian price factor.
▶ See page 1 for details.

Specification Information

Style Number	U.S. Base Price	Add per Sq/Ft of door	Add per frame for 4th hinge when ceiling height and height > 93.71700" or when intermediate height and height > 92.60600"
FEDLSWPSR	\$1454.10	+\$84.08	+\$187.30



 **For Canadian Pricing**
Multiply U.S. Price by the
Canadian price factor.
▶ See page 1 for details.

Pair of Reversible Swing Door Frames



► Need help?
Product details,
page 46

Standard Includes

- Door frame: paint or 8043 Clear Anodized Aluminum
- Height: 82.44100"–123.71627"
- Width: 48"–80"
- Hinges: metal
- Strike plate: 9200 Satin Chrome or 9201 Polished Chrome
- Shim plates for hinges brush seal (when polished glass doors are specified)
- Astragal (when inactive door is specified)

Required to Specify

- 1 Style number
 - 2 Height
 - 3 Width
 - 4 Active door width
 - 5 Paint or anodized aluminum or paint color number for frame
 - 6 Brushed stainless, polished chrome, or black for hinges
 - 7 Paint or anodized aluminum or paint color number for astragal
 - 8 Acoustic seal (see below under Required Selections)
 - 9 Top mount type (see below under Required Selections)
 - 10 Handedness (see below under Required Selections)
 - 11 Door type (see below under Required Selections)
 - 12 Roller latch (see below under Required Selections)
 - 13 Door hardware (see below under Required Selections)
 - 14 Electrification (see below under Required Selections)
 - 15 Options, if selected (see below)
- See *Surface Materials*, page 222.

Tip: When the black finish is specified, the strike plate will default to the satin chrome finish.

Tip: The roller latch plate is not available in 9201 Polished Chrome, therefore, 9200 Satin Chrome will be defaulted when the hardware finish selected is either 9201 Polished Chrome or 9200 Satin Chrome.

Tip: Finishes for door hardware can vary slightly from one component to another depending on base metal materiality and finishing processes. When hardware is specified for common assemblies, all hardware components may not match exactly, but are designed to be compatible within a common door opening.

	Required Selections	U.S. Price	Required to Specify
Acoustic Seal	<ul style="list-style-type: none"> • No seal • Drop seal • Vertical seal • Drop seal and vertical seal 	<ul style="list-style-type: none"> No cost No cost +\$ 1.77 No cost 	<ul style="list-style-type: none"> Specify <i>with no seal</i>. Specify <i>with drop seal</i>. Specify <i>with vertical seal</i>. Specify <i>with drop and vertical seal</i>.
Top Mount Type	<ul style="list-style-type: none"> • Ceiling • Intermediate 	<ul style="list-style-type: none"> No cost No cost 	<ul style="list-style-type: none"> Specify <i>with ceiling mount</i>. Specify <i>with intermediate mount</i>.
Handedness	<ul style="list-style-type: none"> • Right-hand active • Left-hand active • Both hands active 	<ul style="list-style-type: none"> +\$524.44 +\$524.44 No cost 	<ul style="list-style-type: none"> Specify <i>with right-hand active</i>. Specify <i>with left-hand active</i>. Specify <i>with both hands active</i>.
Door Type	<ul style="list-style-type: none"> • Solid • Polished edge 	<ul style="list-style-type: none"> No cost +\$382.08 	<ul style="list-style-type: none"> Specify <i>with solid door</i>. Specify <i>with polished edge door</i>.
Roller Latch	<ul style="list-style-type: none"> • No roller latch • Roller latch 	<ul style="list-style-type: none"> No cost No cost 	<ul style="list-style-type: none"> Specify <i>with no roller latch</i>. Specify <i>with roller latch</i>.
Door Hardware	<ul style="list-style-type: none"> • Satin chrome • Low gloss black • Polished chrome (6 hinges) 	<ul style="list-style-type: none"> No cost No cost +\$219.16 	<ul style="list-style-type: none"> Specify <i>with satin chrome</i>. Specify <i>with low gloss black</i>. Specify <i>with polished chrome</i>.
Electrification	<ul style="list-style-type: none"> • No electrification • Electrification lock • Electrification strike 	<ul style="list-style-type: none"> No cost –\$216.11 –\$216.11 	<ul style="list-style-type: none"> Specify <i>with no electrification</i>. Specify <i>with electrification lock</i>. Specify <i>with electrification strike</i>.

	Options	U.S. Price	Required to Specify
Surface Materials	Frames <ul style="list-style-type: none"> • Paint price group 1 • Paint price group 2 • Paint price group 3 • Anodized 	<ul style="list-style-type: none"> No cost +\$ 1.30 +\$ 2.30 +\$ 1.09 	<ul style="list-style-type: none"> Specify paint color number. Specify paint color number. Specify paint color number. Specify <i>with anodized</i>.
	Astragal <ul style="list-style-type: none"> • Paint price group 1 • Paint price group 2 • Paint price group 3 • Anodized 	<ul style="list-style-type: none"> No cost No cost No cost No cost 	<ul style="list-style-type: none"> Specify paint color number. Specify paint color number. Specify paint color number. Specify <i>with anodized</i>.



For Canadian Pricing

Multiply U.S. Price by the Canadian price factor.

► See page 1 for details.

Specification Information

Style Number	U.S. Base Price	Add per inch height of frame	Add per frame when frame is not equal to 80"	Add per frame for 4th hinge when ceiling height and height > 93.71700" or when intermediate height and height > 92.60600"
FEDFSWPR	\$5081.87	+\$3.23	+\$93.75	+\$ 524.04 (for solid door) +\$1016.66 (for polished edge door)
:	:	:	:	:



 **For Canadian Pricing**
Multiply U.S. Price by the
Canadian price factor.
▶ See page 1 for details.

Pair of Reversible Solid Swing Door Leaves

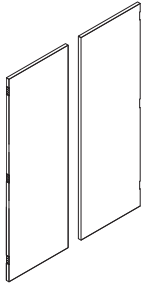

Standard Includes		Required to Specify
<ul style="list-style-type: none"> ▶ Need help? Product details, page 46 	<ul style="list-style-type: none"> • Door leaf: paint or veneer • Height: 82.44100"–123.71627" • Width: 48"–80" 	<ol style="list-style-type: none"> 1 Style number 2 Height 3 Width 4 Active door width 5 Paint or veneer color number for door leaves 6 Acoustic seal (see below under Required Selections) 7 Top mount type (see below under Required Selections) 8 Handedness (see below under Required Selections) 9 Latch prep (see below under Required Selections) 10 Roller latch (see below under Required Selections) 11 Door closer (see below under Required Selections) 12 Electrification (see below under Required Selections) 13 Options, if selected (see below) <p>▶ See <i>Surface Materials</i>, page 222.</p>

	Required Selections	U.S. Price	Required to Specify
Acoustic Seal	<ul style="list-style-type: none"> • No seal • Drop seal • Vertical seal • Drop seal and vertical seal 	<ul style="list-style-type: none"> No cost +\$ 146.83 +\$ 31.25 +\$ 178.09 	<ul style="list-style-type: none"> Specify <i>with no seal</i>. Specify <i>with drop seal</i>. Specify <i>with vertical seal</i>. Specify <i>with drop and vertical seal</i>.
Top Mount Type	<ul style="list-style-type: none"> • Ceiling • Intermediate 	<ul style="list-style-type: none"> No cost No cost 	<ul style="list-style-type: none"> Specify <i>with ceiling mount</i>. Specify <i>with intermediate mount</i>.
Handedness	<ul style="list-style-type: none"> • Right-hand active • Left-hand active • Both hands active 	<ul style="list-style-type: none"> No cost No cost No cost 	<ul style="list-style-type: none"> Specify <i>with right-hand active</i>. Specify <i>with left-hand active</i>. Specify <i>with both hands active</i>.
Latch Prep	<ul style="list-style-type: none"> • Cylindrical • Ladder, aligned • Ladder, offset • Mortise • No latch prep • Push/pull handles 	<ul style="list-style-type: none"> No cost No cost No cost +\$ 31.25 No cost No cost 	<ul style="list-style-type: none"> Specify <i>with cylindrical latch prep</i>. Specify <i>with ladder, aligned latch prep</i>. Specify <i>with ladder, offset latch prep</i>. Specify <i>with mortise latch prep</i>. Specify <i>with no latch prep</i>. Specify <i>with push/pull handles latch prep</i>.
Roller Latch (only if ladder or no latch prep)	<ul style="list-style-type: none"> • No roller latch • Roller latch 	<ul style="list-style-type: none"> No cost +\$ 31.25 	<ul style="list-style-type: none"> Specify <i>with no roller latch</i>. Specify <i>with roller latch</i>.
Door Closer	<ul style="list-style-type: none"> • No door closer • Surface mounted door closer 	<ul style="list-style-type: none"> No cost No cost 	<ul style="list-style-type: none"> Specify <i>with no door closer</i>. Specify <i>with surface mounted door closer</i>.
Electrification	<ul style="list-style-type: none"> • No electrification • Electrification lock 	<ul style="list-style-type: none"> No cost +\$ 173.05 	<ul style="list-style-type: none"> Specify <i>with no electrification</i>. Specify <i>with electrification lock</i>.

	Options	U.S. Price	Required to Specify
Surface Materials	<ul style="list-style-type: none"> • Paint price group 1 • Paint price group 3 • Composite veneer price group 1 • Composite veneer price group 2 • Flat-cut wood veneer • Quarter-cut/rift-cut wood veneer • Wood group 2 • Wood group 3 • Customiz stain 	<ul style="list-style-type: none"> No cost +\$ 339.66 +\$ 188.76 +\$ 935.08 +\$ 207.64 +\$ 592.68 +\$1028.60 +\$3594.58 +\$ 207.64 	<ul style="list-style-type: none"> Specify paint color number. Specify paint color number. Specify composite veneer color number. Specify composite veneer color number. Specify flat-cut wood color number. Specify quarter-cut/rift-cut wood color number. Specify wood color number. Specify wood color number. Specify <i>with customiz stain</i>.



For Canadian Pricing
 Multiply U.S. Price by the Canadian price factor.
 ▶ See page 1 for details.

Specification Information

Style Number	U.S. Base Price	Add per inch height of frame when height >82.44100"	Add per frame when frame is not equal to 80"	Add per frame for 4th hinge when ceiling height and height > 93.71700" or when intermediate height and height > 92.60600"
FEDLSWSPR	\$5052.72	+\$40.32	+\$92.02	+\$99.68

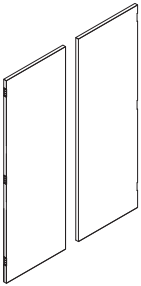

 **For Canadian Pricing**
Multiply U.S. Price by the
Canadian price factor.
▶ See page 1 for details.

Pair of Reversible Polished Edge Swing Door Leaves

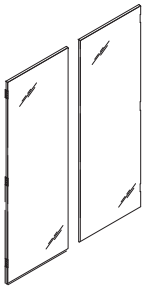

Standard Includes		Required to Specify
▶ Need help? Product details, page 46	<ul style="list-style-type: none"> • Door leaf: polished edge glass • Height: 82.44100"–123.71627" • Width: 48"–80" • Housings for roller latch, if selected 	<ol style="list-style-type: none"> 1 Style number 2 Height 3 Width 4 Active door width 5 Glass number for door leaf 6 Glass orientation (see below under Required Selections) 7 Top mount type (see below under Required Selections) 8 Handedness (see below under Required Selections) 9 Latch prep (see below under Required Selections) 10 Roller latch (see below under Required Selections) 11 Door closer (see below under Required Selections) 12 Hardware finish (roller latch), if selected (see below under Required Selections) 13 Options, if selected (see below)
		▶ See <i>Surface Materials</i> , page 222.

Tip: Glass orientation applies only when satin or bamboo glass finishes specified.

	Required Selections	U.S. Price	Required to Specify
Glass Orientation	<ul style="list-style-type: none"> • Polished to inside • Polished to outside 	No cost No cost	Specify with <i>polished to inside</i> . Specify with <i>polished to outside</i> .
Top Mount Type	<ul style="list-style-type: none"> • Ceiling • Intermediate 	No cost	Specify with <i>ceiling mount</i> . Specify with <i>intermediate mount</i> .
Handedness	<ul style="list-style-type: none"> • Both hands active 	No cost	Specify with <i>both hands active</i> .
Latch Prep	<ul style="list-style-type: none"> • Ladder, aligned • Ladder, offset • Push/pull handles 	No cost No cost No cost	Specify with <i>ladder, aligned latch prep</i> . Specify with <i>ladder, offset latch prep</i> . Specify with <i>push/pull handles latch prep</i> .
Roller Latch	<ul style="list-style-type: none"> • No roller latch • Roller latch 	No cost +\$1418.19	Specify with <i>no roller latch</i> . Specify with <i>roller latch</i> .
Door Closer	<ul style="list-style-type: none"> • No door closer • Surface mounted door closer 	No cost +\$ 374.61	Specify with <i>no door closer</i> . Specify with <i>surface mounted door closer</i> .
Hardware Finish	<ul style="list-style-type: none"> • Satin chrome • Low gloss black 	No cost +\$ 435.98	Specify with <i>satin chrome</i> . Specify with <i>low gloss black</i> .

Tip: Finishes for door hardware can vary slightly from one component to another depending on base metal materiality and finishing processes. When hardware is specified for common assemblies, all hardware components may not match exactly, but are designed to be compatible within a common door opening.

	Options	U.S. Price	Required to Specify
Surface Materials	Glass (per square foot of door)		
	<ul style="list-style-type: none"> • Glass price group 1 • Glass price group 3 • COG (Customer's Own Glass) 	No cost +\$ 34.50 -\$ 6.57	Specify paint color number. Specify paint color number. Specify paint color number.

Specification Information			
Style Number	U.S. Base Price	Add per Sq/Ft of door	Add per frame for 4th hinge when ceiling height and height > 93.71700" or when intermediate height and height > 92.60600"
FEDLSWPPR	\$2165.94	+\$84.08	+\$374.60



For Canadian Pricing
Multiply U.S. Price by the Canadian price factor.
▶ See page 1 for details.

Cylindrical Latch Set

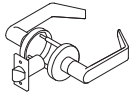

Tip: When the black finish is specified on latch sets, the strike plate will default to the satin chrome finish.

Tip: Lock cores are only available in 9200 Satin Chrome.

Standard Includes	Required to Specify
<ul style="list-style-type: none"> ▶ Need help? Product details, page 47 • Cylindrical latch set: metal 	<ol style="list-style-type: none"> 1 Style number 2 Hardware finish (see below under Required Selections) 3 Latch prep (see below under Required Selections) 4 Keying (see below under Required Selections)

	Required Selections	U.S. Price	Required to Specify
Hardware Finish	<ul style="list-style-type: none"> • Low gloss black • Satin chrome • Polished chrome 	<p>No cost</p> <p>No cost</p> <p>+\$ 36.52</p>	<p>Specify with <i>low gloss black</i>.</p> <p>Specify with <i>satin chrome</i>.</p> <p>Specify with <i>polished chrome</i>.</p>
Latch Prep	<ul style="list-style-type: none"> • Passage • Lockset 	<p>No cost</p> <p>+\$336.86</p>	<p>Specify with <i>passage latch prep</i>.</p> <p>Specify with <i>lockset latch prep</i>.</p>
Keying	<ul style="list-style-type: none"> • Core, keyed random • No core • No key 	<p>No cost</p> <p>No cost</p> <p>No cost</p>	<p>Specify with <i>core random keyed</i>.</p> <p>Specify with <i>no core</i>.</p> <p>Specify with <i>no key</i>.</p>

Specification Information	
Style Number	U.S. Base Price
FEDCLO	\$919.28
.	.

Reversible Swing Doors

For Canadian Pricing
 Multiply U.S. Price by the Canadian price factor.
 ▶ See page 1 for details.

Mortise Latch Set

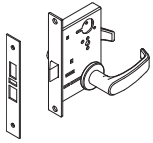

Tip: When using mortise latch sets, once a wood door or a glass door lock housing has been face drilled, it will not be reversible.

Tip: When the black finish is specified on latch sets, the strike plate will default to the satin chrome finish.

Tip: Lock cores are only available in 9200 Satin Chrome.

Standard Includes		Required to Specify	
<ul style="list-style-type: none"> Need help? Product details, page 47 	<ul style="list-style-type: none"> Mortise latch set: metal 	<ol style="list-style-type: none"> Style number Hardware finish (see below under Required Selections) Latch prep (see below under Required Selections) Keying (see below under Required Selections) 	
Required Selections	U.S. Price	Required to Specify	
Hardware Finish <ul style="list-style-type: none"> Low gloss black Satin chrome Polished chrome 	No cost No cost +\$ 53.09	Specify <i>with low gloss black</i> . Specify <i>with satin chrome</i> . Specify <i>with polished chrome</i> .	
Latch Prep <ul style="list-style-type: none"> Passage Lockset 	No cost +\$302.00	Specify <i>with passage latch prep</i> . Specify <i>with lockset latch prep</i> .	
Keying <ul style="list-style-type: none"> Core, keyed random No core No key 	No cost No cost No cost	Specify <i>with core random keyed</i> . Specify <i>with no core</i> . Specify <i>with no key</i> .	

Specification Information

Style Number	U.S. Base Price
FEDMLO	\$1556.64

Push/Pull Handle

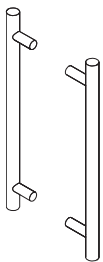

Standard Includes		Required to Specify	
<ul style="list-style-type: none"> Need help? Product details, page 47 	<ul style="list-style-type: none"> Push/pull handle: metal 	<ol style="list-style-type: none"> Style number Hardware finish (see below under Required Selections) 	
Required Selections	U.S. Price	Required to Specify	
Hardware Finish <ul style="list-style-type: none"> Brushed stainless Low gloss black 	No cost +\$46.95	Specify <i>with brushed stainless</i> . Specify <i>with low gloss black</i> .	
Specification Information			
Style Number	U.S. Base Price		
FEDPPH	\$225.17		



For Canadian Pricing
 Multiply U.S. Price by the Canadian price factor.
 ▶ See page 1 for details.

Door Closer

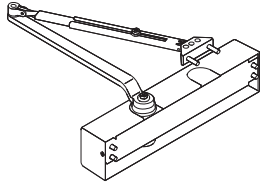

Standard Includes		Required to Specify
<ul style="list-style-type: none"> ▶ Need help? Product details, page 48 	<ul style="list-style-type: none"> • Surface mounted door closer: metal 	<ul style="list-style-type: none"> 1 Style number 2 Door type (see below under Required Selections) 3 Surface materials (see below under Required Selections)

Required Selections	U.S. Price	Required to Specify
Door Type <ul style="list-style-type: none"> • Solid • Polished edge 	<ul style="list-style-type: none"> No cost No cost 	<ul style="list-style-type: none"> Specify with <i>solid door</i>. Specify with <i>polished edge door</i>.
Surface Materials <ul style="list-style-type: none"> • Low gloss black • Platinum metallic 	<ul style="list-style-type: none"> No cost No cost 	<ul style="list-style-type: none"> Specify with <i>low gloss black</i>. Specify with <i>platinum metallic</i>.

Specification Information	
Style Number	U.S. Price
FEDCLS	\$1003.42

Roller Latch



Roller Latchset for Solid Door

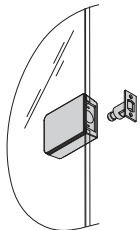

Roller Latchset for Polished Edge Door

Standard Includes		Required to Specify
<ul style="list-style-type: none"> ▶ Need help? Product details, page 48 	<ul style="list-style-type: none"> • Roller latch: 8031 Brushed Stainless 	<ul style="list-style-type: none"> Style number

Specification Information	
Style Number	U.S. Price
FEDRL	\$217.84

Reversible Swing Doors



For Canadian Pricing
 Multiply U.S. Price by the Canadian price factor.
 ▶ See page 1 for details.

Door Drop Seal

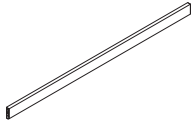

Tip: Dome stops and base stops are not recommended when using polished glass doors with drop seals.

Standard Includes		Required to Specify
<ul style="list-style-type: none"> ▶ Need help? Product details, page 48 	<ul style="list-style-type: none"> • Door drop seal for reversible swing door: metal • Width: 28"–44.445" 	<ol style="list-style-type: none"> 1 Style number 2 Width 3 Door type (see below under Required Selections) 4 Drop seal finish (see below under Required Selections)

Required Selections	U.S. Price	Required to Specify
Drop Seal <ul style="list-style-type: none"> • Paint price group 1 • Paint price group 2 • Paint price group 3 • Anodized aluminum 	No cost +\$ 6.59 +\$27.20 No cost	Specify paint color number. Specify paint color number. Specify paint color number. Specify with anodized aluminum.
Door Type <ul style="list-style-type: none"> • Solid • Polished edge 	No cost No cost	Specify with solid door. Specify with polished edge door.

Specification Information	
• Style Number	• U.S. Base Price
FEDDS	\$495.24

Electric Hinge

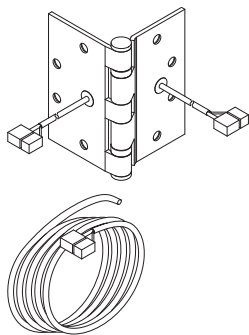

Standard Includes		Required to Specify
<ul style="list-style-type: none"> ▶ Need help? Product details, page 48 	<ul style="list-style-type: none"> • One electric hinge with wire conductors and modular connectors • Low voltage harness X 132" 	<ol style="list-style-type: none"> 1 Style number 2 Hardware finish (see below under Required Selections)

Required Selections	U.S. Price	Required to Specify
Hardware Finish <ul style="list-style-type: none"> • Satin chrome • Polished chrome • Low gloss black 	No cost +\$ 36.52 +\$131.93	Specify with satin chrome. Specify with polished chrome. Specify with low gloss black.

Specification Information	
• Style Number	• U.S. Base Price
FEDHE	\$1065.80



For Canadian Pricing
 Multiply U.S. Price by the Canadian price factor.
 ▶ See page 1 for details.

Ladder Pull, Aligned

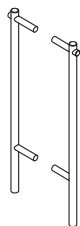

Tip: Latch prep with lockset includes cylinder with random keyed removable core.

Tip: Lock cores are only available in 9200 Satin Chrome.

Standard Includes		Required to Specify
▶ Need help? Product details, page 48	• Ladder pull, aligned: metal	1 Style number 2 Hardware finish (see below under Required Selections) 3 Latch prep (see below under Required Selections) 4 Door type (see below under Required Selections) ▶ See <i>Surface Materials</i> , page 222.

Required Selections	U.S. Price	Required to Specify
Hardware Finish • Low gloss black • Brushed stainless	No cost +\$ 898.40	Specify with <i>low gloss black</i> . Specify with <i>brushed stainless</i> .
Latch Prep • Passage • Lockset	No cost +\$2875.92	Specify with <i>passage latch prep</i> . Specify with <i>lockset latch prep</i> .
Door Type • Polished edge • Solid	No cost +\$ 336.23	Specify with <i>polished edge door</i> . Specify with <i>solid door</i> .

Specification Information	
Style Number	U.S. Base Price
FEDLPA	\$2308.47

Ladder Pull, Offset

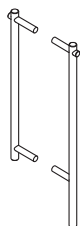

Tip: Latch prep with lockset includes cylinder with random keyed removable core.

Tip: Lock cores are only available in 9200 Satin Chrome.

Standard Includes		Required to Specify
▶ Need help? Product details, page 48	• Ladder pull, offset: metal	1 Style number 2 Hardware finish (see below under Required Selections) 3 Latch prep (see below under Required Selections) 4 Door type (see below under Required Selections) ▶ See <i>Surface Materials</i> , page 222.

Required Selections	U.S. Price	Required to Specify
Hardware Finish • Low gloss black • Brushed stainless	No cost +\$ 662.66	Specify with <i>low gloss black</i> . Specify with <i>brushed stainless</i> .
Latch Prep • Passage • Lockset	No cost +\$2875.92	Specify with <i>passage latch prep</i> . Specify with <i>lockset latch prep</i> .
Door Type • Polished edge • Solid	No cost +\$ 336.23	Specify with <i>polished edge door</i> . Specify with <i>solid door</i> .

Specification Information	
Style Number	U.S. Base Price
FEDLPO	\$2308.47

 **For Canadian Pricing**
Multiply U.S. Price by the Canadian price factor.
▶ See page 1 for details.

Reversible Swing Doors

Door Drop Seals

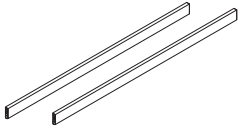

Standard Includes		Required to Specify
<ul style="list-style-type: none"> ▶ Need help? Product details, page 48 	<ul style="list-style-type: none"> • Pair of door drop seals: metal 	<ul style="list-style-type: none"> 1 Style number 2 Door type (see below under Required Selections) 3 Drop seal finish (see below under Required Selections)

Required Selections	U.S. Price	Required to Specify
Drop Seal Finish <ul style="list-style-type: none"> • Paint price group 1 • Paint price group 2 • Paint price group 3 • Anodized aluminum 	<ul style="list-style-type: none"> No cost +\$13.21 +\$54.39 No cost 	<ul style="list-style-type: none"> Specify paint color number. Specify paint color number. Specify paint color number. Specify <i>with anodized aluminum</i>.
Door Type <ul style="list-style-type: none"> • Solid • Polished edge 	<ul style="list-style-type: none"> No cost No cost 	<ul style="list-style-type: none"> Specify <i>with solid door</i>. Specify <i>with polished edge door</i>.

Specification Information	
Style Number	U.S. Base Price
FEDDSP	\$990.48

Flush Bolts



Standard Includes		Required to Specify
<ul style="list-style-type: none"> ▶ Need help? Product details, page 49 	<ul style="list-style-type: none"> • Pair of flush bolts: metal 	<ul style="list-style-type: none"> 1 Style number 2 Hardware finish (see below under Required Selections)

Required Selections	U.S. Price	Required to Specify
Hardware Finish <ul style="list-style-type: none"> • Satin chrome • Polished chrome • Low gloss black 	<ul style="list-style-type: none"> No cost +\$ 72.70 +\$100.52 	<ul style="list-style-type: none"> Specify <i>with satin chrome</i>. Specify <i>with polished chrome</i>. Specify <i>with low gloss black</i>.

Specification Information	
Style Number	U.S. Base Price
FEDFBP	\$432.83



For Canadian Pricing
 Multiply U.S. Price by the Canadian price factor.
 ▶ See page 1 for details.

Specifying Slider Doors

Single Surface Mounted Slider Door Frame	172
Single Surface Mounted Polished Edge Slider Door Leaf	173
Basic Single Surface Mounted Slider Door Track	174
Reinforced Single Surface Mounted Slider Door Track	176
Frame for Pair of Surface Mounted Slider Doors	177
Pair of Surface Mounted Polished Edge Slider Door Leaves	178
Reinforced Track for Pair of Surface Mounted Slider Doors	179
Slider Door Track Bracket	180

Single Surface Mounted Slider Door Frame

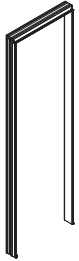

Standard Includes		Required to Specify
<ul style="list-style-type: none"> ▶ Need help? Product details, page 52 	<ul style="list-style-type: none"> • Door frame: paint or 8043 Clear Anodized Aluminum • Height: 80.984"–120" • Width: 38"–48" • Door type: polished edge • Tubular door pull: metal • Door frame seals: platinum 	<ol style="list-style-type: none"> 1 Style number 2 Height 3 Width 4 Paint or anodized aluminum color number for frame 5 Top mount type (see below under Required Selections) 6 Handedness (see below under Required Selections) 7 Lock (see below under Required Selections) 8 Pull (see below under Required Selections) 9 Keying (see below under Required Selections) 10 Lever (see below under Required Selections) 11 Cylinder orientation (see below under Required Selections) 12 Hardware lockset and pull finish (see below under Required Selections) 13 Options, if selected (see below) <p>▶ See <i>Surface Materials</i>, page 222.</p>

	Required Selections	U.S. Price	Required to Specify
Top Mount Type	<ul style="list-style-type: none"> • Ceiling • Intermediate 	No cost No cost	Specify with <i>ceiling mount</i> . Specify with <i>intermediate mount</i> .
Handedness	<ul style="list-style-type: none"> • Right hand • Left hand 	No cost No cost	Specify with <i>right hand</i> . Specify with <i>left hand</i> .
Lock	<ul style="list-style-type: none"> • No lever lock • Lever lock 	No cost +\$2435.16	Specify with <i>no lock</i> . Specify with <i>lever lock</i> .
Pull	<ul style="list-style-type: none"> • Push/pull • Separate pull 	No cost –\$ 257.19	Specify with <i>push/pull</i> . Specify with <i>separate pull</i> .
Hardware Lockset and Pull Finish	<ul style="list-style-type: none"> • Brushed stainless • Low gloss black 	No cost No cost	Specify with <i>brushed stainless</i> . Specify with <i>low gloss black</i> .
Keying	<ul style="list-style-type: none"> • No cylinder • Core, keyed random 	–\$ 70.89 No cost	Specify with <i>no cylinder</i> . Specify with <i>core</i> .
Lever	<ul style="list-style-type: none"> • No lever • Lever one 	–\$ 347.70 No cost	Specify with <i>no lever</i> . Specify with <i>lever one</i> .
Cylinder Orientation	<ul style="list-style-type: none"> • Key inside • Key outside 	No cost No cost	Specify with <i>key inside</i> . Specify with <i>key outside</i> .

Tip: Lock cores are only available in 9200 Satin Chrome.

Tip: Finishes for door hardware can vary slightly from one component to another depending on base metal materiality and finishing processes. When hardware is specified for common assemblies, all hardware components may not match exactly, but are designed to be compatible within a common door opening.

	Options	U.S. Price	Required to Specify
Surface Materials	Frames <ul style="list-style-type: none"> • Paint price group 1 • Paint price group 2 • Paint price group 3 • Anodized 	Per Sq/Ft No cost +\$ 1.30 +\$ 2.30 +\$ 1.09	Specify paint color number. Specify paint color number. Specify paint color number. Specify with <i>anodized</i> .

Specification Information			
Style Number	U.S. Base Price	Add per inch height of frame	Add per inch width of frame
FEDFSLSM	\$1548.23	+\$5.03	+\$5.03

 **For Canadian Pricing**
 Multiply U.S. Price by the Canadian price factor.
 ▶ See page 1 for details.

Single Surface Mounted Polished Edge Slider Door Leaf

Single Surface Mounted
Polished Edge Slider
Door Leaf

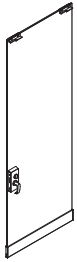

Standard Includes		Required to Specify
<ul style="list-style-type: none"> ▶ Need help? Product details, page 52 	<ul style="list-style-type: none"> • Door leaf: 1/2" thick polished edge glass • Bottom trim: paint or 8043 Clear Anodized Aluminum • Height: 80.984"-120" • Width: 38"-48" 	<ol style="list-style-type: none"> 1 Style number 2 Height 3 Width 4 Glass color number for door leaf 5 Paint or anodized aluminum color number for bottom trim 6 Glass surface orientation (see below for Required Selections) 7 Top mount type (see below for Required Selections) 8 Handedness (see below for Required Selections) 9 Latch prep (see below for Required Selections) 10 Acoustic seal (see below for Required Selections) 11 Options, if selected (see below) <ul style="list-style-type: none"> ▶ See <i>Surface Materials</i>, page 222.

Required Selections	U.S. Price	Required to Specify
Glass Surface Orientation <ul style="list-style-type: none"> • Polished to inside • Polished to outside 	No cost No cost	Specify <i>with polished to inside</i> . Specify <i>with polished to outside</i> .
Top Mount Type <ul style="list-style-type: none"> • Ceiling • Intermediate 	No cost No cost	Specify <i>with ceiling mount</i> . Specify <i>with intermediate mount</i> .
Handedness <ul style="list-style-type: none"> • Right hand • Left hand 	No cost No cost	Specify <i>with right hand</i> . Specify <i>with left hand</i> .
Latch Prep <ul style="list-style-type: none"> • Ladder aligned • Ladder offset • Lever lock • Push/pull 	No cost No cost +\$360.37 No cost	Specify <i>with ladder aligned latch prep</i> . Specify <i>with ladder offset latch prep</i> . Specify <i>with lever lock latch prep</i> . Specify <i>with push/pull latch prep</i> .
Acoustic Seal <ul style="list-style-type: none"> • No seal • Drop seal 	No cost +\$239.92	Specify <i>with no seal</i> . Specify <i>with drop seal</i> .

Options	U.S. Price		Required to Specify	
Surface Materials	Bottom trim	Per Frame	Per Sq/Ft	
	• Paint price group 1	No cost	N.A.	Specify paint color number.
	• Paint price group 2	+\$ 11.18	N.A.	Specify paint color number.
	• Paint price group 3	+\$ 23.53	N.A.	Specify paint color number.
	• Anodized	+\$ 8.08	N.A.	Specify <i>with anodized</i> .
	• Glass price group 1	N.A.	No cost	Specify paint color number.
	• Glass price group 3	N.A.	+\$34.23	Specify paint color number.
	• COG (Customer's Own Glass)	N.A.	-\$ 6.33	Specify paint color number.

Specification Information		
Style Number	U.S. Base Price	
.....
	 Add per Sq/Ft of door
FEDLSLPSM	\$999.16	+\$75.19
.....

 **For Canadian Pricing**
Multiply U.S. Price by the Canadian price factor.
▶ See page 1 for details.

Slider Doors

Basic Single Surface Mounted Slider Door Track

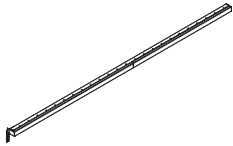

Tip: Minimum slider door track width with hardware is 69.337"W.

Standard Includes		Required to Specify
<ul style="list-style-type: none"> ▶ Need help? Product details, page 52 	<ul style="list-style-type: none"> • Door track: paint or 8043 Clear Anodized Aluminum • Width: 6"-144" • Door type: polished edge 	<ol style="list-style-type: none"> 1 Style number 2 Width 3 Paint or anodized aluminum color number for door track 4 Hardware (see below under Required Selections) 5 Handedness (see below under Required Selections) 6 End configuration left (see below under Required Selections) 7 End configuration right (see below under Required Selections) 8 Utility panel configuration (see below under Required Selections) 9 End notch (see below under Required Selections) 10 Bracket hole count (see below under Required Selections) 11 Bracket hole location (see below under Required Selections) 12 Options, if selected (see below) <p>▶ See <i>Surface Materials</i>, page 222.</p>

Tip: Handedness, bracket hole count, and bracket hole location only required if hardware is selected.

	Required Selections	U.S. Price	Required to Specify
Hardware	<ul style="list-style-type: none"> • No hardware • Hardware 	<p>-\$1614.33</p> <p>No cost</p>	<p>Specify <i>with no hardware</i>.</p> <p>Specify <i>with hardware</i>.</p>
Handedness	<ul style="list-style-type: none"> • Right hand • Left hand 	<p>No cost</p> <p>No cost</p>	<p>Specify <i>with right hand</i>.</p> <p>Specify <i>with left hand</i>.</p>
End Configuration, Left	<ul style="list-style-type: none"> • Actual • At adapter • L junction • Support junction • At junction • At bypass • Support bypass • Cut 	<p>No cost</p> <p>No cost</p> <p>No cost</p> <p>No cost</p> <p>No cost</p> <p>No cost</p> <p>No cost</p> <p>No cost</p>	<p>Specify actual.</p> <p>Specify at adapter.</p> <p>Specify at L junction.</p> <p>Specify at support junction.</p> <p>Specify at junction.</p> <p>Specify at bypass.</p> <p>Specify at support bypass.</p> <p>Specify cut.</p>
End Configuration, Right	<ul style="list-style-type: none"> • Actual • At adapter • L junction • Support junction • At junction • At bypass • Support bypass • Cut 	<p>No cost</p> <p>No cost</p> <p>No cost</p> <p>No cost</p> <p>No cost</p> <p>No cost</p> <p>No cost</p> <p>No cost</p>	<p>Specify actual.</p> <p>Specify at adapter.</p> <p>Specify at L junction.</p> <p>Specify at support junction.</p> <p>Specify at junction.</p> <p>Specify at bypass.</p> <p>Specify at support bypass.</p> <p>Specify cut.</p>
End Notch	<ul style="list-style-type: none"> • No notch • Left notch • Right notch • Both notch 	<p>No cost</p> <p>No cost</p> <p>No cost</p> <p>No cost</p>	<p>Specify no notch.</p> <p>Specify left notch.</p> <p>Specify right notch.</p> <p>Specify both notch.</p>
Bracket Hole Count	<ul style="list-style-type: none"> • One hole • Two holes 	<p>No cost</p> <p>No cost</p>	<p>Specify <i>with one hole</i>.</p> <p>Specify <i>with two holes</i>.</p>
Bracket Hole Location	<ul style="list-style-type: none"> • Hole one location • Hole two location, if selected 	<p>No cost</p> <p>No cost</p>	<p>Specify X dimension for hole one.</p> <p>Specify X dimension for hole two, if selected.</p>



For Canadian Pricing
 Multiply U.S. Price by the Canadian price factor.
 ▶ See page 1 for details.

Options	U.S. Price	Required to Specify
Surface Materials	Per inch of track	
• Paint price group 1	No cost	Specify paint color number.
• Paint price group 2	+\$0.27	Specify paint color number.
• Paint price group 3	+\$0.43	Specify paint color number.
• Anodized	+\$0.77	Specify <i>with anodized</i> .

Specification Information

Style Number	U.S. Base Price	
•	•	
:	:	
:	:	
:	:	
:	:	: Add per inch width of track
FEDTSLSMB	\$1820.48	+\$5.03
:	:	:

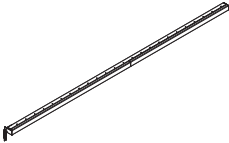

 **For Canadian Pricing**
Multiply U.S. Price by the
Canadian price factor.
▶ See page 1 for details.

Reinforced Single Surface Mounted Slider Door Track

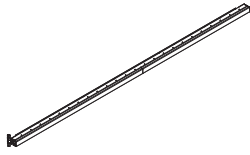

Standard Includes		Required to Specify
<ul style="list-style-type: none"> ▶ Need help? Product details, page 52 	<ul style="list-style-type: none"> • Door track: paint or 8043 Clear Anodized Aluminum • Width: 98.00001"–168" • Door type: polished edge 	<ol style="list-style-type: none"> 1 Style number 2 Width 3 Paint or anodized aluminum color number for door track 4 Handedness (see below under Required Selections) 5 End configuration left (see below under Required Selections) 6 End configuration right (see below under Required Selections) 7 Bracket hole location (see below under Required Selections) 8 Options, if selected (see below) <ul style="list-style-type: none"> ▶ See <i>Surface Materials</i>, page 222.

	Required Selections	U.S. Price	Required to Specify
Handedness	<ul style="list-style-type: none"> • Right hand • Left hand 	No cost No cost	Specify <i>with right hand</i> . Specify <i>with left hand</i> .
End Configuration, Left	<ul style="list-style-type: none"> • Actual 	No cost	Specify actual.
End Configuration, Right	<ul style="list-style-type: none"> • Actual 	No cost	Specify actual.
Bracket Hole Location	<ul style="list-style-type: none"> • Hole one location 	No cost	Specify X dimension for hole one.

	Options	U.S. Price	Required to Specify
Surface Materials	<ul style="list-style-type: none"> • Paint price group 1 • Paint price group 2 • Paint price group 3 • Anodized 	Per inch of track No cost +\$0.27 +\$0.43 +\$0.77	Specify paint color number. Specify paint color number. Specify paint color number. Specify <i>with anodized</i> .

Specification Information		
Style Number	U.S. Base Price	Add per inch width of track
FEDTSLSMR	\$3795.43	+\$10.49



For Canadian Pricing
Multiply U.S. Price by the Canadian price factor.
▶ See page 1 for details.

Frame for Pair of Surface Mounted Slider Doors

Frame for Pair of Surface Mounted Slider Doors

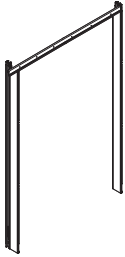

Standard Includes		Required to Specify
<ul style="list-style-type: none"> ▶ Need help? Product details, page 52 	<ul style="list-style-type: none"> • Door frame: paint or 8043 Clear Anodized Aluminum • Height: 80.984"–120" • Width: 60"–80" • Door type: polished edge 	<ol style="list-style-type: none"> 1 Style number 2 Height 3 Width 4 Paint or anodized aluminum color number for frame 5 Top mount type (see below under Required Selections) 6 Options, if selected (see below) <ul style="list-style-type: none"> ▶ See <i>Surface Materials</i>, page 222.

	Required Selections	U.S. Price	Required to Specify
Top Mount Type	<ul style="list-style-type: none"> • Ceiling • Intermediate 	<p>No cost</p> <p>No cost</p>	<p>Specify <i>with ceiling mount</i>.</p> <p>Specify <i>with intermediate mount</i>.</p>

	Options	U.S. Price	Required to Specify
Surface Materials	<p>Frames</p> <ul style="list-style-type: none"> • Paint price group 1 • Paint price group 2 • Paint price group 3 • Anodized 	<p>Per Sq/Ft</p> <p>No cost</p> <p>+\$1.30</p> <p>+\$2.30</p> <p>+\$1.09</p>	<p>Specify paint color number.</p> <p>Specify paint color number.</p> <p>Specify paint color number.</p> <p>Specify <i>with anodized</i>.</p>

Specification Information			
Style Number	U.S. Base Price	Add per inch height of frame	Add per inch width of frame
FEDFSLPM	\$2398.75	+\$5.03	+\$5.03
:	:	:	:
:	:	:	:

 **For Canadian Pricing**
 Multiply U.S. Price by the Canadian price factor.
 ▶ See page 1 for details.

Pair of Surface Mounted Polished Edge Slider Door Leaves

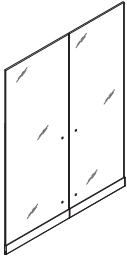

Standard Includes		Required to Specify
<ul style="list-style-type: none"> ▶ Need help? Product details, page 52 	<ul style="list-style-type: none"> • Door leaf: 1/2" thick polished edge glass • Bottom trim: paint or 8043 Clear Anodized Aluminum • Height: 80.984" - 120" • Width: 60" - 80" 	<ol style="list-style-type: none"> 1 Style number 2 Height 3 Width 4 Glass color number for door leaf 5 Paint or anodized aluminum color number for bottom trim 6 Glass surface orientation (see below under Required Selections) 7 Top mount type (see below under Required Selections) 8 Latch prep (see below under Required Selections) 9 Options, if selected (see below) <ul style="list-style-type: none"> ▶ See <i>Surface Materials</i>, page 222.

Required Selections	U.S. Price	Required to Specify
Glass Surface Orientation <ul style="list-style-type: none"> • Polished to inside • Polished to outside 	No cost No cost	Specify <i>with polished to inside</i> . Specify <i>with polished to outside</i> .
Top Mount Type <ul style="list-style-type: none"> • Ceiling • Intermediate 	No cost No cost	Specify <i>with ceiling mount</i> . Specify <i>with intermediate mount</i> .
Latch Prep <ul style="list-style-type: none"> • Ladder aligned • Ladder offset • Push/pull 	No cost No cost No cost	Specify <i>with ladder aligned latch prep</i> . Specify <i>with ladder offset latch prep</i> . Specify <i>with push/pull latch prep</i> .

Options	U.S. Price		Required to Specify
Surface Materials	Bottom trim	Per Frame	Per Sq/Ft
	• Paint price group 1	No cost	N.A.
	• Paint price group 2	+\$22.81	N.A.
	• Paint price group 3	+\$47.05	N.A.
	• Anodized	+\$15.82	N.A.
	• Glass price group 1	N.A.	No cost
	• Glass price group 3	N.A.	+\$34.23
	• COG (Customer's Own Glass)	N.A.	-\$ 6.33

Specification Information		
Style Number	U.S. Base Price	
.....	: Add per Sq/Ft of door
.....
FEDLSLPPM	\$1998.32	+\$75.19
.....



For Canadian Pricing
 Multiply U.S. Price by the Canadian price factor.
 ▶ See page 1 for details.

Reinforced Track for Pair of Surface Mounted Slider Doors

Reinforced Track for Pair of Surface Mounted Slider Doors

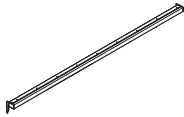

	Standard Includes	Required to Specify
▶ Need help? Product details, page 52	<ul style="list-style-type: none"> Door track: paint or 8043 Clear Anodized Aluminum Width: 106.874" to 288" Door type: polished edge 	<ol style="list-style-type: none"> Style number Width Paint or anodized aluminum color number for door track End configuration left (see below under Required Selections) End configuration right (see below under Required Selections) Bracket hole (see below under Required Selections) Options, if selected (see below) <p>▶ See <i>Surface Materials</i>, page 222.</p>

	Required Selections	U.S. Price	Required to Specify
End Configuration, Left	<ul style="list-style-type: none"> Actual 	No cost	Specify actual.
End Configuration, Right	<ul style="list-style-type: none"> Actual 	No cost	Specify actual.
Bracket Hole Location	<ul style="list-style-type: none"> Hole one location Hole two location 	No cost No cost	Specify X dimension for hole one. Specify X dimension for hole two.

	Options	U.S. Price	Required to Specify
Surface Materials	<ul style="list-style-type: none"> Paint price group 1 Paint price group 2 Paint price group 3 Anodized 	Per inch of track No cost +\$0.27 +\$0.43 +\$0.77	Specify paint color number. Specify paint color number. Specify paint color number. Specify <i>with anodized</i> .

Specification Information		
Style Number	U.S. Base Price	
.....
.....
.....
.....
.....
FEDTSLPMR	\$7590.86	+\$10.49
.....

 **For Canadian Pricing**
 Multiply U.S. Price by the Canadian price factor.
 ▶ See page 1 for details.

Slider Door Track Bracket

Standard Includes		Required to Specify
<ul style="list-style-type: none"> ▶ Need help? Product details, page 54 	<ul style="list-style-type: none"> • Bracket: paint • Height: 80.984"-120" 	<ol style="list-style-type: none"> 1 Style number 2 Paint color number for bracket 3 Height 4 Top mount type (see below under Required Selections) 5 Bracket type (see below under Required Selections) 6 Options, if selected (see below) <ul style="list-style-type: none"> ▶ See <i>Surface Materials</i>, page 222.

	Required Selections	U.S. Price	Required to Specify
Top Mount Type	<ul style="list-style-type: none"> • Ceiling • Intermediate 	<ul style="list-style-type: none"> No cost No cost 	<ul style="list-style-type: none"> Specify <i>with ceiling mount</i>. Specify <i>with intermediate mount</i>.
Bracket Type	<ul style="list-style-type: none"> • L at left • L at right • T at center 	<ul style="list-style-type: none"> No cost No cost No cost 	<ul style="list-style-type: none"> Specify <i>with L at left</i>. Specify <i>with L at right</i>. Specify <i>with T at center</i>.

	Options	U.S. Price	Required to Specify
Surface Materials	<ul style="list-style-type: none"> • Paint price group 1 • Paint price group 2 • Paint price group 3 	<ul style="list-style-type: none"> No cost +\$6.25 +\$9.39 	<ul style="list-style-type: none"> Specify paint color number. Specify paint color number. Specify paint color number.

Specification Information	
Style Number	U.S. Base Price
FEDTSLB	\$218.30
:	:



For Canadian Pricing
 Multiply U.S. Price by the Canadian price factor.
 ▶ See page 1 for details.

Specifying Intersections—Junctions and Adapters

Two-Way Fixed Angle Junction Assembly	182
Two-Way Variable Angle Junction Assembly	183
Three-Way Junction Assembly	184
Four-Way Junction Assembly	185
Junction Covers, Trim, Hardware, and Seals	186
90° T/X Adapter and Finished End	195

Two-Way Fixed Angle Junction Assembly



Standard Includes		Required to Specify
<ul style="list-style-type: none"> ▶ Need help? Product details, page 69 	<ul style="list-style-type: none"> • Junction assembly • Height: 80"–144" • Seal: plastic 	<ol style="list-style-type: none"> 1 Style number 2 Height 3 Plastic color number for seal 4 Angle (see below under Required Selections) 5 Horizontal hole cut-out (see below under Required Selections) <p>▶ See <i>Surface Materials</i>, page 222.</p>

Required Selections	U.S. Price		Required to Specify
	Per Junction	Per Inch	
Fixed Angles <ul style="list-style-type: none"> • 90° • 120° • 135° • 180° 	No cost	N.A.	Specify with 90° angle.
	No cost	N.A.	Specify with 120° angle.
	No cost	N.A.	Specify with 135° angle.
	No cost	N.A.	Specify with 180° angle.
Horizontal Hole Cut-Out <ul style="list-style-type: none"> • No holes • Hole 1 • Hole 2 • Hole 3 • Hole 4 • Hole 5 • Hole 6 • Hole 7 • Hole 8 • Hole 9 • Hole 10 • Hole 11 	No cost	N.A.	Specify with no holes.
	No cost	N.A.	Specify Y dimension for hole 1.
	No cost	N.A.	Specify Y dimension for hole 2.
	No cost	N.A.	Specify Y dimension for hole 3.
	No cost	N.A.	Specify Y dimension for hole 4.
	No cost	N.A.	Specify Y dimension for hole 5.
	No cost	N.A.	Specify Y dimension for hole 6.
	No cost	N.A.	Specify Y dimension for hole 7.
	No cost	N.A.	Specify Y dimension for hole 8.
	No cost	N.A.	Specify Y dimension for hole 9.
	No cost	N.A.	Specify Y dimension for hole 10.
	No cost	N.A.	Specify Y dimension for hole 11.

Specification Information		
Style Number	U.S. Base Price	Per Junction : Per Inch
FEIJA2F	\$903.06	+\$0.63



For Canadian Pricing
 Multiply U.S. Price by the Canadian price factor.
 ▶ See page 1 for details.

Two-Way Variable Angle Junction Assembly

Two-Way Variable Angle
Junction Assembly

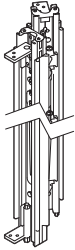

Intersections

Standard Includes		Required to Specify
<ul style="list-style-type: none"> ▶ Need help? Product details, page 69 	<ul style="list-style-type: none"> • Junction assembly • Height: 80"–144" • Seal: plastic 	<ol style="list-style-type: none"> 1 Style number 2 Height 3 Plastic color number for seal 4 Angle (see below under Required Selections) 5 Horizontal hole cut-out (see below under Required Selections) <p>▶ See <i>Surface Materials</i>, page 222.</p>

Variable Angles	Required Selections	U.S. Price		Required to Specify
		Per Junction	Per Inch	
	<ul style="list-style-type: none"> • 91°–119° • 121°–134° • 135°–179° 	No cost	N.A.	Specify angle in 1° increments.
		No cost	N.A.	Specify angle in 1° increments.
		No cost	N.A.	Specify angle in 1° increments.
Horizontal Hole Cut-Out	• No holes	No cost	N.A.	Specify <i>with no holes</i> .
	• Hole 1	No cost	N.A.	Specify Y dimension for hole 1.
	• Hole 2	No cost	N.A.	Specify Y dimension for hole 2.
	• Hole 3	No cost	N.A.	Specify Y dimension for hole 3.
	• Hole 4	No cost	N.A.	Specify Y dimension for hole 4.
	• Hole 5	No cost	N.A.	Specify Y dimension for hole 5.
	• Hole 6	No cost	N.A.	Specify Y dimension for hole 6.
	• Hole 7	No cost	N.A.	Specify Y dimension for hole 7.
	• Hole 8	No cost	N.A.	Specify Y dimension for hole 8.
	• Hole 9	No cost	N.A.	Specify Y dimension for hole 9.
	• Hole 10	No cost	N.A.	Specify Y dimension for hole 10.
	• Hole 11	No cost	N.A.	Specify Y dimension for hole 11.

Specification Information		
Style Number	U.S. Base Price	
	Per Junction	Per Inch
FEIJA2V	\$1080.84	+\$0.63



For Canadian Pricing
Multiply U.S. Price by the Canadian price factor.
▶ See page 1 for details.

Three-Way Junction Assembly



Standard Includes		Required to Specify
<ul style="list-style-type: none"> ▶ Need help? Product details, page 69 	<ul style="list-style-type: none"> • Junction assembly • Height: 80"–144" • Seal: plastic 	<ul style="list-style-type: none"> 1 Style number 2 Height 3 Plastic color number for seal 4 Angle (see below under Required Selections) 5 Horizontal hole cut-out (see below under Required Selections) ▶ See <i>Surface Materials</i>, page 222.

Required Selections	U.S. Price		Required to Specify
	Per Junction	Per Inch	
Angle			
<ul style="list-style-type: none"> • 90° • 120° • 135° 	No cost	N.A.	Specify with 90° angle.
	No cost	N.A.	Specify with 120° angle.
	No cost	N.A.	Specify with 135° angle.
Horizontal Hole Cut-Out			
<ul style="list-style-type: none"> • No holes • Hole 1 • Hole 2 • Hole 3 • Hole 4 • Hole 5 • Hole 6 • Hole 7 • Hole 8 • Hole 9 • Hole 10 • Hole 11 	No cost	N.A.	Specify with no holes.
	No cost	N.A.	Specify Y dimension for hole 1.
	No cost	N.A.	Specify Y dimension for hole 2.
	No cost	N.A.	Specify Y dimension for hole 3.
	No cost	N.A.	Specify Y dimension for hole 4.
	No cost	N.A.	Specify Y dimension for hole 5.
	No cost	N.A.	Specify Y dimension for hole 6.
	No cost	N.A.	Specify Y dimension for hole 7.
	No cost	N.A.	Specify Y dimension for hole 8.
	No cost	N.A.	Specify Y dimension for hole 9.
	No cost	N.A.	Specify Y dimension for hole 10.
	No cost	N.A.	Specify Y dimension for hole 11.

Specification Information		
Style Number	U.S. Base Price	
	Per Junction	Per Inch
FEIJA3	\$1310.69	+\$0.91



For Canadian Pricing
 Multiply U.S. Price by the Canadian price factor.
 ▶ See page 1 for details.

Four-Way Junction Assembly

Four-Way Junction
Assembly

Intersections

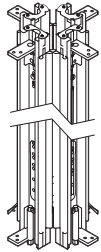

Standard Includes		Required to Specify
▶ Need help? Product details, page 69	<ul style="list-style-type: none"> • Junction assembly • Height: 80"-144" • Seal: plastic 	1 Style number 2 Height 3 Plastic color number for seal 4 Horizontal hole cut-out (see below under Required Selections) ▶ See <i>Surface Materials</i> , page 222.

Required Selections	U.S. Price	Required to Specify
Horizontal Hole Cut-Out <ul style="list-style-type: none"> • No holes • Hole 1 • Hole 2 • Hole 3 • Hole 4 • Hole 5 • Hole 6 • Hole 7 • Hole 8 • Hole 9 • Hole 10 • Hole 11 	Per Junction No cost No cost No cost No cost No cost No cost No cost No cost No cost No cost No cost No cost	Per Inch N.A. N.A. N.A. N.A. N.A. N.A. N.A. N.A. N.A. N.A. N.A.
		Specify <i>with no holes</i> . Specify Y dimension for hole 1. Specify Y dimension for hole 2. Specify Y dimension for hole 3. Specify Y dimension for hole 4. Specify Y dimension for hole 5. Specify Y dimension for hole 6. Specify Y dimension for hole 7. Specify Y dimension for hole 8. Specify Y dimension for hole 9. Specify Y dimension for hole 10. Specify Y dimension for hole 11.

Specification Information		
Style Number	U.S. Base Price	
	Per Junction	Per Inch
FEIJA4	\$1719.96	+\$1.35

 **For Canadian Pricing**
 Multiply U.S. Price by the Canadian price factor.
 ▶ See page 1 for details.

Junction Covers, Trim, Hardware, and Seals

Inner Junction Cover



Standard Includes		Required to Specify
<ul style="list-style-type: none"> ▶ Need help? Product details, page 68 	<ul style="list-style-type: none"> • Junction cover: paint or 8043 Clear Anodized Aluminum • Height: 77.71654"–141.71654" • Seal 	<ol style="list-style-type: none"> 1 Style number 2 Paint or anodized aluminum color number for cover 3 Height 4 Angle (see below under Required Selections) 5 Options, if selected (see below) <ul style="list-style-type: none"> ▶ See <i>Surface Materials</i>, page 222.

Required Selections	U.S. Price		Required to Specify
Fixed Angles	Per Cover	Per Inch	
<ul style="list-style-type: none"> • 120° • 135° 	No cost	N.A.	Specify with 120° angle.
	No cost	N.A.	Specify with 135° angle.

Options	U.S. Price		Required to Specify
Surface Materials	Per Cover	Per Inch	
<ul style="list-style-type: none"> • Anodized • Paint price group 1 • Paint price group 2 • Paint price group 3 	+\$68.28	N.A.	Specify with anodized.
	No cost	N.A.	Specify paint color number.
	+\$24.47	N.A.	Specify paint color number.
	+\$36.85	N.A.	Specify paint color number.

Specification Information		
Style Number	U.S. Base Price	
.....	Per Cover	Per Inch
FEIJCI	\$377.25	+\$0.28
.....



For Canadian Pricing
 Multiply U.S. Price by the Canadian price factor.
 ▶ See page 1 for details.

Variable Angle Inner Junction Cover



Standard Includes	Required to Specify
-------------------	---------------------

<ul style="list-style-type: none"> ▶ Need help? Product details, page 68 • Junction cover: paint • Height: 77.71654"–141.71654" 	<ol style="list-style-type: none"> 1 Style number 2 Paint color number for cover 3 Height 4 Angle (see below under Required Selections) 5 Options, if selected (see below) <p>▶ See <i>Surface Materials</i>, page 222.</p>
--	--

Required Selections	U.S. Price		Required to Specify
---------------------	------------	--	---------------------

Variable Angles <ul style="list-style-type: none"> • 91°–119° • 121°–134° • 136°–179° 	<table border="1"> <thead> <tr> <th style="background-color: #212121; color: white;">Per Cover</th> <th style="background-color: #212121; color: white;">Per Inch</th> </tr> </thead> <tbody> <tr> <td>No cost</td> <td>N.A.</td> </tr> <tr> <td>No cost</td> <td>N.A.</td> </tr> <tr> <td>No cost</td> <td>N.A.</td> </tr> </tbody> </table>	Per Cover	Per Inch	No cost	N.A.	No cost	N.A.	No cost	N.A.	<ul style="list-style-type: none"> Specify angle in 1° increment. Specify angle in 1° increment. Specify angle in 1° increment.
Per Cover	Per Inch									
No cost	N.A.									
No cost	N.A.									
No cost	N.A.									

Options	U.S. Price		Required to Specify
---------	------------	--	---------------------

Surface Materials <ul style="list-style-type: none"> • Paint price group 1 • Paint price group 2 • Paint price group 3 	<table border="1"> <thead> <tr> <th style="background-color: #212121; color: white;">Per Cover</th> <th style="background-color: #212121; color: white;">Per Inch</th> </tr> </thead> <tbody> <tr> <td>No cost</td> <td>N.A.</td> </tr> <tr> <td>+\$24.47</td> <td>N.A.</td> </tr> <tr> <td>+\$36.85</td> <td>N.A.</td> </tr> </tbody> </table>	Per Cover	Per Inch	No cost	N.A.	+\$24.47	N.A.	+\$36.85	N.A.	<ul style="list-style-type: none"> Specify paint color number. Specify paint color number. Specify paint color number.
Per Cover	Per Inch									
No cost	N.A.									
+\$24.47	N.A.									
+\$36.85	N.A.									

Specification Information

Style Number	U.S. Base Price	
	Per Cover	Per Inch
FEIJCIV	\$659.81	+\$0.28
.	.	.



For Canadian Pricing
Multiply U.S. Price by the Canadian price factor.
▶ See page 1 for details.

90° Inner Junction Trim



Standard Includes	Required to Specify
-------------------	---------------------

- | | | |
|---|--|--|
| <ul style="list-style-type: none"> ▶ Need help? Product details, page 68 | <ul style="list-style-type: none"> • Junction trim: paint • Height: 77.71654"–141.71654" | <ul style="list-style-type: none"> 1 Style number 2 Paint color number for trim 3 Height ▶ See <i>Surface Materials</i>, page 222. |
|---|--|--|

Specification Information		
• Style Number	• U.S. Base Price	

• Style Number	• U.S. Base Price	
•	• Per	• Per
•	• Cover	• Inch
•		
•		
•		
•		
FEI90T	\$91.90	+\$0.28
•		
•		



For Canadian Pricing
 Multiply U.S. Price by the Canadian price factor.
 ▶ See page 1 for details.

Outer Junction Cover



Standard Includes		Required to Specify
<ul style="list-style-type: none"> ▶ Need help? Product details, page 68 	<ul style="list-style-type: none"> • Junction cover: paint or 8043 Clear Anodized Aluminum • Height: 77.71654"–141.71654" 	<ol style="list-style-type: none"> 1 Style number 2 Paint or anodized aluminum color number for cover 3 Height 4 Angle (see below under Required Selections) 5 Bottom alignment (for 180° cover) (see below under Required Selections) 6 Options, if selected (see below) <ul style="list-style-type: none"> ▶ See <i>Surface Materials</i>, page 222.

Required Selections	U.S. Price	Required to Specify										
Fixed Angles <ul style="list-style-type: none"> • 90° • 120° • 135° • 180° 	<table border="1"> <thead> <tr> <th>Per Cover</th> <th>Per Inch</th> </tr> </thead> <tbody> <tr> <td>No cost</td> <td>N.A.</td> </tr> <tr> <td>No cost</td> <td>N.A.</td> </tr> <tr> <td>No cost</td> <td>N.A.</td> </tr> <tr> <td>No cost</td> <td>N.A.</td> </tr> </tbody> </table>	Per Cover	Per Inch	No cost	N.A.	No cost	N.A.	No cost	N.A.	No cost	N.A.	<ul style="list-style-type: none"> Specify with 90° angle. Specify with 120° angle. Specify with 135° angle. Specify with 180° angle.
Per Cover	Per Inch											
No cost	N.A.											
No cost	N.A.											
No cost	N.A.											
No cost	N.A.											
Bottom Alignment (for 180° cover) <ul style="list-style-type: none"> • To the skin • To the floor 	<table border="1"> <thead> <tr> <th>Per Cover</th> <th>Per Inch</th> </tr> </thead> <tbody> <tr> <td>No cost</td> <td>N.A.</td> </tr> <tr> <td>No cost</td> <td>N.A.</td> </tr> </tbody> </table>	Per Cover	Per Inch	No cost	N.A.	No cost	N.A.	<ul style="list-style-type: none"> Specify with alignment to the skin. Specify with alignment to the floor. 				
Per Cover	Per Inch											
No cost	N.A.											
No cost	N.A.											

Options	U.S. Price	Required to Specify										
Surface Materials <ul style="list-style-type: none"> • Anodized • Paint price group 1 • Paint price group 2 • Paint price group 3 	<table border="1"> <thead> <tr> <th>Per Cover</th> <th>Per Inch</th> </tr> </thead> <tbody> <tr> <td>+\$68.28</td> <td>N.A.</td> </tr> <tr> <td>No cost</td> <td>N.A.</td> </tr> <tr> <td>+\$24.47</td> <td>N.A.</td> </tr> <tr> <td>+\$36.85</td> <td>N.A.</td> </tr> </tbody> </table>	Per Cover	Per Inch	+\$68.28	N.A.	No cost	N.A.	+\$24.47	N.A.	+\$36.85	N.A.	<ul style="list-style-type: none"> Specify with anodized. Specify paint color number. Specify paint color number. Specify paint color number.
Per Cover	Per Inch											
+\$68.28	N.A.											
No cost	N.A.											
+\$24.47	N.A.											
+\$36.85	N.A.											

Specification Information		
Style Number	U.S. Base Price	
.....	Per Cover	Per Inch
FEIJCO	\$377.25	+\$0.28
.....

 **For Canadian Pricing**
Multiply U.S. Price by the Canadian price factor.
▶ See page 1 for details.

Variable Angle Outer Junction Cover



Standard Includes		Required to Specify
<ul style="list-style-type: none"> ▶ Need help? Product details, page 70 	<ul style="list-style-type: none"> • Junction cover: paint • Height: 77.71654"–141.71654" • Seal 	<ol style="list-style-type: none"> 1 Style number 2 Paint color number for cover 3 Height 4 Angle (see below under Required Selections) 5 Options, if selected (see below) <ul style="list-style-type: none"> ▶ See <i>Surface Materials</i>, page 222.

Required Selections	U.S. Price		Required to Specify
Variable Angles	Per Cover	Per Inch	
• 91°–119°	No cost	N.A.	Specify angle in 1° increment.
• 121°–134°	No cost	N.A.	Specify angle in 1° increment.
• 136°–179°	No cost	N.A.	Specify angle in 1° increment.

Options	U.S. Price		Required to Specify
Surface Materials	Per Cover	Per Inch	
• Paint price group 1	No cost	N.A.	Specify paint color number.
• Paint price group 2	+\$24.47	N.A.	Specify paint color number.
• Paint price group 3	+\$36.85	N.A.	Specify paint color number.

Specification Information		
Style Number	U.S. Base Price	
	Per Cover	Per Inch
FEIJCOV	\$659.81	+\$0.28

Bypass Outer Junction Cover

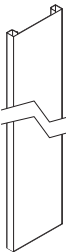

Standard Includes		Required to Specify
<ul style="list-style-type: none"> ▶ Need help? Product details, page 72 	<ul style="list-style-type: none"> • Junction cover: paint or 8043 Clear Anodized Aluminum • Height: 77.71654"–141.71654" • Bottom alignment: to the skin 	<ol style="list-style-type: none"> 1 Style number 2 Paint or anodized aluminum color number for cover 3 Height 4 Options, if selected (see below) <ul style="list-style-type: none"> ▶ See <i>Surface Materials</i>, page 222.

Options	U.S. Price		Required to Specify
Surface Materials	Per Cover	Per Inch	
• Anodized	+\$68.28	N.A.	Specify <i>with anodized</i> .
• Paint price group 1	No cost	N.A.	Specify paint color number.
• Paint price group 2	+\$24.47	N.A.	Specify paint color number.
• Paint price group 3	+\$36.85	N.A.	Specify paint color number.

Specification Information		
Style Number	U.S. Base Price	
	Per Cover	Per Inch
FEIJCOB	\$471.69	+\$0.43

 **For Canadian Pricing**
 Multiply U.S. Price by the Canadian price factor.
 ▶ See page 1 for details.

Two-Way Junction Hardware



Standard Includes		Required to Specify
<ul style="list-style-type: none"> ▶ Need help? Product details, page 68 	<ul style="list-style-type: none"> • Hardware • Height: 80"–144" 	<ul style="list-style-type: none"> 1 Style number 2 Height 3 Angle (see below under Required Selections)

Required Selections	U.S. Price	Required to Specify
Fixed Angles		
<ul style="list-style-type: none"> • 90° • 120° • 135° • 180° 	<ul style="list-style-type: none"> No cost No cost No cost No cost 	<ul style="list-style-type: none"> Specify with 90° angle. Specify with 120° angle. Specify with 135° angle. Specify with 180° angle.

Specification Information		
Style Number	Height	U.S. Price
FEIJH2	≤120"	\$59.17
	>120"	\$73.77

Two-Way Variable Angle Junction Hardware



Standard Includes		Required to Specify
<ul style="list-style-type: none"> ▶ Need help? Product details, page 68 	<ul style="list-style-type: none"> • Hardware • Height: 80"–144" 	<ul style="list-style-type: none"> 1 Style number 2 Height 3 Angle (see below under Required Selections)

Required Selections	U.S. Price	Required to Specify
Variable Angles		
<ul style="list-style-type: none"> • 91°–119° • 121°–134° • 136°–179° 	<ul style="list-style-type: none"> No cost No cost No cost 	<ul style="list-style-type: none"> Specify angle in 1° increment. Specify angle in 1° increment. Specify angle in 1° increment.

Specification Information		
Style Number	Height	U.S. Price
FEIJH2V	≤120"	\$ 90.21
	>120"	\$113.30



For Canadian Pricing
Multiply U.S. Price by the Canadian price factor.
▶ See page 1 for details.

Three-Way Junction Hardware



Standard Includes		Required to Specify
▶ Need help? Product details, page 68	<ul style="list-style-type: none"> • Hardware • Height: 80"–144" 	1 Style number 2 Height 3 Angle (see below under Required Selections)

Required Selections	U.S. Price	Required to Specify
Fixed Angles		
• 90°	No cost	Specify with 90° angle.
• 120°	No cost	Specify with 120° angle.
• 135°	No cost	Specify with 135° angle.

Specification Information		
• Style Number	• Height	• U.S. Price
FEIJH3	≤120"	\$59.17
	>120"	\$73.77
•	•	•
•	•	•

Four-Way Junction Hardware



Standard Includes		Required to Specify
▶ Need help? Product details, page 68	<ul style="list-style-type: none"> • Hardware • Height: 80"–144" 	1 Style number 2 Height

Specification Information		
• Style Number	• Height	• U.S. Price
FEIJH4	≤120"	\$59.17
	>120"	\$73.77
•	•	•
•	•	•



For Canadian Pricing
 Multiply U.S. Price by the
 Canadian price factor.
 ▶ See page 1 for details.

Two-Way Bypass Junction Hardware



Standard Includes	Required to Specify
<ul style="list-style-type: none"> ▶ Need help? Product details, page 68 • Hardware • Height: 80"–144" 	<ul style="list-style-type: none"> 1 Style number 2 Height

Specification Information

• Style Number	• Height	• U.S. Price
FEIJHB	≤120"	\$59.17
	>120"	\$73.77
·	·	·

Junction Nut Plate

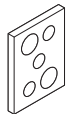

Standard Includes	Required to Specify
<ul style="list-style-type: none"> ▶ Need help? Product details, page 68 • Nut plate 	<ul style="list-style-type: none"> Style number

Specification Information

• Style Number	• U.S. Price
FEIJNP	\$17.43
·	·



For Canadian Pricing
Multiply U.S. Price by the
Canadian price factor.
▶ See page 1 for details.

Junction Seals

Standard Includes	Required to Specify
<ul style="list-style-type: none"> Need help? Product details, page 68 Junction seal 	Style number

Specification Information	
• Style Number	• U.S. Price

Junction Cover Seal

FEIJS	\$36.89
:	:

Bottom Junction Seal

FEIJS	\$30.41
:	:

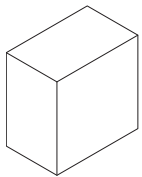
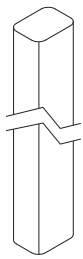

For Canadian Pricing
 Multiply U.S. Price by the Canadian price factor.
 ▶ See page 1 for details.

90° T/X Adapter and Finished End

90° T/X Adapter and
Finished End

Intersections

90° T/X Adapter



Standard Includes		Required to Specify
<ul style="list-style-type: none"> ▶ Need help? Product details, page 68 	<ul style="list-style-type: none"> • Adapter: paint or 8043 Clear Anodized Aluminum • Height: 77.71654"–141.71654" 	<ol style="list-style-type: none"> 1 Style number 2 Paint or anodized aluminum color number for adapter 3 Height 4 Bottom alignment (see below under Required Selections) 5 Options, if selected (see below) <ul style="list-style-type: none"> ▶ See <i>Surface Materials</i>, page 222.

Required Selections	U.S. Price		Required to Specify
Bottom Alignment	• To the skin	Per Cover No cost	N.A. Specify <i>with alignment to the skin</i> .
	• To the floor	Per Inch No cost	N.A. Specify <i>with alignment to the floor</i> .

Options	U.S. Price		Required to Specify
Surface Materials	• Anodized	Per Cover +\$68.28	N.A. Specify <i>with anodized</i> .
	• Paint price group 1	No cost	N.A. Specify paint color number.
	• Paint price group 2	+\$24.47	N.A. Specify paint color number.
	• Paint price group 3	+\$36.85	N.A. Specify paint color number.

Specification Information			
• Style Number	• U.S. Base Price	Per Adapter	Per Inch
.....
FEIA	\$422.24	+\$0.28	
.....

 **For Canadian Pricing**
Multiply U.S. Price by the Canadian price factor.
▶ See page 1 for details.

Finished End



Standard Includes	Required to Specify
-------------------	---------------------

<p>► Need help? Product details, page 68</p> <ul style="list-style-type: none"> • Cover: paint or 8043 Clear Anodized Aluminum • Top trim: paint • Bottom trim: paint • Height: 77.71654"–141.71654" 	<ol style="list-style-type: none"> 1 Style number 2 Height 3 Paint or anodized aluminum color number for cover 4 Paint color number for top trim 5 Paint color number for bottom trim 6 Options, if selected (see below) <p>► See <i>Surface Materials</i>, page 222.</p>
--	---

Options	U.S. Price		Required to Specify
---------	------------	--	---------------------

Surface Materials	Finished end cover	Per Cover	Per Inch	
	• Anodized	+\$68.28	N.A.	Specify <i>with anodized</i> .
	• Paint price group 1	No cost	N.A.	Specify paint color number.
	• Paint price group 2	+\$24.47	N.A.	Specify paint color number.
	• Paint price group 3	+\$36.85	N.A.	Specify paint color number.
	Top trim			
	• Paint price group 1	No cost	N.A.	Specify paint color number.
	• Paint price group 2	+\$10.87	N.A.	Specify paint color number.
	• Paint price group 3	+\$19.80	N.A.	Specify paint color number.
	Bottom trim			
	• Paint price group 1	No cost	N.A.	Specify paint color number.
	• Paint price group 2	+\$10.87	N.A.	Specify paint color number.
	• Paint price group 3	+\$19.80	N.A.	Specify paint color number.

Specification Information		
---------------------------	--	--

Style Number	U.S. Base Price	
.....	Per Cover	Per Inch
FEIFE	\$422.24	+\$0.28

For Canadian Pricing
 Multiply U.S. Price by the Canadian price factor.
 ► See page 1 for details.

Specifying Mini Ends

90° Adjustable Mini End and Mini End Cover	198
Door Frame/Mini End Hardware Kit	200

90° Adjustable Mini End and Mini End Cover

90° Adjustable Mini End



Standard Includes		Required to Specify
<ul style="list-style-type: none"> ▶ Need help? Product details, page 74 	<ul style="list-style-type: none"> • Telescoping mini end: paint or 8043 Clear Anodized Aluminum • Height: 80"–144" 	<ol style="list-style-type: none"> 1 Style number 2 Paint or anodized aluminum color number for mini end 3 Height 4 Width (see below under Required Selections) 5 Options, if selected (see below) <ul style="list-style-type: none"> ▶ See <i>Surface Materials</i>, page 222.

	Required Selections	U.S. Price	Required to Specify
Width	<ul style="list-style-type: none"> • Small • Medium • Large 	<ul style="list-style-type: none"> No cost +\$39.35 +\$84.60 	<ul style="list-style-type: none"> Specify <i>with small width</i>. Specify <i>with medium width</i>. Specify <i>with large width</i>.

	Options	U.S. Price	Required to Specify
Surface Materials	<ul style="list-style-type: none"> • Paint price group 1 • Paint price group 2 • Paint price group 3 • Anodized 	<ul style="list-style-type: none"> No cost +\$24.47 +\$36.85 +\$68.28 	<ul style="list-style-type: none"> Specify paint color number. Specify paint color number. Specify paint color number. Specify <i>with anodized</i>.

Specification Information		
Style Number	U.S. Base Price	
.....	
.....	
.....	
.....	
FEEAM	\$444.17	+\$0.64
.....
.....



For Canadian Pricing
 Multiply U.S. Price by the Canadian price factor.
 ▶ See page 1 for details.

Mini End Cover



Standard Includes		Required to Specify
<ul style="list-style-type: none"> ▶ Need help? Product details, page 74 	<ul style="list-style-type: none"> • Cover: paint or 8043 Clear Anodized Aluminum • Height: 77.71654"–141.71654" 	<ol style="list-style-type: none"> 1 Style number 2 Paint or anodized aluminum color number for cover 3 Height 4 Width (see below under Required Selections) 5 Bottom alignment (see below under Required Selections) 6 Options, if selected (see below) <ul style="list-style-type: none"> ▶ See <i>Surface Materials</i>, page 222.

	Required Selections	U.S. Price	Required to Specify
Width	<ul style="list-style-type: none"> • Small • Medium • Large 	<p>No cost</p> <p>+\$12.72</p> <p>+\$24.47</p>	<p>Specify <i>with small width</i>.</p> <p>Specify <i>with medium width</i>.</p> <p>Specify <i>with large width</i>.</p>
Bottom Alignment	<ul style="list-style-type: none"> • To the skin • To the floor 	<p>No cost</p> <p>No cost</p>	<p>Specify <i>with alignment to the skin</i>.</p> <p>Specify <i>with alignment to the floor</i>.</p>

	Options	U.S. Price	Required to Specify
Surface Materials	<ul style="list-style-type: none"> • Paint price group 1 • Paint price group 2 • Paint price group 3 • Anodized 	<p>No cost</p> <p>+\$24.47</p> <p>+\$36.85</p> <p>+\$68.28</p>	<p>Specify paint color number.</p> <p>Specify paint color number.</p> <p>Specify paint color number.</p> <p>Specify <i>with anodized</i>.</p>

Specification Information		
Style Number	U.S. Base Price	
.....	Per Mini	Per COH
.....	End Cover	Inch
FEEAMC	\$144.21	+\$0.28
.....

Mini Ends

 **For Canadian Pricing**
Multiply U.S. Price by the Canadian price factor.
▶ See page 1 for details.

Door Frame/Mini End Hardware Kit

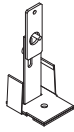

Standard Includes		Required to Specify
▶ Need help? Product details, page 74	• Hardware kit: paint	1 Style number 2 Paint color number for kit ▶ See <i>Surface Materials</i> , page 222.

Specification Information	
• Style • Number	• U.S. • Price
FEEHDM	\$25.07
:	:



For Canadian Pricing
Multiply U.S. Price by the
Canadian price factor.
▶ See page 1 for details.

Specifying Cuttable Ends

90° Cuttable End Assembly	202
90° Cuttable End Inner Channel	202
90° Cuttable End Outer Channel	203
Cuttable End Capture Trim	203
Cuttable End Corner Angle	204
Cuttable End Elbow	204

Cutable Ends

90° Cutable End Assembly

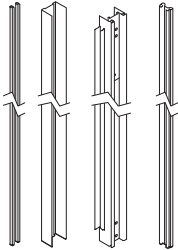

Standard Includes		Required to Specify
-------------------	--	---------------------

▶ Need help? Product details, page 77	<ul style="list-style-type: none"> Cutable end assembly: paint Height: 80"–144" Seal: plastic 	<ol style="list-style-type: none"> Style number Paint color number for cutable end assembly Plastic color number for seal Height Options, if selected (see below) <p>▶ See <i>Surface Materials</i>, page 222.</p>
---	--	---

Options	U.S. Price	Required to Specify
---------	------------	---------------------

Surface Materials	<ul style="list-style-type: none"> Paint price group 1 Paint price group 2 Paint price group 3 	No cost +\$24.47 +\$36.85	Specify paint color number. Specify paint color number. Specify paint color number.
--------------------------	---	---------------------------------	---

Specification Information		
---------------------------	--	--

Style Number	U.S. Base Price	
.....	Per	Per COH
.....	Assy	Inch
FEECEA	\$444.17	+\$0.64
.....

90° Cutable End Inner Channel



Standard Includes		Required to Specify
-------------------	--	---------------------

▶ Need help? Product details, page 76	<ul style="list-style-type: none"> Cutable end inner channel: paint 	<ol style="list-style-type: none"> Style number Paint color number for cutable end assembly Length (see below under Required Selections) Options, if selected (see below) <p>▶ See <i>Surface Materials</i>, page 222.</p>
---	--	--

Required Selections	U.S. Price	Required to Specify
---------------------	------------	---------------------

Length	<ul style="list-style-type: none"> 48" 120" 144" 	No cost +\$ 92.53 +\$125.56	Specify 48" long. Specify 120" long. Specify 144" long.
---------------	---	-----------------------------------	---

Options	U.S. Price	Required to Specify
---------	------------	---------------------

Surface Materials	<ul style="list-style-type: none"> Paint price group 1 Paint price group 2 Paint price group 3 	No cost +\$ 24.47 +\$ 36.85	Specify paint color number. Specify paint color number. Specify paint color number.
--------------------------	---	-----------------------------------	---

Specification Information		
---------------------------	--	--

Style Number	U.S. Base Price	
.....
FEECEI	\$178.81
.....



For Canadian Pricing
 Multiply U.S. Price by the Canadian price factor.
 ▶ See page 1 for details.

90° Cutable End Outer Channel

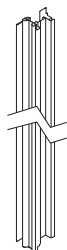

Standard Includes		Required to Specify
<ul style="list-style-type: none"> ▶ Need help? Product details, page 76 	<ul style="list-style-type: none"> • Cutable end outer channel • Seal: plastic 	<ol style="list-style-type: none"> 1 Style number 2 Length (see below under Required Selections) 3 Plastic color number for seal <ul style="list-style-type: none"> ▶ See <i>Surface Materials</i>, page 222.

Required Selections	U.S. Price	Required to Specify
Length		
• 48"	No cost	Specify 48" long.
• 120"	+\$ 92.53	Specify 120" long.
• 144"	+\$125.56	Specify 144" long.

Specification Information	
• Style Number	• U.S. Base Price
FEECEO	\$197.91

Cutable Ends

Cutable End Capture Trim



Standard Includes		Required to Specify
<ul style="list-style-type: none"> ▶ Need help? Product details, page 76 	<ul style="list-style-type: none"> • Cutable end capture trim: paint • Height: 12.1"-144" 	<ol style="list-style-type: none"> 1 Style number 2 Paint color number for capture trim 3 Height 4 Options, if selected (see below) <ul style="list-style-type: none"> ▶ See <i>Surface Materials</i>, page 222.

Options	U.S. Price	Required to Specify
Surface Materials		
• Paint price group 1	No cost	Specify paint color number.
• Paint price group 2	+\$24.47	Specify paint color number.
• Paint price group 3	+\$36.85	Specify paint color number.

Specification Information		
• Style Number	• U.S. Base Price	
FEECECT	\$66.01	+\$0.64

 **For Canadian Pricing**
 Multiply U.S. Price by the Canadian price factor.
 ▶ See page 1 for details.

Cutable End Corner Angle



Standard Includes	Required to Specify
<ul style="list-style-type: none"> ▶ Need help? Product details, page 76 • Cutable end corner angle 	<ul style="list-style-type: none"> Style number

Specification Information	
Style Number	U.S. Price
FEECEAI	\$17.11

Cutable End Elbow



Standard Includes	Required to Specify
<ul style="list-style-type: none"> ▶ Need help? Product details, page 76 • Cutable end elbow 	<ul style="list-style-type: none"> 1 Style number 2 Miter configuration (see below under Required Selections)

Required Selections	U.S. Price	Required to Specify
Miter Configuration <ul style="list-style-type: none"> • Inside corner • Outside corner 	<ul style="list-style-type: none"> No cost No cost 	<ul style="list-style-type: none"> Specify <i>with inside corner.</i> Specify <i>with outside corner.</i>

Specification Information	
Style Number	U.S. Price
FEECEEO	\$42.53



For Canadian Pricing
 Multiply U.S. Price by the Canadian price factor.
 ▶ See page 1 for details.

Specifying Electrical Components

Receptacles and Power Block	206
Power/Communication Receptacle Trim, Blank Cut-Out Cover, and Modular Communication Faceplate	208
Multipurpose Infeed and Power Block Connector	210
Modular Harness and Harness-to-Harness Branching Connector	211
Electrical Mounting Brackets	212
Utility Panel Cover	213

Receptacles and Power Block

Receptacle



15 amp



20 amp

► Need help?
Product details,
page 80

Standard Includes

- Receptacle: plastic

Required to Specify

- 1 Style number
 - 2 Plastic color number for receptacle
 - 3 Wiring schematic (see below under Required Selections)
 - 4 Line (see below under Required Selections)
 - 5 Ground type (see below under Required Selections)
 - 6 Amp type (see below under Required Selections)
 - 7 Options, if selected (see below)
- See *Surface Materials*, page 222.

Tip: If 3SN is specified, there is no Line 4 option.

	Required Selections	U.S. Price	Required to Specify
Wiring Schematic	<ul style="list-style-type: none"> • 3+1 • 2+2 • 3SN 	<p>No cost</p> <p>No cost</p> <p>No cost</p>	<p>Specify with 3+1.</p> <p>Specify with 2+2.</p> <p>Specify with 3SN.</p>
Line	<ul style="list-style-type: none"> • Line 1 • Line 2 • Line 3 • Line 4 	<p>No cost</p> <p>No cost</p> <p>No cost</p> <p>No cost</p>	<p>Specify with line 1.</p> <p>Specify with line 2.</p> <p>Specify with line 3.</p> <p>Specify with line 4.</p>
Ground Type	<ul style="list-style-type: none"> • System • Isolated 	<p>No cost</p> <p>No cost</p>	<p>Specify with system ground.</p> <p>Specify with isolated ground.</p>
Amp Type	<ul style="list-style-type: none"> • 15 amp • 20 amp 	<p>No cost</p> <p>+\$27.07</p>	<p>Specify with 15 amp.</p> <p>Specify with 20 amp.</p>

	Options	U.S. Price	Required to Specify
Controlled Stamp	<ul style="list-style-type: none"> • No stamp • Controlled stamp 	<p>No cost</p> <p>+\$ 7.15</p>	<p>Specify with no stamp.</p> <p>Specify with controlled stamp.</p>

Specification Information	
• Style Number	• U.S. Base Price
FEPRC	\$49.54



For Canadian Pricing

Multiply U.S. Price by the Canadian price factor.

► See page 1 for details.

USB Receptacle



Standard Includes		Required to Specify
▶ Need help? Product details, page 80	<ul style="list-style-type: none"> • USB receptacle: plastic 	<ol style="list-style-type: none"> 1 Style number 2 Plastic color number for receptacle 3 Wiring schematic (see below under Required Selections) 4 Line (see below under Required Selections) <p>▶ See <i>Surface Materials</i>, page 222.</p>

Required Selections	U.S. Price	Required to Specify
Wiring Schematic <ul style="list-style-type: none"> • 3+1 • 2+2 • 3SN 	<ul style="list-style-type: none"> No cost No cost No cost 	<ul style="list-style-type: none"> Specify <i>with 3+1</i>. Specify <i>with 2+2</i>. Specify <i>with 3SN</i>.
Line <ul style="list-style-type: none"> • Line 1 • Line 2 • Line 3 • Line 4 	<ul style="list-style-type: none"> No cost No cost No cost No cost 	<ul style="list-style-type: none"> Specify <i>with line 1</i>. Specify <i>with line 2</i>. Specify <i>with line 3</i>. Specify <i>with line 4</i>.

Tip: If 3SN is specified, there is no Line 4 option.

Specification Information	
Style Number	U.S. Price
FEPRCUSB	\$118.84

Power Block

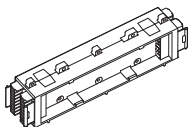

Standard Includes		Required to Specify
▶ Need help? Product details, page 80	<ul style="list-style-type: none"> • Power block 	<ol style="list-style-type: none"> 1 Style number 2 Wire schematic (see below under Required Selections)

Required Selections	U.S. Price	Required to Specify
Wiring Schematic <ul style="list-style-type: none"> • 3+1 • 2+2 • 3SN 	<ul style="list-style-type: none"> No cost No cost No cost 	<ul style="list-style-type: none"> Specify <i>with 3+1</i>. Specify <i>with 2+2</i>. Specify <i>with 3SN</i>.

Specification Information	
Style Number	U.S. Price
FEPB	\$124.92

 **For Canadian Pricing**
Multiply U.S. Price by the Canadian price factor.
▶ See page 1 for details.

Power/Communication Receptacle Trim, Blank Cut-Out Cover, and Modular Communication Faceplate

Power/Communication Receptacle Trim



Standard Includes		Required to Specify
<ul style="list-style-type: none"> ▶ Need help? Product details, page 80 	<ul style="list-style-type: none"> • Receptacle trim: plastic 	<ol style="list-style-type: none"> 1 Style number 2 Plastic color number for receptacle trim 3 Cut-out type (see below under Required Selections) <ul style="list-style-type: none"> ▶ See <i>Surface Materials</i>, page 222.

Required Selections	U.S. Price	Required to Specify
Cut-out Type <ul style="list-style-type: none"> • Power • Communications 	No cost No cost	Specify with <i>power cut-out</i> . Specify with <i>communications cut-out</i> .

Specification Information	
Style Number	U.S. Price
FEPRCT	\$12.17

Blank Cut-Out Cover



Standard Includes		Required to Specify
<ul style="list-style-type: none"> ▶ Need help? Product details, page 80 	<ul style="list-style-type: none"> • Cover cut-out: plastic 	<ol style="list-style-type: none"> 1 Style number 2 Plastic color number for cut-out cover 3 Cut-out type (see below under Required Selections) 4 Wiring schematic, if selected (see below under Required Selections) <ul style="list-style-type: none"> ▶ See <i>Surface Materials</i>, page 222.

Required Selections	U.S. Price	Required to Specify
Cut-Out Type <ul style="list-style-type: none"> • Power • Communications 	No cost No cost	Specify with <i>power cut-out</i> . Specify with <i>communications cut-out</i> .
Wiring Schematic <ul style="list-style-type: none"> • 3+1 • 2+2 • 3SN • No wiring configuration 	No cost No cost No cost No cost	Specify with <i>3+1</i> . Specify with <i>2+2</i> . Specify with <i>3SN</i> . Specify with <i>no wiring configuration</i> .

Tip: Wiring schematic specification only required if cut-out type is power.

Specification Information	
Style Number	U.S. Price
FEPCCB	\$7.61



For Canadian Pricing
 Multiply U.S. Price by the Canadian price factor.
 ▶ See page 1 for details.

Modular Communication Faceplate

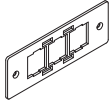

Standard Includes		Required to Specify
<ul style="list-style-type: none"> ▶ Need help? Product details, page 78 	<ul style="list-style-type: none"> • Modular communication faceplate: plastic 	<ol style="list-style-type: none"> 1 Style number 2 Plastic color number for modular communication faceplate 3 Faceplate configuration type (see below under Required Selections) <ul style="list-style-type: none"> ▶ See <i>Surface Materials</i>, page 222.

Required Selections	U.S. Price	Required to Specify
Faceplate Configuration Type <ul style="list-style-type: none"> • RJ45 x 3 • RJ45 + VGA 	No cost No cost	Specify with <i>RJ45 x 3</i> . Specify with <i>RJ45 + VGA</i> .

Specification Information	
Style Number	U.S. Price
FEPFPC	\$54.09

 **For Canadian Pricing**
 Multiply U.S. Price by the
 Canadian price factor.
 ▶ See page 1 for details.

Multipurpose Infeed and Power Block Connector

Multipurpose Infeed

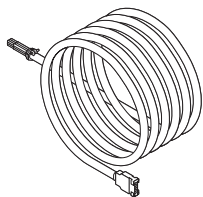

Hardwire

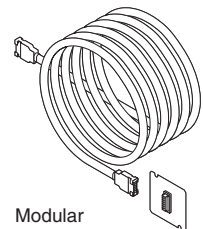

Modular

Standard Includes		Required to Specify
<ul style="list-style-type: none"> ▶ Need help? Product details, page 79 	<ul style="list-style-type: none"> • 24' long infeed • Junction box fittings • Conduit: metal 	<ol style="list-style-type: none"> 1 Style number 2 Wiring schematic type (see below under Required Selections) 3 Building connection type (see below under Required Selections)

	Required Selections	U.S. Price	Required to Specify
Wiring Schematic	<ul style="list-style-type: none"> • 3+1 • 2+2 • 3SN 	<ul style="list-style-type: none"> No cost No cost No cost 	<ul style="list-style-type: none"> Specify with 3+1. Specify with 2+2. Specify with 3SN.
Building Connection Type	<ul style="list-style-type: none"> • Hardwire • Modular 	<ul style="list-style-type: none"> No cost +\$165.67 	<ul style="list-style-type: none"> Specify with hardwire infeed. Specify with modular infeed.

Specification Information	
• Style Number	• U.S. Base Price
•	•
•	•
•	•
FEPIMP	\$800.52
•	•
•	•

Power Block Connector



Standard Includes		Required to Specify
<ul style="list-style-type: none"> ▶ Need help? Product details, page 80 	<ul style="list-style-type: none"> • Power block connector 	<ol style="list-style-type: none"> 1 Style number 2 Wiring schematic (see below under Required Selections)

	Required Selections	U.S. Price	Required to Specify
Wiring Schematic	<ul style="list-style-type: none"> • 3+1 • 2+2 • 3SN 	<ul style="list-style-type: none"> No cost No cost No cost 	<ul style="list-style-type: none"> Specify with 3+1. Specify with 2+2. Specify with 3SN.

Specification Information	
• Style Number	• U.S. Price
•	•
•	•
FEPBC	\$36.18
•	•
•	•

 **For Canadian Pricing**
 Multiply U.S. Price by the Canadian price factor.
 ▶ See page 1 for details.

Modular Harness and Harness-to-Harness Branching Connector

Modular Harness and
Harness-to-Harness
Branching Connector

Modular Harness

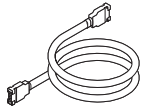

Standard Includes		Required to Specify
<ul style="list-style-type: none"> ▶ Need help? Product details, page 78 	<ul style="list-style-type: none"> • Modular harness 	<ol style="list-style-type: none"> 1 Style number 2 Harness length (see below under Required Selections) 3 Wiring schematic (see below under Required Selections)

Required Selections	U.S. Price	Required to Specify
Harness Length <ul style="list-style-type: none"> • 36" long • 72" long • 144" long 	No cost +\$ 93.29 +\$269.27	Specify with 36" harness. Specify with 72" harness. Specify with 144" harness.
Wiring Schematic <ul style="list-style-type: none"> • 3+1 • 2+2 • 3SN 	No cost No cost No cost	Specify with 3+1. Specify with 2+2. Specify with 3SN.

Specification Information	
Style Number	U.S. Base Price
FEPHN	\$215.17

Harness-to-Harness Branching Connector



Standard Includes		Required to Specify
<ul style="list-style-type: none"> ▶ Need help? Product details, page 80 	<ul style="list-style-type: none"> • Connector 	<ol style="list-style-type: none"> 1 Style number 2 Wiring schematic (see below under Required Selections)

Required Selections	U.S. Price	Required to Specify
Wiring Schematic <ul style="list-style-type: none"> • 3+1 • 2+2 • 3SN 	No cost No cost No cost	Specify with 3+1. Specify with 2+2. Specify with 3SN.

Specification Information	
Style Number	U.S. Price
FEPHNC	\$49.54

Electrical
Components

 **For Canadian Pricing**
Multiply U.S. Price by the
Canadian price factor.
▶ See page 1 for details.

Electrical Mounting Brackets

Electrical Mounting Bracket—Skin

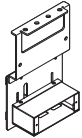

Data

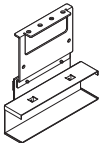

Modular

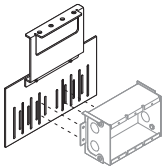

Hardwire

Tip: Hardwire boxes are not included with bracket.

▶ See page 81 for a list of compatible electrical boxes.

Standard Includes		Required to Specify
▶ Need help? Product details, page 78	• Bracket	1 Style number 2 Device type (see below under Required Selections)

Device Type	Required Selections	U.S. Price	Required to Specify
	• Hardwire	No cost	Specify with <i>hardwire</i> .
	• ADA hardwire	No cost	Specify with <i>ADA hardwire</i> .
	• Modular	+\$63.22	Specify with <i>modular</i> .
	• Modular hardwire	+\$63.22	Specify with <i>modular hardwire</i> .
	• Modular communication	+\$75.38	Specify with <i>communication</i> .
	• ADA modular communication	+\$75.38	Specify with <i>ADA modular communication</i> .

Specification Information	
• Style Number	• U.S. Base Price
FEPMBES	\$78.09

Electrical Mounting Bracket—Utility Panel

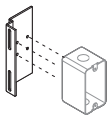

Hardwire box

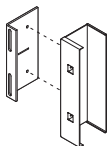

Modular power block

Tip: Hardwire boxes are not included with bracket.

▶ See page 81 for a list of compatible electrical boxes.

Standard Includes		Required to Specify
▶ Need help? Product details, page 78	• Bracket	1 Style number 2 Device type (see below under Required Selections)

Device Type	Required Selections	U.S. Price	Required to Specify
	• Hardwire shallow	No cost	Specify with <i>hardwire shallow</i> .
	• Hardwire deep	No cost	Specify with <i>hardwire deep</i> .
	• Modular	+\$12.17	Specify with <i>modular</i> .

Specification Information	
• Style Number	• U.S. Base Price
FEPMBEU	\$63.22



For Canadian Pricing

Multiply U.S. Price by the Canadian price factor.

▶ See page 1 for details.



Standard Includes		Required to Specify
<ul style="list-style-type: none"> ▶ Need help? Product details, page 81 	<ul style="list-style-type: none"> • Cover: paint or 8043 Clear Anodized Aluminum • Height: 77.71654"–141.71654" 	<ol style="list-style-type: none"> 1 Style number 2 Paint or anodized aluminum color number for cover 3 Height 4 Bottom alignment type (see below under Required Selections) 5 Cut-outs (see below under Required Selections) 6 Cut-out type (see below under Required Selections) 7 Options, if selected (see below) <ul style="list-style-type: none"> ▶ See <i>Surface Materials</i>, page 222.

	Required Selections	U.S. Price	Required to Specify
Bottom Alignment Type	<ul style="list-style-type: none"> • To the skin • To the floor 	<p>No cost</p> <p>No cost</p>	<p>Specify <i>with alignment to the skin</i>.</p> <p>Specify <i>with alignment to the floor</i>.</p>
Cable Management	<p>Cut-out count</p> <ul style="list-style-type: none"> • No holes • One hole • Two holes • Three holes <p>Cut-out type (for each cut-out specified)</p> <ul style="list-style-type: none"> • Clearance notch • Hardwire—2x4 rectangular • Modular power 	<p>No cost</p> <p>No cost</p> <p>No cost</p> <p>No cost</p> <p>No cost</p> <p>+\$ 8.69</p> <p>+\$18.91</p>	<p>Specify <i>with no holes</i>.</p> <p>Specify <i>with one hole</i>.</p> <p>Specify <i>with two holes</i>.</p> <p>Specify <i>with three holes</i>.</p> <p>Specify <i>with clearance notch cut-out type for each applicable location</i>.</p> <p>Specify <i>with hardwire—2x4 rectangular cut-out type for each applicable location</i>.</p> <p>Specify <i>with modular power cut-out type for each applicable location</i>.</p>

	Options	U.S. Price	Required to Specify
Surface Materials	<ul style="list-style-type: none"> • Paint price group 1 • Paint price group 2 • Paint price group 3 • Anodized 	<p>No cost</p> <p>+\$24.47</p> <p>+\$36.85</p> <p>+\$68.28</p>	<p>Specify paint color number.</p> <p>Specify paint color number.</p> <p>Specify paint color number.</p> <p>Specify <i>with anodized</i>.</p>

Specification Information		
Style Number	U.S. Base Price	
.....	Per Cover	Per Inch
FEUPC	\$349.65	+\$0.28

Electrical Components

 **For Canadian Pricing**
 Multiply U.S. Price by the Canadian price factor.
 ▶ See page 1 for details.



Specifying Technology Components

Single Monitor Shroud	216
Double Monitor Shroud	217
Camera Shelf for Monitor Shroud	218

Single Monitor Shroud **X10/26**

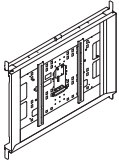

Standard Includes		Required to Specify
<ul style="list-style-type: none"> ▶ Need help? Product details, page 86 	<ul style="list-style-type: none"> • Frame: paint or 8043 Clear Anodized Aluminum • Seal: plastic • Power assembly 	<ol style="list-style-type: none"> 1 Style number 2 Width (see below under Required Selections) 3 Paint or anodized aluminum color number for frame 4 Plastic color number for seal 5 Building connection type (see below under Required Selections) 6 Wiring schematic, if modular connection type selected (see below under Required Selections) 7 Options, if selected (see below) <p>▶ See <i>Surface Materials</i>, page 222.</p>

	Required Selections	U.S. Price	Required to Specify
Width	<ul style="list-style-type: none"> • 34.5" • 42" • 48" • 54" • 60" • 63.5" • 70" • 80" • 89" 	<ul style="list-style-type: none"> –\$ 172.62 No cost +\$ 179.46 +\$ 610.26 +\$1086.93 +\$1408.50 +\$1745.73 +\$2104.33 +\$2483.47 	<ul style="list-style-type: none"> Specify 34.5". Specify 42". Specify 48". Specify 54". Specify 60". Specify 63.5". Specify 70". Specify 80". Specify 89".
Building Connection Type	<ul style="list-style-type: none"> • Hardwire • Modular 	<ul style="list-style-type: none"> No cost No cost 	<ul style="list-style-type: none"> Specify <i>with hardwire</i>. Specify <i>with modular</i>.
Wiring Schematic	<ul style="list-style-type: none"> • 3+1 • 2+2 • 3SN 	<ul style="list-style-type: none"> No cost No cost No cost 	<ul style="list-style-type: none"> Specify <i>with 3+1</i>. Specify <i>with 2+2</i>. Specify <i>with 3SN</i>.

Tip: Wiring schematic only required when building connection type is modular.

Tip: The power assembly connector is configured to connect to circuit 1.

	Options	U.S. Price	Required to Specify
Surface Materials	Frame		
	<ul style="list-style-type: none"> • Anodized • Paint price group 1 • Paint price group 2 • Paint price group 3 	<ul style="list-style-type: none"> No cost +\$ 174.48 +\$ 174.48 +\$ 246.49 	<ul style="list-style-type: none"> Specify <i>with anodized</i>. Specify paint color number. Specify paint color number. Specify paint color number.
	Seal		
	<ul style="list-style-type: none"> • Plastic 	No cost	Specify plastic color number.

Specification Information	
Style Number	U.S. Base Price
FEMSS X10/26	\$4225.76



For Canadian Pricing
 Multiply U.S. Price by the Canadian price factor.
 ▶ See page 1 for details.

X10/26 = Last order entry
 October 18, 2026

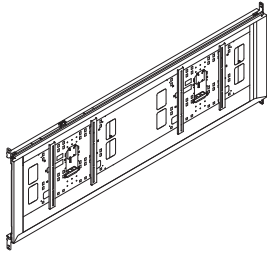

Standard Includes	Required to Specify
<ul style="list-style-type: none"> ▶ Need help? Product details, page 87 • Frame: paint or 8043 Clear Anodized Aluminum • Seal: plastic • Power assembly 	<ol style="list-style-type: none"> 1 Style number 2 Width (see below under Required Selections) 3 Paint or anodized aluminum color number for frame 4 Plastic color number for seal 5 Building connection type (see below under Required Selections) 6 Wiring schematic, if modular connection type selected (see below under Required Selections) 7 Options, if selected (see below) <p>▶ See <i>Surface Materials</i>, page 222.</p>

Required Selections	U.S. Price	Required to Specify
Width <ul style="list-style-type: none"> • 96" • 103" • 120" 	<ul style="list-style-type: none"> No cost +\$ 677.57 +\$1422.18 	<ul style="list-style-type: none"> Specify 96". Specify 103". Specify 120".
Building Connection Type <ul style="list-style-type: none"> • Hardwire • Modular 	<ul style="list-style-type: none"> No cost No cost 	<ul style="list-style-type: none"> Specify <i>with hardwire</i>. Specify <i>with modular</i>.
Wiring Schematic <ul style="list-style-type: none"> • 3+1 • 2+2 • 3SN 	<ul style="list-style-type: none"> No cost No cost No cost 	<ul style="list-style-type: none"> Specify <i>with 3+1</i>. Specify <i>with 2+2</i>. Specify <i>with 3SN</i>.

Tip: Wiring schematic only required when building connection type is modular.

Tip: The power assembly connector is configured to connect to circuit 1.

Tip: A second power assembly can be ordered separately when required to power two monitors and a camera.

Options	U.S. Price	Required to Specify
Surface Materials <ul style="list-style-type: none"> • Frame • Anodized • Paint price group 1 • Paint price group 2 • Paint price group 3 	<ul style="list-style-type: none"> No cost +\$ 293.83 +\$ 293.83 +\$ 387.21 	<ul style="list-style-type: none"> Specify <i>with anodized</i>. Specify paint color number. Specify paint color number. Specify paint color number.
<ul style="list-style-type: none"> • Seal • Plastic 	<ul style="list-style-type: none"> No cost 	<ul style="list-style-type: none"> Specify plastic color number.

Specification Information	
Style Number	U.S. Base Price
FEMSD X10/26	\$6764.59

Technology Components

 **For Canadian Pricing**
 Multiply U.S. Price by the Canadian price factor.
 ▶ See page 1 for details.

X10/26 = Last order entry
 October 18, 2026

Camera Shelf for Monitor Shroud X10/26



Standard Includes		Required to Specify
<ul style="list-style-type: none"> ▶ Need help? Product details, page 86 	<ul style="list-style-type: none"> • Frame: paint 	<ul style="list-style-type: none"> 1 Style number 2 Paint color number for frame 3 Options, if selected (see below) ▶ See <i>Surface Materials</i>, page 222.

Options	U.S. Price	Required to Specify
Surface Materials <ul style="list-style-type: none"> • Paint price group 1 • Paint price group 2 • Paint price group 3 	No cost No cost +\$43.08	Specify paint color number. Specify paint color number. Specify paint color number.

Specification Information	
• Style Number	• U.S. Base Price
FEMSCS X10/26	\$578.58
.	.
.	.



For Canadian Pricing
 Multiply U.S. Price by the Canadian price factor.
 ▶ See page 1 for details.

X10/26 = Last order entry
 October 18, 2026

Specifying Hang-On Components

Universal Systems Worksurface Supports

220

Universal Systems Worksurface Supports

For Use with V.I.A.

On-Module Cantilever

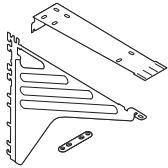

Tip: 30"D straight and transition cantilevered worksurfaces require additional floor support along the front edge, such as a pedestal, end panel, post leg, side support bracket, or an adjacent return worksurface.

Standard Includes	Required to Specify
<ul style="list-style-type: none"> ▶ Need help? Product details, page 97 • One cantilever: paint price group 1 or 2 • Tie plate • Attachment hardware 	<ul style="list-style-type: none"> 1 Style number 2 Paint color number for cantilever ▶ See <i>Surface Materials</i>, page 222.

Specification Information	
: Style Number	: U.S. Price
VUCANT	\$176.00
:	:

Side Support Brackets



Tip: Side support bracket includes a pair of handed brackets, only one of which is required for rear corner support of panel-mounted corner worksurfaces. Specify one for every two corner worksurfaces in on-module applications.

Standard Includes	Required to Specify
<ul style="list-style-type: none"> ▶ Need help? Product details, page 97 • Pair of handed side support brackets: black paint only • Attachment hardware 	<ul style="list-style-type: none"> Style number

Specification Information	
: Style Number	: U.S. Price
VUSSBR	\$63.00
:	:



For Canadian Pricing

Multiply U.S. Price by the Canadian price factor.

▶ See page 1 for details.

Surface Materials

Surface Materials	222
Pleasing Match—Veneer	226
Paint Color and Anodized Aluminum Availability Matrix	227

Surface Materials

This listing includes all the surface material choices that are available for the products in this specification guide. ▶ See *Paint Color and Anodized Aluminum Availability Matrix* on page 227 for exact surface material availability on each V.I.A. component.

Resources

For more information about surface materials, refer to the following resources:

Additional surface material specification tools are available to assist you in the specification process – the Surface Materials Binders.

The global surface materials palette is a core collection of finishes that is available across multiple geographies (Americas/EMEA – Europe, Middle East, and Africa/ APAC – Asia Pacific) and on global product lines, where applicable. For a list of finishes included in the offering, see the *Surface Materials Reference Manual*. Additional details, like product approvals by geography and finish number conversions, can also be found in the *Surface Materials Reference Manual* or see steelcase.com/surface-materials.

Surface Materials Binders

include:

- Surface Materials
- A complete set of swatch cards for hard surfaces, vertical surface fabrics, and seating

V.I.A. Binder

includes:

- Brochures
- Swatch cards

Paint

Tip: All products may not be available in all colors listed below.

▶ See page 227 for an overview of the paint colors available on each component.

Price Group 1

Smooth Paint

4238	Mocha
4239	Clay
4240	Chalk
4242	Milk
4710	Low Gloss Black
4843	Linen
4844	Glacier
4849	Vapor
4858	Seagull

Textured Paint

7190	Platinum Solid
7207	Black
7225	Sand
7237	Slate
7238	Fieldstone
7239	Midnight E
7241	Arctic White
7243	Seagull
7360	Merle

Price Group 2

Smooth Paint

4700	Warm White
------	------------

Smooth Metallic Paint

4750	Champagne Metallic
4798	Sterling Metallic E
4799	Platinum Metallic
4803	Near Black Metallic

Custom Surfaces

Price Group 3

PerfectMatch

PerfectMatch is a service that allows you to create your own paint color. Refer to the *Surface Materials Reference Manual* for more information about this program.

Accent Paint

1ATG	Rose Quartz
4AV4	Baltic
4CL1	Dark Olivine
4CL2	Ice Blue
4CL3	Aura
4CL4	Sea Glass
4CL5	Light Matcha
4CL6	Terra
4CL7	Sandstone
4CL8	Smokey Plum
4CZ6	Lagoon

Lux Coatings

4B22	Matte Brass
4B23	Burnished Bronze
4B24	Night Bronze
4B25	Matte Copper
4B26	Smoked Mica
4B29	Cast Iron

Accent Paint and Lux Coatings

will be added to products that receive the metal and accessories paint finishes.

Metal and Accessory Paint Steelcase Surfaces

Applies to:

- Captured glass frames
 - Inner junction covers
 - Outer junction cover
 - Outer bypass junction cover
 - Adapter
 - Finished end cover and trim
 - Mini end and cover
 - Utility panel cover
 - Door frames
 - Slider door leaves
 - Slider door track
 - Monitor shrouds
- | | |
|------|-------------------------|
| 8043 | Clear Anodized Aluminum |
|------|-------------------------|

Laminate

Steelcase Surfaces

Applies to:

- Laminate skins

High-Pressure Laminate

Price Group 1

Fiber Laminate

2850	Vanadium Fiber
2854	Vellum Fiber E
2860	Granite Fiber
2862	Stucco Fiber E

Micro Laminate

2920	Marl Micro
2921	Gypsum Micro
2922	Clay Micro

Patina Laminate

2870	Blonde Bronze Patina
2873	Instant Iron Patina

Solid Laminate

2722	Cream E
2730	Arctic White
2746	Black
2759	Warm White
2811	Mist E
2883	Seagull
2884	Milk
2885	Dune
2HAA	Persian Salt
2HAB	Rose
2HAC	Indigo
2HAD	Green Citrine E
2HAE	Dark Olivine
2HAF	Cloudy
2HMG	Merle
2HWU	Clay
2HWV	Chalk

Speckle Laminate

2820	Coffee Speckle E
2823	Driftwood Speckle
2824	Smoke Speckle
2825	Vanadium Speckle

Woodgrain Laminate

2406	Clear Cherry E
2409	Clear Maple
2410	Graphite Walnut
2412	Natural Cherry
2422	Medium Cherry E
2511	Winter on Maple E
2535	Virginia Walnut
2536	Blackwood
2538	Clear Walnut
2592	Blonde on Maple E
2714	Natural Walnut E
2897	Desert Oak
2HAK	Clear Oak
2HAN	Ash Noce
2HAT	Acacia
2HAW	Ash Wenge
2HBN	Bisque Noce
2HBW	Bisque Wenge
2HCN	Clay Noce
2HCW	Clay Wenge
2HSN	Storm Noce
2HSW	Storm Wenge
2HWA	Grey Kingswood
2HWB	Planked Walnut
2HWD	Resolute Walnut
2HWE	Natural Recon
2HWF	Smoked Walnut E

Price Group 2

Textured Laminate

2TH2	Fawn Cypress
2TH4	Saddle Oak
2TH5	Veranda Teak
2TH7	Walnut Heights
2UH1	Reclaimed Aggregate
2UH2	Reclaimed Gravel
2UH4	Cement*
2UH6	Sheetrock

Tip: Some wood veneer finishes and woodgrain laminates share the same name. Because of the difference in materials, veneers and laminates of the same name are not an exact match but do coordinate with each other.

* 2UH4 Cement has limited availability, determined by product sizing and/or options.

Price Group 3

Solid Laminate

24H1	Satin White
24H2	Satin Black
24H3	Satin Stone
24H4	Satin Mocha

E = Excluded

Low-Pressure Laminate

Fiber Laminate

- 2L50 Vanadium Fiber LPL
- 2L52 Tungsten Fiber LPL **E**

Solid Laminate

- 247L Black V2 LPL
- 2L30 Arctic White LPL
- 2L83 Seagull LPL
- 2L84 Milk LPL
- 2L85 Dune LPL
- 2LMG Merle LPL

Woodgrain Laminate

- 24L0 Graphite Walnut LPL
- 25L1 Winter on Maple LPL **E**
- 25L5 Virginia Walnut LPL
- 25L6 Blackwood LPL
- 25L8 Clear Walnut LPL
- 26L1 Natural Cherry V2 LPL
- 2L09 Clear Maple LPL
- 2LAK Clear Oak LPL
- 2LAN Ash Noce LPL
- 2LAT Acacia LPL
- 2LAW Ash Wenge LPL
- 2LBN Bisque Noce LPL
- 2LBW Bisque Wenge LPL
- 2LCN Clay Noce LPL
- 2LCW Clay Wenge LPL
- 2LSN Storm Noce LPL
- 2LSW Storm Wenge LPL
- 2LWA Grey Kingswood LPL
- 2LWB Planked Walnut LPL
- 2LWD Resolute Walnut LPL
- 2LWF Smoked Walnut LPL **E**
- 2LWG Natural Recon LPL
- 2TL2 Fawn Cypress LPL

Plastic

Steelcase Surfaces

Applies to:

- Ceiling track
- Post
- Structural horizontals
- Intermediate horizontals
- Cuttable ends
- Seals
- Receptacles
- Receptacle trim
- Modular communication faceplate
- Blank cut-out cover
- Single monitor shroud
- Double monitor shroud

- 6009 Arctic White
- 6249 Platinum Solid
- 6527 Merle
- 6B03 Red (receptacles only)

Applies to:

- Laminate skins
- 6000 Black
- 6001 Coffee **E**
- 6009 Arctic White
- 6034 Natural Cherry
- 6036 Medium Cherry
- 6037 Winter on Maple
- 6038 Blonde on Maple **E**
- 6041 Natural Walnut **E**
- 6052 Milk
- 6053 Seagull
- 6128 Taupe
- 6169 Stone
- 6170 Mocha
- 61AA Persian Salt
- 61AB Rose
- 61AC Indigo
- 61AD Green Citrine **E**
- 61AE Dark Olivine
- 61AF Cloudy
- 6213 Acacia
- 6219 Clear Oak
- 6231 Graphite Walnut
- 6237 Clear Maple
- 6242 Virginia Walnut
- 6243 Blackwood
- 6245 Clear Walnut
- 6249 Platinum Solid
- 6527 Merle
- 6615 Grey V5

- 6619 Ice **E**
- 6631 Cream **E**
- 6635 Dawn **E**
- 6636 Mist
- 6654 Sand
- 6655 Warm White
- 66WA Grey Kingswood
- 66WB Planked Walnut
- 66WD Resolute Walnut
- 66WE Natural Recon
- 66WF Smoked Walnut
- 66WU Clay
- 66WV Chalk
- 6703 Ash Wenge
- 6704 Storm Wenge
- 6705 Bisque Wenge
- 6706 Clay Wenge
- 6707 Ash Noce
- 6708 Bisque Noce
- 6709 Clay Noce
- 6710 Storm Noce
- 6T02 Fawn Cypress
- 6T04 Saddle Oak
- 6T05 Veranda Teak
- 6T07 Walnut Heights
- 6T08 Aggregate
- 6T09 Gravel
- 6T10 Cement
- 6T12 Sheetrock

Custom Surfaces

Open Line Laminate (OLL)

This service allows you to order non-standard laminate at an additional processing fee, plus the cost of the laminate.

High-Pressure Laminate pricing does not include premium or digitally printed patterns from any suppliers. Laminate cost may also vary for basic or standard laminates from other suppliers. Please contact the OLL consultant at 616.475.2426 for pricing. The cost of the laminate will be added to your invoice as a separate line on the acknowledgement.

When processing orders for Open Line laminate on V.I.A. skins, specify 2900 in the laminate finish field and enter the OLL manufacturer information. Enter the required edge finish as you would a standard laminate.

Laminate Approval and Material Requirements

To confirm whether a particular laminate has already been tested for use on a specific Steelcase product or to determine material square requirements:

Visit www.steelcase.com

For additional information, refer to the *Steelcase Surface Materials Reference Manual*.

Markerboard Surface

Steelcase Surfaces

Applies to:

- Ceramic skins
- 7655 High Gloss White

Glass

Steelcase Surfaces

Applies to:

- Single glazed captured glass frame
- Double glazed captured glass frame
- Single side captured glass frames

Price Group 1

- 6500 Clear Glass

Price Group 2

- 6540 Clear Laminated
- 6541 White Laminated

Price Group 3

- 6501 Low Iron Clear
- 6542 Satin

Price Group 7

- 6504 Low Iron Clear Laminated

Customer-specified glass is available.

Applies to:

- Double glazed captured glass frame
- Single side captured glass frames

Back-Painted Glass

Price Group 6

- 6521 Truffle
- 6571 Aubergine
- 6575 Peacock
- 6576 Jungle
- 6577 Merlot
- 6578 Lagoon
- 6579 Saffron
- 6581 Blue Jay
- 6584 Tangerine
- 6586 Green Citrine/
Citrus Green
- 6588 Purple Berry
- 6589 Mercury
- 6591 Merle
- 6593 Greyscale
- 6595 Winter
- 6597 Honey
- 6BB1 Cloud
- 6BB2 Rose Quartz
- 6BB3 Olivine
- 6BB4 Electric Indigo

E = Excluded

Surface Materials, continued

Applies to:

- Polished edge swing door leaves

Price Group 1

6500 Clear Glass

Price Group 3

6501 Low Iron Clear

6542 Satin

Customer-specified glass is available.

Plated Metal

Steelcase Surfaces

Applies to:

- Push/pull handle
- Ladder pulls

4710 Low Gloss Black

8031 Brushed Stainless

- Hinges

- Locksets

- Flush Bolts

4710 Low Gloss Black

9200 Satin Chrome

9201 Polished Chrome

- Roller Latch

8031 Brushed Stainless

- Door Closer

4710 Low Gloss Black

4799 Platinum Metallic

Vertical Surface

Fabric

Steelcase Surfaces

Applies to:

- Solid steel skins

Price Group 1

Abacus **E**

P123 Portico

P124 Opus

P125 Cusp

P126 Artifact

Boccie

P200 New Rice

P201 New Almond

P203 New Camel

P204 New Opal

P205 New Mist

P206 New Plum

P208 New Spearmint

P209 New Sky

Buzz2

5F03 Tomato

5F04 Red **E**

5F05 Burgundy

5F06 Sky **E**

5F07 Blue

5F08 Navy

5F15 Stone

5F16 Grey

5F17 Black

5G50 Dunegrass

5G51 Sable

5G55 Pumpkin

5G57 Rouge

5G59 Meadow

5G61 Cyan

5G62 Atlantic

5G63 Crocus

5G64 Alpine

5G65 Tornado

Charm

P505 Shell

P506 Mimosa

P507 Birch

P508 Sparkle

P510 Debut

P511 Clover

P513 Twilight

Optic

P540 Hazel

P541 Twinkle

P542 Orion

P547 Bath

P548 Whisper

P549 Breezy

P551 Glimmer

Rhythm

P555 Allegro

P556 Tempo

P557 Refrain

P560 Melody

P562 Opus

Tinsel

P516 Lit

P517 Ego

P518 Fizz

P519 Muse

P520 Depth

P521 Bliss

P522 Grow

P523 Dolce

Price Group 2

Bariolage

G200 New Etude

G201 New Andante **E**

G202 New Cantata **E**

G203 New Adagio

G204 New Melody

G205 New Ballata

Code

5FA1 Fossil

5FA2 Gabbro

5FA3 Reed

5FA4 Bluff

5FA5 Sea Salt

5FA6 Cannon

5FA7 Tussah

5FA9 Ecu

5FB1 Bamboo

Dovetail by Designtex

5H39 Light Mocha

5H40 Pebble

5H41 Warm White

5H42 Sandstone

5H43 Honeycomb

5H44 Terra

5H45 Honeydew

5H46 Denim

5H47 Storm

5H48 Ice Blue

5H49 Aura

5H50 Darkest Grey

Fresco

G001 Sandrift

G002 Mistiblu

G003 Faon

Intersection

P211 Summit

P212 Chalk

P213 Lace

Latch

P600 Seashell

P601 Clam

P602 Eggshell

P603 Zen

P604 Cool Gray

P605 Armor

P606 Sentinel

P608 Billow

P609 Nimbus

Stencil

P455 Midnight

P456 Mulberry

P457 Cracked Pepper

P458 Denim

P459 Chartreuse

P460 Bittersweet

P461 Mauvelous

P462 Bermuda

P463 Concrete

P464 Orchid

P465 Parchment

P466 Silk

P467 Sea Salt

P468 Honeydew

P469 Sepia

Select Surfaces

For information on products within Select Surfaces, including accent paints and fabrics from Designtex, Gabriel, Kvadrat, and Pollack, please refer to the *Surface Materials Reference Manual* or visit steelcase.com/surface-materials under the Select Surfaces section.

Custom Surfaces

Price Group COM (Customer's Own Material)

Fabric Approval and Yardage

To confirm whether a particular COM material has already been tested for use on a specific Steelcase product or to determine actual yardage requirements:

- Visit www.steelcase.com

For additional information regarding Customer's Own Material, call 1.888.STEELCASE (1.888.783.3522) or send an e-mail to lineone@steelcase.com.

Wood

Applies to:

- Door leaf
- Solid veneer skins

Steelcase carefully selects veneer and solid wood for consistent color and grain structure. Wood is a natural material and variations will occur in color, grain, and texture. These variations are part of the inherent natural beauty of wood and are not considered defects.

All wood products will darken with age and exposure to ultraviolet light. This is especially apparent with cherry and maple veneer. We recommend that desk accessories be rearranged periodically to ensure even aging of wood surfaces.

When storing your wood furniture, please follow the following guidelines:

- Do not store products in trailers
- Store products in areas that simulate office temperatures (60°F to 90°F)
- Store products in areas that maintain constant, office-like humidity levels
- Keep product away from light. Cover products to make sure they are not exposed to light.

Steelcase Surfaces

Veneers are matched for proper balance and consistency. Veneers are available flat cut or quarter cut, except for Oak, which is rift cut. Refer to the *Surface Materials Reference Manual* for descriptions of each cut.

Open-pore finish is a medium gloss finish that leaves the wood grain texture visible to the eye and distinguishable to the touch.

E = Excluded

Veneer**Wood Group 1****Flat-Cut Open-Pore**

- 3062 FC/OP Graphite Walnut
- 3402 FC/OP Clear Cherry (Aged)
- 3412 FC/OP Natural Cherry **E**
- 3422 FC/OP Medium Cherry
- 3522 FC/OP Clear Maple
- 3702 FC/OP Clear Walnut
- 3712 FC/OP Natural Walnut
- 3752 FC/OP Medium Walnut **E**
- 3762 FC/OP Dark Walnut
- 3772 FC/OP Medium Mahogany on Walnut

Flat-Cut Open-Pore, Natural Veneer

- 3342 FC/OP Black Walnut
- 35A2 FC/OP Blanch Maple
- 37A2 FC/OP Thunder Walnut

Quarter-Cut Open-Pore

- 3042 QC/OP Ash **E**
- 3222 QC/OP Clear Maple
- 3302 QC/OP Clear Walnut
- 3312 QC/OP Natural Walnut
- 3352 QC/OP Medium Walnut **E**
- 3362 QC/OP Dark Walnut
- 3372 QC/OP Medium Mahogany on Walnut
- 3382 QC/OP Graphite Walnut

Quarter-Cut Open-Pore, Natural Veneer

- 32A2 QC/OP Blanch Maple
- 33A2 QC/OP Thunder Walnut
- 3392 QC/OP Black Walnut

Rift-Cut Open-Pore

- 3602 RC/OP Desert Oak

Rift-Cut Open-Pore, Natural Veneer

- 36A2 RC/OP Volcanic Oak

Wood Group 3**Flat-Cut Open-Pore, Natural Veneer**

- 3082 FC/OP Washed Walnut

Wood Group 1**Open-Pore Planked Veneer**

- 3P41 OP Planked Cherry
- 3P51 OP Planked Maple
- 3P61 OP Planked Oak
- 3P71 OP Planked Walnut
- 3VFX OP Unmarked Oak

Tip: Known for its uniqueness, planked veneer has intentional and natural variations that include, but are not limited to: character marks, grain pattern, color, and natural color aging.

E = Excluded

Premium Veneers

A selection of Premium veneers in this collection are available on most Steelcase brand products. The collection will be available as close to standard leadtimes as possible. However, because adequate supplies of veneer and solids must be secured, all orders will be scheduled individually. Leadtimes will vary based on Premium veneer and Premium solids availability at the time the order is placed. The collection is available as Wood Group 3, as part of our Select Surfaces program and supported like standard veneers to make ordering easy. Please see the Steelcase surface materials section on village.steelcase.com for sample information and product line availability. All premium veneers are in clear-coat.

Wood Group 3**Quarter-Cut Open-Pore**

- 3832 QC/OP Figured Anegre

Select Surfaces

For information on products within Select Surfaces, including accent paints and fabrics from Designtex, Gabriel, Kvadrat, and Pollack, please refer to the *Surface Materials Reference Manual* or visit steelcase.com/surface-materials under the Select Surfaces section.

Composite Veneer

Composite veneers are an engineered wood intended to create specific grain patterns and characteristics. They are pre-stained and finished with Steelcase's Clarity water-borne UV topcoat, which protects the environment while providing durability and clarity. Only open-pore finishes are available on composite wood. Composite veneer and matching edge bands are available on most Steelcase brand products. Composites, for use as a solid nosing substitute, are not available. Steelcase does not recommend mixing composite veneers with natural solid nosings because composite and natural wood grain and color matching are rarely compatible. Composite veneers are available as Wood Group 1 pricing as part of our Select Surfaces program.

Composite Veneer Group 1**Composite Flat-Cut Open-Pore**

- 3JJX FC/OP Walnut Composite
- 3LAX FC/OP Graphite on Oak Composite
- 3LCX FC/OP Medium Cherry on Cherry Composite

Composite Quarter-Cut Open-Pore

- 3F8X QC/OP European Walnut Composite
- 3HGX QC/OP Oak Composite
- 3HVX QC/OP Walnut Composite
- 3LBX QC/OP Clear Walnut on Walnut Composite
- 3LDX QC/OP Natural Walnut on Walnut Composite

Composite Veneer Group 2**Composite Flat-Cut Open-Pore**

- 3LHX FC/OP Espresso on Walnut Composite

Composite Quarter-Cut Open-Pore

- 3LEX QC/OP Desert Oak on Oak Composite
- 3LGX QC/OP Chai on Walnut Composite
- 3LJX QC/OP Ebony on Walnut Composite

Custom Surfaces

Customiz stain is a service that allows you to create your own stain colors and finishes on standard veneer. Customiz stain color is available on all product lines that offer wood veneer.

A \$500 stain-matching fee applies on CUSTOMIZ requests (Exception: The \$500 fee does not apply on matches to Coalesse standard finishes or for a low-gloss finish request on a standard color). The \$500 fee covers the cost of formulating the Customiz color finish and applies regardless of whether or not an order for product is placed.

In addition, an approval form must be signed to indicate customer acceptance of Customiz match. A \$1,500 initiation fee will be charged prior to first order entry. This initiation fee activates the finish for unlimited use on any Steelcase product for an 18 month time period. After the 18 month time period has lapsed, the Customiz finish may be reactivated for another 18 months for a \$1,000 fee at any point within five years after the \$1,500 initiation was paid. If the finish is not reactivated within five years after the \$1,500 initiation fee was paid, the finish will be culled and the customer will need to pay the \$1,500 initiation fee again. All style number related Customiz charges products are no cost as of April 2014. The matching and initiation fee are not discountable.

Customiz stain takes 10 days to formulate. Consult the *Surface Materials Reference Manual* for more information. Custom veneers are also available and must be quoted by Steelcase specials group. Customiz stain on custom veneers takes 2 to 4 weeks to formulate.

Requirements and information on ordering a Customiz stain color are found in the *Surface Materials Reference Manual*.

Pleasing Match—Veneer

To help minimize the potential visual differences in grain pattern when applying veneer skins, Steelcase uses a randomly matched veneer configuration known as pleasing match.

The pleasing match veneer configuration is used on V.I.A. veneer skins and veneer doors.

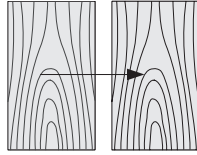

Slip Matching

Successive veneer leaves in a flitch are “slipped” alongside one another without being turned over. The result is a series of grain pattern repeats. In quarter-cut veneer, one side of a leaf may be darker than the veneer on the other side, resulting in a striped look.

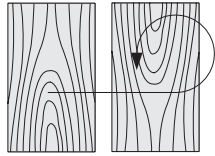

Slip Reverse

Successive veneer leaves in a flitch are slip matched with every other leaf rotating 180°. The characteristic marks in the veneer are alternated with each leaf, which balances out the surface.

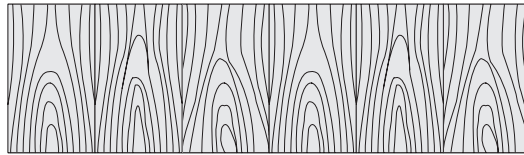

Pleasing Match

Non-successive veneer leaves from multiple flitches are arranged in a non-sequential pattern designed to eliminate repetition of veneer characteristics. This lay-up, used for panel skins, creates an architectural aesthetic.



Resources

Style Number Index

230

Style Number Index

Style Number	Page	Description
FEBSTR	125	Structural Beam
FEBTF	119	Corner Fixed Angle Base Trim
FEBTS	119	Straight Base Trim
FEBTSC	150	Cove Base Trim
FEBTV	120	Corner Variable Angle Base Trim
FECB	129	Cornice Bracket
FECF	118	Ceiling Fastener
FECSPB	131	Cornice Screw Package – Bracket
FECSPT	131	Cornice Screw Package – Track
FECTB	118	T/X Ceiling Track Bracket
FECTBE	128	Cornice Track Beam
FECTBEC	128	Cornice Track Beam Corner
FECTD	128	Cornice Track Deck
FECTDC	128	Cornice Track Deck Corner
FECTF	116	Corner Fixed Angle Ceiling Track
FECTS	116	Straight Ceiling Track
FECTSRC	130	Cornice Reinforcing Track – Corner
FECTSRs	130	Cornice Reinforcing Track – Straight
FECTV	117	Corner Variable Angle Ceiling Track
FEDCLO	165	Cylindrical Latch Set
FEDCLS	167	Door Closer
FEDDS	168	Door Drop Seal
FEDDSP	170	Door Drop Seals
FEDFBP	170	Flush Bolts
FEDFSLPM	177	Frame-Door, Slider, Pair, Surface mounting
FEDFSLSM	172	Sgl Surf Mtd Slider Dr Frame
FEDFSWPR	161	Pair Rvrsble Swing Dr Frame
FEDFSWSR	155	Sgl Rvrsble Swing Dr Frame
FEDHE	168	Electric Hinge
FEDLPA	169	Ladder Pull, Aligned
FEDLPO	169	Ladder Pull, Offset
FEDLSLPPM	178	Leaf-Door, Slider, Pol edge, Pair, Surf mtg
FEDLSLPSM	173	Sgl Surf Mtd Polished Edge Slider Dr Leaf
FEDLSWPPR	164	Pair Rvrsble Polished Edge Swing Dr Leaf
FEDLSWPSR	159	Sgl Rvrsible Polished Edge Swing Dr Leaf
FEDLSWSPR	163	Pair Rvrsble Solid Swing Dr Leaf
FEDLSWSSR	157	Sgl Rvrsible Solid Swing Dr Leaf
FEDMLO	166	Mortise Latch Set
FEDPPH	166	Push/Pull Handle
FEDRL	167	Roller Latch
FEDTSLB	180	Slider Door Track Bracket
FEDTSLPMR	179	Track-Door, Slider, Pair, Surf mtg, Reinforced
FEDTSLSMB	175	Basic Sgl Surf Mtd Slider Dr Track
FEDTSLSMR	176	Reinforced Sgl Surf Mtd Slider Dr Track
FEEAM	198	90° Adjustable Mini End
FEEAMC	199	Mini End Cover
FEECEA	202	90° Cutable End Assembly
FEECEAI	204	Cutable End Corner Angle
FEECECT	203	Cut End Capture Trim
FEECEE0	204	Cutable End Elbow
FEECEI	202	90° Cutable End Inner Channel
FEECEO	203	90° Cut End Outer Channel
FEEHDM	200	Door Frame/Mini End Hardware Kit
FEFG	122	Floor Guide
FEFHCGI	143	Non-Locking Bracket
FEFHCGL	143	Locking Bracket

Style Number	Page	Description
FEFHCGLB	143	Load Bracket
FEFHCGLT	143	T Nuts
FEFRCGA	139	Side A Single Captured Glass Frame
FEFRCGB	140	Single Side Captured Glass Frame—Side B
FEFRCGC	139	Side C Single Captured Glass Frame
FEFRCGD	137	Double Glazed Captured Glass Frame
FEFRCGDBP	141	Single Side Captured Glass Frame—Side D
FEFRCGS	135	Single Glazed Captured Glass Frame
FEFRCGSA	142	Acoustic Seal for Captured Glass
FEFT	121	Floor Track
FEFTS	121	Floor Track Spring
FEI90T	188	90° Inner Junction Trim
FEIA	195	90° T/X Adapter
FEIFE	196	Finished End
FEIJA2F	182	Two-Way Fixed Angle Junction Assembly
FEIJA2V	183	Two-Way Variable Angle Junction Assembly
FEIJA3	184	Three-Way Junction Assembly
FEIJA4	185	Four-Way Junction Assembly
FEIJBs	194	Bottom Junction Seal
FEIJCI	186	Inner Junction Cover
FEIJCIV	187	Variable Angle Inner Junction Cover
FEIJCO	189	Outer Junction Cover
FEIJCOB	190	Bypass Outer Junction Cover
FEIJCOV	190	Variable Angle Outer Junction Cover
FEIJH2	191	Two-Way Junction Hardware
FEIJH2V	191	Two-Way Variable Angle Junction Hardware
FEIJH3	192	Three-Way Junction Hardware
FEIJH4	192	Four-Way Junction Hardware
FEIJHB	193	Two-Way Bypass Junction Hardware
FEIJNP	193	Junction Nut Plate
FEIJRC	151	Acoustic Insulation
FEIJS	194	Junction Cover Seal
FEMSCS	218	Monitor Shroud with Camera Shelf
FEMSD	217	Double Monitor Shroud
FEMSS	216	Single Monitor Shroud
FEPB	207	Power Block
FEPBC	210	Power Block Connector
FEPCCB	208	Blank Cut-Out Cover
FEPFPC	209	Modular Communication Faceplate
FEPHN	211	Modular Harness
FEPHNC	211	Harness-to-Harness Branching Connector
FEPIMP	210	Multipurpose Infeed
FEPLBS	123	Short Post Leveler Bracket
FEPMBES	212	Electrical Mounting Bracket—Skin
FEPMBEU	212	Electrical Mounting Bracket—Utility Panel
FEPRC	206	Receptacle
FEPRCT	208	Power/Communication Receptacle Trim
FEPRCUSB	207	USB Receptacle
FEPVS	114	Post
FEPVSS	124	Post Acoustic Seal Packages
FERHI	115	Intermediate Horizontal
FERHIS	124	Intermediate Horizontal Acoustic Seals
FERHS	115	Structural Horizontal
FERHSS	124	Structural Horizontal Acoustic Seals
FESC	149	Ceramic Skin
FESIA	152	Acoustic Insulation

Style Number	Page	Description
FESSA2	152	Acoustic Skin Seal
FESSB	129	Cornice Skin Structural Bracket
FESSF	150	Flush Skin Seal
FESSFIC90	150	Inside Corner Flush Skin Seal
FESSL	148	Solid Laminate Skin
FESSS	146	Solid Steel Skin
FESSV	147	Solid Veneer Skin
FEUPC	213	Utility Panel Cover
VUCANT	220	On-Module Cantilever
VUSSBR	220	Side Support Brackets

Trademark List

™/® The following is a non-exhaustive list of trademarks and registered trademarks for products of Steelcase Inc. or one of its related corporate entities: Agree, Airtouch, Aisla, Alight, Amia, Answer, Apprise, Aspekt, Avenir, Await, B-Free, Ballet, Bassline, Bindu, Bivi, Bix, Bottomline, Brody, Buoy, Cachet, Campfire, Capa, CF Series, CG_1, Chord, Circa, Clipper, Cobi, Collaboration, Convene, Coupe, Cura, Currency, dash, Divisio, Duo, E-Table 2, Edge Series, Elbrook, Elective Elements, Embold, Empath, Everwall, Exponents, Folio, FrameOne, Gesture, Groupwork, Host, Hosu, i2i, Jenny, Kart, Kathryn, Kick, Lagunitas, Leap, Leela, LessThanFive, LiveBack, LiveSeat, Mackinac, Marien152, Max-Stacker, media:scape, Migration, Millbrae, Mineral, Mitra, Montage, Montara650, MoreThanFive, Move, Node, Ocular, Ology, Opus, Paperflo, Passerelle, Player, Pocket, Potrero415, QiVi, Radia, Regard, Relay, Reply, Ripple, Roam, Sarto, Scoop, Sebastopol, Senti Series, Senza, Shortcut, Sidewalk, Siento, Sieste, SILQ, Soffio, Sorrel, SOTO, Steelcase Eclipse, Steelcase Flex, Steelcase Karman, Steelcase Relay, Steelcase Rise, Steelcase Series, Surround, SW_1, Switch, Sync, Tava, Tenor, Think, Thoughtful, Thread, Together, Train, Trees, Turnstone, Umami, Underscore, V.I.A., Verb, Verge, Verlay, Victor2, Visalia, WorkValet, and X-tenz.

™/® The following are trademarks or registered trademarks of AMQ Solutions, LLC: 3F, Activ, Amobi, Bixby, Bodi, Cluvo, Concur, Embank, FL-X, Iline, Jaku, Kinex, Personality Plus, Revi, S-Series, Siya, Tektis, Tizu, Uptake, and Zilo.

™/® The following are trademarks or registered trademarks of Orangebox Ltd., Cardiff, UK: Air3, Aspect, Avi, Away from the Desk, Border, Campers & Dens, Coppice, Cubb, Kirm, On the QT, Ramsey, Skomer, Sully, Track-B, and Vale.

™/® The following are trademarks or registered trademarks of Viccarbe Habitat, S.L.: Aleta, Cambio, Designed in The Sun, Foro, Funda, Holy Day, Kelly, Last Minute, Noha, Savina, Sistema, Sistema, Viable, and Wrapp.

® The following are registered brands of Steelcase Inc. and its family of companies: Steelcase, AMQ, Coalesse, Designtex, Halcon, Orangebox, Smith System, and Viccarbe.

® The following registered trademarks are under license from AWI Licensing Company, Dover, DE: SoundScapes, DuraBrite, BioBlock, and Armstrong.

® The following registered trademarks are under license from Byrne Electrical, Rockford, MI: Interport, Mini-Port, Axil Z, and Ellora.

® The following is a registered trademark of DuPont, Wilmington, DE: Corian.

® The following is a registered trademark of Genlyte Thomas Company, Louisville, KY: Lightolier.

® The following is a registered trademark of Hilti Corporation, FL-9494 Schaan, Principality of Liechtenstein: Hilti.

® The following is a registered trademark of Leviton Manufacturing Company, Little Neck, NY: Decora.

® The following is a registered trademark of Mechanical Plastics Corp, Elmsford, NY: Toggler.

® The following is a registered trademark of Microsoft Corporation, Redmond, WA: Microsoft.

® The following are registered trademarks of Orangebox Ltd., Cardiff, UK: Orangebox.

® The following is a registered trademark of Panduit Corporation, Lockport, IL: Panduit.

® The following is a registered trademark of Trav (Press), Cuneo, Italy: Assisa.

® The following is a registered trademark of Virtual Ink, Boston, MA: mimioActive.

® The following registered trademarks are under license from Wilkhahn Furniture Products: Avera, Senzo, Versal, and Wilkhahn FS.

® The following are registered trademarks of Polyvision Corp: Flow, Motif, Polyvision, Sans, and Serif.

® The following is a registered trademark of Wilsonart International, Temple, TX: Chemsurf.

® The following is a registered trademark of Wiremold, West Hartford, CT: Wiremold.

® The following is a registered trademark of EMU Group S.P.A., Perugia, Italy: EMU.

® The following is a registered trademark of Security People, Inc.: Digilock.

® The following are registered trademarks of Natural Capital Partners Europe Limited: CarbonNeutral and the CarbonNeutral Certified logo.

™ The following is a trademark of Microsoft Corporation, Redmond, WA: Windows.

™ The following is a trademark of Rodman Industries, Inc., Oconomowoc, WI: ResinCore1.

™ The following is a trademark of Ultrafabrics, LLC, Elmsford, NY: Ultraleather.

™ The following trademarks are under license from Wilkhahn Furniture products: Cana, Linus, Logon, Picto, Range, Stitz, Thema, Timetable, and Tubis.

™ The following trademarks are under license from Walter Knoll: Andoo, Bob, Lazlo, Lox, Ribbon, and Together.

™ The following trademarks are under license from PP Mobler: Bar and Flag Halyard.

™ The following trademarks are under license from Carl Hansen: Elbow, Paddle, Shell, Wing, and Wishbone.

™ The following trademarks are under license from Cambridge Sound Management, LLC Cambridge, MA: QtPro Soundmasking, Qt Quiet Technology, and Sonet Qt.

™ The following is a trademark of Electri-Cable Assemblies, Shelton, CT: Interact.

™ The following is a trademark of Clestra Hauserman: IRYS.

™ The following is a trademark of Wiesner-Hager Möbel GmbH: Nooi.

™ The following are trademarks of Polyvision: Accord, a3, e3, Boundri, and Nota.

™ The following is a trademark of Bostock Company, Inc: SnapCab.

™ The following is a trademark of Williams-Sonoma, Inc: West Elm.

™ The following is a trademark of Elena Marquina Testor: nanimarquina.

™ The following is a trademark of Forbo International SA: Forbo.

Trademarks used herein are the property of Steelcase Inc. or their respective owners.