

Steelcase Health



Volume 2 Casegoods

Specification Guide

Availability

Electronic price list updated with release 204.C (U.S.) and 158.C (Canada), dated June 15, 2026.

All specifications subject to change without notice. Reference the electronic catalog/Hedberg for current pricing.

Transitional products in this specification guide are **maintained for existing customers only** and are likely to be phased out over time. These products are indicated with a . Products that are scheduled to be culled are indicated with an , followed by the last order entry date.

Surface Materials

The surface materials team has announced the launch of the Finish Library, found at www.steelcase.com/finishlibrary/.

► For a list of all trademarks, refer to the last page of this specification guide. © 2026 Steelcase Inc.

Working With This Specification Guide

Ten Tips: How to Get the Most Out of This Book	2
Additional Resources	4

Understanding and Specifying

Casework and Casegoods	5
Technology Support	359

Related Products

Table Products	373
System Products	373
Desk and Worksurface Products	373
Storage Products	373
Collaborative Writing Surface Products	373

Surface Materials	375
--------------------------	------------

Resources	397
------------------	------------



For Canadian Pricing

Canadian factor can be found at www.steelcase.com/CADpricing/. Calculate in the following order to avoid rounding errors:

- Multiply the base price and each option by the Canadian factor.
- Round each to the nearest dollar.
- Add base and options for total list price.

Ten Tips: How to Get the Most Out of This Book

Tip 1

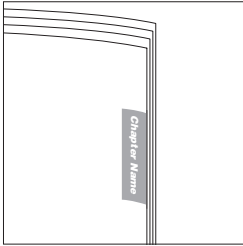

Watch the tabs on the right-hand edges of the pages. They'll always indicate which chapter you are in.

Tip 2

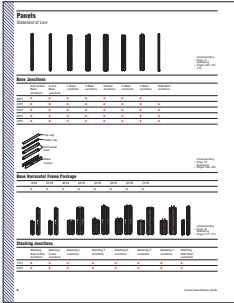

Use the Statement of Line pages for an overview of the available components, their sizes, and page references for additional information. Each *Understanding* chapter includes a statement of line after the table of contents.

Tip 3



Find cross references by looking for page numbers flagged with an arrow.

Tip 4

Study the product detail pages in the *Understanding* section to learn everything an expert knows about specific products. Each product detail page in this section contains the following features, where applicable:

- Product Drawing
- Actual Dimensions
- Product Details
- Connections
- Wiring and Cabling
- Surface Materials
- Application Topics

Product Drawing shows you what the product looks like and points out important features.

Product Details gives specific information on the product and how it is used.

Connections describes how the product is assembled or how it attaches to another product.

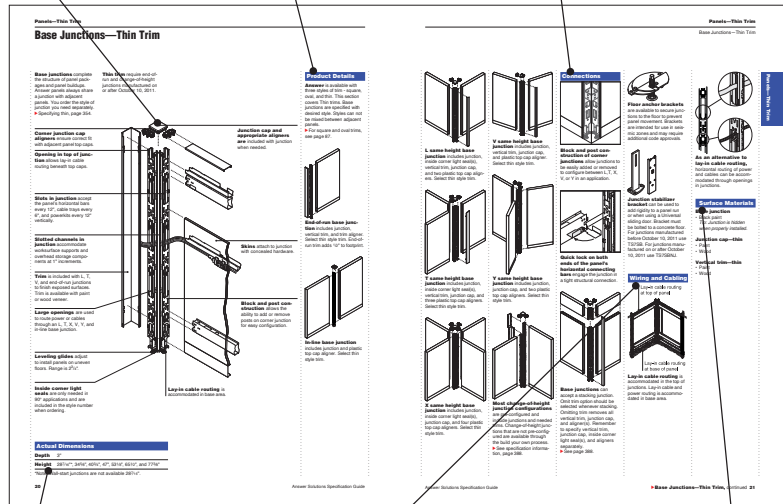

Actual Dimensions table lists the dimensions of the product.

Wiring and Cabling details the power and cable-management and cable routing capabilities of the product.

Surface Materials lists what material is used for each part of the product.

Additional Resources

Steelcase Health products are supported with an array of informational materials, tools, and software to help you plan an installation efficiently.

Product brochures and planning tools can be ordered through your Steelcase area office by calling 1.800.784.0358 or through the Marketing Resources web site at village.steelcase.com.

Printed Materials

Surface Materials Reference Manual

This publication provides surface material information for Steelcase products:

- An explanation of the surface materials
- “Available on” matrices
- Vertical surface fabric selection listing
- Technical data for surface materials
- Surface material care and cleaning instructions

Steelcase Health Specification Guides

These specification guides contain multiple Steelcase, Steelcase Health, and Coalesse products which are most commonly used in healthcare environments. This collection of products has been pulled together for your convenience.

Other Specification Guides

Steelcase offers a comprehensive portfolio of furniture and solutions. For the full offering of products, refer to the individual product specification guides. These can be accessed at the www.steelcase.com web site or at village.steelcase.com.

Planning Tools

Express Program Specification Guide

This specification guide describes all Steelcase and Coalesse products including the finishes and options that are available as Express orders - manufactured and shipped within 7 business days.

Computer Tools

Electronic Catalog

Accurate sales quotations and purchase orders for Steelcase products are created with specification software that uses Steelcase Electronic Catalog data. Use the data to specify and price style numbers and options for every Steelcase product. The data is updated bimonthly by Steelcase and provided to software programs including: the Hedberg Business System, SmartTools – Steelcase’s design and specification software (for more information on SmartTools, please email SmartTools@steelcase.com), the ProjectMatrix ProjectSymbols libraries, as well as 20-20 CAP Studio.

Furniture Symbol Graphic Data

Steelcase creates 2D and 3D furniture symbols (with attributes) for planning and initially specifying Steelcase products. This data is incorporated into several add-on software packages that work in either a Microstation or an AutoCAD drafting environment.

Digital Publications

You can access these digital publications at www.steelcase.com or village.steelcase.com.

Product Training

Basic training for many Steelcase products is part of the Building Product Muscle (BPM) curriculum on the Steelcase University Web site at village.steelcase.com.

More Information

For more information about these and other software tools to help you plan effective healthcare environments, email fsl@steelcase.com

Support

Steelcase Capabilities

Steelcase products are distributed, installed, and serviced through a network of more than 600 dealers worldwide. Steelcase is also represented with offices and corporate showrooms in 26 U.S. cities, 4 Canadian cities, and in France, Germany, Great Britain, and Japan. Every Steelcase product meets our exceptionally high standards of quality and durability and comes with the Steelcase assurance of excellence in service.

For ordering or product assistance,

please call your local dealer, the Steelcase Solutions Resource Team, or the Steelcase Solutions Fulfillment Team at 1.888.STEELCASE (1.888.783.3522) or send an e-mail to lineone@steelcase.com.

Call the Steelcase Solutions Resource Team prior to placing an order, when working on a bid, or when you need information about product applications and specifications.

Call the Steelcase Solutions Fulfillment Team if you have submitted an order to Steelcase and you need to speak to your Solutions Fulfillment Team Representative about the order. Also call if you have any post-shipment quality concerns or service parts questions.

For warranty information, please go to <http://www.steelcase.com/warranty/>.

Outside the U.S.A., Canada, Mexico, Puerto Rico, and the U.S. Virgin Islands, call 1.616.247.2500.

For information about Steelcase, the name of your nearest Steelcase dealer, or for product literature, call 1.800.333.9939 or visit our Web site: www.steelcase.com.

Sustainability

At Steelcase, we believe business can be a force for good. We create long-lasting products that are better for people and better for the planet. Our products and operations use life cycle thinking to meet our commitment to reducing climate change. This commitment is reinforced by practices such as designing to minimize global warming and other life cycle impacts, ensuring material health, and enabling end-of-use strategies.

To learn more at a corporate level, visit: <https://www.steelcase.com/discover/steelcase/esg-overview/environmental/>

Product Environmental Profiles, which provide key environmental attributes such as recycled content, embodied carbon and recyclability, as well as product certifications can be found by searching for Steelcase at Origin.build.

Casework and Casegoods

Modular Casework

Convey **7**

Modular Casegoods

Sync **181**

Folio **203**

Wall-Mounted Folio **293**

Freestanding and Wall-Mounted Casegoods



Park **323**

Senza **329**

Accessories

Mobile Overbed Tables **350**



			
Statement of Line	8	Specifying	
			
Designing with Casework	16	Base Cabinets	100
Understanding		Printer Cabinets	108
General Overview of Modular Casework	28	Pullout Trash Cabinets	112
Sink Bowl Overview	30	Garage Cabinets	114
Guidance for Third-Party Worksurfaces	36	Sink Base Cabinets	118
Height Matrix	37	Wardrobe Cabinets	122
Base Cabinets	40	Tall Storage Cabinets	128
Printer Cabinets	48	Upper Storage Cabinets	132
Pullout Trash Cabinets	52	Upper Microwave Cabinets	136
Garage Cabinets	54	Upper Corner Cabinets	138
Sink Base Cabinets	58	Mobile Storage Cart	140
Wardrobe Cabinets	62	Cover Panels	144
Tall Storage Cabinets	66	Flat Top-Cap Cover Panels	148
Upper Storage Cabinets	70	Sloped Fascia	150
Upper Microwave Cabinets	74	Vertical Fascia	152
Upper Corner Cabinets	78	Worksurfaces	154
Mobile Storage Cart	80	Cantilevers	161
Cover Panels	84	End Panels	162
Top Conditions	86	Mounting Boards	164
Ceiling Clip Application	88	Fillers	166
Worksurfaces	90	Accessories	168
Cantilevers	92		
End Panels	93		
Mounting Boards	94		
Fillers	95		
Accessories	96		

Statement of Line

Convey

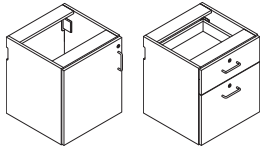

Understanding
 ▶ Page 40
 Specifying
 ▶ Page 100

Base Cabinets, Wall Suspended

			Modular					Parametric	
			15"W	18"W	24"W	30"W	36"W	12"W-48"W	15"W-24"W
Modular	20"D base cabinet with door	23"H	●	●	●	●	●		
	20"D base cabinet with drawers	23"H	●	●	●				
Parametric	14"D-24"D base cabinet with door	23"H						●	
	16"D-24"D base cabinet with drawers	23"H							●

Tip: Increment for parametric depth and width is 1".

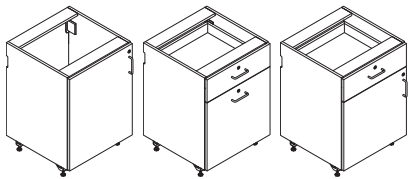

Understanding
 ▶ Page 44
 Specifying
 ▶ Page 102

Base Cabinets, Floor Extended

			Modular					Parametric	
			15"W	18"W	24"W	30"W	36"W	12"W-48"W	15"W-24"W
Modular	24"D base cabinet with door	27"H, 32½"H, 34½"H, 40½"H	●	●	●	●	●		
	24"D base cabinet with drawers	27"H, 32½"H, 34½"H	●	●	●				
	24"D base cabinet with drawer and door	27"H, 32½"H, 34½"H	●	●	●	●	●		
Parametric	14"D-29"D base cabinet with door	27"H, 32½"H, 34½"H, 40½"H						●	
	16"D-29"D base cabinet with drawers	27"H, 32½"H, 34½"H							●
	16"D-29"D base cabinet with drawers and door	27"H, 32½"H, 34½"H						●	

Tip: Increment for parametric depth and width is 1".

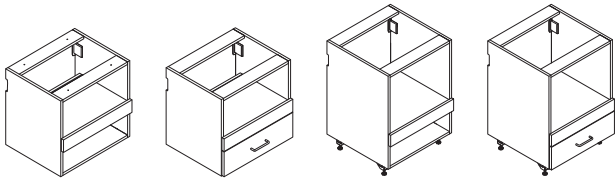

Understanding
 ▶ Page 48
 Specifying
 ▶ Page 108

Printer Cabinets

			Modular			Parametric
			24"W	30"W	36"W	20"W–36"W
Modular	20"D wall-suspended printer cabinet	23"H	●	●	●	
	20"D wall-suspended printer cabinet with drawer	23"H	●	●	●	
	24"D floor-extended printer cabinet	27"H, 32½"H, 34½"H	●	●	●	
	24"D floor-extended printer cabinet with drawer	27"H, 32½"H, 34½"H	●	●	●	
Parametric	16"D–24"D wall-suspended printer cabinet	23"H				●
	16"D–24"D wall-suspended printer cabinet with drawer	23"H				●
	16"D–29"D floor-extended printer cabinet	27"H, 32½"H, 34½"H				●
	16"D–29"D floor-extended printer cabinet with drawer	27"H, 32½"H, 34½"H				●

Tip: Increment for parametric depth and width is 1".

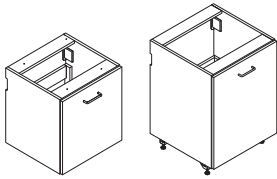

Understanding
 ▶ Page 52
 Specifying
 ▶ Page 112

Pullout Trash Cabinets

			Modular			Parametric
			15"W	18"W	24"W	15"W–24"W
Modular	20"D wall-suspended pullout trash cabinet	23"H	●	●	●	
	24"D floor-extended pullout trash cabinet	32½"H, 34½"H	●	●	●	
Parametric	17"D–24"D wall-suspended pullout trash cabinet	23"H				●
	17"D–29"D floor-extended pullout trash cabinet	32½"H, 34½"H				●

Tip: Increment for parametric depth and width is 1".

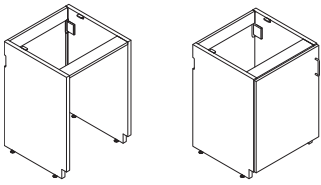

Understanding
 ▶ Page 54
 Specifying
 ▶ Page 114

Garage Cabinets

		Modular			Parametric
		24"W	30"W	36"W	24"W–48"W
Modular	23 ¹ / ₈ "D garage cabinet	32 ¹ / ₂ "H, 34 ¹ / ₂ "H, 40 ¹ / ₂ "H	●	●	●
	24"D garage cabinet with door	32 ¹ / ₂ "H, 34 ¹ / ₂ "H, 40 ¹ / ₂ "H	●	●	●
Parametric	13 ¹ / ₈ "D–28 ¹ / ₈ "D garage cabinet	32 ¹ / ₂ "H, 34 ¹ / ₂ "H, 40 ¹ / ₂ "H			●
	14"D–29"D garage cabinet with door	32 ¹ / ₂ "H, 34 ¹ / ₂ "H, 40 ¹ / ₂ "H			●

Tip: Increment for parametric depth and width is 1".

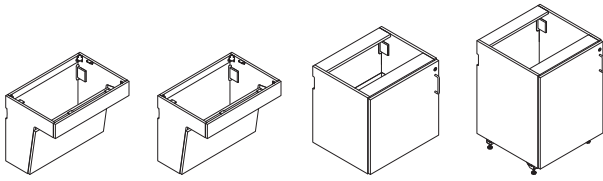

Understanding
 ▶ Page 58
 Specifying
 ▶ Page 118

Sink Base Cabinets

			Modular					Parametric			
			15"W	18"W	24"W	30"W	36"W	42"W	15"W–48"W	30"W–36"W	42"W
Modular	20"D angled sink base cabinet	23"H				●	●	●*			
	24"D angled sink base cabinet	23"H				●	●	●*			
	20"D angled sink base cabinet for change of height	21"H				●	●	●*			
	24"D angled sink base cabinet for change of height	21"H				●	●	●*			
	20"D wall-suspended sink base cabinet with door	23"H	●	●	●	●	●				
	24"D floor-extended sink base cabinet with door	32½"H, 34½"H	●	●	●	●	●				
Parametric	20"D–24"D angled sink base cabinet	23"H							●		●*
	20"D–24"D angled sink base cabinet for change of height	21"H							●		●*
	14"D–24"D wall-suspended sink base cabinet with door	23"H						●			
	14"D–29"D floor-extended sink base cabinet with door	32½"H, 34½"H						●			

* Parametric sizing for angled sink base cabinet and angled sink base cabinet for change of height cannot be specified between 37"W–41"W. These cabinets must be cut to fit on site.

Tip: Increment for parametric depth and width is 1".

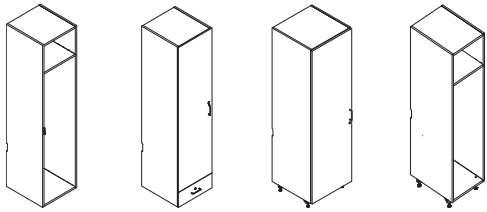

Understanding
 ▶ Page 62
 Specifying
 ▶ Page 122

Wardrobe Cabinets

			Modular					Parametric			
			15"W	18"W	24"W	30"W	36"W	12"W–23"W	12"W–24"W	12"W–36"W	
Modular	19 ¹ / ₈ "D wall-suspended wardrobe	66 ¹ / ₂ "H, 72 ¹ / ₂ "H, 74 ¹ / ₂ "H	●	●							
	20"D wall-suspended wardrobe with door	66 ¹ / ₂ "H, 72 ¹ / ₂ "H, 74 ¹ / ₂ "H	●	●	●						
	23 ¹ / ₈ "D floor-extended wardrobe	84"H	●	●							
	24"D floor-extended wardrobe with door	84"H	●	●	●	●	●				
Parametric	13 ¹ / ₈ "D–23 ¹ / ₈ "D wall-suspended wardrobe	66 ¹ / ₂ "H–74 ¹ / ₂ "H						●			
	14"D–24"D wall-suspended wardrobe with door	66 ¹ / ₂ "H–74 ¹ / ₂ "H							●		
	13 ¹ / ₈ "D–29 ¹ / ₈ "D floor-extended wardrobe	48"H–84"H						●			
	14"D–29"D floor-extended wardrobe with door	48"H–84"H								●	

Tip: Increment for parametric depth, height, and width is 1".

Tip: Wall-suspended wardrobe with door and drawer is only available in 16"D–24"D.

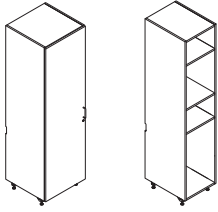

Understanding
 ▶ Page 66
 Specifying
 ▶ Page 128

Tall Storage Cabinets

			Modular			Parametric
			24"W	30"W	36"W	12"W–36"W
Modular	23 $\frac{1}{8}$ "D storage cabinet	84"H	●	●	●	
	24"D storage cabinet with door	84"H	●	●	●	
Parametric	13 $\frac{1}{8}$ "D–28 $\frac{1}{8}$ "D storage cabinet	48"H–84"H				●
	14"D–29"D storage cabinet with door	48"H–84"H				●

Tip: Increment for parametric depth, height, and width is 1".

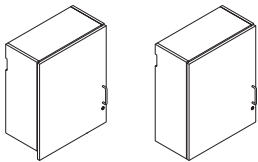

Understanding
 ▶ Page 70
 Specifying
 ▶ Page 132

Upper Storage Cabinets

			Modular					Parametric	
			15"W	18"W	24"W	30"W	36"W	12"W–48"W	15"W–36"W
Modular	12"D upper storage cabinet with door	24"H, 30"H	●	●	●	●	●		
	15"D upper storage cabinet with door	24"H, 30"H	●	●	●	●	●		
	12"D upper storage cabinet with door and no bottom	24"H, 30"H	●	●	●	●	●		
	15"D upper storage cabinet with door and no bottom	24"H, 30"H	●	●	●	●	●		
	9"D upper over-the-sink storage cabinet	24"H, 30"H	●	●	●	●	●		
Parametric	12"D–15"D upper storage cabinet with door	24"H–36"H						●	
	12"D–15"D upper storage cabinet with door and no bottom	24"H–36"H							●
	9"D upper over-the-sink storage cabinet	24"H–36"H							●

Tip: Increment for parametric depth, height, and width is 1".

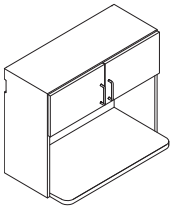

Understanding
 ▶ Page 74
 Specifying
 ▶ Page 136

Upper Microwave Cabinets

		Modular		Parametric
		30"W	36"W	30"W-36"W
Modular	12"D upper microwave storage cabinet with shelf and doors	29 ⁷ / ₈ "H	●	●
	15"D upper microwave storage cabinet with shelf and doors	29 ⁷ / ₈ "H	●	●
Parametric	12"D-15"D upper microwave storage cabinet with shelf and doors	29 ⁷ / ₈ "H- 35 ⁷ / ₈ "H		●

Tip: Increment for parametric depth, height, and width is 1".

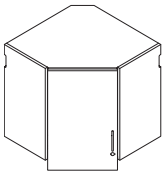

Understanding
 ▶ Page 78
 Specifying
 ▶ Page 138

Upper Corner Storage Cabinets

		Modular		
		23"W	27"W	
Modular	12"D upper corner storage cabinet with door	24"H, 30"H	●	●
	15"D upper corner storage cabinet with door	24"H, 30"H	●	●

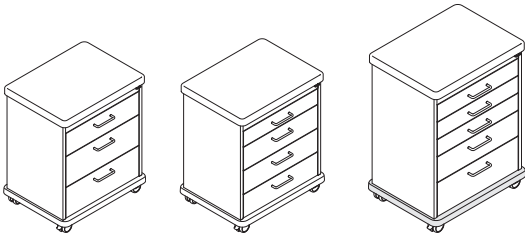

Understanding
 ▶ Page 80
 Specifying
 ▶ Page 140

Mobile Storage Cart

		Overall Width		
		19 ¹ / ₂ "W	22 ¹ / ₂ "W	25 ¹ / ₂ "W
Height	30.144"H	●	●	●
	32.549"H	●	●	●
	34.144"H	●	●	●
	36.549"H	●	●	●
	38.144"H	●	●	●
	40.549"H	●	●	●

Tip: Drawer configuration options are driven by the cart height.
Tip: 40.549"H and 38.144"H carts allow any drawer configuration that adds up to 30".
Tip: 36.549"H and 34.144"H carts allow any drawer configuration that adds up to 26".
Tip: 32.549"H and 30.144"H carts allow drawer configuration that adds up to 22".

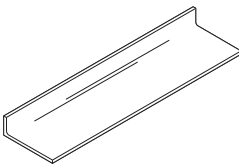

Solid surface worksurface

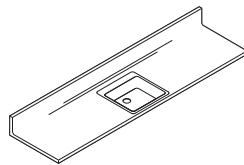

Solid surface worksurface with sink

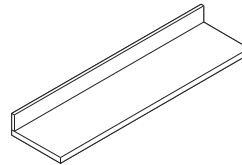

High-Pressure Laminate worksurface

Understanding
 ▶ Page 90
 Specifying
 ▶ Pages 154–158

Worksurfaces

	12"W–120"W	12"W–138"W	30"W–138"W
15"D–30"D High-Pressure Laminate worksurface	●		
15"D–30"D solid surface worksurface		●	
20"D–30"D solid surface worksurface with sink			●

Tip: Solid surface and High-Pressure Laminate parametric depth is 1" and parametric width is 1/8".
Tip: Ten integral sink bowl profiles are available for solid surface worksurface. See page 90 for worksurfaces. See page 30 for sink profile options.

Designing with Casework

Overview

Casework is an architectural product that must be coordinated within the built environment. This means having a head start and being proactive is key to understanding how the product should integrate with all agencies and interface with additional trades including electrical, plumbing, and equipment.

Architectural products fall within the construction process and require coordination with the general contractor on the job. Being involved and engaged in early conversations can help achieve the ultimate goal of being the "basis of design".

Typical project flow of an architectural product



Tip: Concepts and schematic design are often years prior to the order and installation. This tends to be vastly different than furniture products and requires a different structure to support the management and execution.

Key personnel required to have a successful project. These individuals should be involved from the moment purchasing casework becomes a viable opportunity, well before order placement.

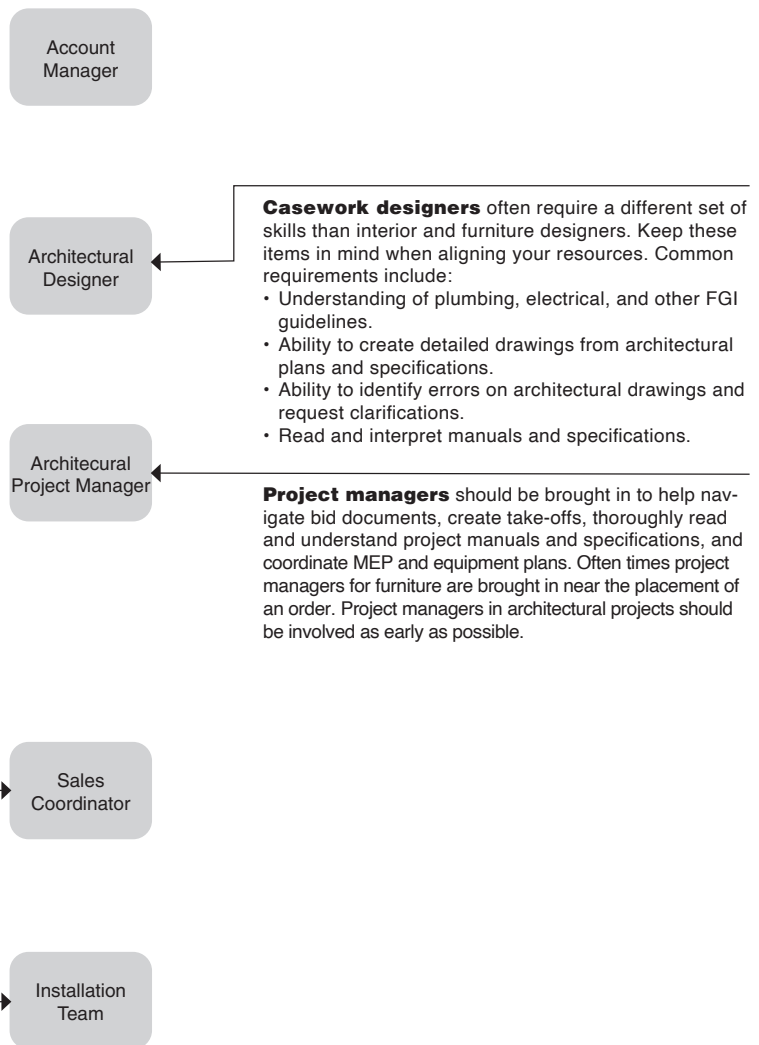

Construction projects often require a DPR (delivery planning report) to properly plan for deliveries on site. This may require a specific skill set to properly plan orders and shipments.

Installers for casework should have a carpentry skill set. This may require bringing in third party resources to support opportunities.

Designing with Casework

Concept–Preliminary Design

At this point, the customer is identifying the need and vets out the idea within their organization. This may include research or the development of an estimate to determine feasibility.

Understanding the customers' pain points can help drive the direction to take with initial concepts. Budget, ADA requirements, storage requirements, workflow, and culture are all things to understand when laying out a space. The Design Studio: Health Ideas has great starting points for common spaces within healthcare environments.

► Visit <https://www.steelcase.com/village/pages/sales-design/design-studio/design-studio-health-ideas/>

Ideally at this point in the project, the customer would need to provide:

- Project narrative
- Floor plans and elevations, if applicable

Important points to understand within the room are:

- Overall footprint
- Electrical and plumbing requirements
- Ceiling heights
- Use of the space, for example, consultation, minor procedure, etc.
- Equipment requirements/Technology storage requirements
- Compliance, for example, ADA

ADA Requirements

The most common compliance component in healthcare are ADA requirements. All ADA requirements can be located at www.ada.gov.

The key areas to focus on include:

- Lavatories and sinks clearances
- Reach ranges

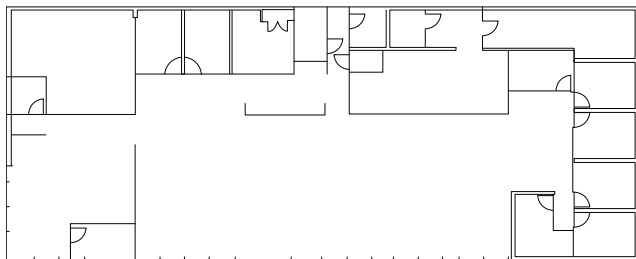
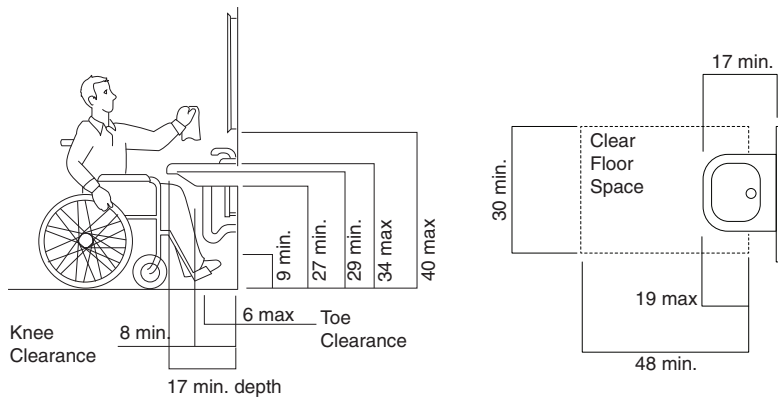

Key Points to Understand During Concept Phase

This is a high-level budgetary estimate that can set the course for future conversations. To become the "basis of design," the architect must write the casework product line into the specifications. CSI (Construction Specifications Institute) specifications are used by the majority of construction professionals in the industry. CSI specifications are broken up into divisions and written in MasterFormat® - which is why the documents to be shared should remain in a word doc format.

Convey has specifications written for both Division 06: Wood, Plastics, Composites, and Division 12: Furnishings. CSI specifications for Convey are located on the Convey product page: <https://www.steelcase.com/resources/documents?search=Convey%20Modular%20Casework>

These outline the key specifications of the product, including materiality, grades of hardware, and construction process. These are different than the *Convey Technical Cut Sheet*. The *Convey Technical Cut Sheet* is utilized to provide additional planning guidelines to architects and general contractors in preparation for designing and receiving product.

▶ See *Convey Technical Cut Sheet*, available at village.steelcase.com

Often times architectural specifications are drawn in with stock cabinetry that may or may not be ideal for the setting. Conversations and thought starters provided to the customer can help generate new ideas and position Steelcase as an insight driver. This can help with utilizing good/better/best scenarios that also outline the differences in cost of different layouts chosen. Positioning the product in this fashion can be helpful when interfacing with a budget-conscious customer.

▶ See the good/better/best scenarios at <https://www.steelcase.com/resources/documents/design-studio-good-better-best-exam/>

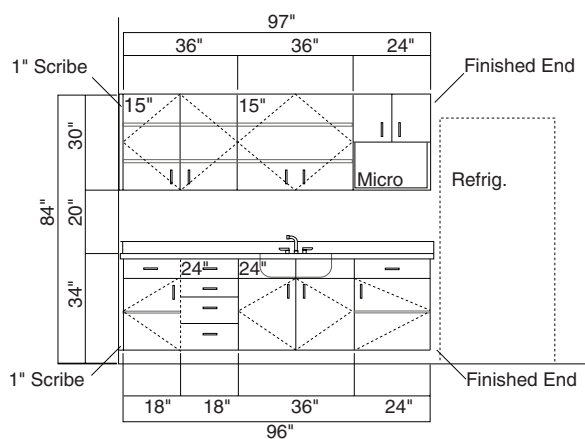

Basic

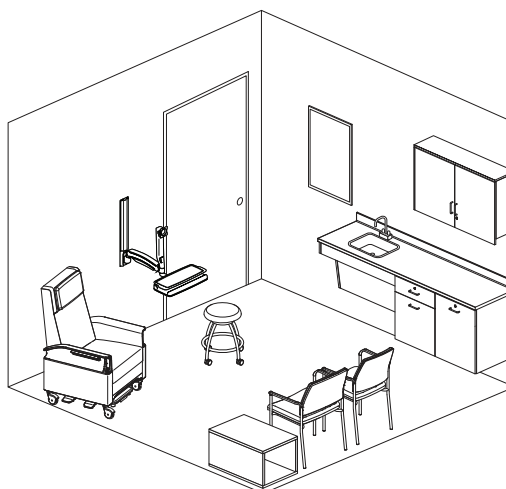

Basic + Mounting Board and Sloped Fascia



Basic + Full Mounting Board/Backsplash and Sloped Fascia



Designing with Casework

Cabinetry and Worksurface Types

Wall Suspended vs. Floor Extended Cabinetry

Determining whether to use wall suspended or floor extended can have multiple effects on the wall structure, the budget, and future modifications.

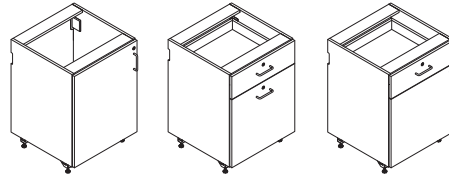
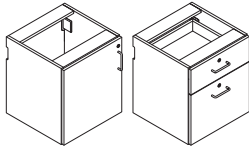

Wall Suspended

Base cabinetry can have a worksurface that extends to 25"D. Most times this will suffice within exam and patient environments.

In non-seismic zones, blocking/banding is required behind base cabinetry. This is an item that should be coordinated with the general contractor.
 ▶ See page 24 for additional blocking/banding specifications.

Wall-suspended cabinetry allows for easier cleaning under the base of cabinets and can be reconfigured or serviced without requiring interaction with a flooring trade.

Wall-suspended base cabinets are always 23"H. Above finished floor height depends on the location of the rail.

Floor Extended

Base cabinetry can have a worksurface that extends to 30"D which may be required for larger equipment.

In non-seismic zones, blocking/banding is not required behind base cabinetry, but is recommended.

Most floor-extended cabinetry in healthcare environments requires cove molding on the base trim. This can require interaction with the flooring trades for future renovations or service work.

Floor-extended base cabinets are available in several planning heights, and often includes more material including four glides that can add to the overall cabinet cost.

Designing with Casework

Top Conditions

Healthcare facilities

often require a top condition that prevents individuals from storing items on top of the cabinetry. Sloped fascia and vertical fascia are frequently utilized for this purpose. Convey offers multiple top conditions.

▶ See page 86 for Convey top conditions.

Components such as vertical fascia

can be used to create the design intent of cabinetry going to the ceiling while providing a flexible solution that can fit within a ceiling grid and often reduce the cost of a cabinet.

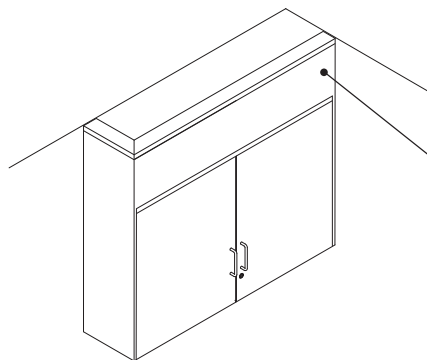

Vertical fascia includes a track system to fit into a grid system or direct to dry wall.

Cabinetry this close to the ceiling

often results in thin gaps that are difficult to fill.

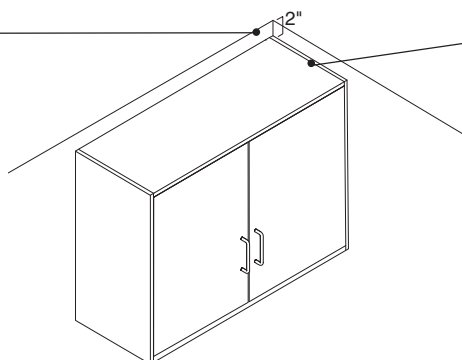

Convey ceiling fillers are scribe-to-fit components which are designed to fill these gaps.

Making cabinets over 36"H tall requires additional hinges and can add cost.

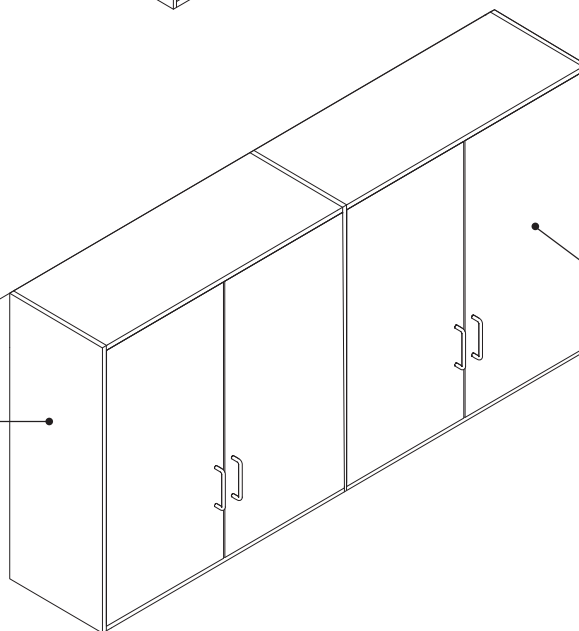

Cabinetry this tall results in unreachable, therefore unusable space.

Designing with Casework

Schematic Design

Within schematic design, a concept is established as a design is being developed and assessed.

Ideally at this point in the project, the customer would need to provide:

- Determine what is driving the specification.
If Steelcase was not involved prior to this point, determine what product is specified and where Steelcase differs.
- Timelines, including other trades coordination and tentative installation timeframe.
- Project narrative
- Project specification, if complete
- Floor plans and elevations CAD drawings

Important points to understand within the room are:

- Overall footprint
- Ceiling heights
- Compliance requirements
- Backing and blocking requirements
- Electrical and plumbing requirements
- Use of the space, for example, consultation, minor procedure, etc.
- Equipment requirements/Technology storage requirements

If cabinetry has already been designed into the space, identify where alternatives may need to be requested. Before diving into design work, it's important to understand the requirements and make suggestions to position Steelcase. Consult the healthcare applications design team for support.

The below image is an example of a layout you may receive from an architect.

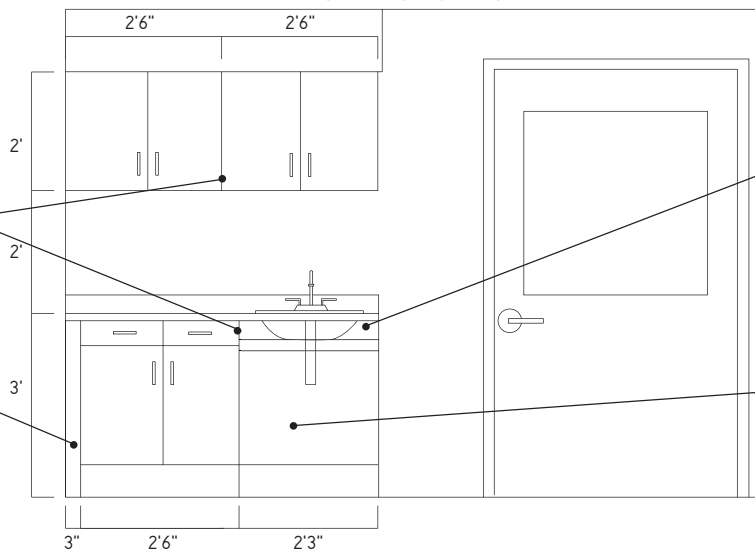

Point out any misalignment between uppers and lowers as this may have been overlooked by the architect or customer.

Convey is designed with fillers to scribe to fit and allow for architectural variances. Clarify if these are required.

Tip: If they are not pictured, a millworker will not quote them.

ADA worksurface height is 34" AFF (Above Finished Floor). Especially since an angled sink is present, clarify with the architect if this was meant to be 36" AFF.

Standard angled front sink cabinets have a minimal value of 18" from the centerline for ADA compliance in most states. Sometimes this is okay to go smaller if they have a side approach, but it should be clarified with the architect.

When laying out a space,

it is good to understand the maximum space constraints within the environment. Having clear communication around storage and equipment requirements can help guide decisions.

Plumbing locations

should be some of the first areas that a clinician can access when entering a room. Putting them on the outside of the run rather than up against a wall can also prevent water splashes and eventual damage to adjacent walls.

Maximum length of run is 60"W

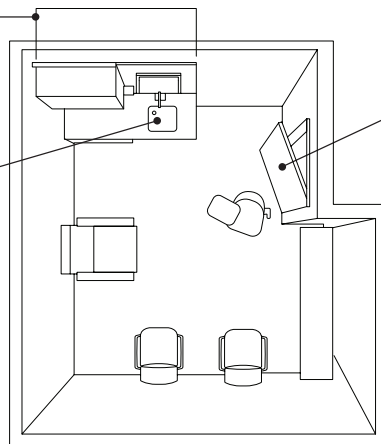

Understanding how the environment, such as door swings may interfere with the furniture and cabinetry, are important to note.

Designing with Casework

Fillers

Architectural walls

are allowed a $\frac{1}{2}$ " variance over a 10' run, which means they will never be perfectly straight even in new builds. Putting a pre-manufactured component into an imperfect environment requires adjustability in the field.

When up against an architectural wall, fillers should always be used, not cover panels.

Ceiling and wall fillers accommodate for architectural variance. These come in 3" increments and are field cut (scribed) for a perfect fit.

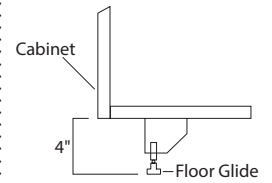
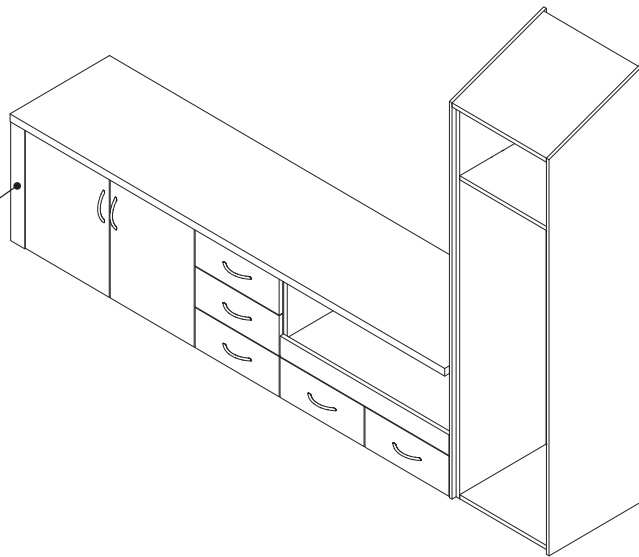

Floor extended cabinetry includes floor glides at all four corners allowing for 2" of adjustment on uneven floors.

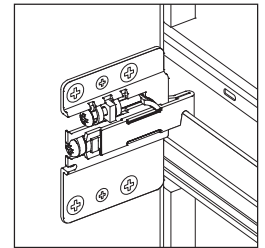

Adjustment on the wall is created through the rail-to-bracket attachment method with Convey. For a visual aid, see *the Convey animation*: <https://youtu.be/41S4GSvY30>.

$\frac{3}{4}$ " fore and aft and $\frac{7}{8}$ " vertical adjustment is allowed through the bracket attachment.

Designing with Casework

Banding and blocking, Attachment Method for Non-Seismic Applications

Banding and blocking is recommended at all casework locations for aid in the installation of the product. The following are requirements for Steelcase's Convey modular casework.

All Convey casework utilizes a continuous anodized aluminum rail system for installation.

- Rails come in 8' sections and are field cut for each application.
- Banding/blocking is required for wall-suspended cabinets. Banding/blocking for floor-extended cabinets may not be required. Check local and state codes for banding/blocking requirements (i.e. seismic zones).
- Wall-suspended base cabinets and cantilevers require 16-gauge x 6" steel banding or 2" x 6" wood blocking inside the wall construction for non-seismic applications.

Standard installation instructions and banding and blocking requirements are outlined for non-seismic applications. Seismic zones are not limited to the west coast. They also are prevalent in areas such as Chicago, Memphis, and Atlanta. The design must be braced for structural stability and specification must be reviewed and approved by a structural engineer.

Banding/Blocking Requirements

Wall Suspended

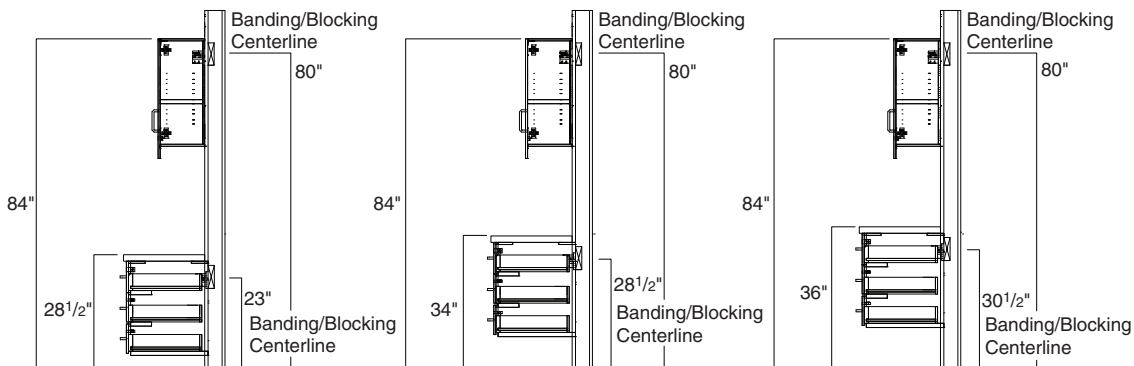

Floor Extended

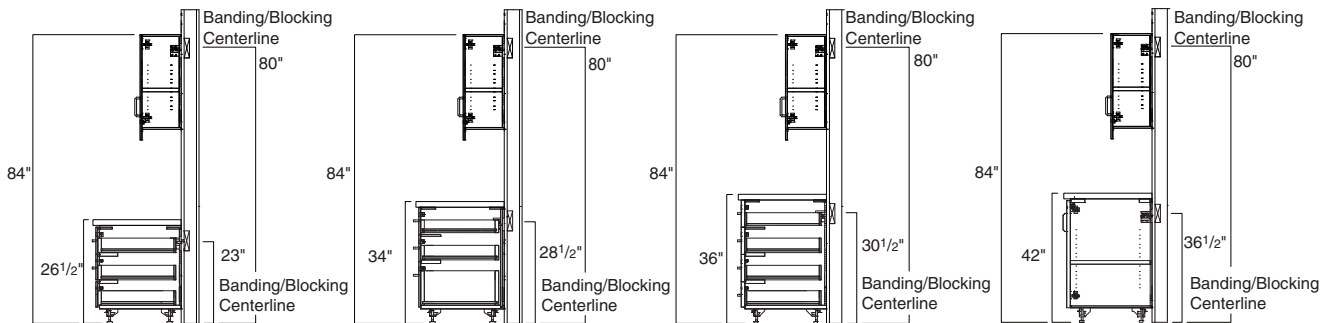

Cantilevers

Tip: Banding and blocking locations depend on rail height.

Example dimensions:

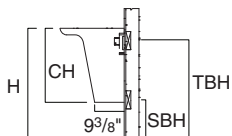

- H = 34"
- CH = 23"
- TBH = 28 1/2"
- SBH = 11"

Designing with Casework

Design Development

During the design development phase, pricing is often updated to reflect any design changes and you start refining accessory components and finish options.

Ideally at this point in the project, the following should be discussed with the customer:

- Determine what is driving the specification. If Steelcase was not involved prior to this point, determine what product is specified and where Steelcase differs. Limited changes are likely allowed at this point in the process.
- Timelines – including other trades coordination and tentative installation timeframe.
- Project specifications
- AutoCAD drawings, such as, Floor Plans, Elevations, RCP (Reflected Ceiling Plan), and MEP (Mechanical Electrical Plumbing)

Key Points

There are multiple aspects of the site that must be understood as it pertains to the design:

- Is the product in a seismic zone? Refer to the backing and blocking details for important items to address.
 - ▶ See page 24.
- What is the ceiling type? This information can be helpful to understand if you are utilizing a vertical fascia that has to go into a ceiling grid, or perhaps working under an architectural bulkhead that requires a filler.
- Is it existing or new construction? Again, this relates back to the wall construction requirements.

Base Cabinet, Angled Sink

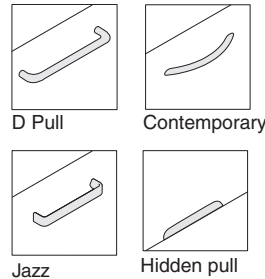
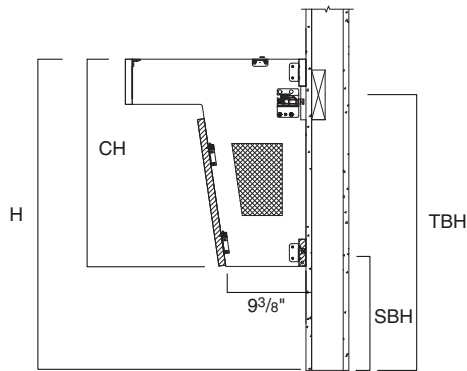

- What are the finish selections, including door and drawer pulls?
 - D pulls, jazz, and contemporary pulls are at a 128 mm spacing.
 - Hidden pulls are available on upper storage cabinets only.
 - Convey offers standard Steelcase finishes as well as select surfaces from Wilsonart and Formica.

- What are the locking requirements?
 - Manual locking
 - Electronic locking
 - Wireless receiver latches can be installed in doors and drawers and are activated by a transmitter (keypad) located within 15' of the cabinets. Receivers can be set to a non-self-locking mode, self-locking mode, or single use mode.
- ▶ See page 98 for more information on locks.

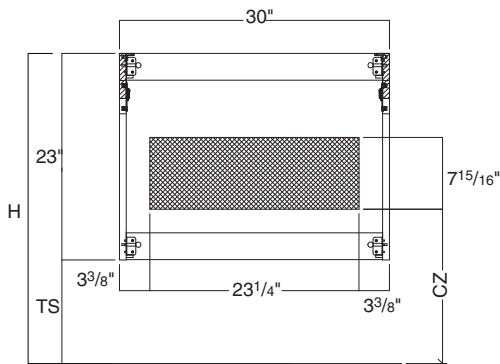

- What are the electrical and plumbing requirements and placement?
 - Convey sections include the section views for all cabinetry and “go, no go” zones to be communicated to the electrician or plumber working on the site. This information should be provided to the appropriate trades early in the process.
 - Sink selection

Designing with Casework

Construction Documents

At this point in a project, the customer has agreed to a final design and documents are being prepared for bid. Typically, no changes are allowed at this point and any design changes need to go through a formal alternate request process.

Submittals

A shop drawing is a drawn description of the information provided in the project's construction documents. It provides greater detail about all aspects of the application including floorplan elevations, detailed drawings of product interface points, as well as finish and hardware schedules. Follow the *Convey Technical Submittal Package Template* for guidelines on how to properly prepare a shop drawing.

► See <https://www.steelcase.com/resources/documents/convey-technical-submittal-package-template/>

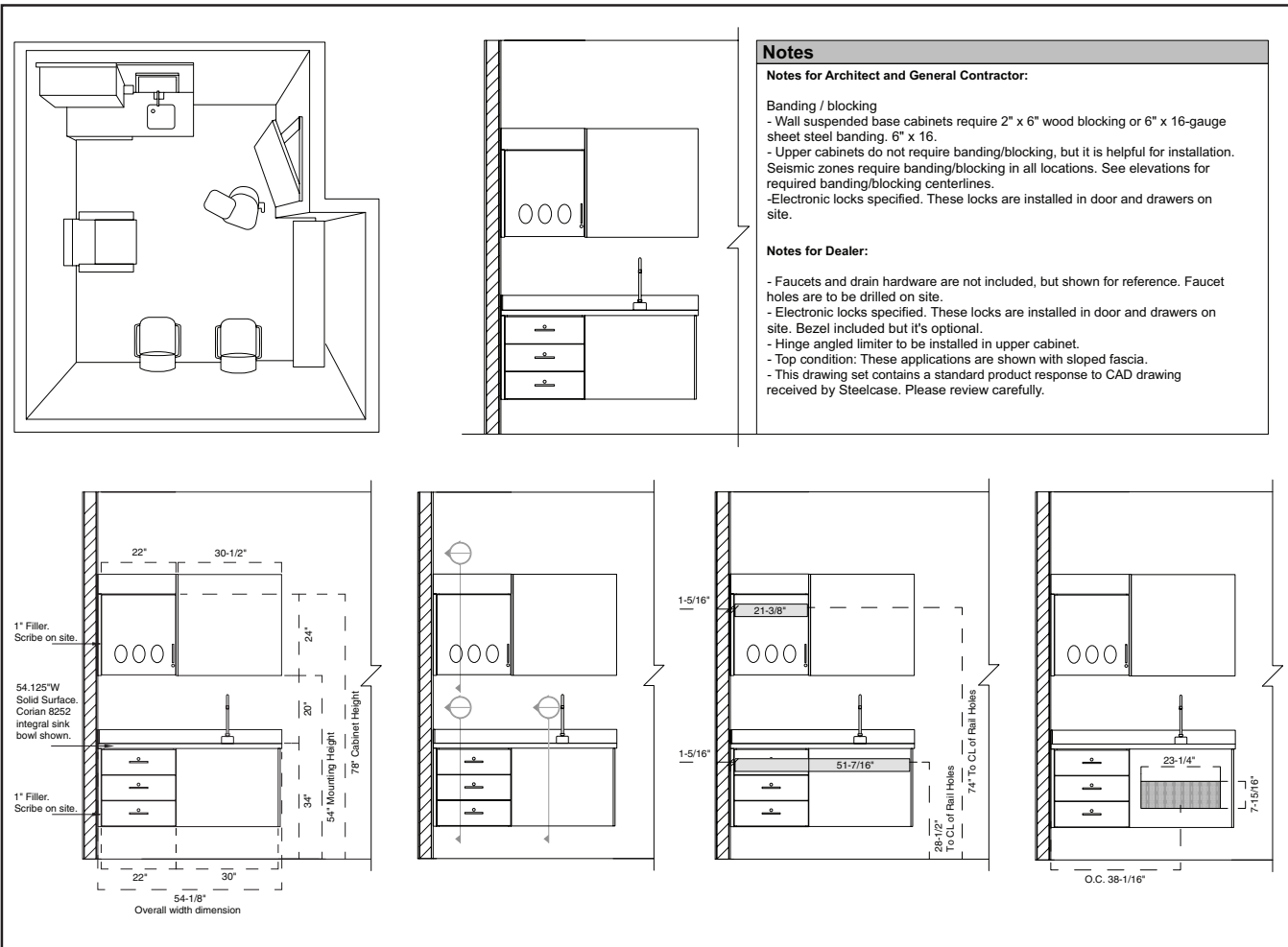

Designing with Casework

Overarching Project Checklist

Preliminary Design

- Needs assessment with the customer
- Intake call when Steelcase support is required within the architectural health team
- Modular solutions positioned
 - ▶ See Convey Village product page, village.steelcase.com, for more information around positioning modular casework.

Schematic Design

- CDA pricing
- Budget operations costs
- Define local installer labor
- Estimate delivery/truck/etc. costs
- 3rd party material/labor costs
- Initial project schedule
- Rough timeline and logistics

Design Finalized

- Elevations and renderings complete for all layouts
- Specials identified
- Review designs and process with customer
- Update quotes and drawings

Field Verification

- Keying conference
- Project execution review
- Steelcase reservations
- Mock-up

Order Finalized

- Attend construction meetings
- Finalize project schedule
- Coordinate dates with general contractor, electrician, voice/data, plumbing, etc.
- Audit final orders
- Install plans created
- Visit site two weeks prior to delivery installation

General Overview of Modular Casework

Wall-Suspended Application

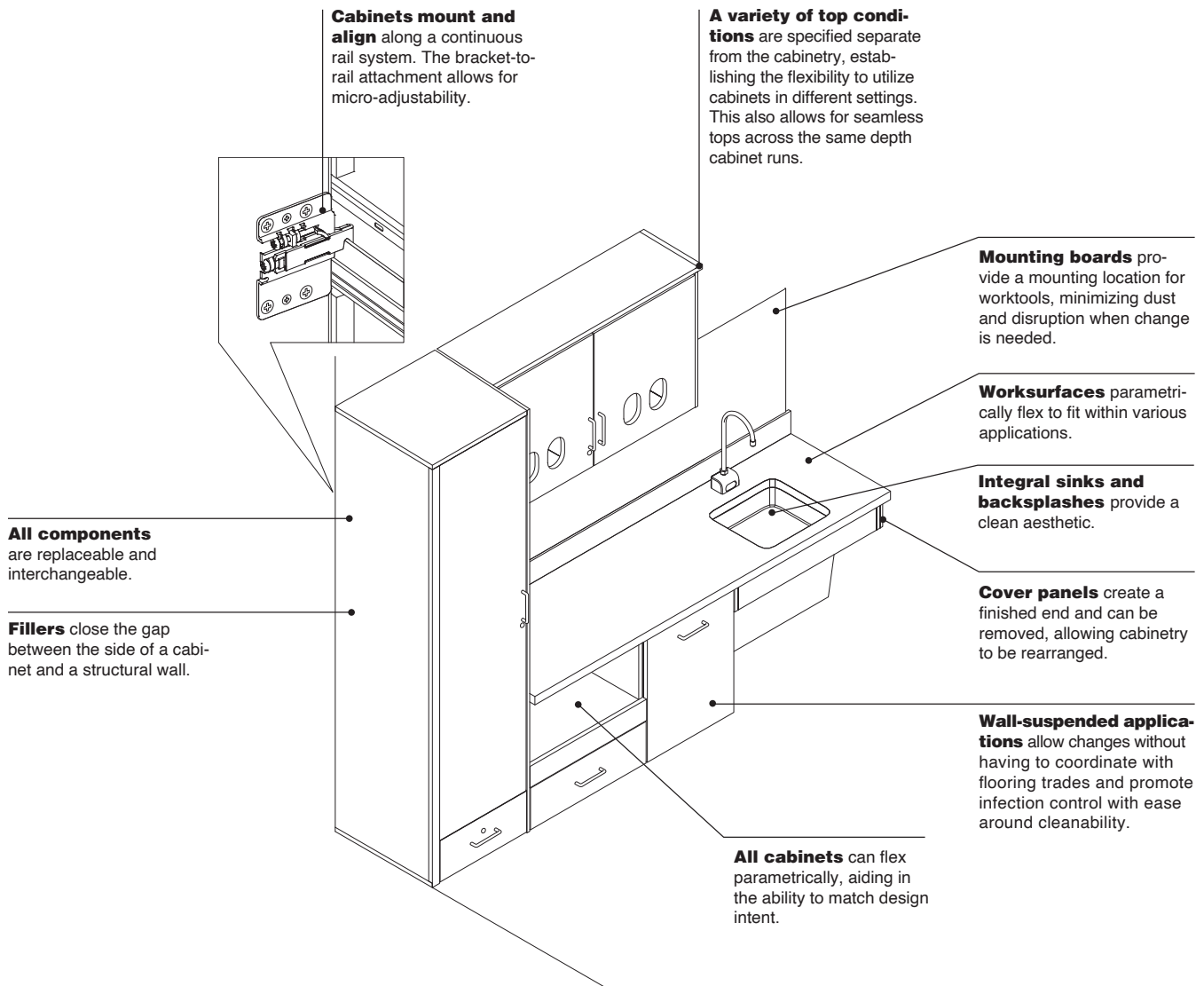

Tip: Visit www.steelcasehealth.com/convey to see the Convey animation.

General Overview of Modular Casework

Floor-Extended Application

General Overview of
Modular Casework

Convey

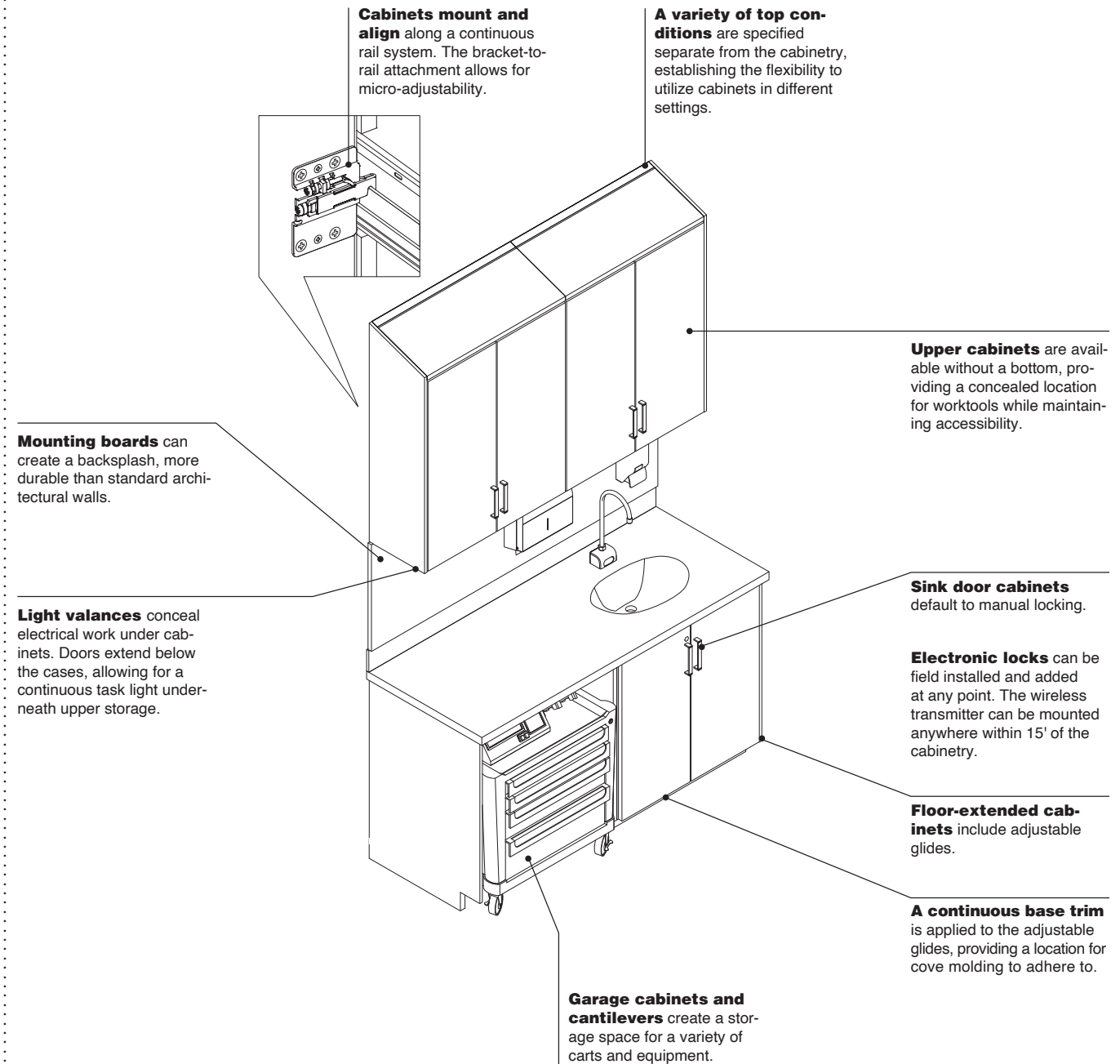

Tip: Visit www.steelcasehealth.com/convey to see the Convey animation.

Sink Bowl Overview

Sink Bowl Types and Actual Dimensions

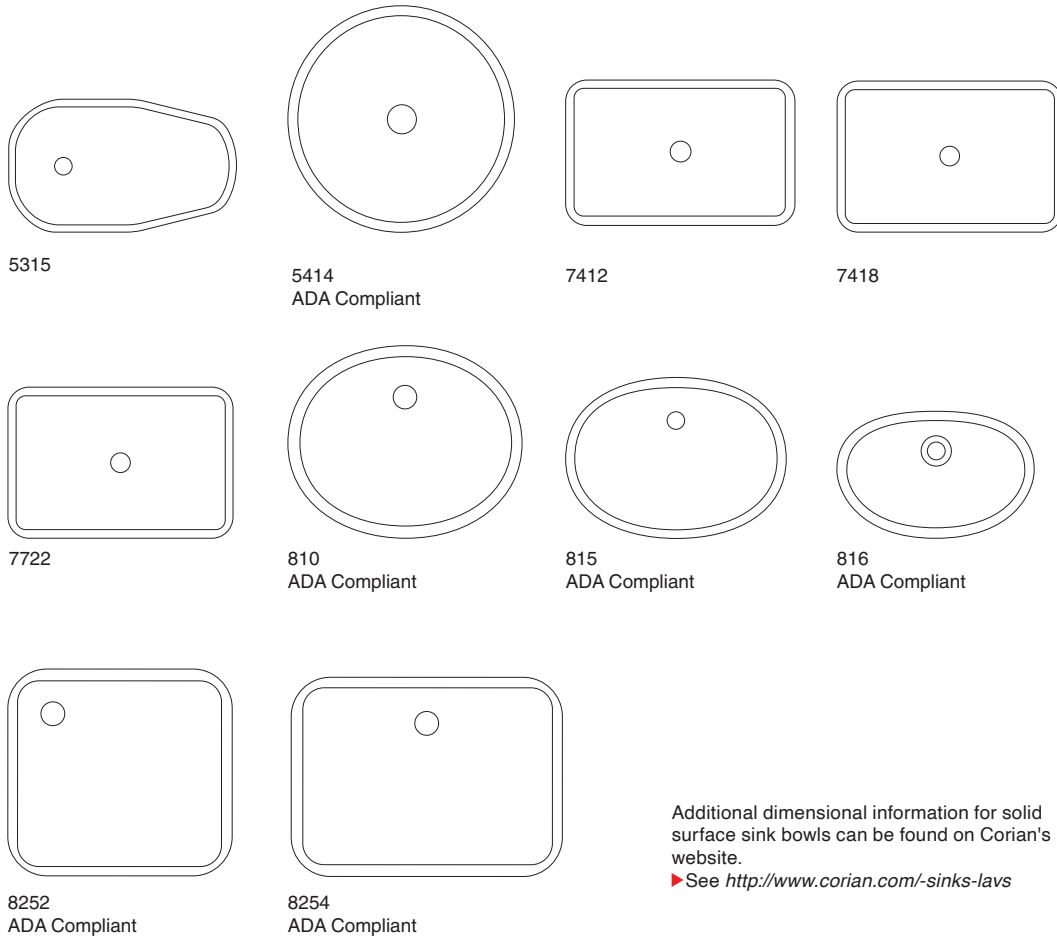

Actual Dimensions

Bowl Style	Overflow	Color	Drain Size	Sink Area	ADA Compliant	Wall-Suspended Flat Front, 20"D	Wall-Suspended Angled Front, 20"D	Floor-Extended Flat Front, 24"D	Wall-Suspended Angled Front, 24"D
810	None	Glacier White	1¾"	158"	Yes	No	No	Min. 21"W	Yes
815	None	Glacier White	1¾"	231"	Yes	No	No	Min. 25"W	No
816	None	Glacier White	1¾"	144"	Yes	Min. 22"W	No	Min. 22"W	Yes
5315	None	Glacier White	1¾"	250"	No	No	No	Min. 27"W	Yes
5414	None	Glacier White	2"	153"	Yes	No	No	Yes	Yes
7412	None	Glacier White	1¾"	192"	No	Min. 26"W	No	Min. 22"W	Yes
7418	None	Glacier White	1¾"	243"	No	No	No	Min. 24"W	No
7722	None	Glacier White	1¾"	243"	No	No	No	Min. 24"W	No
8252	None	Glacier White	1¾"	210"	Yes	No	Yes	Min. 21"W	Yes
8254	None	Glacier White	1¾"	229"	Yes	No	Yes	Min. 22"W	Yes

Sink Bowl Overview

Sink Bowl Fit

Base Cabinet, Angled-Front Sink

Cabinet Depth	Cabinet Width						
	30"	31"	32"	33"	34"	35"	36"
20"	8252, 8254	8252, 8254	8252, 8254	8252, 8254	8252, 8254	8252, 8254	8252, 8254
21"	816, 8252, 8254	816, 8252, 8254	816, 8252, 8254	816, 8252, 8254	816, 8252, 8254	816, 8252, 8254	816, 8252, 8254
22"	816, 7412, 8252, 8254	816, 7412, 8252, 8254	816, 7412, 8252, 8254	816, 7412, 8252, 8254	816, 7412, 8252, 8254	816, 7412, 8252, 8254	816, 7412, 8252, 8254
23"	810, 816, 5315, 5414, 7412, 8252, 8254	810, 816, 5315, 5414, 7412, 8252, 8254	810, 816, 5315, 5414, 7412, 8252, 8254	810, 816, 5315, 5414, 7412, 8252, 8254	810, 816, 5315, 5414, 7412, 8252, 8254	810, 816, 5315, 5414, 7412, 8252, 8254	810, 816, 5315, 5414, 7412, 8252, 8254
24"	810, 816, 5315, 5414, 7412, 8252, 8254	810, 816, 5315, 5414, 7412, 8252, 8254	810, 816, 5315, 5414, 7412, 8252, 8254	810, 816, 5315, 5414, 7412, 8252, 8254	810, 816, 5315, 5414, 7412, 8252, 8254	810, 816, 5315, 5414, 7412, 8252, 8254	810, 816, 5315, 5414, 7412, 8252, 8254

Base Cabinet, Wall-Suspended Sink

Cabinet Depth	Cabinet Width						
	18"	19"	20"	21"	22"	23"	24"
20"	N.A.	N.A.	N.A.	N.A.	816	816	816
21"	N.A.	N.A.	N.A.	N.A.	816, 7412	816, 7412	816, 7412
22"	5414	5414	5414	810, 5414	810, 816, 5414, 7412	810, 816, 5414, 7412	810, 816, 5414, 7412, 7418, 7722
23"	5414	5414	5414	810, 5414	810, 816, 5414, 7412, 8254	810, 816, 5414, 7412, 8254	810, 816, 5414, 7412, 7418, 7722, 8252, 8254
24"	5414	5414	5414	810, 5414, 8252	810, 816, 5414, 7412, 8252, 8254	810, 816, 5414, 7412, 8252, 8254	810, 816, 5414, 7412, 7418, 7722, 8252, 8254

37"	38"	39"	40"	41"	42"
8252, 8254	8252, 8254	8252, 8254	8252, 8254	8252, 8254	8252, 8254
816, 8252, 8254	816, 8252, 8254	816, 8252, 8254	816, 8252, 8254	816, 8252, 8254	816, 8252, 8254
816, 7412, 8252, 8254	816, 7412, 8252, 8254	816, 7412, 8252, 8254	816, 7412, 8252, 8254	816, 7412, 8252, 8254	816, 7412, 8252, 8254
810, 816, 5315, 5414, 7412, 8252, 8254	810, 816, 5315, 5414, 7412, 8252, 8254	810, 816, 5315, 5414, 7412, 8252, 8254	810, 816, 5315, 5414, 7412, 8252, 8254	810, 816, 5315, 5414, 7412, 8252, 8254	810, 816, 5315, 5414, 7412, 8252, 8254
810, 816, 5315, 5414, 7412, 8252, 8254	810, 816, 5315, 5414, 7412, 8252, 8254	810, 816, 5315, 5414, 7412, 8252, 8254	810, 816, 5315, 5414, 7412, 8252, 8254	810, 816, 5315, 5414, 7412, 8252, 8254	810, 816, 5315, 5414, 7412, 8252, 8254

25"	26"	27"	28"	29"	30"	31"-42"
816	816, 7412	816, 7412	816, 7412	816, 7412	816, 7412	816, 7412
816, 7412	816, 7412	816, 5315, 7412	816, 5315, 7412	816, 5315, 7412, 8254	816, 5315, 7412, 7418, 7722, 8254	816, 5315, 7412, 7418, 7722, 8254
810, 816, 5414, 7412, 7418, 7722, 8254	810, 816, 5414, 7412, 7418, 7722, 8252, 8254	810, 816, 5315, 5414, 7412, 7418, 7722, 8252, 8254	810, 816, 5315, 5414, 7412, 7418, 7722, 8252, 8254	810, 816, 5315, 5414, 7412, 7418, 7722, 8252, 8254	810, 816, 5315, 5414, 7412, 7418, 7722, 8252, 8254	810, 816, 5315, 5414, 7412, 7418, 7722, 8252, 8254
810, 815, 816, 5414, 7412, 7418, 7722, 8252, 8254	810, 815, 816, 5414, 7412, 7418, 7722, 8252, 8254	810, 815, 816, 5315, 5414, 7412, 7418, 7722, 8252, 8254	810, 815, 816, 5315, 5414, 7412, 7418, 7722, 8252, 8254	810, 815, 816, 5315, 5414, 7412, 7418, 7722, 8252, 8254	810, 815, 816, 5315, 5414, 7412, 7418, 7722, 8252, 8254	810, 815, 816, 5315, 5414, 7412, 7418, 7722, 8252, 8254
810, 815, 816, 5414, 7412, 7418, 7722, 8252, 8254	810, 815, 816, 5414, 7412, 7418, 7722, 8252, 8254	810, 815, 816, 5315, 5414, 7412, 7418, 7722, 8252, 8254	810, 815, 816, 5315, 5414, 7412, 7418, 7722, 8252, 8254	810, 815, 816, 5315, 5414, 7412, 7418, 7722, 8252, 8254	810, 815, 816, 5315, 5414, 7412, 7418, 7722, 8252, 8254	810, 815, 816, 5315, 5414, 7412, 7418, 7722, 8252, 8254

Sink Bowl Overview, Sink Bowl Fit, continued

Base Cabinet, Floor-Extended Sink							
Cabinet Depth	Cabinet Width						
	18"	19"	20"	21"	22"	23"	24"
20"	N.A.	N.A.	N.A.	816	816	816	816
21"	N.A.	N.A.	N.A.	816, 7412	816, 7412	816, 7412	816, 7412
22"	5414	5414	810, 5414	810, 816, 5414, 7412	810, 816, 5414, 7412	810, 816, 5414, 7412, 7418, 7722	810, 816, 5414, 7412, 7418, 7722
23"	5414	5414	810, 5414	810, 816, 5414, 7412, 8254	810, 816, 5414, 7412, 8254	810, 816, 5414, 7412, 7418, 7722, 8252, 8254	810, 816, 5414, 7412, 7418, 7722, 8252, 8254
24"-25"	5414	5414	810, 5414, 8252	810, 816, 5414, 7412, 8252, 8254	810, 816, 5414, 7412, 8252, 8254	810, 816, 5414, 7412, 7418, 7722, 8252, 8254	810, 816, 5414, 7412, 7418, 7722, 8252, 8254

25"	26"	27"	28"	29"	30"	31"-42"
816	816, 7412	816, 7412	816, 7412	816, 7412	816, 7412	816, 7412
816, 7412	816, 7412	816, 5315, 7412	816, 5315, 7412	816, 5315, 7412, 8254	816, 5315, 7412, 7418, 7722, 8254	816, 5315, 7412, 7418, 7722, 8254
810, 816, 5414, 7412, 7418, 7722, 8254	810, 816, 5414, 7412, 7418, 7722, 8252, 8254	810, 816, 5315, 5414, 7412, 7418, 7722, 8252, 8254	810, 816, 5315, 5414, 7412, 7418, 7722, 8252, 8254	810, 816, 5315, 5414, 7412, 7418, 7722, 8252, 8254	810, 816, 5315, 5414, 7412, 7418, 7722, 8252, 8254	810, 816, 5315, 5414, 7412, 7418, 7722, 8252, 8254
810, 815, 816, 5414, 7412, 7418, 7722, 8252, 8254	810, 815, 816, 5414, 7412, 7418, 7722, 8252, 8254	810, 815, 816, 5315, 5414, 7412, 7418, 7722, 8252, 8254	810, 815, 816, 5315, 5414, 7412, 7418, 7722, 8252, 8254	810, 815, 816, 5315, 5414, 7412, 7418, 7722, 8252, 8254	810, 815, 816, 5315, 5414, 7412, 7418, 7722, 8252, 8254	810, 815, 816, 5315, 5414, 7412, 7418, 7722, 8252, 8254
810, 815, 816, 5414, 7412, 7418, 7722, 8252, 8254	810, 815, 816, 5414, 7412, 7418, 7722, 8252, 8254	810, 815, 816, 5315, 5414, 7412, 7418, 7722, 8252, 8254	810, 815, 816, 5315, 5414, 7412, 7418, 7722, 8252, 8254	810, 815, 816, 5315, 5414, 7412, 7418, 7722, 8252, 8254	810, 815, 816, 5315, 5414, 7412, 7418, 7722, 8252, 8254	810, 815, 816, 5315, 5414, 7412, 7418, 7722, 8252, 8254

Guidance For Third-Party Worksurfaces

Convey worksurfaces are available in solid surface and High-Pressure Laminate. Certain worksurface types and conditions warrant the use of third-party worksurfaces.

Tip: When utilizing third-party worksurfaces, weights exceeding those of the standard solid surface tops and thicknesses should be verified by the structural engineer of record. Alternative fasteners from those provided with Convey may be required for appropriate length.

Know when to source surfaces locally. The most common applications and situations where locally sourced tops are required include:

- Alcoves
- Corners
- Convey cabinets longer than 138"W with solid-surface worksurfaces
- Changes in depth of surface
- Drop-in sinks with solid-surface worksurfaces
- Different materiality including granite, phenolic resin, and stainless steel

To properly plan for a locally sourced worksurface, coordination is required between the client/plumber and the dealer supplied submittal package. Areas to take into consideration include:

• Application

- Planning height—ADA or non-ADA
- Cover panels—present or not
- Adjacent casework
- Adjacent architectural components

• Local Worksurface

- Who is the subcontractor?
Tip: Shop drawings (submittal packages) should be exchanged.
- Materiality—solid surface, laminate, stone, etc.
- Size—width and depth
Tip: Also consider whether an overhang is being requested.
- Worksurface thickness
- Backsplash—required or not and thickness

• Sink Bowl Sink

- Type—drop in, undermount, etc.
- Integral—if using integral, provide information regarding the Dupont Corian sink bowls that have been vetted in the Convey casework based on width and depth that Steelcase recommends. See page 32.
- Size—depth, width, and height
- Drain location

• Faucet

- Specifications

Additional Considerations

Steelcase does not provide faucets or drain hardware with standard worksurfaces. However, this information still needs to be coordinated both when the tops are Steelcase supplied or locally supplied.

When the worksurfaces are not in the Steelcase scope, typically the Architect or General Contractor is validating the application to ensure all work by the various subcontractors is coordinated and planned.

Templating the locally sourced top in the field after the casework is installed is the ideal scenario to ensure a proper fit. If tops are made prior to installation, be sure to overlay the worksurface and/or sink bowl over the Convey section views to verify there will be no interferences between the plumbing and the cabinetry. Section views are available at village.steelcase.com.

Height Matrix—Wall-Suspended Cabinets

Tip: Cabinet heights are different than AFF (Above Finished Floor) heights. The chart assumes Convey solid surface worksurfaces are being used, which have a thickness of 1 1/2". If supplying worksurfaces locally, worksurface thickness should be added onto cabinet height to determine AFF (Above Finished Floor) heights.

Tip: This chart assumes AFF (Above Finished Floor) planning heights of 34", 36", and 42". Wall-suspended cabinets can be mounted at whatever height the customer specifies, based on the rail location chosen.

34"H Planning Height Wall-Suspended Cabinets

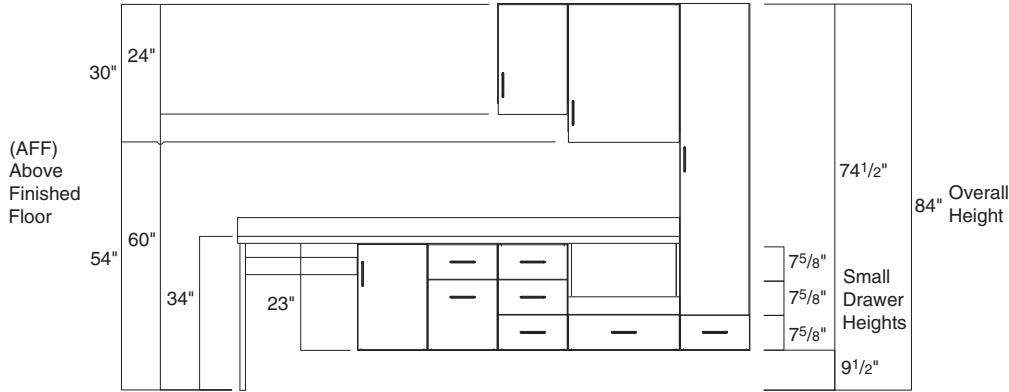

36"H Planning Height Wall-Suspended Cabinets

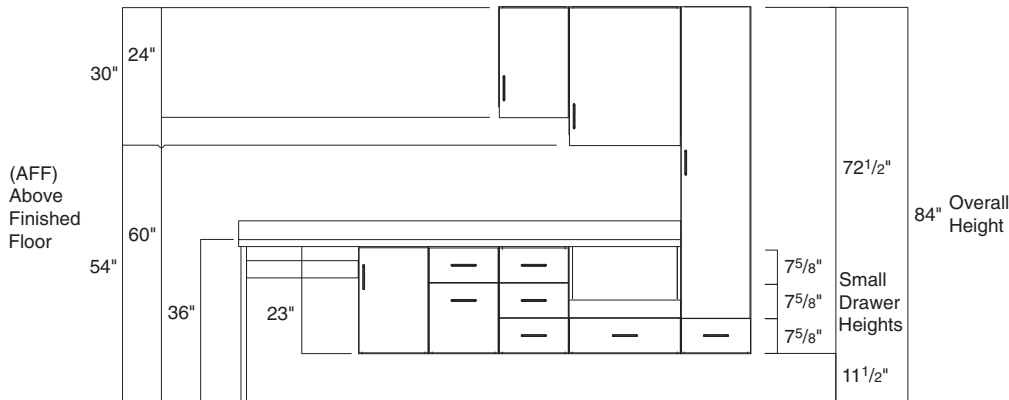

42"H Planning Height Wall-Suspended Cabinets

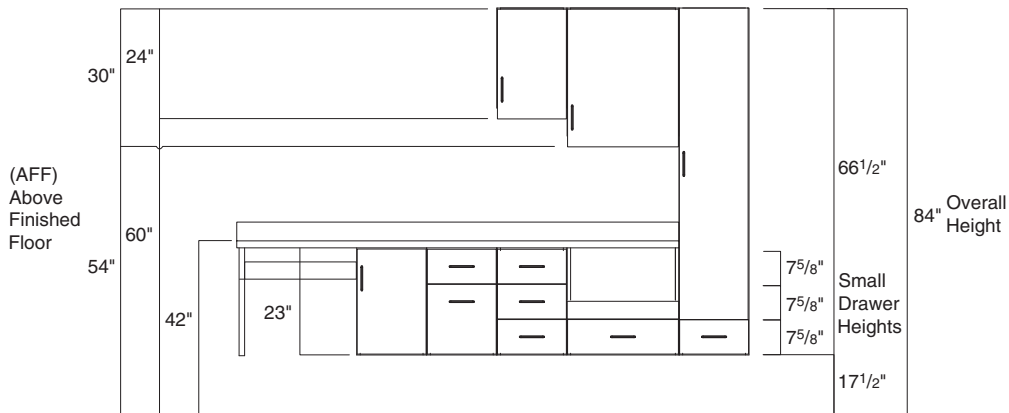

Height Matrix—Floor-Extended Cabinets

Tip: Cabinet heights are different than AFF (Above Finished Floor) heights. The chart assumes Convey solid surface worksurfaces are being used, which have a thickness of 1 1/2". If supplying worksurfaces locally, worksurface thickness should be added onto cabinet height to determine AFF (Above Finished Floor) heights.

Floor-Extended Base Cabinets with Doors

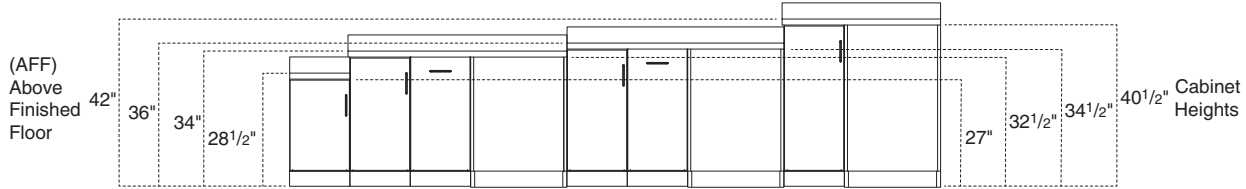

Floor-Extended Base Cabinets with Drawers and Specialty Cabinets

Tip: Drawer heights are designed to align consistently across all layouts at the same plan height.

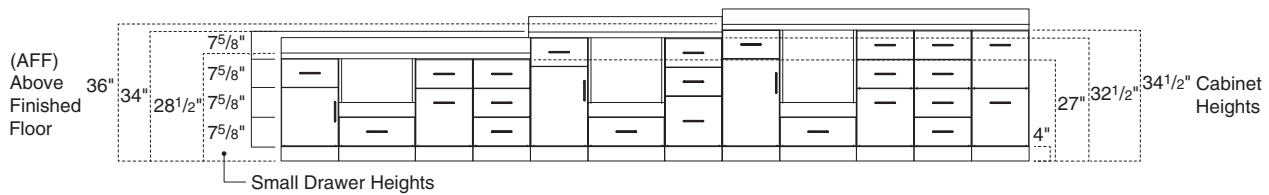

Floor-Extended Tall Storage and Wardrobes

Tip: Tall storage and wardrobe cabinets drive the location of the upper cabinets when using a continuous rail. Space between a worksurface and the base of an upper cabinet will be driven by this mounting location.

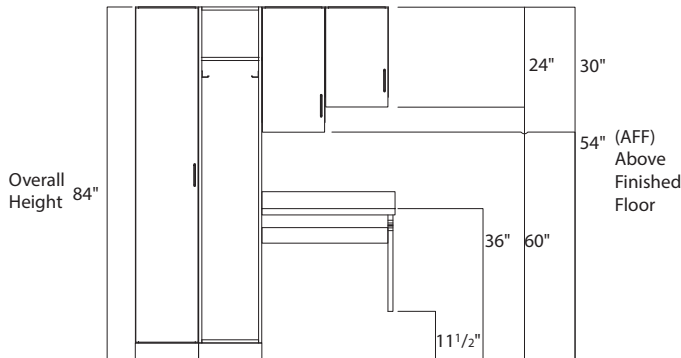

Convey Base Cabinets

Wall Suspended

Wall-suspended base cabinets meet storage needs in a variety of settings.
▶ Specifying, page 100

Tops of cabinets are open and require attachment to a worksurface that is ordered separately. Attachment hardware is included with the cabinetry.

Cabinet interiors are finished with 2730 Arctic White High-Pressure Laminate.

Notches must be covered by cover panels or a notch filler for end-of-run conditions.
▶ See page 144 for cover panels.

Adjustable shelf is standard inside the cabinets with doors. Shelves adjust in 32 mm increments. Additional shelves are available and must be ordered separately.
▶ See page 168 for accessories.

Seismic clips are available for adjustable shelves. These clips lock the shelf and prevent movement from front to back, as well as up and down.

Blocking/banding will be required in architectural walls behind the rail. Placement of blocking/banding is to be coordinated with responsible trades.

Cabinets mount and align along a continuous rail system. The bracket-to-rail attachment allows for micro-adjustability. Brackets and bracket covers are included with every cabinet. Rail must be ordered separately from the cabinet.
▶ See page 168 for rail.

Drawers and doors can be locked manually or electronically. Electronic locks are available as an option or can be ordered separately.
▶ See page 174 for electronic locks.

Drawers include heavy-duty, full-extension drawer slides.

D pulls are standard on doors and drawers and are in a nickel finish. Additional finishes and pull options are available.

Wall-suspended base cabinets flex parametrically in 1" increments for width and depth.

All edges are finished from the factory with matching plastic edge banding.

Product Details

Cabinets have a wet glue and dowel, case clamp construction.

All surfaces, including cabinet interiors, are finished with High-Pressure Laminate.

Edges on cabinets are matching 1 mm plastic edge banding. Drawer and door edges are matching 3 mm plastic edge banding.

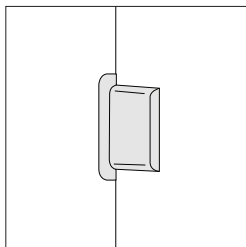

Bracket covers are included with cabinets and come in white only.

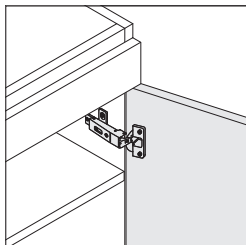

Euro hinge is standard on cabinet door and allows the door to open a full 110°.

Soft close door hinges are standard.

Hinge angle limiter is available for door units and limits the angle to 87°. This is recommended when near adjacent walls or in corner applications.

▶ See page 172 for hinge angle limiter.

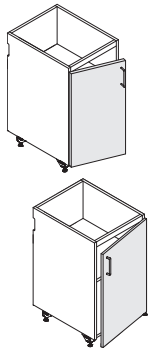

Single-door cabinets are hinged on the left or right side. A left-hand unit has the hinge on the left side of the door. A right-hand unit has the hinge on the right side of the door.

Cabinets 24"W or less have a single door. Cabinets 25"W or wider default to two doors.

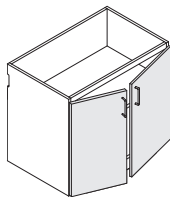

Double-door cabinets open from the center out.

Double doors include a sequential latch. The right door must be opened prior to the left. This is beneficial when locking the cabinet as only the right door needs the locking mechanism. The sequential latch can be removed in the field.

All door cabinets include one adjustable shelf.

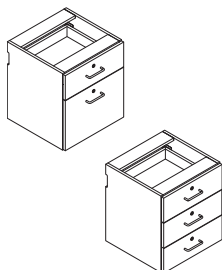

Wall-suspended base cabinets are available with one small drawer and one large drawer or with three small drawers.

If third party file storage is required in large drawers, please reference the *Convey Section Views* for clearances, available at village.steelcase.com.

Cabinets with drawers cannot exceed 24"W.

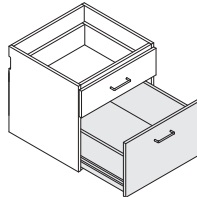

Drawers include heavy-duty, full-extension drawer slides.

The top drawer extends 2" less than others due to the bracket clearance.

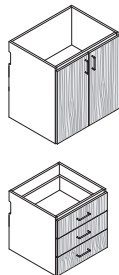

Woodgrain laminate matches on all door and drawer sets and is always applied vertically.

Wall-suspended base cabinets are only available in one height: 23"H. Width and depth can adjust parametrically in 1" increments.

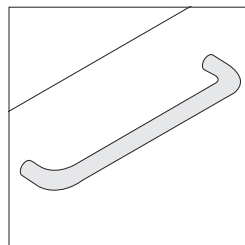

D pulls are standard.

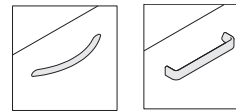

Contemporary Jazz

Additional door and drawer pull options are available. Optional pulls include:

- Contemporary
- Jazz
- No pull

Tip: Cabinets with no pull option selected come with no drawer pulls or drill holes.

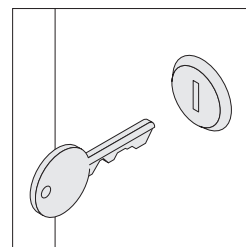

Locks are optional and only available with master keying. Locks are field installed and must be specified separately. ▶ *Lock and Keying*, page 398

When manual locks are specified, a lock plug will default in all doors and drawers of the individual cabinet.

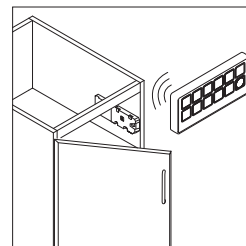

Electronic locks are optional and field installed. Lock receivers are installed on drawers and doors and are wirelessly controlled by a transmitter. *Tip: Transmitters are ordered separately.* ▶ See page 174 for electronic locks.

When electronic locks are specified, all doors and drawers will default to locking on the individual cabinet.

Connections

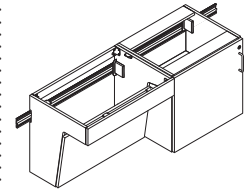

Base cabinets attach to a rail system utilizing a bracket connection. The rail aids in alignment to adjacent cabinets. The rail must be ordered separate from the cabinet. ▶ See page 168 for rails.

Cabinets should be ganged together with screws provided.

Integrated rail attachment bracket's micro-adjustability accounts for architectural wall variances to deliver refined alignment.

For minimum wall construction and electrical clearances, see *Convey Technical Cut Sheet*, available at village.steelcase.com.

Surface Materials

Cabinet, drawer front, door front, and shelf

- High-Pressure Laminate

Edges

- Matching plastic

Cabinet interior

- 2730 Arctic White

D pulls, contemporary, and jazz pulls

- 0835 Black
- 9201 Polished Chrome
- 9211 Nickel
- 9212 Silver

Bracket covers

- 6009 Arctic White

Euro hinges

- Nickel

Lock

- 9201 Polished Chrome only

Shipping

All cabinets ship fully assembled.

Handles will be shipped on the cabinets, but facing the interior to prevent damage.

Application Topics

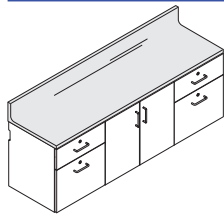

Worksurface will span entire length of run of cabinets, up to 138"W for solid surface worksurfaces and up to 120"W for High-Pressure Laminate worksurfaces.
 ▶ See pages 154-158 for worksurfaces.

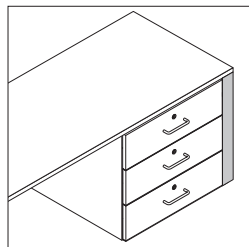

Fillers close the gap between the side of a cabinet and a structural wall. Additional length worksurface will be required.
 ▶ See page 166 for fillers.

Notch fillers or cover panels must be used to conceal the bracket-to-rail connection at the end of a run. Cover panels attach to the side of casework and add a 1/2" to the overall planning width.
 ▶ See page 144 for cover panels.

V.I.A. will accept Convey wall-suspended cabinets and upper cabinets. Convey follows all V.I.A. application rules for hang on components. See the *V.I.A. Specification Guide* for more details.

Maximum plan width for V.I.A. vertical posts with Convey is 48"W. Skins may be specified longer than 48"W and span these vertical components.

The Convey rail can span multiple 48"W lengths.

Reinforcing structural beams (FEBSTR) are required at rail locations inside the V.I.A. frame. An additional structural beam is required at the bottom to distribute the load evenly.

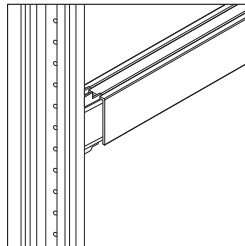

Convey rails attach to the structural beam by screwing through the skins. The V.I.A. spacer is required to fill the gap between the skin and the beam. Spacers are not visible once the skin is in place. Spacers span the width of the structural beam.
 ▶ See page 178 for V.I.A. spacer.

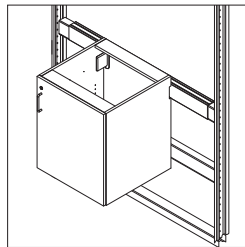

Base cabinets cannot be planned at 28 1/2" surface height as there is not enough room to support the structural beams needed at the bottom and top of the case.

Convey Base Cabinets

Floor Extended

Floor-extended base cabinets meet storage needs in a variety of settings.

► Specifying, page 102

Tops of cabinets are open and require attachment to a worksurface that is ordered separately. Attachment hardware is included with the cabinetry.

Notches must be covered by cover panels or a notch filler for end-of-run conditions.

► See page 144 for cover panels.

All edges are finished from the factory with matching plastic edge banding.

Blocking/banding may not be required in architectural walls behind the rail, depending on the application. Check local and state codes for blocking/banding requirements (i.e. seismic zones). Placement of blocking/banding is to be coordinated with the responsible trades.

Cabinets mount and align along a continuous rail system. The bracket-to-rail attachment allows for micro-adjustability. Brackets and bracket covers are included with every cabinet. Rail must be ordered separately from the cabinet.

► See page 168 for rails.

Base trim must be added to floor-extended base cabinets prior to application of cove molding. Cove molding is required and is to be supplied by others. Base trim is always black. Base trim must be ordered separately.

► See page 172 for base trim.

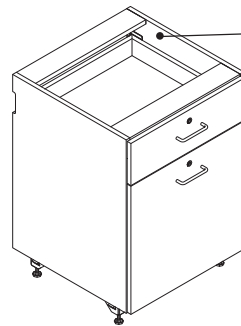
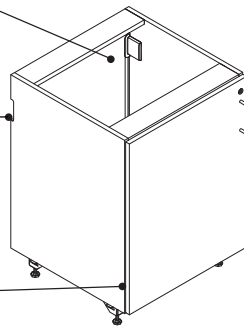

Cabinet interiors are finished with 2730 Arctic White High-Pressure Laminate.

Adjustable shelf is standard inside cabinets with doors. Shelves adjust in 32 mm increments. Additional shelves are available, and must be ordered separately.

► See page 168 for accessories.

Seismic clips are available for adjustable shelves. These clips lock the shelf and prevent movement from front to back, as well as up and down.

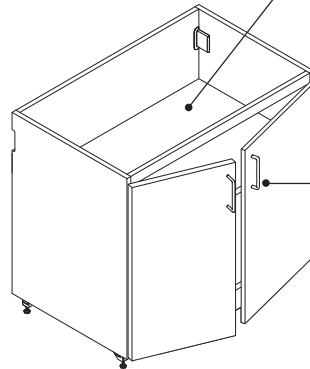

D pulls are standard on doors and drawers in a nickel finish. Additional finishes and pull options are available.

Drawers and doors can be locked manually or electronically. Electronic locks are available as an option or can be ordered separately.

► See page 174 for electronic locks.

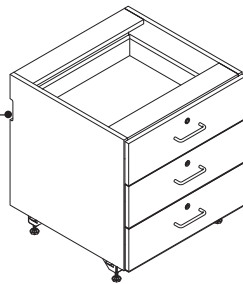

Drawers include heavy-duty, full-extension drawer slides.

Floor-extended base cabinets flex parametrically in 1" increments for width and depth.

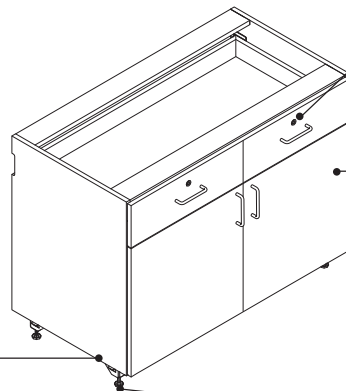

Adjustable glides adjust for installation on uneven floors. Adjustability range is 2".

Product Details

Cabinets have a wet glue and dowel, case clamp construction.

All surfaces, including cabinet interiors, are finished with High-Pressure Laminate.

Edges on cabinets are matching 1 mm plastic edge banding. Drawer and door edges are matching 3 mm plastic edge banding.

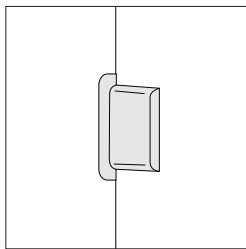

Bracket covers are included with cabinets and come in white only.

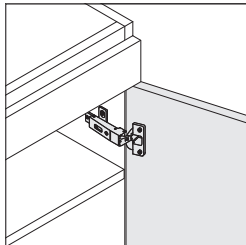

Euro hinge is standard on cabinet door and allows the door to open a full 110°.

Soft close door hinges are standard.

Hinge angle limiter is available for door units and limits the angle to 87°. This is recommended when near adjacent walls or in corner applications.
▶ See page 172 for hinge angle limiter.

Door cabinets 24"W or less have a single door. Cabinets 25"W or wider default to two doors.

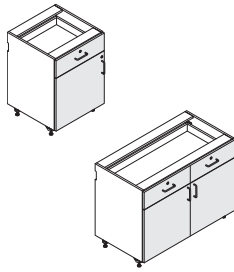

Drawer/door cabinets 24"W or less have one door and one drawer. Drawer/door cabinets 25"W or wider default to two side-by-side drawers and two doors.

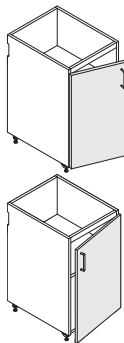

Single-door cabinets are hinged on the left or right side. A left-hand unit has the hinge on the left side of the door. A right-hand unit has the hinge on the right side of the door.

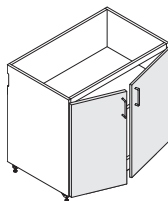

Double-door cabinets open from the center out.

Double doors include a sequential latch. The right door must be opened prior to the left. This is beneficial when locking the cabinet as only the right door needs the locking mechanism. The sequential latch can be removed in the field.

All door cabinets include one adjustable shelf.

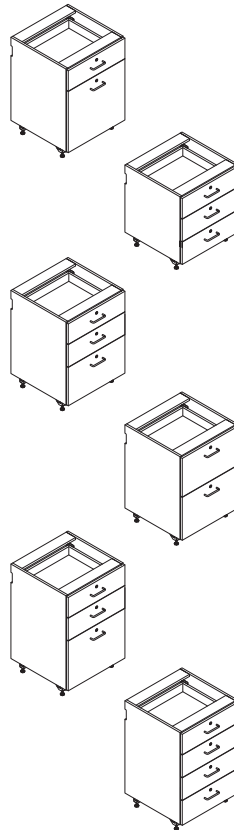

Floor-extended base cabinets are available with various drawer configurations, depending on the height:

- 27"H cabinets can have one small and one large drawer, or three small drawers.
- 32¹/₂"H cabinets can have two small drawers and one medium drawer.
- 34¹/₂"H cabinets can have two large drawers, two small drawers and one large drawer, or four small drawers.

If third party file storage is required in large drawers, please reference the *Convey Section Views* for clearances, available at village.steelcase.com.

Cabinets with only drawers cannot exceed 24"W.

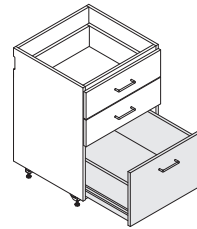

Drawers include heavy-duty full-extension drawer slides.

The top drawer extends 2" less than others due to the bracket clearance.

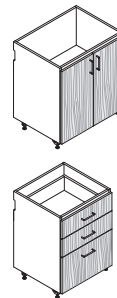

Woodgrain laminate matches on all door and drawer sets and is always applied vertically.

Floor-extended base cabinets are only available in modular heights. Widths and depths can adjust parametrically in 1" increments.

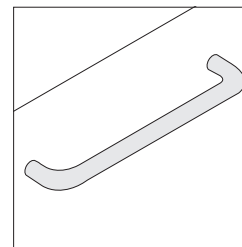

D pulls are standard.

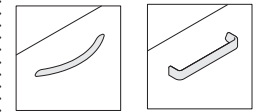

Contemporary Jazz

Additional door and drawer pull options are available. Optional pulls include:

- Contemporary
- Jazz
- No pull

Tip: Cabinets with no pull option selected come with no drawer pulls or drill holes.

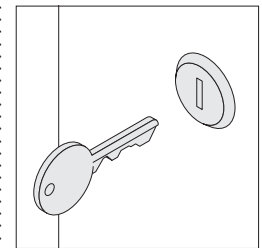

Locks are optional and only available with master keying. Locks are field installed and must be specified separately.
▶ *Lock and Keying,* page 398

When manual locks are specified, a lock plug will default in all doors and drawers of the individual cabinet.

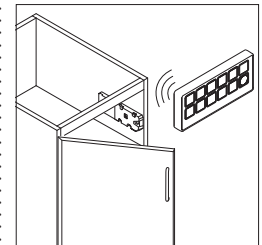

Electronic locks are optional and field installed. Lock receivers are installed on drawers and doors and are wirelessly controlled by a transmitter.
Tip: Transmitters are ordered separately.
▶ See page 174 for electronic locks.

When electronic locks are specified, all doors and drawers will default to locking on the individual cabinet.

Connections

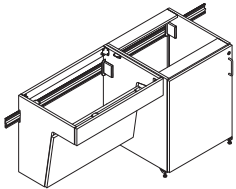

Base cabinets attach to a rail system utilizing a bracket connection. The rail aids in alignment to adjacent cabinets. The rail must be ordered separate from the cabinet.

▶ See page 168 for rails.

Cabinets should be ganged together with screws provided.

Integrated rail attachment bracket's micro-adjustability accounts for architectural wall variances to deliver refined alignment.

For minimum wall construction and electrical clearances, see *Convey Technical Cut Sheet*, available at *village.steelcase.com*.

Surface Materials

Cabinet, drawer front, door front, and shelf

- High-Pressure Laminate

Edges

- Matching plastic

Cabinet interior

- 2730 Arctic White

D pulls, contemporary, and jazz pulls

- 0835 Black
- 9201 Polished Chrome
- 9211 Nickel
- 9212 Silver

Bracket covers

- 6009 Arctic White

Euro hinges

- Nickel

Lock

- 9201 Polished Chrome only

Shipping

All cabinets ship fully assembled.

Handles will be shipped on the cabinets, but facing the interior to prevent damage.

Floor-extended glides are not installed on the cabinets prior to shipping. Holes are pre-drilled. These items must be field-installed.

Application Topics

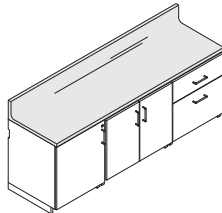

Worksurface will span entire length of run of cabinets, up to 138"W for solid surface worksurfaces and up to 120"W for High-Pressure Laminate worksurfaces.

▶ See pages 154-158 for worksurfaces.

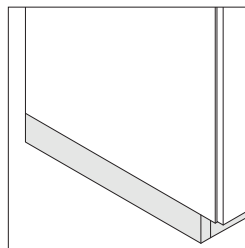

Base trim must be added under base cabinet prior to application of cove molding. Cove molding is applied over base trim and is generally supplied by general contractor or client and must be coordinated. Base trim is always black.

▶ See page 172 for base trim.

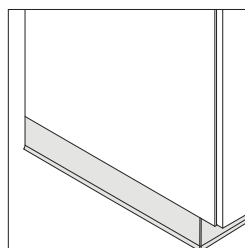

Cove molding must be field installed on base trim to complete an installation and is supplied locally. The base trim on the cabinet is inset. See *Convey Technical Cut Sheet*, available at *village.steelcase.com*.

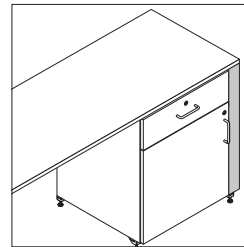

Fillers close the gap between the side of a cabinet and a structural wall.

▶ See page 166 for fillers.

Notch fillers or cover panels must be used to conceal the bracket-to-rail connection at the end of a run. Cover panels attach to the side of casework and add a 1/2" to the overall planning width.

▶ See page 144 for cover panels.

Convey Printer Cabinets

Floor-extended and wall-suspended printer cabinets

provide a pullout shelf for easy access to a printer or other storage items.

▶ See page 108 for specifying.

Tops of cabinets are open and require attachment to a worksurface that is ordered separately. Attachment hardware is included with the cabinetry.

Notches must be covered by cover panels or notch filler for end-of-run conditions.

▶ See page 144 for cover panels.

D pulls are standard on drawers in a nickel finish. Additional finishes and pull options are available.

All edges are finished from the factory with matching plastic edge banding.

Blocking/banding is required for wall-suspended cabinets. Blocking/banding for floor-extended cabinets may not be required in architectural walls behind the rail, depending on the application. Check local and state codes for blocking/banding requirements (i.e. seismic zones). Placement of blocking/banding is to be coordinated with the responsible trades.

Base trim must be added to floor-extended base cabinets prior to application of cove molding. Cove molding is required and is to be supplied by others. Base trim is always black. Base trim must be ordered separately.

▶ See page 172 for base trim.

For floor-extended printer cabinets, adjustable glides adjust for installation on uneven floors. Adjustability range is 2".

Drawers include heavy-duty, full-extension drawer slides.

Pull-out printer cabinets can also be utilized for ADA height microwave storage. Equipment specifications and ventilation requirements should be verified.

Floor-extended and wall-suspended base cabinets flex parametrically in 1" increments for width and depth.

Cabinets mount and align along a continuous rail system. The bracket-to-rail attachment allows for micro-adjustability. Brackets and bracket covers are included with every cabinet. Rail must be ordered separately from the cabinet.

▶ See page 168 for rails.

Printer cabinets can be specified with or without a drawer under the pullout shelf.

Printer cabinet exposed interiors are finished with the specified High-Pressure Laminate. Drawer interiors and the interior of pullout shelf fronts are finished with 2730 Arctic White High-Pressure Laminate.

Product Details

Cabinets have a wet glue and dowel, case clamp construction.

All surfaces, including cabinet interiors, are finished with High-Pressure Laminate.

Edges on cabinets are matching 1 mm plastic edge banding. Drawer edges are matching 3 mm plastic edge banding.

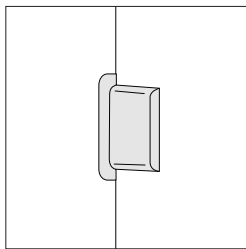

Bracket covers are included with cabinets and come in white only.

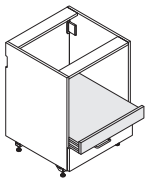

Pullout printer shelves fully extend, providing easy access and visibility.

A 2 1/4" gap is present at the back of the pullout printer shelf which allows space for cable management.

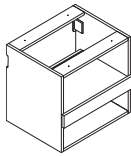

Printer cabinets without a drawer will have an open cavity below the pull-out shelf. The open cavity is 6 3/8"H.

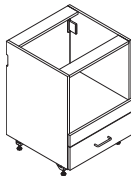

When adding a drawer to the printer cabinet, cabinets 24"W or less will include a single drawer. Cabinets 25"W or wider default to two drawers, side by side.

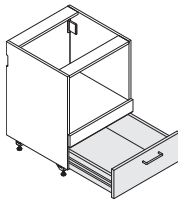

Drawers include heavy-duty, full-extension drawer slides.

Printer cabinets are only available in modular heights. Widths and depths can adjust parametrically in 1" increments.

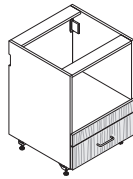

Woodgrain laminate matches on all drawer sets and is always applied vertically.

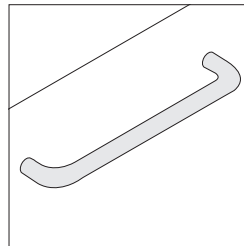

D pulls are standard.

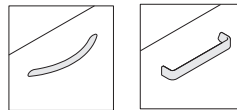

Additional drawer pull options are available. Optional pulls include:

- Contemporary
 - Jazz
 - No pull
- Tip: Cabinets with no pull option selected come with no drawer pulls or drill holes.*

Surface Materials

Cabinet, drawer front, and shelf

- High-Pressure Laminate

Edges

- Matching plastic

Drawer interior and pullout shelf front interior

- 2730 Arctic White

D pulls, contemporary, and jazz pulls

- 0835 Black
- 9201 Polished Chrome
- 9211 Nickel
- 9212 Silver

Bracket covers

- 6009 Arctic White
- 6527 Merle

Shipping

All cabinets ship fully assembled.

Handles will be shipped on the cabinets, but facing the interior to prevent damage.

Floor-extended glides are not installed on the cabinets prior to shipping. Holes are pre-drilled. These items must be field-installed.

Connections

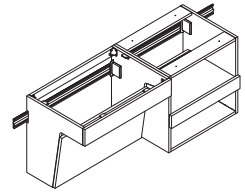

Printer cabinets attach to a rail system utilizing a bracket connection. The rail aids in alignment to adjacent cabinets. The rail must be ordered separate from the cabinet.
▶ See page 168 for rails.

Cabinets should be ganged together with screws provided.

Integrated rail attachment bracket's micro-adjustability accounts for architectural wall variances to deliver refined alignment.

For minimum wall construction and electrical clearances, see *Convey Technical Cut Sheet*, available at village.steelcase.com.

Convey Printer Cabinets, continued

Application Topics

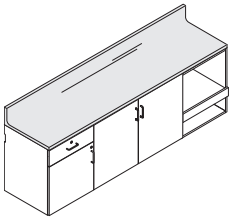

Workspace will span entire length of run of cabinets, up to 138"W for solid surface worksurfaces and up to 120"W for High-Pressure Laminate worksurfaces. ▶ See pages 154-158 for worksurfaces.

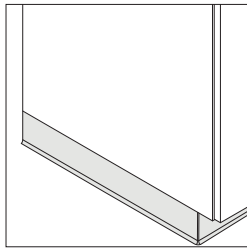

Cove molding must be field installed on base trim to complete an installation and is supplied locally. The base trim on the cabinet is inset. See *Convey Technical Cut Sheet*, available at village.steelcase.com.

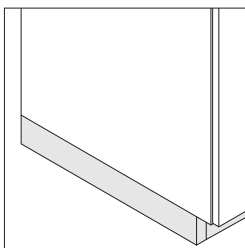

Base trim must be added to floor-extended printer cabinets prior to application of cove molding. Base trim is always black. Base trim must be ordered separately. ▶ See page 172 for base trim.

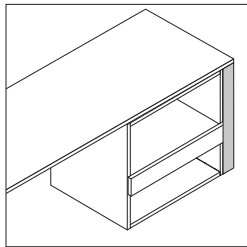

Fillers close the gap between the side of a cabinet and a structural wall. ▶ See page 144 for fillers.

Notch fillers or cover panels must be used to conceal the bracket-to-rail connection at the end of a run. Cover panels attach to the side of casework and add a 1/2" to the overall planning width. ▶ See page 146 for cover panels.

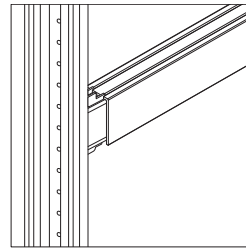

Convey rails attach to the structural beam by screwing through the skins. The V.I.A. spacer is required to fill the gap between the skin and the beam. Spacers are not visible once the skin is in place. Spacers span the width of the structural beam. ▶ See page 178 for V.I.A. spacer.

V.I.A. will accept Convey wall-suspended cabinets and upper cabinets. Convey follows all V.I.A. application rules for hang on components. See the *V.I.A. Specification Guide* for more details.

Maximum plan width for V.I.A. vertical posts with Convey is 48"W. Skins may be specified longer than 48"W and span these vertical components.

The Convey rail can span multiple 48"W lengths.

Reinforcing structural beams (FEBSTR) are required at rail locations inside the V.I.A. frame. An additional structural beam is required at the bottom to distribute the load evenly.

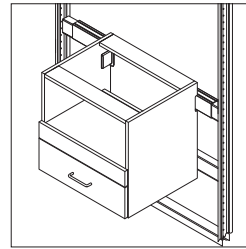

Base cabinets cannot be planned at 28 1/2" surface height as there is not enough room to support the structural beams needed at the bottom and top of the case.

Electrical Clearance Zones

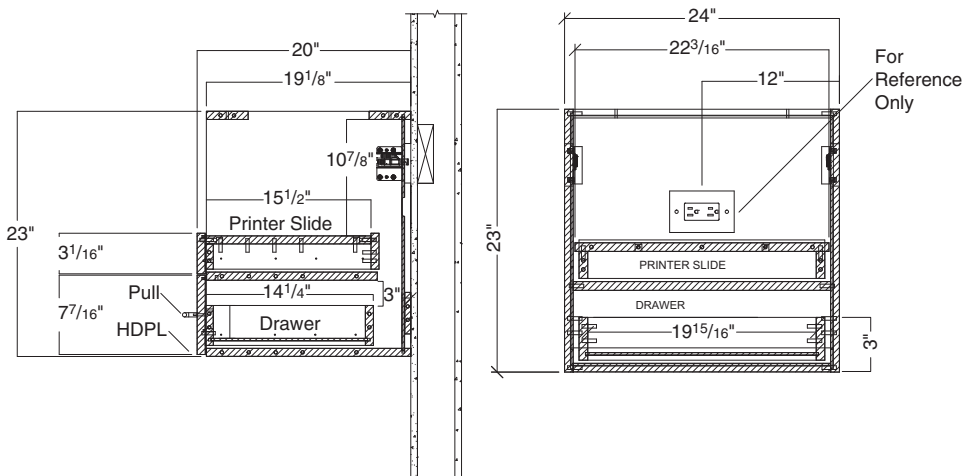

Tip: See all Convey sections by visiting <https://www.steelcase.com/resources/documents/convey-sections/>

Convey Pullout Trash Cabinets

Floor-extended and wall-suspended pullout trash cabinets provide a concealed storage location for trash, soiled linens, and other customer-supplied bins.

Tip: Trash bins are not included.

► Specifying, page 112

Tops of cabinets are open and require attachment to a worksurface that is ordered separately. Attachment hardware is included with the cabinetry.

Notches must be covered by cover panels or a notch filler for end-of-run conditions.

► See page 144 for cover panels.

All edges are finished from the factory with matching plastic edge banding.

Blocking/banding is required for wall-suspended cabinets. Blocking/banding for floor-extended cabinets may not be required in architectural walls behind the rail, depending on the application. Check local and state codes for blocking/banding requirements (i.e. seismic zones). Placement of blocking/banding is to be coordinated with the responsible trades.

Base trim must be added to floor-extended base cabinets prior to application of cove molding. Cove molding is required and is to be supplied by others. Base trim is always black. Base trim must be ordered separately.
► See page 172 for base trim.

Cabinet interiors are finished with 2730 Arctic White High-Pressure Laminate.

D pulls are standard on drawers in a nickel finish. Additional finishes and pull options are available.

Pullout trash cabinets include a wire hoop utilized to hold customer-supplied interior bins in place.

Drawers include heavy-duty, full-extension drawer slides.

Cabinets mount along a continuous rail system. The bracket-to-rail attachment allows for micro-adjustability. Brackets and bracket covers are included with every cabinet. Rail must be ordered separately from the cabinet.
► See page 168 for rails.

For floor-extended trash cabinets, adjustable glides adjust for installation on uneven floors. Adjustability range is 2".

Floor-extended and wall-suspended base cabinets flex parametrically in 1" increments for width and depth.

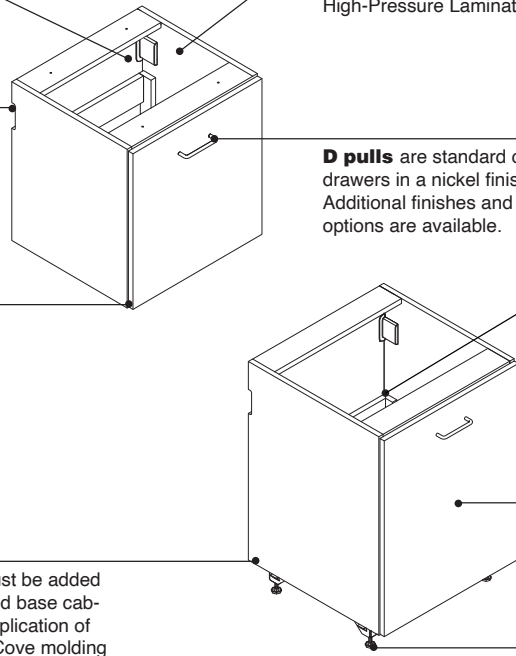

Product Details

Cabinets have a wet glue and dowel, case clamp construction.

All surfaces, including cabinet interiors, are finished with High-Pressure Laminate.

Edges on cabinets are matching 1 mm plastic edge banding. Drawer edges are matching 3 mm plastic edge banding.

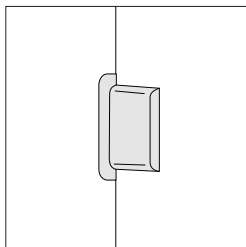

Bracket covers are included with cabinets and come in white only.

Pullout drawer includes heavy-duty, full extension slides, providing easy access and visibility.

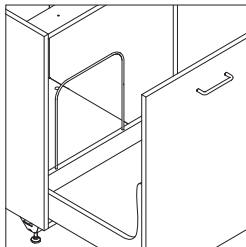

A removable wire hoop is included in the pullout drawer to hold customer supplied interior bins in place.

Trash cabinets are only available in modular heights. Widths and depths can adjust parametrically in 1" increments. See the *Convey Technical Cut Sheet* for interior dimensions ([village.steelcase.com](#)).

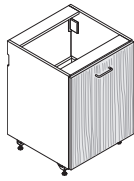

Woodgrain laminate is always applied vertically.

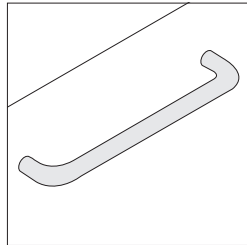

D pulls are standard.

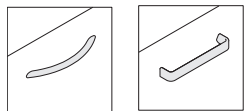

Contemporary Jazz

Additional drawer pull options are available. Optional pulls include:

- Contemporary
- Jazz
- No pull

Tip: Cabinets with no pull option selected come with no drawer pulls or drill holes.

Connections

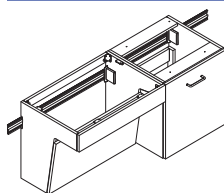

Trash cabinets attach to a rail system utilizing a bracket connection. The rail aids in alignment to adjacent cabinets. The rail must be ordered separate from the cabinet. ▶ See page 168 for rails.

Cabinets should be ganged together with screws provided.

Integrated rail attachment bracket's micro-adjustability accounts for architectural wall variances to deliver refined alignment.

For minimum wall construction and electrical clearances, see *Convey Technical Cut Sheet*, available at [village.steelcase.com](#).

Surface Materials

Cabinet and drawer front

- High-Pressure Laminate

Edges

- Matching plastic

Drawer interior

- 2730 Arctic White

D pulls, contemporary, and jazz pulls

- 0835 Black
- 9201 Polished Chrome
- 9211 Nickel
- 9212 Silver

Bracket covers

- 6009 Arctic White

Shipping

All cabinets ship fully assembled.

Handles will be shipped on the cabinets, but facing the interior to prevent damage.

Floor-extended glides are not installed on the cabinets prior to shipping. Holes are pre-drilled. These items must be field-installed.

Application Topics

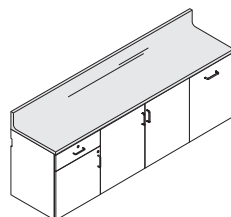

Worksurface will span entire length of run of cabinets, up to 138"W for solid surface worksurfaces and up to 120"W for High-Pressure Laminate worksurfaces. ▶ See pages 154-158 for worksurfaces.

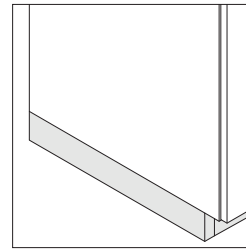

Base trim must be added under base cabinet prior to application of cove molding. Base trim is always black. ▶ See page 172 for base trim.

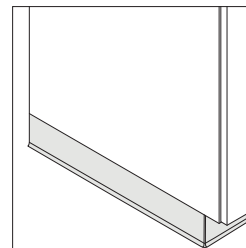

Cove molding must be field installed on base trim to complete an installation and is supplied locally. The base trim on the cabinet is inset. See *Convey Technical Cut Sheet*, available at [village.steelcase.com](#).

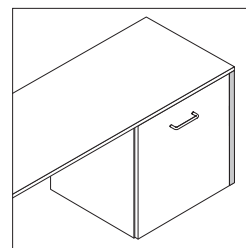

Fillers close the gap between the side of a cabinet and a structural wall. Additional length worksurface will be required. ▶ See page 166 for fillers.

Notch fillers or cover panels must be used to conceal the bracket-to-rail connection at the end of a run. Cover panels attach to the side of casework and add a 1/2" to the overall planning width. ▶ See page 144 for cover panels.

V.I.A. will accept Convey wall-suspended cabinets and upper cabinets. Convey follows all V.I.A. application rules for hang on components. See the *V.I.A. Specification Guide* for more details.

Maximum plan width for V.I.A. vertical posts with Convey is 48"W. Skins may be specified longer than 48"W and span these vertical components.

The Convey rail can span multiple 48"W lengths.

Reinforcing structural beams (FEBSTR) are required at rail locations inside the V.I.A. frame. An additional structural beam is required at the bottom to distribute the load evenly.

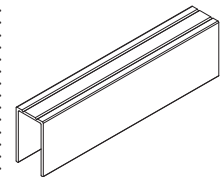

Convey rails attach to the structural beam by screwing through the skins. The V.I.A. spacer is required to fill the gap between the skin and the beam. Spacers are not visible once the skin is in place. Spacers span the width of the structural beam. ▶ See page 178 for V.I.A. spacer.

Base cabinets cannot be planned at 28 1/2" surface height as there is not enough room to support the structural beams needed at the bottom and top of the case.

Convey Garage Cabinets

Garage cabinets are floor extended and provide a storage location for carts and other equipment.

► Specifying, page 114

Tops of cabinets are open and require attachment to a worksurface that is ordered separately. Attachment hardware is included with the cabinetry.

Notches must be covered by cover panels or a notch filler for end-of-run conditions.

► See page 144 for cover panels.

All edges are finished from the factory with matching plastic edge banding.

Blocking/banding may not be required in architectural walls behind the rail, depending on the application. Check local and state codes for blocking/banding requirements (i.e. seismic zones). Placement of blocking/banding is to be coordinated with the responsible trades.

Cove molding is required and is to be supplied by others.

Exposed interiors are finished with the specified High-Pressure Laminate.

Cabinets mount and align along a continuous rail system. The bracket-to-rail attachment allows for micro-adjustability. Brackets and bracket covers are included with every cabinet. Rail must be ordered separately from the cabinet.

► See page 168 for rails.

D pulls are standard on doors in a nickel finish. Additional finishes and pull options are available.

Garage cabinets can be ordered with or without a back, depending on the plumbing, electrical, or venting requirements.

Adjustable glides adjust for installation on uneven floors. Adjustability range is 2".

Floor-extended base cabinets flex parametrically in 1" increments for width and depth.

Garage cabinets can be ordered with or without a door.

Product Details

Cabinets have a wet glue and dowel, case clamp construction.

All surfaces, including cabinet interiors, are finished with High-Pressure Laminate.

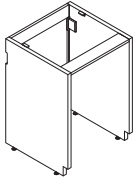

Garage cabinets extend to the floor and have inset floor glides.

Garage cabinets do not have a base and are open to the floor.

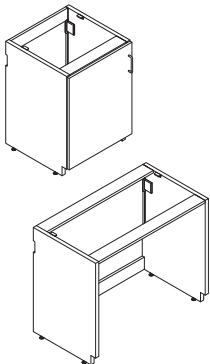

Garage cabinets can be specified with or without a back and with or without a door. Open back garage cabinets include upper and lower stretchers. Reference the *Convey Section Views* for clearance zones, available at village.steelcase.com.

Edges on cabinets are matching 1 mm plastic edge banding. Door edges are matching 3 mm edge banding.

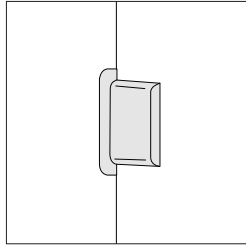

Bracket covers are included with cabinets and are available in white or merle.

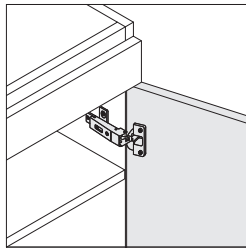

Euro hinge is standard on cabinet door and allows the door to open a full 110°.

Garage hinges encroach the interior clearance by 2 5/8" per side.

Soft close door hinges are standard.

Hinge angle limiter is available for door units and limits the angle to 87°. This is recommended when near adjacent walls or in corner applications.

▶ See page 172 for hinge angle limiter.

Single-door cabinets are hinged on the left or right side. A left-hand unit has the hinge on the left side of the door. A right-hand unit has the hinge on the right side of the door.

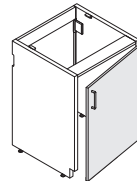
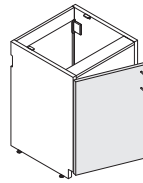

Cabinets 24"W or less have a single door. Cabinets 25"W or wider default to two doors.

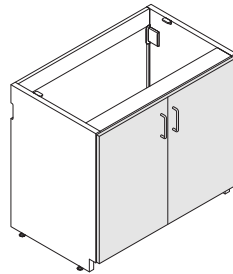

Double-door cabinets open from the center out.

Garage cabinets are only available in modular heights. Widths and depths can adjust parametrically in 1" increments.

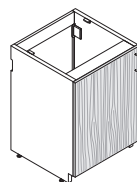

Woodgrain laminate matches on all door sets and is always applied vertically.

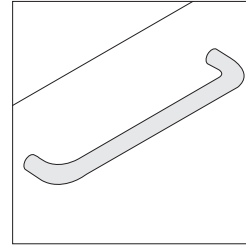

D pulls are standard.

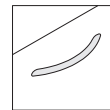

Contemporary

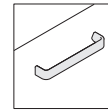

Jazz

Additional door pull options are available.

Optional pulls include:

- Contemporary
- Jazz
- No pull

Tip: Cabinets with no pull option selected come with no door pulls or drill holes.

Connections

Garage cabinets attach to a rail system utilizing a bracket connection. The rail aids in alignment to adjacent cabinets. The rail must be ordered separate from the cabinet.

▶ See page 168 for rails.

Integrated rail attachment bracket's micro-adjustability

accounts for architectural wall variances to deliver refined alignment.

For minimum wall construction and electrical clearances, see *Convey Technical Cut Sheet*, available at village.steelcase.com.

Surface Materials

Cabinet and door fronts

- High-Pressure Laminate

Edges

- Matching plastic

Cabinet interior on garage cabinets with doors

- 2730 Arctic White

D pulls, contemporary, and jazz pulls

- 0835 Black
- 9201 Polished Chrome
- 9211 Nickel
- 9212 Silver

Bracket covers

- 6009 Arctic White
- 6527 Merle (option on open garage cabinets only)

Euro hinges

- Nickel

Shipping

All cabinets ship fully assembled.

Handles will be shipped on the cabinets, but facing the interior to prevent damage.

Application Topics

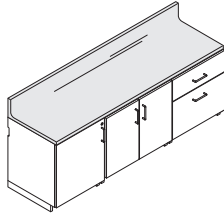

Worksurface will span entire length of run of cabinets, up to 138"W for solid surface worksurfaces and up to 120"W for High-Pressure Laminate worksurfaces.

▶ See pages 154-158 for worksurfaces.

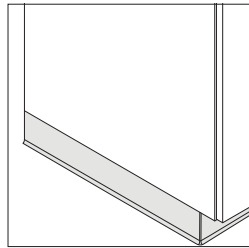

Cove molding must be field installed onto the garage cabinet base to complete an installation and is supplied locally. See *Convey Technical Cut Sheet*, available at village.steelcase.com.

Fillers close the gap between the side of a cabinet and a structural wall. Additional length worksurface will be required.

▶ See page 166 for fillers.

Notch fillers or cover panels must be used to conceal the bracket-to-rail connection at the end of a run. Cover panels attach to the side of casework and add a 1/2" to the overall planning width.

▶ See page 144 for cover panels.

Convey Sink Base Cabinets

Sink base cabinets are available with doors in a floor-extended or wall-suspended application, or in a wall-suspended cabinet with a removable angled front.

▶ See page 118

Sinks are specified with the worksurface for work-surfaces with sinks and are integral.

▶ See page 154

Notches must be covered by cover panels or a notch filler for end-of-run conditions.

▶ See page 146 for cover panels.

All edges are finished from the factory with matching plastic edge banding.

Angled sink base cabinets are designed to coordinate with both floor-extended and wall-suspended adjacent cabinets.

Back of sink base cabinets are open to access plumbing.

Blocking/banding is required for wall-suspended cabinets. Blocking/banding for floor-extended cabinets may not be required in architectural walls behind the rail, depending on the application. Check local and state codes for blocking/banding requirements (i.e. seismic zones). Placement of blocking/banding is to be coordinated with the responsible trades.

Cabinets mount and align along a continuous rail system. The bracket-to-rail attachment allows for micro-adjustability. Brackets and bracket covers are included with every cabinet. Rail must be ordered separately from the cabinet.

▶ See page 168 for rails.

Cabinet interiors are finished with 2730 Arctic White High-Pressure Laminate.

Tops of cabinets are open and require attachment to a worksurface that is ordered separately. Attachment hardware is included with the cabinetry.

D pulls are standard on doors in a nickel finish. Additional finishes and pull options are available.

For floor-extended sink base cabinets, adjustable glides adjust for installation on uneven floors. Adjustability range is 2".

Floor-extended and wall-suspended base cabinets flex parametrically in 1" increments for width and depth.

Base trim must be added to floor-extended sink base cabinets prior to application of cove molding. Cove molding is required and is to be supplied by others. Base trim is always black. Base trim must be ordered separately.

▶ See page 172 for base trim.

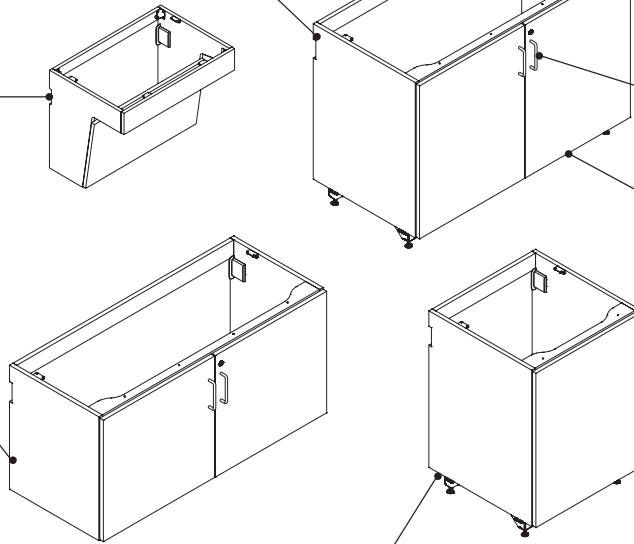

Product Details

Cabinets have a wet glue and dowel, case clamp construction.

All surfaces, including cabinet interiors, are finished with High-Pressure Laminate.

Edges on cabinets are matching 1 mm plastic edge banding. Drawer and door edges are matching 3 mm plastic edge banding.

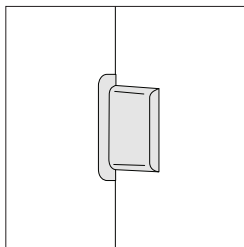

Bracket covers are included with cabinets and come in white only.

Angled sink base cabinets meet the guidelines set forth in the United States Department of Justice 2010 ADA Standards for Accessible Design (www.ada.gov/2010A-DA-standards). Floor to underside of cabinet must clear dimension of 27"H. For compliance, worksurface must be maximum 34" AFF (Above Finished Floor). Not all states follow the same ADA guidelines. Reference local codes.

Angled sink base cabinets are available 21"H and 23"H. Change-of-height angled-sink cabinets are 21"H and allow for installation of a 34" AFF (Above Finished Floor) sink cabinet next to 36"H AFF (Above Finished Floor) base cabinets. This is required to allow for one continuous rail.

When sizes between 37"W-42"W are required, a 42"W cabinet must be specified and be cut to fit in the field.

Angled sink base cabinets have a removable panel that can be removed without tools for easy access to plumbing.

All sink cabinets are open to the wall, providing easy access to plumbing.

Wall-suspended sink base cabinets do not have a base and are open to the floor.

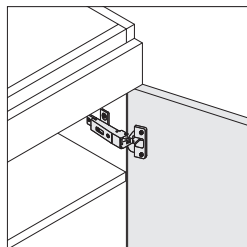

Euro hinge is standard on cabinet door and allows the door to open a full 110°.

Soft close door hinges are standard.

Hinge angle limiter is available for door units and limits the angle to 87°. This is recommended when near adjacent walls or in corner applications. ▶ See page 172 for hinge angle limiter.

Cabinets 24"W or less have a single door. Cabinets 25"W or wider default to two doors.

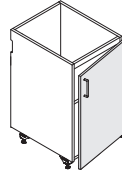
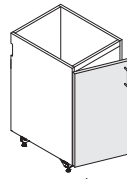

Single-door cabinets are hinged on the left or right side. A left-hand unit has the hinge on the left side of the door. A right-hand unit has the hinge on the right side of the door.

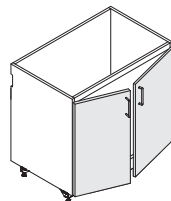

Double-door cabinets open from the center out.

Double-door include a sequential latch. The right door must be opened prior to the left.

Double doors include a sequential latch. The right door must be opened prior to the left. This is beneficial when locking the cabinet as only the right door needs the locking mechanism. The sequential latch can be removed in the field.

All door cabinets include one adjustable shelf.

Sink base cabinets are only available in modular heights. Widths and depths can parametrically adjust in 1" increments.

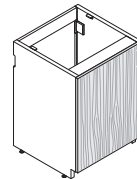

Woodgrain laminate matches on all door sets and is always applied vertically.

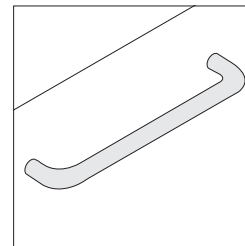

D pulls are standard.

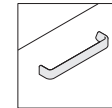
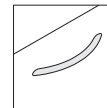

Contemporary Jazz

Additional door pull options are available. Optional pulls include:

- Contemporary
- Jazz
- No pull

Tip: Cabinets with no pull option selected come with no door pulls or drill holes.

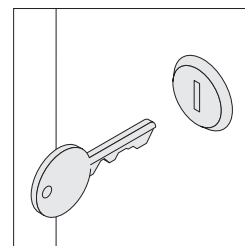

Sink base cabinets with doors default to locking.

Locks are only available with master keying. Locks are field installed and must be specified separately. ▶ *Lock and Keying*, page 398

When manual locks are specified, a lock plug will default in all doors of the individual cabinet.

Electronic locks should not be used with sink cabinets.

Surface Materials

Cabinet and door fronts

- High-Pressure Laminate

Edges

- Matching plastic

Cabinet interior

- 2730 Arctic White

D pulls, contemporary, and jazz pulls

- 0835 Black
- 9201 Polished Chrome
- 9211 Nickel
- 9212 Silver

Bracket covers

- 6009 Arctic White

Euro hinges

- Nickel

Lock

- 9201 Polished Chrome only

Shipping

All cabinets ship fully assembled.

Handles will be shipped on the cabinets, but facing the interior to prevent damage.

Floor-extended glides are not installed on the cabinets prior to shipping. Holes are pre-drilled. These items must be field-installed.

Connections

Sink base cabinets attach to a rail system utilizing a bracket connection. The rail aids in alignment to adjacent cabinets. The rail must be ordered separate from the cabinet.
▶ See page 168 for rails.

Integrated rail attachment bracket's micro-adjustability accounts for architectural wall variances to deliver refined alignment.

Cabinets should be ganged together with screws provided.

For minimum wall construction and electrical clearances, see Convey Technical Cut Sheet, available at village.steelcase.com.

Application Topics

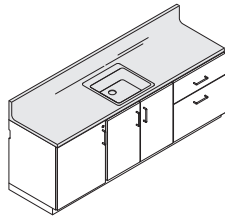

Worksurface will span entire length of run of cabinets, up to 138"W for solid surface worksurfaces and up to 120"W for High-Pressure Laminate worksurfaces.
▶ See pages 154-158 for worksurfaces.

Integral, seamless solid surface sink bowl and integral back-splash is available on solid surface work-surface only. Additive backsplash is available for High-Pressure Laminate worksurface. Additive sidesplash is available for both solid surface and High-Pressure Laminate worksurfaces.

Faucet and drain hardware are not offered from Steelcase and must be coordinated with parties responsible. Faucet holes are not factory drilled and must be coordinated in the field.
▶ See pages 154-158 for worksurfaces.

Sinks must be field supplied and installed for High-Pressure Laminate worksurfaces.

Plumbing must be coordinated and communicated with responsible trades.

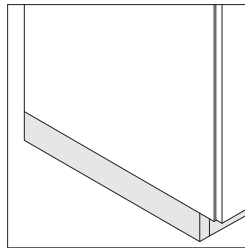

Base trim must be added to floor-extended sink base cabinets prior to application of cove molding. Base trim is always black. Base trim must be ordered separately.
▶ See page 172 for base trim.

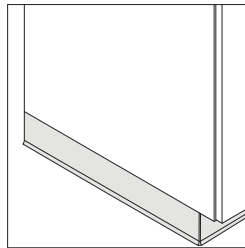

Cove molding must be field installed on base trim to complete an installation and is supplied locally. The base trim on the cabinet is inset. See *Convey Technical Cut Sheet*, available at village.steelcase.com.

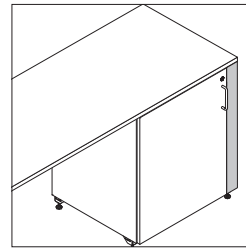

The Convey rail can span multiple 48"W lengths.

Reinforcing structural beams (FEBSTR) are required at rail locations inside the V.I.A. frame. An additional structural beam is required at the bottom to distribute the load evenly.

Fillers close the gap between the side of a sink base cabinet with doors and a structural wall. Fillers are not available on angled sinks. Additional length worksurface will be required.
▶ See page 166 for fillers.

Notch fillers or cover panels must be used to conceal the bracket-to-rail connection at the end of a run. Cover panels attach to the side of case-work and add a 1/2" to the overall planning width.
▶ See page 144 for cover panels.

V.I.A. will accept Convey wall-suspended cabinets and upper cabinets. Convey follows all V.I.A. application rules for hang on components. See the *V.I.A. Specification Guide* for more details.

Maximum plan width for V.I.A. vertical posts with Convey is 48"W. Skins may be specified longer than 48"W and span these vertical components.

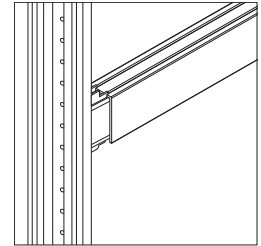

Convey rails attach to the structural beam by screwing through the skins. The V.I.A. spacer is required to fill the gap between the skin and the beam. Spacers are not visible once the skin is in place. Spacers span the width of the structural beam.
▶ See page 178 for V.I.A. spacer.

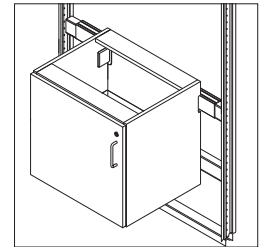

Base cabinets cannot be planned at 28 1/2" surface height as there is not enough room to support the structural beams needed at the bottom and top of the case.

Plumbing Clearance Zones

Base Cabinet, Angled Sink

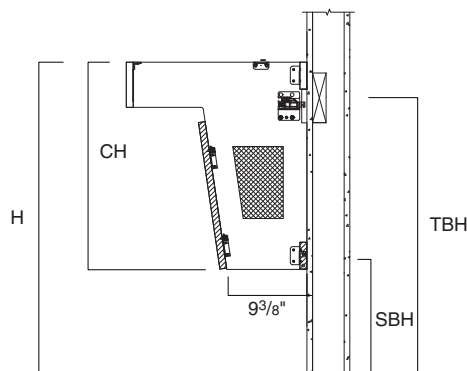

Tip: See all Convey sections by visiting <https://www.steelcase.com/resources/documents/convey-sections/>



Convey Wardrobe Cabinets

Floor-extended and wall-suspended wardrobe cabinets

are available with hooks or rods for patient or caregiver belongings.

► Specifying, page 122

All edges are finished from the factory with matching plastic edge banding.

Cabinets mount and align along a continuous rail system. The bracket-to-rail attachment allows for micro-adjustability. Brackets and bracket covers are included with every cabinet. Rail must be ordered separately from the cabinet.
► See page 168 for rails.

Blocking/banding is required for wall-suspended cabinets. Blocking/banding for floor-extended cabinets may not be required in architectural walls behind the rail, depending on the application. Check local and state codes for blocking/banding requirements (i.e. seismic zones). Placement of blocking/banding is to be coordinated with the responsible trades.

Drawers include heavy-duty, full-extension drawer slides.

Notches must be covered by cover panels or a notch filler for end-of-run conditions.
► See page 144 for cover panels.

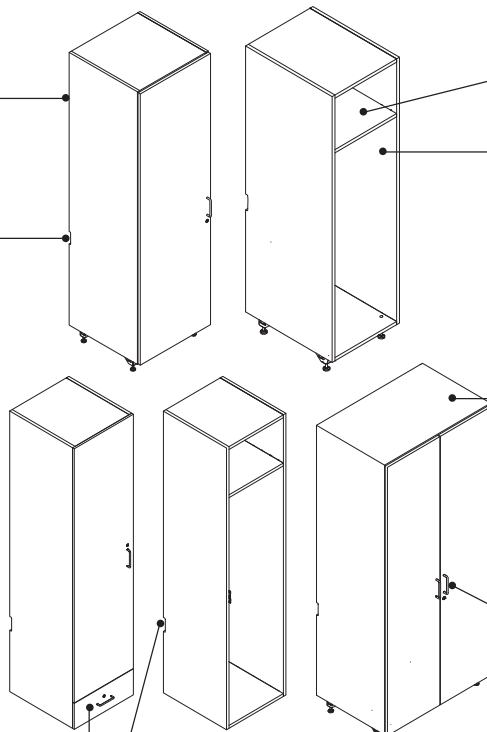

Base trim must be added to floor-extended wardrobe cabinets prior to application of cove molding. Cove molding is required and is to be supplied by others. Base trim is always black. Base trim must be ordered separately.

► See page 172 for base trim.

Wardrobe cabinets default with one fixed upper shelf.

Open wardrobe cabinets exposed interiors are finished with the specified High-Pressure Laminate. Drawer interiors and the interior of closed wardrobe cabinets are finished in 2730 Arctic White High-Pressure Laminate.

The tops of the wardrobe cabinets are finished.

Top conditions can be specified separate from the wardrobe cabinets, including sloped fascia, vertical fascia, flat top-cap cover panels, or ceiling fillers.
► See pages 148–152 for top conditions.

D pulls are standard on doors in a nickel finish. Additional finishes and pull options are available.

For floor-extended wardrobe cabinets, adjustable glides adjust for installation on uneven floors. Adjustability range is 2".

Wall-suspended wardrobe cabinets can be specified with or without a drawer in the base.

Wardrobe cabinets can be specified open or closed with a hinged door.

Wardrobe cabinets flex parametrically in 1" increments for width, depth, and height.

Product Details

Cabinets have a wet glue and dowel, case clamp construction.

All surfaces, including cabinet interiors, are finished with High-Pressure Laminate.

Edges on cabinets are matching 1 mm plastic edge banding. Drawer and door edges are matching 3 mm plastic edge banding.

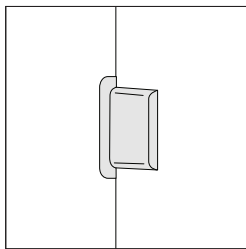

Bracket covers are included with cabinets and come in white only.

Wall-suspended wardrobe cabinets require both an upper and lower rail. Floor-extended cabinets only require an upper rail.

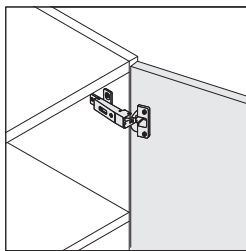

Euro hinge is standard on cabinet door and allows the door to open a full 110°.

Soft close door hinges are standard.

Hinge angle limiter is available for door units and limits the angle to 87°. This is recommended when near adjacent walls or in corner applications.

▶ See page 172 for hinge angle limiter.

Cabinets 24"W or less have a single door. Cabinets 25"W or wider default to two doors.

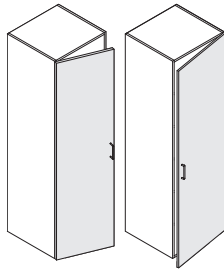

Single-door cabinets are hinged on the left or right side. A left-hand unit has the hinge on the left side of the door. A right-hand unit has the hinge on the right side of the door.

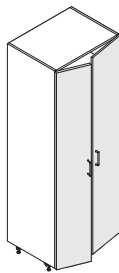

Double-door cabinets open from the center out.

Double doors include a sequential latch. The right door must be opened prior to the left.

Double doors include a sequential latch. The right door must be opened prior to the left. This is beneficial when locking the cabinet as only the right door needs the locking mechanism. The sequential latch can be removed in the field.

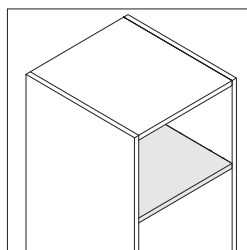

Wardrobe cabinets come with one fixed shelf.

Wardrobe cabinets less than 24"D and less than 24"W include two hooks, one on the inside left and one on the inside right. Floor-extended wardrobe cabinets greater than 24"D and less than 30"W will have a coat rod side to side. Wall-suspended wardrobe cabinets 24"D and 24"W include a clothing rod front to back.

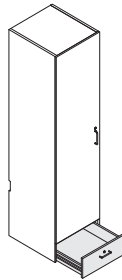

Optional drawer on wall-suspended wardrobe with door includes heavy-duty, full-extension slides.

Wardrobe cabinet heights, widths, and depths can parametrically adjust in 1" increments.

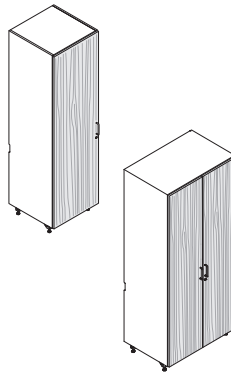

Woodgrain laminate matches on all door and drawer fronts and is always applied vertically.

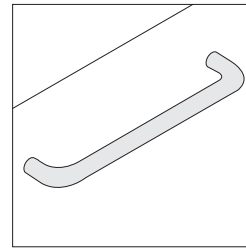

D pulls are standard.

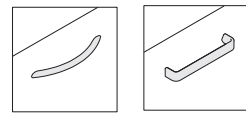

Contemporary Jazz

Additional door pull options are available.

Optional pulls include:

- Contemporary
- Jazz
- No pull

Tip: Cabinets with no pull option selected come with no drawer pulls or drill holes.

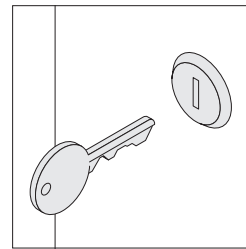

Locks are optional and only available with master keying. Locks are field installed and must be specified separately.

▶ *Lock and Keying*, page 398

When manual locks are specified, a lock plug will default in all doors and drawers of the individual cabinet.

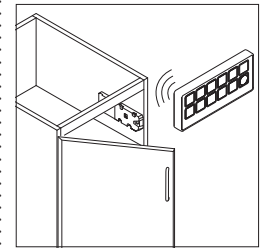

Electronic locks are optional and field installed. Lock receivers can be installed on drawers and doors and are wirelessly controlled by a transmitter.

Tip: Transmitters are ordered separately.

▶ See page 174 for electronic locks.

When electronic locks are specified, all doors and drawers will default to locking on the individual cabinet.

Connections

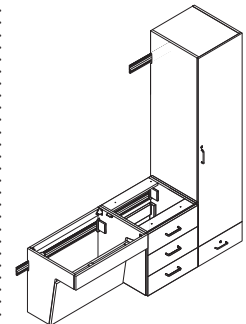

Cabinets attach to a rail system utilizing a bracket connection. The rail aids in alignment to adjacent cabinets. The rail must be ordered separate from the cabinet.

▶ See page 168 for rails.

Cabinets should be ganged together with screws provided.

Integrated rail attachment bracket's micro-adjustability accounts for architectural wall variances to deliver refined alignment.

For minimum wall construction and electrical clearances, see *Convey Technical Cut Sheet*, available at village.steelcase.com.

Surface Materials

Cabinet, door, and drawer front

- High-Pressure Laminate

Edges

- Matching plastic

Drawer interior and closed wardrobe cabinet interior

- 2730 Arctic White

D pulls, contemporary, and jazz pulls

- 0835 Black
- 9201 Polished Chrome
- 9211 Nickel
- 9212 Silver

Bracket covers

- 6009 Arctic White
- 6527 Merle (option on open wardrobe cabinets only)

Euro hinges

- Nickel

Lock

- 9201 Polished Chrome only

Shipping

All cabinets ship fully assembled.

Handles will be shipped on the cabinets, but facing the interior to prevent damage.

Floor-extended glides are not installed on the cabinets prior to shipping. Holes are pre-drilled. These items must be field-installed.

Application Topics

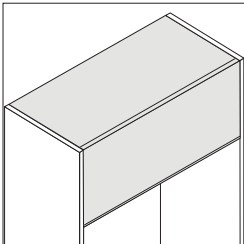
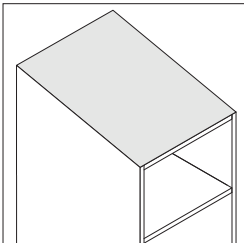

Sloped fascia, vertical fascia, or flat top-cap cover panels

can be specified as a top condition on the wardrobe.

▶ See pages 148–152 for top conditions.

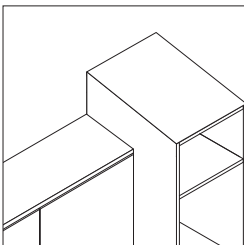

Wardrobe cabinets

specified with a sloped fascia top condition, and installed next to an upper cabinet of a different depth, will result in a step down. Doors will align between upper cabinet and wardrobe cabinet. Cover panels will be required in between the wardrobe cabinet and upper cabinet.

▶ See pages 148–152 for top conditions.

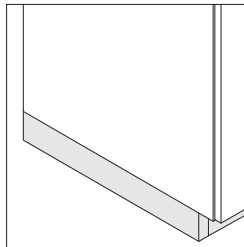

Base trim must be added to floor-extended wardrobe cabinets prior to application of cove molding. Base trim is always black. Base trim must be ordered separately. ▶ See page 172 for base trim.

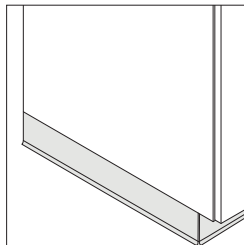

Cove molding must be field installed on base trim to complete an installation and is supplied locally. The base trim on the cabinet is inset. See the *Convey Technical Cut Sheet*, available at village.steelcase.com.

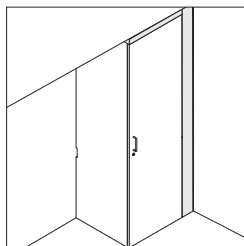

Fillers close the gap between the side of a cabinet and a structural wall. Ceiling fillers can also be specified to fill the gap between the top of a wardrobe cabinet and a structural ceiling.

Notch fillers or cover panels must be used to conceal the bracket-to-rail connection at the end of a run. Cover panels attach to the side of casework and add a 1/2" to the overall planning width. ▶ See page 144 for cover panels.

V.I.A. will accept Convey wall-suspended cabinets and upper cabinets. Convey follows all V.I.A. application rules for hang on components. See the *V.I.A. Specification Guide* for more details.

Maximum plan width for V.I.A. vertical posts with Convey is 48"W. Skins may be specified longer than 48"W and span these vertical components.

The Convey rail can span multiple 48"W lengths.

Reinforcing structural beams (FEBSTR) are required at rail locations inside the V.I.A. frame. An additional structural beam is required at the bottom to distribute the load evenly.

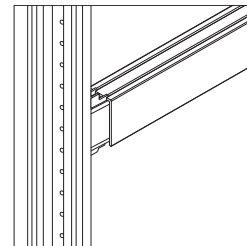

Convey rails attach to the structural beam by screwing through the skins. The V.I.A. spacer is required to fill the gap between the skin and the beam. Spacers are not visible once the skin is in place. Spacers span the width of the structural beam. ▶ See page 178 for V.I.A. spacer.

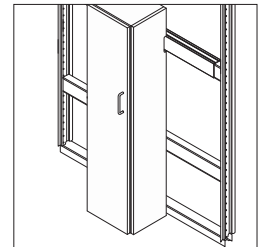

Base cabinets cannot be planned at 28 1/2" surface height as there is not enough room to support the structural beams needed at the bottom and top of the case.



Convey Tall Storage Cabinets

Storage cabinets are available as floor extended only.

▶ Specifying, page 128

Storage cabinets include shelves and can be specified with or without a hinged door.

Storage cabinets default with one centered, fixed shelf. Additional adjustable shelves are dependent on the height of the cabinet.

Cabinets mount and align along a continuous rail system. The bracket-to-rail attachment allows for micro-adjustability. Brackets and bracket covers are included with every cabinet. Rail must be ordered separately from the cabinet.

▶ See page 168 for rails.

Blocking/banding may not be required in architectural walls behind the rail, depending on the application. Check local and state codes for blocking/banding requirements (i.e. seismic zones). Placement of blocking/banding is to be coordinated with the responsible trades.

Notches must be covered by cover panels or a notch filler for end-of-run conditions.

▶ See page 144 for cover panels.

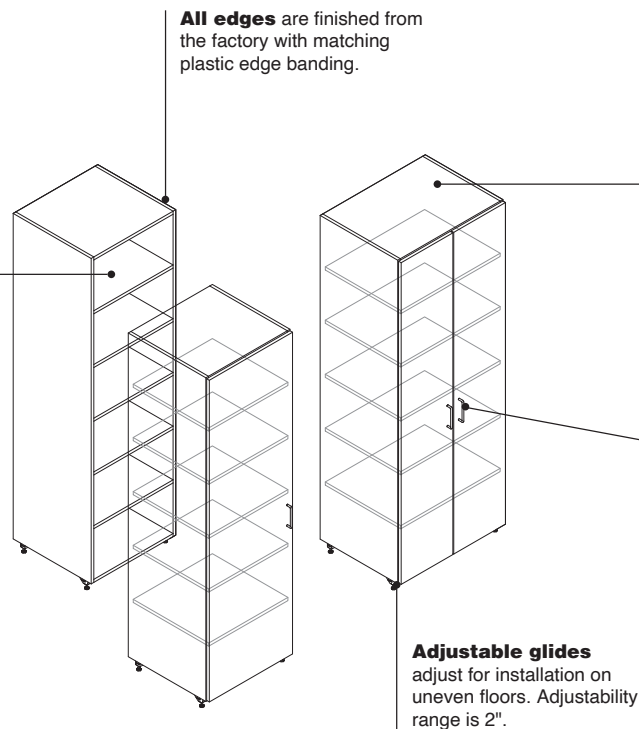

Base trim must be added to storage cabinets prior to application of cove molding. Cove molding is required and is to be supplied by others. Base trim is always black. Base trim must be ordered separately.

▶ See page 172 for base trim.

Open storage cabinets exposed interiors are finished with the specified High-Pressure Laminate. Interiors of closed storage cabinets are finished in 2730 Arctic White High-Pressure Laminate.

▶ See page 152 for vertical fascia.

The tops of the storage cabinet are finished.

Top conditions can be specified separate from the storage cabinets, including sloped fascia, vertical fascia, flat top-cap cover panels, or ceiling fillers.

▶ See pages 148–152 for top conditions.

D pulls are standard on doors in a nickel finish. Additional finishes and pull options are available.

Tall storage cabinets flex parametrically in 1" increments for width, depth, and height.

Product Details

Cabinets have a wet glue and dowel, case clamp construction.

All surfaces, including cabinet interiors, are finished with High-Pressure Laminate.

Edges on cabinets are matching 1 mm plastic edge banding. Drawer and door edges are matching 3 mm plastic edge banding.

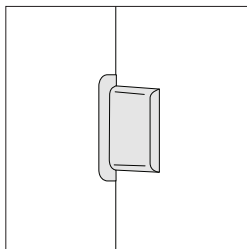

Bracket covers are included with cabinets. They can be specified in white or merle, when open. They are white only when closed.

Storage cabinets require an upper rail only.

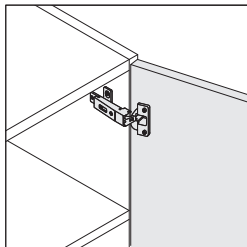

Euro hinge is standard on cabinet door and allows the door to open a full 110°.

Soft close door hinges are standard.

Hinge angle limiter is available for door units and limits the angle to 87°. This is recommended when near adjacent walls or in corner applications.
▶ See page 172 for hinge angle limiter.

Cabinets 24"W or less have a single door. Cabinets 25"W or wider default to two doors.

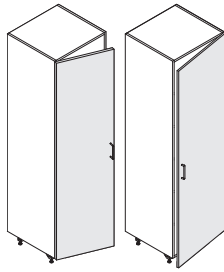

Single-door cabinets are hinged on the left or right side. A left-hand unit has the hinge on the left side of the door. A right-hand unit has the hinge on the right side of the door.

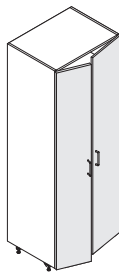

Double-door cabinets open from the center out.

Double doors include a sequential latch. The right door must be opened prior to the left.

Storage cabinets default to one centered, fixed shelf. Additional adjustable shelves are dependent on the height of the cabinet. Cabinets less than 60"H receive two adjustable shelves. Cabinets 60"H or greater, but less than 72"H, receive three adjustable shelves. Cabinets 72"H or greater receive four adjustable shelves.

Tip: There is a forced shelf count within storage cabinets. Extra adjustable shelves must be ordered separately.
▶ See page 168 for accessories.

Seismic clips are available for adjustable shelves. Clips lock the shelf and prevent movement front to back and up and down.

Storage cabinet heights, widths, and depths can adjust parametrically in 1" increments.

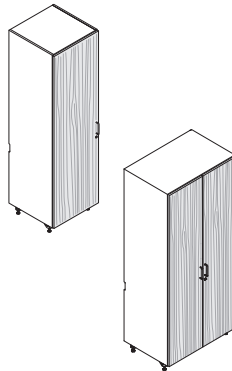

Woodgrain laminate matches on all doors fronts and is always applied vertically.

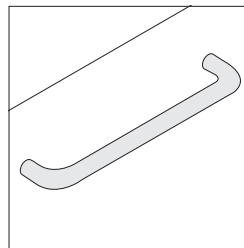

D pulls are standard.

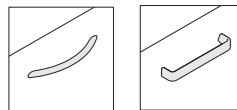

Contemporary Jazz

Additional door pull options are available. Optional pulls include:
• Contemporary
• Jazz
• No pull
Tip: Cabinets with no pull option selected come with no drawer pulls or drill holes.

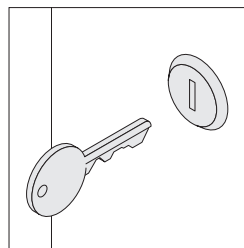

Locks are optional and only available with master keying. Locks are field installed and must be specified separately.
▶ *Lock and Keying*, page 398

When manual locks are specified, a lock plug will default in all doors and drawers of the individual cabinet.

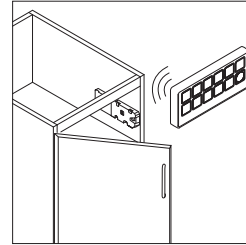

Electronic locks are optional and field installed. Lock receivers can be installed on drawers and doors and are wirelessly controlled by a transmitter.
Tip: Transmitters are ordered separately.
▶ See page 174 for electronic locks.

When electronic locks are specified, all doors will default to locking on the individual cabinet.

Connections

Cabinets attach to a rail system utilizing a bracket connection. The rail aids in alignment to adjacent cabinets. The rail must be ordered separate from the cabinet.
▶ See page 168 for rails.

Integrated rail attachment bracket's micro-adjustability accounts for architectural wall variances to deliver refined alignment.

Cabinets should be ganged together with screws provided.

For minimum wall construction and electrical clearances, see *Convey Technical Cut Sheet*, available at village.steelcase.com

Surface Materials

Cabinet, door front, and shelf
• High-Pressure Laminate

Edges
• Matching plastic

Closed storage cabinet interior
• 2730 Arctic White

D pulls, contemporary, and jazz pulls
• 0835 Black
• 9201 Polished Chrome
• 9211 Nickel
• 9212 Silver

Bracket covers
• 6009 Arctic White
• 6527 Merle (option on open storage cabinets only)

Euro hinges
• Nickel

Lock
• 9201 Polished Chrome only

Shipping

All cabinets ship fully assembled.

Handles will be shipped on the cabinets, but facing the interior to prevent damage.

Floor-extended glides are not installed on the cabinets prior to shipping. Holes are pre-drilled. These items must be field-installed.

Application Topics

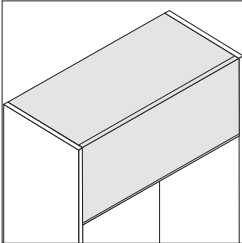
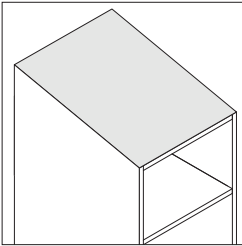

Sloped fascia, vertical fascia, or flat top-cap cover panels can be specified as a top condition on the storage cabinet.
 ▶ See pages 148–152 for top conditions.

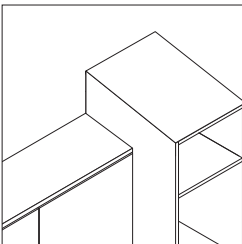

Storage cabinets specified with a sloped fascia top condition, and installed next to an upper cabinet of a different depth, will result in a step down. Doors will align between upper cabinet and tall storage cabinets. Cover panels will be required in between the storage cabinet and upper cabinet.
 ▶ See pages 148–152 for top conditions.

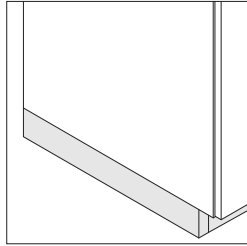

Base trim must be added to storage cabinets prior to application of cove molding. Base trim is always black. Base trim must be ordered separately.
 ▶ See page 172 for base trim.

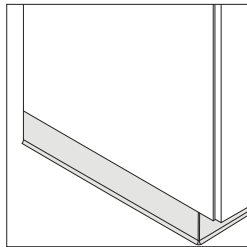

Cove molding must be field installed on base trim to complete an installation and is supplied locally. The base trim on the cabinet is inset. See the *Convey Technical Cut Sheet*, available at village.steelcase.com.

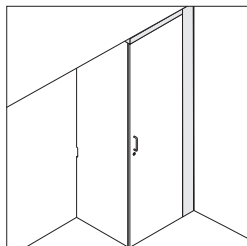

Fillers close the gap between the side of a cabinet and a structural wall. Ceiling fillers can also be specified to fill the gap between the top of a tall storage cabinet and a structural ceiling.

Notch fillers or cover panels must be used to conceal the bracket-to-rail connection at the end of a run. Cover panels attach to the side of casework and add a 1/2" to the overall planning width.
 ▶ See page 144 for cover panels.

Convey Upper Storage Cabinets

Upper storage cabinets

address storage needs above a worksurface.
 ▶ Specifying, page 132

Tops of upper cabinets are finished.

Seismic clips are available for adjustable shelves. These clips lock the shelf and prevent movement front to back and up and down.

Adjustable shelf is standard inside cabinets with doors. Shelves adjust in 32 mm increments. Additional shelves are available and must be ordered separately.
 ▶ See page 168 for accessories.

Cabinets can be specified with or without glove cutouts and holders, creating an organized solution for gloves. Width determines the quantity of glovebox supplies.

A no-bottom cabinet can be specified for easy access to suspended supplies.

Over-the-sink, no-bottom cabinet can be specified to conceal worktools behind the cabinet door, while maintaining easy access to supplies. The cabinet's shallower depth accommodates for proper head clearance when over a sink.

Blocking/banding may not be required in architectural walls behind the rail depending on the application. Check local and state codes for blocking/banding requirements (i.e. seismic zones). Placement of blocking/banding is to be coordinated with the responsible trades.

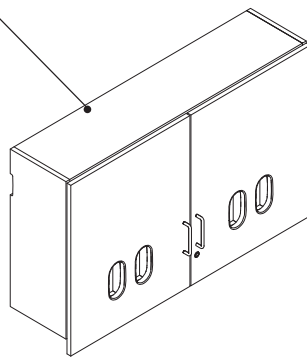

Cabinet interiors are finished with 2730 Arctic White High-Pressure Laminate.

All edges are finished from the factory with matching plastic edge banding.

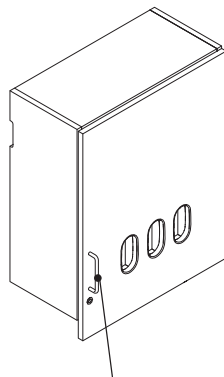

D pulls are standard on doors in a nickel finish. Additional finishes and pull options are available.

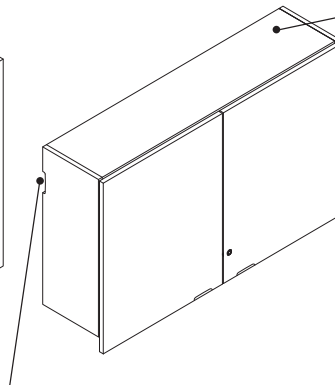

Notches must be covered by cover panels or a notch filler for end-of-run conditions.
 ▶ See page 144 for cover panels.

Top conditions can be specified separate from the storage cabinets, including sloped fascia, vertical fascia, flat top-cap cover panels, or ceiling fillers.
 ▶ See pages 148–152 for top conditions.

Product Details

Cabinets have a wet glue and dowel, case clamp construction.

All surfaces, including cabinet interiors, are finished with High-Pressure Laminate.

Edges on cabinets are matching 1 mm plastic edge banding. Door edges are matching 3 mm plastic edge banding.

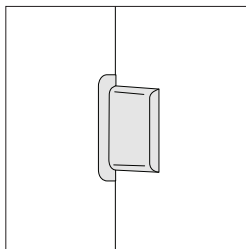

Bracket covers are included with cabinets and come in white only.

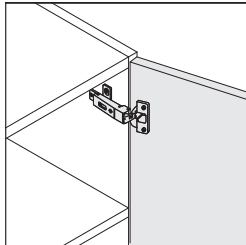

Euro hinge is standard on cabinet door and allows the door to open a full 110°.

Soft close door hinges are standard.

Hinge angle limiter is available for door units and limits the angle to 87°. This is recommended when near adjacent walls or in corner applications.

▶ See page 172 for hinge angle limiter.

Cabinets 24"W or less have a single door. Cabinets 25"W or wider default to two doors.

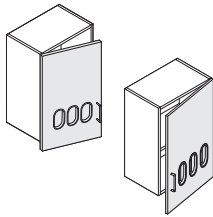

Single-door cabinets are hinged on the left or right side. A left-hand unit has the hinge on the left side of the door. A right-hand unit has the hinge on the right side of the door.

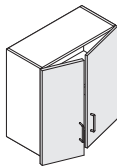

Double-door cabinets open from the center out.

Double doors include a sequential latch. The right door must be opened prior to the left. This is beneficial when locking the cabinet as only the right door needs the locking mechanism. The sequential latch can be removed in the field.

All door cabinets include one adjustable shelf.

Cabinets can be specified with glove cutouts, with glove holders, or with both cutouts and holders.

Over-the-sink, no-bottom cabinet includes one adjustable shelf that defaults to a seismic clip. No additional adjustable shelves can be added.

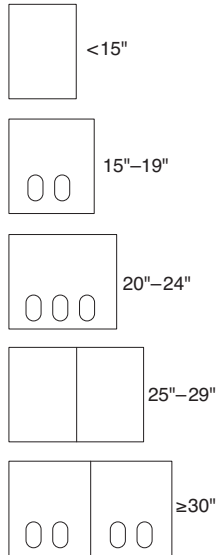

Glovebox cutouts are driven by the width of the cabinet doors. Cabinets less than 15"W do not offer glovebox cutouts. Cabinets 15"W–19"W will have two glovebox cutouts. Cabinets greater than 19"W and less than or equal to 24"W will have three glovebox cutouts. Cabinets greater than 24"W and less than 30"W do not offer glovebox cutouts due to each door being less than 15"W. Cabinets 30"W or greater will have four glovebox cutouts, split between the doors, i.e. two glovebox cutouts in each door.

Glovebox cutouts are only available with vertical orientation.

Grommets are fitted within the cutouts and are always merle.

Glovebox holders should not be specified in no bottom cabinets. There is not enough room to suspend paper towel holders or soap dispensers behind glove box holders.

▶ See *Convey Section Views* for exact clearances, available at village.steelcase.com.

Glove box holders can accommodate a glove box up to 3 1/2"D and 5 1/4"W.

Upper storage cabinets height, width, and depth can adjust parametrically in 1" increments.

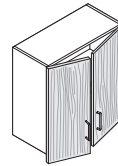

Woodgrain laminate matches on all doors and is always applied vertically.

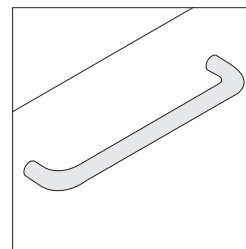

D pulls are standard.

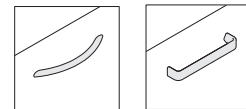

Contemporary Jazz

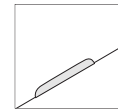

Hidden pull

Additional door pull options are available.

Optional pulls include:

- Contemporary
- Jazz
- Hidden pull
- No pull

Tip: Cabinets with no pull option selected come with no door pulls or drill holes.

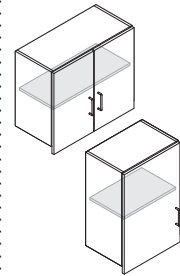

Cabinets include one adjustable shelf. Shelves are adjustable and removable. Additional adjustable shelves can be ordered separately.

▶ See page 168 for accessories.

Seismic clips are available for adjustable shelves. Clips lock the shelf and prevent movement front to back and up and down.

Cabinet doors extend 2 1/2" below the bottom of case. This provides a space for a light valance and allows for a continuous task light in between adjacent cases.

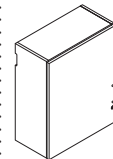

No-bottom cabinet doors match the case.

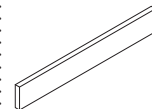

Light valances can be ordered when using task lighting to conceal the cables.

▶ See page 173 for accessories.

Light valances cannot be installed on a no-bottom cabinet.

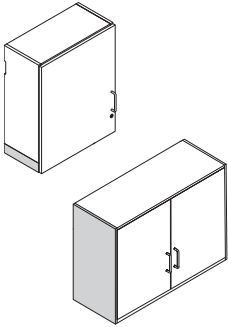
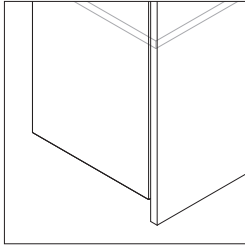

To enclose ends, a cover panel or light valance should be added.

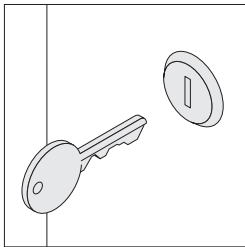

Locks are optional and only available with master keying. Locks are field installed and must be specified separately.

When manual locks are specified, a lock plug will default in all doors of the individual cabinet.

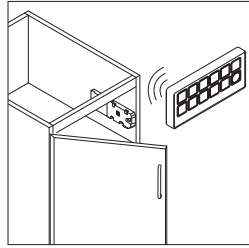

Electronic locks are optional and field installed. Lock receivers can be installed on drawers and doors and are wirelessly controlled by a transmitter. *Tip: Transmitters are ordered separately.*
▶ See page 174 for electronic locks.

When electronic locks are specified, all doors will default to locking on the individual cabinet.

Connections

Upper storage cabinets attach to a rail system utilizing a bracket connection. The rail aids in alignment to adjacent cabinets. The rail must be ordered separate from the cabinet.
▶ See page 168 for rails.

Integrated rail attachment bracket's micro-adjustability accounts for architectural wall variances to deliver refined alignment.

For minimum wall construction and electrical clearances, see *Convey Technical Cut Sheet*, available at village.steelcase.com.

Surface Materials

Cabinet, door front, and shelf
• High-Pressure Laminate

Edges
• Matching plastic

Cabinet interior
• 2730 Arctic White

D pulls, contemporary, and jazz pulls
• 0835 Black
• 9201 Polished Chrome
• 9211 Nickel
• 9212 Silver

Hidden pulls
• 4798 Nickel Metallic
• 4799 Platinum Metallic

Bracket covers
• 6009 Arctic White

Euro hinges
• Nickel

Lock
• 9201 Polished Chrome only

Shipping

All cabinets ship fully assembled.

Handles will be shipped on the cabinets, but facing the interior to prevent damage.

Application Topics

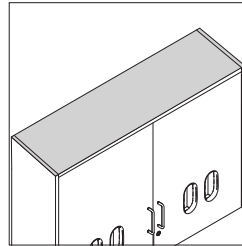
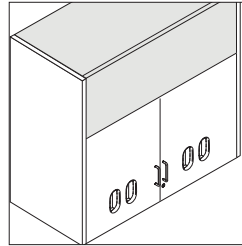

Sloped fascia, vertical fascia, or flat top-cap cover panels can be specified as a top condition on the upper cabinets.

▶ See pages 148–152 for top conditions.

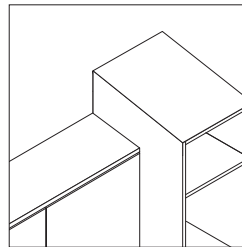

Upper cabinets specified with a sloped fascia top condition and installed next to a wardrobe or tall storage cabinet of a different depth will result in a step down. Doors will align between upper cabinet and wardrobe or tall storage. Cover panels will be required in between the wardrobe or tall storage cabinet and upper cabinet.

▶ See pages 148–152 for top conditions.

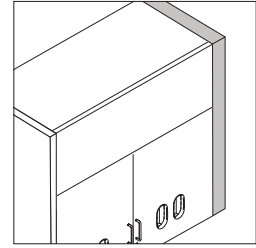

Fillers close the gap between the side of a cabinet and a structural wall. Ceiling fillers close the gap between upper cabinets and the ceiling.
▶ See page 166 for fillers.

Notch fillers or cover panels must be used to conceal the bracket-to-rail connection at the end of a run. Cover panels attach to the side of casework and add a 1/2" to the overall planning width.
▶ See page 144 for cover panels.

V.I.A. will accept Convey wall-suspended cabinets and upper cabinets. Convey follows all V.I.A. application rules for hang on components. See the *V.I.A. Specification Guide* for more details.

Maximum plan width for V.I.A. vertical posts with Convey is 48"W. Skins may be specified longer than 48"W and span these vertical components.

The Convey rail can span multiple 48"W lengths.

Reinforcing structural beams (FEBSTR) are required at rail locations inside the V.I.A. frame. An additional structural beam is required at the bottom to distribute the load evenly.

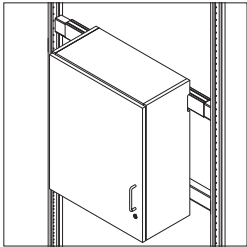
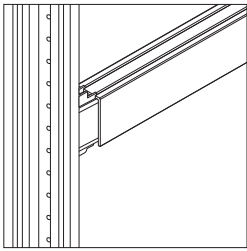

Convey rails attach to the structural beam by screwing through the skins. The V.I.A. spacer is required to fill the gap between the skin and the beam. Spacers are not visible once the skin is in place. Spacers span the width of the structural beam.
▶ See page 178 for V.I.A. spacer.

Convey Upper Microwave Cabinets

Upper microwave cabinets include an extended lower shelf, which is designed to adequately store microwaves, or other equipment, while adding additional cabinet storage above.

▶ Specifying, page 136

Tops of upper cabinets are finished.

Notches must be covered by cover panels or a notch filler for end-of-run conditions.

▶ See page 144 for cover panels.

Interior of open and closed storage is finished with the specified High-Pressure Laminate.

Blocking/banding may not be required in architectural walls behind the rail depending on the application. Check local and state codes for blocking/banding requirements (i.e. seismic zones). Placement of blocking/banding is to be coordinated with the responsible trades.

Cabinets mount and align along a continuous rail system. The bracket-to-rail attachment allows for micro-adjustability. Brackets and bracket covers are included with every cabinet. Rail must be ordered separately from the cabinet.

▶ See page 168 for rails.

All edges are finished from the factory with matching plastic edge banding.

D pulls are standard on doors in a nickel finish. Additional finishes and pull options are available.

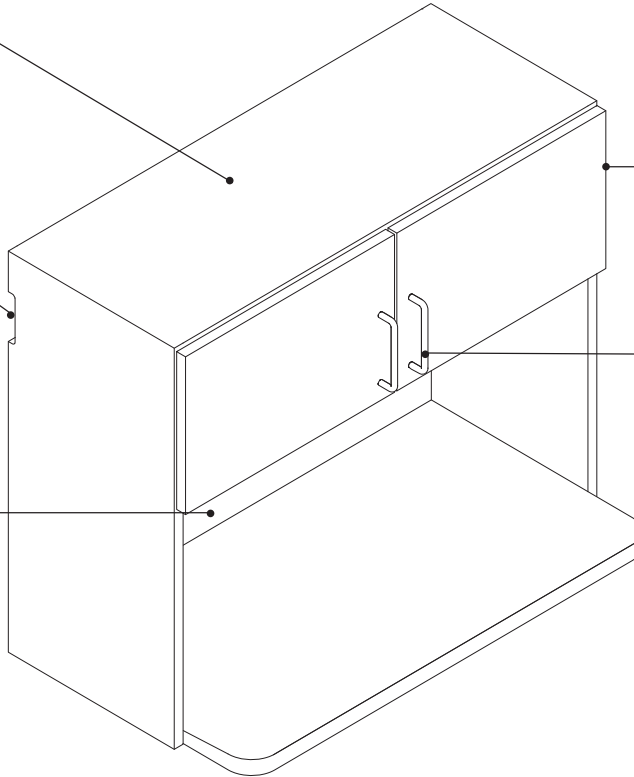

Product Details

Cabinets have a wet glue and dowel, case clamp construction.

All surfaces, including cabinet interiors, are finished with High-Pressure Laminate.

Edges on cabinets are matching 1 mm plastic edge banding. Door edges are matching 3 mm plastic edge banding.

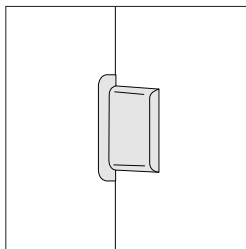

Bracket covers are included with cabinets and come in white only.

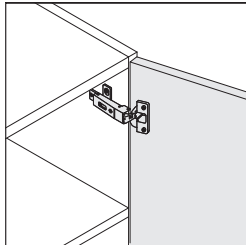

Euro hinge is standard on cabinet door and allows the door to open a full 110°.

Soft close door hinges are standard.

Hinge angle limiter is available for door units and limits the angle to 87°. This is recommended when near adjacent walls or in corner applications.

▶ See page 172 for hinge angle limiter.

The microwave shelf is always 20"D, regardless of the depth of the upper door cabinet.

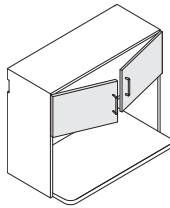

Upper cabinets always include double doors and open from the center out.

Double doors include a sequential latch. The right door must be opened prior to the left.

Microwave cabinets height, width, and depth can adjust parametrically in 1" increments.

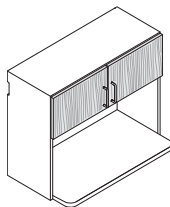

Woodgrain laminate matches on all doors and is always applied vertically.

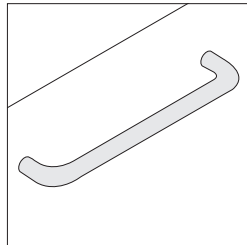

D pulls are standard.

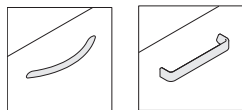

Contemporary Jazz

Additional door pull options are available. Optional pulls include:

- Contemporary
- Jazz
- No pull

Tip: Cabinets with no pull option selected come with no door pulls or drill holes.

Application Topics

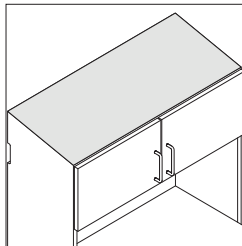

Sloped fascia, vertical fascia, or flat top-cap cover panels can be specified as a top condition on the microwave cabinet. ▶ See pages 148–152 for top conditions.

For internal microwave storage clearances see *Convey Technical Cut Sheet*, available at village.steelcase.com.

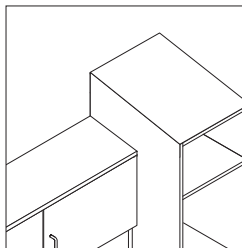

Microwave upper cabinets, specified with a sloped fascia top condition and installed next to a wardrobe or tall storage cabinet of a different depth, will result in a step down. Doors will align between microwave cabinet and wardrobe or tall storage. Cover panels will be required in between the wardrobe or tall storage cabinet and upper microwave cabinet. ▶ See pages 148–152 for top conditions.

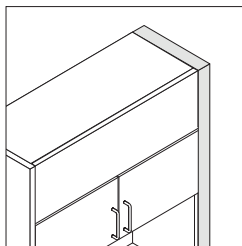

Fillers close the gap between the side of a cabinet and a structural wall. Ceiling fillers close the gap between upper microwave cabinets and the ceiling. ▶ See page 166 for fillers.

Notch fillers or cover panels must be used to conceal the bracket-to-rail connection at the end of a run. Cover panels attach to the side of casework and add a 1/2" to the overall planning width. ▶ See page 144 for cover panels.

V.I.A. will accept Convey wall-suspended cabinets and upper cabinets. Convey follows all V.I.A. application rules for hang on components. See the *V.I.A. Specification Guide* for more details.

Maximum plan width for V.I.A. vertical posts with Convey is 48"W. Skins may be specified longer than 48"W and span these vertical components.

The Convey rail can span multiple 48"W lengths.

Reinforcing structural beams (FEBSTR) are required at rail locations inside the V.I.A. frame. An additional structural beam is required at the bottom to distribute the load evenly.

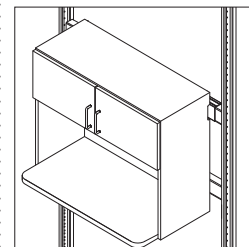
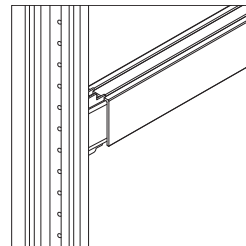

Convey rails attach to the structural beam by screwing through the skins. The V.I.A. spacer is required to fill the gap between the skin and the beam. Spacers are not visible once the skin is in place. Spacers span the width of the structural beam. ▶ See page 178 for V.I.A. spacer.

Surface Materials

Cabinet, door front, and shelf

- High-Pressure Laminate

Edges

- Matching plastic

D pulls, contemporary, and jazz pulls

- 0835 Black
- 9201 Polished Chrome
- 9211 Nickel
- 9212 Silver

Bracket covers

- 6009 Arctic White

Euro hinges

- Nickel

Shipping

All cabinets ship fully assembled.

Handles will be shipped on the cabinets, but facing the interior to prevent damage.

Connections

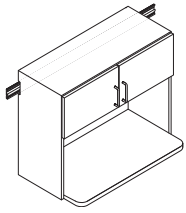

Upper microwave cabinets attach to a rail system utilizing a bracket connection. The rail aids in alignment to adjacent cabinets. The rail must be ordered separate from the cabinet.

▶ See page 168 for rails.

Integrated rail attachment bracket's micro-adjustability

accounts for architectural wall variances to deliver refined alignment.

Cabinets should be ganged together with screws provided.

For minimum wall construction and electrical clearances, see *Convey Technical Cut Sheet*, available at village.steelcase.com.

Electrical Clearance Zones

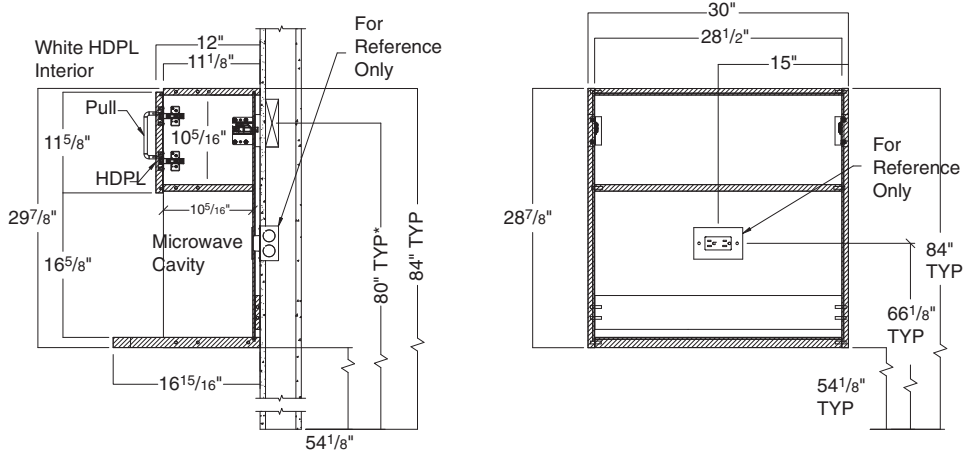

Tip: See all Convey sections by visiting <https://www.steelcase.com/resources/documents/convey-sections/>



Convey Upper Corner Cabinets

Tops of upper corner cabinets are finished.

Cabinet interiors are finished with 2730 Arctic White High-Pressure Laminate.

Cabinets mount and align along a continuous rail system. The bracket-to-rail attachment allows for micro-adjustability. Brackets and bracket covers are included with every cabinet. Rail must be ordered separately from the cabinet.
▶ See page 168 for rails.

Blocking/banding may not be required in architectural walls behind the rail depending on the application. Check local and state codes for blocking/banding requirements (i.e. seismic zones). Placement of blocking/banding is to be coordinated with the responsible trades.

D pulls are standard on doors in a nickel finish. Additional finishes and pull options are available.

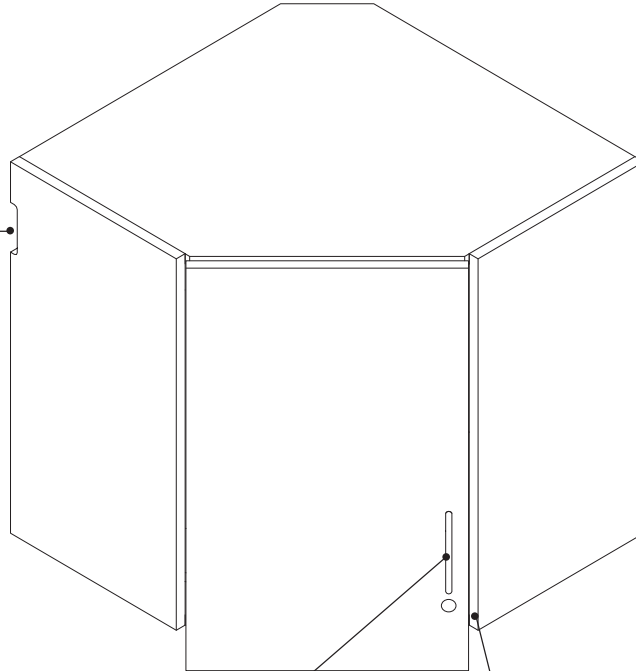

All edges are finished from the factory with matching plastic edge banding.

Product Details

Cabinets have a wet glue and dowel, case clamp construction.

All surfaces, including cabinet interiors, are finished with High-Pressure Laminate.

Edges on cabinets are matching 1 mm plastic edge banding. Door edges are matching 3 mm plastic edge banding.

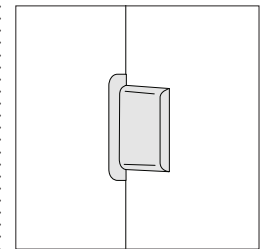

Bracket covers are included with cabinets and come in white only.

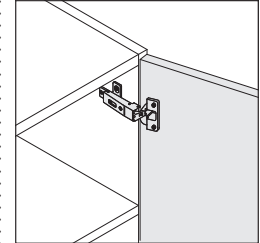

Euro hinge is standard on cabinet door and allows the door to open a full 110°.

Soft close door hinges are standard.

Hinge angle limiter is available for door units and limits the angle to 87°. This is recommended when near adjacent walls or in corner applications.

▶ See page 172 for hinge angle limiter.

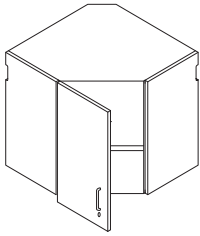

Cabinets are hinged on the left or right side. A left-hand unit has the hinge on the left side of the door. A right-hand unit has the hinge on the right side of the door.

Upper corner cabinets are only available in modular widths and depths. Upper corner cabinet's height can adjust parametrically in 1" increments.

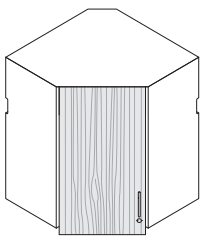

Woodgrain laminate matches on all doors and is always applied vertically.

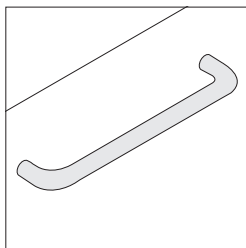

D pulls are standard.

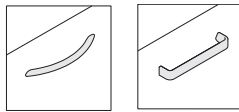

Contemporary Jazz

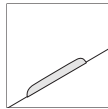

Hidden pull

Additional door pull options are available.

Optional pulls include:

- Contemporary
- Jazz
- Hidden pull
- No pull

Tip: Cabinets with no pull option selected come with no drawer pulls or drill holes.

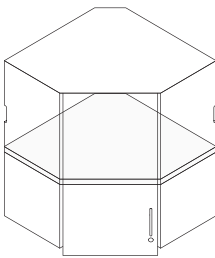

Corner cabinets 30"H include one fixed shelf. Cabinets less than 30"H do not include a shelf.

Light valances can be ordered when using task lighting to conceal the cables.

▶ See page 172 for accessories.

Field modification is required when using a light valance on a corner cabinet to properly align with adjacent light valances and cover panels.

Connections

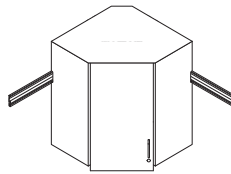

Upper corner cabinets attach to a rail system utilizing a bracket connection. The rail aids in alignment to adjacent cabinets. The rail must be ordered separate from the cabinet.
▶ See page 168 for rails.

Integrated rail attachment bracket's micro-adjustability accounts for architectural wall variances to deliver refined alignment.

For minimum wall construction and electrical clearances, see *Convey Technical Cut Sheet*, available at village.steelcase.com.

Surface Materials

Cabinet, door front, and shelf

- High-Pressure Laminate

D pulls, contemporary, and jazz pulls

- 0835 Black
- 9201 Polished Chrome
- 9211 Nickel
- 9212 Silver

Cabinet interior

- 2730 Arctic White

Hidden pulls

- 4798 Nickel Metallic
- 4799 Platinum Metallic

Bracket covers

- 6009 Arctic White

Euro hinges

- Nickel

Shipping

All cabinets ship fully assembled.

Handles will be shipped on the cabinets, but facing the interior to prevent damage.

Application Topics

Vertical fascia can be specified as a top condition on the corner cabinet.

▶ See pages 148–152 for top conditions.

Fillers close the gap between the side of a cabinet and a structural wall. Ceiling fillers close the gap between upper cabinets and the ceiling.

▶ See page 166 for fillers.

V.I.A. will accept Convey wall-suspended cabinets and upper cabinets. Convey follows all V.I.A. application rules for hang on components. See the *V.I.A. Specification Guide* for more details.

Maximum plan width for V.I.A. vertical posts with Convey is 48"W. Skins may be specified longer than 48"W and span these vertical components.

The Convey rail can span multiple 48"W lengths.

Reinforcing structural beams (FEBSTR) are required at rail locations inside the V.I.A. frame. An additional structural beam is required at the bottom to distribute the load evenly.

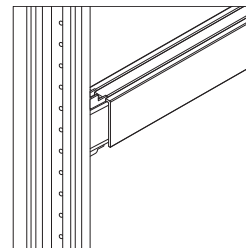

Convey rails attach to the structural beam by screwing through the skins. The V.I.A. spacer is required to fill the gap between the skin and the beam. Spacers are not visible once the skin is in place. Spacers span the width of the structural beam.
▶ See page 178 for V.I.A. spacer.

Convey Mobile Storage Cart

Carts are available in a range of sizes and configurations to provide a flexible storage solution that fits within a Convey setting. Carts can also provide storage and workspace on their own.

Carts have High-Pressure Laminate on both the exterior and interior surfaces. Cart interior is standard in 2730 Arctic White laminate for increased visibility when cleaning.

Tops can be seamless thermoform with a raised lip or solid surface.

Base is a durable thermoform bumper.

Casters are 65 mm low-profile or 4" high mobility.

Drawer dividers are available to help organize cart contents. Dividers are available in 4" and 6" heights.



Front-locking casters are standard.

Locks are available in both keyed and keyless options.

Pulls are available in different profiles and finishes, including a no pull option.

Various drawer configurations are available to best serve storage needs.

Drawers are wood core, wet glue and dowel construction, with full-extension heavy-duty slides.

Drawer fronts are High-Pressure Laminate with 3 mm edge band for increased durability in a high-touch-point space.

Actual Dimensions

Depth	19 ¹ / ₂ "
Overall Width	19 ¹ / ₂ ", 22 ¹ / ₂ ", and 25 ¹ / ₂ "
Height	30.144", 32.549", 34.144", 36.549", 38.144", and 40.549"

Product Details

Case is a wet glue and dowel case clamp construction.

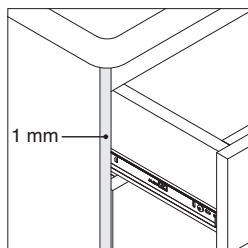

Edges of cabinet cases are complimenting 1 mm edge band. Contrasting edge band is not offered.

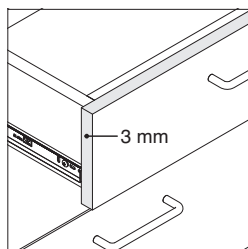

Edges of drawer fronts are complimenting 3 mm edge band for increased durability in a high touch point space. Contrasting edge band is not offered.

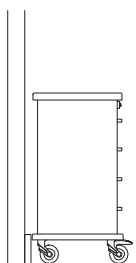

Cart outer base protects walls by interacting with walls before the case.



Drawer configuration options are driven by the cart height.

- 40.549"H and 38.144"H carts allow any drawer configuration that adds up to 30".
- 36.549"H and 34.144"H carts allow any drawer configuration that adds up to 26".
- 32.549"H and 30.144"H carts allow drawer configuration that adds up to 22".

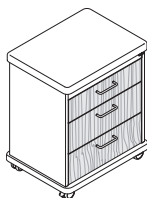

Grain direction matches vertically on all drawer sets in cart.

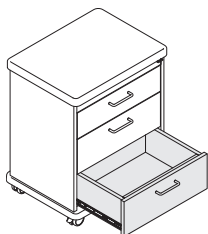

Drawers include heavy-duty, full-extension drawer slides.

Carts are available with a thermoform or solid surface top.

Thermoform tops have a raised lip on the perimeter to help trap liquid and supplies.

Thermoform and solid surface tops overhang with "finger pull" underneath for easy maneuvering when in tight spaces or under countertops.

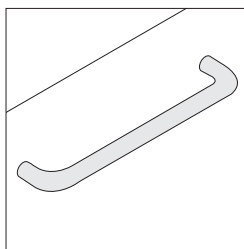

D pulls are standard.

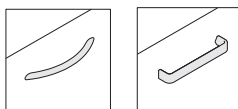

Contemporary Jazz

Additional drawer pull options are available,

- Contemporary
- Jazz
- No pull

Tip: Carts with no pull option selected come with no drawer pulls or drill holes.

Drop-in drawer dividers with moveable interiors

can be specified for all drawers. Lower height dividers fit the 4"H drawers. The taller dividers should be used in both the 6"H and 8"H drawers. Due to precise fit within the drawers, the larger dividers require the drawer to be disengaged from the slide assembly and slid forward about 1" (not removed) for the dividers to drop into the drawer as an assembly.

Drawer divider label holders are also available to order.

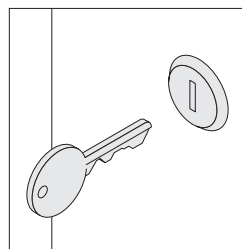

Locks are optional and only available with master keying. Locks are field installed and must be specified separately.
▶ See *Lock and Keying*, page 398.

Accessory rails can be added to the cart sides and back for storage of supplies and tools. Accessory rails are a Paladin profile.

Accessories can be ordered through medical device manufacturers to pair up with the rail. Rail and rail accessories will add to the total width of the unit, particularly important when placing cart within a garage application.
Tip: Rails on the back add to the depth of the cart.

Connections

Carts are designed to be standalone or integrated within a Convey application.

Carts are freestanding and do not need to be ganged to other furniture or bolted to the floor.

Surface Materials

Cart

- High-Pressure Laminate

Edges

- 3 mm plastic
- 1 mm plastic

Top

- Thermoform
- Solid surface

Base

- 6059 Sterling Dark Solid

D pull

- 0835 Black
- 9201 Polished Chrome
- 9211 Nickel
- 9212 Silver

Contemporary pull

- 0835 Black
- 9201 Polished Chrome
- 9211 Nickel
- 9212 Silver

Jazz pull

- 0835 Black
- 9201 Polished Chrome
- 9211 Nickel
- 9212 Silver

Casters

- 6059 Sterling Dark

Keyed lock

- 9201 Polished Chrome

Keyless lock

- 4799 Platinum Metallic

Storage Capacities and Dimensions

Storage Cart Drawers

For Convey Carts

4"H Drawers

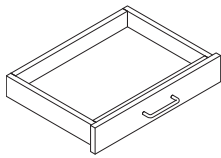

Size/Type	Inside Dimensions			Inside Height Clearance
	D	W	H	
19 ¹ / ₂ "W Drawer	13.639"	13.768"	2.385"	2.385"
22 ¹ / ₂ "W Drawer	13.639"	16.768"	2.385"	2.385"
25 ¹ / ₂ "W Drawer	13.639"	19.768"	2.385"	2.385"

6"H Drawers

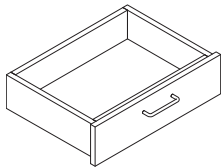

Size/Type	Inside Dimensions			Inside Height Clearance
	D	W	H	
19 ¹ / ₂ "W Drawer	13.639"	13.768"	4.385"	4.385"
22 ¹ / ₂ "W Drawer	13.639"	16.768"	4.385"	4.385"
25 ¹ / ₂ "W Drawer	13.639"	19.768"	4.385"	4.385"

8"H Drawers

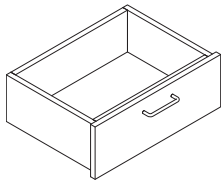

Size/Type	Inside Dimensions			Inside Height Clearance
	D	W	H	
19 ¹ / ₂ "W Drawer	13.639"	13.768"	6.385"	6.385"
22 ¹ / ₂ "W Drawer	13.639"	16.768"	6.385"	6.385"
25 ¹ / ₂ "W Drawer	13.639"	19.768"	6.385"	6.385"

Convey Cover Panels

Cover panels create a finished end and can be removed, allowing cabinetry to be rearranged.

▶ See page 144

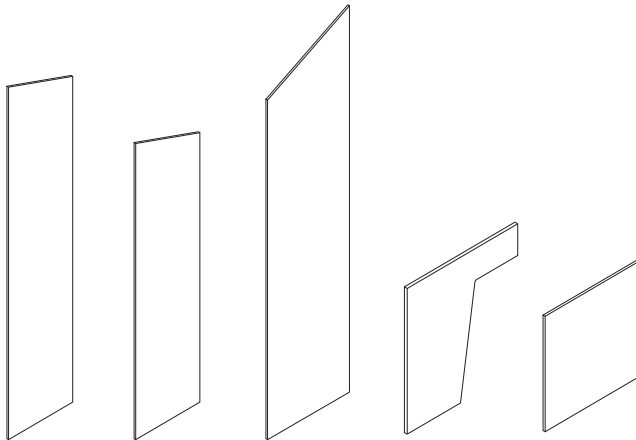

Cover panels attach directly to the side of casework.

Cover panels may or may not be required, based on the application. Refer to SmartTools.

Cover panels are an additive piece that increase the overall width of a layout by $\frac{9}{16}$ " per panel.

Finish options for the panels are chosen independent of the casework and can be an opportunity to create a framed-in look.

Product Details

Cover panels are High-Pressure Laminate and 1 mm edge banding.

Cover panels are $\frac{9}{16}$ " thick.

Cover panels include a cut-to-fit option in SmartTools, which will add an extra inch to the cover panel depth. This creates the ability to scribe the panel onsite for a premium fit and finish in an imperfect built-in environment. This option is typically not required.

Wood grain on cover panels is always vertical.

Cover panel height and depth flex parametrically to match adjacent cabinets. See SmartTools.

Top conditions must be chosen when specifying a cover panel. No top extension for cabinets is available, as all cabinets have a finished top.

When choosing vertical fascia, a 24" or 30" addition will be added to the cover panels.

▶ See pages 148–152 for top conditions.

Cover panels include guide locations for attaching to the cabinet.

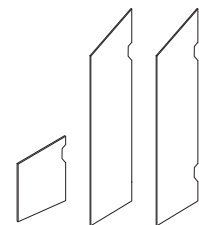

Depending on the application chosen, cover panels will either include no cutouts, one top cutout, one bottom cutout, or two cutouts (top and bottom). The cutout provides a space for the continuous rail when in the middle of a run of cabinetry. Refer to SmartTools.

When cover panels are not required, a notch filler could be utilized to cover the notch created by the bracket-to-rail connection.

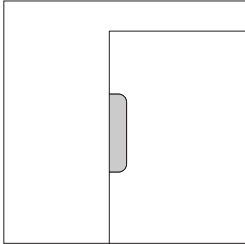
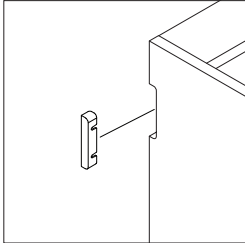

Notch fillers come in a pack of ten.

Surface Materials

- Cover panels**
 - High-Pressure Laminate
- Cover panel edges**
 - Matching plastic

- Notch filler**
 - 6009 Arctic White
 - 6527 Merle

Application Topics

When specifying a sloped fascia or a vertical fascia, a cavity is created and must be enclosed with a cover panel.

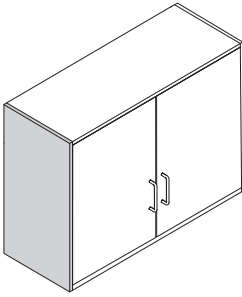

Cover panels will align with the fronts of doors and drawers.

Cabinet tops are finished to create a flat top. A flat top-cap cover panel can be utilized, along with side cover panels, if desired.

▶ See page 86 for more information on top conditions.

Convey Top Conditions

Flat Top-Cap Cover Panels, Sloped Fascia, and Vertical Fascia

Flat top-cap cover panels can be added to create a framed in look when paired with side cover panels.
▶ Specifying, page 148

Sloped fascia is the best practice for infection control, due to the ease of cleanability.
▶ Specifying, page 150

Sloped fascia is always a 20° slope.

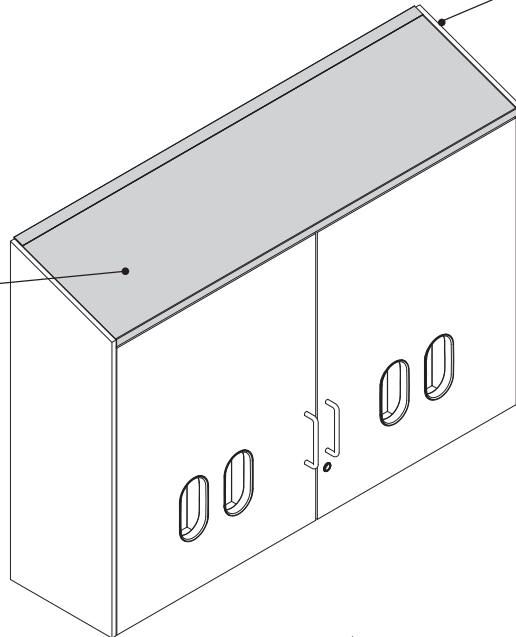

Vertical fascia adds a continuous finished look to the ceiling.
▶ Specifying, page 152

Ceiling fillers can be utilized to fill the space between a cabinet and a structural ceiling.
▶ See page 166 for fillers.

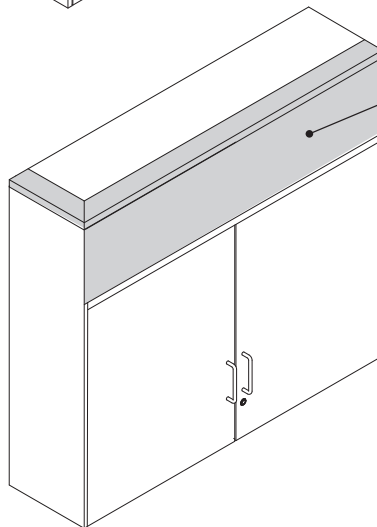

Product Details

Sloped fascia adds a 20° slope to the top of upper cabinets, wardrobes, and tall storage cabinets.

Vertical fascia can be ordered in 24" or 30" heights and scribed to fit in the field.

Cover panels must be utilized to enclose the cavity created by the sloped and vertical fascia.

▶ See page 144 for cover panels.

Sloped fascia and vertical fascia come in widths up to 96", creating a continuous run across multiple cabinets, without seams.

Sloped fascia and vertical fascia can be specified with a horizontal or vertical grain direction. Widths greater than 48" are only available in horizontal grain.

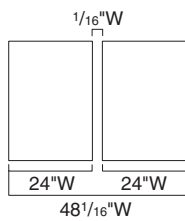

For appropriate fit and finish a 1/16" gap is created between adjacent cabinets. For example: Two 24"W side-by-side cabinets will actually be 48 1/16"W.

This will cause the sloped or vertical fascia to exceed the 48"W maximum for vertical grain so the grain must be horizontal.

Vertical grain in the fascias will not match the vertical grain in the cabinets it is mounted on.

Vertical grain is allowed up to 48" wide.

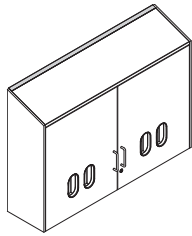

Sloped fascia trim is utilized to attach sloped fascia to the wall.

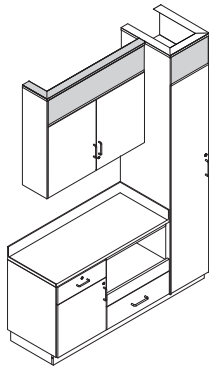

Vertical fascia trim is utilized to attach vertical fascia to the ceiling.

Sloped and vertical fascia width flexes in 1/16" increments.

Vertical fascia can be ordered in 24" or 30" heights and scribed to fit in the field.

Cabinetry is finished on all sides. A flat top-cap cover panel can be utilized, along with side cover panels, to create a framed aesthetic.

Ceiling clips must be specified with vertical fascia. Identify the type of ceiling grid the clips will be used on. ▶ See pages 88 and 89 for examples.

Surface Materials

Sloped fascia and vertical fascia

- High-Pressure Laminate. Select Surfaces (Laminate price group B) are only available with a vertical grain.

Sloped fascia trim and vertical fascia trim

- 4140 Arctic White Gloss
- 4799 Platinum Metallic
- 7360 Merle

Application Topics

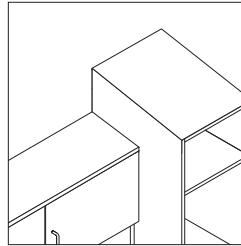

Upper cabinets specified with a sloped fascia top condition and installed next to a wardrobe or tall storage cabinet of a different depth will result in a step down. Doors will align between upper cabinet and wardrobe or tall storage. Cover panels will be required in between the wardrobe or tall storage cabinet and upper cabinet.

Ceiling Clip Application

Tip: All planning and application guidelines contained in this section of the specification guide are based on the requirement that ceiling track is connected to a ceiling in order to properly install and align the wall components as shown. When any partition is fastened to a suspended ceiling grid, it may be necessary for an architect or engineer to verify that the grid can adequately support the partition. Local codes may require additional bracing.

T Grid Ceiling Fastener Kits

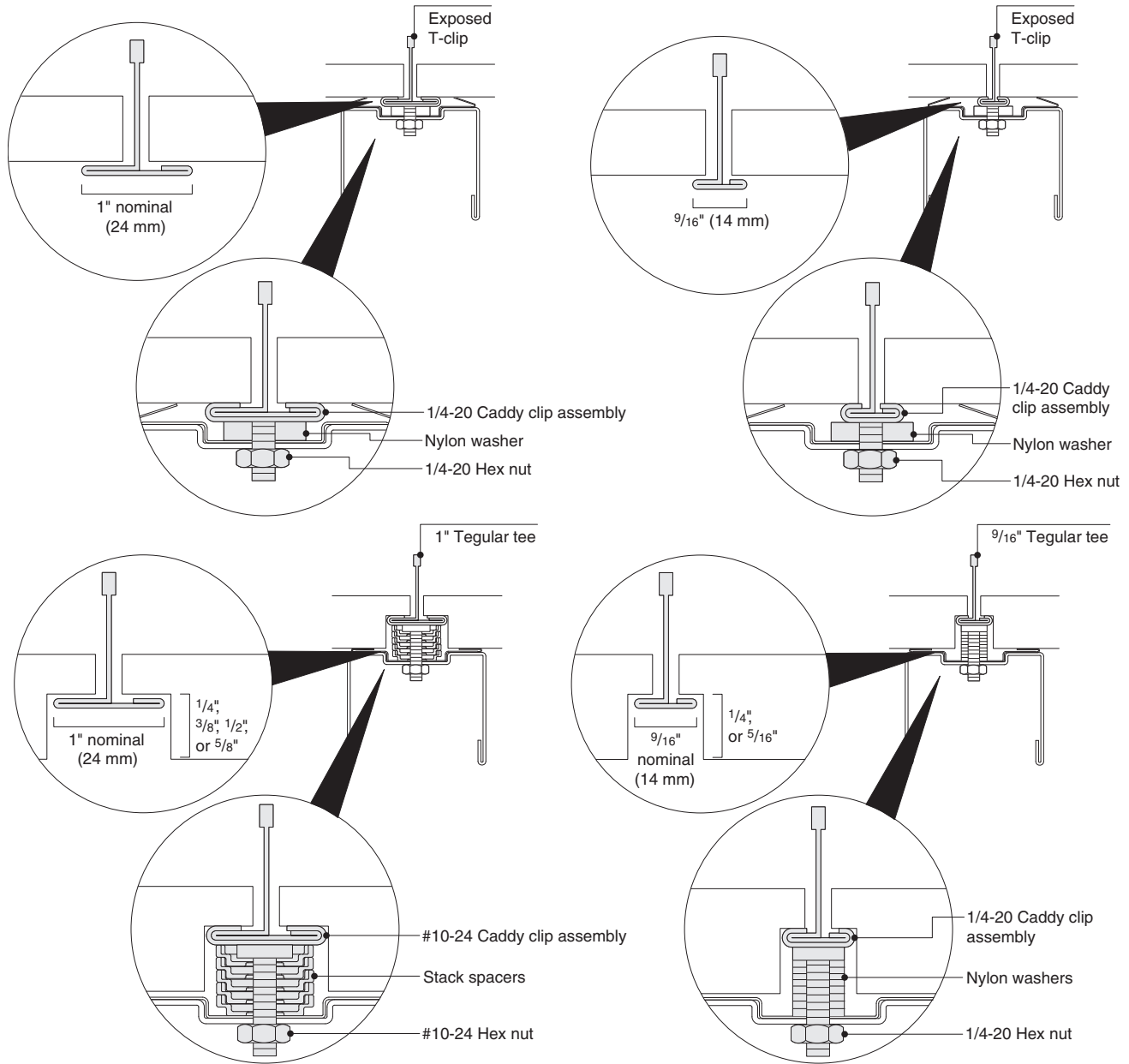

Bolt Slot Grids Ceiling Fastener Kits

Ceiling clips support the most common types of ceiling systems.

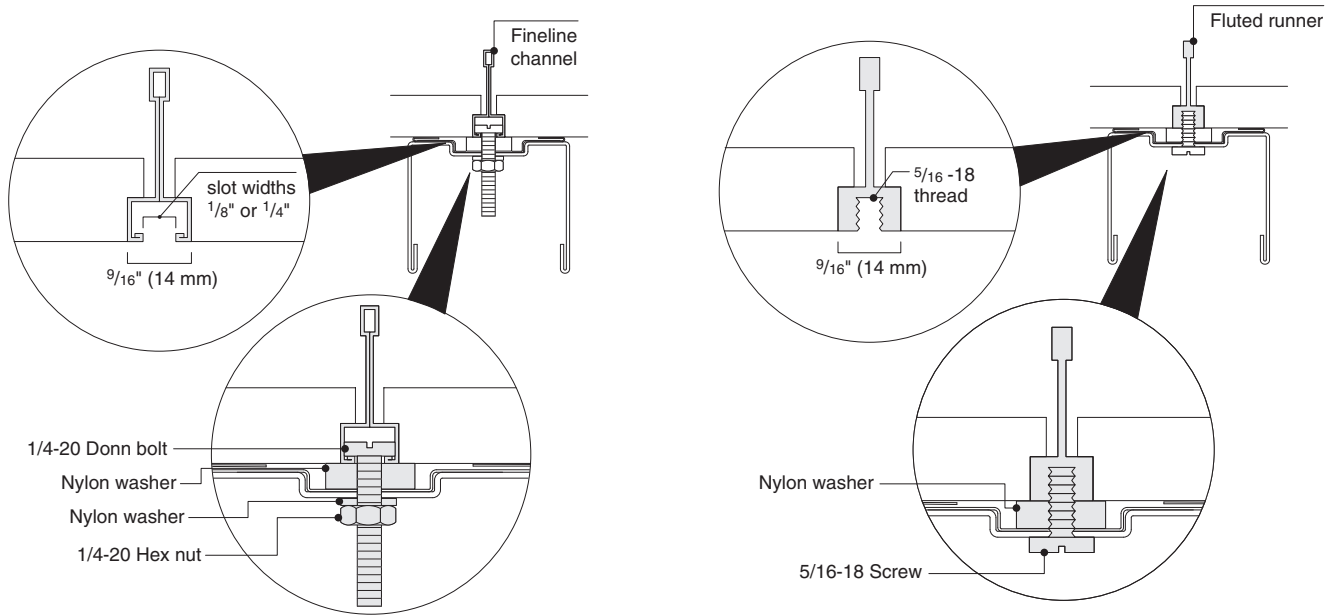

Concealed Grids - Field-Purchased Generic Fasteners

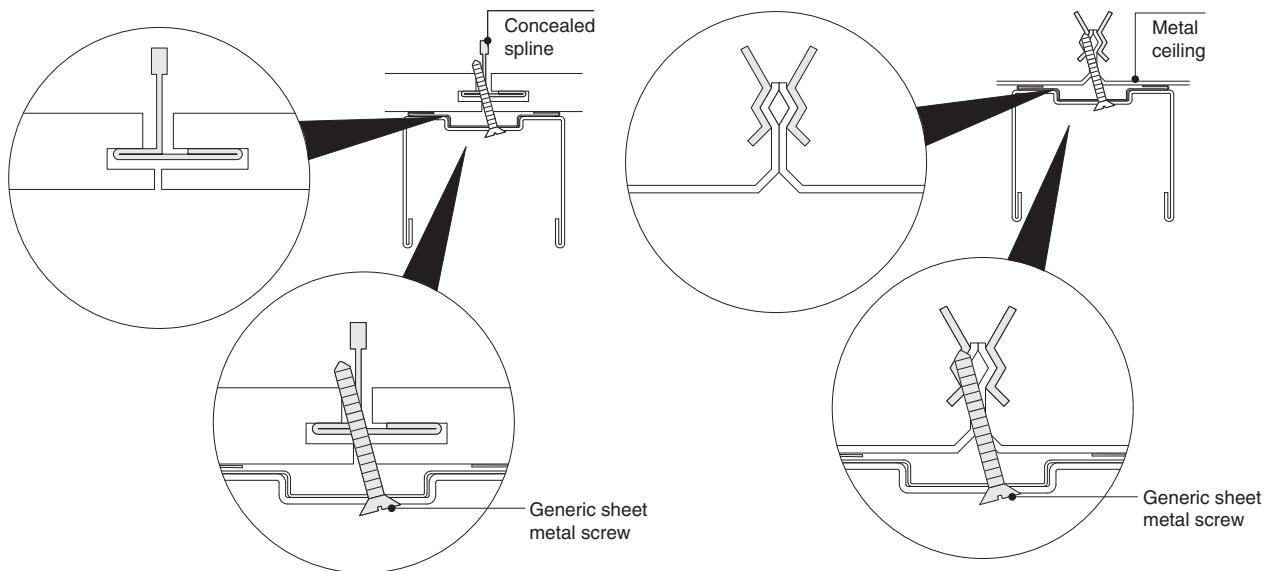

For these and other types of ceilings, the following fasteners can be sourced locally by the installer:

Concealed spline	#7 - 17 x 1 5/8" Bugle Head Self-Drilling Screws
Drywall	#14 - 1" Phillips Head SMS with plastic anchor
Plaster	1/4 - 20 Toggle Bolt
Concrete	Tapcon Anchor x 2"
Metal Pan	#7 - 17 x 1" Bugle Head Self-Drilling Screws

Convey Worksurfaces

Solid surface worksur-
faces attach to the top of
base cabinets and can be
specified with or without an
integral sink.

▶ Specifying, pages 154-158

Solid surface work-
surfaces have the option
to include an integral
backsplash.

All solid surface work-
surfaces are Corian.

Solid surface worksur-
faces have a thickness of
1½".

Solid surface work-
surfaces include a ½"
overhang on the side and 1"
overhang on the front, with a
built-in drip edge.

Ten integral sink bowl
options are available for
solid surface worksurfaces.
▶ See page 154 for sink bowl
options.

No corresponding
sinks are included with the
High-Pressure Laminate
worksurfaces. If a sink is
desired, it must be field cut.

Moisture resistant core
(MR10) is available as an
option for the High-Pressure
Laminate worksurface,
backsplash, and sidesplash.
MR10 is recommended for
areas where liquids may be
present.

*Tip: MR10 core is not
available when specifying
Formica finishes.*

High-Pressure
Laminate worksurfaces
include a ½" overhang on
the side and a 1" overhang
on the front. High-Pressure
Laminate worksurfaces do
not have a drip edge.

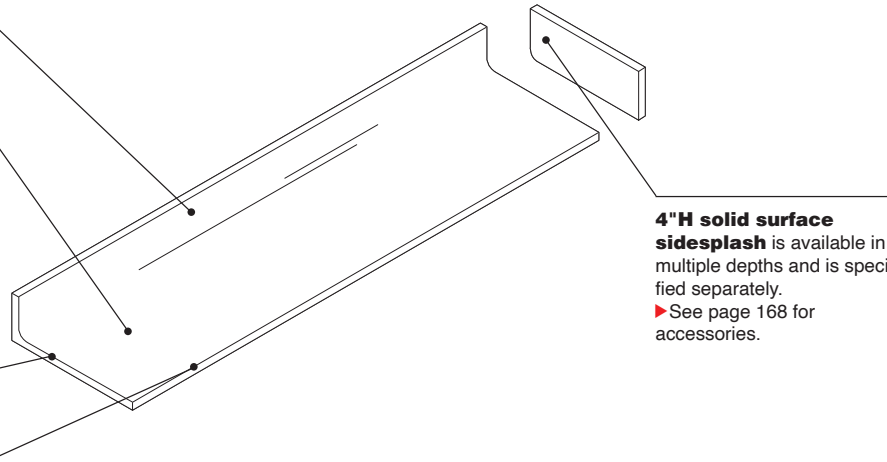

4"H solid surface
sidesplash is available in
multiple depths and is speci-
fied separately.

▶ See page 168 for
accessories.

4"H High-Pressure
Laminate backsplash
is available. High-Pressure
Laminate edges have 1 mm
edgebanding.

4"H High-Pressure
Laminate sidesplash is
available in multiple depths
and is specified separately.
High-Pressure Laminate
sidesplash edges have 1
mm edgebanding.

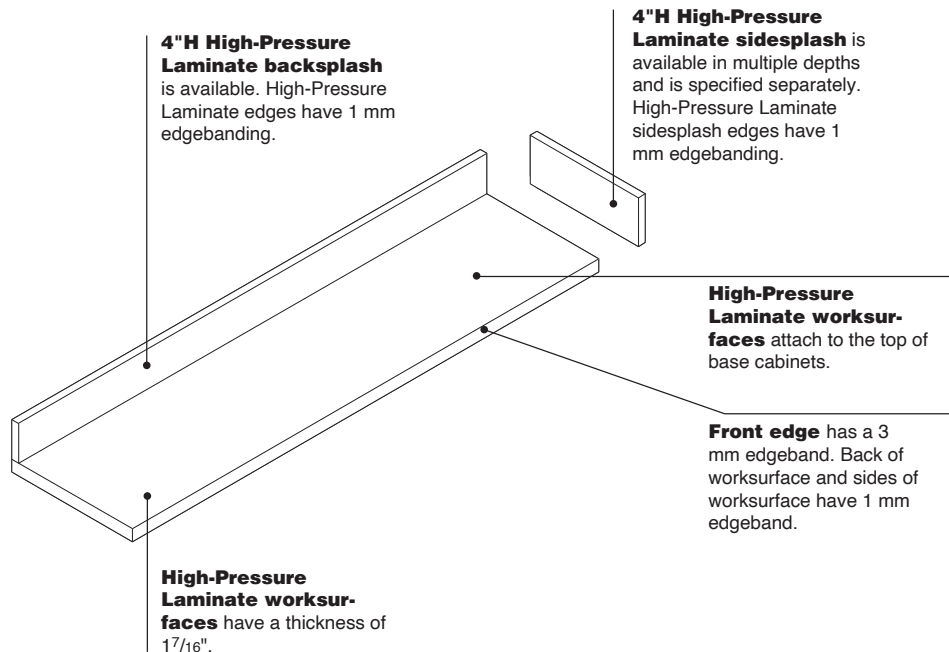

High-Pressure
Laminate worksur-
faces attach to the top of
base cabinets.

Front edge has a 3
mm edgeband. Back of
worksurface and sides of
worksurface have 1 mm
edgeband.

High-Pressure
Laminate worksur-
faces have a thickness of
17/16".

Product Details

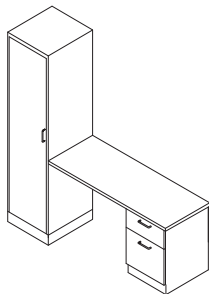

Worksurfaces can attach to the top of one base cabinet or can span entire length of run of cabinets, up to 138"W for solid surface worksurfaces and up to 120"W for High-Pressure Laminate worksurfaces.

Solid surface worksurfaces have a thickness of 1½". 1" is particle board substrate covered by ½" of solid surface.

High-Pressure Laminate worksurfaces have a thickness of 17/16".

Solid surface worksurfaces include ½" overhang on the side and 1" overhang on the front, with a built-in drip edge.

High-Pressure Laminate worksurfaces include ½" overhang on the side and 1" overhang on the front, with no drip edge.

High-Pressure Laminate worksurfaces have 3 mm edge banding on front edge.

Solid surface worksurfaces can be specified with or without an integral sink.

MR10 core is standard on all solid surface worksurfaces.

MR10 core is available on High-Pressure Laminate worksurfaces, backsplashes, and sidesplashes. MR10 is recommended for areas where liquids may be present.
Tip: MR10 core is not available when specifying Formica finishes.

Integral sink bowls can be added to solid surface worksurfaces a minimum of 30"W and up to 138"W.

▶ See page 30 for *Sink Bowl Overview*.

Ten sink bowl options are available for solid surface worksurfaces. All sink bowls are white. No corresponding sinks are included with the High-Pressure Laminate worksurfaces. If a sink is desired, it must be field cut.

Most sink drains are 1¾" in diameter. The drain on the 5414 sink is 2". Drain hardware is provided by responsible trades.

Some sink bowls offer offset drains. For sink bowl details see page 30.

Faucets must be sourced locally and faucet holes must be field drilled by responsible trades.

Backsplash is available on High-Pressure Laminate worksurfaces and is ¾" thick.

Integral backsplashes are available on solid surface worksurfaces. Solid surface integral backsplashes are ½" thick.

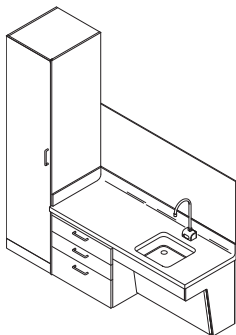

Sidesplash is available for solid surface and High-Pressure Laminate worksurfaces.

Sidesplash is available in multiple depths and must be ordered separately. Solid surface sidesplash is available left or right handed. High-Pressure Laminate sidesplashes and backsplashes have 1 mm edgebanding.

High-Pressure Laminate backsplashes and sidesplashes have horizontal laminate grain direction.

Sidesplash depth is determined by the adjacencies, (i.e. a wardrobe cabinet, etc).

Sidesplash must be adhered to adjacent cabinet or wall and sealed to the worksurface by responsible trades.

Sidesplashes are recommended near wet zones.

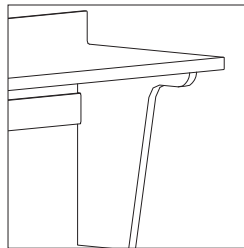

Floating worksurfaces can be achieved using cantilevers.
▶ See page 161 for cantilevers.

Unique worksurface configurations, shapes, or cutouts should be sourced locally.

Worksurfaces and sidesplash depths flex parametrically in 1" increments. Widths flex parametrically in ⅛" increments.

For more details on sink fit, see page 30.

Connections

Some cabinets include brackets that are used to attach the worksurface to the base cabinets in the field and are included with the cabinets. Others involve attachment directly to stretchers.

Surface Materials

Worksurface, backsplash, and sidesplash

- Solid surface
- High-Pressure Laminate

Sink bowls

- White Frost
- Glacier White

Tip: Glacier White only applies to sink bowls 815 and 816.

Edge on High-Pressure Laminate worksurface and sidesplash

- Plastic

Application Topics

Worksurfaces always include 1" overhang on the front and ½" overhang on the sides. Refer to SmartTools.

Convey Cantilevers

Cantilevers can be used to suspend a worksurface. ▶ See page 161

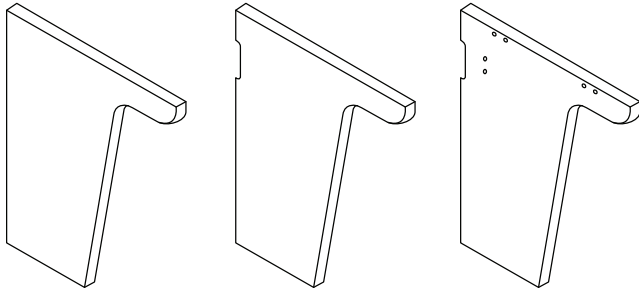

Cantilevers must be located every 48" on center, or less.

Cantilevers can be specified as right, left, or intermediate. This determines whether the cantilever is at the end of a run or located in the middle, allowing the rail to pass through.

Cantilevers mount and align along a continuous rail system. The bracket-to-rail attachment allows for micro-adjustability. Brackets and bracket covers are included with every cantilever. Rail must be ordered separately from the cabinet. ▶ See page 168 for rails.

Cantilevers are designed for worksurfaces no deeper than 25"D.

Blocking/banding is required at the top and bottom of cantilevers. Check local and state codes for blocking/banding requirements (i.e. seismic zones). Placement of blocking/banding is to be coordinated with the responsible trades. ▶ See page 16 for *Designing with Casework*.

Product Details

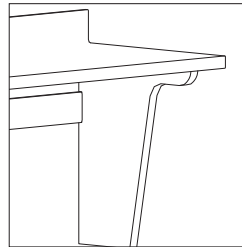

Exposed rail under the worksurface can be concealed using a rail cover. ▶ See page 168 for accessories.

Cantilevers include a cantilever bracket cover. A package of one merle and one white cover will be included.

Cantilever depths flex parametrically in 1" increments.

Connections

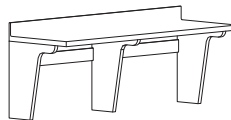

Cantilevers attach to a rail system, utilizing a bracket connection. The rail aids in alignment to adjacent cabinets. The rail must be ordered separate from the cantilever. ▶ See page 168 for rails.

Integrated rail attachment bracket's micro-adjustability accounts for architectural wall variances to deliver refined alignment.

For minimum wall construction and electrical clearances, see *Convey Technical Cut Sheet*, available at village.steelcase.com.

Surface Materials

Cantilevers

- High-Pressure Laminate

Bracket covers

- 6009 Arctic White
- 6527 Merle

Application Topics

Worksurfaces will span the entire length of run up to 138"W. Hardware packages for attachment are included with the cantilevers. ▶ See page 154 for worksurfaces.

Cantilevers cannot stand alone. They must have another cabinet, cantilever, or end panel to support the worksurface.

V.I.A. will accept Convey wall-suspended cabinets and upper cabinets. Convey follows all V.I.A. application rules for hang on components. See the *V.I.A. Specification Guide* for more details.

Maximum plan width for V.I.A. vertical posts with Convey is 48"W. Skins may be specified longer than 48"W and span these vertical components.

The Convey rail can span multiple 48"W lengths.

Reinforcing structural beams (FEBSTR) are required at rail locations inside the V.I.A. frame. An additional structural beam is required at the bottom to distribute the load evenly.

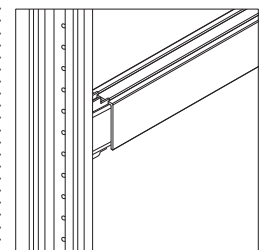

Convey rails attach to the structural beam by screwing through the skins. The V.I.A. spacer is required to fill the gap between the skin and the beam. Spacers are not visible once the skin is in place. Spacers span the width of the structural beam. ▶ See page 178 for V.I.A. spacer.

End panels can be used to create a garage for carts or equipment or as a desk space.

▶ Specifying, page 162

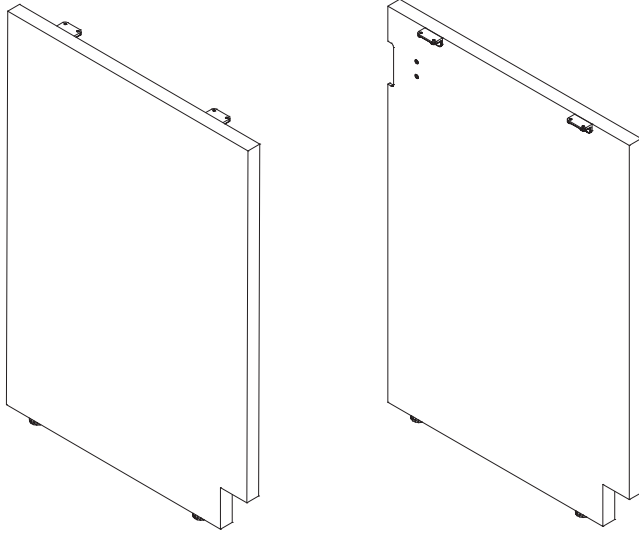

End panels can be specified as left hand or right hand. This determines which side of the end panel will be finished, and which will be notched for the rail location.

End panels mount and align along a continuous rail system. The bracket-to-rail attachment allows for micro-adjustability. Brackets and bracket covers are included with every end panel. Rail must be ordered separately from the cabinet. ▶ See page 168 for rails.

Blocking/banding may not be required in architectural walls behind the rail, depending on the application. Check local and state codes for blocking/banding requirements (i.e. seismic zones). Placement of blocking/banding is to be coordinated with the responsible trades.

Product Details

End panels are available in modular heights. End panel depths flex parametrically in 1" increments.

Exposed rail under the worksurface can be concealed using a rail cover.

▶ See page 168 for accessories.

End panels include a bracket cover. A package of one white and one merle cover will be included.

Connections

End panels attach to a rail system, utilizing a bracket connection. The rail aids in alignment to adjacent cabinets. The rail must be ordered separate from the end panel.

▶ See page 168 for rails.

Integrated rail attachment bracket's micro-adjustability accounts for architectural wall variances to deliver refined alignment.

For minimum wall construction and electrical clearances, see *Convey Technical Cut Sheet*, available at village.steelcase.com.

Surface Materials

End panels

- High-Pressure Laminate

Bracket covers

- 6009 Arctic White
- 6527 Merle

Application Topics

Worksurfaces will span the entire length of run, up to 138"W. Hardware packages for attachment are included with the cantilevers.

▶ See page 154 for worksurfaces.

End panels cannot stand alone. They must have another cabinet, cantilever, or end panel to support the worksurface.

Convey Mounting Boards

Mounting boards provide a location for mounting clinician worktools. They eliminate the need to continually drill into the drywall.

▶ See page 164

If height is greater than 48", width must be less than or equal to 48" and vice versa.

If the width and height are 12"–48", horizontal or vertical grain can be specified. If the width is greater than 48"W, only horizontal grain can be specified. If height is greater than 48"H, only vertical grain can be specified.

Mounting board height and width flex parametrically in 1/8" increments.

Mounting boards include brackets for attachment. These allow for removal.

Brackets mount into channel on back of mounting board. This allows for flexible placement.

Mounting boards have a slight gap between the board and the wall. This is created by the attachment brackets and provides access to remove the board at a later date.

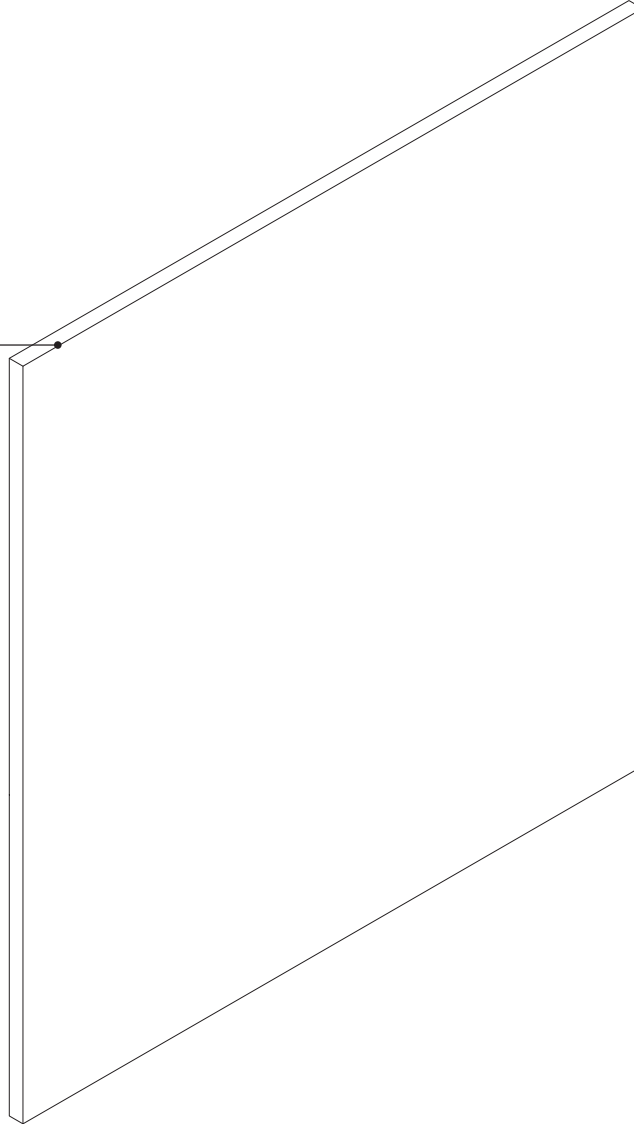

Surface Materials

Mounting board

- High-Pressure Laminate. Select Surfaces (Laminate price group B) are only available with a vertical grain.

Fillers are available for use with base cabinets, wardrobe cabinets, tall storage cabinets, and upper storage cabinets.

► Specifying, page 166

Fillers close the gap between a cabinet and a structural wall or structural ceiling. Field cutting a filler may be required to achieve architectural fit.

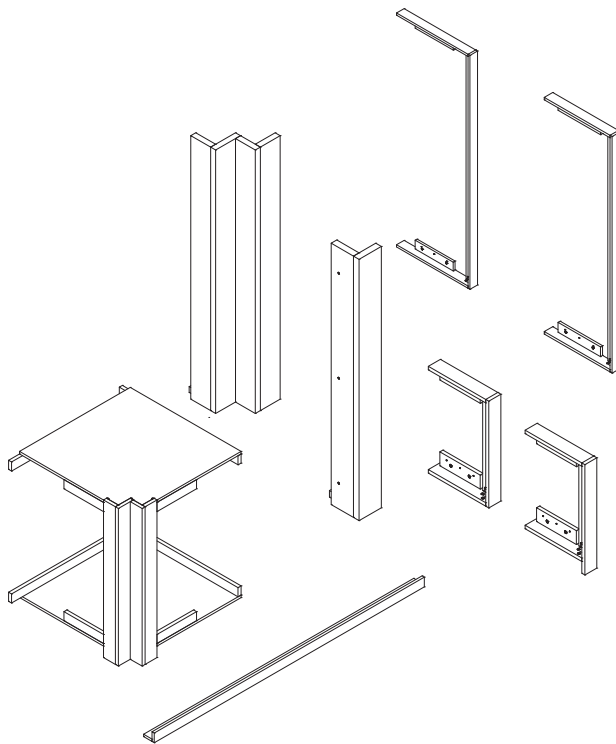

Product Details

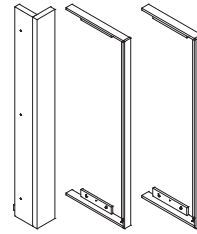

Wall fillers enclose the space between a cabinet and a wall on the front, top, and bottom.

Wall and ceiling fillers come in 3" widths. Plan for 1 1/2"-2" for the filler to be scribed on site.

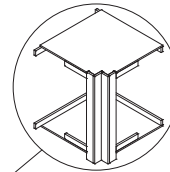

Upper cabinets and wall-suspended base cabinets utilize the side corner filler to enclose the space made where the corner meets. This includes the reveal, the top, and bottom of the run.

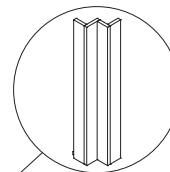

Floor-extended base cabinets can utilize the floor-extended corner filler to enclose the gap where the corners meet.

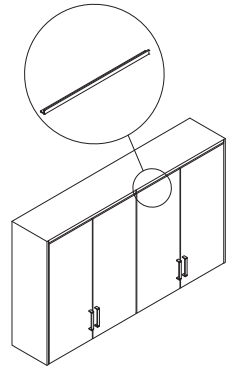

Upper cabinets, wardrobe cabinets, and tall storage cabinets utilize the ceiling filler to enclose the gap between the cabinets and the ceiling or bulkhead.

Ceiling fillers come in 8 foot lengths and are cut to fit on site.

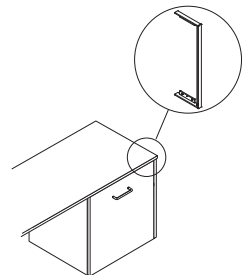

Wall-suspended base cabinets and upper cabinets can utilize the wall fillers to enclose the gap between a cabinet and a wall on the front, top, and bottom.

Filler depth and height flex parametrically in 1" increments.

Surface Materials

Fillers

- High-Pressure Laminate

Convey Accessories

Rail

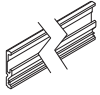

► Specifying, page 168

Product Details

Rails are required to mount all casework components onto architectural walls.

Rails come in 8' sections and are cut to fit in the field.

Rails drive precise alignment and fit through a common connection point.

Rails are exposed on end-of-run conditions and require a notch filler or cover panel.

Blocking/banding is required for wall-suspended cabinets. Blocking/banding for floor-extended cabinets may not be required in architectural walls behind the rail, depending on the application. Check local and state codes for blocking/banding requirements (i.e. seismic zones). Placement of blocking/banding is to be coordinated with the responsible trades.

Surface Materials

Rail

- Clear anodized aluminum

Rail Cover

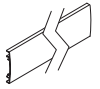

► Specifying, page 168

Product Details

In any application where the rail is exposed, a rail cover is recommended. Examples of this would include the garage without doors and a worksurface with cantilever applications.

Rail cover comes in 8' sections and is cut to fit in the field.

Surface Materials

Rail cover

- 6527 Merle

Adjustable Shelf

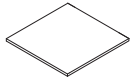

► Specifying, page 170

Product Details

Adjustable shelves can be added to upper storage cabinets, base storage cabinets, and tall storage cabinets.

Shelves adjust in 32 mm increments.

Seismic clips are available for adjustable shelves. Clips lock the shelf and prevent movement front to back, and up and down.

Adjustable shelves flex parametrically in relation to the cabinets in which they are installed.

Surface Materials

Shelf

- High-Pressure Laminate

Edge

- 1 mm plastic matching edge band

Notch Filler

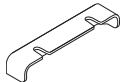

► Specifying, page 172

Product Details

When cover panels are not required, a notch filler could be utilized to cover the notch created by the bracket-to-rail connection.

Notch fillers come in a package of 10.

Surface Materials

Notch filler

- 6009 Arctic White
- 6527 Merle

Hinge Angle Limiter

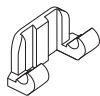

► Specifying, page 172

Product Details

Hinge angle limiter is available for door units and limits the angle to 87°.

Hinge angle limiter comes in a package of 25.

Hinge angle limiter quantity required based on cabinet:

- All upper cabinets and base cabinets require two **HCMHAL** per door. Example: a double-door upper cabinet requires four hinge angle limiters.
- Tall storage cabinets, floor-extended, and wall-suspended wardrobe cabinets require four **HCMHAL** per door.

Surface Materials

Hinge angle limiter

- Nickel

Base Trim

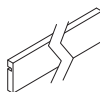

► Specifying, page 172

Product Details

Base trim is required on all floor-extended cabinets and provides a location for cove molding to adhere to. Cove molding must be field installed on base trim to complete an installation and is supplied locally.

Base trim is always black.

Base trim is provided in 8' lengths and is cut to fit in the field.

Base trim contains moisture-resistant properties.

Base trim includes three clips to attach to the face of the floor extended cabinet glides; this is two for the fronts and one extra. If the cabinet does not have any adjacencies, an additional clip will be required. See Service Parts to order.

Surface Materials

Base trim

- 2746 Black High-Pressure Laminate

Edge

- 1 mm plastic matching edge band

Light Valance

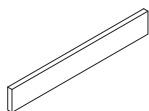

► Specifying, page 173

Product Details

Light valances can be added to upper storage cabinets to conceal task lights and electrical components mounted underneath.

Brackets are included to attach underneath cabinets.

Cabinets are designed to allow a continuous run of light valance and customer supplied task lighting.

Surface Materials

Light valance

- High-Pressure Laminate

Edge

- 1 mm plastic matching edge band

Application Tips

Steelcase offers LED Lights that work well with Convey upper cabinetry.

LED Shelf Lights

All LED shelf lights are 18"W x 2 1/2"D x 1/2"H
 LSL18* - Standalone light (includes 18"W power supply)
 LSL18YA* - Daisy chain starter light (includes 60"W power supply only)
 LSL18YB* - Daisy chain secondary light (includes daisy chain cords only)
 *Optional fastener kit for use with wood shelf needs to be chosen when specified

LED Linear Shelf Lights

LED linear shelf lights come standard with both magnet mount and wood mounting attachment.
 LLL17 - 17"W Standalone light (includes 18"W power supply)
 LLL17YA - 17"W Daisy chain starter light (includes 60"W power supply only)
 LLL17YB - 17"W Daisy chain secondary light (includes daisy chain cords only)
 LLL31 - 31"W Standalone or daisy chain starter light (includes 60"W power supply only)
 LLL31YB - 31"W Daisy chain secondary light (includes daisy chain cords only)
 LL44 - 44"W - Standalone or daisy chain starter light (includes 60"W power supply only)
 LLL44YB - 44"W Daisy chain secondary light (includes daisy chain cords only)
 LLL58 - 58"W Standalone or daisy chain starter light (includes 60"W power supply only)
 LLL58YB - 58"W Daisy chain secondary light (includes daisy chain cords only)

Wall Trim



► Specifying, page 174

Product Details

Wall trim can be used to conceal the bracket-to-rail connection at the end of a run.

Wall trim comes in 10' lengths.

Wall trim ships with an adhesive strip that must be applied during installation.

Surface Materials

Wall trim

- Plastic

Electronic Locks

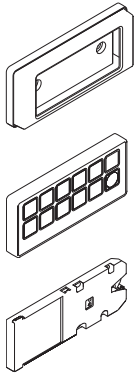

► Specifying, page 174

Product Details

Electronic locks are available and are field installed to secure the door and drawers of a cabinet. Components include a transmitter, receiver, and an optional bezel. One transmitter pad can operate single or multiple receiver latches.

When electronic locks are chosen, all drawers and doors will include a receiver.

Receivers are installed within cabinet drawers and doors.

Receivers are not visible from the exterior of the cabinet.

Wireless receiver latches

can be installed in doors and drawers and are activated by a transmitter (keypad) located within 15' of the cabinets. Receivers can be set to a non-self-locking mode, self-locking mode, or single use mode.

- Non-self-locking mode allows the cabinet to be used by a single code. This requires a code and unlock button to open and a code and lock button to re-engage the lock.
- Self-locking mode automatically re-locks the receiver latch after a programmed amount of time between 2-60 seconds.
- Single use mode allows for a revolving user code, so the lock may be used by multiple people without having to reprogram the receiver latch each time.

Receiver latches

utilize four AAA batteries (included), and the transmitter utilizes a CR2032 coin battery (included).

Lock receivers are not visible on the exterior of the cabinets.

One transmitter pad

can activate an unlimited number of receiver latches.

Receivers can accept one supervisor and one user code. For programming information, please visit www.stealthlock.com.

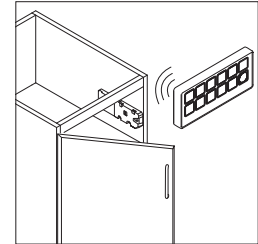

The transmitter pad operates within a 15' range. Keypads are user programmable with optional modes of operations for single-use or self-lock.

The bezel is optional to frame in and secure the transmitter to a mounting location. The bezel is offered in black only.

► See the *Installation and Programming Instructions* at village.steelcase.com/convey.

Convey Base Cabinets

Wall Suspended

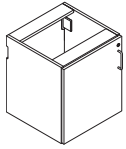

	Standard Includes	Required to Specify
▶ Need help? Product details, page 40	<ul style="list-style-type: none"> • Base cabinet: High-Pressure Laminate • D pull and euro hinges: nickel • Bracket cover: 6009 Arctic White • Edges: matching 3 mm plastic on doors and drawers and matching 1 mm plastic on all other edges • Base cabinets with door, if selected: <ul style="list-style-type: none"> – Shelf attachment: shelf pin – One adjustable shelf 	<ol style="list-style-type: none"> 1 Style number 2 Cabinet depth (see below under Required Selections) 3 Cabinet height (see below under Required Selections) 4 Cabinet width (see below under Required Selections) 5 Laminate color number for base cabinet 6 Handedness (see below under Required Selections) 7 Drawer configuration (see below under Required Selections) 8 Options, if selected (see below) <p>▶ See <i>Surface Materials</i>, page 376.</p>

Tip: The increment for parametric depth and width is 1".

Tip: Refer to page 37 for planning heights.

	Required Selections	U.S. Price	Required to Specify
Cabinet Depth	Parametric depth		
	• Base cabinet with doors – 14"D–24"D	Prices at right	Specify with 14"D–24"D.
	• Base cabinet with drawers and base cabinet with drawer or door – 16"D–24"D	Prices at right	Specify with 16"D–24"D.
Cabinet Height	• 23"H	Prices at right	Specify with 23"H.
Cabinet Width	Parametric width		
	• Base cabinet with door(s) – 12"W–48"W	Prices at right	Specify with 12"W–48"W.
	• Base cabinet with drawers – 15"W–24"W	Prices at right	Specify with 15"W–24"W.
Handedness	Base cabinet with door		
	• Left hand	No cost	Specify with left hand.
	• Right hand	No cost	Specify with right hand.
Drawer Configuration	Base cabinet with drawers		
	• One small drawer and one large drawer	Prices at right	Specify with one small drawer and one large drawer.
	• Three small drawers	Prices at right	Specify with three small drawers.

Tip: Handedness is only required on 24"W cabinets and smaller. 25"W cabinets or wider default to two doors, side-by-side.

Tip: Left and right is determined when facing units.

	Options	U.S. Price	Required to Specify
Surface Materials	Case		
	• Solid HPL	No cost	Specify laminate color number.
	• Woodgrain HPL	No cost	Specify laminate color number.
	• Laminate price group B	Prices at right	Specify laminate color number.
	• Laminate price group 2	Prices at right	Specify laminate color number.
	Door and drawer pulls		
	• 0835 Black	No cost	Specify with 0835 Black.
	• 9201 Polished Chrome	No cost	Specify with 9201 Polished Chrome.
	• 9211 Nickel	No cost	Specify with 9211 Nickel.
	• 9212 Silver	No cost	Specify with 9212 Silver.
Door and Drawer Pull	• No pull	No cost	Specify with no pull.
	• D pull	No cost	Specify with D pull.
	• Contemporary pull	No cost	Specify with contemporary pull.
	• Jazz pull	+\$28 per pull	Specify with jazz pull.
Shelf Attachment	• Shelf pin	No cost	Specify with shelf pin.
	• Seismic shelf clip	No cost	Specify with seismic shelf clip.
Lock and Keying	• No lock	No cost	Specify with no lock.
	• Manual lock with master key plug	+\$88	Specify with manual lock.
	Keying		
	• Factory and field-installed keying		▶ Page 398

Tip: For finish codes and more information on laminate price group B, see *Surface Materials*.

▶ See page 376

Tip: Electronic locks are available and must be installed in the field.

▶ See page 174

Tip: Please refer to SmartTools to specify sizes.

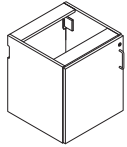

Specification Information

Style Number	Dimensions			U.S. Base Price	Options (Add \$ to Base Price)	
	D	W	H		Laminate Price Group B	HPL Price Group 2

Wall-Suspended Base Cabinet with Door(s)

HCMBDW	14"-20"	12"-15"	22.956"	\$1030	+\$ 52	+\$ 55
	14"-20"	16"-18"	22.956"	\$1082	+\$ 53	+\$ 56
	14"-20"	19"-24"	22.956"	\$1189	+\$ 58	+\$ 61
	14"-20"	25"-30"	22.956"	\$1294	+\$ 63	+\$ 66
	14"-20"	31"-36"	22.956"	\$1401	+\$ 70	+\$ 74
	14"-20"	37"-42"	22.956"	\$1507	+\$ 76	+\$ 80
	14"-20"	43"-48"	22.956"	\$1612	+\$ 80	+\$ 84
	21"-24"	12"-15"	22.956"	\$1082	+\$ 53	+\$ 56
	21"-24"	16"-18"	22.956"	\$1140	+\$ 56	+\$ 60
	21"-24"	19"-24"	22.956"	\$1255	+\$ 62	+\$ 65
	21"-24"	25"-30"	22.956"	\$1368	+\$ 68	+\$ 71
	21"-24"	31"-36"	22.956"	\$1484	+\$ 74	+\$ 79
	21"-24"	37"-42"	22.956"	\$1598	+\$ 79	+\$ 83
	21"-24"	43"-48"	22.956"	\$1713	+\$ 85	+\$ 90

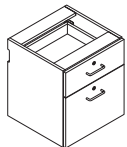

Wall-Suspended Base Cabinet with One Small and One Large Drawer

HCMBDWRW	16"-20"	15"	22.956"	\$1806	+\$ 89	+\$ 93
	16"-20"	16"-18"	22.956"	\$1877	+\$ 93	+\$ 99
	16"-20"	19"-24"	22.956"	\$2015	+\$100	+\$106
	21"-24"	15"	22.956"	\$2161	+\$108	+\$114
	21"-24"	16"-18"	22.956"	\$2241	+\$112	+\$117
	21"-24"	19"-24"	22.956"	\$2399	+\$119	+\$127

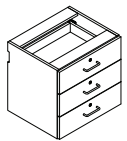

Wall-Suspended Base Cabinet with Three Small Drawers

HCMBDWRW	16"-20"	15"	22.956"	\$2455	+\$122	+\$129
	16"-20"	16"-18"	22.956"	\$2533	+\$127	+\$133
	16"-20"	19"-24"	22.956"	\$2687	+\$133	+\$142
	21"-24"	15"	22.956"	\$2745	+\$137	+\$145
	21"-24"	16"-18"	22.956"	\$2793	+\$139	+\$147
	21"-24"	19"-24"	22.956"	\$2886	+\$142	+\$152

 **For Canadian Pricing**
 Multiply U.S. Price by the Canadian price factor.
 ▶ See page 1 for details.

Convey Base Cabinets

Floor Extended

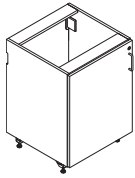

► Need help?
Product details,
page 44

Standard Includes

- Base cabinet: High-Pressure Laminate
- D pull and euro hinges: nickel
- Bracket cover: 6009 Arctic White
- Four adjustable glides
- Edges: matching 3 mm plastic on doors and drawers and matching 1 mm plastic on all other edges
- Base cabinets with door(s):
 - Shelf attachment: shelf pin
 - One adjustable shelf

Required to Specify

- 1 Style number
 - 2 Cabinet depth (see below under Required Selections)
 - 3 Cabinet height (see below under Required Selections)
 - 4 Cabinet width (see below under Required Selections)
 - 5 Laminate color number for base cabinet
 - 6 Handedness (see below under Required Selections)
 - 7 Drawer configuration (see below under Required Selections)
 - 8 Options, if selected (see below)
- See *Surface Materials*, page 376.

Tip: The increment for parametric depth and width is 1".

Tip: Refer to page 38 for planning heights.

	Required Selections	U.S. Price	Required to Specify
Cabinet Depth	Parametric depth <ul style="list-style-type: none"> • Base cabinet with drawers and base cabinet with drawer and door <ul style="list-style-type: none"> – 16"D–29"D • Base cabinet with doors <ul style="list-style-type: none"> – 14"D–29"D 	Prices at right Prices at right	Specify with 16"D–29"D. Specify with 14"D–29"D.
Cabinet Height	Parametric height <ul style="list-style-type: none"> • Base cabinet with door(s) <ul style="list-style-type: none"> – 27"H–40½"H • Base cabinet with drawers and base cabinet with drawer and door <ul style="list-style-type: none"> – 27"H–34½"H 	Prices at right Prices at right	Specify with 27"H–40½"H. Specify with 27"H–34½"H.
Cabinet Width	Parametric width <ul style="list-style-type: none"> • Base cabinet with door(s) and base cabinet with drawer and door <ul style="list-style-type: none"> – 12"W–48"W • Base cabinet with drawers <ul style="list-style-type: none"> – 15"W–24"W 	Prices at right Prices at right	Specify with 12"W–48"W. Specify with 15"W–24"W.
Handedness	Base cabinet with door and base cabinet with drawer and door <ul style="list-style-type: none"> • Left hand • Right hand 	No cost No cost	Specify with left hand. Specify with right hand.
Drawer Configuration	Base cabinet with drawer and door <ul style="list-style-type: none"> • One small drawer • Two small drawers, side-by-side Base cabinet with drawers <ul style="list-style-type: none"> • 27"H–32"H base cabinets <ul style="list-style-type: none"> – One small and one large drawer – Three small drawers • 32½"H–34"H base cabinets <ul style="list-style-type: none"> – Two small and one medium drawer • 34½"H base cabinets <ul style="list-style-type: none"> – Two large drawers – Two small and one large drawer – Four small drawers 	Prices at right Prices at right Prices at right Prices at right Prices at right Prices at right Prices at right Prices at right	Specify with one small drawer. Specify with two small drawers, side-by-side. Specify with one small and one large drawer. Specify with three small drawers. Specify with two small and one medium drawer. Specify with two large drawers. Specify with two small and one large drawer. Specify with four small drawers.

Tip: Handedness is only required on 24"W cabinets and smaller. 25"W cabinets or wider defaults to two doors and/or drawers side-by-side.

Tip: Left and right is determined when facing units.

Tip: Drawer configuration for base cabinets with drawers and doors default to two side-by-side on cabinets 25"W or wider. Base cabinets with drawers and doors 24"W or less will have one small drawer.



For Canadian Pricing

Multiply U.S. Price by the Canadian price factor.

► See page 1 for details.

Tip: For finish codes and more information on laminate price group B, see Surface Materials.
▶ See page 376

Options	U.S. Price	Required to Specify
Surface Materials	Case	
	• Solid HPL	No cost
	• Woodgrain HPL	No cost
	• Laminate price group B	Prices below and at right
	• Laminate price group 2	Prices below and at right
	Door and drawer pulls	
	• 0835 Black	No cost
	• 9201 Polished Chrome	No cost
	• 9211 Nickel	No cost
	• 9212 Silver	No cost
Door and Drawer Pull		
	• No pull	No cost
	• D pull	No cost
	• Contemporary pull	No cost
	• Jazz pull	+\$28 per pull
Shelf Attachment	Base cabinet with door(s) and base cabinet with drawer and door	
	• Shelf pin	No cost
	• Seismic shelf clip	No cost
Lock and Keying		
	• No lock	No cost
	• Manual lock with master key plug	+\$88
	Keying	
	• Factory and field-installed keying	

Tip: Electronic locks are available and must be installed in the field.
▶ See page 174

▶ Page 398

Specification Information

Style Number	Dimensions D W H	U.S. Base Price	Options (Add \$ to Base Price)
			Laminate Price : HPL Price Group B : Group 2

Floor-Extended Base Cabinet with Door(s)

HCMBDF	14"-24"	12"-15"	27"	U.S. Base Price	Options	Price
	14"-24"	16"-18"	27"	\$1078	+\$53	+\$56
	14"-24"	19"-24"	27"	\$1149	+\$56	+\$60
	14"-24"	25"-30"	27"	\$1287	+\$63	+\$66
	14"-24"	31"-36"	27"	\$1426	+\$72	+\$75
	14"-24"	37"-42"	27"	\$1562	+\$78	+\$82
	14"-24"	43"-48"	27"	\$1702	+\$84	+\$89
	25"-29"	12"-15"	27"	\$1838	+\$90	+\$94
	25"-29"	16"-18"	27"	\$1228	+\$60	+\$63
	25"-29"	19"-24"	27"	\$1283	+\$63	+\$66
	25"-29"	25"-30"	27"	\$1395	+\$70	+\$74
	25"-29"	31"-36"	27"	\$1507	+\$76	+\$80
	25"-29"	37"-42"	27"	\$1618	+\$80	+\$84
	25"-29"	43"-48"	27"	\$1730	+\$85	+\$90
	25"-29"	43"-48"	27"	\$1842	+\$90	+\$94

▶ Specification Information, continued on next page

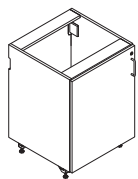

Tip: Please refer to SmartTools to specify sizes.

For Canadian Pricing
Multiply U.S. Price by the Canadian price factor.
▶ See page 1 for details.

► Specification Information, continued from previous page

Specification Information						
Style Number	Dimensions			U.S. Base Price	Options (Add \$ to Base Price)	
	D	W	H		Laminate Price	HPL Price
					Group B	Group 2

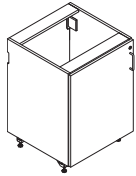

Tip: Please refer to SmartTools to specify sizes.

Floor-Extended Base Cabinet with Door(s), continued

HCMBDF	14"-24"	12"-15"	28"-32½"	\$1248	+\$ 62	+\$ 65
	14"-24"	16"-18"	28"-32½"	\$1319	+\$ 64	+\$ 68
	14"-24"	19"-24"	28"-32½"	\$1457	+\$ 73	+\$ 78
	14"-24"	25"-30"	28"-32½"	\$1597	+\$ 79	+\$ 83
	14"-24"	31"-36"	28"-32½"	\$1737	+\$ 87	+\$ 91
	14"-24"	37"-42"	28"-32½"	\$1877	+\$ 93	+\$ 99
	14"-24"	43"-48"	28"-32½"	\$2015	+\$100	+\$106
	25"-29"	12"-15"	28"-32½"	\$1339	+\$ 65	+\$ 69
	25"-29"	16"-18"	28"-32½"	\$1401	+\$ 70	+\$ 74
	25"-29"	19"-24"	28"-32½"	\$1523	+\$ 77	+\$ 81
	25"-29"	25"-30"	28"-32½"	\$1647	+\$ 81	+\$ 87
	25"-29"	31"-36"	28"-32½"	\$1770	+\$ 88	+\$ 92
	25"-29"	37"-42"	28"-32½"	\$1893	+\$ 93	+\$ 99
	25"-29"	43"-48"	28"-32½"	\$2016	+\$100	+\$106
	14"-24"	12"-15"	33"-34½"	\$1311	+\$ 64	+\$ 68
	14"-24"	16"-18"	33"-34½"	\$1380	+\$ 68	+\$ 71
	14"-24"	19"-24"	33"-34½"	\$1520	+\$ 77	+\$ 81
	14"-24"	25"-30"	33"-34½"	\$1661	+\$ 82	+\$ 88
	14"-24"	31"-36"	33"-34½"	\$1800	+\$ 89	+\$ 93
	14"-24"	37"-42"	33"-34½"	\$1940	+\$ 95	+\$101
	14"-24"	43"-48"	33"-34½"	\$2080	+\$103	+\$110
	25"-29"	12"-15"	33"-34½"	\$1379	+\$ 68	+\$ 71
	25"-29"	16"-18"	33"-34½"	\$1442	+\$ 73	+\$ 78
	25"-29"	19"-24"	33"-34½"	\$1571	+\$ 78	+\$ 82
	25"-29"	25"-30"	33"-34½"	\$1696	+\$ 84	+\$ 89
	25"-29"	31"-36"	33"-34½"	\$1825	+\$ 90	+\$ 94
	25"-29"	37"-42"	33"-34½"	\$1954	+\$ 98	+\$103
	25"-29"	43"-48"	33"-34½"	\$2082	+\$103	+\$110
	14"-24"	12"-15"	35"-40½"	\$1495	+\$ 76	+\$ 80
	14"-24"	16"-18"	35"-40½"	\$1565	+\$ 78	+\$ 82
	14"-24"	19"-24"	35"-40½"	\$1708	+\$ 84	+\$ 89
	14"-24"	25"-30"	35"-40½"	\$1849	+\$ 91	+\$ 95
	14"-24"	31"-36"	35"-40½"	\$1990	+\$ 99	+\$104
	14"-24"	37"-42"	35"-40½"	\$2131	+\$107	+\$113
	14"-24"	43"-48"	35"-40½"	\$2271	+\$113	+\$118

► Specification Information, continued on next page

 **For Canadian Pricing**
 Multiply U.S. Price by the Canadian price factor.
 ► See page 1 for details.

Tip: Please refer to SmartTools to specify sizes.

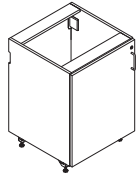

► Specification Information, continued from previous page

Specification Information

Style Number	Dimensions			U.S. Base Price	Options (Add \$ to Base Price)	
	D	W	H		Laminate Price Group B	HPL Price Group 2

Floor-Extended Base Cabinet with Door(s), continued

HCMBDF	25"-29"	12"-15"	35"-40½"	\$1497	+\$ 76	+\$ 80
	25"-29"	16"-18"	35"-40½"	\$1568	+\$ 78	+\$ 82
	25"-29"	19"-24"	35"-40½"	\$1710	+\$ 85	+\$ 90
	25"-29"	25"-30"	35"-40½"	\$1850	+\$ 91	+\$ 95
	25"-29"	31"-36"	35"-40½"	\$1993	+\$ 99	+\$104
	25"-29"	37"-42"	35"-40½"	\$2132	+\$107	+\$113
	25"-29"	43"-48"	35"-40½"	\$2272	+\$113	+\$118



Floor-Extended Base Cabinet with One Small and One Large Drawer

HCMBDWR	16"-24"	15"	27"	\$2134	+\$107	+\$113
	16"-24"	16"-18"	27"	\$2219	+\$111	+\$116
	16"-24"	19"-24"	27"	\$2387	+\$119	+\$127
	25"-29"	15"	27"	\$2267	+\$113	+\$118
	25"-29"	16"-18"	27"	\$2367	+\$117	+\$123
	25"-29"	19"-24"	27"	\$2566	+\$128	+\$134



Floor-Extended Base Cabinet with Three Small Drawers

HCMBDWR	16"-24"	15"	27"	\$2397	+\$119	+\$127
	16"-24"	16"-18"	27"	\$2513	+\$126	+\$132
	16"-24"	19"-24"	27"	\$2745	+\$137	+\$145
	25"-29"	15"	27"	\$2535	+\$127	+\$133
	25"-29"	16"-18"	27"	\$2642	+\$131	+\$139
	25"-29"	19"-24"	27"	\$2857	+\$141	+\$149

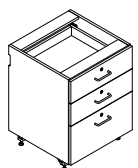

Floor-Extended Base Cabinet with Two Small and One Medium Drawer

HCMBDWR	16"-24"	15"	32½"-34"	\$2621	+\$130	+\$136
	16"-24"	16"-18"	32½"-34"	\$2712	+\$136	+\$143
	16"-24"	19"-24"	32½"-34"	\$2898	+\$142	+\$152
	25"-29"	15"	32½"-34"	\$2742	+\$137	+\$145
	25"-29"	16"-18"	32½"-34"	\$2863	+\$141	+\$149
	25"-29"	19"-24"	32½"-34"	\$3103	+\$155	+\$165

► Specification Information, continued on next page

 **For Canadian Pricing**
 Multiply U.S. Price by the Canadian price factor.
 ► See page 1 for details.

► **Specification Information, continued from previous page**

Tip: Please refer to SmartTools to specify sizes.



Specification Information						
Style Number	Dimensions			U.S. Base Price	Options (Add \$ to Base Price)	
	D	W	H		Laminate Price	HPL Price Group B

Floor-Extended Base Cabinet with Two Large Drawers

HCMBDWRF	16"-24"	15"	34½"	\$2174	+\$110	+\$115
	16"-24"	16"-18"	34½"	\$2265	+\$113	+\$118
	16"-24"	19"-24"	34½"	\$2448	+\$122	+\$129
	25"-29"	15"	34½"	\$2316	+\$115	+\$121
	25"-29"	16"-18"	34½"	\$2418	+\$120	+\$128
	25"-29"	19"-24"	34½"	\$2623	+\$130	+\$136



Floor-Extended Base Cabinet with Four Small Drawers

HCMBDWRF	16"-24"	15"	34½"	\$2897	+\$142	+\$152
	16"-24"	16"-18"	34½"	\$3013	+\$151	+\$158
	16"-24"	19"-24"	34½"	\$3250	+\$161	+\$171
	25"-29"	15"	34½"	\$3077	+\$154	+\$162
	25"-29"	16"-18"	34½"	\$3217	+\$160	+\$170
	25"-29"	19"-24"	34½"	\$3498	+\$175	+\$185



Floor-Extended Base Cabinet with Two Small and One Large Drawer

HCMBDWRF	16"-24"	15"	34½"	\$2174	+\$110	+\$115
	16"-24"	16"-18"	34½"	\$2265	+\$113	+\$118
	16"-24"	19"-24"	34½"	\$2448	+\$122	+\$129
	25"-29"	15"	34½"	\$2774	+\$138	+\$146
	25"-29"	16"-18"	34½"	\$2896	+\$142	+\$152
	25"-29"	19"-24"	34½"	\$3138	+\$156	+\$166

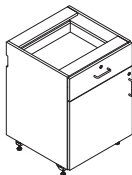

Floor-Extended Base Cabinet with One Small Drawer and One Door

HCMBDWRDF	16"-24"	12"-15"	27"	\$1607	+\$ 80	+\$ 84
	16"-24"	16"-18"	27"	\$1669	+\$ 82	+\$ 88
	16"-24"	19"-24"	27"	\$1794	+\$ 89	+\$ 93
	25"-29"	12"-15"	27"	\$1690	+\$ 84	+\$ 89
	25"-29"	16"-18"	27"	\$1751	+\$ 87	+\$ 91
	25"-29"	19"-24"	27"	\$1876	+\$ 93	+\$ 99
	16"-24"	12"-15"	28"-32½"	\$1697	+\$ 84	+\$ 89
	16"-24"	16"-18"	28"-32½"	\$1767	+\$ 88	+\$ 92
	16"-24"	19"-24"	28"-32½"	\$1906	+\$ 94	+\$100
	25"-29"	12"-15"	28"-32½"	\$1783	+\$ 88	+\$ 92
	25"-29"	16"-18"	28"-32½"	\$1852	+\$ 91	+\$ 95
	25"-29"	19"-24"	28"-32½"	\$1988	+\$ 99	+\$104

 **For Canadian Pricing**
Multiply U.S. Price by the Canadian price factor.
► See page 1 for details.

► **Specification Information, continued on next page**

► Specification Information, continued from previous page

Tip: Please refer to SmartTools to specify sizes.

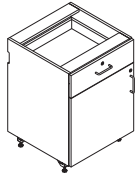

Specification Information						
Style Number	Dimensions			U.S. Base Price	Options (Add \$ to Base Price)	
	D	W	H		Laminate Price Group B	HPL Price Group 2

Floor-Extended Base Cabinet with One Small Drawer and One Door, continued

HCMBDWRDF	D	W	H	U.S. Base Price	Laminate Price Group B	HPL Price Group 2
	16"-24"	12"-15"	33"-34½"	\$1733	+\$ 85	+\$ 90
	16"-24"	16"-18"	33"-34½"	\$1803	+\$ 89	+\$ 93
	16"-24"	19"-24"	33"-34½"	\$1946	+\$ 95	+\$101
	25"-29"	12"-15"	33"-34½"	\$1817	+\$ 90	+\$ 94
	25"-29"	16"-18"	33"-34½"	\$1888	+\$ 93	+\$ 99
	25"-29"	19"-24"	33"-34½"	\$2030	+\$100	+\$106

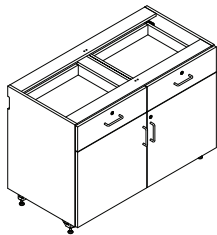

Floor-Extended Base Cabinet with Two Small Side-by-Side Drawers and Doors

HCMBDWRDF	D	W	H	U.S. Base Price	Laminate Price Group B	HPL Price Group 2
	16"-24"	25"-30"	27"	\$2400	+\$119	+\$127
	16"-24"	31"-36"	27"	\$2523	+\$127	+\$133
	16"-24"	37"-42"	27"	\$2647	+\$131	+\$139
	16"-24"	43"-48"	27"	\$2770	+\$138	+\$146
	25"-29"	25"-30"	27"	\$2515	+\$126	+\$132
	25"-29"	31"-36"	27"	\$2659	+\$132	+\$140
	25"-29"	37"-42"	27"	\$2800	+\$139	+\$147
	25"-29"	43"-48"	27"	\$2942	+\$148	+\$155
	16"-24"	25"-30"	28"-32½"	\$2529	+\$127	+\$133
	16"-24"	31"-36"	28"-32½"	\$2666	+\$132	+\$140
	16"-24"	37"-42"	28"-32½"	\$2802	+\$139	+\$147
	16"-24"	43"-48"	28"-32½"	\$2939	+\$148	+\$155
	25"-29"	25"-30"	28"-32½"	\$2643	+\$131	+\$139
	25"-29"	31"-36"	28"-32½"	\$2799	+\$139	+\$147
	25"-29"	37"-42"	28"-32½"	\$2956	+\$149	+\$156
	25"-29"	43"-48"	28"-32½"	\$3113	+\$155	+\$165
	16"-24"	25"-30"	33"-34½"	\$2575	+\$128	+\$134
	16"-24"	31"-36"	33"-34½"	\$2718	+\$136	+\$143
	16"-24"	37"-42"	33"-34½"	\$2860	+\$141	+\$149
	16"-24"	43"-48"	33"-34½"	\$3003	+\$150	+\$157
	25"-29"	25"-30"	33"-34½"	\$2688	+\$133	+\$142
	25"-29"	31"-36"	33"-34½"	\$2850	+\$141	+\$149
	25"-29"	37"-42"	33"-34½"	\$3013	+\$151	+\$158
	25"-29"	43"-48"	33"-34½"	\$3173	+\$158	+\$168



 **For Canadian Pricing**
 Multiply U.S. Price by the Canadian price factor.
 ► See page 1 for details.

Convey Printer Cabinets

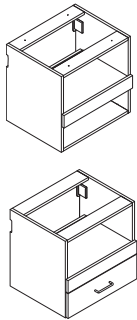

► Need help?
Product details,
page 48

Standard Includes

- Printer cabinet: High-Pressure Laminate
- D pull and euro hinges: nickel
- Bracket cover: plastic
- Edges: matching 3 mm plastic drawers and matching 1 mm plastic on all other edges
- Four adjustable glides for floor-extended printer cabinet, if selected
- Printer pullout shelf

Required to Specify

- 1 Style number
 - 2 Cabinet depth (see below under Required Selections)
 - 3 Cabinet height (see below under Required Selections)
 - 4 Cabinet width (see below under Required Selections)
 - 5 Laminate color number for printer cabinet
 - 6 Plastic color number for bracket cover:
6009 Arctic White
6527 Merle
 - 7 Drawer configuration (see below under Required Selections)
 - 8 Options, if selected (see below)
- See *Surface Materials*, page 376.

Tip: The increment for parametric depth and width is 1".

Tip: Refer to page 37 for planning heights.

Tip: Drawer configuration defaults to two side-by-side on cabinets 25"W or wider. Cabinets 24"W or less will have one small drawer.

*Tip: For finish codes and more information on laminate price group B, see *Surface Materials*.*

► See page 376

	Required Selections	U.S. Price	Required to Specify
Cabinet Depth	Parametric depth		
	• Wall-suspended printer cabinets – 16"D–24"D	Prices at right	Specify with 16"D–24"D.
	• Floor-extended printer cabinets – 16"D–29"D	Prices at right	Specify with 16"D–29"D.
Cabinet Height	• Wall-suspended printer cabinets – 23"H	Prices at right	Specify with 23"H.
	• Floor-extended printer cabinets – 32½"H–34½"H	Prices at right	Specify with 32½"H–40½"H.
Cabinet Width	Parametric width		
	• 20"W–36"W	Prices at right	Specify with 20"W–36"W.
Drawer Configuration	• One small drawer	Prices at right	Specify with <i>one small drawer</i> .
	• Two small drawers, side-by-side	Prices at right	Specify with <i>two small drawers, side-by-side</i> .
	Options	U.S. Price	Required to Specify
Surface Materials	Case		
	• Solid HPL	No cost	Specify laminate color number.
	• Woodgrain HPL	No cost	Specify laminate color number.
	• Laminate price group B	Prices at right	Specify laminate color number.
	• Laminate price group 2	Prices at right	Specify laminate color number.
	Door and drawer pulls		
	• 0835 Black	No cost	Specify with <i>0835 Black</i> .
	• 9201 Polished Chrome	No cost	Specify with <i>9201 Polished Chrome</i> .
	• 9211 Nickel	No cost	Specify with <i>9211 Nickel</i> .
	• 9212 Silver	No cost	Specify with <i>9212 Silver</i> .
Drawer Pull	• No pull	No cost	Specify with <i>no pull</i> .
	• D pull	No cost	Specify with <i>D pull</i> .
	• Contemporary pull	No cost	Specify with <i>contemporary pull</i> .
	• Jazz pull	+\$28 per pull	Specify with <i>jazz pull</i> .



For Canadian Pricing

Multiply U.S. Price by the Canadian price factor.

► See page 1 for details.

Tip: Please refer to SmartTools to specify sizes.

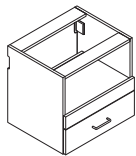
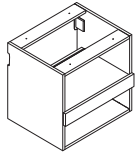

Specification Information

Style Number	Dimensions			U.S. Base Price	Options (Add \$ to Base Price)	
	D	W	H		Laminate Price Group B	HPL Price Group 2

Wall-Suspended Printer Cabinet

HCMBPW	D	W	H	U.S. Base Price	Laminate Price Group B	HPL Price Group 2
	16"-20"	20"-24"	22.956"	\$1548	+\$ 78	+\$ 82
	16"-20"	25"-30"	22.956"	\$1683	+\$ 84	+\$ 89
	16"-20"	31"-36"	22.956"	\$1818	+\$ 90	+\$ 94
	21"-24"	20"-24"	22.956"	\$1724	+\$ 85	+\$ 90
	21"-24"	25"-30"	22.956"	\$1861	+\$ 91	+\$ 95
	21"-24"	31"-36"	22.956"	\$2000	+\$ 99	+\$104

Wall-Suspended Printer Cabinet with Drawer(s)

HCMBDWRW	D	W	H	U.S. Base Price	Laminate Price Group B	HPL Price Group 2
	16"-20"	20"-24"	22.956"	\$2021	+\$100	+\$106
	16"-20"	25"-30"	22.956"	\$2374	+\$117	+\$123
	16"-20"	31"-36"	22.956"	\$2723	+\$136	+\$143
	21"-24"	20"-24"	22.956"	\$2327	+\$115	+\$121
	21"-24"	25"-30"	22.956"	\$2694	+\$133	+\$142
	21"-24"	31"-36"	22.956"	\$3064	+\$154	+\$162

► Specification Information, continued on next page



 **For Canadian Pricing**
 Multiply U.S. Price by the Canadian price factor.
 ► See page 1 for details.

► **Specification Information, continued from previous page**

Specification Information						
Style Number	Dimensions			U.S. Base Price	Options (Add \$ to Base Price)	
	D	W	H		Laminate Price	HPL Price
					Group B	Group 2

Floor-Extended Printer Cabinet

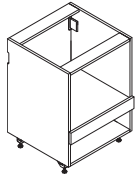

Tip: Please refer to SmartTools to specify sizes.

HCMBPF	16"-20"	20"-24"	27"	U.S. Base Price	Options	Options
				\$1597	+\$ 79	+\$ 83
	16"-20"	25"-30"	27"	\$1761	+\$ 87	+\$ 91
	16"-20"	31"-36"	27"	\$1917	+\$ 94	+\$100
	21"-24"	20"-24"	27"	\$1708	+\$ 84	+\$ 89
	21"-24"	25"-30"	27"	\$1881	+\$ 93	+\$ 99
	21"-24"	31"-36"	27"	\$2049	+\$101	+\$109
	25"-29"	20"-24"	27"	\$1843	+\$ 90	+\$ 94
	25"-29"	25"-30"	27"	\$2035	+\$101	+\$109
	25"-29"	31"-36"	27"	\$2212	+\$111	+\$116
	16"-20"	20"-24"	28"-32½"	\$1605	+\$ 80	+\$ 84
	16"-20"	25"-30"	28"-32½"	\$1792	+\$ 89	+\$ 93
	16"-20"	31"-36"	28"-32½"	\$1983	+\$ 99	+\$104
	21"-24"	20"-24"	28"-32½"	\$1713	+\$ 85	+\$ 90
	21"-24"	25"-30"	28"-32½"	\$1915	+\$ 94	+\$100
	21"-24"	31"-36"	28"-32½"	\$2116	+\$107	+\$113
	25"-29"	20"-24"	28"-32½"	\$1849	+\$ 91	+\$ 95
	25"-29"	25"-30"	28"-32½"	\$2067	+\$103	+\$110
	25"-29"	31"-36"	28"-32½"	\$2280	+\$114	+\$120
	16"-20"	20"-24"	33"-34½"	\$1607	+\$ 80	+\$ 84
	16"-20"	25"-30"	33"-34½"	\$1802	+\$ 89	+\$ 93
	16"-20"	31"-36"	33"-34½"	\$2010	+\$100	+\$106
	21"-24"	20"-24"	33"-34½"	\$1715	+\$ 85	+\$ 90
	21"-24"	25"-30"	33"-34½"	\$1926	+\$ 95	+\$101
	21"-24"	31"-36"	33"-34½"	\$2142	+\$108	+\$114
	25"-29"	20"-24"	33"-34½"	\$1852	+\$ 91	+\$ 95
	25"-29"	25"-30"	33"-34½"	\$2080	+\$103	+\$110
	25"-29"	31"-36"	33"-34½"	\$2304	+\$115	+\$121

► **Specification Information, continued on next page**



For Canadian Pricing

Multiply U.S. Price by the Canadian price factor.

► See page 1 for details.

► Specification Information, continued from previous page

Specification Information						
Style Number	Dimensions			U.S. Base Price	Options (Add \$ to Base Price)	
	D	W	H		Laminate Price	HPL Price

Floor-Extended Printer Cabinet with Drawer(s)

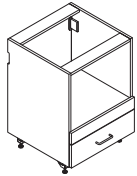

Tip: Please refer to SmartTools to specify sizes.

Style Number	D	W	H	U.S. Base Price	Laminate Price	HPL Price
HCMBPDWRF	16"-20"	20"-24"	27"	\$1945	+\$ 95	+\$101
	16"-20"	25"-30"	27"	\$2295	+\$114	+\$120
	16"-20"	31"-36"	27"	\$2642	+\$131	+\$139
	21"-24"	20"-24"	27"	\$2010	+\$100	+\$106
	21"-24"	25"-30"	27"	\$2410	+\$119	+\$127
	21"-24"	31"-36"	27"	\$2805	+\$139	+\$147
	25"-29"	20"-24"	27"	\$2091	+\$106	+\$111
	25"-29"	25"-30"	27"	\$2551	+\$128	+\$134
	25"-29"	31"-36"	27"	\$3011	+\$151	+\$158
	16"-20"	20"-24"	28"-32½"	\$2039	+\$101	+\$109
	16"-20"	25"-30"	28"-32½"	\$2387	+\$119	+\$127
	16"-20"	31"-36"	28"-32½"	\$2743	+\$137	+\$145
	21"-24"	20"-24"	28"-32½"	\$2103	+\$106	+\$111
	21"-24"	25"-30"	28"-32½"	\$2501	+\$126	+\$132
	21"-24"	31"-36"	28"-32½"	\$2900	+\$142	+\$152
	25"-29"	20"-24"	28"-32½"	\$2184	+\$110	+\$115
	25"-29"	25"-30"	28"-32½"	\$2643	+\$131	+\$139
	25"-29"	31"-36"	28"-32½"	\$3105	+\$155	+\$165
	16"-20"	20"-24"	33"-34½"	\$2072	+\$103	+\$110
	16"-20"	25"-30"	33"-34½"	\$2422	+\$120	+\$128
	16"-20"	31"-36"	33"-34½"	\$2769	+\$138	+\$146
	21"-24"	20"-24"	33"-34½"	\$2135	+\$107	+\$113
	21"-24"	25"-30"	33"-34½"	\$2535	+\$127	+\$133
	21"-24"	31"-36"	33"-34½"	\$2933	+\$148	+\$155
	25"-29"	20"-24"	33"-34½"	\$2218	+\$111	+\$116
	25"-29"	25"-30"	33"-34½"	\$2679	+\$132	+\$140
	25"-29"	31"-36"	33"-34½"	\$3138	+\$156	+\$166



 **For Canadian Pricing**
 Multiply U.S. Price by the Canadian price factor.
 ► See page 1 for details.

Convey Pullout Trash Cabinets

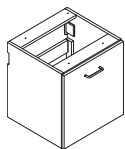

Standard Includes	Required to Specify
<ul style="list-style-type: none"> ▶ Need help? Product details, page 52 • Trash cabinet: High-Pressure Laminate • D pull: nickel • Bracket cover: 6009 Arctic White • Edges: matching 3 mm plastic on drawers and matching 1 mm plastic on all other edges • Four adjustable glides for floor-extended cabinet, if selected 	<ol style="list-style-type: none"> 1 Style number 2 Cabinet depth (see below under Required Selections) 3 Cabinet height (see below under Required Selections) 4 Cabinet width (see below under Required Selections) 5 Laminate color number for trash cabinet 6 Options, if selected (see below) <ul style="list-style-type: none"> ▶ See <i>Surface Materials</i>, page 376.

Tip: The increment for parametric depth and width is 1".

Tip: Refer to page 37 for planning heights.

Required Selections	U.S. Price	Required to Specify
Cabinet Depth Parametric depth <ul style="list-style-type: none"> • Wall-suspended pullout trash base cabinets – 17"D–24"D • Floor-extended pullout trash base cabinets – 17"D–29"D 	<p>Prices at right</p> <p>Prices at right</p>	<p>Specify with 17"D–24"D.</p> <p>Specify with 17"D–29"D.</p>
Cabinet Height <ul style="list-style-type: none"> • Wall-suspended pullout trash cabinets – 23"H • Floor-extended pullout trash cabinets – 32½"H–34½"H 	<p>Prices at right</p> <p>Prices at right</p>	<p>Specify with 23"H.</p> <p>Specify with 32½"H–34½"H.</p>
Cabinet Width Parametric width <ul style="list-style-type: none"> • 15"W–24"W 	<p>Prices at right</p>	<p>Specify with 15"W–24"W.</p>

Tip: For finish codes and more information on laminate price group B, see *Surface Materials*.
▶ See page 376

Options	U.S. Price	Required to Specify
Surface Materials Case <ul style="list-style-type: none"> • Solid HPL • Woodgrain HPL • Laminate price group B • Laminate price group 2 	<p>No cost</p> <p>No cost</p> <p>Prices at right</p> <p>Prices at right</p>	<p>Specify laminate color number.</p> <p>Specify laminate color number.</p> <p>Specify laminate color number.</p> <p>Specify laminate color number.</p>
Door and drawer pulls <ul style="list-style-type: none"> • 0835 Black • 9201 Polished Chrome • 9211 Nickel • 9212 Silver 	<p>No cost</p> <p>No cost</p> <p>No cost</p> <p>No cost</p>	<p>Specify with 0835 Black.</p> <p>Specify with 9201 Polished Chrome.</p> <p>Specify with 9211 Nickel.</p> <p>Specify with 9212 Silver.</p>
Drawer Pull <ul style="list-style-type: none"> • No pull • D pull • Contemporary pull • Jazz pull 	<p>No cost</p> <p>No cost</p> <p>No cost</p> <p>+\$28 per pull</p>	<p>Specify with no pull.</p> <p>Specify with D pull.</p> <p>Specify with contemporary pull.</p> <p>Specify with jazz pull.</p>



For Canadian Pricing
 Multiply U.S. Price by the Canadian price factor.
 ▶ See page 1 for details.

Tip: Please refer to SmartTools to specify sizes.

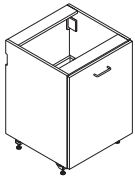
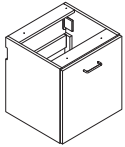

Specification Information

Style Number	Dimensions			U.S. Base Price	Options (Add \$ to Base Price)	
	D	W	H		Laminate Price Group B	HPL Price Group 2

Wall-Suspended with Pullout Trash Cabinet

HCMBTW	Dimensions D	Dimensions W	Dimensions H	U.S. Base Price	Laminate Price Group B	HPL Price Group 2
	17"-20"	15"	22.956"	\$1883	+\$ 93	+\$ 99
	17"-20"	16"-18"	22.956"	\$1935	+\$ 95	+\$101
	17"-20"	19"-24"	22.956"	\$2037	+\$101	+\$109
	21"-24"	15"	22.956"	\$1912	+\$ 94	+\$100
	21"-24"	16"-18"	22.956"	\$1957	+\$ 98	+\$103
	21"-24"	19"-24"	22.956"	\$2049	+\$101	+\$109

Floor-Extended with Pullout Trash Cabinet

HCMBTF	Dimensions D	Dimensions W	Dimensions H	U.S. Base Price	Laminate Price Group B	HPL Price Group 2
	17"-20"	15"	32½"	\$1919	+\$ 94	+\$100
	17"-20"	16"-18"	32½"	\$1982	+\$ 99	+\$104
	17"-20"	19"-24"	32½"	\$2111	+\$106	+\$111
	21"-24"	15"	32½"	\$2013	+\$100	+\$106
	21"-24"	16"-18"	32½"	\$2080	+\$103	+\$110
	21"-24"	19"-24"	32½"	\$2212	+\$111	+\$116
	25"-29"	15"	32½"	\$2131	+\$107	+\$113
	25"-29"	16"-18"	32½"	\$2201	+\$111	+\$116
	25"-29"	19"-24"	32½"	\$2339	+\$116	+\$122
	17"-20"	15"	33"-34½"	\$1924	+\$ 94	+\$100
	17"-20"	16"-18"	33"-34½"	\$1986	+\$ 99	+\$104
	17"-20"	19"-24"	33"-34½"	\$2113	+\$107	+\$113
	21"-24"	15"	33"-34½"	\$2019	+\$100	+\$106
	21"-24"	16"-18"	33"-34½"	\$2084	+\$103	+\$110
	21"-24"	19"-24"	33"-34½"	\$2216	+\$111	+\$116
	25"-29"	15"	33"-34½"	\$2134	+\$107	+\$113
	25"-29"	16"-18"	33"-34½"	\$2206	+\$111	+\$116
	25"-29"	19"-24"	33"-34½"	\$2342	+\$116	+\$122



 **For Canadian Pricing**
 Multiply U.S. Price by the Canadian price factor.
 ▶ See page 1 for details.

Convey Garage Cabinets

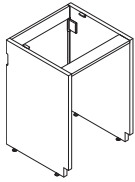

► Need help?
Product details,
page 54

Standard Includes

- Base cabinet: High-Pressure Laminate
- D pull and euro hinges, if selected: nickel
- Bracket cover: plastic
- Edges: matching 3 mm plastic on doors and matching 1 mm plastic on all other edges
- Four adjustable glides
- Integrated base trim

Required to Specify

- 1 Style number
 - 2 Cabinet depth (see below under Required Selections)
 - 3 Cabinet height (see below under Required Selections)
 - 4 Cabinet width (see below under Required Selections)
 - 5 Handedness (see below under Required Selections)
 - 6 Laminate color number for garage cabinet
 - 7 Plastic color number for bracket cover:
6009 Arctic White
6527 Merle
 - 8 Options, if selected (see below)
- See *Surface Materials*, page 376.

Tip: The increment for parametric depth, height, and width is 1".

Tip: Refer to page 38 for planning heights.

Tip: Handedness is only required on 24"W cabinets and smaller. 25"W cabinets or wider defaults to two doors.

Tip: Left and right is determined when facing units.

Tip: For finish codes and more information on laminate price group B, see Surface Materials.

► See page 376

	Required Selections	U.S. Price	Required to Specify
Cabinet Depth	Parametric depth		
	• Garage cabinet – 13.132"D–28.132"D	Prices at right	Specify with 13.132"D–28.132"D.
	• Garage cabinet with door(s) – 14"D–29"D	Prices at right	Specify with 14"D–29"D.
Cabinet Height	Parametric height		
	• 32½"H–40½"H	Prices at right	Specify with 32½"H–40½"H.
Cabinet Width	Parametric width		
	• 24"W–48"W	Prices at right	Specify with 24"W–48"W.
Handedness	Garage cabinet with door		
	• Left hand	No cost	Specify with <i>left hand</i> .
	• Right hand	No cost	Specify with <i>right hand</i> .

	Options	U.S. Price	Required to Specify
Surface Materials	Case		
	• Solid HPL	No cost	Specify laminate color number.
	• Woodgrain HPL	No cost	Specify laminate color number.
	• Laminate price group B	Prices at right	Specify laminate color number.
	• Laminate price group 2	Prices at right	Specify laminate color number.
	Door pulls		
	• 0835 Black	No cost	Specify with <i>0835 Black</i> .
	• 9201 Polished Chrome	No cost	Specify with <i>9201 Polished Chrome</i> .
	• 9211 Nickel	No cost	Specify with <i>9211 Nickel</i> .
	• 9212 Silver	No cost	Specify with <i>9212 Silver</i> .
Door Pull	• No pull	No cost	Specify with <i>no pull</i> .
	• D pull	No cost	Specify with <i>D pull</i> .
	• Contemporary pull	No cost	Specify with <i>contemporary pull</i> .
	• Jazz pull	+\$ 28 per pull	Specify with <i>jazz pull</i> .
Back Panel	• With back panel	+\$162	Specify with <i>back panel</i> .
	• No back panel	No cost	Specify with <i>no back panel</i> .



For Canadian Pricing

Multiply U.S. Price by the Canadian price factor.

► See page 1 for details.

Specification Information

Style Number	Dimensions D	W	H	U.S. Base Price	Options (Add \$ to Base Price)	
					Laminate Price Group B	HPL Price Group 2

Floor-Extended Garage Cabinet

HCMBGF	Dimensions D	W	H	U.S. Base Price	Laminate Price Group B	HPL Price Group 2
	13.132"-23.132"	24"	32½"	\$ 789	+\$38	+\$40
	13.132"-23.132"	25"-30"	32½"	\$ 829	+\$40	+\$42
	13.132"-23.132"	31"-36"	32½"	\$ 856	+\$42	+\$44
	13.132"-23.132"	37"-42"	32½"	\$ 880	+\$43	+\$47
	13.132"-23.132"	43"-48"	32½"	\$ 906	+\$46	+\$49
	24"-28.132"	24"	32½"	\$ 803	+\$38	+\$40
	24"-28.132"	25"-30"	32½"	\$ 843	+\$42	+\$44
	24"-28.132"	31"-36"	32½"	\$ 868	+\$43	+\$47
	24"-28.132"	37"-42"	32½"	\$ 895	+\$46	+\$49
	24"-28.132"	43"-48"	32½"	\$ 920	+\$46	+\$49
	13.132"-23.132"	24"	33½"-34½"	\$ 836	+\$40	+\$42
	13.132"-23.132"	25"-30"	33½"-34½"	\$ 886	+\$43	+\$47
	13.132"-23.132"	31"-36"	33½"-34½"	\$ 919	+\$46	+\$49
	13.132"-23.132"	37"-42"	33½"-34½"	\$ 953	+\$49	+\$51
	13.132"-23.132"	43"-48"	33½"-34½"	\$ 986	+\$50	+\$52
	24"-28.132"	24"	33½"-34½"	\$ 850	+\$42	+\$44
	24"-28.132"	25"-30"	33½"-34½"	\$ 898	+\$46	+\$49
	24"-28.132"	31"-36"	33½"-34½"	\$ 933	+\$47	+\$50
	24"-28.132"	37"-42"	33½"-34½"	\$ 967	+\$49	+\$51
	24"-28.132"	43"-48"	33½"-34½"	\$ 999	+\$50	+\$52
	13.132"-23.132"	24"	35"-40½"	\$ 996	+\$50	+\$52
	13.132"-23.132"	25"-30"	35"-40½"	\$1053	+\$52	+\$55
	13.132"-23.132"	31"-36"	35"-40½"	\$1110	+\$54	+\$57
	13.132"-23.132"	37"-42"	35"-40½"	\$1167	+\$58	+\$61
	13.132"-23.132"	43"-48"	35"-40½"	\$1225	+\$60	+\$63
	24"-28.132"	24"	35"-40½"	\$1011	+\$51	+\$53
	24"-28.132"	25"-30"	35"-40½"	\$1068	+\$53	+\$56
	24"-28.132"	31"-36"	35"-40½"	\$1125	+\$55	+\$59
	24"-28.132"	37"-42"	35"-40½"	\$1184	+\$58	+\$61
	24"-28.132"	43"-48"	35"-40½"	\$1239	+\$60	+\$63

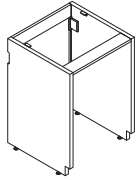

Tip: Please refer to SmartTools to specify sizes.

► Specification Information, continued on next page

 **For Canadian Pricing**
 Multiply U.S. Price by the Canadian price factor.
 ► See page 1 for details.

► Specification Information, continued from previous page

Specification Information						
Style Number	Dimensions			U.S. Base Price	Options (Add \$ to Base Price)	
	D	W	H		Laminate Price	HPL Price
					Group B	Group 2

Floor-Extended Garage Cabinet with Door(s)

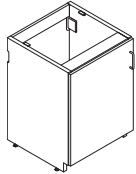

Tip: Please refer to SmartTools to specify sizes.

HCMBGDF	14"-24"	24"	32 1/2"	\$1097	+\$54	+\$57
	14"-24"	25"-30"	32 1/2"	\$1137	+\$55	+\$59
	14"-24"	31"-36"	32 1/2"	\$1183	+\$58	+\$61
	14"-24"	37"-42"	32 1/2"	\$1223	+\$60	+\$63
	14"-24"	43"-48"	32 1/2"	\$1265	+\$62	+\$65
	25"-29"	24"	32 1/2"	\$1109	+\$54	+\$57
	25"-29"	25"-30"	32 1/2"	\$1152	+\$56	+\$60
	25"-29"	31"-36"	32 1/2"	\$1193	+\$59	+\$62
	25"-29"	37"-42"	32 1/2"	\$1236	+\$60	+\$63
	25"-29"	42"-48"	32 1/2"	\$1278	+\$63	+\$66
	14"-24"	24"	33"-34 1/2"	\$1150	+\$56	+\$60
	14"-24"	25"-30"	33"-34 1/2"	\$1201	+\$59	+\$62
	14"-24"	31"-36"	33"-34 1/2"	\$1251	+\$62	+\$65
	14"-24"	37"-42"	33"-34 1/2"	\$1303	+\$64	+\$68
	14"-24"	43"-48"	33"-34 1/2"	\$1354	+\$65	+\$69
	25"-29"	24"	33"-34 1/2"	\$1163	+\$56	+\$60
	25"-29"	25"-30"	33"-34 1/2"	\$1215	+\$59	+\$62
	25"-29"	31"-36"	33"-34 1/2"	\$1266	+\$62	+\$65
	25"-29"	37"-42"	33"-34 1/2"	\$1317	+\$64	+\$68
	25"-29"	43"-48"	33"-34 1/2"	\$1367	+\$68	+\$71
	14"-24"	24"	35"-40 1/2"	\$1312	+\$64	+\$68
	14"-24"	25"-30"	35"-40 1/2"	\$1392	+\$70	+\$74
	14"-24"	31"-36"	35"-40 1/2"	\$1469	+\$74	+\$79
	14"-24"	37"-42"	35"-40 1/2"	\$1547	+\$78	+\$82
	14"-24"	43"-48"	35"-40 1/2"	\$1624	+\$80	+\$84
	25"-29"	24"	35"-40 1/2"	\$1325	+\$64	+\$68
	25"-29"	25"-30"	35"-40 1/2"	\$1404	+\$70	+\$74
	25"-29"	31"-36"	35"-40 1/2"	\$1482	+\$74	+\$79
	25"-29"	37"-42"	35"-40 1/2"	\$1558	+\$78	+\$82
	25"-29"	43"-48"	35"-40 1/2"	\$1636	+\$81	+\$87



For Canadian Pricing
 Multiply U.S. Price by the Canadian price factor.
 ► See page 1 for details.

Convey Sink Base Cabinets

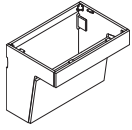

► Need help?
Product details,
page 58

Standard Includes

- Sink base cabinet: High-Pressure Laminate
- D pull and euro hinges, if selected: nickel
- Bracket cover: 6009 Arctic White
- Edges: matching 3 mm plastic on doors and matching 1 mm plastic on all other edges
- Four adjustable glides for floor-extended sink base cabinet, if selected
- Manual lock, if selected

Required to Specify

- 1 Style number
 - 2 Cabinet depth (see below under Required Selections)
 - 3 Cabinet height (see below under Required Selections)
 - 4 Cabinet width (see below under Required Selections)
 - 5 Laminate color number for sink base cabinet
 - 6 Handedness for sink base cabinets with door (see below under Required Selections)
 - 7 Options, if selected (see below)
- See *Surface Materials*, page 376.

Tip: The increment for parametric depth and width is 1".

Tip: Refer to page 37 for planning heights.

Tip: Handedness is only required on 24"W cabinets and smaller.

Tip: 25"W cabinets or wider default to two doors.

Tip: Left and right is determined when facing units.

	Required Selections	U.S. Price	Required to Specify
Cabinet Depth	Parametric depth <ul style="list-style-type: none"> • Wall-suspended sink base cabinet with door(s) <ul style="list-style-type: none"> – 14"D–24"D • Floor-extended sink base cabinet with door(s) <ul style="list-style-type: none"> – 14"D–29"D • Angled sink base cabinet and angled sink base cabinet for change of height <ul style="list-style-type: none"> – 20"D–24"D 	Prices at right Prices at right Prices at right	Specify with 14"D–24"D. Specify with 14"D–29"D. Specify with 20"D–24"D.
Cabinet Height	<ul style="list-style-type: none"> • Angled sink base cabinet for change of height <ul style="list-style-type: none"> – 20.956"H • Wall-suspended sink base cabinet with door(s) and angled sink base cabinet <ul style="list-style-type: none"> – 22.956"H • Floor-extended sink base cabinet with door(s) <ul style="list-style-type: none"> – 32½"H–34½"H 	Prices at right Prices at right Prices at right	Specify with 20.956"H. Specify with 22.956"H. Specify with 32½"H– 34½"H.
Cabinet Width	Parametric width <ul style="list-style-type: none"> • Wall-suspended and floor-extended sink base cabinets with door(s) <ul style="list-style-type: none"> – 15"W–48"W • Angled sink base cabinet and angled sink base cabinet for change of height <ul style="list-style-type: none"> – 30"W–36"W – 42"W 	Prices at right Prices at right Prices at right	Specify with 15"W–48"W. Specify with 30"W–36"W. Specify with 42"W.
Handedness	Sink base cabinets with door <ul style="list-style-type: none"> • Left hand • Right hand 	No cost No cost	Specify with left hand. Specify with right hand.



For Canadian Pricing

Multiply U.S. Price by the Canadian price factor.

► See page 1 for details.

Tip: For finish codes and more information on laminate price group B, see Surface Materials.
▶ See page 376

Options	U.S. Price	Required to Specify
Surface Materials	Case	
	• Solid HPL	No cost
	• Woodgrain HPL	No cost
	• Laminate price group B	Prices below and at right
	• Laminate price group 2	Prices below and at right
	Door pulls	
	• 0835 Black	No cost
	• 9201 Polished Chrome	No cost
	• 9211 Nickel	No cost
	• 9212 Silver	No cost
Door Pulls		
	• No pull	No cost
	• D pull	No cost
	• Contemporary pull	No cost
	• Jazz pull	+\$28 per pull
Lock and Keying		
	• No lock	
	• Manual lock with master key plug	+\$88
	Keying	
	• Factory and field-installed keying	

▶ Page 398

Specification Information						
Style Number	Dimensions			U.S. Base Price	Options (Add \$ to Base Price)	
	D	W	H		Laminate Price Group B	HPL Price Group 2
.....

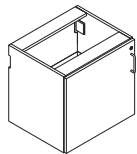

Tip: Please refer to SmartTools to specify sizes.

Wall-Suspended Sink Base Cabinet with Door(s)

HCMB SINK DW	14"-20"	15"	22.956"	\$ 897	+\$46	+\$49
	14"-20"	16"-18"	22.956"	\$ 925	+\$47	+\$50
	14"-20"	19"-24"	22.956"	\$ 984	+\$50	+\$52
	14"-20"	25"-30"	22.956"	\$1043	+\$52	+\$55
	14"-20"	31"-36"	22.956"	\$1101	+\$54	+\$57
	14"-20"	37"-42"	22.956"	\$1159	+\$56	+\$60
	14"-20"	43"-48"	22.956"	\$1217	+\$59	+\$62
	21"-24"	15"	22.956"	\$ 932	+\$47	+\$50
	21"-24"	16"-18"	22.956"	\$ 959	+\$49	+\$51
	21"-24"	19"-24"	22.956"	\$1019	+\$51	+\$53
	21"-24"	25"-30"	22.956"	\$1076	+\$53	+\$56
	21"-24"	31"-36"	22.956"	\$1135	+\$55	+\$59
	21"-24"	37"-42"	22.956"	\$1192	+\$59	+\$62
	21"-24"	43"-48"	22.956"	\$1250	+\$62	+\$65

▶ Specification Information, continued on next page

 **For Canadian Pricing**
Multiply U.S. Price by the Canadian price factor.
▶ See page 1 for details.

Convey Sink Base Cabinets, continued

► **Specification Information, continued from previous page**

Tip: Please refer to SmartTools to specify sizes.

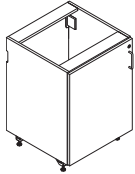

Tip: Handedness is only required on 24"W cabinets and smaller.

Specification Information						
Style Number	Dimensions			U.S. Base Price	Options (Add \$ to Base Price)	
	D	W	H		Laminate Price Group B	HPL Price Group 2

Floor-Extended Sink Base Cabinet with Right-Hand or Left-Hand Door

HCMB SINKDF	D	W	H	U.S. Base Price	Laminate Price Group B	HPL Price Group 2
	14"-24"	15"	32½"	\$1116	+\$55	+\$59
	14"-24"	16"-18"	32½"	\$1157	+\$56	+\$60
	14"-24"	19"-24"	32½"	\$1235	+\$60	+\$63
	25"-29"	15"	32½"	\$1161	+\$56	+\$60
	25"-29"	16"-18"	32½"	\$1202	+\$59	+\$62
	25"-29"	19"-24"	32½"	\$1283	+\$63	+\$66
	14"-24"	15"	33½"-34½"	\$1179	+\$58	+\$61
	14"-24"	16"-18"	33½"-34½"	\$1219	+\$59	+\$62
	14"-24"	19"-24"	33½"-34½"	\$1298	+\$63	+\$66
	25"-29"	15"	33½"-34½"	\$1201	+\$59	+\$62
	25"-29"	16"-18"	33½"-34½"	\$1244	+\$60	+\$63
	25"-29"	19"-24"	33½"-34½"	\$1329	+\$65	+\$69

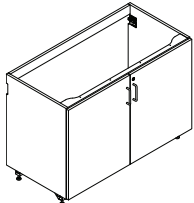

Tip: 25"W cabinets or wider default to two doors.

Floor-Extended Sink Base Cabinet with Double Doors

HCMB SINKDF	D	W	H	U.S. Base Price	Laminate Price Group B	HPL Price Group 2
	14"-24"	25"-30"	32½"	\$1312	+\$64	+\$68
	14"-24"	31"-36"	32½"	\$1389	+\$70	+\$74
	14"-24"	37"-42"	32½"	\$1468	+\$74	+\$79
	14"-24"	43"-48"	32½"	\$1546	+\$77	+\$81
	25"-29"	25"-30"	32½"	\$1366	+\$68	+\$71
	25"-29"	31"-36"	32½"	\$1447	+\$73	+\$78
	25"-29"	37"-42"	32½"	\$1530	+\$77	+\$81
	25"-29"	43"-48"	32½"	\$1612	+\$80	+\$84
	14"-24"	25"-30"	33½"-34½"	\$1375	+\$68	+\$71
	14"-24"	31"-36"	33½"-34½"	\$1452	+\$73	+\$78
	14"-24"	37"-42"	33½"-34½"	\$1530	+\$77	+\$81
	14"-24"	43"-48"	33½"-34½"	\$1608	+\$80	+\$84
	25"-29"	25"-30"	33½"-34½"	\$1418	+\$72	+\$75
	25"-29"	31"-36"	33½"-34½"	\$1503	+\$76	+\$80
	25"-29"	37"-42"	33½"-34½"	\$1589	+\$79	+\$83
	25"-29"	43"-48"	33½"-34½"	\$1677	+\$82	+\$88

► **Specification Information, continued on next page**



For Canadian Pricing

Multiply U.S. Price by the Canadian price factor.

► See page 1 for details.

► **Specification Information, continued from previous page**

Tip: Please refer to SmartTools to specify sizes.

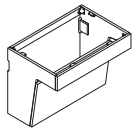
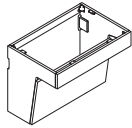

Specification Information						
Style Number	Dimensions			U.S. Base Price	Options (Add \$ to Base Price)	
	D	W	H		Laminate Price Group B	HPL Price Group 2

Angled Sink Base Cabinet

HCMBBSINK	D	W	H	U.S. Base Price	Laminate Price Group B	HPL Price Group 2
	20"	30"	22.956"	\$1133	+\$55	+\$57
	20"	31"-36"	22.956"	\$1226	+\$59	+\$61
	20"	42"	22.956"	\$1319	+\$65	+\$66
	21"-24"	30"	22.956"	\$1193	+\$57	+\$60
	21"-24"	31"-36"	22.956"	\$1287	+\$63	+\$65
	21"-24"	42"	22.956"	\$1381	+\$68	+\$69

Angled Sink Base Cabinet for Change of Height

HCMBBSINKCOH	D	W	H	U.S. Base Price	Laminate Price Group B	HPL Price Group 2
	20"	30"	20.956"	\$1102	+\$54	+\$56
	20"	31"-36"	20.956"	\$1195	+\$57	+\$60
	20"	42"	20.956"	\$1287	+\$63	+\$65
	21"-24"	30"	20.956"	\$1164	+\$56	+\$59
	21"-24"	31"-36"	20.956"	\$1257	+\$61	+\$63
	21"-24"	42"	20.956"	\$1349	+\$66	+\$68



 **For Canadian Pricing**
 Multiply U.S. Price by the Canadian price factor.
 ► See page 1 for details.

Convey Wardrobe Cabinets

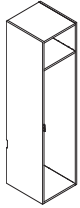

► Need help?
Product details,
page 62

Standard Includes

- Wardrobe cabinet: High-Pressure Laminate
- D pull and euro hinges: nickel
- Bracket cover: plastic
- Edges: matching 3 mm plastic on doors and matching 1 mm plastic on all other edges
- One fixed shelf
- Four adjustable glides for floor-extended wardrobe cabinet, if selected
- Less than 24"W wall-suspended wardrobe cabinet, if selected: hooks
- 24"W wall-suspended wardrobe cabinet, if selected: clothing rod
- Less than 24"D floor-extended wardrobe cabinet, if selected: hooks
- 24"D or deeper floor-extended wardrobe cabinet, if selected: clothing rod

Required to Specify

- 1 Style number
 - 2 Wardrobe cabinet depth (see below under Required Selections)
 - 3 Wardrobe cabinet height (see below under Required Selections)
 - 4 Wardrobe cabinet width (see below under Required Selections)
 - 5 Laminate color number for wardrobe cabinet
 - 6 Plastic color number for bracket cover: 6009 Arctic White
6527 Merle
 - 7 Handedness for wardrobe cabinets with door (see below under Required Selections)
 - 8 Options, if selected (see below)
- See *Surface Materials*, page 376.

Tip: The increment for parametric depth, height, and width is 1".

Tip: Wall-suspended wardrobe with a small drawer can only go down to 16"D.

Tip: Refer to page 37 for planning heights.

	Required Selections	U.S. Price	Required to Specify
Wardrobe Depth	Parametric depth		
	• Wall-suspended wardrobe cabinet – 13.132"D–23.132"D	Prices at right	Specify with 13.132"D–23.132"D.
	• Wall-suspended wardrobe cabinet with door(s) – 14"D–24"D	Prices at right	Specify with 14"D–24"D.
	• Floor-extended wardrobe cabinet – 13.132"D–28.132"D	Prices at right	Specify with 13.132"D–28.132"D.
Wardrobe Height	• Floor-extended wardrobe cabinet with door(s) – 14"D–29"D	Prices at right	Specify with 14"D–29"D.
	Parametric height		
Wardrobe Width	• Wall-suspended wardrobe cabinet – 66½"H–74½"H	Prices at right	Specify with 66½"H–74½"H.
	• Floor-extended wardrobe cabinet – 48"H–84"H	Prices at right	Specify with 48"H–84"H.
	Parametric width		
Handedness	• Wall-suspended and floor-extended wardrobe cabinets – 12"W–23"W	Prices at right	Specify with 12"W–23"W.
	• Wall-suspended wardrobe cabinet with door(s) – 12"W–24"W	Prices at right	Specify with 12"W–24"W.
	• Floor-extended wardrobe cabinet with door(s) – 12"W–36"W	Prices at right	Specify with 12"W–36"W.
Wardrobe cabinet with door	• Left hand	No cost	Specify with <i>left hand</i> .
	• Right hand	No cost	Specify with <i>right hand</i> .

Tip: Left and right is determined when facing units.

Tip: Handedness is only required on 24"W wardrobes with doors and smaller, 25"W or wider wardrobes default to two doors.



For Canadian Pricing

Multiply U.S. Price by the Canadian price factor.

► See page 1 for details.

Tip: For finish codes and more information on laminate price group B, see Surface Materials.
▶ See page 376

	Options	U.S. Price	Required to Specify
Surface Materials	Case • Solid HPL • Woodgrain HPL • Laminate price group B • Laminate price group 2	No cost No cost Prices below and at right Prices below and at right	Specify laminate color number. Specify laminate color number. Specify laminate color number. Specify laminate color number.
Materials	Door pulls • 0835 Black • 9201 Polished Chrome • 9211 Nickel • 9212 Silver	No cost No cost No cost No cost	Specify with 0835 Black. Specify with 9201 Polished Chrome. Specify with 9211 Nickel. Specify with 9212 Silver.
Drawer Configuration	Wall-suspended wardrobe cabinet with door • No drawer • One small drawer	No cost Prices below and at right	Specify with no drawer. Specify with one small drawer.
Door and Drawer Pull	• No pull • D pull • Contemporary pull • Jazz pull	No cost No cost No cost +\$28 per pull	Specify with no pull. Specify with D pull. Specify with contemporary pull. Specify with jazz pull.
Lock and Keying	• No lock • Manual lock with key plug	No cost +\$88	Specify with no lock. Specify with manual lock.
	Keying • Factory and field-installed keying		▶ Page 398

Tip: Electronic locks are available and must be installed in the field.
▶ See page 174

Specification Information						
Style Number	Dimensions			U.S. Base Price	Options (Add \$ to Base Price)	
	D	W	H		Laminate Price Group B	HPL Price Group 2

Wall-Suspended Wardrobe Cabinet

HCMWARDW	Dimensions (D x W x H)	U.S. Base Price	Laminate Price Group B	HPL Price Group 2
	13.132"-19.132" 12"-15" 66½"	\$1822	+\$ 90	+\$ 94
	13.132"-19.132" 16"-18" 66½"	\$1893	+\$ 93	+\$ 99
	13.132"-19.132" 19"-23" 66½"	\$2013	+\$100	+\$106
	13.132"-19.132" 12"-15" 67½"-72½"	\$1826	+\$ 90	+\$ 94
	13.132"-19.132" 16"-18" 67½"-72½"	\$1900	+\$ 94	+\$100
	13.132"-19.132" 19"-23" 67½"-72½"	\$2019	+\$100	+\$106
	13.132"-19.132" 12"-15" 73½"-74½"	\$1828	+\$ 90	+\$ 94
	13.132"-19.132" 16"-18" 73½"-74½"	\$1901	+\$ 94	+\$100
	13.132"-19.132" 19"-23" 73½"-74½"	\$2020	+\$100	+\$106
	20.132"-23.132" 12"-15" 66½"	\$1998	+\$ 99	+\$104
	20.132"-23.132" 16"-18" 66½"	\$2068	+\$103	+\$110
	20.132"-23.132" 19"-23" 66½"	\$2185	+\$110	+\$115
	20.132"-23.132" 12"-15" 67½"-72½"	\$2002	+\$ 99	+\$104
	20.132"-23.132" 16"-18" 67½"-72½"	\$2072	+\$103	+\$110
	20.132"-23.132" 19"-23" 67½"-72½"	\$2189	+\$110	+\$115
	20.132"-23.132" 12"-15" 73½"-74½"	\$2003	+\$ 99	+\$104
	20.132"-23.132" 16"-18" 73½"-74½"	\$2074	+\$103	+\$110
	20.132"-23.132" 19"-23" 73½"-74½"	\$2192	+\$110	+\$115

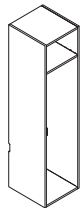

Tip: Please refer to SmartTools to specify sizes.

For Canadian Pricing
Multiply U.S. Price by the Canadian price factor.
▶ See page 1 for details.

▶ **Specification Information, on next page**

► **Specification Information, continued from previous page**

Tip: Please refer to SmartTools to specify sizes.



Specification Information						
Style Number	Dimensions			U.S. Base Price	Options (Add \$ to Base Price)	
	D	W	H		Laminate Price Group B	HPL Price Group 2

Wall-Suspended Wardrobe Cabinet with Door and One Small Drawer

HCMWARDDW	14"-20"	12"-15"	66½"	\$2667	+\$132	+\$140
	14"-20"	16"-18"	66½"	\$2793	+\$139	+\$147
	14"-20"	19"-24"	66½"	\$3043	+\$152	+\$159
	14"-20"	12"-15"	67½"-72½"	\$2671	+\$132	+\$140
	14"-20"	16"-18"	67½"-72½"	\$2798	+\$139	+\$147
	14"-20"	19"-24"	67½"-72½"	\$3049	+\$152	+\$159
	14"-20"	12"-15"	73½"-74½"	\$2672	+\$132	+\$140
	14"-20"	16"-18"	73½"-74½"	\$2799	+\$139	+\$147
	14"-20"	19"-24"	73½"-74½"	\$3051	+\$152	+\$159
	21"-24"	12"-15"	66½"	\$2899	+\$142	+\$152
	21"-24"	16"-18"	66½"	\$3043	+\$152	+\$159
	21"-24"	19"-24"	66½"	\$3332	+\$166	+\$174
	21"-24"	12"-15"	67½"-72½"	\$2902	+\$145	+\$153
	21"-24"	16"-18"	67½"-72½"	\$3048	+\$152	+\$159
	21"-24"	19"-24"	67½"-72½"	\$3339	+\$167	+\$175
	21"-24"	12"-15"	73½"-74½"	\$2903	+\$145	+\$153
	21"-24"	16"-18"	73½"-74½"	\$3050	+\$152	+\$159
	21"-24"	19"-24"	73½"-74½"	\$3342	+\$167	+\$175

Wall-Suspended Wardrobe Cabinet with Door

HCMWARDDW	14"-20"	12"-15"	66½"	\$2280	+\$114	+\$120
	14"-20"	16"-18"	66½"	\$2382	+\$117	+\$123
	14"-20"	19"-24"	66½"	\$2585	+\$129	+\$135
	14"-20"	12"-15"	67½"-72½"	\$2288	+\$114	+\$120
	14"-20"	16"-18"	67½"-72½"	\$2389	+\$119	+\$127
	14"-20"	19"-24"	67½"-72½"	\$2592	+\$129	+\$135
	14"-20"	12"-15"	73½"-74½"	\$2289	+\$114	+\$120
	14"-20"	16"-18"	73½"-74½"	\$2390	+\$119	+\$127
	14"-20"	19"-24"	73½"-74½"	\$2594	+\$129	+\$135
	21"-24"	12"-15"	66½"	\$2455	+\$122	+\$129
	21"-24"	16"-18"	66½"	\$2576	+\$129	+\$135
	21"-24"	19"-24"	66½"	\$2820	+\$140	+\$148
	21"-24"	12"-15"	67½"-72½"	\$2458	+\$122	+\$129
	21"-24"	16"-18"	67½"-72½"	\$2581	+\$129	+\$135
	21"-24"	19"-24"	67½"-72½"	\$2824	+\$140	+\$148
	21"-24"	12"-15"	73½"-74½"	\$2460	+\$122	+\$129
	21"-24"	16"-18"	73½"-74½"	\$2582	+\$129	+\$135
	21"-24"	19"-24"	73½"-74½"	\$2827	+\$140	+\$148



 **For Canadian Pricing**
Multiply U.S. Price by the Canadian price factor.
► See page 1 for details.

► **Specification Information, continued on next page**

► Specification Information, continued from previous page

Specification Information						
Style Number	Dimensions			U.S. Base Price	Options (Add \$ to Base Price)	
	D	W	H		Laminate Price Group B	HPL Price Group 2

Floor-Extended Wardrobe Cabinet

HCMWARDF	Dimensions D	Dimensions W	Dimensions H	U.S. Base Price	Laminate Price Group B	HPL Price Group 2
	13.132"-23.132"	12"-15"	48"-60"	\$1903	+\$ 93	+\$ 95
	13.132"-23.132"	16"-18"	48"-60"	\$1976	+\$ 96	+\$100
	13.132"-23.132"	19"-23"	48"-60"	\$2101	+\$103	+\$109
	13.132"-23.132"	12"-15"	61"-72"	\$1910	+\$ 93	+\$ 95
	13.132"-23.132"	16"-18"	61"-72"	\$1986	+\$ 97	+\$101
	13.132"-23.132"	19"-23"	61"-72"	\$2110	+\$103	+\$109
	13.132"-23.132"	12"-15"	73"-84"	\$1918	+\$ 93	+\$ 95
	13.132"-23.132"	16"-18"	73"-84"	\$1993	+\$ 97	+\$101
	13.132"-23.132"	19"-23"	73"-84"	\$2121	+\$103	+\$109
	24.132"-28.132"	12"-15"	48"-60"	\$2041	+\$101	+\$104
	24.132"-28.132"	16"-18"	48"-60"	\$2121	+\$103	+\$109
	24.132"-28.132"	19"-23"	48"-60"	\$2248	+\$113	+\$115
	24.132"-28.132"	12"-15"	61"-72"	\$2053	+\$101	+\$104
	24.132"-28.132"	16"-18"	61"-72"	\$2129	+\$106	+\$110
	24.132"-28.132"	19"-23"	61"-72"	\$2258	+\$113	+\$115
	24.132"-28.132"	12"-15"	73"-84"	\$2060	+\$101	+\$104
	24.132"-28.132"	16"-18"	73"-84"	\$2140	+\$106	+\$110
	24.132"-28.132"	19"-23"	73"-84"	\$2272	+\$114	+\$116

► Specification Information, continued on next page

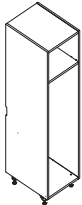

Tip: Please refer to SmartTools to specify sizes.

Convey

For Canadian Pricing
 Multiply U.S. Price by the Canadian price factor.
 ► See page 1 for details.

► **Specification Information, continued from previous page**

Specification Information						
Style Number	Dimensions			U.S. Base Price	Options (Add \$ to Base Price)	
	D	W	H		Laminate Price	HPL Price
					Group B	Group 2

Floor-Extended Wardrobe Cabinet with Door(s)

HCMWARDDF	14"-24"	12"-15"	48"-60"	\$2339	+\$116	+\$118
	14"-24"	16"-18"	48"-60"	\$2497	+\$123	+\$128
	14"-24"	19"-24"	48"-60"	\$2808	+\$139	+\$143
	14"-24"	25"-30"	48"-60"	\$3123	+\$155	+\$158
	14"-24"	31"-36"	48"-60"	\$3437	+\$171	+\$175
	25"-29"	12"-15"	48"-60"	\$2345	+\$117	+\$120
	25"-29"	16"-18"	48"-60"	\$2504	+\$123	+\$128
	25"-29"	19"-24"	48"-60"	\$2821	+\$140	+\$145
	25"-29"	25"-30"	48"-60"	\$3135	+\$156	+\$159
	25"-29"	31"-36"	48"-60"	\$3450	+\$171	+\$175
	14"-24"	12"-15"	61"-72"	\$2357	+\$117	+\$120
	14"-24"	16"-18"	61"-72"	\$2514	+\$126	+\$129
	14"-24"	19"-24"	61"-72"	\$2831	+\$140	+\$145
	14"-24"	25"-30"	61"-72"	\$3148	+\$156	+\$159
	14"-24"	31"-36"	61"-72"	\$3466	+\$172	+\$177
	25"-29"	12"-15"	61"-72"	\$2544	+\$127	+\$130
	25"-29"	16"-18"	61"-72"	\$2723	+\$134	+\$139
	25"-29"	19"-24"	61"-72"	\$3084	+\$154	+\$157
	25"-29"	25"-30"	61"-72"	\$3445	+\$171	+\$175
	25"-29"	31"-36"	61"-72"	\$3805	+\$189	+\$195
	14"-24"	12"-15"	73"-84"	\$2552	+\$127	+\$130
	14"-24"	16"-18"	73"-84"	\$2734	+\$134	+\$139
	14"-24"	19"-24"	73"-84"	\$3095	+\$154	+\$157
	14"-24"	25"-30"	73"-84"	\$3456	+\$171	+\$175
	14"-24"	31"-36"	73"-84"	\$3818	+\$189	+\$195
	25"-29"	12"-15"	73"-84"	\$2562	+\$127	+\$130
	25"-29"	16"-18"	73"-84"	\$2742	+\$135	+\$140
	25"-29"	19"-24"	73"-84"	\$3105	+\$155	+\$158
	25"-29"	25"-30"	73"-84"	\$3471	+\$172	+\$177
	25"-29"	31"-36"	73"-84"	\$3835	+\$191	+\$196



Tip: Please refer to SmartTools to specify sizes.



For Canadian Pricing
 Multiply U.S. Price by the Canadian price factor.
 ► See page 1 for details.



Convey Tall Storage Cabinets

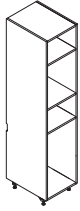

	Standard Includes	Required to Specify
▶ Need help? Product details, page 66	<ul style="list-style-type: none"> Storage cabinet: High-Pressure Laminate Bracket cover: plastic D pull and euro hinges: nickel Edges: matching 3 mm plastic on doors and drawers and matching 1 mm plastic on all other edges Shelf attachment: shelf pin One fixed shelf Adjustable shelves: <ul style="list-style-type: none"> – Two, if 48"H – 60"H is selected – Three, if 61"H – 72"H is selected – Four, if 73"H – 84"H is selected Four adjustable glides 	<ol style="list-style-type: none"> Style number Cabinet depth (see below under Required Selections) Cabinet height (see below under Required Selections) Cabinet width (see below under Required Selections) Laminate color number for cabinet Plastic color number for bracket cover: <ul style="list-style-type: none"> 6009 Arctic White 6527 Merle Handedness (see below under Required Selections) Options, if selected (see below) ▶ See <i>Surface Materials</i> , page 376.

Tip: The increment for parametric depth, height, and width is 1".

Tip: Refer to page 38 for planning heights.

Tip: Handedness is only required on 24"W storage cabinets with doors and smaller, 25"W storage cabinets or wider default to two doors.

Tip: Left and right is determined when facing units.

Tip: For finish codes and more information on laminate price group B, see *Surface Materials*.

▶ See page 376

Tip: Electronic locks are available and must be installed in the field.

▶ See page 174



For Canadian Pricing

Multiply U.S. Price by the Canadian price factor.

▶ See page 1 for details.

	Required Selections	U.S. Price	Required to Specify
Cabinet Depth	Parametric depth <ul style="list-style-type: none"> Storage cabinet <ul style="list-style-type: none"> – 13.132"D–28.132"D Storage cabinet with door(s) <ul style="list-style-type: none"> – 14"D–29"D 	Prices at right	Specify with 13.132"D–28.132"D.
Cabinet Height	Parametric height <ul style="list-style-type: none"> 48"H–84"H 	Prices at right	Specify with 48"H–84"H.
Cabinet Width	Parametric width <ul style="list-style-type: none"> 12"W–36"W 	Prices at right	Specify with 12"W–36"W.
Handedness	Storage cabinet with door <ul style="list-style-type: none"> Left hand Right hand 	No cost No cost	Specify with <i>left hand</i> . Specify with <i>right hand</i> .
Surface Materials	Case <ul style="list-style-type: none"> Solid HPL Woodgrain HPL Laminate price group B Laminate price group 2 Door pulls <ul style="list-style-type: none"> 0835 Black 9201 Polished Chrome 9211 Nickel 9212 Silver 	No cost No cost Prices at right Prices at right No cost No cost No cost No cost	Specify laminate color number. Specify laminate color number. Specify laminate color number. Specify laminate color number. Specify with <i>0835 Black</i> . Specify with <i>9201 Polished Chrome</i> . Specify with <i>9211 Nickel</i> . Specify with <i>9212 Silver</i> .
Shelf Attachment	<ul style="list-style-type: none"> Shelf pin Seismic shelf clip 	No cost No cost	Specify with <i>shelf pin</i> . Specify with <i>seismic shelf clip</i> .
Door Pull	Storage cabinet with door(s) <ul style="list-style-type: none"> No pull D pull Contemporary pull Jazz pull 	No cost No cost No cost +\$28 per pull	Specify with <i>no pull</i> . Specify with <i>D pull</i> . Specify with <i>contemporary pull</i> . Specify with <i>jazz pull</i> .
Lock and Keying	Storage cabinet with door(s) <ul style="list-style-type: none"> No lock Manual lock with master key plug Keying <ul style="list-style-type: none"> Factory and field-installed keying 	No cost +\$88	Specify with <i>no lock</i> . Specify with <i>manual lock</i> . ▶ Page 398

Specification Information

Style Number	Dimensions D	W	H	U.S. Base Price	Options (Add \$ to Base Price)	
					Laminate Price Group B	HPL Price Group 2

Tall Storage Cabinet

HCMSCF	Dimensions D	W	H	U.S. Base Price	Laminate Price Group B	HPL Price Group 2
	13.132"-23.132"	12"-20"	48"-60"	\$2253	+\$113	+\$115
	13.132"-23.132"	21"-24"	48"-60"	\$2447	+\$120	+\$123
	13.132"-23.132"	25"-30"	48"-60"	\$2734	+\$134	+\$139
	13.132"-23.132"	31"-36"	48"-60"	\$3017	+\$152	+\$155
	13.132"-23.132"	12"-20"	61"-72"	\$2265	+\$114	+\$116
	13.132"-23.132"	21"-24"	61"-72"	\$2456	+\$120	+\$123
	13.132"-23.132"	25"-30"	61"-72"	\$2745	+\$135	+\$140
	13.132"-23.132"	31"-36"	61"-72"	\$3032	+\$152	+\$155
	13.132"-23.132"	12"-20"	73"-84"	\$2276	+\$114	+\$116
	13.132"-23.132"	21"-24"	73"-84"	\$2467	+\$122	+\$127
	13.132"-23.132"	25"-30"	73"-84"	\$2759	+\$135	+\$140
	13.132"-23.132"	31"-36"	73"-84"	\$3046	+\$153	+\$156
	24.132"-28.132"	12"-20"	48"-60"	\$2574	+\$129	+\$132
	24.132"-28.132"	21"-24"	48"-60"	\$2804	+\$139	+\$143
	24.132"-28.132"	25"-30"	48"-60"	\$3158	+\$158	+\$162
	24.132"-28.132"	31"-36"	48"-60"	\$3507	+\$173	+\$178
	24.132"-28.132"	12"-20"	61"-72"	\$2583	+\$129	+\$132
	24.132"-28.132"	21"-24"	61"-72"	\$2819	+\$139	+\$143
	24.132"-28.132"	25"-30"	61"-72"	\$3170	+\$158	+\$162
	24.132"-28.132"	31"-36"	61"-72"	\$3522	+\$174	+\$179
	24.132"-28.132"	12"-20"	73"-84"	\$2592	+\$129	+\$132
	24.132"-28.132"	21"-24"	73"-84"	\$2828	+\$140	+\$145
	24.132"-28.132"	25"-30"	73"-84"	\$3182	+\$158	+\$162
	24.132"-28.132"	31"-36"	73"-84"	\$3536	+\$174	+\$179

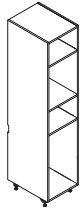

Tip: Please refer to SmartTools to specify sizes.

Convey

► Specification Information, continued on next page

 **For Canadian Pricing**
 Multiply U.S. Price by the Canadian price factor.
 ► See page 1 for details.

► **Specification Information, continued from previous page**

Specification Information						
Style Number	Dimensions			U.S. Base Price	Options (Add \$ to Base Price)	
	D	W	H		Laminate Price	HPL Price

Tall Storage Cabinet with Door(s)

HCMSCDF	D	W	H	U.S. Base Price	Laminate Price	HPL Price
	14"-24"	12"-20"	48"-60"	\$2874	+\$141	+\$146
	14"-24"	21"-24"	48"-60"	\$2895	+\$142	+\$147
	14"-24"	25"-30"	48"-60"	\$3238	+\$160	+\$166
	14"-24"	31"-36"	48"-60"	\$3582	+\$178	+\$183
	14"-24"	12"-20"	61"-72"	\$2885	+\$142	+\$147
	14"-24"	21"-24"	61"-72"	\$2905	+\$143	+\$148
	14"-24"	25"-30"	61"-72"	\$3252	+\$161	+\$167
	14"-24"	31"-36"	61"-72"	\$3595	+\$178	+\$183
	14"-24"	12"-20"	73"-84"	\$2683	+\$133	+\$136
	14"-24"	21"-24"	73"-84"	\$2917	+\$143	+\$148
	14"-24"	25"-30"	73"-84"	\$3263	+\$161	+\$167
	14"-24"	31"-36"	73"-84"	\$3610	+\$179	+\$185
	25"-29"	12"-20"	48"-60"	\$3430	+\$170	+\$174
	25"-29"	21"-24"	48"-60"	\$3666	+\$181	+\$187
	25"-29"	25"-30"	48"-60"	\$3900	+\$193	+\$198
	25"-29"	31"-36"	48"-60"	\$4370	+\$217	+\$223
	25"-29"	12"-20"	61"-72"	\$3127	+\$155	+\$158
	25"-29"	21"-24"	61"-72"	\$3440	+\$171	+\$175
	25"-29"	25"-30"	61"-72"	\$3911	+\$195	+\$200
	25"-29"	31"-36"	61"-72"	\$4384	+\$218	+\$224
	25"-29"	12"-20"	73"-84"	\$3135	+\$156	+\$159
	25"-29"	21"-24"	73"-84"	\$3451	+\$171	+\$175
	25"-29"	25"-30"	73"-84"	\$3925	+\$195	+\$200
	25"-29"	31"-36"	73"-84"	\$4397	+\$218	+\$224

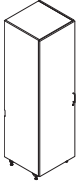

Tip: Please refer to SmartTools to specify sizes.



For Canadian Pricing
 Multiply U.S. Price by the Canadian price factor.
 ► See page 1 for details.

Convey Upper Storage Cabinets

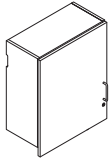

	Standard Includes	Required to Specify
▶ Need help? Product details, page 70	<ul style="list-style-type: none"> Upper storage cabinet, door fronts, and shelves: High-Pressure Laminate D pull and euro hinge: nickel Bracket cover: 6009 Arctic White Edges: matching 3 mm plastic on doors and matching 1 mm plastic on all other edges Shelf attachment <ul style="list-style-type: none"> Shelf pin or seismic shelf clip, if upper storage cabinet with door(s) is selected Seismic shelf clip, if upper storage cabinet with door(s), over-the-sink cabinet no bottom, or no bottom is selected Adjustable shelf, if cabinet with door selected 	<ol style="list-style-type: none"> Style number Cabinet depth (see below under Required Selections) Cabinet height (see below under Required Selections) Cabinet width (see below under Required Selections) Laminate color number for upper storage cabinet Handedness (see below under Required Selections) Shelf attachment, if upper storage cabinet with door(s) is selected Options, if selected (see below) <p>▶ See <i>Surface Materials</i>, page 376.</p>

Tip: The increment for parametric depth, height, and width is 1".

	Required Selections	U.S. Price	Required to Specify
Cabinet Depth	Parametric depth <ul style="list-style-type: none"> Upper over-the-sink storage cabinet with door and no bottom <ul style="list-style-type: none"> – 9"D Upper storage cabinet with door(s) and upper storage cabinet with door(s) and no bottom <ul style="list-style-type: none"> – 12"D–15"D 	<p>Prices at right</p> <p>Prices at right</p>	<p>Specify with 9"D.</p> <p>Specify with 12"D–15"D.</p>
Cabinet Height	Parametric height <ul style="list-style-type: none"> 24"H–36"H 	Prices at right	Specify with 24"H–36"H.
Cabinet Width	Parametric width <ul style="list-style-type: none"> Upper storage cabinet with door(s) <ul style="list-style-type: none"> – 12"W–48"W Upper storage cabinet with door(s) and no bottom and upper over-the-sink storage cabinet with door(s) and no bottom <ul style="list-style-type: none"> – 15"W–36"W 	<p>Prices at right</p> <p>Prices at right</p>	<p>Specify with 12"W–48"W.</p> <p>Specify with 15"W–36"W.</p>
Handedness	<ul style="list-style-type: none"> Left hand Right hand 	<p>No cost</p> <p>No cost</p>	<p>Specify with left hand.</p> <p>Specify with right hand.</p>

Tip: Handedness is only required on 24"W cabinets and smaller, 25"W cabinets or wider default to two doors.

Tip: Left and right is determined when facing units.

Tip: For finish codes and more information on laminate price group B, see *Surface Materials*.

▶ See page 376

	Options	U.S. Price	Required to Specify
Surface Materials	Case <ul style="list-style-type: none"> Solid HPL Woodgrain HPL Laminate price group B Laminate price group 2 	<p>No cost</p> <p>No cost</p> <p>Prices at right</p> <p>Prices at right</p>	<p>Specify laminate color number.</p> <p>Specify laminate color number.</p> <p>Specify laminate color number.</p> <p>Specify laminate color number.</p>
	D pull, contemporary pull, and jazz pull finish <ul style="list-style-type: none"> 0835 Black 9201 Polished Chrome 9211 Nickel 9212 Silver 	<p>No cost</p> <p>No cost</p> <p>No cost</p> <p>No cost</p>	<p>Specify with 0835 Black.</p> <p>Specify with 9201 Polished Chrome.</p> <p>Specify with 9211 Nickel.</p> <p>Specify with 9212 Silver.</p>
	Hidden pull finish <ul style="list-style-type: none"> 4799 Platinum Metallic 	No cost	Specify with 4799 Platinum Metallic.

▶ Options, continued on next page



For Canadian Pricing
Multiply U.S. Price by the Canadian price factor.
▶ See page 1 for details.

► Options, continued from previous page

Options	U.S. Price	Required to Specify
Door Pull		
• No pull	No cost	Specify with no pull.
• D pull	No cost	Specify with D pull.
• Contemporary pull	No cost	Specify with contemporary pull.
• Jazz pull	+\$ 28 per pull	Specify with jazz pull.
• Hidden pull	+\$ 28 per pull	Specify with hidden pull.
Lock and Keying	Upper storage cabinet with door(s)	
• No lock	No cost	Specify with no lock.
• Manual lock with master key plug	+\$ 88	Specify with manual lock.
	Keying	
• Factory and field-installed keying		► Page 398
Glove Holders		
• No glove holders		Specify with no glove holders.
• Glove holders with no cutouts	+\$ 89 per door	Specify with glove holders with no cutouts.
• Glove holders with cutouts	+\$109 per door	Specify with glove holders with cutouts.
Glove Holders Location	Upper storage cabinet over-the-sink with door(s) and no bottom	
• Two left glove holders	No cost	Specify with two left glove holders.
• Two right glove holders	No cost	Specify with two right glove holders.
• Three glove holders	No cost	Specify with three glove holders.
• Two left and two right glove holders	No cost	Specify with two left and two right glove holders.

Tip: Glovebox cutouts are driven by the width of the cabinet doors. Cabinets less than 15"W do not offer glovebox cutouts. Cabinets 15"W–19"W will have two glovebox cutouts. Cabinets greater than 19"W and less than or equal to 24"W will have three glovebox cutouts. Cabinets greater than 24"W and less than 30"W do not offer glovebox cutouts due to the doors being less than 15"W. Cabinets 30"W or greater will have four glovebox cutouts, split between the doors, i.e. two glovebox cutouts in each door.

Tip: When width is greater than 30", only two or four glove holders are options.

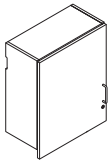

Tip: Please refer to SmartTools to specify sizes.

Specification Information

Style Number	Dimensions			U.S. Base Price	Options (Add \$ to Base Price)	
	D	W	H		Laminate Price Group B	HPL Price Group 2

Upper Storage Cabinet with Door(s)

HCMUD	D	W	H	U.S. Base Price	Laminate Price Group B	HPL Price Group 2
	12"	12"–15"	24"	\$ 905	+\$44	+\$47
	12"	16"–18"	24"	\$ 975	+\$49	+\$50
	12"	19"–24"	24"	\$1113	+\$54	+\$56
	12"	25"–30"	24"	\$1251	+\$60	+\$62
	12"	31"–36"	24"	\$1386	+\$68	+\$69
	12"	37"–42"	24"	\$1526	+\$76	+\$79
	12"	43"–48"	24"	\$1661	+\$82	+\$84
	12"	12"–15"	25"–30"	\$ 948	+\$49	+\$50
	12"	16"–18"	25"–30"	\$1017	+\$51	+\$52
	12"	19"–24"	25"–30"	\$1156	+\$56	+\$59
	12"	25"–30"	25"–30"	\$1289	+\$63	+\$65
	12"	31"–36"	25"–30"	\$1424	+\$72	+\$74
	12"	37"–42"	25"–30"	\$1564	+\$78	+\$80
	12"	43"–48"	25"–30"	\$1699	+\$83	+\$87
	12"	12"–15"	31"–36"	\$1087	+\$53	+\$55
	12"	16"–18"	31"–36"	\$1156	+\$56	+\$59
	12"	19"–24"	31"–36"	\$1289	+\$63	+\$65
	12"	25"–30"	31"–36"	\$1424	+\$72	+\$74
	12"	31"–36"	31"–36"	\$1561	+\$78	+\$80
	12"	37"–42"	31"–36"	\$1699	+\$83	+\$87
	12"	43"–48"	31"–36"	\$1831	+\$90	+\$92

 **For Canadian Pricing**
Multiply U.S. Price by the Canadian price factor.

► See page 1 for details.

► Specification Information, continued on next page

► **Specification Information, continued from previous page**

Tip: Please refer to SmartTools to specify sizes.

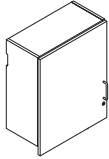

Specification Information						
Style Number	Dimensions			U.S. Base Price	Options (Add \$ to Base Price)	
	D	W	H		Laminate Price	HPL Price
					Group B	Group 2

Upper Storage Cabinet with Door(s), continued

HCMUD	D	W	H	U.S. Base Price	Laminate Price	HPL Price
	13"-15"	12"-15"	24"	\$ 942	+\$47	+\$ 49
	13"-15"	16"-18"	24"	\$1010	+\$51	+\$ 52
	13"-15"	19"-24"	24"	\$1145	+\$56	+\$ 59
	13"-15"	25"-30"	24"	\$1280	+\$61	+\$ 63
	13"-15"	31"-36"	24"	\$1416	+\$70	+\$ 71
	13"-15"	37"-42"	24"	\$1551	+\$78	+\$ 80
	13"-15"	43"-48"	24"	\$1687	+\$83	+\$ 87
	13"-15"	12"-15"	25"-30"	\$ 989	+\$50	+\$ 51
	13"-15"	16"-18"	25"-30"	\$1067	+\$53	+\$ 55
	13"-15"	19"-24"	25"-30"	\$1224	+\$59	+\$ 61
	13"-15"	25"-30"	25"-30"	\$1379	+\$68	+\$ 69
	13"-15"	31"-36"	25"-30"	\$1532	+\$76	+\$ 79
	13"-15"	37"-42"	25"-30"	\$1689	+\$83	+\$ 87
	13"-15"	43"-48"	25"-30"	\$1845	+\$91	+\$ 93
	13"-15"	12"-15"	31"-36"	\$1145	+\$56	+\$ 59
	13"-15"	16"-18"	31"-36"	\$1224	+\$59	+\$ 61
	13"-15"	19"-24"	31"-36"	\$1379	+\$68	+\$ 69
	13"-15"	25"-30"	31"-36"	\$1532	+\$76	+\$ 79
	13"-15"	31"-36"	31"-36"	\$1689	+\$83	+\$ 87
	13"-15"	37"-42"	31"-36"	\$1845	+\$91	+\$ 93
	13"-15"	43"-48"	31"-36"	\$1999	+\$97	+\$101

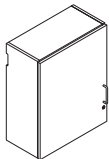

Upper Storage Cabinet with Door(s) and No Bottom

HCMUDNB	D	W	H	U.S. Base Price	Laminate Price	HPL Price
	12"	15"	24"	\$1000	+\$50	+\$ 51
	12"	16"-18"	24"	\$1082	+\$53	+\$ 55
	12"	19"-24"	24"	\$1251	+\$60	+\$ 62
	12"	25"-30"	24"	\$1418	+\$70	+\$ 71
	12"	31"-36"	24"	\$1583	+\$79	+\$ 81
	12"	15"	25"-30"	\$1043	+\$52	+\$ 53
	12"	16"-18"	25"-30"	\$1111	+\$54	+\$ 56
	12"	19"-24"	25"-30"	\$1252	+\$60	+\$ 62
	12"	25"-30"	25"-30"	\$1390	+\$68	+\$ 69
	12"	31"-36"	25"-30"	\$1530	+\$76	+\$ 79
	12"	15"	31"-36"	\$1334	+\$65	+\$ 66
	12"	16"-18"	31"-36"	\$1418	+\$70	+\$ 71
	12"	19"-24"	31"-36"	\$1583	+\$79	+\$ 81
	12"	25"-30"	31"-36"	\$1749	+\$87	+\$ 89
	12"	31"-36"	31"-36"	\$1917	+\$93	+\$ 95

 **For Canadian Pricing**
 Multiply U.S. Price by the Canadian price factor.
 ► See page 1 for details.

► **Specification Information, continued on next page**

► Specification Information, continued from previous page

Tip: Please refer to SmartTools to specify sizes.

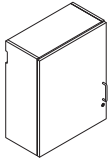

Specification Information						
Style Number	Dimensions			U.S. Base Price	Options (Add \$ to Base Price)	
	D	W	H		Laminate Price	HPL Price
					Group B	Group 2

Upper Storage Cabinet with Door(s) and No Bottom, continued

HCMUDNB	13"-15"	15"	24"	\$1027	+\$51	+\$52
	13"-15"	16"-18"	24"	\$1092	+\$54	+\$56
	13"-15"	19"-24"	24"	\$1226	+\$59	+\$61
	13"-15"	25"-30"	24"	\$1359	+\$66	+\$68
	13"-15"	31"-36"	24"	\$1490	+\$75	+\$78
	13"-15"	15"	25"-30"	\$1076	+\$53	+\$55
	13"-15"	16"-18"	25"-30"	\$1147	+\$56	+\$59
	13"-15"	19"-24"	25"-30"	\$1293	+\$63	+\$65
	13"-15"	25"-30"	25"-30"	\$1438	+\$72	+\$74
	13"-15"	31"-36"	25"-30"	\$1583	+\$79	+\$81
	13"-15"	15"	31"-36"	\$1222	+\$59	+\$61
	13"-15"	16"-18"	31"-36"	\$1293	+\$63	+\$65
	13"-15"	19"-24"	31"-36"	\$1438	+\$72	+\$74
	13"-15"	25"-30"	31"-36"	\$1583	+\$79	+\$81
	13"-15"	31"-36"	31"-36"	\$1729	+\$84	+\$88

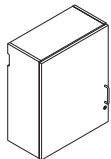

Upper Over-the-Sink Storage Cabinet with Door(s) and No Bottom

HCMUOSSDNB	9"	15"	24"	\$ 901	+\$44	+\$47
	9"	16"-18"	24"	\$ 933	+\$47	+\$49
	9"	19"-24"	24"	\$ 997	+\$50	+\$51
	9"	25"-30"	24"	\$1057	+\$52	+\$53
	9"	31"-36"	24"	\$1119	+\$55	+\$57
	9"	15"	25"-30"	\$ 940	+\$47	+\$49
	9"	16"-18"	25"-30"	\$1010	+\$51	+\$52
	9"	19"-24"	25"-30"	\$1148	+\$56	+\$59
	9"	25"-30"	25"-30"	\$1288	+\$63	+\$65
	9"	31"-36"	25"-30"	\$1428	+\$72	+\$74
	9"	15"	31"-36"	\$1044	+\$52	+\$53
	9"	16"-18"	31"-36"	\$1115	+\$54	+\$56
	9"	19"-24"	31"-36"	\$1259	+\$61	+\$63
	9"	25"-30"	31"-36"	\$1400	+\$70	+\$71
	9"	31"-36"	31"-36"	\$1542	+\$78	+\$80

 **For Canadian Pricing**
 Multiply U.S. Price by the Canadian price factor.
 ► See page 1 for details.

Convey Upper Microwave Cabinet

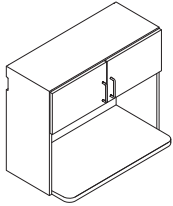

Standard Includes		Required to Specify
<ul style="list-style-type: none"> ▶ Need help? Product details, page 74 	<ul style="list-style-type: none"> • Upper microwave cabinet, door fronts, and shelves: High-Pressure Laminate • D pull and euro hinge: nickel • Bracket cover: plastic • Edges: matching 3 mm plastic on doors and drawers and matching 1 mm plastic on all other edges • 20"D microwave shelf 	<ol style="list-style-type: none"> 1 Style number 2 Cabinet depth (see below under Required Selections) 3 Cabinet height (see below under Required Selections) 4 Cabinet width (see below under Required Selections) 5 Laminate color number for cabinet 6 Plastic color number for bracket cover: 6009 Arctic White 6527 Merle 7 Handedness (see below under Required Selections) 8 Options, if selected (see below) <ul style="list-style-type: none"> ▶ See <i>Surface Materials</i>, page 376.

Tip: The increment for parametric depth, height, and width is 1".

Required Selections	U.S. Price	Required to Specify
Cabinet Depth Parametric depth <ul style="list-style-type: none"> • 12"D–15"D 	Prices below	Specify with 12"D–15"D.
Cabinet Height Parametric height <ul style="list-style-type: none"> • 29⁷/₈"H–35⁷/₈"H 	Prices below	Specify with 29 ⁷ / ₈ "H–35 ⁷ / ₈ "H.
Cabinet Width Parametric width <ul style="list-style-type: none"> • 30"W–36"W 	Prices below	Specify with 30"W–36"W.

Tip: For finish codes and more information on laminate price group B, see *Surface Materials*.
▶ See page 376

Options	U.S. Price	Required to Specify
Surface Materials Case <ul style="list-style-type: none"> • Solid HPL • Woodgrain HPL • Laminate price group B • Laminate price group 2 	<ul style="list-style-type: none"> No cost No cost Prices below Prices below 	<ul style="list-style-type: none"> Specify laminate color number. Specify laminate color number. Specify laminate color number. Specify laminate color number.
D pull, contemporary pull, and jazz pull finish <ul style="list-style-type: none"> • 0835 Black • 9201 Polished Chrome • 9211 Nickel • 9212 Silver 	<ul style="list-style-type: none"> No cost No cost No cost No cost 	<ul style="list-style-type: none"> Specify with 0835 Black. Specify with 9201 Polished Chrome. Specify with 9211 Nickel. Specify with 9212 Silver.
Door Pull <ul style="list-style-type: none"> • No pull • D pull • Contemporary pull • Jazz pull 	<ul style="list-style-type: none"> No cost No cost No cost +\$28 per pull 	<ul style="list-style-type: none"> Specify with no pull. Specify with D pull. Specify with contemporary pull. Specify with jazz pull.

Tip: Please refer to *SmartTools* to specify sizes.

Specification Information						
Style Number	Dimensions			U.S. Base Price	Options (Add \$ to Base Price)	
	D	W	H		Laminate Price Group B	HPL Price Group 2
HCMUMSHLFD	12"	30"	29 ⁷ / ₈ "	\$1449	+\$72	+\$74
	12"	31"–36"	29 ⁷ / ₈ "	\$1570	+\$79	+\$81
	12"	30"	30 ⁷ / ₈ "–35 ⁷ / ₈ "	\$1570	+\$79	+\$81
	12"	31"–36"	30 ⁷ / ₈ "–35 ⁷ / ₈ "	\$1752	+\$87	+\$89
	13"–15"	30"	29 ⁷ / ₈ "	\$1512	+\$76	+\$79
	13"–15"	31"–36"	29 ⁷ / ₈ "	\$1631	+\$81	+\$83
	13"–15"	30"	30 ⁷ / ₈ "–35 ⁷ / ₈ "	\$1631	+\$81	+\$83
	13"–15"	31"–36"	30 ⁷ / ₈ "–35 ⁷ / ₈ "	\$1814	+\$89	+\$91

 **For Canadian Pricing**
Multiply U.S. Price by the Canadian price factor.
▶ See page 1 for details.



Convey Upper Corner Cabinet

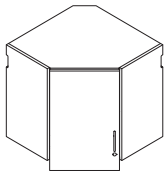

► Need help?
Product details,
page 78

Standard Includes

- Upper corner cabinet, door fronts, and shelves: High-Pressure Laminate
- D pull and euro hinge: nickel
- Bracket cover: 6009 Arctic White
- Edges: matching 3 mm plastic on doors and matching 1 mm plastic on all other edges

Required to Specify

- 1 Style number
 - 2 Cabinet depth (see below under Required Selections)
 - 3 Cabinet height (see below under Required Selections)
 - 4 Cabinet width (see below under Required Selections)
 - 5 Laminate color number for cabinet
 - 6 Handedness (see below under Required Selections)
 - 7 Options, if selected (see below)
- See *Surface Materials*, page 376.

Tip: The increment for parametric height is 1".

Tip: Corner cabinets 30"H include one fixed shelf. Cabinets less than 30"H do not include a shelf.

Tip: For finish codes and more information on laminate price group B, see Surface Materials.
► See page 376

Tip: Electronic locks are available and must be installed in the field.
► See page 174

 **For Canadian Pricing**
Multiply U.S. Price by the Canadian price factor.
► See page 1 for details.

	Required Selections	U.S. Price	Required to Specify
Cabinet Depth	Modular depth • 12"D • 15"D	Prices at right Prices at right	Specify with 12"D. Specify with 15"D.
Cabinet Height	Parametric height • 24"H–36"H	Prices at right	Specify with 24"H–36"H.
Cabinet Width	Modular width • 23"W • 27"W	Prices at right Prices at right	Specify with 23"W. Specify with 27"W.
Handedness	• Left hand • Right hand	No cost No cost	Specify with <i>left hand</i> . Specify with <i>right hand</i> .
	Options	U.S. Price	Required to Specify
Surface Materials	Case • Solid HPL • Woodgrain HPL • Laminate price group B • Laminate price group 2	No cost No cost Prices at right Prices at right	Specify laminate color number. Specify laminate color number. Specify laminate color number. Specify laminate color number.
	D pull, contemporary pull, and jazz pull finish • 0835 Black • 9201 Polished Chrome • 9211 Nickel • 9212 Silver	No cost No cost No cost No cost	Specify with <i>0835 Black</i> . Specify with <i>9201 Polished Chrome</i> . Specify with <i>9211 Nickel</i> . Specify with <i>9212 Silver</i> .
	Hidden pull finish • 4799 Platinum Metallic	No cost	Specify with <i>4799 Platinum Metallic</i> .
Door Pull	• No pull • D pull • Contemporary pull • Jazz pull • Hidden pull	No cost No cost No cost +\$28 per pull +\$28 per pull	Specify with <i>no pull</i> . Specify with <i>D pull</i> . Specify with <i>contemporary pull</i> . Specify with <i>jazz pull</i> . Specify with <i>hidden pull</i> .
Lock and Keying	• No lock • Manual lock with master key plug	No cost +\$88	Specify with <i>no lock</i> . Specify with <i>manual lock</i> .
	Keying • Factory and field-installed keying		► Page 398

Specification Information

Style Number	Dimensions			U.S. Base Price	Options (Add \$ to Base Price)	
	D	W	H		Laminate Price Group B	HPL Price Group 2
HCMUCORNERD	12"	23"	24"	\$1315	+\$65	+\$66
	12"	27"	24"	\$1464	+\$74	+\$75
	12"	23"	25"-30"	\$1532	+\$76	+\$79
	12"	27"	25"-30"	\$1680	+\$83	+\$87
	12"	23"	31"-36"	\$1748	+\$87	+\$89
	12"	27"	31"-36"	\$1891	+\$92	+\$94
	15"	23"	24"	\$1353	+\$66	+\$68
	15"	27"	24"	\$1443	+\$72	+\$74
	15"	23"	25"-30"	\$1546	+\$78	+\$80
	15"	27"	25"-30"	\$1655	+\$82	+\$84
	15"	23"	31"-36"	\$1737	+\$87	+\$89
	15"	27"	31"-36"	\$1869	+\$91	+\$93

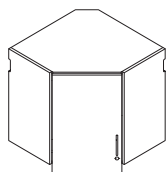

Tip: Please refer to SmartTools to specify sizes.



 **For Canadian Pricing**
Multiply U.S. Price by the Canadian price factor.
▶ See page 1 for details.

Convey Mobile Storage Cart

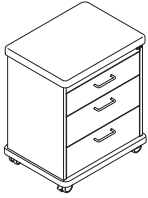

Tip: 40.549"H and 38.144"H carts allow any drawer configuration that adds up to 36".

Tip: 36.549"H and 34.144"H carts allow any drawer configuration that adds up to 26".

Tip: 32.549"H and 30.144"H carts allow drawer configuration that adds up to 22".

Tip: For finish codes and more information on laminate price group B, see Surface Materials. ▶ See page 376

Tip: 4" caster upcharge is included in the base price of 32.549"H, 36.549"H, and 40.549"H carts.



For Canadian Pricing
Multiply U.S. Price by the Canadian price factor.
▶ See page 1 for details.

	Standard Includes	Required to Specify
▶ Need help? Product details, page 80	<ul style="list-style-type: none"> Storage cart case: High-Pressure Laminate price group 1 Storage cart top: thermoform with raised lip Edges: matching 3 mm plastic on drawers and matching 1 mm plastic on all other edges Front locking 65 mm casters, if 30.144"H, 34.144"H, or 38.144"H cart selected 4" casters, if 32.549"H, 36.549"H, or 40.549"H cart selected 	<ol style="list-style-type: none"> Style number Height (see below under Required Selections) Width (see below under Required Selections) Drawer configuration (see below under Required Selections) Laminate color number for storage cart case Options, if selected (see below) <p>▶ See <i>Surface Materials</i>, page 376.</p>

	Required Selections	U.S. Price	Required to Specify
Height	<ul style="list-style-type: none"> 30.144"H 32.549"H 34.144"H 36.549"H 38.144"H 40.549"H 	Prices at right Prices at right Prices at right Prices at right Prices at right Prices at right	Specify with 30.144"H. Specify with 32.549"H. Specify with 34.144"H. Specify with 36.549"H. Specify with 38.144"H. Specify with 40.549"H.
Width	<ul style="list-style-type: none"> 19½"W 22½"W 25½"W 	Prices at right Prices at right Prices at right	Specify with 19½"W. Specify with 22½"W. Specify with 25½"W.
Drawer Configuration	<ul style="list-style-type: none"> 4", 6", 6", 6", 8" drawers 4", 4", 6", 8", 8" drawers 6", 6", 6", 6", 6" drawers 4", 4", 4", 6", 8" drawers 6", 6", 6", 8" drawers 4", 4", 6", 8" drawers 4", 6", 6", 6" drawers 6", 8", 8" drawers 	Prices at right Prices at right Prices at right Prices at right Prices at right Prices at right Prices at right Prices at right	Specify with 4", 6", 6", 6", 8" drawers. Specify with 4", 4", 6", 8", 8" drawers. Specify with 6", 6", 6", 6", 6" drawers. Specify with 4", 4", 4", 6", 8" drawers. Specify with 6", 6", 6", 8" drawers. Specify with 4", 4", 6", 8" drawers. Specify with 4", 6", 6", 6" drawers. Specify with 6", 8", 8" drawers.

	Options	U.S. Price	Required to Specify
Surface Materials	Case <ul style="list-style-type: none"> High-Pressure Laminate price group 1 High-Pressure Laminate price group 2 Laminate price group B Top surface <ul style="list-style-type: none"> Thermoform Solid surface price group A Solid surface price group B Solid surface price group C Solid surface price group D 	No cost Prices at right Prices at right No cost Prices at right Prices at right Prices at right Prices at right	Specify laminate color number. Specify laminate color number. Specify laminate color number. Specify thermoform color number. Specify solid surface color number. Specify solid surface color number. Specify solid surface color number.
Pulls	<ul style="list-style-type: none"> No pull D pull Contemporary pull Jazz pull 	No cost No cost No cost +\$ 28 per pull	Specify with no pull. Specify with D pull and select finish color number. Specify with contemporary pull and select finish color number. Specify with jazz pull and select finish color number.
Caster Type	<ul style="list-style-type: none"> 65 mm 4" 	No cost +\$132 included in base price	Specify with 65 mm casters. Specify with 4" casters.
Lock and Keying	<ul style="list-style-type: none"> No lock Manual lock with master key plug Key pad lock 	No cost +\$115 +\$298	Specify with no lock. Specify with manual lock. Specify with key pad lock.

Specification Information

Style Number	Caster Type	Drawer Quantity	Drawer Configuration	Dimensions		U.S. Base Price	Options (Add \$ to Base Price)				
				D	H		Case	Top	Price Group	Price Group	Price Group
							HPL Price Group 2 and Laminate Price Group B	Solid Surface Price Group A	Price Group B	Price Group C	Price Group D

19½"W Storage Carts



HCMCART	Caster Type	Drawer Quantity	Drawer Configuration	D	H	U.S. Base Price	Case	Top	Price Group	Price Group	Price Group	Price Group				
	65 mm	3	6", 8", 8"	19½"	30.144"	\$3975	+	\$ 987	+	\$1156	+	\$1184	+	\$1727		
	65 mm	4	4", 6", 6", 6"	19½"	30.144"	\$4323	+	\$216	+	\$ 987	+	\$1156	+	\$1184	+	\$1727
	65 mm	4	6", 6", 6", 8"	19½"	34.144"	\$4344	+	\$217	+	\$ 987	+	\$1156	+	\$1184	+	\$1727
	65 mm	5	4", 4", 4", 6", 8"	19½"	34.144"	\$4693	+	\$235	+	\$ 987	+	\$1156	+	\$1184	+	\$1727
	65 mm	5	4", 6", 6", 6", 8"	19½"	38.144"	\$4714	+	\$236	+	\$ 987	+	\$1156	+	\$1184	+	\$1727
	4"	3	6", 8", 8"	19½"	32.549"	\$4107	+	\$199	+	\$ 987	+	\$1156	+	\$1184	+	\$1727
	4"	4	4", 4", 6", 8"	19½"	32.549"	\$4455	+	\$216	+	\$ 987	+	\$1156	+	\$1184	+	\$1727
	4"	4	6", 6", 6", 8"	19½"	36.549"	\$4476	+	\$217	+	\$ 987	+	\$1156	+	\$1184	+	\$1727
	4"	5	4", 4", 4", 6", 8"	19½"	36.549"	\$4825	+	\$235	+	\$ 987	+	\$1156	+	\$1184	+	\$1727
	4"	5	6", 6", 6", 6", 6"	19½"	40.549"	\$4846	+	\$236	+	\$ 987	+	\$1156	+	\$1184	+	\$1727
	4"	5	4", 4", 6", 8", 8"	19½"	40.549"	\$4846	+	\$236	+	\$ 987	+	\$1156	+	\$1184	+	\$1727

22½"W Storage Carts



HCMCART	Caster Type	Drawer Quantity	Drawer Configuration	D	H	U.S. Base Price	Case	Top	Price Group	Price Group	Price Group	Price Group				
	65 mm	3	6", 8", 8"	19½"	30.144"	\$4028	+	\$202	+	\$1053	+	\$1240	+	\$1270	+	\$1868
	65 mm	4	4", 6", 6", 6"	19½"	30.144"	\$4376	+	\$219	+	\$1053	+	\$1240	+	\$1270	+	\$1868
	65 mm	4	6", 6", 6", 8"	19½"	34.144"	\$4397	+	\$220	+	\$1053	+	\$1240	+	\$1270	+	\$1868
	65 mm	5	4", 4", 4", 6", 8"	19½"	34.144"	\$4745	+	\$237	+	\$1053	+	\$1240	+	\$1270	+	\$1868
	65 mm	5	4", 6", 6", 6", 8"	19½"	38.144"	\$4766	+	\$238	+	\$1053	+	\$1240	+	\$1270	+	\$1868
	4"	3	6", 8", 8"	19½"	32.549"	\$4160	+	\$202	+	\$1053	+	\$1240	+	\$1270	+	\$1868
	4"	4	4", 4", 6", 8"	19½"	32.549"	\$4508	+	\$219	+	\$1053	+	\$1240	+	\$1270	+	\$1868
	4"	4	6", 6", 6", 8"	19½"	36.549"	\$4529	+	\$220	+	\$1053	+	\$1240	+	\$1270	+	\$1868
	4"	5	4", 4", 4", 6", 8"	19½"	36.549"	\$4877	+	\$237	+	\$1053	+	\$1240	+	\$1270	+	\$1868
	4"	5	6", 6", 6", 6", 6"	19½"	40.549"	\$4898	+	\$238	+	\$1053	+	\$1240	+	\$1270	+	\$1868
	4"	5	4", 4", 6", 8", 8"	19½"	40.549"	\$4898	+	\$238	+	\$1053	+	\$1240	+	\$1270	+	\$1868

► Specification Information, continued on next page

Convey Mobile Storage Cart, continued

► **Specification Information, continued from previous page**

Specification Information											
Style Number	Caster Type	Drawer Quantity	Drawer Configuration	Dimensions		U.S. Base Price	Options (Add \$ to Base Price)				
				D	H		Case	Top	Solid Surface		
							HPL Price Group 2 and Laminate Price Group B	Price Group A	Price Group B	Price Group C	Price Group D

25½"W Storage Carts



HCMCART	Caster	Quantity	Configuration	D	H	U.S. Base Price	Case	Top	Price Group A	Price Group B	Price Group C	Price Group D				
	65 mm	3	6", 8", 8"	19½"	30.144"	\$4081	+	\$205	+	\$1120	+	\$1324	+	\$1358	+	\$2010
	65 mm	4	4", 6", 6", 6"	19½"	30.144"	\$4429	+	\$222	+	\$1120	+	\$1324	+	\$1358	+	\$2010
	65 mm	4	6", 6", 6", 8"	19½"	34.144"	\$4450	+	\$223	+	\$1120	+	\$1324	+	\$1358	+	\$2010
	65 mm	5	4", 4", 4", 6", 8"	19½"	34.144"	\$4798	+	\$241	+	\$1120	+	\$1324	+	\$1358	+	\$2010
	65 mm	5	4", 6", 6", 6", 8"	19½"	38.144"	\$4819	+	\$242	+	\$1120	+	\$1324	+	\$1358	+	\$2010
	4"	3	6", 8", 8"	19½"	32.549"	\$4213	+	\$205	+	\$1120	+	\$1324	+	\$1358	+	\$2010
	4"	4	4", 4", 6", 8"	19½"	32.549"	\$4561	+	\$222	+	\$1120	+	\$1324	+	\$1358	+	\$2010
	4"	4	6", 6", 6", 8"	19½"	36.549"	\$4582	+	\$223	+	\$1120	+	\$1324	+	\$1358	+	\$2010
	4"	5	4", 4", 4", 6", 8"	19½"	36.549"	\$4930	+	\$241	+	\$1120	+	\$1324	+	\$1358	+	\$2010
	4"	5	6", 6", 6", 6", 6"	19½"	40.549"	\$4951	+	\$242	+	\$1120	+	\$1324	+	\$1358	+	\$2010
	4"	5	4", 4", 6", 8", 8"	19½"	40.549"	\$4951	+	\$242	+	\$1120	+	\$1324	+	\$1358	+	\$2010

Tip: Please refer to SmartTools to specify sizes.



For Canadian Pricing

Multiply U.S. Price by the Canadian price factor.

► See page 1 for details.

Convey Cover Panels



Tip: The increment for parametric depth and height is 1".

Tip: Cover panels flex parametrically in relation to the cabinets they are adjacent to.

Tip: For finish codes and more information on laminate price group B, see Surface Materials. ▶ See page 376

Tip: Left and right is determined when facing units.

Tip: Fascia height needs to be specified when vertical fascia top extension is chosen.

Tip: Some applications require cutouts to be applied when a mounting rail will go through the cover panel.

Standard Includes	Required to Specify
<ul style="list-style-type: none"> ▶ Need help? Product details, page 84 Cover panel: High-Pressure Laminate Edges: matching 1 mm plastic on edges 	<ol style="list-style-type: none"> Style number Panel depth (see below under Required Selections) Panel height (see below under Required Selections) Laminate color number for cover panel Options, if selected (see below) <p>▶ See <i>Surface Materials</i>, page 376.</p>

Panel Depth	Required Selections	U.S. Price	Required to Specify
Panel Depth	Parametric depth		
	• Upper storage cover panel – 9"D–16"D	Prices at right	Specify with 9"D–16"D.
	• Wall-suspended base cabinets and wardrobe cover panel – 14"D–25"D	Prices at right	Specify with 14"D–25"D.
	• Angled-sink cover panel – 20"D–25"D	Prices at right	Specify with 20"D–25"D.
	• Floor-extended cover panel – 14"D–30"D	Prices at right	Specify with 14"D–30"D.

Panel Height	Required Selections	U.S. Price	Required to Specify
Panel Height	Parametric height		
	• Angled-sink cover panel – 20 ¹⁵ / ₁₆ "H–22 ¹⁵ / ₁₆ "H	Prices at right	Specify with 20 ¹⁵ / ₁₆ "H–22 ¹⁵ / ₁₆ "H.
	• Upper storage cover panel – 24"H–36"H	Prices at right	Specify with 24"H–36"H.
	• Floor-extended cover panel – 27"H–84"H	Prices at right	Specify with 27"H–84"H.
	• Wall-suspended wardrobe cover panel – 66 ¹ / ₂ "H–74 ¹ / ₂ "H	Prices at right	Specify with 66 ¹ / ₂ "H–74 ¹ / ₂ "H.

Surface Materials	Options	U.S. Price	Required to Specify
Surface Materials	Surface		
	• Solid HPL	No cost	Specify laminate color number.
	• Woodgrain HPL	No cost	Specify laminate color number.
	• Laminate price group B	Prices at right	Specify laminate color number.
	• Laminate price group 2	Prices at right	Specify laminate color number.

Handedness	Upper storage, wall-suspended wardrobe, floor-extended, and angled-sink cover panels		
Handedness	• Left hand	No cost	Specify with left hand.
	• Right hand	No cost	Specify with right hand.

Top Condition	Upper storage, wall-suspended wardrobe, and floor-extended cover panels		
Top Condition	• No top extension	No cost	Specify with no top extension.
	• Ceiling filler	No cost	Specify with ceiling filler.
	• Sloped fascia	+\$ 32	Specify with sloped fascia.
	• Vertical fascia 6"–23"	No cost	Specify with vertical fascia 6"–23".
	• Vertical fascia 24"–29"	+\$ 95	Specify with vertical fascia 24"–29".
	• Vertical fascia 30"–36"	+\$120	Specify with vertical fascia 30"–36".

Fascia Height	Upper storage, wall-suspended wardrobe, and floor-extended cover panels		
Fascia Height	• 6"H–30"H	No cost	Specify with 6"H–30"H.

Cutout Configuration	Upper storage, wall-suspended wardrobe, and floor-extended cover panels		
Cutout Configuration	• No cutouts	No cost	Specify with no cutouts.
	• One top cutout	+\$ 11	Specify with one top cutout.

Wall-suspended wardrobe cover panel			
Cutout Configuration	• No cutouts	No cost	Specify with no cutouts.
	• One top cutout	+\$ 11	Specify with one top cutout.
	• One bottom cutout	+\$ 11	Specify with one bottom cutout.
	• Two cutouts, top and bottom	+\$ 25	Specify with two cutouts, top and bottom.

Tip: Please refer to SmartTools to specify sizes.



Specification Information

Style Number	Dimensions		U.S. Base Price	Options (Add \$ to Base Price)	
	D	H		Laminate Price	HPL Price

Upper Storage Cover Panel

HCMCPU	D	H	U.S. Base Price	Laminate Price	HPL Price
	9"-12"	24"	\$216	+\$ 7	+\$ 7
	9"-12"	25"-30"	\$229	+\$ 8	+\$ 8
	9"-12"	31"-36"	\$239	+\$ 8	+\$ 8
	13"-15"	24"	\$229	+\$ 8	+\$ 8
	13"-15"	25"-30"	\$242	+\$ 8	+\$ 8
	13"-15"	31"-36"	\$262	+\$ 9	+\$ 9
	16"	24"	\$233	+\$ 8	+\$ 8
	16"	25"-30"	\$248	+\$ 8	+\$ 8
	16"	31"-36"	\$265	+\$ 9	+\$ 9

Wall-Suspended Base Cabinet Cover Panel

HCMCPBW	D	H	U.S. Base Price	Laminate Price	HPL Price
	14"-20"	22.956"	\$248	+\$ 8	+\$ 8
	21"-25"	22.956"	\$253	+\$ 9	+\$ 9

Wall-Suspended Wardrobe Cover Panel

HCMCPW	D	H	U.S. Base Price	Laminate Price	HPL Price
	14"-20"	66½"	\$391	+\$17	+\$18
	14"-20"	67½"-72½"	\$408	+\$17	+\$18
	14"-20"	73½"-74½"	\$418	+\$18	+\$20
	21"-25"	66½"	\$447	+\$20	+\$22
	21"-25"	67½"-72½"	\$467	+\$20	+\$22
	21"-25"	73½"-74½"	\$482	+\$23	+\$23

► Specification Information, continued on next page

Convey

 **For Canadian Pricing**
 Multiply U.S. Price by the Canadian price factor.
 ► See page 1 for details.

► **Specification Information, continued from previous page**

Tip: Please refer to SmartTools to specify sizes.



Specification Information					
Style Number	Dimensions		U.S. Base Price	Options (Add \$ to Base Price)	
	D	H		Laminate Price Group B	HPL Price Group 2

Floor-Extended Cover Panel

HCMCPF	Dimensions D	Dimensions H	U.S. Base Price	Laminate Price Group B	HPL Price Group 2
	14"-20"	27"	\$242	+\$ 9	+\$ 9
	14"-20"	27½"-32½"	\$263	+\$ 9	+\$ 9
	14"-20"	33"-34½"	\$267	+\$ 9	+\$ 9
	14"-20"	35"-40½"	\$286	+\$11	+\$12
	14"-20"	41"-60"	\$348	+\$16	+\$17
	14"-20"	60½"-72"	\$387	+\$17	+\$18
	14"-20"	72½"-84"	\$425	+\$20	+\$22
	21"-24"	27"	\$263	+\$ 9	+\$ 9
	21"-24"	27½"-32½"	\$282	+\$11	+\$12
	21"-24"	33"-34½"	\$290	+\$11	+\$12
	21"-24"	35"-40½"	\$313	+\$12	+\$13
	21"-24"	41"-60"	\$389	+\$18	+\$20
	21"-24"	60½"-72"	\$434	+\$20	+\$22
	21"-24"	72½"-84"	\$482	+\$24	+\$24
	25"-30"	27"	\$287	+\$11	+\$12
	25"-30"	27½"-32½"	\$314	+\$12	+\$13
	25"-30"	33"-34½"	\$324	+\$12	+\$13
	25"-30"	35"-40½"	\$354	+\$16	+\$17
	25"-30"	41"-60"	\$448	+\$23	+\$23
	25"-30"	60½"-72"	\$503	+\$24	+\$24
	25"-30"	72½"-84"	\$560	+\$26	+\$26

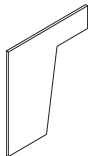

Angled-Sink Cover Panel

HCMCPAS	Dimensions D	Dimensions H	U.S. Base Price	Laminate Price Group B	HPL Price Group 2
	20"	20.956" or 22.956"	\$248	+\$ 8	+\$ 8
	21"-24"	20.956" or 22.956"	\$268	+\$ 9	+\$ 9
	25"	20.956" or 22.956"	\$270	+\$ 9	+\$ 9



For Canadian Pricing
 Multiply U.S. Price by the Canadian price factor.
 ► See page 1 for details.

Convey Flat Top-Cap Cover Panel

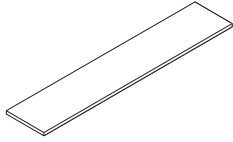

Standard Includes		Required to Specify
<ul style="list-style-type: none"> ▶ Need help? Product details, page 86 	<ul style="list-style-type: none"> • Cover panel: High-Pressure Laminate • Edges: matching 1 mm plastic on edges 	<ol style="list-style-type: none"> 1 Style number 2 Panel depth (see below under Required Selections) 3 Panel width (see below under Required Selections) 4 Laminate color number for cover panel 5 Options, if selected (see below) <ul style="list-style-type: none"> ▶ See <i>Surface Materials</i>, page 376.

Tip: The increment for parametric depth is 1" and 1/16" for width.

Required Selections	U.S. Price	Required to Specify
Panel Depth Parametric depth <ul style="list-style-type: none"> • 9"D–30"D 	Prices below and at right	Specify with 9"D–30"D.
Panel Width Parametric width <ul style="list-style-type: none"> • 12"W–96"W 	Prices below and at right	Specify with 12"W–96"W.

Tip: For finish codes and more information on laminate price group B, see *Surface Materials*.

▶ See page 376

Options	U.S. Price	Required to Specify
Surface Materials <ul style="list-style-type: none"> • Solid HPL • Woodgrain HPL • Laminate price group B • Laminate price group 2 	No cost No cost Prices below and at right Prices below and at right	Specify laminate color number. Specify laminate color number. Specify laminate color number. Specify laminate color number.

Tip: Please refer to *SmartTools* to specify sizes.

Specification Information					
Style Number	Dimensions		U.S. Base Price	Options (Add \$ to Base Price)	
	D	W		Laminate Price Group B	HPL Price Group 2
HCMTC	9"–12"	12"–15"	\$282	+\$11	+\$12
	9"–12"	15 1/16"–18"	\$285	+\$11	+\$12
	9"–12"	18 1/16"–24"	\$290	+\$11	+\$12
	9"–12"	24 1/16"–30"	\$294	+\$11	+\$12
	9"–12"	30 1/16"–36"	\$299	+\$12	+\$13
	9"–12"	36 1/16"–48"	\$309	+\$12	+\$13
	9"–12"	48 1/16"–60"	\$318	+\$12	+\$13
	9"–12"	60 1/16"–72"	\$326	+\$12	+\$13
	9"–12"	72 1/16"–84"	\$337	+\$16	+\$17
	9"–12"	84 1/16"–96"	\$347	+\$16	+\$17
	13"–15"	12"–15"	\$283	+\$11	+\$12
	13"–15"	15 1/16"–18"	\$285	+\$11	+\$12
	13"–15"	18 1/16"–24"	\$291	+\$11	+\$12
	13"–15"	24 1/16"–30"	\$296	+\$11	+\$12
	13"–15"	30 1/16"–36"	\$300	+\$12	+\$13
	13"–15"	36 1/16"–48"	\$310	+\$12	+\$13
	13"–15"	48 1/16"–60"	\$320	+\$12	+\$13
	13"–15"	60 1/16"–72"	\$328	+\$16	+\$17
	13"–15"	72 1/16"–84"	\$339	+\$16	+\$17
	13"–15"	84 1/16"–96"	\$349	+\$16	+\$17

▶ Specification Information, continued on next page



For Canadian Pricing
 Multiply U.S. Price by the Canadian price factor.
 ▶ See page 1 for details.

► **Specification Information, continued from previous page**

Specification Information					
Style Number	Dimensions		U.S. Base Price	Options (Add \$ to Base Price)	
	D	W		Laminate Price Group B	HPL Price Group 2
HCMT C	16"-20"	12"-15"	\$286	+\$11	+\$12
	16"-20"	15 ¹ / ₁₆ "-18"	\$290	+\$11	+\$12
	16"-20"	18 ¹ / ₁₆ "-24"	\$294	+\$11	+\$12
	16"-20"	24 ¹ / ₁₆ "-30"	\$300	+\$12	+\$13
	16"-20"	30 ¹ / ₁₆ "-36"	\$304	+\$12	+\$13
	16"-20"	36 ¹ / ₁₆ "-48"	\$313	+\$12	+\$13
	16"-20"	48 ¹ / ₁₆ "-60"	\$324	+\$12	+\$13
	16"-20"	60 ¹ / ₁₆ "-72"	\$332	+\$16	+\$17
	16"-20"	72 ¹ / ₁₆ "-84"	\$343	+\$16	+\$17
	16"-20"	84 ¹ / ₁₆ "-96"	\$352	+\$16	+\$17
	21"-24"	12"-15"	\$291	+\$11	+\$12
	21"-24"	15 ¹ / ₁₆ "-18"	\$292	+\$11	+\$12
21"-24"	18 ¹ / ₁₆ "-24"	\$299	+\$12	+\$13	
21"-24"	24 ¹ / ₁₆ "-30"	\$303	+\$12	+\$13	
21"-24"	30 ¹ / ₁₆ "-36"	\$308	+\$12	+\$13	
21"-24"	36 ¹ / ₁₆ "-48"	\$318	+\$12	+\$13	
21"-24"	48 ¹ / ₁₆ "-60"	\$326	+\$12	+\$13	
21"-24"	60 ¹ / ₁₆ "-72"	\$337	+\$16	+\$17	
21"-24"	72 ¹ / ₁₆ "-84"	\$347	+\$16	+\$17	
21"-24"	84 ¹ / ₁₆ "-96"	\$357	+\$16	+\$17	
25"-30"	12"-15"	\$296	+\$11	+\$12	
25"-30"	15 ¹ / ₁₆ "-18"	\$299	+\$12	+\$13	
25"-30"	18 ¹ / ₁₆ "-24"	\$303	+\$12	+\$13	
25"-30"	24 ¹ / ₁₆ "-30"	\$308	+\$12	+\$13	
25"-30"	30 ¹ / ₁₆ "-36"	\$311	+\$12	+\$13	
25"-30"	36 ¹ / ₁₆ "-48"	\$323	+\$12	+\$13	
25"-30"	48 ¹ / ₁₆ "-60"	\$329	+\$16	+\$17	
25"-30"	60 ¹ / ₁₆ "-72"	\$341	+\$16	+\$17	
25"-30"	72 ¹ / ₁₆ "-84"	\$351	+\$16	+\$17	
25"-30"	84 ¹ / ₁₆ "-96"	\$361	+\$17	+\$18	

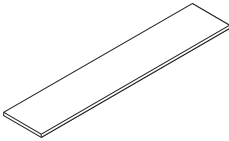

Tip: Please refer to SmartTools to specify sizes.

Convey



For Canadian Pricing
Multiply U.S. Price by the Canadian price factor.
► See page 1 for details.

Convey Sloped Fascia

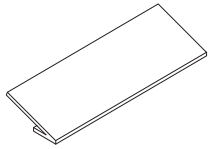

Standard Includes		Required to Specify
<ul style="list-style-type: none"> ▶ Need help? Product details, page 86 	<ul style="list-style-type: none"> Sloped fascia: High-Pressure Laminate Edges: matching 1 mm plastic edges Trim: paint 	<ol style="list-style-type: none"> Style number Fascia depth (see below under Required Selections) Fascia width (see below under Required Selections) Laminate color number for fascia Paint color number for trim: <ul style="list-style-type: none"> 4140 Arctic White Gloss 4728 Nickel Metallic 4799 Platinum Metallic 7380 Merle Grain direction (see below under Required Selections) Options, if selected (see below) <p>▶ See <i>Surface Materials</i>, page 376.</p>

Tip: The increment for parametric depth is 1" and 1/16" for width.

Required Selections	U.S. Price	Required to Specify
Fascia Depth Parametric depth <ul style="list-style-type: none"> 9"D–29"D 	Prices below and at right	Specify with 9"D–29"D.
Fascia Width Parametric width <ul style="list-style-type: none"> 12"W–96"W 	Prices below and at right	Specify with 12"W–96"W.
Grain Direction <ul style="list-style-type: none"> No grain direction Vertical Horizontal 	No cost No cost No cost	Specify with <i>no grain direction</i> . Specify with <i>vertical grain direction</i> . Specify with <i>horizontal grain direction</i> .

Tip: When laminate price group B is selected, grain direction defaults to vertical.

Tip: For finish codes and more information on laminate price group B, see *Surface Materials*.

▶ See page 376

Tip: Please refer to *SmartTools* to specify sizes.

Options	U.S. Price	Required to Specify
Surface Materials <ul style="list-style-type: none"> Solid HPL Woodgrain HPL Laminate price group B Laminate price group 2 	No cost No cost Prices below and at right Prices below and at right	Specify laminate color number. Specify laminate color number. Specify laminate color number. Specify laminate color number.

Specification Information					
Style Number	Dimensions		U.S. Base Price	Options (Add \$ to Base Price)	
	D	W		Laminate Price Group B	HPL Price Group 2
HCMFASCIASLPD	9"–12"	12"–15 ¹⁵ / ₁₆ "	\$154	+\$18	+\$20
	9"–12"	16"–18 ¹⁵ / ₁₆ "	\$161	+\$20	+\$22
	9"–12"	19"–24 ¹⁵ / ₁₆ "	\$185	+\$20	+\$22
	9"–12"	25"–30 ¹⁵ / ₁₆ "	\$210	+\$23	+\$23
	9"–12"	31"–36 ¹⁵ / ₁₆ "	\$229	+\$23	+\$23
	9"–12"	37"–48 ¹⁵ / ₁₆ "	\$276	+\$24	+\$24
	9"–12"	49"–60 ¹⁵ / ₁₆ "	\$324	+\$25	+\$25
	9"–12"	61"–72 ¹⁵ / ₁₆ "	\$365	+\$26	+\$26
	9"–12"	73"–84 ¹⁵ / ₁₆ "	\$414	+\$27	+\$27
	9"–12"	85"–96"	\$459	+\$28	+\$28

▶ Specification Information, continued on next page



For Canadian Pricing

Multiply U.S. Price by the Canadian price factor.

▶ See page 1 for details.

► Specification Information, continued from previous page

Specification Information

Style Number	Dimensions		U.S. Base Price	Options (Add \$ to Base Price)	
	D	W		Laminate Price Group B	HPL Price Group 2
HCMFASCIASLPD	13"-15"	12"-15 ¹ / ₁₆ "	\$169	+\$20	+\$22
	13"-15"	16"-18 ¹ / ₁₆ "	\$184	+\$20	+\$22
	13"-15"	19"-24 ¹ / ₁₆ "	\$218	+\$23	+\$23
	13"-15"	25"-30 ¹ / ₁₆ "	\$255	+\$24	+\$24
	13"-15"	31"-36 ¹ / ₁₆ "	\$288	+\$25	+\$25
	13"-15"	37"-48 ¹ / ₁₆ "	\$359	+\$26	+\$26
	13"-15"	49"-60 ¹ / ₁₆ "	\$427	+\$28	+\$28
	13"-15"	61"-72 ¹ / ₁₆ "	\$496	+\$30	+\$30
	13"-15"	73"-84 ¹ / ₁₆ "	\$564	+\$32	+\$34
	13"-15"	85"-96"	\$634	+\$34	+\$35
	16"-20"	12"-15 ¹ / ₁₆ "	\$180	+\$20	+\$22
	16"-20"	16"-18 ¹ / ₁₆ "	\$199	+\$23	+\$23
	16"-20"	19"-24 ¹ / ₁₆ "	\$244	+\$24	+\$24
	16"-20"	25"-30 ¹ / ₁₆ "	\$285	+\$24	+\$24
	16"-20"	31"-36 ¹ / ₁₆ "	\$326	+\$25	+\$25
	16"-20"	37"-48 ¹ / ₁₆ "	\$409	+\$27	+\$27
	16"-20"	49"-60 ¹ / ₁₆ "	\$495	+\$30	+\$30
	16"-20"	61"-72 ¹ / ₁₆ "	\$577	+\$32	+\$34
	16"-20"	73"-84 ¹ / ₁₆ "	\$660	+\$35	+\$36
	16"-20"	85"-96"	\$745	+\$37	+\$38
	21"-24"	12"-15 ¹ / ₁₆ "	\$229	+\$23	+\$23
	21"-24"	16"-18 ¹ / ₁₆ "	\$252	+\$24	+\$24
	21"-24"	19"-24 ¹ / ₁₆ "	\$299	+\$25	+\$25
	21"-24"	25"-30 ¹ / ₁₆ "	\$341	+\$26	+\$26
	21"-24"	31"-36 ¹ / ₁₆ "	\$387	+\$27	+\$27
	21"-24"	37"-48 ¹ / ₁₆ "	\$476	+\$30	+\$30
	21"-24"	49"-60 ¹ / ₁₆ "	\$564	+\$32	+\$34
	21"-24"	61"-72 ¹ / ₁₆ "	\$656	+\$35	+\$36
	21"-24"	73"-84 ¹ / ₁₆ "	\$742	+\$37	+\$38
	21"-24"	85"-96"	\$836	+\$39	+\$40
	25"-29"	12"-15 ¹ / ₁₆ "	\$265	+\$24	+\$24
	25"-29"	16"-18 ¹ / ₁₆ "	\$287	+\$24	+\$24
	25"-29"	19"-24 ¹ / ₁₆ "	\$333	+\$26	+\$26
	25"-29"	25"-30 ¹ / ₁₆ "	\$378	+\$27	+\$27
	25"-29"	31"-36 ¹ / ₁₆ "	\$425	+\$28	+\$28
	25"-29"	37"-48 ¹ / ₁₆ "	\$514	+\$31	+\$31
	25"-29"	49"-60 ¹ / ₁₆ "	\$612	+\$34	+\$35
	25"-29"	61"-72 ¹ / ₁₆ "	\$701	+\$36	+\$37
	25"-29"	73"-84 ¹ / ₁₆ "	\$791	+\$38	+\$39
	25"-29"	85"-96"	\$956	+\$41	+\$42

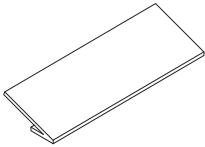

Tip: Please refer to SmartTools to specify sizes.



 **For Canadian Pricing**
 Multiply U.S. Price by the Canadian price factor.
 ► See page 1 for details.

Convey Vertical Fascia

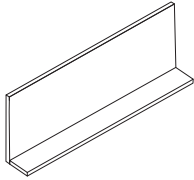

Standard Includes		Required to Specify
<ul style="list-style-type: none"> ▶ Need help? Product details, page 86 	<ul style="list-style-type: none"> • Vertical fascia: High-Pressure Laminate • Edges: matching 1 mm plastic edges • Trim: paint 	<ol style="list-style-type: none"> 1 Style number 2 Fascia height (see below under Required Selections) 3 Fascia width (see below under Required Selections) 4 Laminate color number for fascia 5 Paint color number for trim: <ul style="list-style-type: none"> 4140 Arctic White Gloss 4728 Nickel Metallic 4799 Platinum Metallic 7380 Merle 6 Grain direction (see below under Required Selections) 7 Options, if selected (see below) <ul style="list-style-type: none"> ▶ See <i>Surface Materials</i>, page 376.

Tip: The increment for parametric width is 1/16".

	Required Selections	U.S. Price	Required to Specify
Fascia Height	Parametric height <ul style="list-style-type: none"> • 6"H–30"H 	Prices below and at right	Specify with 6"H–30"H.
Fascia Width	Parametric width <ul style="list-style-type: none"> • 12"W–96"W 	Prices below and at right	Specify with 12"W–96"W.
Grain Direction	<ul style="list-style-type: none"> • No grain direction • Vertical • Horizontal 	No cost No cost No cost	Specify with <i>no grain direction</i> . Specify with <i>vertical grain direction</i> . Specify with <i>horizontal grain direction</i> .

Tip: Vertical grain direction is allowed up to 48" wide.

	Options	U.S. Price	Required to Specify
Surface Materials	<ul style="list-style-type: none"> • Solid HPL • Woodgrain HPL • Laminate price group B • Laminate price group 2 	No cost No cost Prices below and at right Prices below and at right	Specify laminate color number. Specify laminate color number. Specify laminate color number. Specify laminate color number.

Tip: When laminate price group B is selected, grain direction defaults to vertical.

Tip: For finish codes and more information on laminate price group B, see *Surface Materials*.

▶ See page 376

Tip: Please refer to *SmartTools* to specify sizes.

Tip: Ceiling clips must be specified with vertical fascia. Identify the type of ceiling grid the clips will be used on.

▶ See pages 88 and 89 for examples.

Specification Information					
Style Number	Dimensions		U.S. Base Price	Options (Add \$ to Base Price)	
	W	H		Laminate Price Group B	HPL Price Group 2
HCMFASCIAVERT	12"–15 ¹⁵ / ₁₆ "	6"–14"	\$337	+\$20	+\$22
	16"–18 ¹⁵ / ₁₆ "	6"–14"	\$346	+\$20	+\$22
	19"–24 ¹⁵ / ₁₆ "	6"–14"	\$365	+\$20	+\$22
	25"–30 ¹⁵ / ₁₆ "	6"–14"	\$385	+\$23	+\$23
	31"–36 ¹⁵ / ₁₆ "	6"–14"	\$405	+\$23	+\$23
	37"–48 ¹⁵ / ₁₆ "	6"–14"	\$444	+\$24	+\$24
	49"–60 ¹⁵ / ₁₆ "	6"–14"	\$480	+\$25	+\$25
	61"–72 ¹⁵ / ₁₆ "	6"–14"	\$520	+\$26	+\$26
	73"–84 ¹⁵ / ₁₆ "	6"–14"	\$558	+\$27	+\$27
	85"–96"	6"–14"	\$601	+\$28	+\$28
	12"–15 ¹⁵ / ₁₆ "	15"–20"	\$358	+\$20	+\$22
	16"–18 ¹⁵ / ₁₆ "	15"–20"	\$376	+\$23	+\$23
	19"–24 ¹⁵ / ₁₆ "	15"–20"	\$406	+\$23	+\$23
	25"–30 ¹⁵ / ₁₆ "	15"–20"	\$437	+\$24	+\$24
	31"–36 ¹⁵ / ₁₆ "	15"–20"	\$469	+\$25	+\$25
	37"–48 ¹⁵ / ₁₆ "	15"–20"	\$532	+\$26	+\$26
49"–60 ¹⁵ / ₁₆ "	15"–20"	\$594	+\$28	+\$28	

▶ **Specification Information, continued on next page**

 **For Canadian Pricing**
 Multiply U.S. Price by the Canadian price factor.
 ▶ See page 1 for details.

► **Specification Information, continued from previous page**

Specification Information					
Style Number	Dimensions		U.S. Base Price	Options (Add \$ to Base Price)	
	W	H		Laminate Price Group B	HPL Price Group 2
HCMFASCIAVERT	61"-72 ¹ / ₁₆ "	15"-20"	\$ 658	+\$30	+\$30
	73"-84 ¹ / ₁₆ "	15"-20"	\$ 723	+\$32	+\$34
	85"-96"	15"-20"	\$ 786	+\$34	+\$35
	12"-15 ¹ / ₁₆ "	21"-24"	\$ 378	+\$23	+\$23
	16"-18 ¹ / ₁₆ "	21"-24"	\$ 392	+\$23	+\$23
	19"-24 ¹ / ₁₆ "	21"-24"	\$ 420	+\$24	+\$24
	25"-30 ¹ / ₁₆ "	21"-24"	\$ 455	+\$25	+\$25
	31"-36 ¹ / ₁₆ "	21"-24"	\$ 484	+\$25	+\$25
	37"-48 ¹ / ₁₆ "	21"-24"	\$ 542	+\$27	+\$27
	49"-60 ¹ / ₁₆ "	21"-24"	\$ 606	+\$28	+\$28
	61"-72 ¹ / ₁₆ "	21"-24"	\$ 665	+\$30	+\$30
	73"-84 ¹ / ₁₆ "	21"-24"	\$ 727	+\$32	+\$34
	85"-96"	21"-24"	\$ 787	+\$34	+\$35
	12"-15 ¹ / ₁₆ "	25"-30"	\$ 380	+\$23	+\$23
	16"-18 ¹ / ₁₆ "	25"-30"	\$ 409	+\$23	+\$23
	19"-24 ¹ / ₁₆ "	25"-30"	\$ 465	+\$25	+\$25
	25"-30 ¹ / ₁₆ "	25"-30"	\$ 520	+\$26	+\$26
	31"-36 ¹ / ₁₆ "	25"-30"	\$ 580	+\$28	+\$28
	37"-48 ¹ / ₁₆ "	25"-30"	\$ 695	+\$31	+\$31
	49"-60 ¹ / ₁₆ "	25"-30"	\$ 809	+\$35	+\$36
61"-72 ¹ / ₁₆ "	25"-30"	\$ 923	+\$38	+\$39	
73"-84 ¹ / ₁₆ "	25"-30"	\$1038	+\$41	+\$42	
85"-96"	25"-30"	\$1152	+\$47	+\$49	

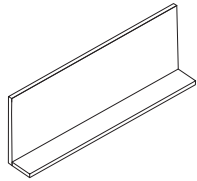

Tip: Please refer to SmartTools to specify sizes.



 **For Canadian Pricing**
 Multiply U.S. Price by the Canadian price factor.
 ► See page 1 for details.

Convey Worksurfaces

Solid Surface

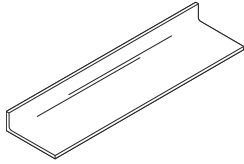

Standard Includes	Required to Specify
<ul style="list-style-type: none"> ▶ Need help? Product details, page 90 • Worksurface: solid surface price group A • Moisture resistance: MR 10 • Backsplash 	<ol style="list-style-type: none"> 1 Style number 2 Solid surface color number for worksurface and backsplash 3 Worksurface depth (see below under Required Selections) 4 Worksurface width (see below under Required Selections) 5 Sink bowl, if solid surface worksurface with sink is selected (see below under Required Selections) 6 Options, if selected (see below) <p>▶ See <i>Surface Materials</i>, page 376.</p>

Tip: Worksurface depths flex parametrically in 1" increments. Widths flex parametrically in 1/8" increments.

Tip: Integral sink bowls can be added to worksurfaces a minimum of 30"W and up to 138"W.

Tip: Add sink cost to tops with sinks. See separate table with list price. Specifying the X or Y sink bowl position does not add cost.

Required Selections	U.S. Price	Required to Specify
Worksurface Depth <ul style="list-style-type: none"> • Parametric depth • Solid surface worksurface – 15"D–30"D • Solid surface worksurface with sink – 20"D–30"D 	<p>Prices at right</p> <p>Prices at right</p>	<p>Specify with 15"D–30"D.</p> <p>Specify with 20"D–30"D.</p>
Worksurface Width <ul style="list-style-type: none"> • Parametric width • Solid surface worksurface – 12"W–138"W • Solid surface worksurface with sink – 30"W–138"W 	<p>Prices at right</p> <p>Prices at right</p>	<p>Specify with 12"W–138"W.</p> <p>Specify with 30"W–138"W.</p>
Sink Bowl <ul style="list-style-type: none"> • Solid surface worksurface with sink • 810 no overflow • 5414 no overflow • 816 no overflow • 8254 no overflow • 8252 no overflow • 7412 no overflow • 7418 no overflow • 7722 no overflow • 815 no overflow • 5315 no overflow 	<p>+\$ 878</p> <p>+\$ 932</p> <p>+\$ 987</p> <p>+\$1002</p> <p>+\$1071</p> <p>+\$1110</p> <p>+\$1221</p> <p>+\$1221</p> <p>+\$1393</p> <p>+\$1847</p>	<p>Specify with 810 no overflow.</p> <p>Specify with 5414 no overflow.</p> <p>Specify with 816 no overflow.</p> <p>Specify with 8254 no overflow.</p> <p>Specify with 8252 no overflow.</p> <p>Specify with 7412 no overflow.</p> <p>Specify with 7418 no overflow.</p> <p>Specify with 7722 no overflow.</p> <p>Specify with 815 no overflow.</p> <p>Specify with 5315 no overflow</p>

Options	U.S. Price	Required to Specify
Surface Materials <ul style="list-style-type: none"> • Top surface • Solid surface group A • Solid surface group B • Solid surface group C • Solid surface group D 	<p>Prices at right</p> <p>Prices at right</p> <p>Prices at right</p> <p>Prices at right</p>	<p>▶ See <i>Surface Materials</i>, page 376.</p> <p>▶ See <i>Surface Materials</i>, page 376.</p> <p>▶ See <i>Surface Materials</i>, page 376.</p> <p>▶ See <i>Surface Materials</i>, page 376.</p>
Backsplash <ul style="list-style-type: none"> • No backsplash • With backsplash 	<p>Prices at right</p> <p>Prices at right</p>	<p>Specify with no backsplash.</p> <p>Specify with backsplash.</p>



For Canadian Pricing

Multiply U.S. Price by the Canadian price factor.

▶ See page 1 for details.

Specification Information

Style Number	Dimensions		U.S. Base Prices			
	D	W	Solid Surface Grade A	Solid Surface Grade B	Solid Surface Grade C	Solid Surface Grade D

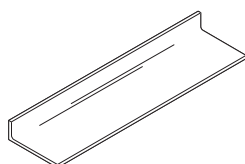

Tip: Please refer to SmartTools to specify sizes.

Solid Surface Worksurface with Backsplash

HCMWRKSFSS	D	W	Grade A	Grade B	Grade C	Grade D
	15"-21"	12"-27"	\$1752	\$2982	\$3436	\$4183
	15"-21"	27 1/8"-37"	\$1858	\$3010	\$3464	\$4212
	15"-21"	37 1/8"-41"	\$1978	\$3017	\$3474	\$4222
	15"-21"	41 1/8"-47"	\$2110	\$3037	\$3492	\$4239
	15"-21"	47 1/8"-56"	\$2163	\$3063	\$3517	\$4262
	15"-21"	56 1/8"-71"	\$2534	\$3276	\$3741	\$4471
	15"-21"	71 1/8"-113"	\$3504	\$3645	\$4075	\$4838
	15"-21"	113 1/8"-138"	\$3796	\$5548	\$6479	\$7960
	21 1/8"-25"	12"-27"	\$2189	\$3111	\$3564	\$4310
	21 1/8"-25"	27 1/8"-37"	\$2222	\$3140	\$3591	\$4337
	21 1/8"-25"	37 1/8"-41"	\$2248	\$3149	\$3602	\$4349
	21 1/8"-25"	41 1/8"-47"	\$2402	\$3185	\$3651	\$4390
	21 1/8"-25"	47 1/8"-56"	\$2480	\$3211	\$3676	\$4414
	21 1/8"-25"	56 1/8"-71"	\$2865	\$3410	\$3873	\$4612
	21 1/8"-25"	71 1/8"-113"	\$4033	\$5577	\$6539	\$8040
	21 1/8"-25"	113 1/8"-138"	\$4312	\$5681	\$6607	\$8088
	25 1/8"-30"	12"-27"	\$2202	\$3114	\$3567	\$4312
	25 1/8"-30"	27 1/8"-37"	\$2228	\$3143	\$3594	\$4339
	25 1/8"-30"	37 1/8"-41"	\$2255	\$3152	\$3605	\$4351
	25 1/8"-30"	41 1/8"-47"	\$2408	\$3188	\$3653	\$4392
	25 1/8"-30"	47 1/8"-56"	\$2488	\$3214	\$3678	\$4416
	25 1/8"-30"	56 1/8"-71"	\$2872	\$3412	\$3875	\$4617
	25 1/8"-30"	71 1/8"-113"	\$4040	\$5580	\$6541	\$8043
	25 1/8"-30"	113 1/8"-138"	\$4320	\$5683	\$6611	\$8089

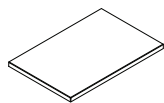

Solid Surface Worksurface without Backsplash

HCMWRKSFSS	D	W	Grade A	Grade B	Grade C	Grade D
	15"-21"	12"-27"	\$1573	\$2843	\$3300	\$4052
	15"-21"	27 1/8"-37"	\$1658	\$2870	\$3326	\$4075
	15"-21"	37 1/8"-41"	\$1771	\$2878	\$3335	\$4086
	15"-21"	41 1/8"-47"	\$1911	\$2896	\$3352	\$4100
	15"-21"	47 1/8"-56"	\$1938	\$2917	\$3375	\$4122
	15"-21"	56 1/8"-71"	\$2308	\$3123	\$3591	\$4323
	15"-21"	71 1/8"-113"	\$3231	\$3473	\$3909	\$4674
	15"-21"	113 1/8"-138"	\$3524	\$5381	\$6311	\$7794

► Specification Information, continued on next page

 **For Canadian Pricing**
 Multiply U.S. Price by the Canadian price factor.
 ► See page 1 for details.

► **Specification Information, continued from previous page**

Tip: Please refer to SmartTools to specify sizes.

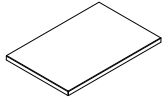

Specification Information

Style Number	Dimensions		U.S. Base Prices			
	D	W	Solid Surface Grade A	Solid Surface Grade B	Solid Surface Grade C	Solid Surface Grade D

Solid Surface Worksurface without Backsplash, continued

HCMWRKSFSS	Dimensions (D x W)	Price (Grade A)	Price (Grade B)	Price (Grade C)	Price (Grade D)	
	21 1/8"-25"	12"-27"	\$1579	\$2844	\$3302	\$4053
	21 1/8"-25"	27 1/8"-37"	\$1667	\$2872	\$3327	\$4078
	21 1/8"-25"	37 1/8"-41"	\$1780	\$2880	\$3336	\$4088
	21 1/8"-25"	41 1/8"-47"	\$1925	\$2913	\$3379	\$4123
	21 1/8"-25"	47 1/8"-56"	\$1952	\$2935	\$3403	\$4147
	21 1/8"-25"	56 1/8"-71"	\$2316	\$3123	\$3592	\$4337
	21 1/8"-25"	71 1/8"-113"	\$3239	\$3474	\$3910	\$4675
	21 1/8"-25"	113 1/8"-138"	\$3530	\$5381	\$6313	\$7795
	25 1/8"-30"	12"-27"	\$1858	\$2845	\$3303	\$4054
	25 1/8"-30"	27 1/8"-37"	\$1884	\$2873	\$3329	\$4078
	25 1/8"-30"	37 1/8"-41"	\$1911	\$2884	\$3337	\$4089
	25 1/8"-30"	41 1/8"-47"	\$2055	\$2914	\$3381	\$4125
	25 1/8"-30"	47 1/8"-56"	\$2149	\$2937	\$3406	\$4147
	25 1/8"-30"	56 1/8"-71"	\$2474	\$3124	\$3594	\$4338
	25 1/8"-30"	71 1/8"-113"	\$3662	\$5287	\$6249	\$7756
	25 1/8"-30"	113 1/8"-138"	\$3941	\$5382	\$6314	\$7795

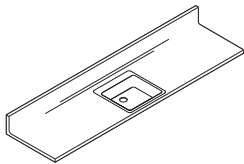

Solid Surface Worksurface with Sink and Backsplash

HCMWRKSFSSINKSS	Dimensions (D x W)	Price (Grade A)	Price (Grade B)	Price (Grade C)	Price (Grade D)	
	20"-21"	30"-37"	\$1858	\$3010	\$3464	\$4212
	20"-21"	37 1/8"-41"	\$1978	\$3017	\$3474	\$4222
	20"-21"	41 1/8"-47"	\$2110	\$3037	\$3492	\$4239
	20"-21"	47 1/8"-56"	\$2163	\$3063	\$3517	\$4262
	20"-21"	56 1/8"-71"	\$2534	\$3276	\$3741	\$4471
	20"-21"	71 1/8"-113"	\$3504	\$3645	\$4075	\$4838
	20"-21"	113 1/8"-138"	\$3796	\$5548	\$6479	\$7960
	21 1/8"-25"	30"-37"	\$2222	\$3140	\$3591	\$4337
	21 1/8"-25"	37 1/8"-41"	\$2248	\$3149	\$3602	\$4349
	21 1/8"-25"	41 1/8"-47"	\$2402	\$3185	\$3651	\$4390
	21 1/8"-25"	47 1/8"-56"	\$2480	\$3211	\$3676	\$4414
	21 1/8"-25"	56 1/8"-71"	\$2865	\$3410	\$3873	\$4612
	21 1/8"-25"	71 1/8"-113"	\$4033	\$5577	\$6539	\$8040
	21 1/8"-25"	113 1/8"-138"	\$4312	\$5681	\$6607	\$8088

► **Specification Information, continued on next page**



For Canadian Pricing
 Multiply U.S. Price by the Canadian price factor.
 ► See page 1 for details.

► Specification Information, continued from previous page

Tip: Please refer to SmartTools to specify sizes.

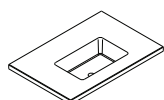
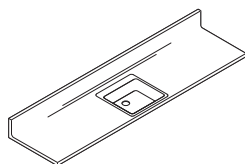

Specification Information

Style Number	Dimensions		U.S. Base Prices			
	D	W	Solid Surface Grade A	Solid Surface Grade B	Solid Surface Grade C	Solid Surface Grade D

Solid Surface Worksurface with Sink and Backsplash, continued

HCMWRKSFSINKSS	D	W	Grade A	Grade B	Grade C	Grade D
	25 1/8"-30"	30"-37"	\$2228	\$3143	\$3594	\$4339
	25 1/8"-30"	37 1/8"-41"	\$2255	\$3152	\$3605	\$4351
	25 1/8"-30"	41 1/8"-47"	\$2408	\$3188	\$3653	\$4392
	25 1/8"-30"	47 1/8"-56"	\$2488	\$3214	\$3678	\$4416
	25 1/8"-30"	56 1/8"-71"	\$2872	\$3412	\$3875	\$4617
	25 1/8"-30"	71 1/8"-113"	\$4040	\$5580	\$6541	\$8043
	25 1/8"-30"	113 1/8"-138"	\$4320	\$5683	\$6611	\$8089

Solid Surface Worksurface with Sink and without Backsplash

HCMWRKSFSINKSS	D	W	Grade A	Grade B	Grade C	Grade D
	20"-21"	30"-37"	\$1658	\$2870	\$3326	\$4075
	20"-21"	37 1/8"-41"	\$1771	\$2878	\$3335	\$4086
	20"-21"	41 1/8"-47"	\$1911	\$2896	\$3352	\$4100
	20"-21"	47 1/8"-56"	\$1938	\$2917	\$3375	\$4122
	20"-21"	56 1/8"-71"	\$2308	\$3123	\$3591	\$4323
	20"-21"	71 1/8"-113"	\$3231	\$3473	\$3909	\$4674
	20"-21"	113 1/8"-138"	\$3524	\$5381	\$6311	\$7794
	21 1/8"-25"	30"-37"	\$1667	\$2872	\$3327	\$4078
	21 1/8"-25"	37 1/8"-41"	\$1780	\$2880	\$3336	\$4088
	21 1/8"-25"	41 1/8"-47"	\$1925	\$2913	\$3379	\$4123
	21 1/8"-25"	47 1/8"-56"	\$1952	\$2935	\$3403	\$4147
	21 1/8"-25"	56 1/8"-71"	\$2316	\$3123	\$3592	\$4337
	21 1/8"-25"	71 1/8"-113"	\$3239	\$3474	\$3910	\$4675
	21 1/8"-25"	113 1/8"-138"	\$3530	\$5381	\$6313	\$7795
	25 1/8"-30"	30"-37"	\$1884	\$2873	\$3329	\$4078
	25 1/8"-30"	37 1/8"-41"	\$1911	\$2884	\$3337	\$4089
	25 1/8"-30"	41 1/8"-47"	\$2055	\$2914	\$3381	\$4125
	25 1/8"-30"	47 1/8"-56"	\$2149	\$2937	\$3406	\$4147
	25 1/8"-30"	56 1/8"-71"	\$2474	\$3124	\$3594	\$4338
	25 1/8"-30"	71 1/8"-113"	\$3662	\$5287	\$6249	\$7756
	25 1/8"-30"	113 1/8"-138"	\$3941	\$5382	\$6314	\$7795



 **For Canadian Pricing**
 Multiply U.S. Price by the Canadian price factor.
 ► See page 1 for details.

Convey Worksurfaces

High-Pressure Laminate

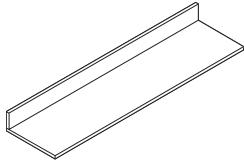

Tip: Illustration above is shown with backslash.

Tip: Worksurface depths and widths flex parametrically in 1/8" increments.

Tip: MR10 core is not available when specifying Formica finishes.

Tip: To calculate total upcharge for moisture resistance on worksurface, round worksurface width selection up to nearest whole number and subtract 12, then multiply by \$2 and add \$24.

Tip: To calculate total upcharge for backslash on worksurface, round worksurface width selection up to nearest whole number and subtract 12, then multiply by \$3 and add \$52.

Tip: To calculate total upcharge for moisture resistance and backslash on worksurface, round worksurface width selection up to nearest whole number and subtract 12, then multiply by \$7 and add \$56.

Standard Includes	Required to Specify
<ul style="list-style-type: none"> ▶ Need help? Product details, page 90 • Worksurface: High-Pressure Laminate price group 1 • Front edgeband: 3 mm plastic price group 1 • Back and side of worksurface edgeband: 1 mm plastic price group 1 	<ol style="list-style-type: none"> 1 Style number 2 Laminate color number for worksurface 3 Plastic color number for worksurface edge 4 Worksurface depth (see below under Required Selections) 5 Worksurface width (see below under Required Selections) 6 Options, if selected (see below) <p>▶ See <i>Surface Materials</i>, page 376.</p>

	Required Selections	U.S. Price	Required to Specify
Worksurface Depth	Parametric depth <ul style="list-style-type: none"> • High-Pressure Laminate worksurface – 15"D–30"D 	Prices at right	Specify with 15"D–30"D.
Worksurface Width	Parametric width <ul style="list-style-type: none"> • High-Pressure Laminate worksurface – 12"W–120"W 	Prices at right	Specify with 12"W–120"W.

	Options	U.S. Price	Required to Specify
Surface Materials	Worksurface <ul style="list-style-type: none"> • Laminate price group 1 • Laminate price group 2 	Prices at right Prices at right	Specify laminate color number. Specify laminate color number.
	Backslash <ul style="list-style-type: none"> • Laminate price group 1 • Laminate price group 2 – On 12"W–41"W worksurface – On 41 1/8"W–65"W worksurface – On 65 1/8"W–77"W worksurface – On 77 1/8"W–101"W worksurface – On 101 1/8"W–120"W worksurface 	No cost No cost +\$ 9 +\$18 +\$24 +\$38 +\$49	Specify laminate color number. Specify laminate color number. Specify laminate color number. Specify laminate color number. Specify laminate color number. Specify laminate color number.
Moisture Resistance and Backslash	<ul style="list-style-type: none"> • No MR • MR10 	No cost +\$24 plus additional \$2 per worksurface inch (see information at left)	Specify with no moisture resistance. Specify with MR10.
	<ul style="list-style-type: none"> • No backslash • With backslash 	No cost +\$52 plus additional \$3 per worksurface inch (see information at left)	Specify with no backslash. Specify with backslash.
	<ul style="list-style-type: none"> • With MR10 and backslash 	+\$56 plus additional \$7 per worksurface inch (see information at left)	Specify with MR10 and backslash.

Specification Information

Style Number	Dimensions D	W	U.S. Base Price	Options (Add \$ to Base Price)
				HPL Price Group 2

High-Pressure Laminate Worksurface

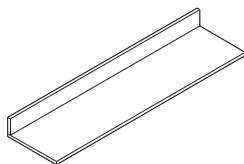

Tip: Illustration above is shown with backsplash.

Tip: Sinks are not included. Sink hole is cut in the field.

Tip: Please refer to SmartTools to specify sizes.

HCMWRKSFL	15"-21"	12"-23"	\$ 232	+\$18
	15"-21"	23 ¹ / ₈ "-29"	\$ 250	+\$18
	15"-21"	29 ¹ / ₈ "-35"	\$ 271	+\$18
	15"-21"	35 ¹ / ₈ "-41"	\$ 293	+\$18
	15"-21"	41 ¹ / ₈ "-47"	\$ 315	+\$27
	15"-21"	47 ¹ / ₈ "-53"	\$ 380	+\$27
	15"-21"	53 ¹ / ₈ "-59"	\$ 407	+\$27
	15"-21"	59 ¹ / ₈ "-65"	\$ 437	+\$27
	15"-21"	65 ¹ / ₈ "-71"	\$ 510	+\$36
	15"-21"	71 ¹ / ₈ "-77"	\$ 568	+\$36
	15"-21"	77 ¹ / ₈ "-83"	\$ 727	+\$44
	15"-21"	83 ¹ / ₈ "-89"	\$ 768	+\$44
	15"-21"	89 ¹ / ₈ "-95"	\$ 812	+\$44
	15"-21"	95 ¹ / ₈ "-101"	\$ 851	+\$44
	15"-21"	101 ¹ / ₈ "-107"	\$ 893	+\$44
	15"-21"	107 ¹ / ₈ "-113"	\$ 932	+\$53
	15"-21"	113 ¹ / ₈ "-120"	\$ 971	+\$53
	21 ¹ / ₈ "-25"	12"-23"	\$ 247	+\$18
	21 ¹ / ₈ "-25"	23 ¹ / ₈ "-29"	\$ 266	+\$18
	21 ¹ / ₈ "-25"	29 ¹ / ₈ "-35"	\$ 286	+\$18
	21 ¹ / ₈ "-25"	35 ¹ / ₈ "-41"	\$ 304	+\$18
	21 ¹ / ₈ "-25"	41 ¹ / ₈ "-47"	\$ 328	+\$27
	21 ¹ / ₈ "-25"	47 ¹ / ₈ "-53"	\$ 392	+\$27
	21 ¹ / ₈ "-25"	53 ¹ / ₈ "-59"	\$ 420	+\$27
	21 ¹ / ₈ "-25"	59 ¹ / ₈ "-65"	\$ 449	+\$27
	21 ¹ / ₈ "-25"	65 ¹ / ₈ "-71"	\$ 513	+\$36
	21 ¹ / ₈ "-25"	71 ¹ / ₈ "-77"	\$ 572	+\$36
	21 ¹ / ₈ "-25"	77 ¹ / ₈ "-83"	\$ 750	+\$44
	21 ¹ / ₈ "-25"	83 ¹ / ₈ "-89"	\$ 812	+\$44
	21 ¹ / ₈ "-25"	89 ¹ / ₈ "-95"	\$ 848	+\$44
	21 ¹ / ₈ "-25"	95 ¹ / ₈ "-101"	\$ 900	+\$44
	21 ¹ / ₈ "-25"	101 ¹ / ₈ "-107"	\$ 941	+\$44
	21 ¹ / ₈ "-25"	107 ¹ / ₈ "-113"	\$ 983	+\$53
	21 ¹ / ₈ "-25"	113 ¹ / ₈ "-120"	\$1023	+\$53

► Specification Information, continued on next page

 **For Canadian Pricing**
 Multiply U.S. Price by the Canadian price factor.
 ► See page 1 for details.

► **Specification Information, continued from previous page**

Specification Information				
Style Number	Dimensions D	W	U.S. Base Price	Options (Add \$ to Base Price) HPL Price Group 2

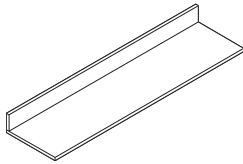

Tip: Illustration above is shown with backsplash.

Tip: Sinks are not included. Sink hole is cut in the field.

Tip: Please refer to SmartTools to specify sizes.

High-Pressure Laminate Worksurface, continued

HCMWRKSFL	Dimensions D	W	U.S. Base Price	Options (Add \$ to Base Price)
	25 ¹ / ₈ "-30"	12"-23"	\$ 263	+\$18
	25 ¹ / ₈ "-30"	23 ¹ / ₈ "-29"	\$ 280	+\$18
	25 ¹ / ₈ "-30"	29 ¹ / ₈ "-35"	\$ 300	+\$18
	25 ¹ / ₈ "-30"	35 ¹ / ₈ "-41"	\$ 315	+\$18
	25 ¹ / ₈ "-30"	41 ¹ / ₈ "-47"	\$ 341	+\$27
	25 ¹ / ₈ "-30"	47 ¹ / ₈ "-53"	\$ 406	+\$27
	25 ¹ / ₈ "-30"	53 ¹ / ₈ "-59"	\$ 433	+\$27
	25 ¹ / ₈ "-30"	59 ¹ / ₈ "-65"	\$ 459	+\$27
	25 ¹ / ₈ "-30"	65 ¹ / ₈ "-71"	\$ 515	+\$36
	25 ¹ / ₈ "-30"	71 ¹ / ₈ "-77"	\$ 574	+\$36
	25 ¹ / ₈ "-30"	77 ¹ / ₈ "-83"	\$ 771	+\$44
	25 ¹ / ₈ "-30"	83 ¹ / ₈ "-89"	\$ 857	+\$44
	25 ¹ / ₈ "-30"	89 ¹ / ₈ "-95"	\$ 886	+\$44
	25 ¹ / ₈ "-30"	95 ¹ / ₈ "-101"	\$ 947	+\$44
	25 ¹ / ₈ "-30"	101 ¹ / ₈ "-107"	\$ 990	+\$44
	25 ¹ / ₈ "-30"	107 ¹ / ₈ "-113"	\$1033	+\$53
	25 ¹ / ₈ "-30"	113 ¹ / ₈ "-120"	\$1075	+\$53



For Canadian Pricing

Multiply U.S. Price by the Canadian price factor.

► See page 1 for details.

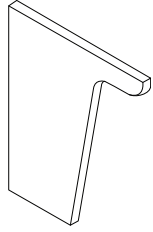

Tip: The increment for parametric depth is 1".

Tip: For finish codes and more information on laminate price group B, see Surface Materials.

▶ See page 376

Standard Includes		Required to Specify
▶ Need help? Product details, page 92	<ul style="list-style-type: none"> • 23"H cantilever: High-Pressure Laminate • 1 mm edge band to match • Bracket covers: one white and one merle 	<ol style="list-style-type: none"> 1 Style number 2 Laminate color number for cantilever 3 Cantilever depth (see below under Required Selections) 4 Cantilever position (see below under Required Selections) 5 Options, if selected (see below) <p>▶ See <i>Surface Materials</i>, page 376.</p>

Required Selections	U.S. Price	Required to Specify
Cantilever Depth <ul style="list-style-type: none"> • Parametric depth • 12³/₄"D–19³/₄"D 	Price below	Specify with 12 ³ / ₄ "D–19 ³ / ₄ "D.
Cantilever Position <ul style="list-style-type: none"> • Left • Right • Intermediate 	No cost No cost No cost	Specify with <i>left</i> . Specify with <i>right</i> . Specify with <i>intermediate</i> .

Options	U.S. Price	Required to Specify
Surface Materials <ul style="list-style-type: none"> • Solid HPL • Woodgrain HPL • Laminate price group B • Laminate price group 2 	No cost No cost Price below Price below	Specify laminate color number. Specify laminate color number. Specify laminate color number. Specify laminate color number.

Specification Information					
Style Number	Dimensions		U.S. Base Price	Options (Add \$ to Base Price)	
	D	H		Laminate Price Group B	HPL Price Group 2
HMCANTLVR	12 ³ / ₄ "–19 ³ / ₄ "	22.956"	\$506	+\$24	+\$25
.

 **For Canadian Pricing**
 Multiply U.S. Price by the Canadian price factor.
 ▶ See page 1 for details.

Convey End Panels

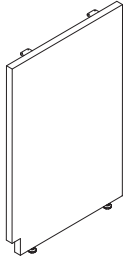

Tip: The increment for parametric depth and height is 1".

Standard Includes		Required to Specify
<ul style="list-style-type: none"> ▶ Need help? Product details, page 93 	<ul style="list-style-type: none"> • End panel: High-Pressure Laminate • Edges: matching 1 mm plastic on edges • Bracket covers: one white and one merle 	<ol style="list-style-type: none"> 1 Style number 2 Panel depth (see below under Required Selections) 3 Panel height (see below under Required Selections) 4 Laminate color number for end panel 5 Handedness (see below under Required Selections) 6 Options, if selected (see below) <p>▶ See <i>Surface Materials</i>, page 376.</p>

Required Selections	U.S. Price	Required to Specify
Panel Depth Parametric depth <ul style="list-style-type: none"> • 14"D–29"D 	Prices below	Specify with 14"D–29"D.
Panel Height Modular height <ul style="list-style-type: none"> • 27"H • 32½"H • 34½"H 	Prices below Prices below Prices below	Specify with 27"H. Specify with 32½"H. Specify with 34½"H.
Handedness <ul style="list-style-type: none"> • Left hand • Right hand 	No cost No cost	Specify with <i>left hand</i> . Specify with <i>right hand</i> .

Tip: For finish codes and more information on laminate price group B, see *Surface Materials*.
▶ See page 376

Options	U.S. Price	Required to Specify
Surface Materials <ul style="list-style-type: none"> • Solid HPL • Woodgrain HPL • Laminate price group B • Laminate price group 2 	No cost No cost Prices below Prices below	Specify laminate color number. Specify laminate color number. Specify laminate color number. Specify laminate color number.

Tip: Please refer to *SmartTools* to specify sizes.

Specification Information					
Style Number	Dimensions		U.S. Base Price	Options (Add \$ to Base Price)	
	D	H		Laminate Price Group B	HPL Price Group 2
HCMEPF	14"–20"	27"	\$350	+\$17	+\$18
	14"–20"	32½"	\$388	+\$18	+\$20
	14"–20"	34½"	\$406	+\$20	+\$22
	21"–24"	27"	\$379	+\$18	+\$20
	21"–24"	32½"	\$419	+\$20	+\$22
	21"–24"	34½"	\$437	+\$22	+\$23
	25"–29"	27"	\$415	+\$20	+\$22
	25"–29"	32½"	\$457	+\$22	+\$23
	25"–29"	34½"	\$472	+\$23	+\$24



For Canadian Pricing
 Multiply U.S. Price by the Canadian price factor.
 ▶ See page 1 for details.

Convey Mounting Boards

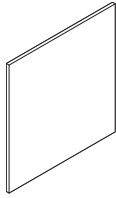

Standard Includes		Required to Specify
<ul style="list-style-type: none"> ▶ Need help? Product details, page 94 	<ul style="list-style-type: none"> • Mounting board: High-Pressure Laminate • Edges: matching 1 mm plastic edges 	<ol style="list-style-type: none"> 1 Style number 2 Mounting board height (see below under Required Selections) 3 Mounting board width (see below under Required Selections) 4 Laminate color number for mounting board 5 Grain direction (see below under Required Selections) 6 Options, if selected (see below) <p>▶ See <i>Surface Materials</i>, page 376.</p>

Tip: Vertical grain direction can only be specified on widths less than 48".

Tip: Width and height are specifiable in 1/8" increments.

Tip: When laminate price group B is selected, grain direction defaults to vertical.

Tip: For finish codes and more information on laminate price group B, see *Surface Materials*.

▶ See page 376

	Required Selections	U.S. Price	Required to Specify
Mounting Board Height	Parametric height <ul style="list-style-type: none"> • 12"H-96"H 	Prices below and at right	Specify with 12"H-96"H.
Mounting Board Width	Parametric width <ul style="list-style-type: none"> • 12"W-96"W 	Prices below and at right	Specify with 12"W-96"W.
Grain Direction	<ul style="list-style-type: none"> • No grain direction • Vertical • Horizontal 	No cost No cost No cost	Specify with <i>no grain direction</i> . Specify with <i>vertical grain direction</i> . Specify with <i>horizontal grain direction</i> .

	Options	U.S. Price	Required to Specify
Surface Materials	<ul style="list-style-type: none"> • Solid HPL • Woodgrain HPL • Laminate price group B • Laminate price group 2 	No cost No cost Prices below and at right Prices below and at right	Specify laminate color number. Specify laminate color number. Specify laminate color number. Specify laminate color number.

Specification Information					
Style Number	Dimensions		U.S. Base Price	Options (Add \$ to Base Price)	
	W	H		Laminate Price Group B	HPL Price Group 2
HCMMBOARD	12"-20"	12"-20"	\$ 320	+\$16	+\$17
	12"-20"	21"-28"	\$ 398	+\$20	+\$22
	12"-20"	29"-36"	\$ 478	+\$24	+\$25
	12"-20"	37"-42"	\$ 539	+\$26	+\$27
	12"-20"	43"-48"	\$ 600	+\$30	+\$31
	12"-20"	49"-60"	\$ 720	+\$35	+\$37
	12"-20"	61"-72"	\$ 840	+\$42	+\$44
	12"-20"	73"-84"	\$ 960	+\$49	+\$51
	12"-20"	85"-96"	\$1081	+\$53	+\$56
	21"-28"	12"-20"	\$ 447	+\$23	+\$24
	21"-28"	21"-28"	\$ 522	+\$26	+\$27
	21"-28"	29"-36"	\$ 598	+\$30	+\$31
	21"-28"	37"-42"	\$ 653	+\$33	+\$35
	21"-28"	43"-48"	\$ 710	+\$35	+\$37
	21"-28"	49"-60"	\$ 820	+\$40	+\$42
	21"-28"	61"-72"	\$ 933	+\$47	+\$50
	21"-28"	73"-84"	\$1044	+\$52	+\$55
	21"-28"	85"-96"	\$1157	+\$56	+\$60

Tip: Please refer to *SmartTools* to specify sizes.

 **For Canadian Pricing**
Multiply U.S. Price by the Canadian price factor.
▶ See page 1 for details.

▶ **Specification Information, continued on next page**

► Specification Information, continued from previous page

Specification Information					
Style Number	Dimensions		U.S. Base Price	Options (Add \$ to Base Price)	
	W	H		Laminate Price Group B	HPL Price Group 2
HCMMBOARD	29"-34"	12"-20"	\$ 518	+\$26	+\$27
	29"-34"	21"-28"	\$ 600	+\$30	+\$31
	29"-34"	29"-36"	\$ 685	+\$34	+\$36
	29"-34"	37"-42"	\$ 745	+\$36	+\$38
	29"-34"	43"-48"	\$ 808	+\$38	+\$40
	29"-34"	49"-60"	\$ 933	+\$47	+\$50
	29"-34"	61"-72"	\$1057	+\$53	+\$56
	29"-34"	73"-84"	\$1184	+\$58	+\$61
	29"-34"	85"-96"	\$1307	+\$64	+\$68
	35"-48"	12"-20"	\$ 728	+\$35	+\$37
	35"-48"	21"-28"	\$ 813	+\$40	+\$42
	35"-48"	29"-36"	\$ 898	+\$46	+\$49
	35"-48"	37"-42"	\$ 963	+\$49	+\$51
	35"-48"	43"-48"	\$1027	+\$51	+\$53
	35"-48"	49"-60"	\$1157	+\$56	+\$60
	35"-48"	61"-72"	\$1283	+\$63	+\$66
	35"-48"	73"-84"	\$1413	+\$72	+\$75
	35"-48"	85"-96"	\$1542	+\$77	+\$81
	49"-60"	12"-20"	\$ 857	+\$42	+\$44
	49"-60"	21"-28"	\$ 943	+\$47	+\$50
	49"-60"	29"-36"	\$1027	+\$51	+\$53
	49"-60"	37"-42"	\$1090	+\$54	+\$57
	49"-60"	43"-48"	\$1157	+\$56	+\$60
	61"-72"	12"-20"	\$ 984	+\$50	+\$52
	61"-72"	21"-28"	\$1072	+\$53	+\$56
	61"-72"	29"-36"	\$1157	+\$56	+\$60
	61"-72"	37"-42"	\$1220	+\$60	+\$63
	61"-72"	43"-48"	\$1283	+\$63	+\$66
	73"-84"	12"-20"	\$1112	+\$55	+\$59
	73"-84"	21"-28"	\$1197	+\$59	+\$62
	73"-84"	29"-36"	\$1283	+\$63	+\$66
	73"-84"	37"-42"	\$1349	+\$65	+\$69
	73"-84"	43"-48"	\$1413	+\$72	+\$75
	85"-96"	12"-20"	\$1242	+\$60	+\$63
	85"-96"	21"-28"	\$1326	+\$64	+\$68
	85"-96"	29"-36"	\$1413	+\$72	+\$75
	85"-96"	37"-42"	\$1477	+\$74	+\$79
	85"-96"	43"-48"	\$1542	+\$77	+\$81

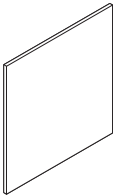

Tip: Please refer to SmartTools to specify sizes.

Convey



For Canadian Pricing
 Multiply U.S. Price by the Canadian price factor.
 ► See page 1 for details.

Convey Fillers

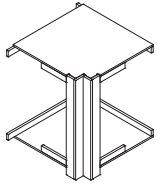

Tip: Fillers close the gap between a cabinet and structural wall. Field cutting of filler may be required to achieve architectural fit.

Tip: The increment for parametric depth and height is 1".

Tip: Ceiling filler **HCMFLRUWC** comes in 8 foot lengths and is cut to fit on site.

Tip: For finish codes and more information on laminate price group B, see Surface Materials.
▶ See page 376

 **For Canadian Pricing**
Multiply U.S. Price by the Canadian price factor.
▶ See page 1 for details.

Standard Includes	Required to Specify
<ul style="list-style-type: none"> ▶ Need help? Product details, page 95 • Filler: High-Pressure Laminate • 1 mm edge band 	<ol style="list-style-type: none"> 1 Style number 2 Laminate color number for filler 3 Filler depth (see below under Required Selections) 4 Filler height (see below under Required Selections) 5 Options, if selected (see below) <ul style="list-style-type: none"> ▶ See <i>Surface Materials</i>, page 376.

Filler Depth	Required Selections	U.S. Price	Required to Specify
Filler Depth	Parametric depth		
	• Wall filler for use with upper storage cabinets – 9"D–15"D	Prices at right	Specify with 9"D–15"D.
	• Wall filler for use with wall-suspended wardrobe cabinets and wall filler for use with wall-suspended base cabinets – 14"D–24"D	Prices at right	Specify with 14"D–24"D.
	• Wall filler for use with floor-extended wardrobes cabinets – 14"D–29"D	Prices at right	Specify with 14"D–29"D.

Filler Height	Required Selections	U.S. Price	Required to Specify
Filler Height	Parametric height		
	• Inside corner filler for use with upper storage cabinets and wall-suspended base cabinets – 22 ³¹ / ₃₂ "H–36"H	Prices at right	Specify with 22 ³¹ / ₃₂ "H–36"H.
	• Wall filler for use with upper storage cabinets – 24"H–36"H	Prices at right	Specify with 24"H–36"H.
	• Wall filler for use with floor-extended wardrobe cabinets – 48"H–84"H	Prices at right	Specify with 48"H–84"H.
	• Wall filler for use with wall-suspended wardrobe cabinets – 66 ¹ / ₂ "H–74 ¹ / ₂ "H	Prices at right	Specify with 66 ¹ / ₂ "H–74 ¹ / ₂ "H.

Surface Materials	Options	U.S. Price	Required to Specify
Surface Materials	• Solid HPL	No cost	Specify laminate color number.
	• Woodgrain HPL	No cost	Specify laminate color number.
	• Laminate price group B	Prices at right	Specify laminate color number.
	• Laminate price group 2	Prices at right	Specify laminate color number.

Application	Available on inside corner filler for upper storage cabinets and wall-suspended base cabinets	U.S. Price	Required to Specify
Application	• Upper	No cost	Specify with upper application.
	• Wall-Suspended Base	No cost	Specify with wall-suspended base application.



Specification Information							
Style Number	Dimensions			U.S. Base Price	Options (Add \$ to Base Price)		
	D	W	H		Laminate Price Group B	HPL Price Group 2	

Wall Filler for Wall-Suspended Base Cabinets

HCMFLRBW	14"-24"	3"	22.956"	\$ 327	+\$16	+\$17	
-----------------	---------	----	---------	--------	-------	-------	--

Wall Filler for Floor-Extended Base Cabinets

HCMFLRWF	N.A.	3"	27", 32½", 34½", 40½"	\$ 327	+\$16	+\$17	
-----------------	------	----	-----------------------	--------	-------	-------	--

Inside Corner Filler for Floor-Extended Base Cabinets

HCMFLRINCRNF	N.A.	N.A.	27", 32½", 34½", 40½"	\$ 653	+\$32	+\$34	
---------------------	------	------	-----------------------	--------	-------	-------	--

Wall Filler for Wall-Suspended Wardrobe Cabinets

HCMFLRWARDW	14"-24"	3"	66½"-74½"	\$ 466	+\$24	+\$24	
--------------------	---------	----	-----------	--------	-------	-------	--

Wall Filler for Floor-Extended Wardrobe Cabinets

HCMFLRWARDF	14"-29"	3"	48"-84"	\$ 466	+\$24	+\$24	
--------------------	---------	----	---------	--------	-------	-------	--

Wall Filler for Upper Storage Cabinets

HCMFLRU	9"-15"	3"	24"-36"	\$ 327	+\$16	+\$17	
----------------	--------	----	---------	--------	-------	-------	--

Inside Corner Filler for Upper Storage Cabinets and Wall-Suspended Base Cabinets

HCMFLRUINDCRNW	N.A.	N.A.	22.956"-36"	\$1142	+\$55	+\$57	
-----------------------	------	------	-------------	--------	-------	-------	--

Ceiling Filler for Upper Storage Cabinets and Wardrobe Cabinets

HCMFLRUWC	N.A.	96"	N.A.	\$ 290	+\$12	+\$13	
------------------	------	-----	------	--------	-------	-------	--

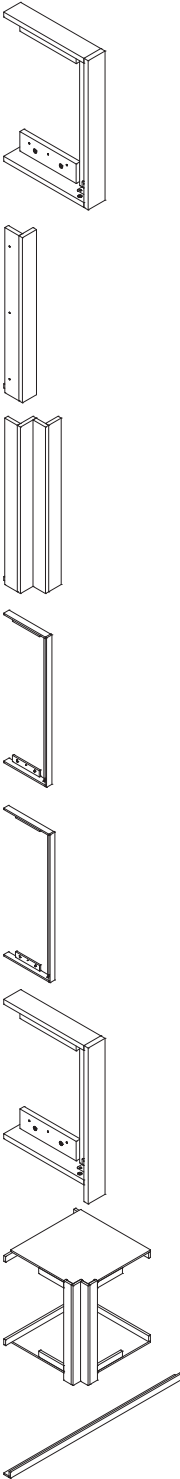

Convey Accessories

Rail



Standard Includes	Required to Specify
<ul style="list-style-type: none"> ▶ Need help? Product details, page 96 • 8' rail cabinet support: clear anodized aluminum 	Style number

Specification Information	
• Style Number	• U.S. Price
HCMRAIL	\$230
·	·

Rail Cover



Standard Includes	Required to Specify
<ul style="list-style-type: none"> ▶ Need help? Product details, page 96 • 8' rail cover: 6527 Merle 	Style number

Specification Information	
• Style Number	• U.S. Price
HCMRAILCOVER	\$177
·	·



For Canadian Pricing
 Multiply U.S. Price by the Canadian price factor.
 ▶ See page 1 for details.

Adjustable Shelf

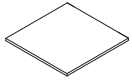

	Standard Includes	Required to Specify
▶ Need help? Product details, page 96	<ul style="list-style-type: none"> Shelf: High-Pressure Laminate price group 1 Edges: matching 1 mm plastic on edges Shelf attachment: shelf pin 	<ol style="list-style-type: none"> Style number Adjustable shelf depth (see below under Required Selections) Adjustable shelf width (see below under Required Selections) Pin hole application (see below under Required Selections) Laminate color number for shelf Options, if selected (see below) <p>▶ See <i>Surface Materials</i>, page 376.</p>

Tip: The increment for parametric depth and width is 1/8". Adjustable shelf sizing is dependent upon the cabinet they are being used in.

	Required Selections	U.S. Price	Required to Specify
Adjustable Shelf Depth	Parametric depth <ul style="list-style-type: none"> 9"D–29"D 	Prices at right	Specify with 9"D–29"D.
Adjustable Shelf Width	Parametric width <ul style="list-style-type: none"> 12"W–48"W 	Prices at right	Specify with 12"W–48"W.
Pin Hole Application	<ul style="list-style-type: none"> Pin hole for HCMSCDF application Pin hole for HCMSCF application Pin hole for HCMBDWRDF application Pin hole for HCMBDF application Pin hole for HCMUDNB application Pin hole for HCMUD application Pin hole for HCMBDW application 	No cost No cost No cost No cost No cost No cost No cost	Specify with pin hole for HCMSCDF application. Specify with pin hole for HCMSCF application. Specify with pin hole for HCMBDWRDF application. Specify with pin hole for HCMBDF application. Specify with pin hole for HCMUDNB application. Specify with pin hole for HCMUD application. Specify with pin hole for HCMBDW application.

Tip: For finish codes and more information on laminate price group B, see *Surface Materials*.
▶ See page 376

	Options	U.S. Price	Required to Specify
Surface Materials	<ul style="list-style-type: none"> Solid HPL Woodgrain HPL Laminate price group B Laminate price group 2 	No cost No cost Prices at right Prices at right	Specify laminate color number. Specify laminate color number. Specify laminate color number. Specify laminate color number.
Shelf Attachment	<ul style="list-style-type: none"> Shelf pin Seismic shelf clip 	No cost No cost	Specify with shelf pin. Specify with seismic shelf clip.



For Canadian Pricing
Multiply U.S. Price by the Canadian price factor.
▶ See page 1 for details.

Specification Information

Style Number	Dimensions		U.S. Base Price	Options (Add \$ to Base Price)	
	D	W		Laminate Price Group B	HPL Price Group 2
HCMADJSHLF	9"-12"	12"-15"	\$152	+\$5	+\$5
	9"-12"	16"-18"	\$154	+\$5	+\$5
	9"-12"	19"-24"	\$155	+\$5	+\$5
	9"-12"	25"-30"	\$156	+\$5	+\$5
	9"-12"	31"-36"	\$157	+\$5	+\$5
	9"-12"	37"-42"	\$158	+\$5	+\$5
	9"-12"	43"-48"	\$160	+\$5	+\$5
	13"-15"	12"-15"	\$154	+\$5	+\$5
	13"-15"	16"-18"	\$155	+\$5	+\$5
	13"-15"	19"-24"	\$156	+\$5	+\$5
	13"-15"	25"-30"	\$157	+\$5	+\$5
	13"-15"	31"-36"	\$158	+\$5	+\$5
	13"-15"	37"-42"	\$160	+\$5	+\$5
	13"-15"	43"-48"	\$161	+\$5	+\$5
	16"-20"	12"-15"	\$155	+\$5	+\$5
	16"-20"	16"-18"	\$156	+\$5	+\$5
	16"-20"	19"-24"	\$157	+\$5	+\$5
	16"-20"	25"-30"	\$158	+\$5	+\$5
	16"-20"	31"-36"	\$160	+\$5	+\$5
	16"-20"	37"-42"	\$161	+\$5	+\$5
	16"-20"	43"-48"	\$162	+\$7	+\$7
	21"-24"	12"-15"	\$156	+\$5	+\$5
	21"-24"	16"-18"	\$157	+\$5	+\$5
	21"-24"	19"-24"	\$158	+\$5	+\$5
	21"-24"	25"-30"	\$160	+\$5	+\$5
	21"-24"	31"-36"	\$161	+\$5	+\$5
	21"-24"	37"-42"	\$162	+\$7	+\$7
	21"-24"	43"-48"	\$164	+\$7	+\$7
	25"-29"	12"-15"	\$157	+\$5	+\$5
	25"-29"	16"-18"	\$158	+\$5	+\$5
	25"-29"	19"-24"	\$160	+\$5	+\$5
	25"-29"	25"-30"	\$161	+\$5	+\$5
	25"-29"	31"-36"	\$162	+\$7	+\$7
	25"-29"	37"-42"	\$164	+\$7	+\$7
	25"-29"	43"-48"	\$166	+\$7	+\$7

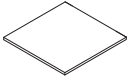

Tip: Please refer to SmartTools to specify sizes.

Convey



For Canadian Pricing
 Multiply U.S. Price by the Canadian price factor.
 ▶ See page 1 for details.

Notch Filler

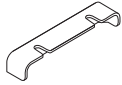

Standard Includes	Required to Specify
<ul style="list-style-type: none"> ▶ Need help? Product details, page 96 • Notch filler: plastic • Package of ten 	<ul style="list-style-type: none"> 1 Style number 2 Plastic color number for notch filler: 6009 Arctic White, 6527 Merle

Specification Information	
• Style Number	• U.S. Price
HCMN	\$34

Hinge Angle Limiter

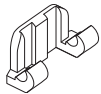

Tip: Hinge angle limiter is an option for any cabinets with doors.

*Tip: **HCMHAL** is used for all cabinets except garage.*

Standard Includes	Required to Specify
<ul style="list-style-type: none"> ▶ Need help? Product details, page 97 • Hinge angle limiter: nickel • Package of 25 	<ul style="list-style-type: none"> Style number

Specification Information	
• Style Number	• U.S. Price
HCMHAL	\$68

Hinge Angle Limiter

HCMHAL	\$68
---------------	------

Garage Hinge Angle Limiter

HCMGHAL	\$82
----------------	------

Base Trim

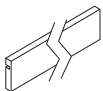

Standard Includes	Required to Specify
<ul style="list-style-type: none"> ▶ Need help? Product details, page 97 • 8' base trim: 2746 Black High-Pressure Laminate • 1 mm matching edge band 	<ul style="list-style-type: none"> Style number

Specification Information	
• Style Number	• U.S. Price
HCMBTRIM	\$417

 **For Canadian Pricing**
 Multiply U.S. Price by the Canadian price factor.
 ▶ See page 1 for details.

Sloped Fascia Trim

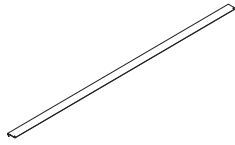

Standard Includes	Required to Specify
-------------------	---------------------

<ul style="list-style-type: none"> ▶ Need help? Product details, page 86 	<ul style="list-style-type: none"> • 8' trim: paint 	<ul style="list-style-type: none"> 1 Style number 2 Paint color number for trim: <ul style="list-style-type: none"> 4140 Arctic White Gloss 4728 Nickel Metallic 4799 Platinum Metallic 7380 Merle
---	--	---

Specification Information	
---------------------------	--

Style Number	U.S. Price
HCMSLPDTRIM	\$444

Vertical Fascia Trim

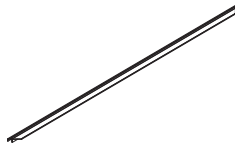

Standard Includes	Required to Specify
-------------------	---------------------

<ul style="list-style-type: none"> ▶ Need help? Product details, page 86 	<ul style="list-style-type: none"> • 8' trim: paint 	<ul style="list-style-type: none"> 1 Style number 2 Paint color number for trim: <ul style="list-style-type: none"> 4140 Arctic White Gloss 4728 Nickel Metallic 4799 Platinum Metallic 7380 Merle
---	--	---

Specification Information	
---------------------------	--

Style Number	U.S. Price
HCMVERTTRIM	\$266

Light Valance

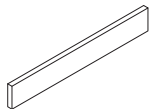

Standard Includes	Required to Specify
-------------------	---------------------

<ul style="list-style-type: none"> ▶ Need help? Product details, page 97 	<ul style="list-style-type: none"> • 8' light valance: High-Pressure Laminate • 1 mm edge band to match • Attachment brackets 	<ul style="list-style-type: none"> 1 Style number 2 Laminate color number for light valance 3 Options, if selected (see below) ▶ See <i>Surface Materials</i>, page 376.
---	--	--

Specification Information		
---------------------------	--	--

Style Number	U.S. Base Price	Option (Add \$to Base Price)
HCMLV	\$233	+ \$9
		HPL Price Group 2



For Canadian Pricing
 Multiply U.S. Price by the Canadian price factor.
 ▶ See page 1 for details.

Wall Trim



Standard Includes		Required to Specify
<ul style="list-style-type: none"> ▶ Need help? Product details, page 98 	<ul style="list-style-type: none"> • 10' trim: plastic 	<ul style="list-style-type: none"> 1 Style number 2 Plastic color number for trim ▶ See <i>Surface Materials</i>, page 376.

Specification Information	
Style Number	U.S. Price
HCMWTRIM	\$56

Electronic Locks

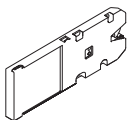
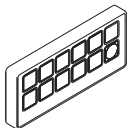
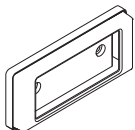

Standard Includes		Required to Specify
<ul style="list-style-type: none"> ▶ Need help? Product details, page 98 	<ul style="list-style-type: none"> • Electronic lock • Bezel, if selected: black 	<ul style="list-style-type: none"> Style number

Specification Information	
Style Number	U.S. Price
Bezel	
HCMELBZL	\$ 54

Transmitter	
HCMELTRNS	\$117

Receiver	
HCMELR	\$233



For Canadian Pricing
 Multiply U.S. Price by the Canadian price factor.
 ▶ See page 1 for details.

Sidesplash for Solid Surface Worksurfaces

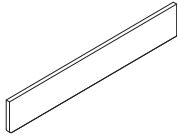

Standard Includes		Required to Specify
<ul style="list-style-type: none"> ▶ Need help? Product details, page 90 	<ul style="list-style-type: none"> • Sidesplash: solid surface price group A 	<ol style="list-style-type: none"> 1 Style number 2 Solid surface color number for sidesplash 3 Alignment (see below under Required Selections) 4 Depth (see below under Required Selections) 5 Handedness (see below under Required Selections) 6 Options, if selected (see below) <ul style="list-style-type: none"> ▶ See <i>Surface Materials</i>, page 376.

Tip: The parametric increment for depth of worksurface is 1". The parametric increment for depth of adjacent cabinet is 1", ending in 1/8" for open cabinets and whole numbers for closed.

Tip: Left and right is determined when facing units.

	Required Selections	U.S. Price	Required to Specify
Alignment	<ul style="list-style-type: none"> • Depth of adjacent cabinet • Depth of worksurface 	No cost No cost	Specify with <i>depth of adjacent cabinet</i> . Specify with <i>depth of worksurface</i> .
Depth	Depth of adjacent cabinet		
	<ul style="list-style-type: none"> • 13¹/₈"D–29"D 	No cost	Specify with <i>13¹/₈"D–29"D</i> .
	Depth of worksurface		
	<ul style="list-style-type: none"> • 15"D–30"D 	No cost	Specify with <i>15"D–30"D</i> .
Handedness	<ul style="list-style-type: none"> • Left hand • Right hand 	No cost No cost	Specify with <i>left hand</i> . Specify with <i>right hand</i> .

	Options	U.S. Price	Required to Specify	
Surface Materials	Top surface			
	<ul style="list-style-type: none"> • Solid surface group A • Solid surface group B • Solid surface group C • Solid surface group D 	Prices below Prices below Prices below Prices below	<ul style="list-style-type: none"> ▶ See <i>Surface Materials</i>, page 376. ▶ See <i>Surface Materials</i>, page 376. ▶ See <i>Surface Materials</i>, page 376. ▶ See <i>Surface Materials</i>, page 376. 	
	Backsplash	<ul style="list-style-type: none"> • No backsplash • With backsplash 	No cost No cost	Specify with <i>no backsplash</i> . Specify with <i>backsplash</i> .
	Cover Panel	Available on sidesplash with adjacent cabinet alignment		
	<ul style="list-style-type: none"> • No cover panel • With cover panel 	No cost No cost	Specify with <i>no cover panel</i> . Specify with <i>cover panel</i> .	
Storage	Available on sidesplash with adjacent cabinet alignment			
	<ul style="list-style-type: none"> • Open • Closed 	No cost No cost	Specify open storage. Specify closed storage.	

Specification Information							
Style Number	Dimensions		U.S. Base Prices				
	D	H	Solid Surface Grade A	Solid Surface Grade B	Solid Surface Grade C	Solid Surface Grade D	

Tip: Specify size with or without cover panel and with or without backsplash.

Tip: Specify size depth for adjacent cabinet or depth of worksurface.



For Canadian Pricing
Multiply U.S. Price by the Canadian price factor.
▶ See page 1 for details.

Sidesplash for Solid Surface Worksurfaces—Depth of Adjacent Cabinet

HCMSPLSH	13.132"–29"	4"	\$274	\$307	\$318	\$330

Sidesplash for Solid Surface Worksurfaces—Depth of Worksurface

HCMSPLSH	15"–30"	4"	\$274	\$307	\$318	\$330

Sidesplash for High-Pressure Laminate Worksurfaces

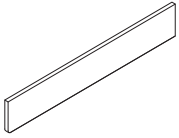

Tip: Specify size with or without cover panel and with or without backsplash.

Tip: Specify size depth for adjacent cabinet or depth of worksurface.

Tip: The parametric increment for depth of worksurface is 1". The parametric increment for depth of adjacent cabinet is 1", ending in 0.132" for open cabinets and whole numbers for closed.

Tip: Sidesplash dimensions are dependent on the depth of the worksurface, adjacencies, and if a backsplash is specified.

Standard Includes		Required to Specify
<ul style="list-style-type: none"> ▶ Need help? Product details, page 90 	<ul style="list-style-type: none"> • Sidesplash: High-Pressure Laminate price group 1 • Edge band: 1 mm plastic price group 1 	<ol style="list-style-type: none"> 1 Style number 2 Laminate color number for sidesplash 3 Plastic color number for edge on sideplash 4 Alignment (see below under Required Selections) 5 Depth (see below under Required Selections) 6 Options, if selected (see below) <ul style="list-style-type: none"> ▶ See <i>Surface Materials</i>, page 376.

	Required Selections	U.S. Price	Required to Specify
Alignment	<ul style="list-style-type: none"> • Depth of adjacent cabinet • Depth of worksurface 	Prices at right Prices at right	Specify <i>with depth of adjacent cabinet</i> . Specify <i>with depth of worksurface</i> .
Depth	Depth of adjacent cabinet		
	<ul style="list-style-type: none"> • With open cabinet: 13.132"D–28.132"D • With closed cabinet: 14"D–29"D 	Prices at right Prices at right	Specify <i>with open storage</i> and select 13.132"D–28.132"D. Specify <i>with closed storage</i> and select 14"D–29"D.
	Depth of worksurface		
	<ul style="list-style-type: none"> • 15"D–30"D 	Prices at right	Specify <i>with 15"D–30"D</i> .

	Options	U.S. Price	Required to Specify
Surface Materials	Top surface		
	<ul style="list-style-type: none"> • Laminate price group 1 • Laminate price group 2 	Prices at right Prices at right	<ul style="list-style-type: none"> ▶ See <i>Surface Materials</i>, page 376. ▶ See <i>Surface Materials</i>, page 376.
Backsplash	<ul style="list-style-type: none"> • No backsplash • With backsplash 	No cost No cost	Specify <i>with no backsplash</i> . Specify <i>with backsplash</i> .
Cover Panel	Available on sidesplash with adjacent cabinet alignment		
	<ul style="list-style-type: none"> • No cover panel • With cover panel 	No cost No cost	Specify <i>with no cover panel</i> . Specify <i>with cover panel</i> .
Storage	Available on sidesplash with adjacent cabinet alignment		
	<ul style="list-style-type: none"> • Open • Closed 	No cost No cost	Specify open storage. Specify closed storage.
Moisture Resistance	<ul style="list-style-type: none"> • No MR • MR–10 	No cost Prices at right	Specify <i>with no moisture resistance</i> . Specify <i>with MR-10</i> .



For Canadian Pricing
 Multiply U.S. Price by the Canadian price factor.
 ▶ See page 1 for details.

Specification Information

Style Number	Dimensions		H	U.S. Base Price	Options (Add \$ to Base Price)	
	D	Open Cabinet / Closed Cabinet			HPL Price Group 2	Moisture Barrier

Sidesplash for High-Pressure Laminate Worksurfaces—With Adjacent Cabinet Alignment

HCMSPLSHL	D	Open Cabinet / Closed Cabinet	H	U.S. Base Price	HPL Price Group 2	Moisture Barrier
	13.132"	14"	4"	\$ 60	+\$9	+\$ 3
	14.132"	15"	4"	\$ 63	+\$9	+\$ 5
	15.132"	16"	4"	\$ 66	+\$9	+\$ 7
	16.132"	17"	4"	\$ 69	+\$9	+\$ 9
	17.132"	18"	4"	\$ 72	+\$9	+\$11
	18.132"	19"	4"	\$ 75	+\$9	+\$13
	19.132"	20"	4"	\$ 78	+\$9	+\$15
	20.132"	21"	4"	\$ 81	+\$9	+\$17
	21.132"	22"	4"	\$ 84	+\$9	+\$19
	22.132"	23"	4"	\$ 87	+\$9	+\$21
	23.132"	24"	4"	\$ 90	+\$9	+\$23
	24.132"	25"	4"	\$ 93	+\$9	+\$25
	25.132"	26"	4"	\$ 96	+\$9	+\$27
	26.132"	27"	4"	\$ 99	+\$9	+\$29
	27.132"	28"	4"	\$102	+\$9	+\$31
	28.132"	29"	4"	\$105	+\$9	+\$33

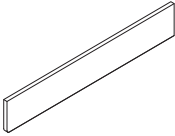

Tip: Please refer to SmartTools to specify sizes.

Style Number	Dimensions		H	U.S. Base Price	Options (Add \$ to Base Price)	
	D	Open Cabinet / Closed Cabinet			HPL Price Group 2	Moisture Barrier

Sidesplash for High-Pressure Laminate Worksurfaces—With Adjacent Worksurface Alignment

HCMSPLSHL	D	Open Cabinet / Closed Cabinet	H	U.S. Base Price	HPL Price Group 2	Moisture Barrier
	15"		4"	\$ 63	+\$9	+\$ 5
	16"		4"	\$ 66	+\$9	+\$ 7
	17"		4"	\$ 69	+\$9	+\$ 9
	18"		4"	\$ 72	+\$9	+\$11
	19"		4"	\$ 75	+\$9	+\$13
	20"		4"	\$ 78	+\$9	+\$15
	21"		4"	\$ 81	+\$9	+\$17
	22"		4"	\$ 84	+\$9	+\$19
	23"		4"	\$ 87	+\$9	+\$21
	24"		4"	\$ 90	+\$9	+\$23
	25"		4"	\$ 93	+\$9	+\$25
	26"		4"	\$ 96	+\$9	+\$27
	27"		4"	\$ 99	+\$9	+\$29
	28"		4"	\$102	+\$9	+\$31
	29"		4"	\$105	+\$9	+\$33
	30"		4"	\$108	+\$9	+\$35

 **For Canadian Pricing**
 Multiply U.S. Price by the Canadian price factor.
 ▶ See page 1 for details.



V.I.A. Spacer

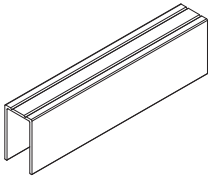

Standard Includes	Required to Specify
<ul style="list-style-type: none"> ▶ Need help? Product details, page 92 • Spacer 	Style number

Specification Information	
• Style Number	• U.S. Price
HCMVSPCR	\$122

Accessory Rail

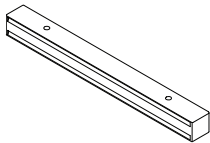

Tip: Attaching rail to unit will add to overall footprint of cart. Rail is approximately 12¹/₂" in length and 1³/₁₆" in depth and height.

Tip: Accessory rail can be ordered through medical device manufacturers.

Standard Includes	Required to Specify
<ul style="list-style-type: none"> ▶ Need help? Product details, page 92 • Mobile storage cart accessory rail 	Style number

Specification Information	
• Style Number	• U.S. Price
HCMCACCSRAIL	\$190

4"H Drawer Divider

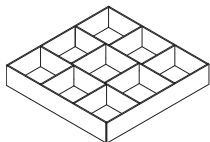

Tip: Use these drawer dividers for 4"H drawers.

Tip: Due to precise fit within the drawers, the larger dividers require the drawer to be disengaged from the slide assembly and slid forward about 1" (not removed) for the dividers to drop into the drawer as an assembly.

Standard Includes	Required to Specify
<ul style="list-style-type: none"> ▶ Need help? Product details, page 92 • 4"H drawer divider, for mobile storage cart • Widths: 19¹/₂", 22¹/₂", or 25¹/₂" 	1 Style number 2 Width

Specification Information	
• Style Number	• U.S. Price
HCMCDWRDIV4	\$166

Tip: Designed and sized for use in the mobile storage cart.

6"H Drawer Divider

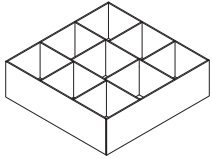

Tip: Use these drawer dividers for 6"H and 8"H drawers.

Tip: Due to precise fit within the drawers, the larger dividers require the drawer to be disengaged from the slid assembly and slide forward about 1" (not removed) for the dividers to drop into the drawer as an assembly.

Tip: Designed and sized for use in the mobile storage cart.

Standard Includes		Required to Specify
<ul style="list-style-type: none"> ▶ Need help? Product details, page 92 	<ul style="list-style-type: none"> • 6"H drawer divider, for mobile storage cart • Widths: 19¹/₂", 22¹/₂", or 25¹/₂" 	<ul style="list-style-type: none"> 1 Style number 2 Width

Specification Information	
Style Number	U.S. Price
HCMCDWRDIV6	\$339

Drawer Divider Label

Standard Includes		Required to Specify
<ul style="list-style-type: none"> ▶ Need help? Product details, page 92 	<ul style="list-style-type: none"> • Drawer divider label, for use with drawer dividers • Package of ten 	<ul style="list-style-type: none"> Style number

Specification Information	
Style Number	U.S. Price
HCMCDWRDIVL	\$68



For Canadian Pricing

Multiply U.S. Price by the Canadian price factor.

▶ See page 1 for details.

Sync



Statement of Line **182**



Understanding

Double-Sided Bases and Worksurfaces	184
Single-Sided Bases and Worksurfaces	188
Single Leg Bases and Worksurfaces	190
Technology Stretcher Computer Capacities	192
Monitor Mount Suggestions	193



Specifying

Double-Sided Bases	194
Worksurfaces for Use with Double-Sided Bases	196
Single-Sided Bases	198
Worksurfaces for Use with Single-Sided Bases	199
Single Leg Bases	200
Full Arc and Scoop Worksurfaces for Use with Single Leg Bases	201
Accessories	202

Statement of Line

Sync

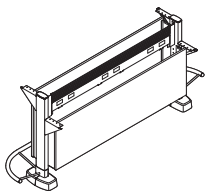

Upper Height 36"
Lower Height 28 1/2"

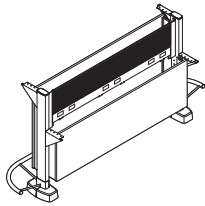

Upper Height 42"
Lower Height 28 1/2"

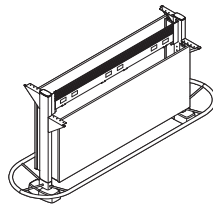

Upper Height 42"
Lower Height 36"

Understanding
▶ Page 184
Specifying
▶ Page 194

Double-Sided Bases

Upper Height	Lower Height	72"W	84"W	96"W	108"W
36"	28 1/2"H	●	●	●	●
42"	28 1/2"H	●	●	●	●
42"	36"H	●	●	●	●



Interaction

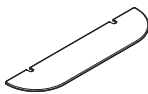

Process

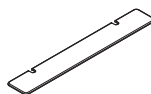

Transaction

Understanding
▶ Page 184
Specifying
▶ Page 196

Upper Worksurfaces for Use with Double-Sided Bases

	72"W	84"W	96"W	108"W
Interaction	●	●	●	●
Process	●	●	●	●
Transaction	●	●	●	●



Interaction

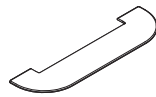

Process

Understanding
▶ Page 184
Specifying
▶ Page 196

Lower Worksurfaces for Use with Double-Sided Bases

	72"W	84"W	96"W	108"W
Interaction	●	●	●	●
Process	●	●	●	●

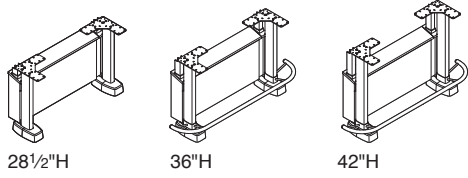

Understanding
 ▶ Page 188
 Specifying
 ▶ Page 198

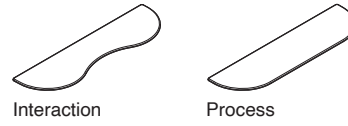

Understanding
 ▶ Page 188
 Specifying
 ▶ Page 199

Single-Sided Bases

	72"W	84"W	96"W	108"W
28 1/2"H	●	●	●	●
36"H	●	●	●	●
42"H	●	●	●	●

Worksurfaces for Use with Single-Sided Bases

	72"W	84"W	96"W	108"W
Interaction	●	●	●	●
Process	●	●	●	●

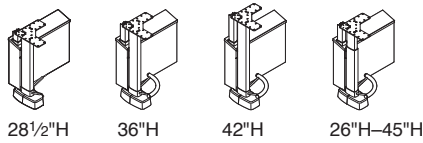

Understanding
 ▶ Page 190
 Specifying
 ▶ Page 200

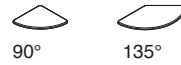

Understanding
 ▶ Page 190
 Specifying
 ▶ Page 201

Single Leg Bases

	Fixed	Electronically Adjustable
28 1/2"H	●	
36"H	●	
42"H	●	
26"H–45"H		●

Full Arc Worksurfaces for Use with Leg Bases

	90°	135°
Full Arc	●	●

Tip: Full arc worksurfaces are for use with single leg bases.

Left-hand units shown. Right-hand units available.



Understanding
 ▶ Page 190
 Specifying
 ▶ Page 201

Scoop Worksurface for Use with Leg Bases

	135°
Scoop	●

Tip: Scoop worksurfaces are for use with single leg bases.

Sync

Double-Sided Bases and Worksurfaces

Double-sided units have fixed height combinations and accommodate multiple clinical workers. Two work-surfaces allow for collaboration and sharing of technology to support the work process.

Worksurfaces are available in High-Pressure Laminate and solid surface finishes.

Flush caps are standard.

Upper and lower work-surfaces are different widths to help support numerous users.

Legs are bolted to floor for stability and leveling.

Base power-in cover is standard and bolts to the floor.

Foot covers are standard.

Tile encases technology stretcher and is standard in High-Pressure Laminate. An optional frame tile for custom inserts is available. Tile is removable for easy access to technology.

Technology stretcher has CPU hangers with straps to accommodate two large CPUs or up to eight thin client PCs.
 ▶ See *Technology Stretcher Computer Capacities*, page 192.

360° foot ring is standard on 36"H and 42"H combination units. Foot ring not available on 28½"H side.

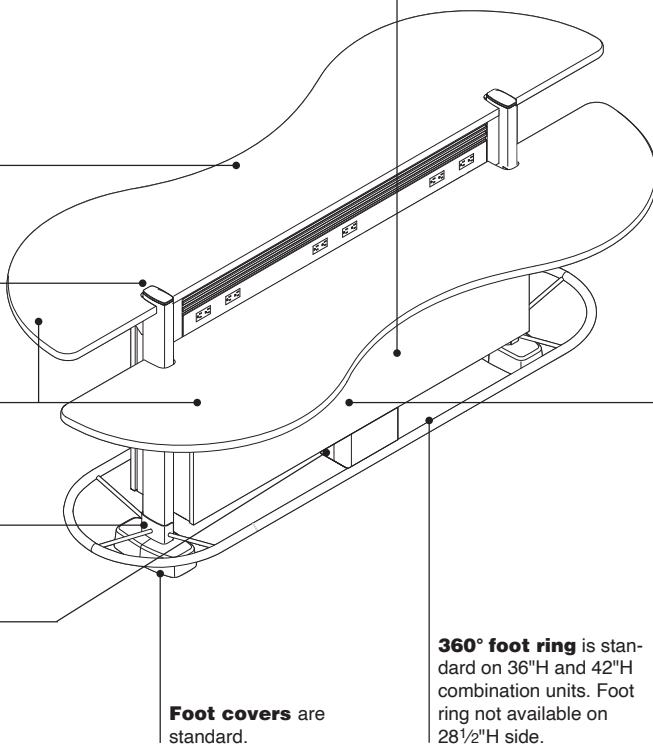

Actual Dimensions

Worksurface

Upper Width	64", 76", 88", or 100"
Lower Width	72", 84", 96", or 108"

Base

Width*	72", 84", 96", or 108"
Upper Height	36" or 42"
Lower Height	28½" or 36"

*Nominal planning dimension

Product Details

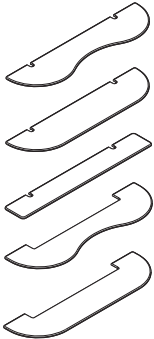

Worksurfaces are available in three shapes: interaction, process, and transaction for upper worksurface heights and two shapes: interaction and process for lower worksurface heights.

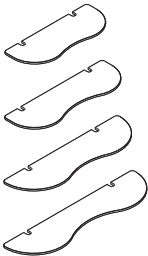

Worksurfaces are available in four widths: 72", 84", 96", and 108". The width of the worksurface must match the width of the base.

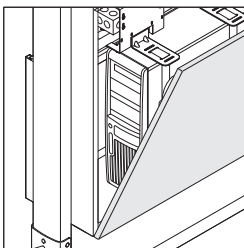

Tile can snap open for easy accessibility to technology and CPUs. Straps hold the tile in the open position and can be released to remove tile completely.

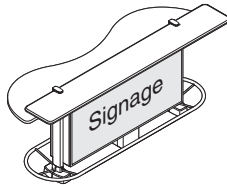

Custom signage can be attached to create a more personalized aesthetic.

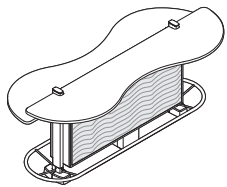

Frame tile allows user to have a custom insert other than standard High-Pressure Laminate. Custom inserts are provided by the dealer or customer and are field installed. Frame tile will be located on the taller side of the double-sided base, standard High-Pressure Laminate must be specified for the lower tile.

Frame tile fits customer's own material, insert material is not provided by Steelcase Health. Actual dimensions are available at village.steelcase.com or contact 1.800.342.8562 (see assembly directions for custom tile replacement).

Frame tile will be located on the taller side of the double-sided base, standard High-Pressure Laminate must be specified for the lower tile.

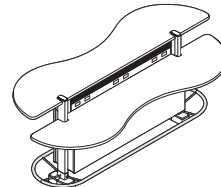

42"H and 36"W

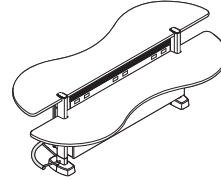

36"H and 28 1/2"W

360° foot ring is standard on all 36"H and 42"H combination units. Foot ring not available on 28 1/2"W side.

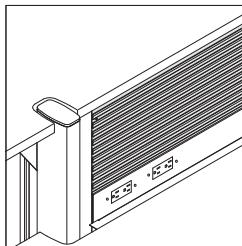

Slatwall is standard and varies in size depending on choice of worksurface heights and widths.

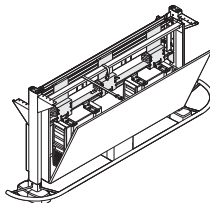

Technology Stretcher includes CPU straps that allow up to two large sized CPUs or up to eight thin client PCs.

▶ See *Technology Stretcher Computer Capacities*, page 192.

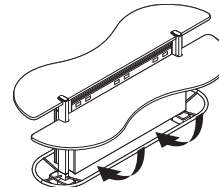

Airflow is supported with openings above and below technology stretcher for proper circulation.

Connections

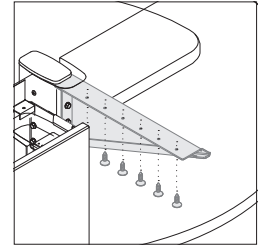
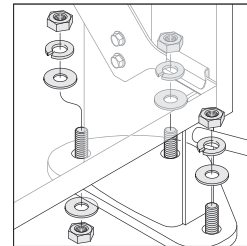

Worksurfaces are secured to standard cantilevers for support. Transaction cantilevers are available to support transaction depth worksurfaces and are specified as an option to the base unit.

Wiring & Cabling

Power is hardwired in the field by a certified electrician.

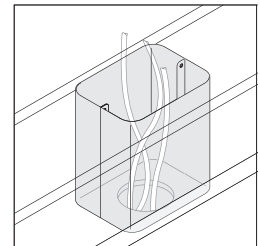

Base power-in cover mounts to floor to allow cables to run from the floor into the unit.

Floor attachment bolts are not provided with the unit. The Engineer of Record must specify appropriate attachment hardware. Plate loading information is available at village.steelcase.com or by contacting 1.800.342.8562. Bolts will secure the leg to the floor and will provide the leveling system to ensure stability on uneven floors. Template is available to position loading plates to aid installation.

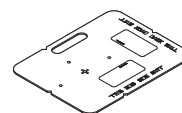

Template can be ordered as a service part, 943102528SR. This template can be used with all double-sided bases, single-sided bases and single leg bases with 90° top.

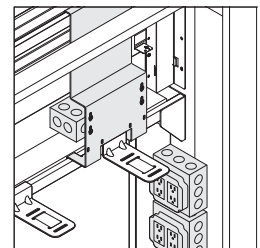

Junction box mounting locations are standard. Eight boxes fit into the 72"W and 84"W bases. Twelve boxes fit into 96"W and 108"W bases. Junction boxes are field installed and provided by the electrical contractor.

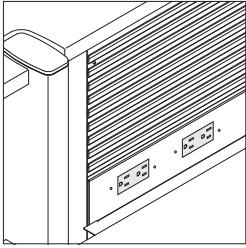

Receptacle openings are standard on the lower side of the unit. 72"W units have four openings. 84"W and 96"W and 108"W units have six openings. Receptacles are provided by the electrical contractor.

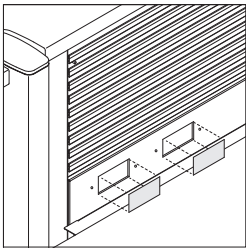

Receptacle opening fillers fill in the electrical cutouts when not required and are ordered separately, as a customer service part, 943102877SR.

Surface Materials

Worksurface

- High-Pressure Laminate
- Solid surface

Legs

- 4799 Platinum Metallic Paint only

Tile

- High-Pressure Laminate

Edge band on High-Pressure Laminate worksurface and tile

- Plastic

Technology stretcher frame

- 4799 Platinum Metallic Paint

Side panels and base power-in cover

- 4798 Sterling

Sync Single-Sided Bases and Worksurfaces

Single-sided fixed height units accommodate multiple clinical workers. The unit is placed along a wall for easy access to power and data connections.

Worksurfaces are available in High-Pressure Laminate and solid surface finishes.

Tile encases technology stretcher and is standard in High-Pressure Laminate. An optional frame tile for custom inserts is available. Top cap and tile are removable for easy access to technology.

Technology stretcher has straps to accommodate two desk top CPUs or two thin client PCs.
▶ See *Technology Stretcher Computer Capacities*, page 192.

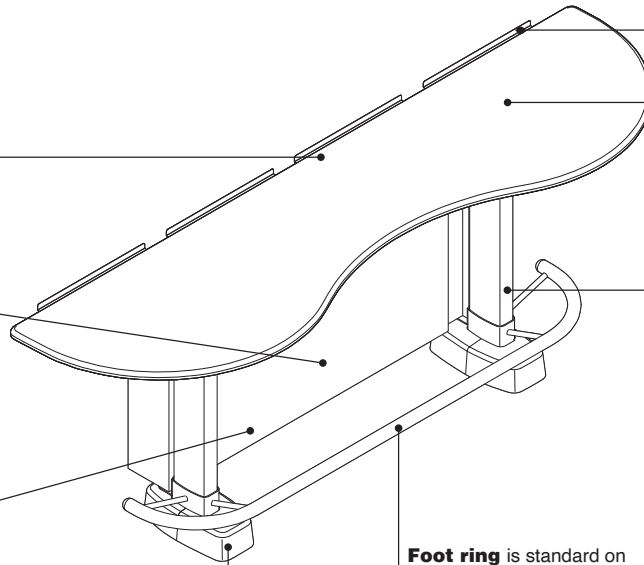

Cable trays are standard.

Worksurfaces are fixed-height, and accommodate seated, counter, and standing heights.

Legs are bolted to floor for stability and leveling.

Foot ring is standard on 36"H and 42"H units. Foot ring is not available on 28½"H units.

Foot covers are standard.

Actual Dimensions

Worksurface

Width 72", 84", 96", or 108"

Base

Width* 72", 84", 96", or 108"

Height 28½", 36", or 42"

*Nominal planning dimension

Product Details

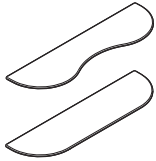

Worksurfaces are available in two shapes: interaction and process.

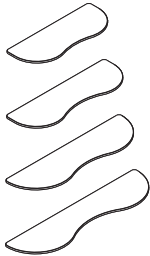

Worksurfaces are available in four widths, 72", 84", 96", and 108". The width of the worksurface must match the width of the base.

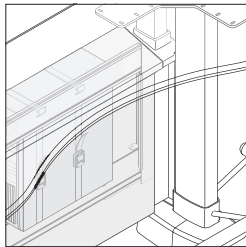

Top cap and tile can be removed for easy accessibility to technology and CPUs.

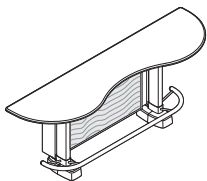

Frame tile allows user to have a custom insert other than standard High-Pressure Laminate. Custom inserts are provided by the dealer or customer and are field installed.

Frame tile fits customer's own material, insert material is not provided by Steelcase Health. Actual dimensions are available at village.steelcase.com or contact 1.800.342.8562 (see assembly directions for custom tile replacement).

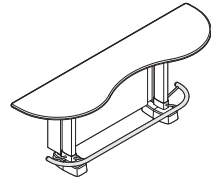

36"H

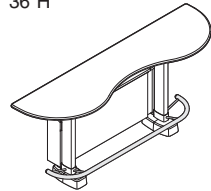

42"H

Foot ring wraps 180° around base on 36"H and 42"H units. Foot ring not available on 28½"H units.

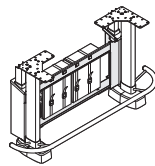

Technology stretcher includes CPU straps that allow up to two desk top CPUs or two thin client PCs. ▶ See *Technology Stretcher Computer Capacities*, page 192.

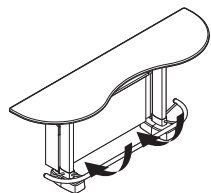

Airflow is supported with openings under technology stretcher and open back for proper circulation.

Connections

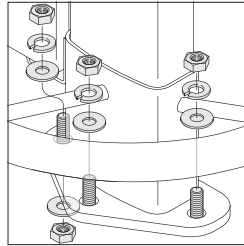

Floor attachment bolts are not provided with the unit. The Engineer of Record must specify appropriate attachment hardware. Plate loading information is available at village.steelcase.com or by contacting 1.800.342.8562. Bolts will secure the leg to the floor and will utilize a leveling system to provide the stability on uneven floors. Template is available to position loading plates to aid installation.

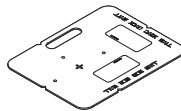

Template can be ordered as a service part, 943102528SR. This template can be used with all double-sided bases, single-sided bases and single leg bases with 90° top.

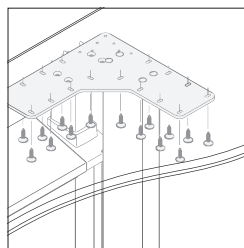

Worksurfaces are secured to standard mounting plate for support.

Wiring & Cabling

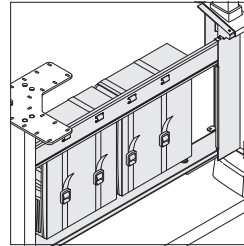

Open back of technology stretcher allows power and data access into the technology stretcher from wall.

USB extensions or USB hub are needed to extend keyboard and mouse cables and other USB accessories.

Surface Materials

Worksurface

- High-Pressure Laminate
- Solid surface

Legs

- 4799 Platinum Metallic Paint only

Tile

- High-Pressure Laminate

Edge band on High-Pressure Laminate worksurface and tile

- Plastic

Technology stretcher frame

- 4799 Platinum Metallic Paint

Side panels

- 4798 Sterling

Sync Single Leg Bases and Worksurfaces

Single fixed and adjustable units provide flexible ergonomic support for clinical workers. The worksurfaces allow for a single user or collaboration between users. The unit is placed along a wall for easy access to power and cable.

Cable trays are standard on both sides of the worksurface.

Vertical cable manager extends with height adjustable leg. The cable manager keeps all necessary cables for monitor, keyboard, and mouse enclosed.

Tile encases technology stretcher and is standard in High-Pressure Laminate. An optional frame tile for custom inserts is available. Top cap and tile are removable for easy access to technology.

Technology stretcher has CPU straps to accommodate one CPU on single leg units. Stretchers are available in 24"W.

► See *Technology Stretcher Computer Capacities*, page 192.

Worksurfaces are available in High-Pressure Laminate and solid surface finishes. Worksurfaces are available in full arc or scoop shapes to support one or two user operation.

Push button simple touch controller adjusts height at a rate of 1½" per second.

Legs are electronically height adjustable for single or double leg units or fixed positions for single leg units. Adjustable units range from sitting height of 26"H to a standing height of 45"H. Legs are bolted to the floor for stability and leveling.

Foot covers are standard.

Individual foot rings are standard on all units excluding single leg fixed 28½"H applications. Foot rings must be specified for 90° or 135° applications.

Actual Dimensions

Worksurface

Depth	25¾"
Width	25¾" or 43⅔"

Legs

Width*	24"
Fixed Height	28½", 36", or 42"
Adjustable Height	26"–45"

*Nominal planning dimension

Product Details



Worksurfaces are available in 90° and 135° full arc and 135° scoop shapes.

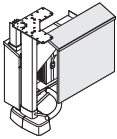

Top cap and tile can be removed for easy accessibility to technology and CPUs.

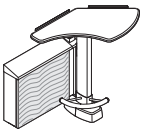

Frame tile fits customer's own material. Actual dimensions are available at village.steelcase.com (see assembly directions for custom tile replacement) or contact 1.800.342.8562.

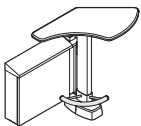

36"H, 42"H, or height-adjustable

Foot ring is standard on 36"H and 42"H bases. Foot ring is not available on 28½"H fixed base.

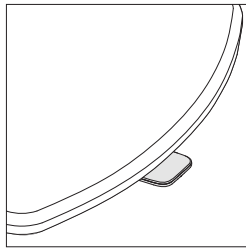

Simple touch controller easily adjusts the height of the work surface, at a rate of 1½" per second. The controller is field installed and the cord for the controller will attach at the top of the single leg base under the work surface.

Worksurfaces are factory drilled for easy simple touch controller installation.

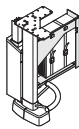

Technology stretcher for the single leg unit is 24" and accommodates one CPU and adjustability control box if adjustability is selected. If desktop CPU is used, control box will need to be mounted to the underside of work surface. ▶ See *Technology Stretcher Computer Capacities*, page 192.

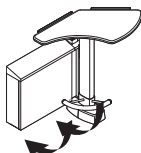

Airflow is supported with an opening under technology stretcher and open back for proper circulation.

Connections

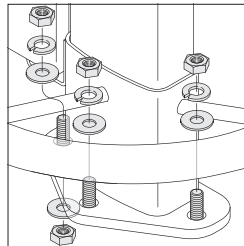

Floor attachment bolts are not provided with the unit. The Engineer of Record must specify appropriate attachment hardware. Plate loading information is available at village.steelcase.com or by contacting 1.800.342.8562. Bolts will secure the leg to the floor and will utilize a leveling system to provide the stability on uneven floors. Template is available to position loading plates to aid installation.

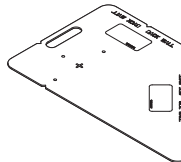
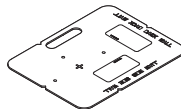

Two templates are available for single leg base units. For 90° tops order service part 943102528SR. For 135° tops order service part 943102529SR.

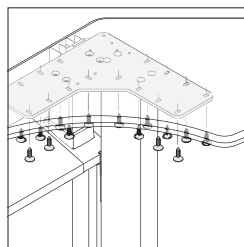

Worksurface is secured by use of the surface mounting plate which is standard with the base.

Wiring & Cabling

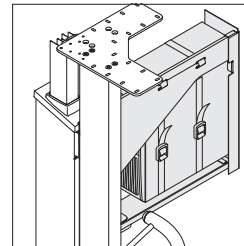

Open back of technology stretcher allows power and data to enter into technology stretcher from wall.

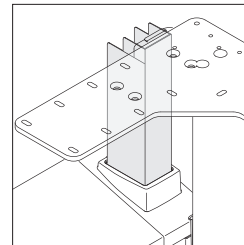

Vertical cable manager attaches from stretcher and opens up to work surface.

USB extensions or USB hub are needed to extend keyboard and mouse cables and other USB accessories.

Surface Materials

Worksurface

- High-Pressure Laminate
- Solid surface

Legs

- 4799 Platinum Metallic Paint only

Tile

- High-Pressure Laminate

Edge band on High-Pressure Laminate work surface and tile

- Plastic

Technology stretcher frame

- 4799 Platinum Metallic Paint only

Side panels

- 4798 Sterling

Simple touch controller

- Black plastic

Sync Technology Stretcher Computer Capacities

Computer Types and Dimensions

Mini Tower



Dimensions		
D	W	H
17 $\frac{1}{3}$ "	7 $\frac{1}{3}$ "	16 $\frac{1}{3}$ "

Desk Top



Dimensions		
D	W	H
14"	15 $\frac{3}{4}$ "	4 $\frac{1}{2}$ "

Small Form Factor



Dimensions		
D	W	H
13 $\frac{1}{2}$ "	12 $\frac{1}{2}$ "	3 $\frac{3}{4}$ "

Ultra Small Form Factor



Dimensions		
D	W	H
10"	3 $\frac{1}{2}$ "	10 $\frac{1}{3}$ "

Technology Stretcher Capacities

Double-Sided Bases

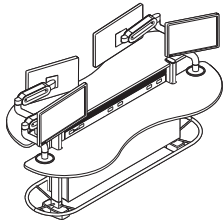

Size	Inside Dimensions			Number of Mini Towers	Number of Desk Tops	Number of Small Form Factors	Number of Ultra Small Form Factors
	D	W	H				
72"W	8 $\frac{1}{2}$ "	34"	15 $\frac{1}{2}$ "	2	4	4	4
84"W	8 $\frac{1}{2}$ "	49"	15 $\frac{1}{2}$ "	2	4	6	6
96"W	8 $\frac{1}{2}$ "	49"	15 $\frac{1}{2}$ "	2	4	6	6
108"W	8 $\frac{1}{2}$ "	61"	15 $\frac{1}{2}$ "	3	4	6	8

Single-Sided Bases

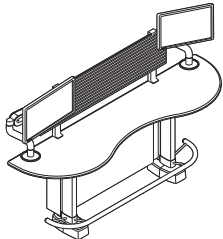

Size	Inside Dimensions			Number of Mini Towers	Number of Desk Tops	Number of Small Form Factors	Number of Ultra Small Form Factors
	D	W	H				
72"W	4 $\frac{2}{5}$ "	36"	15 $\frac{1}{2}$ "	0	2	2	2
84"W	4 $\frac{2}{5}$ "	48"	15 $\frac{1}{2}$ "	0	2	2	2
96"W	4 $\frac{2}{5}$ "	48"	15 $\frac{1}{2}$ "	0	2	2	2
108"W	4 $\frac{2}{5}$ "	61"	15 $\frac{1}{2}$ "	0	2	2	2

Single Leg Bases

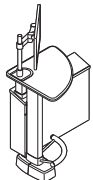

Size	Inside Dimensions			Number of Mini Towers	Number of Desk Tops	Number of Small Form Factors	Number of Ultra Small Form Factors
	D	W	H				
28 $\frac{1}{2}$ "H	4 $\frac{2}{5}$ "	19"	15 $\frac{1}{2}$ "	0	1	1	1
36"H	4 $\frac{2}{5}$ "	19"	15 $\frac{1}{2}$ "	0	1	1	1
42"H	4 $\frac{2}{5}$ "	19"	15 $\frac{1}{2}$ "	0	1	1	1

Sync Monitor Mount Suggestions

Monitor Arm Placement

Monitor arms with slatwall brackets can be placed anywhere on the slatwall. Slatwall is only available on double sided applications with 42" upper height and 28½" lower. Only two slatwall-mounted monitor arms per application.
Tip: Slatwall brackets allow for a maximum monitor weight of 12 pounds.

Tip: Slatwall brackets must be mounted directly above electrical junction boxes for structural support.

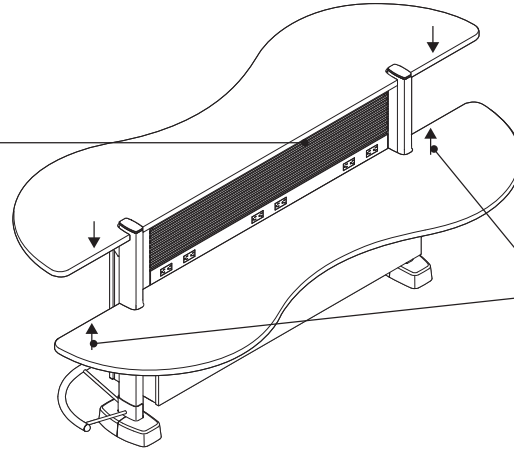

Upper Height 42"
Lower Height 28½"

CF Series Intro, CF Plus, CF PlusHD monitor arms with C-clamp bracket can be placed in the locations with arrows.

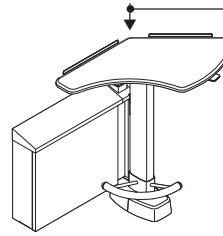

Upper Height 42"
Lower Height 28½"

CF Series Intro, CF Plus, CF PlusHD monitor arms with C-clamp can be placed here.

Sync Monitor Mount Comparison

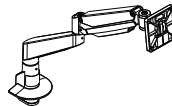
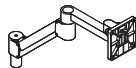

	CFPLUS (CF Plus/PlusHD)	CFINTRO (CF Series Intro)
Arm Option Compatible with Sync	Single	Single
Bracket Options Compatible with Sync	C-clamp – CFSERIESCC Slatwall Bracket – CFSPSW	C-clamp – CFSERIESCC
Weight Range	CF Plus: 7-17 lb. CF PlusHD: 13-28 lb.	2–20 lb.
Max Monitor Size (in 16:9 aspect ratio)	32"	32"
Focal Adjustment	24"	23 ⁷ / ₁₀ "
Height Adjustment Range	16"	13 ¹ / ₅ "
Finishes	<ul style="list-style-type: none"> • 0835 Black • 7018 Pewter • ZW01 Pearl Snow 	<ul style="list-style-type: none"> • 0835 Black • 7018 Pewter • ZW01 Pearl Snow

► For additional monitor mount information, please see the *Worktools Specification Guide*.

Sync Double-Sided Bases

Tip: Worksurface heights are in fixed positions. Units can not be adjusted.

Tip: Up to two large CPUs and eight thin client computers can fit in each technology stretcher.

▶ See *Technology Stretcher Computer Capacities*, page 192.

Tip: Frame tile should be specified when using custom inserts. Custom inserts are provided by dealer or customer and are field installed.

Tip: Transaction top available on 36"H and 42"H sides only.

Tip: To aid installation, order template.

▶ See page 185

Tip: Dimensions shown represent interaction and process top depths. When transaction top is specified overall depth is 40½". The width of the worksurface must match the width of the base.

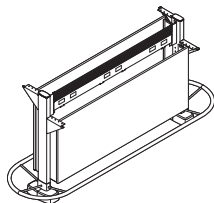
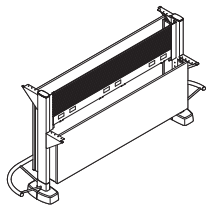
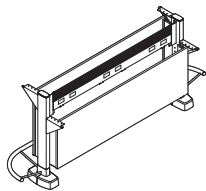

Standard Includes		Required to Specify
▶ Need help? Product details, page 184	<ul style="list-style-type: none"> • Legs: 4799 Platinum only • Foot ring: 4799 Platinum only • Foot cover • Tile: High-Pressure Laminate • Tile edge band: 3 mm plastic • Cantilever • CPU hanging straps • Base power-in cover: 4798 Sterling 	<ol style="list-style-type: none"> 1 Style number 2 High-Pressure Laminate color number for tile 3 Plastic color number for tile edge band 4 Options, if selected (see below) <p>▶ See <i>Surface Materials</i>, page 375.</p>

Options	U.S. Price	Required to Specify
Surface Materials	<ul style="list-style-type: none"> • Steelcase Health High-Pressure Laminate • Steelcase High-Pressure Laminate 	<p>No cost</p> <p>+\$111</p> <p>▶ See <i>Surface Materials</i>, page 375.</p> <p>▶ See <i>Surface Materials</i>, page 375.</p>
Cantilever	<ul style="list-style-type: none"> • For use with transaction tops 	No cost
Tile	<ul style="list-style-type: none"> • Frame tile: 4799 Platinum only 	No cost
Related Products	<ul style="list-style-type: none"> • Accessories 	▶ Page 202

Specification Information					
Dimensions		Style		U.S.	
D	W	Upper Base Height	Lower Base Height	Number	Base Price

Upper Base 36"H, Lower Base 28½"H

49½"	72"	36"	28½"	HBB723628	\$8165
49½"	84"	36"	28½"	HBB843628	\$8264
49½"	96"	36"	28½"	HBB963628	\$8370
49½"	108"	36"	28½"	HBB1083628	\$8479

Upper Base 42"H, Lower Base 28½"H

49½"	72"	42"	28½"	HBB724228	\$8409
49½"	84"	42"	28½"	HBB844228	\$8514
49½"	96"	42"	28½"	HBB964228	\$8623
49½"	108"	42"	28½"	HBB1084228	\$8735

Upper Base 42"H, Lower Base 36"H

49½"	72"	42"	36"	HBB724236	\$8575
49½"	84"	42"	36"	HBB844236	\$8685
49½"	96"	42"	36"	HBB964236	\$8797
49½"	108"	42"	36"	HBB1084236	\$8911

Sync Worksurfaces for Use with Double-Sided Bases

Standard Includes		Required to Specify
<ul style="list-style-type: none"> ▶ Need help? Product details, page 184 	<ul style="list-style-type: none"> • High-Pressure Laminate worksurface, if selected • Solid surface worksurface, if selected: price group A • Edge band on High-Pressure Laminate worksurface, if selected: 3 mm plastic 	<ol style="list-style-type: none"> 1 Style number 2 High-Pressure Laminate or solid surface color number for worksurface 3 Plastic color number for edge band, if selected 4 Options, if selected (see below) <ul style="list-style-type: none"> ▶ See <i>Surface Materials</i>, page 375.

Tip: The width of the work-surface must match the width of the base.

Options	U.S. Price	Required to Specify
Surface Materials <ul style="list-style-type: none"> • Steelcase Health High-Pressure Laminate • Steelcase High-Pressure Laminate • Solid surface 	No cost +\$111 Prices below and at right	<ul style="list-style-type: none"> ▶ See <i>Surface Materials</i>, page 375. ▶ See <i>Surface Materials</i>, page 375. Specify solid surface color number.

Specification Information							
Dimensions		Style Number	U.S. Base Prices				
D	W		High-Pressure Laminate	Solid Surface Grade A	Solid Surface Grade B	Solid Surface Grade C	Solid Surface Grade D
..

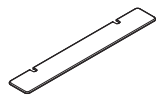

Tip: Transaction top available on 36"H and 42"H sides only.

Upper Transaction Worksurfaces

High-Pressure Laminate

15"	72"	HT72UTL	\$549	N.A.	N.A.	N.A.	N.A.
15"	84"	HT84UTL	\$569	N.A.	N.A.	N.A.	N.A.
15"	96"	HT96UTL	\$602	N.A.	N.A.	N.A.	N.A.
15"	108"	HT108UTL	\$656	N.A.	N.A.	N.A.	N.A.

Solid Surface

15"	72"	HT72UTS	N.A.	\$1373	\$1568	\$1605	\$1630
15"	84"	HT84UTS	N.A.	\$1842	\$2127	\$2186	\$2222
15"	96"	HT96UTS	N.A.	\$2033	\$2356	\$2415	\$2453
15"	108"	HT108UTS	N.A.	\$2318	\$2700	\$2779	\$2826



Tip: When using the WFCS Slatwall Stanchion and Eyesite monitor arms on solid surface tops, a filler bracket (HBRKTS) also needs to be specified.
▶ See page 202.

Upper Interaction Worksurfaces

High-Pressure Laminate

24"	72"	HT72UNL	\$774	N.A.	N.A.	N.A.	N.A.
24"	84"	HT84UNL	\$829	N.A.	N.A.	N.A.	N.A.
24"	96"	HT96UNL	\$903	N.A.	N.A.	N.A.	N.A.
24"	108"	HT108UNL	\$995	N.A.	N.A.	N.A.	N.A.

Solid Surface

24"	72"	HT72UNS	N.A.	\$2313	\$2688	\$2715	\$2749
24"	84"	HT84UNS	N.A.	\$2655	\$3116	\$3150	\$3205
24"	96"	HT96UNS	N.A.	\$3000	\$3532	\$3586	\$3646
24"	108"	HT108UNS	N.A.	\$3604	\$4452	\$4530	\$4614

▶ Specification Information, continued on next page



For Canadian Pricing
Multiply U.S. Price by the Canadian price factor.
▶ See page 1 for details.

► **Specification Information, continued from previous page**

Specification Information							
Dimensions		Style Number	U.S. Base Prices				
D	W		High-Pressure Laminate	Solid Surface Grade A	Solid Surface Grade B	Solid Surface Grade C	Solid Surface Grade D

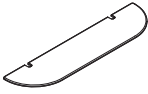

Upper Process Worksurfaces

High-Pressure Laminate

24"	72"	HT72UPL	\$774	N.A.	N.A.	N.A.	N.A.
24"	84"	HT84UPL	\$829	N.A.	N.A.	N.A.	N.A.
24"	96"	HT96UPL	\$903	N.A.	N.A.	N.A.	N.A.
24"	108"	HT108UPL	\$995	N.A.	N.A.	N.A.	N.A.

Solid Surface

24"	72"	HT72UPS	N.A.	\$2313	\$2688	\$2715	\$2749
24"	84"	HT84UPS	N.A.	\$2655	\$3116	\$3150	\$3205
24"	96"	HT96UPS	N.A.	\$3000	\$3532	\$3586	\$3646
24"	108"	HT108UPS	N.A.	\$3604	\$4452	\$4530	\$4614



Lower Interaction Worksurfaces

High-Pressure Laminate

27 ³ / ₈ "	72"	HT72LNL	\$774	N.A.	N.A.	N.A.	N.A.
27 ³ / ₈ "	84"	HT84LNL	\$829	N.A.	N.A.	N.A.	N.A.
27 ³ / ₈ "	96"	HT96LNL	\$903	N.A.	N.A.	N.A.	N.A.
27 ³ / ₈ "	108"	HT108LNL	\$995	N.A.	N.A.	N.A.	N.A.

Solid Surface

27 ³ / ₈ "	72"	HT72LNS	N.A.	\$2439	\$2699	\$2762	\$2802
27 ³ / ₈ "	84"	HT84LNS	N.A.	\$2702	\$3120	\$3198	\$3252
27 ³ / ₈ "	96"	HT96LNS	N.A.	\$3016	\$3535	\$3624	\$3688
27 ³ / ₈ "	108"	HT108LNS	N.A.	\$3648	\$4455	\$4579	\$4661



Lower Process Worksurfaces

High-Pressure Laminate

27 ³ / ₈ "	72"	HT72LPL	\$774	N.A.	N.A.	N.A.	N.A.
27 ³ / ₈ "	84"	HT84LPL	\$829	N.A.	N.A.	N.A.	N.A.
27 ³ / ₈ "	96"	HT96LPL	\$903	N.A.	N.A.	N.A.	N.A.
27 ³ / ₈ "	108"	HT108LPL	\$995	N.A.	N.A.	N.A.	N.A.

Solid Surface

27 ³ / ₈ "	72"	HT72LPS	N.A.	\$2439	\$2699	\$2762	\$2802
27 ³ / ₈ "	84"	HT84LPS	N.A.	\$2702	\$3120	\$3198	\$3252
27 ³ / ₈ "	96"	HT96LPS	N.A.	\$3016	\$3535	\$3624	\$3688
27 ³ / ₈ "	108"	HT108LPS	N.A.	\$3648	\$4455	\$4579	\$4661



For Canadian Pricing
Multiply U.S. Price by the
Canadian price factor.
► See page 1 for details.

Sync Single-Sided Bases

Tip: Worksurface heights are in fixed positions. Units can not be adjusted.

Tip: Up to two desk top CPUs or two thin client computers can fit in each technology stretcher.

▶ See *Technology Stretcher Computer Capacities*, page 192.

Tip: Frame tile should be specified when using custom insert. Custom inserts are provided by dealer or customer and are field installed.

Tip: Foot ring is not standard on 28½"H fixed height bases.

Tip: To aid installation, order template.

▶ See page 185

Tip: The width of the work-surface must match the width of the base.

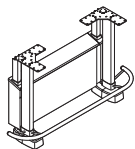
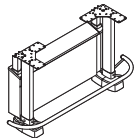
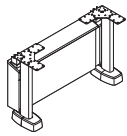

Standard Includes		Required to Specify	
▶ Need help?	• Legs: 4799 Platinum only	1 Style number	
▶ Product details, page 188	• Foot ring: 4799 Platinum only	2 Appropriate tile	
	• Foot cover	3 High-Pressure Laminate color number for tile, if selected	
	• Tile: High-Pressure Laminate or frame	4 Plastic color number for tile edge band, if selected	
	• Tile edge band for High-Pressure Laminate tile, if selected: 3 mm plastic	5 Options, if selected (see below)	
	• Worksurface mounting plate	▶ See <i>Surface Materials</i> , page 375.	
	• CPU hanging straps		
	• Four cable trays: 4799 Platinum		

Options	U.S. Price	Required to Specify
Surface Materials	• Steelcase Health High-Pressure Laminate	▶ See <i>Surface Materials</i> , page 375.
	• Steelcase High-Pressure Laminate	▶ See <i>Surface Materials</i> , page 375.
Tile	• High-Pressure Laminate tile	Specify with <i>High-Pressure Laminate tile</i> , select High-Pressure Laminate color and plastic color number for edge.
	• Frame tile: 4799 Platinum only	Specify with <i>frame tile</i> .
Related Products	• Accessories	▶ Page 202

Specification Information				
Dimensions			Style Number	U.S. Base Price
D	W	H		
28½"H				
27 ³ / ₈ "	72"	28½"	HBA7228	\$5650
27 ³ / ₈ "	84"	28½"	HBA8428	\$5722
27 ³ / ₈ "	96"	28½"	HBA9628	\$5800
27 ³ / ₈ "	108"	28½"	HBA10828	\$5951
36"H				
27 ³ / ₈ "	72"	36"	HBA7236	\$5818
27 ³ / ₈ "	84"	36"	HBA8436	\$5894
27 ³ / ₈ "	96"	36"	HBA9636	\$5974
27 ³ / ₈ "	108"	36"	HBA10836	\$6128
42"H				
27 ³ / ₈ "	72"	42"	HBA7242	\$5935
27 ³ / ₈ "	84"	42"	HBA8442	\$6011
27 ³ / ₈ "	96"	42"	HBA9642	\$6092
27 ³ / ₈ "	108"	42"	HBA10842	\$6247



For Canadian Pricing

Multiply U.S. Price by the Canadian price factor.

▶ See page 1 for details.

Sync Worksurfaces for Use with Single-Sided Bases

Sync
Worksurfaces for Use with
Single-Sided Bases

Tip: The width of the work-
surface must match the
width of the base.

Standard Includes		Required to Specify
▶ Need help? Product details, page 188	<ul style="list-style-type: none"> High-Pressure Laminate worksurface, if selected Solid surface worksurface, if selected: price group A Edge band for High-Pressure Laminate worksurface, if selected: 3 mm plastic 	<ol style="list-style-type: none"> Style number High-Pressure Laminate or solid surface color number for worksurface Plastic color number for edge band, if selected Options, if selected (see below) <p>▶ See <i>Surface Materials</i>, page 375.</p>

Options	U.S. Price	Required to Specify
Surface Materials	<ul style="list-style-type: none"> Steelcase Health High-Pressure Laminate Steelcase High-Pressure Laminate Solid surface 	<p>No cost</p> <p>+\$111</p> <p>Prices below</p> <p>▶ See <i>Surface Materials</i>, page 375.</p> <p>▶ See <i>Surface Materials</i>, page 375.</p> <p>Specify solid surface color number.</p>

Specification Information						
Dimensions		Style Number	U.S. Base Prices			
D	W		High-Pressure Laminate	Solid Surface Grade A	Solid Surface Grade B	Solid Surface Grade C

Interaction Worksurfaces

High-Pressure Laminate

27 ³ / ₈ "	72"	HT72NL	\$774	N.A.	N.A.	N.A.	N.A.
27 ³ / ₈ "	84"	HT84NL	\$829	N.A.	N.A.	N.A.	N.A.
27 ³ / ₈ "	96"	HT96NL	\$903	N.A.	N.A.	N.A.	N.A.
27 ³ / ₈ "	108"	HT108NL	\$995	N.A.	N.A.	N.A.	N.A.

Solid Surface

27 ³ / ₈ "	72"	HT72NS	N.A.	\$2303	\$2672	\$2732	\$2776
27 ³ / ₈ "	84"	HT84NS	N.A.	\$2729	\$3191	\$3270	\$3322
27 ³ / ₈ "	96"	HT96NS	N.A.	\$3129	\$3652	\$3746	\$3812
27 ³ / ₈ "	108"	HT108NS	N.A.	\$3794	\$4523	\$4647	\$4728

Process Worksurfaces

High-Pressure Laminate

27 ³ / ₈ "	72"	HT72PL	\$774	N.A.	N.A.	N.A.	N.A.
27 ³ / ₈ "	84"	HT84PL	\$829	N.A.	N.A.	N.A.	N.A.
27 ³ / ₈ "	96"	HT96PL	\$903	N.A.	N.A.	N.A.	N.A.
27 ³ / ₈ "	108"	HT108PL	\$995	N.A.	N.A.	N.A.	N.A.

Solid Surface

27 ³ / ₈ "	72"	HT72PS	N.A.	\$2303	\$2672	\$2732	\$2776
27 ³ / ₈ "	84"	HT84PS	N.A.	\$2729	\$3191	\$3270	\$3322
27 ³ / ₈ "	96"	HT96PS	N.A.	\$3129	\$3652	\$3746	\$3812
27 ³ / ₈ "	108"	HT108PS	N.A.	\$3794	\$4523	\$4647	\$4728



 **For Canadian Pricing**
Multiply U.S. Price by the
Canadian price factor.
▶ See page 1 for details.

Sync Single Leg Bases

For Use with Full Arc and Scoop Worksurfaces

Standard Includes		Required to Specify
<ul style="list-style-type: none"> ▶ Need help? Product details, page 190 	<ul style="list-style-type: none"> • Legs: 4799 Platinum only • Foot ring: 4799 Platinum only • Foot cover • Tile: High-Pressure Laminate or frame • Tile edge band for High-Pressure Laminate tile, if selected: 3 mm plastic • Worksurface mounting plate • CPU hanging straps • Two cable trays: 4799 Platinum • Simple touch controller (if adjustable-height leg base is selected) 	<ol style="list-style-type: none"> 1 Style number 2 Appropriate foot ring 3 Appropriate tile 4 High-Pressure Laminate color number for tile, if selected 5 Plastic color number for tile edge band, if selected 6 Options, if selected (see below) <p>▶ See <i>Surface Materials</i>, page 375.</p>

Options	U.S. Price	Required to Specify
Surface Materials <ul style="list-style-type: none"> • Steelcase Health High-Pressure Laminate • Steelcase High-Pressure Laminate 	No cost +\$111	<p>▶ See <i>Surface Materials</i>, page 375.</p> <p>▶ See <i>Surface Materials</i>, page 375.</p>
Foot Ring <ul style="list-style-type: none"> • 90° foot ring • 135° foot ring 	No cost +\$ 84	Specify with 90° foot ring. Specify with 135° foot ring.
Tile <ul style="list-style-type: none"> • High-Pressure Laminate tile • Frame tile: 4799 Platinum only 	No cost No cost	Specify with High-Pressure Laminate tile, select High-Pressure Laminate color and plastic color number for edge. Specify with frame tile.
Related Products <ul style="list-style-type: none"> • Accessories 		<p>▶ Page 202</p>

Tip: To aid installation, order template.
▶ See page 185

Tip: Frame tile should be specified when using custom insert. Custom inserts are provided by dealer or customer and are field installed.

Tip: Left or right is determined when facing Sync.

Specification Information				
Dimensions			Style Number	U.S. Base Price
D	W	H		

Adjustable-Height Leg Bases

Left

25¾"	24"	26"-45"	HBC24AL	\$4291
------	-----	---------	----------------	--------

Right

25¾"	24"	26"-45"	HBC24AR	\$4291
------	-----	---------	----------------	--------

Fixed-Height Leg Bases

Left

25¾"	24"	28½"	HBC2428L	\$2533
------	-----	------	-----------------	--------

25¾"	24"	36"	HBC2436L	\$2607
------	-----	-----	-----------------	--------

25¾"	24"	42"	HBC2442L	\$2684
------	-----	-----	-----------------	--------

Right

25¾"	24"	28½"	HBC2428R	\$2533
------	-----	------	-----------------	--------

25¾"	24"	36"	HBC2436R	\$2607
------	-----	-----	-----------------	--------

25¾"	24"	42"	HBC2442R	\$2684
------	-----	-----	-----------------	--------

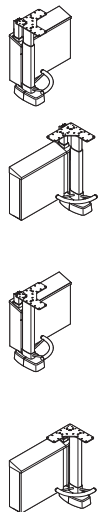

 **For Canadian Pricing**
 Multiply U.S. Price by the Canadian price factor.
 ▶ See page 1 for details.

Sync Full Arc and Scoop Worksurfaces for Use with Single Leg Bases

Sync
Full Arc and Scoop
Worksurfaces
for Use with Single
Leg Bases

Standard Includes		Required to Specify
▶ Need help? Product details, page 190	<ul style="list-style-type: none"> High-Pressure Laminate worksurface, if selected Solid surface worksurface, if selected: price group A Edge band on High-Pressure Laminate worksurface, if selected: 3 mm plastic 	<ol style="list-style-type: none"> Style number High-Pressure Laminate or solid surface color number for worksurface Plastic color number for edge band, if selected Options, if selected (see below) ▶ See <i>Surface Materials</i> , page 375.

Options	U.S. Price	Required to Specify
Surface Materials	<ul style="list-style-type: none"> Steelcase Health High-Pressure Laminate Steelcase High-Pressure Laminate Solid surface 	No cost +\$111 Prices below
Related Products	<ul style="list-style-type: none"> Accessories 	▶ See <i>Surface Materials</i> , page 375. ▶ See <i>Surface Materials</i> , page 375. Specify solid surface color number. ▶ Page 202

Specification Information							
Dimensions		Style	U.S. Base Prices				
D	W	Number	High-Pressure Laminate	Solid Surface Grade A	Solid Surface Grade B	Solid Surface Grade C	Solid Surface Grade D
25 3/4"	25 1/2"	HT90FL	\$422	N.A.	N.A.	N.A.	N.A.
25 3/4"	25 1/2"	HT90FS	N.A.	\$1338	\$1556	\$1768	\$1809

90° Full Arc Worksurfaces

High-Pressure Laminate

25 3/4"	25 1/2"	HT90FL	\$422	N.A.	N.A.	N.A.	N.A.
---------	---------	--------	-------	------	------	------	------

Solid Surface

25 3/4"	25 1/2"	HT90FS	N.A.	\$1338	\$1556	\$1768	\$1809
---------	---------	--------	------	--------	--------	--------	--------

135° Full Arc Worksurfaces

High-Pressure Laminate

25 3/4"	43 1/2"	HT135FL	\$542	N.A.	N.A.	N.A.	N.A.
---------	---------	---------	-------	------	------	------	------

Solid Surface

25 3/4"	43 1/2"	HT135FS	N.A.	\$1599	\$1899	\$1931	\$1957
---------	---------	---------	------	--------	--------	--------	--------

135° Scoop Worksurfaces

High-Pressure Laminate Left-Hand

25 3/4"	43 1/2"	HT135SLHL	\$542	N.A.	N.A.	N.A.	N.A.
---------	---------	-----------	-------	------	------	------	------

High-Pressure Laminate Right-Hand

25 3/4"	43 1/2"	HT135SRHL	\$542	N.A.	N.A.	N.A.	N.A.
---------	---------	-----------	-------	------	------	------	------

Solid Surface Left-Hand

25 3/4"	43 1/2"	HT135SLHS	N.A.	\$1599	\$1899	\$1931	\$1957
---------	---------	-----------	------	--------	--------	--------	--------

Solid Surface Right-Hand

25 3/4"	43 1/2"	HT135SRHS	N.A.	\$1599	\$1899	\$1931	\$1957
---------	---------	-----------	------	--------	--------	--------	--------



 **For Canadian Pricing**
Multiply U.S. Price by the
Canadian price factor.
▶ See page 1 for details.

Sync Accessories

Solid Top Bridge Bracket

*Tip: When using the **WFCS** Slatwall stanchion and Eyesite monitor arms on solid surface tops, a filler bracket (**HBRKTS**) also needs to be specified.*

Standard Includes	Required to Specify
• Bracket: 7207 Black only	Style number



Specification Information

Style Number	U.S. Price
HBRKTS	\$88



For Canadian Pricing
 Multiply U.S. Price by the Canadian price factor.
 ▶ See page 1 for details.

Folio

			
Statement of Line	204	Specifying	
			
Understanding			
28"H Base Cabinets	212	28"H Base Cabinets	256
33"H ADA Base Cabinets	216	33"H ADA Base Cabinets	260
36"H Base Cabinets	220	36"H Base Cabinets	264
Sink Cabinets	224	Sink Cabinets	268
Corner Cabinets	228	Corner Cabinets	269
Storage Cabinets	230	84"H Storage Cabinets	270
Wardrobe Cabinets	234	92"H Storage Cabinets with Sloped Top	272
Bookcases	238	84"H Wardrobe Cabinets	274
Upper Storage Cabinets	242	92"H Wardrobe Cabinets with Sloped Top	275
Worksurfaces	246	84"H Bookcases	276
Desk Frames	248	89"H Bookcases with Sloped Top	278
Accessories	251	Upper Storage Cabinets	280
Storage Capacities	252	Upper Storage Cabinets with Sloped Top	282
		Laminate Worksurfaces	284
		4"H Laminate Sidesplash	285
		Solid Surface Worksurfaces	286
		4"H Solid Surface Sidesplash	287
		Desk Frames	288
		Accessories	290

Statement of Line

Folio

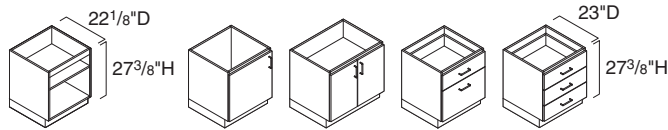

*Cabinet depth without the doors or drawers is 22 1/8\".

Understanding
 ▶ Page 212
 Specifying
 ▶ Page 256

28\"H Base Cabinets

	12\"W	18\"W	21\"W	24\"W	30\"W	36\"W
Open with one adjustable shelf	●	●	●	●	●	●
With single door and one adjustable shelf	●	●	●	●		
With double doors and one adjustable shelf					●	●
With one small drawer and one large drawer	●	●	●	●	●	●
With three small drawers	●	●	●	●	●	●

Tip: Dimensions are for reference only. See shop drawings for actual measurements at village.steelcase.com.

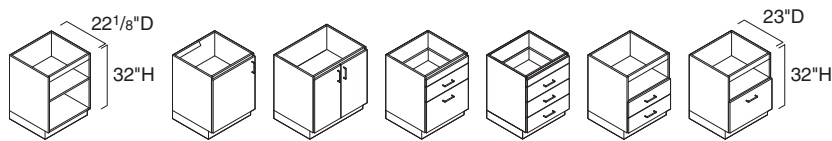

*Cabinet depth without the doors or drawers is 22 1/8\".

Understanding
 ▶ Page 216
 Specifying
 ▶ Page 260

33\"H ADA Base Cabinets

	12\"W	18\"W	21\"W	24\"W	30\"W	36\"W
Open with one adjustable shelf	●	●	●	●	●	●
With single door and one adjustable shelf	●	●	●	●		
With double doors and one adjustable shelf					●	●
With one small drawer and one large drawer	●	●	●	●	●	●
With three small drawers	●	●	●	●	●	●
With open shelf and two small drawers	●	●	●	●	●	●
With open shelf and one large drawer	●	●	●	●	●	●

Tip: Dimensions are for reference only. See shop drawings for actual measurements at village.steelcase.com.

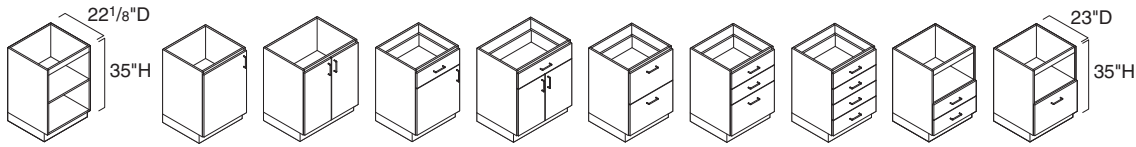

*Cabinet depth without the doors or drawers is 22 1/8".

Understanding
 ▶ Page 220
 Specifying
 ▶ Page 264

36"H Base Cabinets

	12"W	18"W	21"W	24"W	30"W	36"W
Open with one adjustable shelf	●	●	●	●	●	●
With single door and one adjustable shelf	●	●	●	●		
With double doors and one adjustable shelf					●	●
With one small drawer, single door, and one adjustable shelf	●	●	●	●		
With one small drawer, double doors, and one adjustable shelf					●	●
With two large drawers	●	●	●	●	●	●
With two small drawers and one large drawer	●	●	●	●	●	●
With four small drawers	●	●	●	●	●	●
With open shelf and two small drawers	●	●	●	●	●	●
With open shelf and one large drawer	●	●	●	●	●	●

Tip: Dimensions are for reference only. See shop drawings for actual measurements at village.steelcase.com.

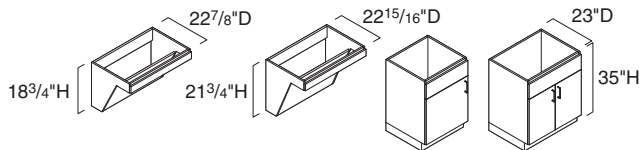

*Cabinet depth without the doors or drawers is 22 1/8".

Understanding
 ▶ Page 224
 Specifying
 ▶ Page 268

Sink Cabinets

	24"W	30"W	36"W
32"H with angled front		●	●
35"H with angled front		●	●
35"H with single door	●		
35"H with double doors		●	●

Tip: Dimensions are for reference only. See shop drawings for actual measurements at village.steelcase.com.

Statement of Line, Folio, continued

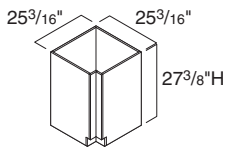

Understanding
 ▶ Page 228
 Specifying
 ▶ Page 269

Corner Cabinets

	24"W
For use with 28"H base cabinets	●
For use with 33"H base cabinets	●
For use with 36"H base cabinets	●

Tip: Dimensions are for reference only. See shop drawings for actual measurements at village.steelcase.com.

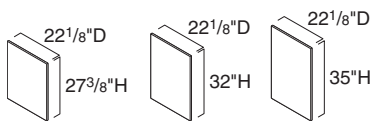

Specifying
 ▶ Pages 258, 262,
 and 267

Support End Panels

Adjacent Cabinet Height	28"H	33"H	36"H
24"D	●	●	●

Tip: Dimensions are for reference only. See shop drawings for actual measurements at village.steelcase.com.

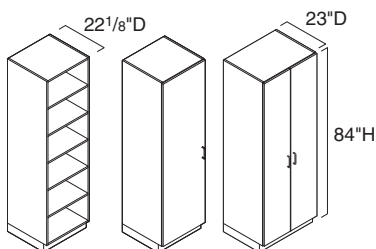

*Cabinet depth without the doors or drawers is 22 1/8".

Understanding
 ▶ Page 230
 Specifying
 ▶ Page 270

84"H Storage Cabinets

	12"W	18"W	21"W	24"W	30"W	36"W
Open with five shelves	●	●	●	●	●	●
With single door and five shelves	●	●	●	●		
With double doors and five shelves					●	●

Tip: Dimensions are for reference only. See shop drawings for actual measurements at village.steelcase.com.

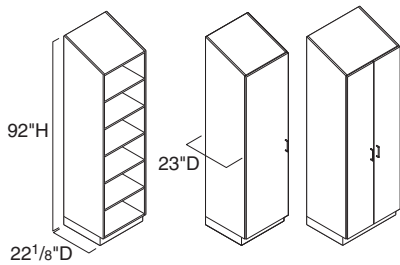

*Cabinet depth without the doors or drawers is 22 1/8".

Understanding
 ▶ Page 230
 Specifying
 ▶ Page 272

92"H Storage Cabinets with Sloped Top

	12"W	18"W	21"W	24"W	30"W	36"W
Open with five shelves	●	●	●	●	●	●
With single door and five shelves	●	●	●	●		
With double doors and five shelves					●	●

Tip: Dimensions are for reference only. See shop drawings for actual measurements at village.steelcase.com.

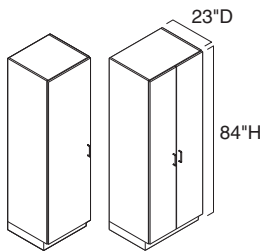

*Cabinet depth without the doors or drawers is 22 1/8".

Understanding
 ▶ Page 234
 Specifying
 ▶ Page 274

84"H Wardrobe Cabinets

	12"W	18"W	21"W	24"W	30"W	36"W
With single door and one fixed shelf	●	●	●	●		
With double doors and one fixed shelf					●	●

Tip: Dimensions are for reference only. See shop drawings for actual measurements at village.steelcase.com.

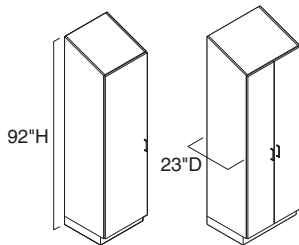

*Cabinet depth without the doors or drawers is 22 1/16".

Understanding
 ▶ Page 234
 Specifying
 ▶ Page 275

92"H Wardrobe Cabinets with Sloped Top

	12"W	18"W	21"W	24"W	30"W	36"W
With single door and one fixed shelf	●	●	●	●		
With double doors and one fixed shelf					●	●

Tip: Dimensions are for reference only. See shop drawings for actual measurements at village.steelcase.com.

Statement of Line, Folio, continued

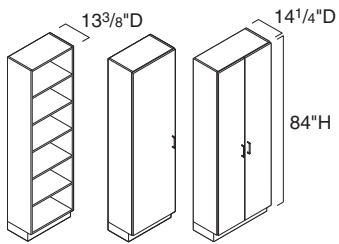

*Cabinet depth without the doors or drawers is 13 3/8".

Understanding
 ▶ Page 238
 Specifying
 ▶ Page 276

84"H Bookcases

	12"W	18"W	21"W	24"W	30"W	36"W
Open with five shelves	●	●	●	●	●	●
With single door and five shelves	●	●	●	●		
With double doors and five shelves					●	●

Tip: Dimensions are for reference only. See shop drawings for actual measurements at village.steelcase.com.

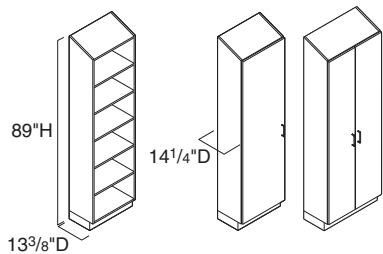

*Cabinet depth without the doors or drawers is 13 3/8".

Understanding
 ▶ Page 238
 Specifying
 ▶ Page 278

89"H Bookcases with Sloped Top

	12"W	18"W	21"W	24"W	30"W	36"W
Open with five shelves	●	●	●	●	●	●
With single door and five shelves	●	●	●	●		
With double doors and five shelves					●	●

Tip: Dimensions are for reference only. See shop drawings for actual measurements at village.steelcase.com.

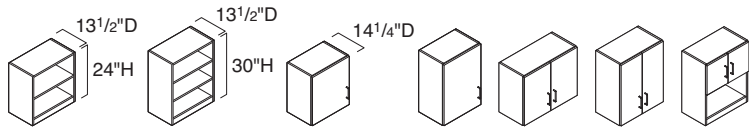

*Cabinet depth without the doors or drawers is 13 1/2\"/>

Understanding
 ▶ Page 242
 Specifying
 ▶ Page 280

Upper Storage Cabinets

	12\"/>
24\"/>	
30\"/>	
24\"/>	
30\"/>	
24\"/>	
30\"/>	
24\"/>	
30\"/>	
30\"/>	

Tip: Dimensions are for reference only. See shop drawings for actual measurements at village.steelcase.com.

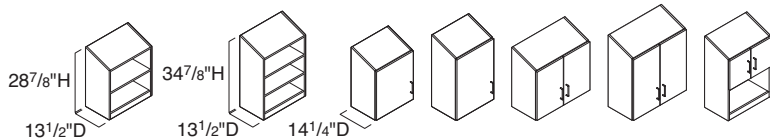

*Cabinet depth without the doors or drawers is 13 1/2\"/>

Understanding
 ▶ Page 242
 Specifying
 ▶ Page 282

Upper Storage Cabinets with Sloped Top

	12\"/>
29\"/>	
35\"/>	
29\"/>	
35\"/>	
29\"/>	
35\"/>	
35\"/>	

Tip: Dimensions are for reference only. See shop drawings for actual measurements at village.steelcase.com.



Statement of Line, Folio, continued

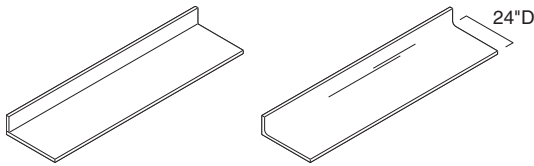

Understanding
 ▶ Page 246
 Specifying
 ▶ Pages 284 and 286

Worksurfaces

24\"/>

12\"/>
54\"/>

24\"/>

12\"/>
54\"/>

Tip: Dimensions are for reference only. See shop drawings for actual measurements at village.steelcase.com.

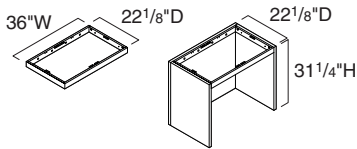

Understanding
 ▶ Page 248
 Specifying
 ▶ Page 288

Desk Frames

	12\"/>									
Without back panel for use with common top	●	●	●	●	●	●	●	●	●	●
With back panel for use with common top			●	●	●					

Tip: Dimensions are for reference only. See shop drawings for actual measurements at village.steelcase.com.

Folio

28"H Base Cabinets

28"H base cabinets meet storage needs in clinical settings. Base cabinets connect to a worksurface to create a single unit or a multicabinet wall unit.

Top of cabinet is open and requires attachment to a worksurface that is ordered separately.

Sides are finished so the cabinet can stand alone or be used in right- or left-hand positions.

All edges are finished from the factory with matching plastic edge banding.

Large drawers and 36"W small drawers have single-wall steel sides and full extension, heavy-duty slides to handle the additional load.

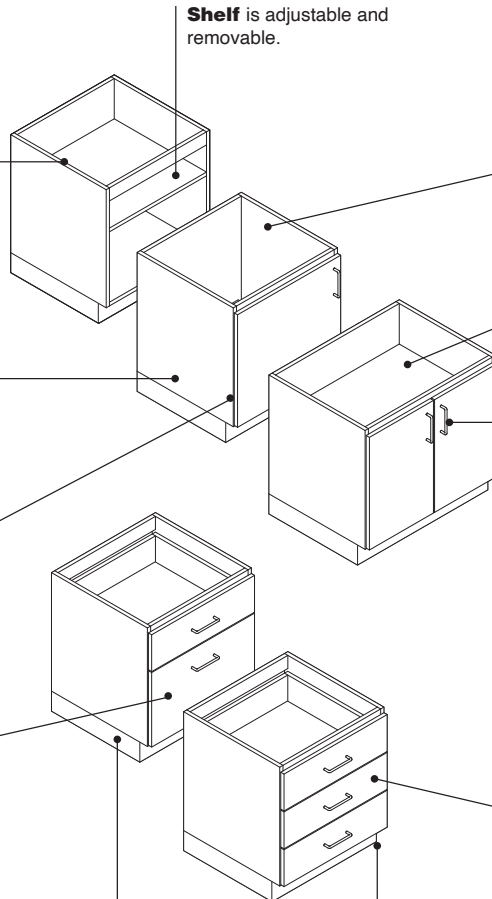

Shelf is adjustable and removable.

The interior and exterior are finished with matching Low-Pressure Laminate.

Adjustable shelf is standard inside the cabinet. Shelves adjust in 1/4" increments. Additional shelves are available, and must be specified separately.

D pulls are standard on doors and drawers and are nickel only. Additional pull styles are available as an option.

Adjustable glides adjust for installation on uneven floors. Adjustability range is 1/2".

Small drawers have single-wall steel sides, and three quarter extension slides. Drawer configurations are available to accommodate supplies and equipment.
Tip: 36"W small drawers have full extension, heavy-duty slides to handle the additional load.

Base elevates the cabinet and is 3/4"H with the glide in the lowest position.

Actual Dimensions

Features	Overall Depth	Width	Height without Worksurface	Height with High-Pressure Laminate Worksurface	Height with Solid Worksurface
With open shelves	21 1/8"	12", 18", 21", 24", 30", or 36"	27 7/16"	28 5/8"	28 7/16"
With single door	23"	12", 18", 21", or 24"	27 7/16"	28 5/8"	28 7/16"
With double doors	23"	30" or 36"	27 7/16"	28 5/8"	28 7/16"
With drawers	23"	12", 18", 21", 24", 30", or 36"	27 7/16"	28 5/8"	28 7/16"

*Height with Solid Worksurface assumes 1/2" solid surface and 1/2" substrate. Contractor specified Solid Surface may be 1 1/2".

Product Details

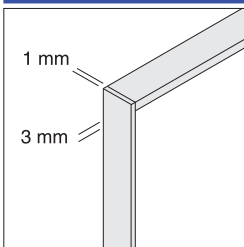

Edges on cabinets are matching 1 mm plastic edge banding. Drawer and door edges are matching 3 mm plastic edge banding.

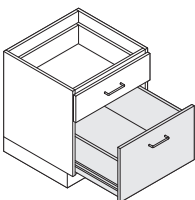

Large drawers and 36"W small drawers, when opened, extend their full depth.

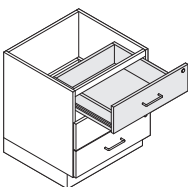

Small drawers with the exception of 36"W small drawers, when opened, extend three quarters of their depth.

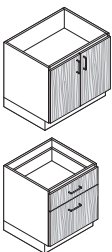

Woodgrain Low-Pressure Laminate matches on all drawer and door sets on base cabinets.

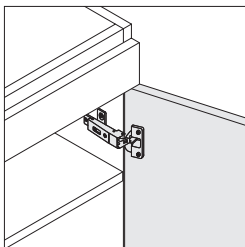

Euro hinge is standard on cabinet door and allows the door to open a full 110°.

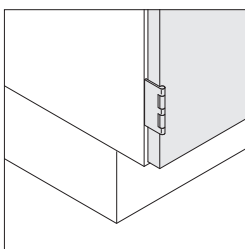

Five-knuckle hinge is optional and allows the door to open 270° or 180° if connected to adjacent cabinet.

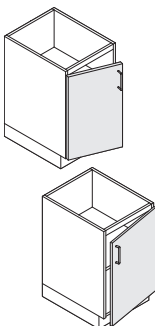

Single-door cabinets are hinged on the left or right side. A left-hand unit has the hinge on the left side of the door. A right-hand unit has the hinge on the right side of the door.

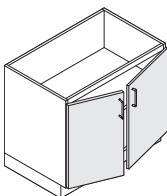

Double-door cabinets open from the center out.

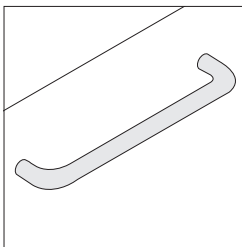

D pulls are standard.

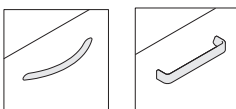

Contemporary Jazz

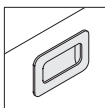

Opus

Additional door and drawer pull options are available. Optional pulls include:

- Contemporary
- Jazz
- Opus

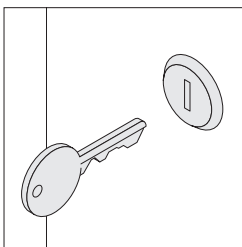

Lock is optional and factory- or field-installed to secure the doors or top drawer of the cabinet. Factory-installed locks are available keyed random only. Optional field-installed locks are available with consecutive, specific, or random keying options. Master-keyed locks are also available. Field-installed lock cylinders must be specified separately.

► Lock and Keying, Page 398

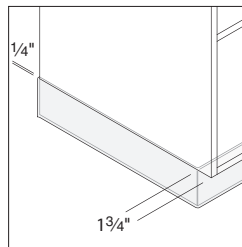

Cove molding must be field installed on base to complete installation. The front base of cabinet is recessed 1 3/4". The sides and back are set in 1/4" to allow cove molding to fit flush. Cove molding must be supplied locally.

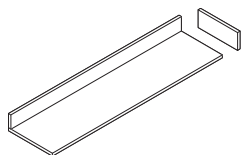

Laminate worksurface, ordered separately, is available with High-Pressure Laminate. High-Pressure Laminate has a matching 3 mm plastic front edge and 1 mm plastic edge on sides and back. Backsplash is standard with the worksurface. High-Pressure Laminate sidesplash is also available in two depths and must be ordered separately.

► Page 284

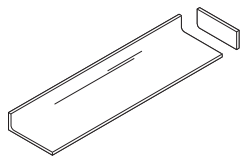

Solid surface worksurface, ordered separately, has an integrated backsplash. A solid surface sidesplash is also available in two depths and must be ordered separately.

Connections

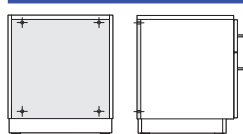

Base cabinets must always be fastened to a wall. Attachment hardware is included with cabinets.

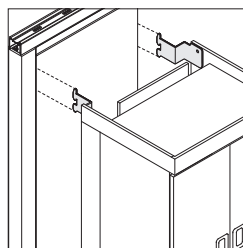

V.I.A. hang-on bracket option must be used when mounting to V.I.A. on module. Brackets include one left- and one right-hand bracket.

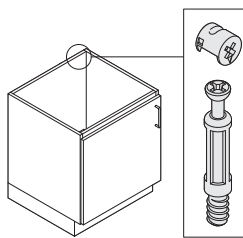

Cam-lock assembly hardware is used.

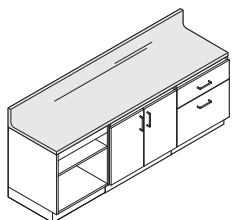

Worksurface is available to connect to one cabinet or to span multiple cabinets. It fastens to the top of cabinet with brackets and is field-installed. Brackets are included as standard with base cabinets.

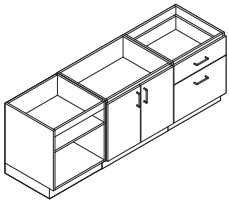

Bolts are used to align adjacent cabinets in a multi-unit configuration. The bolts can be removed and reinstalled if a different multi-unit configuration is desired.

Tip: Side of cabinet will be defaced by bolts. Exposed bolt holes will require field fix.



Filler closes the gap between a cabinet and a structural wall. Additional length worksurface will be required. Field cutting of filler and worksurface may be required to achieve architectural fit.

▶ Page 291

Surface Materials

Cabinet, drawer front, door front, and shelf

- Low-Pressure Laminate

Edges

- Matching plastic

Drawer sides

- White paint only

D pulls, contemporary, and jazz pulls

- Nickel

Opus pulls

- Champagne

Euro and five-knuckle hinges

- Nickel

Face lock

- 9201 Polished Chrome only

Filler

- Low-Pressure Laminate

Shipping

All cabinets ship fully assembled.

Application Topics

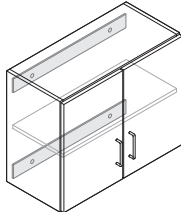

Cleat systems must be used when mounting to drywall. Mounting cleats and attachment hardware are included with upper storage cabinets. Check local codes.

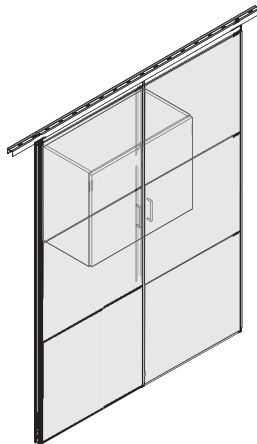

Skin configuration must allow access to V.I.A. structure in a width that matches Folio product.



Reinforcing structural beams (FEBSTR) must be specified to allow cabinet to attach off module to V.I.A. There is no weight applied to the skin itself.

▶ See *V.I.A. Specification Guide*.

Cabinets can be mounted from both faces of a structural beam.

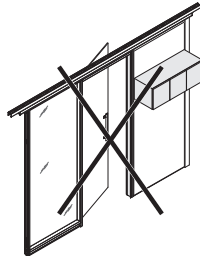

Hang-on components should not be mounted in a wall with a door frame (reversible or sliding).

Since most hang-ons are not designed to be viewed from the back, it is not recommended to mount hang-ons over glass frames except for back-painted glass.

For minimum wall construction and electrical clearances, see *Folio Technical Cut Sheet*, available at village.steelcase.com.



Folio

33"H ADA Base Cabinets

33"H ADA base cabinets provide a modular solution to meet storage needs in clinical settings. Base cabinets connect to a worksurface to create a single unit or a multicabinet wall unit.

Top of cabinet is open and requires attachment to a worksurface that is ordered separately.

Sides are finished so the cabinet can stand alone or be used in right- or left-hand positions.

Adjustable glides adjust for installation on uneven floors. Adjustability range is 1 1/2".

Small drawers have single-wall steel sides, and three quarter extension slides. Drawer configurations are available to accommodate supplies and equipment.
Tip: 36"W small drawers have full extension, heavy-duty slides to handle the additional load.

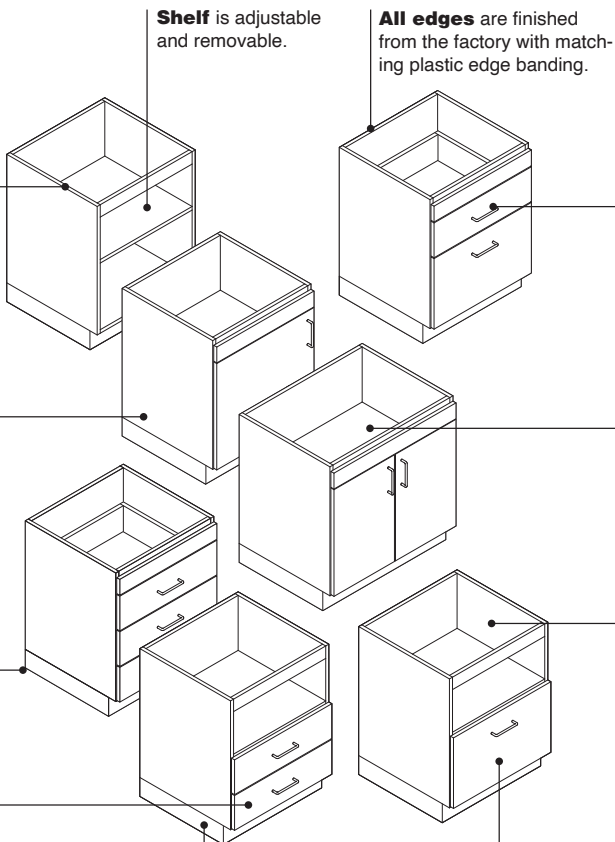

Shelf is adjustable and removable.

All edges are finished from the factory with matching plastic edge banding.

D pulls are standard on doors and drawers and are nickel only. Additional pull styles are available as an option.

Adjustable shelf is standard inside the cabinet. Shelves adjust in 1/4" increments. Additional shelves are available and must be specified separately.

The interior and exterior are finished with matching Low-Pressure Laminate.

Base elevates the cabinet and is 3 3/4"H with the glide in the lowest position.

Large drawers and 36"W small drawers have single-wall steel sides and full extension, heavy-duty slides to handle the additional load.

Actual Dimensions

Features	Overall Depth	Width	Height without Worksurface	Height with High-Pressure Laminate Worksurface	Height with Solid Worksurface
With open shelves	21 1/8"	12", 18", 21", 24", 30", or 36"	32"	33 3/16"	33"
With single door	23"	12", 18", 21", or 24"	32"	33 3/16"	33"
With double doors	23"	30" or 36"	32"	33 3/16"	33"
With drawers	23"	12", 18", 21", 24", 30", or 36"	32"	33 3/16"	33"

*Height with Solid Worksurface assumes 1/2" solid surface and 1/2" substrate. Contractor specified Solid Surface may be 1 1/2".

Product Details

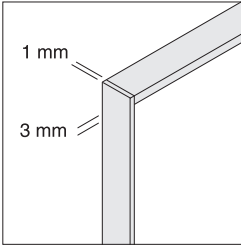

Edges on cabinets are matching 1 mm plastic edge banding. Drawer and door edges are matching 3 mm plastic edge banding.

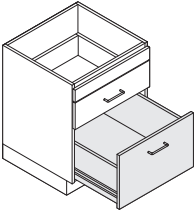

Large drawers and 36"W small drawers, when opened, extend their full depth.

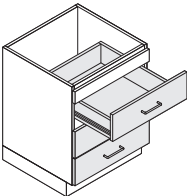

Small drawers with the exception of 36"W small drawers, when opened, extend three quarters of their depth.

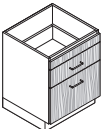
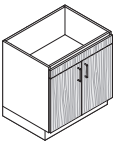

Woodgrain Low-Pressure Laminate matches on all drawer and door sets on base cabinets.

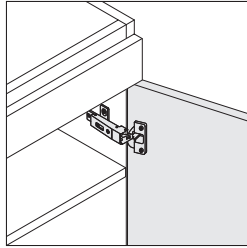

Euro hinge is standard on cabinet door and allows the door to open a full 110°.

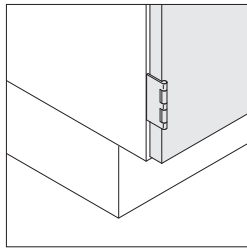

Five-knuckle hinge is optional and allows the door to open 270° or 180° if connected to adjacent cabinet.

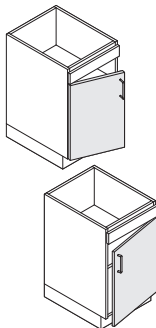

Single-door cabinets are hinged on the left or right side. A left-hand unit has the hinge on the left side of the door. A right-hand unit has the hinge on the right side of the door.

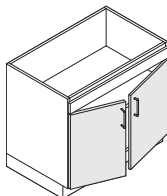

Double-door cabinets open from the center out.

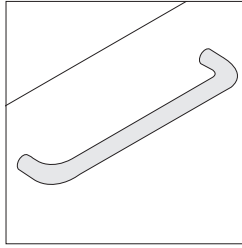

D pulls are standard.

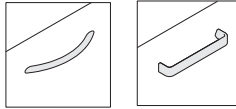

Contemporary Jazz

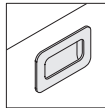

Opus

Additional door and drawer pull options are available. Optional pulls include:

- Contemporary
- Jazz
- Opus

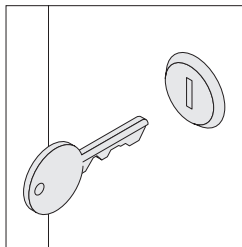

Lock is optional and factory- or field-installed to secure the doors or top drawer of the cabinet. Factory-installed locks are available keyed random only. Optional field-installed locks are available with consecutive, specific, or random keying options. Master-keyed locks are also available. Field-installed lock cylinders must be specified separately.
▶ Lock and Keying, Page 398

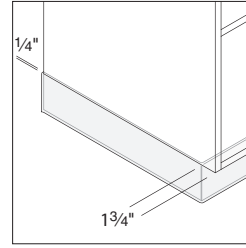

Cove molding must be field installed on base to complete installation. The front base of cabinet is recessed 1 3/4". The sides and back are set in 1/4" to allow cove molding to fit flush. Cove molding must be supplied locally.

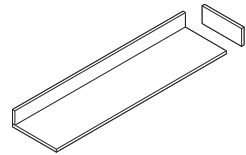

Laminate worksurface, ordered separately, is available with High-Pressure Laminate. High-Pressure Laminate has a matching 3 mm plastic front edge and 1 mm plastic edge on sides and back. Backsplash is standard with the worksurface. High-Pressure Laminate sidesplash is also available in two depths and must be ordered separately.
▶ Page 284

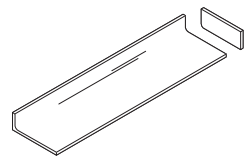

Solid surface worksurface, ordered separately, has an integrated backsplash. A solid surface sidesplash is also available in two depths and must be ordered separately.

Connections

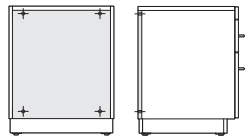

Base cabinets must always be fastened to a wall. Attachment hardware is included with cabinets.

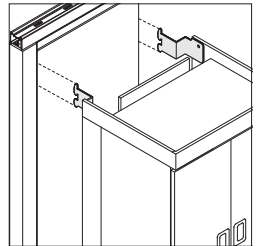

V.I.A. hang-on bracket option must be used when mounting to V.I.A. on module. Brackets include one left- and one right-hand bracket.

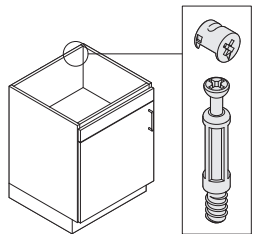

Cam-lock assembly hardware is used.

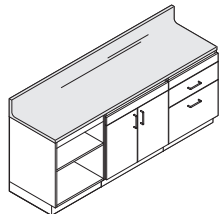

Worksurface is available to connect to one cabinet or to span multiple cabinets. It fastens to the top of cabinet with brackets and is field-installed. Brackets are included as standard with base cabinets.

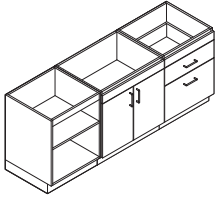

Bolts are used to align adjacent cabinets in a multi-unit configuration. The bolts can be removed and reinstalled if a different multi-unit configuration is desired.

Tip: Side of cabinet will be defaced by bolts. Exposed bolt holes will require field fix.



Filler closes the gap between a cabinet and a structural wall. Additional length worksurface will be required. Field cutting of filler and worksurface may be required to achieve architectural fit.

▶ Page 291

Surface Materials

Cabinet, drawer front, door front, and shelf

- Low-Pressure Laminate

Edges

- Matching plastic

Drawer sides

- White paint only

D pulls, contemporary, and jazz pulls

- Nickel

Opus pulls

- Champagne

Euro and five-knuckle hinges

- Nickel

Face lock

- 9201 Polished Chrome only

Shipping

All cabinets ship fully assembled.

Application Topics

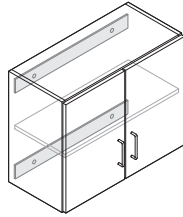

Cleat systems must be used when mounting to drywall. Mounting cleats and attachment hardware are included with upper storage cabinets. Check local codes.



Reinforcing structural beams (FEBSTR) must be specified to allow cabinet to attach off module to V.I.A. There is no weight applied to the skin itself.
▶ See *V.I.A. Specification Guide*.

Cabinets can be mounted from both faces of a structural beam.

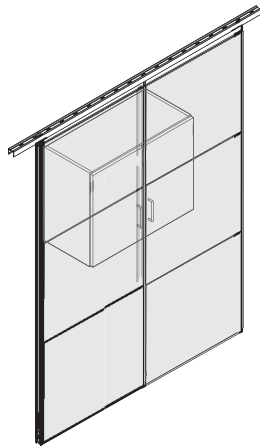

Skin configuration must allow access to V.I.A. structure in a width that matches Folio product.

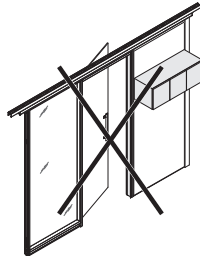

Hang-on components should not be mounted in a wall with a door frame (reversible or sliding).

Since most hang-ons are not designed to be viewed from the back, it is not recommended to mount hang-ons over glass frames except for back-painted glass.

For minimum wall construction and electrical clearances, see *Folio Technical Cut Sheet*, available at village.steelcase.com.

Folio

36"H Base Cabinets

36"H base cabinets provide a standing-height modular solution to meet storage needs in clinical settings. Base cabinets connect to a worksurface to create a single unit or a multicabinet wall unit.

Top of cabinet is open and requires attachment to a worksurface that is ordered separately.

Adjustable shelf is standard inside the cabinet. Shelves adjust in 1 1/4" increments. Additional shelves are available. They must be specified separately.

The interior and exterior are finished with matching Low-Pressure Laminate.

Base elevates the cabinet and is 3 3/4"H with the glide in the lowest position.

Sides are finished so the cabinet can stand alone or be used in right- or left-hand positions.

Shelf is adjustable and removable.

All edges are finished from the factory with matching plastic edge banding.

D pulls are standard on doors and drawers and are nickel only. Additional pull styles are available as an option.

Small drawers have single-wall steel sides, and three quarter extension slides. Drawer configurations are available to accommodate supplies and equipment.
Tip: 36"W small drawers have full extension, heavy-duty slides to handle the additional load.

Tip: Inside height dimension is 13.342".

Large drawers and 36"W small drawers have single-wall steel sides and full extension, heavy-duty slides to handle the additional load.

Tip: Inside height dimension is 13.342".

Adjustable glides adjust for installation on uneven floors. Adjustability range is 1 1/2".

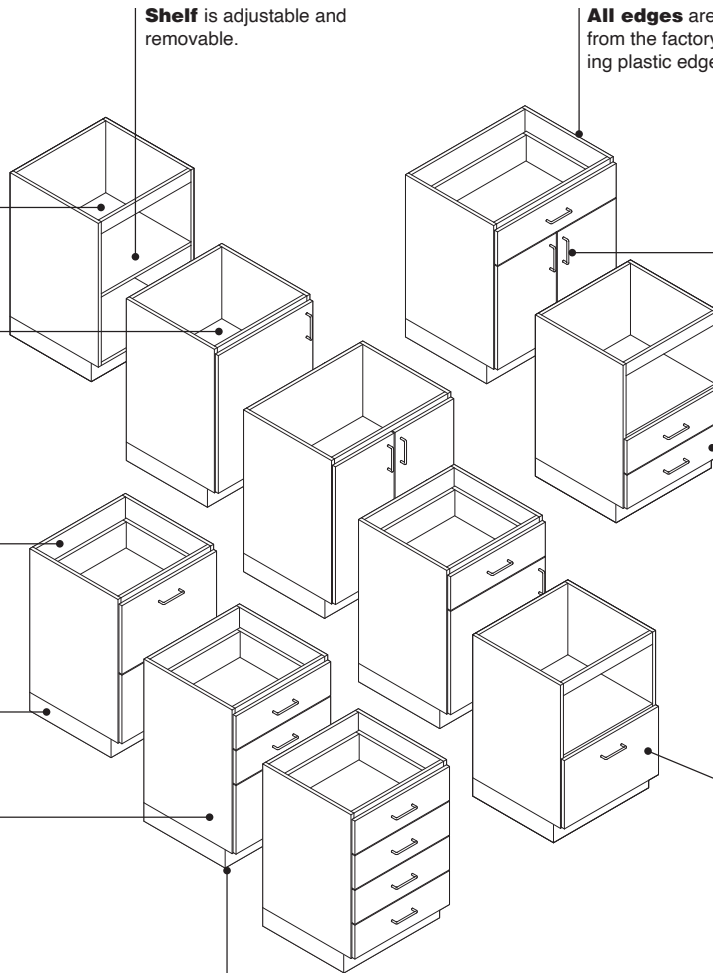

Actual Dimensions

Features	Overall Depth	Width	Height without Worksurface	Height with High-Pressure Laminate Worksurface	Height with Solid Worksurface
With open shelves	21 1/8"	12", 18", 21", 24", 30", or 36"	35"	36 3/16"	36"
With single door	23"	12", 18", 21", or 24"	35"	36 3/16"	36"
With double doors	23"	30" or 36"	35"	36 3/16"	36"
With drawers	23"	12", 18", 21", 24", 30", or 36"	35"	36 3/16"	36"

*Height with Solid Worksurface assumes 1/2" solid surface and 1/2" substrate. Contractor specified Solid Surface may be 1 1/2".

Product Details

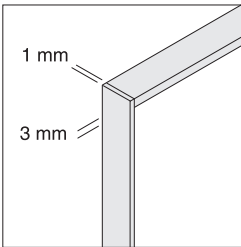

Edges on cabinets are matching 1 mm plastic edge banding. Drawer and door edges are matching 3 mm plastic edge banding.

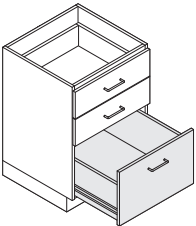

Large drawers and 36"W small drawers, when opened, extend their full depth.

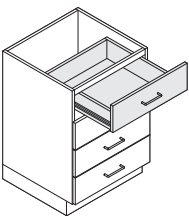

Small drawers with the exception of 36"W small drawers, when opened, extend three quarters of their depth.

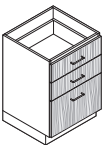
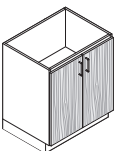

Woodgrain Low-Pressure Laminate matches on all drawer and door sets on base cabinets.

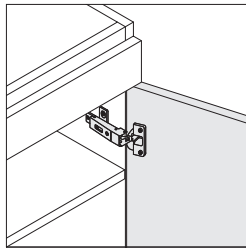

Euro hinge is standard on cabinet door and allows the door to open a full 110°.

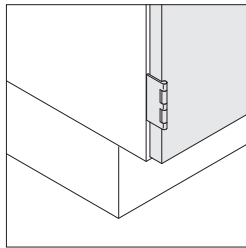

Five-knuckle hinge is optional and allows the door to open 270° or 180° if connected to adjacent cabinet.

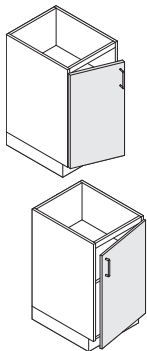

Single-door cabinets are hinged on the left or right side. A left-hand unit has the hinge on the left side of the door. A right-hand unit has the hinge on the right side of the door.

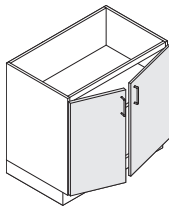

Double-door cabinets open from the center out.

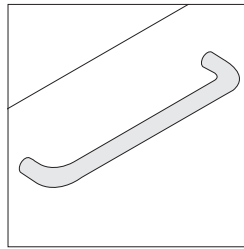

D pulls are standard.

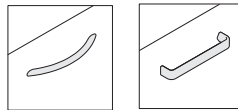

Contemporary Jazz

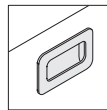

Opus

Additional door and drawer pull options are available. Optional pulls include:

- Contemporary
- Jazz
- Opus

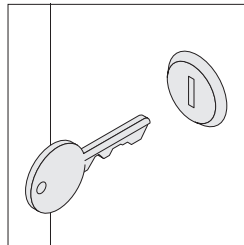

Lock is optional and factory- or field-installed to secure the doors or top drawer of the cabinet. Factory-installed locks are available keyed random only. Optional field-installed locks are available with consecutive, specific, or random keying options. Master-keyed locks are also available. Field-installed lock cylinders must be specified separately.

► Lock and Keying, Page 398

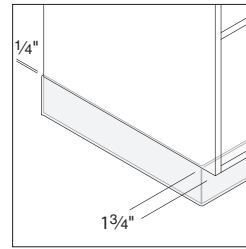

Cove molding must be field installed on base to complete installation. The front base of cabinet is recessed 1 3/4". The sides and back are set in 1/4" to allow cove molding to fit flush. Cove molding must be supplied locally.

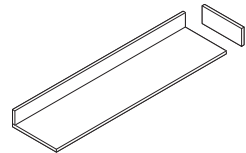

Laminate work surface, ordered separately, is available with High-Pressure Laminate. High-Pressure Laminate has a matching 3 mm plastic front edge and 1 mm plastic edge on sides and back. Backsplash is standard with the work surface. High-Pressure Laminate sidesplash is also available in two depths and must be ordered separately.

► Page 284

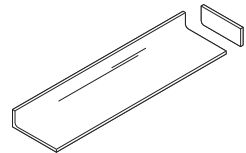

Solid surface work surface, ordered separately, has an integrated backsplash. A solid surface sidesplash is also available in two depths and must be ordered separately.

Connections

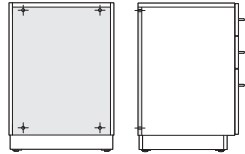

Base cabinets must always be fastened to a wall. Attachment hardware is included with cabinets.

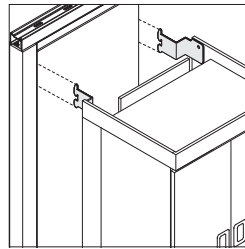

V.I.A. hang-on bracket option must be used when mounting to V.I.A. on module. Brackets include one left- and one right-hand bracket.

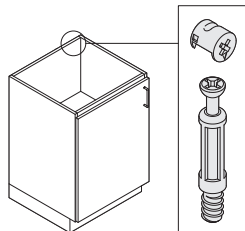

Cam-lock assembly hardware is used.

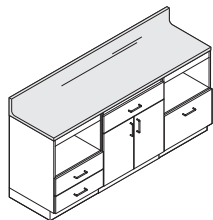

Work surface is available to connect to one cabinet or to span multiple cabinets. It fastens to the top of cabinet with brackets and is field-installed. Brackets are included as standard with base cabinets.

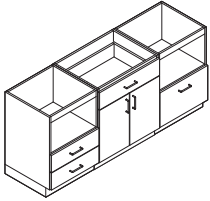

Bolts are used to align adjacent cabinets in a multi-unit configuration. The bolts can be removed and reinstalled if a different multi-unit configuration is desired.
Tip: Side of cabinet will be defaced by bolts. Exposed bolt holes will require field fix.



Filler closes the gap between a cabinet and a structural wall. Additional length worksurface will be required. Field cutting of filler and worksurface may be required to achieve architectural fit.
 ▶ Page 291

Surface Materials

Cabinet, drawer front, door front, and shelf

- Low-Pressure Laminate

Edges

- Matching plastic

Drawer sides

- White paint only

D pulls, contemporary, and jazz pulls

- Nickel

Opus pulls

- Champagne

Euro and five-knuckle hinges

- Nickel

Face lock

- 9201 Polished Chrome only

Filler

- Low-Pressure Laminate

Shipping

All cabinets ship fully assembled.

Application Topics

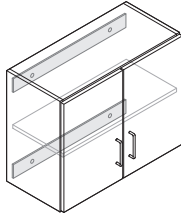

Cleat systems must be used when mounting to drywall. Mounting cleats and attachment hardware are included with upper storage cabinets. Check local codes.



Reinforcing structural beams (FEBSTR) must be specified to allow cabinet to attach off module to V.I.A. There is no weight applied to the skin itself.
 ▶ See *V.I.A. Specification Guide*.

Cabinets can be mounted from both faces of a structural beam.

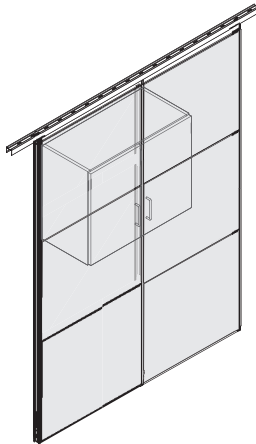

Skin configuration must allow access to V.I.A. structure in a width that matches Folio product.

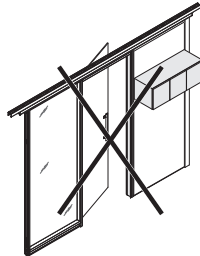

Hang-on components should not be mounted in a wall with a door frame (reversible or sliding).

Since most hang-ons are not designed to be viewed from the back, it is not recommended to mount hang-ons over glass frames except for back-painted glass.

For minimum wall construction and electrical clearances, see *Folio Technical Cut Sheet*, available at village.steelcase.com.



Folio Sink Cabinets

Sink cabinet accommodates a sink, which is independently purchased and field installed. Cabinets are available with a removable angled front or with doors.

Angled front panel can be removed without tools for easy access to plumbing and allows toe space.

The interior and exterior are finished with matching Low-Pressure Laminate.

Back of sink cabinet with angled front is open to access plumbing.

All edges are finished from the factory with matching plastic edge banding.

Top of cabinet is open and requires attachment to a worksurface that is ordered separately.

Back of sink cabinet with single door or double doors is closed.

Sides of cabinet are finished so the cabinet can be used as a single unit or be used in right- or left-hand positions.

Adjustable glides adjust for installation on uneven floors. Adjustability range is 1 1/2".

Sink cabinet front panel is fixed.

D pulls are standard on sink units with doors and are nickel only. Additional pull styles are available as an option.

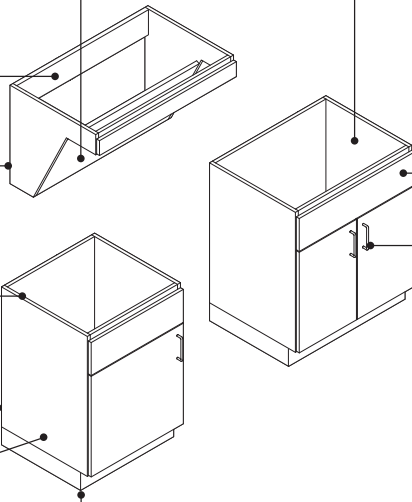

Actual Dimensions

Features	Overall Depth	Width	Inside Depth	Width	Height	Height without Worksurface	Height with High-Pressure Laminate Worksurface	Height with Solid Worksurface
33"H ADA Sink Cabinet with angled front	22 7/8"	30" or 36"	20"	32"	4 2/5"	18 3/4"	19 7/8"	19 3/4"
36"H Sink Cabinet with angled front	22 15/16"	30" or 36"	20"	32"	7 2/5"	21 3/4"	22 7/8"	22 3/4"
36"H Sink Cabinet with single door	23"	24"	21"	20"	N.A.	35"	36 3/16"	36"
36"H Sink Cabinet with double doors	23"	30" or 36"	21"	26" or 32"	N.A.	35"	36 3/16"	36"

*Height with Solid Worksurface assumes 1/2" solid surface and 1/2" substrate. Contractor specified Solid Surface may be 1 1/2".

Product Details

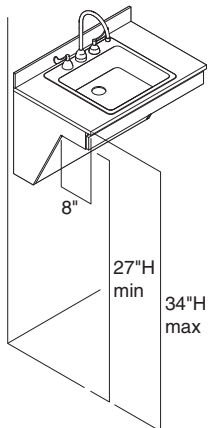

ADA sink cabinets meet the guidelines as set forth in the United States Department of Justice 2010 ADA Standards for Accessible Design (www.ada.gov/2010ADA-standards). Floor to underside of cabinet clear dimension is 27"H.

For minimum wall construction, plumbing, and electrical clearances, see *Folio Technical Cut Sheet*, available at village.steelcase.com.

ADA sink cabinets, when used in an application where adjacent casework/architecture is not present on both sides, require a special bracket called the 'Perry Bracket'. This should be acquired utilizing eSpecials.

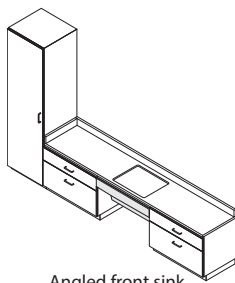

Angled front sink and base cabinet

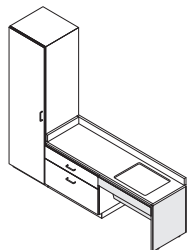

Angled front sink and end panel

Sink cabinets with angled front must be attached to an end cabinet, end panel, or wall with the ability to connect on both sides. If connected to wall, hardware will not be included.

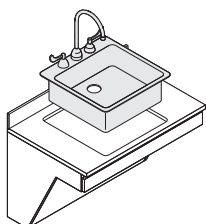

Sink must be independently purchased and field installed. Sink cutout must be cut in field.
Tip: Sink for ADA cabinet must meet ADA guidelines. Check with sink manufacturer.

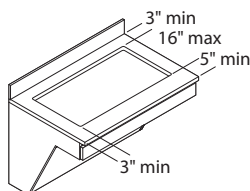

Maximum sink cutout size is 16" front to back. Minimum cutout requirements are 5" from front edge and 3" from back and side edges.

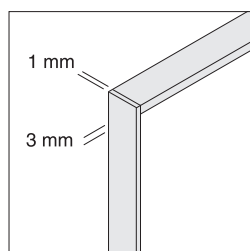

Edge, on cabinets are matching 1 mm plastic edge banding. Door edges are matching 3 mm plastic edge banding.

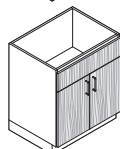
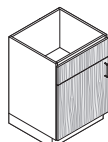

Woodgrain Low-Pressure Laminate matches on all drawer and door sets on base cabinets.

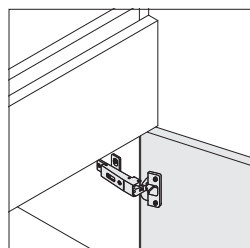

Euro hinge is standard on cabinet door and allows the door to open a full 110°.

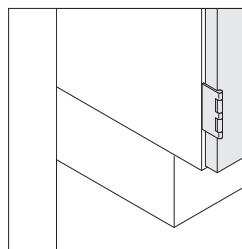

Five-knuckle hinge is optional and allows the door to open 270° or 180° if connected to adjacent cabinet.

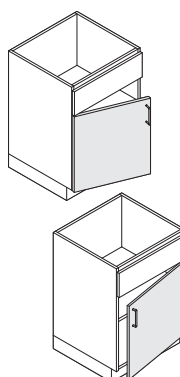

Single-door cabinets are hinged on the left or right side. A left-hand unit has the hinge on the left side of the door. A right-hand unit has the hinge on the right side of the door.

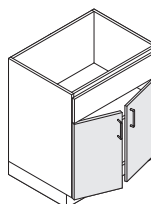

Double-door cabinets open from the center out.

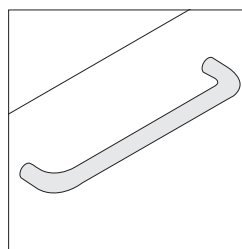

D pulls are standard.

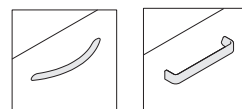

Contemporary Jazz

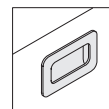

Opus

Additional door pull options are available. Optional pulls include:

- Contemporary
- Jazz
- Opus

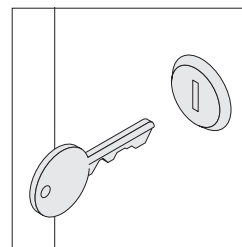

Lock is optional and factory- or field-installed to secure the doors. Factory-installed locks are available keyed random only. Optional field-installed locks are available with consecutive, specific, or random keying options. Master-keyed locks are also available. Field-installed lock cylinders must be specified separately.
▶ Lock and Keying, Page 398

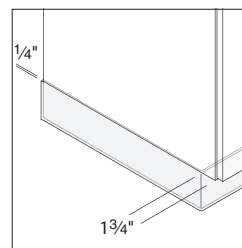

Cove molding must be field installed on base to complete installation. The front base of cabinet is recessed 1 3/4". The sides and back are set in 1/4" to allow cove molding to fit flush. Cove molding must be supplied locally. Sink cabinets with angled fronts do not extend fully to the floor and do not require cove molding.

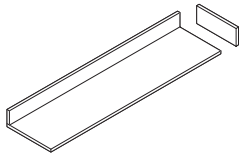

Laminate worksurface, ordered separately, is available with High-Pressure Laminate. High-Pressure Laminate has a matching 3 mm plastic front edge and 1 mm plastic edge on sides and back. Backsplash is standard with the worksurface. High-Pressure Laminate sidesplash is also available in two depths and must be ordered separately.
▶ Page 284

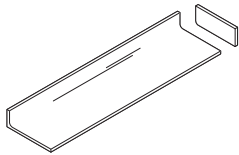

Solid surface worksurface, ordered separately, has an integrated backsplash. A solid surface sidesplash is also available in two depths and must be ordered separately.

Integrated solid sink bowl is available. Use engineering quote to specify location.

Connections

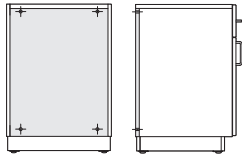

Base cabinets must always be fastened to a wall. Attachment hardware is included with cabinets.

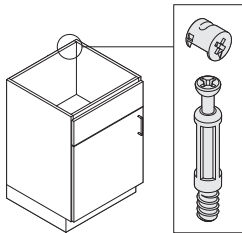

Cam-lock assembly hardware is used.

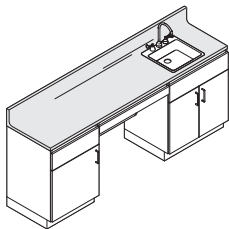

Worksurface is available to connect to one cabinet or to span multiple cabinets. It fastens to the top of cabinet with brackets and is field-installed. Brackets are included as standard with base cabinets.

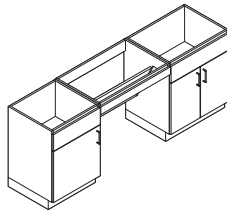

Bolts are used to align adjacent cabinets in a multi-unit configuration. The bolts can be removed and reinstalled if a different multi-unit configuration is desired.
Tip: Side of cabinet will be defaced by bolts. Exposed bolt holes will require field fix.



Filler closes the gap between a cabinet and a structural wall. Additional length worksurface will be required. Field cutting of filler and worksurface may be required to achieve architectural fit.
▶ Page 291

Surface Materials

Sink cabinet and door fronts

- Low-Pressure Laminate

Edges

- Matching plastic

D pulls, contemporary, and jazz pulls

- Nickel

Opus pulls

- Champagne

Euro and five-knuckle hinges

- Nickel

Face lock

- 9201 Polished Chrome only

Filler

- Low-Pressure Laminate

Shipping

All cabinets ship fully assembled.

Folio Corner Cabinets

Corner cabinets meet storage needs in clinical settings. Base cabinets connect to a worksurface to create a single unit or a multicabinet wall unit.

Top of cabinet is open and requires attachment to a worksurface that is ordered separately.

The interior and exterior are finished with matching Low-Pressure Laminate.

Sides are finished, but there is visible core material near the toe kick. Therefore, cabinets should not stand alone and should have an adjacent cabinet.

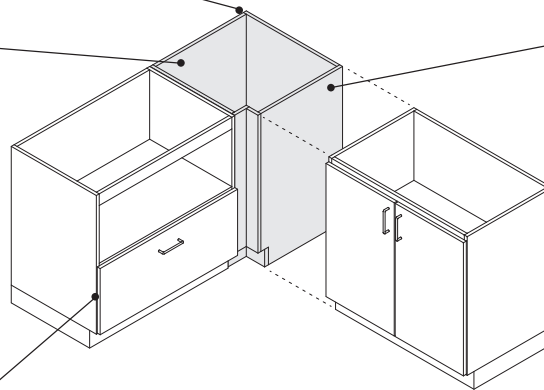

All edges are finished from the factory with matching plastic edge banding.

Actual Dimensions

Features	Overall Depth	Width	Height without Worksurface	Height with High-Pressure Laminate Worksurface	Height with Solid Worksurface
For use with 28"H base cabinet	24"	24"	27 ³ / ₈ "	28 ¹ / ₂ "	28 ³ / ₈ "
For use with 33"H base cabinet	24"	24"	32"	33 ¹ / ₈ "	33"
For use with 36"H base cabinet	24"	24"	35"	36 ¹ / ₈ "	36"

Tip: Dimensions are for reference only. See shop drawings for actual measurements at village.steelcase.com.

Product Details

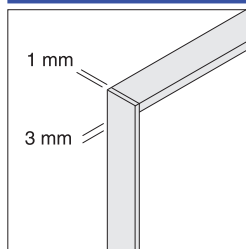

Edges on cabinets are matching 1 mm plastic edge banding.

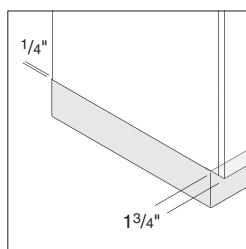

Cove molding must be field installed on base to complete installation. The front base of cabinet is recessed 1 3/4". The sides and back are set in 1/4" to allow cove molding to fit flush. Cove molding must be supplied locally.

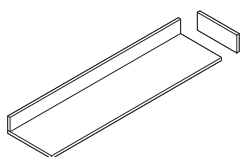

Laminate worksurface, ordered separately, is available with High-Pressure Laminate. High-Pressure Laminate has a matching 3 mm plastic front edge and 1 mm plastic edge on sides and back. Backsplash is standard with the worksurface. High-Pressure Laminate sidesplash is also available in two depths and must be ordered separately.
▶ Pages 284–287

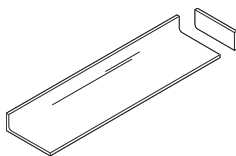

Solid surface worksurface, ordered separately, has an integrated backsplash. A solid surface sidesplash is also available in two depths and must be ordered separately.

Connections

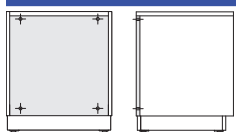

Corner cabinets must always be fastened to a wall. Attachment hardware is included with cabinets.

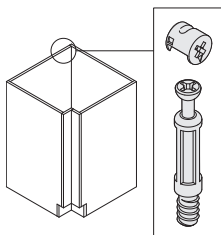

Cam-lock assembly hardware is used.

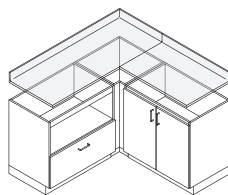

Worksurface is available to connect to one cabinet or to span multiple cabinets. It fastens to the top of cabinet with brackets and is field-installed. Brackets are included as standard with base cabinets.

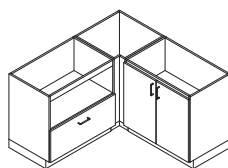

Bolts are used to align adjacent cabinets in a multi-unit configuration. The bolts can be removed and reinstalled if a different multi-unit configuration is desired.
Tip: Side of cabinet will be defaced by bolts. Exposed bolt holes will require field fix.

Surface Materials

Cabinet

- Low-Pressure Laminate

Edges

- Matching plastic

Shipping

All cabinets ship fully assembled.

Application Topics

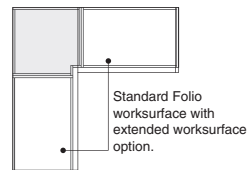
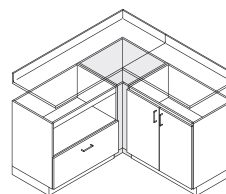

Corner cabinets support worksurfaces in a corner application. Field cutting of worksurface may be required to achieve architectural fit.

For minimum wall construction and electrical clearances, see *Folio Technical Cut Sheet*, available at village.steelcase.com.

Folio Storage Cabinets

Storage cabinets include open shelf and closed cabinet storage configurations for clinical settings. Storage cabinets are available in 84"H with flat top and 92"H with sloped top.

Top is finished.

Sides are finished.

Five shelves are standard inside the storage cabinet. One shelf is fixed at 36"H and all other shelves are adjustable. Shelves adjust in 1 1/4" increments. Additional shelves are available and must be specified separately.

Base elevates the cabinet and is 3 3/4"H with the glide in the lowest position.

The interior and exterior are finished with matching Low-Pressure Laminate.

All edges are finished from the factory with matching plastic edge banding.

Sloped top style cabinets are available to comply with certain local codes. Check local codes for specific requirements.

D pulls are standard on doors and are nickel only. Additional pull styles are available as an option.

Adjustable glides adjust for installation on uneven floors. Adjustability range is 1 1/2".

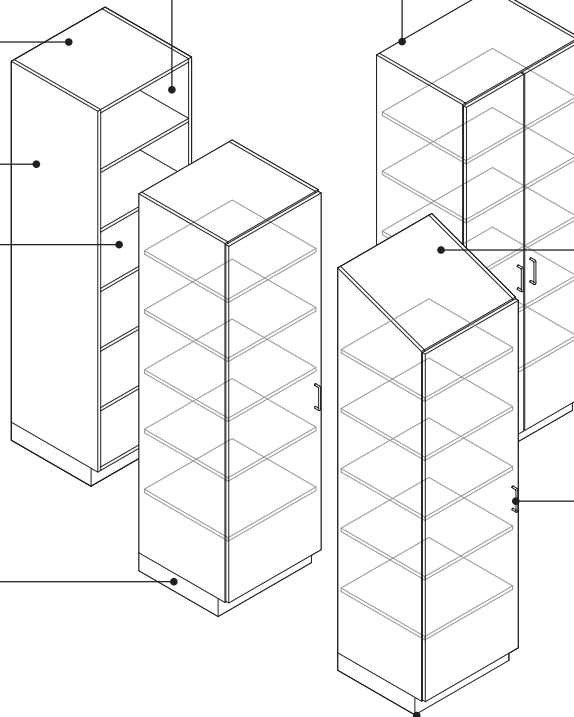

Actual Dimensions

• Features	• Overall Depth	• Width	• Height without Worksurface
Flat top with open shelves	22 1/8"	12", 18", 21", 24", 30", or 36"	84"
Flat top with single door	23"	12", 18", 21", or 24"	84"
Flat top with double doors	23"	30" or 36"	84"
Sloped top with open shelves	22 1/8"	12", 18", 21", 24", 30", or 36"	92"
Sloped top with single door	23"	12", 18", 21", or 24"	92"
Sloped top with double doors	23"	30" or 36"	92"

Tip: Dimensions are for reference only. See shop drawings for actual measurements at village.steelcase.com.

Product Details

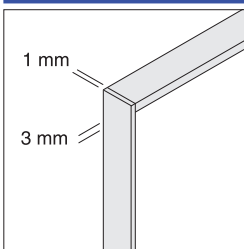

Edges on cabinets are matching 1 mm plastic edge banding. Drawer and door edges are matching 3 mm plastic edge banding.

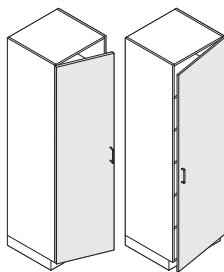

Single-door cabinets are hinged on the left or right side. A left-hand unit has the hinge on the left side of the door. A right-hand unit has the hinge on the right side of the door.

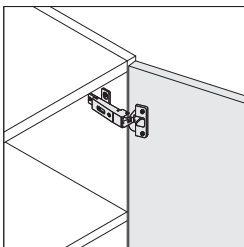

Euro hinge is standard on cabinet door and allows the door to open a full 110°.

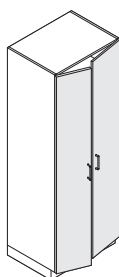

Double-door cabinets open from the center out.

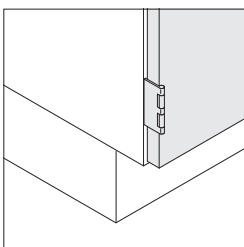

Five-knuckle hinge is optional and allows the door to open 270° or 180° if connected to adjacent cabinet.

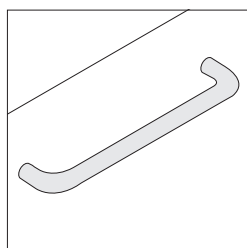

D pulls are standard.

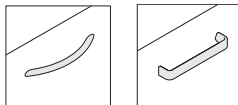

Contemporary Jazz

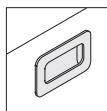

Opus

Additional door pull options are available.

Optional pulls include:

- Contemporary
- Jazz
- Opus

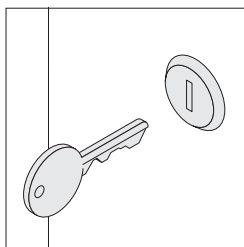

Lock is optional and factory- or field-installed to secure the doors. Factory-installed locks are available keyed random only. Optional field-installed locks are available with consecutive, specific, or random keying options. Master-keyed locks are also available. Field-installed lock cylinders must be specified separately.
▶ Lock and Keying, Page 398

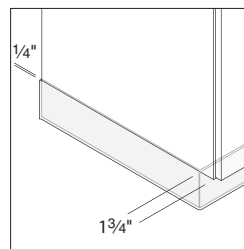

Cove molding must be field installed on base to complete installation. The front base of cabinet is recessed 1 3/4". The sides and back are set in 1/4" to allow cove molding to fit flush. Cove molding must be supplied locally.

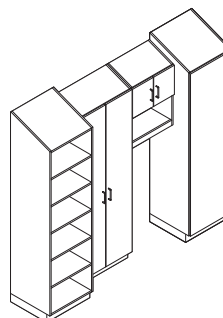

Sloped tops on storage, wardrobe, bookcase, and upper storage cabinets have a 20° slope. The height of a 24"D storage or wardrobe cabinet with a slope top is 92"H. The height of a 14"D bookcase cabinet with a sloped top or a 14"D wall-mounted upper storage cabinet with a sloped top is 89"H. The difference in heights is to allow the door fronts to align on adjacent cabinets of different depths. Storage and wardrobe cabinets are 24"D and bookcase and upper storage cabinets are 14"D. When placing a bookcase or upper storage cabinets with sloped top next to a storage or wardrobe cabinet with a sloped top, a step-down in height of 3" will result, but doors on all units will align.

Connections

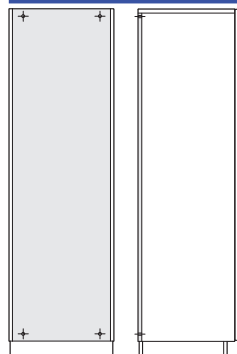

Storage cabinets must always be fastened to a wall. Attachment hardware is included with cabinets.

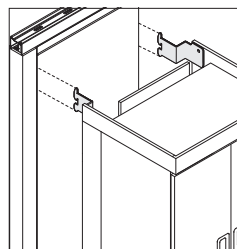

V.I.A. hang-on bracket option must be used when mounting to V.I.A. on module. Brackets include one left- and one right-hand bracket.

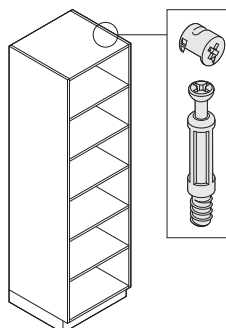

Cam-lock assembly hardware is used.

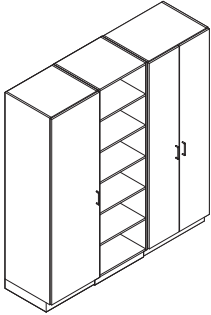

Bolts are used to align adjacent cabinets in a multi-unit configuration. The bolts can be removed and reinstalled if a different multi-unit configuration is desired.
Tip: Side of cabinet will be defaced by bolts. Exposed bolt holes will require field fix.

Surface Materials

Cabinet, door front, and shelf

- Low-Pressure Laminate

Edges

- Matching plastic

D pulls, contemporary, and jazz pulls

- Nickel

Opus pulls

- Champagne

Euro and five-knuckle hinges

- Nickel

Face lock

- 9201 Polished Chrome only

Shipping

All cabinets ship fully assembled.

Application Topics

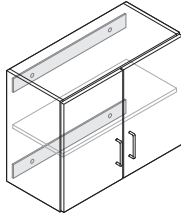

Cleat systems must be used when mounting to drywall. Mounting cleats and attachment hardware are included with upper storage cabinets. Check local codes.

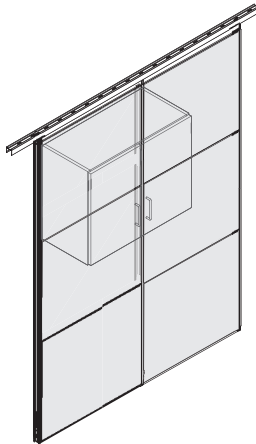

Skin configuration must allow access to V.I.A. structure in a width that matches Folio product.



Reinforcing structural beams (FEBSTR) must be specified to allow cabinet to attach off module to V.I.A. There is no weight applied to the skin itself.
 ▶ See V.I.A. Specification Guide.

Cabinets can be mounted from both faces of a structural beam.

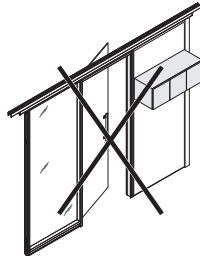

Hang-on components should not be mounted in a wall with a door frame (reversible or sliding).

Since most hang-ons are not designed to be viewed from the back, it is not recommended to mount hang-ons over glass frames except for back-painted glass.

For minimum wall construction and electrical clearances, see *Folio Technical Cut Sheet*, available at village.steelcase.com.

Folio Wardrobe Cabinets

Wardrobe cabinets offer coat and other storage for a clinical setting. Wardrobe cabinets are available in 84"H with flat top and 92"H with sloped top.

Top is finished.

The interior and exterior are finished with matching Low-Pressure Laminate.

Sloped top style cabinets are available to comply with certain local codes. Check local codes for specific requirements.

Hanger bar runs the width of the cabinet.

Sides are finished.

Base elevates the cabinet and is 3¾"H with the glide in the lowest position.

Adjustable glides adjust for installation on uneven floors. Adjustability range is 1½".

All edges are finished from the factory with matching plastic edge banding.

Shelf is fixed at 64¼"H.

D pulls are standard on doors and are nickel only. Additional pull styles are available as an option.

Product Details

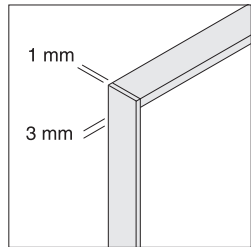

Edges on cabinets are matching 1 mm plastic edge banding. Drawer and door edges are matching 3 mm plastic edge banding.

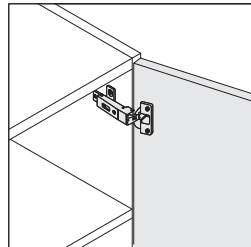

Euro hinge is standard on cabinet door and allows the door to open a full 110°.

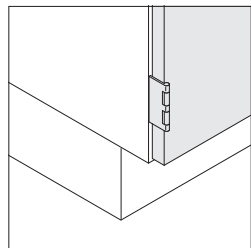

Five-knuckle hinge is optional and allows the door to open 270° or 180° if connected to adjacent cabinet.

Actual Dimensions

Features	Overall Depth	Width	Height
Flat top with single door	23"	12", 18", 21", or 24"	84"
Flat top with double doors	23"	30" or 36"	84"
Sloped top with single door	23"	12", 18", 21", or 24"	92"
Sloped top with double doors	23"	30" or 36"	92"

Tip: Dimensions are for reference only. See shop drawings for actual measurements at village.steelcase.com.

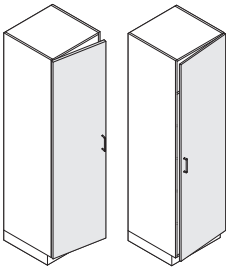

Single-door cabinets are hinged on the left or right side. A left-hand unit has the hinge on the left side of the door. A right-hand unit has the hinge on the right side of the door.

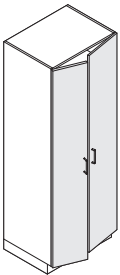

Double-door cabinets open from the center out.

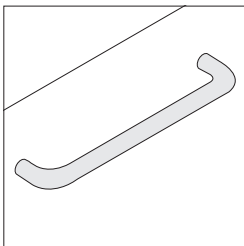

Cove molding must be field installed on base to complete installation. The front base of cabinet is recessed 1 3/4". The sides and back are set in 1/4" to allow cove molding to fit flush. Cove molding must be supplied locally.

D pulls are standard.

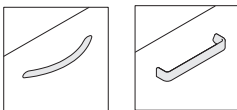

Contemporary Jazz

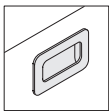

Opus

Additional door pull options are available.

- Optional pulls include:
- Contemporary
 - Jazz
 - Opus

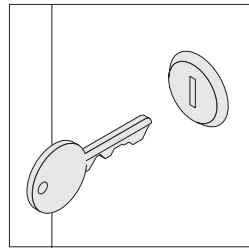

Lock is optional and factory- or field-installed to secure the doors. Factory-installed locks are available with consecutive, specific, or random keying options. Master-keyed locks are also available. Field-installed lock cylinders must be specified separately. ▶ Lock and Keying, Page 398

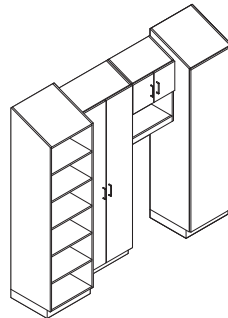

Sloped tops on storage, wardrobe, bookcase, and upper storage cabinets have a 20° slope. The height of a 24"D storage or wardrobe cabinet with a sloped top is 92"H. The height of a 14"D bookcase cabinet with a sloped top or a 14"D wall-mounted upper storage cabinet with a sloped top is 89"H. The difference in heights is to allow the door fronts to align on adjacent cabinets of different depths. Storage and wardrobe cabinets are 24"D and bookcase and upper storage cabinets are 14"D. When placing a bookcase or upper storage cabinets with sloped top next to a storage or wardrobe cabinet with a sloped top, a step-down in height of 3" will result, but doors on all units will align.

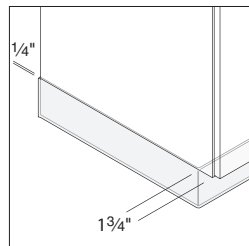

Connections

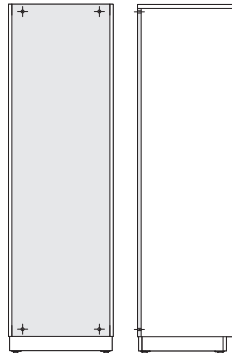

Wardrobe cabinets must always be fastened to a wall. Attachment hardware is included with cabinets.

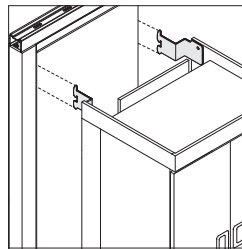

V.I.A. hang-on bracket option must be used when mounting to V.I.A. on module. Brackets include one left- and one right-hand bracket.

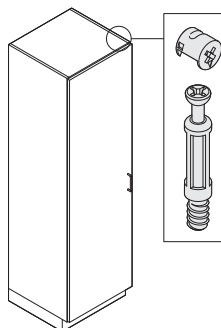

Cam-lock assembly hardware is used.

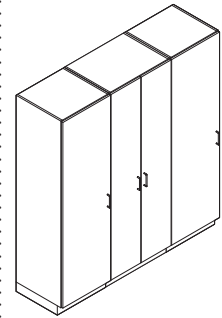

Bolts are used to align adjacent cabinets in a multi-unit configuration. The bolts can be removed and reinstalled if a different multi-unit configuration is desired. *Tip: Side of cabinet will be defaced by bolts. Exposed bolt holes will require field fix.*

Surface Materials

Cabinet, door front, and shelf

- Low-Pressure Laminate

Edges

- Matching plastic

D pulls, contemporary, and jazz pulls

- Nickel

Opus pulls

- Champagne

Euro and five-knuckle hinges

- Nickel

Hanger bar

- Black

Face lock

- 9201 Polished Chrome only

Shipping

All cabinets ship fully assembled.

Application Topics

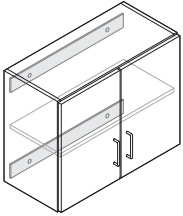

Cleat systems must be used when mounting to drywall. Mounting cleats and attachment hardware are included with upper storage cabinets. Check local codes.



Reinforcing structural beams (FEBSTR) must be specified to allow cabinet to attach off module to V.I.A. There is no weight applied to the skin itself.
▶ See *V.I.A. Specification Guide*.

Cabinets can be mounted from both faces of a structural beam.

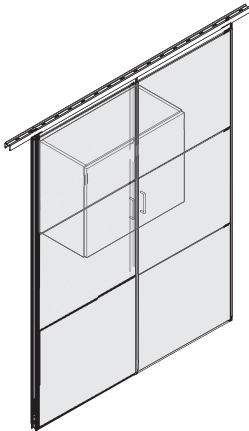

Skin configuration must allow access to V.I.A. structure in a width that matches Folio product.

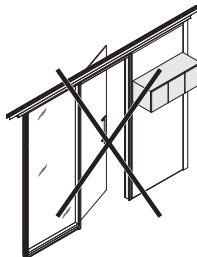

Hang-on components should not be mounted in a wall with a door frame (reversible or sliding).

Since most hang-ons are not designed to be viewed from the back, it is not recommended to mount hang-ons over glass frames except for back-painted glass.

For minimum wall construction and electrical clearances, see *Folio Technical Cut Sheet*, available at village.steelcase.com.

Folio Bookcases

Bookcases offer convenient storage for binders, books, and other objects used in a clinical setting. Bookcases are available in 84"H with flat top and 89"H with sloped top.

Top is finished.

Sides are finished.

Five shelves are standard in the bookcase. One shelf is fixed at 36"H and all other shelves are adjustable. Shelves adjust in 1¼" increments. Additional shelves are available and must be specified separately.

Base elevates the bookcase and is 3¾"H with the glide in the lowest position.

The interior and exterior are finished with matching Low-Pressure Laminate.

All edges are finished from the factory with matching plastic edge banding.

Sloped top style cabinets are available to comply with certain local codes. Check local codes for specific requirements.

D pulls are standard on doors and are nickel only. Additional pull styles are available as an option.

Adjustable glides adjust for installation on uneven floors. Adjustability range is 1½".

Actual Dimensions

Features	Overall Depth	Width	Height
Flat top with open shelves	13⅜"	12", 18", 21", 24", 30", or 36"	84"
Flat top with single door	14¼"	12", 18", 21", or 24"	84"
Flat top with double doors	14¼"	30" or 36"	84"
Sloped top with open shelves	13⅜"	12", 18", 21", 24", 30", or 36"	88⅞"
Sloped top with single door	14¼"	12", 18", 21", or 24"	88⅞"
Sloped top with double doors	14¼"	30" or 36"	88⅞"

Tip: Dimensions are for reference only. See shop drawings for actual measurements at village.steelcase.com.

Product Details

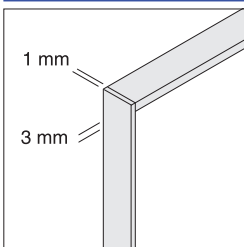

Edges on cabinets are matching 1 mm plastic edge banding. Drawer and door edges are matching 3 mm plastic edge banding.

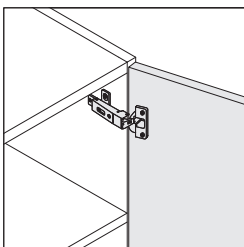

Euro hinge is standard on cabinet door and allows the door to open a full 110°.

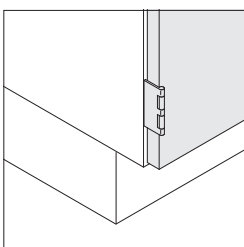

Five-knuckle hinge is optional and allows the door to open 270° or 180° if connected to adjacent cabinet.

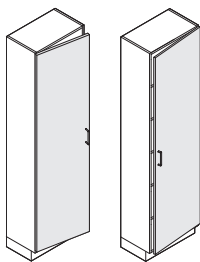

Single-door cabinets are hinged on the left or right side. A left-hand unit has the hinge on the left side of the door. A right-hand unit has the hinge on the right side of the door.

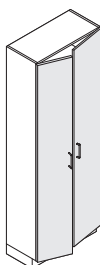

Double-door cabinets open from the center out.

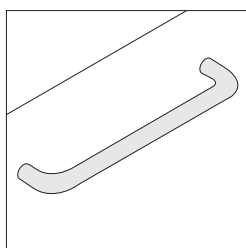

D pulls are standard.

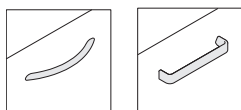

Contemporary Jazz

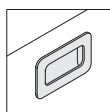

Opus

Additional door pull options are available.

- Optional pulls include:
- Contemporary
 - Jazz
 - Opus

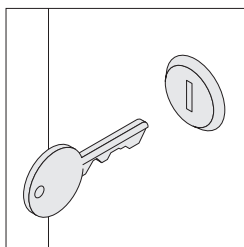

Lock is optional and factory- or field-installed to secure the doors. Factory-installed locks are available keyed random only. Optional field-installed locks are available with consecutive, specific, or random keying options. Master-keyed locks are also available. Field-installed lock cylinders must be specified separately. ▶ Lock and Keying, Page 398

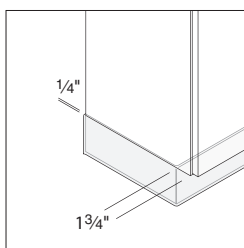

Cove molding must be field installed on base to complete installation. The front base of cabinet is recessed 1 3/4". The sides and back are set in 1/4" to allow cove molding to fit flush. Cove molding must be supplied locally.

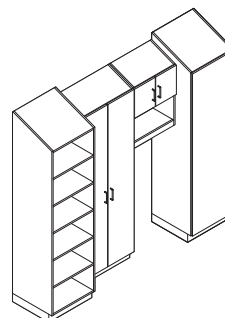

Sloped tops on storage, wardrobe, bookcase, and upper storage cabinets have a 20° slope. The height of a 24"D storage or wardrobe cabinet with a sloped top is 92"H. The height of a 14"D bookcase cabinet with a sloped top or a 14"D wall-mounted upper storage cabinet with a sloped top is 89"H. The difference in heights is to allow the door fronts to align on adjacent cabinets of different depths. Storage and wardrobe cabinets are 24"D and bookcase and upper storage cabinets are 14"D. When placing a bookcase or upper storage cabinets with sloped top next to a storage or wardrobe cabinet with a sloped top, a step-down in height of 3" will result, but doors on all units will align.

Connections

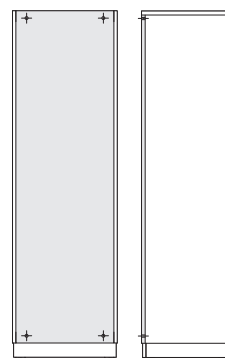

Bookcase cabinets must always be fastened to a wall. Attachment hardware is included with cabinets.

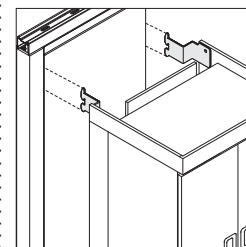

V.I.A. hang-on bracket option must be used when mounting to V.I.A. on module. Brackets include one left- and one right-hand bracket.

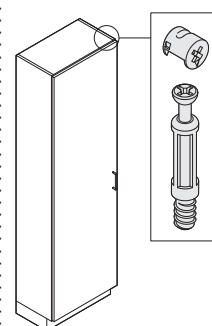

Cam-lock assembly hardware is used.

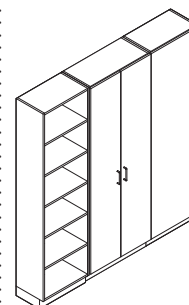

Bolts are used to align adjacent cabinets in a multi-unit configuration. The bolts can be removed and reinstalled if a different multi-unit configuration is desired. *Tip: Side of cabinet will be defaced by bolts. Exposed bolt holes will require field fix.*

Surface Materials

Cabinet, door front, and shelf

- Low-Pressure Laminate

Edges

- Matching plastic

D pulls, contemporary, and jazz pulls

- Nickel

Opus pulls

- Champagne

Euro and five-knuckle hinges

- Nickel

Face lock

- 9201 Polished Chrome only

Shipping

All cabinets ship fully assembled.

Application Topics

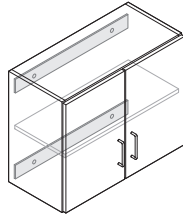

Cleat systems must be used when mounting to drywall. Mounting cleats and attachment hardware are included with upper storage cabinets. Check local codes.

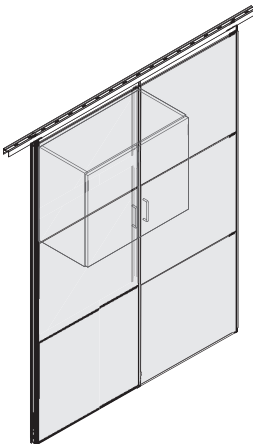

Skin configuration must allow access to V.I.A. structure in a width that matches Folio product.



Reinforcing structural beams (FEBSTR) must be specified to allow cabinet to attach off module to V.I.A. There is no weight applied to the skin itself.
▶ See *V.I.A. Specification Guide*.

Bookcases can be mounted from both faces of a structural beam.

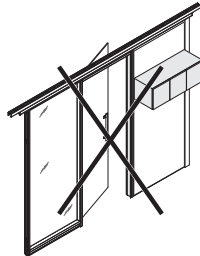

Hang-on components should not be mounted in a wall with a door frame (reversible or sliding).

Since most hang-ons are not designed to be viewed from the back, it is not recommended to mount hang-ons over glass frames except for back-painted glass.

For minimum wall construction and electrical clearances, see *Folio Technical Cut Sheet*, available at village.steelcase.com.

Folio Upper Storage Cabinets

Upper storage cabinets address storage needs above a worksurface. They are available in open shelf, closed cabinet, and combination open shelf with closed cabinet models. They are available with a flat top or sloped top.

The interior and exterior are finished with matching Low-Pressure Laminate.

Top is finished.

Shelf is adjustable and removable. Shelves adjust in 1¼" increments. Additional shelves are available and must be specified separately.

Sides are finished.

Sloped top style cabinets are available to comply with certain local codes. Check local codes for specific requirements.

D pulls are standard on doors and are nickel only. Additional pull styles are available as an option.

All edges are finished from the factory with matching plastic edge banding.

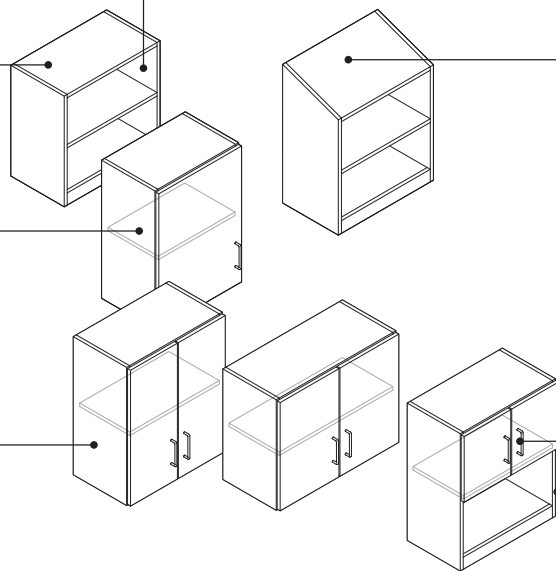

Actual Dimensions

Features	Overall Depth	Width	Height
Flat top with open shelves	13 ³ / ₈ "	12", 18", 21", 24", 30", or 36"	24" or 30"
Flat top with single door	14 ¹ / ₄ "	12", 18", or 21"	24" or 30"
Flat top with double doors	14 ¹ / ₄ "	24", 30", or 36"	24" or 30"
Flat top with double doors and open shelf	14 ¹ / ₄ "	24", 30", or 36"	30"
Sloped top with open shelves	13 ³ / ₈ "	12", 18", 21", 24", 30", or 36"	28 ⁷ / ₈ " or 34 ⁷ / ₈ "
Sloped top with single door	14 ¹ / ₄ "	12", 18", or 21"	28 ⁷ / ₈ " or 34 ⁷ / ₈ "
Sloped top with double doors	14 ¹ / ₄ "	24", 30", or 36"	28 ⁷ / ₈ " or 34 ⁷ / ₈ "
Sloped top with double doors and open shelf	14 ¹ / ₄ "	24", 30", or 36"	34 ⁷ / ₈ "

Tip: Dimensions are for reference only. See shop drawings for actual measurements at village.steelcase.com.

Product Details

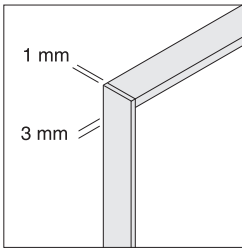

Edges on cabinets are matching 1 mm plastic edge banding. Door edges are matching 3 mm plastic edge banding.

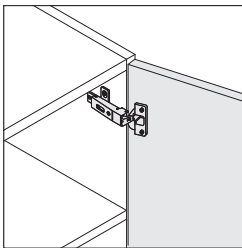

Euro hinge is standard on cabinet door and allows the door to open a full 110°.

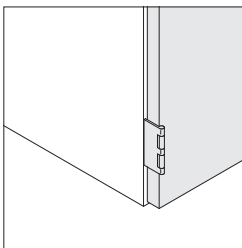

Five-knuckle hinge is optional and allows the door to open 270° or 180° if connected to adjacent cabinet.

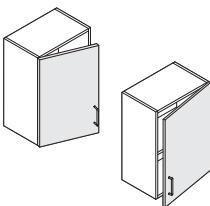

Single-door cabinets are hinged on the left or right side. A left-hand unit has the hinge on the left side of the door. A right-hand unit has the hinge on the right side of the door.

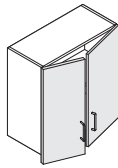

Double-door cabinets open from the center out.

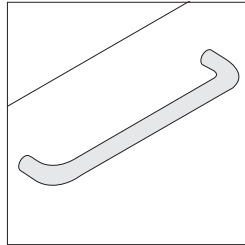

D pulls are standard.

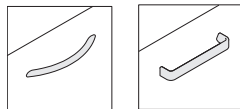

Contemporary Jazz

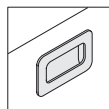

Opus

Additional door pull options are available.

- Optional pulls include:
- Contemporary
 - Jazz
 - Opus

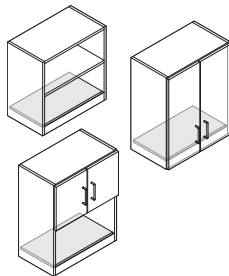

Bottom shelf is fixed on all upper storage cabinets.

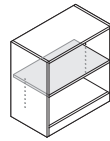

Open shelf is adjustable. 24"H units include one adjustable shelf and the 30"H units include two adjustable shelves.

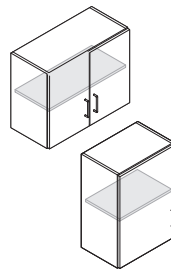

Shelf behind full door is adjustable and removable.

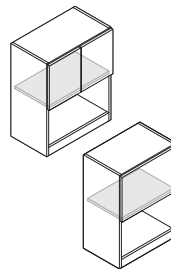

Shelf on upper storage cabinet with single or double door and open shelf is fixed.

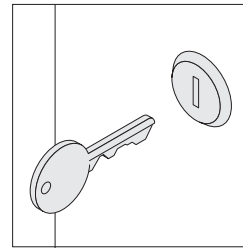

Lock is optional and factory- or field-installed to secure the doors of the cabinet. Factory-installed locks are available keyed-random only. Optional field-installed locks are available with consecutive, specific, or random keying options. Master-keyed locks are also available. Field-installed lock cylinders must be specified separately.
▶ Lock and Keying, Page 398.

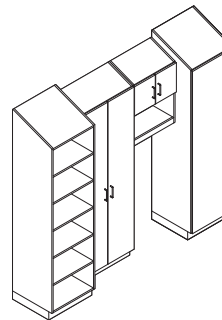

Sloped tops on storage, wardrobe, bookcase, and upper storage cabinets have a 20° slope. The height of a 24"D storage or wardrobe cabinet with a slope top is 92"H. The height of a 14"D bookcase cabinet with a sloped top or a 14"D wall-mounted upper storage cabinet with a sloped top is 89"H. The difference in heights is to allow the door fronts to align on adjacent cabinets of different depths. Storage and wardrobe cabinets are 24"D and bookcase and upper storage cabinets are 14"D. When placing a bookcase or upper storage cabinets with sloped top next to a storage or wardrobe cabinet with a sloped top, a step-down in height of 3" will result, but doors on all units will align.

Connections

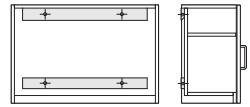

Cabinets must always be fastened to wall. It is recommended that upper storage cabinet be mounted to a wall stud. Mounting cleats and attachment hardware are included with upper storage cabinets.

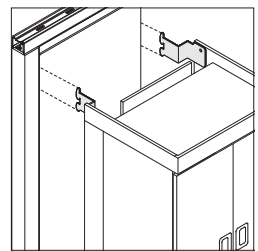

V.I.A. hang-on bracket option must be used when mounting to V.I.A. on module. Brackets include four left- and four right-hand brackets.

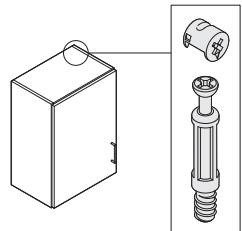

Cam-lock assembly hardware is used.

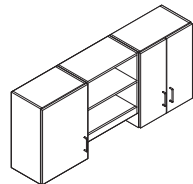

Bolts are used to align adjacent cabinets in a multi-unit configuration. The bolts can be removed and reinstalled if a different multi-unit configuration is desired.
Tip: Side of cabinet will be defaced by bolts. Exposed bolt holes will require field fix.



Filler closes the gap between an upper storage cabinet and a structural wall.

Wiring & Cabling

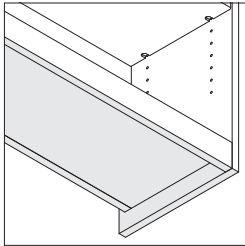

Recessed area under the cabinet provides space for task lighting that is ordered separately.

The recessed area actual dimensions are:

Cabinet Width	Recessed Area		
	Depth	Width	Height
12"	12 ¹¹ / ₁₆ "	10 ¹ / ₂ "	1 ⁷ / ₈ "
18"	12 ¹¹ / ₁₆ "	16 ¹ / ₂ "	1 ⁷ / ₈ "
21"	12 ¹¹ / ₁₆ "	19 ¹ / ₂ "	1 ⁷ / ₈ "
24"	12 ¹¹ / ₁₆ "	22 ¹ / ₂ "	1 ⁷ / ₈ "
30"	12 ¹¹ / ₁₆ "	28 ¹ / ₂ "	1 ⁷ / ₈ "
36"	12 ¹¹ / ₁₆ "	34 ¹ / ₂ "	1 ⁷ / ₈ "

Surface Materials

Cabinet, door front, and shelf

- Low-Pressure Laminate

Edges

- Matching plastic

D pulls, contemporary, and jazz pulls

- Nickel

Opus pulls

- Champagne

Euro and five-knuckle hinges

- Nickel

Face lock

- 9201 Polished Chrome only

Shipping

All cabinets ship fully assembled.

Application Topics

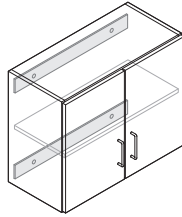

Cleat systems must be used when mounting to drywall. Mounting cleats and attachment hardware are included with upper storage cabinets. Check local codes.

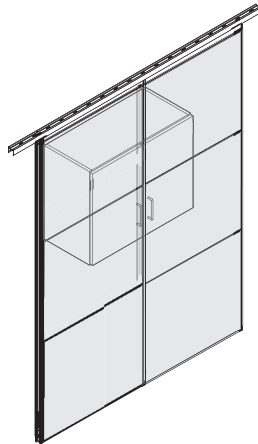

Skin configuration must allow access to V.I.A. structure in a width that matches Folio product.



Reinforcing structural beams (FEBSTR) must be specified to allow cabinet to attach off module to V.I.A. There is no weight applied to the skin itself.

▶ See *V.I.A. Specification Guide*.

Cabinets can be mounted from both faces of a structural beam.

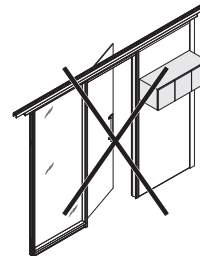

Hang-on components should not be mounted in a wall with a door frame (reversible or sliding).

Since most hang-ons are not designed to be viewed from the back, it is not recommended to mount hang-ons over glass frames except for back-painted glass.

For minimum wall construction and electrical clearances, see *Folio Technical Cut Sheet*, available at village.steelcase.com.



Folio Worksurfaces

Worksurfaces attach to the top of base or sink cabinets. They provide a writing or display surface.

Backsplash is standard with each worksurface. Laminate backsplash must be field installed. Solid surface has integrated backsplash.

Edges on High-Pressure Laminate worksurface are finished with 3 mm edge banding on front and 1 mm plastic edge banding on sides and back. High-Pressure Laminate sidesplash has 1 mm matching plastic edge banding all around.

High-Pressure Laminate worksurface and backsplash have a particle board core with a High-Pressure Laminate surface.

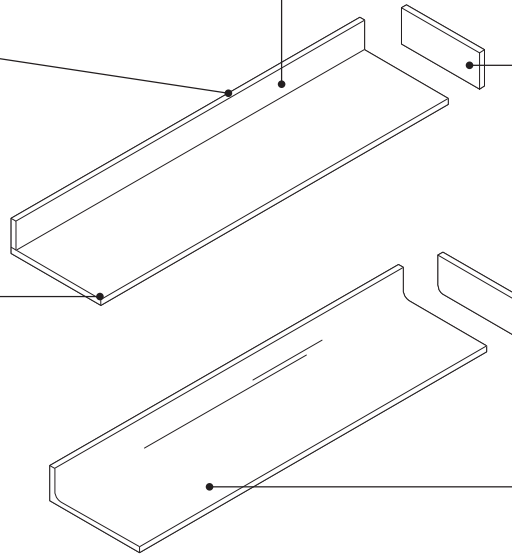

Sidesplash in High-Pressure Laminate or solid surface is available in two depths to accommodate various applications. High-Pressure Laminate sidesplash is non-handed. Solid surface sidesplash is available right- or left-handed. Sidesplashes must be ordered separately.

Solid surface worksurface with integrated backsplash is available.

Actual Dimensions

Features Depth	Overall Width	Height	
High-Pressure Laminate worksurfaces	24"	12", 18", 21", 24", 27", 30", 33", 36", 39", 42", 45", 48", 51", 54", 60", 66", 72", 78", 84", 90", 96", 102", 108", 114", or 120"	1 ³ / ₁₆ "
High-Pressure Laminate sidesplash	21", 24"	1 ³ / ₁₆ "	4"
Solid surface sidesplash	21", 24"	1/2"	4"
Solid worksurfaces	24"	12", 18", 21", 24", 27", 30", 33", 36", 39", 42", 45", 48", 51", 54", 60", 66", 72", 78", 84", 90", 96", 102", 108", 114", or 120"	1"

Tip: Dimensions are for reference only. See shop drawings for actual measurements at village.steelcase.com.

Product Details

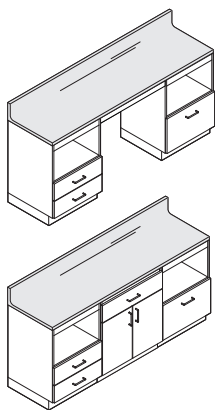

Worksurface can attach to the top of one base cabinet or desk frame, or it can span multiple storage cabinets to create a wall unit.

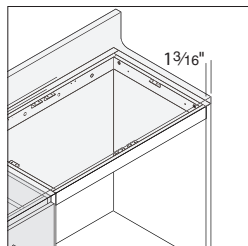

Extended worksurface option is available and adds 1³/₁₆" length to the worksurface for attachment to one support end panel. Support end panel must be ordered separately.

Tip: 12"W, 18"W, 21"W, and 120"W worksurfaces are not available with the extended worksurface option.

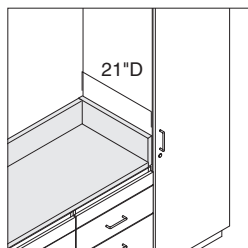

Overall length of 21"D sidesplash is intended to be used adjacent to tall cabinets to eliminate interaction with doors.

Connections

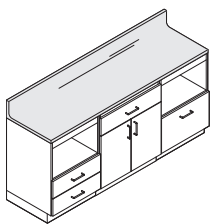

Brackets are used to attach the worksurface to the base cabinet in the field. Brackets are included as standard with base cabinets.

Integrated sink bowls for solid surface worksurfaces can be coordinated through Specials.

Field support from a third party is often required for drop-in or under-mount stainless steel sink bowls with the High-Pressure Laminate worksurfaces. Careful coordination is required to ensure the sink sizes match the cutout sizes in the worksurfaces and that the sinks are appropriately sized to fit in the sink base cabinet.

Surface Materials

Worksurface, backsplash, and sidesplash

- High-Pressure Laminate
- Solid surface

Tip: Select Surface solid surfaces are available.

▶ See Surface Materials section for complete listing.

Edges

- Plastic on High-Pressure Laminate worksurface

Folio Desk Frames

Desk frames attach under a worksurface and to an adjacent base or sink cabinet or structural wall to create a desk or garage configuration to store carts or other items.

Worksurface must be attached to a desk frame. Specify worksurface separately.

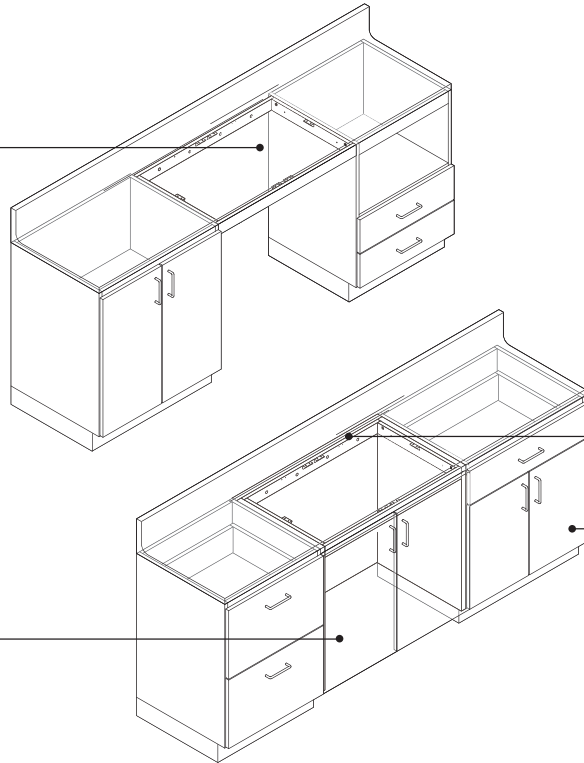

Desk frames are available with or without a back panel.

Base or sink cabinet or structural wall must be attached to one or both sides of a desk frame.

Doors are optional on desk frames with back panels to create a garage application.

Actual Dimensions

	Without Back Panel	With Back Panel
Depth	22 ¹ / ₈ "	22 ¹ / ₈ "
Width	12", 18", 24", 30", 36", 42", 48", 54", 60", or 72"	24", 30", or 36"
Height	2 ⁵ / ₈ "	35"

Tip: Dimensions are for reference only. See shop drawings for actual measurements at village.steelcase.com.

Product Details

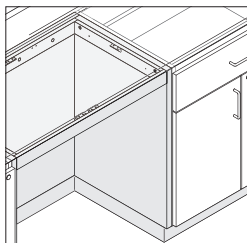

When desk frame with back panel is selected, side panels are included. This unit is nominally 31" in height, it is meant to be used in conjunction with the 35"H base cabinets or end panels. It is not meant to be freestanding, nor to be used on the end of a run with additional support. Side and back panels extend to the top of the base of the adjacent cabinet to allow for easy installation of the cove molding.

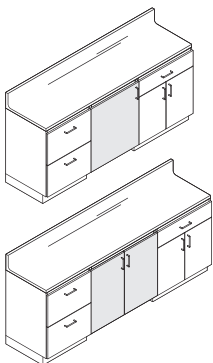

Doors are optional on desk frames with back panels. Single doors, hinged left or right, are available on 24"W desk frames. Double doors are available on 30"W and 36"W desk frames.

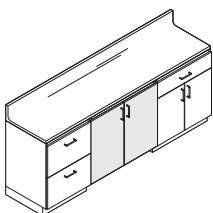

Doors align with doors on adjacent cabinets to allow visual access at floor level.

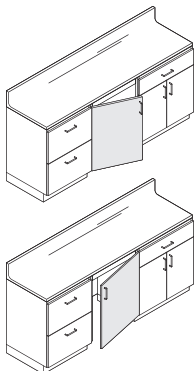

Desk frames with the single-door option are hinged on the left or right side. A left-hand unit has the hinge on the left side of the door. A right-hand unit has the hinge on the right side of the door.

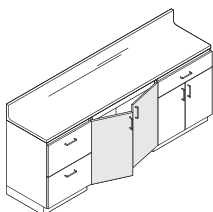

Desk frames with the double-door option open from the center out.

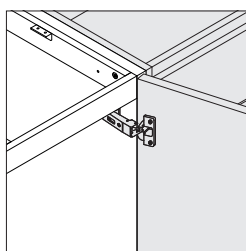

Euro hinge is standard on units with doors and allows the door to open a full 110°.

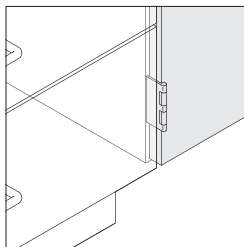

Five-knuckle hinge is optional on units with doors and allows the door to open 270° or 180° if connected to adjacent cabinet.

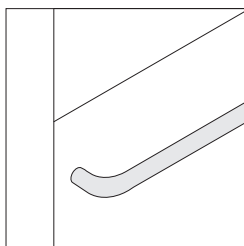

D pulls are standard when doors are specified.

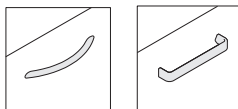

Contemporary Jazz

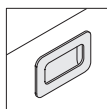

Opus

Additional door pull options are available.

Optional pulls include:

- Contemporary
- Jazz
- Opus

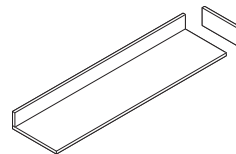

Laminate worksurface, ordered separately, is available with High-Pressure Laminate. High-Pressure Laminate has a matching 3 mm plastic front edge and 1 mm plastic edge on sides and back. Backsplash is standard with the worksurface. High-Pressure Laminate sidesplash is also available in two depths and must be ordered separately. ▶ Pages 284–287

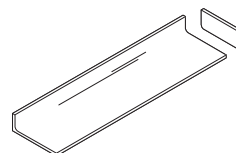

Solid surface worksurface, ordered separately, has an integrated backsplash. A solid surface sidesplash in two depths is also available and must be ordered separately.

Connections

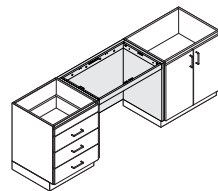

Base or sink cabinets, or structural wall, must be attached to one or both sides of desk frame.

When utilizing end panels on both sides of the desk frame, anchoring end panels to the floor and the desk frame to the architectural wall is required. If end panels cannot be anchored to the floor, angle brackets can be used to secure the end panel to the rear architectural wall.

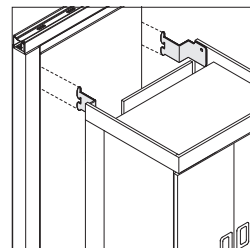

V.I.A. hang-on bracket option must be used when mounting to V.I.A. on module. Brackets include one left- and one right-hand bracket.

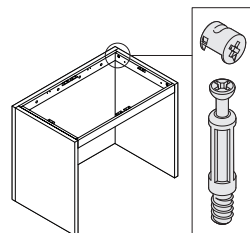

Cam-lock assembly hardware is used.

Surface Materials

Desk frame

- Low-Pressure Laminate

D pulls, contemporary, and jazz pulls

- Nickel

Opus pulls

- Champagne

Euro and five-knuckle hinges

- Nickel

Application Topics



Reinforcing structural beams (FEBSTR) must be specified to allow cabinet to attach off module to V.I.A. There is no weight applied to the skin itself.

▶ See *V.I.A. Specification Guide*.

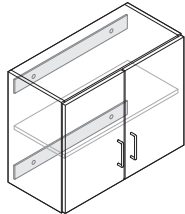

Cleat systems must be used when mounting to drywall. Mounting cleats and attachment hardware are included with upper storage cabinets. Check local codes.

Cabinets can be mounted from both faces of a structural beam.

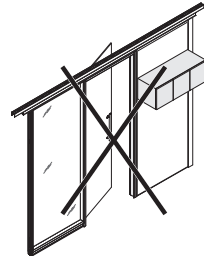

Hang-on components should not be mounted in a wall with a door frame (reversible or sliding).

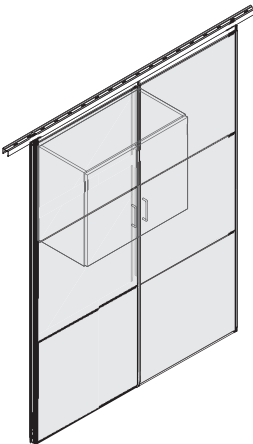

Skin configuration must allow access to V.I.A. structure in a width that matches Folio product.

Since most hang-ons are not designed to be viewed from the back, it is not recommended to mount hang-ons over glass frames except for back-painted glass.

For minimum wall construction and electrical clearances, see *Folio Technical Cut Sheet*, available at village.steelcase.com.

Storage Shelves

► Specifying, page 290

Product Details



Extra shelves are available for use in storage cabinets, bookcases, upper storage cabinets, and base cabinets.

Surface Materials

Shelves

- Low-Pressure Laminate

Actual Dimensions

Depth	12 ¹ / ₂ " or 21 ³ / ₈ "
Width	12", 18", 21", 24", 30", or 36"

Tip: Dimensions are for reference only. See shop drawings for actual measurements at village.steelcase.com.

Fillers

► Specifying, page 291

Product Details



Fillers are available for use with base cabinets and upper storage cabinets.

Fillers close the gap between a cabinet and structural wall. Field cutting of filler may be required to achieve architectural fit.

Surface Materials

Fillers

- Low-Pressure Laminate

Actual Dimensions

Fillers	
Depth	5 ³ / ₄ ", 13 ³ / ₈ ", 21 ⁷ / ₈ ", 22 ¹ / ₈ "
Width	6"
Height	24", 29", 30", 33", 35", 36", 84", or 92"

Tip: Fillers may be field cut from 1" to 6" wide.

Tip: Dimensions are for reference only. See shop drawings for actual measurements at village.steelcase.com.

Mounting Board

► Specifying, page 292

Product Details

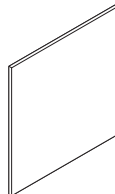

Mounting boards are available to provide a surface for equipment attachment.

Surface Materials

Mounting board

- Low-Pressure Laminate

Actual Dimensions

Depth	3/4"
Width	34"
Height	36"

Tip: Dimensions are for reference only. See shop drawings for actual measurements at village.steelcase.com.

Folio

Storage Capacities

Cabinets with Adjustable Shelves

28"H Cabinet

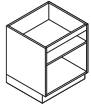

Size	Inside Dimensions		
	D	W	H
12"W Cabinet	20½"	10½"	20½"
18"W Cabinet	20½"	16½"	20½"
21"W Cabinet	20½"	19½"	20½"
24"W Cabinet	20½"	22½"	20½"
30"W Cabinet	20½"	28½"	20½"
36"W Cabinet	20½"	34½"	20½"

33"H ADA Cabinet

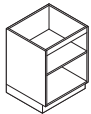

Size	Inside Dimensions		
	D	W	H
12"W Cabinet	20½"	10½"	25"
18"W Cabinet	20½"	16½"	25"
21"W Cabinet	20½"	19½"	25"
24"W Cabinet	20½"	22½"	25"
30"W Cabinet	20½"	28½"	25"
36"W Cabinet	20½"	34½"	25"

36"H Cabinet

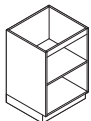

Size	Inside Dimensions		
	D	W	H
12"W Cabinet	20½"	10½"	28"
18"W Cabinet	20½"	16½"	28"
21"W Cabinet	20½"	19½"	28"
24"W Cabinet	20½"	22½"	28"
30"W Cabinet	20½"	28½"	28"
36"W Cabinet	20½"	34½"	28"

Note: Shelf adjusts in 1¼" vertical increments.

Note: Height of adjustable shelf is ¾".

Tip: Dimensions are for reference only. See shop drawings for actual measurements at village.steelcase.com.

Cabinets with Drawers

7³/₈"H Small Drawer

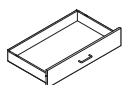

Size	Inside Dimensions		
	D	W	H
12"W Cabinet	19 ³ / ₁₆ "	9 ¹ / ₄ "	4"
18"W Cabinet	19 ³ / ₁₆ "	15 ¹ / ₄ "	4"
21"W Cabinet	19 ³ / ₁₆ "	18 ¹ / ₄ "	4"
24"W Cabinet	19 ³ / ₁₆ "	21 ¹ / ₄ "	4"
30"W Cabinet	19 ³ / ₁₆ "	27 ¹ / ₄ "	4"
36"W Cabinet	19 ³ / ₁₆ "	33 ¹ / ₄ "	4"

14⁷/₈"H Large Drawer

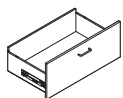

Size	Inside Dimensions		
	D	W	H
12"W Cabinet	19 ¹ / ₄ "	9 ¹ / ₄ "	7 ⁷ / ₈ "
18"W Cabinet	19 ¹ / ₄ "	15 ¹ / ₄ "	7 ⁷ / ₈ "
21"W Cabinet	19 ¹ / ₄ "	18 ¹ / ₄ "	7 ⁷ / ₈ "
24"W Cabinet	19 ¹ / ₄ "	21 ¹ / ₄ "	7 ⁷ / ₈ "
30"W Cabinet	19 ¹ / ₄ "	27 ¹ / ₄ "	7 ⁷ / ₈ "
36"W Cabinet	19 ¹ / ₄ "	33 ¹ / ₄ "	7 ⁷ / ₈ "

Tip: Dimensions are for reference only. See shop drawings for actual measurements at village.steelcase.com.

Cabinets with Fixed Open Shelf

Fixed Open Shelf in 33"H ADA Cabinet



Size	Inside Dimensions		
	D	W	H
12"W Cabinet	21 ¹ / ₄ "	10 ¹ / ₂ "	10 ¹ / ₄ "
18"W Cabinet	21 ¹ / ₄ "	16 ¹ / ₂ "	10 ¹ / ₄ "
21"W Cabinet	21 ¹ / ₄ "	19 ¹ / ₂ "	10 ¹ / ₄ "
24"W Cabinet	21 ¹ / ₄ "	22 ¹ / ₂ "	10 ¹ / ₄ "
30"W Cabinet	21 ¹ / ₄ "	28 ¹ / ₂ "	10 ¹ / ₄ "
36"W Cabinet	21 ¹ / ₄ "	34 ¹ / ₂ "	10 ¹ / ₄ "

Fixed Open Shelf in 36"H Cabinet

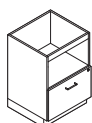

Size	Inside Dimensions		
	D	W	H
12"W Cabinet	21 ¹ / ₄ "	10 ¹ / ₂ "	13 ¹ / ₄ "
18"W Cabinet	21 ¹ / ₄ "	16 ¹ / ₂ "	13 ¹ / ₄ "
21"W Cabinet	21 ¹ / ₄ "	19 ¹ / ₂ "	13 ¹ / ₄ "
24"W Cabinet	21 ¹ / ₄ "	22 ¹ / ₂ "	13 ¹ / ₄ "
30"W Cabinet	21 ¹ / ₄ "	28 ¹ / ₂ "	13 ¹ / ₄ "
36"W Cabinet	21 ¹ / ₄ "	34 ¹ / ₂ "	13 ¹ / ₄ "

Tip: Dimensions are for reference only. See shop drawings for actual measurements at village.steelcase.com.

Sink Cabinets

33"H ADA Cabinet

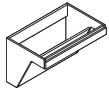

Size	Inside Dimensions		
	D	W	H
30"W Cabinet	20 ¹ / ₈ "	28 ¹ / ₂ "	18 ³ / ₄ "
36"W Cabinet	20 ¹ / ₈ "	34 ¹ / ₂ "	18 ³ / ₄ "

36"H Cabinet

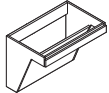

Size	Inside Dimensions		
	D	W	H
30"W Cabinet	20 ¹ / ₈ "	28 ¹ / ₂ "	21 ³ / ₄ "
36"W Cabinet	20 ¹ / ₈ "	34 ¹ / ₂ "	21 ³ / ₄ "

Tip: Dimensions are for reference only. See shop drawings for actual measurements at village.steelcase.com.

Storage Cabinets

84"H or 92"H Cabinet

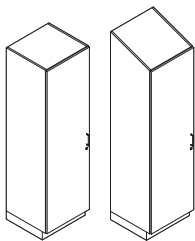

Size	Inside Dimensions			Height Below Fixed 36"H Shelf
	D	W	Height Above Fixed 36"H Shelf	
12"W Cabinet	21 ¹ / ₄ "	10 ¹ / ₂ "	47 ¹ / ₄ "	30 ³ / ₄ "
18"W Cabinet	21 ¹ / ₄ "	16 ¹ / ₂ "	47 ¹ / ₄ "	30 ³ / ₄ "
21"W Cabinet	21 ¹ / ₄ "	19 ¹ / ₂ "	47 ¹ / ₄ "	30 ³ / ₄ "
24"W Cabinet	21 ¹ / ₄ "	22 ¹ / ₂ "	47 ¹ / ₄ "	30 ³ / ₄ "
30"W Cabinet	21 ¹ / ₄ "	28 ¹ / ₂ "	47 ¹ / ₄ "	30 ³ / ₄ "
36"W Cabinet	21 ¹ / ₄ "	34 ¹ / ₂ "	47 ¹ / ₄ "	30 ³ / ₄ "

Tip: One shelf is fixed at 36"H.

Note: Shelf adjusts in 1¹/₄" vertical increments with the exception of the middle shelf.

Note: Height of adjustable shelf is 3³/₄".

Tip: Dimensions are for reference only. See shop drawings for actual measurements at village.steelcase.com.

Wardrobe Cabinets

84"H or 92"H Cabinet

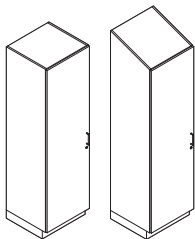

Size	Inside Dimensions			Height Below Fixed Shelf (Wardrobe Area)
	D	W	Height Above Fixed Shelf	
12"W Cabinet	21 ¹ / ₄ "	10 ¹ / ₂ "	13"	64 ¹³ / ₁₆ "
18"W Cabinet	21 ¹ / ₄ "	16 ¹ / ₂ "	13"	64 ¹³ / ₁₆ "
21"W Cabinet	21 ¹ / ₄ "	19 ¹ / ₂ "	13"	64 ¹³ / ₁₆ "
24"W Cabinet	21 ¹ / ₄ "	22 ¹ / ₂ "	13"	64 ¹³ / ₁₆ "
30"W Cabinet	21 ¹ / ₄ "	28 ¹ / ₂ "	13"	64 ¹³ / ₁₆ "
36"W Cabinet	21 ¹ / ₄ "	34 ¹ / ₂ "	13"	64 ¹³ / ₁₆ "

Tip: Dimensions are for reference only. See shop drawings for actual measurements at village.steelcase.com.

Bookcases

84"H or 89"H Bookcase

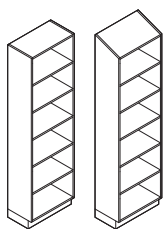

Size	Inside Dimensions			Height Above Fixed 36"H Shelf	Height Below Fixed 36"H Shelf
	D	W	H		
12"W Bookcase	11¼"	10½"	47¼"	30¾"	
18"W Bookcase	11¼"	16½"	47¼"	30¾"	
21"W Bookcase	11¼"	19½"	47¼"	30¾"	
24"W Bookcase	11¼"	22½"	47¼"	30¾"	
30"W Bookcase	11¼"	28½"	47¼"	30¾"	
36"W Bookcase	11¼"	34½"	47¼"	30¾"	

Tip: One shelf is fixed at 36"H.

Note: Shelf adjusts in 1¼" vertical increments with the exception of the middle shelf.

Note: Height of adjustable shelf is ¾".

Tip: Dimensions are for reference only. See shop drawings for actual measurements at village.steelcase.com.

Upper Storage Cabinets

24"H or 29"H Cabinet

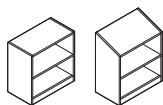

Size	Inside Dimensions		
	D	W	H
12"W Cabinet	11⅞"	10½"	20½"
18"W Cabinet	11⅞"	16½"	20½"
21"W Cabinet	11⅞"	19½"	20½"
24"W Cabinet	11⅞"	22½"	20½"
30"W Cabinet	11⅞"	28½"	20½"
36"W Cabinet	11⅞"	34½"	20½"

Tip: 24"H units include one adjustable shelf and the 30"H units include two adjustable shelves.

30"H or 35"H Cabinet

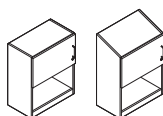

Size	Inside Dimensions		
	D	W	H
12"W Cabinet	11⅞"	10½"	26½"
18"W Cabinet	11⅞"	16½"	26½"
21"W Cabinet	11⅞"	19½"	26½"
24"W Cabinet	11⅞"	22½"	26½"
30"W Cabinet	11⅞"	28½"	26½"
36"W Cabinet	11⅞"	34½"	26½"

Note: Shelf adjusts in 1¼" vertical increments.

Note: Height of adjustable shelf is ¾".

Tip: Dimensions are for reference only. See shop drawings for actual measurements at village.steelcase.com.

Folio

28"H Base Cabinets

	Standard Includes	Required to Specify
▶ Need help? Product details, page 212	<ul style="list-style-type: none"> Base cabinet, door and drawer fronts, and shelves: Low-Pressure Laminate D pull, if selected: nickel only Euro hinge, if selected: nickel only Edges: matching 3 mm plastic on doors and drawers and matching 1 mm plastic on all other edges Shelf pins Adjustable glides 	1 Style number 2 Laminate color number for base cabinet 3 Options, if selected (see below) ▶ See <i>Surface Materials</i> , page 375.

Tip: The V.I.A. bracket must be used when a single cabinet is mounted to V.I.A. on module. V.I.A. attachment bracket is not required when mounting off module. Check local codes.
 ▶ See Application Topics page 214

Tip: Lock secures top drawer only on units with multiple drawers or a drawer and door combination.

Tip: Additional shelves are available and must be specified separately.

Tip: Dimensions are for reference only. See shop drawings for actual measurements at village.steelcase.com.

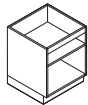

Tip: Height is for base cabinet without work surface.

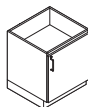
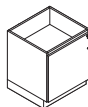

	Options	U.S. Price	Required to Specify
Door and Drawer Pulls	<ul style="list-style-type: none"> Contemporary: nickel only Opus: champagne only Jazz: nickel only 	No cost +\$26 per pull +\$28 per pull	Specify with <i>contemporary pull</i> . Specify with <i>Opus pull</i> . Specify with <i>jazz pull</i> .
Five-Knuckle Hinges	<ul style="list-style-type: none"> For cabinet with single door: nickel only For cabinet with double doors: nickel only 	+\$35 +\$70	Specify with <i>five-knuckle hinge</i> . Specify with <i>five-knuckle hinge</i> .
V.I.A. Bracket	<ul style="list-style-type: none"> Attachment brackets 	+\$52	Specify with <i>V.I.A. hang-on brackets</i> .
Lock and Keying	Lock <ul style="list-style-type: none"> 9201 Polished Chrome only Keying <ul style="list-style-type: none"> Factory and field-installed keying 	+\$52	Specify with <i>lock</i> . ▶ Page 398
Related Products	<ul style="list-style-type: none"> Shelves for base cabinets Fillers for base cabinets 		▶ Page 290 ▶ Page 291

Specification Information				
Dimensions			Style	U.S. Base
D	W	H	Number	Price

Open Cabinets with One Adjustable Shelf

22 ¹ / ₈ "	12"	27 ³ / ₈ "	HXBP1228	\$1000
22 ¹ / ₈ "	18"	27 ³ / ₈ "	HXBP1828	\$1054
22 ¹ / ₈ "	21"	27 ³ / ₈ "	HXBP2128	\$1090
22 ¹ / ₈ "	24"	27 ³ / ₈ "	HXBP2428	\$1128
22 ¹ / ₈ "	30"	27 ³ / ₈ "	HXBP3028	\$1143
22 ¹ / ₈ "	36"	27 ³ / ₈ "	HXBP3628	\$1242

Cabinets with Single Door and One Adjustable Shelf

Hinged Left				
23"	12"	27 ³ / ₈ "	HXBD1228L	\$1212
23"	18"	27 ³ / ₈ "	HXBD1828L	\$1298
23"	21"	27 ³ / ₈ "	HXBD2128L	\$1356
23"	24"	27 ³ / ₈ "	HXBD2428L	\$1398
Hinged Right				
23"	12"	27 ³ / ₈ "	HXBD1228R	\$1212
23"	18"	27 ³ / ₈ "	HXBD1828R	\$1298
23"	21"	27 ³ / ₈ "	HXBD2128R	\$1356
23"	24"	27 ³ / ₈ "	HXBD2428R	\$1398

▶ Specification Information, continued on next page

► **Specification Information, continued from previous page**

Specification Information

Dimensions			Style Number	U.S. Base Price
D	W	H		

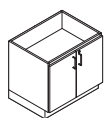

Cabinets With Double Doors and One Adjustable Shelf

23"	30"	27 ³ / ₈ "	HXBD3028	\$1636
23"	36"	27 ³ / ₈ "	HXBD3628	\$1767

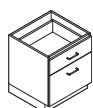

Cabinets With One Small Drawer and One Large Drawer

23"	12"	27 ³ / ₈ "	HXBC1228	\$1819
23"	18"	27 ³ / ₈ "	HXBC1828	\$1938
23"	21"	27 ³ / ₈ "	HXBC2128	\$2015
23"	24"	27 ³ / ₈ "	HXBC2428	\$2074
23"	30"	27 ³ / ₈ "	HXBC3028	\$2114
23"	36"	27 ³ / ₈ "	HXBC3628	\$2249



Cabinets With Three Small Drawers

23"	12"	27 ³ / ₈ "	HXBM1228	\$1960
23"	18"	27 ³ / ₈ "	HXBM1828	\$2142
23"	21"	27 ³ / ₈ "	HXBM2128	\$2281
23"	24"	27 ³ / ₈ "	HXBM2428	\$2356
23"	30"	27 ³ / ₈ "	HXBM3028	\$2391
23"	36"	27 ³ / ₈ "	HXBM3628	\$2534

 **For Canadian Pricing**
Multiply U.S. Price by the
Canadian price factor.
► See page 1 for details.

Support End Panel

For 28"H Base Cabinets



Tip: An end panel must be attached to a worksurface. When ordering a worksurface for attachment to an end panel, the extended worksurface option must be specified. Worksurfaces are specified separately.

Tip: Height is for support end panel without worksurface attached.

Tip: End panel must be ganged with adjacent product.

Tip: V.I.A. hang-on bracket option must be used when mounting to V.I.A. on module. One bracket included.

Tip: Dimensions are for reference only. See shop drawings for actual measurements at village.steelcase.com.

Standard Includes	Required to Specify
-------------------	---------------------

- Support end panel: Low-Pressure Laminate
- Edges: matching 1 mm plastic

- 1 Style number
 - 2 Laminate color number for support end panel
 - 3 Options, if selected (see below)
- ▶ See *Surface Materials*, page 375.

Options	U.S. Price	Required to Specify
---------	------------	---------------------

V.I.A. Bracket • Attachment brackets

+\$26

Specify with V.I.A. hang-on brackets.

Specification Information

• Dimensions			• Style	• U.S.
D	W	H	Number	Base Price
22 ¹ / ₈ "	1 ³ / ₁₆ "	27 ³ / ₈ "	HXBE28	\$276



For Canadian Pricing

Multiply U.S. Price by the Canadian price factor.

▶ See page 1 for details.



Folio

33"H ADA Base Cabinets

	Standard Includes	Required to Specify
▶ Need help? Product details, page 216	<ul style="list-style-type: none"> Storage cabinet, door and drawer fronts, and shelves: Low-Pressure Laminate D pull, if selected: nickel only Euro hinge, if selected: nickel only Edges: matching 3 mm plastic on doors and drawers and matching 1 mm plastic on all other edges Shelf pins Adjustable glides 	<ol style="list-style-type: none"> Style number Laminate color number for base cabinet Options, if selected (see below) ▶ See <i>Surface Materials</i> , page 375.

Tip: The V.I.A. bracket must be used when a single cabinet is mounted to V.I.A. on module. V.I.A. attachment bracket is not required when mounting off module. Check local codes.
▶ See Application Topics page 218

Tip: Lock secures top drawer only on units with multiple drawers or a drawer and door combination.

Tip: Additional shelves are available and must be specified separately.

Tip: Dimensions are for reference only. See shop drawings for actual measurements at village.steelcase.com.

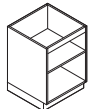

Tip: Height is for base cabinet without worksurface.

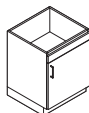
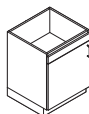

	Options	U.S. Price	Required to Specify
Door and Drawer Pulls	<ul style="list-style-type: none"> Contemporary: nickel only Opus: champagne only Jazz: nickel only 	No cost +\$26 per pull +\$28 per pull	Specify with <i>contemporary pull</i> . Specify with <i>Opus pull</i> . Specify with <i>jazz pull</i> .
Five-Knuckle Hinges	<ul style="list-style-type: none"> For cabinet with single door: nickel only For cabinet with double doors: nickel only 	+\$35 +\$70	Specify with <i>five-knuckle hinge</i> . Specify with <i>five-knuckle hinge</i> .
V.I.A. Bracket	<ul style="list-style-type: none"> Attachment brackets 	+\$52	Specify with <i>V.I.A. hang-on brackets</i> .
Lock and Keying	Lock <ul style="list-style-type: none"> 9201 Polished Chrome only Keying <ul style="list-style-type: none"> Factory and field-installed keying 	+\$52	Specify with <i>lock</i> . ▶ Page 398
Related Products	<ul style="list-style-type: none"> Shelves for base cabinets Fillers for base cabinets 		▶ Page 290 ▶ Page 291

Specification Information				
Dimensions			Style	U.S. Base
D	W	H	Number	Price

Open Cabinets with One Adjustable Shelf

22 ¹ / ₈ "	12"	32"	HXBP1233A	\$1044
22 ¹ / ₈ "	18"	32"	HXBP1833A	\$1078
22 ¹ / ₈ "	21"	32"	HXBP2133A	\$1110
22 ¹ / ₈ "	24"	32"	HXBP2433A	\$1151
22 ¹ / ₈ "	30"	32"	HXBP3033A	\$1204
22 ¹ / ₈ "	36"	32"	HXBP3633A	\$1235

Cabinets with Single Door and One Adjustable Shelf

Hinged Left				
23"	12"	32"	HXBD1233AL	\$1163
23"	18"	32"	HXBD1833AL	\$1219
23"	21"	32"	HXBD2133AL	\$1265
23"	24"	32"	HXBD2433AL	\$1305
Hinged Right				
23"	12"	32"	HXBD1233AR	\$1163
23"	18"	32"	HXBD1833AR	\$1219
23"	21"	32"	HXBD2133AR	\$1265
23"	24"	32"	HXBD2433AR	\$1305

▶ Specification Information, continued on next page

► Specification Information, continued from previous page

Specification Information

Dimensions			Style Number	U.S. Base Price
D	W	H		

Cabinets with Double Doors and One Adjustable Shelf

23"	30"	32"	HXBD3033A	\$1568
23"	36"	32"	HXBD3633A	\$1624

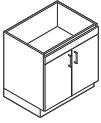

Cabinets with One Small Drawer and One Large Drawer

23"	12"	32"	HXBC1233A	\$1863
23"	18"	32"	HXBC1833A	\$1962
23"	21"	32"	HXBC2133A	\$2035
23"	24"	32"	HXBC2433A	\$2097
23"	30"	32"	HXBC3033A	\$2175
23"	36"	32"	HXBC3633A	\$2242



Cabinets with Three Small Drawers

23"	12"	32"	HXBM1233A	\$2004
23"	18"	32"	HXBM1833A	\$2166
23"	21"	32"	HXBM2133A	\$2301
23"	24"	32"	HXBM2433A	\$2379
23"	30"	32"	HXBM3033A	\$2452
23"	36"	32"	HXBM3633A	\$2527



Cabinets with Open Shelf and Two Small Drawers

23"	12"	32"	HXCN1233A	\$1746
23"	18"	32"	HXCN1833A	\$1872
23"	21"	32"	HXCN2133A	\$1978
23"	24"	32"	HXCN2433A	\$2047
23"	30"	32"	HXCN3033A	\$2122
23"	36"	32"	HXCN3633A	\$2187



► Specification Information, continued on next page



For Canadian Pricing
Multiply U.S. Price by the
Canadian price factor.
► See page 1 for details.

► **Specification Information, continued from previous page**

Specification Information				
Dimensions			Style	U.S.
D	W	H	Number	Base Price

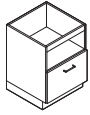

Cabinets with Open Shelf and One Large Drawer

23"	12"	32"	HXBL1233A	\$1605
23"	18"	32"	HXBL1833A	\$1668
23"	21"	32"	HXBL2133A	\$1712
23"	24"	32"	HXBL2433A	\$1765
23"	30"	32"	HXBL3033A	\$1845
23"	36"	32"	HXBL3633A	\$1902

Support End Panel

For 33"H ADA Base Cabinets



Tip: An end panel must be attached to a worksurface. When ordering a worksurface for attachment to an end panel, the extended worksurface option must be specified. Worksurfaces are specified separately.

Tip: Height is for support end panel without worksurface attached.

Tip: End panel must be ganged with adjacent product.

Tip: V.I.A. hang-on bracket option must be used when mounting to V.I.A. on module. One bracket included.

Tip: Dimensions are for reference only. See shop drawings for actual measurements at village.steelcase.com.

Standard Includes	Required to Specify
<ul style="list-style-type: none"> Support end panel: Low-Pressure Laminate Edges: matching 1 mm plastic 	<ul style="list-style-type: none"> 1 Style number 2 Laminate color number for support end panel 3 Options, if selected (see below) ► See <i>Surface Materials</i>, page 375.

V.I.A. Bracket	Options	U.S. Price	Required to Specify
	• Attachment brackets	+\$26	Specify with V.I.A. hang-on brackets.

Specification Information				
Dimensions			Style	U.S.
D	W	H	Number	Base Price
22 ¹ / ₈ "	13 ¹ / ₁₆ "	32"	HXBE33A	\$420



For Canadian Pricing

Multiply U.S. Price by the Canadian price factor.

► See page 1 for details.

Folio

36"H Base Cabinets

	Standard Includes	Required to Specify
▶ Need help? Product details, page 220	<ul style="list-style-type: none"> Base cabinet, door and drawer fronts, and shelves: Low-Pressure Laminate D pull, if selected: nickel only Euro hinge, if selected: nickel only Edges: matching 3 mm plastic on doors and drawers and matching 1 mm plastic on all other edges Shelf pins Adjustable glides 	1 Style number 2 Laminate color number for base cabinet 3 Options, if selected (see below) ▶ See <i>Surface Materials</i> , page 375.

Tip: The V.I.A. bracket must be used when a single cabinet is mounted to V.I.A. on module. V.I.A. attachment bracket is not required when mounting off module. Check local codes.

▶ See Application Topics page 222

Tip: Lock secures top drawer only on units with multiple drawers or a drawer and door combination.

Tip: Additional shelves are available and must be specified separately.

Tip: Dimensions are for reference only. See shop drawings for actual measurements at village.steelcase.com.

	Options	U.S. Price	Required to Specify
Door and Drawer Pulls	<ul style="list-style-type: none"> Contemporary: nickel only Opus: champagne only Jazz: nickel only 	No cost +\$26 per pull +\$28 per pull	Specify with <i>contemporary pull</i> . Specify with <i>Opus pull</i> . Specify with <i>jazz pull</i> .
Five-Knuckle Hinges	<ul style="list-style-type: none"> For cabinet with single door: nickel only For cabinet with double doors: nickel only 	+\$35 +\$70	Specify with <i>five-knuckle hinge</i> . Specify with <i>five-knuckle hinge</i> .
V.I.A. Bracket	<ul style="list-style-type: none"> Attachment brackets 	+\$52	Specify with <i>V.I.A. hang-on brackets</i> .
Lock and Keying	Lock <ul style="list-style-type: none"> 9201 Polished Chrome only Keying <ul style="list-style-type: none"> Factory and field-installed keying 	+\$52	Specify with <i>lock</i> . ▶ Page 398
Related Products	<ul style="list-style-type: none"> Shelves for base cabinets Fillers for base cabinets 		▶ Page 290 ▶ Page 291

Specification Information				
Dimensions			Style	U.S.
D	W	H	Number	Base Price

Open Cabinets with One Adjustable Shelf

22 ¹ / ₈ "	12"	35"	HXBP1236	\$1044
22 ¹ / ₈ "	18"	35"	HXBP1836	\$1117
22 ¹ / ₈ "	21"	35"	HXBP2136	\$1145
22 ¹ / ₈ "	24"	35"	HXBP2436	\$1167
22 ¹ / ₈ "	30"	35"	HXBP3036	\$1211
22 ¹ / ₈ "	36"	35"	HXBP3636	\$1257

Cabinets with Single Door and One Adjustable Shelf

Hinged Left

23"	12"	35"	HXBD1236L	\$1256
23"	18"	35"	HXBD1836L	\$1361
23"	21"	35"	HXBD2136L	\$1411
23"	24"	35"	HXBD2436L	\$1437

Hinged Right

23"	12"	35"	HXBD1236R	\$1256
23"	18"	35"	HXBD1836R	\$1361
23"	21"	35"	HXBD2136R	\$1411
23"	24"	35"	HXBD2436R	\$1437

▶ Specification Information, continued on next page

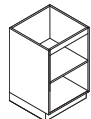

Tip: Height is for base cabinet without worksurface.

Tip: Depth is 22¹/₈" without door and drawer fronts.

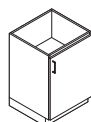
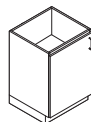

► Specification Information, continued from previous page

Specification Information

Dimensions			Style Number	U.S. Base Price
D	W	H		

Cabinets With Double Doors and One Adjustable Shelf

23"	30"	35"	HXBD3036	\$1704
23"	36"	35"	HXBD3636	\$1782

Cabinets with One Small Drawer, Single Door, and One Adjustable Shelf

Hinged Left

23"	12"	35"	HXBG1236L	\$1607
23"	18"	35"	HXBG1836L	\$1758
23"	21"	35"	HXBG2136L	\$1845
23"	24"	35"	HXBG2436L	\$1885

Hinged Right

23"	12"	35"	HXBG1236R	\$1607
23"	18"	35"	HXBG1836R	\$1758
23"	21"	35"	HXBG2136R	\$1845
23"	24"	35"	HXBG2436R	\$1885

Cabinets with One Small Drawer, Double Doors, and One Adjustable Shelf

23"	30"	35"	HXBG3036	\$2163
23"	36"	35"	HXBG3636	\$2258

Cabinets with Two Large Drawers

23"	12"	35"	HXBF1236	\$2073
23"	18"	35"	HXBF1836	\$2194
23"	21"	35"	HXBF2136	\$2238
23"	24"	35"	HXBF2436	\$2279
23"	30"	35"	HXBF3036	\$2364
23"	36"	35"	HXBF3636	\$2455

Cabinets with Two Small Drawers and One Large Drawer

23"	12"	35"	HXBC1236	\$2214
23"	18"	35"	HXBC1836	\$2398
23"	21"	35"	HXBC2136	\$2504
23"	24"	35"	HXBC2436	\$2561
23"	30"	35"	HXBC3036	\$2641
23"	36"	35"	HXBC3636	\$2740

► Specification Information, continued on next page

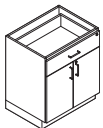
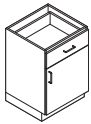
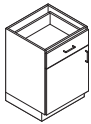
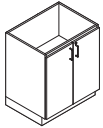

For Canadian Pricing
Multiply U.S. Price by the
Canadian price factor.
► See page 1 for details.

► **Specification Information, continued from previous page**

Specification Information

Dimensions			Style Number	U.S. Base Price
D	W	H		



Cabinets with Four Small Drawers

23"	12"	35"	HXBR1236	\$2355
23"	18"	35"	HXBR1836	\$2602
23"	21"	35"	HXBR2136	\$2770
23"	24"	35"	HXBR2436	\$2843
23"	30"	35"	HXBR3036	\$2918
23"	36"	35"	HXBR3636	\$3025



Cabinets with Open Shelf and Two Small Drawers

23"	12"	35"	HXBN1236	\$1746
23"	18"	35"	HXBN1836	\$1911
23"	21"	35"	HXBN2136	\$2013
23"	24"	35"	HXBN2436	\$2063
23"	30"	35"	HXBN3036	\$2129
23"	36"	35"	HXBN3636	\$2209

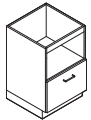

Cabinets with Open Shelf and One Large Drawer

23"	12"	35"	HXBL1236	\$1605
23"	18"	35"	HXBL1836	\$1707
23"	21"	35"	HXBL2136	\$1747
23"	24"	35"	HXBL2436	\$1781
23"	30"	35"	HXBL3036	\$1852
23"	36"	35"	HXBL3636	\$1924



For Canadian Pricing

Multiply U.S. Price by the Canadian price factor.

► See page 1 for details.

Support End Panel For 36"H Base Cabinets



Tip: An end panel must be attached to a worksurface. When ordering a worksurface for attachment to an end panel, the extended worksurface option must be specified. Worksurfaces are specified separately.

Tip: Height is for support end panel without worksurface attached.

Tip: End panel must be ganged with adjacent product.

Tip: V.I.A. hang-on bracket option must be used when mounting to V.I.A. on module. One bracket included.

Tip: Dimensions are for reference only. See shop drawings for actual measurements at village.steelcase.com.

Standard Includes	Required to Specify
<ul style="list-style-type: none"> Support end panel: Low-Pressure Laminate Edges: matching 1 mm plastic 	<ol style="list-style-type: none"> Style number Laminate color number for support end panel Options, if selected (see below) <p>▶ See <i>Surface Materials</i>, page 375.</p>

Options	U.S. Price	Required to Specify
V.I.A. Bracket • Attachment brackets	+\$26	Specify with V.I.A. hang-on brackets.

Specification Information				
Dimensions			Style Number	U.S. Base Price
D	W	H		
22 ¹ / ₈ "	1 ³ / ₁₆ "	35"	HXBE36	\$420



For Canadian Pricing
Multiply U.S. Price by the Canadian price factor.
▶ See page 1 for details.

Folio Sink Cabinets

Tip: ADA sink cabinets meet the guidelines as set forth in the United States Department of Justice 2010 ADA Standards for Accessible Design (www.ada.gov/2010ADASTandards). Floor to underside of cabinet clear dimension is 27"H.

Tip: V.I.A. bracket is not available for use with Folio sink cabinets.

Tip: Dimensions are for reference only. See shop drawings for actual measurements at village.steelcase.com.

Tip: For inside dimensions of sink cabinets, ▶ See page 224.

Standard Includes		Required to Specify	
▶ Need help? Product details, page 224	<ul style="list-style-type: none"> Sink cabinet: Low-Pressure Laminate D pull, if selected: nickel only Euro hinge, if selected: nickel only Edges: matching 3 mm plastic on doors and drawers and matching 1 mm plastic on all other edges Shelf pins Adjustable glides 	<ol style="list-style-type: none"> Style number Laminate color number for sink cabinet Options, if selected (see below) 	▶ See <i>Surface Materials</i> , page 375.

Options	U.S. Price	Required to Specify	
Door Pulls	<ul style="list-style-type: none"> Contemporary: nickel only No cost Opus: champagne only +\$26 per pull Jazz: nickel only +\$28 per pull 	Specify with <i>contemporary pull</i> . Specify with <i>Opus pull</i> . Specify with <i>jazz pull</i> .	
Five-Knuckle Hinges	<ul style="list-style-type: none"> For cabinet with single door: nickel only +\$35 For cabinet with double doors: nickel only +\$70 	Specify with <i>five-knuckle hinge</i> . Specify with <i>five-knuckle hinge</i> .	
V.I.A. Bracket	<ul style="list-style-type: none"> Attachment brackets +\$52 	Specify with <i>V.I.A. hang-on brackets</i> .	
Lock and Keying	<p>Lock</p> <ul style="list-style-type: none"> 9201 Polished Chrome only +\$52 <p>Keying</p> <ul style="list-style-type: none"> Factory and field-installed keying 	Specify with <i>lock</i> . ▶ Page 398	
Related Products	<ul style="list-style-type: none"> Shelves for sink cabinets Fillers for sink cabinets 	▶ Page 290 ▶ Page 291	

Specification Information

Dimensions			Style Number	U.S. Base Price
D	W	H		
...

Sink Cabinets with Angled Front

33"H ADA Sink Cabinet

227/8"	30"	18¾"	HXBK3033	\$1531
227/8"	36"	18¾"	HXBK3633A	\$1593

36"H Sink Cabinet

2215/16"	30"	21¾"	HXBK3036	\$1564
2215/16"	36"	21¾"	HXBK3636	\$1627

Sink Cabinets with Single Door

Hinged Left

23"	24"	35"	HXBKD2436L	\$1556
-----	-----	-----	-------------------	--------

Hinged Right

23"	24"	35"	HXBKD2436R	\$1556
-----	-----	-----	-------------------	--------

Sink Cabinets with Double Doors

23"	30"	35"	HXBKD3036	\$1806
23"	36"	35"	HXBKD3636	\$1846

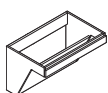

Tip: Height is for sink cabinet without worksurface.

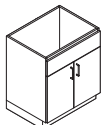
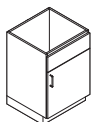
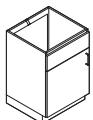
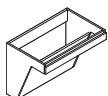

Folio Corner Cabinets

Folio
Corner Cabinets

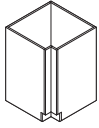

Tip: Corner filler to be approximately 2 1/2" wider than corner in both directions to clear doors and drawers.

Tip: Corner cabinet not intended as island application.

Tip: A full depth sidesplash or Integrated solid surface side-splash may be required for the application.

Tip: Must specify two standard extended tops to complete the corner application.

Tip: Corner units are factory drilled for assembly to desk frames and base cabinets.

Tip: Dimensions are for reference only. See shop drawings for actual measurements at village.steelcase.com.

Standard Includes		Required to Specify
▶ Need help? Product details, page 228	<ul style="list-style-type: none"> • Base cabinet: Low-Pressure Laminate • Edges: 1 mm plastic on all edges • Adjustable glides 	1 Style number 2 Laminate color number for base cabinet ▶ See <i>Surface Materials</i> , page 375.

Specification Information			
Dimensions		Style	U.S.
D	H	Number	Price
For 28"H Base Cabinets			
24"	27 ³ / ₈ "	HXBP2428C	\$1279
For 33"H Base Cabinets			
24"	32"	HXBP2433AC	\$1300
For 36"H Base Cabinets			
24"	35"	HXBP2436C	\$1305

Folio

 **For Canadian Pricing**
 Multiply U.S. Price by the Canadian price factor.
 ▶ See page 1 for details.

Folio

84"H Storage Cabinets

Tip: One shelf is fixed at 36"H. All other shelves are adjustable.

	Standard Includes	Required to Specify
▶ Need help? Product details, page 230	<ul style="list-style-type: none"> Storage cabinet, door fronts, and shelves: Low-Pressure Laminate D pull, if selected: nickel only Euro hinge, if selected: nickel only Edges: matching 3 mm plastic on doors and drawers and matching 1 mm plastic on all other edges Shelf pins Adjustable glides 	<ol style="list-style-type: none"> Style number Laminate color number for storage cabinet Options, if selected (see below) <ul style="list-style-type: none"> ▶ See <i>Surface Materials</i>, page 375.

	Options	U.S. Price	Required to Specify
Door Pulls	<ul style="list-style-type: none"> Contemporary: nickel only Opus: champagne only Jazz: nickel only 	No cost +\$ 26 per pull +\$ 28 per pull	Specify with <i>contemporary pull</i> . Specify with <i>Opus pull</i> . Specify with <i>jazz pull</i> .
Five-Knuckle Hinges	<ul style="list-style-type: none"> For cabinet with single door: nickel only For cabinet with double doors: nickel only 	+\$ 70 +\$140	Specify with <i>five-knuckle hinge</i> . Specify with <i>five-knuckle hinge</i> .
V.I.A. Bracket	<ul style="list-style-type: none"> Attachment brackets 	+\$ 52	Specify with <i>V.I.A. hang-on brackets</i> .
Lock and Keying	Lock <ul style="list-style-type: none"> 9201 Polished Chrome only Keying <ul style="list-style-type: none"> Factory and field-installed keying 	+\$ 52	Specify with <i>lock</i> . ▶ Page 398
Related Products	<ul style="list-style-type: none"> Shelves for storage cabinets 		▶ Page 290

Tip: The V.I.A. bracket must be used when a single cabinet is mounted to V.I.A. on module. V.I.A. attachment bracket is not required when mounting off module. Check local codes.

▶ See Application Topics page 232

Tip: Additional shelves are available and must be specified separately.

Tip: Dimensions are for reference only. See shop drawings for actual measurements at village.steelcase.com.

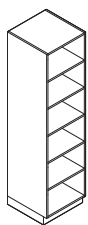

Specification Information				
Dimensions			Style	U.S.
D	W	H	Number	Base Price

Open Cabinets with Five Shelves

22 ¹ / ₈ "	12"	84"	HXCP1284	\$1619
22 ¹ / ₈ "	18"	84"	HXCP1884	\$1942
22 ¹ / ₈ "	21"	84"	HXCP2184	\$2175
22 ¹ / ₈ "	24"	84"	HXCP2484	\$2409
22 ¹ / ₈ "	30"	84"	HXCP3084	\$2734
22 ¹ / ₈ "	36"	84"	HXCP3684	\$3107

▶ Specification Information, continued on next page



For Canadian Pricing

Multiply U.S. Price by the Canadian price factor.

▶ See page 1 for details.

► **Specification Information, continued from previous page**

Specification Information

Dimensions			Style	U.S.
D	W	H	Number	Base Price

Cabinets with Single Door and Five Shelves

Hinged Left

23"	12"	84"	HXCD1284L	\$1996
23"	18"	84"	HXCD1884L	\$2393
23"	21"	84"	HXCD2184L	\$2685
23"	24"	84"	HXCD2484L	\$2975

Hinged Right

23"	12"	84"	HXCD1284R	\$1996
23"	18"	84"	HXCD1884R	\$2393
23"	21"	84"	HXCD2184R	\$2685
23"	24"	84"	HXCD2484R	\$2975

Cabinets with Double Doors and Five Shelves

23"	30"	84"	HXCD3084	\$3375
23"	36"	84"	HXCD3684	\$3850

Tip: Depth is 22¹/₈" without doors.

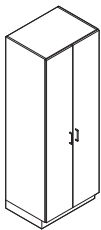
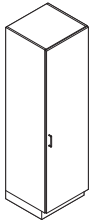
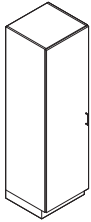

For Canadian Pricing

Multiply U.S. Price by the Canadian price factor.

► See page 1 for details.

Folio

92"H Storage Cabinets with Sloped Top

Tip: One shelf is fixed at 36"H. All other shelves are adjustable.

	Standard Includes	Required to Specify
▶ Need help? Product details, page 230	<ul style="list-style-type: none"> Storage cabinet, sloped top, door fronts, and shelves: Low-Pressure Laminate D pull, if selected: nickel only Euro hinge, if selected: nickel only Edges: matching 3 mm plastic on doors and matching 1 mm plastic on all other edges Shelf pins Adjustable glides 	<ol style="list-style-type: none"> Style number Laminate color number for storage cabinet Options, if selected (see below) <ul style="list-style-type: none"> ▶ See <i>Surface Materials</i>, page 375.

	Options	U.S. Price	Required to Specify
Door Pulls	<ul style="list-style-type: none"> Contemporary: nickel only Opus: champagne only Jazz: nickel only 	No cost +\$ 26 per pull +\$ 28 per pull	Specify with <i>contemporary pull</i> . Specify with <i>Opus pull</i> . Specify with <i>jazz pull</i> .
Five-Knuckle Hinges	<ul style="list-style-type: none"> For cabinet with single door: nickel only For cabinet with double doors: nickel only 	+\$ 70 +\$140	Specify with <i>five-knuckle hinge</i> . Specify with <i>five-knuckle hinge</i> .
V.I.A. Bracket	<ul style="list-style-type: none"> Attachment brackets 	+\$ 52	Specify with <i>V.I.A. hang-on brackets</i> .
Lock and Keying	Lock <ul style="list-style-type: none"> 9201 Polished Chrome only Keying <ul style="list-style-type: none"> Factory and field-installed keying 	+\$ 52	Specify with <i>lock</i> . ▶ Page 398
Related Products	<ul style="list-style-type: none"> Shelves for storage cabinets 		▶ Page 290

Tip: The V.I.A. bracket must be used when a single cabinet is mounted to V.I.A. on module. V.I.A. attachment bracket is not required when mounting off module. Check local codes.

▶ See *Application Topics*, page 232

Tip: Additional shelves are available and must be specified separately.

Tip: Dimensions are for reference only. See shop drawings for actual measurements at village.steelcase.com.

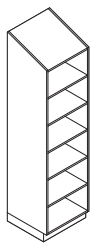

Specification Information				
Dimensions			Style	U.S.
D	W	H	Number	Base Price

Open Cabinets with Five Shelves

22 ¹ / ₈ "	12"	92"	HXCP1292S	\$1778
22 ¹ / ₈ "	18"	92"	HXCP1892S	\$2136
22 ¹ / ₈ "	21"	92"	HXCP2192S	\$2582
22 ¹ / ₈ "	24"	92"	HXCP2492S	\$2652
22 ¹ / ₈ "	30"	92"	HXCP3092S	\$3007
22 ¹ / ₈ "	36"	92"	HXCP3692S	\$3416

▶ **Specification Information, continued on next page**



For Canadian Pricing

Multiply U.S. Price by the Canadian price factor.

▶ See page 1 for details.

► **Specification Information, continued from previous page**

Specification Information

Dimensions			Style	U.S.
D	W	H	Number	Base Price

Cabinets with Single Door and Five Shelves

Hinged Left

23"	12"	92"	HXCD1292LS	\$2198
23"	18"	92"	HXCD1892LS	\$2632
23"	21"	92"	HXCD2192LS	\$2950
23"	24"	92"	HXCD2492LS	\$3275

Hinged Right

23"	12"	92"	HXCD1292RS	\$2198
23"	18"	92"	HXCD1892RS	\$2632
23"	21"	92"	HXCD2192RS	\$2950
23"	24"	92"	HXCD2492RS	\$3275

Cabinets with Double Doors and Five Shelves

23"	30"	92"	HXCD3092S	\$3706
23"	36"	92"	HXCD3692S	\$4232

Tip: Depth is 22¹/₁₆" without doors.

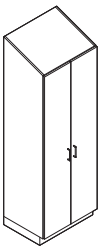
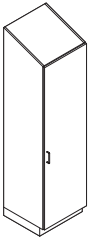
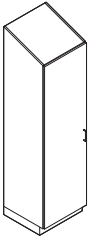

For Canadian Pricing

Multiply U.S. Price by the Canadian price factor.

► See page 1 for details.

Folio

84"H Wardrobe Cabinets

	Standard Includes	Required to Specify
▶ Need help? Product details, page 234	<ul style="list-style-type: none"> Wardrobe, door fronts, and fixed shelf: Low-Pressure Laminate D pull, if selected: nickel only Euro hinge, if selected: nickel only Edges: matching 3 mm plastic on doors and matching 1 mm plastic on all other edges Adjustable glides Hanger bar: chrome 	1 Style number 2 Laminate color number for wardrobe cabinet 3 Options, if selected (see below) ▶ See <i>Surface Materials</i> , page 375.

	Options	U.S. Price	Required to Specify
Door Pulls	<ul style="list-style-type: none"> Contemporary: nickel only Opus: champagne only Jazz: nickel only 	No cost +\$ 26 per pull +\$ 28 per pull	Specify with <i>contemporary pull</i> . Specify with <i>Opus pull</i> . Specify with <i>jazz pull</i> .
Five-Knuckle Hinges	<ul style="list-style-type: none"> For cabinet with single door: nickel only For cabinet with double doors: nickel only 	+\$ 70 +\$140	Specify with <i>five-knuckle hinge</i> . Specify with <i>five-knuckle hinge</i> .
V.I.A. Bracket	<ul style="list-style-type: none"> Attachment brackets 	+\$ 52	Specify with <i>V.I.A. hang-on brackets</i> .
Lock and Keying	Lock <ul style="list-style-type: none"> 9201 Polished Chrome only Keying <ul style="list-style-type: none"> Factory and field-installed keying 	+\$ 52	Specify with <i>lock</i> . ▶ Page 398

Tip: The V.I.A. bracket must be used when a single cabinet is mounted to V.I.A. on module. V.I.A. attachment bracket is not required when mounting off module. Check local codes.

▶ See Application Topics page 236

Tip: Dimensions are for reference only. See shop drawings for actual measurements at village.steelcase.com.

Tip: Depth is 22 1/8" without doors.

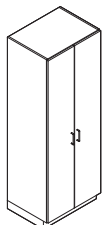
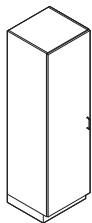

Specification Information				
Dimensions	Style			U.S. Base Price
	D	W	H	

Wardrobe Cabinets with Single Door and One Fixed Shelf

Hinged Left				
23"	12"	84"	HXCW1284L	\$1776
23"	18"	84"	HXCW1884L	\$2074
23"	21"	84"	HXCW2184L	\$2305
23"	24"	84"	HXCW2484L	\$2531
Hinged Right				
23"	12"	84"	HXCW1284R	\$1776
23"	18"	84"	HXCW1884R	\$2074
23"	21"	84"	HXCW2184R	\$2305
23"	24"	84"	HXCW2484R	\$2531

Wardrobe Cabinets with Double Doors and One Fixed Shelf

23"	30"	84"	HXCW3084	\$2834
23"	36"	84"	HXCW3684	\$3132

Folio 92"H Wardrobe Cabinets with Sloped Top

Folio
92"H Wardrobe
Cabinets with
Sloped Top

Standard Includes		Required to Specify
▶ Need help? Product details, page 234	<ul style="list-style-type: none"> Wardrobe, sloped top, door fronts, and fixed shelf: Low-Pressure Laminate D pull, if selected: nickel only Euro hinge, if selected: nickel only Edges: matching 3 mm plastic on doors and matching 1 mm plastic on all other edges Adjustable glides Hanger bar: chrome 	1 Style number 2 Laminate color number for wardrobe cabinet 3 Options, if selected (see below) ▶ See <i>Surface Materials</i> , page 375.

Options	U.S. Price	Required to Specify
Door Pulls	<ul style="list-style-type: none"> Contemporary: nickel only No cost Opus: champagne only +\$ 26 per pull Jazz: nickel only +\$ 28 per pull 	Specify with <i>contemporary pull</i> . Specify with <i>Opus pull</i> . Specify with <i>jazz pull</i> .
Five-Knuckle Hinges	<ul style="list-style-type: none"> For cabinet with single door: nickel only +\$ 70 For cabinet with double doors: nickel only +\$140 	Specify with <i>five-knuckle hinge</i> . Specify with <i>five-knuckle hinge</i> .
V.I.A. Bracket	<ul style="list-style-type: none"> Attachment brackets +\$ 52 	Specify with <i>V.I.A. hang-on brackets</i> .
Lock and Keying	Lock <ul style="list-style-type: none"> 9201 Polished Chrome only +\$ 52 Keying <ul style="list-style-type: none"> Factory and field-installed keying 	Specify with <i>lock</i> . ▶ Page 398

Tip: The V.I.A. bracket must be used when a single cabinet is mounted to V.I.A. on module. V.I.A. attachment bracket is not required when mounting off module. Check local codes.

▶ See Application Topics page 236

Tip: Dimensions are for reference only. See shop drawings for actual measurements at village.steelcase.com.

Tip: Depth is 22 1/16" without doors.

Specification Information				
Dimensions			Style	U.S.
D	W	H	Number	Base Price

Wardrobe Cabinets with Single Door and One Fixed Shelf

Hinged Left

23"	12"	92"	HXCW1292LS	\$1953
23"	18"	92"	HXCW1892LS	\$2282
23"	21"	92"	HXCW2192LS	\$2532
23"	24"	92"	HXCW2492LS	\$2788

Hinged Right

23"	12"	92"	HXCW1292RS	\$1953
23"	18"	92"	HXCW1892RS	\$2282
23"	21"	92"	HXCW2192RS	\$2532
23"	24"	92"	HXCW2492RS	\$2788

Wardrobe Cabinets with Double Doors and One Fixed Shelf

23"	30"	92"	HXCW3092S	\$3118
23"	36"	92"	HXCW3692S	\$3449

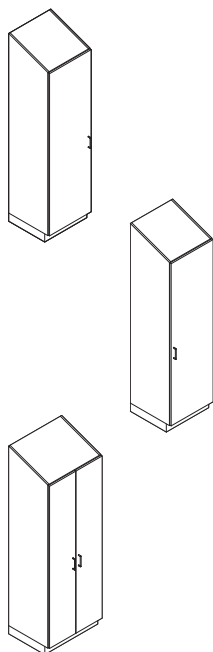

Folio 84"H Bookcases

Tip: One shelf is fixed at 36"H. All other shelves are adjustable.

Tip: The V.I.A. bracket must be used when a single cabinet is mounted to V.I.A. on module. V.I.A. attachment bracket is not required when mounting off module. Check local codes.

▶ See Application Topics page 240

Tip: Additional shelves are available and must be specified separately.

Tip: Dimensions are for reference only. See shop drawings for actual measurements at village.steelcase.com.



Standard Includes		Required to Specify	
▶ Need help? Product details, page 238	<ul style="list-style-type: none"> Bookcase, door fronts, and shelves: Low-Pressure Laminate D pull, if selected: nickel only Euro hinge, if selected: nickel only Edges: matching 3 mm plastic on doors and matching 1 mm plastic on all other edges Shelf pins Adjustable glides 	1 Style number 2 Laminate color number for bookcase 3 Options, if selected (see below) ▶ See <i>Surface Materials</i> , page 375.	
Options	U.S. Price	Required to Specify	
Door Pulls	<ul style="list-style-type: none"> Contemporary: nickel only No cost Opus: champagne only +\$ 26 per pull Jazz: nickel only +\$ 28 per pull 	Specify with <i>contemporary pull</i> . Specify with <i>Opus pull</i> . Specify with <i>jazz pull</i> .	
Five-Knuckle Hinges	<ul style="list-style-type: none"> For cabinet with single door: nickel only +\$ 70 For cabinet with double doors: nickel only +\$140 	Specify with <i>five-knuckle hinge</i> . Specify with <i>five-knuckle hinge</i> .	
V.I.A. Bracket	<ul style="list-style-type: none"> Attachment brackets +\$ 52 	Specify with <i>V.I.A. hang-on brackets</i> .	
Lock and Keying	<p>Lock</p> <ul style="list-style-type: none"> 9201 Polished Chrome only +\$ 52 <p>Keying</p> <ul style="list-style-type: none"> Factory and field-installed keying 	Specify with <i>lock</i> . ▶ Page 398	
Related Products	<ul style="list-style-type: none"> Shelves for bookcases 	▶ Page 290	

Specification Information				
Dimensions			Style	U.S.
D	W	H	Number	Base Price

Open Bookcase with Five Shelves

133 $\frac{3}{8}$ "	12"	84"	HXCBP1284	\$1459
133 $\frac{3}{8}$ "	18"	84"	HXCBP1884	\$1649
133 $\frac{3}{8}$ "	21"	84"	HXCBP2184	\$1848
133 $\frac{3}{8}$ "	24"	84"	HXCBP2484	\$2047
133 $\frac{3}{8}$ "	30"	84"	HXCBP3084	\$2321
133 $\frac{3}{8}$ "	36"	84"	HXCBP3684	\$2643

▶ Specification Information, continued on next page

 **For Canadian Pricing**
Multiply U.S. Price by the Canadian price factor.
▶ See page 1 for details.

► **Specification Information, continued from previous page**

Specification Information

Dimensions			Style Number	U.S. Base Price
D	W	H		

Tip: Depth is 13³/₈" without doors.



Bookcases with Single Door and Five Shelves

Hinged Left

14 ¹ / ₄ "	12"	84"	HXCBD1284L	\$1699
14 ¹ / ₄ "	18"	84"	HXCBD1884L	\$2037
14 ¹ / ₄ "	21"	84"	HXCBD2184L	\$2282
14 ¹ / ₄ "	24"	84"	HXCBD2484L	\$2527



Hinged Right

14 ¹ / ₄ "	12"	84"	HXCBD1284R	\$1699
14 ¹ / ₄ "	18"	84"	HXCBD1884R	\$2037
14 ¹ / ₄ "	21"	84"	HXCBD2184R	\$2282
14 ¹ / ₄ "	24"	84"	HXCBD2484R	\$2527

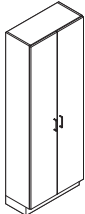

Bookcases with Double Doors and Five Shelves

14 ¹ / ₄ "	30"	84"	HXCBD3084	\$2862
14 ¹ / ₄ "	36"	84"	HXCBD3684	\$3274



For Canadian Pricing

Multiply U.S. Price by the Canadian price factor.

► See page 1 for details.

Folio

89"H Bookcases with Sloped Top

Tip: One shelf is fixed at 36"H. All other shelves are adjustable.

	Standard Includes	Required to Specify
▶ Need help? Product details, page 238	<ul style="list-style-type: none"> Bookcase, sloped top, door fronts, and shelves: Low-Pressure Laminate D pull, if selected: nickel only Euro hinge, if selected: nickel only Edges: matching 3 mm plastic on doors and matching 1 mm plastic on all other edges Shelf pins Adjustable glides 	1 Style number 2 Laminate color number for bookcase 3 Options, if selected (see below) ▶ See <i>Surface Materials</i> , page 375.

	Options	U.S. Price	Required to Specify
Door Pulls	<ul style="list-style-type: none"> Contemporary: nickel only Opus: champagne only Jazz: nickel only 	No cost +\$ 26 per pull +\$ 28 per pull	Specify with <i>contemporary pull</i> . Specify with <i>Opus pull</i> . Specify with <i>jazz pull</i> .
Five-Knuckle Hinges	<ul style="list-style-type: none"> For cabinet with single door: nickel only For cabinet with double doors: nickel only 	+\$ 70 +\$140	Specify with <i>five-knuckle hinge</i> . Specify with <i>five-knuckle hinge</i> .
V.I.A. Bracket	<ul style="list-style-type: none"> Attachment brackets 	+\$ 52	Specify with <i>V.I.A. hang-on brackets</i> .
Lock and Keying	Lock <ul style="list-style-type: none"> 9201 Polished Chrome only Keying <ul style="list-style-type: none"> Factory and field-installed keying 	+\$ 52	Specify with <i>lock</i> . ▶ Page 398
Related Products	<ul style="list-style-type: none"> Shelves for bookcases 		▶ Page 290

Tip: The V.I.A. bracket must be used when a single cabinet is mounted to V.I.A. on module. V.I.A. attachment bracket is not required when mounting off module. Check local codes.

▶ See Application Topics page 240

Tip: Additional shelves are available and must be specified separately.

Tip: Dimensions are for reference only. See shop drawings for actual measurements at village.steelcase.com.

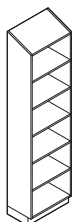

Specification Information				
Dimensions			Style	U.S.
D	W	H	Number	Base Price

Open Bookcase with Five Shelves

13 ³ / ₈ "	12"	88 ⁷ / ₈ "	HXCBP1289S	\$1512
13 ³ / ₈ "	18"	88 ⁷ / ₈ "	HXCBP1889S	\$1815
13 ³ / ₈ "	21"	88 ⁷ / ₈ "	HXCBP2189S	\$2034
13 ³ / ₈ "	24"	88 ⁷ / ₈ "	HXCBP2489S	\$2250
13 ³ / ₈ "	30"	88 ⁷ / ₈ "	HXCBP3089S	\$2556
13 ³ / ₈ "	36"	88 ⁷ / ₈ "	HXCBP3689S	\$2908

▶ Specification Information, continued on next page



For Canadian Pricing

Multiply U.S. Price by the Canadian price factor.

▶ See page 1 for details.

► **Specification Information, continued from previous page**

Specification Information

Dimensions			Style Number	U.S. Base Price
D	W	H		

Tip: Depth is 13³/₈" without doors and drawer fronts.

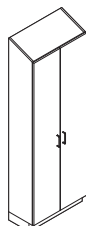
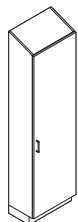
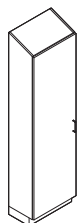

Bookcases with Single Door and Five Shelves

Hinged Left

14 ¹ / ₄ "	12"	88 ⁷ / ₈ "	HXCBD1289LS	\$1864
14 ¹ / ₄ "	18"	88 ⁷ / ₈ "	HXCBD1889LS	\$2239
14 ¹ / ₄ "	21"	88 ⁷ / ₈ "	HXCBD2189LS	\$2511
14 ¹ / ₄ "	24"	88 ⁷ / ₈ "	HXCBD2489LS	\$2781

Hinged Right

14 ¹ / ₄ "	12"	88 ⁷ / ₈ "	HXCBD1289RS	\$1864
14 ¹ / ₄ "	18"	88 ⁷ / ₈ "	HXCBD1889RS	\$2239
14 ¹ / ₄ "	21"	88 ⁷ / ₈ "	HXCBD2189RS	\$2511
14 ¹ / ₄ "	24"	88 ⁷ / ₈ "	HXCBD2489RS	\$2781

Bookcases with Double Doors and Five Shelves

14 ¹ / ₄ "	30"	88 ⁷ / ₈ "	HXCBD3089S	\$3151
14 ¹ / ₄ "	36"	88 ⁷ / ₈ "	HXCBD3689S	\$3600



For Canadian Pricing

Multiply U.S. Price by the Canadian price factor.

► See page 1 for details.

Folio

Upper Storage Cabinets

Tip: Shelves in open upper storage cabinet are adjustable.

Standard Includes		Required to Specify
<ul style="list-style-type: none"> ▶ Need help? Product details, page 242 	<ul style="list-style-type: none"> Upper storage cabinet, door fronts, and shelves: Low-Pressure Laminate D pull, if selected: nickel only Euro hinge, if selected: nickel only Edges: matching 3 mm plastic on doors and matching 1 mm plastic on all other edges Wall attachment brackets Shelf pins 	<ol style="list-style-type: none"> Style number Laminate color number for upper storage cabinet Options, if selected (see below) <ul style="list-style-type: none"> ▶ See <i>Surface Materials</i>, page 375.

Tip: The V.I.A. bracket must be used when a single cabinet is mounted to V.I.A. on module. V.I.A. attachment bracket is not required when mounting off module. Check local codes.

▶ See Application Topics page 244

Tip: Dimensions are for reference only. See shop drawings for actual measurements at village.steelcase.com.

Options	U.S. Price	Required to Specify
Door Pulls <ul style="list-style-type: none"> Contemporary: nickel only Opus: champagne only Jazz: nickel only 	No cost +\$ 26 per pull +\$ 28 per pull	Specify with <i>contemporary pull</i> . Specify with <i>Opus pull</i> . Specify with <i>jazz pull</i> .
Five-Knuckle Hinges <ul style="list-style-type: none"> For cabinet with single door: nickel only For cabinet with double doors: nickel only 	+\$ 35 +\$ 70	Specify with <i>five-knuckle hinge</i> . Specify with <i>five-knuckle hinge</i> .
V.I.A. Bracket <ul style="list-style-type: none"> Attachment brackets 	+\$208	Specify with <i>V.I.A. hang-on brackets</i> .
Lock and Keying <ul style="list-style-type: none"> Lock <ul style="list-style-type: none"> 9201 Polished Chrome only Keying <ul style="list-style-type: none"> Factory and field-installed keying 	+\$ 52	Specify with <i>lock</i> . ▶ Page 398
Related Products <ul style="list-style-type: none"> Shelves for upper storage cabinets Fillers for upper storage cabinets 		▶ Page 290 ▶ Page 291

Specification Information					
Dimensions			Style	Number	U.S. Base
D	W	H	Number	of Shelves	Price

Open Upper Storage Cabinets					
13 ³ / ₈ "	12"	24"	HXUP1224	1	\$ 755
13 ³ / ₈ "	18"	24"	HXUP1824	1	\$ 794
13 ³ / ₈ "	21"	24"	HXUP2124	1	\$ 860
13 ³ / ₈ "	24"	24"	HXUP2424	1	\$ 926
13 ³ / ₈ "	30"	24"	HXUP3024	1	\$ 966
13 ³ / ₈ "	36"	24"	HXUP3624	1	\$1051
13 ³ / ₈ "	12"	30"	HXUP1230	2	\$ 808
13 ³ / ₈ "	18"	30"	HXUP1830	2	\$ 861
13 ³ / ₈ "	21"	30"	HXUP2130	2	\$ 942
13 ³ / ₈ "	24"	30"	HXUP2430	2	\$ 979
13 ³ / ₈ "	30"	30"	HXUP3030	2	\$1013
13 ³ / ₈ "	36"	30"	HXUP3630	2	\$1095

▶ Specification Information, continued on next page



Tip: 24"H units include one adjustable shelf and 30"H units include two adjustable shelves.

 **For Canadian Pricing**
 Multiply U.S. Price by the Canadian price factor.
 ▶ See page 1 for details.

► **Specification Information, continued from previous page**

Specification Information

Dimensions			Style	Number	U.S. Base
D	W	H	Number	of Shelves	Price

Upper Storage Cabinets with Single Door

Hinged Left

14 1/4"	12"	24"	HXUD1224L	1	\$ 913
14 1/4"	18"	24"	HXUD1824L	1	\$1009
14 1/4"	21"	24"	HXUD2124L	1	\$1042
14 1/4"	12"	30"	HXUD1230L	2	\$1162
14 1/4"	18"	30"	HXUD1830L	2	\$1193
14 1/4"	21"	30"	HXUD2130L	2	\$1228

Hinged Right

14 1/4"	12"	24"	HXUD1224R	1	\$ 913
14 1/4"	18"	24"	HXUD1824R	1	\$1009
14 1/4"	21"	24"	HXUD2124R	1	\$1042
14 1/4"	12"	30"	HXUD1230R	2	\$1162
14 1/4"	18"	30"	HXUD1830R	2	\$1193
14 1/4"	21"	30"	HXUD2130R	2	\$1228

Upper Storage Cabinets with Double Doors

14 1/4"	24"	24"	HXUD2424	1	\$1138
14 1/4"	30"	24"	HXUD3024	1	\$1244
14 1/4"	36"	24"	HXUD3624	1	\$1377
14 1/4"	24"	30"	HXUD2430	2	\$1239
14 1/4"	30"	30"	HXUD3030	2	\$1407
14 1/4"	36"	30"	HXUD3630	2	\$1515

Upper Storage Cabinets with Double Doors and Open Shelf

14 1/4"	24"	30"	HXUDP2430	1	\$1196
14 1/4"	30"	30"	HXUDP3030	1	\$1409
14 1/4"	36"	30"	HXUDP3630	1	\$1590

Tip: Depth is 13 3/8" without doors and drawer fronts.



Tip: Shelves behind full doors are adjustable.

Tip: 24"H units include one adjustable shelf and 30"H units include two adjustable shelves.

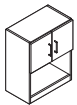

 **For Canadian Pricing**
Multiply U.S. Price by the Canadian price factor.
► See page 1 for details.

Folio

Upper Storage Cabinets with Sloped Top

Tip: Shelves in open upper storage cabinet are adjustable.

Standard Includes		Required to Specify
<ul style="list-style-type: none"> ▶ Need help? Product details, page 242 	<ul style="list-style-type: none"> • Upper storage cabinet, sloped top, door fronts, and shelves: Low-Pressure Laminate • D pull, if selected: nickel only • Euro hinge, if selected: nickel only • Edges: matching 3 mm plastic on doors and matching 1 mm plastic on all other edges • Wall attachment brackets • Shelf pins 	<ol style="list-style-type: none"> 1 Style number 2 Laminate color number for upper storage cabinet 3 Options, if selected (see below) <ul style="list-style-type: none"> ▶ See <i>Surface Materials</i>, page 375.

Tip: The V.I.A. bracket must be used when a single cabinet is mounted to V.I.A. on module. V.I.A. attachment bracket is not required when mounting off module. Check local codes.

▶ See Application Topics page 244

Tip: Dimensions are for reference only. See shop drawings for actual measurements at village.steelcase.com.

Options	U.S. Price	Required to Specify
Door Pulls <ul style="list-style-type: none"> • Contemporary: nickel only • Opus: champagne only • Jazz: nickel only 	No cost +\$ 26 per pull +\$ 28 per pull	Specify with <i>contemporary pull</i> . Specify with <i>Opus pull</i> . Specify with <i>jazz pull</i> .
Five-Knuckle Hinges <ul style="list-style-type: none"> • For cabinet with single door: nickel only • For cabinet with double doors: nickel only 	+\$ 35 +\$ 70	Specify with <i>five-knuckle hinge</i> . Specify with <i>five-knuckle hinge</i> .
V.I.A. Bracket <ul style="list-style-type: none"> • Attachment brackets 	+\$208	Specify with <i>V.I.A. hang-on brackets</i> .
Lock and Keying <ul style="list-style-type: none"> • Lock <ul style="list-style-type: none"> • 9201 Polished Chrome only • Keying <ul style="list-style-type: none"> • Factory and field-installed keying 	+\$ 52	Specify with <i>lock</i> . ▶ Page 398
Related Products <ul style="list-style-type: none"> • Shelves for upper storage cabinets • Fillers for upper storage cabinets 		▶ Page 290 ▶ Page 291

Specification Information					
Dimensions			Style	Number	U.S. Base
D	W	H	Number	of Shelves	Price

Open Upper Storage Cabinets					
13 ³ / ₈ "	12"	28 ⁷ / ₈ "	HXUP1229S	1	\$ 827
13 ³ / ₈ "	18"	28 ⁷ / ₈ "	HXUP1829S	1	\$ 865
13 ³ / ₈ "	21"	28 ⁷ / ₈ "	HXUP2129S	1	\$ 940
13 ³ / ₈ "	24"	28 ⁷ / ₈ "	HXUP2429S	1	\$1008
13 ³ / ₈ "	30"	28 ⁷ / ₈ "	HXUP3029S	1	\$1056
13 ³ / ₈ "	36"	28 ⁷ / ₈ "	HXUP3629S	1	\$1153
13 ³ / ₈ "	12"	34 ⁷ / ₈ "	HXUP1235S	2	\$ 882
13 ³ / ₈ "	18"	34 ⁷ / ₈ "	HXUP1835S	2	\$ 941
13 ³ / ₈ "	21"	34 ⁷ / ₈ "	HXUP2135S	2	\$1025
13 ³ / ₈ "	24"	34 ⁷ / ₈ "	HXUP2435S	2	\$1070
13 ³ / ₈ "	30"	34 ⁷ / ₈ "	HXUP3035S	2	\$1100
13 ³ / ₈ "	36"	34 ⁷ / ₈ "	HXUP3635S	2	\$1192

▶ Specification Information, continued on next page

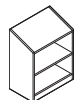

 **For Canadian Pricing**
 Multiply U.S. Price by the Canadian price factor.
 ▶ See page 1 for details.

► **Specification Information, continued from previous page**

Specification Information

Dimensions			Style	Number	U.S. Base
D	W	H	Number	of Shelves	Price

Upper Storage Cabinets with Single Door

Hinged Left

14¼"	12"	28⅞"	HXUD1229LS	1	\$1279
14¼"	18"	28⅞"	HXUD1829LS	1	\$1390
14¼"	21"	28⅞"	HXUD2129LS	1	\$1471
14¼"	12"	34⅞"	HXUD1235LS	2	\$1354
14¼"	18"	34⅞"	HXUD1835LS	2	\$1451
14¼"	21"	34⅞"	HXUD2135LS	2	\$1490

Hinged Right

14¼"	12"	28⅞"	HXUD1229RS	1	\$1279
14¼"	18"	28⅞"	HXUD1829RS	1	\$1390
14¼"	21"	28⅞"	HXUD2129RS	1	\$1471
14¼"	12"	34⅞"	HXUD1235RS	2	\$1354
14¼"	18"	34⅞"	HXUD1835RS	2	\$1451
14¼"	21"	34⅞"	HXUD2135RS	2	\$1490

Upper Storage Cabinets with Double Doors

14¼"	24"	28⅞"	HXUD2429S	1	\$1505
14¼"	30"	28⅞"	HXUD3029S	1	\$1533
14¼"	36"	28⅞"	HXUD3629S	1	\$1633
14¼"	24"	34⅞"	HXUD2435S	2	\$1647
14¼"	30"	34⅞"	HXUD3035S	2	\$1655
14¼"	36"	34⅞"	HXUD3635S	2	\$1667

Upper Storage Cabinets with Double Doors and Open Shelf

14¼"	24"	34⅞"	HXUDP2435S	1	\$1481
14¼"	30"	34⅞"	HXUDP3035S	1	\$1699
14¼"	36"	34⅞"	HXUDP3635S	1	\$1974

Tip: Depth is 13⅜" without doors and drawer fronts.

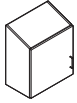

Tip: Shelves behind full doors are adjustable.

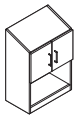
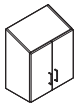
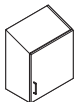

For Canadian Pricing

Multiply U.S. Price by the Canadian price factor.

► See page 1 for details.

Folio High-Pressure Laminate Worksurfaces

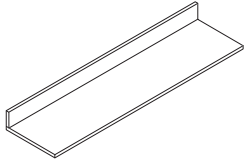

Standard Includes	Required to Specify
<ul style="list-style-type: none"> ▶ Need help? Product details, page 246 • Standard length High-Pressure Laminate worksurface with backsplash • Edge band: 3 mm plastic on front and 1 mm plastic on sides, back, and all backsplash edges 	<ol style="list-style-type: none"> 1 Style number 2 Laminate color number for worksurface and backsplash 3 Plastic color number for edge on worksurface 4 Options, if selected (see below) <ul style="list-style-type: none"> ▶ See <i>Surface Materials</i>, page 375.

Options	U.S. Price	Required to Specify
Surface Materials <ul style="list-style-type: none"> • Steelcase Health High-Pressure Laminate • Steelcase High-Pressure Laminate 	No cost	▶ See <i>Surface Materials</i> , page 375.
Extended Worksurface <ul style="list-style-type: none"> • Extended worksurface 	No cost	Specify with extended worksurface.

Tip: Extended worksurface option adds 1³/₁₆" length to worksurface for use with one end panel.

Tip: 12"W, 18"W, 21"W, and 120"W worksurfaces are not available with the extended worksurface option.

Tip: Worksurfaces must be attached to base cabinets or desk frames.

Tip: Dimensions are for reference only. See shop drawings for actual measurements at village.steelcase.com.

Specification Information		
Dimensions	Style Number	U.S. Price
D	W	Price

High-Pressure Laminate Worksurfaces with 4" Backsplash

24"	12"	HXW1224L	\$ 431
24"	18"	HXW1824L	\$ 463
24"	21"	HXW2124L	\$ 488
24"	24"	HXW2424L	\$ 519
24"	27"	HXW2724L	\$ 546
24"	30"	HXW3024L	\$ 572
24"	33"	HXW3324L	\$ 602
24"	36"	HXW3624L	\$ 631
24"	39"	HXW3924L	\$ 656
24"	42"	HXW4224L	\$ 685
24"	45"	HXW4524L	\$ 711
24"	48"	HXW4824L	\$ 742
24"	51"	HXW5124L	\$ 769
24"	54"	HXW5424L	\$ 797
24"	60"	HXW6024L	\$ 825
24"	66"	HXW6624L	\$ 872
24"	72"	HXW7224L	\$ 917
24"	78"	HXW7824L	\$ 966
24"	84"	HXW8424L	\$1011
24"	90"	HXW9024L	\$1058
24"	96"	HXW9624L	\$1104
24"	102"	HXW10224L	\$1152
24"	108"	HXW10824L	\$1196
24"	114"	HXW11424L	\$1244
24"	120"	HXW12024L	\$1289



For Canadian Pricing
Multiply U.S. Price by the Canadian price factor.
▶ See page 1 for details.

Folio

4"H High-Pressure Laminate Sidesplash

Folio
4"H High-Pressure
Laminate Sidesplash



Tip: Overall length of 21"D sidesplash is intended to be used adjacent to tall cabinets to eliminate interaction with doors.

▶ See page 247

Tip: Dimensions are for reference only. See shop drawings for actual measurements at village.steelcase.com.

Standard Includes		Required to Specify
▶ Need help? Product details, page 246	<ul style="list-style-type: none"> High-Pressure Laminate sidesplash Edge band: 1 mm plastic 	1 Style number 2 Laminate color number for sidesplash 3 Plastic color number for edge on sidesplash 4 Options, if selected (see below) ▶ See <i>Surface Materials</i> , page 375.

Options	U.S. Price	Required to Specify
Surface Materials		
<ul style="list-style-type: none"> Steelcase Health High-Pressure Laminate Steelcase High-Pressure Laminate 	No cost	▶ See <i>Surface Materials</i> , page 375.
	No cost	▶ See <i>Surface Materials</i> , page 375.

Specification Information			
Dimensions		Style Number	U.S. Price
D	H		
21"	4"	HXWS421L	\$ 93
24"	4"	HXWS424L	\$104
:	:	:	:

Folio



For Canadian Pricing

Multiply U.S. Price by the Canadian price factor.

▶ See page 1 for details.

Folio Solid Surface Worksurfaces

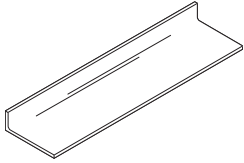

Tip: Extended work surface option adds 1³/₁₆" length to work surface for use with one end panel.

Tip: 12"W, 18"W, 21"W, and 120"W work surfaces are not available with the extended work surface option.

Tip: Worksurfaces must be attached to base cabinets or desk frames.

Tip: Dimensions are for reference only. See shop drawings for actual measurements at village.steelcase.com.

Standard Includes	Required to Specify
<ul style="list-style-type: none"> Need help? Product details, page 246 Solid surface work surface with integrated backsplash 	<ol style="list-style-type: none"> Style number Solid surface color number for work surface and backsplash Options, if selected (see below) <p>▶ See <i>Surface Materials</i>, page 375.</p>

Options	U.S. Price	Required to Specify
Extended Worksurface <ul style="list-style-type: none"> Extended work surface 	No cost	Specify with extended work surface.

Specification Information						
Dimensions D	W	Style Number	U.S. Prices			
			Price Group A	Price Group B	Price Group C	Price Group D

Solid Surface Worksurfaces with Integrated Backsplash

24"	12"	HXW1224S	\$1003	\$1084	\$1116	\$1244
24"	18"	HXW1824S	\$1069	\$1153	\$1186	\$1325
24"	21"	HXW2124S	\$1131	\$1219	\$1254	\$1404
24"	24"	HXW2424S	\$1320	\$1415	\$1452	\$1606
24"	27"	HXW2724S	\$1357	\$1458	\$1497	\$1660
24"	30"	HXW3024S	\$1518	\$1631	\$1667	\$1847
24"	33"	HXW3324S	\$1725	\$1841	\$1883	\$2075
24"	36"	HXW3624S	\$1898	\$2020	\$2068	\$2267
24"	39"	HXW3924S	\$1936	\$2068	\$2117	\$2326
24"	42"	HXW4224S	\$2229	\$2365	\$2416	\$2638
24"	45"	HXW4524S	\$2245	\$2390	\$2443	\$2675
24"	48"	HXW4824S	\$2247	\$2396	\$2453	\$2702
24"	51"	HXW5124S	\$2282	\$2439	\$2497	\$2758
24"	54"	HXW5424S	\$2526	\$2692	\$2753	\$3020
24"	60"	HXW6024S	\$2814	\$2995	\$3064	\$3357
24"	66"	HXW6624S	\$3056	\$3252	\$3328	\$3642
24"	72"	HXW7224S	\$3302	\$3513	\$3591	\$3938
24"	78"	HXW7824S	\$3374	\$3607	\$3699	\$4070
24"	84"	HXW8424S	\$3658	\$3912	\$4008	\$4419
24"	90"	HXW9024S	\$3835	\$4109	\$4210	\$4655
24"	96"	HXW9624S	\$4377	\$4672	\$4781	\$5261
24"	102"	HXW10224S	\$4554	\$4864	\$4988	\$5498
24"	108"	HXW10824S	\$4990	\$5329	\$5451	\$5995
24"	114"	HXW11424S	\$5237	\$5590	\$5722	\$6293
24"	120"	HXW12024S	\$5483	\$5852	\$5990	\$6591



For Canadian Pricing
Multiply U.S. Price by the Canadian price factor.
▶ See page 1 for details.

Folio

4"H Solid Surface Sidesplash

Folio
4"H Solid Surface
Sidesplash

Tip: Overall length of 21"D sidesplash is intended to be used adjacent to tall cabinets to eliminate interaction with doors.
▶ See page 247

Tip: Dimensions are for reference only. See shop drawings for actual measurements at village.steelcase.com.



Standard Includes	Required to Specify
<ul style="list-style-type: none"> ▶ Need help? Product details, page 246 • Solid surface sidesplash 	<ul style="list-style-type: none"> 1 Style number 2 Solid surface color number for sidesplash ▶ See <i>Surface Materials</i>, page 375.

Specification Information						
Dimensions		Style Number	U.S. Prices			
D	W		Price Group A	Price Group B	Price Group C	Price Group D

Left-Hand Sidesplash

21"	4"	HXWS421LS	\$263	\$283	\$290	\$326
24"	4"	HXWS424LS	\$299	\$319	\$326	\$362
.

Right-Hand Sidesplash

21"	4"	HXWS421RS	\$263	\$283	\$290	\$326
24"	4"	HXWS424RS	\$299	\$319	\$326	\$362
.



For Canadian Pricing
Multiply U.S. Price by the Canadian price factor.
▶ See page 1 for details.

Folio Desk Frames

For Use with Common Tops

Standard Includes		Required to Specify
▶ Need help? Product details, page 248	<ul style="list-style-type: none"> • Desk frame without back panel, if selected: Low-Pressure Laminate • Desk frame, back panel, and side panel, if selected: Low-Pressure Laminate • Door, if selected: Low-Pressure Laminate • D pull, if door option selected: nickel only • Euro hinge, if door option selected: nickel only 	<ol style="list-style-type: none"> 1 Style number 2 Laminate color number for desk frame, and back panel 3 Options, if selected (see below) ▶ See <i>Surface Materials</i> , page 375.

Tip: If door option is selected, door color will default to match desk frame.

Tip: When door option is specified, a garage application is created.

Tip: Door pulls may only be specified when door option has been specified.

Tip: Five-knuckle hinge may only be specified when door option has been specified.

Tip: The V.I.A. bracket must be used when a single cabinet is mounted to V.I.A. on module. V.I.A. attachment bracket is not required when mounting off module. Check local codes.

▶ See Application Topics page 250

Options	U.S. Price	Required to Specify
Door		
• Left hand door for use on 24"W desk frame with back panel only	+\$203	Specify with left hand door.
• Right hand door for use on 24"W desk frame with back panel only	+\$203	Specify with right hand door.
• Double doors for use on 30"W and 36"W desk frame with back panel only	+\$406	Specify with double doors.
Door Pulls		
• Contemporary: nickel only	No cost	Specify with contemporary pull.
• Opus: champagne only	+\$ 26 per pull	Specify with Opus pull.
• Jazz: nickel only	+\$ 28 per pull	Specify with jazz pull.
Five-Knuckle Hinges		
• For desk frames with one door: nickel only	+\$ 35	Specify with five-knuckle hinge.
• For desk frames with double doors: nickel only	+\$ 70	Specify with five-knuckle hinge.
V.I.A. Bracket	• Attachment brackets	+\$ 52
		Specify with V.I.A. hang-on brackets.
Related Products	<ul style="list-style-type: none"> • Storage cabinets • Wardrobes • Base or sink cabinets • Worksurfaces 	<ul style="list-style-type: none"> ▶ Page 270 ▶ Page 274 ▶ Page 256 ▶ Page 284

Specification Information

Dimensions	Style Number	U.S. Base Price
D W H		
.....

Desk Frames without Back Panel for Use with Common Top

22 ¹ / ₈ "	12"	2 ¹ / ₂ "	HXDF1224	\$572
22 ¹ / ₈ "	18"	2 ¹ / ₂ "	HXDF1824	\$579
22 ¹ / ₈ "	24"	2 ¹ / ₂ "	HXDF2424	\$597
22 ¹ / ₈ "	30"	2 ¹ / ₂ "	HXDF3024	\$611
22 ¹ / ₈ "	36"	2 ¹ / ₂ "	HXDF3624	\$630
22 ¹ / ₈ "	42"	2 ¹ / ₂ "	HXDF4224	\$656
22 ¹ / ₈ "	48"	2 ¹ / ₂ "	HXDF4824	\$671
22 ¹ / ₈ "	54"	2 ¹ / ₂ "	HXDF5424	\$694
22 ¹ / ₈ "	60"	2 ¹ / ₂ "	HXDF6024	\$711
22 ¹ / ₈ "	72"	2 ¹ / ₂ "	HXDF7224	\$728

▶ Specification Information, continued on next page

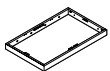

Tip: Desk frames must be attached to adjacent 24"D cabinet or structural wall.

Tip: Desk frames must be attached to worksurface. Specify worksurfaces separately.

Tip: Dimensions are for reference only. See shop drawings for actual measurements at village.steelcase.com.



For Canadian Pricing

Multiply U.S. Price by the Canadian price factor.

▶ See page 1 for details.

► **Specification Information, continued from previous page**

Specification Information

Dimensions			Style	U.S.
D	W	H	Number	Base Price

Desk Frames with Back Panel for Use with Common Top

22 1/8"	24"	31 1/4"	HXDFB2424	\$1235
22 1/8"	30"	31 1/4"	HXDFB3024	\$1347
22 1/8"	36"	31 1/4"	HXDFB3624	\$1384

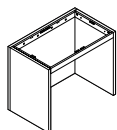

Tip: Desk frames are 31"H, to be used with 36"H base cabinets or end panels. This unit is not meant to be freestanding.



For Canadian Pricing

Multiply U.S. Price by the Canadian price factor.

► See page 1 for details.

Folio Accessories

Storage Shelves

Tip: Dimensions are for reference only. See shop drawings for actual measurements at village.steelcase.com.

Standard Includes	Required to Specify
<ul style="list-style-type: none"> ▶ Need help? Product details, page 251 • Shelves: Low-Pressure Laminate • Edges: matching 3 mm plastic on fronts and matching 1 mm plastic on sides and back • Shelf pins 	<ul style="list-style-type: none"> 1 Style number 2 Laminate color number for shelf ▶ See <i>Surface Materials</i>, page 375.

Specification Information

Dimensions D W	Style Number	U.S. Price
----------------------	-----------------	---------------

Shelves for Base Cabinets

21 1/4" 12"	HXBS1224	\$188
21 1/4" 18"	HXBS1824	\$213
21 1/4" 21"	HXBS2124	\$226
21 1/4" 24"	HXBS2424	\$235
21 1/4" 30"	HXBS3024	\$263
21 1/4" 36"	HXBS3624	\$280



Tip: For use with base cabinets only.

Shelves for Storage Cabinets

21 1/4" 12"	HXCS1224	\$115
21 1/4" 18"	HXCS1824	\$131
21 1/4" 21"	HXCS2124	\$139
21 1/4" 24"	HXCS2424	\$148
21 1/4" 30"	HXCS3024	\$165
21 1/4" 36"	HXCS3624	\$253



Tip: For use with storage cabinets only.

Shelves for Bookcases

12 1/2" 12"	HXCBS1214	\$215
12 1/2" 18"	HXCBS1814	\$250
12 1/2" 21"	HXCBS2114	\$257
12 1/2" 24"	HXCBS2414	\$272
12 1/2" 30"	HXCBS3014	\$304
12 1/2" 36"	HXCBS3614	\$331



Tip: For use with bookcases only.

Shelves for Upper Storage Cabinets

11 13/16" 12"	HXUS1214	\$215
11 13/16" 18"	HXUS1814	\$250
11 13/16" 21"	HXUS2114	\$257
11 13/16" 24"	HXUS2414	\$279
11 13/16" 30"	HXUS3014	\$306
11 13/16" 36"	HXUS3614	\$337



Tip: For use with upper storage cabinets only.



For Canadian Pricing
Multiply U.S. Price by the Canadian price factor.
▶ See page 1 for details.

Fillers

Tip: Fillers close the gap between a cabinet and structural wall. Field cutting of filler may be required to achieve architectural fit.

Tip: Fillers may be field cut from 1" to 6" wide.

Tip: Dimensions are for reference only. See shop drawings for actual measurements at village.steelcase.com.

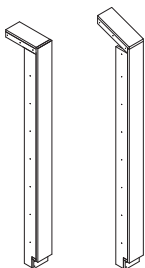

Tip: Filler should be used with flat upper storage cabinets.

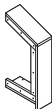

Standard Includes	Required to Specify
-------------------	---------------------

▶ Need help? Product details, page 251

- Filler: Low-Pressure Laminate

- 1 Style number
- 2 Laminate color number for filler
- ▶ See *Surface Materials*, page 375.

Specification Information

Dimensions		Style Number	U.S. Price
W	H		

Fillers for Use with Base or Sink Cabinet

5¾"	26 ¹⁵ / ₁₆ "	HXFB628	\$345
5¾"	31½"	HXFB633	\$345
5¾"	34½"	HXFB636	\$345

Fillers for Use with Storage Cabinets

22 ¹ / ₈ "	83½"	HXFCWB684S	\$574
13 ³ / ₈ "	83½"	HXFCWB684	\$574

Filler for Use with Sloped Wardrobe Cabinets

21 ⁷ / ₈ "	91 ⁷ / ₁₆ "	HXFCW692	\$574
----------------------------------	-----------------------------------	-----------------	-------

Fillers for Use with Upper Storage Cabinets

6"	24"	HXFU624	\$430
6"	30"	HXFU630	\$430

Fillers for Use with Sloped Upper Storage Cabinet

6"	29"	HXFU629	\$430
6"	35"	HXFU635	\$430

Mounting Board

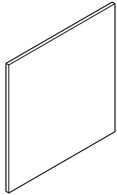

Tip: Dimensions are for reference only. See shop drawings for actual measurements at village.steelcase.com.

Standard Includes		Required to Specify
<ul style="list-style-type: none"> ▶ Need help? Product details, page 251 	<ul style="list-style-type: none"> • Mounting board: Low-Pressure Laminate • Edges: 1 mm plastic • Attachment hardware 	<ul style="list-style-type: none"> 1 Style number 2 Laminate color number for mounting board 3 Edge band color number for mounting board ▶ See <i>Surface Materials</i>, page 375.

Specification Information			
Dimensions		Style Number	U.S. Price
W	H		
34"	36"	HXAB3436	\$290
:	:	:	:



For Canadian Pricing
 Multiply U.S. Price by the Canadian price factor.
 ▶ See page 1 for details.

Wall-Mounted Folio



Statement of Line 294



Understanding

Wall-Mounted 24"H Base Cabinets	296
Wall-Mounted Sink Cabinets	298
Wall-Mounted Wardrobe Cabinets	300
Wall-Mounted Bookcases	302
Wall-Mounted Worksurfaces	304
Wall-Mounted Desk Frames	306
Wall-Mounted Accessories	308
Wall-Mounted Storage Capacities	310



Specifying

Wall-Mounted 24"H Base Cabinets	312
Wall-Mounted Sink Cabinets	313
Wall-Mounted 73"H Wardrobe Cabinets	314
Wall-Mounted 79"H Wardrobe Cabinets with Sloped Top	315
Wall-Mounted 73"H Bookcase	316
Wall-Mounted Laminate Worksurfaces	318
Wall-Mounted 4"H Laminate Sidesplash	319
Wall-Mounted Solid Surface Worksurfaces	320
Wall-Mounted Desk Frames	321
Wall-Mounted Accessories	322

Statement of Line

Wall-Mounted Folio

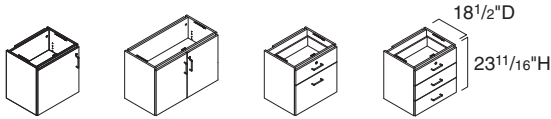

Understanding
 ▶ Page 296
 Specifying
 ▶ Page 312

Wall-Mounted 24"H Base Cabinets

	18"W	24"W	36"W
With single door and one adjustable shelf	●	●	
With double doors and one adjustable shelf			●
With one small drawer and one large drawer	●	●	
With three small drawers	●	●	

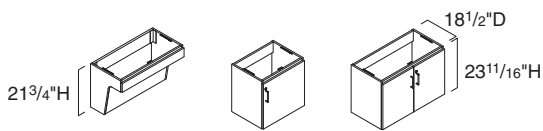

Understanding
 ▶ Page 298
 Specifying
 ▶ Page 313

Wall-Mounted Sink Cabinets

	24"W	36"W
Sink cabinet with angled front		●
24"H with single door	●	
24"H with double doors		●

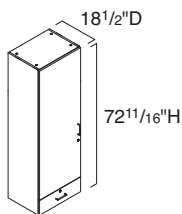

Understanding
 ▶ Page 300
 Specifying
 ▶ Page 314

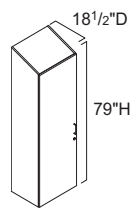

Understanding
 ▶ Page 300
 Specifying
 ▶ Page 315

Wall-Mounted 73"H Wardrobe Cabinets

	24"W
With single door, one fixed shelf, and small drawer	●

Wall-Mounted 79"H Wardrobe Cabinets with Sloped Top

	24"W
With sloped top, single door, and one fixed shelf	●

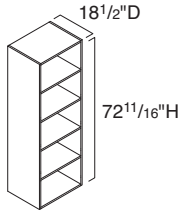

Understanding
 ▶ Page 302
 Specifying
 ▶ Page 316

Wall-Mounted 73"H Bookcases

	24"W
Open with five shelves	●
With single door and five shelves	●

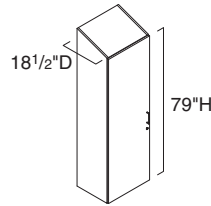

Understanding
 ▶ Page 302
 Specifying
 ▶ Page 317

Wall-Mounted 79"H Bookcase with Sloped Top

	24"W
With single door and five shelves	●

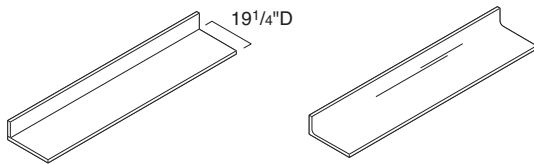

Understanding
 ▶ Page 304
 Specifying
 ▶ Pages 318 and 320

Wall-Mounted Worksurfaces

	18"W	24"W	36"W	42"W	48"W	60"W	72"W
18"D High-Pressure Laminate worksurfaces with 4"H backsplash	●	●	●	●	●	●	●
18"D Solid surface worksurfaces with integrated backsplash		●	●	●	●	●	●

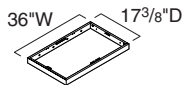

Understanding
 ▶ Page 306
 Specifying
 ▶ Page 321

Wall-Mounted Desk Frames

	18"W	24"W	36"W	42"W	48"W	60"W	72"W
18"D without back panel for use with common top	●	●	●	●	●	●	●

Folio

Wall-Mounted 24"H Base Cabinets

24"H Wall-mounted base cabinets meet storage needs in clinical settings. Base cabinets connect to a worksurface to create a single unit or a multicabinet wall unit.

Top of cabinet is open and requires attachment to a worksurface that is ordered separately.

Interior is finished with matching Low-Pressure Laminate.

Sides are finished so the cabinet can stand alone or be used in right- or left-hand positions.

All edges are finished from the factory with matching plastic edge banding.

Large drawers have a full extension and small drawers have a $\frac{3}{4}$ extension. Drawers have a single-wall drawer body construction.

Shelf is adjustable and removable.

Adjustable shelf is standard inside the cabinet. Shelves adjust in $1\frac{1}{4}$ " increments. Additional shelves are available, and must be specified separately.

D pulls are standard on doors and drawers and are nickel only. Additional pull styles are available as an option.

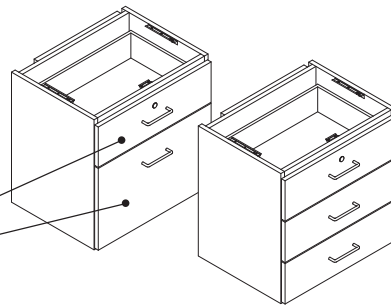
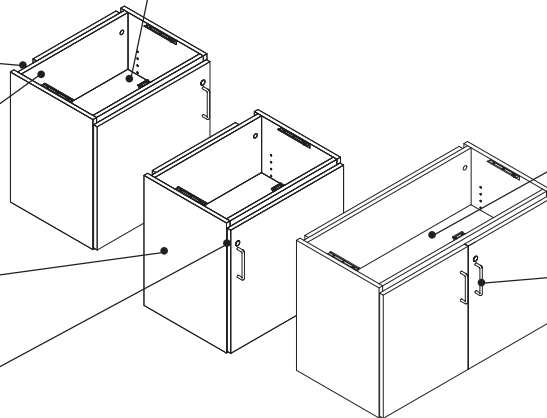

Actual Dimensions

Features	Overall Depth	Width	Height without Worksurface	Height with High-Pressure Laminate Worksurface	Height with Solid Worksurface
With single door and one adjustable shelf	18 $\frac{1}{2}$ "	18" or 24"	23 $\frac{11}{16}$ "	25 $\frac{1}{16}$ "	24 $\frac{11}{16}$ "
With one small drawer and one large drawer	18 $\frac{1}{2}$ "	18" or 24"	23 $\frac{11}{16}$ "	25 $\frac{1}{16}$ "	24 $\frac{11}{16}$ "
With double door and one adjustable shelf	18 $\frac{1}{2}$ "	36"	23 $\frac{11}{16}$ "	25 $\frac{1}{16}$ "	24 $\frac{11}{16}$ "
With three small drawers	18 $\frac{1}{2}$ "	18" or 24"	23 $\frac{11}{16}$ "	25 $\frac{1}{16}$ "	24 $\frac{11}{16}$ "

Product Details

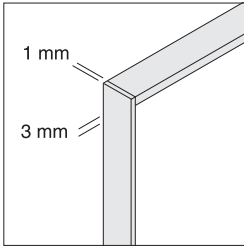

Edges on cabinets are matching 1 mm plastic edge banding. Drawer and door edges are matching 3 mm plastic edge banding.

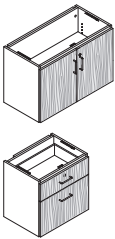

Woodgrain and solid laminate matches on all door and drawer sets, and interior of base cabinets.

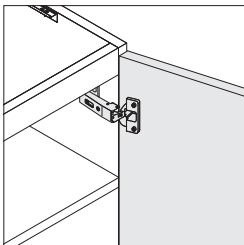

Euro hinge is standard on cabinet door and allows the door to open a full 110°.

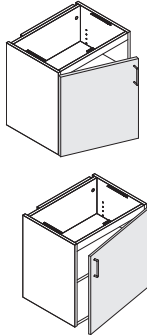

Single-door cabinets are hinged on the left or right side. A left-hand unit has the hinge on the left side of the door. A right-hand unit has the hinge on the right side of the door.

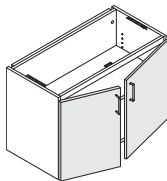

Double-door cabinets open from the center out.

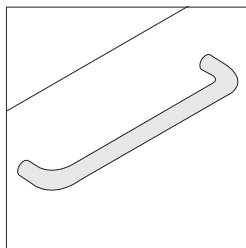

D pulls are standard.

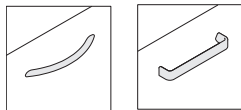

Contemporary Jazz

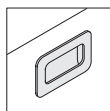

Opus

Additional door and drawer pull options are available. Optional pulls include:

- Contemporary
- Jazz
- Opus

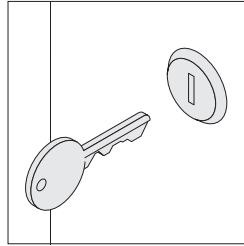

Lock is optional and factory- or field-installed to secure the doors or top drawer of the cabinet. Factory-installed locks are available keyed random only. Optional field-installed locks are available with consecutive, specific, or random keying options. Master-keyed locks are also available. Field-installed lock cylinders must be specified separately.
▶ Lock and Keying, Page 398

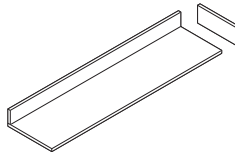

Laminate worksurface, ordered separately, is available with High-Pressure Laminate. High-Pressure Laminate has a matching 3 mm plastic front edge and 1 mm plastic edge on sides and back. Backsplash is standard with the worksurface. High-Pressure Laminate sidesplash is also available in two depths and must be ordered separately.
▶ Pages 318–319

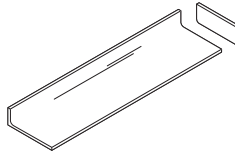

Solid surface worksurface, ordered separately, has an integrated backsplash. A solid surface sidesplash is also available in two depths and must be ordered separately.

Wall-mounted units must be coordinated with electrical and plumbing stub-outs.

Connections

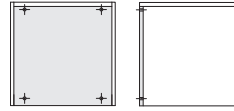

Base cabinets must always be fastened to a wall. Attachment hardware is included with cabinets.

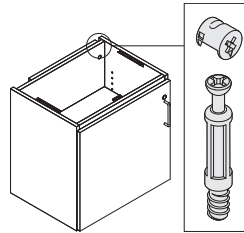

Cam-lock assembly hardware is used.

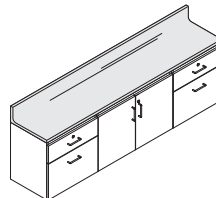

Worksurface is available to connect to one cabinet or to span multiple cabinets. It fastens to the top of cabinet with brackets and is field-installed. Brackets are included as standard with base cabinets.

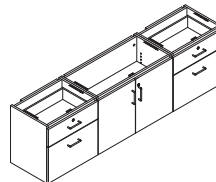

Bolts are used to align adjacent cabinets in a multi-unit configuration. The bolts can be removed and reinstalled if a different multi-unit configuration is desired.
Tip: Side of cabinet will be defaced by bolts. Exposed bolt holes will require field fix.

For minimum wall construction and electrical clearances, see *Folio Technical Cut Sheet*, available at village.steelcase.com.



Filler closes the gap between a cabinet and a structural wall. Additional length worksurface will be required. Field cutting of filler and worksurface may be required to achieve architectural fit.
▶ Page 322

Surface Materials

Cabinet, drawer front, door front, and shelf

- Low-Pressure Laminate

Edges

- Matching plastic

Drawer sides

- White paint only

D pulls, contemporary, and jazz pulls

- Nickel

Opus pulls

- Champagne

Euro hinges

- Nickel

Face lock

- 9201 Polished Chrome only

Filler

- Low-Pressure Laminate

Shipping

All cabinets ship fully assembled.

Folio Wall-Mounted Sink Cabinets

Sink cabinet accommodates a sink, which is independently purchased and field installed. Cabinets are available with a removable angled front or with doors.

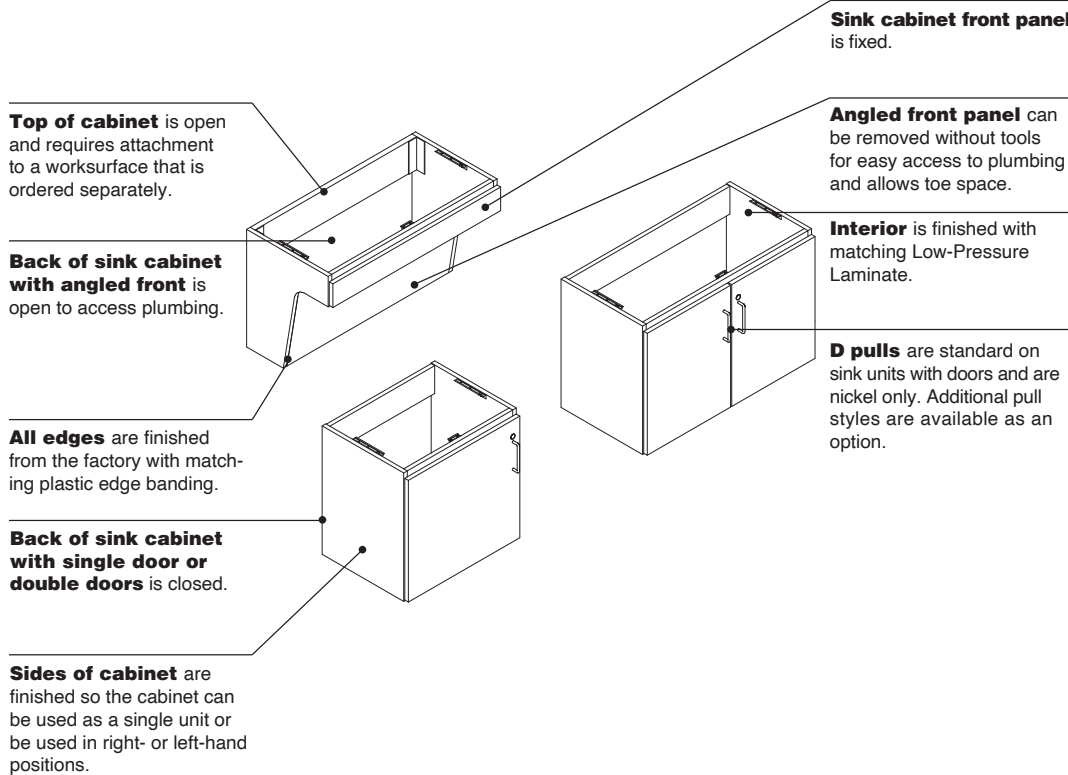

Product Details

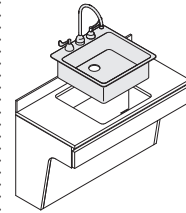

Sink must be independently purchased and field installed. Sink cutout must be cut in field. For clinical sink application guidelines, see *Folio Technical Cut Sheet*, available at village.steelcase.com.

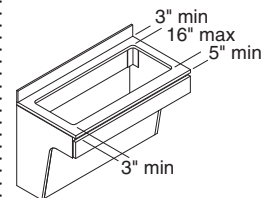

Maximum sink cutout size is 16" front to back. Minimum cutout requirements are 5" from front edge and 3" from back and side edges.

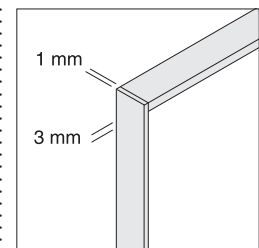

Edge, on cabinets are matching 1 mm plastic edge banding. Door edges are matching 3 mm plastic edge banding.

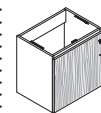
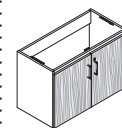

Woodgrain laminate matches on all drawer and door sets on base cabinets.

Actual Dimensions

Features	Overall Depth	Width	Inside Depth	Width	Height	Height without Worksurface	Height with High-Pressure Laminate Worksurface	Height with Solid Worksurface
22"H Sink Cabinet with angled front	18 ¹ / ₄ "	36"	15 ⁹ / ₁₆ "	34 ¹ / ₂ "	21 ¹¹ / ₁₆ "	21 ¹¹ / ₁₆ "	22 ⁷ / ₈ "	22 ¹¹ / ₁₆ "
24"H Sink Cabinet with single door	18 ¹⁵ / ₁₆ "	24"	15 ¹⁵ / ₁₆ "	22 ¹ / ₂ "	23 ¹¹ / ₁₆ "	23 ¹¹ / ₁₆ "	24 ⁷ / ₈ "	24 ¹¹ / ₁₆ "
24"H Sink Cabinet with double doors	18 ¹⁵ / ₁₆ "	36"	15 ¹⁵ / ₁₆ "	34 ¹ / ₂ "	23 ¹¹ / ₁₆ "	23 ¹¹ / ₁₆ "	24 ⁷ / ₈ "	24 ¹¹ / ₁₆ "

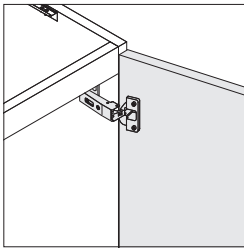

Euro hinge is standard on cabinet door and allows the door to open a full 110°.

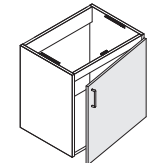
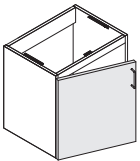

Single-door cabinets are hinged on the left or right side. A left-hand unit has the hinge on the left side of the door. A right-hand unit has the hinge on the right side of the door.

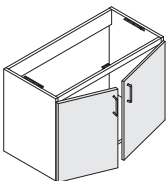

Double-door cabinets open from the center out.

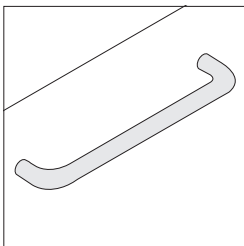

D pulls are standard.

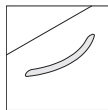

Contemporary Jazz

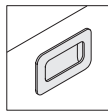
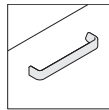

Opus

Additional door pull options are available.

Optional pulls include:

- Contemporary
- Jazz
- Opus

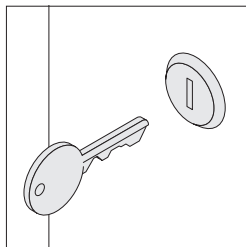

Lock is optional and factory- or field-installed to secure the doors. Factory-installed locks are available keyed random only. Optional field-installed locks are available with consecutive, specific, or random keying options. Master-keyed locks are also available. Field-installed lock cylinders must be specified separately. ▶ Lock and Keying, Page 398

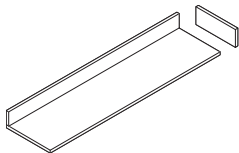

Laminate worksurface, ordered separately, is available with High-Pressure Laminate or custom laminate. High-Pressure Laminate has a matching 3 mm plastic front edge and 1 mm plastic edge on sides and back. Backsplash is standard with the worksurface. High-Pressure Laminate side-splash is also available in two depths and must be ordered separately. ▶ Page 318–319

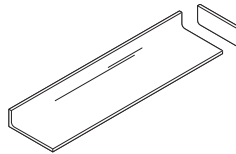

Solid surface worksurface, ordered separately, has an integrated backsplash. A solid surface sidesplash is also available in two depths and must be ordered separately.

Wall-mounted units must be coordinated with electrical and plumbing stub-outs.

Connections

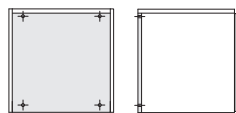

Base cabinets must always be fastened to a wall. Attachment hardware is included with cabinets.

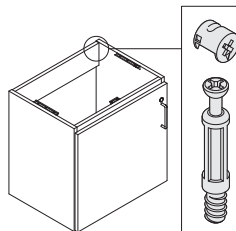

Cam-lock assembly hardware is used.

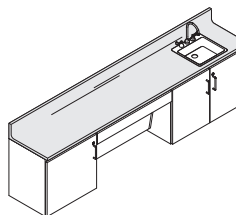

Worksurface is available to connect to one cabinet or to span multiple cabinets. It fastens to the top of cabinet with brackets and is field-installed. Brackets are included as standard with base cabinets.

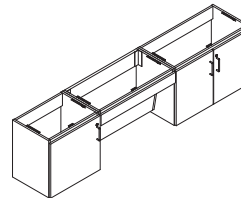

Bolts are used to align adjacent cabinets in a multi-unit configuration. The bolts can be removed and reinstalled if a different multi-unit configuration is desired.

Tip: Side of cabinet will be defaced by bolts. Exposed bolt holes will require field fix.

For minimum wall construction, plumbing, and electrical clearances, see *Folio Technical Cut Sheet*, available at village.steelcase.com.



Filler closes the gap between a cabinet and a structural wall. Additional length worksurface will be required. Field cutting of filler and worksurface may be required to achieve architectural fit. ▶ Page 322

Surface Materials

Sink cabinet and door fronts

- Low-Pressure Laminate

Edges

- Matching plastic

D pulls, contemporary, and jazz pulls

- Nickel

Opus pulls

- Champagne

Euro hinges

- Nickel

Face lock

- 9201 Polished Chrome only

Filler

- Low-Pressure Laminate

Shipping

All cabinets ship fully assembled.

Folio

Wall-Mounted Wardrobe Cabinets

Wardrobe cabinets offer coat and other storage for a clinical setting. Wardrobe cabinets are available in 73"H with flat top or 79"H with sloped top.

Top is finished.

Interior is finished with matching Low-Pressure Laminate.

Sloped top style cabinets are available to comply with certain local codes. Check local codes for specific requirements.

Hanger bar runs front-to-back.

Sides are finished.

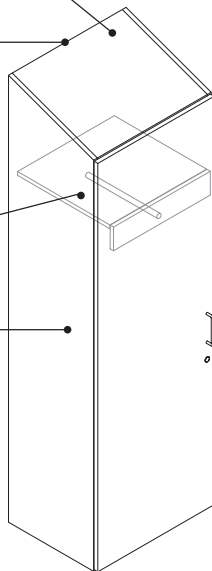

All edges are finished from the factory with matching plastic edge banding.

Shelf is fixed at 64 $\frac{1}{4}$ "H.

D pulls are standard on doors and are nickel only. Additional pull styles are available as an option.

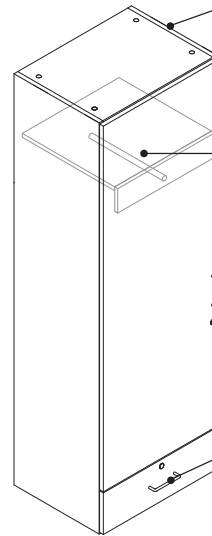

Actual Dimensions

Features	Overall Depth	Width	Height
Single door, one fixed shelf, and small drawer	18 $\frac{1}{2}$ "	24"	72 $\frac{1}{16}$ "
Sloped top, single door, and one fixed shelf	18 $\frac{1}{2}$ "	24"	79"
Sloped top, single door, one fixed shelf, and small drawer	18 $\frac{1}{2}$ "	24"	79"

Product Details

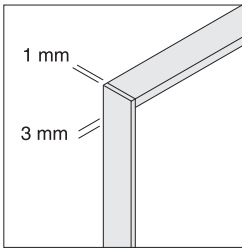

Edges on cabinets are matching 1 mm plastic edge banding. Drawer and door edges are matching 3 mm plastic edge banding.

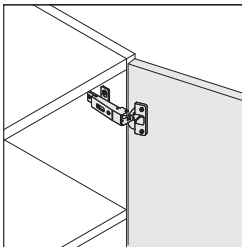

Euro hinge is standard on cabinet door and allows the door to open a full 110°.

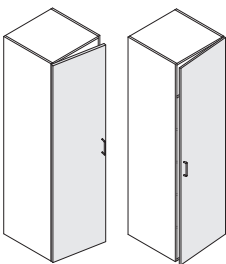

Single-door cabinets are hinged on the left or right side. A left-hand unit has the hinge on the left side of the door. A right-hand unit has the hinge on the right side of the door.

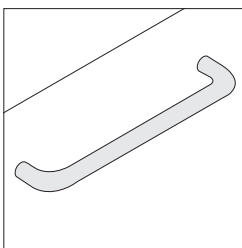

D pulls are standard.

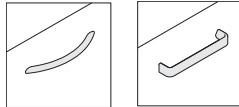

Contemporary Jazz

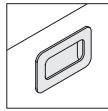

Opus

Additional door pull options are available.

Optional pulls include:

- Contemporary
- Jazz
- Opus

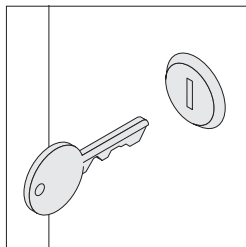

Lock is optional and factory- or field-installed to secure the doors. Factory-installed locks are available keyed random only. Optional field-installed locks are available with consecutive, specific, or random keying options. Master-keyed locks are also available. Field-installed lock cylinders must be specified separately. ▶ Lock and Keying, Page 398

Wall-mounted units must be coordinated with electrical and plumbing stub-outs.

Connections

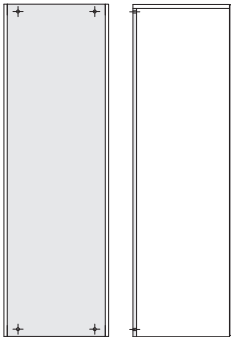

Wardrobe cabinets must always be fastened to a wall. Attachment hardware is included with cabinets.

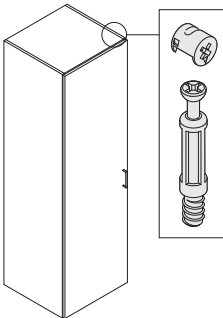

Cam-lock assembly hardware is used.

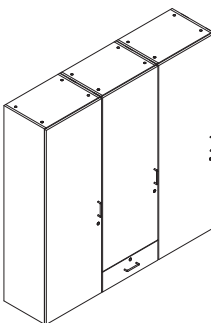

Bolts are used to align adjacent cabinets in a multi-unit configuration. The bolts can be removed and reinstalled if a different multi-unit configuration is desired.

Tip: Side of cabinet will be defaced by bolts. Exposed bolt holes will require field fix.

For minimum wall construction and electrical clearances, see *Folio Technical Cut Sheet*, available at village.steelcase.com.

Surface Materials

Cabinet, door front, and shelf

- Low-Pressure Laminate

Edges

- Matching plastic

D pulls, contemporary, and jazz pulls

- Nickel

Opus pulls

- Champagne

Euro hinges

- Nickel

Hanger bar

- Black

Face lock

- 9201 Polished Chrome only

Shipping

All cabinets ship fully assembled.

Folio Wall-Mounted Bookcases

Bookcases offer convenient storage for binders, books, and other objects used in a clinical setting. Bookcases are available in 73"H with flat top.

Sloped top style cabinets are available with a 20° slope to comply with certain local codes. Check local codes for specific requirements.

All edges are finished from the factory with matching plastic edge banding.

Top is finished.

Sides are finished.

Interior is finished with matching Low-Pressure Laminate.

Five shelves are standard in the bookcase. One shelf is fixed at 36"H and all other shelves are adjustable. Shelves adjust in 1¼" increments. Additional shelves are available and must be specified separately.

D pulls are standard on doors and are nickel only. Additional pull styles are available as an option.

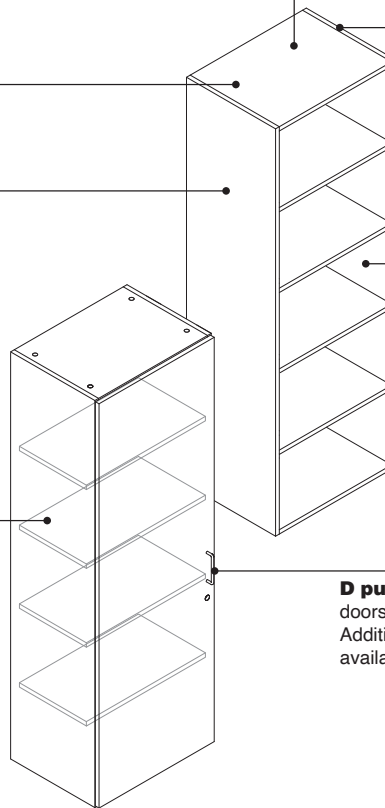

Actual Dimensions

Features	Overall Depth	Width	Height
Flat top with open shelves	18½"	24"	72 ¹¹ / ₁₆ "
Flat top with single door	18½"	24"	72 ¹¹ / ₁₆ "
Sloped top with single door	18½"	24"	79"

Product Details

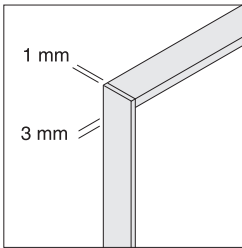

Edges on cabinets are matching 1 mm plastic edge banding. Drawer and door edges are matching 3 mm plastic edge banding.

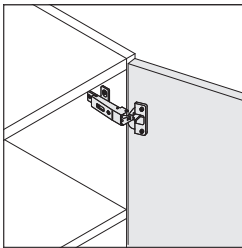

Euro hinge is standard on cabinet door and allows the door to open a full 110°.

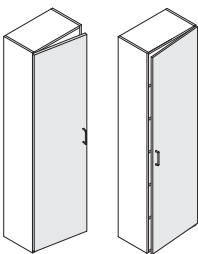

Single-door cabinets are hinged on the left or right side. A left-hand unit has the hinge on the left side of the door. A right-hand unit has the hinge on the right side of the door.

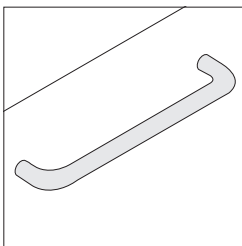

D pulls are standard.

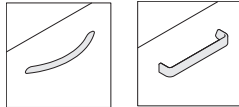

Contemporary Jazz

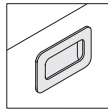

Opus

Additional door pull options are available.

Optional pulls include:

- Contemporary
- Jazz
- Opus

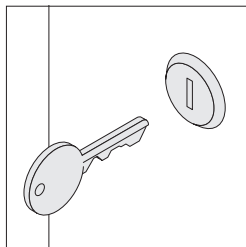

Lock is optional and factory- or field-installed to secure the doors. Factory-installed locks are available keyed random only. Optional field-installed locks are available with consecutive, specific, or random keying options. Master-keyed locks are also available. Field-installed lock cylinders must be specified separately.
▶ Lock and Keying, Page 398

Wall-mounted units must be coordinated with electrical and plumbing stub-outs.

Connections

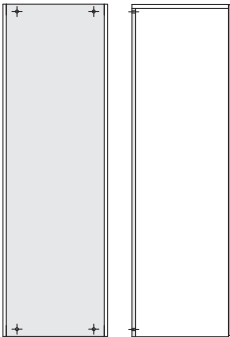

Bookcase cabinets must always be fastened to a wall. Attachment hardware is included with cabinets.

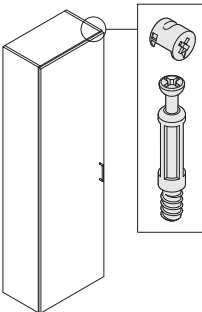

Cam-lock assembly hardware is used.

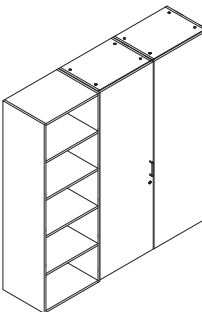

Bolts are used to align adjacent cabinets in a multi-unit configuration. The bolts can be removed and reinstalled if a different multi-unit configuration is desired.
Tip: Side of cabinet will be defaced by bolts. Exposed bolt holes will require field fix.

For minimum wall construction and electrical clearances, see *Folio Technical Cut Sheet*, available at village.steelcase.com.

Surface Materials

Cabinet, door front, and shelf

- Low-Pressure Laminate

Edges

- Matching plastic

D pulls, contemporary, and jazz pulls

- Nickel

Opus pulls

- Champagne

Euro hinges

- Nickel

Face lock

- 9201 Polished Chrome only

Shipping

All cabinets ship fully assembled.

Folio

Wall-Mounted Worksurfaces

Worksurfaces attach to the top of base or sink cabinets. They provide a writing or display surface.

Backsplash is standard with each worksurface. High-Pressure Laminate backsplash must be field installed. Solid surface has integrated backsplash.

Edges on High-Pressure Laminate worksurface are finished with 3 mm edge banding on front and 1 mm plastic edge banding on sides and back. High-Pressure Laminate sidesplash has 1 mm matching plastic edge banding all around.

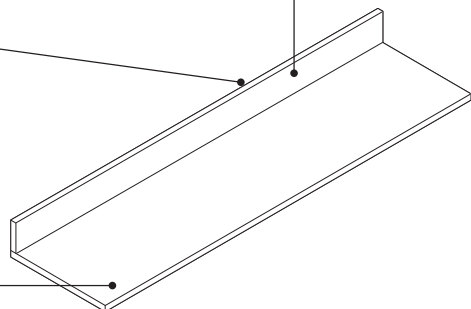

High-Pressure Laminate worksurface and backsplash have a particle board core with a High-Pressure Laminate surface.

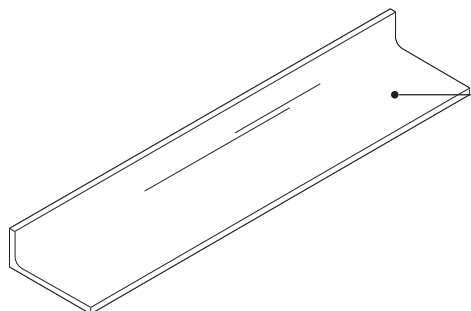

Solid surface worksurface with integrated backsplash is available.

Actual Dimensions

Features	Overall Depth	Width	Height
High-Pressure Laminate worksurfaces	19¼"	18", 24", 36", 42", 48", 60", or 72"	1⅜"
Solid worksurfaces	19¼"	24", 36", 42", 48", 60", or 72"	1"

Product Details

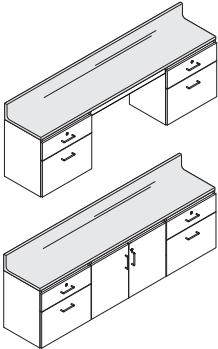

Worksurface can attach to the top of one base cabinet or desk frame, or it can span multiple storage cabinets to create a wall unit.

Connections

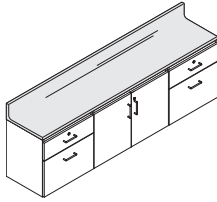

Brackets are used to attach the worksurface to the base cabinet in the field. Brackets are included as standard with base cabinets.

Surface Materials

Worksurface, back-splash, and sidesplash

- High-Pressure Laminate
- Solid surface

Tip: Select Surface solid surfaces are available.

▶ See *Surface Materials* section for complete listing.

Edges

- Plastic on High-Pressure Laminate worksurface

Folio

Wall-Mounted Desk Frames

Desk frames attach under a worksurface and to an adjacent base or sink cabinet or structural wall to create a desk or garage configuration to store carts or other items.

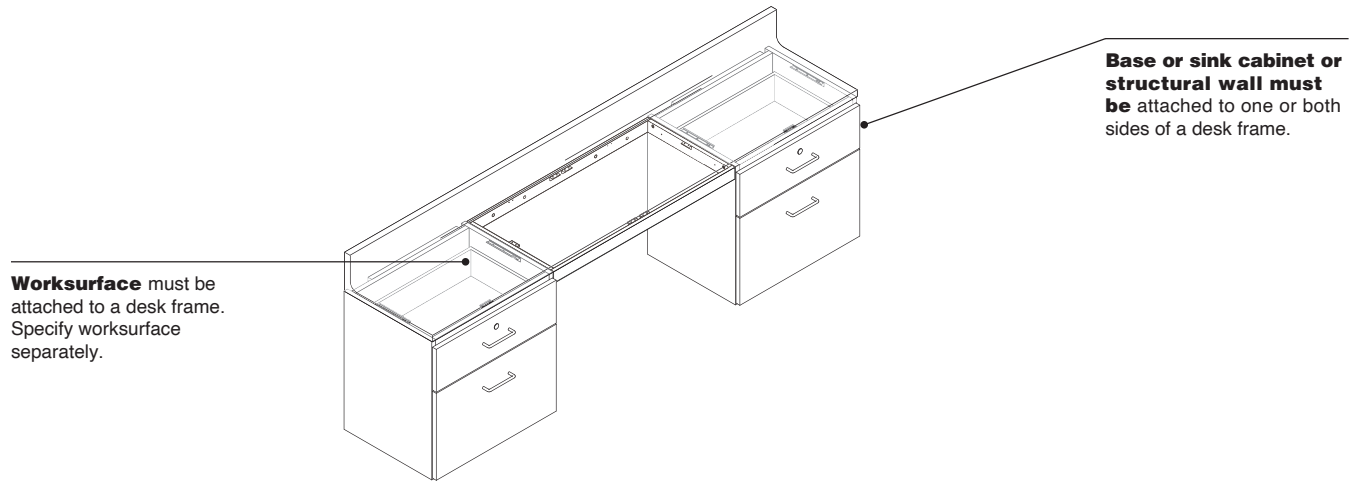

Worksurface must be attached to a desk frame. Specify worksurface separately.

Base or sink cabinet or structural wall must be attached to one or both sides of a desk frame.

Actual Dimensions

Without Back Panel

Depth	17 ³ / ₈ "
Width	18", 24", 36", 42", 48", 60", or 72"

Product Details

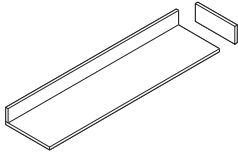

High-Pressure Laminate work surface, ordered separately, is available with High-Pressure Laminate. High-Pressure Laminate has a matching 3 mm plastic front edge and 1 mm plastic edge on sides and back. Backsplash is standard with the work surface. High-Pressure Laminate side-splash is also available in two depths and must be ordered separately.

► Pages 318–319

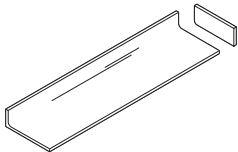

Solid surface work surface, ordered separately, has an integrated backsplash. A solid surface sidesplash in two depths is also available and must be ordered separately.

Wall-mounted units must be coordinated with electrical and plumbing stub-outs.

Connections

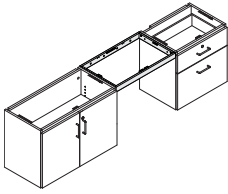

Base or sink cabinets, or structural wall, must be attached to one or both sides of desk frame.

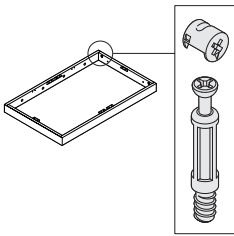

Cam-lock assembly hardware is used.

For minimum wall construction and electrical clearances, see *Folio Technical Cut Sheet*, available at village.steelcase.com.

Surface Materials

Desk frame

- Low-Pressure Laminate

D pulls, contemporary, and jazz pulls

- Nickel

Opus pulls

- Champagne

Euro hinges

- Nickel

Folio

Wall-Mounted Accessories

Wall-Mounted Fillers

► Specifying, page 322

Product Details



Fillers are available for use with base cabinets and upper storage cabinets.

Fillers close the gap between a cabinet and structural wall. Field cutting of filler may be required to achieve architectural fit.

Surface Materials

Fillers

- Low-Pressure Laminate

Actual Dimensions

Fillers

Depth	5/8"
Width	6"
Height	23 ¹¹ / ₁₆ ", 72 ¹¹ / ₁₆ "

Folio

Wall-Mounted Storage Capacities

Cabinets with Adjustable Shelves

Wall-Mounted Base Cabinets



Size	Inside Dimensions		
	D	W	H
18"W Cabinet	15 $\frac{1}{8}$ "	16 $\frac{1}{2}$ "	22 $\frac{15}{16}$ "
24"W Cabinet	15 $\frac{1}{8}$ "	22 $\frac{1}{2}$ "	22 $\frac{15}{16}$ "
36"W Cabinet	15 $\frac{1}{8}$ "	34 $\frac{1}{2}$ "	22 $\frac{15}{16}$ "

Cabinets with Drawers

7 $\frac{3}{8}$ " Small Drawer

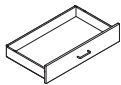

Size	Inside Dimensions		
	D	W	H
18"W Cabinet	13 $\frac{1}{4}$ "	15 $\frac{1}{4}$ "	4 $\frac{1}{8}$ "
24"W Cabinet	13 $\frac{1}{4}$ "	21 $\frac{1}{4}$ "	4 $\frac{1}{8}$ "

14 $\frac{7}{8}$ " H Large Drawer

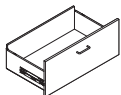

Size	Inside Dimensions		
	D	W	H
18"W Cabinet	13 $\frac{1}{4}$ "	14 $\frac{1}{2}$ "	7 $\frac{3}{4}$ "
24"W Cabinet	13 $\frac{1}{4}$ "	20 $\frac{1}{2}$ "	7 $\frac{3}{4}$ "

Wall-Mounted Sink Cabinets

22"H Cabinet

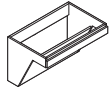

Size	Inside Dimensions		
	D	W	H
36"W Cabinet	15 ¹¹ / ₁₆ "	34 ¹ / ₂ "	21 ¹¹ / ₁₆ "

24"H Cabinet with Single Door



Size	Inside Dimensions		
	D	W	H
24"W Cabinet	15 ¹⁵ / ₁₆ "	22 ¹ / ₂ "	23 ¹¹ / ₁₆ "

24"H Cabinet with Double Door

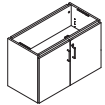

Size	Inside Dimensions		
	D	W	H
24"W Cabinet	15 ¹⁵ / ₁₆ "	34 ¹ / ₂ "	23 ¹¹ / ₁₆ "

Wall-Mounted Wardrobe Cabinets

73"H or 79"H Cabinet

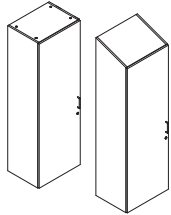

Size	Inside Dimensions	
	D	W
24"W Cabinet	15 ¹⁵ / ₁₆ "	22 ¹ / ₂ "

Wall-Mounted Bookcases

73"H or 79"H Bookcase

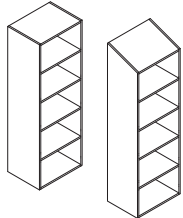

Size	Inside Dimensions	
	D	W
24"W Bookcase	15 ¹⁵ / ₁₆ "	22 ¹ / ₂ "

Folio

Wall-Mounted 24"H Base Cabinets

Standard Includes		Required to Specify
<ul style="list-style-type: none"> ▶ Need help? Product details, page 296 	<ul style="list-style-type: none"> • Base cabinet, door and drawer fronts, and shelves: Low-Pressure Laminate • D pull, if selected: nickel only • Euro hinge, if selected: nickel only • Edges: matching 3 mm plastic on doors and drawers and matching 1 mm plastic on all other edges • Shelf pins 	<ol style="list-style-type: none"> 1 Style number 2 Laminate color number for base cabinet 3 Options, if selected (see below) <ul style="list-style-type: none"> ▶ See <i>Surface Materials</i>, page 375.

Options	U.S. Price	Required to Specify
Door and Drawer Pulls <ul style="list-style-type: none"> • Contemporary: nickel only • Opus: champagne only • Jazz: nickel only 	No cost +\$26 per pull +\$28 per pull	Specify with <i>contemporary pull</i> . Specify with <i>Opus pull</i> . Specify with <i>jazz pull</i> .
Lock and Keying <ul style="list-style-type: none"> • 9201 Polished Chrome only • Factory and field-installed keying 	+\$52	Specify with <i>lock</i> . ▶ Page 398
Related Products <ul style="list-style-type: none"> • Shelves for wall-mounted base cabinets • Fillers for wall-mounted base cabinets 		▶ Page 321 ▶ Page 322

Tip: Lock secures top drawer only on units with multiple drawers or a drawer and door combination.

Tip: Additional shelves are available and must be specified separately.

Specification Information				
Dimensions			Style	U.S.
D	W	H	Number	Base Price

Cabinets with Single Door and One Adjustable Shelf

Hinged Left

18½"	18"	23 ¹¹ / ₁₆ "	HXBD1824L8	\$1470
18½"	24"	23 ¹¹ / ₁₆ "	HXBD2424L8	\$1584

Hinged Right

18½"	18"	23 ¹¹ / ₁₆ "	HXBD1824R8	\$1470
18½"	24"	23 ¹¹ / ₁₆ "	HXBD2424R8	\$1584

Cabinets With Double Doors and One Adjustable Shelf

18½"	36"	23 ¹¹ / ₁₆ "	HXBD36248	\$1972
------	-----	------------------------------------	------------------	--------

Cabinets With One Small Drawer and One Large Drawer

18½"	18"	23 ¹¹ / ₁₆ "	HXBC18248	\$2221
18½"	24"	23 ¹¹ / ₁₆ "	HXBC24248	\$2380

Cabinets With Three Small Drawers

18½"	18"	23 ¹¹ / ₁₆ "	HXBM18248	\$2457
18½"	24"	23 ¹¹ / ₁₆ "	HXBM24248	\$2707

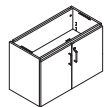

 **For Canadian Pricing**
 Multiply U.S. Price by the Canadian price factor.
 ▶ See page 1 for details.

Folio Wall-Mounted Sink Cabinets

Folio
Wall-Mounted
Sink Cabinets

Standard Includes		Required to Specify
<ul style="list-style-type: none"> ▶ Need help? Product details, page 298 	<ul style="list-style-type: none"> Sink cabinet: Low-Pressure Laminate D pull, if selected: nickel only Euro hinge, if selected: nickel only Edges: matching 3 mm plastic on doors and drawers and matching 1 mm plastic on all other edges Shelf pins 	<ul style="list-style-type: none"> 1 Style number 2 Laminate color number for sink cabinet 3 Options, if selected (see below) ▶ See <i>Surface Materials</i>, page 375.

Options	U.S. Price	Required to Specify
Door Pulls <ul style="list-style-type: none"> Contemporary: nickel only Opus: champagne only Jazz: nickel only 	No cost +\$26 per pull +\$28 per pull	Specify with <i>contemporary pull</i> . Specify with <i>Opus pull</i> . Specify with <i>jazz pull</i> .
Lock and Keying <ul style="list-style-type: none"> Lock 9201 Polished Chrome only Keying Factory and field-installed keying 	+\$52	Specify with <i>lock</i> . ▶ Page 398
Related Products <ul style="list-style-type: none"> Shelves for wall-mounted sink cabinets Fillers for wall-mounted sink cabinets 		▶ Page 321 ▶ Page 322

Tip: For inside dimensions of sink cabinets, ▶ See page 311.

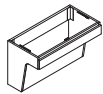

Tip: Height is for sink cabinet without worksurface.

Specification Information				
Dimensions			Style	U.S.
D	W	H	Number	Base Price

Sink Cabinets with Angled Front

Sink Cabinet				
18 ¹ / ₂ "	36"	23 ¹¹ / ₁₆ "	HXBK3622A8	\$1857

Sink Cabinets with Single Door

Hinged Left				
18 ¹ / ₂ "	24"	23 ¹¹ / ₁₆ "	HXBKD2424L8	\$1757

Hinged Right				
18 ¹ / ₂ "	24"	23 ¹¹ / ₁₆ "	HXBKD2424R8	\$1757

Sink Cabinets with Double Doors

18 ¹ / ₂ "	36"	23 ¹¹ / ₁₆ "	HXBKD36248	\$2144
----------------------------------	-----	------------------------------------	-------------------	--------

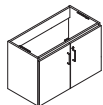

 **For Canadian Pricing**
 Multiply U.S. Price by the Canadian price factor.
 ▶ See page 1 for details.

Folio

73"H Wall-Mounted Wardrobe Cabinets

Standard Includes		Required to Specify
<ul style="list-style-type: none"> ▶ Need help? Product details, page 300 	<ul style="list-style-type: none"> Wardrobe, door fronts, and fixed shelf: Low-Pressure Laminate D pull, if selected: nickel only Euro hinge, if selected: nickel only Edges: matching 3 mm plastic on doors and matching 1 mm plastic on all other edges Hanger bar: chrome 	<ol style="list-style-type: none"> Style number Laminate color number for wardrobe cabinet Options, if selected (see below) <ul style="list-style-type: none"> ▶ See <i>Surface Materials</i>, page 375.

Options	U.S. Price	Required to Specify
Door Pulls <ul style="list-style-type: none"> Contemporary: nickel only Opus: champagne only Jazz: nickel only 	No cost +\$26 per pull +\$28 per pull	Specify <i>with contemporary pull</i> . Specify <i>with Opus pull</i> . Specify <i>with jazz pull</i> .
Lock and Keying <ul style="list-style-type: none"> Lock 9201 Polished Chrome only Keying Factory and field-installed keying 	+\$52	Specify <i>with lock</i> . ▶ Page 398
Related Products <ul style="list-style-type: none"> Fillers for wall-mounted wardrobe cabinets 		▶ Page 321

Specification Information				
Dimensions			Style	U.S.
D	W	H	Number	Base Price

Wardrobe Cabinets with Single Door, One Fixed Shelf, and One Small Drawer Hinged Left

Hinged Left

18½"	24"	72 ¹¹ / ₁₆ "	HXCW2473LD8	\$3140
------	-----	------------------------------------	--------------------	--------

Hinged Right

18½"	24"	72 ¹¹ / ₁₆ "	HXCW2473RD8	\$3140
------	-----	------------------------------------	--------------------	--------

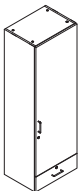

For Canadian Pricing

Multiply U.S. Price by the Canadian price factor.

▶ See page 1 for details.

Folio

79"H Wall-Mounted Wardrobe Cabinets with Sloped Top

Folio
79"H Wall-Mounted
Wardrobe Cabinets
with Sloped Top

Standard Includes	Required to Specify
<ul style="list-style-type: none"> ▶ Need help? Product details, page 300 • Wardrobe, sloped top, door fronts, and fixed shelf: Low-Pressure Laminate • D pull, if selected: nickel only • Euro hinge, if selected: nickel only • Edges: matching 3 mm plastic on doors and matching 1 mm plastic on all other edges • Hanger bar: chrome 	<ol style="list-style-type: none"> 1 Style number 2 Laminate color number for wardrobe cabinet 3 Options, if selected (see below) <ul style="list-style-type: none"> ▶ See <i>Surface Materials</i>, page 375.

Options	U.S. Price	Required to Specify
Door Pulls <ul style="list-style-type: none"> • Contemporary: nickel only • Opus: champagne only • Jazz: nickel only 	No cost +\$26 per pull +\$28 per pull	Specify with <i>contemporary pull</i> . Specify with <i>Opus pull</i> . Specify with <i>jazz pull</i> .
Lock and Keying <ul style="list-style-type: none"> • 9201 Polished Chrome only • Factory and field-installed keying 	+\$52	Specify with <i>lock</i> . ▶ Page 398

Tip: Bottom panel is flush with bottom of end panels.

Tip: Panel thicknesses are ⁴⁹/₆₄" Low-Pressure Laminate.

Specification Information				
Dimensions			Style	U.S.
D	W	H	Number	Base Price

Wardrobe Cabinets with Single Door and One Fixed Shelf

Hinged Left				
18½"	24"	79"	HXCW2479LS8	\$3344

Hinged Right				
18½"	24"	79"	HXCW2479RS8	\$3344

Wardrobe Cabinets with Single Door, One Fixed Shelf, and One Small Drawer Hinged Left

Hinged Left				
18½"	24"	79"	HXCW2479LSD8	\$3449

Hinged Right				
18½"	24"	79"	HXCW2479RSD8	\$3449

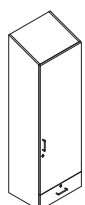
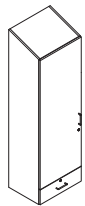
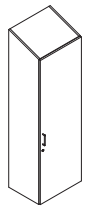
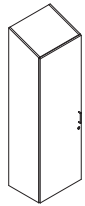

Folio

73"H Wall-Mounted Bookcases

Standard Includes		Required to Specify
<ul style="list-style-type: none"> ▶ Need help? Product details, page 302 	<ul style="list-style-type: none"> Bookcase, door fronts, and shelves: Low-Pressure Laminate D pull, if selected: nickel only Euro hinge, if selected: nickel only Edges: matching 3 mm plastic on doors and matching 1 mm plastic on all other edges Shelf Pins 	<ul style="list-style-type: none"> 1 Style number 2 Laminate color number for bookcase 3 Options, if selected (see below) ▶ See <i>Surface Materials</i>, page 375.

Options	U.S. Price	Required to Specify
Door Pulls <ul style="list-style-type: none"> Contemporary: nickel only Opus: champagne only Jazz: nickel only 	No cost +\$26 +\$28	Specify with <i>contemporary pull</i> . Specify with <i>Opus pull</i> . Specify with <i>jazz pull</i> .
Lock and Keying <ul style="list-style-type: none"> Lock 9201 Polished Chrome only Keying Factory and field-installed keying 	+\$52	Specify with <i>lock</i> . ▶ Page 398
Related Products <ul style="list-style-type: none"> Wall-mounted wardrobe cabinets 		▶ Page 314

Tip: Additional shelves are available and must be specified separately.

Specification Information				
Dimensions			Style	U.S.
D	W	H	Number	Base Price

Open Bookcase with Five Shelves

18½"	24"	72 ¹¹ / ₁₆ "	HXCBP24738	\$2891
------	-----	------------------------------------	-------------------	--------

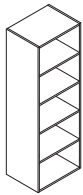

Bookcases with Single Door and Five Shelves

Hinged Left

18½"	24"	72 ¹¹ / ₁₆ "	HXCBD2473L8	\$3572
------	-----	------------------------------------	--------------------	--------

Hinged Right

18½"	24"	72 ¹¹ / ₁₆ "	HXCBD2473R8	\$3572
------	-----	------------------------------------	--------------------	--------

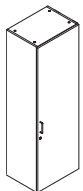

For Canadian Pricing

Multiply U.S. Price by the Canadian price factor.

▶ See page 1 for details.

Folio

79"H Wall-Mounted Bookcase with Sloped Top

Folio
79"H Wall-Mounted
Bookcase with Sloped Top



Tip: One shelf is fixed at 36"H. All other shelves are adjustable.

Tip: Additional shelves are available and must be specified separately.

Standard Includes		Required to Specify
<ul style="list-style-type: none"> ▶ Need help? Product details, page 302 	<ul style="list-style-type: none"> • Bookcase, sloped top, door fronts, and shelves: Low-Pressure Laminate • D pull, if selected: nickel only • Euro hinge, if selected: nickel only • Edges: matching 3 mm plastic on doors and matching 1 mm plastic on all other edges • Shelf pins 	<ul style="list-style-type: none"> 1 Style number 2 Laminate color number for bookcase 3 Options, if selected (see below) ▶ See <i>Surface Materials</i>, page 375.

Options	U.S. Price	Required to Specify
Door Pulls <ul style="list-style-type: none"> • Contemporary: nickel only • Opus: champagne only • Jazz: nickel only 	No cost +\$26 +\$28	Specify with <i>contemporary pull</i> . Specify with <i>Opus pull</i> . Specify with <i>jazz pull</i> .
Lock and Keying <ul style="list-style-type: none"> • 9201 Polished Chrome only • Factory and field-installed keying 	+\$52	Specify with <i>lock</i> . ▶ Page 398
Related Products <ul style="list-style-type: none"> • Wall-mounted wardrobe cabinets 		▶ Page 314

Specification Information				
Dimensions			Style	U.S.
D	W	H	Number	Base Price
:	:	:	:	:

Bookcase with Single Door and Five Shelves

Hinged Left

18 1/2"	24"	79"	HXCBD2479L8S	\$3929
:	:	:	:	:



For Canadian Pricing

Multiply U.S. Price by the Canadian price factor.

▶ See page 1 for details.

Folio High-Pressure Laminate Wall-Mounted Worksurfaces

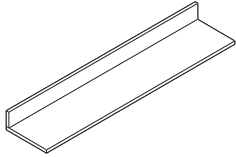

Tip: Worksurfaces must be attached to base cabinets or desk frames.

Standard Includes		Required to Specify
<ul style="list-style-type: none"> ▶ Need help? Product details, page 304 	<ul style="list-style-type: none"> • Standard length High-Pressure Laminate worksurface with backplash • Edge band: 3 mm plastic on front and 1 mm plastic on sides, back, and all backplash edges 	<ol style="list-style-type: none"> 1 Style number 2 Laminate color number for worksurface and backplash 3 Plastic color number for edge on worksurface 4 Options, if selected (see below) <ul style="list-style-type: none"> ▶ See <i>Surface Materials</i>, page 375.

Options	U.S. Price	Required to Specify
Surface Materials <ul style="list-style-type: none"> • Steelcase Health High-Pressure Laminate • Steelcase High-Pressure Laminate 	No cost	<ul style="list-style-type: none"> ▶ See <i>Surface Materials</i>, page 375. ▶ See <i>Surface Materials</i>, page 375.

Specification Information

Dimensions		Style Number	U.S. Price
D	W		
High-Pressure Laminate Worksurfaces with 4" Backplash			
19 ¹ / ₄ "	18"	HXW1818L	\$ 553
19 ¹ / ₄ "	24"	HXW2418L	\$ 620
19 ¹ / ₄ "	36"	HXW3618L	\$ 757
19 ¹ / ₄ "	42"	HXW4218L	\$ 825
19 ¹ / ₄ "	48"	HXW4818L	\$ 890
19 ¹ / ₄ "	60"	HXW6018L	\$ 992
19 ¹ / ₄ "	72"	HXW7218L	\$1100



For Canadian Pricing
Multiply U.S. Price by the Canadian price factor.
▶ See page 1 for details.

Folio

4"H High-Pressure Laminate Wall-Mounted Sidesplash

Folio
4"H High-Pressure Laminate
Wall-Mounted Sidesplash



Standard Includes		Required to Specify
▶ Need help? Product details, page 304	<ul style="list-style-type: none"> High-Pressure Laminate sidesplash Edge band: 1 mm plastic 	1 Style number 2 Laminate color number for sidesplash 3 Plastic color number for edge on side-splash 4 Options, if selected (see below) ▶ See <i>Surface Materials</i> , page 375.

Options	U.S. Price	Required to Specify
Surface Materials		
<ul style="list-style-type: none"> Steelcase Health High-Pressure Laminate Steelcase High-Pressure Laminate 	No cost	▶ See <i>Surface Materials</i> , page 375.
	No cost	▶ See <i>Surface Materials</i> , page 375.

Specification Information			
Dimensions		Style Number	U.S. Price
D	H		
16 ¹ / ₄ "	4"	HXWS416L	\$110
18 ¹ / ₈ "	4"	HXWS418L	\$114



For Canadian Pricing
Multiply U.S. Price by the
Canadian price factor.
▶ See page 1 for details.

Folio

Wall-Mounted Solid Surface Worksurfaces

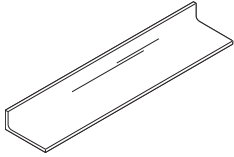

Worksurfaces are designed with a 1" overhang.

Tip: Worksurfaces must be attached to base cabinets or desk frames.

Standard Includes	Required to Specify
<ul style="list-style-type: none"> ▶ Need help? Product details, page 304 • Solid surface worksurface with integrated backsplash 	<ul style="list-style-type: none"> 1 Style number 2 Solid surface color number for worksurface and backsplash ▶ See <i>Surface Materials</i>, page 375.

Specification Information

Dimensions		Style Number	U.S. Prices			
D	W		Price Group A	Price Group B	Price Group C	Price Group D

Solid Surface Worksurfaces with Integrated Backsplash						
D	W	Style Number	Price Group A	Price Group B	Price Group C	Price Group D
19 1/4"	24"	HXW2418S	\$1358	\$1472	\$1510	\$1691
19 1/4"	36"	HXW3618S	\$1964	\$2129	\$2186	\$2446
19 1/4"	42"	HXW4218S	\$2190	\$2369	\$2440	\$2728
19 1/4"	48"	HXW4818S	\$2420	\$2618	\$2693	\$3013
19 1/4"	60"	HXW6018S	\$2891	\$3129	\$3217	\$3601
19 1/4"	72"	HXW7218S	\$3391	\$3668	\$3772	\$4226



For Canadian Pricing
 Multiply U.S. Price by the Canadian price factor.
 ▶ See page 1 for details.

Folio Wall-Mounted Desk Frames

For Use with Common Tops

Folio
Wall-Mounted Desk Frames

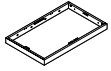

Standard Includes		Required to Specify
<ul style="list-style-type: none"> ▶ Need help? Product details, page 306 	<ul style="list-style-type: none"> • Desk frame without back panel, if selected: Low-Pressure Laminate • Desk frame, back panel, and side panel, if selected: Low-Pressure Laminate • Door, if selected: Low-Pressure Laminate • D pull, if door option selected: nickel only • Euro hinge, if door option selected: nickel only 	<ul style="list-style-type: none"> 1 Style number 2 Laminate color number for desk frame, and back panel ▶ See <i>Surface Materials</i>, page 375.

Related Products	
<ul style="list-style-type: none"> • Wall-mounted wardrobe cabinets • Wall-mounted base or sink cabinets • Wall-mounted worksurfaces 	<ul style="list-style-type: none"> ▶ Page 314 ▶ Pages 312 and 313 ▶ Pages 318

Specification Information

Dimensions		Style	U.S.
D	W	Number	Price

Desk Frames without Back Panel for Use with Common Top			
17 ³ / ₈ "	18"	HXDF1818	\$353
17 ³ / ₈ "	24"	HXDF2418	\$364
17 ³ / ₈ "	36"	HXDF3618	\$387
17 ³ / ₈ "	42"	HXDF4218	\$401
17 ³ / ₈ "	48"	HXDF4818	\$411
17 ³ / ₈ "	60"	HXDF6018	\$431
17 ³ / ₈ "	72"	HXDF7218	\$443

Tip: Desk frames must be attached to worksurface. Specify worksurfaces separately.

Tip: Desk frames must be attached to adjacent 14"D or 18"D structural wall or cabinet.

 **For Canadian Pricing**
Multiply U.S. Price by the Canadian price factor.
▶ See page 1 for details.

Folio

Wall-Mounted Accessories

Storage Shelves



Standard Includes	Required to Specify
<ul style="list-style-type: none"> Shelves: Low-Pressure Laminate Edges: matching 3 mm plastic on fronts and matching 1 mm plastic on sides and back Shelf pins 	<ul style="list-style-type: none"> 1 Style number 2 Laminate color number for shelf ▶ See <i>Surface Materials</i>, page 375.

Specification Information

Dimensions			Style Number	U.S. Price
D	W	H		

Shelves for Wall-Mounted Base Cabinets

18"	18"	3/4"	HXBS1818	\$110
18"	24"	3/4"	HXBS2418	\$121
18"	36"	3/4"	HXBS3618	\$147

Tip: For use with base cabinets only.

Wall-Mounted Fillers

Tip: Fillers close the gap between a cabinet and structural wall. Field cutting of filler may be required to achieve architectural fit.

Standard Includes	Required to Specify
<ul style="list-style-type: none"> Need help? Product details, page 308 Filler: Low-Pressure Laminate 	<ul style="list-style-type: none"> 1 Style number 2 Laminate color number for filler ▶ See <i>Surface Materials</i>, page 375.

Specification Information

Dimensions			Style Number	U.S. Price
D	W	H		

Filler for Use with Wall-Mounted Base or Sink Cabinets

57/8"	6"	23 ¹¹ / ₁₆ "	HXFB624	\$333
-------	----	------------------------------------	----------------	-------



Fillers for Use with Wall-Mounted Wardrobe Cabinets

57/8"	6"	72 ¹¹ / ₁₆ "	HXFCWB673	\$349
-------	----	------------------------------------	------------------	-------

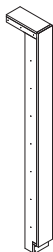

For Canadian Pricing

Multiply U.S. Price by the Canadian price factor.

▶ See page 1 for details.

Park

	
Statement of Line	324

	
Understanding	
Bedside Tables	326

	
Specifying	
Bedside Tables	328

Statement of Line

Park

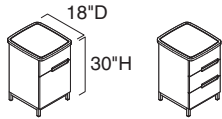

Understanding
▶ Page 326
Specifying
▶ Page 328

Bedside Tables

	18"W
With one drawer and one door	●
With three drawers	●

Park Bedside Tables

Bedside tables are available in three configurations to meet the storage needs of the patient.

Top is rigid thermoform foil. Spill collector top is standard.

Back is Low-Pressure Laminate and finished to match cabinet.

Drawers are wood core, miter-fold construction with full-extension, 1/2" ball-bearing slides.

Door is hinged and is rigid thermoform foil.

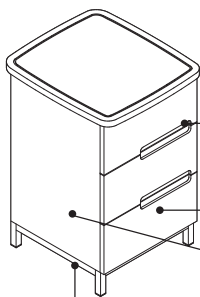
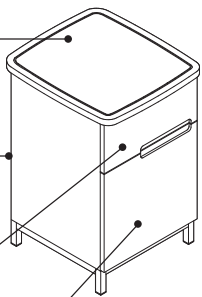

Integral pull on doors and drawers is standard.

Drawer fronts are rigid thermoform foil.

Bedside table case is Low-Pressure Laminate.

Base is painted in 4799 Platinum Metallic only.

Actual Dimensions

Depth 18"

Box Width 18"

Top Width 24¹/₄"

Height 30"

Product Details

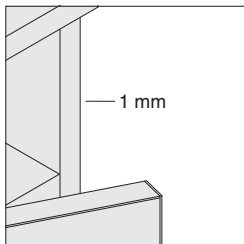

Edges on cabinet cases are matching 1 mm plastic trim for Low-Pressure Laminate. Rigid thermoform drawer and door front edges are wrapped in thermoform foil.

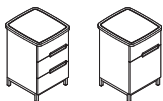

30"H bedside tables are available with three drawers or with one small drawer and a door cabinet below. Door is available hinged on the left or right. A left-hand unit has hinge on left side of door. A right-hand unit has the hinge on right side of door.

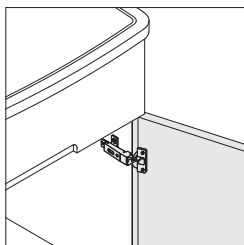

Euro hinge is standard on cabinet doors and allows the door to open a full 110° for easy access.

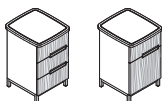

Grain direction matches vertically on all drawer and door sets in cabinet.

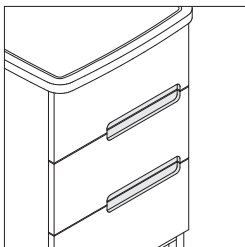

Integral drawer pulls are standard.

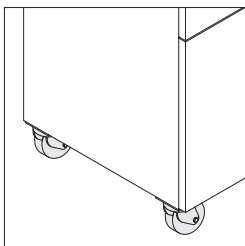

Casters are optional. They have a 2½" diameter and are non-marring. The front casters swivel for steering and are lockable to hold the table in place when necessary. The back casters swivel and do not lock.

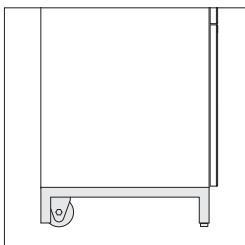

Rear rollers and front glides are optional to assist in moving the table. Rear rollers are non-directional and are placed adjacent to the rear legs.

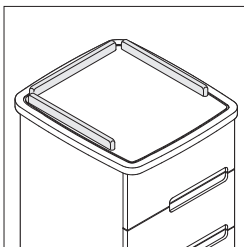

Gallery rails are available as an option. Rails are a stained veneer that match the case finish.

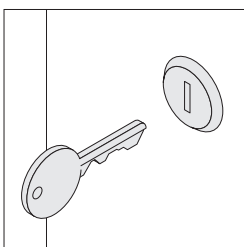

Lock is optional and factory- or field-installed to secure the doors or top drawer of the cabinet. Factory-installed locks are available keyed random only. Optional field-installed locks are available with consecutive, specific, or random keying options. Master-keyed locks are also available. Field-installed lock cylinders must be specified separately.

► Lock and Keying, Page 398.

Connections

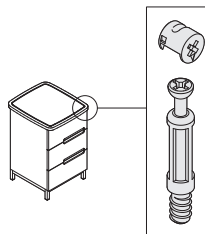

Cam-lock assembly hardware is used.

Bedside tables are free-standing and do not need to be ganged to other furniture or bolted to the floor.

Surface Materials

Bedside table

- Low-Pressure Laminate

Door and drawer fronts

- Rigid thermoform

Top

- Rigid thermoform

Drawer pulls

- Integral pulls

Base

- 4799 Platinum Metallic paint only

Casters

- Black only

Locks

- 9201 Polished Chrome only

Park Bedside Tables

Standard Includes		Required to Specify
<ul style="list-style-type: none"> ▶ Need help? Product details, page 326 	<ul style="list-style-type: none"> • Bedside table case: Low-Pressure Laminate • Door and drawer fronts: rigid thermoform • Base: 4799 Platinum Metallic only • Top: rigid thermoform • Integral pull on doors and drawers • Adjustable glides 	<ol style="list-style-type: none"> 1 Style number 2 Laminate color number for bedside table case 3 Rigid thermoform color number for bedside table front 4 Rigid thermoform color number for top 5 Options, if selected (see below) <ul style="list-style-type: none"> ▶ See <i>Surface Materials</i>, page 375.

Options	U.S. Price	Required to Specify
Gallery Rail	• Gallery rail +\$162	Specify <i>with gallery rail</i> .
Casters	• Casters (set of four) +\$ 41 • Rear roller casters with front glides +\$ 84	Specify <i>with casters</i> . Specify <i>with rear roller casters</i> .
Lock and Keying	Lock with random key • 9201 Polished Chrome only +\$ 52	Specify <i>with lock</i> .
	Keying • Factory- and field-installed keying	▶ Page 398
Related Products	• Accessories • Overbed tables	▶ Page 357 ▶ Page 354

Tip: Lock, if selected, will only secure top drawer of cabinet.

Tip: 18" deep bedside tables have a 15 $\frac{5}{8}$ " deep drawer and the slide has 14" of travel.

Tip: Depth and width dimensions are for box unit and do not include overhang of top.

Specification Information				
Dimensions			Style	U.S.
D	W	H	Number	Base Price
:	:	:	:	:
:	:	:	:	:

With Three Drawers

18"	18"	30"	H4BM30R	\$1750
:	:	:	:	:

With One Drawer and One Door Cabinets

Door Hinged on Left

18"	18"	30"	H4BG30LR	\$1494
-----	-----	-----	-----------------	--------

Door Hinged on Right

18"	18"	30"	H4BG30RR	\$1494
:	:	:	:	:



For Canadian Pricing

Multiply U.S. Price by the Canadian price factor.

▶ See page 1 for details.

Senza



Statement of Line **330**



Understanding

Wardrobe Cabinets	332
Dressers	334
Bedside Tables	336



Specifying

Wardrobe Cabinets	338
Dressers	342
Bedside Tables	344

Statement of Line

Senza

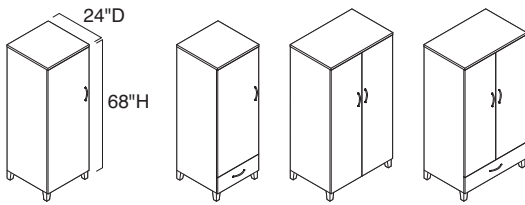

Understanding
 ▶ Page 332
 Specifying
 ▶ Pages 338–340

Wardrobe Cabinets

	24\"/>	
Single-door wardrobe	●	
Single-door wardrobe with one drawer	●	
Double-door wardrobe		●
Double-door wardrobe with one drawer		●

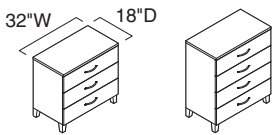

Understanding
 ▶ Page 334
 Specifying
 ▶ Pages 342–343

Dressers

	30\"/>	
With three drawers	●	
With four drawers		●

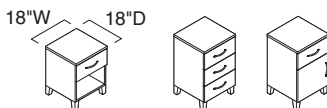

Understanding
 ▶ Page 336
 Specifying
 ▶ Pages 344–345

Bedside Tables

	24\"/>	
Night table with one drawer and open shelf	●	
Bedside table with three drawers		●
Bedside table with one drawer and one door		●

Senza Wardrobe Cabinets

Wardrobe cabinets are available in single-door and double-door versions and may be specified with drawers to meet diverse storage needs.

Top is Low-Pressure Laminate with 3 mm plastic edge to match fronts.

Hanger bar runs the width of each cabinet.

Wardrobe cabinets are provided in Low-Pressure Laminate to match fronts.

Back is finished to match fronts.

Doors have hinges and are available in rigid thermoform or Low-Pressure Laminate.

Wood-leg base is standard on cabinets.

Fixed shelf provides an additional storage surface. Shelf is Low-Pressure Laminate to match case.

Bow pulls on doors and drawers are standard in brushed nickel.

Drawers are wood core, miter-fold construction with full-extension, 1/2" ball-bearing sides.

Drawer fronts are rigid thermoform or Low-Pressure Laminate.

Adjustable glides adjust for installation on uneven floors. Adjustability range is 1 1/2".

Product Details

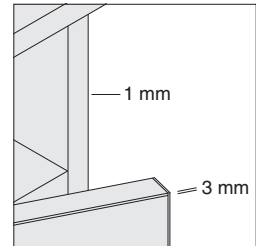

Edges on cabinet cases are matching 1 mm plastic trim for Low-Pressure Laminate. Drawer and door edges are matching 3 mm plastic trim for Low-Pressure Laminate. Rigid thermoform drawer and door fronts have the edges wrapped in thermoform foil.

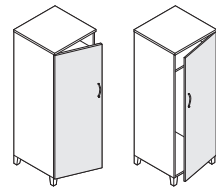

Single-door cabinets are hinged on the left or right side. A left-hand unit has the hinge on the left side of the door. A right-hand unit has the hinge on the right side of the door.

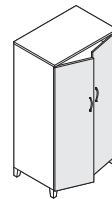

Double-door cabinets open from the center out.

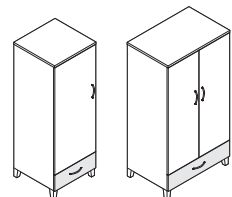

Bottom drawer is available on single- and double-door cabinets.

Actual Dimensions

Depth 24"

Width 24" or 36"

Height 68"

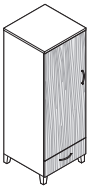

Grain direction matches vertically on all door combinations. Grain direction also matches vertically on all drawer sets.

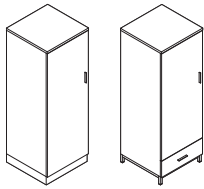

Additional bases are available as an option. Optional bases include:

- Enclosed base on cabinets with rigid thermoform or Low-Pressure Laminate fronts.
- Metal base on cabinets with rigid thermoform or Low-Pressure Laminate.

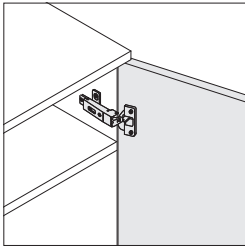

Euro hinge is standard on cabinet doors and allows the door to open a full 110° for easy access.

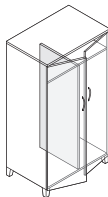

Center vertical divider is optional for use on 36"W double-door cabinets only. Divider matches the finish of the cabinet and is Low-Pressure Laminate for Low-Pressure Laminate cabinets. The center divider is shipped installed.

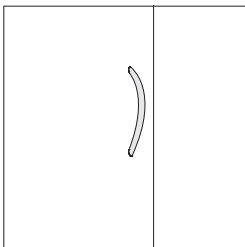

Bow pulls are standard.

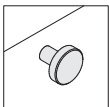

Flat Knob

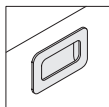

Opus

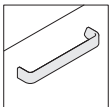

Jazz

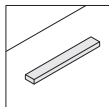

Line

Additional door and drawer pull options are available. Optional pulls include:

- Flat knob pull
- Opus pull
- Jazz pull
- Line pull

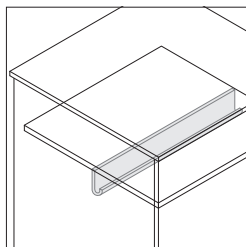

J-bar cotrod is available as an option on 24" and 36" wide wardrobes and attaches to the underside of the fixed shelf. This is the suggested option when patient safety is a concern.

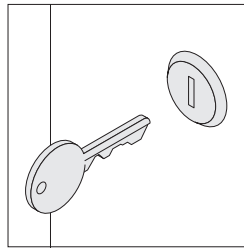

Lock is optional and factory- or field-installed on single-door and double-door wardrobe cabinets without drawers. Factory-installed locks are available with consecutive, specific, or random keying options. Master-keyed locks are also available. Field-installed lock cylinders must be specified separately.

► Lock and Keying, Page 398

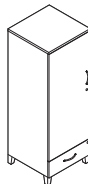

Single-door wardrobe with drawer has one lock in door and one lock in drawer. Locks are available field-installed only.

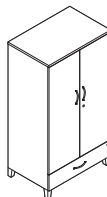

Double-door wardrobe with drawer has one lock for doors and one lock in drawer. Locks are available field-installed only.

Connections

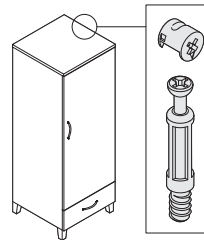

Cam-lock assembly hardware is used.

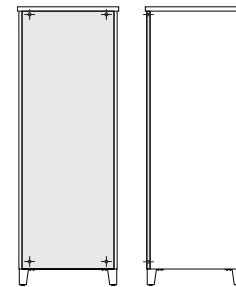

Wardrobe cabinets must always be fastened to a wall. Attachment hardware is included with cabinets.

Surface Materials

Wardrobe cabinet and fixed shelf

- Low-Pressure Laminate

Top

- Low-Pressure Laminate with 3 mm matching plastic edge

Drawer fronts

- Low-Pressure Laminate
- Rigid thermoform

Door fronts

- Low-Pressure Laminate
- Rigid thermoform

Door and drawer pulls

- Brushed nickel on bow pull
- 9211 Nickel on flat knob pull (option)
- Champagne on Opus pull (option)
- 9211 Nickel on Jazz pull (option)
- 4799 Platinum Metallic on line pull (option)

Hanger bar

- Black only

Base

- Low-Pressure Laminate on enclosed base
- Wood veneer on wood-leg base
- 4799 Platinum Metallic on metal base

Locks

- 9201 Polished Chrome only

Senza Dressers

Dressers are available with three- and four-drawer configurations for storage of clothing in patient rooms.

Dresser is available in Low-Pressure Laminate to match fronts.

Top is available in rigid thermoform to match rigid thermoform fronts and High-Pressure Laminate with 3 mm plastic edges to match Low-Pressure Laminate fronts.

Back is finished to match fronts.

Drawers are wood core, miter-fold construction with full-extension, 1/2" ball-bearing sides.

Adjustable glides adjust for installation on uneven floors. Adjustability range is 1 1/2".

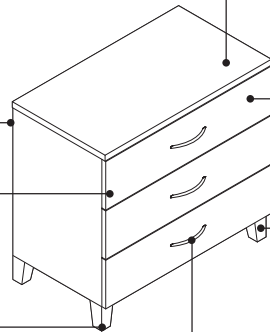

Drawer fronts are rigid thermoform or Low-Pressure Laminate.

Wood-leg base is standard on cabinets.

Bow pulls on drawers are standard in brushed nickel.

Actual Dimensions

Depth 18"

Width 32"

Height 30" or 38"

Product Details

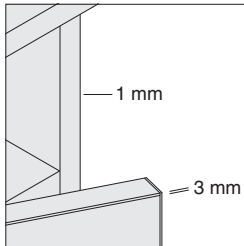

Edges on cabinet cases are matching 1 mm plastic trim for Low-Pressure Laminate. Drawer and door edges are matching 3 mm plastic trim for Low-Pressure Laminate. Rigid thermoform drawer and door fronts have the edges wrapped in thermoform foil.



Grain direction matches vertically on all drawer sets in cabinet.

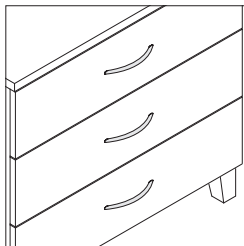

Bow pulls are standard.

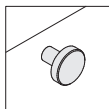

Flat Knob

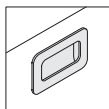

Opus

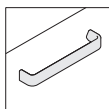

Jazz

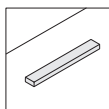

Line

Additional door and drawer pull options

are available. Optional pulls include:

- Flat knob pull
- Opus pull
- Jazz pull
- Line pull

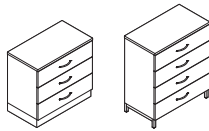

Additional bases are available as an option. Optional bases include:

- Enclosed base on cabinets with rigid thermo form or Low-Pressure Laminate fronts.
- Metal base on cabinets with rigid thermoform or Low-Pressure Laminate.

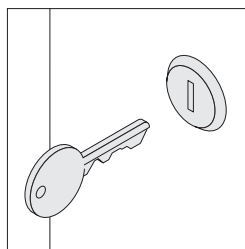

Lock is optional and factory- or field-installed to secure the top drawer of the cabinet. Factory-installed locks are available keyed random only. Optional field-installed locks are available with consecutive, specific, or random keying options. Master-keyed locks are also available. Field-installed lock cylinders must be specified separately.

▶ Lock and Keying, Page 398

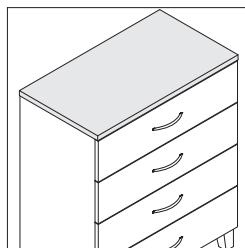

Solid surface top is available as an option on cabinets with Low-Pressure Laminate or wood fronts only.

Connections

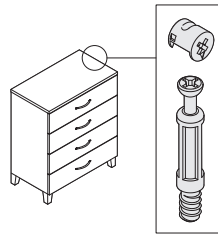

Cam-lock assembly hardware is used.

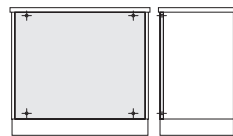

Dressers must always be fastened to a wall. Attachment hardware is included with dressers.

Surface Materials

Dresser

- Low-Pressure Laminate, with the exception of the High-Pressure Laminate top

Top

- High-Pressure Laminate with 3 mm plastic edge
- Rigid thermoform
- Solid surface (option for cabinets with Low-Pressure Laminate)

Tip: Select Surface solid surfaces are available.

▶ See *Surface Materials* section for complete listing.

Drawer fronts

- Low-Pressure Laminate
- Rigid thermoform

Drawer pulls

- Brushed nickel on bow pull
- 9211 Nickel on flat knob pull (option)
- Champagne on Opus pull (option)
- 9211 Nickel on Jazz pull (option)
- 4799 Platinum Metallic on line pull (option)

Base

- Low-Pressure Laminate on enclosed base
- Wood veneer on wood-leg base
- 4799 Platinum Metallic on metal base

Locks

- 9201 Polished Chrome only

Senza Bedside Tables

Bedside tables are available in three configurations to meet storage needs of the patient.

Back is finished to match fronts.

Drawer fronts are rigid thermoform or Low-Pressure Laminate.

Wood-leg base is standard on cabinets.

Glides are standard.

Bedside table case is available in Low-Pressure Laminate to match fronts.

Top is available in rigid thermoform to match rigid thermoform fronts and High-Pressure Laminate with 3 mm plastic edges to match Low-Pressure Laminate fronts.

Bow pulls on doors and drawers are standard in brushed nickel.

Doors have hinges and are available in rigid thermoform or Low-Pressure Laminate.

Open shelf area keeps overnight bags, other personal items, and equipment off the floor and out of traffic areas.

Drawers are wood core, miter-fold construction with full-extension, 1/2" ball-bearing sides.

Product Details

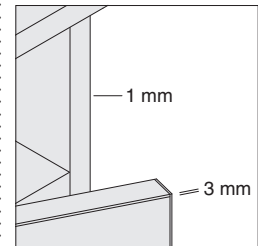

Edges on cabinet cases are matching 1 mm plastic trim for Low-Pressure Laminate. Drawer and door edges are matching 3 mm plastic trim for Low-Pressure Laminate. Rigid thermoform drawer and door fronts have the edges wrapped in thermoform foil.



24"H night table includes one small drawer with an open shelf below.

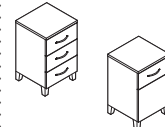

30"H bedside tables are available with three drawers, or with one small drawer and a door cabinet below. Door is available hinged on the left or right. A left-hand unit has hinge on left side of the door. A right-hand unit has hinge on right side of the door.

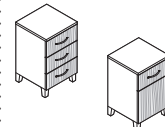

Grain direction matches vertically on all drawer sets in cabinet.

Actual Dimensions

Depth 18"

Width 18"

Height 24" or 30"

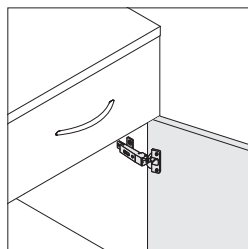

Euro hinge is standard on cabinet doors and allows the door to open a full 110° for easy access.

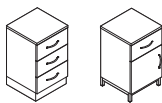

Additional bases are available as an option. Optional bases include:

- Enclosed base on cabinets with rigid thermoform or Low-Pressure Laminate fronts.
- Metal base on cabinets with rigid thermoform or Low-Pressure Laminate fronts.

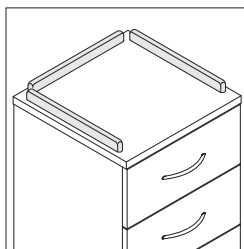

Gallery rails are available as an option. Solid wood rails are positioned on the back and sides of the top.

Connections

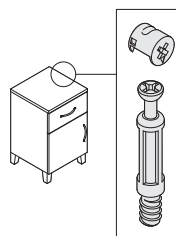

Cam-lock assembly hardware is used.

Bedside tables are free-standing and do not need to be ganged to other furniture or bolted to the floor.

Surface Materials

Bedside table

- Low-Pressure Laminate

Top

- High-Pressure Laminate with 3 mm plastic edge
- Rigid thermoform
- Solid surface (option for cabinets with Low-Pressure Laminate)

Tip: Select Surface solid surfaces are available.

► See *Surface Materials* section for complete listing.

Door and drawer pulls

- Brushed nickel on bow pull
- 9211 Nickel on flat knob pull (option)
- Champagne on Opus pull (option)
- 9211 Nickel on Jazz pull (option)
- 4799 Platinum Metallic on line pull (option)

Drawer fronts

- Low-Pressure Laminate
- Rigid thermoform

Door fronts

- Low-Pressure Laminate
- Rigid thermoform

Base

- Low-Pressure Laminate on enclosed base
- Wood veneer on wood-leg base
- 4799 Platinum Metallic on metal base

Locks

- 9201 Polished Chrome only

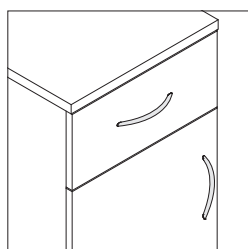

Bow pulls are standard.

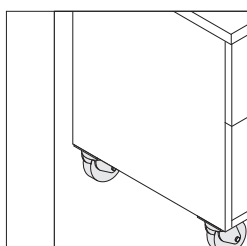

Casters are optional. They have a 2½" diameter and are non-marring. The front casters swivel for steering and are lockable to hold the table in place when necessary. The back casters swivel and do not lock.

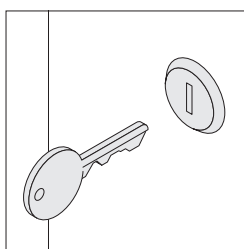

Lock is optional and factory- or field-installed to secure the top drawer of the cabinet. Factory-installed locks are available keyed random only. Optional field-installed locks are available with consecutive, specific, or random keying options. Master-keyed locks are also available. Field-installed lock cylinders must be specified separately.

► Lock and Keying, Page 398

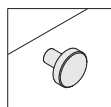

Flat Knob

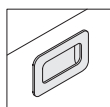

Opus

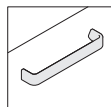

Jazz

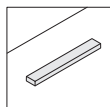

Line

Additional door and drawer pull options are available. Optional pulls include:

- Flat knob pull
- Opus pull
- Jazz pull
- Line pull

Vent slot extends the entire width of the cabinet for even airflow and improved moisture control.

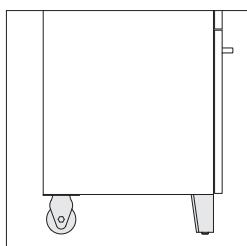

Rear rollers and front glides are optional to assist in moving the table. When selecting option for metal or enclosed base, rear rollers are non-directional and are placed adjacent to the rear legs. When selecting option for wood base, rear rollers are non-directional and replace rear legs.

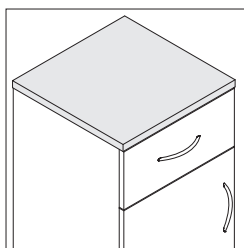

Solid surface top is available as an option on cabinets with Low-Pressure Laminate fronts only.

Senza Wardrobe Cabinets

with Low-Pressure Laminate Fronts

Standard Includes		Required to Specify
<ul style="list-style-type: none"> ▶ Need help? Product details, page 332 	<ul style="list-style-type: none"> • Wardrobe case: Low-Pressure Laminate to match fronts • Door and drawer fronts: Low-Pressure Laminate • Wood-leg base: wood veneer to match fronts • Top: Low-Pressure Laminate with 3 mm plastic edge to match fronts • Bow pull on doors and drawers: brushed nickel only • Hanger bar: black only • Adjustable glides • Fixed shelf 	<ol style="list-style-type: none"> 1 Style number 2 Laminate color number for door and drawer fronts 3 Options, if selected (see below) <ul style="list-style-type: none"> ▶ See <i>Surface Materials</i>, page 375.

Options	U.S. Price	Required to Specify
Door and Drawer Pulls <ul style="list-style-type: none"> • Flat knob pull: matte stainless steel only • Opus pull: champagne only • Jazz pull: nickel only • Line pull: 4799 Platinum Metallic only 	+\$ 24 per pull +\$ 26 per pull +\$ 28 per pull +\$ 32 per pull	Specify with flat knob pull. Specify with Opus pull. Specify with jazz pull. Specify with line pull.
Base <ul style="list-style-type: none"> • Enclosed base • Metal-leg base 	+\$ 93 +\$171	Specify with enclosed base. Specify with metal-leg base.
Center Vertical Divider <ul style="list-style-type: none"> • For 36"W wardrobe cabinets only 	+\$254	Specify with center vertical divider.
J-bar Coatrod <ul style="list-style-type: none"> • For 24"W wardrobe cabinets • For 36"W wardrobe cabinets 	+\$130 +\$197	Specify with J-bar. Specify with J-bar.
Lock and Keying <ul style="list-style-type: none"> • Single-door wardrobe cabinets • Single-door with drawer or double-door wardrobe cabinets 	+\$ 52 +\$103	Specify with lock. Specify with lock.
	Keying <ul style="list-style-type: none"> • Factory- and field-installed keying 	▶ Page 398
Related Products <ul style="list-style-type: none"> • Accessories • Overbed tables 		▶ Page 357 ▶ Page 354

Tip: J-bar coatrod not available on 42"W wardrobe cabinets.

Tip: Wardrobe cabinets with a single lock are available with factory- or field-installed locks. Wardrobe cabinets with multiple locks are available field-installed only.

Specification Information			
Dimensions	Style	U.S.	
D W H	Number	Base Price	

Single-Door Wardrobe Cabinets

Door Hinged on Left

24"	24"	68"	H3W124LL	\$2018
-----	-----	-----	-----------------	--------

Door Hinged on Right

24"	24"	68"	H3W124RL	\$2018
-----	-----	-----	-----------------	--------

▶ Specification Information, continued on next page

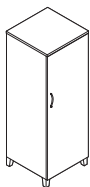
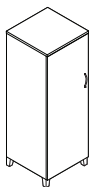

► **Specification Information, continued from previous page**

Specification Information

Dimensions			Style	U.S.
D	W	H	Number	Base Price

Single-Door Wardrobe Cabinets with One Drawer

Door Hinged on Left

24"	24"	68"	H3W1C24LL	\$2018
-----	-----	-----	------------------	--------

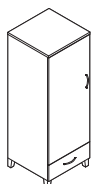

Door Hinged on Right

24"	24"	68"	H3W1C24RL	\$2018
-----	-----	-----	------------------	--------

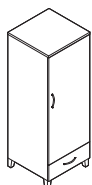

Tip: Single-door wardrobe cabinet with drawer has one lock in door and one lock in drawer. Locks are available field-installed only.

Double-Door Wardrobe Cabinet

24"	36"	68"	H3W236L	\$2584
-----	-----	-----	----------------	--------

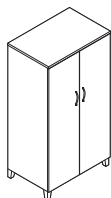

Double-Door Wardrobe Cabinet with One Drawer

24"	36"	68"	H3W2C36L	\$2658
-----	-----	-----	-----------------	--------

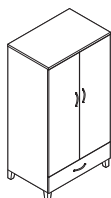

Tip: Double-door wardrobe cabinet with drawer has one lock for doors and one lock in drawer. Locks are available field-installed only.



For Canadian Pricing

Multiply U.S. Price by the Canadian price factor.

► See page 1 for details.

Senza Wardrobe Cabinets

with Rigid Thermoform Fronts

	Standard Includes	Required to Specify
▶ Need help? Product details, page 332	<ul style="list-style-type: none"> • Wardrobe case: Low-Pressure Laminate to match fronts • Door and drawer fronts: rigid thermoform • Wood-leg base: wood veneer to match fronts • Top: Low-Pressure Laminate with 3 mm plastic edge to match fronts • Bow pull on doors and drawers: brushed nickel only • Hanger bar: black only • Adjustable glides • Fixed shelf 	<ol style="list-style-type: none"> 1 Style number 2 Rigid thermoform color number for door and drawer fronts 3 Options, if selected (see below) <ul style="list-style-type: none"> ▶ See <i>Surface Materials</i>, page 375.

	Options	U.S. Price	Required to Specify
Door and Drawer Pulls	<ul style="list-style-type: none"> • Flat knob pull: matte stainless steel only • Opus pull: champagne only • Jazz pull: nickel only • Line pull: 4799 Platinum Metallic only 	<ul style="list-style-type: none"> +\$ 24 per pull +\$ 26 per pull +\$ 28 per pull +\$ 32 per pull 	<ul style="list-style-type: none"> Specify with flat knob pull. Specify with Opus pull. Specify with jazz pull. Specify with line pull.
Base	<ul style="list-style-type: none"> • Enclosed base • Metal-leg base 	<ul style="list-style-type: none"> +\$ 93 +\$171 	<ul style="list-style-type: none"> Specify with enclosed base. Specify with metal-leg base.
Center Vertical Divider	<ul style="list-style-type: none"> • For 36"W wardrobe cabinets only 	<ul style="list-style-type: none"> +\$254 	<ul style="list-style-type: none"> Specify with center vertical divider.
J-bar Coatrod	<ul style="list-style-type: none"> • For 24"W wardrobe cabinets • For 36"W wardrobe cabinets 	<ul style="list-style-type: none"> +\$130 +\$197 	<ul style="list-style-type: none"> Specify with J-bar. Specify with J-bar.
Lock and Keying	Lock with random key: 9201 Polished Chrome only		
	<ul style="list-style-type: none"> • Single-door wardrobe cabinets • Single-door with drawer or double-door wardrobe cabinets 	<ul style="list-style-type: none"> +\$ 52 +\$103 	<ul style="list-style-type: none"> Specify with lock. Specify with lock.
	Keying		
	<ul style="list-style-type: none"> • Factory- and field-installed keying 		▶ Page 398
Related Products	<ul style="list-style-type: none"> • Accessories • Overbed tables 		<ul style="list-style-type: none"> ▶ Page 357 ▶ Page 354

Tip: J-bar coatrod not available on 42"W wardrobe cabinets.

Tip: Wardrobe cabinets with a single lock are available with factory- or field-installed locks. Wardrobe cabinets with multiple locks are available field-installed only.

Specification Information			
Dimensions	Style	U.S.	
D W H	Number	Base Price	

Single-Door Wardrobe Cabinets

Door Hinged on Left

24"	24"	68"	H3W124LR	\$2509
-----	-----	-----	-----------------	--------

Door Hinged on Right

24"	24"	68"	H3W124RR	\$2509
-----	-----	-----	-----------------	--------

▶ Specification Information, continued on next page

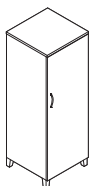
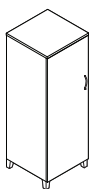

► **Specification Information, continued from previous page**

Specification Information

Dimensions			Style	U.S.
D	W	H	Number	Base Price

Single-Door Wardrobe Cabinets with One Drawer

Door Hinged on Left

24"	24"	68"	H3W1C24LR	\$2219
-----	-----	-----	------------------	--------

Door Hinged on Right

24"	24"	68"	H3W1C24RR	\$2219
-----	-----	-----	------------------	--------

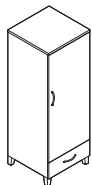
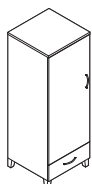

Tip: Single-door wardrobe cabinet with drawer has one lock in door and one lock in drawer. Locks are available field-installed only.

Double-Door Wardrobe Cabinet

24"	36"	68"	H3W236R	\$2803
-----	-----	-----	----------------	--------

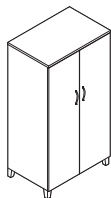

Double-Door Wardrobe Cabinet with One Drawer

24"	36"	68"	H3W2C36R	\$3211
-----	-----	-----	-----------------	--------

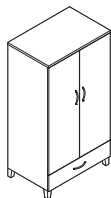

Tip: Double-door wardrobe cabinet with drawer has one lock for doors and one lock in drawer. Locks are available field-installed only.



For Canadian Pricing

Multiply U.S. Price by the Canadian price factor.

► See page 1 for details.

Senza Dressers

with Low-Pressure Laminate Fronts

Standard Includes		Required to Specify
<ul style="list-style-type: none"> ▶ Need help? Product details, page 334 	<ul style="list-style-type: none"> • Dresser case: Low-Pressure Laminate to match fronts • Drawer fronts: Low-Pressure Laminate • Wood-leg base: wood veneer to match fronts • Top: High-Pressure Laminate with 3 mm plastic edge to match fronts • Bow pull on drawers: brushed nickel only • Adjustable glides 	<ul style="list-style-type: none"> 1 Style number 2 Laminate color number for drawer fronts 3 Options, if selected (see below) ▶ See <i>Surface Materials</i>, page 375.

Options	U.S. Price	Required to Specify
Solid Surface <ul style="list-style-type: none"> • Solid surface price group A • Solid surface price group B • Solid surface price group C • Solid surface price group D 	+\$1203 +\$1243 +\$1307 +\$1449	Specify solid surface color number. Specify solid surface color number. Specify solid surface color number. Specify solid surface color number.
Drawer Pulls <ul style="list-style-type: none"> • Flat knob pull: matte stainless steel only • Opus pull: champagne only • Jazz pull: nickel only • Line pull: 4799 Platinum Metallic only 	+\$ 24 per pull +\$ 26 per pull +\$ 28 per pull +\$ 32 per pull	Specify <i>with flat knob pull</i> . Specify <i>with Opus pull</i> . Specify <i>with jazz pull</i> . Specify <i>with line pull</i> .
Base <ul style="list-style-type: none"> • Enclosed base • Metal-leg base 	+\$ 93 +\$ 171	Specify <i>with enclosed base</i> . Specify <i>with metal-leg base</i> .
Lock and Keying <ul style="list-style-type: none"> • Lock with random key • 9201 Polished Chrome only 	+\$ 52	Specify <i>with lock</i> .
	Keying <ul style="list-style-type: none"> • Factory- and field-installed keying 	▶ Page 398
Related Products <ul style="list-style-type: none"> • Accessories • Overbed tables 		▶ Page 357 ▶ Page 354

Specification Information				
Dimensions			Style	U.S.
D	W	H	Number	Base Price

With Three Drawers

18"	32"	30"	H3D330L	\$1783

With Four Drawers

18"	32"	38"	H3D438L	\$2506



For Canadian Pricing

Multiply U.S. Price by the Canadian price factor.

▶ See page 1 for details.

Senza Dressers

with Rigid Thermoform Fronts

Senza Dressers

Standard Includes		Required to Specify
<ul style="list-style-type: none"> ▶ Need help? Product details, page 334 	<ul style="list-style-type: none"> • Dresser case: Low-Pressure Laminate to match fronts • Drawer fronts: rigid thermoform • Wood-leg base: wood veneer to match fronts • Top: rigid thermoform to match fronts • Bow pull on drawers: brushed nickel only • Adjustable glides 	<ul style="list-style-type: none"> 1 Style number 2 Rigid thermoform color number for drawer fronts 3 Options, if selected (see below) ▶ See <i>Surface Materials</i>, page 375.

Options	U.S. Price	Required to Specify
Drawer Pulls		
• Flat knob pull: matte stainless steel only	+\$ 24 per pull	Specify with <i>flat knob pull</i> .
• Opus pull: champagne only	+\$ 26 per pull	Specify with <i>Opus pull</i> .
• Jazz pull: nickel only	+\$ 28 per pull	Specify with <i>jazz pull</i> .
• Line pull: 4799 Platinum Metallic only	+\$ 32 per pull	Specify with <i>line pull</i> .
Base		
• Enclosed base	+\$ 93	Specify with <i>enclosed base</i> .
• Metal-leg base	+\$171	Specify with <i>metal-leg base</i> .
Lock and Keying		
Lock with random key		
• 9201 Polished Chrome only	+\$ 52	Specify with <i>lock</i> .
Keying		
• Factory- and field-installed keying		▶ Page 398
Related Products		
• Accessories		▶ Page 357
• Overbed tables		▶ Page 354

Specification Information				
Dimensions			Style	U.S.
D	W	H	Number	Base Price

With Three Drawers

18"	32"	30"	H3D330R	\$1967
:	:	:	:	:

With Four Drawers

18"	32"	38"	H3D438R	\$2320
:	:	:	:	:



 **For Canadian Pricing**
 Multiply U.S. Price by the Canadian price factor.
 ▶ See page 1 for details.

Senza Bedside Tables

with Low-Pressure Laminate Fronts

Tip: 18" deep bedside tables have a 15⁵/₈" deep drawer and the slide has 14" of travel. 24" deep bedside tables have a 19⁵/₈" deep drawer and a slide 21" of travel.

Standard Includes		Required to Specify
▶ Need help? Product details, page 336	<ul style="list-style-type: none"> • Bedside table case: Low-Pressure Laminate to match fronts • Door and drawer fronts: Low-Pressure Laminate • Wood-leg base: wood veneer to match fronts • Top: High-Pressure Laminate with 3 mm plastic edge to match fronts • Bow pull on doors and drawers: brushed nickel only • Glides: black only 	1 Style number 2 Laminate color number for door and drawer fronts 3 Options, if selected (see below) ▶ See <i>Surface Materials</i> , page 375.

Options	U.S. Price	Required to Specify
Solid Surface <ul style="list-style-type: none"> • Solid surface price group A • Solid surface price group B • Solid surface price group C • Solid surface price group D 	+\$795 +\$821 +\$861 +\$953	Specify solid surface color number. Specify solid surface color number. Specify solid surface color number. Specify solid surface color number.
Drawer Pulls <ul style="list-style-type: none"> • Flat knob pull: matte stainless steel only • Opus pull: champagne only • Jazz pull: nickel only • Line pull: 4799 Platinum Metallic only 	+\$ 24 per pull +\$ 26 per pull +\$ 28 per pull +\$ 32 per pull	Specify with <i>flat knob pull</i> . Specify with <i>Opus pull</i> . Specify with <i>jazz pull</i> . Specify with <i>line pull</i> .
Base <ul style="list-style-type: none"> • Enclosed base • Metal-leg base 	+\$ 93 +\$171	Specify with <i>enclosed base</i> . Specify with <i>metal-leg base</i> .
Casters <ul style="list-style-type: none"> • Casters (set of four) • Rear roller casters with front glides 	+\$ 41 +\$ 84	Specify with <i>casters</i> . Specify with <i>rear roller casters</i> .
Gallery Rails <ul style="list-style-type: none"> • Gallery rails (set of three) 	+\$162	Specify with <i>gallery rails</i> .
Lock and Keying <ul style="list-style-type: none"> • Lock with random key • 9201 Polished Chrome only 	+\$ 52	Specify with <i>lock</i> .
	Keying <ul style="list-style-type: none"> • Factory- and field-installed keying 	▶ Page 398
Related Products <ul style="list-style-type: none"> • Accessories • Overbed tables 		▶ Page 357 ▶ Page 354

Tip: Lock, if selected, will only secure top drawer of cabinet.

Specification Information				
Dimensions			Style	U.S.
D	W	H	Number	Base Price
:	:	:	:	:

Night Table with One Drawer and Open Shelf				
18"	18"	24"	H3NE24L	\$1346
:	:	:	:	:

Bedside Table with Three Drawers				
18"	18"	30"	H3BM30L	\$1505
:	:	:	:	:

Bedside Tables with One Drawer and One Door				
Door Hinged on Left				
18"	18"	30"	H3BG30LL	\$1158
Door Hinged on Right				
18"	18"	30"	H3BG30RL	\$1158
:	:	:	:	:



For Canadian Pricing
 Multiply U.S. Price by the Canadian price factor.
 ▶ See page 1 for details.

Senza Bedside Tables

with Rigid Thermoform Fronts

Tip: 18" deep bedside tables have a 15⁵/₈" deep drawer and the slide has 14" of travel. 24" deep bedside tables have a 19⁵/₈" deep drawer and a slide 21" of travel.

Standard Includes	Required to Specify
<ul style="list-style-type: none"> Need help? Product details, page 336 Bedside table case: Low-Pressure Laminate to match fronts Door and drawer fronts: rigid thermoform Wood-leg base: wood veneer to match fronts Top: rigid thermoform to match fronts Bow pull on doors and drawers: brushed nickel only Glides: black only 	<ol style="list-style-type: none"> Style number Rigid thermoform color number for door and drawer fronts Options, if selected (see below) <p>▶ See <i>Surface Materials</i>, page 375.</p>

Options	U.S. Price	Required to Specify
Drawer Pulls		
• Flat knob pull: matte stainless steel only	+\$ 24 per pull	Specify with <i>flat knob pull</i> .
• Opus pull: champagne only	+\$ 26 per pull	Specify with <i>Opus pull</i> .
• Jazz pull: nickel only	+\$ 28 per pull	Specify with <i>jazz pull</i> .
• Line pull: 4799 Platinum Metallic only	+\$ 32 per pull	Specify with <i>line pull</i> .
Base		
• Enclosed base	+\$ 93	Specify with <i>enclosed base</i> .
• Metal-leg base	+\$171	Specify with <i>metal-leg base</i> .
Casters		
• Casters (set of four)	+\$ 41	Specify with <i>casters</i> .
• Rear roller casters with front glides	+\$ 84	Specify with <i>rear roller casters</i> .
Gallery Rails		
• Gallery rails (set of three)	+\$162	Specify with <i>gallery rails</i> .
Lock and Keying		
Lock with random key		
• 9201 Polished Chrome only	+\$ 52	Specify with <i>lock</i> .
Keying		
• Factory- and field-installed keying		▶ Page 398
Related Products		
• Accessories		▶ Page 357
• Overbed tables		▶ Page 354

Tip: Lock, if selected, will only secure top drawer of cabinet.

Specification Information				
Dimensions			Style	U.S.
D	W	H	Number	Base Price

Night Table with One Drawer and Open Shelf				
18"	18"	24"	H3NE24R	\$1393

Bedside Table with Three Drawers				
18"	18"	30"	H3BM30R	\$1782

Bedside Tables with One Drawer and One Door				
Door Hinged on Left				
18"	18"	30"	H3BG30LR	\$1459
Door Hinged on Right				
18"	18"	30"	H3BG30RR	\$1459



 **For Canadian Pricing**
Multiply U.S. Price by the Canadian price factor.
▶ See page 1 for details.

Accessories



Statement of Line **348**

Mobile Overbed Tables

Opus Mobile Overbed Table	350
With C-Base	352
With U-Base	353

Mobile Overbed Tables

Opus Mobile Overbed Table	354
With C-Base	355
With U-Base	356

Statement of Line

Accessories

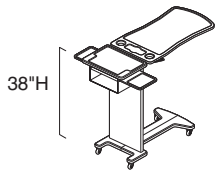

Understanding
 ▶ Page 350
 Specifying
 ▶ Page 354

Opus Mobile Overbed Table

48"W

Mobile Overbed Table ●

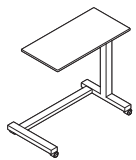

Understanding
 ▶ Page 352
 Specifying
 ▶ Page 355

Mobile Overbed Tables with C-Base

Rectangular top

High-Pressure Laminate ●

Thermoform ●

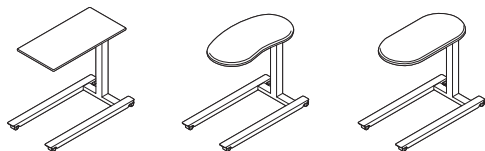

Understanding
 ▶ Page 353
 Specifying
 ▶ Page 356

Mobile Overbed Tables with U-Base

Rectangular top Kidney top Oval top

High-Pressure Laminate ●

Thermoform ● ● ●

Opus Mobile Overbed Table

Mobile overbed table with mechanical column

provides a height-adjustable surface to support patient and caregiver needs including eating, writing, or personal storage space.

Table top is seamless thermoform overcoated top. Patient's primary surface provides spill retaining edges and height adjustability.

Cup holders are integrated to avoid spills. It is 3½" in diameter.

Caregiver and patient secondary surface remains stationary for ready-use.

Open cubby on end of secondary surface accommodates charts or other materials.

Primary vertical surfaces allows for mounting of accessories and matches Opus finishes and aesthetics.

Concave surface enables table to be close to the patient.

Lever on both sides of top allows for non-handed application.

Supplemental sliding surfaces are available for non-handed application. This option reduces the height of the open cubby from 6.4" to 4.05".

Impact resistant plastic column bumper protects table as it interfaces with other elements.

Dual casters are standard for easy maneuverability.

Base cap is seamless impact resistant plastic with a low profile to slide easily under beds and chairs.

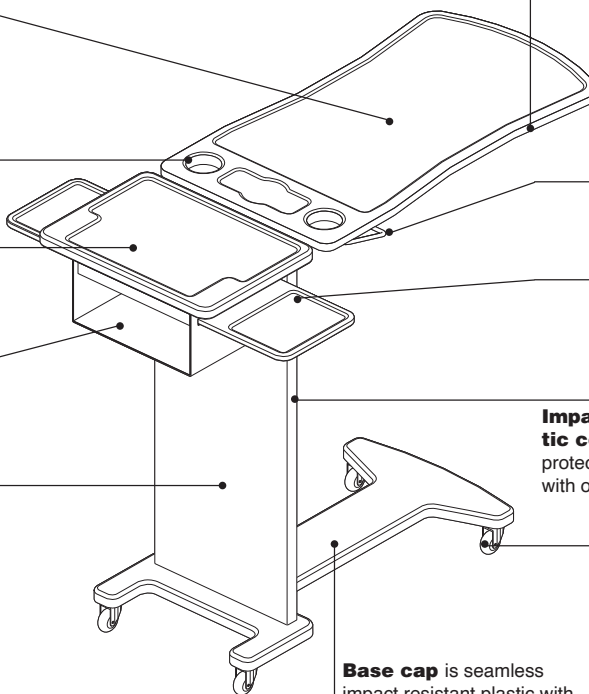

Actual Dimensions

Overall depth	18"
Overall width	48"
Height with fixed surface	38"
Height with adjustable surface	28½"-44"
Depth of fixed surface	18"
Width of fixed surface	13"
Depth of adjustable surface	18"
Width of adjustable surface	34"
Depth of base	16½"
Height of base	27⁄8"

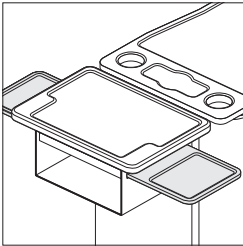
Product Details

Supplemental sliding surfaces are available as an option to provide extra surface space on both sides. This option reduces the height of the open cubby from 6.4" to 4.05".

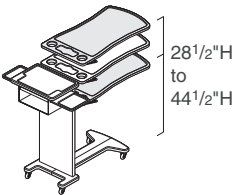

Adjustable height range of overbed table with mechanical column allows the table top height to be positioned in a 28 1/2"H-44 1/2"H range from floor. Breakaway safety feature is standard.

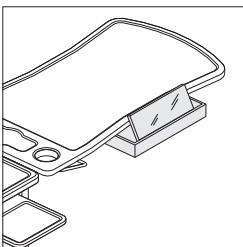

Vanity drawer mirror option is available for placement under patient surface. Two-sided for non-handed applications.

Surface Materials**Table top and supplemental sliding surface**

- Dune thermoform

Tip: As of February 2020, finish name has changed from sand to dune.

Primary vertical surface

- High-Pressure Laminate with 3 mm plastic edge band

Mechanical column

- Chrome

Casters

- Black only

Base

- Dune only

Vanity drawer

- Arctic white

Shipping

Table ships fully assembled.

Mobile Overbed Tables with C-Base

Mobile overbed tables with C-base are available to hold food trays, and personal items, and to provide a writing surface.

Rectangular tops are offered in High-Pressure Laminate with plastic edge band or rigid thermoform with spill collector top.

Mechanical column adjusts table height. Breakaway safety feature is standard.

Adjustable-height, heavy duty C-base is standard in chrome.

Casters allow the tables to move easily.

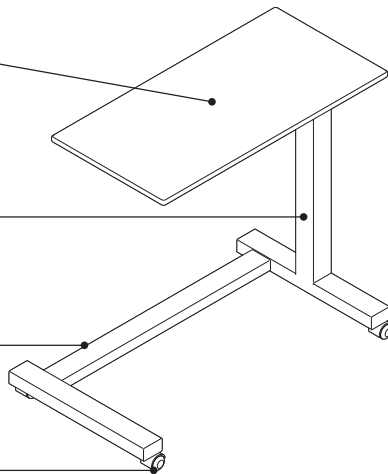

Product Details

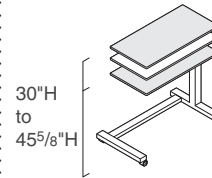

Adjustable-height C-base allows the table top height to be positioned in a 30"H–45⁵/₈"H range (to top of table).

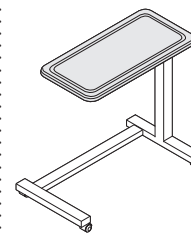

Spill collector top includes a trough to collect and prevent liquids from spilling over the edge.

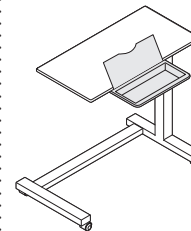

Vanity drawer is available as an option to store small personal items. Drawer includes a mirror and is non-locking. Two-sided for non-handed applications.
Tip: Vanity drawer is not available with kidney top overbed tables.

Surface Materials

Rectangular table top

- High-Pressure Laminate
- Rigid thermoform

Edge band on top

- 3 mm plastic to match High-Pressure Laminate top

Adjustable-height C-base

- Chrome

Vanity drawer

- Arctic white

Casters

- Black only

Shipping

All tables ship knocked down.

Actual Dimensions

Width of top	34"
Depth of top	18"
Table top height	30"–45 ⁵ / ₈ "
Width of base	33"
Depth of base	18"
Height of base	3 ⁷ / ₈ "

Mobile Overbed Tables with U-Base

Mobile Overbed Tables with U-Base

Accessories

Mobile overbed tables with U-base are available in three top shapes and two sizes to hold food trays, and personal items, and to provide a writing surface.

Rectangular table top is High-Pressure Laminate with plastic edge band or rigid thermoform with spill collector top.

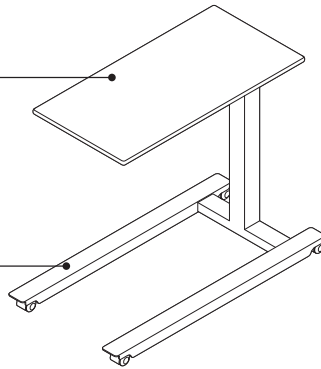

Rectangular top

Adjustable-height U-base has a low profile and is standard in chrome.

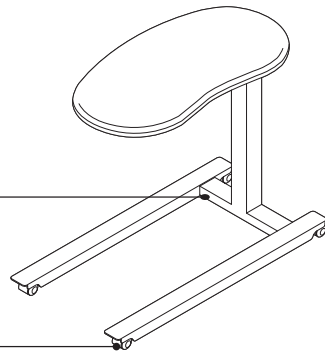

Kidney top

Low profile U-base

Casters allow the tables to move easily.

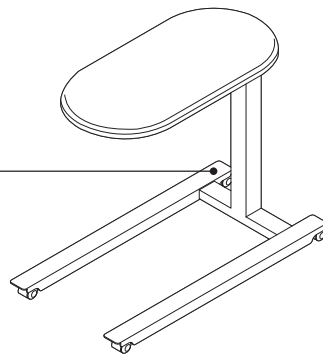

Oval top

Mechanical column adjusts table height. Breakaway safety feature is standard.

Product Details

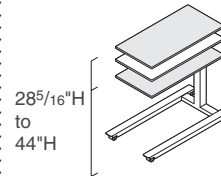

28⁵/₁₆"H to 44"H

Adjustable-height U-base allows the table top height to be positioned in a 28⁵/₁₆"H–44"H range (to top of table).

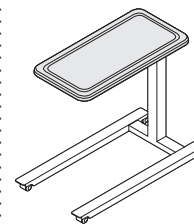

Spill collector top includes a trough to collect and prevent liquids from spilling over the edge.

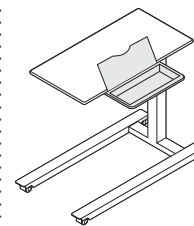

Vanity drawer is available as an option to store small personal items. Drawer includes a mirror and is non-locking. Two-sided for non-handed applications. *Tip: Vanity drawer is not available with kidney top overbed tables.*

Surface Materials

Rectangular table top

- High-Pressure Laminate
- Rigid thermoform

Kidney and Oval table tops

- Rigid thermoform with spill collector

Edge band on top

- 3 mm plastic to match High-Pressure Laminate top

Adjustable-height U-base

- Polished chrome
- Platinum metallic

Vanity drawer

- Arctic white

Casters

- Black only

Shipping

All tables ship knocked down.

Actual Dimensions

Width of top	30" or 34"
Depth of top	15" or 18"
Table top height	28 ⁵ / ₁₆ "–44"
Width of base	34 ³ / ₄ "
Depth of base	18"
Height of bases	2 ¹ / ₂ "

Opus Mobile Overbed Table

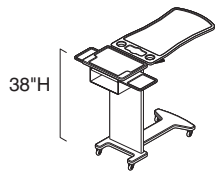

Standard Includes		Required to Specify
<ul style="list-style-type: none"> ▶ Need help? Product details, page 350 	<ul style="list-style-type: none"> • Table top: dune thermoform • Primary vertical surface: High-Pressure Laminate with 3 mm plastic edge band • Mechanical column, if selected: chrome • H-base: dune only • Casters: black 	<ol style="list-style-type: none"> 1 Style number 2 Laminate color number for primary vertical surface 3 Edge band color number for primary vertical surface 4 Options, if selected (see below) <ul style="list-style-type: none"> ▶ See <i>Surface Materials</i>, page 375.

Options	U.S. Price	Required to Specify
Surface Materials <ul style="list-style-type: none"> • Supplemental surface 	+\$205	Specify <i>with supplemental surface</i> .
Drawer <ul style="list-style-type: none"> • Vanity drawer with mirror 	+\$228	Specify <i>with vanity drawer</i> .

Specification Information				
Dimensions			Style	U.S.
D	W	H	Number	Base Price
:	:	:	:	:
:	:	:	:	:

With Mechanical Column

18"	48"	28½"–44½"	HT4818BCHP	\$2628
:	:	:	:	:



For Canadian Pricing
 Multiply U.S. Price by the Canadian price factor.
 ▶ See page 1 for details.

Mobile Overbed Tables with C-Base

Mobile Overbed Tables
with C-Base

Accessories

Standard Includes		Required to Specify
<ul style="list-style-type: none"> ▶ Need help? Product details, page 352 	<ul style="list-style-type: none"> • Table top: High-Pressure Laminate or rigid thermoform with spill collector • Edge band: 3 mm plastic to match the High-Pressure Laminate top • Mechanical adjustable-height, heavy duty C-base: chrome • Casters: black 	<ul style="list-style-type: none"> 1 Style number 2 Laminate color number for top, if selected 3 Thermoform color number for top, if selected 4 Options, if selected (see below) ▶ See <i>Surface Materials</i>, page 375.

Tip: Optional base paint colors black, grey, brown, and almond have been removed, but are available through Specials.

Options	U.S. Price	Required to Specify
Drawer <ul style="list-style-type: none"> • Vanity drawer with mirror 	+\$222	Specify <i>with vanity drawer</i> .

Specification Information

Dimensions			Style	U.S.
D	W	H	Number	Base Price

With High-Pressure Laminate Top

18"	34"	30"–45 ⁵ / ₈ "	HTC1834RL	\$1673
-----	-----	--------------------------------------	------------------	--------

With Thermoformed Top

18"	34"	30"–45 ⁵ / ₈ "	HTC1834RR	\$1610
-----	-----	--------------------------------------	------------------	--------



For Canadian Pricing
Multiply U.S. Price by the Canadian price factor.
▶ See page 1 for details.

Mobile Overbed Tables with U-Base

Standard Includes		Required to Specify
<ul style="list-style-type: none"> ▶ Need help? Product details, page 353 	<ul style="list-style-type: none"> • Table top: High-Pressure Laminate or rigid thermoform with spill collector • Edge band: 3 mm plastic to match the High-Pressure Laminate top • Mechanical adjustable-height U-base: polished chrome • Casters: black 	<ol style="list-style-type: none"> 1 Style number 2 Laminate color number for top, if selected 3 Thermoform color number for top, if selected 4 Options, if selected (see below) <ul style="list-style-type: none"> ▶ See <i>Surface Materials</i>, page 375.

Tip: Optional base paint colors black, grey, brown, and almond have been removed, but are available through Specials.

Options	U.S. Price	Required to Specify
Base Finish <ul style="list-style-type: none"> • Polished chrome • Platinum metallic 	No cost -\$ 34	Specify with <i>polished chrome</i> . Specify with <i>platinum metallic</i> .
Drawer <ul style="list-style-type: none"> • Vanity drawer with mirror 	+\$222	Specify with <i>vanity drawer</i> .

Specification Information				
Dimensions			Style Number	U.S. Base Price
D	W	H		

With Rectangular High-Pressure Laminate Top

15"	30"	28 ⁵ / ₁₆ "-44"	HTU1530RL	\$1870
-----	-----	---------------------------------------	------------------	--------

With Thermoformed Top

Rectangular

15"	30"	28 ⁵ / ₁₆ "-44"	HTU1530RR	\$1807
18"	34"	28 ⁵ / ₁₆ "-44"	HTU1834RR	\$1887

Kidney

15"	30"	28 ⁵ / ₁₆ "-44"	HTU1530KR	\$1864
-----	-----	---------------------------------------	------------------	--------

Oval

18"	34"	28 ⁵ / ₁₆ "-44"	HTU1834VR	\$1944
-----	-----	---------------------------------------	------------------	--------

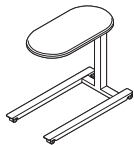
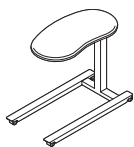
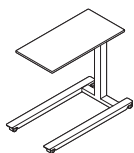
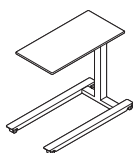

 **For Canadian Pricing**
Multiply U.S. Price by the Canadian price factor.
▶ See page 1 for details.

Coat Hooks



Standard Includes	Required to Specify
<ul style="list-style-type: none"> Coat hooks: champagne paint only Package of two 	Style number

Specification Information



Style Number	U.S. Price
HAH	\$111



For Canadian Pricing
 Multiply U.S. Price by the
 Canadian price factor.
 ▶ See page 1 for details.



Technology Support

	
Statement of Line	360
	
Pocket	
Understanding	362
Specifying	364
Relay	
Understanding	368
Specifying	370

Statement of Line

Technology Support

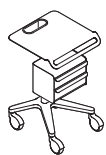

With Two Bin Unit

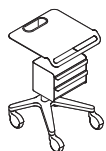

With Two Bin Unit

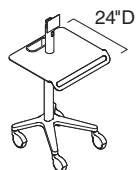

With Monitor Mount

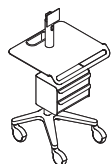

With Monitor Mount
and With Two Bin Unit

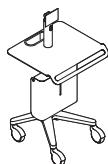

With Monitor Mount and
With Technology Bay

Understanding
 ▶ Page 362
 Specifying
 ▶ Pages 364–365

Pocket

	36"H Fixed Height	31 ³ / ₈ "H–41"H Adjustable Height
18"W	●	●
22"W	●	●
25"W	●	●

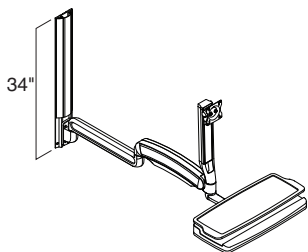

With Extension



Standard CPU Holder



Enclosed CPU Holder

Understanding
▶ Page 368
Specifying
▶ Pages 370–371

Relay

Pocket

Pocket includes easy to roll carts that provide a mobile worksurface, simple technology support, light storage, and magnetic accessories.

Cubby is molded soft plastic and provides for cable storage. Easily removeable without use of tools for cleaning.

Top is textured powder coated steel with softened edges and waterfall front edge with integral handle.

Fixed or adjustable height column is available and accommodates cable pass through from monitor down to the cable cubby with grommated outlet through the bottom of the cubby.

Back and side wrap of bin unit is available in 7243 Seagull paint only.

Technology bay back wrapper is available in 7190 Platinum Solid paint only.

Technology bay front wrapper is available in 7243 Seagull paint only.

Technology bay is powder coated steel with internal adjustable nylon strap for secure retention of technical components. Bays have front and rear ventilation and a grommated opening in rear for cable outlet.

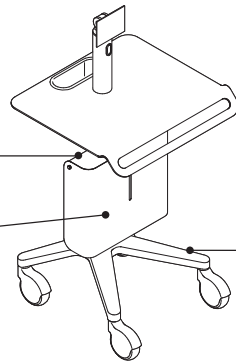
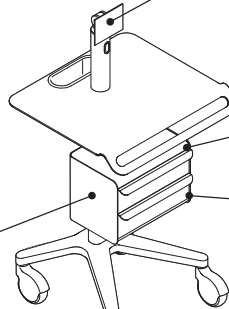
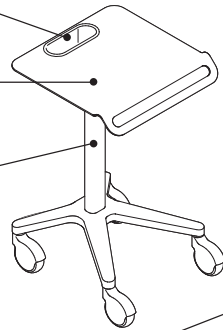

Monitor mount is standard on 25"x24" top surface. 75 and 100MM VESA mount allows for 20 pound capacity. VESA mount is adjust-able for various angles on the vertical axis and accommodates cables. Monitor mount adds 13½" to overall height.

Drawers and top and bottom of bin unit are available in 6249 Platinum Solid or 6260 Coastal plastic.

Two bin unit has wrapped sides and back and is textured painted steel. Bins have integral pulls and molded slides with in and out stops. Bins are interchangeable and easily removeable for cleaning. Interior dimensions are approximately 12" x 8½" x 4".

Quiet soft casters have quick locking mechanism on front casters and are 4".

Base is powder coated cast aluminum available in 7243 Seagull paint only.

Actual Dimensions

	Width	Depth	Top Surface Height	Height
Fixed Height Models	18"	21½"	36"	N.A.
	22"	22½"	36"	N.A.
	24"	23½"	36"	N.A.
Adjustable Height Models	18"	21½"	31⅜"-41"	N.A.
	22"	22½"	31⅜"-41"	N.A.
	24"	23½"	31⅜"-41"	N.A.
Technology Bay	17"	5⅒"	N.A.	15¼"

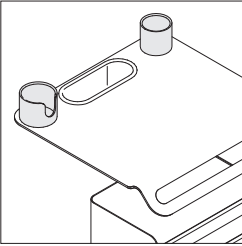
Product Details

Scanner holder and cup holder are injection molded soft plastic with encapsulated magnet. They are available as accessory items.

Surface Materials**Top surface**

- 7191 Coastal powder coat paint
- 7243 Seagull powder coat paint

Bin unit drawers, top, and bottom

- 6249 Platinum Solid plastic
- 6260 Coastal plastic

Tip: When 7191 Coastal paint is selected for the top surface; the bin unit drawers, top, and bottom will be 6260 Coastal plastic. When 7243 Seagull paint is selected for the top surface; the bin unit drawers, top, and bottom will be 6249 Platinum solid plastic.

Bin unit side and back wrapper

- 7243 Seagull paint

Technology bay front wrapper

- 7243 Seagull paint

Technology bay back wrapper

- 7190 Platinum Solid paint

Cubby

- Gray only

Base

- 7243 Seagull powder coat paint only

Casters

- Gray only

Scanner holder and cup holder

- Gray injection molded plastic only

Pocket Without Monitor Mount

Standard Includes	Required to Specify
<ul style="list-style-type: none"> ▶ Need help? Product details, page 362 • Top surface: powder coat painted steel top • Column and base: 7243 Seagull paint only • Two bin unit, if selected: plastic to match top • Casters: 4" soft casters, gray only 	<ul style="list-style-type: none"> 1 Style number 2 Paint color number for top surface ▶ See <i>Surface Materials</i>, page 375.

Specification Information				
Dimensions			Style	U.S.
D	W	H	Number	Price

Fixed Height

Without Two Bin Unit

21½"	18"	36"	HP1822F	\$2219
22½"	22"	36"	HP2322F	\$2262

With Two Bin Unit

21½"	18"	36"	HP1822FB	\$2916
22½"	22"	36"	HP2322FB	\$2959

Adjustable Height

Without Two Bin Unit

21½"	18"	31⅜"-41"	HP1822A	\$3631
22½"	22"	31⅜"-41"	HP2322A	\$3673

With Two Bin Unit

21½"	18"	31⅜"-41"	HP1822AB	\$4328
22½"	22"	31⅜"-41"	HP2322AB	\$4370

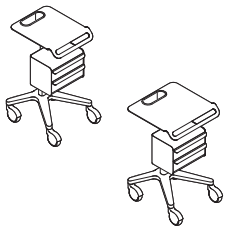
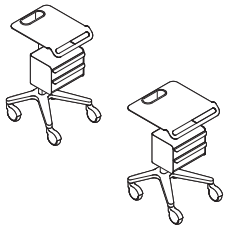

For Canadian Pricing
Multiply U.S. Price by the
Canadian price factor.
▶ See page 1 for details.

Pocket With Monitor Mount

Pocket With Monitor Mount

Standard Includes		Required to Specify
▶ Need help? Product details, page 362	<ul style="list-style-type: none"> • Top surface: powder coat painted steel top • Column and base: 7243 Seagull paint only • Two bin unit, if selected: plastic to match top • Technology bay, if selected: 7243 Seagull paint, only • Casters: 4" soft casters, gray only 	1 Style number 2 Paint color number for top surface ▶ See <i>Surface Materials</i> , page 375.

Specification Information

Dimensions			Style Number	U.S. Price
D	W	H		

Fixed Height

With Monitor Mount Only

23½"	24"	36"	HP2225F	\$2838
------	-----	-----	----------------	--------

With Two Bin Unit

23½"	24"	36"	HP2225FB	\$3535
------	-----	-----	-----------------	--------

Adjustable Height

With Monitor Mount Only

23½"	24"	31⅜"–41"	HP2225A	\$4252
------	-----	----------	----------------	--------

With Two Bin Unit

23½"	24"	31⅜"–41"	HP2225AB	\$4949
------	-----	----------	-----------------	--------

With Technology Bay

23½"	24"	31⅜"–41"	HP2225AC	\$5026
------	-----	----------	-----------------	--------

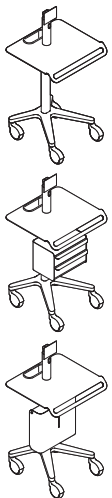
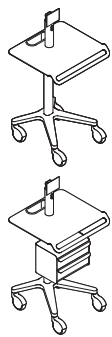

Technology
Support

 **For Canadian Pricing**
 Multiply U.S. Price by the
 Canadian price factor.
 ▶ See page 1 for details.

Pocket Accessories

Scanner Holder



Standard Includes	Required to Specify
<ul style="list-style-type: none"> ▶ Need help? Product details, page 363 • Scanner holder: molded soft plastic with encapsulated magnet, gray only 	Style number

Specification Information		
Style Number	U.S. Price	Quantity
HPSCANNER	\$72	1
:	:	:

Cup Holder



Standard Includes	Required to Specify
<ul style="list-style-type: none"> ▶ Need help? Product details, page 363 • Cup holder: molded soft plastic with encapsulated magnet, gray only 	Style number

Specification Information		
Style Number	U.S. Price	Quantity
HPCUP	\$72	1
:	:	:



For Canadian Pricing
 Multiply U.S. Price by the Canadian price factor.
 ▶ See page 1 for details.

Relay

Relay arm provides a fixed platform for technology that is easy to use and offers incremental height adjustment to meet user needs in a health-care environment.

Relay arm is standard with 75 mm/100 mm VESA mounting bracket and supports monitors weighing up to 20 pounds.

Wall-mount column is available with 34" track length and includes cable cover.

Track allows 22" of height adjustment to accommodate the transition from standing to sitting positions.

Pivot limiter protects unit by eliminating contact with the wall.

Extension arm for 34" tracks, ordered separately, provides a 20" extension.

Worksurface provides a 27"W x 10"D surface to accommodate documents or accessories.

Keyboard tray for 34" tracks flips up for easy storage when not in use.

Whiteboard on underside of keyboard tray.

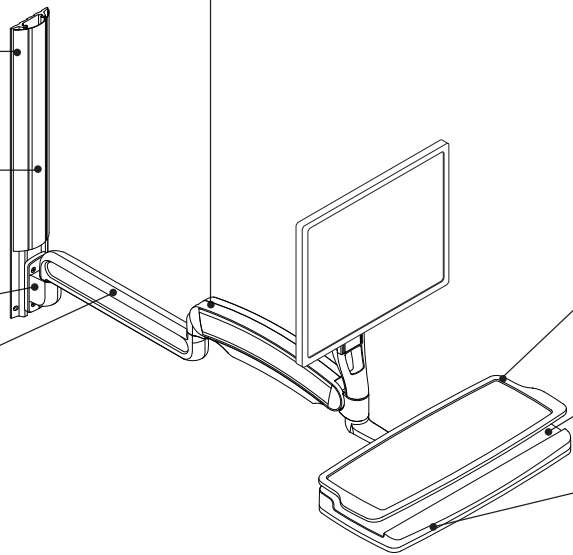

Features

	• Monitor Height Adjustment	• Maximum Weight	• Arm Reach	• Monitor Rotation	• Tilt Range	• Mounting Standard
Relay Arm	9½"H	20 lb	10"L–42"L	180°	45°	VESA 75 mm/100 mm

Product Details

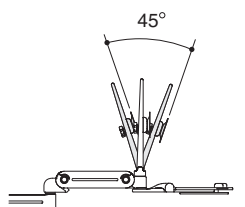

Monitor tilt range is 45°.

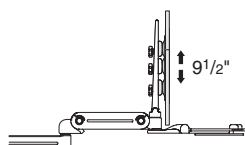

Monitor has a height adjustment range of 9 1/2".

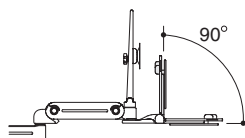

Keyboard tray flips up for easy storage when not in use.

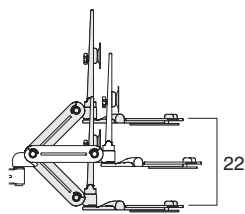

Track allows height adjustment of 22", to accommodate the transition from standing to sitting positions.



Pivot limiter provides varying degrees of stop rotation and is standard.

Adjustable keyboard tray angle adjusts from 0° to 15°.



Extension arm adds 20" to the length of arm unit and is ordered separately.



Standard CPU holder is 10"W and 7 1/4"H.



Enclosed CPU holder provides for an increased level of security for the CPU. Enclosed CPU holder is 4"D x 15 3/4"W x 12 1/8"H. Maximum recommended wattage of CPU is 396 watts.



Relay arm conveniently stores 9 1/2" from the wall when not in use.



Wall-mount column is available with 34" track length, and is 5" wide.

Monitor rotates independently 180° left to right.

Surface Materials

Wall-mount column

- White paint

Track

- White satin

Keyboard tray

- Gray paint

Extension arm cover

- White paint

Relay Arm

- White paint

CPU holders

- White paint

Pivot limiter

- White paint

Worksurface

- White paint

Installation

Fully assembled unit allows for easy installation and direct to drywall application.

Relay Arm

Wall-Mount Column

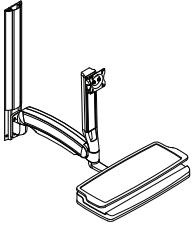

Standard Includes		Required to Specify
<ul style="list-style-type: none"> ▶ Need help? Product details, page 368 	<ul style="list-style-type: none"> • Wall-mount column: white paint • Track: white satin • Keyboard tray: gray high density polyethylene 	<ul style="list-style-type: none"> Style number

Specification Information		
Length	Style Number	U.S. Price
34"	HTW34	\$2299



For Canadian Pricing
 Multiply U.S. Price by the Canadian price factor.
 ▶ See page 1 for details.

Extension Arm



Tip: Use with 34" wall mount unit.

Standard Includes		Required to Specify
▶ Need help? Product details, page 369	• Extension arm: white paint	Style number

Specification Information		
Depth	Style Number	U.S. Price
20"	HTAX2	\$463

Technology Support

CPU Holders



Standard Includes		Required to Specify
▶ Need help? Product details, page 369	• CPU holder: white paint	Style number

Specification Information				
Dimensions			Style Number	U.S. Price
D	W	H		
Standard CPU Holder				
1¼"-4"	10"	7¼"	HTCU2	\$307
Enclosed CPU Holder				
4"	15¾"	12⅛"	HTCS2	\$615

Tip: Maximum recommended wattage of CPU is 396 watts.

 **For Canadian Pricing**
 Multiply U.S. Price by the Canadian price factor.
 ▶ See page 1 for details.



Related Products

Understanding Table Products

- Train ▶ See *Coalesse Tables, Storage, and Accessories Specification Guide*
- Groupwork Tables, Legs, Bases, and Components ▶ See *Conference and Collaborative Tables Specification Guide*

Understanding Systems Products

- Answer ▶ See *Answer Solutions Specification Guide*
- Kick ▶ See *Kick Solutions Specification Guide*
- Montage ▶ See *Montage Solutions Specification Guide*

Understanding Desk and Worksurface Products

- Airtouch and Height-Adjustable Worksurfaces ▶ See *Height-Adjustable Desks Specification Guide*
- Currency ▶ See *Currency Specification Guide*
- Universal Tables ▶ See *Conference and Collaborative Tables Specification Guide*
- Universal Systems Worksurfaces ▶ See *Steelcase Systems Specification Guides*

Understanding Storage Products

- Tower Too, Universal Bins and Shelves, Universal Storage Products, and Universal Pedestals ▶ See *Storage Specification Guide*

Understanding Collaborative Writing Surface Products

- Edge Series, Motif, Flow, Sans, Serif, Mobile, and Collaborative ToolBar ▶ See *Collaborative Surfaces Specification Guide*

▶ Refer to product specification guides for complete product and specification information.



Surface Materials

Steelcase Health Surface Materials	376
Color Availability Matrix for Steelcase Health Casegoods	378
Recommended Worksurface Edge Finishes	386
Modular Casegoods Directional Laminate	388
Freestanding Casegoods Directional Laminate	390
Upholstery and Color Numbers	392
Steelcase Health Select Surface Programs	
Solid Surface	394
Upholstery	394
Fabric Application Direction Guidelines	395

Steelcase Health Surface Materials

This listing includes all the surface material choices that are available for Steelcase and Steelcase Health products in this specification guide.

Resources

For more information about Steelcase Health surface materials or to get surface material samples, contact Steelcase Health at 1.800.342.8562.

Materials and colors are not available on every product. Refer to the Color Availability Matrices before specifying.

Paint

► See *Paint Color Availability Matrix* on page 378 for color availability by product line.

Steelcase Surfaces

Price Group 1

Smooth Paint

4238 Mocha
4239 Clay
4240 Chalk
4242 Milk

Metal and Accessory Paint

4710 Low Gloss Black

Textured Paint

7207 Black
7225 Sand
7237 Slate
7238 Fieldstone
7239 Midnight **E**
7241 Arctic White
7243 Seagull
7250 Sterling Dark Solid
7278 Dark Bronze
7360 Merle

Price Group 2

Smooth Paint

0835 Black
4700 Warm White

Smooth Metallic Paint

4140 Arctic White Gloss
4750 Champagne Metallic
4798 Sterling Metallic **E**
4799 Platinum Metallic
4803 Near Black Metallic

Price Group 3

Accent Paint

1ATG Rose Quartz
4AV3 Blue Jay
4AV4 Baltic
4AY2 Chili
4AX1 Citron
4AZ5 Marlin
4CL1 Dark Olivine
4CL2 Ice Blue
4CL3 Aura
4CL4 Sea Glass
4CL5 Light Matcha
4CL6 Terra
4CL7 Sandstone
4CL8 Smokey Plum
4CZ5 Honey
4CZ6 Lagoon
4CZ8 Light Peacock

Coatings

1ATT Cast Shadow

Laminate

Tip: All products may not be available in all colors listed below. See laminate availability matrix on page 378 for availability by product line.

Steelcase Surfaces

High-Pressure Laminate

Price Group 1

Tip: All products may not be available in all colors listed below.

Fiber High-Pressure Laminate

2850 Vanadium Fiber
2854 Vellum Fiber **E**
2860 Granite Fiber
2862 Stucco Fiber **E**

Micro High-Pressure Laminate

2920 Marl Micro
2921 Gypsum Micro
2922 Clay Micro

Patina High-Pressure Laminate

2870 Blonde Bronze Patina
2873 Instant Iron Patina

Solid High-Pressure Laminate

2722 Cream **E**
2730 Arctic White
2746 Black
2759 Warm White
2811 Mist **E**
2883 Seagull
2884 Milk
2885 Dune
2HAA Persian Salt
2HAB Rose
2HAC Indigo
2HAD Green Citrine **E**
2HAE Dark Olivine
2HAF Cloudy
2HMG Merle
2HWU Clay
2HVV Chalk

Speckle High-Pressure Laminate

2820 Coffee Speckle **E**
2823 Driftwood Speckle
2824 Smoke Speckle
2825 Vanadium Speckle

Woodgrain High-Pressure Laminate

2406 Clear Cherry **E**
2409 Clear Maple
2410 Graphite Walnut
2412 Natural Cherry
2422 Medium Cherry **E**
2511 Winter on Maple **E**
2535 Virginia Walnut
2536 Blackwood
2538 Clear Walnut
2592 Blonde on Maple **E**
2714 Natural Walnut **E**
2HAK Clear Oak
2HAN Ash Noce
2HAT Acacia
2HAW Ash Wenge
2HBN Bisque Noce
2HBW Bisque Wenge
2HCN Clay Noce
2HCW Clay Wenge
2HSN Storm Noce
2HSW Storm Wenge
2HWA Grey Kingswood
2HWB Planked Walnut
2HWD Resolute Walnut
2HWE Natural Recon
2HWF Smoked Walnut **E**
2HZA Waxed Maple
2HZB Natural Ash
2HZC Aged Ash
2HZD Ashwood Oak
2HZE Ashwood Beige
2HZF White Washed Birchply

Price Group 2

Textured High-Pressure Laminate

2TH2 Fawn Cypress
2TH4 Saddle Oak
2TH5 Veranda Teak
2TH7 Walnut Heights
2UH1 Reclaimed Aggregate
2UH2 Reclaimed Gravel
2UH4 Cement*
2UH6 Sheetrock

*2UH4 Cement has limited availability, determined by product sizing and/or options.

Price Group 3

Solid High-Pressure Laminate

24H1 Satin White
24H2 Satin Black
24H3 Satin Stone
24H4 Satin Mocha

Low-Pressure Laminates

Solid Low-Pressure Laminate

247L Black
2L30 Arctic White
2L83 Seagull
2L84 Milk
2L85 Dune
2LMG Merle

Woodgrain Low-Pressure Laminate

24L0 Graphite Walnut
25L1 Winter On Maple **E**
25L5 Virginia Walnut
25L6 Blackwood
25L8 Clear Walnut
26L1 Natural Cherry
2L09 Clear Maple
2LAK Clear Oak
2LAN Ash Noce
2LAT Acacia
2LAW Ash Wenge
2LBN Bisque Noce
2LBW Bisque Wenge
2LCN Clay Noce
2LCW Clay Wenge
2LSN Storm Noce
2LSW Storm Wenge

E = Excluded

Open Line Laminate (OLL)

This service allows you to order non-standard laminate at an additional fee per unit. See the specification pages for upcharge information.

Applies to:

- Sync worksurfaces

Steelcase Health Laminates that are not called out as standard on Steelcase products will be processed as an Open Line Laminate and Open Line Laminate charges will apply.

High-Pressure Laminate pricing does not include premium or digitally printed patterns from any suppliers. Laminate cost may also vary for basic or standard laminates from other suppliers. Please contact the OLL consultant at 616.475.2426 for pricing. The cost of the laminate will be added to your invoice as a separate line on the acknowledgement.

When processing orders for Open Line Laminate on Folio and Sync, specify 2900 in the laminate finish field and enter the OLL manufacturer information.

Edge bands must also be specified using the plastic edge band offering.

Formica

Convey Select High-Pressure Laminate

Price Group B

118-58	Finnish Oak
459-58	Brite White
464-58	Graystone
503-58	Stone Grafix
515-58	Graphite Grafix
5904-58	Wild Cherry
6402-58	Thermo Walnut
7197-58	Dover White
7284-58	Figured Annigre
756-58	Natural Maple
758-58	Blossom
	Cherrywood
7739-58	Cocoa Maple
7759-58	Select Cherry
7813-58	Cardboard Solid
7919-60	Amber Cherry
837-58	Graphite
8751-58	Mojave
9011-58	Zebrano
909-58	Black
912-58	Storm
918-58	Neutral White
920-58	Almond
9237-58	Sand Maple
9238-58	Chelsea Maple
9240-58	Cherry Heartwood
9242-58	Gull Grey
9243-58	Zen Grey
927-58	Folkstone
933-58	Mission White
949-58	White
961-58	Fog

Wilsonart

Convey Select High-Pressure Laminate

Price Group B

10745-60	Fonthill Pear
10776-60	Kensington
	Maple
1500-60	Grey
1572-60	Antique White
1573-60	Frosty White
4142-60	Grey Glace
4622-60	Grey Nebula
4623-60	Graphite Nebula
4841-60	Desert Zephyr
4879-38	Steel Mesh
4882-38	Oiled Soapstone
7012-58	Amber Maple
7039-60	Windsor
	Mahogany
7040-60	Figured
	Mahogany
7054-60	Wild Cherry
7110-60	Montana Walnut
7122-60	Empire
	Mahogany
7806-60	Bannister Oak
7850-60	Beigewood
7909-60	Fusion Maple
7922-60	Brighton Walnut
7924-60	Biltmore Cherry
7925-60	Monticello Maple
7929-60	Huntington Maple
7935-60	Shaker Cherry
7936-60	Williamsburg
	Cherry
7937-38	River Cherry
7941-38	Tan Echo
7942-60	Cocobala
7946-60	Brazilwood
7949-38	Asian Night
7952-38	Asian Sand
7960-38	Studio Teak
7964-38	Skyline Walnut
7980-38	Zebrawood
7993-38	Florence Walnut
8200-60	White Driftwood
8210-38	Portico Teak
8211-38	Phantom Pearl
8212-38	Phantom Ecru
D30-60	Natural Almond
D315-60	Platinum
D327-60	Pepperdust
D381-60	Fashion Grey
D427-60	Linen
D439-60	Wallaby
D495-60	Coffee Bean
D90-60	Northsea
D91-60	Slate Grey
D92-60	Dove Grey
D96-60	Shadow

Thermoform

2030	Arctic White
2031	Seagull
2032	Dune
2035	Ultra White
6775	Sand

Solid Surface

Price Group A

2801	Glacier White
2973	Linen
2975	Bisque
2978	Cameo White
2979	Silver Grey

Price Group B

2972	Antarctica
------	------------

Price Group C

2974 Canvas
▶ See page 394 for additional Select Surface solid surfaces.

Plastic Edge Band

Steelcase Surfaces

6023	Dark Rum Cherry
6024	Shiraz Cherry
6036	Medium Cherry
6038	Blonde on Maple E
6041	Natural Walnut E
6231	Graphite Walnut
6237	Clear Maple
6245	Clear Walnut

Applies to:

- Convey wall trim
- 6000 Black
- 6009 Arctic White
- 6023 Dark Rum Cherry
- 6024 Shiraz Cherry
- 6034 Natural Cherry
- 6036 Medium Cherry
- 6037 Winter on Maple
- 6038 Blonde on Maple **E**
- 6041 Natural Walnut **E**
- 6052 Milk
- 6053 Seagull
- 6213 Acacia
- 61AA Persian Salt
- 61AB Rose
- 61AC Indigo
- 61AD Green Citrine **E**
- 61AE Dark Olivine
- 61AF Cloudy
- 6219 Clear Oak
- 6231 Graphite Walnut
- 6237 Clear Maple
- 6242 Virginia Walnut
- 6243 Blackwood
- 6245 Clear Walnut
- 6527 Merle
- 6654 Sand
- 6655 Warm White
- 6703 Ash Wenge
- 6704 Storm Wenge
- 6705 Bisque Wenge
- 6706 Clay Wenge
- 6707 Ash Noce
- 6708 Bisque Noce
- 6709 Clay Noce
- 6710 Storm Noce
- ▶ See page 386 recommended worksurface edge colors.

Applies to:

- Convey notch filler
- Convey bracket cover on open cabinets only
- 6009 Arctic White
- 6527 Merle

Upholstery

▶ See page 392 for a complete listing of upholstery colors and numbers.

E = Excluded

Color Availability Matrix for Steelcase Health Casegoods

Legend

- = Not available
- = Available
- Ⓢ = Excluded

	Convey	Convey HPL Worksurfaces	Folio Cabinets	Folio Worksurfaces	Groupwork Tables	Health Overbed Table	Opus Overbed Table	Park	Senza	Senza Tops	Sync Worksurfaces
High-Pressure Laminates (HPL) Price Group 1											
Fiber Laminates											
2850 Vanadium Fiber	•	■	•	■	■	•	•	•	•	•	■
2854 Vellum Fiber Ⓢ	•	■	•	■	■	•	•	•	•	•	■
2860 Granite Fiber	•	■	•	■	■	•	•	•	•	•	■
2862 Stucco Fiber Ⓢ	•	■	•	■	■	•	•	•	•	•	■
Micro Laminates											
2920 Marl Micro	•	■	•	■	■	•	•	•	•	•	■
2921 Gypsum Micro	•	■	•	■	■	•	•	•	•	•	■
2922 Clay Micro	•	■	•	■	■	•	•	•	•	•	■
Patina Laminates											
2870 Blonde Bronze Patina	•	■	•	■	■	•	•	•	•	•	■
2873 Instant Iron Patina	•	■	•	■	■	•	•	•	•	•	■
Solid Laminates											
2722 Cream Ⓢ	•	•	•	■	■	•	•	•	•	•	■
2730 Arctic White	■	■	•	■	■	■	■	•	•	•	■
2746 Black	■	■	•	■	■	•	•	•	•	•	■
2759 Warm White	■	■	•	■	■	■	■	•	•	•	■
2811 Mist Ⓢ	•	•	•	■	■	•	•	•	•	•	■
2883 Seagull	■	■	•	■	■	■	■	•	•	•	■
2884 Milk	■	■	•	■	■	■	■	•	•	•	■
2885 Dune	■	■	•	■	■	■	■	•	•	•	■
2HAA Persian Salt	■	■	•	•	•	■	•	•	•	•	■
2HAB Rose	■	■	•	•	•	■	•	•	•	•	■
2HAC Indigo	■	■	•	•	•	■	•	•	•	•	■
2HAD Green Citrine Ⓢ	■	■	•	•	•	■	•	•	•	•	■
2HAE Dark Olivine	■	■	•	•	•	■	•	•	•	•	■
2HAF Cloudy	■	■	•	•	•	■	•	•	•	•	■
2HMG Merle	■	■	•	■	■	■	•	•	•	•	■
2HWU Clay	■	■	•	■	■	■	■	•	•	•	■
2HWV Chalk	■	■	•	■	■	■	■	•	•	•	■

Legend

- = Not available
- = Available
- Ⓢ = Excluded

	Convey	Convey HPL Worksurfaces	Folio Cabinets	Folio Worksurfaces	Groupwork Tables	Health Overbed Table	Opus Overbed Table	Park	Senza	Senza Tops	Sync Worksurfaces
High-Pressure Laminates (HPL) Price Group 1											
Speckle Laminates											
2820 Coffee Speckle Ⓢ	•	•	•	■	■	•	•	•	•	•	■
2823 Driftwood Speckle	•	■	•	■	■	•	•	•	•	•	■
2824 Smoke Speckle	•	■	•	■	■	•	•	•	•	•	■
2825 Vanadium Speckle	•	■	•	■	■	•	•	•	•	•	■
Woodgrain Laminates											
2406 Clear Cherry Ⓢ	■	■	•	■	■	■	•	•	•	•	■
2409 Clear Maple	■	■	•	■	■	■	•	•	•	■	■
2410 Graphite Walnut	■	■	•	■	■	■	•	•	•	■	■
2412 Natural Cherry	■	■	•	■	■	■	•	•	•	•	■
2422 Medium Cherry Ⓢ	■	■	•	■	■	■	•	•	•	•	■
2511 Winter On Maple Ⓢ	■	■	•	■	■	■	•	•	•	•	■
2535 Virginia Walnut	■	■	•	■	■	■	•	•	•	•	■
2536 Blackwood	■	■	•	■	■	■	•	•	•	•	■
2538 Clear Walnut	■	■	•	■	■	■	•	•	•	■	■
2539 Warm Oak	•	•	•	■	■	•	•	•	•	•	■
2592 Blonde On Maple Ⓢ	■	■	•	■	■	■	•	•	•	•	■
2714 Natural Walnut Ⓢ	■	■	•	■	■	■	•	•	•	•	■
2HAK Clear Oak	■	■	•	■	■	■	•	•	•	•	■
2HAN Ash Noce	■	■	•	■	■	■	•	•	•	•	■
2HAT Acacia	■	■	•	■	■	■	•	•	•	•	■
2HAW Ash Wenge	■	■	•	■	■	■	•	•	•	•	■
2HBN Bisque Noce	■	■	•	■	■	■	•	•	•	•	■
2HBW Bisque Wenge	■	■	•	■	■	■	•	•	•	•	■
2HCN Clay Noce	■	■	•	■	■	■	•	•	•	•	■
2HCW Clay Wenge	■	■	•	■	■	■	•	•	•	•	■
2HSN Storm Noce	■	■	•	■	■	■	•	•	•	•	■
2HSW Storm Wenge	■	■	•	■	■	■	•	•	•	•	■
2HWA Grey Kingswood	•	•	•	•	•	■	•	•	•	•	■
2HWB Planked Walnut	•	•	•	•	•	■	•	•	•	•	■
2HWD Resolute Walnut	•	•	•	•	•	■	•	•	•	•	■
2HWE Natural Recon	•	•	•	•	•	■	•	•	•	•	■
2HWF Smoked Walnut Ⓢ	•	•	•	•	•	■	•	•	•	•	■
2HZA Waxed Maple	■	■	■	■	•	•	•	•	•	•	■
2HZB Natural Ash	■	■	■	■	•	•	•	•	•	•	■
2HZC Aged Ash	■	■	■	■	•	•	•	•	•	•	■
2HZD Ashwood Oak	■	■	■	■	•	•	•	•	•	•	■
2HZE Ashwood Beige	■	■	■	■	•	•	•	•	•	•	■
2HZF White Washed Birchply	■	■	■	■	•	•	•	•	•	•	■

Color Availability Matrix for Steelcase Health Casegoods, continued

Legend

- = Not available
- = Available

	Convey	Convey HPL Worksurfaces	Folio Cabinets	Folio Worksurfaces	Groupwork Tables	Health Overbed Table	Opus Overbed Table	Park	Senza	Senza Tops	Sync Worksurfaces
High-Pressure Laminates (HPL) Price Group 2											
Textured Laminate											
2TH2 Fawn Cypress	•	■	•	•	•	•	•	•	•	•	•
2TH4 Saddle Oak	•	■	•	•	•	•	•	•	•	•	•
2TH5 Veranda Teak	•	■	•	•	•	•	•	•	•	•	•
2TH7 Walnut Heights	•	■	•	•	•	•	•	•	•	•	•
2UH1 Reclaimed Aggregate	•	■	•	•	•	•	•	•	•	•	•
2UH2 Reclaimed Gravel	•	■	•	•	•	•	•	•	•	•	•
2UH4 Cement	•	■	•	•	•	•	•	•	•	•	•
2UH6 Sheetrock	•	■	•	•	•	•	•	•	•	•	•
High-Pressure Laminates (HPL) Select Surfaces Price Grade B											
Formica											
118-58 Finnish Oak	■	•	•	•	•	•	•	•	•	•	•
459-58 Brite White	■	•	•	•	•	•	•	•	•	•	•
464-58 Graystone	■	•	•	•	•	•	•	•	•	•	•
503-58 Stone Grafix	■	•	•	•	•	•	•	•	•	•	•
515-58 Graphite Grafix	■	•	•	•	•	•	•	•	•	•	•
5904-58 Wild Cherry	■	•	•	•	•	•	•	•	•	•	•
6402-58 Thermo Walnut	■	•	•	•	•	•	•	•	•	•	•
7197-58 Dover White	■	•	•	•	•	•	•	•	•	•	•
7284-58 Figured Annigre	■	•	•	•	•	•	•	•	•	•	•
756-58 Natural Maple	■	•	•	•	•	•	•	•	•	•	•
758-58 Blossom Cherrywood	■	•	•	•	•	•	•	•	•	•	•
7739-58 Cocoa Maple	■	•	•	•	•	•	•	•	•	•	•
7759-58 Select Cherry	■	•	•	•	•	•	•	•	•	•	•
7813-58 Cardboard Solidz	■	•	•	•	•	•	•	•	•	•	•
7919-60 Amber Cherry	■	•	•	•	•	•	•	•	•	•	•
837-58 Graphite	■	•	•	•	•	•	•	•	•	•	•
8751-58 Mojave	■	•	•	•	•	•	•	•	•	•	•
9011-58 Zebrano	■	•	•	•	•	•	•	•	•	•	•
909-58 Black	■	•	•	•	•	•	•	•	•	•	•
912-58 Storm	■	•	•	•	•	•	•	•	•	•	•
918-58 Neutral White	■	•	•	•	•	•	•	•	•	•	•
920-58 Almond	■	•	•	•	•	•	•	•	•	•	•
9237-58 Sand Maple	■	•	•	•	•	•	•	•	•	•	•
9238-58 Chelsea Maple	■	•	•	•	•	•	•	•	•	•	•
9240-58 Cherry Heartwood	■	•	•	•	•	•	•	•	•	•	•
9242-58 Gull Grey	■	•	•	•	•	•	•	•	•	•	•
9243-58 Zen Grey	■	•	•	•	•	•	•	•	•	•	•
927-58 Folkstone	■	•	•	•	•	•	•	•	•	•	•
933-58 Mission White	■	•	•	•	•	•	•	•	•	•	•
949-58 White	■	•	•	•	•	•	•	•	•	•	•
961-58 Fog	■	•	•	•	•	•	•	•	•	•	•

Legend

- = Not available
- = Available

	Convey	Convey HPL Worksurfaces	Folio Cabinets	Folio Worksurfaces	Groupwork Tables	Health Overbed Table	Opus Overbed Table	Park	Senza	Senza Tops	Sync Worksurfaces
High-Pressure Laminates (HPL) Select Surfaces Price Grade B											
Wilsonart											
10745-60 Fonthill Pear	■	•	•	•	•	•	•	•	•	•	•
10776-60 Kensington Maple	■	•	•	•	•	•	•	•	•	•	•
1500-60 Grey	■	•	•	•	•	•	•	•	•	•	•
1572-60 Antique White	■	•	•	•	•	•	•	•	•	•	•
1573-60 Frosty White	■	•	•	•	•	•	•	•	•	•	•
4142-60 Grey Glace	■	•	•	•	•	•	•	•	•	•	•
4622-60 Grey Nebula	■	•	•	•	•	•	•	•	•	•	•
4623-60 Graphite Nebula	■	•	•	•	•	•	•	•	•	•	•
4841-60 Desert Zephyr	■	•	•	•	•	•	•	•	•	•	•
4879-38 Steel Mesh	■	•	•	•	•	•	•	•	•	•	•
4882-38 Oiled Soapstone	■	•	•	•	•	•	•	•	•	•	•
7012-58 Amber Maple	■	•	•	•	•	•	•	•	•	•	•
7039-60 Windsor Mahogany	■	•	•	•	•	•	•	•	•	•	•
7040-60 Figured Mahogany	■	•	•	•	•	•	•	•	•	•	•
7054-60 Wild Cherry	■	•	•	•	•	•	•	•	•	•	•
7110-60 Montana Walnut	■	•	•	•	•	•	•	•	•	•	•
7122-60 Empire Mahogany	■	•	•	•	•	•	•	•	•	•	•
7806-60 Bannister Oak	■	•	•	•	•	•	•	•	•	•	•
7850-60 Beigewood	■	•	•	•	•	•	•	•	•	•	•
7909-60 Fusion Maple	■	•	•	•	•	•	•	•	•	•	•
7922-60 Brighton Walnut	■	•	•	•	•	•	•	•	•	•	•
7924-60 Biltmore Cherry	■	•	•	•	•	•	•	•	•	•	•
7925-60 Monticello Maple	■	•	•	•	•	•	•	•	•	•	•
7929-60 Huntington Maple	■	•	•	•	•	•	•	•	•	•	•
7935-60 Shaker Cherry	■	•	•	•	•	•	•	•	•	•	•
7936-60 Williamsburg Cherry	■	•	•	•	•	•	•	•	•	•	•

Color Availability Matrix for Steelcase Health Casegoods, continued

Legend

- = Not available
- = Available

	Convey	Convey HPL Worksurfaces	Folio Cabinets	Folio Worksurfaces	Groupwork Tables	Health Overbed Table	Opus Overbed Table	Park	Senza	Senza Tops	Sync Worksurfaces
High-Pressure Laminates (HPL) Select Surfaces Price Grade B											
Wilsonart											
7937-38 River Cherry	■	•	•	•	•	•	•	•	•	•	•
7941-38 Tan Echo	■	•	•	•	•	•	•	•	•	•	•
7942-60 Cocobala	■	•	•	•	•	•	•	•	•	•	•
7946-60 Brazilwood	■	•	•	•	•	•	•	•	•	•	•
7949-38 Asian Night	■	•	•	•	•	•	•	•	•	•	•
7952-38 Asian Sand	■	•	•	•	•	•	•	•	•	•	•
7960-38 Studio Teak	■	•	•	•	•	•	•	•	•	•	•
7964-38 Skyline Walnut	■	•	•	•	•	•	•	•	•	•	•
7980-38 Zebrawood	■	•	•	•	•	•	•	•	•	•	•
7993-38 Florence Walnut	■	•	•	•	•	•	•	•	•	•	•
8200-60 White Driftwood	■	•	•	•	•	•	•	•	•	•	•
8210-38 Portico Teak	■	•	•	•	•	•	•	•	•	•	•
8211-38 Phantom Pearl	■	•	•	•	•	•	•	•	•	•	•
8212-38 Phantom Ecu	■	•	•	•	•	•	•	•	•	•	•
D30-60 Natural Almond	■	•	•	•	•	•	•	•	•	•	•
D315-60 Platinum	■	•	•	•	•	•	•	•	•	•	•
D327-60 Pepperdust	■	•	•	•	•	•	•	•	•	•	•
D381-60 Fashion Grey	■	•	•	•	•	•	•	•	•	•	•
D427-60 Linen	■	•	•	•	•	•	•	•	•	•	•
D439-60 Wallaby	■	•	•	•	•	•	•	•	•	•	•
D495-60 Coffee Bean	■	•	•	•	•	•	•	•	•	•	•
D90-60 Northsea	■	•	•	•	•	•	•	•	•	•	•
D91-60 Slate Grey	■	•	•	•	•	•	•	•	•	•	•
D92-60 Dove Grey	■	•	•	•	•	•	•	•	•	•	•
D96-60 Shadow	■	•	•	•	•	•	•	•	•	•	•

Legend

- = Not available
- = Available
- Ⓢ = Excluded

	Convey	Convey HPL Worksurfaces	Folio Cabinets	Folio Worksurfaces	Groupwork Tables	Health Overbed Table	Opus Overbed Table	Park	Senza	Senza Tops	Sync Worksurfaces
Low-Pressure Laminates (LPL)											
Solid Laminates											
247L Black	•	•	■	•	•	•	•	•	•	•	•
2L30 Arctic White	•	•	■	•	•	•	•	■	•	•	•
2L83 Seagull	•	•	■	•	•	•	•	■	•	•	•
2L84 Milk	•	•	■	•	•	•	•	•	•	•	•
2L85 Dune	•	•	■	•	•	•	•	■	•	•	•
2LMG Merle	•	•	■	•	•	•	•	•	•	•	•
Woodgrain Laminates											
24L0 Graphite Walnut	•	•	■	•	•	•	•	•	■	•	•
25L1 Winter On Maple Ⓢ	•	•	■	•	•	•	•	•	•	•	•
25L5 Virginia Walnut	•	•	■	•	•	•	•	•	•	•	•
25L6 Blackwood	•	•	■	•	•	•	•	•	•	•	•
25L8 Clear Walnut	•	•	■	•	•	•	•	•	■	•	•
26L1 Natural Cherry	•	•	■	•	•	•	•	•	•	•	•
2L09 Clear Maple	•	•	■	•	•	•	•	•	■	•	•
2LAK Clear Oak	•	•	■	•	•	•	•	•	•	•	•
2LAN Ash Noce	•	•	■	•	•	•	•	•	•	•	•
2LAT Acacia	•	•	■	•	•	•	•	•	•	•	•
2LAW Ash Wenge	•	•	■	•	•	•	•	•	•	•	•
2LBN Bisque Noce	•	•	■	•	•	•	•	•	•	•	•
2LBW Bisque Wenge	•	•	■	•	•	•	•	•	•	•	•
2LCN Clay Noce	•	•	■	•	•	•	•	•	•	•	•
2LCW Clay Wenge	•	•	■	•	•	•	•	•	•	•	•
2LSN Storm Noce	•	•	■	•	•	•	•	•	•	•	•
2LSW Storm Wenge	•	•	■	•	•	•	•	•	•	•	•
Thermoform											
2030 Arctic White	•	•	•	•	•	■	•	■	•	•	•
2031 Seagull	•	•	•	•	•	■	•	•	•	•	•
2032 Dune	•	•	•	•	•	■	■	•	•	•	•
2035 Ultra White	•	•	•	•	•	■	•	•	•	•	•
6775 Sand	•	•	•	•	•	•	•	•	•	•	•

Color Availability Matrix for Steelcase Health Casegoods, continued

Legend

- = Not available
- = Available

	Convey	Convey HPL Worksurfaces	Folio Cabinets	Folio Worksurfaces	Groupwork Tables	Health Overbed Table	Opus Overbed Table	Park	Senza	Senza Tops	Sync Worksurfaces
Solid Surface											
Price Group A											
2801 Glacier White	■	•	•	•	•	•	•	•	•	■	•
2973 Linen	■	•	•	•	•	•	•	•	•	■	•
2975 Bisque	■	•	•	•	•	•	•	•	•	■	•
2978 Cameo White	■	•	•	•	•	•	•	•	•	■	•
2979 Silver Grey	■	•	•	•	•	•	•	•	•	■	•
Price Group B											
2972 Antarctica	■	•	•	•	•	•	•	•	•	■	•
Price Group C											
2974 Canvas	■	•	•	•	•	•	•	•	•	■	•

Legend

- = Not available
- = Available
- Ⓢ = Excluded

	Convey	Convey HPL Worksurfaces	Folio Cabinets	Folio Worksurfaces	Groupwork Tables	Health Overbed Table	Opus Overbed Table	Park	Senza	Senza Tops	Sync Worksurfaces
Paint (Price Group 1)											
Smooth Paint											
4238 Mocha	•	•	•	•	■	•	•	•	•	•	•
4239 Clay	•	•	•	•	■	•	•	•	•	•	•
4240 Chalk	•	•	•	•	■	•	•	•	•	•	•
4242 Milk	•	•	•	•	■	•	•	•	•	•	•
Metal And Accessory Paint											
4710 Low Gloss Black	•	•	•	•	■	•	•	•	•	•	•
9201 Polished Chrome	■	•	•	•	•	•	•	•	•	•	•
9211 Nickel	■	•	■	•	•	•	•	•	•	•	•
9212 Silver	■	•	•	•	•	•	•	•	•	•	•
Textured Paint											
7207 Black	•	•	•	•	■	•	•	•	•	•	•
7225 Sand	•	•	•	•	■	•	•	•	•	•	•
7237 Slate	•	•	•	•	■	•	•	•	•	•	•
7238 Fieldstone	•	•	•	•	■	•	•	•	•	•	•
7239 Midnight Ⓢ	•	•	•	•	■	•	•	•	•	•	•
7241 Arctic White	•	•	•	•	■	•	•	•	•	•	•
7243 Seagull	•	•	•	•	■	•	•	•	•	•	•
7250 Sterling Dark Solid	•	•	•	•	■	•	•	•	•	•	•
7278 Dark Bronze	•	•	•	•	■	•	•	•	•	•	•
7360 Merle	•	•	•	•	■	•	•	•	•	•	•
Paint (Price Group 2)											
Smooth Paint											
0835 Black	■	•	•	•	■	•	•	•	•	•	•
4700 Warm White	•	•	•	•	■	•	•	•	•	•	•
Smooth Metallic Paint											
4140 Arctic White Gloss	•	•	•	•	■	•	•	•	•	•	•
4750 Champagne Metallic	•	•	•	•	■	•	•	■	■	•	•
4798 Sterling Metallic Ⓢ	•	•	•	•	■	•	•	•	•	•	•
4799 Platinum Metallic	■	•	•	•	■	•	•	■	■	•	•
4803 Near Black Metallic	•	•	•	•	■	•	•	•	•	•	•

Recommended Worksurface Edge Finishes

High-Pressure Laminate

Edges

The recommended edge color will complement the High-Pressure Laminate color you specify. Edge color is specified separately.

Steelcase Health High-Pressure Laminate Color	Recommended 3 mm Edge Color
---	-----------------------------

Fiber

2850 Vanadium Fiber	6654 Sand
2854 Vellum Fiber E	6655 Warm White
2860 Granite Fiber	6000 Black
2862 Stucco Fiber E	6053 Seagull

Micro

2920 Marl Micro	6053 Seagull
2921 Gypsum Micro	6654 Sand
2922 Clay Micro	6654 Sand

Patina

2870 Blonde Bronze Patina	6654 Sand
2873 Instant Iron Patina	6527 Merle

Solid

24H1 Satin White	6009 Arctic White
24H2 Satin Black	6000 Black
24H3 Satin Stone	6169 Stone
24H4 Satin Mocha	6170 Mocha
2722 Cream E	6631 Cream E
2730 Arctic White	6697 Fog
2746 Black	6000 Black
2759 Warm White	6655 Warm White
2811 Mist E	6636 Mist
2883 Seagull	6053 Seagull
2884 Milk	6052 Milk
2885 Dune	6654 Sand
2HAA Persian Salt	61AA Persian Salt
2HAB Rose	61AB Rose
2HAC Indigo	61AC Indigo
2HAD Green Citrine E	61AD Green Citrine E
2HAE Dark Olivine	61AE Dark Olivine
2HAF Cloudy	61AF Cloudy
2HMG Merle	6527 Merle
2HWU Clay	66WU Clay
2HWV Chalk	66WV Chalk

Speckle

2820 Coffee Speckle E	6631 Cream E
2823 Driftwood Speckle	6631 Cream E
2824 Smoke Speckle	6636 Mist
2825 Vanadium Speckle	6619 Ice E

Steelcase Health High-Pressure Laminate Color	Recommended 3 mm Edge Color
---	-----------------------------

Woodgrain

2406 Clear Cherry E	6234 Clear Cherry
2409 Clear Maple	6237 Clear Maple
2410 Graphite Walnut	6231 Graphite Walnut
2412 Natural Cherry	6034 Natural Cherry
2422 Medium Cherry E	6036 Medium Cherry
2511 Winter on Maple E	6037 Winter on Maple
2535 Virginia Walnut	6242 Virginia Walnut
2536 Blackwood	6243 Blackwood
2538 Clear Walnut	6245 Clear Walnut
2592 Blonde on Maple E	6038 Blonde on Maple E
2714 Natural Walnut E	6041 Natural Walnut E
2HAK Clear Oak	6219 Clear Oak
2HAN Ash Noce	6707 Ash Noce
2HAT Acacia	6213 Acacia
2HAW Ash Wenge	6703 Ash Wenge
2HBN Bisque Noce	6708 Bisque Noce
2HBW Bisque Wenge	6705 Bisque Wenge
2HCN Clay Noce	6709 Clay Noce
2HCW Clay Wenge	6706 Clay Wenge
2HSN Storm Noce	6710 Storm Noce
2HSW Storm Wenge	6704 Storm Wenge
2HWA Grey Kingswood	66WA Grey Kingswood
2HWB Planked Walnut	66WB Planked Walnut
2HWD Resolute Walnut	66WD Resolute Walnut
2HWE Natural Recon	66WE Natural Recon
2HWF Smoked Walnut E	66WF Smoked Walnut
2HZA Waxed Maple	6X50 Waxed Maple
2HZB Natural Ash	6X51 Natural Ash
2HZC Aged Ash	6X10 Aged Ash
2HZD Ashwood Oak	6X52 Ashwood Oak
2HZE Ashwood Beige	6X53 Ashwood Beige
2HZF White Washed Birchply	6X54 White Washed Birchply

Textured

2TH2 Fawn Cypress	6T02 Fawn Cypress
2TH4 Saddle Oak	6T04 Saddle Oak
2TH5 Veranda Teak	6T05 Veranda Teak
2TH7 Walnut Heights	6T07 Walnut Heights
2UH1 Reclaimed Aggregate	6T08 Aggregate
2UH2 Reclaimed Gravel	6T09 Gravel
2UH4 Cement	6T10 Cement
2UH6 Sheetrock	6T12 Sheetrock

E = Excluded

Low-Pressure Laminate

Edges

The recommended edge color will complement the Low-Pressure Laminate color you specify. Edge color is specified separately.

Steelcase Health Low-Pressure Laminate Color	Recommended 3 mm Edge Color
--	--------------------------------

Solid

247L Black	6000 Black
2L30 Arctic White	6009 Arctic White
2L83 Seagull	6053 Seagull
2L84 Milk	6052 Milk
2L85 Dune	6654 Sand
2LMG Merle	6527 Merle

Woodgrain

24L0 Graphite Walnut	6231 Graphite Walnut
25L1 Winter On Maple E	6037 Winter On Maple
25L5 Virginia Walnut	6242 Virginia Walnut
25L6 Blackwood	6243 Blackwood
25L8 Clear Walnut	6245 Clear Walnut
26L1 Natural Cherry	6034 Natural Cherry
2L09 Clear Maple	6237 Clear Maple
2LAK Clear Oak	6219 Clear Oak
2LAN Ash Noce	6707 Ash Noce
2LAT Acacia	6213 Acacia
2LAW Ash Wenge	6703 Ash Wenge
2LBN Bisque Noce	6708 Bisque Noce
2LBW Bisque Wenge	6705 Bisque Wenge
2LCN Clay Noce	6709 Clay Noce
2LCW Clay Wenge	6706 Clay Wenge
2LSN Storm Noce	6710 Storm Noce
2LSW Storm Wenge	6704 Storm Wenge

E = Excluded

Modular Casegoods Directional Laminate

The appearance of laminate may change slightly depending on the angle from which it is viewed. This natural phenomenon is called polarization, and it can be seen on natural veneer, and to a lesser extent on composite veneer. Polarization is often noticed on worksurfaces installed at a 90° angle with each other. Please refer to the following illustrations for an understanding of grain direction on your installation.

Convey

Laminate Worksurfaces

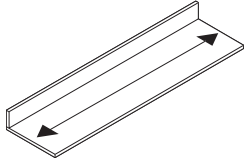

Available on all widths

Sloped Fascia

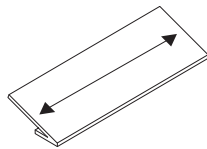

Available on all widths

Sloped Fascia

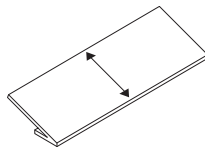

Available up to 48"W

Vertical Fascia

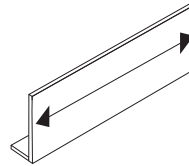

Available on all widths

Vertical Fascia

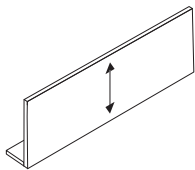

Available up to 48"W

Mounting Board

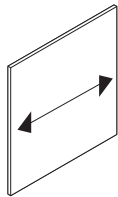

Available on all widths when less than or equal to 48"H
▶ See tips on page 164

Mounting Board

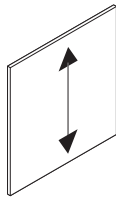

Available up to 48"W

Sync

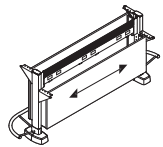

Double-Sided Bases

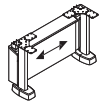

Single-Sided Bases



Single Leg Bases



Upper Transaction, Upper Interaction, Upper Process, Lower Interaction, and Lower Process Worksurfaces for Use with Double-Sided Bases



Interaction and Process Worksurfaces for Use with Single-Sided Bases



90° Full Arc Worksurfaces



135° Full Arc Worksurfaces



135° Scoop Worksurfaces

Folio



28"H, 33"H ADA,
and 36"H Base
Cabinets



Sink Cabinets

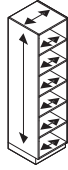

Storage Cabinets



Wardrobe Cabinets



Bookcases



Upper Storage
Cabinets



Shelves

Regard

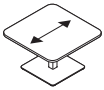

Square Tables

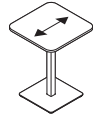

Personal Tables

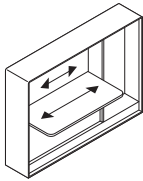

Open Desk Cabinet

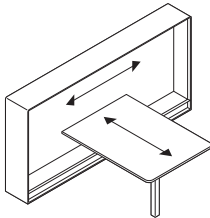

Booth with Table

Freestanding Casegoods Directional Laminate

The appearance of laminate may change slightly depending on the angle from which it is viewed. This natural phenomenon is called polarization, and it can be seen on natural veneer, and to a lesser extent on composite veneer. Polarization is often noticed on worksurfaces installed at a 90° angle with each other. Please refer to the following illustrations for an understanding of grain direction on your installation.

Park



Bedside Tables

Senza



Wardrobe Cabinets



Dressers



Bedside Tables

Upholstery and Color Numbers

Upholstery

Not all fabrics are available on all products. See the COM database for specific product and fabric availability.

Price Group 1

Buzz2

5F03 Tomato
 5F04 Red **E**
 5F05 Burgundy
 5F06 Sky **E**
 5F07 Blue
 5F08 Navy
 5F15 Stone
 5F16 Grey
 5F17 Black
 5G50 Dunegrass
 5G51 Sable
 5G55 Pumpkin
 5G57 Rouge
 5G59 Meadow
 5G61 Cyan
 5G62 Atlantic
 5G63 Crocus
 5G64 Alpine
 5G65 Tornado

Era

5ER0 Cobalt
 5ER1 Harbor
 5ER2 Blue Nickel
 5ER3 Pistachio
 5ER4 Canary
 5ER5 Comet
 5ER6 Truffle
 5ER7 Saffron
 5ER8 Pink Lemonade
 5ER9 Onyx
 5ES0 Scarlet
 5ES1 Lentil
 5ES2 Oatmeal
 5ES3 Persimmon
 5ES4 Sprout
 5ES5 Blue Mint
 5ES6 Royal Blue
 5ES7 Night Owl
 5ET1 Rose Quartz
 5ET3 Olivine
 5EU2 Electric Indigo
 5EU3 Green Citrine
 5EU4 Storm Cloud

Jacks

5B61 Taupe **E**
 5B63 Camel **E**
 5B64 Pewter **E**
 5B70 Midnight **E**

Link

5A24 Blue
 5A25 Navy
 5A27 Black

New Black

5J10 New Black: Bruce
 5J11 New Black: Henry
Tip: New Black upholstery has color numbers in both price group 1 and price group 2.

Price Group 2

Chainmail

5551 Space
 5552 Silver Dollar
 5553 Volcano
 5555 Tricycle
 5559 Lagoon

Cogent: Connect

5S15 Coconut
 5S16 Turmeric/Honey
 5S17 Tangerine
 5S18 Scarlet
 5S19 Concord
 5S21 Blue Jay
 5S23 Wasabi
 5S24 Nickel
 5S25 Graphite
 5S26 Licorice
 5S27 Malt
 5S28 Root Beer
 5S93 Indigo/Blueprint
 5S94 Lizard/Jungle
 5S95 Sailor
 5S96 Quicksilver
 5S99 Lipstick/Merlot
 5SD0 Royal Blue
 5SD1 Aubergine
 5SD2 Peacock
 5SD3 Lagoon
 5SD4 Saffron
 5SD5 Citrine
 5SD6 Rose Quartz
 5SD7 Sea Salt
 5SF3 Storm Cloud
 5SF4 Olivine

Foundation

5875 Black
 5876 Navy
 5877 Foggy Night
 5878 Sailor
 5879 Ivory
 5880 Seal
 5881 Peat
 5882 New Sand
 5883 Cranberry
 5884 Spring
 5885 Honey
 5886 Folkstone
 5887 Pebble
 5888 Oregano

New Black

5J08 New Black: Jack
 5J09 New Black: James
 5J12 New Black: Harley
Tip: New Black upholstery has color numbers in both price group 1 and price group 2.

Stand In

5621 Sleet
 5622 Lunar
 5623 Cyclone
 5624 Eclipse
 5625 Powder
 5626 Chardonnay
 5627 Graham
 5628 Sediment
 5629 Allspice
 5630 Apple
 5631 Lava
 5632 Cayenne
 5633 Plantain
 5634 Parsley
 5635 Scallion
 5636 Atlantis
 5691 Orca
 5740 Burlap
 5741 Porter
 5742 Tusk
 5743 Putty
 5744 Blueberry
 5745 Chartreuse
 5746 Mango
 5747 Sedona
 5748 Juniper
 5749 Peanut

Price Group 3

Billiard Multi-Use by Designtex

5H11 Poppy
 5H12 Tangelo
 5H13 Citrine/Citron
 5H14 Avocado
 5H16 Indigo
 5H17 Mallard
 5H18 Teak
 5H19 Cumulus
 5H20 Pewter
 5H21 Gunmetal
 5H22 Ink
 5H23 Rose Quart
 5H24 Sea Salt
 5H25 Storm Cloud
 5H26 Olivine

Gaja

5W40 Black
 5W41 Pepper
 5W42 Pearl Grey
 5W43 Crimson
 5W44 Ink
 5W45 Night Blue
 5W48 Sepia
 5W51 Camellia Red
 5W52 Emerald
 5W53 Snow Pea
 5W54 Olive
 5W56 Maroon
 5W57 Black Raspberry
 5W58 Spruce
 5W60 Deep Blue
 5W61 Chili Pepper

Redeem

TM50 Brick
 TM52 Cinnamon
 TM55 Water
 TM58 Mallard
 TM60 Greyhound
 TM62 Iceberg
 TM63 Chestnut
 TM64 Granite
 TM66 Barnwood

Retrieve

TM31 Lake
 TM32 Gala
 TM37 Submarine
 TM40 Quarry
 TM42 Shadow
 TM43 Seal

Price Group 5

Bo Peep

5G67 Bone
 5G72 Honey Mustard
 5G73 Marmalade
 5G74 Picnic
 5G75 Pinot
 5G76 Bloom
 5G77 Grapevine
 5G79 Artichoke
 5G80 Serpent
 5G81 Carolina
 5G82 Blue Bonnet
 5G83 Nautical
 5G84 Gravel
 5G85 Sharkskin
 5G86 Kohl

Silk

5L31 Dijon
 5L32 Seaweed
 5L33 Boysenberry
 5L35 Marina
 5L36 Heather Blue
 5L37 Blue Raspberry
 5L38 Cauldron
 5L39 Flaxen

Remix

RE01 Rust
 RE03 Pebble
 RE04 Dark Chocolate
 RE06 Linen Beige
 RE08 Concrete Grey
 RE09 Sky Blue
 RE10 Blue Jean
 RE11 Ivy Green
 RE13 Night Blue

E = Excluded

Price Group 6

Brisa

- BR01 Black Onyx
- BR04 Truffle
- BR06 Ash
- BR07 Sage
- BR08 Celery
- BR09 Sterling Blue
- BR10 Night Navy
- BR11 Cambridge Blue
- BR12 Abyss
- BR14 Pompeian Red
- BR16 Cinnabar
- BR18 New Sand
- BR20 White
- BR21 Moccasin
- BR22 Buckskin
- BR24 Mineral
- BR25 Skyway
- BR26 Iron
- BR27 Stormy
- BR28 Esmeralda
- BR29 Seaweed
- BR30 Bone
- BR31 Caramel
- BR32 Bridle
- BR33 Moon

Price Group 7

Steelcut Trio

- TR01 Mist Grey
- TR02 Stone Grey
- TR03 Cassonade Beige
- TR04 Nutmeg Beige
- TR06 Licorice Black
- TR11 Ice Blue
- TR15 Brown Frost
- TR18 Coastal Oasis
- TR19 Deep Sea

Steelcase Leather

- L107 Black **E**
- L207 Mahogany **E**
- L220 Soapstone **E**
- L221 Rocky **E**

Select Surfaces

For information on products within Select Surfaces, including accent paints and fabrics from Designtex, Gabriel, Kvadrat, and Pollack, please refer to the *Surface Materials Reference Manual* or visit steelcase.com/surface-materials under the Select Surfaces section.

E = Excluded

Custom Surfaces

Price Group COM (Customer's Own Material)

Fabric Approval and Yardage

To confirm whether a particular COM material has already been tested for use on a specific Steelcase or Steelcase Health product or to determine actual yardage requirements:

- Visit www.steelcase.com

For additional information regarding Customer's Own Material, call

1.888.STEELCASE (1.888.783.3522) or send an e-mail to lineone@steelcase.com.

For Steelcase Health products, call 1.800.342.8562.

Steelcase Health Select Surface Programs

Steelcase Health Select Surface Program: Solid Surface

A collection of solid surfaces are available as part of a Select Surface Program. The collection is from the Corian solid surface offering. Samples can be ordered through corian.com

These solid surfaces are Select Surface for the Convey, Folio, Sync, and Senza products only. The collection on these pages is not Select Surface for other Steelcase brands or product lines.

To order these solid surfaces, enter the finish code which corresponds with the solid surface price group.

Price Group	Finish Code
A	29DA
B	29DB
C	29DC
D	29DD

Then enter the solid surface information in the Special Solid Surface Information pop up window. If prompted, enter the finish code CORIAN001 based on the solid surface supplier.

Solid Surface Offering

Price Group A

Cameo White
Vanilla

Price Group B

Abalone
Aurora
Canyon
Modern White
Platinum
Sahara
Sandstone
Savannah
Silt

Price Group C

Arctic Ice
Concrete
Deep Night Sky
Deep Nocturne
Designer White
Doeskin
Dove
Glacier Ice
Matterhorn
Rice Paper
Serene Sage
Silver Birch
Silverite
Venaro White
Whisper
White Jasmine
Willow

Price Group D

Arrowroot
Clam Shell
Juniper
Lava Rock
Natural Gray
Rain Cloud
Rosemary
Sagebrush
Sand Storm
Sandalwood
Sorrel
Witch Hazel

Standard Steelcase Health Solid Surface finishes:

Price Group A

2801 Glacier White
2973 Linen
2975 Bisque
2978 Cameo White
2979 Silver Grey

Price Group B

2972 Antarctica

Price Group C

2974 Canvas

Steelcase Health Select Surface Program: Upholstery

Steelcase Health Select Surface Program Partners:

Architex
Arc-Com
CF Stinson
Designtex
Mayer
Momentum
Ultrafabrics

A collection of textiles

are available as part of a Select Surface Program. The collection from the leading suppliers in the market consists of high-performance textiles that meet the demands of healthcare environments. Note that not all fabrics can be applied to all seating products. Refer to the Steelcase COM database for the most current application information.

To order these fabrics, enter the finish code which corresponds with the fabric price group.

Price Group	Finish Code
2	59DB
3	59DC
4	59DD
5	59DE
6	59DF
7	59DG
8	59DH
9	59DJ
10	59DK

Then enter the fabric information in the Special Fabric Information pop up window.

Fabric application direction must be specified.

► See page 395 for *Fabric Application Direction Guidelines* to ensure fabric is specified in the correct direction.

For a comprehensive list of patterns and price grades in Steelcase Health offering, visit steelcasehealth.com/resources/grade-in

What is the issue?

Some textiles are simple and look the same regardless of how you apply them to a product. Other fabrics are patterned, textured, or have luster that will have a distinctly different appearance applied in a different direction on a chair. Because of these differences, and the fact that there are limits to how some fabrics can be applied to Steelcase Health products, it is important to understand fabric application direction when ordering a product to avoid being disappointed.

Talking about direction

Fabrics come on rolls. The long yarns that run down the length of the roll are called the “warp” yarns. These yarns are used to define the direction you are viewing the fabric as it is applied to a chair. Fabric directionality is determined by how the fabric comes off the roll.

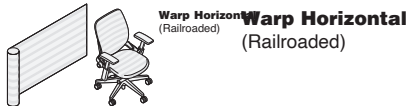

It is NOT determined by the way the pattern looks on the product. For example, the image below shows the fabric applied warped horizontal although the stripes appear vertical.

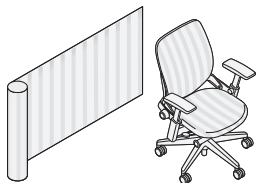

Terminology

Steelcase uses the terms warped horizontal and warped vertical. There are other terms within the industry that are used that have the same meaning:

- Warped horizontal is also referred to as: railroaded or across roll
- Warped vertical is also referred to as: woven way, down roll, or top out

Why is it important?

Dealers must specify fabric application direction when ordering COMs and Steelcase Health Select Surface fabrics. We require the dealer to specify the direction because we do not know which way customers want to see a pattern on the furniture. Therefore, it is critical to know how the pattern is run on the roll to ensure that Steelcase Health builds and ships each order to the customer's expectation each and every time.



Incorrect?



Correct?



Incorrect?



Correct?



Incorrect?



Correct?



Incorrect?



Correct?

How do I know which way the fabric comes off the roll?

Most textile companies will swatch their fabrics in a warp vertical (woven way, down roll) direction. Some exceptions might be made to address patterns especially with stripes. Typically, when a fabric is swatched in a warp horizontal (railroad or across roll) direction, the direction is noted on the swatch card or fabric sample. If in doubt of a fabric direction, we encourage you to contact the textile vendor for clarification.

Vinyl

Vinyl generally only passes on Steelcase Health product in a horizontal or across roll direction. This is due to physical properties of the material. If a vinyl is applied in the opposite direction, too much stretch in the material can compromise the overall aesthetics of the final upholstery. If a patterned vinyl is being specified and the vinyl must be run in a vertical direction, pre-approval must be arranged through Steelcase Health. Steelcase Health will consider the request and a decision will be made based on the specific vinyl and product combination. Contact Steelcase Health's Customer Care line.

Required Action Steps before Specifying

1. Verify by using Steelcase's COM website that the fabric is approved on the product.
2. Verify the direction that the fabric can be applied. Occasionally a fabric is only approved in one direction.
3. Confirm with the customer how they want the fabric to look on the furniture.
4. Confirm using the swatch card or vendor's website the direction the sample is shown.
5. Now you're ready to place the order.



Resources

Lock and Keying	398
Wood Touch-Up Kits	400
Style Number Index	402

Lock and Keying

For Use with Convey, Folio, Park, and Senza

Locks are optional and factory or field-installed to secure the doors or top drawers of a cabinet. Factory-installed locks are available keyed random with consecutive, specific, or random keying options. Master key locks are also available. Field-installed lock cylinders must be specified separately.

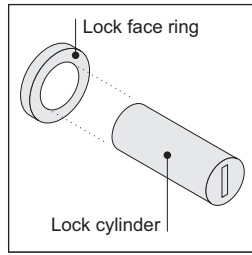

Locks consist of a factory- or field-installed lock cylinder and a factory-installed lock face ring.

be opened with a single master key.

Two types of locks are available — the standard keying system (FR series) and the master keying system (XF series). All the locks in the XF series can

Factory-Installed Keying

Optional factory-installed locks are always key random or master key random. Key random means that the locks will be assigned arbitrarily at the factory with key numbers ranging from FR305 to FR999 (Master keying numbers: XF1001 to XF3000).
Tip: Random keying can mean that different furniture units will have the same key number. If you must have all locks keyed differently,

you should specify field-installed, key specific or key consecutive lock cylinders.
▶ See below.

Key Random

- FR305
 - FR421
 - FR305
 - or
 - XF1011
 - XF1042
 - XF1011
- } XF Master Key

Required to Specify

Master key random	+\$39	Specify with master key random.
--------------------------	-------	---------------------------------

Field-Installed Keying

Field-installed locks are only available on products that include factory-installed lock mechanisms.

Front-removable lock cylinders must be specified separately. You must also order a special lock tool to install or remove lock cylinders in the field.
Tip: Lock tools are reusable. You do not need to order additional lock tools with every furniture order.

Lock cylinders will be shipped separately so that you can install the locks when you are ready.

Specify "plug" when specifying furniture, and the product will ship with a plastic plug in place of the lock cylinder.

Three keying choices are available for field installation — random (standard), specific, and consecutive. All three are also available with master keying, which means that all locks can be opened with a single master key.

Key Random

- FR305
 - FR421
 - FR305
 - or
 - XF1011
 - XF1042
 - XF1011
- } XF Master Key

Key random means that the locks will be assigned arbitrarily at the factory with key numbers ranging from FR305 to FR999 (Master keying numbers: XF1001 to XF3000).
Tip: Random keying can mean that different furniture units will have the same key number. If you must have all locks keyed differently, you should specify key specific or key consecutive lock cylinders.

Key specific means that you can specify any key number from FR305 to FR999 (Master keying numbers: XF1001 to XF3000). This option can be used to key all the furniture units in a workstation or department the same.
Tip: Designate the quantity per key number in your specification.
▶ See example at right.

Key Specific

- FR350
 - FR350
 - FR350
 - or
 - XF1020
 - XF1020
 - XF1020
- } XF Master Key

Key consecutive means that you can specify lock numbers in a consecutive order to ensure that no two locks have the same key number until the key sequence repeats. You must select a beginning key number from FR305 to FR999 (Master keying numbers: XF1001 to XF3000).

Key Consecutive

- FR350
 - FR351
 - FR352
 - or
 - XF1020
 - XF1021
 - XF1022
- } XF Master Key

Example of a typical lock cylinder specification is shown below:

- 10 LOCKFR FR320
 - 5 LOCKFR FR350
 - 15 LOCKXF XF1100
-
- 30 Total
 - 1 877102003SR standard lock tool
 - 1 877102002SR master lock tool

Field-Installed Lock Cylinders

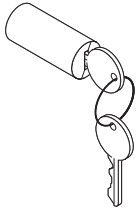

Tip: Lock price is included in price of furniture with locks.

Tip: For replacement lock cylinders, refer to Service Parts.

Tip: You can change lock cylinders in the field by using the appropriate lock tool.

Standard Includes	Required to Specify
-------------------	---------------------

<ul style="list-style-type: none"> • Lock cylinder • Two keys 	<ol style="list-style-type: none"> 1 Style number 2 Lock finish 9201 Polished Chrome 9250 Ember Chrome 3 Options, if selected (see below)
---	--

Options	U.S. Price	Required to Specify
---------	------------	---------------------

Key specific	No cost	Select key number from FR305–FR999.
Key consecutive	No cost	Specify <i>key consecutive</i> and select beginning key number from FR305–FR999.
Master key random	+\$39 each	Specify <i>master key random</i> .
Master key specific	+\$39 each	Specify key number from XF1001–XF3000.
Master key consecutive	+\$39 each	Specify <i>master key consecutive</i> and select beginning key number from XF1001–XF3000.

Specification Information	
---------------------------	--

Style Number	U.S. Base Price

FR Series (Standard Keying System)—Lock Cylinder

LOCKFR	No cost
---------------	---------

Standard Lock Tool

877102003SR	\$39
--------------------	------

XF Series (Master Keying System)—Lock Cylinder

LOCKXF	No additional cost. Price included in price of furniture with master-keyed locks.
---------------	---

Master Lock Tool

877102002SR	\$39
--------------------	------



For Canadian Pricing

Multiply U.S. Price by the Canadian price factor.

▶ See page 1 for details.

Wood Touch-Up Kits

How to Order Wood Touch-Up Kits

Order wood finish touch-up kits from J.Kaltz Co. Specific Steelcase finish codes (such as 3422) can be found under Finishes > Dealer Kits. Each kit contains one brush tip marker and one fill stick.

Place orders as follows:

- Phone: 616.942.6070
- Web: <http://www.jkaltzco.com>

Style Number Index

Style Number	Page	Description
877102002SR	399	Master Lock Tool
877102003SR	399	Standard Lock Tool
H3BG30LL	344	Senza Bedside Table
H3BG30LR	345	Senza Bedside Table
H3BG30RL	344	Senza Bedside Table
H3BG30RR	345	Senza Bedside Table
H3BM30L	344	Senza Bedside Table
H3BM30R	345	Senza Bedside Table
H3D330L	342	Senza Dresser
H3D330R	343	Senza Dresser
H3D438L	342	Senza Dresser
H3D438R	343	Senza Dresser
H3NE24L	344	Senza Bedside Table
H3NE24R	345	Senza Bedside Table
H3W124LL	338	Senza Wardrobe Cabinet
H3W124LR	340	Senza Wardrobe Cabinet
H3W124RL	338	Senza Wardrobe Cabinet
H3W124RR	340	Senza Wardrobe Cabinet
H3W1C24LL	339	Senza Wardrobe Cabinet
H3W1C24LR	341	Senza Wardrobe Cabinet
H3W1C24RL	339	Senza Wardrobe Cabinet
H3W1C24RR	341	Senza Wardrobe Cabinet
H3W236L	339	Senza Wardrobe Cabinet
H3W236R	341	Senza Wardrobe Cabinet
H3W2C36L	339	Senza Wardrobe Cabinet
H3W2C36R	341	Senza Wardrobe Cabinet
H4BG30LR	328	Park Bedside Table
H4BG30RR	328	Park Bedside Table
H4BM30R	328	Park Bedside Table
HAH	357	Coat Hooks
HBA10828	198	Sync Single-Sided Base
HBA10836	198	Sync Single-Sided Base
HBA10842	198	Sync Single-Sided Base
HBA7228	198	Sync Single-Sided Base
HBA7236	198	Sync Single-Sided Base
HBA7242	198	Sync Single-Sided Base
HBA8428	198	Sync Single-Sided Base
HBA8436	198	Sync Single-Sided Base
HBA8442	198	Sync Single-Sided Base
HBA9628	198	Sync Single-Sided Base
HBA9636	198	Sync Single-Sided Base
HBA9642	198	Sync Single-Sided Base
HBB1083628	194	Sync Double-Sided Base
HBB1084228	194	Sync Double-Sided Base
HBB1084236	194	Sync Double-Sided Base
HBB723628	194	Sync Double-Sided Base
HBB724228	194	Sync Double-Sided Base
HBB724236	194	Sync Double-Sided Base
HBB843628	194	Sync Double-Sided Base
HBB844228	194	Sync Double-Sided Base
HBB844236	194	Sync Double-Sided Base
HBB963628	194	Sync Double-Sided Base
HBB964228	194	Sync Double-Sided Base
HBB964236	194	Sync Double-Sided Base
HBC2428L	200	Sync Single Leg Base
HBC2428R	200	Sync Single Leg Base

Style Number	Page	Description
HBC2436L	200	Sync Single Leg Base
HBC2436R	200	Sync Single Leg Base
HBC2442L	200	Sync Single Leg Base
HBC2442R	200	Sync Single Leg Base
HBC244L	200	Sync Single Leg Base
HBC24AR	200	Sync Single Leg Base
HBRKTS	202	Solid Top Bridge Bracket
HCMADJSHLF	171	Convey Shelf,Adj
HCMBDF	103-105	Convey Cabt-Base,Dr,Flr extnd
HCMBDW	101	Convey Cabt-Base,Dr,Wall spnd
HCMBDWRDF	106-107	Convey Cabt-Base,Dwr,Dr,Flr extnd
HCMBDWRF	105-106	Convey Cabt-Base,Drawers,Flr extnd
HCMBDWRW	101	Convey Cabt-Base,Drawers,Wall spnd
HCMBGDF	116	Convey Cabt-Base,Garage,Dr,Flr extnd
HCMBGF	115	Convey Cabt-Base,Garage,Flr extnd
HCMBPDWRF	111	Convey Cabt-Base,Prntr,Dwr,Flr extnd
HCMBPDWRW	109	Convey Cabt-Base,Prntr,Dwr,Wall spnd
HCMBPF	110	Convey Cabt-Base,Prntr,Flr extnd
HCMBPW	109	Convey Cabt-Base,Prntr,Wall spnd
HCMBSINK	121	Convey Cabt-Base,Angld sink
HCMBSINKCOH	121	Convey Cabt-Base,Angld sink,Chg of H
HCMBSINKDF	120	Convey Cabt-Base,Sink,Dr,Flr extnd
HCMBSINKDW	119	Convey Cabt-Base,Sink,Dr,Wall spnd
HCMBTf	113	Convey Cabt-Base,PO trash,Flr extnd
HCMBTRIM	172	Convey Base trim
HCMBTW	113	Convey Cabt-Base,PO trash,Wall spnd
HCMCACCSRAIL	178	Convey; Accessory Rail
HCMCANTLVR	161	Convey Cant
HCMCART	141-142	Convey; Storage Cart
HCMCDWRDIV4	178	Convey; 4" Drawer Divider
HCMCDWRDIV6	179	Convey; 6" Drawer Divider
HCMCDWRDIVL	179	Convey; Drawer Divider Labels
HCMCPAS	146	Convey Cvr pnl,Angld sink
HCMCPBW	145	Convey Cvr pnl,Wall spnd,Base cabt
HCMCPF	146	Convey Cvr pnl,Flr extnd
HCMCPU	145	Convey Cvr pnl,Upr stg cabt
HCMCPW	145	Convey Cvr pnl,Wall spnd
HCMELBZL	174	Convey Elctrn lck,Bezel
HCMELR	174	Convey Elctrn lck,Rcwr
HCMELTRNS	174	Convey Elctrn lck,Trmsmtr
HCMEPF	162	Convey End pnl,Flr extnd
HCMFASCIASLPD	150-151	Convey Fascia,Sloped
HCMFASCIAVERT	152-153	Convey Fascia,Vert
HCMFLRBW	167	Convey Filler-Wall,Wall spnd,Bse cab appl
HCMFLRINCRNF	167	Convey Firl-Ins cnr,Flr extnd,Bse cab appl
HCMFLRU	167	Convey Firl-Wll,Upr,Wll spnd,Bse cab appl
HCMFLRUINDCRNW	167	Convey Firl-Ins cnr,Upr,Wll spnd,Bse cab
HCMFLRUWC	167	Convey Filler-Ceil,Upr,Wrdrb
HCMFLRWARDf	167	Convey Filler-Wall,Flr extnd,Wrdrb appl
HCMFLRWARDW	167	Convey Filler-Wall spnd,Wrdrb appl
HCMFLRWF	167	Convey Filler-Wall,Flr extnd,Bse cab appl
HCMGHAL	172	Convey Grg Hng Angl Lmtr Qty 25
HCMHAL	172	Convey Hng-Angl lmtr,Pkg qty Pkg 25
HCMLV	173	Convey Lt val
HCMMBBOARD	164-165	Convey Bd,Mntng
HCMN	172	Convey Filler-Rail,Pkg qty 10,Ntchd

Style Number	Page	Description	Style Number	Page	Description
HCMRAIL	168	Convey Rail cbnt sprt	HT135SRHL	201	Sync 135° Scoop Worksurface
HCMRAILCOVER	168	Convey Rail cvr	HT135SRHS	201	Sync 135° Scoop Worksurface
HCMSCDF	130	Convey Stg cabt,Dr,Flr extnd	HT4818BCHP	354	Opus Mobile Over-Bed Table
HCMSCF	129	Convey Stg cabt,Flr extnd	HT72LNL	197	Sync Worksurface
HCMSLPDTRIM	173	Convey Sloped Fascia Trim	HT72LNS	197	Sync Worksurface
HCMSPLSH	175	Convey Sidesplash, Sld surf	HT72LPL	197	Sync Worksurface
HCMSPLSHL	177	Convey Sidesplash, HPL	HT72LPS	197	Sync Worksurface
HCMTC	148-149	Convey Cvr pnl-TC	HT72NL	199	Sync Worksurface
HCMUCORNERD	139	Convey Upr stg cabt,Cnr,Dr	HT72NS	199	Sync Worksurface
HCMUD	133-134	Convey Upr stg cabt,Dr	HT72PL	199	Sync Worksurface
HCMUDNB	134-135	Convey Upr stg cabt,Dr,No btm	HT72PS	199	Sync Worksurface
HCMUMSHLFD	136	Convey Upr stg cabt,Microwave,Shelf,Dr	HT72UNL	196	Sync Worksurface
HCMUOSSDNB	135	Convey Upr stg cab,Ovr snk stg,Dr,No btm	HT72UNS	196	Sync Worksurface
HCMVERTTRIM	173	Convey Vertical Fascia Trim	HT72UPL	197	Sync Worksurface
HCMVSPCR	178	Convey V.I.A. Spacer	HT72UPS	197	Sync Worksurface
HCMWARDDF	126	Convey Wrdrb,Dr,Flr extnd	HT72UTL	196	Sync Worksurface
HCMWARDDW	124	Convey Wrdrb,Dr,Wall spnd	HT72UTS	196	Sync Worksurface
HCMWARDF	125	Convey Wrdrb,Flr extnd	HT84LNL	197	Sync Worksurface
HCMWARDW	123	Convey Wrdrb,Wall spnd	HT84LNS	197	Sync Worksurface
HCMWRKSFL	159-160	Convey Worksurface, HPL	HT84LPL	197	Sync Worksurface
HCMWRKSFSINKSS	156-157	Convey Wksf,Sink,Sld surf	HT84LPS	197	Sync Worksurface
HCMWRKSFSS	155-156	Convey Wksf,Sld surf	HT84NL	199	Sync Worksurface
HCMWTRIM	174	Convey Wall trim	HT84NS	199	Sync Worksurface
HP1822A	364	Pocket without Monitor Mount	HT84PL	199	Sync Worksurface
HP1822AB	364	Pocket without Monitor Mount	HT84PS	199	Sync Worksurface
HP1822F	364	Pocket without Monitor Mount	HT84UNL	196	Sync Worksurface
HP1822FB	364	Pocket without Monitor Mount	HT84UNS	196	Sync Worksurface
HP2225A	365	Pocket With Monitor Mount	HT84UPL	197	Sync Worksurface
HP2225AB	365	Pocket With Monitor Mount	HT84UPS	197	Sync Worksurface
HP2225AC	365	Pocket With Monitor Mount	HT84UTL	196	Sync Worksurface
HP2225F	365	Pocket With Monitor Mount	HT84UTS	196	Sync Worksurface
HP2225FB	365	Pocket With Monitor Mount	HT90FL	201	Sync Full Arc Worksurface
HP2322A	364	Pocket Without Monitor Mount	HT90FS	201	Sync Full Arc Worksurface
HP2322AB	364	Pocket Without Monitor Mount	HT96LNL	197	Sync Worksurface
HP2322F	364	Pocket Without Monitor Mount	HT96LNS	197	Sync Worksurface
HP2322FB	364	Pocket Without Monitor Mount	HT96LPL	197	Sync Worksurface
HPCUP	366	Pocket Cup Holder	HT96LPS	197	Sync Worksurface
HPSCANNER	366	Pocket Scanner Holder	HT96NL	199	Sync Worksurface
HT108LNL	197	Sync Worksurface	HT96NS	199	Sync Worksurface
HT108LNS	197	Sync Worksurface	HT96PL	199	Sync Worksurface
HT108LPL	197	Sync Worksurface	HT96PS	199	Sync Worksurface
HT108LPS	197	Sync Worksurface	HT96UNL	196	Sync Worksurface
HT108NL	199	Sync Worksurface	HT96UNS	196	Sync Worksurface
HT108NS	199	Sync Worksurface	HT96UPL	197	Sync Worksurface
HT108PL	199	Sync Worksurface	HT96UPS	197	Sync Worksurface
HT108PS	199	Sync Worksurface	HT96UTL	196	Sync Worksurface
HT108UNL	196	Sync Worksurface	HT96UTS	196	Sync Worksurface
HT108UNS	196	Sync Worksurface	HTAX2	371	Extension Arm
HT108UPL	197	Sync Worksurface	HTC1834RL	355	Mobile Overbed Table with C-Base
HT108UPS	197	Sync Worksurface	HTC1834RR	355	Mobile Overbed Table with C-Base
HT108UTL	196	Sync Worksurface	HTCS2	371	Enclosed CPU Holder
HT108UTS	196	Sync Worksurface	HTCU2	371	Standard CPU Holder
HT135FL	201	Sync Full Arc Worksurface	HTU1530KR	356	Mobile Overbed Table with U-Base
HT135FS	201	Sync Full Arc Worksurface	HTU1530RL	356	Mobile Overbed Table with U-Base
HT135SLHL	201	Sync 135° Scoop Worksurface	HTU1530RR	356	Mobile Overbed Table with U-Base
HT135SLHS	201	Sync 135° Scoop Worksurface	HTU1834RR	356	Mobile Overbed Table with U-Base

Style Number Index, continued

Style Number	Page	Description
HTU1834VR	356	Mobile Overbed Table with U-Base
HTW34	370	Relay Arm
HXAB3436	292	Folio Mounting Board
HXBC1228	257	Folio 28"H Base Cabinet
HXBC1233A	261	Folio 33"H Base Cabinet
HXBC1236	265	Folio 36"H Base Cabinet
HXBC18248	312	Folio Wall-Mounted 24" Base Cabinet
HXBC1828	257	Folio 28"H Base Cabinet
HXBC1833A	261	Folio 33"H Base Cabinet
HXBC1836	265	Folio 36"H Base Cabinet
HXBC2128	257	Folio 28"H Base Cabinet
HXBC2133A	261	Folio 33"H Base Cabinet
HXBC2136	265	Folio 36"H Base Cabinet
HXBC24248	312	Folio Wall-Mounted 24" Base Cabinet
HXBC2428	257	Folio 28"H Base Cabinet
HXBC2433A	261	Folio 33"H Base Cabinet
HXBC2436	265	Folio 36"H Base Cabinet
HXBC3028	257	Folio 28"H Base Cabinet
HXBC3033A	261	Folio 33"H Base Cabinet
HXBC3036	265	Folio 36"H Base Cabinet
HXBC3628	257	Folio 28"H Base Cabinet
HXBC3633A	261	Folio 33"H Base Cabinet
HXBC3636	265	Folio 36"H Base Cabinet
HXBD1228L	256	Folio 28"H Base Cabinet
HXBD1228R	256	Folio 28"H Base Cabinet
HXBD1233AL	260	Folio 33"H Base Cabinet
HXBD1233AR	260	Folio 33"H Base Cabinet
HXBD1236L	264	Folio 36"H Base Cabinet
HXBD1236R	264	Folio 36"H Base Cabinet
HXBD1824L8	312	Folio Wall-Mounted 24"H Base Cabinet
HXBD1824R8	312	Folio Wall-Mounted 24"H Base Cabinet
HXBD1828L	256	Folio 28"H Base Cabinet
HXBD1828R	256	Folio 28"H Base Cabinet
HXBD1833AL	260	Folio 33"H Base Cabinet
HXBD1833AR	260	Folio 33"H Base Cabinet
HXBD1836L	264	Folio 36"H Base Cabinet
HXBD1836R	264	Folio 36"H Base Cabinet
HXBD2128L	256	Folio 28"H Base Cabinet
HXBD2128R	256	Folio 28"H Base Cabinet
HXBD2133AL	260	Folio 33"H Base Cabinet
HXBD2133AR	260	Folio 33"H Base Cabinet
HXBD2136L	264	Folio 36"H Base Cabinet
HXBD2136R	264	Folio 36"H Base Cabinet
HXBD2424L8	312	Folio Wall-Mounted 24"H Base Cabinet
HXBD2424R8	312	Folio Wall-Mounted 24"H Base Cabinet
HXBD2428L	256	Folio 28"H Base Cabinet
HXBD2428R	256	Folio 28"H Base Cabinet
HXBD2433AL	260	Folio 33"H Base Cabinet
HXBD2433AR	260	Folio 33"H Base Cabinet
HXBD2436L	264	Folio 36"H Base Cabinet
HXBD2436R	264	Folio 36"H Base Cabinet
HXBD3028	257	Folio 28"H Base Cabinet
HXBD3033A	261	Folio 33"H Base Cabinet
HXBD3036	265	Folio 36"H Base Cabinet
HXBD36248	312	Folio Wall-Mounted 24"H Base Cabinet
HXBD3628	257	Folio 28"H Base Cabinet

Style Number	Page	Description
HXBD3633A	261	Folio 33"H Base Cabinet
HXBD3636	265	Folio 36"H Base Cabinet
HXBE28	258	Folio 28"H Support End Panel
HXBE33A	262	Folio 33"H Support End Panel
HXBE36	267	Folio 36"H Support End Panel
HXBF1236	265	Folio 36"H Base Cabinet
HXBF1836	265	Folio 36"H Base Cabinet
HXBF2136	265	Folio 36"H Base Cabinet
HXBF2436	265	Folio 36"H Base Cabinet
HXBF3036	265	Folio 36"H Base Cabinet
HXBF3636	265	Folio 36"H Base Cabinet
HXBG1236L	265	Folio 36"H Base Cabinet
HXBG1236R	265	Folio 36"H Base Cabinet
HXBG1836L	265	Folio 36"H Base Cabinet
HXBG1836R	265	Folio 36"H Base Cabinet
HXBG2136L	265	Folio 36"H Base Cabinet
HXBG2136R	265	Folio 36"H Base Cabinet
HXBG2436L	265	Folio 36"H Base Cabinet
HXBG2436R	265	Folio 36"H Base Cabinet
HXBG3036	265	Folio 36"H Base Cabinet
HXBG3636	265	Folio 36"H Base Cabinet
HXBK3033	268	Folio Sink Cabinet
HXBK3036	268	Folio Sink Cabinet
HXBK3622A8	313	Folio Wall-Mounted Sink Cabinet
HXBK3633A	268	Folio Sink Cabinet
HXBK3636	268	Folio Sink Cabinet
HXBKD2424L8	313	Folio Wall-Mounted Sink Cabinet
HXBKD2424R8	313	Folio Wall-Mounted Sink Cabinet
HXBKD2436L	268	Folio Sink Cabinet
HXBKD2436R	268	Folio Sink Cabinet
HXBKD3036	268	Folio Sink Cabinet
HXBKD36248	313	Folio Wall-Mounted Sink Cabinet
HXBKD3636	268	Folio Sink Cabinet
HXBL1233A	262	Folio 33"H Base Cabinet
HXBL1236	266	Folio 36"H Base Cabinet
HXBL1833A	262	Folio 33"H Base Cabinet
HXBL1836	266	Folio 36"H Base Cabinet
HXBL2133A	262	Folio 33"H Base Cabinet
HXBL2136	266	Folio 36"H Base Cabinet
HXBL2433A	262	Folio 33"H Base Cabinet
HXBL2436	266	Folio 36"H Base Cabinet
HXBL3033A	262	Folio 33"H Base Cabinet
HXBL3036	266	Folio 36"H Base Cabinet
HXBL3633A	262	Folio 33"H Base Cabinet
HXBL3636	266	Folio 36"H Base Cabinet
HXBM1228	257	Folio 28"H Base Cabinet
HXBM1233A	261	Folio 33"H Base Cabinet
HXBM18248	312	Folio Wall-Mounted 24"H Base Cabinet
HXBM1828	257	Folio 28"H Base Cabinet
HXBM1833A	261	Folio 33"H Base Cabinet
HXBM2128	257	Folio 28"H Base Cabinet
HXBM2133A	261	Folio 33"H Base Cabinet
HXBM24248	312	Folio Wall-Mounted 24"H Base Cabinet
HXBM2428	257	Folio 28"H Base Cabinet
HXBM2433A	261	Folio 33"H Base Cabinet
HXBM3028	257	Folio 28"H Base Cabinet

Style Number	Page	Description	Style Number	Page	Description
HXBM3033A	261	Folio 33"H Base Cabinet	HXCBD2189RS	279	Folio 89"H Bookcase
HXBM3628	257	Folio 28"H Base Cabinet	HXCBD2473L8	316	Folio 73"H Wall-Mounted Bookcase
HXBM3633A	261	Folio 33"H Base Cabinet	HXCBD2473R8	316	Folio 73"H Wall-Mounted Bookcase
HXBN1236	266	Folio 36"H Base Cabinet	HXCBD2479L8S	317	Folio 79"H Wall-Mounted Bookcase
HXBN1836	266	Folio 36"H Base Cabinet	HXCBD2484L	277	Folio 84"H Bookcase
HXBN2136	266	Folio 36"H Base Cabinet	HXCBD2484R	277	Folio 84"H Bookcase
HXBN2436	266	Folio 36"H Base Cabinet	HXCBD2489LS	279	Folio 89"H Bookcase
HXBN3036	266	Folio 36"H Base Cabinet	HXCBD2489RS	279	Folio 89"H Bookcase
HXBN3636	266	Folio 36"H Base Cabinet	HXCBD3084	277	Folio 84"H Bookcase
HXBP1228	256	Folio 28"H Base Cabinet	HXCBD3089S	279	Folio 89"H Bookcase
HXBP1233A	260	Folio 33"H Base Cabinet	HXCBD3684	277	Folio 84"H Bookcase
HXBP1236	264	Folio 36"H Base Cabinet	HXCBD3689S	279	Folio 89"H Bookcase
HXBP1828	256	Folio 28"H Base Cabinet	HXCBP1284	276	Folio 84"H Bookcase
HXBP1833A	260	Folio 33"H Base Cabinet	HXCBP1289S	278	Folio 89"H Bookcase
HXBP1836	264	Folio 36"H Base Cabinet	HXCBP1884	276	Folio 89"H Bookcase
HXBP2128	256	Folio 28"H Base Cabinet	HXCBP1889S	278	Folio 89"H Bookcase
HXBP2133A	260	Folio 33"H Base Cabinet	HXCBP2184	276	Folio 84"H Bookcase
HXBP2136	264	Folio 36"H Base Cabinet	HXCBP2189S	278	Folio 89"H Bookcase
HXBP2428	256	Folio 28"H Base Cabinet	HXCBP24738	316	Folio 73"H Wall-Mounted Bookcase
HXBP2428C	269	Folio Corner Cabinet	HXCBP2484	276	Folio 84"H Bookcase
HXBP2433A	260	Folio 33"H Base Cabinet	HXCBP2489S	278	Folio 89"H Bookcase
HXBP2433AC	269	Folio Corner Cabinet	HXCBP3084	276	Folio 84"H Bookcase
HXBP2436	264	Folio 36"H Base Cabinet	HXCBP3089S	278	Folio 89"H Bookcase
HXBP2436C	269	Folio Corner Cabinet	HXCBP3684	276	Folio 84"H Bookcase
HXBP3028	256	Folio 28"H Base Cabinet	HXCBP3689S	278	Folio 89"H Bookcase
HXBP3033A	260	Folio 33"H Base Cabinet	HXCBS1214	290	Folio Storage Shelf
HXBP3036	264	Folio 36"H Base Cabinet	HXCBS1814	290	Folio Storage Shelf
HXBP3628	256	Folio 28"H Base Cabinet	HXCBS2114	290	Folio Storage Shelf
HXBP3633A	260	Folio 33"H Base Cabinet	HXCBS2414	290	Folio Storage Shelf
HXBP3636	264	Folio 36"H Base Cabinet	HXCBS3014	290	Folio Storage Shelf
HXBR1236	266	Folio 36"H Base Cabinet	HXCBS3614	290	Folio Storage Shelf
HXBR1836	266	Folio 36"H Base Cabinet	HXCD1284L	271	Folio 84"H Storage Cabinet
HXBR2136	266	Folio 36"H Base Cabinet	HXCD1284R	271	Folio 84"H Storage Cabinet
HXBR2436	266	Folio 36"H Base Cabinet	HXCD1292LS	273	Folio 92"H Storage Cabinet
HXBR3036	266	Folio 36"H Base Cabinet	HXCD1292RS	273	Folio 92"H Storage Cabinet
HXBR3636	266	Folio 36"H Base Cabinet	HXCD1884L	271	Folio 84"H Storage Cabinet
HXBS1224	290	Folio Storage Shelf	HXCD1884R	271	Folio 84"H Storage Cabinet
HXBS1818	322	Folio Wall-Mounted Storage Shelf	HXCD1892LS	273	Folio 92"H Storage Cabinet
HXBS1824	290	Folio Storage Shelf	HXCD1892RS	273	Folio 92"H Storage Cabinet
HXBS2124	290	Folio Storage Shelf	HXCD2184L	271	Folio 84"H Storage Cabinet
HXBS2418	322	Folio Wall-Mounted Storage Shelf	HXCD2184R	271	Folio 84"H Storage Cabinet
HXBS2424	290	Folio Storage Shelf	HXCD2192LS	273	Folio 92"H Storage Cabinet
HXBS3024	290	Folio Storage Shelf	HXCD2192RS	273	Folio 92"H Storage Cabinet
HXBS3618	322	Folio Wall-Mounted Storage Shelf	HXCD2484L	271	Folio 84"H Storage Cabinet
HXBS3624	290	Folio Storage Shelf	HXCD2484R	271	Folio 84"H Storage Cabinet
HXCBD1284L	277	Folio 84"H Bookcase	HXCD2492LS	273	Folio 92"H Storage Cabinet
HXCBD1284R	277	Folio 84"H Bookcase	HXCD2492RS	273	Folio 92"H Storage Cabinet
HXCBD1289LS	279	Folio 89"H Bookcase	HXCD3084	271	Folio 84"H Storage Cabinet
HXCBD1289RS	279	Folio 89"H Bookcase	HXCD3092S	273	Folio 92"H Storage Cabinet
HXCBD1884L	277	Folio 84"H Bookcase	HXCD3684	271	Folio 84"H Storage Cabinet
HXCBD1884R	277	Folio 84"H Bookcase	HXCD3692S	273	Folio 92"H Storage Cabinet
HXCBD1889LS	279	Folio 89"H Bookcase	HXCN1233A	261	Folio 33"H Base Cabinet
HXCBD1889RS	279	Folio 89"H Bookcase	HXCN1833A	261	Folio 33"H Base Cabinet
HXCBD2184L	277	Folio 84"H Bookcase	HXCN2133A	261	Folio 33"H Base Cabinet
HXCBD2184R	277	Folio 84"H Bookcase	HXCN2433A	261	Folio 33"H Base Cabinet
HXCBD2189LS	279	Folio 89"H Bookcase	HXCN3033A	261	Folio 33"H Base Cabinet

Style Number Index, continued

Style Number	Page	Description
HXCN3633A	261	Folio 33"H Base Cabinet
HXCP1284	270	Folio 84"H Storage Cabinet
HXCP1292S	272	Folio 92"H Storage Cabinet
HXCP1884	270	Folio 84"H Storage Cabinet
HXCP1892S	272	Folio 92"H Storage Cabinet
HXCP2184	270	Folio 84"H Storage Cabinet
HXCP2192S	272	Folio 92"H Storage Cabinet
HXCP2484	270	Folio 84"H Storage Cabinet
HXCP2492S	272	Folio 92"H Storage Cabinet
HXCP3084	270	Folio 84"H Storage Cabinet
HXCP3092S	272	Folio 92"H Storage Cabinet
HXCP3684	270	Folio 84"H Storage Cabinet
HXCP3692S	272	Folio 92"H Storage Cabinet
HXCS1224	290	Folio Storage Shelf
HXCS1824	290	Folio Storage Shelf
HXCS2124	290	Folio Storage Shelf
HXCS2424	290	Folio Storage Shelf
HXCS3024	290	Folio Storage Shelf
HXCS3624	290	Folio Storage Shelf
HXCW1284L	274	Folio 84"H Wardrobe Cabinet
HXCW1284R	274	Folio 84"H Wardrobe Cabinet
HXCW1292LS	275	Folio 92"H Wardrobe Cabinet
HXCW1292RS	275	Folio 92"H Wardrobe Cabinet
HXCW1884L	274	Folio 84"H Wardrobe Cabinet
HXCW1884R	274	Folio 84"H Wardrobe Cabinet
HXCW1892LS	275	Folio 92"H Wardrobe Cabinet
HXCW1892RS	275	Folio 92"H Wardrobe Cabinet
HXCW2184L	274	Folio 84"H Wardrobe Cabinet
HXCW2184R	274	Folio 84"H Wardrobe Cabinet
HXCW2192LS	275	Folio 92"H Wardrobe Cabinet
HXCW2192RS	275	Folio 92"H Wardrobe Cabinet
HXCW2473LD8	314	Folio 73"H Wall-Mtn Wardrobe Cab
HXCW2473RD8	314	Folio 73"H Wall-Mtn Wardrobe Cab
HXCW2479LS8	315	Folio 79"H Wall-Mtn Wardrobe Cab
HXCW2479LSD8	315	Folio 79"H Wall-Mtn Wardrobe Cab
HXCW2479RS8	315	Folio 79"H Wall-Mtn Wardrobe Cab
HXCW2479RSD8	315	Folio 79"H Wall-Mtn Wardrobe Cab
HXCW2484L	274	Folio 84"H Wardrobe Cabinet
HXCW2484R	274	Folio 84"H Wardrobe Cabinet
HXCW2492LS	275	Folio 92"H Wardrobe Cabinet
HXCW2492RS	275	Folio 92"H Wardrobe Cabinet
HXCW3084	274	Folio 84"H Wardrobe Cabinet
HXCW3092S	275	Folio 92"H Wardrobe Cabinet
HXCW3684	274	Folio 84"H Wardrobe Cabinet
HXCW3692S	275	Folio 92"H Wardrobe Cabinet
HXDF1224	288	Folio Desk Frame
HXDF1818	321	Folio Wall-Mounted Desk Frame
HXDF1824	288	Folio Desk Frame
HXDF2418	321	Folio Wall-Mounted Desk Frame
HXDF2424	288	Folio Desk Frame
HXDF3024	288	Folio Desk Frame
HXDF3618	321	Folio Wall-Mounted Desk Frame
HXDF3624	288	Folio Desk Frame
HXDF4218	321	Folio Wall-Mounted Desk Frame
HXDF4224	288	Folio Desk Frame
HXDF4818	321	Folio Wall-Mounted Desk Frame

Style Number	Page	Description
HXDF4824	288	Folio Desk Frame
HXDF5424	288	Folio Desk Frame
HXDF6018	321	Folio Wall-Mounted Desk Frame
HXDF6024	288	Folio Desk Frame
HXDF7218	321	Folio Wall-Mounted Desk Frame
HXDF7224	288	Folio Desk Frame
HXDFB2424	289	Folio Desk Frame
HXDFB3024	289	Folio Desk Frame
HXDFB3624	289	Folio Desk Frame
HXFB624	322	Folio Wall-Mounted Filler
HXFB628	291	Folio Filler
HXFB633	291	Folio Filler
HXFB636	291	Folio Filler
HXFCW692	291	Folio Filler
HXFCWB673	322	Folio Wall-Mounted Filler
HXFCWB684	291	Folio Filler
HXFCWB684S	291	Folio Filler
HXFU624	291	Folio Filler
HXFU629	291	Folio Filler
HXFU630	291	Folio Filler
HXFU635	291	Folio Filler
HXUD1224L	281	Folio Upper Storage Cabinet
HXUD1224R	281	Folio Upper Storage Cabinet
HXUD1229LS	283	Folio Upper Storage Cabinet
HXUD1229RS	283	Folio Upper Storage Cabinet
HXUD1230L	281	Folio Upper Storage Cabinet
HXUD1230R	281	Folio Upper Storage Cabinet
HXUD1235LS	283	Folio Upper Storage Cabinet
HXUD1235RS	283	Folio Upper Storage Cabinet
HXUD1824L	281	Folio Upper Storage Cabinet
HXUD1824R	281	Folio Upper Storage Cabinet
HXUD1829LS	283	Folio Upper Storage Cabinet
HXUD1829RS	283	Folio Upper Storage Cabinet
HXUD1830L	281	Folio Upper Storage Cabinet
HXUD1830R	281	Folio Upper Storage Cabinet
HXUD1835LS	283	Folio Upper Storage Cabinet
HXUD1835RS	283	Folio Upper Storage Cabinet
HXUD2124L	281	Folio Upper Storage Cabinet
HXUD2124R	281	Folio Upper Storage Cabinet
HXUD2129LS	283	Folio Upper Storage Cabinet
HXUD2129RS	283	Folio Upper Storage Cabinet
HXUD2130L	281	Folio Upper Storage Cabinet
HXUD2130R	281	Folio Upper Storage Cabinet
HXUD2135LS	283	Folio Upper Storage Cabinet
HXUD2135RS	283	Folio Upper Storage Cabinet
HXUD2424	281	Folio Upper Storage Cabinet
HXUD2429S	283	Folio Upper Storage Cabinet
HXUD2430	281	Folio Upper Storage Cabinet
HXUD2435S	283	Folio Upper Storage Cabinet
HXUD3024	281	Folio Upper Storage Cabinet
HXUD3029S	283	Folio Upper Storage Cabinet
HXUD3030	281	Folio Upper Storage Cabinet
HXUD3035S	283	Folio Upper Storage Cabinet
HXUD3624	281	Folio Upper Storage Cabinet
HXUD3629S	283	Folio Upper Storage Cabinet
HXUD3630	281	Folio Upper Storage Cabinet

Style Number	Page	Description	Style Number	Page	Description
HXUD3635S	283	Folio Upper Storage Cabinet	HXW2724L	284	Folio Worksurface
HXUDP2430	281	Folio Upper Storage Cabinet	HXW2724S	286	Folio Worksurface
HXUDP2435S	283	Folio Upper Storage Cabinet	HXW3024L	284	Folio Worksurface
HXUDP3030	281	Folio Upper Storage Cabinet	HXW3024S	286	Folio Worksurface
HXUDP3035S	283	Folio Upper Storage Cabinet	HXW3324L	284	Folio Worksurface
HXUDP3630	281	Folio Upper Storage Cabinet	HXW3324S	286	Folio Worksurface
HXUDP3635S	283	Folio Upper Storage Cabinet	HXW3618L	318	Folio Laminate Wall-Mounted Wrfs
HXUP1224	280	Folio Upper Storage Cabinet	HXW3618S	320	Folio Wall-Mounted Solid Surface Wrfs
HXUP1229S	282	Folio Upper Storage Cabinet	HXW3624L	284	Folio Worksurface
HXUP1230	280	Folio Upper Storage Cabinet	HXW3624S	286	Folio Worksurface
HXUP1235S	282	Folio Upper Storage Cabinet	HXW3924L	284	Folio Worksurface
HXUP1824	280	Folio Upper Storage Cabinet	HXW3924S	286	Folio Worksurface
HXUP1829S	282	Folio Upper Storage Cabinet	HXW4218L	318	Folio Laminate Wall-Mounted Wrfs
HXUP1830	280	Folio Upper Storage Cabinet	HXW4218S	320	Folio Wall-Mounted Solid Surface Wrfs
HXUP1835S	282	Folio Upper Storage Cabinet	HXW4224L	284	Folio Worksurface
HXUP2124	280	Folio Upper Storage Cabinet	HXW4224S	286	Folio Worksurface
HXUP2129S	282	Folio Upper Storage Cabinet	HXW4524L	284	Folio Worksurface
HXUP2130	280	Folio Upper Storage Cabinet	HXW4524S	286	Folio Worksurface
HXUP2135S	282	Folio Upper Storage Cabinet	HXW4818L	318	Folio Laminate Wall-Mounted Wrfs
HXUP2424	280	Folio Upper Storage Cabinet	HXW4818S	320	Folio Wall-Mounted Solid Surface Wrfs
HXUP2429S	282	Folio Upper Storage Cabinet	HXW4824L	284	Folio Worksurface
HXUP2430	280	Folio Upper Storage Cabinet	HXW4824S	286	Folio Worksurface
HXUP2435S	282	Folio Upper Storage Cabinet	HXW5124L	284	Folio Worksurface
HXUP3024	280	Folio Upper Storage Cabinet	HXW5124S	286	Folio Worksurface
HXUP3029S	282	Folio Upper Storage Cabinet	HXW5424L	284	Folio Worksurface
HXUP3030	280	Folio Upper Storage Cabinet	HXW5424S	286	Folio Worksurface
HXUP3035S	282	Folio Upper Storage Cabinet	HXW6018L	318	Folio Laminate Wall-Mounted Wrfs
HXUP3624	280	Folio Upper Storage Cabinet	HXW6018S	320	Folio Wall-Mounted Solid Surface Wrfs
HXUP3629S	282	Folio Upper Storage Cabinet	HXW6024L	284	Folio Worksurface
HXUP3630	280	Folio Upper Storage Cabinet	HXW6024S	286	Folio Worksurface
HXUP3635S	282	Folio Upper Storage Cabinet	HXW6624L	284	Folio Worksurface
HXUS1214	290	Folio Storage Shelf	HXW6624S	286	Folio Worksurface
HXUS1814	290	Folio Storage Shelf	HXW7218L	318	Folio Laminate Wall-Mounted Wrfs
HXUS2114	290	Folio Storage Shelf	HXW7218S	320	Folio Wall-Mounted Solid Surface Wrfs
HXUS2414	290	Folio Storage Shelf	HXW7224L	284	Folio Worksurface
HXUS3014	290	Folio Storage Shelf	HXW7224S	286	Folio Worksurface
HXUS3614	290	Folio Storage Shelf	HXW7824L	284	Folio Worksurface
HXW10224L	284	Folio Worksurface	HXW7824S	286	Folio Worksurface
HXW10224S	286	Folio Worksurface	HXW8424L	284	Folio Worksurface
HXW10824L	284	Folio Worksurface	HXW8424S	286	Folio Worksurface
HXW10824S	286	Folio Worksurface	HXW9024L	284	Folio Worksurface
HXW11424L	284	Folio Worksurface	HXW9024S	286	Folio Worksurface
HXW11424S	286	Folio Worksurface	HXW9624L	284	Folio Worksurface
HXW12024L	284	Folio Worksurface	HXW9624S	286	Folio Worksurface
HXW12024S	286	Folio Worksurface	HXWS416L	319	Folio 4"H Lam. Wall-Mounted Sidesplash
HXW1224L	284	Folio Worksurface	HXWS418L	319	Folio 4"H Lam. Wall-Mounted Sidesplash
HXW1224S	286	Folio Worksurface	HXWS421L	285	Folio Worksurface
HXW1818L	318	Folio Laminate Wall-Mounted Wrfs	HXWS421LS	287	Folio Sidesplash
HXW1824L	284	Folio Worksurface	HXWS421RS	287	Folio Sidesplash
HXW1824S	286	Folio Worksurface	HXWS424L	285	Folio Worksurface
HXW2124L	284	Folio Worksurface	HXWS424LS	287	Folio Sideplash
HXW2124S	286	Folio Worksurface	HXWS424RS	287	Folio Sideplash
HXW2418L	318	Folio Laminate Wall-Mounted Wrfs	LOCKFR	399	Lock Cylinder
HXW2418S	320	Folio Wall-Mounted Solid Surface Wrfs	LOCKXF	399	Lock Cylinder
HXW2424L	284	Folio Worksurface			
HXW2424S	286	Folio Worksurface			

Trademark List

™/® The following is a non-exhaustive list of trademarks and registered trademarks for products of Steelcase Inc. or one of its related corporate entities: Agree, Airtouch, Aisla, Alight, Amia, Answer, Apprise, Aspekt, Avenir, Await, B-Free, Ballet, Bassline, Bindu, Bivi, Bix, Bottomline, Brody, Buoy, Cachet, Campfire, Capa, CF Series, CG_1, Chord, Circa, Clipper, Cobi, Collaboration, Convene, Coupe, Cura, Currency, dash, Divisio, Duo, E-Table 2, Edge Series, Elbrook, Elective Elements, Embold, Empath, Everwall, Exponents, Folio, FrameOne, Gesture, Groupwork, Host, Hosu, i2i, Jenny, Kart, Kathryn, Kick, Lagunitas, Leap, Leela, LessThanFive, LiveBack, LiveSeat, Mackinac, Marien152, Max-Stacker, media:scape, Migration, Millbrae, Mineral, Mitra, Montage, Montara650, MoreThanFive, Move, Node, Ocular, Ology, Opus, Paperflo, Passerelle, Player, Pocket, Potrero415, QiVi, Radia, Regard, Relay, Reply, Ripple, Roam, Sarto, Scoop, Sebastopol, Senti Series, Senza, Shortcut, Sidewalk, Siento, Sieste, SILQ, Soffio, Sorrel, SOTO, Steelcase Eclipse, Steelcase Flex, Steelcase Karman, Steelcase Relay, Steelcase Rise, Steelcase Series, Surround, SW_1, Switch, Sync, Tava, Tenor, Think, Thoughtful, Thread, Together, Train, Trees, Turnstone, Umami, Underscore, V.I.A., Verb, Verge, Verlay, Victor2, Visalia, WorkValet, and X-tenz.

™/® The following are trademarks or registered trademarks of AMQ Solutions, LLC: 3F, Activ, Amobi, Bixby, Bodi, Cluvo, Concur, Embank, FL-X, Iline, Jaku, Kinex, Personality Plus, Revi, S-Series, Siya, Tektis, Tizu, Uptake, and Zilo.

™/® The following are trademarks or registered trademarks of Orangebox Ltd., Cardiff, UK: Air3, Aspect, Avi, Away from the Desk, Border, Campers & Dens, Coppice, Cubb, Kirm, On the QT, Ramsey, Skomer, Sully, Track-B, and Vale.

™/® The following are trademarks or registered trademarks of Viccarbe Habitat, S.L.: Aleta, Cambio, Designed in The Sun, Foro, Funda, Holy Day, Kelly, Last Minute, Noha, Savina, Sistema, Sistema, Viable, and Wrapp.

® The following are registered brands of Steelcase Inc. and its family of companies: Steelcase, AMQ, Coalesse, Designtex, Halcon, Orangebox, Smith System, and Viccarbe.

® The following registered trademarks are under license from AWI Licensing Company, Dover, DE: SoundScapes, DuraBrite, BioBlock, and Armstrong.

® The following registered trademarks are under license from Byrne Electrical, Rockford, MI: Interport, Mini-Port, Axil Z, and Ellora.

® The following is a registered trademark of DuPont, Wilmington, DE: Corian.

® The following is a registered trademark of Genlyte Thomas Company, Louisville, KY: Lightolier.

® The following is a registered trademark of Hilti Corporation, FL-9494 Schaan, Principality of Liechtenstein: Hilti.

® The following is a registered trademark of Leviton Manufacturing Company, Little Neck, NY: Decora.

® The following is a registered trademark of Mechanical Plastics Corp, Elmsford, NY: Toggler.

® The following is a registered trademark of Microsoft Corporation, Redmond, WA: Microsoft.

® The following are registered trademarks of Orangebox Ltd., Cardiff, UK: Orangebox.

® The following is a registered trademark of Panduit Corporation, Lockport, IL: Panduit.

® The following is a registered trademark of Trav (Press), Cuneo, Italy: Assisa.

® The following is a registered trademark of Virtual Ink, Boston, MA: mimioActive.

® The following registered trademarks are under license from Wilkhahn Furniture Products: Avera, Senzo, Versal, and Wilkhahn FS.

® The following are registered trademarks of Polyvision Corp: Flow, Motif, Polyvision, Sans, and Serif.

® The following is a registered trademark of Wilsonart International, Temple, TX: Chemsurf.

® The following is a registered trademark of Wiremold, West Hartford, CT: Wiremold.

® The following is a registered trademark of EMU Group S.P.A., Perugia, Italy: EMU.

® The following is a registered trademark of Security People, Inc.: Digilock.

® The following are registered trademarks of Natural Capital Partners Europe Limited: CarbonNeutral and the CarbonNeutral Certified logo.

™ The following is a trademark of Microsoft Corporation, Redmond, WA: Windows.

™ The following is a trademark of Rodman Industries, Inc., Oconomowoc, WI: ResinCore1.

™ The following is a trademark of Ultrafabrics, LLC, Elmsford, NY: Ultraleather.

™ The following trademarks are under license from Wilkhahn Furniture products: Cana, Linus, Logon, Picto, Range, Stitz, Thema, Timetable, and Tubis.

™ The following trademarks are under license from Walter Knoll: Andoo, Bob, Lazlo, Lox, Ribbon, and Together.

™ The following trademarks are under license from PP Mobler: Bar and Flag Halyard.

™ The following trademarks are under license from Carl Hansen: Elbow, Paddle, Shell, Wing, and Wishbone.

™ The following trademarks are under license from Cambridge Sound Management, LLC Cambridge, MA: QtPro Soundmasking, Qt Quiet Technology, and Sonet Qt.

™ The following is a trademark of Electri-Cable Assemblies, Shelton, CT: Interact.

™ The following is a trademark of Clestra Hauserman: IRYS.

™ The following is a trademark of Wiesner-Hager Möbel GmbH: Nooi.

™ The following are trademarks of Polyvision: Accord, a3, e3, Boundri, and Nota.

™ The following is a trademark of Bostock Company, Inc: SnapCab.

™ The following is a trademark of Williams-Sonoma, Inc: West Elm.

™ The following is a trademark of Elena Marquina Testor: nanimarquina.

™ The following is a trademark of Forbo International SA: Forbo.

Trademarks used herein are the property of Steelcase Inc. or their respective owners.