



Orangebox Specification Guide

Availability

Electronic price list updated with release 204.C (U.S.) and 158.C (Canada), dated June 15, 2026.

All specifications subject to change without notice. Reference the electronic catalog/Hedberg for current pricing.

Transitional products in this specification guide are **maintained for existing customers only** and are likely to be phased out over time. These products are indicated with a . Products that are scheduled to be culled are indicated with an , followed by the last order entry date.

Surface Materials

The surface materials team has announced the launch of the Finish Library, found at www.steelcase.com/finishlibrary/.

► For a list of all trademarks, refer to the last page of this specification guide. © 2026 Steelcase Inc.

Working with This Specification Guide

Ten Tips: How to Get The Most Out of This Book	2
Additional Resources	4

Statement of Line

5

Product Details

Air ³	16
Campers & Dens	20
On the QT	36
Aspect	40
Sully, Ramsey, and Skomer	42
Border	44
Away from the Desk	46
Cubb Seating and Tables	50

Specifying

55

Style Number Index

286



For Canadian Pricing

Canadian factor can be found at www.steelcase.com/CADpricing/. Calculate in the following order to avoid rounding errors:

- Multiply the base price and each option by the Canadian factor.
- Round each to the nearest dollar.
- Add base and options for total list price.

Ten Tips: How to Get the Most Out of This Book

Tip 1

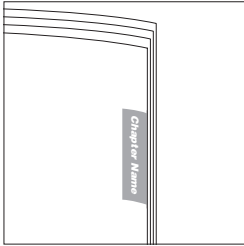

Watch the tabs on the right-hand edges of the pages. They'll always indicate which chapter you are in.

Tip 2

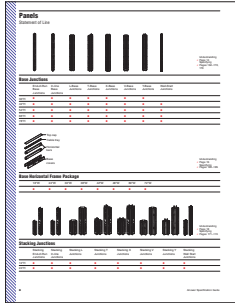

Use the Statement of Line pages for an overview of the available components, their sizes, and page references for additional information. Each *Understanding* chapter includes a statement of line after the table of contents.

Tip 3



Find cross references by looking for page numbers flagged with an arrow.

Tip 4

Study the product detail pages in the *Understanding* section to learn everything an expert knows about specific products. Each product detail page in this section contains the following features, where applicable:

- Product Drawing
- Actual Dimensions
- Product Details
- Connections
- Wiring and Cabling
- Surface Materials
- Application Topics

Product Drawing shows you what the product looks like and points out important features.

Product Details gives specific information on the product and how it is used.

Connections describes how the product is assembled or how it attaches to another product.

Actual Dimensions table lists the dimensions of the product.

Wiring and Cabling details the power and cable-management and cable routing capabilities of the product.

Surface Materials lists what material is used for each part of the product.

Tip 5

Refer to the specifying pages for all the information needed to order a product. Each product specifying page contains a variety of elements to help you complete a specification:

- Product Drawing
- Standard Includes
- Options
- Specification Information
- Dimensions
- Style Number
- Price

Product Drawing shows you what the product looks like.

Standard Includes (under the red or dark grey band) provides a list of what comes standard with the product.

Specification Information (under the teal or light grey band) provides product dimensions, style numbers, and prices for the standard product and any surface material choices that are available.

Base Horizontal Frame Packages—Thin Trim
Full Panel Buildups

Standard Includes	Options	U.S. Price	Required to Specify
<ul style="list-style-type: none"> Standard 3/4" x 3/4" x 1/4" aluminum extrusion Base trim with no backstops on 1/2" x 1/2" panel price Base trim with backstops (2" x 1/2" panel price) Standard 1/2" x 1/2" x 1/4" aluminum extrusion 	<ul style="list-style-type: none"> Panel price group 1 Panel price group 2 Panel price group 3 	<ul style="list-style-type: none"> 1511 1512 1513 	<ul style="list-style-type: none"> Specify panel size Specify panel depth Specify panel width Specify panel height Specify panel material

Options

- Panel price group 1
- Panel price group 2
- Panel price group 3

Standard Includes

- Standard 3/4" x 3/4" x 1/4" aluminum extrusion
- Base trim with no backstops on 1/2" x 1/2" panel price
- Base trim with backstops (2" x 1/2" panel price)
- Standard 1/2" x 1/2" x 1/4" aluminum extrusion

Options

- Panel price group 1
- Panel price group 2
- Panel price group 3

Standard Includes

- Standard 3/4" x 3/4" x 1/4" aluminum extrusion
- Base trim with no backstops on 1/2" x 1/2" panel price
- Base trim with backstops (2" x 1/2" panel price)
- Standard 1/2" x 1/2" x 1/4" aluminum extrusion

Options

- Panel price group 1
- Panel price group 2
- Panel price group 3

Panel—Thin Trim
Base Horizontal Frame Packages—Thin Trim

Style Number	Price
1511	1511
1512	1512
1513	1513

Options

- Panel price group 1
- Panel price group 2
- Panel price group 3

Standard Includes

- Standard 3/4" x 3/4" x 1/4" aluminum extrusion
- Base trim with no backstops on 1/2" x 1/2" panel price
- Base trim with backstops (2" x 1/2" panel price)
- Standard 1/2" x 1/2" x 1/4" aluminum extrusion

Options

- Panel price group 1
- Panel price group 2
- Panel price group 3

Options (under the black band) lists all the options that apply to the product, their price, and what is required to specify.

Tip 6

Required to Specify

Specify with Customiz Stain

Italic typeface on specifying pages usually identifies wording that you should use in your order.

i

Tip 7

To determine how many skins are needed to complete a panel, consult the table at the right.
Tip: Remember to order skins for both sides of the panel buildup.

Watch for tips throughout the text that give you explanations and helpful instructions.

Tip 8

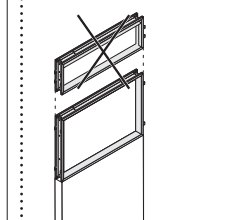

Learn what you cannot do by looking for drawings crossed out with an "X".

Tip 9

Style Number	Page
TS7042BL	131
TS7042S	130
TS7048BL	131
TS7048S	130
TS7060BL	131
TS7060S	130
TS7072BL	131

Refer to the style number index when you know a style number and you need to find the page that has more details about the product.

Additional Resources

Orangebox products are supported with informational materials, tools, and software to help you plan, specify, and order an installation efficiently.

Printed Materials

Other Specification Guides

Steelcase offers a comprehensive portfolio of furniture and solutions. For the full offering of products, refer to the individual product specification guides. These can be accessed at the www.steelcase.com web site or at village.steelcase.com

Computer Tools

Electronic Catalog

Accurate sales quotations and purchase orders for Steelcase products are created with specification software that uses Steelcase Electronic Catalog data. Use the data to specify and price style numbers and options for every Steelcase product. The data is updated bimonthly by Steelcase and provided to software programs including: the Hedberg Business System, SmartTools—Steelcase's design and specification software (for more information on SmartTools, please email SmartTools@steelcase.com), the ProjectMatrix Project Symbols libraries, as well as 20-20 CAP Studio.

Furniture Symbol Graphic Data

Steelcase creates 2D and 3D furniture symbols (with attributes) for planning and initially specifying Steelcase products. This data is incorporated into several add-on software packages that work in either a Microstation or an AutoCAD drafting environment.

Digital Publications

You can access these digital publications at www.steelcase.com or village.steelcase.com.

Support

Steelcase Capabilities

Steelcase products are distributed, installed, and serviced through a network of more than 600 dealers worldwide. Steelcase is also represented with offices and corporate showrooms in 26 U.S. cities, 4 Canadian cities, and in France, Germany, Great Britain, and Japan. Every Steelcase product meets our exceptionally high standards of quality and durability and comes with the Steelcase assurance of excellence in service.

For ordering or product assistance,

please call your local dealer, the Steelcase Solutions Resource Team, or the Steelcase Solutions Fulfillment Team at 1.888.STEELCASE (1.888.783.3522) or send an e-mail to lineone@steelcase.com.

Call the Steelcase Solutions Resource Team prior to placing an order, when working on a bid, or when you need information about product applications and specifications.

Call the Steelcase Solutions Fulfillment Team if you have submitted an order to Steelcase and you need to speak to your Solutions Fulfillment Team Representative about the order. Also call if you have any post-shipment quality concerns or service parts questions.

For warranty information, please go to: <http://www.steelcase.com/warranty/>.

Outside the U.S.A., Canada, Mexico, Puerto Rico, and the U.S. Virgin Islands, call 1.616.247.2500.

For information about Steelcase, the name of your nearest Steelcase dealer, or for product literature, call 1.800.333.9939 or visit our Web site: www.steelcase.com.

Air³

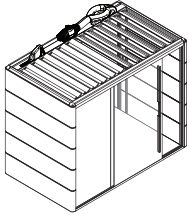

Half Square with Opening Roof

Understanding
 ▶ Page 16
 Specifying
 ▶ Page 56

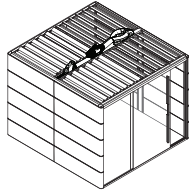

Square with Opening Roof

Understanding
 ▶ Page 16
 Specifying
 ▶ Page 58

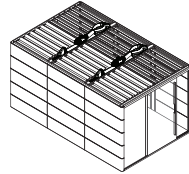

Rectangle with Opening Roof

Understanding
 ▶ Page 16
 Specifying
 ▶ Page 60

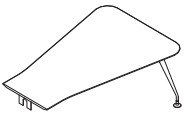

Small Pod Table

Understanding
 ▶ Page 16
 Specifying
 ▶ Page 62

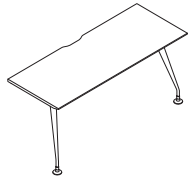

Short, Straight Pod Table

Understanding
 ▶ Page 16
 Specifying
 ▶ Page 63

Campers & Dens

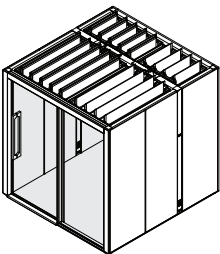

CD02 Glass Front and Rear, Left Hand Door

Understanding
 ▶ Page 20
 Specifying
 ▶ Page 66

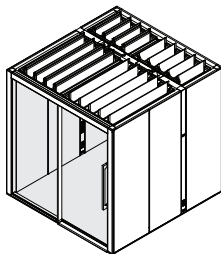

CD02 Glass Front and Rear, Right Hand Door

Understanding
 ▶ Page 20
 Specifying
 ▶ Page 66

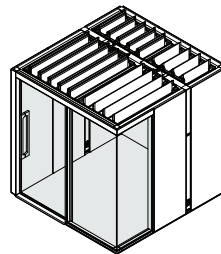

CD02 Corner Glass Front, Left Hand Door

Understanding
 ▶ Page 20
 Specifying
 ▶ Page 78

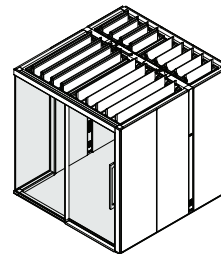

CD02 Corner Glass Front, Right Hand Door

Understanding
 ▶ Page 20
 Specifying
 ▶ Page 94

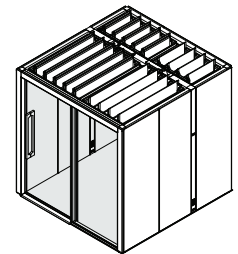

CD02 Glass Front, Left Hand Door

Understanding
 ▶ Page 20
 Specifying
 ▶ Page 110

Campers & Dens, continued

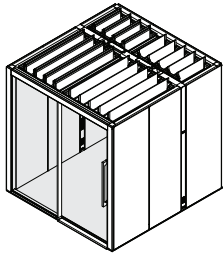

CD02 Glass Front, Right Hand Door
 Understanding
 ▶ Page 20
 Specifying
 ▶ Page 110

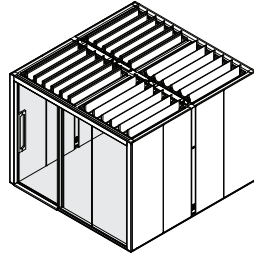

CD05 Glass Front and Rear, Left Hand Door
 Understanding
 ▶ Page 20
 Specifying
 ▶ Page 72

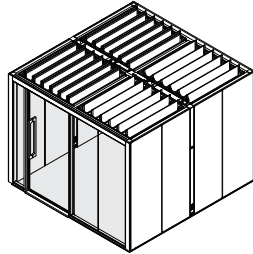

CD05 Glass Front and Rear (with Infill), Left Hand Door
 Understanding
 ▶ Page 20
 Specifying
 ▶ Page 72

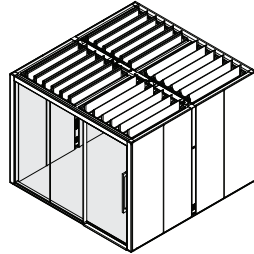

CD05 Glass Front and Rear, Right Hand Door
 Understanding
 ▶ Page 20
 Specifying
 ▶ Page 72

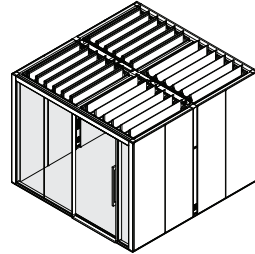

CD05 Glass Front and Rear (with Infill), Right Hand Door
 Understanding
 ▶ Page 20
 Specifying
 ▶ Page 72

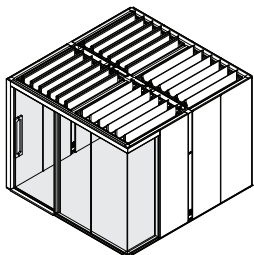

CD05 Corner Glass Front, Left Hand Door
 Understanding
 ▶ Page 20
 Specifying
 ▶ Page 86

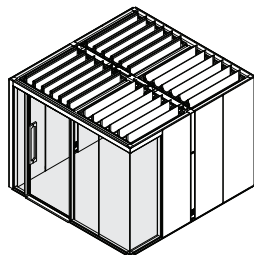

CD05 Corner Glass Front (with Infill), Left Hand Door
 Understanding
 ▶ Page 20
 Specifying
 ▶ Page 86

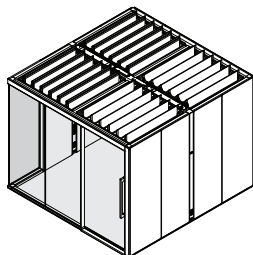

CD05 Corner Glass Front, Right Hand Door
 Understanding
 ▶ Page 20
 Specifying
 ▶ Page 102

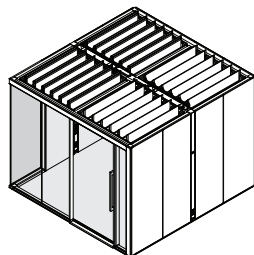

CD05 Corner Glass Front (with Infill), Right Hand Door
 Understanding
 ▶ Page 20
 Specifying
 ▶ Page 102

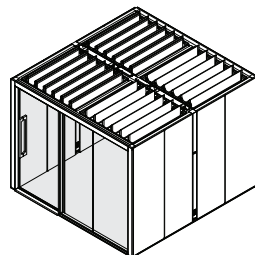

CD05 Glass Front, Left Hand Door
 Understanding
 ▶ Page 20
 Specifying
 ▶ Page 118

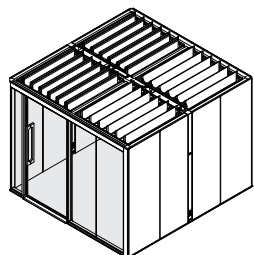

CD05 Glass Front (with Infill), Left Hand Door
 Understanding
 ▶ Page 20
 Specifying
 ▶ Page 118

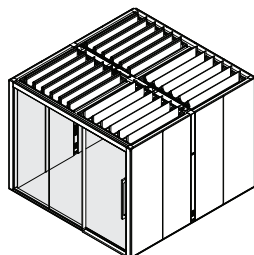

CD05 Glass Front, Right Hand Door
 Understanding
 ▶ Page 20
 Specifying
 ▶ Page 118

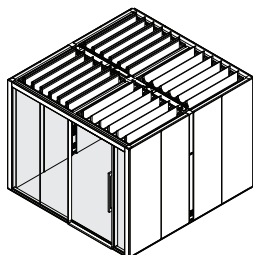

CD05 Glass Front (with Infill), Right Hand Door
 Understanding
 ▶ Page 20
 Specifying
 ▶ Page 118

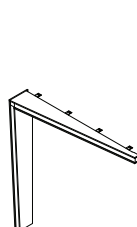

88" Kink, Left
 Understanding
 ▶ Page 26
 Specifying
 ▶ Page 126

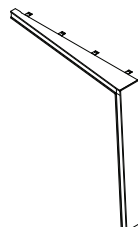

88" Kink, Right
 Understanding
 ▶ Page 26
 Specifying
 ▶ Page 126

Campers & Dens, continued

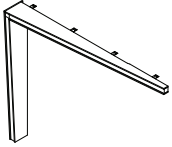
**115" Kink, Left**

Understanding
 ▶ Page 26
 Specifying
 ▶ Page 128

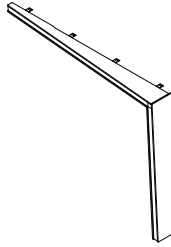
**115" Kink, Right**

Understanding
 ▶ Page 26
 Specifying
 ▶ Page 128

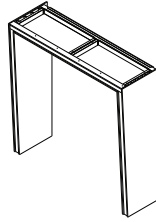
**88" Cabin**

Understanding
 ▶ Page 27
 Specifying
 ▶ Page 130

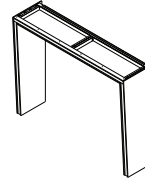
**115" Cabin**

Understanding
 ▶ Page 27
 Specifying
 ▶ Page 131

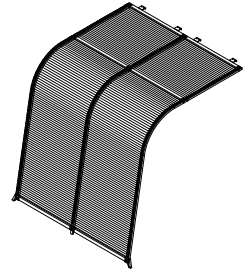
**88" Awning**

Understanding
 ▶ Page 28
 Specifying
 ▶ Page 132

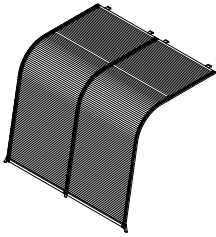
**115" Awning**

Understanding
 ▶ Page 28
 Specifying
 ▶ Page 132

**92" Up to Corner, Wood Slat**

Understanding
 ▶ Page 29
 Specifying
 ▶ Page 134

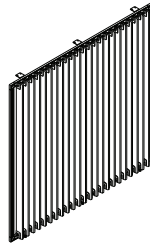
**92" Full Depth, Wood Slat**

Understanding
 ▶ Page 29
 Specifying
 ▶ Page 134

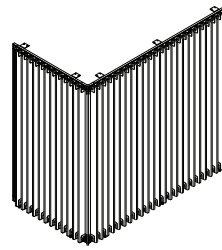
**92" Around Corner, Wood Slat**

Understanding
 ▶ Page 29
 Specifying
 ▶ Page 135

**119" Up to The Corner, Wood Slat**

Understanding
 ▶ Page 29
 Specifying
 ▶ Page 135

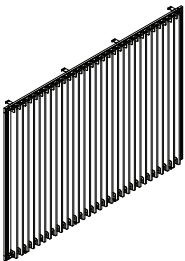
**119" Full Depth, Wood Slat**

Understanding
 ▶ Page 29
 Specifying
 ▶ Page 136

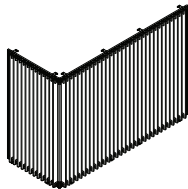
**119" Around Corner, Wood Slat**

Understanding
 ▶ Page 29
 Specifying
 ▶ Page 136

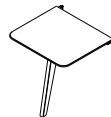
**Wall Mounted Table, Small**

Understanding
 ▶ Page 30
 Specifying
 ▶ Page 137

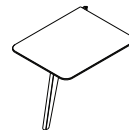
**Wall Mounted Table, Medium**

Understanding
 ▶ Page 30
 Specifying
 ▶ Page 137

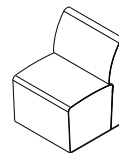
**Upholstered Seat, Single**

Understanding
 ▶ Page 31
 Specifying
 ▶ Page 140

Campers & Dens, continued

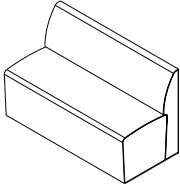

Upholstered Seat, Double

Understanding
▶ Page 31
Specifying
▶ Page 141

On the QT

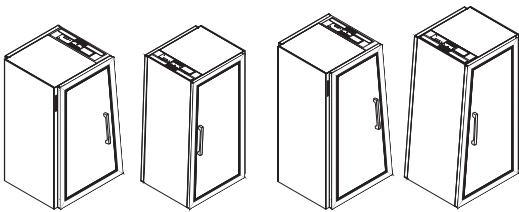

Short Angled Phone Booth, LH or RH Hinge

Understanding
▶ Page 36
Specifying
▶ Page 142

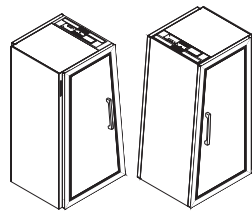

Tall Angled Phone Booth, LH or RH Hinge

Understanding
▶ Page 36
Specifying
▶ Page 146

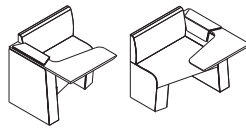

Furniture Seat, LH or RH Application

Understanding
▶ Page 36
Specifying
▶ Page 150

Aspect



One Seat Work Unit with Curved Arm

Understanding
▶ Page 40
Specifying
▶ Page 152

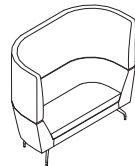

Two Seat Work Unit with Curved Arm

Understanding
▶ Page 40
Specifying
▶ Page 154

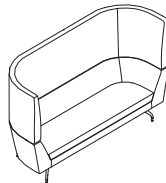

Three Seat Work Unit with Curved Arm

Understanding
▶ Page 40
Specifying
▶ Page 156

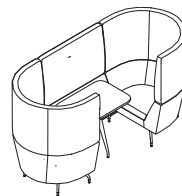

Two Seat Work Screened Unit with Fixed Table

Understanding
▶ Page 40
Specifying
▶ Page 158

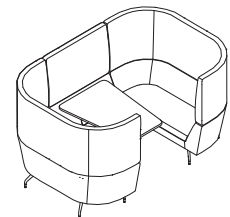

Four Seat Work Screened Unit with Fixed Table

Understanding
▶ Page 40
Specifying
▶ Page 162

Aspect, continued

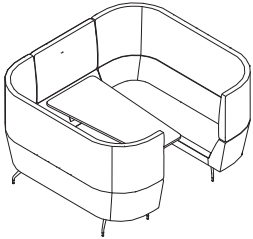

Six Seat Work Screened Unit with Fixed Table

Understanding

- ▶ Page 40
- Specifying
- ▶ Page 166

Sully, Skomer, and Ramsey

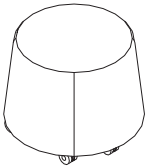

Upholstered Stool

Understanding

- ▶ Page 42
- Specifying
- ▶ Page 170

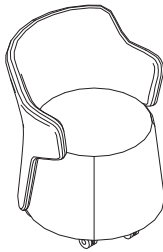

Upholstered Arm Chair

Understanding

- ▶ Page 42
- Specifying
- ▶ Page 172

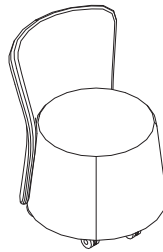

Upholstered Work Chair

Understanding

- ▶ Page 42
- Specifying
- ▶ Page 174

Border

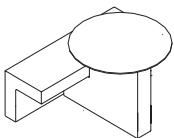

One Seat, Low, with Table

Understanding

- ▶ Page 44
- Specifying
- ▶ Page 176

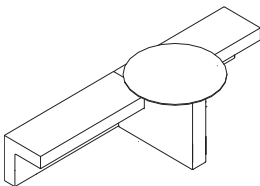

Two Seat Low, with Table

Understanding

- ▶ Page 44
- Specifying
- ▶ Page 178

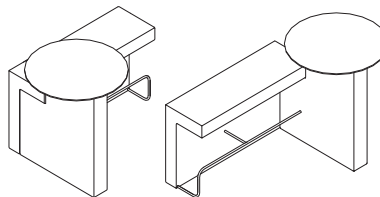

One Seat High, with Left or Right Hand Table

Understanding

- ▶ Page 44
- Specifying
- ▶ Page 180

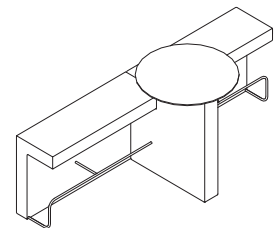

Two Seat, High, with Table

Understanding

- ▶ Page 44
- Specifying
- ▶ Page 182

Away from the Desk

Seating

Understanding
▶ Page 46
Specifying
▶ Pages 184–232

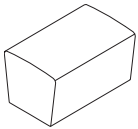

**31 1/2" W Modular
Straight Seat**

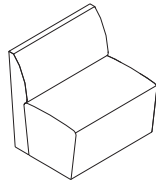

**31 1/2" W Modular
Straight Seat with
Back**

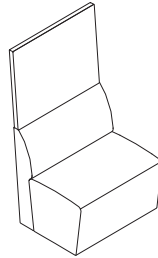

**31 1/2" W Modular
Straight Seat with
Back and Screen**

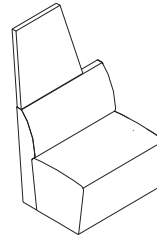

**31 1/2" W Modular
Straight Seat with
Back and Left Hand
Tapered Screen**

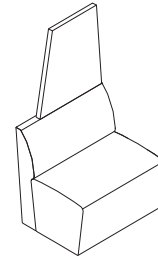

**31 1/2" W Modular
Straight Seat with
Back and Right Hand
Tapered Screen**

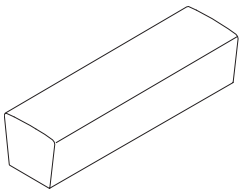

**70 7/8" W Modular
Straight Seat**

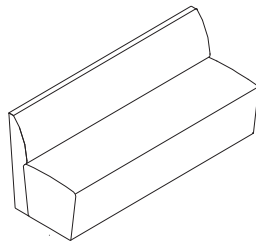

**70 7/8" W Modular
Straight Seat with
Back**

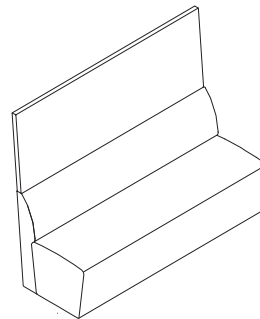

**70 7/8" W Modular
Straight Seat with
Back and Screen**

Away from the Desk, continued

Seating

Understanding
▶ Page 46
Specifying
▶ Pages 184–232

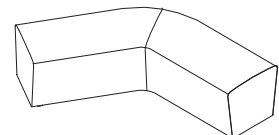

120° Modular Seat

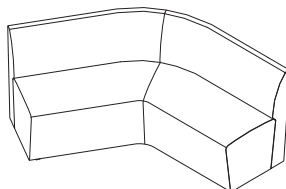

120° Modular Seat with External Back

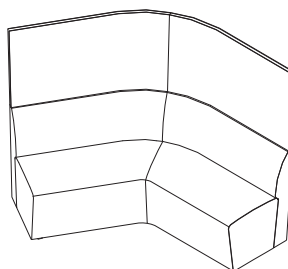

120° Modular Seat with External Back and Screen

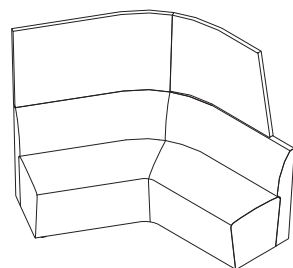

120° Modular Seat with External Back and Left Hand Tapered Screen

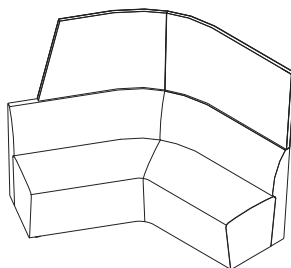

120° Modular Seat with External Back and Right Hand Tapered Screen

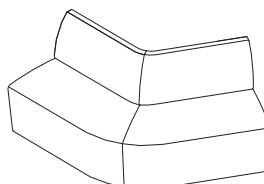

120° Modular Seat with Internal Back

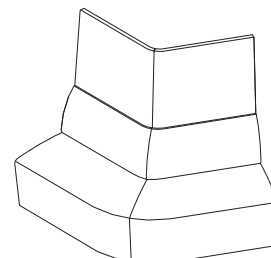

120° Modular Seat with Internal Back and Screen

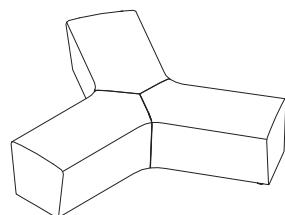

120° Modular Tri-Seat

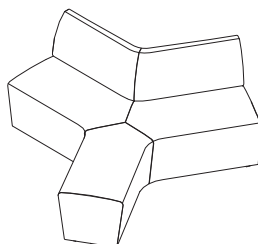

120° Modular Tri-Seat with Internal Back

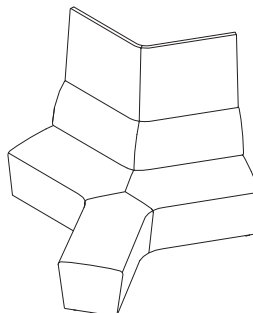

120° Modular Tri-Seat with Internal Back and Screen

Away from the Desk, continued

Seating

Understanding
▶ Page 46
Specifying
▶ Pages 184–232

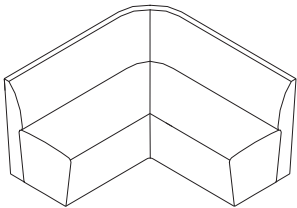

90° Modular Seat with Back

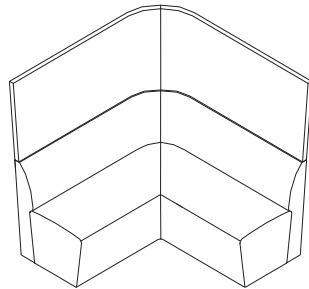

90° Modular Seat with Back and Screen

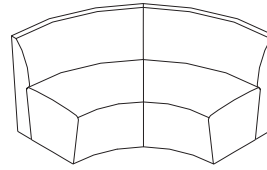

90° Modular Curved Seat with Back

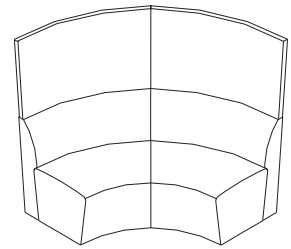

90° Modular Curved Seat with Back and Screen

Away from the Desk

Tables

Understanding
▶ Page 46
Specifying
▶ Pages 234–237

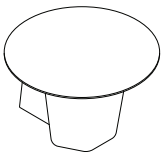

Modular Small Round Top with Large Upholstered Tapered Base

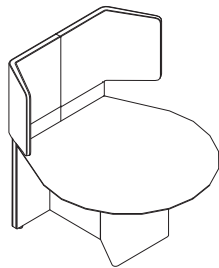

Media Unit with Low, D Shaped Top

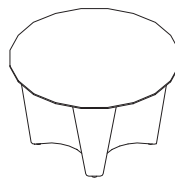

47¹/₄ Dia. Huddle Buddy Group Working Table

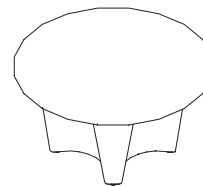

55¹/₈ Dia. Huddle Buddy Group Working Table

Away from the Desk

Detached Seating

Understanding
▶ Page 46
Specifying
▶ Pages 238–246

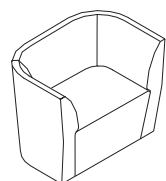

Single Seat Detached Unit

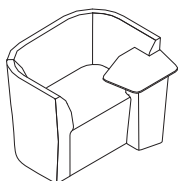

Single Seat Detached Unit with Left Hand Integrated Tablet

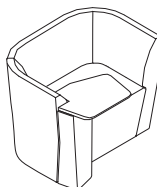

Single Seat Detached Unit with Right Hand Integrated Tablet

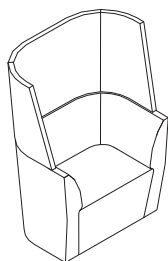

Single Seat Detached Unit with Screen

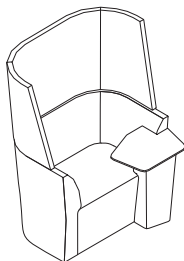

Single Seat Detached Unit with Screen and Left Hand Integrated Tablet

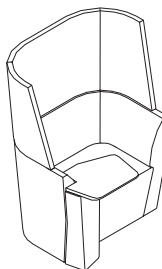

Single Seat Detached Unit with Screen and Right Hand Integrated Tablet

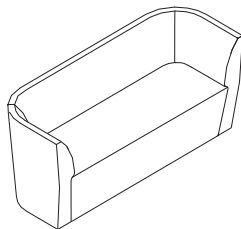

Three Seat Detached Unit

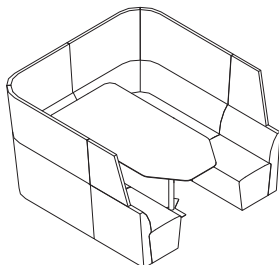

Enclosed Media Den

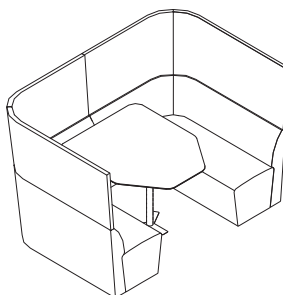

Enclosed Media Den for Four to Six People

Cubb Seating

Understanding
▶ Page 50
Specifying
▶ Pages 248–263



Armless Chair with Wood Legs



Upholstered Arm Chair with Wood Legs



Wire Arm Chair with Wood Legs



Armless Chair on 4-Star Trestle Base



Upholstered Arm Chair on 4-Star Trestle Base



Wire Arm Chair on 4-Star Trestle Base



Armless Chair with Wire Frame Base

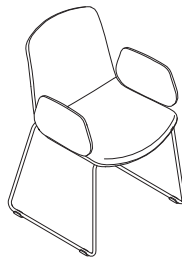

Upholstered Arm Chair with Wire Frame Base

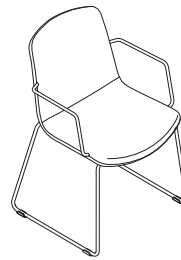

Wire Arm Chair with Wire Frame Base



Armless Chair on 5-Star Base



Upholstered Arm Chair on 5-Star Base

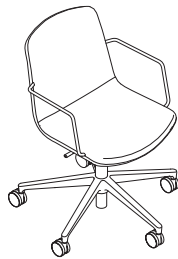

Wire Arm Chair on 5-Star Base

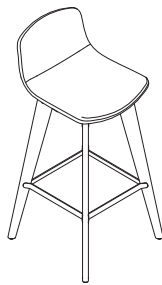

Barstool with Oak Base

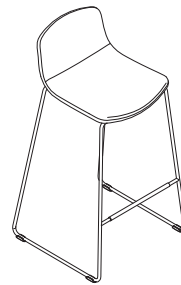

Barstool with Wire Frame Base



Occasional Stool with Oak Base

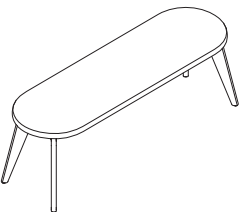

Two Seat Bench

Cubb Tables

Understanding
 ▶ Page 52
 Specifying
 ▶ Pages 264–284



Four Person Round Meeting Table



Six Person Round Meeting Table

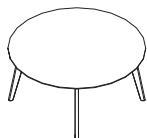

Seven Person Round Meeting Table

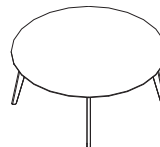

Eight Person Round Meeting Table

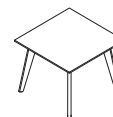

Four Person Square Meeting Table



Four Person Square Meeting Table with Softened Corners

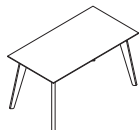

Four Person Rectangle Meeting Table

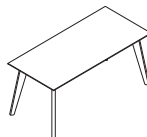

Four to Six Person Rectangle Meeting Table

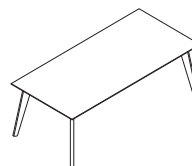

Six to Eight Person Rectangle Meeting Table

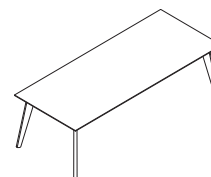

Eight Person Rectangle Meeting Table

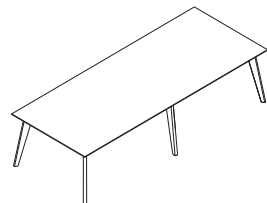

47"D Eight to Ten Person Rectangle Meeting Table

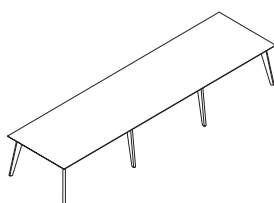

47"D 12-14 Person Rectangle Meeting Table

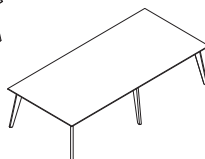

55"D Eight to Ten Person Rectangle Meeting Table

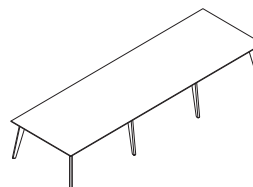

55"D 12-14 Person Rectangle Meeting Table

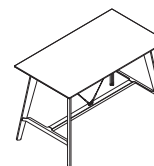

Four to Six Person Standing Height Project Table

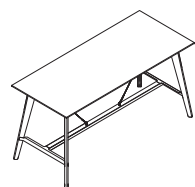

Six to Eight Person Standing Height Project Table

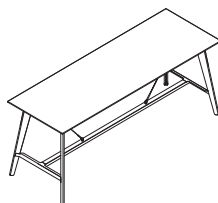

Eight to Ten Person Standing Height Project Table



23 5/8"W Round Occasional Table



31"W Round Occasional Table

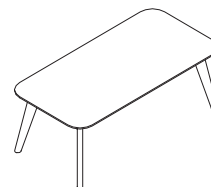

Rectangle Occasional Table



Square Occasional Table

Air³

Air³ is a modular freestanding meeting room. Its internationally patented opening roof system features an advanced fire safety system developed specifically for sprinklered office environments.

► Specifying, pages 56–58

Louved roof controlled by motion sensor as well as user control buttons.

Air circulation fan.

Exterior and interior side panels are upholstered acoustic panels.

Front and back panel glass are tempered glass.

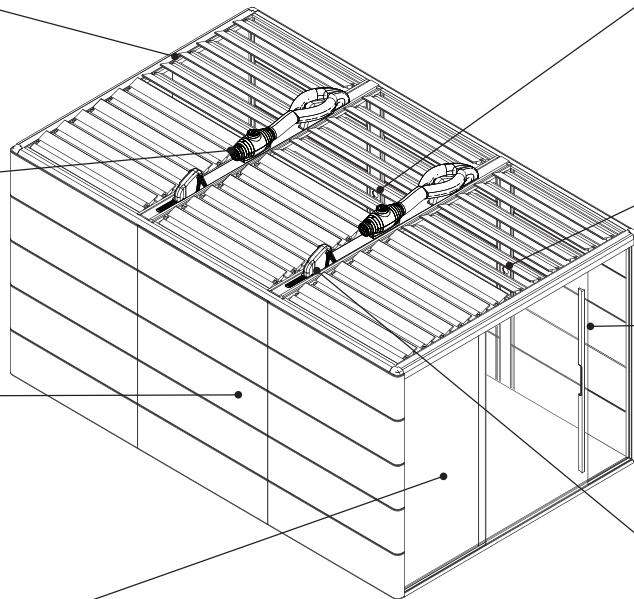

Service hoop control panel side includes touch button controls for lighting, air circulation, and roof.

Service hoop power side includes three NEMA 5-15 3-prong power outlets and two data connection cutouts.

Sliding glass door can be fitted to open right to left, or left to right, at time of installation.

Service hoop horizontal bar includes three LED lights, two heat detectors, monitor sensor, and fan.

Pod Dimensions

	External Dimensions			Internal Dimensions			
	Depth	Width	Height	Depth	Width	Height*	Weight
OB1AIR23	5' 6"	9' 2"	8' 4"	5' 1"	8' 7"	7'	1017 lb
OB1AIR25	9' 9"	9' 2"	8' 4"	9' 5"	8' 7"	7'	1313 lb
OB1AIR27	14' 5"	9' 2"	8' 4"	14' 1"	8' 7"	7'	1738 lb

Tip: Minimum height recommended for a sprinkler covered space is 9'3" to allow for 18" clearance between the top of the open roof blade and a sprinkler head above it. These are recommendations as it is still up to the local authority having jurisdiction to identify their building requirements.

**Internal height when roof blades open is 6'9".*

Table Dimensions

	Depth	Width	Height	Weight
OB1AIR30	69"	45"	29"	56 lb
OB1AIR35	24"	61"	29"	47 lb

Product Details

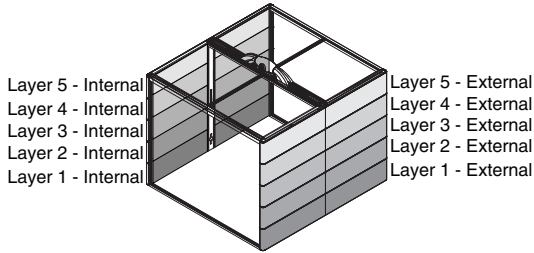

Fabric panel layer numbering begins from the bottom position.

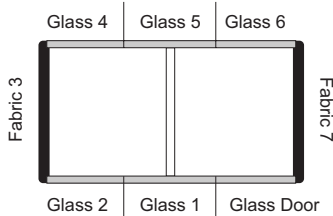

Air23 configuration

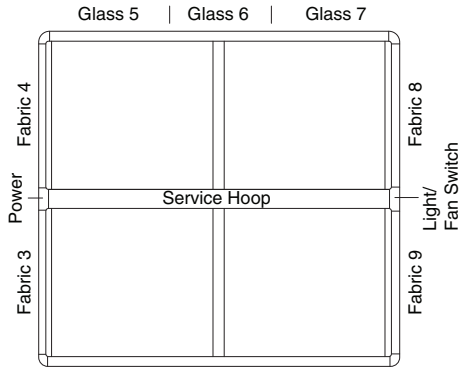

Air25 configuration

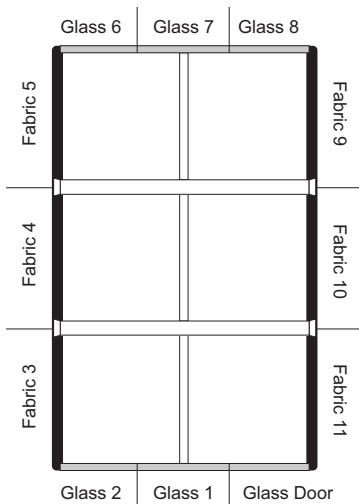

Air27 configuration

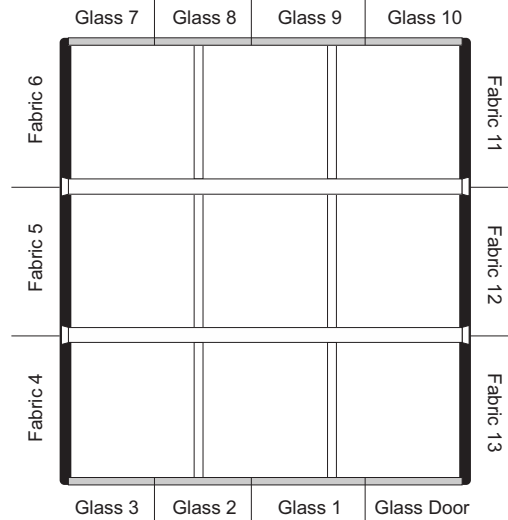

Air29 configuration

Panel positions account for both glass and fabric panels and are determined when standing outside of the pod with a right to left opening door.

Optional whiteboards can be installed in place of internal fabric panels on layers 3 and 4. Dimensions are 50³/₄" x 34³/₄".

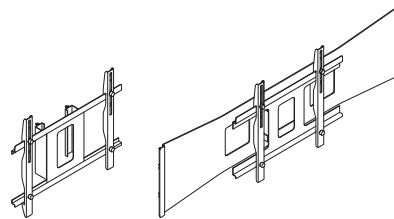

Monitor brackets are available in two different styles and both support a monitor up to a maximum weight of 55 pounds:

- Over upholstery monitor brackets—mounted directly to the fabric panels on layers 3 and 4.
- Hoop mounted monitor brackets—attached to the power side of the service hoop.

Space Layout Constraints

Do not obstruct exit corridor. Ensure visibility to on site alarm strobes is not blocked. If sprinklers are not required interior to the unit, be advised that local codes typically prohibit obstructions within 18" (457.2 mm) of the existing building sprinklers. Ensure final placement of the unit does not block airflow inlets or outlets of the building or unit ventilation systems.

Electrical Connections

All Air³ units come standard with a 3-prong, 9' electrical cord. However, the units can be hardwired at installation. If hardwired, the hardwired connection must be routed to a junction box in the floor, wall, or ceiling via a conduit whip. Orangebox does not provide the conduit whip to make the power connection to the building. It is the responsibility of the qualified site electrician to supply and install a suitable power connection to the building in accordance with local codes.

The assembly directions and user guide describe the enclosures which contain the electrical services such as power, lighting, and airflow. Lighting, fan, outlets, and sensors share one circuit within the unit. The enclosure may accommodate a single 15 Amp connection. The maximum loading of the components within the enclosure is 1.8 Kilowatts at 120 VAC.

Power usage when occupied is 100W (not including any plugged-in external equipment) per hoop.

Electrical Components

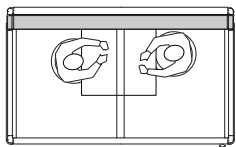
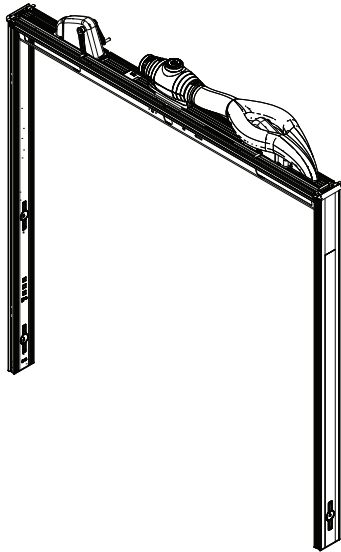

The service hoop contains all the electrical services, including power, lighting, and airflow.

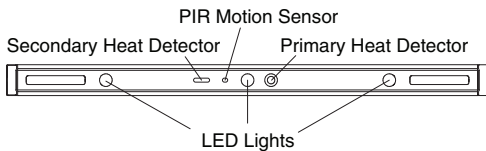

Service hoop horizontal bar includes three LED lights, two heat detectors, motion sensor, and fan.

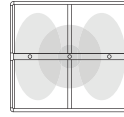

Work

Lux level at table height: 450-850
Center light: 100%
Outer light: 100%

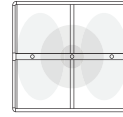

Think

Lux level at table height: 120-400
Center light: 50%
Outer light: 20%

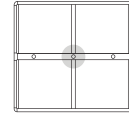

Present

Lux level at table height: 50-60
Center light: 20%
Outer light: OFF

Three LED lights are used for illumination. The lights are 4000K with a max brightness of 1300 lumens.

Passive inferred (PIR) motion sensor turns on the power to the pod when activated. Power is shut off within the pod after five minutes of inactivity.

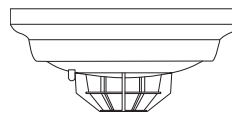

Primary heat detector will cut all power in the pod and open the roof fully if heat at 135°F (57°C) is detected.

Secondary heat detector acts as a failsafe fusible link and will cut all power in the pod and open the roof fully if heat at 150.8°F (66°C) is detected.

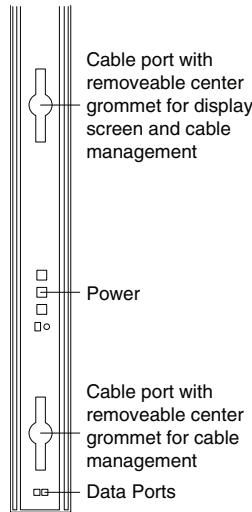

Service hoop power side comes standard with three NEMA 5-15 3-prong power outlets, two data connection cutouts, and two cable ports with removable center grommet for cable management.

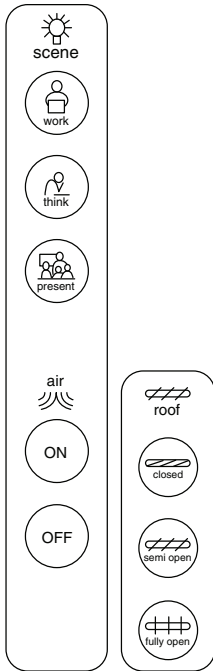

Service hoop control panel side includes touch button controls for lighting, air circulation, and roof.

The patented louvred roof has three settings: fully open, semi open, and closed. When the pod is unoccupied, the roof is always open. When entering the pod, the passive inferred sensor (PIR) senses movement and closes the roof to create acoustic privacy. When the pod is occupied, it is possible to select either 10° (semi) or 90° (fully) open position manually for enhanced airflow. The PIR turns the power off after five minutes and the roof automatically opens.

Occupancy sensor activates the lights and fan. The sensor operates at low voltage and utilizes both ultrasonic and infrared sensing to avoid false triggering.

Airflow and Handling

Ventilation fans are rated at 330 cubic feet of air per minute (CFM) and 23 dBA.

Tip: Fan CFM ratings alone cannot be used to determine the actual system ventilation rate.

Building and Fire Code Compliance

Seismic considerations: For seismic considerations, the building's Structural Engineer of Record (SEOR) must be consulted. Seismic structural analysis report prepared by a licensed professional engineer may be required for specific locations.

Fire suppression: Sprinkler requirements are an important consideration for product assembly. Local codes may impact the number and location of mandated sprinklers. It is important to check with the local authorities to ensure product installation meets local requirements. If required, sprinkler location options within the unit are identified in product-specific assembly directions.

Fire alarms: National Fire Protection Agency (NFPA) 72 requires a fire alarm to be at least 15 dB above ambient to ensure occupants can hear the alarm. This is an on-site requirement. This may require a visible and/or audible notifier within the unit. If the unit is equipped with a fire detection system, some jurisdictions may require it be connected to the building's fire detection system.

Energy efficiency: ASHRAE 90.1 and California Energy Commission (CEC) Title 24 identify lighting controls and power density requirements. This is an on-site requirement. Ensure this unit in its final environment adheres to these standards by confirming with local authorities.

Surface Materials

External and Internal Air³ Panels

- Camira Synergy
- Designtex Billiard Panel
- Designtex Billiard Select Surfaces
- Designtex Brushed Flannel
- Designtex Everywhere Texture
- Dovetail by Designtex*
- Gabriel Europost 2
- Gabriel Medley
- Guilford of Maine Anchorage*
- Kvadrat Divina MD*
- Kvadrat Divina Mélange 3*
- Kvadrat Divina 3*
- Maharam Mode*

**Tip: Only fabrics permitted for use in Canada.*

Tip: Fabrics are Graded-In. Please reference the COM database to identify appropriate price grade.

Table Top Finish

- Fiber HPL
- Micro HPL
- Patina HPL
- Solid HPL
- Speckle HPL
- Woodgrain HPL
- Textured Industrial HPL
- Textured Woodgrain HPL

Table Edge Finish

- Plastic

Table Leg Finish

- Black
- Polished
- Silver

Tip: For comparable finish, please reference Steelcase standard finishes 7207 Textured Black, 4799 Platinum Metallic, 9201/9207 Polished Trivalent Chrome.

Frame

- RAL9003 Signal White

Roof Blades

- RAL7035 Light Grey

Campers & Dens

Camper

Louvered roof is controlled by a motion sensor as well as user buttons.

Service hoop control panel side includes touch button controls for lighting, air circulation, and roof. Control panel side of hoop is on the door side.

Service hoop power side includes 3 NEMA power outlets as standard. USB A & C and Data and HDMI can be selected as an option. Power side of the hoop is opposite of the door.

Service hoop horizontal bar includes LED lights, smoke detector, motion sensor, and fan.

Frame comes standard in 7207 Black paint.

Exterior side panels come with fabric, laminate, or plywood.

Fascia is available in paint or fabric.

Exterior contrasting panels can be selected where one panel per wall can be a contrasting fabric, laminate, or plywood.

Door handle is available in natural oak or black oak.

Sliding glass doors, right- or left-handed style numbers available. Handedness is indicated by door position when facing unit.

Power access is through floor or ceiling.

Air circulation fan comes standard.

Interior wall panels default to fabric. One panel per wall can be a contrasting fabric or laminate. Interior panels cannot have two hard surfaces meet at corners.

Panel glass has three different glass configurations available. Glass is 8 mm tempered glass.

Tip: Styles ending with an NB will have a glass infill on the front of the unit to offset the door from the side wall by 12".

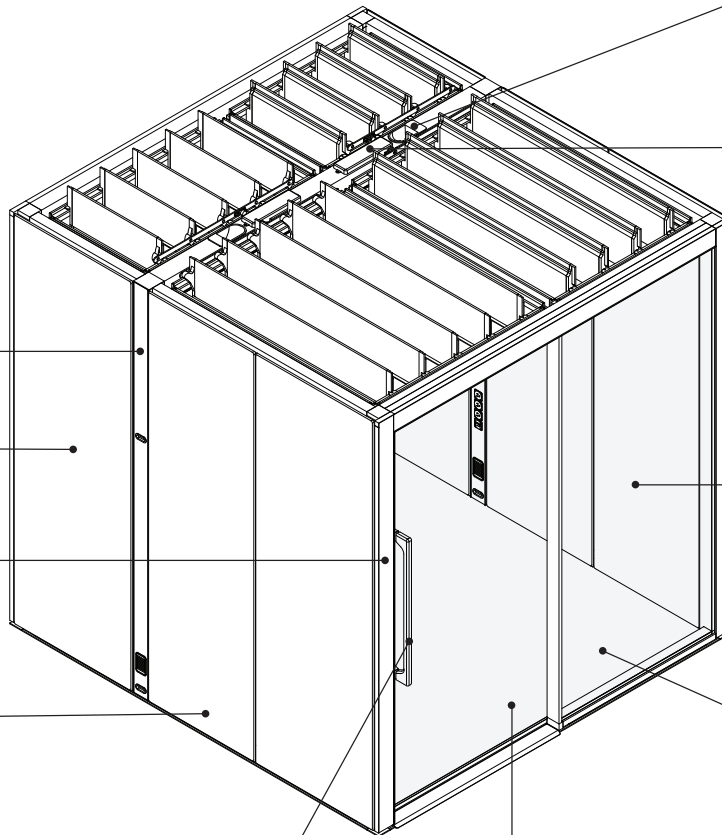

Camper Configurations

Panel configuration B:
Glass front and rear

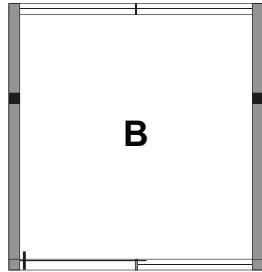

Panel configuration C:
Corner glass front

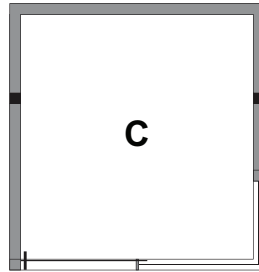

Panel configuration D:
Glass front

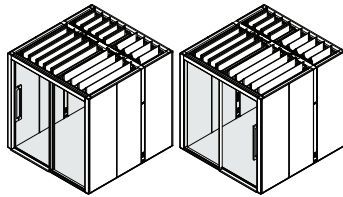
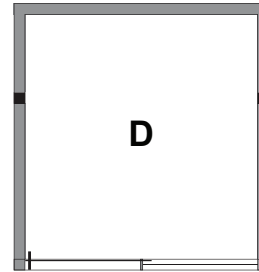

Glass Front and Rear

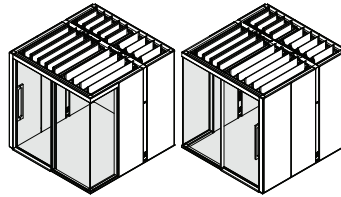

Corner Glass Front

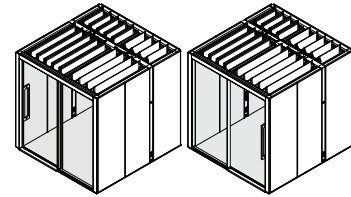

Glass Front

Panel configuration B:
Glass front and rear

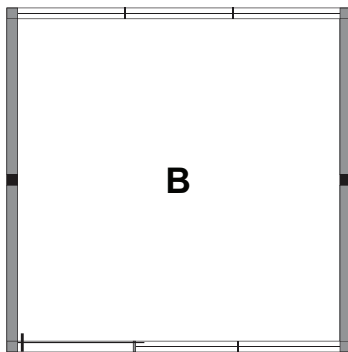

Panel configuration C:
Corner glass front

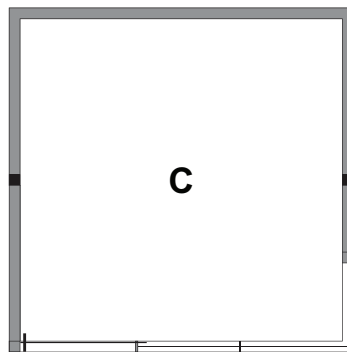

Panel configuration D:
Glass front

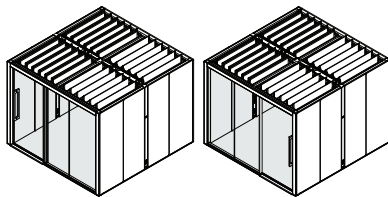
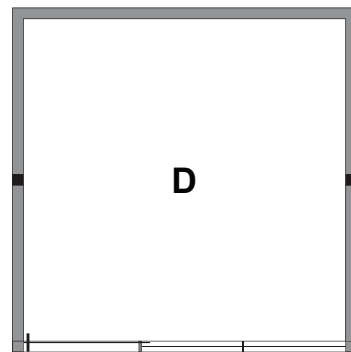

Glass Front and Rear

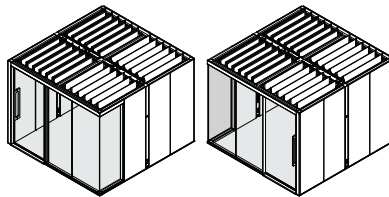

Corner Glass Front

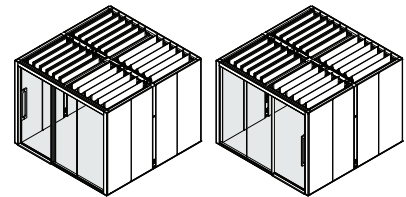

Glass Front

Campers & Dens, Camper, continued

Pod Dimensions							
	External Dimensions			Internal Dimensions			
	Depth	Width	Height	Depth	Width	Height*	Weight
OB1CD02BLS	92"	88"	92½"	84"	79"	84"	1556 lb
OB1CD02BRS	92"	88"	92½"	84"	79"	84"	1556 lb
OB1CD02CLS	92"	88"	92½"	84"	79"	84"	1438 lb
OB1CD02CRS	92"	88"	92½"	84"	79"	84"	1438 lb
OB1CD02DLS	92"	88"	92½"	84"	79"	84"	1479 lb
OB1CD02DRS	92"	88"	92½"	84"	79"	84"	1479 lb
OB1CD05BLS	119"	115"	92½"	111"	106"	84"	1924 lb
OB1CD05BRS	119"	115"	92½"	111"	106"	84"	1924 lb
OB1CD05CLS	119"	115"	92½"	111"	106"	84"	1917 lb
OB1CD05CRS	119"	115"	92½"	111"	106"	84"	1917 lb
OB1CD05DLS	119"	115"	92½"	111"	106"	84"	1941 lb
OB1CD05DRS	119"	115"	92½"	111"	106"	84"	1941 lb

Tip: Minimum height recommended for a sprinkler covered space is 9'3" to allow for 18" clearance between the top of the open roof blade and a sprinkler head above it. These are recommendations as it is still up to the local authority having jurisdiction to identify their building requirements.

*Internal height when roof blades open is 6'9".

Tip: All NB styles are the same dimensions as the respective style numbers.

Table Dimensions				
	Depth	Width	Height	Weight
OB1CDWT01	24½"	28¾"	29¾"	30 lb
OB1CDWT02	35½"	28¾"	29¾"	30 lb

Lounge Dimensions						
	Depth	Width	Height	Seat Height	Seat Depth	Weight
OB1CDUS01	24½"	24"	32"	18¾"	17½"	44 lb
OB1CDUS02	24½"	50½"	32"	18¾"	17½"	89 lb

Awning Dimensions			
	Depth	Width	Height
OB1AW01	88"	88"	92"
OB1AW02	88"	115"	92"

Cabin Dimensions							
	External Dimensions			Internal Dimensions			
	Depth	Width	Height	Bottom Depth	Top Depth	Width	Height
OB1CDC01	28½"	88"	92½"	24"	28½"	79½"	84¾"
OB1CDC02	28½"	115"	92½"	24"	28½"	106¾"	84¾"

Kink Dimensions

	Depth	Width
OB1CDK01L	14"	88"
OB1CDK01R	14"	88"
OB1CDK02L	14"	115"
OB1CDK02R	14"	115"

Hacking Dimensions

	Depth	Width	Height
HACK08	11"	56 ⁸ / ₉ "	90"
HACK09	11"	91 ¹ / ₂ "	90"
HACK10	51"	137 ⁴ / ₅ "	90"
HACK11	11"	87 ³ / ₈ "	90"
HACK12	11"	118"	90"
HACK13	53 ¹ / ₂ "	164 ² / ₅ "	90"

Product Details

Panel specification: internal and external panels can be specified by wall or by individual panel. If contrasting is selected, only one panel per wall can be contrasting.

CD02 styles

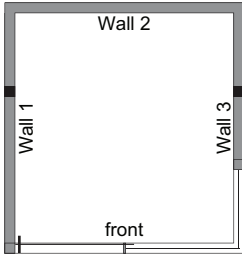

CD05 styles

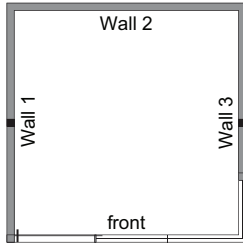

CD02 style

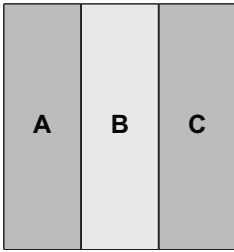

CD05 style

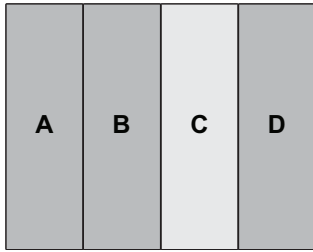

Tip: Only a single panel will be specifiable as contrasting.

Corner glass will replace single interior and exterior panels.

For **CD02CLS**, the glass will replace interior wall 3, panel C and exterior wall 3, panel A.

For **CD02CRS**, the glass will replace interior wall 1, panel A and exterior wall 3, panel C.

For **CD05CLS**, the glass will replace interior wall 3, panel D and exterior wall 3, panel A.

For **CD05CRS**, the glass will replace interior wall 3, panel A and exterior wall 3, panel D.

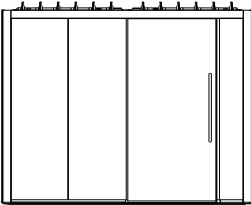

CD05 style with an NB suffix have a glass infill on the front of the camper that offsets the door by 12". This infill allows for the unit to be AODA compliant in Ontario, Canada.

Campers & Dens

Kink

Interior and exterior are available in laminate, fabric, or plywood.
Tip: Kinks can only be applied to the front door wall. Handedness matches the door opening direction.

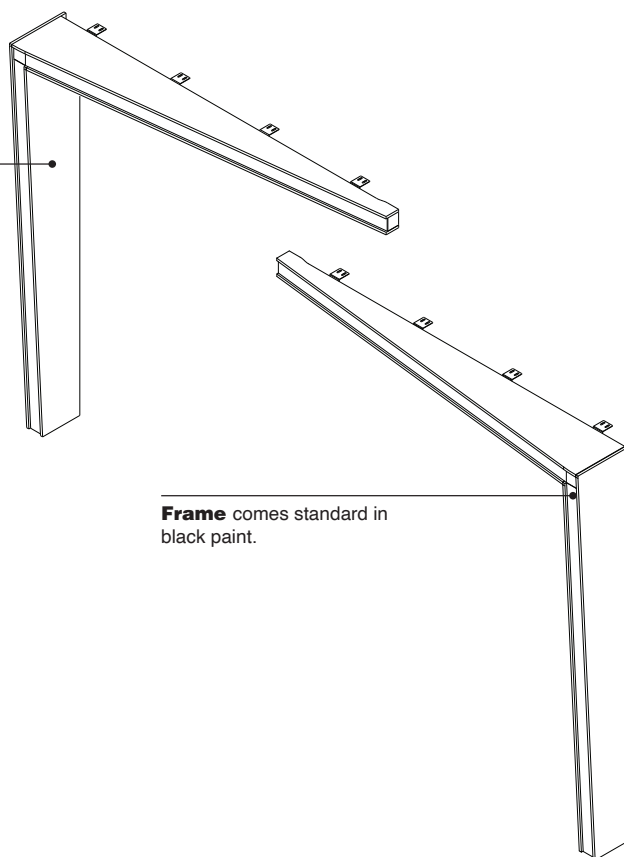

Frame comes standard in black paint.

Cabin

Cabin is only available on the back side (wall 2) of the camper.

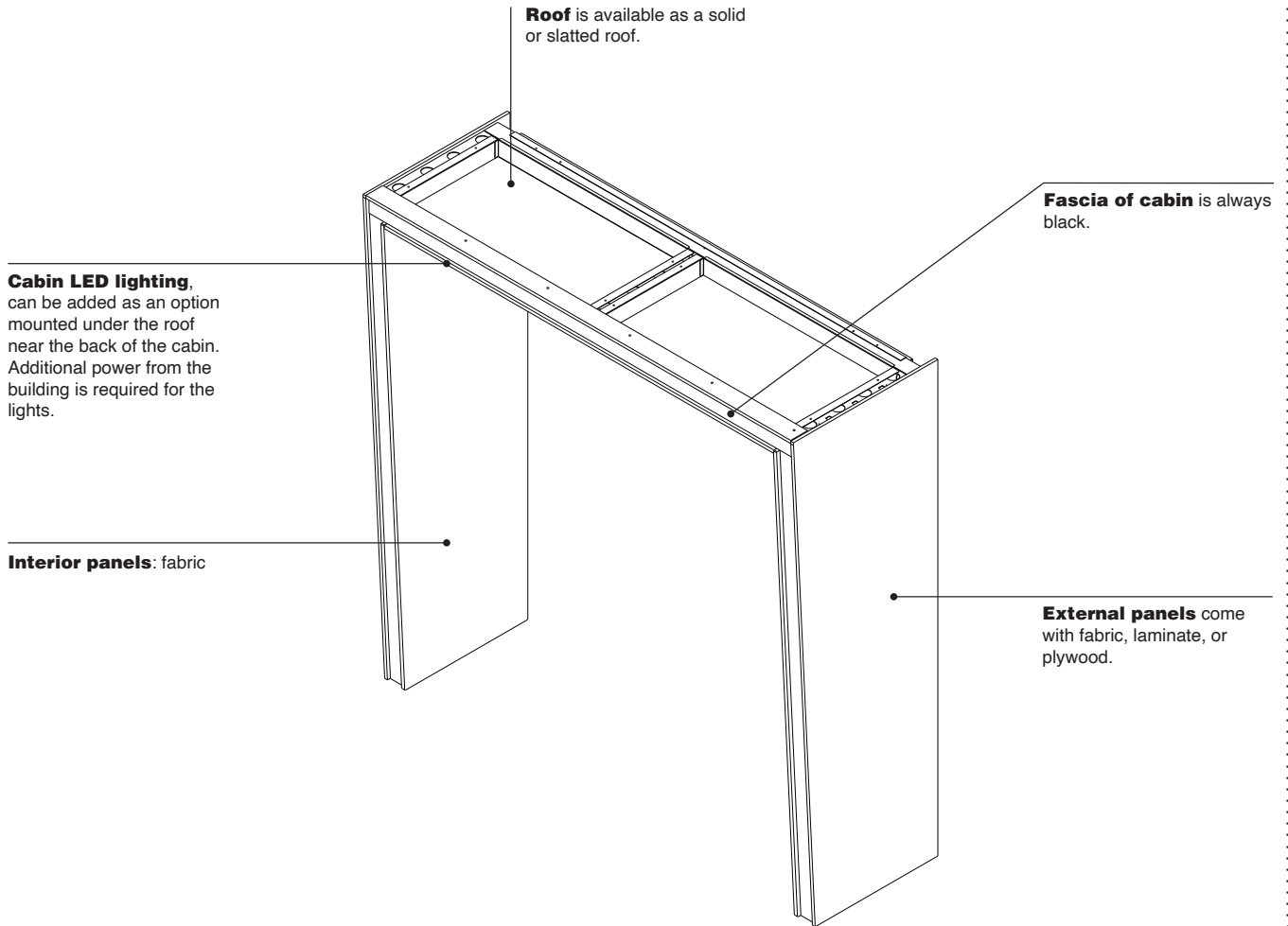

Campers & Dens

Awning

Frame is available in black paint.

Tip: Awnings can attach to any wall of a camper, including the front.

Awning accessories total maximum loading is 44 pounds.

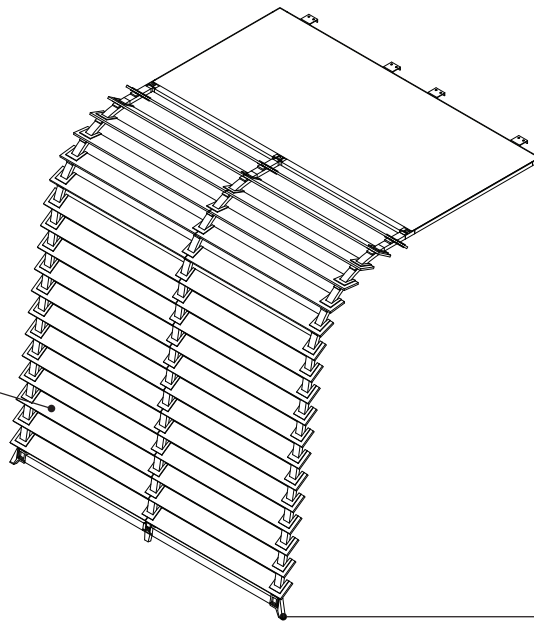

Plywood slats.

Foot is available in natural oak or black oak.

Top is available in sheer fabric or cord.

Sheer fabric.

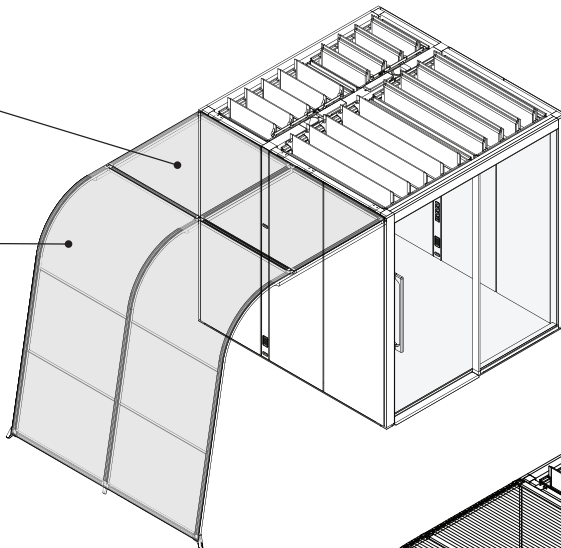

Side is available in sheer fabric, cord, PET slats, or plywood slats.

Cord.

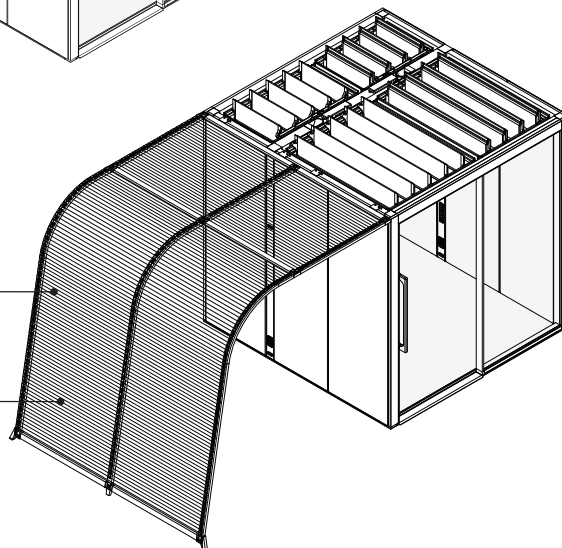

Hacking

Hackings are made out of poplar plywood.

The slat design is available with straight or wavy slats. Straight slats are shown.

Tip: Hacking cannot cover door or share wall with cabin, kink, or awning.

Tip: Full depth hacking cannot be applied on back wall.

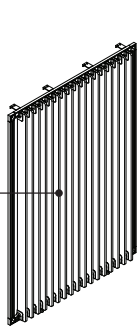

Up to Glass Corner

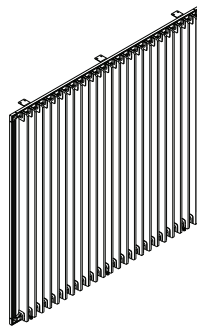

Full Pod Depth

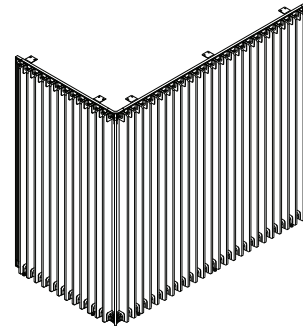

Around Corner

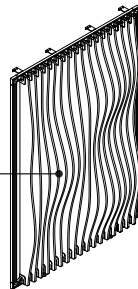

Up to Glass Corner

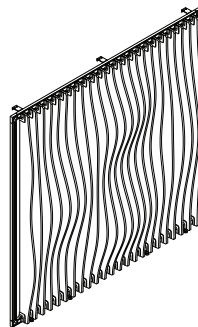

Full Pod Depth

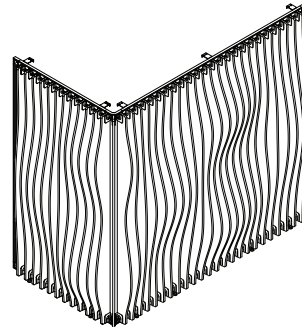

Around Corner

Wavy slats.

Campers & Dens

Tables

Tables come standard with a blade edge.

Tables can be mounted on the camper center panel(s) or mounted on the hoop.

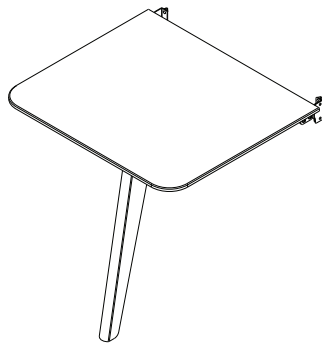

Small Wall Mounted Table

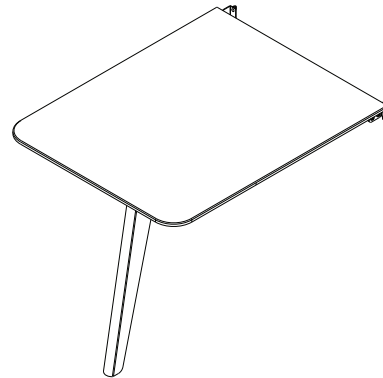

Medium Wall Mounted Table

Lounges

Lounges are freestanding and work well within the camper, cabin, or other adjacent settings.

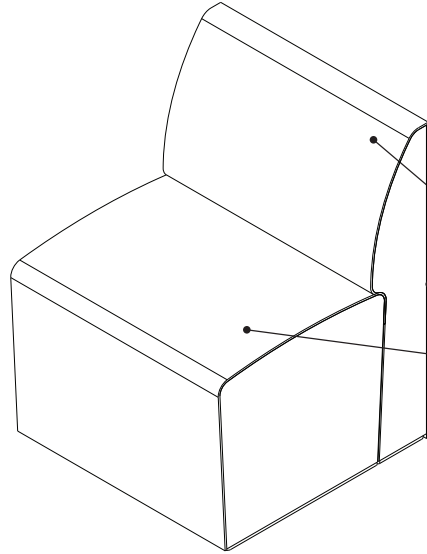

Single

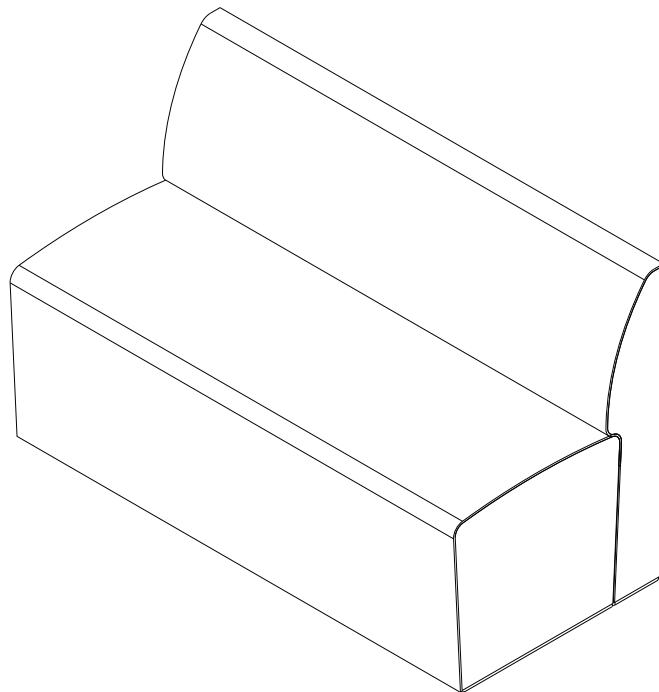

Double

Campers & Dens

Monitor Brackets

Mount height is flexible and can be determined during the installation.

Maximum monitor weight is 100 pounds.

Monitor brackets can mount to the interior or exterior of the camper.

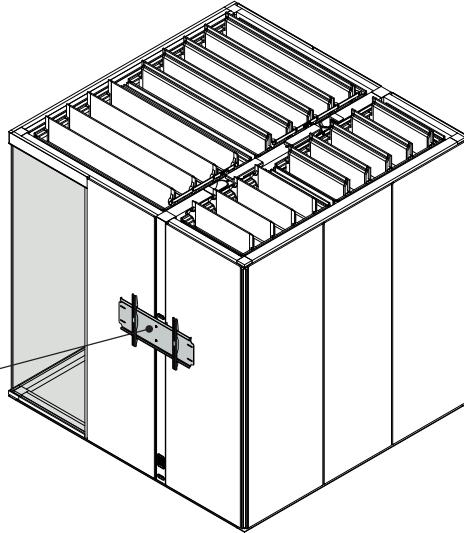

All monitor brackets are suitable up to a maximum Video Electronics Standards Association (VESA) Pattern of 640 mm width and 400 mm height.

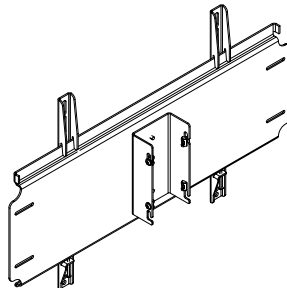

Hoop mounted monitor bracket attaches to the hoop.

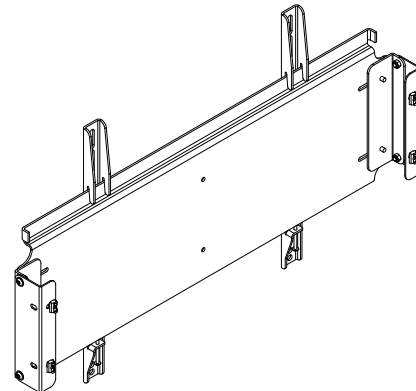
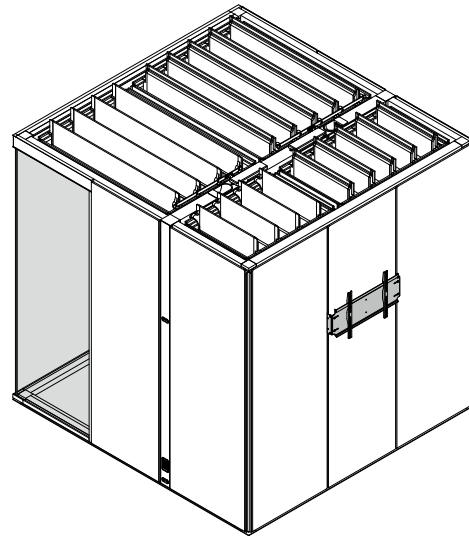

Panel mounted monitor brackets center on a panel.

Space Layout Constraints

Do not obstruct exit corridor. Ensure visibility to on site alarm strobes is not blocked. If sprinklers are not required interior to the unit, be advised that local codes typically prohibit obstructions within 18" (457.2 mm) of the existing building sprinklers. Ensure final placement of the unit does not block airflow inlets or outlets of the building or unit ventilation systems.

The product contains a magnet in the door-post assembly.

Integrated Power Overview

Campers and dens include integrated, plug-and-play power designed to support lighting and technology needs without hardwiring. Power is delivered through the service hoop, which houses power, lighting, airflow, and controls.

Main power is always fed into the "power side" vertical hoop, which can be oriented during installation to best align with the building's power source. The unit requires a standard 120V/15A building power connection. A 9-foot power cord is provided and extends from the camper to the building power source.

The power cord may be routed through one of the following locations:

- An interior floor box
- An exterior floor box or wall outlet
- An exterior ceiling feed (ceiling feed installations result in a shorter exposed cord length)

Tip: Campers are not hardwired. All power connections are via plug-in cords only.

Power is located on the power side of the service hoop, opposite the standard door location. Campers are available in left-handed or right-handed configurations.

Electrical Components

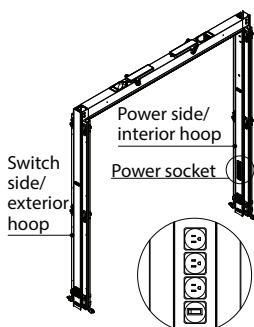

The service hoop can be reversed at installation so the power side aligns closest to the building's power source, or is positioned on the same side as the door if required.

Standard interior power is located beneath the worksurface on the power side. It includes: three power outlets and an isolator switch.

Power outlets are vertically arranged within the service hoop.

Additional power locations may be specified as an option. Each additional power location includes its own dedicated power cord. Up to three additional power cords may be added, for a total of up to four building power connections per camper. All additional power locations are available only on the standard 3-power configuration.

Optional power may be specified on:

- Interior or exterior faces of the service hoop
- Power side or switch side of the camper

Important Considerations

Optional power on the switch side requires an additional building receptacle. If a cabin with lighting is specified, an additional cord is required to power the cabin lighting (typically plugged into the same building power source as the camper).

USB-A + USB-C may be added as an option. When selected, USB replaces one standard power outlet in the interior power stack.

	Standard	Optional
Power Outlet		
Isolator Switch		

HDMI, data ports, and cables are available as options. When specified, ports are located on the service hoop at worksurface height. A building data outlet is required to support these connections.

Electrical Capacity & Usage:

The enclosure is designed to accommodate:

- 120V / 15A power connections with a maximum combined loading of 1.8 kW.
- Typical occupied power usage for the enclosure is approximately 100W, excluding any user-supplied external equipment.

Power and data cables can be routed internally through the service hoop and panel cavities. The recommended floor box placement is near the service hoop, either inside or outside the camper.

Power cords are optimized for standard building outlet locations.

Important Usage Guidelines

To ensure safe operation: do not overload socket receptacles and do not plug the following into camper outlets:

- Space heaters
- Vacuum cleaners
- Air conditioning units
- Extension cords or power strips
- Other high-amperage equipment

Use camper outlets only for computer equipment and associated peripherals.

Building and Fire Code Compliance

Seismic considerations: For seismic considerations, the building's Structural Engineer of Record (SEOR) must be consulted. Seismic structural analysis report prepared by a licensed professional engineer may be required for specific locations. Seismic bracket kit is available with style number **OB1CDSBK**.

Fire suppression: Sprinkler requirements are an important consideration for product assembly. Local codes may impact the number and location of mandated sprinklers. It is important to check with the local authorities to ensure product installation meets local requirements. If required, sprinkler location options within the unit are identified in product-specific assembly directions.

Fire alarms: National Fire Protection Agency (NFPA) 72 requires a fire alarm to be at least 15 dB above ambient to ensure occupants can hear the alarm. This is an on site requirement. This may require a visible and/or audible notifier within the unit. If the unit is equipped with a fire detection system, some jurisdictions may require it be connected to the building's fire detection system.

Energy efficiency: ASHRAE 90.1 and California Energy Commission (CEC) Title 24 identify lighting controls and power density requirements. This is an on-site requirement. Ensure this unit in its final environment adheres to these standards by confirming with local authorities.

Surface Materials

Frame finish (camper, awning, cabin, and kink)

- Black Price Group 1

Fascia

Paint

- Smooth Paint Price Group 1
- Textured Paint Price Group 1
- Smooth Paint Price Group 2
- Smooth Metallic Paint Price Group 2
- Accent Paint Price Group 3
- Lux Coatings Price Group 3

Fabric

- Billiard Multi-Use Price Group 2
- Intersection Price Group 2
- Stencil Price Group 2
- Dovetail Price Group 2
- SoftNext Price Group 2
- Graded-In Price Group 1-10
- Customer's Own Material (COM)

Panels

Fabric

- Billiard Multi-Use Price Group 2
- Intersection Price Group 2
- Stencil Price Group 2
- SoftNext Price Group 2
- Graded-in Price Group 1-10
- Customer's Own Material (COM)

Laminate

- Fiber HPL Price Group 1
- Micro HPL Price Group 1
- Patina HPL Price Group 1
- Solid HPL Price Group 1
- Speckle HPL Price Group 1
- Textured Woodgrain HPL Price Group 2
- Woodgrain HPL Price Group 1
- Textured Industrial HPL Price Group 2
- Open Line laminate

Plywood (exterior panels only)

- Poplar

Cabin and Kink

Fabric

- Billiard Multi-Use Price Group 2
- Intersection Price Group 2
- Stencil Price Group 2
- Dovetail Price Group 2
- SoftNext Price Group 2

Laminate

- Fiber HPL Price Group 1
- Micro HPL Price Group 1
- Patina HPL Price Group 1
- Solid HPL Price Group 1
- Speckle HPL Price Group 1
- Textured Woodgrain HPL Price Group 2
- Woodgrain HPL Price Group 1
- Textured Industrial HPL Price Group 2
- Open Line laminate

Plywood (exterior only)

- Poplar Price Group 1

Cabin Interior Finish

Fabric

- Billiard Multi-Use Price Group 2
- Intersection Price Group 2
- Stencil Price Group 2
- Dovetail Price Group 2
- SoftNext Price Group 2

Awning

Fabric (Designtex sheer fabric)

- P451 Merle Price Group 8
- P452 Seagull Price Group 8
- P453 Storm Cloud Price Group 8
- P454 Chardonnay Price Group 8

Cord (nylon)

- 9023 Bright Orange Price Group 1
- 9024 Dark Olivine Price Group 1
- 9025 Pewter Price Group 1
- 9026 Black Price Group 1

PET slats

- PC16 Empire Price Group 1
- PC17 Flatiron Price Group 1

Plywood slat

- Poplar Price Group 1

Hacking

- Poplar Plywood

Door handles, awning leg, and table legs

- V3AK Natural Oak Price Group 1
- VP03 Black Oak Price Group 1

On the QT

On the QT phone booths

were designed to provide compact enclosed space in open plan workspaces to allow work to be carried out more effectively with reduced distractions.

► Specifying, pages 142–150

Frame constructed of aluminum.

Cover caps frame the glass door and glass wall. Available in a range of paint finishes.

Front and back panel glass are clear laminated glass.

Seat designed with ergonomic focus to promote comfortable longer term use.

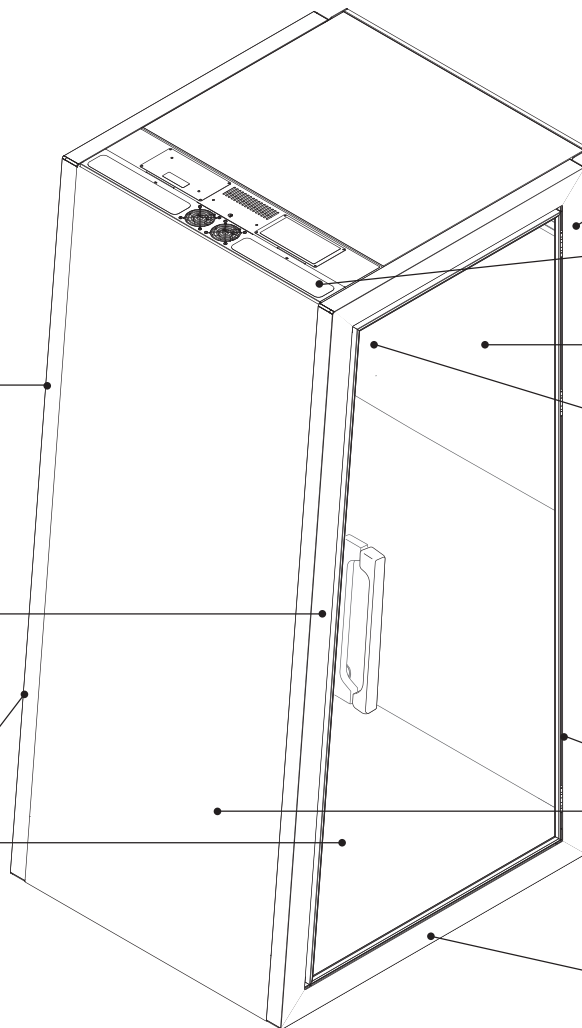

Occupancy light illuminates red when booth is in use.

Fan built discretely into the roof panel.

Interior cladding is polyester felt.

Lighting positioned near the front of the booth for optimal work lighting.

Front and rear cladding is laminate as standard, with option of fabric, painted steel, plywood, or whiteboard.

Threshold height is 5" min to 7" max.

Tablet included as standard.

Angled seat face creates a comfortable pivot space to enter the booth and sit.

Phone Booths								
	External Dimensions					Internal Dimensions		
	Depth	Width	Height	Weight*	Shelf Height	Depth	Width	Height
OB1QT01/OB1QT02	39 ³ / ₈ "	47 ¹ / ₄ "	74 ⁴ / ₅ "	535 lb	28 ³ / ₄ "	36"	39"	69 ⁷ / ₈ "
OB1QT03/OB1QT04	39 ³ / ₈ "	47 ¹ / ₄ "	86 ³ / ₅ "	661 lb	41 ³ / ₄ "	36"	39"	78 ³ / ₄ "

Furniture Units						
	Depth	Width	Height	Weight	Seat Height	Tablet Height
OB1QTF01/OB1QTF02	25"	35"	32"	101 lb	18 ⁸ / ₉ "	28 ³ / ₄ "

*includes plywood cladding

Product Details

Left hand (LH) and right hand (RH) are determined by the location of the door hinge when entering the booth.

Front and rear are determined based on the user seated position. "Front" will indicate the wall the user faces, while "rear" will indicate the wall behind the user.

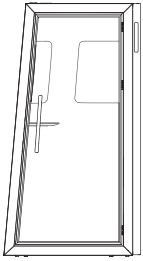

Baffles can be optioned to add an additional layer of visual and acoustic privacy. These fully upholstered baffles are available as a privacy screen or lean pad.

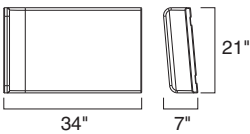
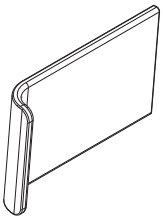

Privacy screens install to the front of the phone booth and sit above worksurface height.

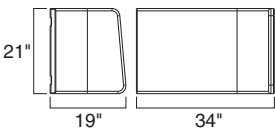
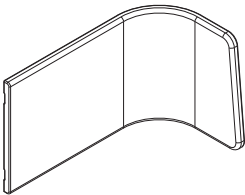

Lean pads install to the rear of the phone booth and sit at shoulder/head height.

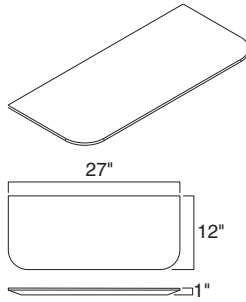

Shelf can be specified in both the short and tall phone booths. When specified, the shelf height is 28³/₄" in the short booth and 41³/₄" in the tall booth.
Tip: Shelf should not be optioned if an On the QT furniture unit (OB1QTF01 or OB1QTF02) is specified.

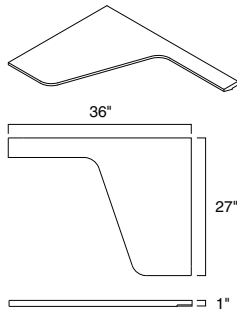

L-shelf can be specified in the tall phone booths only. When specified, the shelf height is 41³/₄".

All worksurfaces come standard in High-Pressure Laminate.

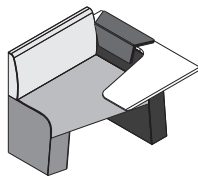

Contrasting upholstery option available on lounge furniture units with four specifiable upholstery surfaces.

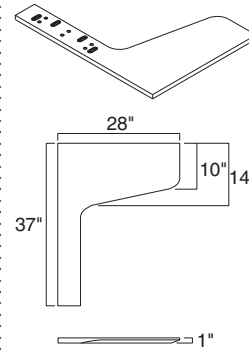

Each furniture unit comes standard with an integrated worksurface in laminate.

Occupancy light is available as an option. When the phone booth is in use, the occupancy light will illuminate red. When not specified, illumination will not occur.

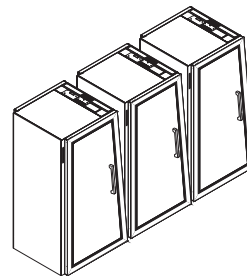

Do not obstruct exit corridor. Ensure visibility to on site alarm strobes is not blocked. If sprinklers are not required interior to the unit, be advised that local codes typically prohibit obstructions within 18" of the existing building sprinklers. Ensure final placement of the unit does not block airflow inlets or outlets of the building or unit ventilation systems.

Electrical Connections

Hardwired units: Electric power is delivered through a hardwired connection which must be routed to a junction box in the floor, wall, or ceiling via a conduit whip. Orangebox does not provide the conduit whip to make the power connection to the building. It is the responsibility of the qualified site electrician to supply and install a suitable power connection to the building in accordance with local codes.

The assembly directions and user guide describe the enclosures which contain the electrical services such as power, lighting, and airflow. Lighting, fan, outlets, and sensors share one circuit within the unit. The enclosure may accommodate a single 15 Amp connection. The maximum loading of the components within the enclosure is 1.8 Kilowatts at 120 VAC.

Cord and plug units: The unit is provided with a flexible power cord which is to be plugged directly into a building's hardwired electrical receptacle. A minimum spacing of 4" between the receptacle and the assembled unit is needed to protect the plug from damage.

Total cord length is 12' from the point of connection at the power distribution unit (PDU). Exposed length will be dependent on exit location.

Short phone booth:

- 116" when exiting from front
- 77" when exiting from rear

Tall phone booth:

- 103" when exiting from the front
- 64" when exiting from the rear

Power usage: when occupied is 30W (not including any plugged-in external equipment).

Electrical Components

Occupancy sensor activates the lights and fan. The sensor operates at low voltage and utilizes both ultrasonic and infrared sensing to avoid false triggering. Three minutes after the booth is vacated, all features will power down.

One LED light panel is used for illumination. The light is 3000K and 450 lux at worksurface height.

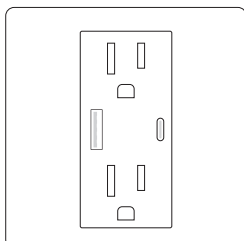

When selected, unit includes two power outlets, one USB A, and one USB C port. Each outlet will supply 3 Amps max with a total of 4.5 Amp max draw collectively.

An isolator switch is located directly below the power outlets and can be used to turn off all power to the booth.

Airflow and Handling

The air handling ventilation system is designed to provide a minimum of 10 air changes per hour when the unit is occupied, per Business & Institutional Furniture Manufacturer's Association (BIFMA) Guidance for Pods (2020) and American Society of Heating Refrigerating and Air Conditioning Engineers (ASHRAE) 111 Testing, Adjusting, and Balancing of Building HVAC Systems.

On the QT has been designed to perform 35 (short booth) and 30 (tall booth) air changes per hour (ACH).

Ventilation fans are rated at 21.9 CFM and 21.5 dBA.

Tip: Fan CFM ratings alone cannot be used to determine the actual system ventilation rate.

Building and Fire Code Compliance

Seismic considerations: For seismic considerations, the building's Structural Engineer of Record (SEOR) must be consulted. Seismic structural analysis report prepared by a licensed professional engineer may be required for specific locations.

Fire suppression: Sprinkler requirements are an important consideration for product assembly. Local codes may impact the number and location of mandated sprinklers. It is important to check with the local authorities to ensure product installation meets local requirements. If required, sprinkler location options within the unit are identified in product-specific assembly directions.

Fire alarms: National Fire Protection Agency (NFPA) 72 requires a fire alarm to be at least 15 dB above ambient to ensure occupants can hear the alarm. This is an on-site requirement. This may require a visible and/or audible notifier within the unit. If the unit is equipped with a fire detection system, some jurisdictions may require it be connected to the building's fire detection system.

Energy efficiency: ASHRAE 90.1 and California Energy Commission (CEC) Title 24 identify lighting controls and power density requirements. This is an on-site requirement. Ensure this unit in its final environment adheres to these standards by confirming with local authorities.

Surface Materials

Frame

- 7207 Textured Black

Door handle

- V3AK Natural Oak
- VP03 Black Oak

Cover caps

- Accent paint
- Accessory paint
- Smooth metallic
- Smooth paint
- Textured paint
- Textured metallic

Front and rear cladding

Laminate

- Fiber HPL
- Micro HPL
- Patina HPL
- Solid HPL
- Speckle HPL
- Textured Woodgrain HPL
- Woodgrain HPL
- Textured Industrial HPL
- Open Line laminate

Whiteboard

- 2977 White Markerboard

Painted Metal

- Accent paint
- Accessory paint
- Smooth metallic
- Smooth paint
- Textured paint
- Textured metallic

Fabric

- Graded-In Price Group 1-10
- Customer's Own Material (COM)

Plywood

- 3862 BirchPly

Internal cladding

- PT19 Charcoal
- PT36 Silver

Privacy screen

- Fabric
- Customer's Own Material (COM)

Lean pad

- Fabric
- Customer's Own Material (COM)

Furniture upholstery

- Fabric
- Customer's Own Material (COM)

Tip: This product does not use glue due to the environmental impact. Because of this, occasional dressing of the upholstery may be required.

Shelf and tablet

- Fiber HPL
- Micro HPL
- Patina HPL
- Solid HPL
- Speckle HPL
- Textured Woodgrain HPL
- Woodgrain HPL
- Textured Industrial HPL
- Open Line laminate

Custom Surfaces

Applies to:

- Cover caps
- Front and rear cladding

PerfectMatch

PerfectMatch is a service that allows you to create your own paint color. Refer to the *Surface Materials Reference Guide* for more information about this program.

Aspect

Aspect is a high back, semi-enclosed sofa line. Aspect sofas can be connected via a screen to create semi-private working booths with power and media capabilities.
 ▶ Specifying, pages 152–166

Aspect booths are available for two, four, and six person configurations.

This product does not use glue due to environmental impact. Because of this, occasional dressing of the upholstery may be required.

Optional hanging monitor bracket holds monitors up to 32".

Legs are 8" high with glide feet adjustable up to 1/2".

Aspect sofas are available in 1-seat, 2-seat or 3-seat configurations, ranging from 41" to 87" in length.

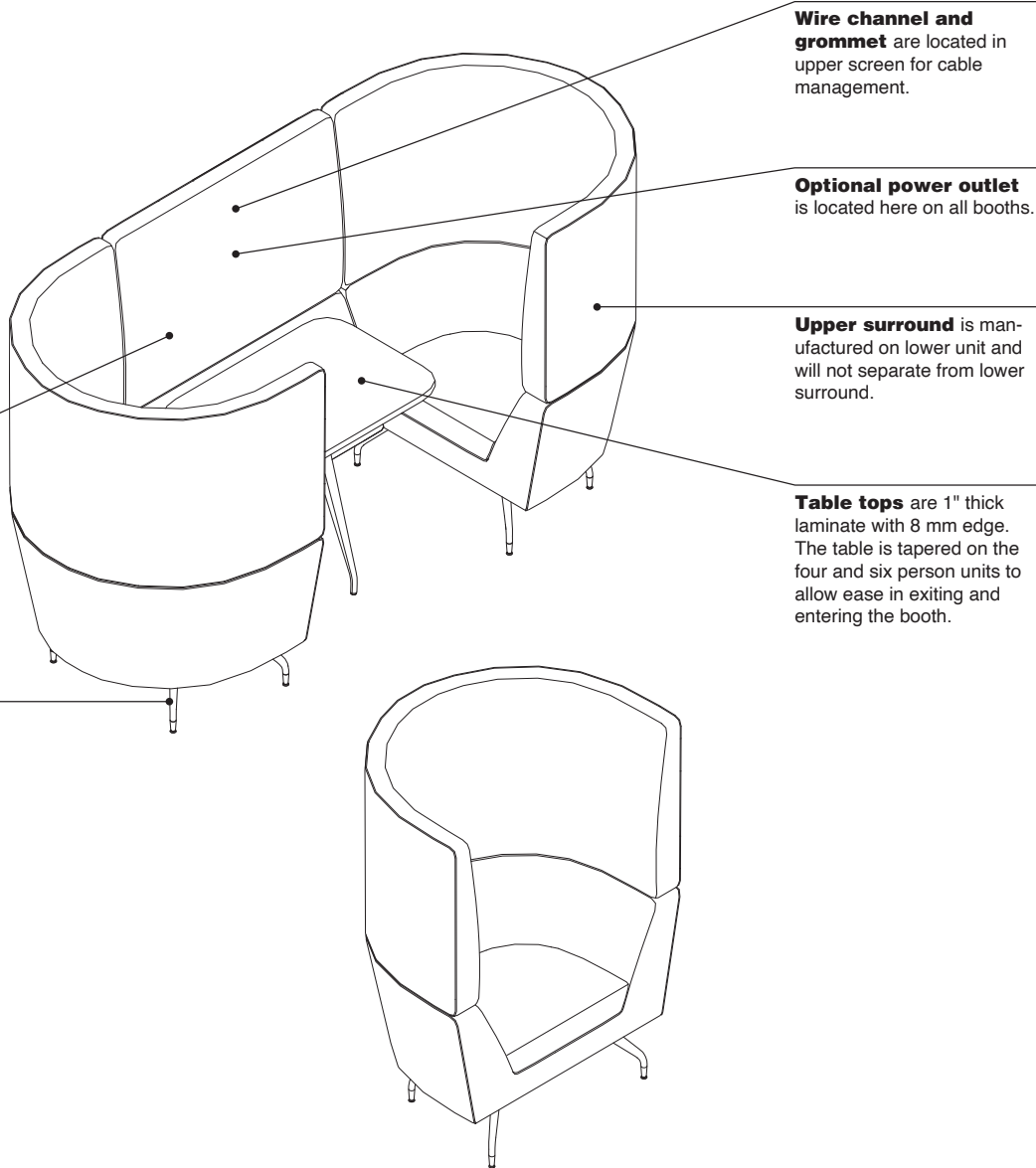

Wire channel and grommet are located in upper screen for cable management.

Optional power outlet is located here on all booths.

Upper surround is manufactured on lower unit and will not separate from lower surround.

Table tops are 1" thick laminate with 8 mm edge. The table is tapered on the four and six person units to allow ease in exiting and entering the booth.

Actual Dimensions

	Depth	Width	Height	Weight	Seat Depth	Seat Height	Width 1	Length	Width 2	Worksurface Height (to top of worksurface)	Worksurface Height (to bottom of worksurface)
Sofa											
OBASPECT07HB	29"	41"	54"	100 lb	19"	17"	N.A.	N.A.	N.A.	N.A.	N.A.
OBASPECT08HB	29"	64"	54"	131 lb	19"	17"	N.A.	N.A.	N.A.	N.A.	N.A.
OBASPECT09HB	29"	87"	54"	166 lb	19"	17"	N.A.	N.A.	N.A.	N.A.	N.A.
Booth											
OBASPECT57HB	87"	41"	54"	277 lb	19"	17"	21 ⁵ / ₈ "	21 ⁵ / ₈ "	N.A.	26 ³ / ₈ "	25 ⁵ / ₈ "
OBASPECT58HB	97"	64"	54"	371 lb	19"	17"	42 ¹ / ₄ "	31 ¹ / ₂ "	23 ⁵ / ₈ "	26 ³ / ₈ "	25 ⁵ / ₈ "
OBASPECT59HB	97"	87"	54"	457 lb	19"	17"	63"	31 ¹ / ₂ "	23 ⁵ / ₈ "	26 ³ / ₈ "	25 ⁵ / ₈ "

Product Details

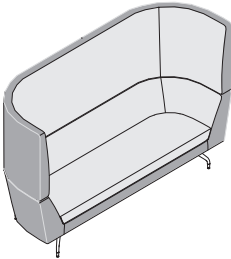

Two-tone contrasting upholstery option is available through specifying inner and outer contrasting colorways.

Tip: Inner/outer selection must stay in the same fabric family.

Patterned fabric works best when specified on the seat only. Patterns should be avoided on the upper and lower body due to predominant double stitch seams making pattern matching unachievable.

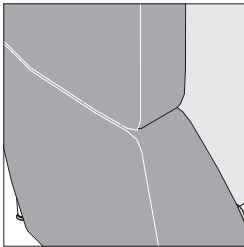

Reveal seam matches seat as standard but can match body finish or "other." Other allows specification to be independent of the seat and body finish selection.

Tip: Reveal seam not allowed to match seat when patterned.

Tip: Reveal seam may only be vinyl if body is also vinyl.

Power and Media

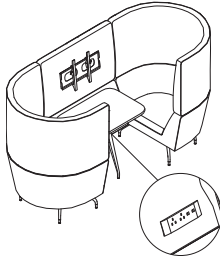

Power integrated in lower screen when optioned on media den units.

- 4 power outlets
- 2 power, 1 CAT6 data, 1 dual USB-A outlets
- 2 power, 1 CAT6 data, 1 HDMI outlets
- 2 power, 2 CAT6 data outlets

72" cord length exits through bottom of lower screen and comes fitted with a standard NEMA 5–15 plug.

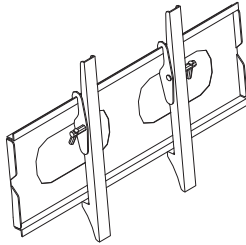

Tilting monitor brackets available as an option on media den units. Monitor bracket supports a single screen up to 32" and 44 pounds.

Wire channel and grommet are located in the upper screen for cable management.

Surface Materials

Upholstery

- Fabric
- Customer's Own Material (COM)

Tip: This product does not use glue due to the environmental impact. Because of this, occasional dressing of the upholstery may be required.

Tip: Check the COM database for approve fabrics; not all price groups may pass on Aspect.

Table tops

- Fiber HPL
- Micro HPL
- Patina HPL
- Solid HPL
- Speckle HPL
- Textured Woodgrain HPL
- Woodgrain HPL
- Textured Industrial HPL
- Open Line laminate

Legs/feet paint

- Black
- Silver
- Polished chrome

Tip: For comparable finish, please reference Steelcase standard finishes 7207 Textured Black, 4799 Platinum Metallic, 9201/9207 Polished Trivalent Chrome.

Power

- 4118 Warm Platinum
- 7015 Silk Textured
- 7207 Black

Sully, Ramsey, and Skomer

Sully, Ramsey, and Skomer are fully upholstered chairs designed to work together in small clusters or as part of larger configurations.
 ▶ Specifying, pages 170–174

This product does not use glue due to environmental impact. Because of this, occasional dressing of the upholstery may be required.

The curvature of the back is open to accommodate many body types and postures.

Casters with no brakes are standard. Casters with brakes are available. 2½" multi-directional casters are suitable for all floor types.

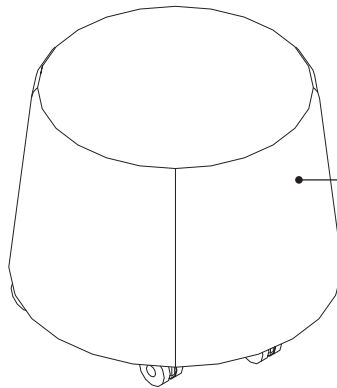

Seat height is 18", optimized to be used with most 28" tables.

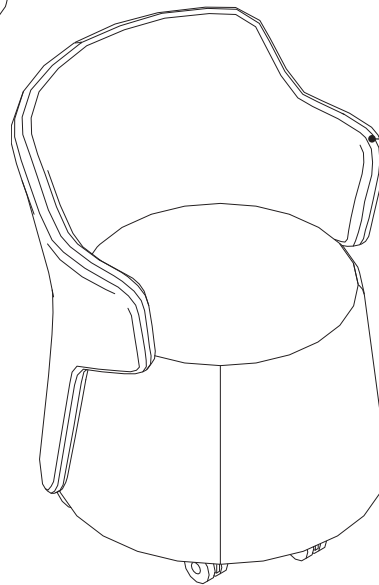
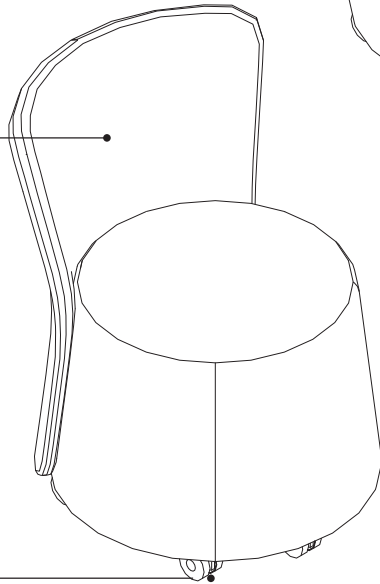

The integrated upholstered arms are designed to support the body and side sitting postures.

Actual Dimensions

	Depth	Width	Height	Weight	Seat Depth	Seat Height
OBSSULLY01	21"	21"	19"	18 lb	16"	18"
OBSSRAMSEY01	26"	23"	32"	29 lb	19"	18"
OBSSSKOMER01	26"	26"	32"	34 lb	19"	18"

Product Details

Sully is a mobile, fully upholstered ottoman.
Ramsey is a mobile, fully upholstered lounge chair.
Skomer is a mobile, fully upholstered arm chair.

Two-tone contrasting upholstery is available as an option by selecting fabric areas independently (excludes Sully).

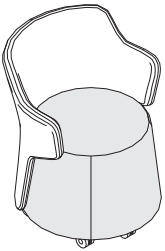

Option 1—seat and back.
Tip: If two-tone upholstered option one is selected, contrasting price groups are available. Total seat finish and back finish price is driven by highest price group selection.

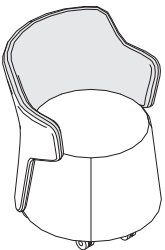

Option 2—seat and outer back with contrasting inner back.
Tip: If two-tone upholstered option two is selected, contrasting price groups are not available. Total seat and outer back finish and inner back finish must come from the same finish family.

Surface Materials

Upholstery

- Fabric
- Customer's Own Material (COM)
- Customer's Own Leather (COL)

Tip: This product does not use glue due to the environmental impact. Because of this, occasional dressing of the upholstery may be required.

Casters

- Black
- Grey

Border

Border is an upholstered bench with an attached table that transforms small vestibules, landings, and hallways into places where people gather.
 ▶ Specifying, pages 176–182

This product does not use glue due to environmental impact. Because of this, occasional dressing of the upholstery may be required.

Table top available in 32" or 40" diameter with square edge standard or tapered edge option.

Foot rail 11" high. Low units do not have foot rail.

Single seat units available with centered, left-, or right-sided tables.

Optional power is located in table base column above bench seat.

Available at seated (low, 18") and café (high, 30") bench heights.

Table top height is 42½" (low units) or 50" (high units) from the floor.

Plastic glides set unit 7/10" from floor.

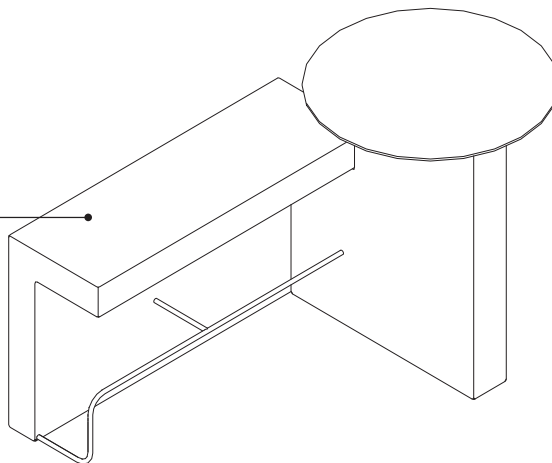
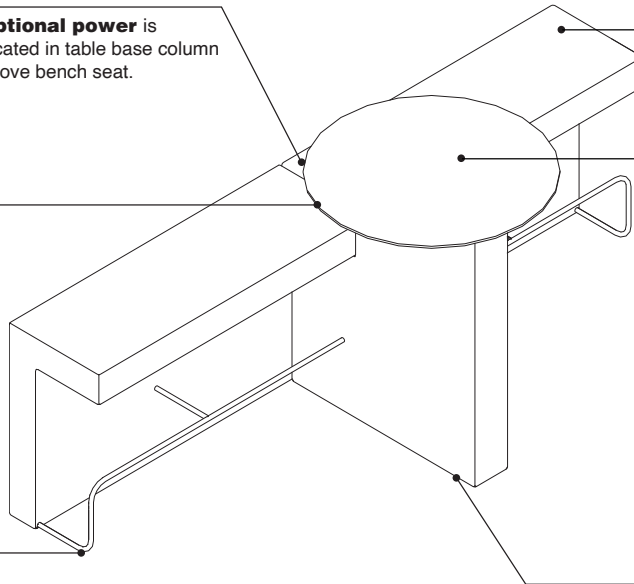

Actual Dimensions

	Description	Depth with Table	Width	Height	Weight	Seat Depth	Seat Height	Table Height
OBORDER01	Low Single, Centered Table	42½" or 50"	47"	30"	80 lb	16"	18"	30"
OBORDER02	Low Double Table	42½" or 50"	94"	30"	111 lb	16"	18"	30"
OBORDER03/ OBORDER04	High Single, Left Table High Single, Right Table	42½" or 50"	47"	42"	106 lb	16"	30"	42"
OBORDER05	High Double Table	42½" or 50"	94"	42"	146 lb	16"	30"	42"

Product Details

Border combines an upholstered bench and a worktable at both work (low) and café (high) heights. The single (one seat) units are available with a center, left, or a right sided table. The double (two seat) units have a centered table.

The chrome footrest on the high units is 11"H.

The bent design attaches from the underside of the bench with added braces for stability. The footrest is not on the low height units.

Black glides provide protection for flooring and set the unit $\frac{7}{16}$ " from the floor.

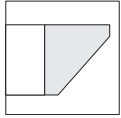
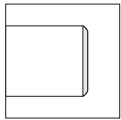

The rounded integrated table is available in 32" diameter (standard) or 40" diameter with two edge styles: square (standard) or tapered. The table surface is 1" thick HPL with a 3 mm matching edge band.

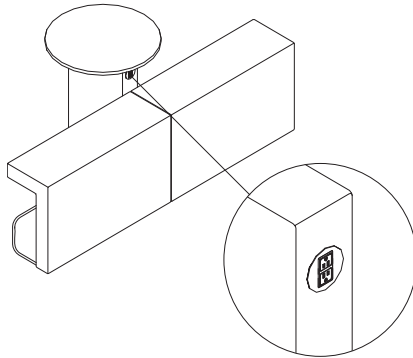

Optional power is embedded in the table base column with several module choices available. The power outlet is conveniently located on the bench side of the table base column providing easy access and is hidden from view. Power is not available in the tabletop due to the presence of a mounting plate.

The power node is available with the following operations and in multiple cover plate finish colors.

- 2 power outlets.
- 1 power, 1 dual USB-A outlets.
- 1 power, 1 HDMI outlets.
- 1 power, 1 CAT6 data outlets.

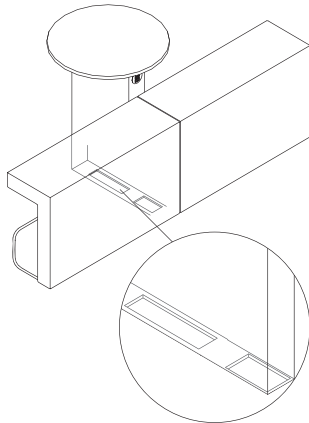

120" power cord length exits through the bottom of the table base and comes fitted with a standard NEMA 5-15 plug.

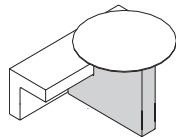

Optional contrasting upholstery can be applied to the seat and table base. The table base and seat can be different price groups. If two-tone upholstery is selected, contrasting price groups are available. Total seat finish and table base finish price is driven by highest group selection.

Surface Materials

Table tops

- Fiber HPL
- Micro HPL
- Patina HPL
- Solid HPL
- Speckle HPL
- Textured Woodgrain HPL
- Woodgrain HPL
- Textured Industrial HPL
- Open Line laminate

Upholstery

- Fabric
- Customer's Own Material (COM)
- Customer's Own Leather (COL)

Tip: This product does not use glue due to the environmental impact. Because of this, occasional dressing of the upholstery may be required.

Foot rail

- Chrome

Power

- 4118 Warm Platinum
- 7015 Silk Textured
- 7207 Black

Away from the Desk

Away from the Desk

is a soft upholstery seating system designed with comfort, work, and study.

► Specifying, pages 184–246

Patterned fabric works best when specified on either the seat or inner back. Patterns should be avoided on the outer back and screen.

Three styles are available for most components: straight seat/bench, seat and back, and seat and back with screen.

Linking brackets to secure configuration.

Optional full screens offer visual privacy and space division. Left- or right-handed tapered screens are available on most components. Screen height is 58".

Inner back designed to provide proper lumbar support. Back height is 32".

Arms with tablet surfaces available as an option.

Optional power is available on the arm, table, or table base. Specific locations are preselected. Multiple power configurations choices are available.

Glides are black and adjustable from 1" to 2".

Seat height is 19" and optimized for working at standard height tables.

Integrated HPL tables are available to attach in the center of units or at the junctions between two units. 90 and 120 degree units utilize a table based in the inner corner and specialized tables with shaped tops for the corner. Tables heights are 29".

Upholstered arms attach at the end of configurations.

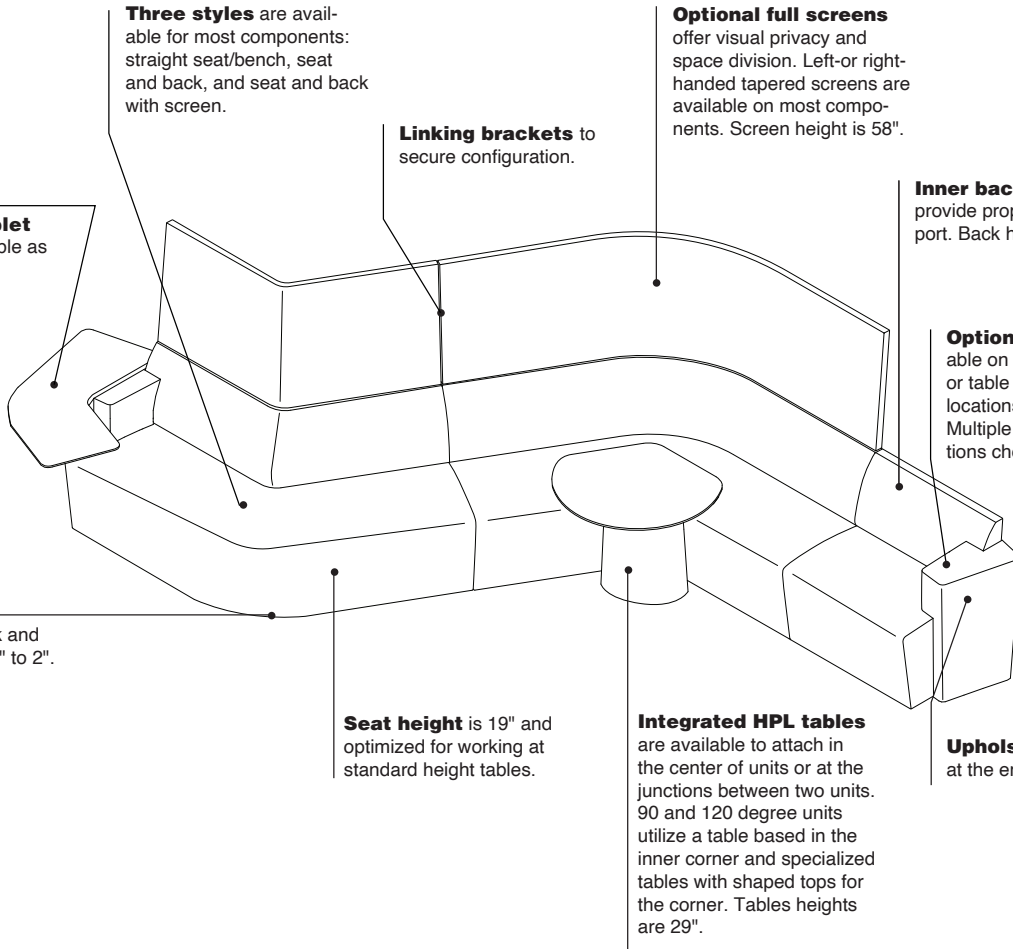

Actual Dimensions

	Description	Depth	Width	Height	Weight	Seat Depth	Seat Height
OBAD01	Str Seat-Mod, 31 1/2"W	20"	31 1/2"	19"	32 lb	20"	19"
OBAD02	Str Seat-Mod, Back, 31 1/2"W	26"	31 1/2"	32"	39 lb	20"	19"
OBAD03	Str Seat-Mod, Back, Scr, 31 1/2"W	28"	31 1/2"	58"	62 lb	20"	19"
OBAD03LC	Str Seat-Back, LH,Tprd Scr, 31 1/2"W	28"	31 1/2"	58"	59 lb	20"	19"
OBAD03RC	Str Seat-Back, RH,Tprd Scr, 31 1/2"W	28"	31 1/2"	58"	59 lb	20"	19"
OBAD11	Str Seat-Mod, 70 7/8"W	28"	71 7/8"	19"	55 lb	20"	19"
OBAD12	Str Seat-Mod, Back, 70 7/8"W	24"	71 7/8"	32"	98 lb	20"	19"
OBAD13	Str Seat-Mod, Back, Scr, 70 7/8"W	28"	71 7/8"	58"	115 lb	20"	19"
OBAD21	Seat-Mod, 120°	36"	78"	19"	71 lb	20"	19"
OBAD22	Seat-Ext back, 120°, Mod	42"	84"	32"	135 lb	20"	19"
OBAD23	Seat-Ext back, 120°, Scr, Mod	44"	86"	58"	160 lb	20"	19"
OBAD23LC	Seat-Ext back, 120°, LH, Tprd Scr, Mod	44"	85"	58"	154 lb	20"	19"
OBAD23RC	Seat-Ext back, 120°, RH, Tprd Scr, Mod	44"	85"	58"	154 lb	20"	19"
OBAD24	Seat-Intl back, 120°, Mod	41"	78"	32"	135 lb	20"	19"
OBAD25	Seat-Intl back, 120°, Scr, Mod	43"	78"	58"	160 lb	20"	19"
OBAD31	Tri Seat-Mod, 120°	68"	78"	19"	111 lb	20"	19"
OBAD32	Tri Seat-Intl back, 120°, Mod	73"	78"	32"	159 lb	20"	19"
OBAD33	Tri Seat-Intl back, 120°, Scr, Mod	74"	78"	58"	181 lb	20"	19"
OBAD42	Seat-Back, 90°, Mod	57"	57"	32"	135 lb	20"	19"
OBAD43	Seat-Back, 90°, Scr, Mod	59"	59"	58"	161 lb	20"	19"
OBAD52	Curved Seat-Back, 90°, Mod	33"	72"	32"	120 lb	20"	19"
OBAD53	Curved Seat-Back, 90°, Scr, Mod	35"	75"	58"	142 lb	20"	19"
OBAD64SRO	Lrg Uph Trpd base-Round top, Small, Wood	43"	43"	29"	78 lb	N.A.	N.A.
OBAD81DS	Media unit-Low, Top, D shaped	53"	51"	57"	100 lb	N.A.	N.A.
OBAD91SRO	Huddle buddle-Group working table, 55 1/8" dia	47"	47"	29"	100 lb	N.A.	N.A.
OBAD91LRO	Huddle buddle-Group working table, 47 1/4" dia	55"	55"	29"	111 lb	N.A.	N.A.
OBAD101	Sgl Seat-Det, Unit	26"	41"	32"	58 lb	20"	19"
OBAD101LT	Sgl Seat-Det, Unit, Int tablet, RH	36"	41"	32"	71 lb	20"	19"
OBAD101RT	Sgl Seat-Det, Unit, Scr	36"	41"	32"	71 lb	20"	19"
OBAD102	Sgl Seat-Det, Unit, Int tablet, LH	28"	45"	58"	86 lb	20"	19"
OBAD102LT	Sgl Seat-Det, Unit, Scr, Int tablet, LH	38"	45"	58"	100 lb	20"	19"
OBAD102RT	Sgl Seat-Det, Unit, Scr, Int tablet, RH	38"	45"	58"	100 lb	20"	19"
OBAD103	Three Seat-Det, Unit	26"	72"	32"	128 lb	20"	19"
OBAD85	Media den-Enclosed	90"	93"	58"	474 lb	20"	19"
OBAD85A	Media den-Enclosed, 4 to 6 ppl	59"	93"	58"	358 lb	20"	19"

► **Actual Dimensions, continued on next page**

- Tip: For **OBAD02, OBAD03, OBAD12, OBAD13, OBAD42, OBAD43, OBAD52, OBAD53**, tablet is selectable on one end only.
- Tip: **OBAD01, OBAD03LC, OBAD03RC** are not standalone units and must connect to another units as part of a larger configuration.
- Tip: **OBAD21, OBAD22, OBAD23, OBAD23LC, OBAD23RC, OBAD31, OBAD32, OBAD33** units use **AD-72 120** corner table with modified shape.
- Tip: **OBAD42** unit uses **AD-71 90** corner table with modified shape.
- Tip: The **AD62LC** or **RC** tablet option can only be specified on an **OBAD02** and **OBAD12** when it is connected to another unit and part of a larger configuration.
- Tip: **OBAD02** with tablet attached to **OBAD11** and **OBAD12** with tablet attached to **OBAD01** cannot stand alone in final configuration.

► **Actual Dimensions, continued from previous page**

Actual Dimensions, continued						
	Depth	Width	Height	Weight	Seat Depth	Seat Height
AD-61LA*	18"	11"	28"	16 lb	N.A.	N.A.
AD-61RA*	18"	11"	28"	16 lb	N.A.	N.A.
AD-62LC*	41"	31"	29"	25 lb	N.A.	N.A.
AD-62RC*	41"	31"	29"	25 lb	N.A.	N.A.
AD-71*	31"	24"	29"	23 lb	N.A.	N.A.
AD-72*	28"	31"	29"	23 lb	N.A.	N.A.

* AD-61LA, AD-61RA, AD-62LC, AD-62RC, AD-71, and AD-72 tables are not available as standalone styles. Please refer to Away from the Desk specifying pages for styles that have AD-71 and AD-72 tables available as an option.

Power and Media

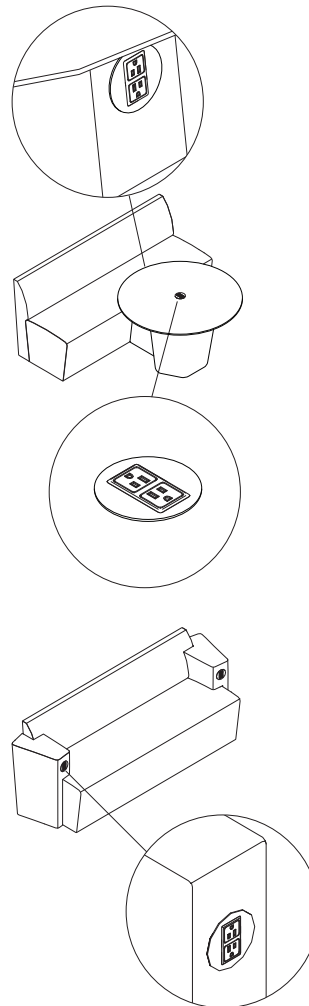

Round power modules are available as an option on table tops, table bases, and arm:

- 2 power outlets
- 1 power, 1 dual USB-A outlets
- 1 power, 1 HDMI outlets
- 1 power, 1 CAT6 data outlets

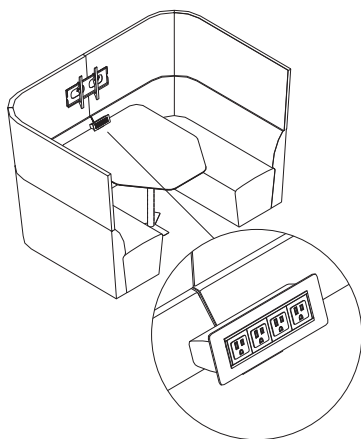

Table mounted power is available as an option for booth style numbers:

- 4 power outlets
- 2 power, 1 CAT6 data, 1 dual USB-A outlets
- 2 power, 1 CAT6 data, 1 HDMI outlets
- 2 power, 2 CAT6 data outlets

120" cord length exits through base of the tables and arms and comes fitted with a standard NEMA 5-15 plug.

Tilting monitor brackets available as an option on media den units. Monitor bracket supports a single screen up to 32" and 44 pounds.

Application Topics

Handedness of units and connection points are determined based on the user sitting position.

Arms can only connect to the outer most ends of a configuration.

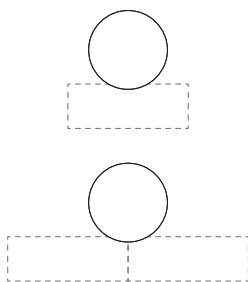

Tables can connect to the center of a single unit or at the junction between units.

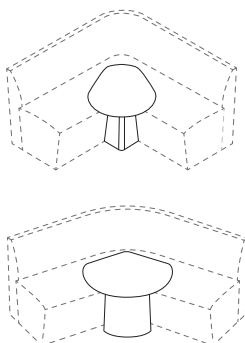

Dedicated tables AD-71 and AD-72 can only be specified for use with 90° and 120° units respectively.

Surface Materials

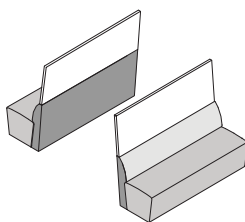

Contrasting upholstery option possible through specifying each surface independently.

The four main upholstery surfaces are:

- Seat
- Backrest inner
- Backrest outer
- Screen

Patterned fabric works best when specified on the seat or inner back only. Patterns should be avoided on the outer back and screen due to predominant double stitch seams making pattern matching unachievable.

Away from the Desk is upholstered utilizing the width of fabric rolls. This means when a pattern is specified it will always lie railroad.

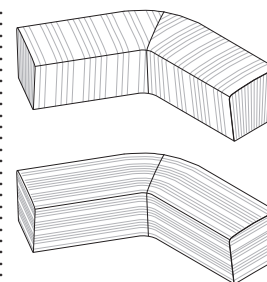

The use of patterned fabrics on curved units may result in the "chevron effect". This effect is apparent at the seam of two fabric panels that run in different directions.

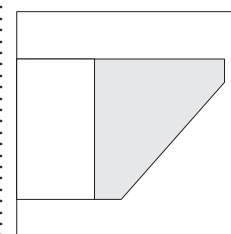

Edge profile is tapered as standard on tables and tablets.

Table tops

- Fiber HPL
- Micro HPL
- Patina HPL
- Solid HPL
- Speckle HPL
- Textured Woodgrain HPL
- Woodgrain HPL
- Textured Industrial HPL
- Open Line laminate

Upholstery

- Fabric
 - Customer's Own Material (COM)
- Tip: This product does not use glue due to the environmental impact. Because of this, occasional dressing of the upholstery may be required.*

Power

- 4118 Warm Platinum
- 7015 Silk Textured
- 7207 Black

Cubb Seating

Cubb seating is available in four bases with a single upholstered seat and three arm options.
 ▶ Specifying, pages 248–261

Upholstered arms are 7.4" above the seat.

Wood legs made of solid white oak with glides.

Metal chassis secure legs to each other as well as seat shell.

Wire arms designed to complement wire frame base. Wire frame arms are 7.2" (183 mm) above the seat.

Wire frame arms are 1/2" tubular steel.

Wire frame sled base is 1/2" tubular steel with plastic glides suitable for all surfaces. Available in both chair and stool heights.

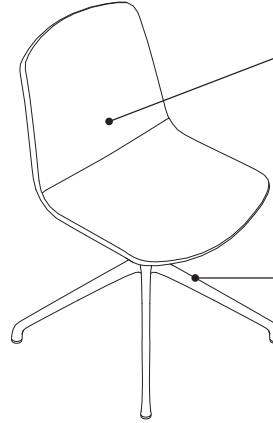
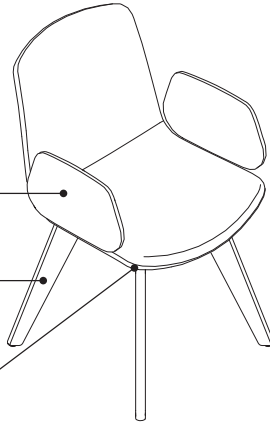

Seat shell is gently curved, offering integrated lumbar support.

4-star trestle base swivels 360° with hard glides as standard. Soft glides available.

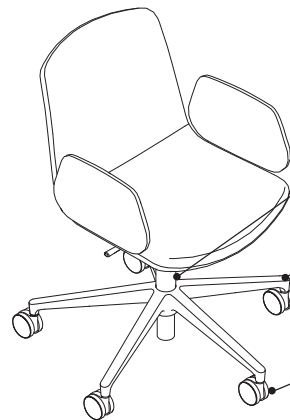
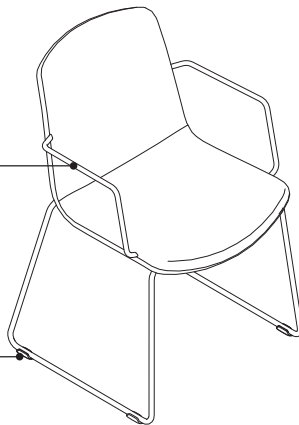

Gas lift allows for travel up to 5" of seat height adjustment.

5-arm base swivels 360° with hard casters for use on carpet are standard. Soft casters are available.

Casters are 2 1/2" in diameter. Hard casters for use on carpet as standard.

Actual Dimensions

	Description	Depth	Width	Height	Weight	Seat Depth	Seat Height
OBCUBB01	Wood Base, Armless	18"	19"	33"	20 lb	16"	19"
OBCUBB02	Wood Base, Uph Arm	18"	21"	33"	26 lb	16"	19"
OBCUBB03	Wood Base, Wire Arm	18"	21"	33"	22 lb	16"	19"
OBCUBB04	Trestle Base, Armless	22"	19"	33"	19 lb	16"	19"
OBCUBB05	Trestle Base, Uph Arm	22"	21"	33"	27 lb	16"	19"
OBCUBB06	Trestle Base, Wire Arm	22"	21"	33"	20 lb	16"	19"
OBCUBB07	Wire Frame Sled, Armless	22"	19"	33"	19 lb	16"	19"
OBCUBB08	Wire Frame Sled, Uph Arm	22"	21"	33"	25 lb	16"	19"
OBCUBB09	Wire Frame Sled, Wire Frame Arm	22"	21"	33"	20 lb	16"	19"
OBCUBB10	5-Arm Base, Armless	26"	26"	30"–35"	25 lb	16"	17"–22"
OBCUBB11	5-Arm Base, Uph Arm	26"	26"	30"–35"	31 lb	16"	17"–22"
OBCUBB12	5-Arm Base, Wire Frame Arm	26"	26"	30"–35"	26 lb	16"	17"–22"
OBCUBB13	Wood Base Bar Stool	19"	18"	39"	21 lb	15"	30"
OBCUBB14	Wire Frame Sled Bar Stool	20"	20"	39"	21 lb	15"	30"
OBCUBB15	3-Leg Wood Base Occasional Stool	17"	18"	19"	10 lb	17"	19"
OBCUBB19	Wood Leg 2-Seat Upholstered Bench	16"	51"	19"	27 lb	16"	19"

Product Details

Cubb seating utilizes the same core seat with a combination of two arm options and four base styles.

Cubb seating comes fully assembled and does not stack.

All chair seating has a seat height of 19" optimized to work with standard height tables.

Stools have a seat height of 30".

Both the trestle and five-star base options swivel 360°.

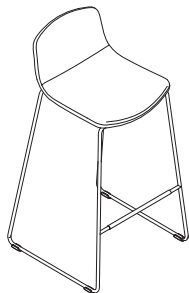
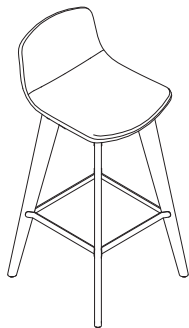

Featuring a modified back and seat without arms, the fully upholstered Cubb Stools are available in both the wood leg and wire frame base.

Cubb stools have a 30" seat height from the floor and are 39" tall overall.

A foot rail cover is available as an option on wire base stool. The foot rail cover is made of black PVC.

On the wood stool, the foot rail finish will match that of under seat chassis.



The occasional stool features three tapered solid oak wood legs with an upholstered cushion top. It has a seated height of 19".

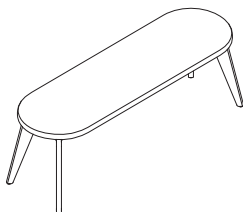

The two-seat bench has four tapered solid oak wood legs with an upholstered oval shaped top. It has a seated height of 19".

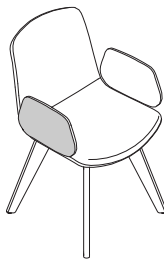

Two-tone contrasting upholstery option is available.

Tip: If two-tone upholstered option is selected, contrasting price groups are available. Total seat finish and outer seat finish price is driven by highest price group selection.

Surface Materials

Upholstery

- Fabric
- Customer's Own Material (COM)
- Customer's Own Leather (COL)

Wood leg base

- 31WK Medium Walnut on Oak
- 3652 Dark Distressed Oak Stain
- V3AK Natural Oak
- VP03 Black Oak

Metal chassis

- Accent paint
- Accessory paint
- Smooth metallic
- Smooth paint
- Textured paint
- Textured metallic

Wire frame base

- Accent paint
- Accessory paint
- Polished chrome
- Smooth metallic
- Smooth paint
- Textured paint
- Textured metallic
- Lux coatings

Trestle base

- Black
- Polished chrome

5-Star base

- Black
- Polished chrome

Wire arms

- Accent paint
- Accessory paint
- Smooth metallic
- Smooth paint
- Textured paint
- Textured metallic

Tip: Wire arms will always match finish of base when base is trestle or five-star.

Applies to:

- Metal chassis
- Wire frame base
- Wire arms

Custom Surfaces

Perfect Match

PerfectMatch is a service that allows you to create your own paint color. Refer to the *Surface Materials Reference Guide* for more information about this program.

Cubb Tables

Cubb tables are a distinctive range of meeting and project tables with a laid-back, informal feel—great for any environment.

► Specifying, pages 264–284

Meeting tables sit 29"H and are available in widths ranging from 35" to 177".

Worksurface available with tapered edge detail as standard.

Metal chassis secure legs to each other as well as worksurface.

Project tables stand 41³/₈"H and are available at 63", 82¹/₁₆", or 102³/₈"W.

Footrail designed to match the finish of the metal chassis.

Leg channel allows for cables to be managed seamlessly through any leg.

Cables provide additional stability and support.

Actual Dimensions

	Depth	Width	Height	Weight
OBCUBBRCM01	30"	56"	30"	70 lb
OBCUBBRCM02	30"	63"	30"	78 lb
OBCUBBRCM03	40"	83"	30"	121 lb
OBCUBBRCM04	40"	95"	30"	138 lb
OBCUBBRCM05	48"	119"	30"	198 lb
OBCUBBRCM07	48"	178"	30"	289 lb
OBCUBBRCM09	56"	119"	30"	222 lb
OBCUBBRCM11	56"	178"	30"	325 lb
OBCUBBRCP01	48"	24"	18"	43 lb
OBCUBBRCP01	36"	63"	42"	113 lb
OBCUBBRCP02	36"	83"	42"	139 lb
OBCUBBRCP03	36"	103"	42"	166 lb
OBCUBBRDM01	48"	48"	30"	70 lb
OBCUBBRDM02	56"	56"	30"	88 lb
OBCUBBRDM03	63"	63"	30"	109 lb
OBCUBBRDM04	71"	71"	30"	137 lb
OBCUBBRDO01	27"	27"	18"	19 lb
OBCUBBRDO02	32"	32"	18"	37 lb
OBCUBBSQM01	36"	36"	30"	57 lb
OBCUBBSQO01	24"	24"	18"	24 lb
OBCUBBSSM01	36"	36"	30"	57 lb

Product Details

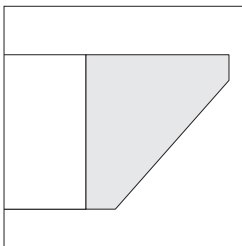

Edge profile is tapered as standard.

Integrated power available in all meeting and project table worksurfaces. All power cords are 10' long and available with either a standard three prong NEMA plug or hardwire.

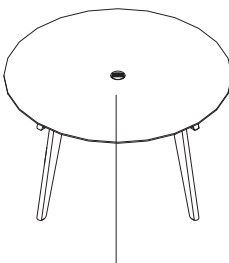

Round meeting tables

can accept a single centrally located round face power unit in the following configurations:

- 2 power outlets
- 1 power, 1 USB A+C outlets

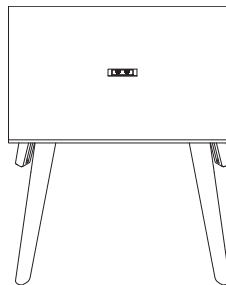
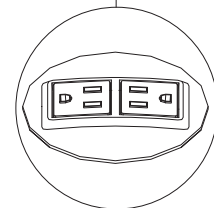

Square meeting tables

can accept a centrally located rectangular face power unit in the following configurations:

- 2 power outlets
- 1 power, 1 USB A+C outlets

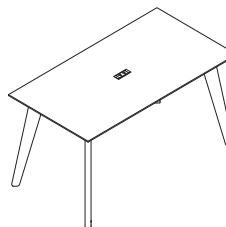

Small, rectangular meeting tables

can accept a centrally located rectangular face power unit in the following configurations:

- 2 power outlets
- 1 power, 1 USB A+C outlets
- 3 power, 1 USB A+C outlets
- 2 power, 2 USB A+C outlets
- 3 power, 1 USB-C outlets

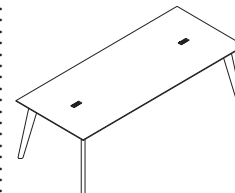

Medium and large rectangular meeting tables

can accept multiple rectangular face power units in the following configurations:

- 2 power outlets
- 1 power, 1 USB A+C outlets
- 3 power, 1 USB A+C outlets
- 2 power, 2 USB A+C outlets
- 3 power, 1 USB-C outlets

Cubb Tables, continued



Center only



Left and center



Left and right

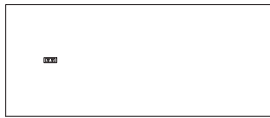

Left only

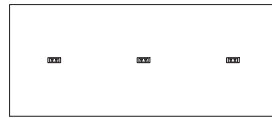

Left, right and center

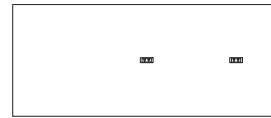

Center and right



Right only

When multiple power units are specified, power location can be left, right, or center of the table.
Tip: Location and quantity allowed is dependent on the style number.

Wiring and Cabling

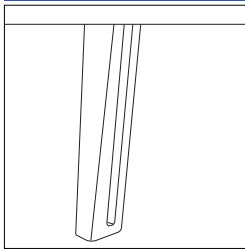

Wood legs designed with a channel for seamless cable management. Each leg come standard with a channel and rubber riser insert (black).

When multiple power units per table are specified, Interlink daisy chaining will come standard with a single plug located at the end of the configuration.

Multiple hardwire power units per table do not daisy chain and require independent connections.

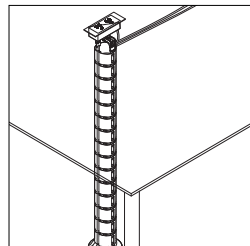
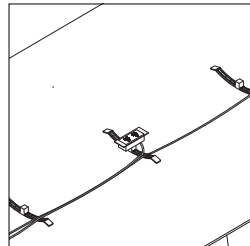

Additional cable management options are available through specification of a set of cable clips or a vertical cable carrier, AHCC.

Surface Materials

Worksurface

- Fiber LPL
- Solid LPL
- Woodgrain LPL
- Fiber HPL
- Micro HPL
- Patina HPL
- Solid HPL
- Speckle HPL
- Textured Woodgrain HPL
- Woodgrain HPL
- Textured Industrial HPL
- Open Line laminate



Woodgrain laminate on single-piece tables will always be oriented at 0° with the grain direction running parallel with the length of the table top.



Woodgrain laminate on multi-piece tables will always be oriented at 90° with the grain direction running perpendicular with the length of the table top.

Woodgrain laminates cannot be grain matched.

Wood leg base

- 31WK Medium Walnut on Oak
- 3652 Dark Distressed Oak Stain
- V3AK Natural Oak
- VP03 Black Oak

Metal chassis

- Accent paint
- Accessory paint
- Smooth metallic
- Smooth paint
- Textured paint
- Textured metallic

Tip: Project table foot rail will always match finish of the chassis finish.

Power

- 0835 Black
- 4242 Milk
- 4799 Platinum
- 7360 Merle

Applies to:
 • Metal chassis

Custom Surfaces

Perfect Match

PerfectMatch is a service that allows you to create your own paint color Refer to the *Surface Materials Reference Guide* for more information about this program.

Specifying

Air³	
Acoustic Pods	56
Air³ Tables	62
Accessories	64
Campers & Dens	
Campers	66
Kinks	126
Cabin	130
Awning	132
Hacking	134
Tables	137
Monitor Brackets and Kits	138
Seating	140
On the QT	
Phone Booths	142
Seating	150
Seating	
Aspect	
Work Unit with Curved Arm	152
Work Screened Units with Fixed Table	158
Sully, Skomer, and Ramsey	170
Border	176
Away from the Desk	
Seating	184
Tables	234
Detached Seating	238
Media Dens	244
Cubb Seating and Tables	
Seating	248
Tables	264

Air³ Half-Square with Opening Roof

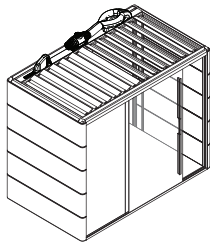

Tip: All Air³ models must be installed by Orangebox certified installers or warranty is void.

	Standard Includes	Required to Specify
▶ Need help? Product details, page 16	<ul style="list-style-type: none"> One service hoop: <ul style="list-style-type: none"> three NEMA 5-15 3-prong power outlets three LED lights heat detector occupancy sensor user control panel 10 exterior fabric panels: one grommet 10 interior fabric panels Five glass panels (clear): <ul style="list-style-type: none"> one 85⁷/₁₆" x 26³/₄" four 85⁷/₁₆" x 34³/₈" One 86³/₁₆" x 45¹¹/₁₆" glass sliding door: clear One air circulation fan Two louvered roof ceiling squares: aluminum roof blades (grey) 	<ol style="list-style-type: none"> Style number Fabric color number for exterior panels Fabric color number for interior panels Options, if selected (see below) <p>▶ See Product Understanding for Surface Materials.</p>

	Options	U.S. Price	Required to Specify
Internal Fabric	Single grade (for all five layers)		
	<ul style="list-style-type: none"> Grade 2 Grade 3 Grade 4 Grade 5 Grade 6 Grade 7 Grade 8 Grade 9 Grade 10 	<ul style="list-style-type: none"> +\$ 940 +\$1170 +\$1490 +\$1985 +\$2605 +\$3185 +\$3705 +\$4815 +\$6065 	<ul style="list-style-type: none"> Specify with grade 2 internal fabric. Specify with grade 3 internal fabric. Specify with grade 4 internal fabric. Specify with grade 5 internal fabric. Specify with grade 6 internal fabric. Specify with grade 7 internal fabric. Specify with grade 8 internal fabric. Specify with grade 9 internal fabric. Specify with grade 10 internal fabric.
External Fabric	Layered grade (per layer)		
	<ul style="list-style-type: none"> Grade 2 layer Grade 3 layer Grade 4 layer Grade 5 layer Grade 6 layer Grade 7 layer Grade 8 layer Grade 9 layer Grade 10 layer 	<ul style="list-style-type: none"> +\$ 188 +\$ 234 +\$ 298 +\$ 397 +\$ 521 +\$ 637 +\$ 741 +\$ 963 +\$1213 	<ul style="list-style-type: none"> Specify with grade 2 layer. Specify with grade 3 layer. Specify with grade 4 layer. Specify with grade 5 layer. Specify with grade 6 layer. Specify with grade 7 layer. Specify with grade 8 layer. Specify with grade 9 layer. Specify with grade 10 layer.
Internal Fabric	Single grade (for all five layers)		
	<ul style="list-style-type: none"> Grade 2 Grade 3 Grade 4 Grade 5 Grade 6 Grade 7 Grade 8 Grade 9 Grade 10 	<ul style="list-style-type: none"> +\$1250 +\$1555 +\$1970 +\$2640 +\$3460 +\$4240 +\$4930 +\$6410 +\$8075 	<ul style="list-style-type: none"> Specify with grade 2 external fabric. Specify with grade 3 external fabric. Specify with grade 4 external fabric. Specify with grade 5 external fabric. Specify with grade 6 external fabric. Specify with grade 7 external fabric. Specify with grade 8 external fabric. Specify with grade 9 external fabric. Specify with grade 10 external fabric.
External Fabric	Layered grade (per layer)		
	<ul style="list-style-type: none"> Grade 2 layer Grade 3 layer Grade 4 layer Grade 5 layer Grade 6 layer Grade 7 layer Grade 8 layer Grade 9 layer Grade 10 layer 	<ul style="list-style-type: none"> +\$ 250 +\$ 311 +\$ 394 +\$ 528 +\$ 692 +\$ 848 +\$ 986 +\$1282 +\$1615 	<ul style="list-style-type: none"> Specify with grade 2 layer. Specify with grade 3 layer. Specify with grade 4 layer. Specify with grade 5 layer. Specify with grade 6 layer. Specify with grade 7 layer. Specify with grade 8 layer. Specify with grade 9 layer. Specify with grade 10 layer.

▶ Options, continued on next page



For Canadian Pricing
Multiply U.S. Price by the Canadian price factor.
▶ See page 1 for details.

► Options, continued from previous page

	Options	U.S. Price	Required to Specify
Over Upholstery Fixed Monitor Bracket	• No over upholstery monitor bracket	No cost	Specify with no over upholstery monitor bracket.
	• Over upholstery fixed monitor bracket	+\$1379	Specify with over upholstery fixed monitor bracket.
	• Two over upholstery fixed monitor bracket	+\$2758	Specify with two over upholstery fixed monitor bracket.
Whiteboard	• No whiteboard	No cost	Specify with no whiteboard.
	• Straight glass magnetic whiteboard	+\$3436	Specify with straight glass magnetic whiteboard.
	• Two straight glass magnetic whiteboards	+\$6872	Specify with two straight glass magnetic whiteboards.
Door Size	• Standard door size	No cost	Specify with standard door size.
	• Ontario AODA compliant door	+\$5795	Specify with Ontario AODA compliant door.

Specification Information

Style Number	U.S. Base Price
OB1AIR23	\$51,288

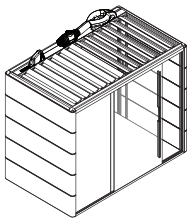

Specifying

 **For Canadian Pricing**
Multiply U.S. Price by the Canadian price factor.
► See page 1 for details.

Air³ Square with Opening Roof

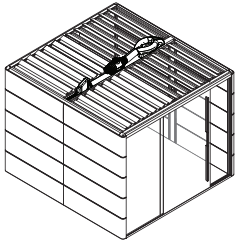

Tip: All Air³ models must be installed by Orangebox certified installers or warranty is void.

Standard Includes	Required to Specify
<ul style="list-style-type: none"> ▶ Need help? Product details, page 16 • One service hoop: <ul style="list-style-type: none"> – three NEMA 5-15 3-prong power outlets – three LED lights – heat detector – occupancy sensor – user control panel • 20 exterior fabric panels: one grommet • 20 interior fabric panels • Five glass panels (clear): <ul style="list-style-type: none"> – one 85⁷/₁₆" x 26³/₄" – four 85⁷/₁₆" x 34³/₈" • One 86³/₁₆" x 45¹¹/₁₆" glass sliding door: clear • One air circulation fan • Four louvered roof ceiling squares: aluminum roof blades (grey) 	<ul style="list-style-type: none"> 1 Style number 2 Fabric color number for exterior panels 3 Fabric color number for interior panels 4 Options, if selected (see below) ▶ See Product Understanding for Surface Materials.

Options	U.S. Price	Required to Specify
Internal Fabric		
Single grade (for all five layers)		
• Grade 2	+\$ 1855	Specify with grade 2 internal fabric.
• Grade 3	+\$ 2320	Specify with grade 3 internal fabric.
• Grade 4	+\$ 2915	Specify with grade 4 internal fabric.
• Grade 5	+\$ 3890	Specify with grade 5 internal fabric.
• Grade 6	+\$ 5045	Specify with grade 6 internal fabric.
• Grade 7	+\$ 6215	Specify with grade 7 internal fabric.
• Grade 8	+\$ 7220	Specify with grade 8 internal fabric.
• Grade 9	+\$ 9390	Specify with grade 9 internal fabric.
• Grade 10	+\$11,830	Specify with grade 10 internal fabric.
Layered grade (per layer)		
• Grade 2 layer	+\$ 371	Specify with grade 2 layer.
• Grade 3 layer	+\$ 464	Specify with grade 3 layer.
• Grade 4 layer	+\$ 583	Specify with grade 4 layer.
• Grade 5 layer	+\$ 778	Specify with grade 5 layer.
• Grade 6 layer	+\$ 1009	Specify with grade 6 layer.
• Grade 7 layer	+\$ 1243	Specify with grade 7 layer.
• Grade 8 layer	+\$ 1444	Specify with grade 8 layer.
• Grade 9 layer	+\$ 1878	Specify with grade 9 layer.
• Grade 10 layer	+\$ 2366	Specify with grade 10 layer.
External Fabric		
Single grade (for all five layers)		
• Grade 2	+\$ 2395	Specify with grade 2 external fabric.
• Grade 3	+\$ 2995	Specify with grade 3 external fabric.
• Grade 4	+\$ 3735	Specify with grade 4 external fabric.
• Grade 5	+\$ 4910	Specify with grade 5 external fabric.
• Grade 6	+\$ 6310	Specify with grade 6 external fabric.
• Grade 7	+\$ 7690	Specify with grade 7 external fabric.
• Grade 8	+\$ 8945	Specify with grade 8 external fabric.
• Grade 9	+\$11,630	Specify with grade 9 external fabric.
• Grade 10	+\$14,655	Specify with grade 10 external fabric.
Layered grade (per layer)		
• Grade 2 layer	+\$ 479	Specify with grade 2 layer.
• Grade 3 layer	+\$ 599	Specify with grade 3 layer.
• Grade 4 layer	+\$ 747	Specify with grade 4 layer.
• Grade 5 layer	+\$ 982	Specify with grade 5 layer.
• Grade 6 layer	+\$ 1262	Specify with grade 6 layer.
• Grade 7 layer	+\$ 1538	Specify with grade 7 layer.
• Grade 8 layer	+\$ 1789	Specify with grade 8 layer.
• Grade 9 layer	+\$ 2326	Specify with grade 9 layer.
• Grade 10 layer	+\$ 2931	Specify with grade 10 layer.

▶ Options, continued on next page



For Canadian Pricing
 Multiply U.S. Price by the Canadian price factor.
 ▶ See page 1 for details.

► Options, continued from previous page

Options	U.S. Price	Required to Specify	
Hoop Mounted Monitor Bracket	• No hoop mounted monitor bracket	No cost	Specify with no hoop mounted monitor bracket.
	• Hoop mounted fixed Monitor bracket	+\$ 891	Specify with hoop mounted fixed monitor bracket.
Over Upholstery Fixed Monitor Bracket	• No over upholstery monitor bracket	No cost	Specify with no over upholstery monitor bracket.
	• Over upholstery fixed monitor bracket	+\$ 1379	Specify with over upholstery fixed monitor bracket.
	• Two over upholstery fixed monitor bracket	+\$ 2758	Specify with two over upholstery fixed monitor bracket.
	• Three over upholstery fixed monitor bracket	+\$ 4137	Specify with three over upholstery fixed monitor bracket.
	• Four over upholstery fixed monitor bracket	+\$ 5516	Specify with four over upholstery fixed monitor bracket.
Whiteboard	• No whiteboard	No cost	Specify with no whiteboard.
	• Straight glass magnetic whiteboard	+\$ 3436	Specify with straight glass magnetic whiteboard.
	• Two straight glass magnetic whiteboards	+\$ 6872	Specify with two straight glass magnetic whiteboard.
	• Three straight glass magnetic whiteboards	+\$10,308	Specify with three straight glass magnetic whiteboard.
	• Four straight glass magnetic whiteboards	+\$13,744	Specify with four straight glass magnetic whiteboard.
Door Size	• Standard door size	No cost	Specify with standard door size.
	• Ontario AODA compliant door	+\$ 5795	Specify with Ontario AODA compliant door.

Specification Information

Style Number	U.S. Base Price
OB1AIR25	\$63,244

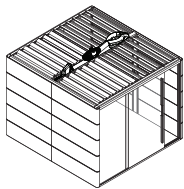

Specifying

 **For Canadian Pricing**
Multiply U.S. Price by the
Canadian price factor.
► See page 1 for details.

Air³ Rectangle with Opening Roof

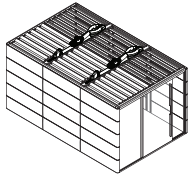

Tip: All Air³ models must be installed by Orangebox certified installers or warranty is void.

Standard Includes	Required to Specify
<ul style="list-style-type: none"> ▶ Need help? Product details, page 16 • Two service hoop: <ul style="list-style-type: none"> – three NEMA 5-15 3-prong power outlets – three LED lights – heat detector – occupancy sensor – user control panel • 30 exterior fabric panels: one grommet • 30 interior fabric panels • Five glass panels (clear): <ul style="list-style-type: none"> – one 85⁷/₁₆" x 26³/₄" – four 85⁷/₁₆" x 34³/₈" • One 86³/₁₆" x 45¹¹/₁₆" glass sliding door: clear • Two air circulation fan • Six louvered roof ceiling squares: aluminum roof blades (grey) 	<ul style="list-style-type: none"> 1 Style number 2 Fabric color number for exterior panels 3 Fabric color number for interior panels 4 Options, if selected (see below) ▶ See Product Understanding for Surface Materials.

Options	U.S. Price	Required to Specify
Internal Fabric		
Single grade (for all five layers)		
• Grade 2	+\$ 2680	Specify with grade 2 internal fabric.
• Grade 3	+\$ 3350	Specify with grade 3 internal fabric.
• Grade 4	+\$ 4215	Specify with grade 4 internal fabric.
• Grade 5	+\$ 5600	Specify with grade 5 internal fabric.
• Grade 6	+\$ 7350	Specify with grade 6 internal fabric.
• Grade 7	+\$ 8945	Specify with grade 7 internal fabric.
• Grade 8	+\$10,400	Specify with grade 8 internal fabric.
• Grade 9	+\$13,525	Specify with grade 9 internal fabric.
• Grade 10	+\$17,040	Specify with grade 10 internal fabric.
Layered grade (per layer)		
• Grade 2 layer	+\$ 536	Specify with grade 2 layer.
• Grade 3 layer	+\$ 670	Specify with grade 3 layer.
• Grade 4 layer	+\$ 843	Specify with grade 4 layer.
• Grade 5 layer	+\$ 1120	Specify with grade 5 layer.
• Grade 6 layer	+\$ 1470	Specify with grade 6 layer.
• Grade 7 layer	+\$ 1789	Specify with grade 7 layer.
• Grade 8 layer	+\$ 2080	Specify with grade 8 layer.
• Grade 9 layer	+\$ 2705	Specify with grade 9 layer.
• Grade 10 layer	+\$ 3408	Specify with grade 10 layer.
External Fabric		
Single grade (for all five layers)		
• Grade 2	+\$ 3185	Specify with grade 2 external fabric.
• Grade 3	+\$ 3985	Specify with grade 3 external fabric.
• Grade 4	+\$ 5000	Specify with grade 4 external fabric.
• Grade 5	+\$ 6660	Specify with grade 5 external fabric.
• Grade 6	+\$ 8645	Specify with grade 6 external fabric.
• Grade 7	+\$10,620	Specify with grade 7 external fabric.
• Grade 8	+\$12,350	Specify with grade 8 external fabric.
• Grade 9	+\$16,050	Specify with grade 9 external fabric.
• Grade 10	+\$20,230	Specify with grade 10 external fabric.
Layered grade (per layer)		
• Grade 2 layer	+\$ 637	Specify with grade 2 layer.
• Grade 3 layer	+\$ 797	Specify with grade 3 layer.
• Grade 4 layer	+\$ 1000	Specify with grade 4 layer.
• Grade 5 layer	+\$ 1332	Specify with grade 5 layer.
• Grade 6 layer	+\$ 1729	Specify with grade 6 layer.
• Grade 7 layer	+\$ 2124	Specify with grade 7 layer.
• Grade 8 layer	+\$ 2470	Specify with grade 8 layer.
• Grade 9 layer	+\$ 3210	Specify with grade 9 layer.
• Grade 10 layer	+\$ 4046	Specify with grade 10 layer.

▶ Options, continued on next page



For Canadian Pricing
Multiply U.S. Price by the Canadian price factor.
▶ See page 1 for details.

► Options, continued from previous page

Options	U.S. Price	Required to Specify
Hoop Mounted Monitor Bracket		
• No hoop mounted monitor bracket	No cost	Specify with no hoop mounted monitor bracket.
• Hoop mounted fixed monitor bracket	+\$ 891	Specify with hoop mounted fixed monitor bracket.
• Two hoop mounted fixed monitor bracket	+\$ 1782	Specify with two hoop mounted fixed monitor bracket.
Over Upholstery Fixed Monitor Bracket		
• No over upholstery monitor bracket	No cost	Specify with no over upholstery monitor bracket.
• Over upholstery fixed monitor bracket	+\$ 1379	Specify with over upholstery fixed monitor bracket.
• Two over upholstery fixed monitor bracket	+\$ 2758	Specify with two over upholstery fixed monitor bracket.
• Three over upholstery fixed monitor bracket	+\$ 4137	Specify with three over upholstery fixed monitor bracket.
• Four over upholstery fixed monitor bracket	+\$ 5516	Specify with four over upholstery fixed monitor bracket.
• Five over upholstery fixed monitor bracket	+\$ 6895	Specify with five over upholstery fixed monitor bracket.
• Six over upholstery fixed monitor bracket	+\$ 8274	Specify with six over upholstery fixed monitor bracket.
Whiteboard		
• No whiteboard	No cost	Specify with no whiteboard.
• Straight glass magnetic whiteboard	+\$ 3436	Specify with straight glass magnetic whiteboard.
• Two straight glass magnetic whiteboards	+\$ 6872	Specify with two straight glass magnetic whiteboard.
• Three straight glass magnetic whiteboards	+\$10,308	Specify with three straight glass magnetic whiteboard.
• Four straight glass magnetic whiteboards	+\$13,744	Specify with four straight glass magnetic whiteboard.
• Five straight glass magnetic whiteboards	+\$17,180	Specify with five straight glass magnetic whiteboard.
• Six straight glass magnetic whiteboards	+\$20,616	Specify with six straight glass magnetic whiteboard.
Door Size		
• Standard door size	No cost	Specify with standard door size.
• Ontario AODA compliant door	+\$ 5795	Specify with Ontario AODA compliant door.

Specifying

Specification Information

Style Number	U.S. Base Price
OB1AIR27	\$96,232
.	.
.	.

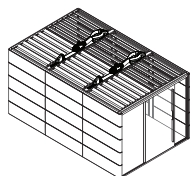

 **For Canadian Pricing**
Multiply U.S. Price by the Canadian price factor.
► See page 1 for details.

Air³ Tables

Air³ Small Pod Table

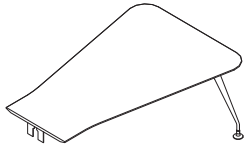

Tip: Recommended for use in **OB1AIR25**.

Standard Includes	Required to Specify
<ul style="list-style-type: none"> ▶ Need help? Product details, page 16 • 1" thick table top: High-Pressure Laminate price group 1 • 3 mm edgeband: plastic price group 1 • Two legs with feet: paint • Attachment bracket with hardware 	<ol style="list-style-type: none"> 1 Style number 2 High-Pressure Laminate color number for top 3 Plastic color number for edgeband 4 Paint color number for leg 5 Options, if selected (see below) <ul style="list-style-type: none"> ▶ See Product Understanding for Surface Materials.

Surface Materials	Options	U.S. Price	Required to Specify
	Top <ul style="list-style-type: none"> • High-Pressure Laminate price group 1 • High-Pressure Laminate price group 2 • High-Pressure Laminate price group 3 • Open Line laminate (OLL) 	<ul style="list-style-type: none"> No cost +\$204 +\$422 +\$111 plus cost of laminate 	<ul style="list-style-type: none"> Specify laminate color number. Specify laminate color number. Specify laminate color number. ▶ See <i>Surface Materials Reference Manual</i>.
	Legs <ul style="list-style-type: none"> • Orangebox paint price group 1 • Orangebox paint price group 2 	<ul style="list-style-type: none"> No cost +\$ 80 	<ul style="list-style-type: none"> Specify Orangebox paint color number. Specify Orangebox paint color number.

Specification Information	
• Style Number	• U.S. Base Price
OB1AIR30	\$3065



For Canadian Pricing
 Multiply U.S. Price by the Canadian price factor.
 ▶ See page 1 for details.

Air³ Short, Straight Pod Table

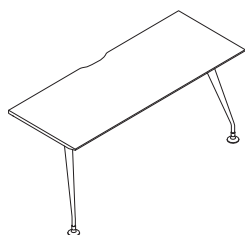

Tip: Recommended for use in **OB1AIR23**.

Standard Includes	Required to Specify
-------------------	---------------------

<ul style="list-style-type: none"> ▶ Need help? Product details, page 16 • 1" thick table top: High-Pressure Laminate price group 1 • 3 mm edgeband: plastic price group 1 • Two legs with feet: paint • Attachment bracket with hardware 	<ol style="list-style-type: none"> 1 Style number 2 High-Pressure Laminate color number for top 3 Plastic color number for edgeband 4 Paint color number for leg 5 Options, if selected (see below) <p>▶ See Product Understanding for Surface Materials.</p>
----------------------------------------------------------------------------------------------------------------------------------------------------------------------------------------------------------------------------------------------------------------------------------------------	------------------------------------------------------------------------------------------------------------------------------------------------------------------------------------------------------------------------------------------------------------------------------------------------------------------

Options	U.S. Price	Required to Specify
---------	------------	---------------------

<p>Surface Materials</p> <ul style="list-style-type: none"> • High-Pressure Laminate price group 1 • High-Pressure Laminate price group 2 • High-Pressure Laminate price group 3 • Open Line laminate (OLL) 	<p>Top</p> <ul style="list-style-type: none"> No cost +\$ 95 +\$199 +\$111 plus cost of laminate 	<ul style="list-style-type: none"> Specify laminate color number. Specify laminate color number. Specify laminate color number. <p>▶ See <i>Surface Materials Reference Manual</i>.</p>
<p>Legs</p> <ul style="list-style-type: none"> • Orangebox paint price group 1 • Orangebox paint price group 2 		<ul style="list-style-type: none"> No cost +\$ 80 <ul style="list-style-type: none"> Specify Orangebox paint color number. Specify Orangebox paint color number.

Specification Information	
Style Number	U.S. Base Price

OB1AIR35	\$2811
:	:
:	:



For Canadian Pricing
 Multiply U.S. Price by the Canadian price factor.
 ▶ See page 1 for details.

Accessories

Brackets

Standard Includes	Required to Specify
• Bracket	Style number

Specification Information

• Style Number	• U.S. Price

Hoop Mounted Monitor Bracket

OB1AIRGA153US	\$ 891

Over Upholstery Monitor Bracket

OB1AIRGA174US	\$1379

Straight Glass Magnetic Whiteboard

OB1AIRGA151	\$3436

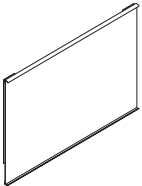
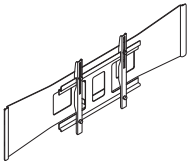
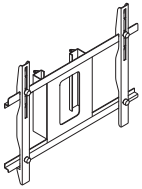

For Canadian Pricing
 Multiply U.S. Price by the
 Canadian price factor.
 ▶ See page 1 for details.

Installation Training

Tip: Use of the installation template is highly recommended. The installation template can be ordered from the CS3 catalog under style number 1379688001SR.

Standard Includes		Required to Specify
• Installation training		Style number
Specification Information		
Style Number	U.S. Price	
Air3 Installation Training, One to Five Units		
OB1AIRINSTALL1	\$3165	
Air3 Installation Training, Six to 10 Units		
OB1AIRINSTALL2	\$4748	
Air3 Installation Training, 11+ Units		
OB1AIRINSTALL3	\$7913	

Specifying

Seismic Brackets

Tip: Seismic kits do not include hardware to anchor brackets to the building.

Standard Includes		Required to Specify
• Seismic bracket		Style number
Specification Information		
Style Number	U.S. Price	
Air23 Pod Seismic Kit		
OB1AIRGA180	\$ 752	
Air25 Pod Seismic Kit		
OB1AIRGA176	\$ 752	
Air27 Pod Seismic Kit		
OB1AIRGA181	\$1163	
Air29 Pod Seismic Kit		
OB1AIRGA204	\$1575	



For Canadian Pricing
 Multiply U.S. Price by the Canadian price factor.
 ▶ See page 1 for details.

Campers 88"W x 92"D Glass Front and Rear

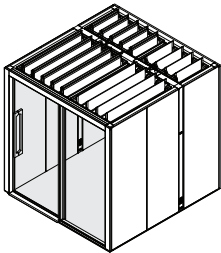

	Standard Includes	Required to Specify
▶ Need help? Product details, page 20	<ul style="list-style-type: none"> • Camper: 88"W x 92"D glass front and rear • Frame: 7207 Black • Glass: 6500 Clear Glass • Door handle pull: wood price group 1 • Power plug: type B • Power outlet: 3 NEMA power outlets • Fascia: paint price group 1 • Air circulation fan 	<ol style="list-style-type: none"> 1 Style number 2 Fascia type 3 Wood color number for door handle pull 4 Paint color number for fascia 5 Options, if selected (see below) <p>▶ See Product Understanding for Surface Materials.</p>

	Options	U.S. Price	Required to Specify
Fascia Type	<ul style="list-style-type: none"> • Paint • Fabric 	<p>No cost</p> <p>+\$ 185</p>	<p>Specify <i>with paint</i>.</p> <p>Specify <i>with fabric</i>.</p>
Fascia Finish	<ul style="list-style-type: none"> • Customer's Own Material (COM) • Fabric price group 1 • Paint price group 1 • Paint price group 2 • Paint price group 3 • Fabric price group 2 • Fabric price group 3 • Fabric price group 4 • Fabric price group 5 • Fabric price group 6 • Fabric price group 7 • Fabric price group 8 • Fabric price group 9 • Fabric price group 10 	<p>No cost</p> <p>No cost</p> <p>No cost</p> <p>+\$ 101</p> <p>+\$ 131</p> <p>+\$ 121</p> <p>+\$ 225</p> <p>+\$ 313</p> <p>+\$ 395</p> <p>+\$ 515</p> <p>+\$ 635</p> <p>+\$ 819</p> <p>+\$1078</p> <p>+\$1209</p>	<p>▶ See <i>Surface Materials Reference Manual</i>.</p> <p>Specify fabric color number.</p> <p>Specify paint color number.</p> <p>Specify paint color number.</p> <p>Specify fabric color number.</p> <p>Specify fabric color number.</p> <p>Specify fabric color number.</p> <p>Specify fabric color number.</p> <p>Specify fabric color number.</p> <p>Specify fabric color number.</p> <p>Specify fabric color number.</p> <p>Specify fabric color number.</p> <p>Specify fabric color number.</p> <p>Specify fabric color number.</p>
Interior Wall 1 Panel Finish	<ul style="list-style-type: none"> • Customer's Own Material (COM) • Fabric price group 1 • Fabric price group 2 • Fabric price group 3 • Fabric price group 4 • Fabric price group 5 • Fabric price group 6 • Fabric price group 7 • Fabric price group 8 • Fabric price group 9 • Fabric price group 10 	<p>No cost</p> <p>No cost</p> <p>+\$ 300</p> <p>+\$ 556</p> <p>+\$ 787</p> <p>+\$ 989</p> <p>+\$1232</p> <p>+\$1398</p> <p>+\$1776</p> <p>+\$2175</p> <p>+\$2472</p>	<p>▶ See <i>Surface Materials Reference Manual</i>.</p> <p>Specify fabric color number.</p> <p>Specify fabric color number.</p> <p>Specify fabric color number.</p> <p>Specify fabric color number.</p> <p>Specify fabric color number.</p> <p>Specify fabric color number.</p> <p>Specify fabric color number.</p> <p>Specify fabric color number.</p> <p>Specify fabric color number.</p> <p>Specify fabric color number.</p>
Interior Wall 1 Contrasting Panel	<ul style="list-style-type: none"> • Non contrasting • Contrasting 	<p>No cost</p> <p>+\$ 319</p>	<p>Specify <i>with non contrasting</i>.</p> <p>Specify <i>with contrasting</i>.</p>
Interior Wall 1 Contrasting Panel Position	<ul style="list-style-type: none"> • Panel A • Panel B • Panel C 	<p>No cost</p> <p>No cost</p> <p>No cost</p>	<p>Specify <i>with contrasting interior wall 1 panel A</i>.</p> <p>Specify <i>with contrasting interior wall 1 panel B</i>.</p> <p>Specify <i>with contrasting interior wall 1 panel C</i>.</p>
Interior Wall 1 Contrasting Panel Type	<ul style="list-style-type: none"> • Fabric • Laminate 	<p>No cost</p> <p>+\$ 495</p>	<p>Specify <i>with fabric</i>.</p> <p>Specify <i>with laminate</i>.</p>

▶ Options, continued on next page



For Canadian Pricing
Multiply U.S. Price by the Canadian price factor.
▶ See page 1 for details.

► Options, continued from previous page

Options	U.S. Price	Required to Specify
Interior Wall 1 Contrasting Panel Finish	<ul style="list-style-type: none"> • Customer's Own Material (COM) No cost • Fabric price group 1 No cost • Fabric price group 2 +\$ 100 • Fabric price group 3 +\$ 186 • Fabric price group 4 +\$ 263 • Fabric price group 5 +\$ 329 • Fabric price group 6 +\$ 410 • Fabric price group 7 +\$ 466 • Fabric price group 8 +\$ 592 • Fabric price group 9 +\$ 725 • Fabric price group 10 +\$ 824 • High-Pressure Laminate price group 1 No cost • High-Pressure Laminate price group 2 +\$ 558 • High-Pressure Laminate price group 3 +\$ 810 • Open Line laminate (OLL) +\$ 111 plus cost of laminate 	<ul style="list-style-type: none"> ► See <i>Surface Materials Reference Manual</i>. Specify fabric color number for contrasting interior wall 1. Specify fabric color number for contrasting interior wall 1. Specify fabric color number for contrasting interior wall 1. Specify fabric color number for contrasting interior wall 1. Specify fabric color number for contrasting interior wall 1. Specify fabric color number for contrasting interior wall 1. Specify fabric color number for contrasting interior wall 1. Specify fabric color number for contrasting interior wall 1. Specify fabric color number for contrasting interior wall 1. Specify fabric color number for contrasting interior wall 1. Specify fabric color number for contrasting interior wall 1. Specify fabric color number for contrasting interior wall 1. Specify fabric color number for contrasting interior wall 1. Specify fabric color number for contrasting interior wall 1. Specify laminate color number for contrasting interior wall 1. Specify laminate color number for contrasting interior wall 1. Specify laminate color number for contrasting interior wall 1. ► See <i>Surface Materials Reference Manual</i>.
Interior Wall 3 Panel Finish	<ul style="list-style-type: none"> • Customer's Own Material (COM) No cost • Fabric price group 1 No cost • Fabric price group 2 +\$ 300 • Fabric price group 3 +\$ 556 • Fabric price group 4 +\$ 787 • Fabric price group 5 +\$ 989 • Fabric price group 6 +\$1232 • Fabric price group 7 +\$1398 • Fabric price group 8 +\$1776 • Fabric price group 9 +\$2175 • Fabric price group 10 +\$2472 	<ul style="list-style-type: none"> ► See <i>Surface Materials Reference Manual</i>. Specify fabric color number. Specify fabric color number. Specify fabric color number. Specify fabric color number. Specify fabric color number. Specify fabric color number. Specify fabric color number. Specify fabric color number. Specify fabric color number. Specify fabric color number. Specify fabric color number.
Interior Wall 3 Contrasting Panel	<ul style="list-style-type: none"> • Non contrasting No cost • Contrasting +\$ 319 	<ul style="list-style-type: none"> Specify <i>with non contrasting</i>. Specify <i>with contrasting</i>.
Interior Wall 3 Contrasting Panel Position	<ul style="list-style-type: none"> • Panel A No cost • Panel B No cost • Panel C No cost 	<ul style="list-style-type: none"> Specify <i>with contrasting interior wall 3 panel A</i>. Specify <i>with contrasting interior wall 3 panel B</i>. Specify <i>with contrasting interior wall 3 panel C</i>.
Interior Wall 3 Contrasting Panel Type	<ul style="list-style-type: none"> • Fabric No cost • Laminate +\$ 495 	<ul style="list-style-type: none"> Specify <i>with fabric</i>. Specify <i>with laminate</i>.

► Options, continued on next page

Specifying



For Canadian Pricing
Multiply U.S. Price by the
Canadian price factor.
► See page 1 for details.

Campers 88"W x 92"D Glass Front and Rear, continued

► Options, continued from previous page

	Options	U.S. Price	Required to Specify
Interior Wall 3 Contrasting Panel Finish	• Customer's Own Material (COM)	No cost	► See <i>Surface Materials Reference Manual</i> . Specify fabric color number for contrasting interior wall 3. Specify fabric color number for contrasting interior wall 3. Specify fabric color number for contrasting interior wall 3. Specify fabric color number for contrasting interior wall 3. Specify fabric color number for contrasting interior wall 3. Specify fabric color number for contrasting interior wall 3. Specify fabric color number for contrasting interior wall 3. Specify fabric color number for contrasting interior wall 3. Specify fabric color number for contrasting interior wall 3. Specify fabric color number for contrasting interior wall 3. Specify fabric color number for contrasting interior wall 3. Specify fabric color number for contrasting interior wall 3. Specify fabric color number for contrasting interior wall 3. Specify fabric color number for contrasting interior wall 3. Specify laminate color number for contrasting interior wall 3. Specify laminate color number for contrasting interior wall 3. Specify laminate color number for contrasting interior wall 3. ► See <i>Surface Materials Reference Manual</i> .
	• Fabric price group 1	No cost	
	• Fabric price group 2	+\$ 100	
	• Fabric price group 3	+\$ 186	
	• Fabric price group 4	+\$ 263	
	• Fabric price group 5	+\$ 329	
	• Fabric price group 6	+\$ 410	
	• Fabric price group 7	+\$ 466	
	• Fabric price group 8	+\$ 592	
	• Fabric price group 9	+\$ 725	
	• Fabric price group 10	+\$ 824	
	• High-Pressure Laminate price group 1	No cost	
	• High-Pressure Laminate price group 2	+\$ 558	
	• High-Pressure Laminate price group 3	+\$ 810	
• Open Line laminate (OLL)	+\$ 111 plus cost of laminate		
Exterior Wall 1 Panel Type	• Fabric	No cost	Specify <i>with fabric</i> .
	• Laminate	+\$1483	Specify <i>with laminate</i> .
	• Plywood	+\$3929	Specify <i>with plywood</i> .
Exterior Wall 1 Panel Finish	• Customer's Own Material (COM)	No cost	► See <i>Surface Materials Reference Manual</i> . Specify plywood color number. Specify fabric color number. Specify fabric color number. Specify fabric color number. Specify fabric color number. Specify fabric color number. Specify fabric color number. Specify fabric color number. Specify fabric color number. Specify fabric color number. Specify fabric color number. Specify fabric color number. Specify fabric color number. Specify fabric color number. Specify laminate color number. Specify laminate color number. Specify laminate color number. ► See <i>Surface Materials Reference Manual</i> .
	• Plywood price group 1	No cost	
	• Fabric price group 1	No cost	
	• Fabric price group 2	+\$ 300	
	• Fabric price group 3	+\$ 556	
	• Fabric price group 4	+\$ 787	
	• Fabric price group 5	+\$ 989	
	• Fabric price group 6	+\$1232	
	• Fabric price group 7	+\$1398	
	• Fabric price group 8	+\$1776	
	• Fabric price group 9	+\$2175	
	• Fabric price group 10	+\$2472	
	• High-Pressure Laminate price group 1	No cost	
	• High-Pressure Laminate price group 2	+\$1116	
	• High-Pressure Laminate price group 3	+\$1619	
	• Open Line laminate (OLL)	+\$ 111 plus cost of laminate	
Exterior Wall 1 Contrasting Panel	• Non contrasting	No cost	Specify <i>with non contrasting</i> .
	• Contrasting	+\$ 319	Specify <i>with contrasting</i> .
Exterior Wall 1 Contrasting Panel Position	• Panel A	No cost	Specify <i>with contrasting exterior wall 1 panel A</i> .
	• Panel B	No cost	Specify <i>with contrasting exterior wall 1 panel B</i> .
	• Panel C	No cost	Specify <i>with contrasting exterior wall 1 panel C</i> .
Exterior Wall 1 Contrasting Panel Type	• Fabric	No cost	Specify <i>with fabric</i> .
	• Laminate	+\$ 495	Specify <i>with laminate</i> .
	• Plywood	+\$1309	Specify <i>with plywood</i> .

 **For Canadian Pricing**
Multiply U.S. Price by the Canadian price factor.
► See page 1 for details.

► Options, continued on next page

► Options, continued from previous page

Options	U.S. Price	Required to Specify
Exterior Wall 1 Contrasting Panel Finish	<ul style="list-style-type: none"> • Customer's Own Material (COM) No cost • Fabric price group 1 No cost • Fabric price group 2 +\$ 100 • Fabric price group 3 +\$ 186 • Fabric price group 4 +\$ 263 • Fabric price group 5 +\$ 329 • Fabric price group 6 +\$ 410 • Fabric price group 7 +\$ 466 • Fabric price group 8 +\$ 592 • Fabric price group 9 +\$ 725 • Fabric price group 10 +\$ 824 • High-Pressure Laminate price group 1 No cost • High-Pressure Laminate price group 2 +\$ 558 • High-Pressure Laminate price group 3 +\$ 810 • Open Line laminate (OLL) +\$ 111 plus cost of laminate 	<ul style="list-style-type: none"> ► See <i>Surface Materials Reference Manual</i>. Specify fabric color number for contrasting exterior wall 1. Specify fabric color number for contrasting exterior wall 1. Specify fabric color number for contrasting exterior wall 1. Specify fabric color number for contrasting exterior wall 1. Specify fabric color number for contrasting exterior wall 1. Specify fabric color number for contrasting exterior wall 1. Specify fabric color number for contrasting exterior wall 1. Specify fabric color number for contrasting exterior wall 1. Specify fabric color number for contrasting exterior wall 1. Specify fabric color number for contrasting exterior wall 1. Specify fabric color number for contrasting exterior wall 1. Specify fabric color number for contrasting exterior wall 1. Specify fabric color number for contrasting exterior wall 1. Specify fabric color number for contrasting exterior wall 1. Specify laminate color number for contrasting exterior wall 1. Specify laminate color number for contrasting exterior wall 1. Specify laminate color number for contrasting exterior wall 1. ► See <i>Surface Materials Reference Manual</i>.
Exterior Wall 3 Panel Type	<ul style="list-style-type: none"> • Fabric No cost • Laminate +\$1483 • Plywood +\$3929 	<ul style="list-style-type: none"> Specify <i>with fabric</i>. Specify <i>with laminate</i>. Specify <i>with plywood</i>.
Exterior Wall 3 Panel Finish	<ul style="list-style-type: none"> • Customer's Own Material (COM) No cost • Plywood price group 1 No cost • Fabric price group 1 No cost • Fabric price group 2 +\$ 300 • Fabric price group 3 +\$ 556 • Fabric price group 4 +\$ 787 • Fabric price group 5 +\$ 989 • Fabric price group 6 +\$1232 • Fabric price group 7 +\$1398 • Fabric price group 8 +\$1776 • Fabric price group 9 +\$2175 • Fabric price group 10 +\$2472 • High-Pressure Laminate price group 1 No cost • High-Pressure Laminate price group 2 +\$1116 • High-Pressure Laminate price group 3 +\$1619 • Open Line laminate (OLL) +\$ 111 plus cost of laminate 	<ul style="list-style-type: none"> ► See <i>Surface Materials Reference Manual</i>. Specify plywood color number. Specify fabric color number. Specify fabric color number. Specify fabric color number. Specify fabric color number. Specify fabric color number. Specify fabric color number. Specify fabric color number. Specify fabric color number. Specify fabric color number. Specify fabric color number. Specify fabric color number. Specify fabric color number. Specify laminate color number. Specify laminate color number. Specify laminate color number. ► See <i>Surface Materials Reference Manual</i>.
Exterior Wall 3 Contrasting Panel	<ul style="list-style-type: none"> • Non contrasting No cost • Contrasting +\$ 319 	<ul style="list-style-type: none"> Specify <i>with non contrasting</i>. Specify <i>with contrasting</i>.
Exterior Wall 3 Contrasting Panel Position	<ul style="list-style-type: none"> • Panel A No cost • Panel B No cost • Panel C No cost 	<ul style="list-style-type: none"> Specify <i>with contrasting exterior wall 3 panel A</i>. Specify <i>with contrasting exterior wall 3 panel B</i>. Specify <i>with contrasting exterior wall 3 panel C</i>.

Specifying



For Canadian Pricing
Multiply U.S. Price by the Canadian price factor.
► See page 1 for details.

► Options, continued on next page

Campers 88"W x 92"D Glass Front and Rear, continued

► Options, continued from previous page

	Options	U.S. Price	Required to Specify
Exterior Wall 3 Contrasting Panel Type	• Fabric	No cost	Specify <i>with fabric</i> .
	• Laminate	+\$ 495	Specify <i>with laminate</i> .
	• Plywood	+\$1309	Specify <i>with plywood</i> .
Exterior Wall 3 Contrasting Panel Finish	• Customer's Own Material (COM)	No cost	► See <i>Surface Materials Reference Manual</i> . Specify plywood color number for contrasting exterior wall 3. Specify fabric color number for contrasting exterior wall 3. Specify fabric color number for contrasting exterior wall 3. Specify fabric color number for contrasting exterior wall 3. Specify fabric color number for contrasting exterior wall 3. Specify fabric color number for contrasting exterior wall 3. Specify fabric color number for contrasting exterior wall 3. Specify fabric color number for contrasting exterior wall 3. Specify fabric color number for contrasting exterior wall 3. Specify fabric color number for contrasting exterior wall 3. Specify fabric color number for contrasting exterior wall 3. Specify fabric color number for contrasting exterior wall 3. Specify laminate color number for contrasting exterior wall 3. Specify laminate color number for contrasting exterior wall 3. Specify laminate color number for contrasting exterior wall 3. ► See <i>Surface Materials Reference Manual</i> .
	• Plywood price group 1	No cost	
	• Fabric price group 1	No cost	
	• Fabric price group 2	+\$ 100	
	• Fabric price group 3	+\$ 186	
	• Fabric price group 4	+\$ 263	
	• Fabric price group 5	+\$ 329	
	• Fabric price group 6	+\$ 410	
	• Fabric price group 7	+\$ 466	
	• Fabric price group 8	+\$ 592	
	• Fabric price group 9	+\$ 725	
	• Fabric price group 10	+\$ 824	
	• High-Pressure Laminate price group 1	No cost	
• High-Pressure Laminate price group 2	+\$ 558		
• High-Pressure Laminate price group 3	+\$ 810		
• Open Line laminate (OLL)	+\$ 111 plus cost of laminate		
Power Configuration	• 3 power	No cost	Specify <i>with 3 power</i> .
	• 2 power, 1 USB A, 1 USB C 20W	+\$ 780	Specify <i>with 2 power, 1 USB A, 1 USB C 20W</i> .
HDMI and Data Configuration	• No HDMI/data	No cost	Specify <i>with no HDMI/data</i> .
	• 1 HDMI, 2 data	+\$ 978	Specify <i>with 1 HDMI, 2 data</i> .
Kink Option	• No kink	No cost	Specify <i>with no kink</i> .
	• With kink	No cost	Specify <i>with kink</i> .
Cabin Option	• No cabin	No cost	Specify <i>with no cabin</i> .
	• With cabin	No cost	Specify <i>with cabin</i> .

Tip: When specifying your camper, please make sure the "kink option" and "cabin option" are entered correctly. For the "kink option" select "with kink" if you plan to add a kink to the camper and "no kink" if you don't intend to add a kink on the camper. Likewise, for the "cabin option", please select "with cabin", if you plan to attach a cabin to the camper and "no cabin" if you don't plan to attach a cabin.

► Specification Information, on next page



For Canadian Pricing

Multiply U.S. Price by the Canadian price factor.

► See page 1 for details.

► Options, on previous page

Specification Information

Style Number	U.S. Base Price
--------------	-----------------

88"W x 92"D Glass Front and Rear—Left Hand

OB1CD02BLS	\$70,993
-------------------	----------

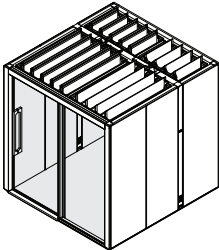

88"W x 92"D Glass Front and Rear—Right Hand

OB1CD02BRS	\$70,993
-------------------	----------

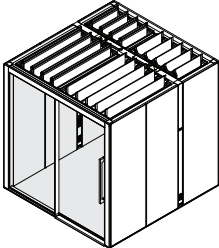

For Canadian Pricing
Multiply U.S. Price by the
Canadian price factor.
► See page 1 for details.

Campers 115"W x 119"D Glass Front and Rear

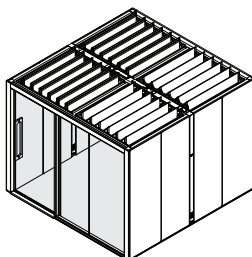

	Standard Includes	Required to Specify
▶ Need help? Product details, page 20	<ul style="list-style-type: none"> • Camper: 115"W x 119"D glass front and rear • Frame: 7207 Black • Glass: 6500 Clear Glass • Door handle pull: wood price group 1 • Power plug: type B • Power outlet: 3 NEMA power outlets • Fascia: paint price group 1 • Air circulation fan 	<ol style="list-style-type: none"> 1 Style number 2 Fascia type 3 Wood color number for door handle pull 4 Paint color number for fascia 5 Options, if selected (see below) <p>▶ See Product Understanding for Surface Materials.</p>

	Options	U.S. Price	Required to Specify
Fascia Type	<ul style="list-style-type: none"> • Paint • Fabric 	<p>No cost</p> <p>+\$ 294</p>	<p>Specify <i>with paint</i>.</p> <p>Specify <i>with fabric</i>.</p>
Fascia Finish	<ul style="list-style-type: none"> • Customer's Own Material (COM) • Fabric price group 1 • Paint price group 1 • Paint price group 2 • Paint price group 3 • Fabric price group 2 • Fabric price group 3 • Fabric price group 4 • Fabric price group 5 • Fabric price group 6 • Fabric price group 7 • Fabric price group 8 • Fabric price group 9 • Fabric price group 10 	<p>No cost</p> <p>No cost</p> <p>No cost</p> <p>+\$ 167</p> <p>+\$ 217</p> <p>+\$ 242</p> <p>+\$ 457</p> <p>+\$ 638</p> <p>+\$ 805</p> <p>+\$1001</p> <p>+\$1145</p> <p>+\$1442</p> <p>+\$1777</p> <p>+\$2017</p>	<p>▶ See <i>Surface Materials Reference Manual</i>.</p> <p>Specify fabric color number.</p> <p>Specify paint color number.</p> <p>Specify paint color number.</p> <p>Specify paint color number.</p> <p>Specify fabric color number.</p> <p>Specify fabric color number.</p> <p>Specify fabric color number.</p> <p>Specify fabric color number.</p> <p>Specify fabric color number.</p> <p>Specify fabric color number.</p> <p>Specify fabric color number.</p> <p>Specify fabric color number.</p> <p>Specify fabric color number.</p>
Interior Wall 1 Panel Finish	<ul style="list-style-type: none"> • Customer's Own Material (COM) • Fabric price group 1 • Fabric price group 2 • Fabric price group 3 • Fabric price group 4 • Fabric price group 5 • Fabric price group 6 • Fabric price group 7 • Fabric price group 8 • Fabric price group 9 • Fabric price group 10 	<p>No cost</p> <p>No cost</p> <p>+\$ 399</p> <p>+\$ 742</p> <p>+\$1050</p> <p>+\$1318</p> <p>+\$1644</p> <p>+\$1864</p> <p>+\$2367</p> <p>+\$2901</p> <p>+\$3296</p>	<p>▶ See <i>Surface Materials Reference Manual</i>.</p> <p>Specify fabric color number.</p> <p>Specify fabric color number.</p> <p>Specify fabric color number.</p> <p>Specify fabric color number.</p> <p>Specify fabric color number.</p> <p>Specify fabric color number.</p> <p>Specify fabric color number.</p> <p>Specify fabric color number.</p> <p>Specify fabric color number.</p> <p>Specify fabric color number.</p>
Interior Wall 1 Contrasting Panel	<ul style="list-style-type: none"> • Non contrasting • Contrasting 	<p>No cost</p> <p>+\$ 319</p>	<p>Specify <i>with non contrasting</i>.</p> <p>Specify <i>with contrasting</i>.</p>
Interior Wall 1 Contrasting Panel Position	<ul style="list-style-type: none"> • Panel A • Panel B • Panel C • Panel D 	<p>No cost</p> <p>No cost</p> <p>No cost</p> <p>No cost</p>	<p>Specify <i>with contrasting interior wall 1 panel A</i>.</p> <p>Specify <i>with contrasting interior wall 1 panel B</i>.</p> <p>Specify <i>with contrasting interior wall 1 panel C</i>.</p> <p>Specify <i>with contrasting interior wall 1 panel D</i>.</p>
Interior Wall 1 Contrasting Panel Type	<ul style="list-style-type: none"> • Fabric • Laminate 	<p>No cost</p> <p>+\$ 495</p>	<p>Specify <i>with fabric</i>.</p> <p>Specify <i>with laminate</i>.</p>
Interior Wall 1 Contrasting Panel Finish	<ul style="list-style-type: none"> • Customer's Own Material (COM) • Fabric price group 1 • Fabric price group 2 • Fabric price group 3 • Fabric price group 4 • Fabric price group 5 • Fabric price group 6 	<p>No cost</p> <p>No cost</p> <p>+\$ 100</p> <p>+\$ 186</p> <p>+\$ 263</p> <p>+\$ 329</p> <p>+\$ 410</p>	<p>▶ See <i>Surface Materials Reference Manual</i>.</p> <p>Specify fabric color number for contrasting interior wall 1.</p> <p>Specify fabric color number for contrasting interior wall 1.</p> <p>Specify fabric color number for contrasting interior wall 1.</p> <p>Specify fabric color number for contrasting interior wall 1.</p> <p>Specify fabric color number for contrasting interior wall 1.</p> <p>Specify fabric color number for contrasting interior wall 1.</p> <p>Specify fabric color number for contrasting interior wall 1.</p>

▶ Options, continued on next page

 **For Canadian Pricing**
Multiply U.S. Price by the Canadian price factor.
▶ See page 1 for details.

► Options, continued from previous page

Options	U.S. Price	Required to Specify	
Interior Wall 1 Contrasting Panel Finish, continued	• Fabric price group 7	+\$ 466	Specify fabric color number for contrasting interior wall 1. Specify fabric color number for contrasting interior wall 1. Specify fabric color number for contrasting interior wall 1. Specify fabric color number for contrasting interior wall 1. Specify laminate color number for contrasting interior wall 1. Specify laminate color number for contrasting interior wall 1. Specify laminate color number for contrasting interior wall 1. ► See <i>Surface Materials Reference Manual</i> .
	• Fabric price group 8	+\$ 592	
	• Fabric price group 9	+\$ 725	
	• Fabric price group 10	+\$ 824	
	• High-Pressure Laminate price group 1	No cost	
	• High-Pressure Laminate price group 2	+\$ 558	
	• High-Pressure Laminate price group 3	+\$ 810	
	• Open Line laminate (OLL)	+\$ 111 plus cost of laminate	
Interior Wall 3 Panel Finish	• Customer's Own Material (COM)	No cost	► See <i>Surface Materials Reference Manual</i> . Specify fabric color number. Specify fabric color number. Specify fabric color number. Specify fabric color number. Specify fabric color number. Specify fabric color number. Specify fabric color number. Specify fabric color number. Specify fabric color number. Specify fabric color number.
	• Fabric price group 1	No cost	
	• Fabric price group 2	+\$ 399	
	• Fabric price group 3	+\$ 742	
	• Fabric price group 4	+\$1050	
	• Fabric price group 5	+\$1318	
	• Fabric price group 6	+\$1644	
	• Fabric price group 7	+\$1864	
	• Fabric price group 8	+\$2367	
	• Fabric price group 9	+\$2901	
• Fabric price group 10	+\$3296		
Interior Wall 3 Contrasting Panel	• Non contrasting	No cost	Specify <i>with non contrasting</i> . Specify <i>with contrasting</i> .
	• Contrasting	+\$ 319	
Interior Wall 3 Contrasting Panel Position	• Panel A	No cost	Specify <i>with contrasting interior wall 3 panel A</i> . Specify <i>with contrasting interior wall 3 panel B</i> . Specify <i>with contrasting interior wall 3 panel C</i> . Specify <i>with contrasting interior wall 3 panel D</i> .
	• Panel B	No cost	
	• Panel C	No cost	
	• Panel D	No cost	
Interior Wall 3 Contrasting Panel Type	• Fabric	No cost	Specify <i>with fabric</i> . Specify <i>with laminate</i> .
	• Laminate	+\$ 495	
Interior Wall 3 Contrasting Panel Finish	• Customer's Own Material (COM)	No cost	► See <i>Surface Materials Reference Manual</i> . Specify fabric color number for contrasting interior wall 3. Specify fabric color number for contrasting interior wall 3. Specify fabric color number for contrasting interior wall 3. Specify fabric color number for contrasting interior wall 3. Specify fabric color number for contrasting interior wall 3. Specify fabric color number for contrasting interior wall 3. Specify fabric color number for contrasting interior wall 3. Specify fabric color number for contrasting interior wall 3. Specify fabric color number for contrasting interior wall 3. Specify laminate color number for contrasting interior wall 3.
	• Fabric price group 1	No cost	
	• Fabric price group 2	+\$ 100	
	• Fabric price group 3	+\$ 186	
	• Fabric price group 4	+\$ 263	
	• Fabric price group 5	+\$ 329	
	• Fabric price group 6	+\$ 410	
	• Fabric price group 7	+\$ 466	
	• Fabric price group 8	+\$ 592	
	• Fabric price group 9	+\$ 725	
• Fabric price group 10	+\$ 824		
• High-Pressure Laminate price group 1	No cost		

► Options, continued on next page



For Canadian Pricing
Multiply U.S. Price by the Canadian price factor.
► See page 1 for details.

Campers 115"W x 119"D Glass Front and Rear, continued

► Options, continued from previous page

	Options	U.S. Price	Required to Specify
Interior Wall 3 Contrasting Panel Finish, continued	• High-Pressure Laminate price group 2	+\$ 558	Specify laminate color number for contrasting interior wall 3.
	• High-Pressure Laminate price group 3	+\$ 810	Specify laminate color number for contrasting interior wall 3.
	• Open Line laminate (OLL)	+\$ 111 plus cost of laminate	Specify laminate color number for contrasting interior wall 3.
Exterior Wall 1 Panel Type	• Fabric	No cost	Specify <i>with fabric</i> .
	• Laminate	+\$1977	Specify <i>with laminate</i> .
	• Plywood	+\$5238	Specify <i>with plywood</i> .
Exterior Wall 1 Panel Finish	• Customer's Own Material (COM)	No cost	► See <i>Surface Materials Reference Manual</i> .
	• Plywood price group 1	No cost	Specify plywood color number.
	• Fabric price group 1	No cost	Specify fabric color number.
	• Fabric price group 2	+\$ 399	Specify fabric color number.
	• Fabric price group 3	+\$ 742	Specify fabric color number.
	• Fabric price group 4	+\$1050	Specify fabric color number.
	• Fabric price group 5	+\$1318	Specify fabric color number.
	• Fabric price group 6	+\$1644	Specify fabric color number.
	• Fabric price group 7	+\$1864	Specify fabric color number.
	• Fabric price group 8	+\$2367	Specify fabric color number.
	• Fabric price group 9	+\$2901	Specify fabric color number.
	• Fabric price group 10	+\$3296	Specify fabric color number.
	• High-Pressure Laminate price group 1	No cost	Specify laminate color number.
	• High-Pressure Laminate price group 2	+\$2233	Specify laminate color number.
	• High-Pressure Laminate price group 3	+\$3239	Specify laminate color number.
• Open Line laminate (OLL)	+\$ 111 plus cost of laminate	► See <i>Surface Materials Reference Manual</i> .	
Exterior Wall 1 Contrasting Panel	• Non contrasting	No cost	Specify <i>with non contrasting</i> .
	• Contrasting	+\$ 319	Specify <i>with contrasting</i> .
Exterior Wall 1 Contrasting Panel Position	• Panel A	No cost	Specify <i>with contrasting exterior wall 1 panel A</i> .
	• Panel B	No cost	Specify <i>with contrasting exterior wall 1 panel B</i> .
	• Panel C	No cost	Specify <i>with contrasting exterior wall 1 panel C</i> .
	• Panel D	No cost	Specify <i>with contrasting exterior wall 1 panel D</i> .
Exterior Wall 1 Contrasting Panel Type	• Fabric	No cost	Specify <i>with fabric</i> .
	• Laminate	+\$ 495	Specify <i>with laminate</i> .
	• Plywood	+\$1309	Specify <i>with plywood</i> .
Exterior Wall 1 Contrasting Panel Finish	• Customer's Own Material (COM)	No cost	► See <i>Surface Materials Reference Manual</i> .
	• Fabric price group 1	No cost	Specify fabric color number for contrasting exterior wall 1.
	• Fabric price group 2	+\$ 100	Specify fabric color number for contrasting exterior wall 1.
	• Fabric price group 3	+\$ 186	Specify fabric color number for contrasting exterior wall 1.
	• Fabric price group 4	+\$ 263	Specify fabric color number for contrasting exterior wall 1.
	• Fabric price group 5	+\$ 329	Specify fabric color number for contrasting exterior wall 1.
	• Fabric price group 6	+\$ 410	Specify fabric color number for contrasting exterior wall 1.
	• Fabric price group 7	+\$ 466	Specify fabric color number for contrasting exterior wall 1.
	• Fabric price group 8	+\$ 592	Specify fabric color number for contrasting exterior wall 1.
	• Fabric price group 9	+\$ 725	Specify fabric color number for contrasting exterior wall 1.
• Fabric price group 10	+\$ 824	Specify fabric color number for contrasting exterior wall 1.	

 **For Canadian Pricing**
Multiply U.S. Price by the Canadian price factor.
► See page 1 for details.

► Options, continued on next page

► Options, continued from previous page

Options	U.S. Price	Required to Specify
Exterior Wall 1 Contrasting Panel Finish, continued	• High-Pressure Laminate price group 1	No cost
	• High-Pressure Laminate price group 2	+\$ 558
	• High-Pressure Laminate price group 3	+\$ 810
	• Open Line laminate (OLL)	+\$ 111 plus cost of laminate
Exterior Wall 3 Panel Type	• Fabric	No cost
	• Laminate	+\$1977
	• Plywood	+\$5238
Exterior Wall 3 Panel Finish	• Customer's Own Material (COM)	No cost
	• Plywood price group 1	No cost
	• Fabric price group 1	No cost
	• Fabric price group 2	+\$ 399
	• Fabric price group 3	+\$ 742
	• Fabric price group 4	+\$1050
	• Fabric price group 5	+\$1318
	• Fabric price group 6	+\$1644
	• Fabric price group 7	+\$1864
	• Fabric price group 8	+\$2367
	• Fabric price group 9	+\$2901
	• Fabric price group 10	+\$3296
	• High-Pressure Laminate price group 1	No cost
	• High-Pressure Laminate price group 2	+\$2233
• High-Pressure Laminate price group 3	+\$3239	
• Open Line laminate (OLL)	+\$ 111 plus cost of laminate	
Exterior Wall 3 Contrasting Panel	• Non contrasting	No cost
	• Contrasting	+\$ 319
Exterior Wall 3 Contrasting Panel Position	• Panel A	No cost
	• Panel B	No cost
	• Panel C	No cost
Exterior Wall 3 Contrasting Panel Type	• Fabric	No cost
	• Laminate	+\$ 495
	• Plywood	+\$1309
Exterior Wall 3 Contrasting Panel Finish	• Customer's Own Material (COM)	No cost
	• Plywood price group 1	No cost
	• Fabric price group 1	No cost
	• Fabric price group 2	+\$ 100
	• Fabric price group 3	+\$ 186
	• Fabric price group 4	+\$ 263
	• Fabric price group 5	+\$ 329
	• Fabric price group 6	+\$ 410
	• Fabric price group 7	+\$ 466
	• Fabric price group 8	+\$ 592
• Fabric price group 9	+\$ 725	

Specifying



For Canadian Pricing

Multiply U.S. Price by the Canadian price factor.

► See page 1 for details.

► Options, continued on next page

► Options, continued from previous page

	Options	U.S. Price	Required to Specify
Exterior Wall 3 Contrasting Panel Finish, continued	• Fabric price group 10	+\$824	Specify fabric color number for contrasting exterior wall 3.
	• High-Pressure Laminate price group 1	No cost	Specify laminate color number for contrasting exterior wall 3.
	• High-Pressure Laminate price group 2	+\$558	Specify laminate color number for contrasting exterior wall 3.
	• High-Pressure Laminate price group 3	+\$810	Specify laminate color number for contrasting exterior wall 3.
	• Open Line laminate (OLL)	+\$111 plus cost of laminate	► See <i>Surface Materials Reference Manual</i> .
Power Configuration	• 3 power	No cost	Specify with 3 power.
	• 2 power, 1 USB A, 1 USB C 20W	+\$780	Specify with 2 power, 1 USB A, 1 USB C 20W.
HDMI and Data Configuration	• No HDMI/data	No cost	Specify with no HDMI/data.
	• 1 HDMI, 2 data	+\$978	Specify with 1 HDMI, 2 data.
Kink Option	• No kink	No cost	Specify with no kink.
	• With kink	No cost	Specify with kink.

Tip: When specifying your camper, please make sure the "kink option" is entered correctly. For the "kink option" select "with kink" if you plan to add a kink to the camper and "no kink" if you don't intend to add a kink on the camper.



For Canadian Pricing

Multiply U.S. Price by the Canadian price factor.

► See page 1 for details.

Specification Information

• Style	• U.S.
• Number	• Base
	• Price

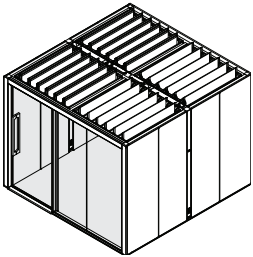

115"W x 119"D Glass Front and Rear—Left Hand

OB1CD05BLS	\$84,557
-------------------	----------

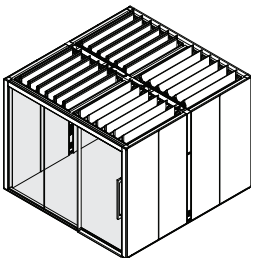

115"W x 119"D Glass Front and Rear—Right Hand

OB1CD05BRS	\$84,557
-------------------	----------

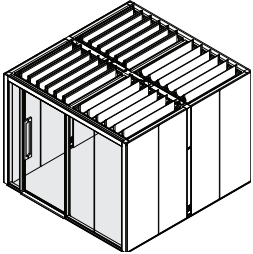

115"W x 119"D Glass Front and Rear (with Infill)—Left Hand

OB1CD05BLSNB	\$86,736
---------------------	----------

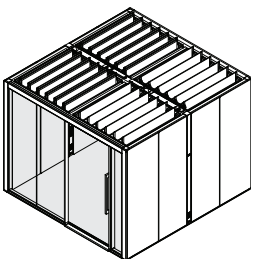

115"W x 119"D Glass Front and Rear (with Infill)—Right Hand

OB1CD05BRSNB	\$86,736
---------------------	----------

Specifying

 **For Canadian Pricing**
 Multiply U.S. Price by the
 Canadian price factor.
 ▶ See page 1 for details.

Campers 88"W x 92"D Corner Glass Front

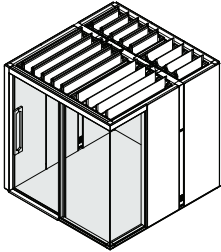

	Standard Includes	Required to Specify
▶ Need help? Product details, page 20	<ul style="list-style-type: none"> • Camper: 88"W x 92"D corner glass front—left hand • Frame: 7207 Black • Glass: 6500 Clear Glass • Door handle pull: wood price group 1 • Power plug: type B • Power outlet: 3 NEMA power outlets • Fascia: paint price group 1 • Air circulation fan 	<ol style="list-style-type: none"> 1 Style number 2 Fascia type 3 Wood color number for door handle pull 4 Paint color number for fascia 5 Options, if selected (see below) <p>▶ See Product Understanding for Surface Materials.</p>

	Options	U.S. Price	Required to Specify
Fascia Type	<ul style="list-style-type: none"> • Paint • Fabric 	<p>No cost</p> <p>+\$ 185</p>	<p>Specify <i>with paint</i>.</p> <p>Specify <i>with fabric</i>.</p>
Fascia Finish	<ul style="list-style-type: none"> • Customer's Own Material (COM) • Fabric price group 1 • Paint price group 1 • Paint price group 2 • Paint price group 3 • Fabric price group 2 • Fabric price group 3 • Fabric price group 4 • Fabric price group 5 • Fabric price group 6 • Fabric price group 7 • Fabric price group 8 • Fabric price group 9 • Fabric price group 10 	<p>No cost</p> <p>No cost</p> <p>No cost</p> <p>+\$ 101</p> <p>+\$ 131</p> <p>+\$ 121</p> <p>+\$ 225</p> <p>+\$ 313</p> <p>+\$ 395</p> <p>+\$ 515</p> <p>+\$ 635</p> <p>+\$ 819</p> <p>+\$1078</p> <p>+\$1209</p>	<p>▶ See <i>Surface Materials Reference Manual</i>.</p> <p>Specify fabric color number.</p> <p>Specify paint color number.</p> <p>Specify paint color number.</p> <p>Specify fabric color number.</p> <p>Specify fabric color number.</p> <p>Specify fabric color number.</p> <p>Specify fabric color number.</p> <p>Specify fabric color number.</p> <p>Specify fabric color number.</p> <p>Specify fabric color number.</p> <p>Specify fabric color number.</p> <p>Specify fabric color number.</p> <p>Specify fabric color number.</p>
Interior Wall 1 Panel Finish	<ul style="list-style-type: none"> • Customer's Own Material (COM) • Fabric price group 1 • Fabric price group 2 • Fabric price group 3 • Fabric price group 4 • Fabric price group 5 • Fabric price group 6 • Fabric price group 7 • Fabric price group 8 • Fabric price group 9 • Fabric price group 10 	<p>No cost</p> <p>No cost</p> <p>+\$ 300</p> <p>+\$ 556</p> <p>+\$ 787</p> <p>+\$ 989</p> <p>+\$1232</p> <p>+\$1398</p> <p>+\$1776</p> <p>+\$2175</p> <p>+\$2472</p>	<p>▶ See <i>Surface Materials Reference Manual</i>.</p> <p>Specify fabric color number.</p> <p>Specify fabric color number.</p> <p>Specify fabric color number.</p> <p>Specify fabric color number.</p> <p>Specify fabric color number.</p> <p>Specify fabric color number.</p> <p>Specify fabric color number.</p> <p>Specify fabric color number.</p> <p>Specify fabric color number.</p> <p>Specify fabric color number.</p>
Interior Wall 1 Contrasting Panel	<ul style="list-style-type: none"> • Non contrasting • Contrasting 	<p>No cost</p> <p>+\$ 319</p>	<p>Specify <i>with non contrasting</i>.</p> <p>Specify <i>with contrasting</i>.</p>
Interior Wall 1 Contrasting Panel Position	<ul style="list-style-type: none"> • Panel A • Panel B • Panel C 	<p>No cost</p> <p>No cost</p> <p>No cost</p>	<p>Specify <i>with contrasting interior wall 1 panel A</i>.</p> <p>Specify <i>with contrasting interior wall 1 panel B</i>.</p> <p>Specify <i>with contrasting interior wall 1 panel C</i>.</p>
Interior Wall 1 Contrasting Panel Type	<ul style="list-style-type: none"> • Fabric • Laminate 	<p>No cost</p> <p>+\$ 495</p>	<p>Specify <i>with fabric</i>.</p> <p>Specify <i>with laminate</i>.</p>
Interior Wall 1 Contrasting Panel Finish	<ul style="list-style-type: none"> • Customer's Own Material (COM) • Fabric price group 1 • Fabric price group 2 • Fabric price group 3 • Fabric price group 4 • Fabric price group 5 • Fabric price group 6 	<p>No cost</p> <p>No cost</p> <p>+\$ 100</p> <p>+\$ 186</p> <p>+\$ 263</p> <p>+\$ 329</p> <p>+\$ 410</p>	<p>▶ See <i>Surface Materials Reference Manual</i>.</p> <p>Specify fabric color number for contrasting interior wall 1.</p> <p>Specify fabric color number for contrasting interior wall 1.</p> <p>Specify fabric color number for contrasting interior wall 1.</p> <p>Specify fabric color number for contrasting interior wall 1.</p> <p>Specify fabric color number for contrasting interior wall 1.</p> <p>Specify fabric color number for contrasting interior wall 1.</p> <p>Specify fabric color number for contrasting interior wall 1.</p>

▶ Options, continued on next page



For Canadian Pricing
Multiply U.S. Price by the Canadian price factor.
▶ See page 1 for details.

► Options, continued from previous page

Options	U.S. Price	Required to Specify	
Exterior Wall 1 Panel Type	<ul style="list-style-type: none"> Fabric Laminate Plywood 	<ul style="list-style-type: none"> No cost +\$1483 +\$3929 	<ul style="list-style-type: none"> Specify with fabric. Specify with laminate. Specify with plywood.
Exterior Wall 1 Panel Finish	<ul style="list-style-type: none"> Customer's Own Material (COM) Plywood price group 1 Fabric price group 1 Fabric price group 2 Fabric price group 3 Fabric price group 4 Fabric price group 5 Fabric price group 6 Fabric price group 7 Fabric price group 8 Fabric price group 9 Fabric price group 10 High-Pressure Laminate price group 1 High-Pressure Laminate price group 2 High-Pressure Laminate price group 3 Open Line laminate (OLL) 	<ul style="list-style-type: none"> No cost No cost No cost +\$ 300 +\$ 556 +\$ 787 +\$ 989 +\$1232 +\$1398 +\$1776 +\$2175 +\$2472 No cost +\$1674 +\$2430 +\$ 111 plus cost of laminate 	<ul style="list-style-type: none"> ► See <i>Surface Materials Reference Manual</i>. Specify plywood color number. Specify fabric color number. Specify fabric color number. Specify fabric color number. Specify fabric color number. Specify fabric color number. Specify fabric color number. Specify fabric color number. Specify fabric color number. Specify fabric color number. Specify fabric color number. Specify fabric color number. Specify laminate color number. Specify laminate color number. Specify laminate color number. ► See <i>Surface Materials Reference Manual</i>.
Exterior Wall 1 Contrasting Panel	<ul style="list-style-type: none"> Non contrasting Contrasting 	<ul style="list-style-type: none"> No cost +\$ 319 	<ul style="list-style-type: none"> Specify with non contrasting. Specify with contrasting.
Exterior Wall 1 Contrasting Panel	<ul style="list-style-type: none"> Panel A Panel B Panel C 	<ul style="list-style-type: none"> No cost No cost No cost 	<ul style="list-style-type: none"> Specify with contrasting exterior wall 1 panel A. Specify with contrasting exterior wall 1 panel B. Specify with contrasting exterior wall 1 panel C.
Exterior Wall 1 Contrasting Panel Type	<ul style="list-style-type: none"> Fabric Laminate Plywood 	<ul style="list-style-type: none"> No cost +\$ 495 +\$1309 	<ul style="list-style-type: none"> Specify with fabric. Specify with laminate. Specify with plywood.
Exterior Wall 1 Contrasting Panel Finish	<ul style="list-style-type: none"> Customer's Own Material (COM) Fabric price group 1 Fabric price group 2 Fabric price group 3 Fabric price group 4 Fabric price group 5 Fabric price group 6 Fabric price group 7 Fabric price group 8 Fabric price group 9 Fabric price group 10 High-Pressure Laminate price group 1 High-Pressure Laminate price group 2 High-Pressure Laminate price group 3 Open Line laminate (OLL) 	<ul style="list-style-type: none"> No cost No cost +\$ 100 +\$ 186 +\$ 263 +\$ 329 +\$ 410 +\$ 466 +\$ 592 +\$ 725 +\$ 824 No cost +\$ 558 +\$ 810 +\$ 111 plus cost of laminate 	<ul style="list-style-type: none"> ► See <i>Surface Materials Reference Manual</i>. Specify fabric color number for contrasting exterior wall 1. Specify fabric color number for contrasting exterior wall 1. Specify fabric color number for contrasting exterior wall 1. Specify fabric color number for contrasting exterior wall 1. Specify fabric color number for contrasting exterior wall 1. Specify fabric color number for contrasting exterior wall 1. Specify fabric color number for contrasting exterior wall 1. Specify fabric color number for contrasting exterior wall 1. Specify fabric color number for contrasting exterior wall 1. Specify fabric color number for contrasting exterior wall 1. Specify fabric color number for contrasting exterior wall 1. Specify fabric color number for contrasting exterior wall 1. Specify laminate color number for contrasting exterior wall 1. Specify laminate color number for contrasting exterior wall 1. Specify laminate color number for contrasting exterior wall 1. Specify laminate color number for contrasting exterior wall 1. ► See <i>Surface Materials Reference Manual</i>.

Specifying



For Canadian Pricing
Multiply U.S. Price by the Canadian price factor.
► See page 1 for details.

► Options, continued on next page

Campers 88"W x 92"D Corner Glass Front, continued

► Options, continued from previous page

	Options	U.S. Price	Required to Specify
Exterior Wall 2 Panel Type	<ul style="list-style-type: none"> Fabric Laminate Plywood 	<ul style="list-style-type: none"> No cost +\$1483 +\$3929 	<ul style="list-style-type: none"> Specify with fabric. Specify with laminate. Specify with plywood.
Exterior Wall 2 Panel Finish	<ul style="list-style-type: none"> Customer's Own Material (COM) Plywood price group 1 Fabric price group 1 Fabric price group 2 Fabric price group 3 Fabric price group 4 Fabric price group 5 Fabric price group 6 Fabric price group 7 Fabric price group 8 Fabric price group 9 Fabric price group 10 High-Pressure Laminate price group 1 High-Pressure Laminate price group 2 High-Pressure Laminate price group 3 Open Line laminate (OLL) 	<ul style="list-style-type: none"> No cost No cost No cost +\$ 300 +\$ 556 +\$ 787 +\$ 989 +\$1232 +\$1398 +\$1776 +\$2175 +\$2472 No cost +\$1674 +\$2430 +\$ 111 plus cost of laminate 	<ul style="list-style-type: none"> ► See <i>Surface Materials Reference Manual</i>. Specify plywood color number. Specify fabric color number. Specify fabric color number. Specify fabric color number. Specify fabric color number. Specify fabric color number. Specify fabric color number. Specify fabric color number. Specify fabric color number. Specify fabric color number. Specify fabric color number. Specify laminate color number. Specify laminate color number. Specify laminate color number. ► See <i>Surface Materials Reference Manual</i>.
Exterior Wall 2 Contrasting Panel	<ul style="list-style-type: none"> Non contrasting Contrasting 	<ul style="list-style-type: none"> No cost +\$ 319 	<ul style="list-style-type: none"> Specify with non contrasting. Specify with contrasting.
Exterior Wall 2 Contrasting Panel Position	<ul style="list-style-type: none"> Panel A Panel B Panel C 	<ul style="list-style-type: none"> No cost No cost No cost 	<ul style="list-style-type: none"> Specify with contrasting exterior wall 2 panel A. Specify with contrasting exterior wall 2 panel B. Specify with contrasting exterior wall 2 panel C.
Exterior Wall 2 Contrasting Panel Type	<ul style="list-style-type: none"> Fabric Laminate Plywood 	<ul style="list-style-type: none"> No cost +\$ 495 +\$1309 	<ul style="list-style-type: none"> Specify with fabric. Specify with laminate. Specify with plywood.
Exterior Wall 2 Contrasting Panel Finish	<ul style="list-style-type: none"> Customer's Own Material (COM) Fabric price group 1 Fabric price group 2 Fabric price group 3 Fabric price group 4 Fabric price group 5 Fabric price group 6 Fabric price group 7 Fabric price group 8 Fabric price group 9 Fabric price group 10 High-Pressure Laminate price group 1 High-Pressure Laminate price group 2 High-Pressure Laminate price group 3 Open Line laminate (OLL) 	<ul style="list-style-type: none"> No cost No cost +\$ 100 +\$ 186 +\$ 263 +\$ 329 +\$ 410 +\$ 466 +\$ 592 +\$ 725 +\$ 824 No cost +\$ 558 +\$ 810 +\$ 111 plus cost of laminate 	<ul style="list-style-type: none"> ► See <i>Surface Materials Reference Manual</i>. Specify fabric color number for contrasting exterior wall 2. Specify fabric color number for contrasting exterior wall 2. Specify fabric color number for contrasting exterior wall 2. Specify fabric color number for contrasting exterior wall 2. Specify fabric color number for contrasting exterior wall 2. Specify fabric color number for contrasting exterior wall 2. Specify fabric color number for contrasting exterior wall 2. Specify fabric color number for contrasting exterior wall 2. Specify fabric color number for contrasting exterior wall 2. Specify fabric color number for contrasting exterior wall 2. Specify laminate color number for contrasting exterior wall 2. Specify laminate color number for contrasting exterior wall 2. Specify laminate color number for contrasting exterior wall 2. ► See <i>Surface Materials Reference Manual</i>.

► Options, continued on next page



For Canadian Pricing
 Multiply U.S. Price by the Canadian price factor.
 ► See page 1 for details.

► Options, continued from previous page

Options	U.S. Price	Required to Specify	
Exterior Wall 3 Panel Type	<ul style="list-style-type: none"> Fabric Laminate Plywood 	<ul style="list-style-type: none"> No cost +\$ 989 +\$2619 	<ul style="list-style-type: none"> Specify with fabric. Specify with laminate. Specify with plywood.
Exterior Wall 3 Panel Finish	<ul style="list-style-type: none"> Customer's Own Material (COM) Plywood price group 1 Fabric price group 1 Fabric price group 2 Fabric price group 3 Fabric price group 4 Fabric price group 5 Fabric price group 6 Fabric price group 7 Fabric price group 8 Fabric price group 9 Fabric price group 10 High-Pressure Laminate price group 1 High-Pressure Laminate price group 2 High-Pressure Laminate price group 3 Open Line laminate (OLL) 	<ul style="list-style-type: none"> No cost No cost No cost +\$ 199 +\$ 370 +\$ 524 +\$ 659 +\$ 822 +\$ 933 +\$1184 +\$1451 +\$1648 No cost +\$1116 +\$1619 +\$ 111 plus cost of laminate 	<ul style="list-style-type: none"> ► See <i>Surface Materials Reference Manual</i>. Specify plywood color number. Specify fabric color number. Specify fabric color number. Specify fabric color number. Specify fabric color number. Specify fabric color number. Specify fabric color number. Specify fabric color number. Specify fabric color number. Specify fabric color number. Specify fabric color number. Specify fabric color number. Specify laminate color number. Specify laminate color number. Specify laminate color number. ► See <i>Surface Materials Reference Manual</i>.
Exterior Wall 3 Contrasting Panel	<ul style="list-style-type: none"> Non contrasting Contrasting 	<ul style="list-style-type: none"> No cost +\$ 319 	<ul style="list-style-type: none"> Specify with contrasting. Specify with non contrasting.
Exterior Wall 3 Contrasting Panel	<ul style="list-style-type: none"> Panel B Panel C 	<ul style="list-style-type: none"> No cost No cost 	<ul style="list-style-type: none"> Specify with contrasting exterior wall 1 panel B. Specify with contrasting exterior wall 1 panel C.
Exterior Wall 3 Contrasting Panel Type	<ul style="list-style-type: none"> Fabric Laminate Plywood 	<ul style="list-style-type: none"> No cost +\$ 495 +\$1309 	<ul style="list-style-type: none"> Specify with fabric. Specify with laminate. Specify with plywood.
Exterior Wall 3 Contrasting Panel Finish	<ul style="list-style-type: none"> Customer's Own Material (COM) Plywood price group 1 Fabric price group 1 Fabric price group 2 Fabric price group 3 Fabric price group 4 Fabric price group 5 Fabric price group 6 Fabric price group 7 Fabric price group 8 Fabric price group 9 Fabric price group 10 High-Pressure Laminate price group 1 High-Pressure Laminate price group 2 High-Pressure Laminate price group 3 Open Line laminate (OLL) 	<ul style="list-style-type: none"> No cost No cost No cost +\$ 100 +\$ 186 +\$ 263 +\$ 329 +\$ 410 +\$ 466 +\$ 592 +\$ 725 +\$ 824 No cost +\$ 558 +\$ 810 +\$ 111 plus cost of laminate 	<ul style="list-style-type: none"> ► See <i>Surface Materials Reference Manual</i>. Specify plywood color number for contrasting exterior wall 3. Specify fabric color number for contrasting exterior wall 3. Specify fabric color number for contrasting exterior wall 3. Specify fabric color number for contrasting exterior wall 3. Specify fabric color number for contrasting exterior wall 3. Specify fabric color number for contrasting exterior wall 3. Specify fabric color number for contrasting exterior wall 3. Specify fabric color number for contrasting exterior wall 3. Specify fabric color number for contrasting exterior wall 3. Specify fabric color number for contrasting exterior wall 3. Specify fabric color number for contrasting exterior wall 3. Specify fabric color number for contrasting exterior wall 3. Specify laminate color number for contrasting exterior wall 3. Specify laminate color number for contrasting exterior wall 3. Specify laminate color number for contrasting exterior wall 3. Specify laminate color number for contrasting exterior wall 3. ► See <i>Surface Materials Reference Manual</i>.

Specifying



For Canadian Pricing
Multiply U.S. Price by the Canadian price factor.
► See page 1 for details.

► Options, continued on next page

Campers 88"W x 92"D Corner Glass Front, continued

► Options, continued from previous page

	Options	U.S. Price	Required to Specify
Power Configuration	<ul style="list-style-type: none"> • 3 power • 2 power, 1 USB A, 1 USB C 20W 	No cost +\$780	Specify with 3 power. Specify with 2 power, 1 USB A, 1 USB C 20W.
HDMI and Data Configuration	<ul style="list-style-type: none"> • No HDMI/data • 1 HDMI, 2 data 	No cost +\$978	Specify with no HDMI/data. Specify with 1 HDMI, 2 data.
Kink Option	<ul style="list-style-type: none"> • No kink • With kink 	No cost No cost	Specify with no kink. Specify with kink.
Cabin Option	<ul style="list-style-type: none"> • No cabin • With cabin 	No cost No cost	Specify with no cabin. Specify with cabin.

Tip: When specifying your camper, please make sure the "kink option" is entered correctly. For the "kink option" select "with kink" if you plan to add a kink to the camper and "no kink" if you don't intend to add a kink on the camper.

Specification Information

Style Number	U.S. Base Price

88"W x 92"D Corner Glass Front—Left Hand

OB1CD02CLS	\$73,122

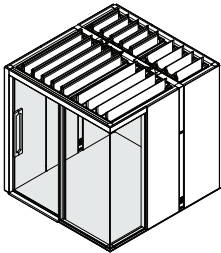

For Canadian Pricing
 Multiply U.S. Price by the Canadian price factor.
 ► See page 1 for details.

Campers 115"W x 119"D Corner Glass

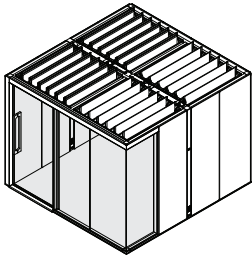

	Standard Includes	Required to Specify
▶ Need help? Product details, page 20	<ul style="list-style-type: none"> • Camper: 115"W x 119"D corner glass front—left hand • Frame: 7207 Black • Glass: 6500 Clear Glass • Door handle pull: wood price group 1 • Power plug: type B • Power outlet: 3 NEMA power outlets • Fascia: paint price group 1 • Air circulation fan 	<ol style="list-style-type: none"> 1 Style number 2 Fascia type 3 Wood color number for door handle pull 4 Paint color number for fascia 5 Options, if selected (see below) <p>▶ See Product Understanding for Surface Materials.</p>

	Options	U.S. Price	Required to Specify
Fascia Type	<ul style="list-style-type: none"> • Paint • Fabric 	<p>No cost</p> <p>+\$ 294</p>	<p>Specify <i>with paint</i>.</p> <p>Specify <i>with fabric</i>.</p>
Fascia Finish	<ul style="list-style-type: none"> • Customer's Own Material (COM) • Fabric price group 1 • Paint price group 1 • Paint price group 2 • Paint price group 3 • Fabric price group 2 • Fabric price group 3 • Fabric price group 4 • Fabric price group 5 • Fabric price group 6 • Fabric price group 7 • Fabric price group 8 • Fabric price group 9 • Fabric price group 10 	<p>No cost</p> <p>No cost</p> <p>No cost</p> <p>+\$ 167</p> <p>+\$ 217</p> <p>+\$ 242</p> <p>+\$ 457</p> <p>+\$ 638</p> <p>+\$ 805</p> <p>+\$1001</p> <p>+\$1145</p> <p>+\$1442</p> <p>+\$1777</p> <p>+\$2017</p>	<p>▶ See <i>Surface Materials Reference Manual</i>.</p> <p>Specify fabric color number.</p> <p>Specify paint color number.</p> <p>Specify paint color number.</p> <p>Specify paint color number.</p> <p>Specify fabric color number.</p> <p>Specify fabric color number.</p> <p>Specify fabric color number.</p> <p>Specify fabric color number.</p> <p>Specify fabric color number.</p> <p>Specify fabric color number.</p> <p>Specify fabric color number.</p> <p>Specify fabric color number.</p> <p>Specify fabric color number.</p> <p>Specify fabric color number.</p>
Interior Wall 1 Panel Finish	<ul style="list-style-type: none"> • Customer's Own Material (COM) • Fabric price group 1 • Fabric price group 2 • Fabric price group 3 • Fabric price group 4 • Fabric price group 5 • Fabric price group 6 • Fabric price group 7 • Fabric price group 8 • Fabric price group 9 • Fabric price group 10 	<p>No cost</p> <p>No cost</p> <p>+\$ 399</p> <p>+\$ 742</p> <p>+\$1050</p> <p>+\$1318</p> <p>+\$1644</p> <p>+\$1864</p> <p>+\$2367</p> <p>+\$2901</p> <p>+\$3296</p>	<p>▶ See <i>Surface Materials Reference Manual</i>.</p> <p>Specify fabric color number.</p> <p>Specify fabric color number.</p> <p>Specify fabric color number.</p> <p>Specify fabric color number.</p> <p>Specify fabric color number.</p> <p>Specify fabric color number.</p> <p>Specify fabric color number.</p> <p>Specify fabric color number.</p> <p>Specify fabric color number.</p> <p>Specify fabric color number.</p>
Interior Wall 1 Contrasting Panel	<ul style="list-style-type: none"> • Non contrasting • Contrasting 	<p>No cost</p> <p>+\$ 319</p>	<p>Specify <i>with non contrasting</i>.</p> <p>Specify <i>with contrasting</i>.</p>
Interior Wall 1 Contrasting Panel Position	<ul style="list-style-type: none"> • Panel A • Panel B • Panel C • Panel D 	<p>No cost</p> <p>No cost</p> <p>No cost</p> <p>No cost</p>	<p>Specify <i>with contrasting interior wall 1 panel A</i>.</p> <p>Specify <i>with contrasting interior wall 1 panel B</i>.</p> <p>Specify <i>with contrasting interior wall 1 panel C</i>.</p> <p>Specify <i>with contrasting interior wall 1 panel D</i>.</p>
Interior Wall 1 Contrasting Panel Type	<ul style="list-style-type: none"> • Fabric • Laminate 	<p>No cost</p> <p>+\$ 495</p>	<p>Specify <i>with fabric</i>.</p> <p>Specify <i>with laminate</i>.</p>
Interior Wall 1 Contrasting Panel Finish	<ul style="list-style-type: none"> • Customer's Own Material (COM) • Fabric price group 1 • Fabric price group 2 • Fabric price group 3 • Fabric price group 4 • Fabric price group 5 • Fabric price group 6 	<p>No cost</p> <p>No cost</p> <p>+\$ 100</p> <p>+\$ 186</p> <p>+\$ 263</p> <p>+\$ 329</p> <p>+\$ 410</p>	<p>▶ See <i>Surface Materials Reference Manual</i>.</p> <p>Specify fabric color number for contrasting interior wall 1.</p> <p>Specify fabric color number for contrasting interior wall 1.</p> <p>Specify fabric color number for contrasting interior wall 1.</p> <p>Specify fabric color number for contrasting interior wall 1.</p> <p>Specify fabric color number for contrasting interior wall 1.</p> <p>Specify fabric color number for contrasting interior wall 1.</p> <p>Specify fabric color number for contrasting interior wall 1.</p>

▶ Options, continued on next page



For Canadian Pricing

Multiply U.S. Price by the Canadian price factor.

▶ See page 1 for details.

► Options, continued from previous page

	Options	U.S. Price	Required to Specify
Interior Wall 1 Contrasting Panel Finish, continued	• Fabric price group 7	+\$ 466	Specify fabric color number for contrasting interior wall 1.
	• Fabric price group 8	+\$ 592	Specify fabric color number for contrasting interior wall 1.
	• Fabric price group 9	+\$ 725	Specify fabric color number for contrasting interior wall 1.
	• Fabric price group 10	+\$ 824	Specify fabric color number for contrasting interior wall 1.
	• High-Pressure Laminate price group 1	No cost	Specify laminate color number for contrasting interior wall 1.
	• High-Pressure Laminate price group 2	+\$ 558	Specify laminate color number for contrasting interior wall 1.
	• High-Pressure Laminate price group 3	+\$ 810	Specify laminate color number for contrasting interior wall 1.
	• Open Line laminate (OLL)	+\$ 111 plus cost of laminate	► See <i>Surface Materials Reference Manual</i> .
Interior Wall 2 Panel Finish	• Customer's Own Material (COM)	No cost	► See <i>Surface Materials Reference Manual</i> .
	• Fabric price group 1	No cost	Specify fabric color number.
	• Fabric price group 2	+\$ 399	Specify fabric color number.
	• Fabric price group 3	+\$ 742	Specify fabric color number.
	• Fabric price group 4	+\$1050	Specify fabric color number.
	• Fabric price group 5	+\$1318	Specify fabric color number.
	• Fabric price group 6	+\$1644	Specify fabric color number.
	• Fabric price group 7	+\$1864	Specify fabric color number.
	• Fabric price group 8	+\$2367	Specify fabric color number.
	• Fabric price group 9	+\$2901	Specify fabric color number.
• Fabric price group 10	+\$3296	Specify fabric color number.	
Interior Wall 2 Contrasting Panel	• Non contrasting	No cost	Specify <i>with non contrasting</i> .
	• Contrasting	+\$ 319	Specify <i>with contrasting</i> .
Interior Wall 2 Contrasting Panel Position	• Panel A	No cost	Specify <i>with contrasting interior wall 2 panel A</i> .
	• Panel B	No cost	Specify <i>with contrasting interior wall 2 panel B</i> .
	• Panel C	No cost	Specify <i>with contrasting interior wall 2 panel C</i> .
	• Panel D	No cost	Specify <i>with contrasting interior wall 2 panel D</i> .
Interior Wall 2 Contrasting Panel Type	• Fabric	No cost	Specify <i>with fabric</i> .
	• Laminate	+\$ 495	Specify <i>with laminate</i> .
Interior Wall 2 Contrasting Panel Finish	• Customer's Own Material (COM)	No cost	► See <i>Surface Materials Reference Manual</i> .
	• Fabric price group 1	No cost	Specify fabric color number for contrasting interior wall 2.
	• Fabric price group 2	+\$ 100	Specify fabric color number for contrasting interior wall 2.
	• Fabric price group 3	+\$ 186	Specify fabric color number for contrasting interior wall 2.
	• Fabric price group 4	+\$ 263	Specify fabric color number for contrasting interior wall 2.
	• Fabric price group 5	+\$ 329	Specify fabric color number for contrasting interior wall 2.
	• Fabric price group 6	+\$ 410	Specify fabric color number for contrasting interior wall 2.
	• Fabric price group 7	+\$ 466	Specify fabric color number for contrasting interior wall 2.
	• Fabric price group 8	+\$ 592	Specify fabric color number for contrasting interior wall 2.
	• Fabric price group 9	+\$ 725	Specify fabric color number for contrasting interior wall 2.
• Fabric price group 10	+\$ 824	Specify fabric color number for contrasting interior wall 2.	
	• High-Pressure Laminate price group 1	No cost	Specify laminate color number for contrasting interior wall 2.

Specifying



For Canadian Pricing
Multiply U.S. Price by the Canadian price factor.
► See page 1 for details.

► Options, continued on next page

Campers 115"W x 119"D Corner Glass, continued

► Options, continued from previous page

	Options	U.S. Price	Required to Specify
Interior Wall 2 Contrasting Panel Finish, continued	• High-Pressure Laminate price group 2	+\$ 558	Specify laminate color number for contrasting interior wall 2.
	• High-Pressure Laminate price group 3	+\$ 810	Specify laminate color number for contrasting interior wall 2.
	• Open Line laminate (OLL)	+\$ 111 plus cost of laminate	► See <i>Surface Materials Reference Manual</i> .
Interior Wall 3 Panel Finish	• Customer's Own Material (COM)	No cost	► See <i>Surface Materials Reference Manual</i> .
	• Fabric price group 1	No cost	Specify fabric color number.
	• Fabric price group 2	+\$ 300	Specify fabric color number.
	• Fabric price group 3	+\$ 556	Specify fabric color number.
	• Fabric price group 4	+\$ 787	Specify fabric color number.
	• Fabric price group 5	+\$ 989	Specify fabric color number.
	• Fabric price group 6	+\$1232	Specify fabric color number.
	• Fabric price group 7	+\$1398	Specify fabric color number.
	• Fabric price group 8	+\$1776	Specify fabric color number.
	• Fabric price group 9	+\$2175	Specify fabric color number.
• Fabric price group 10	+\$2472	Specify fabric color number.	
Interior Wall 3 Contrasting Panel	• Non contrasting	No cost	Specify <i>with non contrasting</i> .
	• Contrasting	+\$ 319	Specify <i>with contrasting</i> .
Interior Wall 3 Contrasting Panel Position	• Panel A	No cost	Specify <i>with contrasting interior wall 3 panel A</i> .
	• Panel B	No cost	Specify <i>with contrasting interior wall 3 panel B</i> .
	• Panel C	No cost	Specify <i>with contrasting interior wall 3 panel C</i> .
Interior Wall 3 Contrasting Panel Type	• Fabric	No cost	Specify <i>with fabric</i> .
	• Laminate	+\$ 495	Specify <i>with laminate</i> .
Interior Wall 3 Contrasting Panel Finish	• Customer's Own Material (COM)	No cost	► See <i>Surface Materials Reference Manual</i> .
	• Fabric price group 1	No cost	Specify fabric color number for contrasting interior wall 3.
	• Fabric price group 2	+\$ 100	Specify fabric color number for contrasting interior wall 3.
	• Fabric price group 3	+\$ 186	Specify fabric color number for contrasting interior wall 3.
	• Fabric price group 4	+\$ 263	Specify fabric color number for contrasting interior wall 3.
	• Fabric price group 5	+\$ 329	Specify fabric color number for contrasting interior wall 3.
	• Fabric price group 6	+\$ 410	Specify fabric color number for contrasting interior wall 3.
	• Fabric price group 7	+\$ 466	Specify fabric color number for contrasting interior wall 3.
	• Fabric price group 8	+\$ 592	Specify fabric color number for contrasting interior wall 3.
	• Fabric price group 9	+\$ 725	Specify fabric color number for contrasting interior wall 3.
	• Fabric price group 10	+\$ 824	Specify fabric color number for contrasting interior wall 3.
	• High-Pressure Laminate price group 1	No cost	Specify laminate color number for price group 1 contrasting interior wall 3.
	• High-Pressure Laminate price group 2	+\$ 558	Specify laminate color number for price group 2 contrasting interior wall 3.
	• High-Pressure Laminate price group 3	+\$ 810	Specify laminate color number for price group 3 contrasting interior wall 3.
• Open Line laminate (OLL)	+\$ 111 plus cost of laminate	► See <i>Surface Materials Reference Manual</i> .	
Exterior Wall 1 Panel Type	• Fabric	No cost	Specify <i>with fabric</i> .
	• Laminate	+\$1977	Specify <i>with laminate</i> .
	• Plywood	+\$5238	Specify <i>with plywood</i> .

Tip: Panel D is not available on interior wall 3 of corner glass left hand unit.

► Options, continued on next page

 **For Canadian Pricing**
Multiply U.S. Price by the Canadian price factor.
► See page 1 for details.

► Options, continued from previous page

Options	U.S. Price	Required to Specify
Exterior Wall 1 Panel Finish	<ul style="list-style-type: none"> • Customer's Own Material (COM) No cost • Plywood price group 1 No cost • Fabric price group 1 No cost • Fabric price group 2 +\$ 399 • Fabric price group 3 +\$ 742 • Fabric price group 4 +\$1050 • Fabric price group 5 +\$1318 • Fabric price group 6 +\$1644 • Fabric price group 7 +\$1864 • Fabric price group 8 +\$2367 • Fabric price group 9 +\$2901 • Fabric price group 10 +\$3296 • High-Pressure Laminate price group 1 No cost • High-Pressure Laminate price group 2 +\$2233 • High-Pressure Laminate price group 3 +\$3239 • Open Line laminate (OLL) +\$ 111 plus cost of laminate 	<ul style="list-style-type: none"> ► See <i>Surface Materials Reference Manual</i>. Specify plywood color number. Specify fabric color number. Specify fabric color number. Specify fabric color number. Specify fabric color number. Specify fabric color number. Specify fabric color number. Specify fabric color number. Specify fabric color number. Specify fabric color number. Specify fabric color number. Specify laminate color number. Specify laminate color number. Specify laminate color number. ► See <i>Surface Materials Reference Manual</i>.
Exterior Wall 1 Contrasting Panel	<ul style="list-style-type: none"> • Non contrasting No cost • Contrasting +\$ 319 	Specify with non contrasting. Specify with contrasting.
Exterior Wall 1 Contrasting Panel Position	<ul style="list-style-type: none"> • Panel A No cost • Panel B No cost • Panel C No cost • Panel D No cost 	Specify with contrasting exterior wall 1 panel A. Specify with contrasting exterior wall 1 panel B. Specify with contrasting exterior wall 1 panel C. Specify with contrasting exterior wall 1 panel D.
Exterior Wall 1 Contrasting Panel Type	<ul style="list-style-type: none"> • Fabric No cost • Laminate +\$ 495 • Plywood +\$1309 	Specify with fabric. Specify with laminate. Specify with plywood.
Exterior Wall 1 Contrasting Panel Finish	<ul style="list-style-type: none"> • Customer's Own Material (COM) No cost • Fabric price group 1 No cost • Fabric price group 2 +\$ 100 • Fabric price group 3 +\$ 186 • Fabric price group 4 +\$ 263 • Fabric price group 5 +\$ 329 • Fabric price group 6 +\$ 410 • Fabric price group 7 +\$ 466 • Fabric price group 8 +\$ 592 • Fabric price group 9 +\$ 725 • Fabric price group 10 +\$ 824 • High-Pressure Laminate price group 1 No cost • High-Pressure Laminate price group 2 +\$ 558 • High-Pressure Laminate price group 3 +\$ 810 • Open Line laminate (OLL) +\$ 111 plus cost of laminate 	<ul style="list-style-type: none"> ► See <i>Surface Materials Reference Manual</i>. Specify fabric color number for contrasting exterior wall 1. Specify fabric color number for contrasting exterior wall 1. Specify fabric color number for contrasting exterior wall 1. Specify fabric color number for contrasting exterior wall 1. Specify fabric color number for contrasting exterior wall 1. Specify fabric color number for contrasting exterior wall 1. Specify fabric color number for contrasting exterior wall 1. Specify fabric color number for contrasting exterior wall 1. Specify fabric color number for contrasting exterior wall 1. Specify fabric color number for contrasting exterior wall 1. Specify laminate color number for contrasting exterior wall 1. Specify laminate color number for contrasting exterior wall 1. Specify laminate color number for contrasting exterior wall 1. Specify laminate color number for contrasting exterior wall 1. Specify laminate color number for contrasting exterior wall 1. ► See <i>Surface Materials Reference Manual</i>.

Specifying

 **For Canadian Pricing**
Multiply U.S. Price by the Canadian price factor.
► See page 1 for details.

► Options, continued on next page

► Options, continued from previous page

	Options	U.S. Price	Required to Specify
Exterior Wall 2 Panel Type	<ul style="list-style-type: none"> Fabric Laminate Plywood 	<ul style="list-style-type: none"> No cost +\$1977 +\$5238 	<ul style="list-style-type: none"> Specify with fabric. Specify with laminate. Specify with plywood.
Exterior Wall 2 Panel Finish	<ul style="list-style-type: none"> Customer's Own Material (COM) Plywood price group 1 Fabric price group 1 Fabric price group 2 Fabric price group 3 Fabric price group 4 Fabric price group 5 Fabric price group 6 Fabric price group 7 Fabric price group 8 Fabric price group 9 Fabric price group 10 High-Pressure Laminate price group 1 High-Pressure Laminate price group 2 High-Pressure Laminate price group 3 Open Line laminate (OLL) 	<ul style="list-style-type: none"> No cost No cost No cost +\$ 399 +\$ 742 +\$1050 +\$1318 +\$1644 +\$1864 +\$2367 +\$2901 +\$3296 No cost +\$2233 +\$3239 +\$ 111 plus cost of laminate 	<ul style="list-style-type: none"> ► See <i>Surface Materials Reference Manual</i>. Specify plywood color number. Specify fabric color number. Specify fabric color number. Specify fabric color number. Specify fabric color number. Specify fabric color number. Specify fabric color number. Specify fabric color number. Specify fabric color number. Specify fabric color number. Specify fabric color number. Specify fabric color number. Specify laminate color number. Specify laminate color number. Specify laminate color number. ► See <i>Surface Materials Reference Manual</i>.
Exterior Wall 2 Contrasting Panel	<ul style="list-style-type: none"> Non contrasting Contrasting 	<ul style="list-style-type: none"> No cost -\$ 319 	<ul style="list-style-type: none"> Specify with non contrasting. Specify with contrasting.
Exterior Wall 2 Contrasting Panel Position	<ul style="list-style-type: none"> Panel A Panel B Panel C Panel D 	<ul style="list-style-type: none"> No cost No cost No cost No cost 	<ul style="list-style-type: none"> Specify with contrasting exterior wall 2 panel A. Specify with contrasting exterior wall 2 panel B. Specify with contrasting exterior wall 2 panel C. Specify with contrasting exterior wall 2 panel D.
Exterior Wall 2 Contrasting Panel Type	<ul style="list-style-type: none"> Fabric Laminate Plywood 	<ul style="list-style-type: none"> No cost +\$ 495 +\$1309 	<ul style="list-style-type: none"> Specify with fabric. Specify with laminate. Specify with plywood.
Exterior Wall 2 Contrasting Panel Finish	<ul style="list-style-type: none"> Customer's Own Material (COM) Fabric price group 1 Fabric price group 2 Fabric price group 3 Fabric price group 4 Fabric price group 5 Fabric price group 6 Fabric price group 7 Fabric price group 8 Fabric price group 9 Fabric price group 10 High-Pressure Laminate price group 1 High-Pressure Laminate price group 2 High-Pressure Laminate price group 3 Open Line laminate (OLL) 	<ul style="list-style-type: none"> No cost No cost +\$ 100 +\$ 186 +\$ 263 +\$ 329 +\$ 410 +\$ 466 +\$ 592 +\$ 725 +\$ 824 No cost -\$ 558 +\$ 810 +\$ 111 plus cost of laminate 	<ul style="list-style-type: none"> ► See <i>Surface Materials Reference Manual</i>. Specify fabric color number for contrasting exterior wall 2. Specify fabric color number for contrasting exterior wall 2. Specify fabric color number for contrasting exterior wall 2. Specify fabric color number for contrasting exterior wall 2. Specify fabric color number for contrasting exterior wall 2. Specify fabric color number for contrasting exterior wall 2. Specify fabric color number for contrasting exterior wall 2. Specify fabric color number for contrasting exterior wall 2. Specify fabric color number for contrasting exterior wall 2. Specify fabric color number for contrasting exterior wall 2. Specify fabric color number for contrasting exterior wall 2. Specify laminate color number for contrasting exterior wall 2. Specify laminate color number for contrasting exterior wall 2. Specify laminate color number for contrasting exterior wall 2. ► See <i>Surface Materials Reference Manual</i>.



For Canadian Pricing
 Multiply U.S. Price by the Canadian price factor.
 ► See page 1 for details.

► Options, continued on next page

► Options, continued from previous page

Options	U.S. Price	Required to Specify	
Exterior Wall 3 Panel Type	<ul style="list-style-type: none"> Fabric Laminate Plywood 	<ul style="list-style-type: none"> No cost +\$1483 +\$3929 	<ul style="list-style-type: none"> Specify with fabric. Specify with laminate. Specify with plywood.
Exterior Wall 3 Panel Finish	<ul style="list-style-type: none"> Customer's Own Material (COM) Plywood price group 1 Fabric price group 1 Fabric price group 2 Fabric price group 3 Fabric price group 4 Fabric price group 5 Fabric price group 6 Fabric price group 7 Fabric price group 8 Fabric price group 9 Fabric price group 10 High-Pressure Laminate price group 1 High-Pressure Laminate price group 2 High-Pressure Laminate price group 3 Open Line laminate (OLL) 	<ul style="list-style-type: none"> No cost No cost No cost +\$ 300 +\$ 556 +\$ 787 +\$ 989 +\$1232 +\$1398 +\$1776 +\$2175 +\$2472 No cost +\$1674 +\$2430 +\$ 111 plus cost of laminate 	<ul style="list-style-type: none"> ► See <i>Surface Materials Reference Manual</i>. Specify plywood color number. Specify fabric color number. Specify fabric color number. Specify fabric color number. Specify fabric color number. Specify fabric color number. Specify fabric color number. Specify fabric color number. Specify fabric color number. Specify fabric color number. Specify fabric color number. Specify fabric color number. Specify laminate color number. Specify laminate color number. Specify laminate color number. ► See <i>Surface Materials Reference Manual</i>.
Exterior Wall 3 Contrasting Panel	<ul style="list-style-type: none"> Non contrasting Contrasting 	<ul style="list-style-type: none"> No cost +\$ 319 	<ul style="list-style-type: none"> Specify with non contrasting. Specify with contrasting.
Exterior Wall 3 Contrasting Panel Position	<ul style="list-style-type: none"> Panel B Panel C Panel D 	<ul style="list-style-type: none"> No cost No cost No cost 	<ul style="list-style-type: none"> Specify with contrasting exterior wall 3 panel B. Specify with contrasting exterior wall 3 panel C. Specify with contrasting exterior wall 3 panel D.
Exterior Wall 3 Contrasting Panel Type	<ul style="list-style-type: none"> Fabric Laminate Plywood 	<ul style="list-style-type: none"> No cost +\$ 495 +\$1309 	<ul style="list-style-type: none"> Specify with fabric. Specify with laminate. Specify with plywood.
Exterior Wall 3 Contrasting Panel Finish	<ul style="list-style-type: none"> Customer's Own Material (COM) Fabric price group 1 Fabric price group 2 Fabric price group 3 Fabric price group 4 Fabric price group 5 Fabric price group 6 Fabric price group 7 Fabric price group 8 Fabric price group 9 Fabric price group 10 High-Pressure Laminate price group 1 High-Pressure Laminate price group 2 High-Pressure Laminate price group 3 Open Line laminate (OLL) 	<ul style="list-style-type: none"> No cost No cost +\$ 100 +\$ 186 +\$ 263 +\$ 329 +\$ 410 +\$ 466 +\$ 592 +\$ 725 +\$ 824 No cost +\$ 558 +\$ 810 +\$ 111 plus cost of laminate 	<ul style="list-style-type: none"> ► See <i>Surface Materials Reference Manual</i>. Specify fabric color number for contrasting exterior wall 3. Specify fabric color number for contrasting exterior wall 3. Specify fabric color number for contrasting exterior wall 3. Specify fabric color number for contrasting exterior wall 3. Specify fabric color number for contrasting exterior wall 3. Specify fabric color number for contrasting exterior wall 3. Specify fabric color number for contrasting exterior wall 3. Specify fabric color number for contrasting exterior wall 3. Specify fabric color number for contrasting exterior wall 3. Specify fabric color number for contrasting exterior wall 3. Specify fabric color number for contrasting exterior wall 3. Specify fabric color number for contrasting exterior wall 3. Specify laminate color number for contrasting exterior wall 3. Specify laminate color number for contrasting exterior wall 3. Specify laminate color number for contrasting exterior wall 3. Specify laminate color number for contrasting exterior wall 3. ► See <i>Surface Materials Reference Manual</i>.

Specifying



For Canadian Pricing
Multiply U.S. Price by the Canadian price factor.
► See page 1 for details.

► Options, continued on next page

► Options, continued from previous page

	Options	U.S. Price	Required to Specify
Power Configuration	<ul style="list-style-type: none"> • 3 power • 2 power, 1 USB A, 1 USB C 20W 	No cost +\$780	Specify with 3 power. Specify with 2 power, 1 USB A, 1 USB C 20W.
HDMI and Data Configuration	<ul style="list-style-type: none"> • No HDMI/data • 1 HDMI, 2 data 	No cost +\$978	Specify with no HDMI/data. Specify with 1 HDMI, 2 data.
Kink Option	<ul style="list-style-type: none"> • No kink • With kink 	No cost No cost	Specify with no kink. Specify with kink.
Cabin Option	<ul style="list-style-type: none"> • No cabin • With cabin 	No cost No cost	Specify with no cabin. Specify with cabin.

Tip: When specifying your camper, please make sure the "kink option" and "cabin option" are entered correctly. For the "kink option" select "with kink" if you plan to add a kink to the camper and "no kink" if you don't intend to add a kink on the camper. Likewise, for the "cabin option", please select "with cabin", if you plan to attach a cabin to the camper and "no cabin" if you don't plan to attach a cabin.

Specification Information

Style Number	U.S. Base Price
--------------	-----------------

115" x 119" Corner Glass Front—Left Hand

OB1CD05CLS \$87,093

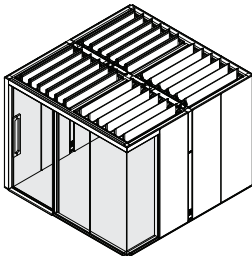

115" x 119" Corner Glass Front (with Infill)—Left Hand

OB1CD05CLSNB \$89,273

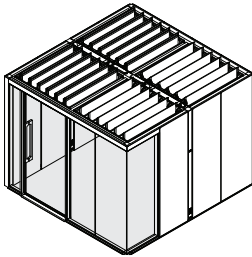

For Canadian Pricing

Multiply U.S. Price by the Canadian price factor.

► See page 1 for details.

Campers 88"W x 92"D Corner Glass Front

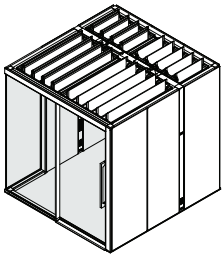

	Standard Includes	Required to Specify
▶ Need help? Product details, page 20	<ul style="list-style-type: none"> • Camper: 88"W x 92"D corner glass front—right hand • Frame: 7207 Black • Glass: 6500 Clear Glass • Door handle pull: wood price group 1 • Power plug: type B • Power outlet: 3 NEMA power outlets • Fascia: paint price group 1 • Air circulation fan 	<ol style="list-style-type: none"> 1 Style number 2 Fascia type 3 Wood color number for door handle pull 4 Paint color number for fascia 5 Options, if selected (see below) <p>▶ See Product Understanding for Surface Materials.</p>

	Options	U.S. Price	Required to Specify
Fascia Type	<ul style="list-style-type: none"> • Paint • Fabric 	<p>No cost</p> <p>+\$ 185</p>	<p>Specify with paint.</p> <p>Specify with fabric.</p>
Fascia Finish	<ul style="list-style-type: none"> • Customer's Own Material (COM) • Fabric price group 1 • Paint price group 1 • Paint price group 2 • Paint price group 3 • Fabric price group 2 • Fabric price group 3 • Fabric price group 4 • Fabric price group 5 • Fabric price group 6 • Fabric price group 7 • Fabric price group 8 • Fabric price group 9 • Fabric price group 10 	<p>No cost</p> <p>No cost</p> <p>No cost</p> <p>+\$ 101</p> <p>+\$ 131</p> <p>+\$ 121</p> <p>+\$ 225</p> <p>+\$ 313</p> <p>+\$ 395</p> <p>+\$ 515</p> <p>+\$ 635</p> <p>+\$ 819</p> <p>+\$1078</p> <p>+\$1209</p>	<p>▶ See <i>Surface Materials Reference Manual</i>.</p> <p>Specify fabric color number.</p> <p>Specify paint color number.</p> <p>Specify paint color number.</p> <p>Specify fabric color number.</p> <p>Specify fabric color number.</p> <p>Specify fabric color number.</p> <p>Specify fabric color number.</p> <p>Specify fabric color number.</p> <p>Specify fabric color number.</p> <p>Specify fabric color number.</p> <p>Specify fabric color number.</p> <p>Specify fabric color number.</p> <p>Specify fabric color number.</p>
Interior Wall 1 Panel Finish	<ul style="list-style-type: none"> • Customer's Own Material (COM) • Fabric price group 1 • Fabric price group 2 • Fabric price group 3 • Fabric price group 4 • Fabric price group 5 • Fabric price group 6 • Fabric price group 7 • Fabric price group 8 • Fabric price group 9 • Fabric price group 10 	<p>No cost</p> <p>No cost</p> <p>+\$ 199</p> <p>+\$ 370</p> <p>+\$ 524</p> <p>+\$ 659</p> <p>+\$ 822</p> <p>+\$ 933</p> <p>+\$1184</p> <p>+\$1451</p> <p>+\$1648</p>	<p>▶ See <i>Surface Materials Reference Manual</i>.</p> <p>Specify fabric color number.</p> <p>Specify fabric color number.</p> <p>Specify fabric color number.</p> <p>Specify fabric color number.</p> <p>Specify fabric color number.</p> <p>Specify fabric color number.</p> <p>Specify fabric color number.</p> <p>Specify fabric color number.</p> <p>Specify fabric color number.</p> <p>Specify fabric color number.</p>
Interior Wall 1 Contrasting Panel	<ul style="list-style-type: none"> • Non contrasting • Contrasting 	<p>No cost</p> <p>+\$ 319</p>	<p>Specify with non contrasting.</p> <p>Specify with contrasting.</p>
Interior Wall 1 Contrasting Panel Position	<ul style="list-style-type: none"> • Panel B • Panel C 	<p>No cost</p> <p>No cost</p>	<p>Specify with contrasting interior wall 1 panel B.</p> <p>Specify with contrasting interior wall 1 panel C.</p>
Interior Wall 1 Contrasting Panel Type	<ul style="list-style-type: none"> • Fabric • Laminate 	<p>No cost</p> <p>+\$ 495</p>	<p>Specify with fabric.</p> <p>Specify with laminate.</p>
Interior Wall 1 Contrasting Panel Finish	<ul style="list-style-type: none"> • Customer's Own Material (COM) • Fabric price group 1 • Fabric price group 2 • Fabric price group 3 • Fabric price group 4 • Fabric price group 5 • Fabric price group 6 • Fabric price group 7 	<p>No cost</p> <p>No cost</p> <p>+\$ 100</p> <p>+\$ 186</p> <p>+\$ 263</p> <p>+\$ 329</p> <p>+\$ 410</p> <p>+\$ 466</p>	<p>▶ See <i>Surface Materials Reference Manual</i>.</p> <p>Specify fabric color number for contrasting interior wall 1.</p> <p>Specify fabric color number for contrasting interior wall 1.</p> <p>Specify fabric color number for contrasting interior wall 1.</p> <p>Specify fabric color number for contrasting interior wall 1.</p> <p>Specify fabric color number for contrasting interior wall 1.</p> <p>Specify fabric color number for contrasting interior wall 1.</p> <p>Specify fabric color number for contrasting interior wall 1.</p> <p>Specify fabric color number for contrasting interior wall 1.</p>

▶ Options, continued on next page



For Canadian Pricing
Multiply U.S. Price by the Canadian price factor.
▶ See page 1 for details.

► Options, continued from previous page

Options	U.S. Price	Required to Specify	
Exterior Wall 1 Panel Type	<ul style="list-style-type: none"> Fabric Laminate Plywood 	<ul style="list-style-type: none"> No cost +\$ 989 +\$2619 	<ul style="list-style-type: none"> Specify with fabric. Specify with laminate. Specify with plywood.
Exterior Wall 1 Panel Finish	<ul style="list-style-type: none"> Customer's Own Material (COM) Plywood price group 1 Fabric price group 1 Fabric price group 2 Fabric price group 3 Fabric price group 4 Fabric price group 5 Fabric price group 6 Fabric price group 7 Fabric price group 8 Fabric price group 9 Fabric price group 10 High-Pressure Laminate price group 1 High-Pressure Laminate price group 2 High-Pressure Laminate price group 3 Open Line laminate (OLL) 	<ul style="list-style-type: none"> No cost No cost No cost +\$ 199 +\$ 370 +\$ 524 +\$ 659 +\$ 822 +\$ 933 +\$1184 +\$1451 +\$1648 No cost +\$1116 +\$1619 +\$ 111 plus cost of laminate 	<ul style="list-style-type: none"> ► See <i>Surface Materials Reference Manual</i>. Specify plywood color number. Specify fabric color number. Specify fabric color number. Specify fabric color number. Specify fabric color number. Specify fabric color number. Specify fabric color number. Specify fabric color number. Specify fabric color number. Specify fabric color number. Specify fabric color number. Specify fabric color number. Specify laminate color number. Specify laminate color number. Specify laminate color number. ► See <i>Surface Materials Reference Manual</i>.
Exterior Wall 1 Contrasting Panel	<ul style="list-style-type: none"> Non contrasting Contrasting 	<ul style="list-style-type: none"> No cost +\$ 319 	<ul style="list-style-type: none"> Specify with non contrasting. Specify with contrasting.
Exterior Wall 1 Contrasting Panel Position	<ul style="list-style-type: none"> Panel A Panel B 	<ul style="list-style-type: none"> No cost No cost 	<ul style="list-style-type: none"> Specify with contrasting exterior wall 1 panel A. Specify with contrasting exterior wall 1 panel B.
Exterior Wall 1 Contrasting Panel Type	<ul style="list-style-type: none"> Fabric Laminate Plywood 	<ul style="list-style-type: none"> No cost +\$ 495 +\$1309 	<ul style="list-style-type: none"> Specify with fabric. Specify with laminate. Specify with plywood.
Exterior Wall 1 Contrasting Panel Finish	<ul style="list-style-type: none"> Customer's Own Material (COM) Fabric price group 1 Fabric price group 2 Fabric price group 3 Fabric price group 4 Fabric price group 5 Fabric price group 6 Fabric price group 7 Fabric price group 8 Fabric price group 9 Fabric price group 10 High-Pressure Laminate price group 1 High-Pressure Laminate price group 2 High-Pressure Laminate price group 3 Open Line laminate (OLL) 	<ul style="list-style-type: none"> No cost No cost +\$ 100 +\$ 186 +\$ 263 +\$ 329 +\$ 410 +\$ 466 +\$ 592 +\$ 725 +\$ 824 No cost +\$ 558 +\$ 810 +\$ 111 plus cost of laminate 	<ul style="list-style-type: none"> ► See <i>Surface Materials Reference Manual</i>. Specify fabric color number for contrasting exterior wall 1. Specify fabric color number for contrasting exterior wall 1. Specify fabric color number for contrasting exterior wall 1. Specify fabric color number for contrasting exterior wall 1. Specify fabric color number for contrasting exterior wall 1. Specify fabric color number for contrasting exterior wall 1. Specify fabric color number for contrasting exterior wall 1. Specify fabric color number for contrasting interior wall 1. Specify fabric color number for contrasting interior wall 1. Specify fabric color number for contrasting interior wall 1. Specify fabric color number for contrasting interior wall 1. Specify laminate color number for contrasting interior wall 1. Specify laminate color number for contrasting interior wall 1. Specify laminate color number for contrasting interior wall 1. ► See <i>Surface Materials Reference Manual</i>.

Specifying

► Options, continued on next page



For Canadian Pricing
Multiply U.S. Price by the Canadian price factor.
► See page 1 for details.

Campers 88"W x 92"D Corner Glass Front, continued

► Options, continued from previous page

	Options	U.S. Price	Required to Specify
Exterior Wall 2 Panel Type	• Fabric	No cost	Specify <i>with fabric</i> .
	• Laminate	+\$1483	Specify <i>with laminate</i> .
	• Plywood	+\$3929	Specify <i>with plywood</i> .
Exterior Wall 2 Panel Finish	• Customer's Own Material (COM)	No cost	► See <i>Surface Materials Reference Manual</i> . Specify fabric color number. Specify fabric color number. Specify fabric color number. Specify fabric color number. Specify fabric color number. Specify fabric color number. Specify fabric color number. Specify fabric color number. Specify fabric color number. Specify fabric color number. Specify laminate color number. Specify laminate color number. Specify laminate color number. ► See <i>Surface Materials Reference Manual</i> .
	• Fabric price group 1	No cost	
	• Fabric price group 2	+\$ 300	
	• Fabric price group 3	+\$ 556	
	• Fabric price group 4	+\$ 787	
	• Fabric price group 5	+\$ 989	
	• Fabric price group 6	+\$1232	
	• Fabric price group 7	+\$1398	
	• Fabric price group 8	+\$1776	
	• Fabric price group 9	+\$2175	
	• Fabric price group 10	+\$2472	
	• High-Pressure Laminate price group 1	No cost	
	• High-Pressure Laminate price group 2	+\$1674	
	• High-Pressure Laminate price group 3	+\$2430	
• Open Line laminate (OLL)	+\$ 111 plus cost of laminate		
Exterior Wall 2 Contrasting Panel	• Non contrasting	No cost	Specify <i>with non contrasting</i> .
	• Contrasting	+\$ 319	Specify <i>with contrasting</i> .
Exterior Wall 2 Contrasting Panel Position	• Panel A	No cost	Specify <i>with contrasting exterior wall 2 panel A</i> .
	• Panel B	No cost	Specify <i>with contrasting exterior wall 2 panel B</i> .
	• Panel C	No cost	Specify <i>with contrasting exterior wall 2 panel C</i> .
Exterior Wall 2 Contrasting Panel Type	• Fabric	No cost	Specify <i>with fabric</i> .
	• Laminate	+\$ 495	Specify <i>with laminate</i> .
	• Plywood	+\$1309	Specify <i>with plywood</i> .
Exterior Wall 2 Contrasting Panel Finish	• Customer's Own Material (COM)	No cost	► See <i>Surface Materials Reference Manual</i> . Specify fabric color number for contrasting exterior wall 2. Specify fabric color number for contrasting exterior wall 2. Specify fabric color number for contrasting exterior wall 2. Specify fabric color number for contrasting exterior wall 2. Specify fabric color number for contrasting exterior wall 2. Specify fabric color number for contrasting exterior wall 2. Specify fabric color number for contrasting exterior wall 2. Specify fabric color number for contrasting exterior wall 2. Specify fabric color number for contrasting exterior wall 2. Specify fabric color number for contrasting exterior wall 2. Specify laminate color number for contrasting exterior wall 2. Specify laminate color number for contrasting exterior wall 2. Specify laminate color number for contrasting exterior wall 2. ► See <i>Surface Materials Reference Manual</i> .
	• Fabric price group 1	No cost	
	• Fabric price group 2	+\$ 100	
	• Fabric price group 3	+\$ 186	
	• Fabric price group 4	+\$ 263	
	• Fabric price group 5	+\$ 329	
	• Fabric price group 6	+\$ 410	
	• Fabric price group 7	+\$ 466	
	• Fabric price group 8	+\$ 592	
	• Fabric price group 9	+\$ 725	
	• Fabric price group 10	+\$ 824	
	• High-Pressure Laminate price group 1	No cost	
	• High-Pressure Laminate price group 2	+\$ 558	
	• High-Pressure Laminate price group 3	+\$ 810	
• Open Line laminate (OLL)	+\$ 111 plus cost of laminate		

► Options, continued on next page



For Canadian Pricing

Multiply U.S. Price by the Canadian price factor.

► See page 1 for details.

► Options, on previous page

Options	U.S. Price	Required to Specify	
Exterior Wall 3 Panel Type	<ul style="list-style-type: none"> Fabric Laminate Plywood 	<ul style="list-style-type: none"> No cost +\$1483 +\$3929 	<ul style="list-style-type: none"> Specify with fabric. Specify with laminate. Specify with plywood.
Exterior Wall 3 Panel Finish	<ul style="list-style-type: none"> Customer's Own Material (COM) Plywood price group 1 Fabric price group 1 Fabric price group 2 Fabric price group 3 Fabric price group 4 Fabric price group 5 Fabric price group 6 Fabric price group 7 Fabric price group 8 Fabric price group 9 Fabric price group 10 High-Pressure Laminate price group 1 High-Pressure Laminate price group 2 High-Pressure Laminate price group 3 Open Line laminate (OLL) 	<ul style="list-style-type: none"> No cost No cost No cost +\$ 300 +\$ 556 +\$ 787 +\$ 989 +\$1232 +\$1398 +\$1776 +\$2175 +\$2472 No cost +\$1674 +\$2430 +\$ 111 plus cost of laminate 	<ul style="list-style-type: none"> ► See <i>Surface Materials Reference Manual</i>. Specify plywood color number. Specify fabric color number. Specify fabric color number. Specify fabric color number. Specify fabric color number. Specify fabric color number. Specify fabric color number. Specify fabric color number. Specify fabric color number. Specify fabric color number. Specify fabric color number. Specify laminate color number. Specify laminate color number. ► See <i>Surface Materials Reference Manual</i>.
Exterior Wall 3 Contrasting Panel	<ul style="list-style-type: none"> Non contrasting Contrasting 	<ul style="list-style-type: none"> No cost +\$ 319 	<ul style="list-style-type: none"> Specify with non contrasting. Specify with contrasting.
Exterior Wall 3 Contrasting Panel Position	<ul style="list-style-type: none"> Panel A Panel B Panel C 	<ul style="list-style-type: none"> No cost No cost No cost 	<ul style="list-style-type: none"> Specify with contrasting exterior wall 3 panel A. Specify with contrasting exterior wall 3 panel B. Specify with contrasting exterior wall 3 panel C.
Exterior Wall 3 Contrasting Panel Type	<ul style="list-style-type: none"> Fabric Laminate Plywood 	<ul style="list-style-type: none"> No cost +\$ 495 +\$1309 	<ul style="list-style-type: none"> Specify with fabric. Specify with laminate. Specify with plywood.
Exterior Wall 3 Contrasting Panel Finish	<ul style="list-style-type: none"> Customer's Own Material (COM) Fabric price group 1 Fabric price group 2 Fabric price group 3 Fabric price group 4 Fabric price group 5 Fabric price group 6 Fabric price group 7 Fabric price group 8 Fabric price group 9 Fabric price group 10 High-Pressure Laminate price group 1 High-Pressure Laminate price group 2 High-Pressure Laminate price group 3 Open Line laminate (OLL) 	<ul style="list-style-type: none"> No cost No cost +\$ 100 +\$ 186 +\$ 263 +\$ 329 +\$ 410 +\$ 466 +\$ 592 +\$ 725 +\$ 824 No cost +\$ 558 +\$ 810 +\$ 111 plus cost of laminate 	<ul style="list-style-type: none"> ► See <i>Surface Materials Reference Manual</i>. Specify fabric color number for contrasting exterior wall 3. Specify fabric color number for contrasting exterior wall 3. Specify fabric color number for contrasting exterior wall 3. Specify fabric color number for contrasting exterior wall 3. Specify fabric color number for contrasting exterior wall 3. Specify fabric color number for contrasting exterior wall 3. Specify fabric color number for contrasting exterior wall 3. Specify fabric color number for contrasting exterior wall 3. Specify fabric color number for contrasting exterior wall 3. Specify fabric color number for contrasting exterior wall 3. Specify fabric color number for contrasting exterior wall 3. Specify laminate color number for contrasting exterior wall 3. Specify laminate color number for contrasting exterior wall 3. Specify laminate color number for contrasting exterior wall 3. ► See <i>Surface Materials Reference Manual</i>.

Specifying



For Canadian Pricing
Multiply U.S. Price by the Canadian price factor.
► See page 1 for details.

► Options, continued on next page

► Options, continued from previous page

	Options	U.S. Price	Required to Specify
Power Configuration	<ul style="list-style-type: none"> • 3 power • 2 power, 1 USB A, 1 USB C 20W 	No cost +\$780	Specify with 3 power. Specify with 2 power, 1 USB A, 1 USB C 20W.
HDMI and Data Configuration	<ul style="list-style-type: none"> • No HDMI/data • 1 HDMI, 2 data 	No cost +\$978	Specify with no HDMI/data. Specify with 1 HDMI, 2 data.
Kink Option	<ul style="list-style-type: none"> • No kink • With kink 	No cost No cost	Specify with no kink. Specify with kink.
Cabin Option	<ul style="list-style-type: none"> • No cabin • With cabin 	No cost No cost	Specify with no cabin. Specify with cabin.

Tip: When specifying your camper, please make sure the "kink option" is entered correctly. For the "kink option" select "with kink" if you plan to add a kink to the camper and "no kink" if you don't intend to add a kink on the camper.

Specification Information

Style Number	U.S. Base Price

88"W x 92"D Corner Glass Front—Right Hand

OB1CD02CRS	\$73,122
-------------------	----------

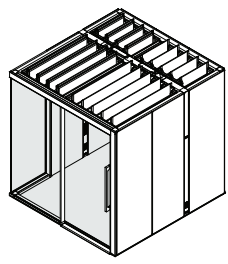

 **For Canadian Pricing**
 Multiply U.S. Price by the Canadian price factor.
 ► See page 1 for details.

Campers 115"W x 119"D Corner Glass Front

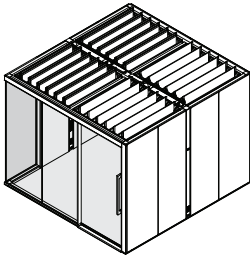

	Standard Includes	Required to Specify
▶ Need help? Product details, page 20	<ul style="list-style-type: none"> • Camper: 115"W x 119"D corner glass front— right hand • Frame: 7207 Black • Glass: 6500 Clear Glass • Door handle pull: wood price group 1 • Power plug: type B • Power outlet: 3 NEMA power outlets • Fascia: paint price group 1 • Air circulation fan 	<ol style="list-style-type: none"> 1 Style number 2 Fascia type 3 Wood color number for door handle pull 4 Paint color number for fascia 5 Options, if selected (see below) <p>▶ See Product Understanding for Surface Materials.</p>

	Options	U.S. Price	Required to Specify
Fascia Type	<ul style="list-style-type: none"> • Paint • Fabric 	<p>No cost</p> <p>+\$ 294</p>	<p>Specify <i>with paint</i>.</p> <p>Specify <i>with fabric</i>.</p>
Fascia Finish	<ul style="list-style-type: none"> • Customer's Own Material (COM) • Fabric price group 1 • Paint price group 1 • Paint price group 2 • Paint price group 3 • Fabric price group 2 • Fabric price group 3 • Fabric price group 4 • Fabric price group 5 • Fabric price group 6 • Fabric price group 7 • Fabric price group 8 • Fabric price group 9 • Fabric price group 10 	<p>No cost</p> <p>No cost</p> <p>No cost</p> <p>+\$ 167</p> <p>+\$ 217</p> <p>+\$ 242</p> <p>+\$ 457</p> <p>+\$ 638</p> <p>+\$ 805</p> <p>+\$1001</p> <p>+\$1145</p> <p>+\$1442</p> <p>+\$1777</p> <p>+\$2017</p>	<p>▶ See <i>Surface Materials Reference Manual</i>.</p> <p>Specify fabric color number.</p> <p>Specify paint color number.</p> <p>Specify paint color number.</p> <p>Specify paint color number.</p> <p>Specify fabric color number.</p> <p>Specify fabric color number.</p> <p>Specify fabric color number.</p> <p>Specify fabric color number.</p> <p>Specify fabric color number.</p> <p>Specify fabric color number.</p> <p>Specify fabric color number.</p> <p>Specify fabric color number.</p> <p>Specify fabric color number.</p> <p>Specify fabric color number.</p>
Interior Wall 1 Panel Finish	<ul style="list-style-type: none"> • Customer's Own Material (COM) • Fabric price group 1 • Fabric price group 2 • Fabric price group 3 • Fabric price group 4 • Fabric price group 5 • Fabric price group 6 • Fabric price group 7 • Fabric price group 8 • Fabric price group 9 • Fabric price group 10 	<p>No cost</p> <p>No cost</p> <p>+\$ 300</p> <p>+\$ 556</p> <p>+\$ 787</p> <p>+\$ 989</p> <p>+\$1232</p> <p>+\$1398</p> <p>+\$1776</p> <p>+\$2175</p> <p>+\$2472</p>	<p>▶ See <i>Surface Materials Reference Manual</i>.</p> <p>Specify fabric color number.</p> <p>Specify fabric color number.</p> <p>Specify fabric color number.</p> <p>Specify fabric color number.</p> <p>Specify fabric color number.</p> <p>Specify fabric color number.</p> <p>Specify fabric color number.</p> <p>Specify fabric color number.</p> <p>Specify fabric color number.</p> <p>Specify fabric color number.</p>
Interior Wall 1 Contrasting Panel	<ul style="list-style-type: none"> • Non contrasting • Contrasting 	<p>No cost</p> <p>+\$ 319</p>	<p>Specify <i>with non contrasting</i>.</p> <p>Specify <i>with contrasting</i>.</p>
Interior Wall 1 Contrasting Panel Position	<ul style="list-style-type: none"> • Panel B • Panel C • Panel D 	<p>No cost</p> <p>No cost</p> <p>No cost</p>	<p>Specify <i>with contrasting interior wall 1 panel B</i>.</p> <p>Specify <i>with contrasting interior wall 1 panel C</i>.</p> <p>Specify <i>with contrasting interior wall 1 panel D</i>.</p>
Interior Wall 1 Contrasting Panel Type	<ul style="list-style-type: none"> • Fabric • Laminate 	<p>No cost</p> <p>+\$ 495</p>	<p>Specify <i>with fabric</i>.</p> <p>Specify <i>with laminate</i>.</p>
Interior Wall 1 Contrasting Panel Finish	<ul style="list-style-type: none"> • Customer's Own Material (COM) • Fabric price group 1 • Fabric price group 2 • Fabric price group 3 • Fabric price group 4 • Fabric price group 5 • Fabric price group 6 	<p>No cost</p> <p>No cost</p> <p>+\$ 100</p> <p>+\$ 186</p> <p>+\$ 263</p> <p>+\$ 329</p> <p>+\$ 410</p>	<p>▶ See <i>Surface Materials Reference Manual</i>.</p> <p>Specify fabric color number for contrasting interior wall 1.</p> <p>Specify fabric color number for contrasting interior wall 1.</p> <p>Specify fabric color number for contrasting interior wall 1.</p> <p>Specify fabric color number for contrasting interior wall 1.</p> <p>Specify fabric color number for contrasting interior wall 1.</p> <p>Specify fabric color number for contrasting interior wall 1.</p> <p>Specify fabric color number for contrasting interior wall 1.</p>

Tip: Panel A is not available on interior wall 1 of corner glass right hand unit.

▶ Options, continued on next page



For Canadian Pricing
Multiply U.S. Price by the Canadian price factor.
▶ See page 1 for details.

► Options, continued from previous page

Options	U.S. Price	Required to Specify	
Interior Wall 1 Contrasting Panel Finish, continued	• Fabric price group 7	+\$ 466	Specify fabric color number for contrasting interior wall 1. Specify fabric color number for contrasting interior wall 1. Specify fabric color number for contrasting interior wall 1. Specify fabric color number for contrasting interior wall 1. Specify fabric color number for contrasting interior wall 1. Specify laminate color number for contrasting interior wall 1. Specify laminate color number for contrasting interior wall 1. Specify laminate color number for contrasting interior wall 1. Specify laminate color number for contrasting interior wall 1. ► See <i>Surface Materials Reference Manual</i> .
	• Fabric price group 8	+\$ 592	
	• Fabric price group 9	+\$ 725	
	• Fabric price group 10	+\$ 824	
	• High-Pressure Laminate price group 1	No cost	
	• High-Pressure Laminate price group 2	+\$ 558	
	• High-Pressure Laminate price group 3	+\$ 810	
	• Open Line laminate (OLL)	+\$ 111 plus cost of laminate	
Interior Wall 2 Panel Finish	• Customer's Own Material (COM)	No cost	► See <i>Surface Materials Reference Manual</i> . Specify fabric color number. Specify fabric color number. Specify fabric color number. Specify fabric color number. Specify fabric color number. Specify fabric color number. Specify fabric color number. Specify fabric color number. Specify fabric color number. Specify fabric color number. Specify fabric color number.
	• Fabric price group 1	No cost	
	• Fabric price group 2	+\$ 399	
	• Fabric price group 3	+\$ 742	
	• Fabric price group 4	+\$1050	
	• Fabric price group 5	+\$1318	
	• Fabric price group 6	+\$1644	
	• Fabric price group 7	+\$1864	
	• Fabric price group 8	+\$2367	
	• Fabric price group 9	+\$2901	
	• Fabric price group 10	+\$3296	
Interior Wall 2 Contrasting Panel	• Non contrasting	No cost	Specify <i>with non contrasting</i> . Specify <i>with contrasting</i> .
	• Contrasting	+\$ 319	
Interior Wall 2 Contrasting Panel Position	• Panel A	No cost	Specify <i>with contrasting interior wall 2 panel A</i> . Specify <i>with contrasting interior wall 2 panel B</i> . Specify <i>with contrasting interior wall 2 panel C</i> . Specify <i>with contrasting interior wall 2 panel D</i> .
	• Panel B	No cost	
	• Panel C	No cost	
	• Panel D	No cost	
Interior Wall 2 Contrasting Panel Type	• Fabric	No cost	Specify <i>with fabric</i> . Specify <i>with laminate</i> .
	• Laminate	+\$ 495	
Interior Wall 2 Contrasting Panel Finish	• Customer's Own Material (COM)	No cost	► See <i>Surface Materials Reference Manual</i> . Specify fabric color number for contrasting interior wall 2. Specify fabric color number for contrasting interior wall 2. Specify fabric color number for contrasting interior wall 2. Specify fabric color number for contrasting interior wall 2. Specify fabric color number for contrasting interior wall 2. Specify fabric color number for contrasting interior wall 2. Specify fabric color number for contrasting interior wall 2. Specify fabric color number for contrasting interior wall 2. Specify fabric color number for contrasting interior wall 2. Specify fabric color number for contrasting interior wall 2. Specify laminate color number for contrasting interior wall 2. Specify laminate color number for contrasting interior wall 2.
	• Fabric price group 1	No cost	
	• Fabric price group 2	+\$ 100	
	• Fabric price group 3	+\$ 186	
	• Fabric price group 4	+\$ 263	
	• Fabric price group 5	+\$ 329	
	• Fabric price group 6	+\$ 410	
	• Fabric price group 7	+\$ 466	
	• Fabric price group 8	+\$ 592	
	• Fabric price group 9	+\$ 725	
	• Fabric price group 10	+\$ 824	
• High-Pressure Laminate price group 1	No cost		
• High-Pressure Laminate price group 2	+\$ 558		

Specifying



For Canadian Pricing
Multiply U.S. Price by the Canadian price factor.
► See page 1 for details.

► Options, continued on next page

Campers 115"W x 119"D Corner Glass Front, continued

► Options, continued from previous page

	Options	U.S. Price	Required to Specify
Interior Wall 2 Contrasting Panel Finish, continued	• High-Pressure Laminate price group 3	+\$ 810	Specify laminate color number for contrasting interior wall 2.
	• Open Line laminate (OLL)	+\$ 111 plus cost of laminate	► See <i>Surface Materials Reference Manual</i> .
Interior Wall 3 Panel Finish	• Customer's Own Material (COM)	No cost	► See <i>Surface Materials Reference Manual</i> .
	• Fabric price group 1	No cost	Specify fabric color number.
	• Fabric price group 2	+\$ 399	Specify fabric color number.
	• Fabric price group 3	+\$ 742	Specify fabric color number.
	• Fabric price group 4	+\$1050	Specify fabric color number.
	• Fabric price group 5	+\$1318	Specify fabric color number.
	• Fabric price group 6	+\$1644	Specify fabric color number.
	• Fabric price group 7	+\$1864	Specify fabric color number.
	• Fabric price group 8	+\$2367	Specify fabric color number.
	• Fabric price group 9	+\$2901	Specify fabric color number.
	• Fabric price group 10	+\$3296	Specify fabric color number.
Interior Wall 3 Contrasting Panel	• Non contrasting	No cost	Specify <i>with non contrasting</i> .
	• Contrasting	+\$ 319	Specify <i>with contrasting</i> .
Interior Wall 3 Contrasting Panel Position	• Panel A	No cost	Specify <i>with contrasting interior wall 3 panel A</i> .
	• Panel B	No cost	Specify <i>with contrasting interior wall 3 panel B</i> .
	• Panel C	No cost	Specify <i>with contrasting interior wall 3 panel C</i> .
	• Panel D	No cost	Specify <i>with contrasting interior wall 3 panel D</i> .
Interior Wall 3 Contrasting Panel Type	• Fabric	No cost	Specify <i>with fabric</i> .
	• Laminate	+\$ 495	Specify <i>with laminate</i> .
Interior Wall 3 Contrasting Panel Finish	• Customer's Own Material (COM)	No cost	► See <i>Surface Materials Reference Manual</i> .
	• Fabric price group 1	No cost	Specify fabric color number for contrasting interior wall 3.
	• Fabric price group 2	+\$ 100	Specify fabric color number for contrasting interior wall 3.
	• Fabric price group 3	+\$ 186	Specify fabric color number for contrasting interior wall 3.
	• Fabric price group 4	+\$ 263	Specify fabric color number for contrasting interior wall 3.
	• Fabric price group 5	+\$ 329	Specify fabric color number for contrasting interior wall 3.
	• Fabric price group 6	+\$ 410	Specify fabric color number for contrasting interior wall 3.
	• Fabric price group 7	+\$ 466	Specify fabric color number for contrasting interior wall 3.
	• Fabric price group 8	+\$ 592	Specify fabric color number for contrasting interior wall 3.
	• Fabric price group 9	+\$ 725	Specify fabric color number for contrasting interior wall 3.
	• Fabric price group 10	+\$ 824	Specify fabric color number for contrasting interior wall 3.
	• High-Pressure Laminate price group 1	No cost	Specify laminate color number for contrasting interior wall 3.
	• High-Pressure Laminate price group 2	+\$ 558	Specify laminate color number for contrasting interior wall 3.
• High-Pressure Laminate price group 3	+\$ 810	Specify laminate color number for contrasting interior wall 3.	
• Open Line laminate (OLL)	+\$ 111 plus cost of laminate	► See <i>Surface Materials Reference Manual</i> .	
Exterior Wall 1 Panel Type	• Fabric	No cost	Specify <i>with fabric</i> .
	• Laminate	+\$1483	Specify <i>with laminate</i> .
	• Plywood	+\$3929	Specify <i>with plywood</i> .

► Options, continued on next page

 **For Canadian Pricing**
Multiply U.S. Price by the Canadian price factor.
► See page 1 for details.

► Options, continued from previous page

Options	U.S. Price	Required to Specify
Exterior Wall 1 Panel Finish	<ul style="list-style-type: none"> • Customer's Own Material (COM) No cost • Plywood price group 1 No cost • Fabric price group 1 No cost • Fabric price group 2 +\$ 300 • Fabric price group 3 +\$ 556 • Fabric price group 4 +\$ 787 • Fabric price group 5 +\$ 989 • Fabric price group 6 +\$1232 • Fabric price group 7 +\$1398 • Fabric price group 8 +\$1776 • Fabric price group 9 +\$2175 • Fabric price group 10 +\$2472 • High-Pressure Laminate price group 1 No cost • High-Pressure Laminate price group 2 +\$1674 • High-Pressure Laminate price group 3 +\$2430 • Open Line laminate (OLL) +\$ 111 plus cost of laminate 	<ul style="list-style-type: none"> ► See <i>Surface Materials Reference Manual</i>. Specify plywood color number. Specify fabric color number. Specify fabric color number. Specify fabric color number. Specify fabric color number. Specify fabric color number. Specify fabric color number. Specify fabric color number. Specify fabric color number. Specify fabric color number. Specify fabric color number. Specify laminate color number. Specify laminate color number. Specify laminate color number. ► See <i>Surface Materials Reference Manual</i>.
Exterior Wall 1 Contrasting Panel	<ul style="list-style-type: none"> • Non contrasting No cost • Contrasting +\$ 319 	<ul style="list-style-type: none"> Specify <i>with non contrasting</i>. Specify <i>with contrasting</i>.
Exterior Wall 1 Contrasting Panel Position	<ul style="list-style-type: none"> • Panel A No cost • Panel B No cost • Panel C No cost 	<ul style="list-style-type: none"> Specify <i>with contrasting exterior wall 1 panel A</i>. Specify <i>with contrasting exterior wall 1 panel B</i>. Specify <i>with contrasting exterior wall 1 panel C</i>.
Exterior Wall 1 Contrasting Panel Type	<ul style="list-style-type: none"> • Fabric No cost • Laminate +\$ 495 • Plywood +\$1309 	<ul style="list-style-type: none"> Specify <i>with fabric</i>. Specify <i>with laminate</i>. Specify <i>with plywood</i>.
Exterior Wall 1 Contrasting Panel Finish	<ul style="list-style-type: none"> • Customer's Own Material (COM) No cost • Fabric price group 1 No cost • Fabric price group 2 +\$ 100 • Fabric price group 3 +\$ 186 • Fabric price group 4 +\$ 263 • Fabric price group 5 +\$ 329 • Fabric price group 6 +\$ 410 • Fabric price group 7 +\$ 466 • Fabric price group 8 +\$ 592 • Fabric price group 9 +\$ 725 • Fabric price group 10 +\$ 824 • High-Pressure Laminate price group 1 No cost • High-Pressure Laminate price group 2 +\$ 558 • High-Pressure Laminate price group 3 +\$ 810 • Open Line laminate (OLL) +\$ 111 plus cost of laminate 	<ul style="list-style-type: none"> ► See <i>Surface Materials Reference Manual</i>. Specify fabric color number for contrasting exterior wall 1. Specify fabric color number for contrasting exterior wall 1. Specify fabric color number for contrasting exterior wall 1. Specify fabric color number for contrasting exterior wall 1. Specify fabric color number for contrasting exterior wall 1. Specify fabric color number for contrasting exterior wall 1. Specify fabric color number for contrasting exterior wall 1. Specify fabric color number for contrasting exterior wall 1. Specify fabric color number for contrasting exterior wall 1. Specify fabric color number for contrasting exterior wall 1. Specify laminate color number for contrasting exterior wall 1. Specify laminate color number for contrasting exterior wall 1. Specify laminate color number for contrasting exterior wall 1. ► See <i>Surface Materials Reference Manual</i>.

Tip: Panel D is not available on exterior wall 1 of corner glass right hand unit.

Specifying



For Canadian Pricing
Multiply U.S. Price by the Canadian price factor.
► See page 1 for details.

► Options, continued on next page

► Options, continued from previous page

	Options	U.S. Price	Required to Specify
Exterior Wall 2 Panel Type	• Fabric	No cost	Specify <i>with fabric</i> .
	• Laminate	+\$1977	Specify <i>with laminate</i> .
	• Plywood	+\$5238	Specify <i>with plywood</i> .
Exterior Wall 2 Panel Finish	• Customer's Own Material (COM)	No cost	► See <i>Surface Materials Reference Manual</i> . Specify plywood color number for contrasting exterior wall 2. Specify fabric color number for contrasting exterior wall 2. Specify fabric color number for contrasting exterior wall 2. Specify fabric color number for contrasting exterior wall 2. Specify fabric color number for contrasting exterior wall 2. Specify fabric color number for contrasting exterior wall 2. Specify fabric color number for contrasting exterior wall 2. Specify fabric color number for contrasting exterior wall 2. Specify fabric color number for contrasting exterior wall 2. Specify fabric color number for contrasting exterior wall 2. Specify fabric color number for contrasting exterior wall 2. Specify exterior color number for contrasting interior wall 2. Specify laminate color number for contrasting exterior wall 2. Specify laminate color number for contrasting exterior wall 2.
	• Plywood price group 1	No cost	
	• Fabric price group 1	No cost	
	• Fabric price group 2	+\$ 399	
	• Fabric price group 3	+\$ 742	
	• Fabric price group 4	+\$1050	
	• Fabric price group 5	+\$1318	
	• Fabric price group 6	+\$1644	
	• Fabric price group 7	+\$1864	
	• Fabric price group 8	+\$2367	
	• Fabric price group 9	+\$2901	
	• Fabric price group 10	+\$3296	
	• High-Pressure Laminate price group 1	No cost	
• High-Pressure Laminate price group 2	+\$2233		
• High-Pressure Laminate price group 3	+\$3239		
Exterior Wall 2 Contrasting Panel	• Non contrasting	No cost	Specify <i>with non contrasting</i> .
	• Contrasting	+\$ 319	Specify <i>with contrasting</i> .
Exterior Wall 2 Contrasting Panel Position	• Panel A	No cost	Specify <i>with contrasting exterior wall 2 panel A</i> .
	• Panel B	No cost	Specify <i>with contrasting exterior wall 2 panel B</i> .
	• Panel C	No cost	Specify <i>with contrasting exterior wall 2 panel C</i> .
	• Panel D	No cost	Specify <i>with contrasting exterior wall 2 panel D</i> .
Exterior Wall 2 Contrasting Panel Type	• Fabric	No cost	Specify <i>with fabric</i> .
	• Laminate	+\$ 495	Specify <i>with laminate</i> .
	• Plywood	+\$1309	Specify <i>with plywood</i> .
Exterior Wall 2 Contrasting Panel Finish	• Customer's Own Material (COM)	No cost	► See <i>Surface Materials Reference Manual</i> . Specify fabric color number for contrasting exterior wall 2. Specify fabric color number for contrasting exterior wall 2. Specify fabric color number for contrasting exterior wall 2. Specify fabric color number for contrasting exterior wall 2. Specify fabric color number for contrasting exterior wall 2. Specify fabric color number for contrasting exterior wall 2. Specify fabric color number for contrasting exterior wall 2. Specify fabric color number for contrasting exterior wall 2.
	• Fabric price group 1	No cost	
	• Fabric price group 2	+\$ 100	
	• Fabric price group 3	+\$ 186	
	• Fabric price group 4	+\$ 263	
	• Fabric price group 5	+\$ 329	
	• Fabric price group 6	+\$ 410	
	• Fabric price group 7	+\$ 466	
	• Fabric price group 8	+\$ 592	
• Fabric price group 9	+\$ 725		

 **For Canadian Pricing**
Multiply U.S. Price by the Canadian price factor.
► See page 1 for details.

► Options, continued on next page

► Options, continued from previous page

Options	U.S. Price	Required to Specify	
Exterior Wall 2 Contrasting Panel Finish, continued	• Fabric price group 10	+\$ 824	Specify fabric color number for contrasting exterior wall 2. Specify laminate color number for contrasting interior wall 2. Specify laminate color number for contrasting interior wall 2. Specify laminate color number for contrasting interior wall 2. Specify laminate color number for contrasting interior wall 2. ► See <i>Surface Materials Reference Manual</i> .
	• High-Pressure Laminate price group 1	No cost	
	• High-Pressure Laminate price group 2	+\$ 558	
	• High-Pressure Laminate price group 3	+\$ 810	
	• Open Line laminate (OLL)	+\$ 111 plus cost of laminate	
Exterior Wall 3 Panel Type	• Fabric	No cost	Specify <i>with fabric</i> . Specify <i>with laminate</i> . Specify <i>with plywood</i> .
	• Laminate	+\$1977	
	• Plywood	+\$5238	
Exterior Wall 3 Panel Finish	• Customer's Own Material (COM)	No cost	► See <i>Surface Materials Reference Manual</i> . Specify plywood color number. Specify fabric color number. Specify fabric color number. Specify fabric color number. Specify fabric color number. Specify fabric color number. Specify fabric color number. Specify fabric color number. Specify fabric color number. Specify fabric color number. Specify fabric color number. Specify fabric color number. Specify laminate color number. Specify laminate color number. Specify laminate color number. ► See <i>Surface Materials Reference Manual</i> .
	• Plywood price group 1	No cost	
	• Fabric price group 1	No cost	
	• Fabric price group 2	+\$ 399	
	• Fabric price group 3	+\$ 742	
	• Fabric price group 4	+\$1050	
	• Fabric price group 5	+\$1318	
	• Fabric price group 6	+\$1644	
	• Fabric price group 7	+\$1864	
	• Fabric price group 8	+\$2367	
	• Fabric price group 9	+\$2901	
	• Fabric price group 10	+\$3296	
	• High-Pressure Laminate price group 1	No cost	
	• High-Pressure Laminate price group 2	+\$2233	
	• High-Pressure Laminate price group 3	+\$3239	
• Open Line laminate (OLL)	+\$ 111 plus cost of laminate		
Exterior Wall 3 Contrasting Panel	• Non contrasting	No cost	Specify <i>with non contrasting</i> . Specify <i>with contrasting</i> .
	• Contrasting	+\$ 319	
Exterior Wall 3 Contrasting Panel Position	• Panel A	No cost	Specify <i>with contrasting exterior wall 3 panel A</i> . Specify <i>with contrasting exterior wall 3 panel B</i> . Specify <i>with contrasting exterior wall 3 panel C</i> . Specify <i>with contrasting exterior wall 3 panel D</i> .
	• Panel B	No cost	
	• Panel C	No cost	
	• Panel D	No cost	
Exterior Wall 3 Contrasting Panel Type	• Fabric	No cost	Specify <i>with fabric</i> . Specify <i>with laminate</i> . Specify <i>with plywood</i> .
	• Laminate	+\$ 495	
	• Plywood	+\$1309	
Exterior Wall 3 Contrasting Panel Finish	• Customer's Own Material (COM)	No cost	► See <i>Surface Materials Reference Manual</i> . Specify plywood color number for contrasting exterior wall 3. Specify fabric color number for contrasting exterior wall 3. Specify fabric color number for contrasting exterior wall 3. Specify fabric color number for contrasting exterior wall 3. Specify fabric color number for contrasting exterior wall 3. Specify fabric color number for contrasting exterior wall 3. Specify fabric color number for contrasting exterior wall 3. Specify fabric color number for contrasting exterior wall 3. Specify fabric color number for contrasting exterior wall 3.
	• Plywood price group 1	No cost	
	• Fabric price group 1	No cost	
	• Fabric price group 2	+\$ 100	
	• Fabric price group 3	+\$ 186	
	• Fabric price group 4	+\$ 263	
	• Fabric price group 5	+\$ 329	
	• Fabric price group 6	+\$ 410	
	• Fabric price group 7	+\$ 466	
• Fabric price group 8	+\$ 592		

Specifying



For Canadian Pricing
Multiply U.S. Price by the
Canadian price factor.
► See page 1 for details.

► Options, continued on next page

Campers 115"W x 119"D Corner Glass Front, continued

► Options, continued from previous page

	Options	U.S. Price	Required to Specify
Exterior Wall 3 Contrasting Panel Finish, continued	• Fabric price group 9	+\$725	Specify fabric color number for contrasting exterior wall 3.
	• Fabric price group 10	+\$824	Specify fabric color number for contrasting exterior wall 3.
	• High-Pressure Laminate price group 1	No cost	Specify laminate color number for contrasting exterior wall 3.
	• High-Pressure Laminate price group 2	+\$558	Specify laminate color number for contrasting exterior wall 3
	• High-Pressure Laminate price group 3	+\$810	Specify laminate color number for contrasting exterior wall 3
	• Open Line laminate (OLL)	+\$111 plus cost of laminate	► See <i>Surface Materials Reference Manual</i> .
Power Configuration	• 3 power	No cost	Specify <i>with power</i> .
	• 2 power, 1 USB A, 1 USB-C 20W	+\$780	Specify <i>with power, 1 USB A, 1 USB-C 20W</i> .
HDMI and Data Configuration	• No HDMI/data	No cost	Specify <i>with no HDMI/data</i> .
	• 1 HDMI, 2 data	+\$978	Specify <i>with 1 HDMI, 2 data</i> .
Kink Option	• No kink	No cost	Specify <i>with no kink</i> .
	• With kink	No cost	Specify <i>with kink</i> .
Cabin Option	• No cabin	No cost	Specify <i>with no cabin</i> .
	• With cabin	No cost	Specify <i>with cabin</i> .

Tip: When specifying your camper, please make sure the "kink option" and "cabin option" are entered correctly. For the "kink option" select "with kink" if you plan to add a kink to the camper and "no kink" if you don't intend to add a kink on the camper. Likewise, for the "cabin option", please select "with cabin", if you plan to attach a cabin to the camper and "no cabin" if you don't plan to attach a cabin.

Specification Information

Style Number	U.S. Base Price

115"W x 119"D Corner Glass Front—Right Hand

OB1CD05CRS	\$87,093
-------------------	----------

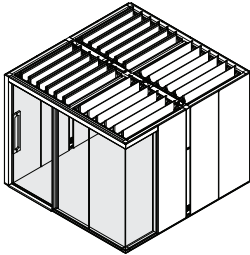

115"W x 119"D Corner Glass Front (with Infill)—Right Hand

OB1CD05CRSNB	\$89,273
---------------------	----------

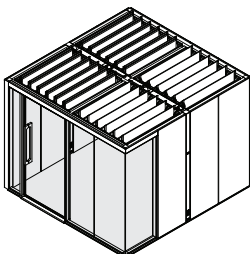

For Canadian Pricing

Multiply U.S. Price by the Canadian price factor.

► See page 1 for details.

Campers 88"W x 92"D Glass Front

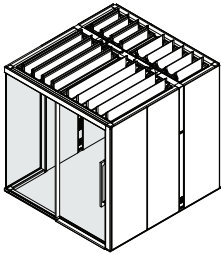

	Standard Includes	Required to Specify
▶ Need help? Product details, page 20	<ul style="list-style-type: none"> • Camper: 88"W x 92"D corner glass front - right hand • Frame: 7207 Black • Glass: 6500 Clear Glass • Door handle pull: wood price group 1 • Power plug: type B • Power outlet: 3 NEMA power outlets • Fascia: paint price group 1 • Air circulation fan 	<ol style="list-style-type: none"> 1 Style number 2 Fascia type 3 Wood color number for door handle pull 4 Paint color number for fascia 5 Options, if selected (see below) <p>▶ See Product Understanding for Surface Materials.</p>

	Options	U.S. Price	Required to Specify
Fascia Type	<ul style="list-style-type: none"> • Paint • Fabric 	<p>No cost</p> <p>+\$ 185</p>	<p>Specify with paint.</p> <p>Specify with fabric.</p>
Fascia Finish	<ul style="list-style-type: none"> • Customer's Own Material (COM) • Fabric price group 1 • Paint price group 1 • Paint price group 2 • Paint price group 3 • Fabric price group 2 • Fabric price group 3 • Fabric price group 4 • Fabric price group 5 • Fabric price group 6 • Fabric price group 7 • Fabric price group 8 • Fabric price group 9 • Fabric price group 10 	<p>No cost</p> <p>No cost</p> <p>No cost</p> <p>+\$ 101</p> <p>+\$ 131</p> <p>+\$ 121</p> <p>+\$ 225</p> <p>+\$ 313</p> <p>+\$ 395</p> <p>+\$ 515</p> <p>+\$ 635</p> <p>+\$ 819</p> <p>+\$1078</p> <p>+\$1209</p>	<p>▶ See <i>Surface Materials Reference Manual</i>.</p> <p>Specify fabric color number.</p> <p>Specify paint color number.</p> <p>Specify paint color number.</p> <p>Specify fabric color number.</p> <p>Specify fabric color number.</p> <p>Specify fabric color number.</p> <p>Specify fabric color number.</p> <p>Specify fabric color number.</p> <p>Specify fabric color number.</p> <p>Specify fabric color number.</p> <p>Specify fabric color number.</p> <p>Specify fabric color number.</p>
Interior Wall 1 Panel Finish	<ul style="list-style-type: none"> • Customer's Own Material (COM) • Fabric price group 1 • Fabric price group 2 • Fabric price group 3 • Fabric price group 4 • Fabric price group 5 • Fabric price group 6 • Fabric price group 7 • Fabric price group 8 • Fabric price group 9 • Fabric price group 10 	<p>No cost</p> <p>No cost</p> <p>+\$ 300</p> <p>+\$ 556</p> <p>+\$ 787</p> <p>+\$ 989</p> <p>+\$1232</p> <p>+\$1398</p> <p>+\$1776</p> <p>+\$2175</p> <p>+\$2472</p>	<p>▶ See <i>Surface Materials Reference Manual</i>.</p> <p>Specify fabric color number.</p> <p>Specify fabric color number.</p> <p>Specify fabric color number.</p> <p>Specify fabric color number.</p> <p>Specify fabric color number.</p> <p>Specify fabric color number.</p> <p>Specify fabric color number.</p> <p>Specify fabric color number.</p> <p>Specify fabric color number.</p> <p>Specify fabric color number.</p>
Interior Wall 1 Contrasting Panel	<ul style="list-style-type: none"> • Non contrasting • Contrasting 	<p>No cost</p> <p>+\$ 319</p>	<p>Specify with non contrasting.</p> <p>Specify with contrasting.</p>
Interior Wall 1 Contrasting Panel Position	<ul style="list-style-type: none"> • Panel A • Panel B • Panel C 	<p>No cost</p> <p>No cost</p> <p>No cost</p>	<p>Specify with contrasting interior wall 1 panel A.</p> <p>Specify with contrasting interior wall 1 panel B.</p> <p>Specify with contrasting interior wall 1 panel C.</p>
Interior Wall 1 Contrasting Panel Type	<ul style="list-style-type: none"> • Fabric • Laminate 	<p>No cost</p> <p>+\$ 495</p>	<p>Specify with fabric.</p> <p>Specify with laminate.</p>
Interior Wall 1 Contrasting Panel Finish	<ul style="list-style-type: none"> • Customer's Own Material (COM) • Fabric price group 1 • Fabric price group 2 • Fabric price group 3 • Fabric price group 4 • Fabric price group 5 • Fabric price group 6 • Fabric price group 7 	<p>No cost</p> <p>No cost</p> <p>+\$ 100</p> <p>+\$ 186</p> <p>+\$ 263</p> <p>+\$ 329</p> <p>+\$ 410</p> <p>+\$ 466</p>	<p>▶ See <i>Surface Materials Reference Manual</i>.</p> <p>Specify fabric color number for contrasting interior wall 1.</p> <p>Specify fabric color number for contrasting interior wall 1.</p> <p>Specify fabric color number for contrasting interior wall 1.</p> <p>Specify fabric color number for contrasting interior wall 1.</p> <p>Specify fabric color number for contrasting interior wall 1.</p> <p>Specify fabric color number for contrasting interior wall 1.</p> <p>Specify fabric color number for contrasting interior wall 1.</p> <p>Specify fabric color number for contrasting interior wall 1.</p>

▶ Options, continued on next page



For Canadian Pricing

Multiply U.S. Price by the Canadian price factor.

▶ See page 1 for details.

► Options, continued from previous page

Options	U.S. Price	Required to Specify	
Interior Wall 1 Contrasting Panel Finish, continued	• Fabric price group 8	+\$ 592	Specify fabric color number for contrasting interior wall 1. Specify fabric color number for contrasting interior wall 1. Specify fabric color number for contrasting interior wall 1. Specify laminate color number for contrasting interior wall 1. Specify laminate color number for contrasting interior wall 1. Specify laminate color number for contrasting interior wall 1. Specify laminate color number for contrasting interior wall 1. ► See <i>Surface Materials Reference Manual</i> .
	• Fabric price group 9	+\$ 725	
	• Fabric price group 10	+\$ 824	
	• High-Pressure Laminate price group 1	No cost	
	• High-Pressure Laminate price group 2	+\$ 558	
	• High-Pressure Laminate price group 3	+\$ 810	
	• Open Line laminate (OLL)	+\$ 111 plus cost of laminate	
Interior Wall 2 Panel Finish	• Customer's Own Material (COM)	No cost	► See <i>Surface Materials Reference Manual</i> . Specify fabric color number. Specify fabric color number. Specify fabric color number. Specify fabric color number. Specify fabric color number. Specify fabric color number. Specify fabric color number. Specify fabric color number. Specify fabric color number. Specify fabric color number.
	• Fabric price group 1	No cost	
	• Fabric price group 2	+\$ 300	
	• Fabric price group 3	+\$ 556	
	• Fabric price group 4	+\$ 787	
	• Fabric price group 5	+\$ 989	
	• Fabric price group 6	+\$1232	
	• Fabric price group 7	+\$1398	
	• Fabric price group 8	+\$1776	
	• Fabric price group 9	+\$2175	
• Fabric price group 10	+\$2472		
Interior Wall 2 Contrasting Panel	• Non contrasting	No cost	Specify <i>with non contrasting</i> . Specify <i>with contrasting</i> .
	• Contrasting	+\$ 319	
Interior Wall 2 Contrasting Panel Position	• Panel A	No cost	Specify <i>with contrasting interior wall 2 panel A</i> . Specify <i>with contrasting interior wall 2 panel B</i> . Specify <i>with contrasting interior wall 2 panel C</i> .
	• Panel B	No cost	
	• Panel C	No cost	
Interior Wall 2 Contrasting Panel Type	• Fabric	No cost	Specify <i>with fabric</i> . Specify <i>with laminate</i> .
	• Laminate	+\$ 495	
Interior Wall 2 Contrasting Panel Finish	• Customer's Own Material (COM)	No cost	► See <i>Surface Materials Reference Manual</i> . Specify fabric color number for contrasting interior wall 2. Specify fabric color number for contrasting interior wall 2. Specify fabric color number for contrasting interior wall 2. Specify fabric color number for contrasting interior wall 2. Specify fabric color number for contrasting interior wall 2. Specify fabric color number for contrasting interior wall 2. Specify fabric color number for contrasting interior wall 2. Specify fabric color number for contrasting interior wall 2. Specify fabric color number for contrasting interior wall 2. Specify fabric color number for contrasting interior wall 2. Specify fabric color number for contrasting interior wall 2. Specify laminate color number for contrasting interior wall 2. Specify laminate color number for contrasting interior wall 2. Specify laminate color number for contrasting interior wall 2. Specify laminate color number for contrasting interior wall 2. ► See <i>Surface Materials Reference Manual</i> .
	• Fabric price group 1	No cost	
	• Fabric price group 2	+\$ 100	
	• Fabric price group 3	+\$ 186	
	• Fabric price group 4	+\$ 263	
	• Fabric price group 5	+\$ 329	
	• Fabric price group 6	+\$ 410	
	• Fabric price group 7	+\$ 466	
	• Fabric price group 8	+\$ 592	
	• Fabric price group 9	+\$ 725	
	• Fabric price group 10	+\$ 824	
	• High-Pressure Laminate price group 1	No cost	
	• High-Pressure Laminate price group 2	+\$ 558	
	• High-Pressure Laminate price group 3	+\$ 810	
• Open Line laminate (OLL)	+\$ 111 plus cost of laminate		

Specifying

 **For Canadian Pricing**
Multiply U.S. Price by the Canadian price factor.
► See page 1 for details.

► Options, continued on next page

► Options, continued from previous page

	Options	U.S. Price	Required to Specify
Interior Wall 3 Panel Finish	• Customer's Own Material (COM)	No cost	► See <i>Surface Materials Reference Manual</i> . Specify fabric color number. Specify fabric color number. Specify fabric color number. Specify fabric color number. Specify fabric color number. Specify fabric color number. Specify fabric color number. Specify fabric color number. Specify fabric color number. Specify fabric color number.
	• Fabric price group 1	No cost	
	• Fabric price group 2	+\$ 300	
	• Fabric price group 3	+\$ 556	
	• Fabric price group 4	+\$ 787	
	• Fabric price group 5	+\$ 989	
	• Fabric price group 6	+\$1232	
	• Fabric price group 7	+\$1398	
	• Fabric price group 8	+\$1776	
	• Fabric price group 9	+\$2175	
• Fabric price group 10	+\$2472		
Interior Wall 3 Contrasting Panel	• Non contrasting	No cost	Specify <i>with non contrasting</i> .
	• Contrasting	+\$ 319	Specify <i>with contrasting</i> .
Interior Wall 3 Contrasting Panel Position	• Panel A	No cost	Specify <i>with contrasting interior wall 3 panel A</i> .
	• Panel B	No cost	Specify <i>with contrasting interior wall 3 panel B</i> .
	• Panel C	No cost	Specify <i>with contrasting interior wall 3 panel C</i> .
Interior Wall 3 Contrasting Panel Type	• Fabric	No cost	Specify <i>with fabric</i> .
	• Laminate	+\$ 495	Specify <i>with laminate</i> .
Interior Wall 3 Contrasting Panel Finish	• Customer's Own Material (COM)	No cost	► See <i>Surface Materials Reference Manual</i> . Specify fabric color number for contrasting interior wall 3. Specify fabric color number for contrasting interior wall 3. Specify fabric color number for contrasting interior wall 3. Specify fabric color number for contrasting interior wall 3. Specify fabric color number for contrasting interior wall 3. Specify fabric color number for contrasting interior wall 3. Specify fabric color number for contrasting interior wall 3. Specify fabric color number for contrasting interior wall 3. Specify fabric color number for contrasting interior wall 3. Specify fabric color number for contrasting interior wall 3. Specify fabric color number for contrasting interior wall 3. Specify fabric color number for contrasting exterior wall 3. ► See <i>Surface Materials Reference Manual</i> .
	• Fabric price group 1	No cost	
	• Fabric price group 2	+\$ 100	
	• Fabric price group 3	+\$ 186	
	• Fabric price group 4	+\$ 263	
	• Fabric price group 5	+\$ 329	
	• Fabric price group 6	+\$ 410	
	• Fabric price group 7	+\$ 466	
	• Fabric price group 8	+\$ 592	
	• Fabric price group 9	+\$ 725	
	• Fabric price group 10	+\$ 824	
	• High-Pressure Laminate price group 1	No cost	
	• High-Pressure Laminate price group 2	+\$ 558	
• High-Pressure Laminate price group 3	+\$ 810		
• Open Line laminate (OLL)	+\$ 111 plus cost of laminate		
Exterior Wall 1 Panel Type	• Fabric	No cost	Specify <i>with fabric</i> .
	• Laminate	+\$1483	Specify <i>with laminate</i> .
	• Plywood	+\$3929	Specify <i>with plywood</i> .
Exterior Wall 1 Panel Finish	• Customer's Own Material (COM)	No cost	► See <i>Surface Materials Reference Manual</i> . Specify plywood color number. Specify fabric color number. Specify fabric color number. Specify fabric color number. Specify fabric color number. Specify fabric color number. Specify fabric color number.
	• Plywood price group 1	No cost	
	• Fabric price group 1	No cost	
	• Fabric price group 2	+\$ 300	
	• Fabric price group 3	+\$ 556	
	• Fabric price group 4	+\$ 787	
	• Fabric price group 5	+\$ 989	
	• Fabric price group 6	+\$1232	
• Fabric price group 7	+\$1398		

Tip: Panel C is not available on right hand unit.

 **For Canadian Pricing**
Multiply U.S. Price by the Canadian price factor.
► See page 1 for details.

► Options, continued on next page

► Options, continued from previous page

	Options	U.S. Price	Required to Specify
Exterior Wall 1 Panel Finish, continued	• Fabric price group 8	+\$1776	Specify fabric color number.
	• Fabric price group 9	+\$2175	Specify fabric color number.
	• Fabric price group 10	+\$2472	Specify fabric color number.
	• High-Pressure Laminate price group 1	No cost	Specify laminate color number.
	• High-Pressure Laminate price group 2	+\$1674	Specify laminate color number.
	• High-Pressure Laminate price group 3	+\$2430	Specify laminate color number.
	• Open Line laminate (OLL)	+\$ 111 plus cost of laminate	► See <i>Surface Materials Reference Manual</i> .
Exterior Wall 1 Contrasting Panel	• Non contrasting	No cost	Specify <i>with non contrasting</i> .
	• Contrasting	+\$ 319	Specify <i>with contrasting</i> .
Exterior Wall 1 Contrasting Panel Position	• Panel A	No cost	Specify <i>with contrasting exterior wall 1 panel A</i> .
	• Panel B	No cost	Specify <i>with contrasting exterior wall 1 panel B</i> .
	• Panel C	No cost	Specify <i>with contrasting exterior wall 1 panel C</i> .
Exterior Wall 1 Contrasting Panel Type	• Fabric	No cost	Specify <i>with fabric</i> .
	• Laminate	+\$ 495	Specify <i>with laminate</i> .
	• Plywood	+\$1309	Specify <i>with plywood</i> .
Exterior Wall 1 Contrasting Panel Finish	• Customer's Own Material (COM)	No cost	► See <i>Surface Materials Reference Manual</i> .
	• Fabric price group 1	No cost	Specify fabric color number for contrasting exterior wall 1.
	• Fabric price group 2	+\$ 100	Specify fabric color number for contrasting exterior wall 1.
	• Fabric price group 3	+\$ 186	Specify fabric color number for contrasting exterior wall 1.
	• Fabric price group 4	+\$ 263	Specify fabric color number for contrasting exterior wall 1.
	• Fabric price group 5	+\$ 329	Specify fabric color number for contrasting exterior wall 1.
	• Fabric price group 6	+\$ 410	Specify fabric color number for contrasting exterior wall 1.
	• Fabric price group 7	+\$ 466	Specify fabric color number for contrasting exterior wall 1.
	• Fabric price group 8	+\$ 592	Specify fabric color number for contrasting exterior wall 1.
	• Fabric price group 9	+\$ 725	Specify fabric color number for contrasting exterior wall 1.
	• Fabric price group 10	+\$ 824	Specify fabric color number for contrasting exterior wall 1.
	• High-Pressure Laminate price group 1	No cost	Specify laminate color number for contrasting exterior wall 1.
	• High-Pressure Laminate price group 2	+\$ 558	Specify laminate color number for contrasting exterior wall 1.
	• High-Pressure Laminate price group 3	+\$ 810	Specify laminate color number for contrasting exterior wall 1.
• Open Line laminate (OLL)	+\$ 111 plus cost of laminate	► See <i>Surface Materials Reference Manual</i> .	
Exterior Wall 2 Panel Type	• Fabric	No cost	Specify <i>with fabric</i> .
	• Laminate	+\$1483	Specify <i>with laminate</i> .
	• Plywood	+\$3929	Specify <i>with plywood</i> .

Tip: Panel C is not available on right hand unit.

Specifying

► Options, continued on next page



For Canadian Pricing
Multiply U.S. Price by the Canadian price factor.
► See page 1 for details.

► Options, continued from previous page

Options	U.S. Price	Required to Specify
Exterior Wall 2 Panel Finish	<ul style="list-style-type: none"> • Customer's Own Material (COM) No cost • Plywood price group 1 No cost • Fabric price group 1 No cost • Fabric price group 2 +\$ 300 • Fabric price group 3 +\$ 556 • Fabric price group 4 +\$ 787 • Fabric price group 5 +\$ 989 • Fabric price group 6 +\$1232 • Fabric price group 7 +\$1398 • Fabric price group 8 +\$1776 • Fabric price group 9 +\$2175 • Fabric price group 10 +\$2472 • High-Pressure Laminate price group 1 No cost • High-Pressure Laminate price group 2 +\$1674 • High-Pressure Laminate price group 3 +\$2430 • Open Line laminate (OLL) +\$ 111 plus cost of laminate 	<ul style="list-style-type: none"> ► See <i>Surface Materials Reference Manual</i>. Specify plywood color number. Specify fabric color number. Specify fabric color number. Specify fabric color number. Specify fabric color number. Specify fabric color number. Specify fabric color number. Specify fabric color number. Specify fabric color number. Specify fabric color number. Specify fabric color number. Specify laminate color number. Specify laminate color number. Specify laminate color number. ► See <i>Surface Materials Reference Manual</i>.
Exterior Wall 2 Contrasting Panel	<ul style="list-style-type: none"> • Non contrasting No cost • Contrasting +\$ 319 	<ul style="list-style-type: none"> Specify <i>with non contrasting</i>. Specify <i>with contrasting</i>.
Exterior Wall 2 Contrasting Panel Position	<ul style="list-style-type: none"> • Panel A No cost • Panel B No cost • Panel C No cost 	<ul style="list-style-type: none"> Specify <i>with contrasting exterior wall 2 panel A</i>. Specify <i>with contrasting exterior wall 2 panel B</i>. Specify <i>with contrasting exterior wall 2 panel C</i>.
Exterior Wall 2 Contrasting Panel Type	<ul style="list-style-type: none"> • Fabric No cost • Laminate +\$ 495 • Plywood +\$1309 	<ul style="list-style-type: none"> Specify <i>with fabric</i>. Specify <i>with laminate</i>. Specify <i>with plywood</i>.
Exterior Wall 2 Contrasting Panel Finish	<ul style="list-style-type: none"> • Customer's Own Material (COM) No cost • Fabric price group 1 No cost • Fabric price group 2 +\$ 100 • Fabric price group 3 +\$ 186 • Fabric price group 4 +\$ 263 • Fabric price group 5 +\$ 329 • Fabric price group 6 +\$ 410 • Fabric price group 7 +\$ 466 • Fabric price group 8 +\$ 592 • Fabric price group 9 +\$ 725 • Fabric price group 10 +\$ 824 • High-Pressure Laminate price group 1 No cost • High-Pressure Laminate price group 2 +\$ 558 • High-Pressure Laminate price group 3 +\$ 810 • Open Line laminate (OLL) +\$ 111 plus cost of laminate 	<ul style="list-style-type: none"> ► See <i>Surface Materials Reference Manual</i>. Specify fabric color number for contrasting exterior wall 2. Specify fabric color number for contrasting exterior wall 2. Specify fabric color number for contrasting exterior wall 2. Specify fabric color number for contrasting exterior wall 2. Specify fabric color number for contrasting exterior wall 2. Specify fabric color number for contrasting exterior wall 2. Specify fabric color number for contrasting exterior wall 2. Specify fabric color number for contrasting exterior wall 2. Specify fabric color number for contrasting exterior wall 2. Specify fabric color number for contrasting exterior wall 2. Specify fabric color number for contrasting exterior wall 2. Specify laminate color number for contrasting exterior wall 2. Specify laminate color number for contrasting exterior wall 2. Specify laminate color number for contrasting exterior wall 2. ► See <i>Surface Materials Reference Manual</i>.
Exterior Wall 3 Panel Type	<ul style="list-style-type: none"> • Fabric No cost • Laminate +\$1483 • Plywood +\$3929 	<ul style="list-style-type: none"> Specify <i>with fabric</i>. Specify <i>with laminate</i>. Specify <i>with plywood</i>.

► Options, continued on next page



For Canadian Pricing
 Multiply U.S. Price by the Canadian price factor.
 ► See page 1 for details.

► Options, continued from previous page

Options	U.S. Price	Required to Specify
Exterior Wall 3 Panel Finish	<ul style="list-style-type: none"> • Customer's Own Material (COM) No cost • Plywood price group 1 No cost • Fabric price group 1 No cost • Fabric price group 2 +\$ 300 • Fabric price group 3 +\$ 556 • Fabric price group 4 +\$ 787 • Fabric price group 5 +\$ 989 • Fabric price group 6 +\$1232 • Fabric price group 7 +\$1398 • Fabric price group 8 +\$1776 • Fabric price group 9 +\$2175 • Fabric price group 10 +\$2472 • High-Pressure Laminate price group 1 No cost • High-Pressure Laminate price group 2 +\$1674 • High-Pressure Laminate price group 3 +\$2430 • Open Line laminate (OLL) +\$ 111 plus cost of laminate 	<ul style="list-style-type: none"> ► See <i>Surface Materials Reference Manual</i>. Specify plywood color number. Specify fabric color number. Specify fabric color number. Specify fabric color number. Specify fabric color number. Specify fabric color number. Specify fabric color number. Specify fabric color number. Specify fabric color number. Specify fabric color number. Specify fabric color number. Specify laminate color number. Specify laminate color number. Specify laminate color number. ► See <i>Surface Materials Reference Manual</i>.
Exterior Wall 3 Contrasting Panel	<ul style="list-style-type: none"> • Non contrasting No cost • Contrasting +\$ 319 	<ul style="list-style-type: none"> Specify <i>with non contrasting</i>. Specify <i>with contrasting</i>.
Exterior Wall 3 Contrasting Panel Position	<ul style="list-style-type: none"> • Panel A No cost • Panel B No cost • Panel C No cost 	<ul style="list-style-type: none"> Specify <i>with contrasting exterior wall 3 panel A</i>. Specify <i>with contrasting exterior wall 3 panel B</i>. Specify <i>with contrasting exterior wall 3 panel C</i>.
Exterior Wall 3 Contrasting Panel Type	<ul style="list-style-type: none"> • Fabric No cost • Laminate +\$ 495 • Plywood +\$1309 	<ul style="list-style-type: none"> Specify <i>with fabric</i>. Specify <i>with laminate</i>. Specify <i>with plywood</i>.
Exterior Wall 3 Contrasting Panel Finish	<ul style="list-style-type: none"> • Customer's Own Material (COM) No cost • Plywood price group 1 No cost • Fabric price group 1 No cost • Fabric price group 2 +\$ 100 • Fabric price group 3 +\$ 186 • Fabric price group 4 +\$ 263 • Fabric price group 5 +\$ 329 • Fabric price group 6 +\$ 410 • Fabric price group 7 +\$ 466 • Fabric price group 8 +\$ 592 • Fabric price group 9 +\$ 725 • Fabric price group 10 +\$ 824 • High-Pressure Laminate price group 1 No cost • High-Pressure Laminate price group 2 +\$ 558 • High-Pressure Laminate price group 3 +\$ 810 • Open Line laminate (OLL) +\$ 111 plus cost of laminate 	<ul style="list-style-type: none"> ► See <i>Surface Materials Reference Manual</i>. Specify plywood color number for contrasting exterior wall 3. Specify fabric color number for contrasting exterior wall 3. Specify fabric color number for contrasting exterior wall 3. Specify fabric color number for contrasting exterior wall 3. Specify fabric color number for contrasting exterior wall 3. Specify fabric color number for contrasting exterior wall 3. Specify fabric color number for contrasting exterior wall 3. Specify fabric color number for contrasting exterior wall 3. Specify fabric color number for contrasting exterior wall 3. Specify fabric color number for contrasting exterior wall 3. Specify fabric color number for contrasting exterior wall 3. Specify fabric color number for contrasting exterior wall 3. Specify laminate color number for contrasting exterior wall 3. Specify laminate color number for contrasting exterior wall 3. Specify laminate color number for contrasting exterior wall 3. Specify laminate color number for contrasting exterior wall 3. ► See <i>Surface Materials Reference Manual</i>.

Specifying



For Canadian Pricing
Multiply U.S. Price by the Canadian price factor.
► See page 1 for details.

► Options, continued on next page

Camper 88"W x 92"D Glass Front, continued

► Options, continued from previous page

	Options	U.S. Price	Required to Specify
Power Configuration	<ul style="list-style-type: none"> • 3 power • 2 power, 1 USB A, 1 USB-C 20W 	No cost +\$780	Specify with power. Specify with power, 1 USB A, 1 USB-C 20W.
HDMI and Data Configuration	<ul style="list-style-type: none"> • No HDMI/data • 1 HDMI, 2 data 	No cost +\$978	Specify with no HDMI/data. Specify with 1 HDMI, 2 data.
Kink Option	<ul style="list-style-type: none"> • No kink • With kink 	No cost No cost	Specify with no kink. Specify with kink.
Cabin Option	<ul style="list-style-type: none"> • No cabin • With cabin 	No cost No cost	Specify with no cabin. Specify with cabin.

Tip: When specifying your camper, please make sure the "kink option" and "cabin option" are entered correctly. For the "kink option" select "with kink" if you plan to add a kink to the camper and "no kink" if you don't intend to add a kink on the camper. Likewise, for the "cabin option", please select "with cabin", if you plan to attach a cabin to the camper and "no cabin" if you don't plan to attach a cabin.

Specification Information

Style Number	U.S. Base Price

88"W x 92"D Glass Front—Left Hand

OB1CD02DLS	\$75,316
-------------------	----------

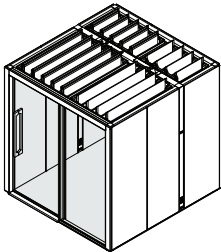

88"W x 92"D Glass Front—Right Hand

OB1CD02DRS	\$75,316
-------------------	----------

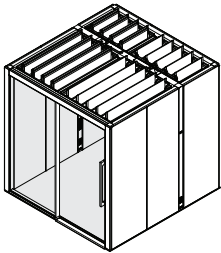

For Canadian Pricing
 Multiply U.S. Price by the Canadian price factor.
 ► See page 1 for details.

Campers 115"W x 119"D Glass Front

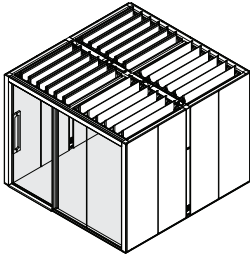

	Standard Includes	Required to Specify
▶ Need help? Product details, page 20	<ul style="list-style-type: none"> • Camper: 115"W x 119"D glass front • Frame: 7207 Black • Glass: 6500 Clear Glass • Door handle pull: wood price group 1 • Power plug: type B • Power outlet: 3 NEMA power outlets • Fascia: paint price group 1 • Air circulation fan 	<ol style="list-style-type: none"> 1 Style number 2 Fascia type 3 Wood color number for door handle pull 4 Paint color number for fascia 5 Options, if selected (see below) <p>▶ See Product Understanding for Surface Materials.</p>

	Options	U.S. Price	Required to Specify
Fascia Type	<ul style="list-style-type: none"> • Paint • Fabric 	<p>No cost</p> <p>+\$ 294</p>	<p>Specify <i>with paint</i>.</p> <p>Specify <i>with fabric</i>.</p>
Fascia Finish	<ul style="list-style-type: none"> • Customer's Own Material (COM) • Fabric price group 1 • Paint price group 1 • Paint price group 2 • Paint price group 3 • Fabric price group 2 • Fabric price group 3 • Fabric price group 4 • Fabric price group 5 • Fabric price group 6 • Fabric price group 7 • Fabric price group 8 • Fabric price group 9 • Fabric price group 10 	<p>No cost</p> <p>No cost</p> <p>No cost</p> <p>+\$ 167</p> <p>+\$ 217</p> <p>+\$ 242</p> <p>+\$ 457</p> <p>+\$ 638</p> <p>+\$ 805</p> <p>+\$1001</p> <p>+\$1145</p> <p>+\$1442</p> <p>+\$1777</p> <p>+\$2017</p>	<p>▶ See <i>Surface Materials Reference Manual</i>.</p> <p>Specify fabric color number.</p> <p>Specify paint color number.</p> <p>Specify paint color number.</p> <p>Specify paint color number.</p> <p>Specify fabric color number.</p> <p>Specify fabric color number.</p> <p>Specify fabric color number.</p> <p>Specify fabric color number.</p> <p>Specify fabric color number.</p> <p>Specify fabric color number.</p> <p>Specify fabric color number.</p> <p>Specify fabric color number.</p> <p>Specify fabric color number.</p> <p>Specify fabric color number.</p>
Interior Wall 1 Panel Finish	<ul style="list-style-type: none"> • Customer's Own Material (COM) • Fabric price group 1 • Fabric price group 2 • Fabric price group 3 • Fabric price group 4 • Fabric price group 5 • Fabric price group 6 • Fabric price group 7 • Fabric price group 8 • Fabric price group 9 • Fabric price group 10 	<p>No cost</p> <p>No cost</p> <p>+\$ 399</p> <p>+\$ 742</p> <p>+\$1050</p> <p>+\$1318</p> <p>+\$1644</p> <p>+\$1864</p> <p>+\$2367</p> <p>+\$2901</p> <p>+\$3296</p>	<p>▶ See <i>Surface Materials Reference Manual</i>.</p> <p>Specify fabric color number.</p> <p>Specify fabric color number.</p> <p>Specify fabric color number.</p> <p>Specify fabric color number.</p> <p>Specify fabric color number.</p> <p>Specify fabric color number.</p> <p>Specify fabric color number.</p> <p>Specify fabric color number.</p> <p>Specify fabric color number.</p> <p>Specify fabric color number.</p>
Interior Wall 1 Contrasting Panel	<ul style="list-style-type: none"> • Non contrasting • Contrasting 	<p>No cost</p> <p>+\$ 319</p>	<p>Specify <i>with non contrasting</i>.</p> <p>Specify <i>with contrasting</i>.</p>
Interior Wall 1 Contrasting Panel Position	<ul style="list-style-type: none"> • Panel A • Panel B • Panel C • Panel D 	<p>No cost</p> <p>No cost</p> <p>No cost</p> <p>No cost</p>	<p>Specify <i>with contrasting interior wall 1 panel A</i>.</p> <p>Specify <i>with contrasting interior wall 1 panel B</i>.</p> <p>Specify <i>with contrasting interior wall 1 panel C</i>.</p> <p>Specify <i>with contrasting interior wall 1 panel D</i>.</p>
Interior Wall 1 Contrasting Panel Type	<ul style="list-style-type: none"> • Fabric • Laminate 	<p>No cost</p> <p>+\$ 495</p>	<p>Specify <i>with fabric</i>.</p> <p>Specify <i>with laminate</i>.</p>
Interior Wall 1 Contrasting Panel Finish	<ul style="list-style-type: none"> • Customer's Own Material (COM) • Fabric price group 1 • Fabric price group 2 • Fabric price group 3 • Fabric price group 4 • Fabric price group 5 	<p>No cost</p> <p>No cost</p> <p>+\$ 100</p> <p>+\$ 186</p> <p>+\$ 263</p> <p>+\$ 329</p>	<p>▶ See <i>Surface Materials Reference Manual</i>.</p> <p>Specify fabric color number for contrasting interior wall 1.</p> <p>Specify fabric color number for contrasting interior wall 1.</p> <p>Specify fabric color number for contrasting interior wall 1.</p> <p>Specify fabric color number for contrasting interior wall 1.</p> <p>Specify fabric color number for contrasting interior wall 1.</p> <p>Specify fabric color number for contrasting interior wall 1.</p>

▶ Options, continued on next page



For Canadian Pricing
Multiply U.S. Price by the Canadian price factor.
▶ See page 1 for details.

► Options, continued from previous page

Options	U.S. Price	Required to Specify	
Interior Wall 1 Contrasting Panel Finish, continued	• Fabric price group 6	+\$ 410	Specify fabric color number for contrasting interior wall 1. Specify fabric color number for contrasting interior wall 1. Specify fabric color number for contrasting interior wall 1. Specify fabric color number for contrasting interior wall 1. Specify fabric color number for contrasting interior wall 1. Specify fabric color number for contrasting interior wall 1. Specify laminate color number for contrasting interior wall 1. Specify laminate color number for contrasting interior wall 1. Specify laminate color number for contrasting interior wall 1. ► See <i>Surface Materials Reference Manual</i> .
	• Fabric price group 7	+\$ 466	
	• Fabric price group 8	+\$ 592	
	• Fabric price group 9	+\$ 725	
	• Fabric price group 10	+\$ 824	
	• High-Pressure Laminate price group 1	No cost	
	• High-Pressure Laminate price group 2	+\$ 558	
	• High-Pressure Laminate price group 3	+\$ 810	
	• Open Line laminate (OLL)	+\$ 111 plus cost of laminate	
	Interior Wall 2 Panel Finish	• Customer's Own Material (COM)	
• Fabric price group 1		No cost	
• Fabric price group 2		+\$ 399	
• Fabric price group 3		+\$ 742	
• Fabric price group 4		+\$1050	
• Fabric price group 5		+\$1318	
• Fabric price group 6		+\$1644	
• Fabric price group 7		+\$1864	
• Fabric price group 8		+\$2367	
• Fabric price group 9		+\$2901	
• Fabric price group 10	+\$3296		
Interior Wall 2 Contrasting Panel	• Non contrasting	No cost	Specify <i>with non contrasting</i> . Specify <i>with contrasting</i> .
	• Contrasting	+\$ 319	
Interior Wall 2 Contrasting Panel Position	• Panel A	No cost	Specify <i>with contrasting interior wall 2 panel A</i> . Specify <i>with contrasting interior wall 2 panel B</i> . Specify <i>with contrasting interior wall 2 panel C</i> . Specify <i>with contrasting interior wall 2 panel D</i> .
	• Panel B	No cost	
	• Panel C	No cost	
	• Panel D	No cost	
Interior Wall 2 Contrasting Panel Type	• Fabric	No cost	Specify <i>with fabric</i> . Specify <i>with laminate</i> .
	• Laminate	+\$ 495	
Interior Wall 2 Contrasting Panel Finish	• Customer's Own Material (COM)	No cost	► See <i>Surface Materials Reference Manual</i> . Specify fabric color number for contrasting interior wall 2. Specify fabric color number for contrasting interior wall 2. Specify fabric color number for contrasting interior wall 2. Specify fabric color number for contrasting interior wall 2. Specify fabric color number for contrasting interior wall 2. Specify fabric color number for contrasting interior wall 2. Specify fabric color number for contrasting interior wall 2. Specify fabric color number for contrasting interior wall 2. Specify fabric color number for contrasting interior wall 2. Specify laminate color number for contrasting interior wall 2.
	• Fabric price group 1	No cost	
	• Fabric price group 2	+\$ 100	
	• Fabric price group 3	+\$ 186	
	• Fabric price group 4	+\$ 263	
	• Fabric price group 5	+\$ 329	
	• Fabric price group 6	+\$ 410	
	• Fabric price group 7	+\$ 466	
	• Fabric price group 8	+\$ 592	
	• Fabric price group 9	+\$ 725	
• Fabric price group 10	+\$ 824		
• High-Pressure Laminate price group 1	No cost		

► Options, continued on next page

Specifying



For Canadian Pricing
Multiply U.S. Price by the Canadian price factor.
► See page 1 for details.

Campers 115"W x 119"D Glass Front, continued

► Options, continued from previous page

	Options	U.S. Price	Required to Specify
Interior Wall 2 Contrasting Panel Finish, continued	• High-Pressure Laminate price group 2	+\$ 558	Specify laminate color number for contrasting interior wall 2.
	• High-Pressure Laminate price group 3	+\$ 810	Specify laminate color number for contrasting interior wall 2.
	• Open Line laminate (OLL)	+\$ 111 plus cost of laminate	► See <i>Surface Materials Reference Manual</i> .
Interior Wall 3 Panel Finish	• Customer's Own Material (COM)	No cost	► See <i>Surface Materials Reference Manual</i> .
	• Fabric price group 1	No cost	Specify fabric color number.
	• Fabric price group 2	+\$ 399	Specify fabric color number.
	• Fabric price group 3	+\$ 742	Specify fabric color number.
	• Fabric price group 4	+\$1050	Specify fabric color number.
	• Fabric price group 5	+\$1318	Specify fabric color number.
	• Fabric price group 6	+\$1644	Specify fabric color number.
	• Fabric price group 7	+\$1864	Specify fabric color number.
	• Fabric price group 8	+\$2367	Specify fabric color number.
	• Fabric price group 9	+\$2901	Specify fabric color number.
• Fabric price group 10	+\$3296	Specify fabric color number.	
Interior Wall 3 Contrasting Panel	• Non contrasting	No cost	Specify <i>with non contrasting</i> .
	• Contrasting	+\$ 319	Specify <i>with contrasting</i> .
Interior Wall 3 Contrasting Panel Position	• Panel A	No cost	Specify <i>with contrasting interior wall 3 panel A</i> .
	• Panel B	No cost	Specify <i>with contrasting interior wall 3 panel B</i> .
	• Panel C	No cost	Specify <i>with contrasting interior wall 3 panel C</i> .
	• Panel D	No cost	Specify <i>with contrasting interior wall 3 panel D</i> .
Interior Wall 3 Contrasting Panel Type	• Fabric	No cost	Specify <i>with fabric</i> .
	• Laminate	+\$ 495	Specify <i>with laminate</i> .
Interior Wall 3 Contrasting Panel Finish	• Customer's Own Material (COM)	No cost	► See <i>Surface Materials Reference Manual</i> .
	• Fabric price group 1	No cost	Specify fabric color number for contrasting interior wall 3.
	• Fabric price group 2	+\$ 100	Specify fabric color number for contrasting interior wall 3.
	• Fabric price group 3	+\$ 186	Specify fabric color number for contrasting interior wall 3.
	• Fabric price group 4	+\$ 263	Specify fabric color number for contrasting interior wall 3.
	• Fabric price group 5	+\$ 329	Specify fabric color number for contrasting interior wall 3.
	• Fabric price group 6	+\$ 410	Specify fabric color number for contrasting interior wall 3.
	• Fabric price group 7	+\$ 466	Specify fabric color number for contrasting interior wall 3.
	• Fabric price group 8	+\$ 592	Specify fabric color number for contrasting interior wall 3.
	• Fabric price group 9	+\$ 725	Specify fabric color number for contrasting interior wall 3.
	• Fabric price group 10	+\$ 824	Specify fabric color number for contrasting interior wall 3.
	• High-Pressure Laminate price group 1	No cost	Specify laminate color number for contrasting interior wall 3.
	• High-Pressure Laminate price group 2	+\$ 558	Specify laminate color number for contrasting interior wall 3.
	• High-Pressure Laminate price group 3	+\$ 810	Specify laminate color number for contrasting interior wall 3.
• Open Line laminate (OLL)	+\$ 111 plus cost of laminate	► See <i>Surface Materials Reference Manual</i> .	
Exterior Wall 1 Panel Type	• Fabric	No cost	Specify <i>with fabric</i> .
	• Laminate	+\$1977	Specify <i>with laminate</i> .
	• Plywood	+\$5238	Specify <i>with plywood</i> .

► Options, continued on next page



For Canadian Pricing
Multiply U.S. Price by the
Canadian price factor.
► See page 1 for details.

► Options, continued from previous page

Options	U.S. Price	Required to Specify
Exterior Wall 1 Panel Finish	<ul style="list-style-type: none"> • Customer's Own Material (COM) No cost • Plywood price group 1 No cost • Fabric price group 1 No cost • Fabric price group 2 +\$ 399 • Fabric price group 3 +\$ 742 • Fabric price group 4 +\$1050 • Fabric price group 5 +\$1318 • Fabric price group 6 +\$1644 • Fabric price group 7 +\$1864 • Fabric price group 8 +\$2367 • Fabric price group 9 +\$2901 • Fabric price group 10 +\$3296 • High-Pressure Laminate price group 1 No cost • High-Pressure Laminate price group 2 +\$2233 • High-Pressure Laminate price group 3 +\$3239 • Open Line laminate (OLL) +\$ 111 plus cost of laminate 	<ul style="list-style-type: none"> ► See <i>Surface Materials Reference Manual</i>. Specify plywood color number. Specify fabric color number. Specify fabric color number. Specify fabric color number. Specify fabric color number. Specify fabric color number. Specify fabric color number. Specify fabric color number. Specify fabric color number. Specify fabric color number. Specify fabric color number. Specify laminate color number. Specify laminate color number. ► See <i>Surface Materials Reference Manual</i>.
Exterior Wall 1 Contrasting Panel	<ul style="list-style-type: none"> • Non contrasting No cost • Contrasting +\$ 319 	Specify with non contrasting. Specify with contrasting.
Exterior Wall 1 Contrasting Panel Position	<ul style="list-style-type: none"> • Panel A No cost • Panel B No cost • Panel C No cost • Panel D No cost 	Specify with contrasting exterior wall 1 panel A. Specify with contrasting exterior wall 1 panel B. Specify with contrasting exterior wall 1 panel C. Specify with contrasting exterior wall 1 panel D.
Exterior Wall 1 Contrasting Panel Type	<ul style="list-style-type: none"> • Fabric No cost • Laminate +\$ 495 • Plywood +\$1309 	Specify with fabric. Specify with laminate. Specify with plywood.
Exterior Wall 1 Contrasting Panel Finish	<ul style="list-style-type: none"> • Customer's Own Material (COM) No cost • Fabric price group 1 No cost • Fabric price group 2 +\$ 100 • Fabric price group 3 +\$ 186 • Fabric price group 4 +\$ 263 • Fabric price group 5 +\$ 329 • Fabric price group 6 +\$ 410 • Fabric price group 7 +\$ 466 • Fabric price group 8 +\$ 592 • Fabric price group 9 +\$ 725 • Fabric price group 10 +\$ 824 • High-Pressure Laminate price group 1 No cost • High-Pressure Laminate price group 2 +\$ 558 • High-Pressure Laminate price group 3 +\$ 810 • Open Line laminate (OLL) +\$ 111 plus cost of laminate 	<ul style="list-style-type: none"> ► See <i>Surface Materials Reference Manual</i>. Specify fabric color number for contrasting exterior wall 1. Specify fabric color number for contrasting exterior wall 1. Specify fabric color number for contrasting exterior wall 1. Specify fabric color number for contrasting exterior wall 1. Specify fabric color number for contrasting exterior wall 1. Specify fabric color number for contrasting exterior wall 1. Specify fabric color number for contrasting exterior wall 1. Specify fabric color number for contrasting exterior wall 1. Specify fabric color number for contrasting exterior wall 1. Specify fabric color number for contrasting exterior wall 1. Specify laminate color number for contrasting exterior wall 1. Specify laminate color number for contrasting exterior wall 1. Specify laminate color number for contrasting exterior wall 1. Specify laminate color number for contrasting exterior wall 1. ► See <i>Surface Materials Reference Manual</i>.

Tip: Panel C is not available on right hand unit.

Specifying

 **For Canadian Pricing**
Multiply U.S. Price by the Canadian price factor.
► See page 1 for details.

► Options, continued on next page

► Options, continued from previous page

	Options	U.S. Price	Required to Specify
Exterior Wall 2 Panel Type	<ul style="list-style-type: none"> Fabric Laminate Plywood 	<ul style="list-style-type: none"> No cost +\$1977 +\$5238 	<ul style="list-style-type: none"> Specify with fabric. Specify with laminate. Specify with plywood.
Exterior Wall 2 Panel Finish	<ul style="list-style-type: none"> Customer's Own Material (COM) Plywood price group 1 Fabric price group 1 Fabric price group 2 Fabric price group 3 Fabric price group 4 Fabric price group 5 Fabric price group 6 Fabric price group 7 Fabric price group 8 Fabric price group 9 Fabric price group 10 High-Pressure Laminate price group 1 High-Pressure Laminate price group 2 High-Pressure Laminate price group 3 Open Line laminate (OLL) 	<ul style="list-style-type: none"> No cost No cost No cost +\$ 399 +\$ 742 +\$1050 +\$1318 +\$1644 +\$1864 +\$2367 +\$2901 +\$3296 No cost +\$2233 +\$3239 +\$ 111 plus cost of laminate 	<ul style="list-style-type: none"> ► See <i>Surface Materials Reference Manual</i>. Specify plywood color number. Specify fabric color number. Specify fabric color number. Specify fabric color number. Specify fabric color number. Specify fabric color number. Specify fabric color number. Specify fabric color number. Specify fabric color number. Specify fabric color number. Specify fabric color number. Specify fabric color number. Specify laminate color number. Specify laminate color number. ► See <i>Surface Materials Reference Manual</i>.
Exterior Wall 2 Contrasting Panel	<ul style="list-style-type: none"> Non contrasting Contrasting 	<ul style="list-style-type: none"> No cost +\$ 319 	<ul style="list-style-type: none"> Specify with non contrasting. Specify with contrasting.
Exterior Wall 2 Contrasting Panel Position	<ul style="list-style-type: none"> Panel A Panel B Panel C Panel D 	<ul style="list-style-type: none"> No cost No cost No cost No cost 	<ul style="list-style-type: none"> Specify with contrasting exterior wall 2 panel A. Specify with contrasting exterior wall 2 panel B. Specify with contrasting exterior wall 2 panel C. Specify with contrasting exterior wall 2 panel D.
Exterior Wall 2 Contrasting Panel Type	<ul style="list-style-type: none"> Fabric Laminate Plywood 	<ul style="list-style-type: none"> No cost +\$ 495 +\$1309 	<ul style="list-style-type: none"> Specify with fabric. Specify with laminate. Specify with plywood.
Exterior Wall 2 Contrasting Panel Finish	<ul style="list-style-type: none"> Customer's Own Material (COM) Fabric price group 1 Fabric price group 2 Fabric price group 3 Fabric price group 4 Fabric price group 5 Fabric price group 6 Fabric price group 7 Fabric price group 8 Fabric price group 9 Fabric price group 10 High-Pressure Laminate price group 1 High-Pressure Laminate price group 2 High-Pressure Laminate price group 3 Open Line laminate (OLL) 	<ul style="list-style-type: none"> No cost No cost +\$ 100 +\$ 186 +\$ 263 +\$ 329 +\$ 410 +\$ 466 +\$ 592 +\$ 725 +\$ 824 No cost +\$ 558 +\$ 810 +\$ 111 plus cost of laminate 	<ul style="list-style-type: none"> ► See <i>Surface Materials Reference Manual</i>. Specify fabric color number for contrasting exterior wall 2. Specify fabric color number for contrasting exterior wall 2. Specify fabric color number for contrasting exterior wall 2. Specify fabric color number for contrasting exterior wall 2. Specify fabric color number for contrasting exterior wall 2. Specify fabric color number for contrasting exterior wall 2. Specify fabric color number for contrasting exterior wall 2. Specify fabric color number for contrasting exterior wall 2. Specify fabric color number for contrasting exterior wall 2. Specify fabric color number for contrasting exterior wall 2. Specify fabric color number for contrasting exterior wall 2. Specify laminate color number for contrasting exterior wall 2. Specify laminate color number for contrasting exterior wall 2. Specify laminate color number for contrasting exterior wall 2. ► See <i>Surface Materials Reference Manual</i>.

► Options, continued on next page



For Canadian Pricing
 Multiply U.S. Price by the Canadian price factor.
 ► See page 1 for details.

► Options, continued from previous page

	Options	U.S. Price	Required to Specify
Exterior Wall 3 Panel Type	<ul style="list-style-type: none"> Fabric Laminate Plywood 	<ul style="list-style-type: none"> No cost +\$1977 +\$5238 	<ul style="list-style-type: none"> Specify with fabric. Specify with laminate. Specify with plywood.
Exterior Wall 3 Panel Finish	<ul style="list-style-type: none"> Customer's Own Material (COM) Plywood price group 1 Fabric price group 1 Fabric price group 2 Fabric price group 3 Fabric price group 4 Fabric price group 5 Fabric price group 6 Fabric price group 7 Fabric price group 8 Fabric price group 9 Fabric price group 10 High-Pressure Laminate price group 1 High-Pressure Laminate price group 2 High-Pressure Laminate price group 3 Open Line laminate (OLL) 	<ul style="list-style-type: none"> No cost No cost No cost +\$ 399 +\$ 742 +\$1050 +\$1318 +\$1644 +\$1864 +\$2367 +\$2901 +\$3296 No cost +\$2233 +\$3239 +\$ 111 plus cost of laminate 	<ul style="list-style-type: none"> ► See <i>Surface Materials Reference Manual</i>. Specify plywood color number. Specify fabric color number. Specify fabric color number. Specify fabric color number. Specify fabric color number. Specify fabric color number. Specify fabric color number. Specify fabric color number. Specify fabric color number. Specify fabric color number. Specify fabric color number. Specify fabric color number. Specify laminate color number. Specify laminate color number. Specify laminate color number. ► See <i>Surface Materials Reference Manual</i>.
Exterior Wall 3 Contrasting Panel	<ul style="list-style-type: none"> Non contrasting Contrasting 	<ul style="list-style-type: none"> No cost +\$ 319 	<ul style="list-style-type: none"> Specify with non contrasting. Specify with contrasting.
Exterior Wall 3 Contrasting Panel Position	<ul style="list-style-type: none"> Panel A Panel B Panel C Panel D 	<ul style="list-style-type: none"> No cost No cost No cost No cost 	<ul style="list-style-type: none"> Specify with contrasting exterior wall 3 panel A. Specify with contrasting exterior wall 3 panel B. Specify with contrasting exterior wall 3 panel C. Specify with contrasting exterior wall 3 panel D.
Exterior Wall 3 Contrasting Panel Type	<ul style="list-style-type: none"> Fabric Laminate Plywood 	<ul style="list-style-type: none"> No cost +\$ 495 +\$1309 	<ul style="list-style-type: none"> Specify with fabric. Specify with laminate. Specify with plywood.
Exterior Wall 3 Contrasting Panel Finish	<ul style="list-style-type: none"> Customer's Own Material (COM) Plywood price group 1 Fabric price group 1 Fabric price group 2 Fabric price group 3 Fabric price group 4 Fabric price group 5 Fabric price group 6 Fabric price group 7 Fabric price group 8 Fabric price group 9 Fabric price group 10 	<ul style="list-style-type: none"> No cost No cost No cost +\$ 100 +\$ 186 +\$ 263 +\$ 329 +\$ 410 +\$ 466 +\$ 592 +\$ 725 +\$ 824 	<ul style="list-style-type: none"> ► See <i>Surface Materials Reference Manual</i>. Specify plywood color number for contrasting exterior wall 3. Specify fabric color number for contrasting exterior wall 3. Specify fabric color number for contrasting exterior wall 3. Specify fabric color number for contrasting exterior wall 3. Specify fabric color number for contrasting exterior wall 3. Specify fabric color number for contrasting exterior wall 3. Specify fabric color number for contrasting exterior wall 3. Specify fabric color number for contrasting exterior wall 3. Specify fabric color number for contrasting exterior wall 3. Specify fabric color number for contrasting exterior wall 3. Specify fabric color number for contrasting exterior wall 3. Specify fabric color number for contrasting exterior wall 3.

Tip: Panel C is not available on right hand unit.

Specifying

 **For Canadian Pricing**
Multiply U.S. Price by the Canadian price factor.
► See page 1 for details.

► Options, continued on next page

Campers 115"W x 119"D Glass Front, continued

► Options, continued from previous page

	Options	U.S. Price	Required to Specify
Exterior Wall 3 Contrasting Panel Finish, continued	• High-Pressure Laminate price group 1	No cost	Specify laminate color number for contrasting exterior wall 3.
	• High-Pressure Laminate price group 2	+\$558	Specify laminate color number for contrasting exterior wall 3.
	• High-Pressure Laminate price group 3	+\$810	Specify laminate color number for contrasting exterior wall 3.
	• Open Line laminate (OLL)	+\$111 plus cost of laminate	► See <i>Surface Materials Reference Manual</i> .
Power Configuration	• 3 power	No cost	Specify <i>with power</i> .
	• 2 power, 1 USB A, 1 USB-C 20W	+\$780	Specify <i>with power, 1 USB A, 1 USB-C 20W</i> .
HDMI and Data Configuration	• No HDMI/data	No cost	Specify <i>with no HDMI/data</i> .
	• 1 HDMI, 2 data	+\$978	Specify <i>with 1 HDMI, 2 data</i> .
Kink Option	• No kink	No cost	Specify <i>with no kink</i> .
	• With kink	No cost	Specify <i>with kink</i> .
Cabin Option	• No cabin	No cost	Specify <i>with no cabin</i> .
	• With cabin	No cost	Specify <i>with cabin</i> .

Tip: When specifying your camper, please make sure the "kink option" and "cabin option" are entered correctly. For the "kink option" select "with kink" if you plan to add a kink to the camper and "no kink" if you don't intend to add a kink on the camper. Likewise, for the "cabin option", please select "with cabin", if you plan to attach a cabin to the camper and "no cabin" if you don't plan to attach a cabin.

Specification Information

Style Number	U.S. Base Price

115"W x 119"D Glass Front—Left Hand

OB1CD05DLS \$89,708

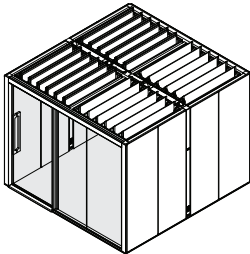

115"W x 119"D Glass Front—Right Hand

OB1CD05DRS \$89,708

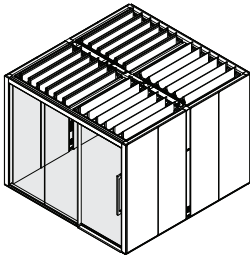

► Specification Information, continued on next page



For Canadian Pricing

Multiply U.S. Price by the Canadian price factor.

► See page 1 for details.

► Specification Information, continued from previous page

Specification Information

Style Number	U.S. Base Price
--------------	-----------------

115"W x 119"D Glass Front (with Infill)—Left Hand

OB1CD05DLSNB	\$91,886
---------------------	----------

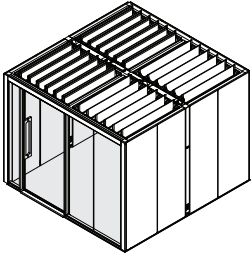

115"W x 119"D Glass Front (with Infill)—Right Hand

OB1CD05DRSNB	\$91,886
---------------------	----------

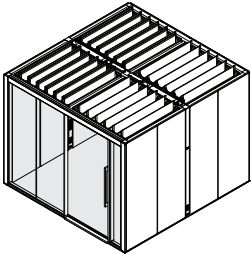

For Canadian Pricing

Multiply U.S. Price by the Canadian price factor.

► See page 1 for details.

88"W Kinks

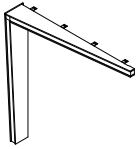

Tip: Kinks can only be applied to the front door wall. Handedness matches the door opening direction.

Tip: When Open Line laminate (OLL) is selected on exterior, edge is specifiable in plastic price group 1 finish.

Standard Includes		Required to Specify
<ul style="list-style-type: none"> ▶ Need help? Product details, page 20 	<ul style="list-style-type: none"> • 88"W kink • Fascia: 7207 Black • Exterior: laminate price group 1 • Interior: laminate price group 1 	<ol style="list-style-type: none"> 1 Style number 2 Laminate color number for exterior 3 Laminate color number for interior 4 Options, if selected (see below) <ul style="list-style-type: none"> ▶ See Product Understanding for Surface Materials.

	Options	U.S. Price	Required to Specify
Exterior Type	<ul style="list-style-type: none"> • Laminate • Fabric • Plywood 	<ul style="list-style-type: none"> No cost +\$ 293 +\$1063 	<ul style="list-style-type: none"> Specify laminate color number. Specify fabric color number. Specify plywood color number.
Exterior Finish	<ul style="list-style-type: none"> • Customer's Own Material (COM) • Fabric price group 1 • Fabric price group 2 • Fabric price group 3 • Fabric price group 4 • Fabric price group 5 • Fabric price group 6 • Fabric price group 7 • Fabric price group 8 • Fabric price group 9 • Fabric price group 10 • High-Pressure Laminate price group 1 • High-Pressure Laminate price group 2 • High-Pressure Laminate price group 3 • Open Line laminate (OLL) 	<ul style="list-style-type: none"> No cost No cost +\$ 111 +\$ 208 +\$ 289 +\$ 367 +\$ 457 +\$ 520 +\$ 657 +\$ 807 +\$ 917 No cost +\$ 133 +\$ 249 +\$ 111 plus cost of laminate 	<ul style="list-style-type: none"> ▶ See <i>Surface Materials Reference Manual</i>. Specify fabric color number. Specify fabric color number. Specify fabric color number. Specify fabric color number. Specify fabric color number. Specify fabric color number. Specify fabric color number. Specify fabric color number. Specify fabric color number. Specify fabric color number. Specify laminate color number. Specify laminate color number. Specify laminate color number. ▶ See <i>Surface Materials Reference Manual</i>.
Interior Type	<ul style="list-style-type: none"> • Laminate • Fabric • Plywood 	<ul style="list-style-type: none"> No cost +\$ 293 +\$1063 	<ul style="list-style-type: none"> Specify laminate color number. Specify fabric color number. Specify plywood color number.
Interior Finish	<ul style="list-style-type: none"> • Customer's Own Material (COM) • Fabric price group 1 • Fabric price group 2 • Fabric price group 3 • Fabric price group 4 • Fabric price group 5 • Fabric price group 6 • Fabric price group 7 • Fabric price group 8 • Fabric price group 9 • Fabric price group 10 • High-Pressure Laminate price group 1 • High-Pressure Laminate price group 2 • High-Pressure Laminate price group 3 • Open Line laminate (OLL) 	<ul style="list-style-type: none"> No cost No cost +\$ 111 +\$ 208 +\$ 289 +\$ 367 +\$ 457 +\$ 520 +\$ 657 +\$ 807 +\$ 917 No cost +\$ 133 +\$ 249 +\$ 111 plus cost of laminate 	<ul style="list-style-type: none"> ▶ See <i>Surface Materials Reference Manual</i>. Specify fabric color number. Specify fabric color number. Specify fabric color number. Specify fabric color number. Specify fabric color number. Specify fabric color number. Specify fabric color number. Specify fabric color number. Specify fabric color number. Specify fabric color number. Specify laminate color number. Specify laminate color number. Specify laminate color number. ▶ See <i>Surface Materials Reference Manual</i>.



For Canadian Pricing
 Multiply U.S. Price by the Canadian price factor.
 ▶ See page 1 for details.

Specification Information

Style Number	U.S. Base Price
--------------	-----------------

88"W Kink, Left

OB1CDK01L	\$4312
------------------	--------

88"W Kink, Right

OB1CDK01R	\$4312
------------------	--------

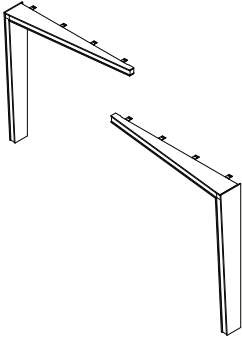

For Canadian Pricing
 Multiply U.S. Price by the
 Canadian price factor.
 ▶ See page 1 for details.

115"W Kinks

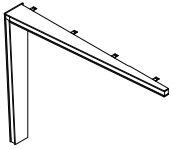

Tip: Kinks can only be applied to the front door wall. Handedness matches the door opening direction.

Tip: When Open Line laminate (OLL) is selected on exterior, edge is specifiable in plastic price group 1 finish.

Standard Includes		Required to Specify
<ul style="list-style-type: none"> ▶ Need help? Product details, page 26 	<ul style="list-style-type: none"> • 115"W kink • Fascia: 7207 Black • Exterior: laminate price group 1 • Interior: laminate price group 1 	<ol style="list-style-type: none"> 1 Style number 2 Laminate color number for exterior 3 Laminate color number for interior 4 Options, if selected (see below) <ul style="list-style-type: none"> ▶ See Product Understanding for Surface Materials.

	Options	U.S. Price	Required to Specify
Exterior Type	<ul style="list-style-type: none"> • Laminate • Fabric • Plywood 	<ul style="list-style-type: none"> No cost +\$ 358 +\$1354 	<ul style="list-style-type: none"> Specify laminate color number. Specify fabric color number. Specify plywood color number.
Exterior Finish	<ul style="list-style-type: none"> • Customer's Own Material (COM) • Fabric price group 1 • Fabric price group 2 • Fabric price group 3 • Fabric price group 4 • Fabric price group 5 • Fabric price group 6 • Fabric price group 7 • Fabric price group 8 • Fabric price group 9 • Fabric price group 10 • High-Pressure Laminate price group 1 • High-Pressure Laminate price group 2 • High-Pressure Laminate price group 3 • Open Line laminate (OLL) 	<ul style="list-style-type: none"> No cost No cost +\$ 135 +\$ 255 +\$ 356 +\$ 452 +\$ 561 +\$ 639 +\$ 807 +\$ 993 +\$1129 No cost +\$ 165 +\$ 308 +\$ 111 plus cost of laminate 	<ul style="list-style-type: none"> ▶ See <i>Surface Materials Reference Manual</i>. Specify fabric color number. Specify fabric color number. Specify fabric color number. Specify fabric color number. Specify fabric color number. Specify fabric color number. Specify fabric color number. Specify fabric color number. Specify fabric color number. Specify fabric color number. Specify laminate color number. Specify laminate color number. Specify laminate color number. ▶ See <i>Surface Materials Reference Manual</i>.
Interior Type	<ul style="list-style-type: none"> • Laminate • Fabric • Plywood 	<ul style="list-style-type: none"> No cost +\$ 358 +\$1354 	<ul style="list-style-type: none"> Specify laminate color number. Specify fabric color number. Specify plywood color number.
Interior Finish	<ul style="list-style-type: none"> • Customer's Own Material (COM) • Fabric price group 1 • Fabric price group 2 • Fabric price group 3 • Fabric price group 4 • Fabric price group 5 • Fabric price group 6 • Fabric price group 7 • Fabric price group 8 • Fabric price group 9 • Fabric price group 10 • High-Pressure Laminate price group 1 • High-Pressure Laminate price group 2 • High-Pressure Laminate price group 3 • Open Line laminate (OLL) 	<ul style="list-style-type: none"> No cost No cost +\$ 135 +\$ 255 +\$ 356 +\$ 452 +\$ 561 +\$ 639 +\$ 807 +\$ 993 +\$1129 No cost +\$ 165 +\$ 308 +\$ 111 plus cost of laminate 	<ul style="list-style-type: none"> ▶ See <i>Surface Materials Reference Manual</i>. Specify fabric color number. Specify fabric color number. Specify fabric color number. Specify fabric color number. Specify fabric color number. Specify fabric color number. Specify fabric color number. Specify fabric color number. Specify fabric color number. Specify fabric color number. Specify laminate color number. Specify laminate color number. Specify laminate color number. ▶ See <i>Surface Materials Reference Manual</i>.



For Canadian Pricing
Multiply U.S. Price by the Canadian price factor.
▶ See page 1 for details.

Specification Information

Style Number	U.S. Base Price
--------------	-----------------

115"W Kink, Left

OB1CDK02L	\$4660
------------------	--------

115"W Kink, Right

OB1CDK02R	\$4660
------------------	--------

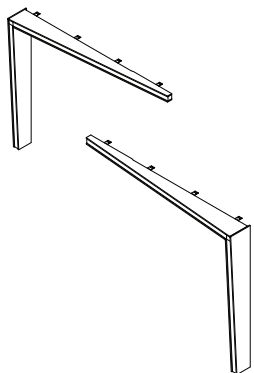

Specifying

 **For Canadian Pricing**
 Multiply U.S. Price by the Canadian price factor.
 ▶ See page 1 for details.

88"W Cabin

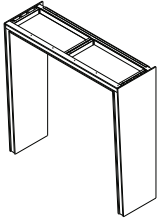

Tip: Cabins can only be applied to the back of the camper (wall 2).

Tip: When Open Line laminate (OLL) is selected on exterior, edge is specifiable in plastic price group 1 finish.

Standard Includes		Required to Specify
▶ Need help? Product details, page 27	<ul style="list-style-type: none"> • 88"W cabin • Fascia: 7207 Black • Cabin roof: solid • Exterior: laminate price group 1 • Interior: fabric price group 1 	<ol style="list-style-type: none"> 1 Style number 2 Laminate color number for exterior 3 Fabric color number for interior 4 Options, if selected (see below) <p>▶ See Product Understanding for Surface Materials.</p>

Options	U.S. Price	Required to Specify
Cabin Roof	<ul style="list-style-type: none"> • Solid No cost • Slat +\$ 342 	<p>Specify with <i>solid roof</i>.</p> <p>Specify with <i>slat roof</i>.</p>
Exterior Type	<ul style="list-style-type: none"> • Laminate No cost • Fabric +\$ 384 • Plywood +\$1601 	<p>Specify laminate color number.</p> <p>Specify fabric color number.</p> <p>Specify plywood color number.</p>
Exterior Finish	<ul style="list-style-type: none"> • Customer's Own Material (COM) No cost • Fabric price group 1 No cost • Fabric price group 2 +\$ 145 • Fabric price group 3 +\$ 178 • Fabric price group 4 +\$ 377 • Fabric price group 5 +\$ 478 • Fabric price group 6 +\$ 593 • Fabric price group 7 +\$ 676 • Fabric price group 8 +\$ 853 • Fabric price group 9 +\$1051 • Fabric price group 10 +\$1191 • High-Pressure Laminate price group 1 No cost • High-Pressure Laminate price group 2 +\$ 173 • High-Pressure Laminate price group 3 +\$ 323 • Plywood price group 1 No cost • Open Line laminate (OLL) +\$ 111 plus cost of laminate 	<p>▶ See <i>Surface Materials Reference Manual</i>.</p> <p>Specify fabric color number.</p> <p>Specify fabric color number.</p> <p>Specify fabric color number.</p> <p>Specify fabric color number.</p> <p>Specify fabric color number.</p> <p>Specify fabric color number.</p> <p>Specify fabric color number.</p> <p>Specify fabric color number.</p> <p>Specify fabric color number.</p> <p>Specify fabric color number.</p> <p>Specify fabric color number.</p> <p>Specify fabric color number.</p> <p>Specify laminate color number.</p> <p>Specify laminate color number.</p> <p>Specify laminate color number.</p> <p>Specify plywood color number.</p> <p>▶ See <i>Surface Materials Reference Manual</i>.</p>
Interior Finish	<ul style="list-style-type: none"> • Customer's Own Material (COM) No cost • Fabric price group 1 No cost • Fabric price group 2 +\$ 145 • Fabric price group 3 +\$ 178 • Fabric price group 4 +\$ 377 • Fabric price group 5 +\$ 478 • Fabric price group 6 +\$ 593 • Fabric price group 7 +\$ 676 • Fabric price group 8 +\$ 853 • Fabric price group 9 +\$1051 • Fabric price group 10 +\$1191 	<p>▶ See <i>Surface Materials Reference Manual</i>.</p> <p>Specify fabric color number.</p> <p>Specify fabric color number.</p> <p>Specify fabric color number.</p> <p>Specify fabric color number.</p> <p>Specify fabric color number.</p> <p>Specify fabric color number.</p> <p>Specify fabric color number.</p> <p>Specify fabric color number.</p> <p>Specify fabric color number.</p> <p>Specify fabric color number.</p> <p>Specify fabric color number.</p>
Light	<ul style="list-style-type: none"> • No light No cost • With light +\$1060 	<p>Specify with <i>no light</i>.</p> <p>Specify with <i>light</i>.</p>

Specification Information	
Style Number	U.S. Base Price
OB1CDC01	\$8966



For Canadian Pricing
 Multiply U.S. Price by the Canadian price factor.
 ▶ See page 1 for details.

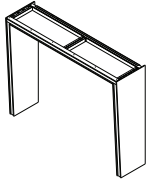

Tip: Cabins can only be applied to the back of the camper (wall 2).

Tip: When Open Line laminate (OLL) is selected on exterior, edge is specifiable in plastic price group 1 finish.

Standard Includes		Required to Specify
▶ Need help? Product details, page 27	<ul style="list-style-type: none"> • 115"W cabin • Fascia: 7207 Black • Cabin roof: solid • Exterior: laminate price group 1 • Interior: fabric price group 1 	<ol style="list-style-type: none"> 1 Style number 2 Laminate color number for exterior 3 Fabric color number for interior 4 Options, if selected (see below) <p>▶ See Product Understanding for Surface Materials.</p>

Options	U.S. Price	Required to Specify
Cabin Roof	<ul style="list-style-type: none"> • Solid No cost • Slat +\$ 504 	<p>Specify with <i>solid roof</i>.</p> <p>Specify with <i>slat roof</i>.</p>
Exterior Type	<ul style="list-style-type: none"> • Laminate No cost • Fabric +\$ 403 • Plywood +\$1682 	<p>Specify laminate color number.</p> <p>Specify fabric color number.</p> <p>Specify plywood color number.</p>
Exterior Finish	<ul style="list-style-type: none"> • Customer's Own Material (COM) No cost • Fabric price group 1 No cost • Fabric price group 2 +\$ 152 • Fabric price group 3 +\$ 187 • Fabric price group 4 +\$ 395 • Fabric price group 5 +\$ 502 • Fabric price group 6 +\$ 622 • Fabric price group 7 +\$ 710 • Fabric price group 8 +\$ 896 • Fabric price group 9 +\$1102 • Fabric price group 10 +\$1251 • High-Pressure Laminate price group 1 No cost • High-Pressure Laminate price group 2 +\$ 183 • High-Pressure Laminate price group 3 +\$ 340 • Plywood price group 1 No cost • Open Line laminate (OLL) +\$ 111 plus cost of laminate 	<p>▶ See <i>Surface Materials Reference Manual</i>.</p> <p>Specify fabric color number.</p> <p>Specify fabric color number.</p> <p>Specify fabric color number.</p> <p>Specify fabric color number.</p> <p>Specify fabric color number.</p> <p>Specify fabric color number.</p> <p>Specify fabric color number.</p> <p>Specify fabric color number.</p> <p>Specify fabric color number.</p> <p>Specify fabric color number.</p> <p>Specify fabric color number.</p> <p>Specify laminate color number.</p> <p>Specify laminate color number.</p> <p>Specify plywood color number.</p> <p>▶ See <i>Surface Materials Reference Manual</i>.</p>
Interior Finish	<ul style="list-style-type: none"> • Customer's Own Material (COM) No cost • Fabric price group 1 No cost • Fabric price group 2 +\$ 152 • Fabric price group 3 +\$ 187 • Fabric price group 4 +\$ 395 • Fabric price group 5 +\$ 502 • Fabric price group 6 +\$ 622 • Fabric price group 7 +\$ 710 • Fabric price group 8 +\$ 896 • Fabric price group 9 +\$1102 • Fabric price group 10 +\$1251 	<p>▶ See <i>Surface Materials Reference Manual</i>.</p> <p>Specify fabric color number.</p> <p>Specify fabric color number.</p> <p>Specify fabric color number.</p> <p>Specify fabric color number.</p> <p>Specify fabric color number.</p> <p>Specify fabric color number.</p> <p>Specify fabric color number.</p> <p>Specify fabric color number.</p> <p>Specify fabric color number.</p> <p>Specify fabric color number.</p>
Light	<ul style="list-style-type: none"> • No light No cost • With light +\$1494 	<p>Specify with <i>no light</i>.</p> <p>Specify with <i>light</i>.</p>

Specification Information	
Style Number	U.S. Base Price
OB1CDC02	\$9464

 **For Canadian Pricing**
 Multiply U.S. Price by the Canadian price factor.
 ▶ See page 1 for details.

Specifying

Cabin 88"W Awning

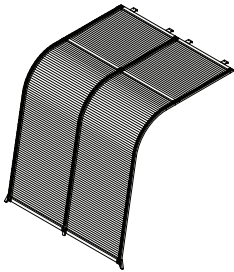

	Standard Includes	Required to Specify
▶ Need help? Product details, page 28	<ul style="list-style-type: none"> • 88"W awning • Frame: 7207 Black • Foot: V3AK Natural Oak or VP03 Black Oak • Side: cord • Top: nylon price group 1 • Top type: cord 	<ol style="list-style-type: none"> 1 Style number 2 Color number for top 3 Color number for side 4 Color number for foot 5 Options, if selected (see below) <p>▶ See Product Understanding for Surface Materials.</p>

	Options	U.S. Price	Required to Specify
Top Type	<ul style="list-style-type: none"> • Cord • Fabric 	<p>No cost</p> <p>+\$ 102</p>	<p>Specify <i>with cord</i>.</p> <p>Specify <i>with fabric</i>.</p>
Top Finish	<ul style="list-style-type: none"> • Customer's Own Material (COM) • Nylon price group 1 • Fabric price group 8 	<p>No cost</p> <p>No cost</p> <p>+\$ 713</p>	<p>▶ See <i>Surface Materials Reference Manual</i>.</p> <p>Specify nylon color number.</p> <p>Specify fabric color number.</p>
Side Type	<ul style="list-style-type: none"> • Cord • Fabric • PET • Plywood 	<p>No cost</p> <p>+\$ 444</p> <p>+\$1490</p> <p>+\$7245</p>	<p>Specify <i>with cord</i>.</p> <p>Specify <i>with fabric</i>.</p> <p>Specify <i>with PET</i>.</p> <p>Specify <i>with plywood</i>.</p>
Side Finish	<ul style="list-style-type: none"> • Customer's Own Material (COM) • Fabric price group 1 • Nylon price group 1 • Plywood price group 1 • Fabric price group 8 	<p>No cost</p> <p>No cost</p> <p>No cost</p> <p>No cost</p> <p>+\$1426</p>	<p>▶ See <i>Surface Materials Reference Manual</i>.</p> <p>Specify fabric color number.</p> <p>Specify nylon color number.</p> <p>Specify plywood color number.</p> <p>Specify fabric color number.</p>

Specification Information	
Style Number	U.S. Base Price
OB1AW01	\$10,361
.	.



For Canadian Pricing
 Multiply U.S. Price by the
 Canadian price factor.
 ▶ See page 1 for details.

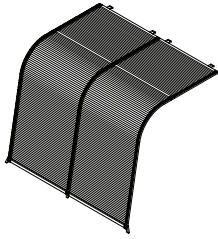

Tip: Awnings can attach to any CD05 camper wall, including door wall.

Standard Includes		Required to Specify
<ul style="list-style-type: none"> ▶ Need help? Product details, page 28 	<ul style="list-style-type: none"> • 115"W awning • Frame: 7207 Black • Foot: V3AK Natural Oak or VP03 Black Oak • Side: cord • Top: nylon price group 1 • Top type: cord 	<ol style="list-style-type: none"> 1 Style number 2 Color number for top 3 Color number for side 4 Color number for foot 5 Options, if selected (see below) <ul style="list-style-type: none"> ▶ See Product Understanding for Surface Materials.

Options	U.S. Price	Required to Specify
Top Type <ul style="list-style-type: none"> • Cord • Fabric 	<ul style="list-style-type: none"> No cost +\$ 102 	<ul style="list-style-type: none"> Specify with cord. Specify with fabric.
Top Finish <ul style="list-style-type: none"> • Customer's Own Material (COM) • Nylon price group 1 • Fabric price group 8 	<ul style="list-style-type: none"> No cost No cost +\$ 713 	<ul style="list-style-type: none"> ▶ See <i>Surface Materials Reference Manual</i>. Specify nylon color number. Specify fabric color number.
Side Type <ul style="list-style-type: none"> • Cord • Fabric • PET • Plywood 	<ul style="list-style-type: none"> No cost +\$ 444 +\$1490 +\$7245 	<ul style="list-style-type: none"> Specify with cord. Specify with fabric. Specify with PET. Specify with plywood.
Side Finish <ul style="list-style-type: none"> • Customer's Own Material (COM) • Fabric price group 1 • Nylon price group 1 • Plywood price group 1 • Fabric price group 8 	<ul style="list-style-type: none"> No cost No cost No cost No cost +\$1426 	<ul style="list-style-type: none"> ▶ See <i>Surface Materials Reference Manual</i>. Specify fabric color number. Specify nylon color number. Specify plywood color number. Specify fabric color number.

Specification Information	
Style Number	U.S. Base Price
OB1AW02	\$10,565
.	.

Specifying

 **For Canadian Pricing**
 Multiply U.S. Price by the Canadian price factor.
 ▶ See page 1 for details.

Hacking

92" Up to Corner, Wood Slat

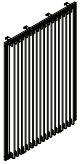

Tip: Hacking cannot cover door or share wall with cabin, kink, or awning.

Standard Includes		Required to Specify	
▶ Need help? Product details, page 29	<ul style="list-style-type: none"> • Straight slats: poplar plywood • Frame: 7207 Black 	1 Style number	2 Options, if selected (see below)
		▶ See Product Understanding for Surface Materials.	
Options		U.S. Price	Required to Specify
Slat Scheme	<ul style="list-style-type: none"> • Straight • Wavy 	No cost +\$1415	Specify with <i>straight slat scheme</i> . Specify with <i>wavy slat scheme</i> .
Specification Information			
• Style Number	• U.S. Base Price		
OB1HACK08	\$10,698		

92" Full Depth, Wood Slat



Tip: Hacking cannot cover door or share wall with cabin, kink, or awning.

Standard Includes		Required to Specify	
▶ Need help? Product details, page 29	<ul style="list-style-type: none"> • Straight slats: poplar plywood • Frame: 7207 Black 	1 Style number	2 Options, if selected (see below)
		▶ See Product Understanding for Surface Materials.	
Options		U.S. Price	Required to Specify
Slat Scheme	<ul style="list-style-type: none"> • Straight • Wavy 	No cost +\$1904	Specify with <i>straight slat scheme</i> . Specify with <i>wavy slat scheme</i> .
Specification Information			
• Style Number	• U.S. Base Price		
OB1HACK09	\$12,998		



For Canadian Pricing
Multiply U.S. Price by the Canadian price factor.
▶ See page 1 for details.

92" Around Corner, Wood Slat

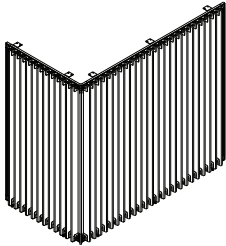

Tip: Hacking cannot cover door or share wall with cabin, kink, or awning.

Standard Includes		Required to Specify
▶ Need help? Product details, page 29	<ul style="list-style-type: none"> • Straight slats: poplar plywood • Frame: 7207 Black 	1 Style number 2 Options, if selected (see below) ▶ See Product Understanding for Surface Materials.

Options	U.S. Price	Required to Specify
Slat Scheme		
<ul style="list-style-type: none"> • Straight • Wavy 	No cost +\$2686	Specify with <i>straight slat scheme</i> . Specify with <i>wavy slat scheme</i> .

Specification Information	
Style Number	U.S. Base Price
OB1HACK10	\$19,117

Specifying

119" Up to Corner, Wood Slat

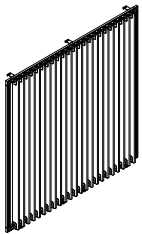

Tip: Hacking cannot cover door or share wall with cabin, kink, or awning.

Standard Includes		Required to Specify
▶ Need help? Product details, page 29	<ul style="list-style-type: none"> • Straight slats: poplar plywood • Frame: 7207 Black 	1 Style number 2 Options, if selected (see below) ▶ See Product Understanding for Surface Materials.

Options	U.S. Price	Required to Specify
Slat Scheme		
<ul style="list-style-type: none"> • Straight • Wavy 	No cost +\$1878	Specify with <i>straight slat scheme</i> . Specify with <i>wavy slat scheme</i> .

Specification Information	
Style Number	U.S. Base Price
OB1HACK11	\$13,061

 **For Canadian Pricing**
 Multiply U.S. Price by the Canadian price factor.
 ▶ See page 1 for details.

119" Full Depth, Wood Slat

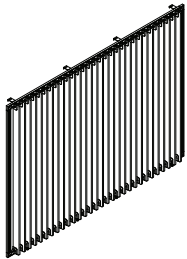

Tip: Hacking cannot cover door or share wall with cabin, kink, or awning.

Standard Includes		Required to Specify
▶ Need help? Product details, page 29	<ul style="list-style-type: none"> • Straight slats: poplar plywood • Frame: 7207 Black 	1 Style number 2 Options, if selected (see below) ▶ See Product Understanding for Surface Materials.

Options	U.S. Price	Required to Specify
Slat Scheme		
<ul style="list-style-type: none"> • Straight • Wavy 	No cost +\$2312	Specify with <i>straight slat scheme</i> . Specify with <i>wavy slat scheme</i> .

Specification Information	
• Style Number	• U.S. Base Price
OB1HACK12	\$15,052

119" Around Corner, Wood Slat

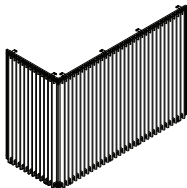

Tip: Hacking cannot cover door or share wall with cabin, kink, or awning.

Standard Includes		Required to Specify
▶ Need help? Product details, page 29	<ul style="list-style-type: none"> • Straight slats: poplar plywood • Frame: 7207 Black 	1 Style number 2 Options, if selected (see below) ▶ See Product Understanding for Surface Materials.

Options	U.S. Price	Required to Specify
Slat Scheme		
<ul style="list-style-type: none"> • Straight • Wavy 	No cost +\$3088	Specify with <i>straight slat scheme</i> . Specify with <i>wavy slat scheme</i> .

Specification Information	
• Style Number	• U.S. Base Price
OB1HACK13	\$21,091



For Canadian Pricing
 Multiply U.S. Price by the Canadian price factor.
 ▶ See page 1 for details.

Wall Mounted Table, Small

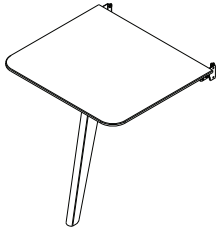

Standard Includes		Required to Specify
<ul style="list-style-type: none"> ▶ Need help? Product details, page 30 	<ul style="list-style-type: none"> • Table: 24$\frac{1}{2}$"D x 28$\frac{3}{4}$"W x 29$\frac{3}{8}$"H • Edge: plastic price group 1 • Top: laminate price group 1 • Leg: V3AK Natural Oak or VP03 Black Oak 	<ol style="list-style-type: none"> 1 Style number 2 Laminate color number for top 3 Plastic color number for edge 4 Wood color number for leg 5 Options, if selected (see below) <ul style="list-style-type: none"> ▶ See Product Understanding for Surface Materials.

Options	U.S. Price	Required to Specify
Top		
• High-Pressure Laminate price group 1	No cost	Specify laminate color number.
• High-Pressure Laminate price group 2	+\$497	Specify laminate color number.
• High-Pressure Laminate price group 3	+\$750	Specify laminate color number.
• Open Line laminate (OLL)	+\$111 plus cost of laminate	▶ See <i>Surface Materials Reference Manual</i> .

Specification Information

Style Number	U.S. Base Price
OB1CDWT01	\$2953

Specifying

Wall Mounted Table, Medium

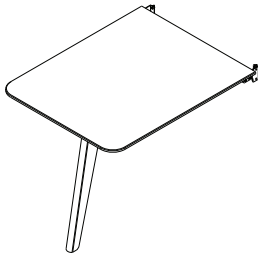

Standard Includes		Required to Specify
<ul style="list-style-type: none"> ▶ Need help? Product details, page 30 	<ul style="list-style-type: none"> • Table: 35$\frac{1}{2}$"D x 28$\frac{3}{4}$"W x 29$\frac{3}{8}$"H • Edge: plastic price group 1 • Top: laminate price group 1 • Leg: V3AK Natural Oak or VP03 Black Oak 	<ol style="list-style-type: none"> 1 Style number 2 Laminate color number for top 3 Plastic color number for edge 4 Wood color number for leg 5 Options, if selected (see below) <ul style="list-style-type: none"> ▶ See Product Understanding for Surface Materials.

Options	U.S. Price	Required to Specify
Top		
• High-Pressure Laminate price group 1	No cost	Specify laminate color number.
• High-Pressure Laminate price group 2	+\$ 842	Specify laminate color number.
• High-Pressure Laminate price group 3	+\$1253	Specify laminate color number.
• Open Line laminate (OLL)	+\$ 111 plus cost of laminate	▶ See <i>Surface Materials Reference Manual</i> .

Specification Information

Style Number	U.S. Base Price
OB1CDWT02	\$3193

 **For Canadian Pricing**
 Multiply U.S. Price by the Canadian price factor.
 ▶ See page 1 for details.

Monitor Brackets and Kits

CD Seismic/Bracing Kit

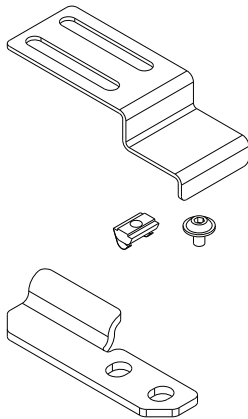

Standard Includes	Required to Specify
<ul style="list-style-type: none"> ▶ Need help? Product details, page 30 • CD seismic/bracing kit 	Style number

Specification Information

Style Number	U.S. Price
OB1CDSBK	\$605

Hoop Mounted Monitor Bracket

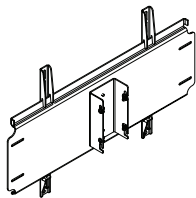

Standard Includes	Required to Specify
<ul style="list-style-type: none"> ▶ Need help? Product details, page 30 • Hoop mounted monitor bracket 	Style number

Specification Information

Style Number	U.S. Price
OB1CDHMMBS	\$487

Off Hoop Mounted Monitor Bracket

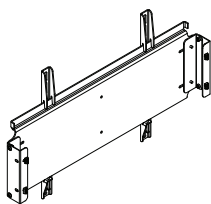

Standard Includes	Required to Specify
<ul style="list-style-type: none"> ▶ Need help? Product details, page 30 • Off hoop mounted monitor bracket 	Style number

Specification Information

Style Number	U.S. Price
OB1CDFHMB	\$487



For Canadian Pricing
 Multiply U.S. Price by the Canadian price factor.
 ▶ See page 1 for details.

Panel Seam Mounted Monitor Bracket

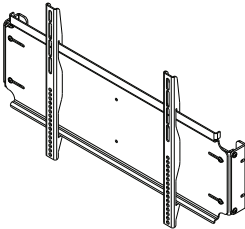

Standard Includes	Required to Specify
<ul style="list-style-type: none"> ▶ Need help? Product details, page 30 • Panel seam mounted monitor bracket 	<ul style="list-style-type: none"> Style number

Specification Information	
Style Number	U.S. Price
OB1CDPSMB	\$486

Hoop or Seam Mounted Conferencing Device Bracket

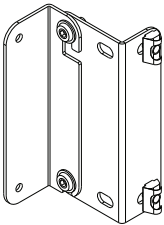

Standard Includes	Required to Specify
<ul style="list-style-type: none"> ▶ Need help? Product details, page 30 • Hoop or seam mounted conferencing device bracket 	<ul style="list-style-type: none"> Style number

Specification Information	
Style Number	U.S. Price
OB1CDHSMB	\$325

CD Sprinkler Fit Kit

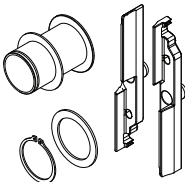

Standard Includes	Required to Specify
<ul style="list-style-type: none"> ▶ Need help? Product details, page 30 • CD sprinkler fit kit 	<ul style="list-style-type: none"> Style number

Specification Information	
Style Number	U.S. Price
OB1CDSPRNK	\$246

For Canadian Pricing
 Multiply U.S. Price by the Canadian price factor.
 ▶ See page 1 for details.

Single Upholstered Seat

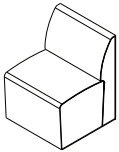

Tip: This is not a standalone unit. Only for use in Campers & Dens.

Standard Includes		Required to Specify
▶ Need help? Product details, page 31	• Fully upholstered seating unit: fabric price group 1	1 Style number 2 Fabric color number for seat 3 Options, if selected (see below) ▶ See Product Understanding for Surface Materials.

Options	U.S. Price	Required to Specify
Upholstery Scheme	• Non contrasting No cost • Contrasting +\$ 149	Specify <i>with non contrasting</i> . Specify <i>with contrasting</i> .
Upholstery Non Contrasting	• Customer's Own Material (COM) No cost • Fabric price group 1 No cost • Fabric price group 2 +\$ 158 • Fabric price group 3 +\$ 413 • Fabric price group 4 +\$ 555 • Fabric price group 5 +\$ 652 • Fabric price group 6 +\$ 793 • Fabric price group 7 +\$ 978 • Fabric price group 8 +\$1190 • Fabric price group 9 +\$1475 • Fabric price group 10 +\$1701	▶ See <i>Surface Materials Reference Manual</i> . Specify fabric color number. Specify fabric color number. Specify fabric color number. Specify fabric color number. Specify fabric color number. Specify fabric color number. Specify fabric color number. Specify fabric color number. Specify fabric color number. Specify fabric color number.
Seat Contrasting	• Customer's Own Material (COM) No cost • Fabric price group 1 No cost • Fabric price group 2 +\$ 62 • Fabric price group 3 +\$ 164 • Fabric price group 4 +\$ 222 • Fabric price group 5 +\$ 260 • Fabric price group 6 +\$ 314 • Fabric price group 7 +\$ 391 • Fabric price group 8 +\$ 477 • Fabric price group 9 +\$ 589 • Fabric price group 10 +\$ 679	▶ See <i>Surface Materials Reference Manual</i> . Specify fabric color number. Specify fabric color number. Specify fabric color number. Specify fabric color number. Specify fabric color number. Specify fabric color number. Specify fabric color number. Specify fabric color number. Specify fabric color number. Specify fabric color number.
Backrest Outer Contrasting	• Customer's Own Material (COM) No cost • Fabric price group 1 No cost • Fabric price group 2 +\$ 56 • Fabric price group 3 +\$ 143 • Fabric price group 4 +\$ 195 • Fabric price group 5 +\$ 228 • Fabric price group 6 +\$ 277 • Fabric price group 7 +\$ 345 • Fabric price group 8 +\$ 418 • Fabric price group 9 +\$ 515 • Fabric price group 10 +\$ 595	▶ See <i>Surface Materials Reference Manual</i> . Specify fabric color number. Specify fabric color number. Specify fabric color number. Specify fabric color number. Specify fabric color number. Specify fabric color number. Specify fabric color number. Specify fabric color number. Specify fabric color number. Specify fabric color number.
Backrest Inner Contrasting	• Customer's Own Material (COM) No cost • Fabric price group 1 No cost • Fabric price group 2 +\$ 39 • Fabric price group 3 +\$ 103 • Fabric price group 4 +\$ 137 • Fabric price group 5 +\$ 162 • Fabric price group 6 +\$ 198 • Fabric price group 7 +\$ 246 • Fabric price group 8 +\$ 300 • Fabric price group 9 +\$ 368 • Fabric price group 10 +\$ 426	▶ See <i>Surface Materials Reference Manual</i> . Specify fabric color number. Specify fabric color number. Specify fabric color number. Specify fabric color number. Specify fabric color number. Specify fabric color number. Specify fabric color number. Specify fabric color number. Specify fabric color number. Specify fabric color number.

Specification Information	
Style Number	U.S. Base Price
OB1CDUS01	\$3368

 **For Canadian Pricing**
Multiply U.S. Price by the Canadian price factor.
▶ See page 1 for details.

Double Upholstered Seat

Double Upholstered Seat

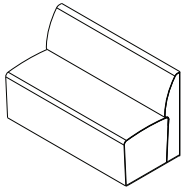

Tip: This is not a standalone unit. Only for use in Campers & Dens.

Standard Includes		Required to Specify
▶ Need help? Product details, page 31	• Fully upholstered seating unit: fabric price group 1	1 Style number 2 Fabric color number for seat 3 Options, if selected (see below) ▶ See Product Understanding for Surface Materials.

Options	U.S. Price	Required to Specify
Upholstery Scheme	• Non contrasting No cost • Contrasting +\$ 149	Specify with non contrasting. Specify with contrasting.
Upholstery Non Contrasting	• Customer's Own Material (COM) No cost • Fabric price group 1 No cost • Fabric price group 2 +\$ 277 • Fabric price group 3 +\$ 721 • Fabric price group 4 +\$ 972 • Fabric price group 5 +\$1142 • Fabric price group 6 +\$1388 • Fabric price group 7 +\$1711 • Fabric price group 8 +\$2084 • Fabric price group 9 +\$2579 • Fabric price group 10 +\$2979	▶ See <i>Surface Materials Reference Manual</i> . Specify fabric color number. Specify fabric color number. Specify fabric color number. Specify fabric color number. Specify fabric color number. Specify fabric color number. Specify fabric color number. Specify fabric color number. Specify fabric color number. Specify fabric color number.
Seat Contrasting	• Customer's Own Material (COM) No cost • Fabric price group 1 No cost • Fabric price group 2 +\$ 118 • Fabric price group 3 +\$ 310 • Fabric price group 4 +\$ 419 • Fabric price group 5 +\$ 490 • Fabric price group 6 +\$ 595 • Fabric price group 7 +\$ 735 • Fabric price group 8 +\$ 896 • Fabric price group 9 +\$1108 • Fabric price group 10 +\$1282	▶ See <i>Surface Materials Reference Manual</i> . Specify fabric color number. Specify fabric color number. Specify fabric color number. Specify fabric color number. Specify fabric color number. Specify fabric color number. Specify fabric color number. Specify fabric color number. Specify fabric color number. Specify fabric color number.
Backrest Outer Contrasting	• Customer's Own Material (COM) No cost • Fabric price group 1 No cost • Fabric price group 2 +\$ 104 • Fabric price group 3 +\$ 273 • Fabric price group 4 +\$ 371 • Fabric price group 5 +\$ 433 • Fabric price group 6 +\$ 525 • Fabric price group 7 +\$ 652 • Fabric price group 8 +\$ 792 • Fabric price group 9 +\$ 979 • Fabric price group 10 +\$1132	▶ See <i>Surface Materials Reference Manual</i> . Specify fabric color number. Specify fabric color number. Specify fabric color number. Specify fabric color number. Specify fabric color number. Specify fabric color number. Specify fabric color number. Specify fabric color number. Specify fabric color number. Specify fabric color number.
Backrest Inner Contrasting	• Customer's Own Material (COM) No cost • Fabric price group 1 No cost • Fabric price group 2 +\$ 52 • Fabric price group 3 +\$ 133 • Fabric price group 4 +\$ 181 • Fabric price group 5 +\$ 211 • Fabric price group 6 +\$ 257 • Fabric price group 7 +\$ 326 • Fabric price group 8 +\$ 384 • Fabric price group 9 +\$ 478 • Fabric price group 10 +\$ 550	▶ See <i>Surface Materials Reference Manual</i> . Specify fabric color number. Specify fabric color number. Specify fabric color number. Specify fabric color number. Specify fabric color number. Specify fabric color number. Specify fabric color number. Specify fabric color number. Specify fabric color number. Specify fabric color number.

Specification Information	
Style Number	U.S. Base Price
OB1CDUS02	\$5172

 **For Canadian Pricing**
Multiply U.S. Price by the Canadian price factor.
▶ See page 1 for details.

On the QT Phone Short Angled Phone Booth

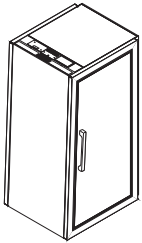

	Standard Includes	Required to Specify
▶ Need help? Product details, page 36	<ul style="list-style-type: none"> • Frame assembly: <ul style="list-style-type: none"> – aluminum framework – acoustic wall cassettes – roof and floor panels (black) • Interior cladding: PET • Carpet • One set of framed laminated glass, door, and wall • One solid oak door handle • Two laminate cladding exterior walls: High-Pressure Laminate price group 1 • Cover cap: paint • Two pressed felt interior cladding walls • Integrated lighting and air ventilation, with motion sensor 	<ol style="list-style-type: none"> 1 Style number 2 High-Pressure Laminate color number for walls 3 Wood color number for door handle 4 Paint color number for cover cap 5 PET color number for interior cladding 6 Options, if selected (see below) <p>▶ See Product Understanding for Surface Materials.</p>

	Options	U.S. Price	Required to Specify
Front Exterior Cladding	<ul style="list-style-type: none"> • Laminate • Painted metal • Whiteboard • Fabric • Plywood 	<ul style="list-style-type: none"> No cost +\$ 209 +\$ 704 +\$1110 +\$1440 	<ul style="list-style-type: none"> Specify with <i>laminate</i>. Specify with <i>painted metal</i>. Specify with <i>whiteboard</i>. Specify with <i>fabric</i>. Specify with <i>plywood</i>.
Front Exterior Cladding Finish	<ul style="list-style-type: none"> • Customer's Own Material (COM) • Fabric price group 1 • High-Pressure Laminate price group 1 • Markerboard price group 1 • Paint price group 1 • Plywood price group 1 • Fabric price group 2 • Fabric price group 3 • Paint price group 2 • High-Pressure Laminate price group 2 • Fabric price group 4 • Paint price group 3 • Fabric price group 5 • High-Pressure Laminate price group 3 • Fabric price group 6 • Fabric price group 7 • Fabric price group 8 • Fabric price group 9 • Fabric price group 10 • Open Line laminate (OLL) 	<ul style="list-style-type: none"> No cost No cost No cost No cost No cost No cost +\$ 42 +\$ 78 +\$ 78 +\$ 95 +\$ 121 +\$ 127 +\$ 188 +\$ 202 +\$ 260 +\$ 329 +\$ 398 +\$ 477 +\$ 551 +\$ 111 	<ul style="list-style-type: none"> ▶ See <i>Surface Materials Reference Manual</i>. Specify fabric color number. Specify laminate color number. Specify markerboard color number. Specify paint color number. Specify plywood color number. Specify fabric color number. Specify fabric color number. Specify fabric color number. Specify paint color number. Specify laminate color number. Specify fabric color number. Specify paint color number. Specify fabric color number. Specify laminate color number. Specify fabric color number. Specify fabric color number. Specify fabric color number. Specify fabric color number. Specify fabric color number. ▶ See <i>Surface Materials Reference Manual</i>.
Rear Exterior Cladding	<ul style="list-style-type: none"> • Laminate • Painted metal • Whiteboard • Fabric • Plywood 	<ul style="list-style-type: none"> No cost +\$ 209 +\$ 704 +\$1110 +\$1440 	<ul style="list-style-type: none"> Specify with <i>laminate</i>. Specify with <i>painted metal</i>. Specify with <i>whiteboard</i>. Specify with <i>fabric</i>. Specify with <i>plywood</i>.
Rear Exterior Cladding Finish	<ul style="list-style-type: none"> • Customer's Own Material (COM) • Fabric price group 1 • High-Pressure Laminate price group 1 • Markerboard price group 1 • Paint price group 1 • Plywood price group 1 • Fabric price group 2 • Fabric price group 3 • Paint price group 2 • High-Pressure Laminate price group 2 	<ul style="list-style-type: none"> No cost No cost No cost No cost No cost No cost +\$ 42 +\$ 78 +\$ 78 +\$ 95 	<ul style="list-style-type: none"> ▶ See <i>Surface Materials Reference Manual</i>. Specify fabric color number. Specify laminate color number. Specify markerboard color number. Specify paint color number. Specify plywood color number. Specify fabric color number. Specify fabric color number. Specify fabric color number. Specify paint color number. Specify laminate color number.

▶ Options, continued on next page



For Canadian Pricing
Multiply U.S. Price by the Canadian price factor.
▶ See page 1 for details.

► Options, continued from previous page

Options	U.S. Price	Required to Specify
Rear Exterior Cladding Finish, continued	<ul style="list-style-type: none"> Fabric price group 4 +\$121 Paint price group 3 +\$127 Fabric price group 5 +\$188 High-Pressure Laminate price group 3 +\$202 Fabric price group 6 +\$260 Fabric price group 7 +\$329 Fabric price group 8 +\$398 Fabric price group 9 +\$477 Fabric price group 10 +\$551 Open Line laminate (OLL) +\$111 	<ul style="list-style-type: none"> Specify fabric color number. Specify paint color number. Specify fabric color number. Specify laminate color number. Specify fabric color number. Specify fabric color number. Specify fabric color number. Specify fabric color number. Specify fabric color number. Specify fabric color number. ► See <i>Surface Materials Reference Manual</i> plus cost of laminate
Cover Cap	<ul style="list-style-type: none"> Paint price group 1 No cost Paint price group 2 +\$ 59 Paint price group 3 +\$120 	<ul style="list-style-type: none"> Specify paint color number. Specify paint color number. Specify paint color number.
Lean Pad	<ul style="list-style-type: none"> No lean pad No cost Lean pad +\$967 	<ul style="list-style-type: none"> Specify <i>with no lean pad</i>. Specify <i>with lean pad</i>.
Lean Pad Finish	<ul style="list-style-type: none"> Customer's Own Material (COM) No cost Fabric price group 1 No cost Fabric price group 2 +\$ 26 Vinyl price group 2 +\$ 26 Fabric price group 3 +\$ 51 Fabric price group 4 +\$ 88 Fabric price group 5 +\$145 Fabric price group 6 +\$202 Fabric price group 7 +\$274 Fabric price group 8 +\$342 Fabric price group 9 +\$398 Fabric price group 10 +\$474 	<ul style="list-style-type: none"> ► See <i>Surface Materials Reference Manual</i>. Specify fabric color number. Specify fabric color number. Specify vinyl color number. Specify fabric color number. Specify fabric color number. Specify fabric color number. Specify fabric color number. Specify fabric color number. Specify fabric color number. Specify fabric color number. Specify fabric color number.
Screen	<ul style="list-style-type: none"> No screen No cost Privacy screen +\$742 	<ul style="list-style-type: none"> Specify <i>with no screen</i>. Specify <i>with privacy screen</i>.
Screen Finish	<ul style="list-style-type: none"> Customer's Own Material (COM) No cost Fabric price group 1 No cost Fabric price group 2 +\$ 26 Vinyl price group 2 +\$ 26 Fabric price group 3 +\$ 51 Fabric price group 4 +\$ 88 Fabric price group 5 +\$145 Fabric price group 6 +\$202 Fabric price group 7 +\$274 Fabric price group 8 +\$342 Fabric price group 9 +\$398 Fabric price group 10 +\$474 	<ul style="list-style-type: none"> ► See <i>Surface Materials Reference Manual</i>. Specify fabric color number. Specify fabric color number. Specify vinyl color number. Specify fabric color number. Specify fabric color number. Specify fabric color number. Specify fabric color number. Specify fabric color number. Specify fabric color number. Specify fabric color number. Specify fabric color number.
Power Plug	<ul style="list-style-type: none"> Hardwire No cost Type B No cost 	<ul style="list-style-type: none"> Specify <i>with hardwire</i>. Specify <i>with type B power plug</i>.
Power Outlet	<ul style="list-style-type: none"> No power outlet No cost Type B No cost 	<ul style="list-style-type: none"> Specify <i>with no power outlet</i>. Specify <i>with type B power plug</i>.
Power Configuration	<ul style="list-style-type: none"> QT 2 power 1 USB A+C +\$279 	<ul style="list-style-type: none"> Specify <i>with QT 2 power 1 USB A+C</i>.
Light	<ul style="list-style-type: none"> No light No cost Occupancy light +\$405 	<ul style="list-style-type: none"> Specify <i>with no light</i>. Specify <i>with occupancy light</i>.
Seismic Kit	<ul style="list-style-type: none"> No kit No cost Seismic kit +\$788 	<ul style="list-style-type: none"> Specify <i>with no seismic kit</i>. Specify <i>with seismic kit</i>.
Shelf	<ul style="list-style-type: none"> No shelf No cost With shelf +\$394 	<ul style="list-style-type: none"> Specify <i>with no shelf</i>. Specify <i>with shelf</i>.

Specifying

Tip: "Type B" is the standard North American NEMA 5-15 plug.

 **For Canadian Pricing**
Multiply U.S. Price by the Canadian price factor.
► See page 1 for details.

► Options, continued on next page

► Options, continued from previous page

	Options	U.S. Price	Required to Specify
Shelf Finish	• High-Pressure Laminate price group 1	No cost	Specify laminate color number.
	• High-Pressure Laminate price group 2	+\$ 82	Specify laminate color number.
	• High-Pressure Laminate price group 3	+\$167	Specify laminate color number.
	• Open Line laminate (OLL)	+\$111 plus cost of laminate	► See <i>Surface Materials Reference Manual</i> .

Specification Information

Style Number	U.S. Base Price

Short Angled Phone Booth, Left-Hand Hinge

OB1QT01	\$22,516

Short Angled Phone Booth, Right-Hand Hinge

OB1QT02	\$22,516

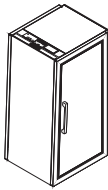
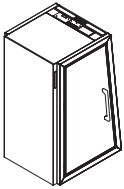

For Canadian Pricing

Multiply U.S. Price by the Canadian price factor.

► See page 1 for details.

On the QT Tall Angled Phone Booth

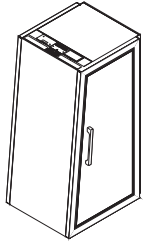

	Standard Includes	Required to Specify
▶ Need help? Product details, page 36	<ul style="list-style-type: none"> Frame assembly: <ul style="list-style-type: none"> – aluminum framework – acoustic wall cassettes – roof and floor panels (black) Carpet One set of framed laminated glass, door, and wall One solid oak door handle Two laminate cladding exterior walls: High-Pressure Laminate price group 1 Cover cap: paint Two pressed felt interior cladding walls Integrated lighting and air ventilation, with motion sensor 	<ol style="list-style-type: none"> Style number High-Pressure Laminate color number for walls Wood color number for door handle Paint color number for cover cap Options, if selected (see below) <p>▶ See Product Understanding for Surface Materials.</p>

	Options	U.S. Price	Required to Specify
Front Exterior Cladding	<ul style="list-style-type: none"> Laminate Painted metal Whiteboard Fabric Plywood 	<ul style="list-style-type: none"> No cost +\$ 271 +\$ 802 +\$1205 +\$1564 	<ul style="list-style-type: none"> Specify with laminate. Specify with painted metal. Specify with whiteboard. Specify with fabric. Specify with plywood.
Front Exterior Cladding Finish	<ul style="list-style-type: none"> Customer's Own Material (COM) Fabric price group 1 High-Pressure Laminate price group 1 Markerboard price group 1 Paint price group 1 Plywood price group 1 Fabric price group 2 Fabric price group 3 Paint price group 2 High-Pressure Laminate price group 2 Fabric price group 4 Paint price group 3 Fabric price group 5 High-Pressure Laminate price group 3 Fabric price group 6 Fabric price group 7 Fabric price group 8 Fabric price group 9 Fabric price group 10 Open Line laminate (OLL) 	<ul style="list-style-type: none"> No cost No cost No cost No cost No cost No cost +\$ 47 +\$ 78 +\$ 92 +\$ 116 +\$ 129 +\$ 156 +\$ 202 +\$ 242 +\$ 274 +\$ 346 +\$ 421 +\$ 503 +\$ 586 +\$ 111 plus cost of laminate 	<ul style="list-style-type: none"> ▶ See <i>Surface Materials Reference Manual</i>. Specify fabric color number. Specify laminate color number. Specify markerboard color number. Specify paint color number. Specify plywood color number. Specify fabric color number. Specify fabric color number. Specify paint color number. Specify laminate color number. Specify fabric color number. Specify paint color number. Specify fabric color number. Specify laminate color number. Specify fabric color number. Specify fabric color number. Specify fabric color number. Specify fabric color number. Specify fabric color number. ▶ See <i>Surface Materials Reference Manual</i>.
Rear Exterior Cladding	<ul style="list-style-type: none"> Laminate Painted metal Whiteboard Fabric Plywood 	<ul style="list-style-type: none"> No cost +\$ 271 +\$ 802 +\$1205 +\$1564 	<ul style="list-style-type: none"> Specify with laminate. Specify with painted metal. Specify with whiteboard. Specify with fabric. Specify with plywood.
Rear Exterior Cladding Finish	<ul style="list-style-type: none"> Customer's Own Material (COM) Fabric price group 1 High-Pressure Laminate price group 1 Markerboard price group 1 Paint price group 1 Plywood price group 1 Fabric price group 2 Fabric price group 3 Paint price group 2 High-Pressure Laminate price group 2 Fabric price group 4 Paint price group 3 Fabric price group 5 	<ul style="list-style-type: none"> No cost No cost No cost No cost No cost No cost +\$ 47 +\$ 81 +\$ 92 +\$ 116 +\$ 129 +\$ 156 +\$ 202 	<ul style="list-style-type: none"> ▶ See <i>Surface Materials Reference Manual</i>. Specify fabric color number. Specify laminate color number. Specify markerboard color number. Specify paint color number. Specify plywood color number. Specify fabric color number. Specify fabric color number. Specify paint color number. Specify laminate color number. Specify fabric color number. Specify paint color number. Specify fabric color number.

▶ Options, continued on next page

 **For Canadian Pricing**
Multiply U.S. Price by the Canadian price factor.
▶ See page 1 for details.

► Options, continued from previous page

Options	U.S. Price	Required to Specify
Rear Exterior Cladding Finish, continued	<ul style="list-style-type: none"> High-Pressure Laminate price group 3 +\$242 Fabric price group 6 +\$274 Fabric price group 7 +\$346 Fabric price group 8 +\$421 Fabric price group 9 +\$503 Fabric price group 10 +\$586 Open Line laminate (OLL) +\$111 plus cost of laminate 	<ul style="list-style-type: none"> Specify laminate color number. Specify fabric color number. Specify fabric color number. Specify fabric color number. Specify fabric color number. Specify fabric color number. ► See <i>Surface Materials Reference Manual</i>.
Cover Cap	<ul style="list-style-type: none"> Paint price group 1 No cost Paint price group 2 +\$ 80 Paint price group 3 +\$152 	<ul style="list-style-type: none"> Specify paint color number. Specify paint color number. Specify paint color number.
Lean Pad	<ul style="list-style-type: none"> No lean pad No cost Lean pad +\$967 	<ul style="list-style-type: none"> Specify <i>with no lean pad</i>. Specify <i>with lean pad</i>.
Lean Pad Finish	<ul style="list-style-type: none"> Customer's Own Material (COM) No cost Fabric price group 1 No cost Fabric price group 2 +\$ 26 Vinyl price group 2 +\$ 26 Fabric price group 3 +\$ 51 Fabric price group 4 +\$ 88 Fabric price group 5 +\$145 Fabric price group 6 +\$202 Fabric price group 7 +\$274 Fabric price group 8 +\$342 Fabric price group 9 +\$398 Fabric price group 10 +\$474 	<ul style="list-style-type: none"> ► See <i>Surface Materials Reference Manual</i>. Specify fabric color number. Specify fabric color number. Specify vinyl color number. Specify fabric color number. Specify fabric color number. Specify fabric color number. Specify fabric color number. Specify fabric color number. Specify fabric color number. Specify fabric color number. Specify fabric color number.
Screen	<ul style="list-style-type: none"> No screen No cost Privacy screen +\$742 	<ul style="list-style-type: none"> Specify <i>with no screen</i>. Specify <i>with privacy screen</i>.
Screen Finish	<ul style="list-style-type: none"> Customer's Own Material (COM) No cost Fabric price group 1 No cost Fabric price group 2 +\$ 26 Vinyl price group 2 +\$ 26 Fabric price group 3 +\$ 51 Fabric price group 4 +\$ 88 Fabric price group 5 +\$145 Fabric price group 6 +\$202 Fabric price group 7 +\$274 Fabric price group 8 +\$342 Fabric price group 9 +\$398 Fabric price group 10 +\$474 	<ul style="list-style-type: none"> ► See <i>Surface Materials Reference Manual</i>. Specify fabric color number. Specify fabric color number. Specify vinyl color number. Specify fabric color number. Specify fabric color number. Specify fabric color number. Specify fabric color number. Specify fabric color number. Specify fabric color number. Specify fabric color number. Specify fabric color number.
Power Plug Type	<ul style="list-style-type: none"> Hardwire No cost Type B No cost 	<ul style="list-style-type: none"> Specify <i>with hardwire</i>. Specify <i>with type B power plug</i>.
Power Outlet Type	<ul style="list-style-type: none"> No power outlet No cost Type B No cost 	<ul style="list-style-type: none"> Specify <i>with no power outlet</i>. Specify <i>with type B power plug</i>.
Power Configuration	<ul style="list-style-type: none"> QT 2 power 1 USB A+C +\$279 	<ul style="list-style-type: none"> Specify <i>with QT 2 power 1 USB A+C</i>.
Light	<ul style="list-style-type: none"> No light No cost Occupancy light +\$405 	<ul style="list-style-type: none"> Specify <i>with no light</i>. Specify <i>with occupancy light</i>.
Seismic Kit	<ul style="list-style-type: none"> No kit No cost Seismic kit +\$788 	<ul style="list-style-type: none"> Specify <i>with no seismic kit</i>. Specify <i>with seismic kit</i>.
Shelf	<ul style="list-style-type: none"> No shelf No cost With shelf +\$394 With L-shelf +\$447 	<ul style="list-style-type: none"> Specify <i>with no shelf</i>. Specify <i>with shelf</i>. Specify <i>with L-shelf</i>.

Tip: "Type B" is the standard North American NEMA 5-15 plug.



For Canadian Pricing
Multiply U.S. Price by the Canadian price factor.
► See page 1 for details.

► Options, continued from previous page

	Options	U.S. Price	Required to Specify
Shelf Finish	• High-Pressure Laminate price group 1	No cost	Specify laminate color number.
	• High-Pressure Laminate price group 2	+\$ 82	Specify laminate color number.
	• High-Pressure Laminate price group 3	+\$167	Specify laminate color number.
	• Open Line laminate (OLL)	+\$111 plus cost of laminate	► See <i>Surface Materials Reference Manual</i> .

Specification Information

Style Number	U.S. Base Price

Tall Angled Phone Booth, Left Hand Hinge

OB1QT03	\$22,641

Tall Angled Phone Booth, Right Hand Hinge

OB1QT04	\$22,641

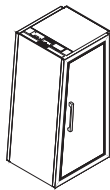
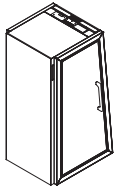

For Canadian Pricing

Multiply U.S. Price by the Canadian price factor.

► See page 1 for details.



On the QT Furniture Seating

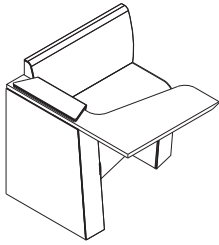

Tip: (OB1QTF01) and (OB1QTF02) are not standalone units and are only for use in On the QT phone booths.

Tip: If contrasting is selected seat, back, arm, and arm pad become selectable.

Standard Includes	Required to Specify
<ul style="list-style-type: none"> ▶ Need help? Product details, page 36 Fully upholstered seating unit: fabric price group 1 1" thick integrated tablet: High-Pressure Laminate price group 1 with 3 mm plastic edge 	<ol style="list-style-type: none"> 1 Style number 2 Fabric color number for seating unit 3 High-Pressure Laminate color number for tablet 4 Plastic color number for tablet edge 5 Options, if selected (see below) <ul style="list-style-type: none"> ▶ See Product Understanding for Surface Materials.

Options	U.S. Price	Required to Specify
Color Scheme <ul style="list-style-type: none"> • Non contrasting No cost • Contrasting +\$111 		Specify with non contrasting. Specify with contrasting.
Surface Materials	Upholstery <ul style="list-style-type: none"> • Customer's Own Material (COM) No cost • Fabric price group 1 No cost • Fabric price group 2 +\$ 91 • Vinyl price group 2 +\$ 91 • Fabric price group 3 +\$241 • Fabric price group 4 +\$326 • Fabric price group 5 +\$381 • Fabric price group 6 +\$463 • Fabric price group 7 +\$572 • Fabric price group 8 +\$694 • Fabric price group 9 +\$862 • Fabric price group 10 +\$993 	<ul style="list-style-type: none"> ▶ See Surface Materials Reference Manual. Specify fabric color number. Specify fabric color number. Specify vinyl color number. Specify fabric color number. Specify fabric color number. Specify fabric color number. Specify fabric color number. Specify fabric color number. Specify fabric color number. Specify fabric color number.
Seat <ul style="list-style-type: none"> • Customer's Own Material (COM) No cost • Fabric price group 1 No cost • Fabric price group 2 +\$ 26 • Vinyl price group 2 +\$ 26 • Fabric price group 3 +\$ 66 • Fabric price group 4 +\$ 89 • Fabric price group 5 +\$104 • Fabric price group 6 +\$127 • Fabric price group 7 +\$156 • Fabric price group 8 +\$188 • Fabric price group 9 +\$234 • Fabric price group 10 +\$270 		<ul style="list-style-type: none"> ▶ See Surface Materials Reference Manual. Specify fabric color number. Specify fabric color number. Specify vinyl color number. Specify fabric color number. Specify fabric color number. Specify fabric color number. Specify fabric color number. Specify fabric color number. Specify fabric color number. Specify fabric color number.
Back <ul style="list-style-type: none"> • Customer's Own Material (COM) No cost • Fabric price group 1 No cost • Fabric price group 2 +\$ 17 • Vinyl price group 2 +\$ 17 • Fabric price group 3 +\$ 42 • Fabric price group 4 +\$ 59 • Fabric price group 5 +\$ 69 • Fabric price group 6 +\$ 84 • Fabric price group 7 +\$104 • Fabric price group 8 +\$127 • Fabric price group 9 +\$156 • Fabric price group 10 +\$179 		<ul style="list-style-type: none"> ▶ See Surface Materials Reference Manual. Specify fabric color number. Specify fabric color number. Specify vinyl color number. Specify fabric color number. Specify fabric color number. Specify fabric color number. Specify fabric color number. Specify fabric color number. Specify fabric color number. Specify fabric color number.
Arm <ul style="list-style-type: none"> • Customer's Own Material (COM) No cost • Fabric price group 1 No cost • Fabric price group 2 +\$ 34 • Vinyl price group 2 +\$ 34 • Fabric price group 3 +\$ 88 • Fabric price group 4 +\$117 • Fabric price group 5 +\$139 • Fabric price group 6 +\$168 • Fabric price group 7 +\$209 • Fabric price group 8 +\$253 • Fabric price group 9 +\$311 • Fabric price group 10 +\$362 		<ul style="list-style-type: none"> ▶ See Surface Materials Reference Manual. Specify fabric color number. Specify fabric color number. Specify vinyl color number. Specify fabric color number. Specify fabric color number. Specify fabric color number. Specify fabric color number. Specify fabric color number. Specify fabric color number. Specify fabric color number.

▶ Options, continued on next page



For Canadian Pricing
Multiply U.S. Price by the Canadian price factor.

▶ See page 1 for details.

► Options, continued from previous page

	Options	U.S. Price	Required to Specify
Surface Materials, continued	Arm pad		
	• Customer's Own Material (COM)	No cost	► See <i>Surface Materials Reference Manual</i> .
	• Fabric price group 1	No cost	Specify fabric color number.
	• Fabric price group 2	+\$ 17	Specify fabric color number.
	• Vinyl price group 2	+\$ 17	Specify vinyl color number.
	• Fabric price group 3	+\$ 42	Specify fabric color number.
	• Fabric price group 4	+\$ 59	Specify fabric color number.
	• Fabric price group 5	+\$ 69	Specify fabric color number.
	• Fabric price group 6	+\$ 84	Specify fabric color number.
	• Fabric price group 7	+\$104	Specify fabric color number.
• Fabric price group 8	+\$127	Specify fabric color number.	
• Fabric price group 9	+\$156	Specify fabric color number.	
• Fabric price group 10	+\$179	Specify fabric color number.	
	Tablet		
	• High-Pressure Laminate price group 1	No cost	Specify laminate color number.
	• High-Pressure Laminate price group 2	+\$ 82	Specify laminate color number.
	• High-Pressure Laminate price group 3	+\$167	Specify laminate color number.
	• Open Line laminate (OLL)	+\$111 plus cost of laminate	► See <i>Surface Materials Reference Manual</i> .

Specification Information

Style Number	U.S. Base Price

Specifying

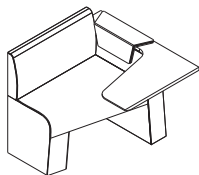

OB1QTF01 only compatible in phone booths **OB1QT01** and **OB1QT03**.

Seat Left Hand Application

OB1QTF01	\$3338
-----------------	--------

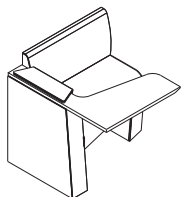

OB1QTF02 only compatible in phone booths **OB1QT02** and **OB1QT04**.

Seat Right Hand Application

OB1QTF02	\$3338
-----------------	--------

 **For Canadian Pricing**
 Multiply U.S. Price by the Canadian price factor.
 ► See page 1 for details.

Aspect One Seat Work Unit with Curved Arm

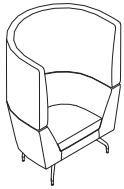

Tip: Body lower and body upper finishes are only selectable if upholstered body configuration is selected.

Tip: Body inner and body outer finishes are only selectable if body inner/outer configuration is selected. Inner/outer selection must stay in the same fabric family.

Standard Includes		Required to Specify
▶ Need help? Product details, page 40	<ul style="list-style-type: none"> Upholstered seating unit in one fabric: fabric price group 1 Reveal seam matches seat and body fabric Leg and foot: black paint 	1 Style number 2 Fabric color number for seating unit 3 Options, if selected (see below) ▶ See Product Understanding for Surface Materials.

Options	U.S. Price	Required to Specify
Body Configuration	<ul style="list-style-type: none"> Upholstered No cost Body inner/outer configuration +\$ 283 	Specify with <i>upholstered</i> . Specify with <i>body inner/outer configuration</i> .

Surface Materials	Body lower	U.S. Price	Required to Specify
	<ul style="list-style-type: none"> Customer's Own Material (COM) No cost Fabric price group 1 No cost Fabric price group 2 +\$ 75 Fabric price group 3 +\$ 149 Fabric price group 4 +\$ 253 Fabric price group 5 +\$ 419 Fabric price group 6 +\$ 587 Fabric price group 7 +\$ 799 Fabric price group 8 +\$ 992 Fabric price group 9 +\$1157 Fabric price group 10 +\$1377 		▶ See <i>Surface Materials Reference Manual</i> . Specify fabric color number.

Body upper	U.S. Price	Required to Specify
<ul style="list-style-type: none"> Customer's Own Material (COM) No cost Fabric price group 1 No cost Fabric price group 2 +\$ 123 Fabric price group 3 +\$ 252 Fabric price group 4 +\$ 425 Fabric price group 5 +\$ 705 Fabric price group 6 +\$ 983 Fabric price group 7 +\$1344 Fabric price group 8 +\$1664 Fabric price group 9 +\$1945 Fabric price group 10 +\$2316 		▶ See <i>Surface Materials Reference Manual</i> . Specify fabric color number.

Body inner	U.S. Price	Required to Specify
<ul style="list-style-type: none"> Customer's Own Material (COM) No cost Fabric price group 1 No cost Fabric price group 2 +\$ 198 Fabric price group 3 +\$ 402 Fabric price group 4 +\$ 677 Fabric price group 5 +\$1125 Fabric price group 6 +\$1569 Fabric price group 7 +\$2144 Fabric price group 8 +\$2655 Fabric price group 9 +\$3101 Fabric price group 10 +\$3694 		▶ See <i>Surface Materials Reference Manual</i> . Specify fabric color number.

Body outer	U.S. Price	Required to Specify
<ul style="list-style-type: none"> Customer's Own Material (COM) No cost Fabric price group 1 No cost Fabric price group 2 No cost Fabric price group 3 No cost Fabric price group 4 No cost Fabric price group 5 No cost Fabric price group 6 No cost Fabric price group 7 No cost Fabric price group 8 No cost Fabric price group 9 No cost Fabric price group 10 No cost 		▶ See <i>Surface Materials Reference Manual</i> . Specify fabric color number.

▶ Options, continued on next page

 **For Canadian Pricing**
Multiply U.S. Price by the Canadian price factor.
▶ See page 1 for details.

► Options, continued from previous page

Options	U.S. Price	Required to Specify
Surface Materials, continued		
Seat		
• Customer's Own Leather (COL)	No cost	► See <i>Surface Materials Reference Manual</i> .
• Customer's Own Material (COM)	No cost	► See <i>Surface Materials Reference Manual</i> .
• Fabric price group 1	No cost	Specify fabric color number.
• Fabric price group 2	+\$ 31	Specify fabric color number.
• Fabric price group 3	+\$ 63	Specify fabric color number.
• Fabric price group 4	+\$109	Specify fabric color number.
• Fabric price group 5	+\$178	Specify fabric color number.
• Fabric price group 6	+\$251	Specify fabric color number.
• Fabric price group 7	+\$342	Specify fabric color number.
• Fabric price group 8	+\$421	Specify fabric color number.
• Fabric price group 9	+\$494	Specify fabric color number.
• Fabric price group 10	+\$588	Specify fabric color number.
Reveal seam		
• Does not match seat or body	No cost	Specify <i>with no match seat or body</i> .
• Matches body	No cost	Specify <i>with matches body</i> .
• Matches body—inner	No cost	Specify <i>with matches body—inner</i> .
• Matches body—outer	No cost	Specify <i>with matches body—outer</i> .
• Matches seat	No cost	Specify <i>with matches seat</i> .
Reveal seam finish		
• Fabric price group 3	+\$177	Specify fabric color number.
• Fabric price group 4	+\$177	Specify fabric color number.
• Fabric price group 8	+\$211	Specify fabric color number.
Leg		
• Orangebox paint price group 1	No cost	Specify Orangebox paint color number.
• Orangebox paint price group 2	+\$135	Specify Orangebox paint color number.
Foot		
• Orangebox paint price group 1	No cost	Specify Orangebox paint color number.
• Orangebox paint price group 2	+\$ 53	Specify Orangebox paint color number.

Tip: Reveal seam finish is only selectable if "Does Not Match Seat or Body" option is chosen.

Specifying

Specification Information

Style Number	U.S. Base Price
OBASPECT07HB	\$8868

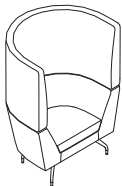

 **For Canadian Pricing**
Multiply U.S. Price by the Canadian price factor.
► See page 1 for details.

Aspect Two Seat Work Unit with Curved Arm

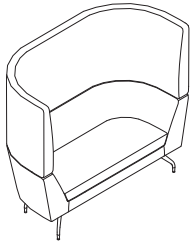

Tip: Body lower and body upper finishes are only selectable if upholstered body configuration is selected.

Tip: Body inner and body outer finishes are only selectable if body inner/outer configuration is selected. Inner/outer selection must stay in the same fabric family.

Standard Includes		Required to Specify
▶ Need help? Product details, page 40	<ul style="list-style-type: none"> Upholstered seating unit in one fabric: fabric price group 1 Reveal seam matches seat and body fabric Leg and foot: black paint 	<ol style="list-style-type: none"> Style number Fabric color number for seating unit Options, if selected (see below) <p>▶ See Product Understanding for Surface Materials.</p>

Options	U.S. Price	Required to Specify
Body Configuration	<ul style="list-style-type: none"> Upholstered No cost Body inner/outer configuration +\$ 428 	Specify with <i>upholstered</i> . Specify with <i>body inner/outer configuration</i> .

Surface Materials	Body lower	U.S. Price	Required to Specify
	<ul style="list-style-type: none"> Customer's Own Material (COM) No cost Fabric price group 1 No cost Fabric price group 2 +\$ 100 Fabric price group 3 +\$ 205 Fabric price group 4 +\$ 343 Fabric price group 5 +\$ 572 Fabric price group 6 +\$ 797 Fabric price group 7 +\$1087 Fabric price group 8 +\$1346 Fabric price group 9 +\$1574 Fabric price group 10 +\$1872 		▶ See <i>Surface Materials Reference Manual</i> . Specify fabric color number.

Body upper	U.S. Price	Required to Specify
<ul style="list-style-type: none"> Customer's Own Material (COM) No cost Fabric price group 1 No cost Fabric price group 2 +\$ 157 Fabric price group 3 +\$ 317 Fabric price group 4 +\$ 535 Fabric price group 5 +\$ 889 Fabric price group 6 +\$1244 Fabric price group 7 +\$1694 Fabric price group 8 +\$2102 Fabric price group 9 +\$2453 Fabric price group 10 +\$2920 		▶ See <i>Surface Materials Reference Manual</i> . Specify fabric color number.

Body inner	U.S. Price	Required to Specify
<ul style="list-style-type: none"> Customer's Own Material (COM) No cost Fabric price group 1 No cost Fabric price group 2 +\$ 257 Fabric price group 3 +\$ 522 Fabric price group 4 +\$ 880 Fabric price group 5 +\$1459 Fabric price group 6 +\$2039 Fabric price group 7 +\$2784 Fabric price group 8 +\$3447 Fabric price group 9 +\$4028 Fabric price group 10 +\$4792 		▶ See <i>Surface Materials Reference Manual</i> . Specify fabric color number.

Body outer	U.S. Price	Required to Specify
<ul style="list-style-type: none"> Customer's Own Material (COM) No cost Fabric price group 1 No cost Fabric price group 2 No cost Fabric price group 3 No cost Fabric price group 4 No cost Fabric price group 5 No cost Fabric price group 6 No cost Fabric price group 7 No cost Fabric price group 8 No cost Fabric price group 9 No cost Fabric price group 10 No cost 		▶ See <i>Surface Materials Reference Manual</i> . Specify fabric color number.

▶ Options, continued on next page



For Canadian Pricing
Multiply U.S. Price by the Canadian price factor.
▶ See page 1 for details.

► Options, continued from previous page

Options	U.S. Price	Required to Specify
Surface Materials, continued		
Seat		
• Customer's Own Leather (COL)	No cost	► See <i>Surface Materials Reference Manual</i> .
• Customer's Own Material (COM)	No cost	► See <i>Surface Materials Reference Manual</i> .
• Fabric price group 1	No cost	Specify fabric color number.
• Fabric price group 2	+\$ 56	Specify fabric color number.
• Fabric price group 3	+\$ 113	Specify fabric color number.
• Fabric price group 4	+\$ 188	Specify fabric color number.
• Fabric price group 5	+\$ 312	Specify fabric color number.
• Fabric price group 6	+\$ 437	Specify fabric color number.
• Fabric price group 7	+\$ 597	Specify fabric color number.
• Fabric price group 8	+\$ 739	Specify fabric color number.
• Fabric price group 9	+\$ 864	Specify fabric color number.
• Fabric price group 10	+\$1028	Specify fabric color number.
Reveal seam		
• Does not match seat or body	No cost	Specify with <i>no match seat or body</i> .
• Matches body	No cost	Specify with <i>matches body</i> .
• Matches body—inner	No cost	Specify with <i>matches body—inner</i> .
• Matches body—outer	No cost	Specify with <i>matches body—outer</i> .
• Matches seat	No cost	Specify with <i>matches seat</i> .
Reveal seam finish		
• Fabric price group 3	+\$ 177	Specify fabric color number.
• Fabric price group 4	+\$ 177	Specify fabric color number.
• Fabric price group 8	+\$ 211	Specify fabric color number.
Leg		
• Orangebox paint price group 1	No cost	Specify Orangebox paint color number.
• Orangebox paint price group 2	+\$ 135	Specify Orangebox paint color number.
Foot		
• Orangebox paint price group 1	No cost	Specify Orangebox paint color number.
• Orangebox paint price group 2	+\$ 53	Specify Orangebox paint color number.

Tip: Reveal seam finish is only selectable if "Does Not Match Seat or Body" option is chosen.

Specifying

Specification Information

Style Number	U.S. Base Price
OBASPECT08HB	\$11,098

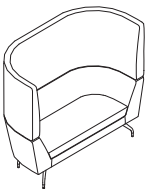

 **For Canadian Pricing**
Multiply U.S. Price by the Canadian price factor.
► See page 1 for details.

Aspect Three Seat Work Unit with Curved Arm

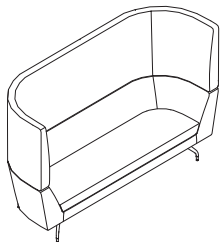

Tip: Body lower and body upper finishes are only selectable if upholstered body configuration is selected.

Tip: Body inner and body outer finishes are only selectable if body inner/outer configuration is selected. Inner/outer selection must stay in the same fabric family.

Standard Includes		Required to Specify
▶ Need help? Product details, page 40	<ul style="list-style-type: none"> Upholstered seating unit in one fabric: fabric price group 1 Reveal seam matches seat and body fabric Leg and foot: black paint 	<ol style="list-style-type: none"> Style number Fabric color number for seating unit Options, if selected (see below) <p>▶ See Product Understanding for Surface Materials.</p>

Options	U.S. Price	Required to Specify
Body Configuration	<ul style="list-style-type: none"> Upholstered Body inner/outer configuration 	<ul style="list-style-type: none"> No cost +\$ 568 <p>Specify with <i>upholstered</i>. Specify with <i>body inner/outer configuration</i>.</p>

Surface Materials	Body lower	U.S. Price	Required to Specify
	<ul style="list-style-type: none"> Customer's Own Material (COM) Fabric price group 1 Fabric price group 2 Fabric price group 3 Fabric price group 4 Fabric price group 5 Fabric price group 6 Fabric price group 7 Fabric price group 8 Fabric price group 9 Fabric price group 10 	<ul style="list-style-type: none"> No cost No cost +\$ 116 +\$ 234 +\$ 395 +\$ 652 +\$ 914 +\$1249 +\$1546 +\$1806 +\$2149 	<p>▶ See <i>Surface Materials Reference Manual</i>. Specify fabric color number. Specify fabric color number. Specify fabric color number. Specify fabric color number. Specify fabric color number. Specify fabric color number. Specify fabric color number. Specify fabric color number. Specify fabric color number. Specify fabric color number.</p>

Body upper	U.S. Price	Required to Specify
<ul style="list-style-type: none"> Customer's Own Material (COM) Fabric price group 1 Fabric price group 2 Fabric price group 3 Fabric price group 4 Fabric price group 5 Fabric price group 6 Fabric price group 7 Fabric price group 8 Fabric price group 9 Fabric price group 10 	<ul style="list-style-type: none"> No cost No cost +\$ 193 +\$ 390 +\$ 655 +\$1089 +\$1522 +\$2080 +\$2576 +\$3009 +\$3583 	<p>▶ See <i>Surface Materials Reference Manual</i>. Specify fabric color number. Specify fabric color number. Specify fabric color number. Specify fabric color number. Specify fabric color number. Specify fabric color number. Specify fabric color number. Specify fabric color number. Specify fabric color number. Specify fabric color number.</p>

Body inner	U.S. Price	Required to Specify
<ul style="list-style-type: none"> Customer's Own Material (COM) Fabric price group 1 Fabric price group 2 Fabric price group 3 Fabric price group 4 Fabric price group 5 Fabric price group 6 Fabric price group 7 Fabric price group 8 Fabric price group 9 Fabric price group 10 	<ul style="list-style-type: none"> No cost No cost +\$ 309 +\$ 624 +\$1051 +\$1744 +\$2438 +\$3330 +\$4120 +\$4814 +\$5732 	<p>▶ See <i>Surface Materials Reference Manual</i>. Specify fabric color number. Specify fabric color number. Specify fabric color number. Specify fabric color number. Specify fabric color number. Specify fabric color number. Specify fabric color number. Specify fabric color number. Specify fabric color number. Specify fabric color number.</p>

Body outer	U.S. Price	Required to Specify
<ul style="list-style-type: none"> Customer's Own Material (COM) Fabric price group 1 Fabric price group 2 Fabric price group 3 Fabric price group 4 Fabric price group 5 Fabric price group 6 Fabric price group 7 Fabric price group 8 Fabric price group 9 Fabric price group 10 	<ul style="list-style-type: none"> No cost No cost No cost No cost No cost No cost No cost No cost No cost No cost No cost 	<p>▶ See <i>Surface Materials Reference Manual</i>. Specify fabric color number. Specify fabric color number. Specify fabric color number. Specify fabric color number. Specify fabric color number. Specify fabric color number. Specify fabric color number. Specify fabric color number. Specify fabric color number. Specify fabric color number.</p>

▶ Options, continued on next page

 **For Canadian Pricing**
Multiply U.S. Price by the Canadian price factor.
▶ See page 1 for details.

► Options, continued from previous page

Options	U.S. Price	Required to Specify
Surface Materials, continued		
Seat		
• Customer's Own Leather (COL)	No cost	► See <i>Surface Materials Reference Manual</i> .
• Customer's Own Material (COM)	No cost	► See <i>Surface Materials Reference Manual</i> .
• Fabric price group 1	No cost	Specify fabric color number.
• Fabric price group 2	+\$ 56	Specify fabric color number.
• Fabric price group 3	+\$ 115	Specify fabric color number.
• Fabric price group 4	+\$ 192	Specify fabric color number.
• Fabric price group 5	+\$ 318	Specify fabric color number.
• Fabric price group 6	+\$ 445	Specify fabric color number.
• Fabric price group 7	+\$ 608	Specify fabric color number.
• Fabric price group 8	+\$ 753	Specify fabric color number.
• Fabric price group 9	+\$ 880	Specify fabric color number.
• Fabric price group 10	+\$1047	Specify fabric color number.
Reveal seam		
• Does not match seat or body	No cost	Specify with <i>no match seat or body</i> .
• Matches body	No cost	Specify with <i>matches body</i> .
• Matches body—inner	No cost	Specify with <i>matches body—inner</i> .
• Matches body—outer	No cost	Specify with <i>matches body—outer</i> .
• Matches seat	No cost	Specify with <i>matches seat</i> .
Reveal seam finish		
• Fabric price group 3	+\$ 177	Specify fabric color number.
• Fabric price group 4	+\$ 177	Specify fabric color number.
• Fabric price group 8	+\$ 211	Specify fabric color number.
Leg		
• Orangebox paint price group 1	No cost	Specify Orangebox paint color number.
• Orangebox paint price group 2	+\$ 135	Specify Orangebox paint color number.
Foot		
• Orangebox paint price group 1	No cost	Specify Orangebox paint color number.
• Orangebox paint price group 2	+\$ 53	Specify Orangebox paint color number.

Tip: Reveal seam finish is only selectable if "Does Not Match Seat or Body" option is chosen.

Specifying

Specification Information

Style Number	U.S. Base Price
OBASPECT09HB	\$12,232

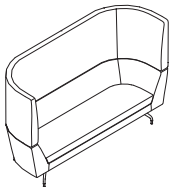

 **For Canadian Pricing**
Multiply U.S. Price by the Canadian price factor.
► See page 1 for details.

Aspect Two Seat Work Screened Unit with Fixed Table

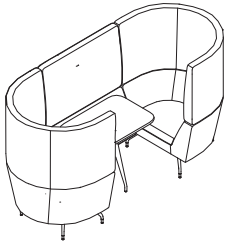

Tip: Body lower and body upper finishes are only selectable if upholstered body configuration is selected.

Tip: Body inner and body outer finishes are only selectable if body inner/outer configuration is selected. Inner/outer selection must stay in the same fabric family.



For Canadian Pricing
Multiply U.S. Price by the Canadian price factor.
▶ See page 1 for details.

Standard Includes		Required to Specify
▶ Need help? Product details, page 40	<ul style="list-style-type: none"> Upholstered seating unit in one fabric: fabric price group 1 Reveal seam matches seat and body fabric Leg and foot: black paint Tabletop: High-Pressure Laminate price group 1 No monitor bracket No power/data 	<ol style="list-style-type: none"> Style number Fabric color number for seating unit High-Pressure Laminate color number for tablet Plastic color number for tablet edge Options, if selected (see below) <p>▶ See Product Understanding for Surface Materials.</p>

Options	U.S. Price	Required to Specify
Body Configuration		
• Upholstered	No cost	Specify with upholstered.
• Body inner/outer configuration	+\$ 430	Specify with body inner/outer configuration.

Surface Materials	Body lower	U.S. Price	Required to Specify
	• Customer's Own Material (COM)	No cost	▶ See Surface Materials Reference Manual. Specify fabric color number.
	• Fabric price group 1	No cost	
	• Fabric price group 2	+\$ 148	
	• Fabric price group 3	+\$ 301	
	• Fabric price group 4	+\$ 505	
	• Fabric price group 5	+\$ 839	
	• Fabric price group 6	+\$1171	
	• Fabric price group 7	+\$1600	
	• Fabric price group 8	+\$1980	
	• Fabric price group 9	+\$2316	
	• Fabric price group 10	+\$2755	

Surface Materials	Body upper	U.S. Price	Required to Specify
	• Customer's Own Material (COM)	No cost	▶ See Surface Materials Reference Manual. Specify fabric color number.
	• Fabric price group 1	No cost	
	• Fabric price group 2	+\$ 246	
	• Fabric price group 3	+\$ 498	
	• Fabric price group 4	+\$ 839	
	• Fabric price group 5	+\$1392	
	• Fabric price group 6	+\$1945	
	• Fabric price group 7	+\$2658	
	• Fabric price group 8	+\$3288	
	• Fabric price group 9	+\$3841	
	• Fabric price group 10	+\$4573	

Surface Materials	Body inner	U.S. Price	Required to Specify
	• Customer's Own Material (COM)	No cost	▶ See Surface Materials Reference Manual. Specify fabric color number.
	• Fabric price group 1	No cost	
	• Fabric price group 2	+\$ 395	
	• Fabric price group 3	+\$ 798	
	• Fabric price group 4	+\$1345	
	• Fabric price group 5	+\$2231	
	• Fabric price group 6	+\$3118	
	• Fabric price group 7	+\$4257	
	• Fabric price group 8	+\$5269	
	• Fabric price group 9	+\$6156	
	• Fabric price group 10	+\$7328	

Surface Materials	Body outer	U.S. Price	Required to Specify
	• Customer's Own Material (COM)	No cost	▶ See Surface Materials Reference Manual. Specify fabric color number.
	• Fabric price group 1	No cost	
	• Fabric price group 2	No cost	
	• Fabric price group 3	No cost	
	• Fabric price group 4	No cost	
	• Fabric price group 5	No cost	
	• Fabric price group 6	No cost	
	• Fabric price group 7	No cost	
	• Fabric price group 8	No cost	
	• Fabric price group 9	No cost	
	• Fabric price group 10	No cost	

▶ Options, continued on next page

► Options, continued from previous page

Options	U.S. Price	Required to Specify
Surface Materials, continued		
Seat		
• Customer's Own Leather (COL)	No cost	► See <i>Surface Materials Reference Manual</i> .
• Customer's Own Material (COM)	No cost	► See <i>Surface Materials Reference Manual</i> .
• Fabric price group 1	No cost	Specify fabric color number.
• Fabric price group 2	+\$ 44	Specify fabric color number.
• Fabric price group 3	+\$ 90	Specify fabric color number.
• Fabric price group 4	+\$ 152	Specify fabric color number.
• Fabric price group 5	+\$ 252	Specify fabric color number.
• Fabric price group 6	+\$ 351	Specify fabric color number.
• Fabric price group 7	+\$ 480	Specify fabric color number.
• Fabric price group 8	+\$ 593	Specify fabric color number.
• Fabric price group 9	+\$ 695	Specify fabric color number.
• Fabric price group 10	+\$ 826	Specify fabric color number.
Reveal seam		
• Does not match seat or body	No cost	Specify with <i>no match seat or body</i> .
• Matches body	No cost	Specify with <i>matches body</i> .
• Matches body—inner	No cost	Specify with <i>matches body—inner</i> .
• Matches body—outer	No cost	Specify with <i>matches body—outer</i> .
• Matches seat	No cost	Specify with <i>matches seat</i> .
Reveal seam finish		
• Fabric price group 3	+\$ 522	Specify fabric color number.
• Fabric price group 4	+\$ 522	Specify fabric color number.
• Fabric price group 8	+\$ 632	Specify fabric color number.
Screen configuration		
• Upholstered	No cost	Specify with <i>upholstery</i> .
• Screen inner/ outer configuration	+\$ 155	Specify with <i>screen inner/outer configuration</i> .
Screen upper		
• Customer's Own Leather (COL)	No cost	► See <i>Surface Materials Reference Manual</i> .
• Customer's Own Material (COM)	No cost	► See <i>Surface Materials Reference Manual</i> .
• Fabric price group 1	No cost	Specify fabric color number.
• Fabric price group 2	+\$ 79	Specify fabric color number.
• Fabric price group 3	+\$ 156	Specify fabric color number.
• Fabric price group 4	+\$ 263	Specify fabric color number.
• Fabric price group 5	+\$ 436	Specify fabric color number.
• Fabric price group 6	+\$ 610	Specify fabric color number.
• Fabric price group 7	+\$ 832	Specify fabric color number.
• Fabric price group 8	+\$1031	Specify fabric color number.
• Fabric price group 9	+\$1204	Specify fabric color number.
• Fabric price group 10	+\$1432	Specify fabric color number.
Screen lower		
• Customer's Own Leather (COL)	No cost	► See <i>Surface Materials Reference Manual</i> .
• Customer's Own Material (COM)	No cost	► See <i>Surface Materials Reference Manual</i> .
• Fabric price group 1	No cost	Specify fabric color number.
• Fabric price group 2	+\$ 65	Specify fabric color number.
• Fabric price group 3	+\$ 132	Specify fabric color number.
• Fabric price group 4	+\$ 223	Specify fabric color number.
• Fabric price group 5	+\$ 369	Specify fabric color number.
• Fabric price group 6	+\$ 518	Specify fabric color number.
• Fabric price group 7	+\$ 703	Specify fabric color number.
• Fabric price group 8	+\$ 871	Specify fabric color number.
• Fabric price group 9	+\$1019	Specify fabric color number.
• Fabric price group 10	+\$1214	Specify fabric color number.

Tip: Reveal seam finish is only selectable if "Does Not Match Seat or Body" option is chosen.

► Options, continued on next page



For Canadian Pricing
Multiply U.S. Price by the
Canadian price factor.
► See page 1 for details.

► Options, continued from previous page

	Options	U.S. Price	Required to Specify	
Surface Materials, continued	Screen inner			
	• Customer's Own Leather (COL)	No cost	► See <i>Surface Materials Reference Manual</i> .	
	• Customer's Own Material (COM)	No cost	► See <i>Surface Materials Reference Manual</i> .	
	• Fabric price group 1	No cost	Specify fabric color number.	
	• Fabric price group 2	+\$ 143	Specify fabric color number.	
	• Fabric price group 3	+\$ 287	Specify fabric color number.	
	• Fabric price group 4	+\$ 485	Specify fabric color number.	
	• Fabric price group 5	+\$ 805	Specify fabric color number.	
	• Fabric price group 6	+\$1126	Specify fabric color number.	
	• Fabric price group 7	+\$1536	Specify fabric color number.	
	• Fabric price group 8	+\$1901	Specify fabric color number.	
	• Fabric price group 9	+\$2223	Specify fabric color number.	
	• Fabric price group 10	+\$2645	Specify fabric color number.	
		Screen outer		
		• Customer's Own Leather (COL)	No cost	► See <i>Surface Materials Reference Manual</i> .
		• Customer's Own Material (COM)	No cost	► See <i>Surface Materials Reference Manual</i> .
		• Fabric price group 1	No cost	Specify fabric color number.
		• Fabric price group 2	No cost	Specify fabric color number.
		• Fabric price group 3	No cost	Specify fabric color number.
		• Fabric price group 4	No cost	Specify fabric color number.
		• Fabric price group 5	No cost	Specify fabric color number.
		• Fabric price group 6	No cost	Specify fabric color number.
		• Fabric price group 7	No cost	Specify fabric color number.
		• Fabric price group 8	No cost	Specify fabric color number.
		• Fabric price group 9	No cost	Specify fabric color number.
		• Fabric price group 10	No cost	Specify fabric color number.
		Leg		
		• Orangebox paint price group 1	No cost	Specify Orangebox paint color number.
		• Orangebox paint price group 2	+\$ 303	Specify Orangebox paint color number.
		Foot		
	• Orangebox paint price group 1	No cost	Specify Orangebox paint color number.	
	• Orangebox paint price group 2	+\$ 110	Specify Orangebox paint color number.	
	Top			
	• High-Pressure Laminate price group 1	No cost	Specify laminate color number.	
	• High-Pressure Laminate price group 2	+\$ 101	Specify laminate color number.	
	• High-Pressure Laminate price group 3	+\$ 211	Specify laminate color number.	
	• Open Line laminate (OLL)	+\$ 111 plus cost of laminate	► See <i>Surface Materials Reference Manual</i> .	
	Monitor Bracket			
	• No monitor bracket	No cost	Specify <i>with no monitor bracket</i> .	
	• Tilting monitor bracket	+\$ 337	Specify <i>with tilting monitor bracket</i> .	
	Lower Screen Power/Data Axil			
	• No power/data required	No cost	Specify <i>with no power/data</i> .	
	• 4 duplex outlets	+\$ 549	Specify <i>with 4 duplex outlets</i> .	
	• 2 outlets with CAT6 and HDMI ports	+\$ 626	Specify <i>with 2 outlets with CAT6 and HDMI ports</i> .	
	• 2 outlets with two CAT6 data ports	+\$ 633	Specify <i>with 2 outlets with two CAT6 data ports</i> .	
	• 2 outlets with CAT6 and USB data ports	+\$ 651	Specify <i>with 2 outlets with CAT6 and USB data ports</i> .	

Tip: Select paint when specifying power.



For Canadian Pricing
 Multiply U.S. Price by the Canadian price factor.
 ► See page 1 for details.

Specification Information

Style Number	U.S. Base Price
OBASPECT57HB	\$22,229

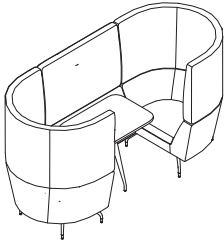

For Canadian Pricing
Multiply U.S. Price by the
Canadian price factor.
▶ See page 1 for details.

Aspect Four Seat Work Screened Unit with Fixed Table

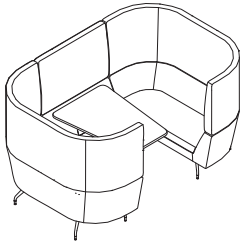

Tip: Body lower and body upper finishes are only selectable if upholstered body configuration is selected.

Tip: Body inner and body outer finishes are only selectable if body inner/outer configuration is selected. Inner/outer selection must stay in the same fabric family.

 **For Canadian Pricing**
Multiply U.S. Price by the Canadian price factor.
▶ See page 1 for details.

Standard Includes		Required to Specify
▶ Need help? Product details, page 40	<ul style="list-style-type: none"> Upholstered seating unit in one fabric: fabric price group 1 Reveal seam matches seat and body fabric Tabletop: High-Pressure Laminate price group 1 Edgeband: price group 1 Leg and foot: black paint No monitor bracket No power/data 	<ol style="list-style-type: none"> Style number Fabric color number for seating unit High-Pressure Laminate color number for tablet Plastic color number for tablet edge Options, if selected (see below) <p>▶ See Product Understanding for Surface Materials.</p>
Options		Required to Specify
Body Configuration	U.S. Price	
<ul style="list-style-type: none"> Upholstered Body inner/outer configuration 	<ul style="list-style-type: none"> No cost +\$ 641 	<p>Specify with upholstered.</p> <p>Specify with body inner/outer configuration.</p>
Surface Materials	Body lower	
	<ul style="list-style-type: none"> Customer's Own Material (COM) No cost Fabric price group 1 No cost Fabric price group 2 +\$ 202 Fabric price group 3 +\$ 407 Fabric price group 4 +\$ 689 Fabric price group 5 +\$1140 Fabric price group 6 +\$1594 Fabric price group 7 +\$2176 Fabric price group 8 +\$2693 Fabric price group 9 +\$3147 Fabric price group 10 +\$3747 	<p>▶ See Surface Materials Reference Manual.</p> <p>Specify fabric color number.</p> <p>Specify fabric color number.</p> <p>Specify fabric color number.</p> <p>Specify fabric color number.</p> <p>Specify fabric color number.</p> <p>Specify fabric color number.</p> <p>Specify fabric color number.</p> <p>Specify fabric color number.</p> <p>Specify fabric color number.</p> <p>Specify fabric color number.</p>
	Body upper	
	<ul style="list-style-type: none"> Customer's Own Material (COM) No cost Fabric price group 1 No cost Fabric price group 2 +\$ 314 Fabric price group 3 +\$ 637 Fabric price group 4 +\$1073 Fabric price group 5 +\$1778 Fabric price group 6 +\$2483 Fabric price group 7 +\$3392 Fabric price group 8 +\$4200 Fabric price group 9 +\$4907 Fabric price group 10 +\$5842 	<p>▶ See Surface Materials Reference Manual.</p> <p>Specify fabric color number.</p> <p>Specify fabric color number.</p> <p>Specify fabric color number.</p> <p>Specify fabric color number.</p> <p>Specify fabric color number.</p> <p>Specify fabric color number.</p> <p>Specify fabric color number.</p> <p>Specify fabric color number.</p> <p>Specify fabric color number.</p> <p>Specify fabric color number.</p>
	Body inner	
	<ul style="list-style-type: none"> Customer's Own Material (COM) No cost Fabric price group 1 No cost Fabric price group 2 +\$ 518 Fabric price group 3 +\$1044 Fabric price group 4 +\$1758 Fabric price group 5 +\$2918 Fabric price group 6 +\$4077 Fabric price group 7 +\$5568 Fabric price group 8 +\$6892 Fabric price group 9 +\$8055 Fabric price group 10 +\$9590 	<p>▶ See Surface Materials Reference Manual.</p> <p>Specify fabric color number.</p> <p>Specify fabric color number.</p> <p>Specify fabric color number.</p> <p>Specify fabric color number.</p> <p>Specify fabric color number.</p> <p>Specify fabric color number.</p> <p>Specify fabric color number.</p> <p>Specify fabric color number.</p> <p>Specify fabric color number.</p> <p>Specify fabric color number.</p>
	Body outer	
	<ul style="list-style-type: none"> Customer's Own Material (COM) No cost Fabric price group 1 No cost Fabric price group 2 No cost Fabric price group 3 No cost Fabric price group 4 No cost Fabric price group 5 No cost Fabric price group 6 No cost Fabric price group 7 No cost Fabric price group 8 No cost Fabric price group 9 No cost Fabric price group 10 No cost 	<p>▶ See Surface Materials Reference Manual.</p> <p>Specify fabric color number.</p> <p>Specify fabric color number.</p> <p>Specify fabric color number.</p> <p>Specify fabric color number.</p> <p>Specify fabric color number.</p> <p>Specify fabric color number.</p> <p>Specify fabric color number.</p> <p>Specify fabric color number.</p> <p>Specify fabric color number.</p> <p>Specify fabric color number.</p>

▶ Options, continued on next page

► Options, continued from previous page

Options	U.S. Price	Required to Specify
Surface Materials, continued		
Seat		
• Customer's Own Leather (COL)	No cost	► See <i>Surface Materials Reference Manual</i> .
• Customer's Own Material (COM)	No cost	► See <i>Surface Materials Reference Manual</i> .
• Fabric price group 1	No cost	Specify fabric color number.
• Fabric price group 2	+\$ 81	Specify fabric color number.
• Fabric price group 3	+\$ 162	Specify fabric color number.
• Fabric price group 4	+\$ 273	Specify fabric color number.
• Fabric price group 5	+\$ 455	Specify fabric color number.
• Fabric price group 6	+\$ 633	Specify fabric color number.
• Fabric price group 7	+\$ 864	Specify fabric color number.
• Fabric price group 8	+\$1070	Specify fabric color number.
• Fabric price group 9	+\$1250	Specify fabric color number.
• Fabric price group 10	+\$1490	Specify fabric color number.
Reveal seam		
• Does not match seat or body	No cost	Specify with <i>no match seat or body</i> .
• Matches body	No cost	Specify with <i>matches body</i> .
• Matches body—inner	No cost	Specify with <i>matches body - inner</i> .
• Matches body—outer	No cost	Specify with <i>matches body - outer</i> .
• Matches seat	No cost	Specify with <i>matches seat</i> .
Reveal seam finish		
• Fabric price group 3	+\$ 522	Specify fabric color number.
• Fabric price group 4	+\$ 522	Specify fabric color number.
• Fabric price group 8	+\$ 632	Specify fabric color number.
Screen configuration		
• Upholstered	No cost	Specify with <i>upholstery</i> .
• Screen inner/ outer configuration	+\$ 155	Specify with <i>screen inner/outer configuration</i> .
Screen upper		
• Customer's Own Leather (COL)	No cost	► See <i>Surface Materials Reference Manual</i> .
• Customer's Own Material (COM)	No cost	► See <i>Surface Materials Reference Manual</i> .
• Fabric price group 1	No cost	Specify fabric color number.
• Fabric price group 2	+\$ 79	Specify fabric color number.
• Fabric price group 3	+\$ 156	Specify fabric color number.
• Fabric price group 4	+\$ 263	Specify fabric color number.
• Fabric price group 5	+\$ 436	Specify fabric color number.
• Fabric price group 6	+\$ 610	Specify fabric color number.
• Fabric price group 7	+\$ 832	Specify fabric color number.
• Fabric price group 8	+\$1031	Specify fabric color number.
• Fabric price group 9	+\$1204	Specify fabric color number.
• Fabric price group 10	+\$1432	Specify fabric color number.
Screen lower		
• Customer's Own Leather (COL)	No cost	► See <i>Surface Materials Reference Manual</i> .
• Customer's Own Material (COM)	No cost	► See <i>Surface Materials Reference Manual</i> .
• Fabric price group 1	No cost	Specify fabric color number.
• Fabric price group 2	+\$ 65	Specify fabric color number.
• Fabric price group 3	+\$ 132	Specify fabric color number.
• Fabric price group 4	+\$ 223	Specify fabric color number.
• Fabric price group 5	+\$ 369	Specify fabric color number.
• Fabric price group 6	+\$ 518	Specify fabric color number.
• Fabric price group 7	+\$ 703	Specify fabric color number.
• Fabric price group 8	+\$ 871	Specify fabric color number.
• Fabric price group 9	+\$1019	Specify fabric color number.
• Fabric price group 10	+\$1214	Specify fabric color number.

► Options, continued on next page

Tip: Reveal seam finish is only selectable if "Does Not Match Seat or Body" option is chosen.



For Canadian Pricing
Multiply U.S. Price by the
Canadian price factor.
► See page 1 for details.

Aspect Four Seat Work Screened Unit with Fixed Table, continued

► Options, continued from previous page

Tip: Screen inner and screen outer finishes are only selectable if screen inner/outer configuration is selected. Inner/outer selection must stay in the same fabric family.

	Options	U.S. Price	Required to Specify
Surface Materials, continued	Screen inner		
	• Customer's Own Leather (COL)	No cost	► See <i>Surface Materials Reference Manual</i> .
	• Customer's Own Material (COM)	No cost	► See <i>Surface Materials Reference Manual</i> .
	• Fabric price group 1	No cost	Specify fabric color number.
	• Fabric price group 2	+\$ 143	Specify fabric color number.
	• Fabric price group 3	+\$ 287	Specify fabric color number.
	• Fabric price group 4	+\$ 485	Specify fabric color number.
	• Fabric price group 5	+\$ 805	Specify fabric color number.
	• Fabric price group 6	+\$1126	Specify fabric color number.
	• Fabric price group 7	+\$1536	Specify fabric color number.
	• Fabric price group 8	+\$1901	Specify fabric color number.
	• Fabric price group 9	+\$2223	Specify fabric color number.
	• Fabric price group 10	+\$2645	Specify fabric color number.
	Screen outer		
	• Customer's Own Leather (COL)	No cost	► See <i>Surface Materials Reference Manual</i> .
	• Customer's Own Material (COM)	No cost	► See <i>Surface Materials Reference Manual</i> .
	• Fabric price group 1	No cost	Specify fabric color number.
	• Fabric price group 2	No cost	Specify fabric color number.
	• Fabric price group 3	No cost	Specify fabric color number.
	• Fabric price group 4	No cost	Specify fabric color number.
	• Fabric price group 5	No cost	Specify fabric color number.
	• Fabric price group 6	No cost	Specify fabric color number.
	• Fabric price group 7	No cost	Specify fabric color number.
	• Fabric price group 8	No cost	Specify fabric color number.
	• Fabric price group 9	No cost	Specify fabric color number.
	• Fabric price group 10	No cost	Specify fabric color number.
	Leg		
	• Orangebox paint price group 1	No cost	Specify Orangebox paint color number.
	• Orangebox paint price group 2	+\$ 303	Specify Orangebox paint color number.
	Foot		
	• Orangebox paint price group 1	No cost	Specify Orangebox paint color number.
	• Orangebox paint price group 2	+\$ 110	Specify Orangebox paint color number.
	Top		
	• High-Pressure Laminate price group 1	No cost	Specify laminate color number.
	• High-Pressure Laminate price group 2	+\$ 183	Specify laminate color number.
	• High-Pressure Laminate price group 3	+\$ 384	Specify laminate color number.
	• Open Line laminate (OLL)	+\$ 111 plus cost of laminate	► See <i>Surface Materials Reference Manual</i> .
	Monitor Bracket		
	• No monitor bracket	No cost	Specify with no monitor bracket.
	• Tilting monitor bracket	+\$ 337	Specify with tilting monitor bracket.
	Lower Screen Power/Data Axil		
	• No power/data required	No cost	Specify with no power/data.
	• 4 duplex outlets	+\$ 549	Specify with 4 duplex outlets.
	• 2 outlets with CAT6 and HDMI ports	+\$ 626	Specify with 2 outlets with CAT6 and HDMI ports.
	• 2 outlets with two CAT6 data ports	+\$ 633	Specify with 2 outlets with two CAT6 data ports.
	• 2 outlets with CAT6 and USB data ports	+\$ 651	Specify with 2 outlets with CAT6 and USB data ports.

Tip: Select paint when specifying power.



For Canadian Pricing

Multiply U.S. Price by the Canadian price factor.

► See page 1 for details.

Specification Information

Style Number	U.S. Base Price
OBASPECT58HB	\$27,272

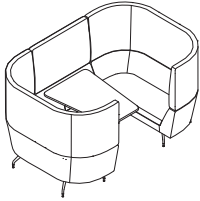

For Canadian Pricing
Multiply U.S. Price by the
Canadian price factor.
▶ See page 1 for details.

Aspect Six Seat Work Screened Unit with Fixed Table

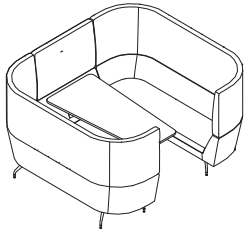

Tip: Body lower and body upper finishes are only selectable if upholstered body configuration is selected.

Tip: Body inner and body outer finishes are only selectable if body inner/outer configuration is selected. Inner/outer selection must stay in the same fabric family.

 **For Canadian Pricing**
Multiply U.S. Price by the Canadian price factor.
▶ See page 1 for details.

Standard Includes		Required to Specify
▶ Need help? Product details, page 40	<ul style="list-style-type: none"> Upholstered seating unit in one fabric: fabric price group 1 Reveal seam matches seat and body fabric Tabletop: High-Pressure Laminate price group 1 Edgeband: price group 1 Leg and foot: black paint No monitor bracket No power/data 	<ol style="list-style-type: none"> Style number Fabric color number for seating unit High-Pressure Laminate color number for tablet Plastic color number for tablet edge Options, if selected (see below) <p>▶ See Product Understanding for Surface Materials.</p>

Options	U.S. Price	Required to Specify
Body Configuration		
• Upholstered	No cost	Specify with upholstered.
• Body inner/outer configuration	+\$ 850	Specify with body inner/outer configuration.

Surface Materials	Body lower	U.S. Price	Required to Specify
	• Customer's Own Material (COM)	No cost	▶ See Surface Materials Reference Manual. Specify fabric color number. Specify fabric color number. Specify fabric color number. Specify fabric color number. Specify fabric color number. Specify fabric color number. Specify fabric color number. Specify fabric color number. Specify fabric color number. Specify fabric color number. Specify fabric color number.
	• Fabric price group 1	No cost	
	• Fabric price group 2	+\$ 228	
	• Fabric price group 3	+\$ 462	
	• Fabric price group 4	+\$ 778	
	• Fabric price group 5	+\$ 1291	
	• Fabric price group 6	+\$ 1805	
	• Fabric price group 7	+\$ 2463	
	• Fabric price group 8	+\$ 3052	
	• Fabric price group 9	+\$ 3564	
	• Fabric price group 10	+\$ 4241	

Surface Materials	Body upper	U.S. Price	Required to Specify
	• Customer's Own Material (COM)	No cost	▶ See Surface Materials Reference Manual. Specify fabric color number. Specify fabric color number. Specify fabric color number. Specify fabric color number. Specify fabric color number. Specify fabric color number. Specify fabric color number. Specify fabric color number. Specify fabric color number. Specify fabric color number.
	• Fabric price group 1	No cost	
	• Fabric price group 2	+\$ 382	
	• Fabric price group 3	+\$ 774	
	• Fabric price group 4	+\$ 1305	
	• Fabric price group 5	+\$ 2164	
	• Fabric price group 6	+\$ 3025	
	• Fabric price group 7	+\$ 4127	
	• Fabric price group 8	+\$ 5110	
	• Fabric price group 9	+\$ 5972	
	• Fabric price group 10	+\$ 7109	

Surface Materials	Body inner	U.S. Price	Required to Specify
	• Customer's Own Material (COM)	No cost	▶ See Surface Materials Reference Manual. Specify fabric color number. Specify fabric color number. Specify fabric color number. Specify fabric color number. Specify fabric color number. Specify fabric color number. Specify fabric color number. Specify fabric color number. Specify fabric color number. Specify fabric color number.
	• Fabric price group 1	No cost	
	• Fabric price group 2	+\$ 611	
	• Fabric price group 3	+\$ 1234	
	• Fabric price group 4	+\$ 2082	
	• Fabric price group 5	+\$ 3454	
	• Fabric price group 6	+\$ 4829	
	• Fabric price group 7	+\$ 6591	
	• Fabric price group 8	+\$ 8160	
	• Fabric price group 9	+\$ 9535	
	• Fabric price group 10	+\$11,350	

Surface Materials	Body outer	U.S. Price	Required to Specify
	• Customer's Own Material (COM)	No cost	▶ See Surface Materials Reference Manual. Specify fabric color number. Specify fabric color number. Specify fabric color number. Specify fabric color number. Specify fabric color number. Specify fabric color number. Specify fabric color number. Specify fabric color number. Specify fabric color number. Specify fabric color number.
	• Fabric price group 1	No cost	
	• Fabric price group 2	No cost	
	• Fabric price group 3	No cost	
	• Fabric price group 4	No cost	
	• Fabric price group 5	No cost	
	• Fabric price group 6	No cost	
	• Fabric price group 7	No cost	
	• Fabric price group 8	No cost	
	• Fabric price group 9	No cost	
	• Fabric price group 10	No cost	

▶ Options, continued on next page

► Options, continued from previous page

Options	U.S. Price	Required to Specify
Surface Materials, continued		
Seat		
• Customer's Own Leather (COL)	No cost	► See <i>Surface Materials Reference Manual</i> .
• Customer's Own Material (COM)	No cost	► See <i>Surface Materials Reference Manual</i> .
• Fabric price group 1	No cost	Specify fabric color number.
• Fabric price group 2	+\$ 114	Specify fabric color number.
• Fabric price group 3	+\$ 228	Specify fabric color number.
• Fabric price group 4	+\$ 385	Specify fabric color number.
• Fabric price group 5	+\$ 638	Specify fabric color number.
• Fabric price group 6	+\$ 891	Specify fabric color number.
• Fabric price group 7	+\$1217	Specify fabric color number.
• Fabric price group 8	+\$1507	Specify fabric color number.
• Fabric price group 9	+\$1758	Specify fabric color number.
• Fabric price group 10	+\$2093	Specify fabric color number.
Reveal seam		
• Does not match seat or body	No cost	Specify with <i>no match seat or body</i> .
• Matches body	No cost	Specify with <i>matches body</i> .
• Matches body—inner	No cost	Specify with <i>matches body—inner</i> .
• Matches body—outer	No cost	Specify with <i>matches body—outer</i> .
• Matches seat	No cost	Specify with <i>matches seat</i> .
Reveal seam finish		
• Fabric price group 3	+\$ 522	Specify fabric color number.
• Fabric price group 4	+\$ 522	Specify fabric color number.
• Fabric price group 8	+\$ 632	Specify fabric color number.
Screen configuration		
• Upholstered	No cost	Specify with <i>upholstery</i> .
• Screen inner/ outer configuration	+\$ 155	Specify with <i>screen inner/outer configuration</i> .
Screen upper		
• Customer's Own Leather (COL)	No cost	► See <i>Surface Materials Reference Manual</i> .
• Customer's Own Material (COM)	No cost	► See <i>Surface Materials Reference Manual</i> .
• Fabric price group 1	No cost	Specify fabric color number.
• Fabric price group 2	+\$ 79	Specify fabric color number.
• Fabric price group 3	+\$ 156	Specify fabric color number.
• Fabric price group 4	+\$ 263	Specify fabric color number.
• Fabric price group 5	+\$ 436	Specify fabric color number.
• Fabric price group 6	+\$ 610	Specify fabric color number.
• Fabric price group 7	+\$ 832	Specify fabric color number.
• Fabric price group 8	+\$1031	Specify fabric color number.
• Fabric price group 9	+\$1204	Specify fabric color number.
• Fabric price group 10	+\$1432	Specify fabric color number.
Screen lower		
• Customer's Own Leather (COL)	No cost	► See <i>Surface Materials Reference Manual</i> .
• Customer's Own Material (COM)	No cost	► See <i>Surface Materials Reference Manual</i> .
• Fabric price group 1	No cost	Specify fabric color number.
• Fabric price group 2	+\$ 65	Specify fabric color number.
• Fabric price group 3	+\$ 132	Specify fabric color number.
• Fabric price group 4	+\$ 223	Specify fabric color number.
• Fabric price group 5	+\$ 369	Specify fabric color number.
• Fabric price group 6	+\$ 518	Specify fabric color number.
• Fabric price group 7	+\$ 703	Specify fabric color number.
• Fabric price group 8	+\$ 871	Specify fabric color number.
• Fabric price group 9	+\$1019	Specify fabric color number.
• Fabric price group 10	+\$1214	Specify fabric color number.

Tip: Reveal seam finish is only selectable if "Does Not Match Seat or Body" option is chosen.

► Options, continued on next page



For Canadian Pricing
Multiply U.S. Price by the
Canadian price factor.
► See page 1 for details.

Aspect Six Seat Work Screened Unit with Fixed Table, continued

► Options, continued from previous page

Tip: Screen inner and screen outer finishes are only selectable if screen inner/outer configuration is selected. Inner/outer selection must stay in the same fabric family.

	Options	U.S. Price	Required to Specify
Surface Materials, continued	Screen inner		
	• Customer's Own Leather (COL)	No cost	► See <i>Surface Materials Reference Manual</i> .
	• Customer's Own Material (COM)	No cost	► See <i>Surface Materials Reference Manual</i> .
	• Fabric price group 1	No cost	Specify fabric color number.
	• Fabric price group 2	+\$ 143	Specify fabric color number.
	• Fabric price group 3	+\$ 287	Specify fabric color number.
	• Fabric price group 4	+\$ 485	Specify fabric color number.
	• Fabric price group 5	+\$ 805	Specify fabric color number.
	• Fabric price group 6	+\$1126	Specify fabric color number.
	• Fabric price group 7	+\$1536	Specify fabric color number.
	• Fabric price group 8	+\$1901	Specify fabric color number.
	• Fabric price group 9	+\$2223	Specify fabric color number.
	• Fabric price group 10	+\$2645	Specify fabric color number.
	Screen outer		
	• Customer's Own Leather (COL)	No cost	► See <i>Surface Materials Reference Manual</i> .
	• Customer's Own Material (COM)	No cost	► See <i>Surface Materials Reference Manual</i> .
	• Fabric price group 1	No cost	Specify fabric color number.
	• Fabric price group 2	No cost	Specify fabric color number.
	• Fabric price group 3	No cost	Specify fabric color number.
	• Fabric price group 4	No cost	Specify fabric color number.
	• Fabric price group 5	No cost	Specify fabric color number.
	• Fabric price group 6	No cost	Specify fabric color number.
	• Fabric price group 7	No cost	Specify fabric color number.
	• Fabric price group 8	No cost	Specify fabric color number.
	• Fabric price group 9	No cost	Specify fabric color number.
	• Fabric price group 10	No cost	Specify fabric color number.
	Leg		
	• Orangebox paint price group 1	No cost	Specify Orangebox paint color number.
	• Orangebox paint price group 2	+\$ 303	Specify Orangebox paint color number.
	Foot		
	• Orangebox paint price group 1	No cost	Specify Orangebox paint color number.
	• Orangebox paint price group 2	+\$ 110	Specify Orangebox paint color number.
	Top		
	• High-Pressure Laminate price group 1	No cost	Specify laminate color number.
	• High-Pressure Laminate price group 2	+\$ 263	Specify laminate color number.
	• High-Pressure Laminate price group 3	+\$ 550	Specify laminate color number.
	• Open Line laminate (OLL)	+\$ 111 plus cost of laminate	► See <i>Surface Materials Reference Manual</i> .
	Monitor Bracket		
	• No monitor bracket	No cost	Specify <i>with no monitor bracket</i> .
	• Tilting monitor bracket	+\$ 337	Specify <i>with tilting monitor bracket</i> .
	Lower Screen Power/Data Axil		
	• No power/data required	No cost	Specify <i>with no power/data</i> .
	• 4 duplex outlets	+\$ 549	Specify <i>with 4 duplex outlets</i> .
	• 2 outlets with CAT6 and HDMI ports	+\$ 626	Specify <i>with 2 outlets with CAT6 and HDMI ports</i> .
	• 2 outlets with two CAT6 data ports	+\$ 633	Specify <i>with 2 outlets with two CAT6 data ports</i> .
	• 2 outlets with CAT6 and USB data ports	+\$ 651	Specify <i>with 2 outlets with CAT6 and USB data ports</i> .

Tip: Select paint when specifying power.



For Canadian Pricing

Multiply U.S. Price by the Canadian price factor.

► See page 1 for details.

Specification Information

Style Number	U.S. Base Price
OBASPECT59HB	\$30,200

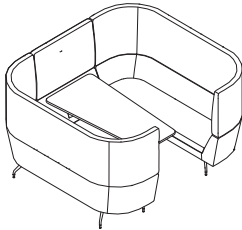

For Canadian Pricing
Multiply U.S. Price by the
Canadian price factor.
▶ See page 1 for details.

Sully Upholstered Stool X 4/27

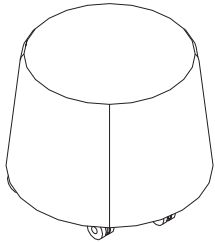

Standard Includes		Required to Specify
<ul style="list-style-type: none"> ▶ Need help? Product details, page 42 	<ul style="list-style-type: none"> Fully upholstered stool: fabric price group 1 Soft casters: black Shipped fully assembled 	<ul style="list-style-type: none"> 1 Style number 2 Fabric color number for stool 3 Options, if selected (see below) ▶ See Product Understanding for Surface Materials.

Options	U.S. Price	Required to Specify
Surface Materials	Seat <ul style="list-style-type: none"> Customer's Own Leather (COL) No cost Customer's Own Material (COM) No cost Fabric price group 1 No cost Fabric price group 2 +\$ 49 Fabric price group 3 +\$ 94 Fabric price group 4 +\$162 Fabric price group 5 +\$269 Fabric price group 6 +\$375 Fabric price group 7 +\$513 Fabric price group 8 +\$634 Fabric price group 9 +\$741 Fabric price group 10 +\$882 Leather price group 1 +\$104 Leather price group 2 +\$209 	<ul style="list-style-type: none"> ▶ See <i>Surface Materials Reference Manual</i>. ▶ See <i>Surface Materials Reference Manual</i>. Specify fabric color number. Specify fabric color number. Specify fabric color number. Specify fabric color number. Specify fabric color number. Specify fabric color number. Specify fabric color number. Specify fabric color number. Specify fabric color number. Specify leather color number. Specify leather color number.
Caster	<ul style="list-style-type: none"> Black soft casters No cost Grey soft casters No cost Black soft casters with brakes +\$ 88 Grey soft casters with brakes +\$ 88 	<ul style="list-style-type: none"> Specify <i>with black soft casters</i>. Specify <i>with grey soft casters</i>. Specify <i>with black soft casters with brakes</i>. Specify <i>with grey soft casters with brakes</i>.

Specification Information	
Style Number	U.S. Base Price
OBSSULLY01 X 4/27	\$1228



For Canadian Pricing
 Multiply U.S. Price by the Canadian price factor.
 ▶ See page 1 for details.

X 4/27 = Last order entry
 April 18, 2027

Skomer Upholstered Arm Chair 4/27

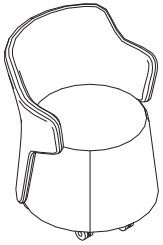

Tip: If two tone upholstered option one is selected, contrasting price groups are available. Total seat finish and back finish price is driven by highest price group selection.

Tip: If two tone upholstered option two is selected, contrasting price groups are not available. Total seat and outer back finish and inner back finish price is driven by highest price group selection.

Standard Includes		Required to Specify
▶ Need help? Product details, page 42	<ul style="list-style-type: none"> Fully upholstered arm chair: fabric price group 1 Soft casters: black Shipped fully assembled 	1 Style number 2 Fabric color number for chair 3 Options, if selected (see below) ▶ See Product Understanding for Surface Materials.

Options	U.S. Price	Required to Specify
Configuration		
• Upholstered	No cost	Specify with upholstered.
• Two tone upholstered—option 1	+\$ 110	Specify with two tone upholstered.
• Two tone upholstered—option 2	+\$ 110	Specify with two tone upholstered.

Surface Materials	Seat	U.S. Price	Required to Specify
	• Customer's Own Leather (COL)	No cost	▶ See Surface Materials Reference Manual.
	• Customer's Own Material (COM)	No cost	▶ See Surface Materials Reference Manual.
	• Fabric price group 1	No cost	Specify fabric color number.
	• Fabric price group 2	+\$ 71	Specify fabric color number.
	• Fabric price group 3	+\$ 145	Specify fabric color number.
	• Fabric price group 4	+\$ 244	Specify fabric color number.
	• Fabric price group 5	+\$ 402	Specify fabric color number.
	• Fabric price group 6	+\$ 561	Specify fabric color number.
	• Fabric price group 7	+\$ 768	Specify fabric color number.
	• Fabric price group 8	+\$ 952	Specify fabric color number.
	• Fabric price group 9	+\$1111	Specify fabric color number.
	• Fabric price group 10	+\$1323	Specify fabric color number.
	• Leather price group 1	+\$ 224	Specify leather color number.
	• Leather price group 2	+\$ 448	Specify leather color number.

Back	U.S. Price	Required to Specify
• Customer's Own Leather (COL)	No cost	▶ See Surface Materials Reference Manual.
• Customer's Own Material (COM)	No cost	▶ See Surface Materials Reference Manual.
• Fabric price group 1	No cost	Specify fabric color number.
• Fabric price group 2	No cost	Specify fabric color number.
• Fabric price group 3	No cost	Specify fabric color number.
• Fabric price group 4	No cost	Specify fabric color number.
• Fabric price group 5	No cost	Specify fabric color number.
• Fabric price group 6	No cost	Specify fabric color number.
• Fabric price group 7	No cost	Specify fabric color number.
• Fabric price group 8	No cost	Specify fabric color number.
• Fabric price group 9	No cost	Specify fabric color number.
• Fabric price group 10	No cost	Specify fabric color number.
• Leather price group 1	No cost	Specify leather color number.
• Leather price group 2	No cost	Specify leather color number.

Seat and outer back	U.S. Price	Required to Specify
• Customer's Own Leather (COL)	No cost	▶ See Surface Materials Reference Manual.
• Customer's Own Material (COM)	No cost	▶ See Surface Materials Reference Manual.
• Fabric price group 1	No cost	Specify fabric color number.
• Fabric price group 2	+\$ 71	Specify fabric color number.
• Fabric price group 3	+\$ 145	Specify fabric color number.
• Fabric price group 4	+\$ 244	Specify fabric color number.
• Fabric price group 5	+\$ 402	Specify fabric color number.
• Fabric price group 6	+\$ 561	Specify fabric color number.
• Fabric price group 7	+\$ 768	Specify fabric color number.
• Fabric price group 8	+\$ 952	Specify fabric color number.
• Fabric price group 9	+\$1111	Specify fabric color number.
• Fabric price group 10	+\$1323	Specify fabric color number.
• Leather price group 1	+\$ 224	Specify leather color number.
• Leather price group 2	+\$ 448	Specify leather color number.

▶ Options, continued on next page



For Canadian Pricing
 Multiply U.S. Price by the Canadian price factor.
 ▶ See page 1 for details.

E34/27 = Last order entry
 April 18, 2027

► Options, continued from previous page

Options	U.S. Price	Required to Specify
Surface Materials, continued Inner back <ul style="list-style-type: none"> • Customer's Own Material (COM) No cost • Fabric price group 1 No cost • Fabric price group 2 No cost • Fabric price group 3 No cost • Fabric price group 4 No cost • Fabric price group 5 No cost • Fabric price group 6 No cost • Fabric price group 7 No cost • Fabric price group 8 No cost • Fabric price group 9 No cost • Fabric price group 10 No cost • Leather price group 1 No cost • Leather price group 2 No cost 		► See <i>Surface Materials Reference Manual</i> . Specify fabric color number. Specify fabric color number. Specify fabric color number. Specify fabric color number. Specify fabric color number. Specify fabric color number. Specify fabric color number. Specify fabric color number. Specify fabric color number. Specify fabric color number. Specify leather color number. Specify leather color number.
Caster <ul style="list-style-type: none"> • Black soft casters No cost • Grey soft casters No cost • Black soft casters with brakes +\$88 • Grey soft casters with brakes +\$88 		Specify with <i>black soft casters</i> . Specify with <i>grey soft casters</i> . Specify with <i>black soft casters with brakes</i> . Specify with <i>grey soft casters with brakes</i> .

Specification Information	
Style Number	U.S. Base Price
OBSSKOMER01	\$2570

Specifying



 **For Canadian Pricing**
 Multiply U.S. Price by the Canadian price factor.
 ► See page 1 for details.

34/27 = Last order entry
 April 18, 2027

Ramsey Upholstered Work Chair **X** 4/27

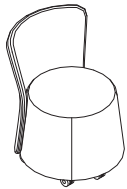

Tip: If two tone upholstered option one is selected, contrasting price groups are available. Total seat finish and back finish price is driven by highest price group selection.

Tip: If two tone upholstered option one is selected, contrasting price groups are available. Total seat finish and back finish price is driven by highest price group selection.

Standard Includes		Required to Specify
▶ Need help? Product details, page 42	<ul style="list-style-type: none"> Fully upholstered armless chair: fabric price group 1 Soft casters: black Shipped fully assembled 	1 Style number 2 Fabric color number for chair 3 Options, if selected (see below) ▶ See Product Understanding for Surface Materials.

Options	U.S. Price	Required to Specify
Configuration		
• Upholstered	No cost	Specify <i>with upholstered</i> .
• Two tone upholstered—option 1	+\$ 110	Specify <i>with two tone upholstered</i> .
• Two tone upholstered—option 2	+\$ 110	Specify <i>with two tone upholstered</i> .

Surface Materials	Seat	U.S. Price	Required to Specify
	• Customer's Own Leather (COL)	No cost	▶ See <i>Surface Materials Reference Manual</i> .
	• Customer's Own Material (COM)	No cost	▶ See <i>Surface Materials Reference Manual</i> .
	• Fabric price group 1	No cost	Specify fabric color number.
	• Fabric price group 2	+\$ 65	Specify fabric color number.
	• Fabric price group 3	+\$ 132	Specify fabric color number.
	• Fabric price group 4	+\$ 223	Specify fabric color number.
	• Fabric price group 5	+\$ 369	Specify fabric color number.
	• Fabric price group 6	+\$ 518	Specify fabric color number.
	• Fabric price group 7	+\$ 703	Specify fabric color number.
	• Fabric price group 8	+\$ 871	Specify fabric color number.
	• Fabric price group 9	+\$1019	Specify fabric color number.
	• Fabric price group 10	+\$1214	Specify fabric color number.
	• Leather price group 1	+\$ 194	Specify leather color number.
	• Leather price group 2	+\$ 388	Specify leather color number.

Back	U.S. Price	Required to Specify
• Customer's Own Leather (COL)	No cost	▶ See <i>Surface Materials Reference Manual</i> .
• Customer's Own Material (COM)	No cost	▶ See <i>Surface Materials Reference Manual</i> .
• Fabric price group 1	No cost	Specify fabric color number.
• Fabric price group 2	No cost	Specify fabric color number.
• Fabric price group 3	No cost	Specify fabric color number.
• Fabric price group 4	No cost	Specify fabric color number.
• Fabric price group 5	No cost	Specify fabric color number.
• Fabric price group 6	No cost	Specify fabric color number.
• Fabric price group 7	No cost	Specify fabric color number.
• Fabric price group 8	No cost	Specify fabric color number.
• Fabric price group 9	No cost	Specify fabric color number.
• Fabric price group 10	No cost	Specify fabric color number.
• Leather price group 1	No cost	Specify leather color number.
• Leather price group 2	No cost	Specify leather color number.

Seat and outer back	U.S. Price	Required to Specify
• Customer's Own Leather (COL)	No cost	▶ See <i>Surface Materials Reference Manual</i> .
• Customer's Own Material (COM)	No cost	▶ See <i>Surface Materials Reference Manual</i> .
• Fabric price group 1	No cost	Specify fabric color number.
• Fabric price group 2	+\$ 65	Specify fabric color number.
• Fabric price group 3	+\$ 132	Specify fabric color number.
• Fabric price group 4	+\$ 223	Specify fabric color number.
• Fabric price group 5	+\$ 369	Specify fabric color number.
• Fabric price group 6	+\$ 518	Specify fabric color number.
• Fabric price group 7	+\$ 703	Specify fabric color number.
• Fabric price group 8	+\$ 871	Specify fabric color number.
• Fabric price group 9	+\$1019	Specify fabric color number.
• Fabric price group 10	+\$1214	Specify fabric color number.
• Leather price group 1	+\$ 194	Specify leather color number.
• Leather price group 2	+\$ 388	Specify leather color number.

▶ Options, continued on next page



For Canadian Pricing
 Multiply U.S. Price by the Canadian price factor.
 ▶ See page 1 for details.

X4/27 = Last order entry
 April 18, 2027

► Options, continued from previous page

	Options	U.S. Price	Required to Specify
Surface Materials, continued	Inner back		
	• Customer's Own Material (COM)	No cost	► See <i>Surface Materials Reference Manual</i> . Specify fabric color number. Specify fabric color number. Specify fabric color number. Specify fabric color number. Specify fabric color number. Specify fabric color number. Specify fabric color number. Specify fabric color number. Specify fabric color number. Specify fabric color number. Specify leather color number. Specify leather color number.
	• Fabric price group 1	No cost	
	• Fabric price group 2	No cost	
	• Fabric price group 3	No cost	
	• Fabric price group 4	No cost	
	• Fabric price group 5	No cost	
	• Fabric price group 6	No cost	
	• Fabric price group 7	No cost	
	• Fabric price group 8	No cost	
	• Fabric price group 9	No cost	
	• Fabric price group 10	No cost	
	• Leather price group 1	No cost	
• Leather price group 2	No cost		
Caster	• Black soft casters	No cost	Specify with <i>black soft casters</i> .
	• Grey soft casters	No cost	Specify with <i>grey soft casters</i> .
	• Black soft casters with brakes	+\$88	Specify with <i>black soft casters with brakes</i> .
	• Grey soft casters with brakes	+\$88	Specify with <i>grey soft casters with brakes</i> .

Specification Information

Style Number	U.S. Base Price
OBSRAMSEY01 ✕34/27	\$2294

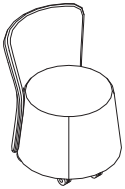

Specifying

 **For Canadian Pricing**
Multiply U.S. Price by the Canadian price factor.
► See page 1 for details.

✕34/27 = Last order entry
April 18, 2027

Border One Seat-Low with Attached Table

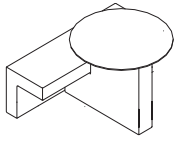

Tip: If two tone upholstered option is selected, contrasting price groups are available. Total seat finish and table base finish price is driven by highest price group selection.

Standard Includes		Required to Specify	
<ul style="list-style-type: none"> ▶ Need help? Product details, page 44 	<ul style="list-style-type: none"> Fully upholstered bench with attached table: fabric price group 1 31¹/₂" dia., 1" thick tabletop with square edge: High-Pressure Laminate price group 1 3 mm edgeband: plastic price group 1 Table base: fabric Two foot rails: polished chrome Plastic feet: black No power 	<ol style="list-style-type: none"> Style number Fabric color number for seat High-Pressure Laminate color number for tabletop Fabric color number for table base Plastic color number for edgeband Options, if selected (see below) <ul style="list-style-type: none"> ▶ See Product Understanding for Surface Materials. 	
Configuration	Options	U.S. Price	Required to Specify
	<ul style="list-style-type: none"> Upholstered Two tone upholstered 	<ul style="list-style-type: none"> No cost +\$ 214 	<ul style="list-style-type: none"> Specify <i>with upholstered</i>. Specify <i>with two tone upholstered</i>.
Surface Materials	Seat		
	<ul style="list-style-type: none"> Customer's Own Leather (COL) No cost Customer's Own Material (COM) No cost Fabric price group 1 No cost Fabric price group 2 +\$ 118 Fabric price group 3 +\$ 241 Fabric price group 4 +\$ 405 Fabric price group 5 +\$ 671 Fabric price group 6 +\$ 939 Fabric price group 7 +\$1281 Fabric price group 8 +\$1585 Fabric price group 9 +\$1852 Fabric price group 10 +\$2205 Leather price group 1 +\$ 255 Leather price group 2 +\$ 467 		<ul style="list-style-type: none"> ▶ See <i>Surface Materials Reference Manual</i>. ▶ See <i>Surface Materials Reference Manual</i>. Specify fabric color number. Specify fabric color number. Specify fabric color number. Specify fabric color number. Specify fabric color number. Specify fabric color number. Specify fabric color number. Specify fabric color number. Specify fabric color number. Specify fabric color number. Specify leather color number. Specify leather color number.
	Top		
	<ul style="list-style-type: none"> High-Pressure Laminate price group 1 No cost High-Pressure Laminate price group 2 +\$ 87 High-Pressure Laminate price group 3 +\$ 177 Open Line laminate (OLL) +\$ 111 plus cost of laminate 		<ul style="list-style-type: none"> Specify laminate color number. Specify laminate color number. Specify laminate color number. ▶ See <i>Surface Materials Reference Manual</i>.
	Table base		
	<ul style="list-style-type: none"> Customer's Own Leather (COL) No cost Customer's Own Material (COM) No cost Fabric price group 1 No cost Fabric price group 2 No cost Fabric price group 3 No cost Fabric price group 4 No cost Fabric price group 5 No cost Fabric price group 6 No cost Fabric price group 7 No cost Fabric price group 8 No cost Fabric price group 9 No cost Fabric price group 10 No cost Leather price group 1 No cost Leather price group 2 No cost 		<ul style="list-style-type: none"> ▶ See <i>Surface Materials Reference Manual</i>. ▶ See <i>Surface Materials Reference Manual</i>. Specify fabric color number. Specify fabric color number. Specify fabric color number. Specify fabric color number. Specify fabric color number. Specify fabric color number. Specify fabric color number. Specify fabric color number. Specify fabric color number. Specify fabric color number. Specify leather color number. Specify leather color number.
Top Size and Edge	<ul style="list-style-type: none"> 31¹/₂" top with square edge No cost 39³/₈" top with square edge +\$ 89 31¹/₂" top with tapered edge +\$ 279 39³/₈" top with tapered edge +\$ 364 		<ul style="list-style-type: none"> Specify <i>with 31¹/₂" top with square edge</i>. Specify <i>with 39³/₈" top with square edge</i>. Specify <i>with 31¹/₂" top with tapered edge</i>. Specify <i>with 39³/₈" top with tapered edge</i>.

▶ Options, continued on next page



For Canadian Pricing
Multiply U.S. Price by the Canadian price factor.
▶ See page 1 for details.

► Options, continued from previous page

	Options	U.S. Price	Required to Specify
Base Power/ Data Node	• No power/data required	No cost	Specify with no power/data.
	• 2 duplex outlets	+\$310	Specify with 2 duplex outlets.
	• Duplex outlets with HDMI video ports	+\$406	Specify with duplex outlets with HDMI video ports.
	• Duplex outlets with CAT6 data ports	+\$414	Specify with duplex outlets with CAT6 data ports.
	• Duplex outlets with USB data ports	+\$427	Specify with duplex outlets with USB data ports.

Tip: Select paint when specifying power.

Specification Information	
Style Number	U.S. Base Price
OBBORDER01	\$5413

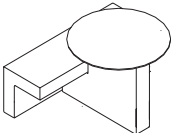

Specifying

 **For Canadian Pricing**
Multiply U.S. Price by the Canadian price factor.
► See page 1 for details.

Border Two Seat-Low with Attached Table

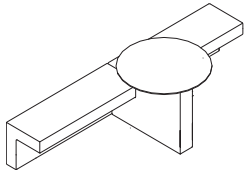

Tip: If two tone upholstered option is selected, contrasting price groups are available. Total seat finish and table base finish price is driven by highest price group selection.

Standard Includes		Required to Specify	
▶ Need help? Product details, page 44	<ul style="list-style-type: none"> Fully upholstered bench with attached table: fabric price group 1 31½" dia., 1" thick tabletop with square edge: High-Pressure Laminate price group 1 3 mm edgeband: plastic price group 1 Two foot rails: polished chrome Plastic feet: black No power 	<ol style="list-style-type: none"> Style number Fabric color number for seat High-Pressure Laminate color number for tabletop Plastic color number for edgeband Options, if selected (see below) 	▶ See Product Understanding for Surface Materials.
Configuration	Options	U.S. Price	Required to Specify
	<ul style="list-style-type: none"> Upholstered Two tone upholstered 	<ul style="list-style-type: none"> No cost +\$ 214 	<ul style="list-style-type: none"> Specify with upholstered. Specify with two tone upholstered.
Surface Materials	Seat		
	<ul style="list-style-type: none"> Customer's Own Leather (COL) Customer's Own Material (COM) Fabric price group 1 Fabric price group 2 Fabric price group 3 Fabric price group 4 Fabric price group 5 Fabric price group 6 Fabric price group 7 Fabric price group 8 Fabric price group 9 Fabric price group 10 Leather price group 1 Leather price group 2 	<ul style="list-style-type: none"> No cost No cost No cost +\$ 177 +\$ 361 +\$ 607 +\$1008 +\$1406 +\$1921 +\$2376 +\$2777 +\$3305 +\$ 416 +\$ 770 	<ul style="list-style-type: none"> ▶ See Surface Materials Reference Manual. ▶ See Surface Materials Reference Manual. Specify fabric color number. Specify fabric color number. Specify fabric color number. Specify fabric color number. Specify fabric color number. Specify fabric color number. Specify fabric color number. Specify fabric color number. Specify fabric color number. Specify fabric color number. Specify leather color number. Specify leather color number.
	Table base		
	<ul style="list-style-type: none"> Customer's Own Leather (COL) Customer's Own Material (COM) Fabric price group 1 Fabric price group 2 Fabric price group 3 Fabric price group 4 Fabric price group 5 Fabric price group 6 Fabric price group 7 Fabric price group 8 Fabric price group 9 Fabric price group 10 Leather price group 1 Leather price group 2 	<ul style="list-style-type: none"> No cost No cost No cost No cost No cost No cost No cost No cost No cost No cost No cost No cost No cost No cost 	<ul style="list-style-type: none"> ▶ See Surface Materials Reference Manual. ▶ See Surface Materials Reference Manual. Specify fabric color number. Specify fabric color number. Specify fabric color number. Specify fabric color number. Specify fabric color number. Specify fabric color number. Specify fabric color number. Specify fabric color number. Specify fabric color number. Specify fabric color number. Specify leather color number. Specify leather color number.
	Top		
	<ul style="list-style-type: none"> High-Pressure Laminate price group 1 High-Pressure Laminate price group 2 High-Pressure Laminate price group 3 Open Line laminate (OLL) 	<ul style="list-style-type: none"> No cost +\$ 87 +\$ 177 +\$ 111 plus cost of laminate 	<ul style="list-style-type: none"> Specify laminate color number. Specify laminate color number. Specify laminate color number. ▶ See Surface Materials Reference Manual.
Top Size and Edge	<ul style="list-style-type: none"> 31½" top with square edge 39⅜" top with square edge 31½" top with tapered edge 39⅜" top with tapered edge 	<ul style="list-style-type: none"> No cost +\$ 89 +\$ 279 +\$ 364 	<ul style="list-style-type: none"> Specify with 31½" top with square edge. Specify with 39⅜" top with square edge. Specify with 31½" top with tapered edge. Specify with 39⅜" top with tapered edge.

▶ Options, continued on next page



For Canadian Pricing
Multiply U.S. Price by the Canadian price factor.
▶ See page 1 for details.

► Options, continued from previous page

Options	U.S. Price	Required to Specify
Base Power/ Data Node		
• No power/data required	No cost	Specify with no power/data.
• 2 duplex outlets	+\$310	Specify with 2 duplex outlets.
• Duplex outlets with HDMI video ports	+\$406	Specify with duplex outlets with HDMI video ports.
• Duplex outlets with CAT6 data ports	+\$414	Specify with duplex outlets with CAT6 data ports.
• Duplex outlets with USB data ports	+\$427	Specify with duplex outlets with USB data ports.

Tip: Select paint when specifying power.

Specification Information

Style Number	U.S. Base Price
OBBORDER02	\$7300

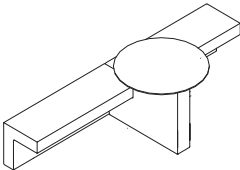

Specifying



For Canadian Pricing
Multiply U.S. Price by the Canadian price factor.
► See page 1 for details.

Border One Seat-High with Attached Table

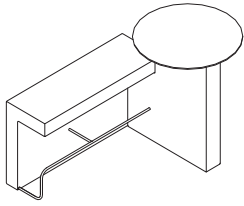

Tip: If two tone upholstered option is selected, contrasting price groups are available. Total seat finish and table base finish price is driven by highest price group selection.

Standard Includes		Required to Specify	
<ul style="list-style-type: none"> ▶ Need help? Product details, page 44 	<ul style="list-style-type: none"> Fully upholstered bench with attached table: fabric price group 1 31½" dia., 1" thick tabletop with square edge: High-Pressure Laminate price group 1 3 mm edgeband on user's side: plastic price group 1 Foot rail: polished chrome Plastic feet: black No power 	<ol style="list-style-type: none"> Style number Fabric color number for seat High-Pressure Laminate color number for tabletop Plastic color number for edgeband Options, if selected (see below) <ul style="list-style-type: none"> ▶ See Product Understanding for Surface Materials. 	
Configuration	Options	U.S. Price	Required to Specify
	<ul style="list-style-type: none"> Upholstered Two tone upholstered 	<ul style="list-style-type: none"> No cost +\$ 214 	<ul style="list-style-type: none"> Specify with upholstered. Specify with two tone upholstered.
Surface Materials	Seat		
	<ul style="list-style-type: none"> Customer's Own Leather (COL) Customer's Own Material (COM) Fabric price group 1 Fabric price group 2 Fabric price group 3 Fabric price group 4 Fabric price group 5 Fabric price group 6 Fabric price group 7 Fabric price group 8 Fabric price group 9 Fabric price group 10 Leather price group 1 Leather price group 2 	<ul style="list-style-type: none"> No cost No cost No cost +\$ 165 +\$ 330 +\$ 556 +\$ 922 +\$1287 +\$1759 +\$2179 +\$2544 +\$3030 +\$ 354 +\$ 652 	<ul style="list-style-type: none"> ▶ See Surface Materials Reference Manual. ▶ See Surface Materials Reference Manual. Specify fabric color number. Specify fabric color number. Specify fabric color number. Specify fabric color number. Specify fabric color number. Specify fabric color number. Specify fabric color number. Specify fabric color number. Specify fabric color number. Specify fabric color number. Specify fabric color number. Specify leather color number. Specify leather color number.
	Table base		
	<ul style="list-style-type: none"> Customer's Own Leather (COL) Customer's Own Material (COM) Fabric price group 1 Fabric price group 2 Fabric price group 3 Fabric price group 4 Fabric price group 5 Fabric price group 6 Fabric price group 7 Fabric price group 8 Fabric price group 9 Fabric price group 10 Leather price group 1 Leather price group 2 	<ul style="list-style-type: none"> No cost No cost No cost No cost No cost No cost No cost No cost No cost No cost No cost No cost No cost No cost 	<ul style="list-style-type: none"> ▶ See Surface Materials Reference Manual. ▶ See Surface Materials Reference Manual. Specify fabric color number. Specify fabric color number. Specify fabric color number. Specify fabric color number. Specify fabric color number. Specify fabric color number. Specify fabric color number. Specify fabric color number. Specify fabric color number. Specify fabric color number. Specify leather color number. Specify leather color number.
	Top		
	<ul style="list-style-type: none"> High-Pressure Laminate price group 1 High-Pressure Laminate price group 2 High-Pressure Laminate price group 3 Open Line laminate (OLL) 	<ul style="list-style-type: none"> No cost +\$ 87 +\$ 177 +\$ 111 plus cost of laminate 	<ul style="list-style-type: none"> Specify laminate color number. Specify laminate color number. Specify laminate color number. ▶ See Surface Materials Reference Manual.
Top Size and Edge	<ul style="list-style-type: none"> 31½" top with square edge 39⅜" top with square edge 31½" top with tapered edge 39⅜" top with tapered edge 	<ul style="list-style-type: none"> No cost +\$ 89 +\$ 279 +\$ 364 	<ul style="list-style-type: none"> Specify with 31½" top with square edge. Specify with 39⅜" top with square edge. Specify with 31½" top with tapered edge. Specify with 39⅜" top with tapered edge.

▶ Options, continued on next page



For Canadian Pricing
Multiply U.S. Price by the Canadian price factor.
▶ See page 1 for details.

► Options, continued from previous page

	Options	U.S. Price	Required to Specify
Base Power/ Data Node	• No power/data required	No cost	Specify with no power/data.
	• 2 duplex outlets	+\$310	Specify with 2 duplex outlets.
	• Duplex outlets with HDMI video ports	+\$406	Specify with duplex outlets with HDMI video ports.
	• Duplex outlets with CAT6 data ports	+\$414	Specify with duplex outlets with CAT6 data ports.
	• Duplex outlets with USB data ports	+\$427	Specify with duplex outlets with USB data ports.

Tip: Select paint when specifying power.

Specification Information

Style Number	U.S. Base Price
OBBORDER03	\$6356
OBBORDER04	\$6356

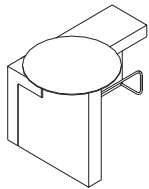
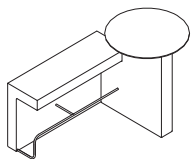

Specifying

 **For Canadian Pricing**
Multiply U.S. Price by the Canadian price factor.
► See page 1 for details.

Border Two Seat-High with Attached Table

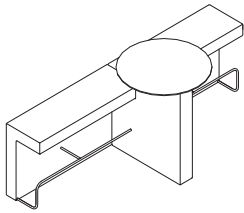

Tip: If two tone upholstered option is selected, contrasting price groups are available. Total seat finish and table base finish price is driven by highest price group selection.

Standard Includes		Required to Specify	
<ul style="list-style-type: none"> ▶ Need help? Product details, page 44 	<ul style="list-style-type: none"> Fully upholstered bench with attached table: fabric price group 1 31½" dia., 1" thick tabletop with square edge: High-Pressure Laminate price group 1 3 mm edgeband on user's side: plastic price group 1 Foot rail: polished chrome Plastic feet: black No power 	<ol style="list-style-type: none"> Style number Fabric color number for seat High-Pressure Laminate color number for tabletop Plastic color number for edgeband Options, if selected (see below) <ul style="list-style-type: none"> ▶ See Product Understanding for Surface Materials. 	
Configuration	Options	U.S. Price	Required to Specify
	<ul style="list-style-type: none"> Upholstered Two tone upholstered 	<ul style="list-style-type: none"> No cost +\$ 214 	<ul style="list-style-type: none"> Specify with upholstered. Specify with two tone upholstered.
Surface Materials	Seat		
	<ul style="list-style-type: none"> Customer's Own Leather (COL) Customer's Own Material (COM) Fabric price group 1 Fabric price group 2 Fabric price group 3 Fabric price group 4 Fabric price group 5 Fabric price group 6 Fabric price group 7 Fabric price group 8 Fabric price group 9 Fabric price group 10 Leather price group 1 Leather price group 2 	<ul style="list-style-type: none"> No cost No cost No cost +\$ 241 +\$ 485 +\$ 820 +\$1359 +\$1898 +\$2593 +\$3208 +\$3748 +\$4464 +\$ 575 +\$1067 	<ul style="list-style-type: none"> ▶ See Surface Materials Reference Manual. ▶ See Surface Materials Reference Manual. Specify fabric color number. Specify fabric color number. Specify fabric color number. Specify fabric color number. Specify fabric color number. Specify fabric color number. Specify fabric color number. Specify fabric color number. Specify fabric color number. Specify fabric color number. Specify leather color number. Specify leather color number.
	Table base		
	<ul style="list-style-type: none"> Customer's Own Leather (COL) Customer's Own Material (COM) Fabric price group 1 Fabric price group 2 Fabric price group 3 Fabric price group 4 Fabric price group 5 Fabric price group 6 Fabric price group 7 Fabric price group 8 Fabric price group 9 Fabric price group 10 Leather price group 1 Leather price group 2 	<ul style="list-style-type: none"> No cost No cost No cost No cost No cost No cost No cost No cost No cost No cost No cost No cost No cost No cost 	<ul style="list-style-type: none"> ▶ See Surface Materials Reference Manual. ▶ See Surface Materials Reference Manual. Specify fabric color number. Specify fabric color number. Specify fabric color number. Specify fabric color number. Specify fabric color number. Specify fabric color number. Specify fabric color number. Specify fabric color number. Specify fabric color number. Specify fabric color number. Specify leather color number. Specify leather color number.
	Top		
	<ul style="list-style-type: none"> High-Pressure Laminate price group 1 High-Pressure Laminate price group 2 High-Pressure Laminate price group 3 Open Line laminate (OLL) 	<ul style="list-style-type: none"> No cost +\$ 87 +\$ 177 +\$ 111 plus cost of laminate 	<ul style="list-style-type: none"> Specify laminate color number. Specify laminate color number. Specify laminate color number. ▶ See Surface Materials Reference Manual.
Top Size and Edge	<ul style="list-style-type: none"> 31½" top with square edge 39⅜" top with square edge 31½" top with tapered edge 39⅜" top with tapered edge 	<ul style="list-style-type: none"> No cost +\$ 89 +\$ 279 +\$ 364 	<ul style="list-style-type: none"> Specify with 31½" top with square edge. Specify with 39⅜" top with square edge. Specify with 31½" top with tapered edge. Specify with 39⅜" top with tapered edge.

▶ Options, continued on next page



For Canadian Pricing
Multiply U.S. Price by the Canadian price factor.
▶ See page 1 for details.

► Options, continued from previous page

Tip: Select paint when specifying power.

	Options	U.S. Price	Required to Specify
Base Power/ Data Node	• No power/data required	No cost	Specify with no power/data.
	• 2 duplex outlets	+\$310	Specify with 2 duplex outlets.
	• Duplex outlets with HDMI video ports	+\$406	Specify with duplex outlets with HDMI video ports.
	• Duplex outlets with CAT6 data ports	+\$414	Specify with duplex outlets with CAT6 data ports.
	• Duplex outlets with USB data ports	+\$427	Specify with duplex outlets with USB data ports.

Specification Information	
Style Number	U.S. Base Price
OBBORDER05	\$9464

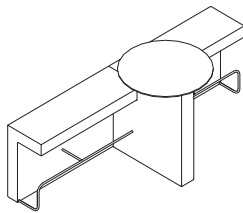

Specifying

 **For Canadian Pricing**
Multiply U.S. Price by the Canadian price factor.
► See page 1 for details.

Away from the Desk 31½"W Modular Straight Seat

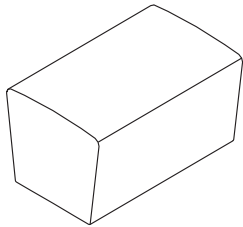

Tip: Customer's Own Material (COM) is available at a price group 1.

Standard Includes		Required to Specify
<ul style="list-style-type: none"> ▶ Need help? Product details, page 46 	<ul style="list-style-type: none"> • Fully upholstered seat: fabric price group 1 • Adjustable glides: black • Linking brackets 	<ul style="list-style-type: none"> 1 Style number 2 Fabric color number for seat 3 Options, if selected (see below) ▶ See Product Understanding for Surface Materials.

Options	U.S. Price	Required to Specify
Surface Materials	Seat <ul style="list-style-type: none"> • Fabric price group 1 No cost • Fabric price group 2 +\$ 44 • Fabric price group 3 +\$ 90 • Fabric price group 4 +\$152 • Fabric price group 5 +\$252 • Fabric price group 6 +\$351 • Fabric price group 7 +\$480 • Fabric price group 8 +\$593 • Fabric price group 9 +\$695 • Fabric price group 10 +\$826 	<ul style="list-style-type: none"> Specify fabric color number. Specify fabric color number. Specify fabric color number. Specify fabric color number. Specify fabric color number. Specify fabric color number. Specify fabric color number. Specify fabric color number. Specify fabric color number. Specify fabric color number.
Left End Configuration <ul style="list-style-type: none"> • Connecting unit • Open 	<ul style="list-style-type: none"> No cost No cost 	<ul style="list-style-type: none"> Specify <i>with connecting unit</i>. Specify <i>with open</i>.
Right End Configuration <ul style="list-style-type: none"> • Connecting unit • Open 	<ul style="list-style-type: none"> No cost No cost 	<ul style="list-style-type: none"> Specify <i>with connecting unit</i>. Specify <i>with open</i>.

Specification Information	
• Style Number	• U.S. Base Price
OBAD01	\$2237
.	.
.	.

 **For Canadian Pricing**
 Multiply U.S. Price by the Canadian price factor.
 ▶ See page 1 for details.

Away from the Desk 31¹/₂"W Modular Straight Seat with Back

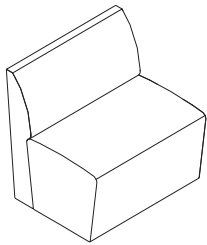

Tip: Customer's Own Material (COM) is available at a price group 1.

Standard Includes		Required to Specify
<ul style="list-style-type: none"> ▶ Need help? Product details, page 46 	<ul style="list-style-type: none"> Fully upholstered seat with back: fabric price group 1 Adjustable glides: black Linking brackets 	<ul style="list-style-type: none"> 1 Style number 2 Fabric color number for seat 3 Options, if selected (see below) ▶ See Product Understanding for Surface Materials.

Options	U.S. Price	Required to Specify
Surface Materials		
Seat		
• Fabric price group 1	No cost	Specify fabric color number.
• Fabric price group 2	+\$ 44	Specify fabric color number.
• Fabric price group 3	+\$ 90	Specify fabric color number.
• Fabric price group 4	+\$152	Specify fabric color number.
• Fabric price group 5	+\$252	Specify fabric color number.
• Fabric price group 6	+\$351	Specify fabric color number.
• Fabric price group 7	+\$480	Specify fabric color number.
• Fabric price group 8	+\$593	Specify fabric color number.
• Fabric price group 9	+\$695	Specify fabric color number.
• Fabric price group 10	+\$826	Specify fabric color number.
Backrest outer		
• Fabric price group 1	No cost	Specify fabric color number.
• Fabric price group 2	+\$ 52	Specify fabric color number.
• Fabric price group 3	+\$104	Specify fabric color number.
• Fabric price group 4	+\$175	Specify fabric color number.
• Fabric price group 5	+\$289	Specify fabric color number.
• Fabric price group 6	+\$406	Specify fabric color number.
• Fabric price group 7	+\$555	Specify fabric color number.
• Fabric price group 8	+\$687	Specify fabric color number.
• Fabric price group 9	+\$802	Specify fabric color number.
• Fabric price group 10	+\$955	Specify fabric color number.
Backrest inner		
• Fabric price group 1	No cost	Specify fabric color number.
• Fabric price group 2	+\$ 39	Specify fabric color number.
• Fabric price group 3	+\$ 81	Specify fabric color number.
• Fabric price group 4	+\$134	Specify fabric color number.
• Fabric price group 5	+\$223	Specify fabric color number.
• Fabric price group 6	+\$311	Specify fabric color number.
• Fabric price group 7	+\$427	Specify fabric color number.
• Fabric price group 8	+\$526	Specify fabric color number.
• Fabric price group 9	+\$617	Specify fabric color number.
• Fabric price group 10	+\$734	Specify fabric color number.
Left arm		
• Fabric price group 1	No cost	Specify fabric color number.
• Fabric price group 2	+\$ 52	Specify fabric color number.
• Fabric price group 3	+\$104	Specify fabric color number.
• Fabric price group 4	+\$175	Specify fabric color number.
• Fabric price group 5	+\$289	Specify fabric color number.
• Fabric price group 6	+\$406	Specify fabric color number.
• Fabric price group 7	+\$555	Specify fabric color number.
• Fabric price group 8	+\$687	Specify fabric color number.
• Fabric price group 9	+\$802	Specify fabric color number.
• Fabric price group 10	+\$955	Specify fabric color number.
Left tablet top		
• High-Pressure Laminate price group 1	No cost	Specify laminate color number.
• High-Pressure Laminate price group 2	+\$ 82	Specify laminate color number.
• High-Pressure Laminate price group 3	+\$167	Specify laminate color number.
• Open Line laminate (OLL)	+\$111 plus cost of laminate	▶ See <i>Surface Materials Reference Manual</i> .

▶ Options, continued on next page

 **For Canadian Pricing**
Multiply U.S. Price by the Canadian price factor.
▶ See page 1 for details.

► Options, continued from previous page

	Options	U.S. Price	Required to Specify
Surface Materials, continued	Right arm		
	• Fabric price group 1	No cost	Specify fabric color number.
	• Fabric price group 2	+\$ 52	Specify fabric color number.
	• Fabric price group 3	+\$ 104	Specify fabric color number.
	• Fabric price group 4	+\$ 175	Specify fabric color number.
	• Fabric price group 5	+\$ 289	Specify fabric color number.
	• Fabric price group 6	+\$ 406	Specify fabric color number.
	• Fabric price group 7	+\$ 555	Specify fabric color number.
	• Fabric price group 8	+\$ 687	Specify fabric color number.
	• Fabric price group 9	+\$ 802	Specify fabric color number.
	• Fabric price group 10	+\$ 955	Specify fabric color number.
	Right tablet top		
	• High-Pressure Laminate price group 1	No cost	Specify laminate color number.
	• High-Pressure Laminate price group 2	+\$ 82	Specify laminate color number.
	• High-Pressure Laminate price group 3	+\$ 167	Specify laminate color number.
	• Open Line laminate (OLL)	+\$ 111 plus cost of laminate	► See <i>Surface Materials Reference Manual</i> .
Left End Configuration	• Connecting unit	No cost	Specify with <i>connecting unit</i> .
	• Open	No cost	Specify with <i>open unit</i> .
	• AD-61 LA upholstered left hand arm	+\$1326	Specify with <i>upholstered left hand arm</i> .
	• AD-62 LC upholstered left hand arm with tablet	+\$2837	Specify with <i>upholstered left hand arm with tablet</i> .
Left Arm Power/Data Node	• No power/data	No cost	Specify with <i>no power/data</i> .
	• 2 duplex outlets	+\$ 310	Specify with <i>2 duplex outlets</i> .
	• Duplex outlet with HDMI video ports	+\$ 406	Specify with <i>duplex outlets with HDMI video ports</i> .
	• Duplex outlet with CAT6 data ports	+\$ 414	Specify with <i>duplex outlets with CAT6 data ports</i> .
	• Duplex outlet with USB data ports	+\$ 427	Specify with <i>duplex outlets with USB data ports</i> .
Right End Configuration	• Connecting unit	No cost	Specify with <i>connecting unit</i> .
	• Open	No cost	Specify with <i>open unit</i> .
	• AD-61 RA upholstered right hand arm	+\$1326	Specify with <i>upholstered right hand arm</i> .
	• AD-62 RC upholstered right hand arm with tablet	+\$2837	Specify with <i>upholstered right hand arm with tablet</i> .
Right Arm Power/Data Node	• No power/data	No cost	Specify with <i>no power/data</i> .
	• 2 duplex outlets	+\$ 310	Specify with <i>2 duplex outlets</i> .
	• Duplex outlet with HDMI video ports	+\$ 406	Specify with <i>duplex outlets with HDMI video ports</i> .
	• Duplex outlet with CAT6 data ports	+\$ 414	Specify with <i>duplex outlets with CAT6 data ports</i> .
	• Duplex outlet with USB data ports	+\$ 427	Specify with <i>duplex outlets with USB data ports</i> .

Tip: Tablet is selectable on one end only.

Tip: The AD-62LC option can only be specified on an **OBAD02** when it is connected to another unit and part of a larger configuration.

Tip: Select paint when specifying power.

Tip: The AD-62RC option can only be specified on an **OBAD02** when it is connected to another unit and part of a larger configuration.

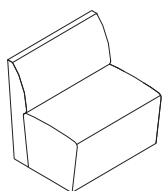

Specification Information

Style Number	U.S. Base Price
OBAD02	\$3841

Away from the Desk 31¹/₂"W Modular Straight Seat with Back and Screen

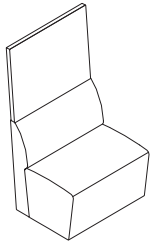

Tip: Customer's Own Material (COM) is available at a price group 1.

Tip: **OBAD03**, **OBAD03LC**, and **OBAD03RC** are not stand-alone units and must connect to another unit as part of a larger configuration.

Standard Includes	Required to Specify
<ul style="list-style-type: none"> ▶ Need help? Product details, page 46 Fully upholstered seat, back, and screen: fabric price group 1 Adjustable glides: black Linking brackets 	<ol style="list-style-type: none"> Style number Fabric color number for seat, back, and screen Options, if selected (see below) <ul style="list-style-type: none"> ▶ See Product Understanding for Surface Materials.

Surface Materials	Options	U.S. Price	Required to Specify
	Seat		
	• Fabric price group 1	No cost	Specify fabric color number.
	• Fabric price group 2	+\$ 44	Specify fabric color number.
	• Fabric price group 3	+\$ 90	Specify fabric color number.
	• Fabric price group 4	+\$152	Specify fabric color number.
	• Fabric price group 5	+\$252	Specify fabric color number.
	• Fabric price group 6	+\$351	Specify fabric color number.
	• Fabric price group 7	+\$480	Specify fabric color number.
	• Fabric price group 8	+\$593	Specify fabric color number.
	• Fabric price group 9	+\$695	Specify fabric color number.
	• Fabric price group 10	+\$826	Specify fabric color number.
	Backrest outer		
	• Fabric price group 1	No cost	Specify fabric color number.
	• Fabric price group 2	+\$ 52	Specify fabric color number.
	• Fabric price group 3	+\$104	Specify fabric color number.
	• Fabric price group 4	+\$175	Specify fabric color number.
	• Fabric price group 5	+\$289	Specify fabric color number.
	• Fabric price group 6	+\$406	Specify fabric color number.
	• Fabric price group 7	+\$555	Specify fabric color number.
	• Fabric price group 8	+\$687	Specify fabric color number.
	• Fabric price group 9	+\$802	Specify fabric color number.
	• Fabric price group 10	+\$955	Specify fabric color number.
	Backrest inner		
	• Fabric price group 1	No cost	Specify fabric color number.
	• Fabric price group 2	+\$ 39	Specify fabric color number.
	• Fabric price group 3	+\$ 81	Specify fabric color number.
	• Fabric price group 4	+\$134	Specify fabric color number.
	• Fabric price group 5	+\$223	Specify fabric color number.
	• Fabric price group 6	+\$311	Specify fabric color number.
	• Fabric price group 7	+\$427	Specify fabric color number.
	• Fabric price group 8	+\$526	Specify fabric color number.
	• Fabric price group 9	+\$617	Specify fabric color number.
	• Fabric price group 10	+\$734	Specify fabric color number.
	Left arm		
	• Fabric price group 1	No cost	Specify fabric color number.
	• Fabric price group 2	+\$ 52	Specify fabric color number.
	• Fabric price group 3	+\$104	Specify fabric color number.
	• Fabric price group 4	+\$175	Specify fabric color number.
	• Fabric price group 5	+\$289	Specify fabric color number.
	• Fabric price group 6	+\$406	Specify fabric color number.
	• Fabric price group 7	+\$555	Specify fabric color number.
	• Fabric price group 8	+\$687	Specify fabric color number.
	• Fabric price group 9	+\$802	Specify fabric color number.
	• Fabric price group 10	+\$955	Specify fabric color number.
	Left tablet top		
	• High-Pressure Laminate price group 1	No cost	Specify laminate color number.
	• High-Pressure Laminate price group 2	+\$ 82	Specify laminate color number.
	• High-Pressure Laminate price group 3	+\$167	Specify laminate color number.
	• Open Line laminate (OLL)	+\$111 plus cost of laminate	

▶ See *Surface Materials Reference Manual*.

▶ **Options, continued on next page**



For Canadian Pricing
Multiply U.S. Price by the Canadian price factor.
▶ See page 1 for details.

► Options, continued from previous page

	Options	U.S. Price	Required to Specify
Surface Materials, continued	Right arm		
	• Fabric price group 1	No cost	Specify fabric color number.
	• Fabric price group 2	+\$ 52	Specify fabric color number.
	• Fabric price group 3	+\$ 104	Specify fabric color number.
	• Fabric price group 4	+\$ 175	Specify fabric color number.
	• Fabric price group 5	+\$ 289	Specify fabric color number.
	• Fabric price group 6	+\$ 406	Specify fabric color number.
	• Fabric price group 7	+\$ 555	Specify fabric color number.
	• Fabric price group 8	+\$ 687	Specify fabric color number.
	• Fabric price group 9	+\$ 802	Specify fabric color number.
	• Fabric price group 10	+\$ 955	Specify fabric color number.
	Right tablet top		
	• High-Pressure Laminate price group 1	No cost	Specify laminate color number.
	• High-Pressure Laminate price group 2	+\$ 82	Specify laminate color number.
	• High-Pressure Laminate price group 3	+\$ 167	Specify laminate color number.
	• Open Line laminate (OLL)	+\$ 111 plus cost of laminate	► See <i>Surface Materials Reference Manual</i> .
Screen Connection	• No screen connections	No cost	Specify <i>with no screen connection</i> .
	• Screen connection left	No cost	Specify <i>with left screen connection</i> .
	• Screen connection left and right	No cost	Specify <i>with left and right screen connection</i> .
	• Screen connection right	No cost	Specify <i>with right screen connection</i> .
Left End Configuration	• Connecting unit	No cost	Specify <i>with connecting unit</i> .
	• Open	No cost	Specify <i>with open unit</i> .
	• AD-61 LA upholstered left hand arm	+\$1326	Specify <i>with upholstered left hand arm</i> .
	• AD-62 LC upholstered left hand arm with tablet	+\$2837	Specify <i>with upholstered left hand arm with tablet</i> .
Left Arm Power/Data Node	• No power/data	No cost	Specify <i>with no power/data</i> .
	• 2 duplex outlets	+\$ 310	Specify <i>with 2 duplex outlets</i> .
	• Duplex outlet with HDMI video ports	+\$ 406	Specify <i>with duplex outlets with HDMI video ports</i> .
	• Duplex outlet with CAT6 data ports	+\$ 414	Specify <i>with duplex outlets with CAT6 data ports</i> .
	• Duplex outlet with USB data ports	+\$ 427	Specify <i>with duplex outlets with USB data ports</i> .
Right End Configuration	• Connecting unit	No cost	Specify <i>with connecting unit</i> .
	• Open	No cost	Specify <i>with open unit</i> .
	• AD-61 RA upholstered right hand arm	+\$1326	Specify <i>with upholstered right hand arm</i> .
	• AD-62 RC upholstered right hand arm with tablet	+\$2837	Specify <i>with upholstered right hand arm with tablet</i> .
Right Arm Power/Data Node	• No power/data	No cost	Specify <i>with no power/data</i> .
	• 2 duplex outlets	+\$ 310	Specify <i>with 2 duplex outlets</i> .
	• Duplex outlet with HDMI video ports	+\$ 406	Specify <i>with duplex outlets with HDMI video ports</i> .
	• Duplex outlet with CAT6 data ports	+\$ 414	Specify <i>with duplex outlets with CAT6 data ports</i> .
	• Duplex outlet with USB data ports	+\$ 427	Specify <i>with duplex outlets with USB data ports</i> .

Tip: Tablet is selectable on one end only.

Tip: The AD-62LC option can only be specified on an **OBAD02** when it is connected to another unit and part of a larger configuration.

Tip: Select paint when specifying power.

Tip: The AD-62RC option can only be specified on an **OBAD02** when it is connected to another unit and part of a larger configuration.

► Specification Information, on next page



For Canadian Pricing

Multiply U.S. Price by the Canadian price factor.

► See page 1 for details.

► Options, on previous page

Specification Information

• Style Number	U.S. Base Prices									
	• Screen Price Groups									
	1	2	3	4	5	6	7	8	9	10

31¹/₂"W Modular Straight Seat with Back and Screen

OBAD03	\$5170	\$5223	\$5279	\$5351	\$5472	\$5591	\$5747	\$5882	\$6005	\$6163
---------------	--------	--------	--------	--------	--------	--------	--------	--------	--------	--------

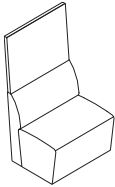

31¹/₂"W Modular Straight Seat with Back and Left Hand Tapered Screen

OBAD03LC	\$5110	\$5149	\$5191	\$5244	\$5333	\$5421	\$5537	\$5636	\$5727	\$5844
-----------------	--------	--------	--------	--------	--------	--------	--------	--------	--------	--------

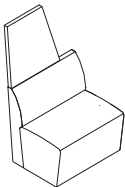

31¹/₂"W Modular Straight Seat with Back and Right Hand Tapered Screen

OBAD03RC	\$5110	\$5149	\$5191	\$5244	\$5333	\$5421	\$5537	\$5636	\$5727	\$5844
-----------------	--------	--------	--------	--------	--------	--------	--------	--------	--------	--------

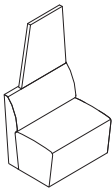

For Canadian Pricing

Multiply U.S. Price by the Canadian price factor.

► See page 1 for details.

Away from the Desk 70⁷/₈"W Modular Straight Seat

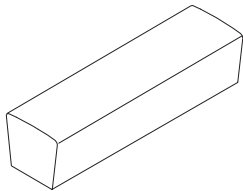

Tip: Customer's Own Material (COM) is available at a price group 1.

Standard Includes		Required to Specify
<ul style="list-style-type: none"> ▶ Need help? Product details, page 46 	<ul style="list-style-type: none"> Fully upholstered seat: fabric price group 1 Adjustable glides: black Linking brackets 	<ul style="list-style-type: none"> 1 Style number 2 Fabric color number for seat 3 Options, if selected (see below) ▶ See Product Understanding for Surface Materials.

Options	U.S. Price	Required to Specify	
Surface Materials	Seat <ul style="list-style-type: none"> Fabric price group 1 Fabric price group 2 Fabric price group 3 Fabric price group 4 Fabric price group 5 Fabric price group 6 Fabric price group 7 Fabric price group 8 Fabric price group 9 Fabric price group 10 	<ul style="list-style-type: none"> No cost +\$ 75 +\$ 149 +\$ 253 +\$ 419 +\$ 587 +\$ 799 +\$ 992 +\$1157 +\$1377 	<ul style="list-style-type: none"> Specify fabric color number. Specify fabric color number. Specify fabric color number. Specify fabric color number. Specify fabric color number. Specify fabric color number. Specify fabric color number. Specify fabric color number. Specify fabric color number. Specify fabric color number.
Left End Configuration	<ul style="list-style-type: none"> Connecting unit Open 	<ul style="list-style-type: none"> No cost No cost 	<ul style="list-style-type: none"> Specify <i>with connecting unit</i>. Specify <i>with open</i>.
Right End Configuration	<ul style="list-style-type: none"> Connecting unit Open 	<ul style="list-style-type: none"> No cost No cost 	<ul style="list-style-type: none"> Specify <i>with connecting unit</i>. Specify <i>with open</i>.

Specification Information	
Style Number	U.S. Base Price
OBAD11	\$3123

 **For Canadian Pricing**
 Multiply U.S. Price by the Canadian price factor.
 ▶ See page 1 for details.

Away from the Desk 70⁷/₈"W Modular Straight Seat with Back

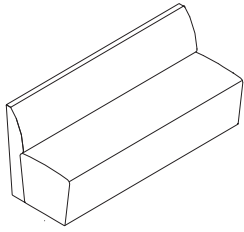

Tip: Customer's Own Material (COM) is available at a price group 1.

Standard Includes		Required to Specify
<ul style="list-style-type: none"> ▶ Need help? Product details, page 46 	<ul style="list-style-type: none"> Fully upholstered seat with back: fabric price group 1 Adjustable glides: black Linking brackets 	<ol style="list-style-type: none"> 1 Style number 2 Fabric color number for seat and back 3 Options, if selected (see below) <ul style="list-style-type: none"> ▶ See Product Understanding for Surface Materials.

Options	U.S. Price	Required to Specify
Surface Materials		
Seat		
• Fabric price group 1	No cost	Specify fabric color number.
• Fabric price group 2	+\$ 75	Specify fabric color number.
• Fabric price group 3	+\$ 149	Specify fabric color number.
• Fabric price group 4	+\$ 253	Specify fabric color number.
• Fabric price group 5	+\$ 419	Specify fabric color number.
• Fabric price group 6	+\$ 587	Specify fabric color number.
• Fabric price group 7	+\$ 799	Specify fabric color number.
• Fabric price group 8	+\$ 992	Specify fabric color number.
• Fabric price group 9	+\$1157	Specify fabric color number.
• Fabric price group 10	+\$1377	Specify fabric color number.
Backrest outer		
• Fabric price group 1	No cost	Specify fabric color number.
• Fabric price group 2	+\$ 71	Specify fabric color number.
• Fabric price group 3	+\$ 145	Specify fabric color number.
• Fabric price group 4	+\$ 244	Specify fabric color number.
• Fabric price group 5	+\$ 402	Specify fabric color number.
• Fabric price group 6	+\$ 561	Specify fabric color number.
• Fabric price group 7	+\$ 768	Specify fabric color number.
• Fabric price group 8	+\$ 952	Specify fabric color number.
• Fabric price group 9	+\$1111	Specify fabric color number.
• Fabric price group 10	+\$1323	Specify fabric color number.
Backrest inner		
• Fabric price group 1	No cost	Specify fabric color number.
• Fabric price group 2	+\$ 42	Specify fabric color number.
• Fabric price group 3	+\$ 89	Specify fabric color number.
• Fabric price group 4	+\$ 148	Specify fabric color number.
• Fabric price group 5	+\$ 246	Specify fabric color number.
• Fabric price group 6	+\$ 343	Specify fabric color number.
• Fabric price group 7	+\$ 469	Specify fabric color number.
• Fabric price group 8	+\$ 580	Specify fabric color number.
• Fabric price group 9	+\$ 678	Specify fabric color number.
• Fabric price group 10	+\$ 808	Specify fabric color number.
Left arm		
• Fabric price group 1	No cost	Specify fabric color number.
• Fabric price group 2	+\$ 52	Specify fabric color number.
• Fabric price group 3	+\$ 104	Specify fabric color number.
• Fabric price group 4	+\$ 175	Specify fabric color number.
• Fabric price group 5	+\$ 289	Specify fabric color number.
• Fabric price group 6	+\$ 406	Specify fabric color number.
• Fabric price group 7	+\$ 555	Specify fabric color number.
• Fabric price group 8	+\$ 687	Specify fabric color number.
• Fabric price group 9	+\$ 802	Specify fabric color number.
• Fabric price group 10	+\$ 955	Specify fabric color number.
Left tablet top		
• High-Pressure Laminate price group 1	No cost	Specify laminate color number.
• High-Pressure Laminate price group 2	+\$ 82	Specify laminate color number.
• High-Pressure Laminate price group 3	+\$ 167	Specify laminate color number.
• Open Line laminate (OLL)	+\$ 111 plus cost of laminate	▶ See <i>Surface Materials Reference Manual</i> .

▶ Options, continued on next page



For Canadian Pricing
Multiply U.S. Price by the Canadian price factor.
▶ See page 1 for details.

► Options, continued from previous page

	Options	U.S. Price	Required to Specify
Surface Materials, continued	Right arm		
	• Fabric price group 1	No cost	Specify fabric color number.
	• Fabric price group 2	+\$ 52	Specify fabric color number.
	• Fabric price group 3	+\$ 104	Specify fabric color number.
	• Fabric price group 4	+\$ 175	Specify fabric color number.
	• Fabric price group 5	+\$ 289	Specify fabric color number.
	• Fabric price group 6	+\$ 406	Specify fabric color number.
	• Fabric price group 7	+\$ 555	Specify fabric color number.
	• Fabric price group 8	+\$ 687	Specify fabric color number.
	• Fabric price group 9	+\$ 802	Specify fabric color number.
• Fabric price group 10	+\$ 955	Specify fabric color number.	
	Right tablet top		
	• High-Pressure Laminate price group 1	No cost	Specify laminate color number.
	• High-Pressure Laminate price group 2	+\$ 82	Specify laminate color number.
	• High-Pressure Laminate price group 3	+\$ 167	Specify laminate color number.
	• Open Line laminate (OLL)	+\$ 111 plus cost of laminate	► See <i>Surface Materials Reference Manual</i> .
	Left End Configuration		
	• Connecting unit	No cost	Specify with connecting unit.
	• Open	No cost	Specify with open unit.
	• AD-61 LA upholstered left hand arm	+\$1326	Specify with upholstered left hand arm.
	• AD-62 LC upholstered left hand arm with tablet	+\$2837	Specify with upholstered left hand arm with tablet.
	Left Arm Power/Data Node		
	• No power/data	No cost	Specify with no power/data.
	• 2 duplex outlets	+\$ 310	Specify with 2 duplex outlets.
	• Duplex outlet with HDMI video ports	+\$ 406	Specify with duplex outlets with HDMI video ports.
	• Duplex outlet with CAT6 data ports	+\$ 414	Specify with duplex outlets with CAT6 data ports.
	• Duplex outlet with USB data ports	+\$ 427	Specify with duplex outlets with USB data ports.
	Right End Configuration		
	• Connecting unit	No cost	Specify with connecting unit.
	• Open	No cost	Specify with open unit.
	• AD-61 RA upholstered right hand arm	+\$1326	Specify with upholstered right hand arm.
	• AD-62 RC upholstered right hand arm with tablet	+\$2837	Specify with upholstered right hand arm with tablet.
	Right Arm Power/Data Node		
	• No power/data	No cost	Specify with no power/data.
	• 2 duplex outlets	+\$ 310	Specify with 2 duplex outlets.
	• Duplex outlet with HDMI video ports	+\$ 406	Specify with duplex outlets with HDMI video ports.
	• Duplex outlet with CAT6 data ports	+\$ 414	Specify with duplex outlets with CAT6 data ports.
	• Duplex outlet with USB data ports	+\$ 427	Specify with duplex outlets with USB data ports.

Tip: Tablet is selectable on one end only.

Tip: The AD-62LC option can only be specified on an **OBAD02** when it is connected to another unit and part of a larger configuration.

Tip: Select paint when specifying power.

Tip: The AD-62RC option can only be specified on an **OBAD02** when it is connected to another unit and part of a larger configuration.

Specifying

Specification Information

Style Number	U.S. Base Price
OBAD12	\$5624

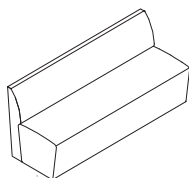

Away from the Desk 70⁷/₈"W Modular Straight Seat with Back and Screen

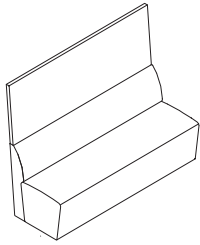

Tip: Customer's Own Material (COM) is available at a price group 1.

Standard Includes	Required to Specify
<ul style="list-style-type: none"> ▶ Need help? Product details, page 46 Fully upholstered seat, back, and screen: fabric price group 1 Adjustable glides: black Linking brackets 	<ol style="list-style-type: none"> Style number Fabric color number for seat, back, and screen Options, if selected (see below) <ul style="list-style-type: none"> ▶ See Product Understanding for Surface Materials.

Surface Materials	Options	U.S. Price	Required to Specify
	Seat		
	• Fabric price group 1	No cost	Specify fabric color number.
	• Fabric price group 2	+\$ 75	Specify fabric color number.
	• Fabric price group 3	+\$ 149	Specify fabric color number.
	• Fabric price group 4	+\$ 253	Specify fabric color number.
	• Fabric price group 5	+\$ 419	Specify fabric color number.
	• Fabric price group 6	+\$ 587	Specify fabric color number.
	• Fabric price group 7	+\$ 799	Specify fabric color number.
	• Fabric price group 8	+\$ 992	Specify fabric color number.
	• Fabric price group 9	+\$1157	Specify fabric color number.
	• Fabric price group 10	+\$1377	Specify fabric color number.
	Backrest outer		
	• Fabric price group 1	No cost	Specify fabric color number.
	• Fabric price group 2	+\$ 71	Specify fabric color number.
	• Fabric price group 3	+\$ 145	Specify fabric color number.
	• Fabric price group 4	+\$ 244	Specify fabric color number.
	• Fabric price group 5	+\$ 402	Specify fabric color number.
	• Fabric price group 6	+\$ 561	Specify fabric color number.
	• Fabric price group 7	+\$ 768	Specify fabric color number.
	• Fabric price group 8	+\$ 952	Specify fabric color number.
	• Fabric price group 9	+\$1111	Specify fabric color number.
	• Fabric price group 10	+\$1323	Specify fabric color number.
	Backrest inner		
	• Fabric price group 1	No cost	Specify fabric color number.
	• Fabric price group 2	+\$ 42	Specify fabric color number.
	• Fabric price group 3	+\$ 89	Specify fabric color number.
	• Fabric price group 4	+\$ 148	Specify fabric color number.
	• Fabric price group 5	+\$ 246	Specify fabric color number.
	• Fabric price group 6	+\$ 343	Specify fabric color number.
	• Fabric price group 7	+\$ 469	Specify fabric color number.
	• Fabric price group 8	+\$ 580	Specify fabric color number.
	• Fabric price group 9	+\$ 678	Specify fabric color number.
	• Fabric price group 10	+\$ 808	Specify fabric color number.
	Left arm		
	• Fabric price group 1	No cost	Specify fabric color number.
	• Fabric price group 2	+\$ 52	Specify fabric color number.
	• Fabric price group 3	+\$ 104	Specify fabric color number.
	• Fabric price group 4	+\$ 175	Specify fabric color number.
	• Fabric price group 5	+\$ 289	Specify fabric color number.
	• Fabric price group 6	+\$ 406	Specify fabric color number.
	• Fabric price group 7	+\$ 555	Specify fabric color number.
	• Fabric price group 8	+\$ 687	Specify fabric color number.
	• Fabric price group 9	+\$ 802	Specify fabric color number.
	• Fabric price group 10	+\$ 955	Specify fabric color number.
	Left tablet top		
	• High-Pressure Laminate price group 1	No cost	Specify laminate color number.
	• High-Pressure Laminate price group 2	+\$ 82	Specify laminate color number.
	• High-Pressure Laminate price group 3	+\$ 167	Specify laminate color number.
	• Open Line laminate (OLL)	+\$ 111 plus cost of laminate	▶ See <i>Surface Materials Reference Manual</i> .

▶ Options, continued on next page



For Canadian Pricing
Multiply U.S. Price by the Canadian price factor.
▶ See page 1 for details.

► Options, continued from previous page

	Options	U.S. Price	Required to Specify
Surface Materials continued	Right arm		
	• Fabric price group 1	No cost	Specify fabric color number.
	• Fabric price group 2	+\$ 52	Specify fabric color number.
	• Fabric price group 3	+\$ 104	Specify fabric color number.
	• Fabric price group 4	+\$ 175	Specify fabric color number.
	• Fabric price group 5	+\$ 289	Specify fabric color number.
	• Fabric price group 6	+\$ 406	Specify fabric color number.
	• Fabric price group 7	+\$ 555	Specify fabric color number.
	• Fabric price group 8	+\$ 687	Specify fabric color number.
	• Fabric price group 9	+\$ 802	Specify fabric color number.
	• Fabric price group 10	+\$ 955	Specify fabric color number.
	Right tablet top		
	• High-Pressure Laminate price group 1	No cost	Specify laminate color number.
	• High-Pressure Laminate price group 2	+\$ 82	Specify laminate color number.
	• High-Pressure Laminate price group 3	+\$ 167	Specify laminate color number.
	• Open Line laminate (OLL)	+\$ 111 plus cost of laminate	► See <i>Surface Materials Reference Manual</i> .
Screen Connection	• No screen connections	No cost	Specify with <i>no screen connection</i> .
	• Screen connection-left	No cost	Specify with <i>left screen connection</i> .
	• Screen connection-left and right	No cost	Specify with <i>left and right screen connection</i> .
	• Screen connection-right	No cost	Specify with <i>right screen connection</i> .
Left End Configuration	• Connecting unit	No cost	Specify with <i>connecting unit</i> .
	• Open	No cost	Specify with <i>open unit</i> .
	• AD-61 LA upholstered left hand arm	+\$1326	Specify with <i>upholstered left hand arm</i> .
	• AD-62 LC upholstered left hand arm with tablet	+\$2837	Specify with <i>upholstered left hand arm with tablet</i> .
Left Arm Power/Data Node	• No power/data	No cost	Specify with <i>no power/data</i> .
	• 2 duplex outlets	+\$ 310	Specify with <i>2 duplex outlets</i> .
	• Duplex outlet with HDMI video ports	+\$ 406	Specify with <i>duplex outlets with HDMI video ports</i> .
	• Duplex outlet with CAT6 data ports	+\$ 414	Specify with <i>duplex outlets with CAT6 data ports</i> .
	• Duplex outlet with USB data ports	+\$ 427	Specify with <i>duplex outlets with USB data ports</i> .
Right End Configuration	• Connecting unit	No cost	Specify with <i>connecting unit</i> .
	• Open	No cost	Specify with <i>open unit</i> .
	• AD-61 RA upholstered right hand arm	+\$1326	Specify with <i>upholstered right hand arm</i> .
	• AD-62 RC upholstered right hand arm with tablet	+\$2837	Specify with <i>upholstered right hand arm with tablet</i> .
Right Arm Power/Data Node	• No power/data	No cost	Specify with <i>no power/data</i> .
	• 2 duplex outlets	+\$ 310	Specify with <i>2 duplex outlets</i> .
	• Duplex outlet with HDMI video ports	+\$ 406	Specify with <i>duplex outlets with HDMI video ports</i> .
	• Duplex outlet with CAT6 data ports	+\$ 414	Specify with <i>duplex outlets with CAT6 data ports</i> .
	• Duplex outlet with USB data ports	+\$ 427	Specify with <i>duplex outlets with USB data ports</i> .

Tip: The AD-62LC option can only be specified on an **OBAD02** when it is connected to another unit and part of a larger configuration.

Tip: Select paint when specifying power.

Tip: The AD-62RC option can only be specified on an **OBAD02** when it is connected to another unit and part of a larger configuration.

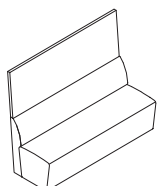

Specification Information

Style Number	U.S. Base Prices									
	Screen Price Groups									
	1	2	3	4	5	6	7	8	9	10
OBAD13	\$7592	\$7679	\$7766	\$7887	\$8077	\$8270	\$8519	\$8740	\$8935	\$9190

Away from the Desk 120° Modular Seat

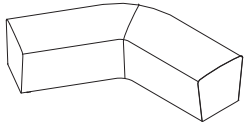

Tip: Customer's Own Material (COM) is available at a price group 1.

Standard Includes	Required to Specify
<ul style="list-style-type: none"> ▶ Need help? Product details, page 46 Fully upholstered seat: fabric price group 1 Adjustable glides: black Linking brackets 	<ul style="list-style-type: none"> 1 Style number 2 Fabric color number for seat 3 Options, if selected (see below) ▶ See Product Understanding for Surface Materials.

Options	U.S. Price	Required to Specify
Surface Materials		
Seat <ul style="list-style-type: none"> Fabric price group 1 Fabric price group 2 Fabric price group 3 Fabric price group 4 Fabric price group 5 Fabric price group 6 Fabric price group 7 Fabric price group 8 Fabric price group 9 Fabric price group 10 	<ul style="list-style-type: none"> No cost +\$ 83 +\$ 168 +\$ 284 +\$ 469 +\$ 655 +\$ 896 +\$1110 +\$1296 +\$1542 	<ul style="list-style-type: none"> Specify fabric color number. Specify fabric color number. Specify fabric color number. Specify fabric color number. Specify fabric color number. Specify fabric color number. Specify fabric color number. Specify fabric color number. Specify fabric color number. Specify fabric color number.
Table top <ul style="list-style-type: none"> High-Pressure Laminate price group 1 High-Pressure Laminate price group 2 High-Pressure Laminate price group 3 Open Line laminate (OLL) 	<ul style="list-style-type: none"> No cost +\$ 82 +\$ 167 +\$ 111 plus cost of laminate 	<ul style="list-style-type: none"> Specify fabric color number. Specify fabric color number. Specify fabric color number. ▶ See <i>Surface Materials Reference Manual</i>.
Table base <ul style="list-style-type: none"> Fabric price group 1 Fabric price group 2 Fabric price group 3 Fabric price group 4 Fabric price group 5 Fabric price group 6 Fabric price group 7 Fabric price group 8 Fabric price group 9 Fabric price group 10 	<ul style="list-style-type: none"> No cost +\$ 39 +\$ 81 +\$ 134 +\$ 223 +\$ 311 +\$ 427 +\$ 526 +\$ 617 +\$ 734 	<ul style="list-style-type: none"> Specify fabric color number. Specify fabric color number. Specify fabric color number. Specify fabric color number. Specify fabric color number. Specify fabric color number. Specify fabric color number. Specify fabric color number. Specify fabric color number. Specify fabric color number.
Left End Configuration <ul style="list-style-type: none"> Connecting unit Open 	<ul style="list-style-type: none"> No cost No cost 	<ul style="list-style-type: none"> Specify with <i>connecting unit</i>. Specify with <i>open</i>.
Right End Configuration <ul style="list-style-type: none"> Connecting unit Open 	<ul style="list-style-type: none"> No cost No cost 	<ul style="list-style-type: none"> Specify with <i>connecting unit</i>. Specify with <i>open</i>.
Table <ul style="list-style-type: none"> No table AD-72 120 corner table 	<ul style="list-style-type: none"> No cost +\$3398 	<ul style="list-style-type: none"> Specify with <i>no table</i>. Specify with <i>AD-72 120° corner table</i>.
Base Power/Data Node <ul style="list-style-type: none"> No power/data 2 duplex outlets Duplex outlet with HDMI video ports Duplex outlet with CAT6 data ports Duplex outlet with USB data ports 	<ul style="list-style-type: none"> No cost +\$ 310 +\$ 406 +\$ 414 +\$ 427 	<ul style="list-style-type: none"> Specify with <i>no power/data</i>. Specify with <i>2 duplex outlets</i>. Specify with <i>duplex outlets with HDMI video ports</i>. Specify with <i>duplex outlets with CAT6 data ports</i>. Specify with <i>duplex outlets with USB data ports</i>.

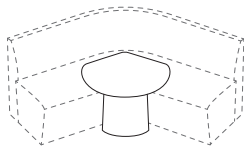

Tip: Select paint when specifying power.



For Canadian Pricing
Multiply U.S. Price by the Canadian price factor.
▶ See page 1 for details.

Specification Information

Style Number	U.S. Base Price
OBAD21	\$3893

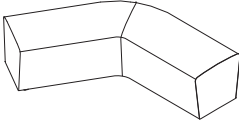

Specifying



For Canadian Pricing
Multiply U.S. Price by the
Canadian price factor.
▶ See page 1 for details.

Away from the Desk 120° Modular Seat with External Back

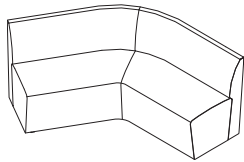

Tip: Customer's Own Material (COM) is available at a price group 1.

Standard Includes	Required to Specify
<ul style="list-style-type: none"> ▶ Need help? Product details, page 46 Fully upholstered seat with back: fabric price group 1 Adjustable glides: black Linking brackets 	<ul style="list-style-type: none"> 1 Style number 2 Fabric color number for seat and back 3 Options, if selected (see below) ▶ See Product Understanding for Surface Materials.

Surface Materials	Options	U.S. Price	Required to Specify
	Seat		
	• Fabric price group 1	No cost	Specify fabric color number.
	• Fabric price group 2	+\$ 83	Specify fabric color number.
	• Fabric price group 3	+\$ 168	Specify fabric color number.
	• Fabric price group 4	+\$ 284	Specify fabric color number.
	• Fabric price group 5	+\$ 469	Specify fabric color number.
	• Fabric price group 6	+\$ 655	Specify fabric color number.
	• Fabric price group 7	+\$ 896	Specify fabric color number.
	• Fabric price group 8	+\$1110	Specify fabric color number.
	• Fabric price group 9	+\$1296	Specify fabric color number.
	• Fabric price group 10	+\$1542	Specify fabric color number.
	Backrest outer		
	• Fabric price group 1	No cost	Specify fabric color number.
	• Fabric price group 2	+\$ 87	Specify fabric color number.
	• Fabric price group 3	+\$ 174	Specify fabric color number.
	• Fabric price group 4	+\$ 295	Specify fabric color number.
	• Fabric price group 5	+\$ 485	Specify fabric color number.
	• Fabric price group 6	+\$ 678	Specify fabric color number.
	• Fabric price group 7	+\$ 927	Specify fabric color number.
	• Fabric price group 8	+\$1148	Specify fabric color number.
	• Fabric price group 9	+\$1343	Specify fabric color number.
	• Fabric price group 10	+\$1598	Specify fabric color number.
	Backrest inner		
	• Fabric price group 1	No cost	Specify fabric color number.
	• Fabric price group 2	+\$ 56	Specify fabric color number.
	• Fabric price group 3	+\$ 113	Specify fabric color number.
	• Fabric price group 4	+\$ 188	Specify fabric color number.
	• Fabric price group 5	+\$ 312	Specify fabric color number.
	• Fabric price group 6	+\$ 437	Specify fabric color number.
	• Fabric price group 7	+\$ 597	Specify fabric color number.
	• Fabric price group 8	+\$ 739	Specify fabric color number.
	• Fabric price group 9	+\$ 864	Specify fabric color number.
	• Fabric price group 10	+\$1028	Specify fabric color number.
	Left arm		
	• Fabric price group 1	No cost	Specify fabric color number.
	• Fabric price group 2	+\$ 52	Specify fabric color number.
	• Fabric price group 3	+\$ 104	Specify fabric color number.
	• Fabric price group 4	+\$ 175	Specify fabric color number.
	• Fabric price group 5	+\$ 289	Specify fabric color number.
	• Fabric price group 6	+\$ 406	Specify fabric color number.
	• Fabric price group 7	+\$ 555	Specify fabric color number.
	• Fabric price group 8	+\$ 687	Specify fabric color number.
	• Fabric price group 9	+\$ 802	Specify fabric color number.
	• Fabric price group 10	+\$ 955	Specify fabric color number.
	Left tablet top		
	• High-Pressure Laminate price group 1	No cost	Specify laminate color number.
	• High-Pressure Laminate price group 2	+ \$ 82	Specify laminate color number.
	• High-Pressure Laminate price group 3	+\$ 167	Specify laminate color number.
	• Open Line laminate (OLL)	+\$ 111 plus cost of laminate	▶ See <i>Surface Materials Reference Manual</i> .

▶ Options, continued on next page



For Canadian Pricing
Multiply U.S. Price by the Canadian price factor.
▶ See page 1 for details.

► Options, continued from previous page

	Options	U.S. Price	Required to Specify
Surface Materials, continued	Right arm		
	• Fabric price group 1	No cost	Specify fabric color number.
	• Fabric price group 2	+\$ 52	Specify fabric color number.
	• Fabric price group 3	+\$ 104	Specify fabric color number.
	• Fabric price group 4	+\$ 175	Specify fabric color number.
	• Fabric price group 5	+\$ 289	Specify fabric color number.
	• Fabric price group 6	+\$ 406	Specify fabric color number.
	• Fabric price group 7	+\$ 555	Specify fabric color number.
	• Fabric price group 8	+\$ 687	Specify fabric color number.
	• Fabric price group 9	+\$ 802	Specify fabric color number.
	• Fabric price group 10	+\$ 955	Specify fabric color number.
	Right tablet top		
	• High-Pressure Laminate price group 1	No cost	Specify laminate color number.
	• High-Pressure Laminate price group 2	+\$ 82	Specify laminate color number.
	• High-Pressure Laminate price group 3	+\$ 167	Specify laminate color number.
	• Open Line laminate (OLL)	+\$ 111 plus cost of laminate	► See <i>Surface Materials Reference Manual</i> .
	Table top		
	• High-Pressure Laminate price group 1	No cost	Specify laminate color number.
	• High-Pressure Laminate price group 2	+\$ 82	Specify laminate color number.
	• High-Pressure Laminate price group 3	+\$ 167	Specify laminate color number.
	• Open Line laminate (OLL)	+\$ 111 plus cost of laminate	► See <i>Surface Materials Reference Manual</i> .
	Table base		
	• Fabric price group 1	No cost	Specify fabric color number.
	• Fabric price group 2	+\$ 39	Specify fabric color number.
	• Fabric price group 3	+\$ 81	Specify fabric color number.
	• Fabric price group 4	+\$ 134	Specify fabric color number.
	• Fabric price group 5	+\$ 223	Specify fabric color number.
	• Fabric price group 6	+\$ 311	Specify fabric color number.
	• Fabric price group 7	+\$ 427	Specify fabric color number.
	• Fabric price group 8	+\$ 526	Specify fabric color number.
	• Fabric price group 9	+\$ 617	Specify fabric color number.
	• Fabric price group 10	+\$ 734	Specify fabric color number.
	Left End Configuration		
	• Connecting unit	No cost	Specify with <i>connecting unit</i> .
	• Open	No cost	Specify with <i>open unit</i> .
	• AD-61 LA upholstered left hand arm	+\$1326	Specify with <i>upholstered left hand arm</i> .
	• AD-62 LC upholstered left hand arm with tablet	+\$2837	Specify with <i>upholstered left hand arm with tablet</i> .
	Left Arm Power/Data Node		
	• No power/data	No cost	Specify with <i>no power/data</i> .
	• 2 duplex outlets	+\$ 310	Specify with <i>2 duplex outlets</i> .
	• Duplex outlet with HDMI video ports	+\$ 406	Specify with <i>duplex outlets with HDMI video ports</i> .
	• Duplex outlet with CAT6 data ports	+\$ 414	Specify with <i>duplex outlets with CAT6 data ports</i> .
	• Duplex outlet with USB data ports	+\$ 427	Specify with <i>duplex outlets with USB data ports</i> .

Tip: Select paint when specifying power.

► Options, continued on next page



For Canadian Pricing
Multiply U.S. Price by the Canadian price factor.
► See page 1 for details.

Away from the Desk 120° Modular Seat with External Back, continued

► Options, continued from previous page

	Options	U.S. Price	Required to Specify
Right End Configuration	• Connecting unit	No cost	Specify with connecting unit.
	• Open	No cost	Specify with open unit.
	• AD-61 RA upholstered right hand arm	+\$1326	Specify with upholstered right hand arm.
	• AD-62 RC upholstered right hand arm with tablet	+\$2837	Specify with upholstered right hand arm with tablet.
Right Arm Power/Data Node	• No power/data	No cost	Specify with no power/data.
	• 2 duplex outlets	+\$ 310	Specify with 2 duplex outlets.
	• Duplex outlet with HDMI video ports	+\$ 406	Specify with duplex outlets with HDMI video ports.
	• Duplex outlet with CAT6 data ports	+\$ 414	Specify with duplex outlets with CAT6 data ports.
	• Duplex outlet with USB data ports	+\$ 427	Specify with duplex outlets with USB data ports.
Table	• No table	No cost	Specify with no table.
	• AD-72 120° corner table	+\$3398	Specify with AD-72 120° corner table.
Base Power/Data Node	• No power/data	No cost	Specify with no power/data.
	• 2 duplex outlets	+\$ 310	Specify with 2 duplex outlets.
	• Duplex outlet with HDMI video ports	+\$ 406	Specify with duplex outlets with HDMI video ports.
	• Duplex outlet with CAT6 data ports	+\$ 414	Specify with duplex outlets with CAT6 data ports.
	• Duplex outlet with USB data ports	+\$ 427	Specify with duplex outlets with USB data ports.

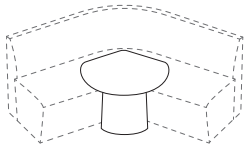

Specification Information

• Style Number	• U.S. Base Price
OBAD22	\$7560

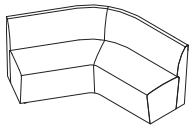

 **For Canadian Pricing**
 Multiply U.S. Price by the Canadian price factor.
 ► See page 1 for details.

Away from the Desk 120° Modular Seat with External Back with Screen

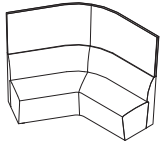

Tip: Customer's Own Material (COM) is available at a price group 1.

Standard Includes	Required to Specify
<ul style="list-style-type: none"> ▶ Need help? Product details, page 46 Fully upholstered seat with back: fabric price group 1 Adjustable glides: black Linking brackets 	<ul style="list-style-type: none"> 1 Style number 2 Fabric color number for seat and back 3 Options, if selected (see below) ▶ See Product Understanding for Surface Materials.

Options	U.S. Price	Required to Specify
Surface Materials		
Seat		
• Fabric price group 1	No cost	Specify fabric color number.
• Fabric price group 2	+\$ 83	Specify fabric color number.
• Fabric price group 3	+\$ 168	Specify fabric color number.
• Fabric price group 4	+\$ 284	Specify fabric color number.
• Fabric price group 5	+\$ 469	Specify fabric color number.
• Fabric price group 6	+\$ 655	Specify fabric color number.
• Fabric price group 7	+\$ 896	Specify fabric color number.
• Fabric price group 8	+\$1110	Specify fabric color number.
• Fabric price group 9	+\$1296	Specify fabric color number.
• Fabric price group 10	+\$1542	Specify fabric color number.
Backrest outer		
• Fabric price group 1	No cost	Specify fabric color number.
• Fabric price group 2	+\$ 87	Specify fabric color number.
• Fabric price group 3	+\$ 174	Specify fabric color number.
• Fabric price group 4	+\$ 295	Specify fabric color number.
• Fabric price group 5	+\$ 485	Specify fabric color number.
• Fabric price group 6	+\$ 678	Specify fabric color number.
• Fabric price group 7	+\$ 927	Specify fabric color number.
• Fabric price group 8	+\$1148	Specify fabric color number.
• Fabric price group 9	+\$1343	Specify fabric color number.
• Fabric price group 10	+\$1598	Specify fabric color number.
Backrest inner		
• Fabric price group 1	No cost	Specify fabric color number.
• Fabric price group 2	+\$ 56	Specify fabric color number.
• Fabric price group 3	+\$ 113	Specify fabric color number.
• Fabric price group 4	+\$ 188	Specify fabric color number.
• Fabric price group 5	+\$ 312	Specify fabric color number.
• Fabric price group 6	+\$ 437	Specify fabric color number.
• Fabric price group 7	+\$ 597	Specify fabric color number.
• Fabric price group 8	+\$ 739	Specify fabric color number.
• Fabric price group 9	+\$ 864	Specify fabric color number.
• Fabric price group 10	+\$1028	Specify fabric color number.
Left arm		
• Fabric price group 1	No cost	Specify fabric color number.
• Fabric price group 2	+\$ 52	Specify fabric color number.
• Fabric price group 3	+\$ 104	Specify fabric color number.
• Fabric price group 4	+\$ 175	Specify fabric color number.
• Fabric price group 5	+\$ 289	Specify fabric color number.
• Fabric price group 6	+\$ 406	Specify fabric color number.
• Fabric price group 7	+\$ 555	Specify fabric color number.
• Fabric price group 8	+\$ 687	Specify fabric color number.
• Fabric price group 9	+\$ 802	Specify fabric color number.
• Fabric price group 10	+\$ 955	Specify fabric color number.
Left tablet top		
• High-Pressure Laminate price group 1	No cost	Specify laminate color number.
• High-Pressure Laminate price group 2	+\$ 82	Specify laminate color number.
• High-Pressure Laminate price group 3	+\$ 167	Specify laminate color number.
• Open Line laminate (OLL)	+\$ 111 plus cost of laminate	▶ See <i>Surface Materials Reference Manual</i> .

▶ Options, continued on next page



For Canadian Pricing
Multiply U.S. Price by the Canadian price factor.
▶ See page 1 for details.

► Options, continued from previous page

Options	U.S. Price	Required to Specify
Surface Materials, continued		
Right arm		
• Fabric price group 1	No cost	Specify fabric color number.
• Fabric price group 2	+\$ 52	Specify fabric color number.
• Fabric price group 3	+\$ 104	Specify fabric color number.
• Fabric price group 4	+\$ 175	Specify fabric color number.
• Fabric price group 5	+\$ 289	Specify fabric color number.
• Fabric price group 6	+\$ 406	Specify fabric color number.
• Fabric price group 7	+\$ 555	Specify fabric color number.
• Fabric price group 8	+\$ 687	Specify fabric color number.
• Fabric price group 9	+\$ 802	Specify fabric color number.
• Fabric price group 10	+\$ 955	Specify fabric color number.
Right tablet top		
• High-Pressure Laminate price group 1	No cost	Specify laminate color number.
• High-Pressure Laminate price group 2	+\$ 82	Specify laminate color number.
• High-Pressure Laminate price group 3	+\$ 167	Specify laminate color number.
• Open Line laminate (OLL)	+\$ 111 plus cost of laminate	► See <i>Surface Materials Reference Manual</i> .
Table top		
• High-Pressure Laminate price group 1	No cost	Specify laminate color number.
• High-Pressure Laminate price group 2	+\$ 82	Specify laminate color number.
• High-Pressure Laminate price group 3	+\$ 167	Specify laminate color number.
• Open Line laminate (OLL)	+\$ 111 plus cost of laminate	► See <i>Surface Materials Reference Manual</i> .
Table base		
• Fabric price group 1	No cost	Specify fabric color number.
• Fabric price group 2	+\$ 39	Specify fabric color number.
• Fabric price group 3	+\$ 81	Specify fabric color number.
• Fabric price group 4	+\$ 134	Specify fabric color number.
• Fabric price group 5	+\$ 223	Specify fabric color number.
• Fabric price group 6	+\$ 311	Specify fabric color number.
• Fabric price group 7	+\$ 427	Specify fabric color number.
• Fabric price group 8	+\$ 526	Specify fabric color number.
• Fabric price group 9	+\$ 617	Specify fabric color number.
• Fabric price group 10	+\$ 734	Specify fabric color number.
Screen Connection		
• No screen connections	No cost	Specify with <i>no screen connection</i> .
• Screen connection-left	No cost	Specify with <i>left screen connection</i> .
• Screen connection-left and right	No cost	Specify with <i>left and right screen connection</i> .
• Screen connection-right	No cost	Specify with <i>right screen connection</i> .
Left End Configuration		
• Connecting unit	No cost	Specify with <i>connecting unit</i> .
• Open	No cost	Specify with <i>open unit</i> .
• AD-61 LA upholstered left hand arm	+\$1326	Specify with <i>upholstered left hand arm</i> .
• AD-62 LC upholstered left hand arm with tablet	+\$2837	Specify with <i>upholstered left hand arm</i> .

► Options, continued on next page



For Canadian Pricing
Multiply U.S. Price by the
Canadian price factor.
► See page 1 for details.

► Options, continued from previous page

Tip: Select paint when specifying power.

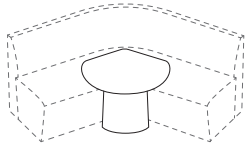

	Options	U.S. Price	Required to Specify
Left Arm Power/Data Node	• No power/data	No cost	Specify with no power/data.
	• 2 duplex outlets	+\$ 310	Specify with 2 duplex outlets.
	• Duplex outlet with HDMI video ports	+\$ 406	Specify with duplex outlets with HDMI video ports.
	• Duplex outlet with CAT6 data ports	+\$ 414	Specify with duplex outlets with CAT6 data ports.
Right End Configuration	• Duplex outlet with USB data ports	+\$ 427	Specify with duplex outlets with USB data ports.
	• Connecting unit	No cost	Specify with connecting unit.
	• Open	No cost	Specify with open unit.
Right Arm Power/Data Node	• AD-61 RA upholstered right hand arm	+\$1326	Specify with upholstered right hand arm.
	• AD-62 RC upholstered right hand arm with tablet	+\$2837	Specify with upholstered right hand arm with tablet.
	• No power/data	No cost	Specify with no power/data.
	• 2 duplex outlets	+\$ 310	Specify with 2 duplex outlets.
Table	• Duplex outlet with HDMI video ports	+\$ 406	Specify with duplex outlets with HDMI video ports.
	• Duplex outlet with CAT6 data ports	+\$ 414	Specify with duplex outlets with CAT6 data ports.
	• Duplex outlet with USB data ports	+\$ 427	Specify with duplex outlets with USB data ports.
	• No table	No cost	Specify with no table.
Base Power/Data Node	• AD-72 120° corner table	+\$3398	Specify with AD-72 120° corner table.
	• No power/data	No cost	Specify with no power/data.
	• 2 duplex outlets	+\$ 310	Specify with 2 duplex outlets.
	• Duplex outlet with HDMI video ports	+\$ 406	Specify with duplex outlets with HDMI video ports.
Table	• Duplex outlet with CAT6 data ports	+\$ 414	Specify with duplex outlets with CAT6 data ports.
	• Duplex outlet with USB data ports	+\$ 427	Specify with duplex outlets with USB data ports.
	• No power/data	No cost	Specify with no power/data.
	• 2 duplex outlets	+\$ 310	Specify with 2 duplex outlets.

 **For Canadian Pricing**
 Multiply U.S. Price by the Canadian price factor.
 ► See page 1 for details.

Specification Information

Style Number	U.S. Base Prices									
	Screen Price Groups									
	1	2	3	4	5	6	7	8	9	10

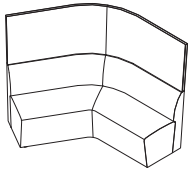

120° Modular Seat with External Back and Screen

OBAD23	\$9615	\$9726	\$9837	\$9990	\$10,234	\$10,481	\$10,801	\$11,081	\$11,329	\$11,654
---------------	--------	--------	--------	--------	----------	----------	----------	----------	----------	----------

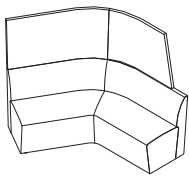

120° Modular Seat with External Back and Left Hand Tapered Screen

OBAD23LC	\$9471	\$9562	\$9657	\$9783	\$ 9992	\$10,199	\$10,464	\$10,699	\$10,907	\$11,181
-----------------	--------	--------	--------	--------	---------	----------	----------	----------	----------	----------

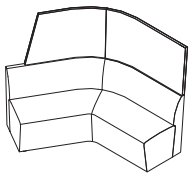

120° Modular Seat with External Back and Right Hand Tapered Screen

OBAD23RC	\$9471	\$9562	\$9657	\$9783	\$ 9992	\$10,199	\$10,464	\$10,699	\$10,907	\$11,181
-----------------	--------	--------	--------	--------	---------	----------	----------	----------	----------	----------

Specifying

 **For Canadian Pricing**
Multiply U.S. Price by the
Canadian price factor.
▶ See page 1 for details.

Away from the Desk 120° Modular Seat with Internal Back

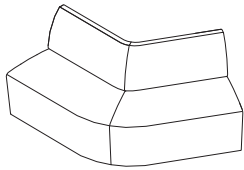

Tip: Customer's Own Material (COM) is available at a price group 1.

Standard Includes	Required to Specify
<ul style="list-style-type: none"> ▶ Need help? Product details, page 46 Fully upholstered seat with back: fabric price group 1 Adjustable glides: black Linking brackets 	<ol style="list-style-type: none"> 1 Style number 2 Fabric color number for seat and back 3 Options, if selected (see below) <ul style="list-style-type: none"> ▶ See Product Understanding for Surface Materials.

Options	U.S. Price	Required to Specify
Surface Materials		
Seat		
• Fabric price group 1	No cost	Specify fabric color number.
• Fabric price group 2	+\$ 83	Specify fabric color number.
• Fabric price group 3	+\$ 168	Specify fabric color number.
• Fabric price group 4	+\$ 284	Specify fabric color number.
• Fabric price group 5	+\$ 469	Specify fabric color number.
• Fabric price group 6	+\$ 655	Specify fabric color number.
• Fabric price group 7	+\$ 896	Specify fabric color number.
• Fabric price group 8	+\$1110	Specify fabric color number.
• Fabric price group 9	+\$1296	Specify fabric color number.
• Fabric price group 10	+\$1542	Specify fabric color number.
Backrest outer		
• Fabric price group 1	No cost	Specify fabric color number.
• Fabric price group 2	+\$ 62	Specify fabric color number.
• Fabric price group 3	+\$ 127	Specify fabric color number.
• Fabric price group 4	+\$ 213	Specify fabric color number.
• Fabric price group 5	+\$ 351	Specify fabric color number.
• Fabric price group 6	+\$ 493	Specify fabric color number.
• Fabric price group 7	+\$ 672	Specify fabric color number.
• Fabric price group 8	+\$ 832	Specify fabric color number.
• Fabric price group 9	+\$ 972	Specify fabric color number.
• Fabric price group 10	+\$1157	Specify fabric color number.
Backrest inner		
• Fabric price group 1	No cost	Specify fabric color number.
• Fabric price group 2	+\$ 39	Specify fabric color number.
• Fabric price group 3	+\$ 81	Specify fabric color number.
• Fabric price group 4	+\$ 134	Specify fabric color number.
• Fabric price group 5	+\$ 223	Specify fabric color number.
• Fabric price group 6	+\$ 311	Specify fabric color number.
• Fabric price group 7	+\$ 427	Specify fabric color number.
• Fabric price group 8	+\$ 526	Specify fabric color number.
• Fabric price group 9	+\$ 617	Specify fabric color number.
• Fabric price group 10	+\$ 734	Specify fabric color number.
Left arm		
• Fabric price group 1	No cost	Specify fabric color number.
• Fabric price group 2	+\$ 52	Specify fabric color number.
• Fabric price group 3	+\$ 104	Specify fabric color number.
• Fabric price group 4	+\$ 175	Specify fabric color number.
• Fabric price group 5	+\$ 289	Specify fabric color number.
• Fabric price group 6	+\$ 406	Specify fabric color number.
• Fabric price group 7	+\$ 555	Specify fabric color number.
• Fabric price group 8	+\$ 687	Specify fabric color number.
• Fabric price group 9	+\$ 802	Specify fabric color number.
• Fabric price group 10	+\$ 955	Specify fabric color number.
Left tablet top		
• High-Pressure Laminate price group 1	No cost	Specify laminate color number.
• High-Pressure Laminate price group 2	+\$ 82	Specify laminate color number.
• High-Pressure Laminate price group 3	+\$ 167	Specify laminate color number.
• Open Line laminate (OLL)	+\$ 111 plus cost of laminate	▶ See <i>Surface Materials Reference Manual</i> .

▶ Options, continued on next page



For Canadian Pricing
Multiply U.S. Price by the Canadian price factor.
▶ See page 1 for details.

► Options, continued from previous page

	Options	U.S. Price	Required to Specify
Surface Materials, continued	Right arm		
	• Fabric price group 1	No cost	Specify fabric color number.
	• Fabric price group 2	+\$ 52	Specify fabric color number.
	• Fabric price group 3	+\$ 104	Specify fabric color number.
	• Fabric price group 4	+\$ 175	Specify fabric color number.
	• Fabric price group 5	+\$ 289	Specify fabric color number.
	• Fabric price group 6	+\$ 406	Specify fabric color number.
	• Fabric price group 7	+\$ 555	Specify fabric color number.
	• Fabric price group 8	+\$ 687	Specify fabric color number.
	• Fabric price group 9	+\$ 802	Specify fabric color number.
	• Fabric price group 10	+\$ 955	Specify fabric color number.
	Right tablet top		
	• High-Pressure Laminate price group 1	No cost	Specify laminate color number.
	• High-Pressure Laminate price group 2	+\$ 82	Specify laminate color number.
	• High-Pressure Laminate price group 3	+\$ 167	Specify laminate color number.
	• Open Line laminate (OLL)	+\$ 111 plus cost of laminate	► See <i>Surface Materials Reference Manual</i> .
Left End Configuration	• Connecting unit	No cost	Specify with connecting unit.
	• Open	No cost	Specify with open unit.
	• AD-61 LA upholstered left hand arm	+\$1326	Specify with upholstered left hand arm.
	• AD-62 LC upholstered left hand arm with tablet	+\$2837	Specify with upholstered left hand arm with tablet.
Left Arm Power/Data Node	• No power/data	No cost	Specify with no power/data.
	• 2 duplex outlets	+\$ 310	Specify with 2 duplex outlets.
	• Duplex outlet with HDMI video ports	+\$ 406	Specify with duplex outlets with HDMI video ports.
	• Duplex outlet with CAT6 data ports	+\$ 414	Specify with duplex outlets with CAT6 data ports.
	• Duplex outlet with USB data ports	+\$ 427	Specify with duplex outlets with USB data ports.
Right End Configuration	• Connecting unit	No cost	Specify with connecting unit.
	• Open	No cost	Specify with open unit.
	• AD-61 RA upholstered right hand arm	+\$1326	Specify with upholstered right hand arm.
	• AD-62 RC upholstered right hand arm with tablet	+\$2837	Specify with upholstered right hand arm with tablet.
Right Arm Power/Data Node	• No power/data	No cost	Specify with no power/data.
	• 2 duplex outlets	+\$ 310	Specify with 2 duplex outlets.
	• Duplex outlet with HDMI video ports	+\$ 406	Specify with duplex outlets with HDMI video ports.
	• Duplex outlet with CAT6 data ports	+\$ 414	Specify with duplex outlets with CAT6 data ports.
	• Duplex outlet with USB data ports	+\$ 427	Specify with duplex outlets with USB data ports.

Tip: Select paint when specifying power.

Specifying

Specification Information

Style Number	U.S. Base Price
OBAD24	\$7045

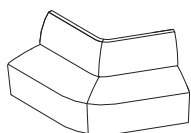

Away from the Desk 120° Modular Seat with Internal Back and Screen

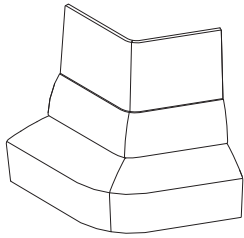

Tip: Customer's Own Material (COM) is available at a price group 1.

Standard Includes	Required to Specify
<ul style="list-style-type: none"> ▶ Need help? Product details, page 46 Fully upholstered seat, back, and screen: <ul style="list-style-type: none"> fabric price group 1 Adjustable glides: black Linking brackets 	<ol style="list-style-type: none"> Style number Fabric color number for seat, back, and screen Options, if selected (see below) <ul style="list-style-type: none"> ▶ See Product Understanding for Surface Materials.

Surface Materials	Options	U.S. Price	Required to Specify
	Seat		
	• Fabric price group 1	No cost	Specify fabric color number.
	• Fabric price group 2	+\$ 83	Specify fabric color number.
	• Fabric price group 3	+\$ 168	Specify fabric color number.
	• Fabric price group 4	+\$ 284	Specify fabric color number.
	• Fabric price group 5	+\$ 469	Specify fabric color number.
	• Fabric price group 6	+\$ 655	Specify fabric color number.
	• Fabric price group 7	+\$ 896	Specify fabric color number.
	• Fabric price group 8	+\$1110	Specify fabric color number.
	• Fabric price group 9	+\$1296	Specify fabric color number.
	• Fabric price group 10	+\$1542	Specify fabric color number.
	Backrest outer		
	• Fabric price group 1	No cost	Specify fabric color number.
	• Fabric price group 2	+\$ 62	Specify fabric color number.
	• Fabric price group 3	+\$ 127	Specify fabric color number.
	• Fabric price group 4	+\$ 213	Specify fabric color number.
	• Fabric price group 5	+\$ 351	Specify fabric color number.
	• Fabric price group 6	+\$ 493	Specify fabric color number.
	• Fabric price group 7	+\$ 672	Specify fabric color number.
	• Fabric price group 8	+\$ 832	Specify fabric color number.
	• Fabric price group 9	+\$ 972	Specify fabric color number.
	• Fabric price group 10	+\$1157	Specify fabric color number.
	Backrest inner		
	• Fabric price group 1	No cost	Specify fabric color number.
	• Fabric price group 2	+\$ 39	Specify fabric color number.
	• Fabric price group 3	+\$ 81	Specify fabric color number.
	• Fabric price group 4	+\$ 134	Specify fabric color number.
	• Fabric price group 5	+\$ 223	Specify fabric color number.
	• Fabric price group 6	+\$ 311	Specify fabric color number.
	• Fabric price group 7	+\$ 427	Specify fabric color number.
	• Fabric price group 8	+\$ 526	Specify fabric color number.
	• Fabric price group 9	+\$ 617	Specify fabric color number.
	• Fabric price group 10	+\$ 734	Specify fabric color number.
	Left arm		
	• Fabric price group 1	No cost	Specify fabric color number.
	• Fabric price group 2	+\$ 52	Specify fabric color number.
	• Fabric price group 3	+\$ 104	Specify fabric color number.
	• Fabric price group 4	+\$ 175	Specify fabric color number.
	• Fabric price group 5	+\$ 289	Specify fabric color number.
	• Fabric price group 6	+\$ 406	Specify fabric color number.
	• Fabric price group 7	+\$ 555	Specify fabric color number.
	• Fabric price group 8	+\$ 687	Specify fabric color number.
	• Fabric price group 9	+\$ 802	Specify fabric color number.
	• Fabric price group 10	+\$ 955	Specify fabric color number.
	Left tablet top		
	• High-Pressure Laminate price group 1	No cost	Specify laminate color number.
	• High-Pressure Laminate price group 2	+\$ 82	Specify laminate color number.
	• High-Pressure Laminate price group 3	+\$ 167	Specify laminate color number.
	• Open Line laminate (OLL)	+\$ 111 plus cost of laminate	▶ See <i>Surface Materials Reference Manual</i> .

▶ Options, continued on next page



For Canadian Pricing
Multiply U.S. Price by the Canadian price factor.
▶ See page 1 for details.

► Options, continued from previous page

	Options	U.S. Price	Required to Specify
Surface Materials, continued	Right arm		
	• Fabric price group 1	No cost	Specify fabric color number.
	• Fabric price group 2	+\$ 52	Specify fabric color number.
	• Fabric price group 3	+\$ 104	Specify fabric color number.
	• Fabric price group 4	+\$ 175	Specify fabric color number.
	• Fabric price group 5	+\$ 289	Specify fabric color number.
	• Fabric price group 6	+\$ 406	Specify fabric color number.
	• Fabric price group 7	+\$ 555	Specify fabric color number.
	• Fabric price group 8	+\$ 687	Specify fabric color number.
	• Fabric price group 9	+\$ 802	Specify fabric color number.
• Fabric price group 10	+\$ 955	Specify fabric color number.	
	Right tablet top		
	• High-Pressure Laminate price group 1	No cost	Specify laminate color number.
	• High-Pressure Laminate price group 2	+\$ 82	Specify laminate color number.
	• High-Pressure Laminate price group 3	+\$ 167	Specify laminate color number.
	• Open Line laminate (OLL)	+\$ 111 plus cost of laminate	► See <i>Surface Materials Reference Manual</i> .
Screen Connection	• No screen connections	No cost	Specify with <i>no screen connection</i> .
	• Screen connection-left	No cost	Specify with <i>left screen connection</i> .
	• Screen connection-left and right	No cost	Specify with <i>left and right screen connection</i> .
	• Screen connection-right	No cost	Specify with <i>right screen connection</i> .
Left End Configuration	• Connecting unit	No cost	Specify with <i>connecting unit</i> .
	• Open	No cost	Specify with <i>open unit</i> .
	• AD-61 LA upholstered left hand arm	+\$1326	Specify with <i>upholstered left hand arm</i> .
	• AD-62 LC upholstered left hand arm with tablet	+\$2837	Specify with <i>upholstered left hand arm with tablet</i> .
Left Arm Power/Data Node	• No power/data	No cost	Specify with <i>no power/data</i> .
	• 2 duplex outlets	+\$ 310	Specify with <i>2 duplex outlets</i> .
	• Duplex outlet with HDMI video ports	+\$ 406	Specify with <i>duplex outlets with HDMI video ports</i> .
	• Duplex outlet with CAT6 data ports	+\$ 414	Specify with <i>duplex outlets with CAT6 data ports</i> .
	• Duplex outlet with USB data ports	+\$ 427	Specify with <i>duplex outlets with USB data ports</i> .
Right End Configuration	• Connecting unit	No cost	Specify with <i>connecting unit</i> .
	• Open	No cost	Specify with <i>open unit</i> .
	• AD-61 RA upholstered right hand arm	+\$1326	Specify with <i>upholstered right hand arm</i> .
	• AD-62 RC upholstered right hand arm with tablet	+\$2837	Specify with <i>upholstered right hand arm with tablet</i> .
Right Arm Power/Data Node	• No power/data	No cost	Specify with <i>no power/data</i> .
	• 2 duplex outlets	+\$ 310	Specify with <i>2 duplex outlets</i> .
	• Duplex outlet with HDMI video ports	+\$ 406	Specify with <i>duplex outlets with HDMI video ports</i> .
	• Duplex outlet with CAT6 data ports	+\$ 414	Specify with <i>duplex outlets with CAT6 data ports</i> .
	• Duplex outlet with USB data ports	+\$ 427	Specify with <i>duplex outlets with USB data ports</i> .

Specifying

Tip: Select paint when specifying power.

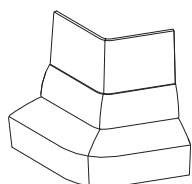

Specification

Style Number	U.S. Base Prices									
	Screen Price Groups									
	1	2	3	4	5	6	7	8	9	10
OBAD25	\$8702	\$8777	\$8851	\$8955	\$9121	\$9289	\$9501	\$9694	\$9859	\$10,079

Away from the Desk 120° Modular Tri Seat

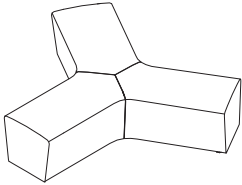

Tip: Customer's Own Material (COM) is available at a price group 1.

Standard Includes	Required to Specify
<ul style="list-style-type: none"> ▶ Need help? Product details, page 46 Fully upholstered seat: fabric price group 1 Adjustable glides: black Linking brackets 	<ul style="list-style-type: none"> 1 Style number 2 Fabric color number for seat 3 Options, if selected (see below) ▶ See Product Understanding for Surface Materials.

Options	U.S. Price	Required to Specify
Surface Materials		
Seat		
• Fabric price group 1	No cost	Specify fabric color number.
• Fabric price group 2	+\$ 118	Specify fabric color number.
• Fabric price group 3	+\$ 241	Specify fabric color number.
• Fabric price group 4	+\$ 405	Specify fabric color number.
• Fabric price group 5	+\$ 671	Specify fabric color number.
• Fabric price group 6	+\$ 939	Specify fabric color number.
• Fabric price group 7	+\$1281	Specify fabric color number.
• Fabric price group 8	+\$1585	Specify fabric color number.
• Fabric price group 9	+\$1852	Specify fabric color number.
• Fabric price group 10	+\$2205	Specify fabric color number.
Table top		
• High-Pressure Laminate price group 1	No cost	Specify laminate color number.
• High-Pressure Laminate price group 2	+\$ 82	Specify laminate color number.
• High-Pressure Laminate price group 3	+\$ 167	Specify laminate color number.
• Open Line laminate (OLL)	+\$ 111 plus cost of laminate	▶ See <i>Surface Materials Reference Manual</i> .
Table base		
• Fabric price group 1	No cost	Specify fabric color number.
• Fabric price group 2	+\$ 39	Specify fabric color number.
• Fabric price group 3	+\$ 81	Specify fabric color number.
• Fabric price group 4	+\$ 134	Specify fabric color number.
• Fabric price group 5	+\$ 223	Specify fabric color number.
• Fabric price group 6	+\$ 311	Specify fabric color number.
• Fabric price group 7	+\$ 427	Specify fabric color number.
• Fabric price group 8	+\$ 526	Specify fabric color number.
• Fabric price group 9	+\$ 617	Specify fabric color number.
• Fabric price group 10	+\$ 734	Specify fabric color number.
Left End Configuration		
• Connecting unit	No cost	Specify <i>with connecting unit</i> .
• Open	No cost	Specify <i>with open</i> .
Center End Configuration		
• Connecting unit	No cost	Specify <i>with connecting unit</i> .
• Open	No cost	Specify <i>with open</i> .
Right End Configuration		
• Connecting unit	No cost	Specify <i>with connecting unit</i> .
• Open	No cost	Specify <i>with open</i> .
Table		
• No table	No cost	Specify <i>with no table</i> .
• AD-72 120° corner table	+\$3398	Specify <i>with AD-72 120° corner table</i> .
Base Power/Data Node		
• No power/data	No cost	Specify <i>with no power/data</i> .
• 2 duplex outlets	+\$ 310	Specify <i>with 2 duplex outlets</i> .
• Duplex outlet with HDMI video ports	+\$ 406	Specify <i>with duplex outlets with HDMI video ports</i> .
• Duplex outlet with CAT6 data ports	+\$ 414	Specify <i>with duplex outlets with CAT6 data ports</i> .
• Duplex outlet with USB data ports	+\$ 427	Specify <i>with duplex outlets with USB data ports</i> .

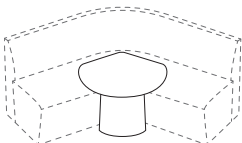

Tip: Select paint when specifying power.



For Canadian Pricing
Multiply U.S. Price by the Canadian price factor.
▶ See page 1 for details.

Specification Information

Style Number	U.S. Base Price
OBAD31	\$5561



For Canadian Pricing
Multiply U.S. Price by the
Canadian price factor.
▶ See page 1 for details.

Away from the Desk 120° Modular Tri Seat with Internal Back

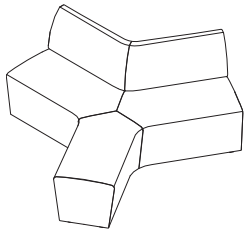

Tip: Customer's Own Material (COM) is available at a price group 1.

Standard Includes	Required to Specify
<ul style="list-style-type: none"> ▶ Need help? Product details, page 46 Fully upholstered seat with back: fabric price group 1 Adjustable glides: black Linking brackets 	<ol style="list-style-type: none"> 1 Style number 2 Fabric color number for seat and back 3 Options, if selected (see below) <ul style="list-style-type: none"> ▶ See Product Understanding for Surface Materials.

Options	U.S. Price	Required to Specify
Surface Materials		
Seat		
• Fabric price group 1	No cost	Specify fabric color number.
• Fabric price group 2	+\$ 118	Specify fabric color number.
• Fabric price group 3	+\$ 241	Specify fabric color number.
• Fabric price group 4	+\$ 405	Specify fabric color number.
• Fabric price group 5	+\$ 671	Specify fabric color number.
• Fabric price group 6	+\$ 939	Specify fabric color number.
• Fabric price group 7	+\$1281	Specify fabric color number.
• Fabric price group 8	+\$1585	Specify fabric color number.
• Fabric price group 9	+\$1852	Specify fabric color number.
• Fabric price group 10	+\$2205	Specify fabric color number.
Backrest outer		
• Fabric price group 1	No cost	Specify fabric color number.
• Fabric price group 2	+\$ 62	Specify fabric color number.
• Fabric price group 3	+\$ 127	Specify fabric color number.
• Fabric price group 4	+\$ 213	Specify fabric color number.
• Fabric price group 5	+\$ 351	Specify fabric color number.
• Fabric price group 6	+\$ 493	Specify fabric color number.
• Fabric price group 7	+\$ 672	Specify fabric color number.
• Fabric price group 8	+\$ 832	Specify fabric color number.
• Fabric price group 9	+\$ 972	Specify fabric color number.
• Fabric price group 10	+\$1157	Specify fabric color number.
Backrest inner		
• Fabric price group 1	No cost	Specify fabric color number.
• Fabric price group 2	+\$ 39	Specify fabric color number.
• Fabric price group 3	+\$ 81	Specify fabric color number.
• Fabric price group 4	+\$ 134	Specify fabric color number.
• Fabric price group 5	+\$ 223	Specify fabric color number.
• Fabric price group 6	+\$ 311	Specify fabric color number.
• Fabric price group 7	+\$ 427	Specify fabric color number.
• Fabric price group 8	+\$ 526	Specify fabric color number.
• Fabric price group 9	+\$ 617	Specify fabric color number.
• Fabric price group 10	+\$ 734	Specify fabric color number.
Left arm		
• Fabric price group 1	No cost	Specify fabric color number.
• Fabric price group 2	+\$ 52	Specify fabric color number.
• Fabric price group 3	+\$ 104	Specify fabric color number.
• Fabric price group 4	+\$ 175	Specify fabric color number.
• Fabric price group 5	+\$ 289	Specify fabric color number.
• Fabric price group 6	+\$ 406	Specify fabric color number.
• Fabric price group 7	+\$ 555	Specify fabric color number.
• Fabric price group 8	+\$ 687	Specify fabric color number.
• Fabric price group 9	+\$ 802	Specify fabric color number.
• Fabric price group 10	+\$ 955	Specify fabric color number.
Left tablet top		
• High-Pressure Laminate price group 1	No cost	Specify laminate color number.
• High-Pressure Laminate price group 2	+\$ 82	Specify laminate color number.
• High-Pressure Laminate price group 3	+\$ 167	Specify laminate color number.
• Open Line laminate (OLL)	+\$ 111 plus cost of laminate	▶ See <i>Surface Materials Reference Manual</i> .

▶ Options, continued on next page



For Canadian Pricing
Multiply U.S. Price by the Canadian price factor.
▶ See page 1 for details.

► Options, continued from previous page

	Options	U.S. Price	Required to Specify
Surface Materials, continued	Right arm		
	• Fabric price group 1	No cost	Specify fabric color number.
	• Fabric price group 2	+\$ 52	Specify fabric color number.
	• Fabric price group 3	+\$ 104	Specify fabric color number.
	• Fabric price group 4	+\$ 175	Specify fabric color number.
	• Fabric price group 5	+\$ 289	Specify fabric color number.
	• Fabric price group 6	+\$ 406	Specify fabric color number.
	• Fabric price group 7	+\$ 555	Specify fabric color number.
	• Fabric price group 8	+\$ 687	Specify fabric color number.
	• Fabric price group 9	+\$ 802	Specify fabric color number.
	• Fabric price group 10	+\$ 955	Specify fabric color number.
	Right tablet top		
	• High-Pressure Laminate price group 1	No cost	Specify laminate color number.
	• High-Pressure Laminate price group 2	+\$ 82	Specify laminate color number.
	• High-Pressure Laminate price group 3	+\$ 167	Specify laminate color number.
	• Open Line laminate (OLL)	+\$ 111 plus cost of laminate	► See <i>Surface Materials Reference Manual</i> .
	Table top		
	• High-Pressure Laminate price group 1	No cost	Specify laminate color number.
	• High-Pressure Laminate price group 2	+\$ 82	Specify laminate color number.
	• High-Pressure Laminate price group 3	+\$ 167	Specify laminate color number.
	• Open Line laminate (OLL)	+\$ 111 plus cost of laminate	► See <i>Surface Materials Reference Manual</i> .
	Table base		
	• Fabric price group 1	No cost	Specify fabric color number.
	• Fabric price group 2	+\$ 39	Specify fabric color number.
	• Fabric price group 3	+\$ 81	Specify fabric color number.
	• Fabric price group 4	+\$ 134	Specify fabric color number.
	• Fabric price group 5	+\$ 223	Specify fabric color number.
	• Fabric price group 6	+\$ 311	Specify fabric color number.
	• Fabric price group 7	+\$ 427	Specify fabric color number.
	• Fabric price group 8	+\$ 526	Specify fabric color number.
	• Fabric price group 9	+\$ 617	Specify fabric color number.
	• Fabric price group 10	+\$ 734	Specify fabric color number.
Left End Configuration	• Connecting unit	No cost	Specify with <i>connecting unit</i> .
	• Open	No cost	Specify with <i>open unit</i> .
	• AD-61 LA upholstered left hand arm	+\$1326	Specify with <i>upholstered left hand arm</i> .
	• AD-62 LC upholstered left hand arm with tablet	+\$2837	Specify with <i>upholstered left hand arm with tablet</i> .
Left Arm Power/Data Node	• No power/data	No cost	Specify with <i>no power/data</i> .
	• 2 duplex outlets	+\$ 310	Specify with <i>2 duplex outlets</i> .
	• Duplex outlet with HDMI video ports	+\$ 406	Specify with <i>duplex outlets with HDMI video ports</i> .
	• Duplex outlet with CAT6 data ports	+\$ 414	Specify with <i>duplex outlets with CAT6 data ports</i> .
	• Duplex outlet with USB data ports	+\$ 427	Specify with <i>duplex outlets with USB data ports</i> .

► Options, continued on next page



For Canadian Pricing
Multiply U.S. Price by the Canadian price factor.
► See page 1 for details.

► Options, continued from previous page

	Options	U.S. Price	Required to Specify
Center End Configuration	• Connecting unit	No cost	Specify with connecting unit.
	• Open	No cost	Specify with open.
Right End Configuration	• Connecting unit	No cost	Specify with connecting unit.
	• Open	No cost	Specify with open unit.
	• AD-61 RA upholstered right hand arm	+\$1326	Specify with upholstered right hand arm.
	• AD-62 RC upholstered right hand arm with tablet	+\$2837	Specify with upholstered right hand arm with tablet.
Right Arm Power/Data Node	• No power/data	No cost	Specify with no power/data.
	• 2 duplex outlets	+\$ 310	Specify with 2 duplex outlets.
	• Duplex outlet with HDMI video ports	+\$ 406	Specify with duplex outlets with HDMI video ports.
	• Duplex outlet with CAT6 data ports	+\$ 414	Specify with duplex outlets with CAT6 data ports.
	• Duplex outlet with USB data ports	+\$ 427	Specify with duplex outlets with USB data ports.
Table	• No table	No cost	Specify with no table.
	• AD-72 120° corner table	+\$3398	Specify with AD-72 120° corner table.
Table Location	• Table—left	No cost	Specify with left table.
	• Table—right	No cost	Specify with right table.
Base Power/Data Node	• No power/data	No cost	Specify with no power/data.
	• 2 duplex outlets	+\$ 310	Specify with 2 duplex outlets.
	• Duplex outlet with HDMI video ports	+\$ 406	Specify with duplex outlets with HDMI video ports.
	• Duplex outlet with CAT6 data ports	+\$ 414	Specify with duplex outlets with CAT6 data ports.
	• Duplex outlet with USB data ports	+\$ 427	Specify with duplex outlets with USB data ports.

Tip: Select paint when specifying power.

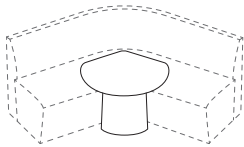

Specification Information

Style Number	U.S. Base Price
OBAD32	\$8708

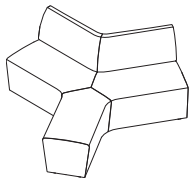

 **For Canadian Pricing**
 Multiply U.S. Price by the Canadian price factor.
 ► See page 1 for details.



Away from the Desk 120° Modular Tri Seat with Internal Back and Screen

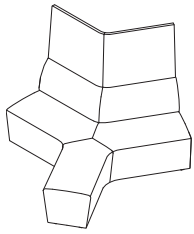

Tip: Customer's Own Material (COM) is available at a price group 1.

Standard Includes	Required to Specify
<ul style="list-style-type: none"> ▶ Need help? Product details, page 46 Fully upholstered seat, back, and screen: <ul style="list-style-type: none"> fabric price group 1 Adjustable glides: black Linking brackets 	<ol style="list-style-type: none"> Style number Fabric color number for seat, back, and screen Options, if selected (see below) <ul style="list-style-type: none"> ▶ See Product Understanding for Surface Materials.

Surface Materials	Options	U.S. Price	Required to Specify
	Seat		
	• Fabric price group 1	No cost	Specify fabric color number.
	• Fabric price group 2	+\$ 118	Specify fabric color number.
	• Fabric price group 3	+\$ 241	Specify fabric color number.
	• Fabric price group 4	+\$ 405	Specify fabric color number.
	• Fabric price group 5	+\$ 671	Specify fabric color number.
	• Fabric price group 6	+\$ 939	Specify fabric color number.
	• Fabric price group 7	+\$1281	Specify fabric color number.
	• Fabric price group 8	+\$1585	Specify fabric color number.
	• Fabric price group 9	+\$1852	Specify fabric color number.
	• Fabric price group 10	+\$2205	Specify fabric color number.
	Backrest outer		
	• Fabric price group 1	No cost	Specify fabric color number.
	• Fabric price group 2	+\$ 62	Specify fabric color number.
	• Fabric price group 3	+\$ 127	Specify fabric color number.
	• Fabric price group 4	+\$ 213	Specify fabric color number.
	• Fabric price group 5	+\$ 351	Specify fabric color number.
	• Fabric price group 6	+\$ 493	Specify fabric color number.
	• Fabric price group 7	+\$ 672	Specify fabric color number.
	• Fabric price group 8	+\$ 832	Specify fabric color number.
	• Fabric price group 9	+\$ 972	Specify fabric color number.
	• Fabric price group 10	+\$1157	Specify fabric color number.
	Backrest inner		
	• Fabric price group 1	No cost	Specify fabric color number.
	• Fabric price group 2	+\$ 39	Specify fabric color number.
	• Fabric price group 3	+\$ 81	Specify fabric color number.
	• Fabric price group 4	+\$ 134	Specify fabric color number.
	• Fabric price group 5	+\$ 223	Specify fabric color number.
	• Fabric price group 6	+\$ 311	Specify fabric color number.
	• Fabric price group 7	+\$ 427	Specify fabric color number.
• Fabric price group 8	+\$ 526	Specify fabric color number.	
• Fabric price group 9	+\$ 617	Specify fabric color number.	
• Fabric price group 10	+\$ 734	Specify fabric color number.	
Left arm			
• Fabric price group 1	No cost	Specify fabric color number.	
• Fabric price group 2	+\$ 52	Specify fabric color number.	
• Fabric price group 3	+\$ 104	Specify fabric color number.	
• Fabric price group 4	+\$ 175	Specify fabric color number.	
• Fabric price group 5	+\$ 289	Specify fabric color number.	
• Fabric price group 6	+\$ 406	Specify fabric color number.	
• Fabric price group 7	+\$ 555	Specify fabric color number.	
• Fabric price group 8	+\$ 687	Specify fabric color number.	
• Fabric price group 9	+\$ 802	Specify fabric color number.	
• Fabric price group 10	+\$ 955	Specify fabric color number.	
Left tablet top			
• High-Pressure Laminate price group 1	No cost	Specify laminate color number.	
• High-Pressure Laminate price group 2	+\$ 82	Specify laminate color number.	
• High-Pressure Laminate price group 3	+\$ 167	Specify laminate color number.	
• Open Line laminate (OLL)	+\$ 111 plus cost of laminate		

▶ See *Surface Materials Reference Manual*.

▶ Options, continued on next page

 **For Canadian Pricing**
Multiply U.S. Price by the Canadian price factor.
▶ See page 1 for details.

► Options, continued from previous page

Options	U.S. Price	Required to Specify
Surface Materials, continued		
Right arm		
• Fabric price group 1	No cost	Specify fabric color number.
• Fabric price group 2	+\$ 52	Specify fabric color number.
• Fabric price group 3	+\$ 104	Specify fabric color number.
• Fabric price group 4	+\$ 175	Specify fabric color number.
• Fabric price group 5	+\$ 289	Specify fabric color number.
• Fabric price group 6	+\$ 406	Specify fabric color number.
• Fabric price group 7	+\$ 555	Specify fabric color number.
• Fabric price group 8	+\$ 687	Specify fabric color number.
• Fabric price group 9	+\$ 802	Specify fabric color number.
• Fabric price group 10	+\$ 955	Specify fabric color number.
Right tablet top		
• High-Pressure Laminate price group 1	No cost	Specify laminate color number.
• High-Pressure Laminate price group 2	+\$ 82	Specify laminate color number.
• High-Pressure Laminate price group 3	+\$ 167	Specify laminate color number.
• Open Line laminate (OLL)	+\$ 111 plus cost of laminate	► See <i>Surface Materials Reference Manual</i> .
Table top		
• High-Pressure Laminate price group 1	No cost	Specify laminate color number.
• High-Pressure Laminate price group 2	+\$ 82	Specify laminate color number.
• High-Pressure Laminate price group 3	+\$ 167	Specify laminate color number.
• Open Line laminate (OLL)	+\$ 111 plus cost of laminate	► See <i>Surface Materials Reference Manual</i> .
Table base		
• Fabric price group 1	No cost	Specify fabric color number.
• Fabric price group 2	+\$ 39	Specify fabric color number.
• Fabric price group 3	+\$ 81	Specify fabric color number.
• Fabric price group 4	+\$ 134	Specify fabric color number.
• Fabric price group 5	+\$ 223	Specify fabric color number.
• Fabric price group 6	+\$ 311	Specify fabric color number.
• Fabric price group 7	+\$ 427	Specify fabric color number.
• Fabric price group 8	+\$ 526	Specify fabric color number.
• Fabric price group 9	+\$ 617	Specify fabric color number.
• Fabric price group 10	+\$ 734	Specify fabric color number.
Screen Connection		
• No screen connections	No cost	Specify with no screen connection.
• Screen connection-left	No cost	Specify with left screen connection.
• Screen connection-left and right	No cost	Specify with left and right screen connection.
• Screen connection-right	No cost	Specify with right screen connection.
Left End Configuration		
• Connecting unit	No cost	Specify with connecting unit.
• Open	No cost	Specify with open unit.
• AD-61 LA upholstered left hand arm	+\$1326	Specify with upholstered left hand arm.
• AD-62 LC upholstered left hand arm with tablet	+\$2837	Specify with upholstered left hand arm with tablet.
Left Arm Power/Data Node		
• No power/data	No cost	Specify with no power/data.
• 2 duplex outlets	+\$ 310	Specify with 2 duplex outlets.
• Duplex outlet with HDMI video ports	+\$ 406	Specify with duplex outlets with HDMI video ports.
• Duplex outlet with CAT6 data ports	+\$ 414	Specify with duplex outlets with CAT6 data ports.
• Duplex outlet with USB data ports	+\$ 427	Specify with duplex outlets with USB data ports.
Center End Configuration		
• Connecting unit	No cost	Specify with connecting unit.
• Open	No cost	Specify with open.

► Options, continued on next page



For Canadian Pricing
Multiply U.S. Price by the Canadian price factor.
► See page 1 for details.

► Options, continued from previous page

	Options	U.S. Price	Required to Specify
Right End Configuration	• Connecting unit	No cost	Specify with connecting unit.
	• Open	No cost	Specify with open unit.
	• AD-61 RA upholstered right hand arm	+\$1326	Specify with upholstered right hand arm.
	• AD-62 RC upholstered right hand arm with tablet	+\$2837	Specify with upholstered right hand arm with tablet.
Right Arm Power/Data Node	• No power/data	No cost	Specify with no power/data.
	• 2 duplex outlets	+\$ 310	Specify with 2 duplex outlets.
	• Duplex outlet with HDMI video ports	+\$ 406	Specify with duplex outlets with HDMI video ports.
	• Duplex outlet with CAT6 data ports	+\$ 414	Specify with duplex outlets with CAT6 data ports.
	• Duplex outlet with USB data ports	+\$ 427	Specify with duplex outlets with USB data ports.
Table	• No table	No cost	Specify with no table.
	• AD-72 120° corner table	+\$3398	Specify with AD-72 120° corner table.
Table Location	• Table—left	No cost	Specify with left table.
	• Table—right	No cost	Specify with right table.
Base Power/Data Node	• No power/data	No cost	Specify with no power/data.
	• 2 duplex outlets	+\$ 310	Specify with 2 duplex outlets.
	• Duplex outlet with HDMI video ports	+\$ 406	Specify with duplex outlets with HDMI video ports.
	• Duplex outlet with CAT6 data ports	+\$ 414	Specify with duplex outlets with CAT6 data ports.
	• Duplex outlet with USB data ports	+\$ 427	Specify with duplex outlets with USB data ports.

Tip: Select paint when specifying power.

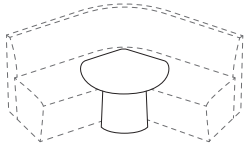

Specification Information

Style Number	U.S. Base Prices									
	Screen Price Groups									
	1	2	3	4	5	6	7	8	9	10
OBAD33	\$10,370	\$10,445	\$10,519	\$10,623	\$10,789	\$10,957	\$11,169	\$11,362	\$11,527	\$11,747

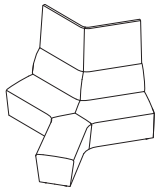

 **For Canadian Pricing**
 Multiply U.S. Price by the Canadian price factor.
 ► See page 1 for details.

Away from the Desk 90° Modular Seat with Back

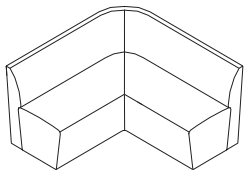

Tip: Customer's Own Material (COM) is available at a price group 1.

Standard Includes	Required to Specify
<ul style="list-style-type: none"> ▶ Need help? Product details, page 46 Fully upholstered seat with back: fabric price group 1 Adjustable glides: black Linking brackets 	<ul style="list-style-type: none"> 1 Style number 2 Fabric color number for seat and back 3 Options, if selected (see below) ▶ See Product Understanding for Surface Materials.

Options	U.S. Price	Required to Specify
Surface Materials		
Seat		
• Fabric price group 1	No cost	Specify fabric color number.
• Fabric price group 2	+\$ 87	Specify fabric color number.
• Fabric price group 3	+\$ 174	Specify fabric color number.
• Fabric price group 4	+\$ 295	Specify fabric color number.
• Fabric price group 5	+\$ 485	Specify fabric color number.
• Fabric price group 6	+\$ 678	Specify fabric color number.
• Fabric price group 7	+\$ 927	Specify fabric color number.
• Fabric price group 8	+\$1148	Specify fabric color number.
• Fabric price group 9	+\$1343	Specify fabric color number.
• Fabric price group 10	+\$1598	Specify fabric color number.
Backrest outer		
• Fabric price group 1	No cost	Specify fabric color number.
• Fabric price group 2	+\$ 95	Specify fabric color number.
• Fabric price group 3	+\$ 198	Specify fabric color number.
• Fabric price group 4	+\$ 332	Specify fabric color number.
• Fabric price group 5	+\$ 554	Specify fabric color number.
• Fabric price group 6	+\$ 774	Specify fabric color number.
• Fabric price group 7	+\$1056	Specify fabric color number.
• Fabric price group 8	+\$1307	Specify fabric color number.
• Fabric price group 9	+\$1528	Specify fabric color number.
• Fabric price group 10	+\$1818	Specify fabric color number.
Backrest inner		
• Fabric price group 1	No cost	Specify fabric color number.
• Fabric price group 2	+\$ 49	Specify fabric color number.
• Fabric price group 3	+\$ 94	Specify fabric color number.
• Fabric price group 4	+\$ 162	Specify fabric color number.
• Fabric price group 5	+\$ 269	Specify fabric color number.
• Fabric price group 6	+\$ 375	Specify fabric color number.
• Fabric price group 7	+\$ 513	Specify fabric color number.
• Fabric price group 8	+\$ 634	Specify fabric color number.
• Fabric price group 9	+\$ 741	Specify fabric color number.
• Fabric price group 10	+\$ 882	Specify fabric color number.
Left arm		
• Fabric price group 1	No cost	Specify fabric color number.
• Fabric price group 2	+\$ 52	Specify fabric color number.
• Fabric price group 3	+\$ 104	Specify fabric color number.
• Fabric price group 4	+\$ 175	Specify fabric color number.
• Fabric price group 5	+\$ 289	Specify fabric color number.
• Fabric price group 6	+\$ 406	Specify fabric color number.
• Fabric price group 7	+\$ 555	Specify fabric color number.
• Fabric price group 8	+\$ 687	Specify fabric color number.
• Fabric price group 9	+\$ 802	Specify fabric color number.
• Fabric price group 10	+\$ 955	Specify fabric color number.
Left tablet top		
• High-Pressure Laminate price group 1	No cost	Specify laminate color number.
• High-Pressure Laminate price group 2	+\$ 82	Specify laminate color number.
• High-Pressure Laminate price group 3	+\$ 167	Specify laminate color number.
• Open Line laminate (OLL)	+\$ 111 plus cost of laminate	▶ See <i>Surface Materials Reference Manual</i> .

▶ Options, continued on next page



For Canadian Pricing
Multiply U.S. Price by the Canadian price factor.
▶ See page 1 for details.

► Options, continued from previous page

	Options	U.S. Price	Required to Specify
Surface Materials, continued	Right arm		
	• Fabric price group 1	No cost	Specify fabric color number.
	• Fabric price group 2	+\$ 52	Specify fabric color number.
	• Fabric price group 3	+\$ 104	Specify fabric color number.
	• Fabric price group 4	+\$ 175	Specify fabric color number.
	• Fabric price group 5	+\$ 289	Specify fabric color number.
	• Fabric price group 6	+\$ 406	Specify fabric color number.
	• Fabric price group 7	+\$ 555	Specify fabric color number.
	• Fabric price group 8	+\$ 687	Specify fabric color number.
	• Fabric price group 9	+\$ 802	Specify fabric color number.
	• Fabric price group 10	+\$ 955	Specify fabric color number.
	Right tablet top		
	• High-Pressure Laminate price group 1	No cost	Specify laminate color number.
	• High-Pressure Laminate price group 2	+\$ 82	Specify laminate color number.
	• High-Pressure Laminate price group 3	+\$ 167	Specify laminate color number.
	• Open Line laminate (OLL)	+\$ 111 plus cost of laminate	► See <i>Surface Materials Reference Manual</i> .
	Table top		
	• High-Pressure Laminate price group 1	No cost	Specify laminate color number.
	• High-Pressure Laminate price group 2	+\$ 82	Specify laminate color number.
	• High-Pressure Laminate price group 3	+\$ 167	Specify laminate color number.
	• Open Line laminate (OLL)	+\$ 111 plus cost of laminate	► See <i>Surface Materials Reference Manual</i> .
	Table base		
	• Fabric price group 1	No cost	Specify fabric color number.
	• Fabric price group 2	+\$ 39	Specify fabric color number.
	• Fabric price group 3	+\$ 81	Specify fabric color number.
	• Fabric price group 4	+\$ 134	Specify fabric color number.
	• Fabric price group 5	+\$ 223	Specify fabric color number.
	• Fabric price group 6	+\$ 311	Specify fabric color number.
	• Fabric price group 7	+\$ 427	Specify fabric color number.
	• Fabric price group 8	+\$ 526	Specify fabric color number.
	• Fabric price group 9	+\$ 617	Specify fabric color number.
	• Fabric price group 10	+\$ 734	Specify fabric color number.
Left End Configuration	• Connecting unit	No cost	Specify <i>with connecting unit</i> .
	• Open	No cost	Specify <i>with open unit</i> .
	• AD-61 LA upholstered left hand arm	+\$1326	Specify <i>with upholstered left hand arm</i> .
	• AD-62 LC upholstered left hand arm with tablet	+\$2837	Specify <i>with upholstered left hand arm with tablet</i> .
Left Arm Power/Data Node	• No power/data	No cost	Specify <i>with no power/data</i> .
	• 2 duplex outlets	+\$ 310	Specify <i>with 2 duplex outlets</i> .
	• Duplex outlet with HDMI video ports	+\$ 406	Specify <i>with duplex outlets with HDMI video ports</i> .
	• Duplex outlet with CAT6 data ports	+\$ 414	Specify <i>with duplex outlets with CAT6 data ports</i> .
	• Duplex outlet with USB data ports	+\$ 427	Specify <i>with duplex outlets with USB data ports</i> .

Tip: Select paint when specifying power.

► Options, continued on next page

Specifying

 **For Canadian Pricing**
Multiply U.S. Price by the Canadian price factor.
► See page 1 for details.

Away from the Desk 90° Modular Seat with Back, continued

► Options, continued from previous page

	Options	U.S. Price	Required to Specify
Right End Configuration	• Connecting unit	No cost	Specify with connecting unit.
	• Open	No cost	Specify with open unit.
	• AD-61 RA upholstered right hand arm	+\$1326	Specify with upholstered right hand arm.
	• AD-62 RC upholstered right hand arm with tablet	+\$2767	Specify with upholstered right hand arm with tablet.
Right Arm Power/Data Node	• No power/data	No cost	Specify with no power/data.
	• 2 duplex outlets	+\$ 310	Specify with 2 duplex outlets.
	• Duplex outlet with HDMI video ports	+\$ 406	Specify with duplex outlets with HDMI video ports.
	• Duplex outlet with CAT6 data ports	+\$ 414	Specify with duplex outlets with CAT6 data ports.
	• Duplex outlet with USB data ports	+\$ 427	Specify with duplex outlets with USB data ports.
Table	• No table	No cost	Specify with no table.
	• AD-71 90° corner table	+\$2923	Specify with AD-71 90° corner table.
Base Power/Data Node	• No power/data	No cost	Specify with no power/data.
	• 2 duplex outlets	+\$ 310	Specify with 2 duplex outlets.
	• Duplex outlet with HDMI video ports	+\$ 406	Specify with duplex outlets with HDMI video ports.
	• Duplex outlet with CAT6 data ports	+\$ 414	Specify with duplex outlets with CAT6 data ports.
	• Duplex outlet with USB data ports	+\$ 427	Specify with duplex outlets with USB data ports.

Tip: Tablet is selectable on one end only.

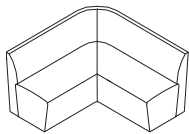
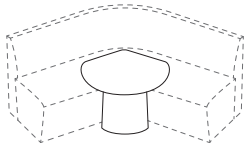

Specification Information

Style Number	U.S. Base Price
OBAD42	\$8395



For Canadian Pricing

Multiply U.S. Price by the Canadian price factor.

► See page 1 for details.



Away from the Desk 90° Modular Seat with Back and Screen

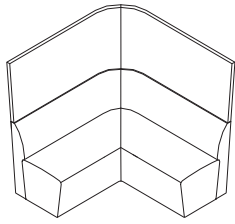

Tip: Customer's Own Material (COM) is available at a price group 1.

Standard Includes	Required to Specify
<ul style="list-style-type: none"> ▶ Need help? Product details, page 46 Fully upholstered seat, back, and screen: fabric price group 1 Adjustable glides: black Linking brackets 	<ol style="list-style-type: none"> 1 Style number 2 Fabric color number for seat, back, and screen 3 Options, if selected (see below) <ul style="list-style-type: none"> ▶ See Product Understanding for Surface Materials.

Surface Materials	Options	U.S. Price	Required to Specify
	Seat		
	• Fabric price group 1	No cost	Specify fabric color number.
	• Fabric price group 2	+\$ 87	Specify fabric color number.
	• Fabric price group 3	+\$ 174	Specify fabric color number.
	• Fabric price group 4	+\$ 295	Specify fabric color number.
	• Fabric price group 5	+\$ 485	Specify fabric color number.
	• Fabric price group 6	+\$ 678	Specify fabric color number.
	• Fabric price group 7	+\$ 927	Specify fabric color number.
	• Fabric price group 8	+\$1148	Specify fabric color number.
	• Fabric price group 9	+\$1343	Specify fabric color number.
	• Fabric price group 10	+\$1598	Specify fabric color number.
	Backrest outer		
	• Fabric price group 1	No cost	Specify fabric color number.
	• Fabric price group 2	+\$ 95	Specify fabric color number.
	• Fabric price group 3	+\$ 198	Specify fabric color number.
	• Fabric price group 4	+\$ 332	Specify fabric color number.
	• Fabric price group 5	+\$ 554	Specify fabric color number.
	• Fabric price group 6	+\$ 774	Specify fabric color number.
	• Fabric price group 7	+\$1056	Specify fabric color number.
	• Fabric price group 8	+\$1307	Specify fabric color number.
	• Fabric price group 9	+\$1528	Specify fabric color number.
	• Fabric price group 10	+\$1818	Specify fabric color number.
	Backrest inner		
	• Fabric price group 1	No cost	Specify fabric color number.
	• Fabric price group 2	+\$ 49	Specify fabric color number.
	• Fabric price group 3	+\$ 94	Specify fabric color number.
	• Fabric price group 4	+\$ 162	Specify fabric color number.
	• Fabric price group 5	+\$ 269	Specify fabric color number.
	• Fabric price group 6	+\$ 375	Specify fabric color number.
	• Fabric price group 7	+\$ 513	Specify fabric color number.
	• Fabric price group 8	+\$ 634	Specify fabric color number.
	• Fabric price group 9	+\$ 741	Specify fabric color number.
	• Fabric price group 10	+\$ 882	Specify fabric color number.
	Left arm		
	• Fabric price group 1	No cost	Specify fabric color number.
	• Fabric price group 2	+\$ 52	Specify fabric color number.
	• Fabric price group 3	+\$ 104	Specify fabric color number.
	• Fabric price group 4	+\$ 175	Specify fabric color number.
	• Fabric price group 5	+\$ 289	Specify fabric color number.
	• Fabric price group 6	+\$ 406	Specify fabric color number.
	• Fabric price group 7	+\$ 555	Specify fabric color number.
	• Fabric price group 8	+\$ 687	Specify fabric color number.
	• Fabric price group 9	+\$ 802	Specify fabric color number.
	• Fabric price group 10	+\$ 955	Specify fabric color number.
	Left tablet top		
	• High-Pressure Laminate price group 1	No cost	Specify laminate color number.
	• High-Pressure Laminate price group 2	+\$ 82	Specify laminate color number.
	• High-Pressure Laminate price group 3	+\$ 167	Specify laminate color number.
	• Open Line laminate (OLL)	+\$ 111 plus cost of laminate	▶ See <i>Surface Materials Reference Manual</i> .

▶ Options, continued on next page



For Canadian Pricing
Multiply U.S. Price by the Canadian price factor.
▶ See page 1 for details.

► Options, continued from previous page

	Options	U.S. Price	Required to Specify
Surface Materials, continued	Right arm		
	• Fabric price group 1	No cost	Specify fabric color number.
	• Fabric price group 2	+\$ 52	Specify fabric color number.
	• Fabric price group 3	+\$ 104	Specify fabric color number.
	• Fabric price group 4	+\$ 175	Specify fabric color number.
	• Fabric price group 5	+\$ 289	Specify fabric color number.
	• Fabric price group 6	+\$ 406	Specify fabric color number.
	• Fabric price group 7	+\$ 555	Specify fabric color number.
	• Fabric price group 8	+\$ 687	Specify fabric color number.
	• Fabric price group 9	+\$ 802	Specify fabric color number.
	• Fabric price group 10	+\$ 955	Specify fabric color number.
	Right tablet top		
	• High-Pressure Laminate price group 1	No cost	Specify laminate color number.
	• High-Pressure Laminate price group 2	+\$ 82	Specify laminate color number.
	• High-Pressure Laminate price group 3	+\$ 167	Specify laminate color number.
	• Open Line laminate (OLL)	+\$ 111 plus cost of laminate	► See <i>Surface Materials Reference Manual</i> .
	Table top		
	• High-Pressure Laminate price group 1	No cost	Specify laminate color number.
	• High-Pressure Laminate price group 2	+\$ 82	Specify laminate color number.
	• High-Pressure Laminate price group 3	+\$ 167	Specify laminate color number.
	• Open Line laminate (OLL)	+\$ 111 plus cost of laminate	► See <i>Surface Materials Reference Manual</i> .
	Table base		
	• Fabric price group 1	No cost	Specify fabric color number.
	• Fabric price group 2	+\$ 39	Specify fabric color number.
	• Fabric price group 3	+\$ 81	Specify fabric color number.
	• Fabric price group 4	+\$ 134	Specify fabric color number.
	• Fabric price group 5	+\$ 223	Specify fabric color number.
	• Fabric price group 6	+\$ 311	Specify fabric color number.
	• Fabric price group 7	+\$ 427	Specify fabric color number.
	• Fabric price group 8	+\$ 526	Specify fabric color number.
	• Fabric price group 9	+\$ 617	Specify fabric color number.
	• Fabric price group 10	+\$ 734	Specify fabric color number.
	Screen Connection		
	• No screen connections	No cost	Specify with <i>no screen connection</i> .
	• Screen connection-left	No cost	Specify with <i>left screen connection</i> .
	• Screen connection-left and right	No cost	Specify with <i>left and right screen connection</i> .
	• Screen connection-right	No cost	Specify with <i>right screen connection</i> .
	Left End Configuration		
	• Connecting unit	No cost	Specify with <i>connecting unit</i> .
	• Open	No cost	Specify with <i>open unit</i> .
	• AD-61 LA upholstered left hand arm	+\$1326	Specify with <i>upholstered left hand arm</i> .
	• AD-62 LC upholstered left hand arm with tablet	+\$2837	Specify with <i>upholstered left hand arm with tablet</i> .
	Left Arm Power/Data Node		
	• No power/data	No cost	Specify with <i>no power/data</i> .
	• 2 duplex outlets	+\$ 310	Specify with <i>2 duplex outlets</i> .
	• Duplex outlet with HDMI video ports	+\$ 406	Specify with <i>duplex outlets with HDMI video ports</i> .
	• Duplex outlet with CAT6 data ports	+\$ 414	Specify with <i>duplex outlets with CAT6 data ports</i> .
	• Duplex outlet with USB data ports	+\$ 427	Specify with <i>duplex outlets with USB data ports</i> .

Tip: Tablet is selectable on one end only.

Tip: Select paint when specifying power.



For Canadian Pricing
Multiply U.S. Price by the Canadian price factor.
► See page 1 for details.

► Options, continued on next page

► Options, continued from previous page

Options	U.S. Price	Required to Specify
Right End Configuration		
• Connecting unit	No cost	Specify with connecting unit.
• Open	No cost	Specify with open unit.
• AD-61 RA upholstered right hand arm	+\$1326	Specify with upholstered right hand arm.
• AD-62 RC upholstered right hand arm with tablet	+\$2837	Specify with upholstered right hand arm with tablet.
Right Arm Power/Data Node		
• No power/data	No cost	Specify with no power/data.
• 2 duplex outlets	+\$ 310	Specify with 2 duplex outlets.
• Duplex outlet with HDMI video ports	+\$ 406	Specify with duplex outlets with HDMI video ports.
• Duplex outlet with CAT6 data ports	+\$ 414	Specify with duplex outlets with CAT6 data ports.
• Duplex outlet with USB data ports	+\$ 427	Specify with duplex outlets with USB data ports.
Table		
• No table	No cost	Specify with no table.
• AD-71 90° corner table	+\$2923	Specify with AD-71 90° corner table.
Table Location		
• Table – left	No cost	Specify with left table.
• Table – right	No cost	Specify with right table.
Base Power/Data Node		
• No power/data	No cost	Specify with no power/data.
• 2 duplex outlets	+\$ 310	Specify with 2 duplex outlets.
• Duplex outlet with HDMI video ports	+\$ 406	Specify with duplex outlets with HDMI video ports.
• Duplex outlet with CAT6 data ports	+\$ 414	Specify with duplex outlets with CAT6 data ports.
• Duplex outlet with USB data ports	+\$ 427	Specify with duplex outlets with USB data ports.

Tip: Tablet is selectable on one end only.

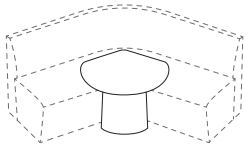

Specification Information

Style Number	U.S. Base Prices									
	Screen Price Groups									
	1	2	3	4	5	6	7	8	9	10
OBAD43	\$10,201	\$10,331	\$10,466	\$10,646	\$10,938	\$11,233	\$11,610	\$11,945	\$12,238	\$12,625

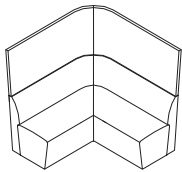

For Canadian Pricing
 Multiply U.S. Price by the Canadian price factor.
 ► See page 1 for details.

Away from the Desk 90° Modular Curved Seat with Back

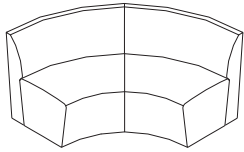

Tip: Customer's Own Material (COM) is available at a price group 1.

Standard Includes	Required to Specify
<ul style="list-style-type: none"> ▶ Need help? Product details, page 46 Fully upholstered seat with back: fabric price group 1 Adjustable glides: black Linking brackets 	<ul style="list-style-type: none"> 1 Style number 2 Fabric color number for seat and back 3 Options, if selected (see below) ▶ See Product Understanding for Surface Materials.

Options	U.S. Price	Required to Specify
Surface Materials		
Seat		
• Fabric price group 1	No cost	Specify fabric color number.
• Fabric price group 2	+\$ 75	Specify fabric color number.
• Fabric price group 3	+\$ 149	Specify fabric color number.
• Fabric price group 4	+\$ 253	Specify fabric color number.
• Fabric price group 5	+\$ 419	Specify fabric color number.
• Fabric price group 6	+\$ 587	Specify fabric color number.
• Fabric price group 7	+\$ 799	Specify fabric color number.
• Fabric price group 8	+\$ 992	Specify fabric color number.
• Fabric price group 9	+\$1157	Specify fabric color number.
• Fabric price group 10	+\$1377	Specify fabric color number.
Backrest outer		
• Fabric price group 1	No cost	Specify fabric color number.
• Fabric price group 2	+\$ 75	Specify fabric color number.
• Fabric price group 3	+\$ 149	Specify fabric color number.
• Fabric price group 4	+\$ 253	Specify fabric color number.
• Fabric price group 5	+\$ 419	Specify fabric color number.
• Fabric price group 6	+\$ 587	Specify fabric color number.
• Fabric price group 7	+\$ 799	Specify fabric color number.
• Fabric price group 8	+\$ 992	Specify fabric color number.
• Fabric price group 9	+\$1157	Specify fabric color number.
• Fabric price group 10	+\$1377	Specify fabric color number.
Backrest inner		
• Fabric price group 1	No cost	Specify fabric color number.
• Fabric price group 2	+\$ 56	Specify fabric color number.
• Fabric price group 3	+\$ 113	Specify fabric color number.
• Fabric price group 4	+\$ 188	Specify fabric color number.
• Fabric price group 5	+\$ 312	Specify fabric color number.
• Fabric price group 6	+\$ 437	Specify fabric color number.
• Fabric price group 7	+\$ 597	Specify fabric color number.
• Fabric price group 8	+\$ 739	Specify fabric color number.
• Fabric price group 9	+\$ 864	Specify fabric color number.
• Fabric price group 10	+\$1028	Specify fabric color number.
Left arm		
• Fabric price group 1	No cost	Specify fabric color number.
• Fabric price group 2	+\$ 52	Specify fabric color number.
• Fabric price group 3	+\$ 104	Specify fabric color number.
• Fabric price group 4	+\$ 175	Specify fabric color number.
• Fabric price group 5	+\$ 289	Specify fabric color number.
• Fabric price group 6	+\$ 406	Specify fabric color number.
• Fabric price group 7	+\$ 555	Specify fabric color number.
• Fabric price group 8	+\$ 687	Specify fabric color number.
• Fabric price group 9	+\$ 802	Specify fabric color number.
• Fabric price group 10	+\$ 955	Specify fabric color number.
Left tablet top		
• High-Pressure Laminate price group 1	No cost	Specify laminate color number.
• High-Pressure Laminate price group 2	+\$ 82	Specify laminate color number.
• High-Pressure Laminate price group 3	+\$ 167	Specify laminate color number.
• Open Line laminate (OLL)	+\$ 111 plus cost of laminate	▶ See <i>Surface Materials Reference Manual</i> .

▶ Options, continued on next page



For Canadian Pricing
Multiply U.S. Price by the Canadian price factor.
▶ See page 1 for details.

► Options, continued from previous page

	Options	U.S. Price	Required to Specify
Surface Materials, continued	Right arm		
	• Fabric price group 1	No cost	Specify fabric color number.
	• Fabric price group 2	+\$ 52	Specify fabric color number.
	• Fabric price group 3	+\$ 104	Specify fabric color number.
	• Fabric price group 4	+\$ 175	Specify fabric color number.
	• Fabric price group 5	+\$ 289	Specify fabric color number.
	• Fabric price group 6	+\$ 406	Specify fabric color number.
	• Fabric price group 7	+\$ 555	Specify fabric color number.
	• Fabric price group 8	+\$ 687	Specify fabric color number.
	• Fabric price group 9	+\$ 802	Specify fabric color number.
• Fabric price group 10	+\$ 955	Specify fabric color number.	
	Right tablet top		
	• High-Pressure Laminate price group 1	No cost	Specify laminate color number.
	• High-Pressure Laminate price group 2	+\$ 82	Specify laminate color number.
	• High-Pressure Laminate price group 3	+\$ 167	Specify laminate color number.
	• Open Line laminate (OLL)	+\$ 111 plus cost of laminate	► See <i>Surface Materials Reference Manual</i> .
Left End Configuration	• Connecting unit	No cost	Specify with connecting unit.
	• Open	No cost	Specify with open unit.
	• AD-61 LA upholstered left hand arm	+\$1326	Specify with upholstered left hand arm.
	• AD-62 LC upholstered left hand arm with tablet	+\$2837	Specify with upholstered left hand arm with tablet.
	Left Arm Power/Data Node	• No power/data	No cost
• 2 duplex outlets		+\$ 310	Specify with 2 duplex outlets.
• Duplex outlet with HDMI video ports		+\$ 406	Specify with duplex outlets with HDMI video ports.
• Duplex outlet with CAT6 data ports		+\$ 414	Specify with duplex outlets with CAT6 data ports.
• Duplex outlet with USB data ports		+\$ 427	Specify with duplex outlets with USB data ports.
Right End Configuration	• Connecting unit	No cost	Specify with connecting unit.
	• Open	No cost	Specify with open unit.
	• AD-61 RA upholstered right hand arm	+\$1326	Specify with upholstered right hand arm.
	• AD-62 RC upholstered right hand arm with tablet	+\$2837	Specify with upholstered right hand arm with tablet.
	Right Arm Power/Data Node	• No power/data	No cost
• 2 duplex outlets		+\$ 310	Specify with 2 duplex outlets.
• Duplex outlet with HDMI video ports		+\$ 406	Specify with duplex outlets with HDMI video ports.
• Duplex outlet with CAT6 data ports		+\$ 414	Specify with duplex outlets with CAT6 data ports.
• Duplex outlet with USB data ports		+\$ 427	Specify with duplex outlets with USB data ports.

Tip: Tablet is selectable on one end only.

Tip: Select paint when specifying power.

Specifying

Specification Information

Style Number	U.S. Base Price
OBAD52	\$7617

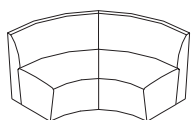

Away from the Desk 90° Modular Curved Seat with Back and Screen

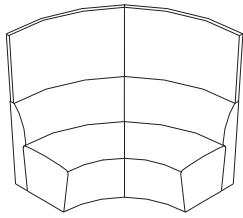

Tip: Customer's Own Material (COM) is available at a price group 1.

Standard Includes	Required to Specify
<ul style="list-style-type: none"> ▶ Need help? Product details, page 46 Fully upholstered seat, back, and screen: fabric price group 1 Adjustable glides: black Linking brackets 	<ol style="list-style-type: none"> 1 Style number 2 Fabric color number for seat, back, and screen 3 Options, if selected (see below) <ul style="list-style-type: none"> ▶ See Product Understanding for Surface Materials.

Surface Materials	Options	U.S. Price	Required to Specify
	Seat		
	• Fabric price group 1	No cost	Specify fabric color number.
	• Fabric price group 2	+\$ 75	Specify fabric color number.
	• Fabric price group 3	+\$ 149	Specify fabric color number.
	• Fabric price group 4	+\$ 253	Specify fabric color number.
	• Fabric price group 5	+\$ 419	Specify fabric color number.
	• Fabric price group 6	+\$ 587	Specify fabric color number.
	• Fabric price group 7	+\$ 799	Specify fabric color number.
	• Fabric price group 8	+\$ 992	Specify fabric color number.
	• Fabric price group 9	+\$1157	Specify fabric color number.
	• Fabric price group 10	+\$1377	Specify fabric color number.
	Backrest outer		
	• Fabric price group 1	No cost	Specify fabric color number.
	• Fabric price group 2	+\$ 75	Specify fabric color number.
	• Fabric price group 3	+\$ 149	Specify fabric color number.
	• Fabric price group 4	+\$ 253	Specify fabric color number.
	• Fabric price group 5	+\$ 419	Specify fabric color number.
	• Fabric price group 6	+\$ 587	Specify fabric color number.
	• Fabric price group 7	+\$ 799	Specify fabric color number.
	• Fabric price group 8	+\$ 992	Specify fabric color number.
	• Fabric price group 9	+\$1157	Specify fabric color number.
	• Fabric price group 10	+\$1377	Specify fabric color number.
	Backrest inner		
	• Fabric price group 1	No cost	Specify fabric color number.
	• Fabric price group 2	+\$ 56	Specify fabric color number.
	• Fabric price group 3	+\$ 113	Specify fabric color number.
	• Fabric price group 4	+\$ 188	Specify fabric color number.
	• Fabric price group 5	+\$ 312	Specify fabric color number.
	• Fabric price group 6	+\$ 437	Specify fabric color number.
	• Fabric price group 7	+\$ 597	Specify fabric color number.
	• Fabric price group 8	+\$ 739	Specify fabric color number.
	• Fabric price group 9	+\$ 864	Specify fabric color number.
	• Fabric price group 10	+\$1028	Specify fabric color number.
	Left arm		
	• Fabric price group 1	No cost	Specify fabric color number.
	• Fabric price group 2	+\$ 52	Specify fabric color number.
	• Fabric price group 3	+\$ 104	Specify fabric color number.
	• Fabric price group 4	+\$ 175	Specify fabric color number.
	• Fabric price group 5	+\$ 289	Specify fabric color number.
	• Fabric price group 6	+\$ 406	Specify fabric color number.
	• Fabric price group 7	+\$ 555	Specify fabric color number.
	• Fabric price group 8	+\$ 687	Specify fabric color number.
	• Fabric price group 9	+\$ 802	Specify fabric color number.
	• Fabric price group 10	+\$ 955	Specify fabric color number.
	Left tablet top		
	• High-Pressure Laminate price group 1	No cost	Specify laminate color number.
	• High-Pressure Laminate price group 2	+\$ 82	Specify laminate color number.
	• High-Pressure Laminate price group 3	+\$ 167	Specify laminate color number.
	• Open Line laminate (OLL)	+\$ 111 plus cost of laminate	▶ See <i>Surface Materials Reference Manual</i> .

▶ Options, continued on next page



For Canadian Pricing
Multiply U.S. Price by the Canadian price factor.
▶ See page 1 for details.

► Options, continued from previous page

	Options	U.S. Price	Required to Specify
Surface Materials, continued	Right arm		
	• Fabric price group 1	No cost	Specify fabric color number.
	• Fabric price group 2	+\$ 52	Specify fabric color number.
	• Fabric price group 3	+\$ 104	Specify fabric color number.
	• Fabric price group 4	+\$ 175	Specify fabric color number.
	• Fabric price group 5	+\$ 289	Specify fabric color number.
	• Fabric price group 6	+\$ 406	Specify fabric color number.
	• Fabric price group 7	+\$ 555	Specify fabric color number.
	• Fabric price group 8	+\$ 687	Specify fabric color number.
	• Fabric price group 9	+\$ 802	Specify fabric color number.
	• Fabric price group 10	+\$ 955	Specify fabric color number.
	Right tablet top		
	• High-Pressure Laminate price group 1	No cost	Specify laminate color number.
	• High-Pressure Laminate price group 2	+\$ 82	Specify laminate color number.
	• High-Pressure Laminate price group 3	+\$ 167	Specify laminate color number.
• Open Line laminate (OLL)	+\$ 111 plus cost of laminate	► See <i>Surface Materials Reference Manual</i> .	
Screen Connection	• No screen connections	No cost	Specify with no screen connection.
	• Screen connection-left	No cost	Specify with left screen connection.
	• Screen connection-left and right	No cost	Specify with left and right screen connection.
	• Screen connection-right	No cost	Specify with right screen connection.
Left End Configuration	• Connecting unit	No cost	Specify with connecting unit.
	• Open	No cost	Specify with open unit.
	• AD-61 LA upholstered left hand arm	+\$1326	Specify with upholstered left hand arm.
	• AD-62 LC upholstered left hand arm with tablet	+\$2837	Specify with upholstered left hand arm with tablet.
Left Arm Power/Data Node	• No power/data	No cost	Specify with no power/data.
	• 2 duplex outlets	+\$ 310	Specify with 2 duplex outlets.
	• Duplex outlet with HDMI video ports	+\$ 406	Specify with duplex outlets with HDMI video ports.
	• Duplex outlet with CAT6 data ports	+\$ 414	Specify with duplex outlets with CAT6 data ports.
	• Duplex outlet with USB data ports	+\$ 427	Specify with duplex outlets with USB data ports.
Right End Configuration	• Connecting unit	No cost	Specify with connecting unit.
	• Open	No cost	Specify with open unit.
	• AD-61 RA upholstered right hand arm	+\$1326	Specify with upholstered right hand arm.
	• AD-62 RC upholstered right hand arm with tablet	+\$2837	Specify with upholstered right hand arm with tablet.
Right Arm Power/Data Node	• No power/data	No cost	Specify with no power/data.
	• 2 duplex outlets	+\$ 310	Specify with 2 duplex outlets.
	• Duplex outlet with HDMI video ports	+\$ 406	Specify with duplex outlets with HDMI video ports.
	• Duplex outlet with CAT6 data ports	+\$ 414	Specify with duplex outlets with CAT6 data ports.
	• Duplex outlet with USB data ports	+\$ 427	Specify with duplex outlets with USB data ports.

Tip: Tablet is selectable on one end only.

Tip: Select paint when specifying power.

Specifying

Specification Information

Style Number	U.S. Base Prices									
	Screen Price Groups									
	1	2	3	4	5	6	7	8	9	10
OBAD53	\$9704	\$9799	\$9902	\$10,036	\$10,258	\$10,478	\$10,760	\$11,011	\$11,232	\$11,522

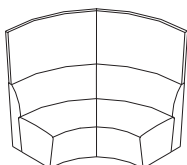

Away from the Desk Modular Small Round Top with Large Upholstered Tapered Base

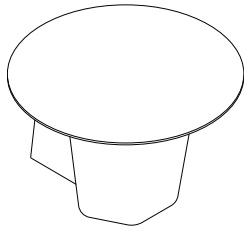

Tip: Customer's Own Material (COM) is available at a price group 1.

Tip: Select paint when specifying power.

Standard Includes		Required to Specify
<ul style="list-style-type: none"> ▶ Need help? Product details, page 46 • 1" thick table top with tapered edge: High-Pressure Laminate price group 1 • 3 mm edgeband: plastic price group 1 • Fully upholstered base: fabric price group 1 • Linking brackets 		<ol style="list-style-type: none"> 1 Style number 2 Laminate color number for table top 3 Plastic color number for edgeband 4 Fabric color number for base 5 Options, if selected (see below) <ul style="list-style-type: none"> ▶ See Product Understanding for Surface Materials.

	Options	U.S. Price	Required to Specify
Surface Materials	Table top		
	<ul style="list-style-type: none"> • High-Pressure Laminate price group 1 • High-Pressure Laminate price group 2 • High-Pressure Laminate price group 3 • Open Line laminate (OLL) 	<ul style="list-style-type: none"> No cost +\$ 87 +\$ 177 +\$ 111 plus cost of laminate 	<ul style="list-style-type: none"> Specify laminate color number. Specify laminate color number. Specify laminate color number. ▶ See <i>Surface Materials Reference Manual</i>.
	Table base		
	<ul style="list-style-type: none"> • Fabric price group 1 • Fabric price group 2 • Fabric price group 3 • Fabric price group 2 • Fabric price group 3 • Fabric price group 4 • Fabric price group 5 • Fabric price group 6 • Fabric price group 7 • Fabric price group 8 • Fabric price group 9 • Fabric price group 10 	<ul style="list-style-type: none"> No cost No cost No cost +\$ 81 +\$ 162 +\$ 273 +\$ 455 +\$ 633 +\$ 864 +\$1070 +\$1250 +\$1490 	<ul style="list-style-type: none"> Specify fabric color number. Specify fabric color number. Specify fabric color number. Specify fabric color number. Specify fabric color number. Specify fabric color number. Specify fabric color number. Specify fabric color number. Specify fabric color number. Specify fabric color number. Specify fabric color number. Specify fabric color number.
Top Power/Data Node	<ul style="list-style-type: none"> • No power/data • 2 duplex outlets • Duplex outlet with HDMI video ports • Duplex outlet with CAT6 data ports • Duplex outlet with USB data ports 	<ul style="list-style-type: none"> No cost +\$ 310 +\$ 406 +\$ 414 +\$ 427 	<ul style="list-style-type: none"> Specify <i>with no power/data</i>. Specify <i>with 2 duplex outlets</i>. Specify <i>with duplex outlets with HDMI video ports</i>. Specify <i>with duplex outlets with CAT6 data ports</i>. Specify <i>with duplex outlets with USB data ports</i>.
Base Power/Data Node	<ul style="list-style-type: none"> • No power/data • 2 duplex outlets • Duplex outlet with HDMI video ports • Duplex outlet with CAT6 data ports • Duplex outlet with USB data ports 	<ul style="list-style-type: none"> No cost +\$ 310 +\$ 406 +\$ 414 +\$ 427 	<ul style="list-style-type: none"> Specify <i>with no power/data</i>. Specify <i>with 2 duplex outlets</i>. Specify <i>with duplex outlets with HDMI video ports</i>. Specify <i>with duplex outlets with CAT6 data ports</i>. Specify <i>with duplex outlets with USB data ports</i>.

Specification Information	
• Style Number	• U.S. Base Price
OBAD64SRO	\$5186
.....

 **For Canadian Pricing**
Multiply U.S. Price by the Canadian price factor.
▶ See page 1 for details.

Away from the Desk Media Unit with Low, D Shaped Top

Away from the Desk Media Unit with Low, D Shaped Top

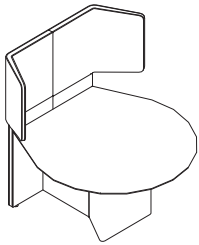

Tip: Customer's Own Material (COM) is available at a price group 1.

Tip: Select paint when specifying power.

Standard Includes		Required to Specify	
▶ Need help? Product details, page 46	<ul style="list-style-type: none"> Upholstered media unit: fabric price group 1 1" thick table top: High-Pressure Laminate price group 1 3 mm edgeband: plastic price group 1 Fixed monitor bracket Adjustable glides: black 	<ol style="list-style-type: none"> Style number Laminate color number for table top Plastic color number for edgeband Fabric color number for base Options, if selected (see below) 	▶ See Product Understanding for Surface Materials.
Options	U.S. Price	Required to Specify	
Surface Materials			
Table top			
• High-Pressure Laminate price group 1	No cost	Specify laminate color number.	
• High-Pressure Laminate price group 2	+\$ 93	Specify laminate color number.	
• High-Pressure Laminate price group 3	+\$ 196	Specify laminate color number.	
• Open Line laminate (OLL)	+\$ 111 plus cost of laminate	▶ See Surface Materials Reference Manual.	
Table base			
• Fabric price group 1	No cost	Specify fabric color number.	
• Fabric price group 2	+\$ 75	Specify fabric color number.	
• Fabric price group 3	+\$ 149	Specify fabric color number.	
• Fabric price group 4	+\$ 253	Specify fabric color number.	
• Fabric price group 5	+\$ 419	Specify fabric color number.	
• Fabric price group 6	+\$ 587	Specify fabric color number.	
• Fabric price group 7	+\$ 799	Specify fabric color number.	
• Fabric price group 8	+\$ 992	Specify fabric color number.	
• Fabric price group 9	+\$1157	Specify fabric color number.	
• Fabric price group 10	+\$1377	Specify fabric color number.	
Screen			
• Fabric price group 1	No cost	Specify fabric color number.	
• Fabric price group 2	+\$ 118	Specify fabric color number.	
• Fabric price group 3	+\$ 241	Specify fabric color number.	
• Fabric price group 4	+\$ 405	Specify fabric color number.	
• Fabric price group 5	+\$ 671	Specify fabric color number.	
• Fabric price group 6	+\$ 939	Specify fabric color number.	
• Fabric price group 7	+\$1281	Specify fabric color number.	
• Fabric price group 8	+\$1585	Specify fabric color number.	
• Fabric price group 9	+\$1852	Specify fabric color number.	
• Fabric price group 10	+\$2205	Specify fabric color number.	
Top Power/Data Node			
• No power/data	No cost	Specify with no power/data.	
• 2 duplex outlets	+\$ 310	Specify with 2 duplex outlets.	
• Duplex outlet with HDMI video ports	+\$ 406	Specify with duplex outlets with HDMI video ports.	
• Duplex outlet with CAT6 data ports	+\$ 414	Specify with duplex outlets with CAT6 data ports.	
• Duplex outlet with USB data ports	+\$ 427	Specify with duplex outlets with USB data ports.	

Specification Information

Style Number	U.S. Base Price
OBAD81DS	\$6143

 **For Canadian Pricing**
 Multiply U.S. Price by the Canadian price factor.
 ▶ See page 1 for details.

Specifying

Away from the Desk 47¹/₄" Dia Huddle Buddle Group Working Table

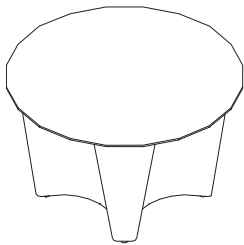

Tip: Customer's Own Material (COM) is available at a price group 1.

Tip: Select paint when specifying power.

Standard Includes		Required to Specify
<ul style="list-style-type: none"> ▶ Need help? Product details, page 46 • 1" thick table top with tapered edge: High-Pressure Laminate price group 1 • 3 mm edgeband: plastic price group 1 • Fully upholstered base: fabric price group 1 • Adjustable glides: black 	<ul style="list-style-type: none"> 1 Style number 2 Laminate color number for table top 3 Plastic color number for edgeband 4 Fabric color number for base 5 Options, if selected (see below) ▶ See Product Understanding for Surface Materials. 	

Options	U.S. Price	Required to Specify
Surface Materials		
<ul style="list-style-type: none"> • Table top • High-Pressure Laminate price group 1 • High-Pressure Laminate price group 2 • High-Pressure Laminate price group 3 • Open Line laminate (OLL) 	<ul style="list-style-type: none"> No cost +\$ 93 +\$ 196 +\$ 111 plus cost of laminate 	<ul style="list-style-type: none"> Specify laminate color number. Specify laminate color number. Specify laminate color number. ▶ See <i>Surface Materials Reference Manual</i>.
Table base		
<ul style="list-style-type: none"> • Fabric price group 1 • Fabric price group 2 • Fabric price group 3 • Fabric price group 4 • Fabric price group 5 • Fabric price group 6 • Fabric price group 7 • Fabric price group 8 • Fabric price group 9 • Fabric price group 10 	<ul style="list-style-type: none"> No cost +\$ 121 +\$ 246 +\$ 416 +\$ 689 +\$ 960 +\$1312 +\$1625 +\$1898 +\$2258 	<ul style="list-style-type: none"> Specify fabric color number. Specify fabric color number. Specify fabric color number. Specify fabric color number. Specify fabric color number. Specify fabric color number. Specify fabric color number. Specify fabric color number. Specify fabric color number. Specify fabric color number.
Top Power/Data Node		
<ul style="list-style-type: none"> • No power/data • 2 duplex outlets • Duplex outlet with HDMI video ports • Duplex outlet with CAT6 data ports • Duplex outlet with USB data ports 	<ul style="list-style-type: none"> No cost +\$ 310 +\$ 406 +\$ 414 +\$ 427 	<ul style="list-style-type: none"> Specify with <i>no power/data</i>. Specify with <i>2 duplex outlets</i>. Specify with <i>duplex outlets with HDMI video ports</i>. Specify with <i>duplex outlets with CAT6 data ports</i>. Specify with <i>duplex outlets with USB data ports</i>.

Specification Information	
Style Number	U.S. Base Price
OBAD91SRO	\$4723

 **For Canadian Pricing**
Multiply U.S. Price by the Canadian price factor.
▶ See page 1 for details.

Away from the Desk 55¹/₈" Dia Huddle Buddle Group Working Table

Away from the Desk
55¹/₈" Dia Huddle Buddle
Group Working Table

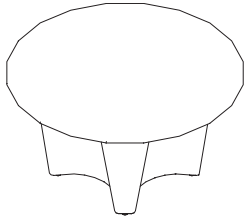

Tip: Customer's Own Material (COM) is available at a price group 1.

Tip: Select paint when specifying power.

Standard Includes		Required to Specify
<ul style="list-style-type: none"> ▶ Need help? Product details, page 46 	<ul style="list-style-type: none"> • 1" thick table top with tapered edge: High-Pressure Laminate price group 1 • 3 mm edgeband: plastic price group 1 • Fully upholstered base: fabric price group 1 • Adjustable glides: black 	<ol style="list-style-type: none"> 1 Style number 2 Laminate color number for table top 3 Plastic color number for edgeband 4 Fabric color number for base 5 Options, if selected (see below) <ul style="list-style-type: none"> ▶ See Product Understanding for Surface Materials.

Options	U.S. Price	Required to Specify
Surface Materials		
Table top		
• High-Pressure Laminate price group 1	No cost	Specify laminate color number.
• High-Pressure Laminate price group 2	+\$ 103	Specify laminate color number.
• High-Pressure Laminate price group 3	+\$ 214	Specify laminate color number.
• Open Line laminate (OLL)	+\$ 111 plus cost of laminate	▶ See Surface Materials Reference Manual.
Table base		
• Fabric price group 1	No cost	Specify fabric color number.
• Fabric price group 2	+\$ 121	Specify fabric color number.
• Fabric price group 3	+\$ 246	Specify fabric color number.
• Fabric price group 4	+\$ 416	Specify fabric color number.
• Fabric price group 5	+\$ 689	Specify fabric color number.
• Fabric price group 6	+\$ 960	Specify fabric color number.
• Fabric price group 7	+\$1312	Specify fabric color number.
• Fabric price group 8	+\$1625	Specify fabric color number.
• Fabric price group 9	+\$1898	Specify fabric color number.
• Fabric price group 10	+\$2258	Specify fabric color number.
Top Power/Data Node		
• No power/data	No cost	Specify with no power/data.
• 2 duplex outlets	+\$ 310	Specify with 2 duplex outlets.
• Duplex outlet with HDMI video ports	+\$ 406	Specify with duplex outlets with HDMI video ports.
• Duplex outlet with CAT6 data ports	+\$ 414	Specify with duplex outlets with CAT6 data ports.
• Duplex outlet with USB data ports	+\$ 427	Specify with duplex outlets with USB data ports.

Specification Information	
Style Number	U.S. Base Price
OBAD91LRO	\$4919

Specifying

 **For Canadian Pricing**
Multiply U.S. Price by the Canadian price factor.
▶ See page 1 for details.

Away from the Desk Single Detached Seating

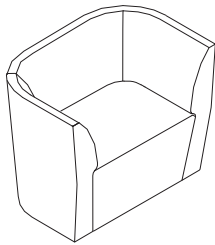

► Need help?
Product details,
page 46

Standard Includes

- Fully upholstered seating unit: fabric price group 1
- 1" thick integrated tablet with tapered edge, if selected:
 - High-Pressure Laminate price group 1
 - 3 mm edgeband: plastic price group 1
- Adjustable glides: black

Required to Specify

- 1 Style number
 - 2 Fabric color number for seat
 - 3 Laminate color number for tablet
 - 4 Plastic color number for edgeband
 - 5 Options, if selected (see below)
- See Product Understanding for Surface Materials.

	Options	U.S. Price	Required to Specify
Surface Materials	Seat		
	• Fabric price group 1	No cost	Specify fabric color number.
	• Fabric price group 2	+\$ 49	Specify fabric color number.
	• Fabric price group 3	+\$ 94	Specify fabric color number.
	• Fabric price group 4	+\$ 162	Specify fabric color number.
	• Fabric price group 5	+\$ 269	Specify fabric color number.
	• Fabric price group 6	+\$ 375	Specify fabric color number.
	• Fabric price group 7	+\$ 513	Specify fabric color number.
	• Fabric price group 8	+\$ 634	Specify fabric color number.
	• Fabric price group 9	+\$ 741	Specify fabric color number.
	• Fabric price group 10	+\$ 882	Specify fabric color number.
	Backrest outer		
	• Fabric price group 1	No cost	Specify fabric color number.
	• Fabric price group 2	+\$ 79	Specify fabric color number.
	• Fabric price group 3	+\$ 156	Specify fabric color number.
	• Fabric price group 4	+\$ 263	Specify fabric color number.
	• Fabric price group 5	+\$ 436	Specify fabric color number.
	• Fabric price group 6	+\$ 610	Specify fabric color number.
	• Fabric price group 7	+\$ 832	Specify fabric color number.
	• Fabric price group 8	+\$1031	Specify fabric color number.
	• Fabric price group 9	+\$1204	Specify fabric color number.
	• Fabric price group 10	+\$1432	Specify fabric color number.
	Backrest inner		
	• Fabric price group 1	No cost	Specify fabric color number.
	• Fabric price group 2	+\$ 56	Specify fabric color number.
	• Fabric price group 3	+\$ 113	Specify fabric color number.
	• Fabric price group 4	+\$ 188	Specify fabric color number.
	• Fabric price group 5	+\$ 312	Specify fabric color number.
	• Fabric price group 6	+\$ 437	Specify fabric color number.
	• Fabric price group 7	+\$ 597	Specify fabric color number.
	• Fabric price group 8	+\$ 739	Specify fabric color number.
	• Fabric price group 9	+\$ 864	Specify fabric color number.
	• Fabric price group 10	+\$1028	Specify fabric color number.
	Arm		
	• Fabric price group 1	No cost	Specify fabric color number.
	• Fabric price group 2	+\$ 39	Specify fabric color number.
	• Fabric price group 3	+\$ 81	Specify fabric color number.
	• Fabric price group 4	+\$ 134	Specify fabric color number.
	• Fabric price group 5	+\$ 223	Specify fabric color number.
	• Fabric price group 6	+\$ 311	Specify fabric color number.
	• Fabric price group 7	+\$ 427	Specify fabric color number.
	• Fabric price group 8	+\$ 526	Specify fabric color number.
	• Fabric price group 9	+\$ 617	Specify fabric color number.
	• Fabric price group 10	+\$ 734	Specify fabric color number.
	Tablet top		
	• High-Pressure Laminate price group 1	No cost	Specify laminate color number.
	• High-Pressure Laminate price group 2	+\$ 71	Specify laminate color number.
	• High-Pressure Laminate price group 3	+\$ 148	Specify laminate color number.
	• Open Line laminate (OLL)	+\$ 111 plus cost of laminate	

► See *Surface Materials Reference Manual*.

► **Options, continued on next page**



For Canadian Pricing

Multiply U.S. Price by the Canadian price factor.

► See page 1 for details.

► Options, continued from previous page

Tip: Select paint when specifying power.

Options	U.S. Price	Required to Specify
Arm Power/ Data Node		
• No power/data	No cost	Specify with no power/data.
• 2 duplex outlets	+\$310	Specify with 2 duplex outlets.
• Duplex outlet with HDMI video ports	+\$406	Specify with duplex outlets with HDMI video ports.
• Duplex outlet with CAT6 data ports	+\$414	Specify with duplex outlets with CAT6 data ports.
• Duplex outlet with USB data ports	+\$427	Specify with duplex outlets with USB data ports.

Specification Information

Style Number	U.S. Base Price

Single Seat Detached Unit

OBAD101	\$4454

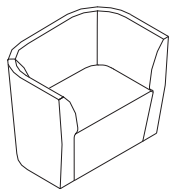

Single Seat Detached Unit with Left Hand Integrated Tablet

OBAD101LT	\$6901

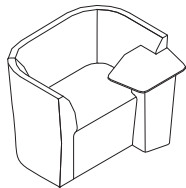

Single Seat Detached Unit with Right Hand Integrated Tablet

OBAD101RT	\$6901

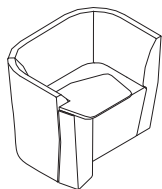

Specifying

 **For Canadian Pricing**
Multiply U.S. Price by the Canadian price factor.
► See page 1 for details.

Away from the Desk Single Detached Seating with Screen

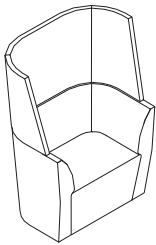

Tip: Customer's Own Material (COM) is available at a price group 1.

Standard Includes		Required to Specify
<ul style="list-style-type: none"> ▶ Need help? Product details, page 46 	<ul style="list-style-type: none"> Fully upholstered seating unit with screen: fabric price group 1 1" thick integrated tablet with tapered edge, if selected: <ul style="list-style-type: none"> – High-Pressure Laminate price group 1 – 3 mm edgeband: plastic price group 1 Adjustable glides: black 	<ol style="list-style-type: none"> Style number Fabric color number for seat Laminate color number for tablet Plastic color number for edgeband Options, if selected (see below) <ul style="list-style-type: none"> ▶ See Product Understanding for Surface Materials.

Options	U.S. Price	Required to Specify
Surface Materials	Seat <ul style="list-style-type: none"> Fabric price group 1 No cost Fabric price group 2 +\$ 49 Fabric price group 3 +\$ 94 Fabric price group 4 +\$ 162 Fabric price group 5 +\$ 269 Fabric price group 6 +\$ 375 Fabric price group 7 +\$ 513 Fabric price group 8 +\$ 634 Fabric price group 9 +\$ 741 Fabric price group 10 +\$ 882 	<ul style="list-style-type: none"> Specify fabric color number. Specify fabric color number. Specify fabric color number. Specify fabric color number. Specify fabric color number. Specify fabric color number. Specify fabric color number. Specify fabric color number. Specify fabric color number. Specify fabric color number.
Backrest outer <ul style="list-style-type: none"> Fabric price group 1 No cost Fabric price group 2 +\$ 79 Fabric price group 3 +\$ 156 Fabric price group 4 +\$ 263 Fabric price group 5 +\$ 436 Fabric price group 6 +\$ 610 Fabric price group 7 +\$ 832 Fabric price group 8 +\$1031 Fabric price group 9 +\$1204 Fabric price group 10 +\$1432 	<ul style="list-style-type: none"> Specify fabric color number. Specify fabric color number. Specify fabric color number. Specify fabric color number. Specify fabric color number. Specify fabric color number. Specify fabric color number. Specify fabric color number. Specify fabric color number. Specify fabric color number. 	
Backrest inner <ul style="list-style-type: none"> Fabric price group 1 No cost Fabric price group 2 +\$ 56 Fabric price group 3 +\$ 113 Fabric price group 4 +\$ 188 Fabric price group 5 +\$ 312 Fabric price group 6 +\$ 437 Fabric price group 7 +\$ 597 Fabric price group 8 +\$ 739 Fabric price group 9 +\$ 864 Fabric price group 10 +\$1028 	<ul style="list-style-type: none"> Specify fabric color number. Specify fabric color number. Specify fabric color number. Specify fabric color number. Specify fabric color number. Specify fabric color number. Specify fabric color number. Specify fabric color number. Specify fabric color number. Specify fabric color number. 	
Arm <ul style="list-style-type: none"> Fabric price group 1 No cost Fabric price group 2 +\$ 39 Fabric price group 3 +\$ 81 Fabric price group 4 +\$ 134 Fabric price group 5 +\$ 223 Fabric price group 6 +\$ 311 Fabric price group 7 +\$ 427 Fabric price group 8 +\$ 526 Fabric price group 9 +\$ 617 Fabric price group 10 +\$ 734 	<ul style="list-style-type: none"> Specify fabric color number. Specify fabric color number. Specify fabric color number. Specify fabric color number. Specify fabric color number. Specify fabric color number. Specify fabric color number. Specify fabric color number. Specify fabric color number. Specify fabric color number. 	
Tablet top <ul style="list-style-type: none"> High-Pressure Laminate price group 1 No cost High-Pressure Laminate price group 2 +\$ 71 High-Pressure Laminate price group 3 +\$ 148 Open Line laminate (OLL) +\$ 111 plus cost of laminate 	<ul style="list-style-type: none"> Specify laminate color number. Specify laminate color number. Specify laminate color number. 	

▶ Options, continued on next page

▶ See Surface Materials Reference Manual.



For Canadian Pricing
Multiply U.S. Price by the Canadian price factor.
▶ See page 1 for details.

► Options, continued from previous page

Options	U.S. Price	Required to Specify
Arm Power/ Data Node		
• No power/data	No cost	Specify with no power/data.
• 2 duplex outlets	+\$310	Specify with 2 duplex outlets.
• Duplex outlet with HDMI video ports	+\$406	Specify with duplex outlets with HDMI video ports.
• Duplex outlet with CAT6 data ports	+\$414	Specify with duplex outlets with CAT6 data ports.
• Duplex outlet with USB data ports	+\$427	Specify with duplex outlets with USB data ports.

Tip: Select paint when specifying power.

Specification Information										
Style Number	U.S. Base Prices Screen Price Groups									
	1	2	3	4	5	6	7	8	9	10

Single Seat Detached Unit with Screen

OBAD102	\$6017	\$6128	\$6239	\$6392	\$6636	\$6883	\$7203	\$7483	\$ 7731	\$ 8056
----------------	--------	--------	--------	--------	--------	--------	--------	--------	---------	---------

Single Seat Detached Unit with Left Hand Integrated Tablet and Screen

OBAD102LT	\$8465	\$8576	\$8687	\$8840	\$9084	\$9331	\$9651	\$9931	\$10,179	\$10,504
------------------	--------	--------	--------	--------	--------	--------	--------	--------	----------	----------

Single Seat Detached Unit with Right Hand Integrated Tablet and Screen

OBAD102RT	\$8465	\$8576	\$8687	\$8840	\$9084	\$9331	\$9651	\$9931	\$10,179	\$10,504
------------------	--------	--------	--------	--------	--------	--------	--------	--------	----------	----------

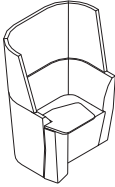
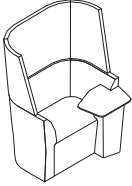
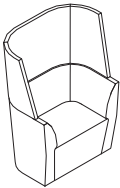

Specifying

 **For Canadian Pricing**
Multiply U.S. Price by the
Canadian price factor.
► See page 1 for details.

Away from the Desk Three Seat Detached Unit

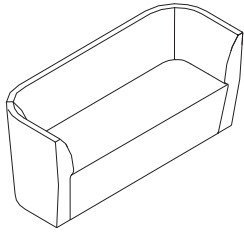

Tip: Customer's Own Material (COM) is available at a price group 1.

Standard Includes	Required to Specify
<ul style="list-style-type: none"> ▶ Need help? Product details, page 46 Fully upholstered seating unit: fabric price group 1 Adjustable glides: black 	<ul style="list-style-type: none"> 1 Style number 2 Fabric color number for seat 3 Options, if selected (see below) ▶ See Product Understanding for Surface Materials.

Surface Materials	Options	U.S. Price	Required to Specify
	Seat		
	• Fabric price group 1	No cost	Specify fabric color number.
	• Fabric price group 2	+\$ 59	Specify fabric color number.
	• Fabric price group 3	+\$ 120	Specify fabric color number.
	• Fabric price group 4	+\$ 202	Specify fabric color number.
	• Fabric price group 5	+\$ 338	Specify fabric color number.
	• Fabric price group 6	+\$ 469	Specify fabric color number.
	• Fabric price group 7	+\$ 641	Specify fabric color number.
	• Fabric price group 8	+\$ 791	Specify fabric color number.
	• Fabric price group 9	+\$ 925	Specify fabric color number.
	• Fabric price group 10	+\$1104	Specify fabric color number.
	Backrest outer		
	• Fabric price group 1	No cost	Specify fabric color number.
	• Fabric price group 2	+\$ 100	Specify fabric color number.
	• Fabric price group 3	+\$ 205	Specify fabric color number.
	• Fabric price group 4	+\$ 343	Specify fabric color number.
	• Fabric price group 5	+\$ 572	Specify fabric color number.
	• Fabric price group 6	+\$ 797	Specify fabric color number.
	• Fabric price group 7	+\$1087	Specify fabric color number.
	• Fabric price group 8	+\$1346	Specify fabric color number.
	• Fabric price group 9	+\$1574	Specify fabric color number.
	• Fabric price group 10	+\$1872	Specify fabric color number.
	Backrest inner		
	• Fabric price group 1	No cost	Specify fabric color number.
	• Fabric price group 2	+\$ 51	Specify fabric color number.
	• Fabric price group 3	+\$ 101	Specify fabric color number.
	• Fabric price group 4	+\$ 172	Specify fabric color number.
	• Fabric price group 5	+\$ 285	Specify fabric color number.
	• Fabric price group 6	+\$ 398	Specify fabric color number.
	• Fabric price group 7	+\$ 545	Specify fabric color number.
	• Fabric price group 8	+\$ 673	Specify fabric color number.
	• Fabric price group 9	+\$ 786	Specify fabric color number.
	• Fabric price group 10	+\$ 938	Specify fabric color number.

Specification Information	
Style Number	U.S. Base Price
OBAD103	\$6724



For Canadian Pricing
Multiply U.S. Price by the Canadian price factor.
▶ See page 1 for details.

Away from the Desk Enclosed Media Den

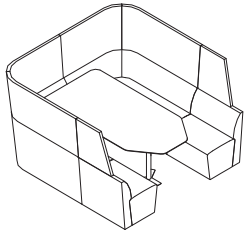

Tip: Customer's Own Material (COM) is available at a price group 1.

	Standard Includes	Required to Specify
▶ Need help? Product details, page 46	<ul style="list-style-type: none"> Fully upholstered booth: fabric price group 1 1" thick table top with tapered edge: <ul style="list-style-type: none"> High-Pressure Laminate price group 1 Fixed 3 mm edgeband: plastic price group 1 Single table leg with foot Adjustable glides: black Linking brackets 	<ol style="list-style-type: none"> Style number Fabric color number for seat Laminate color number for table top Plastic color number for edgeband Options, if selected (see below) <p>▶ See Product Understanding for Surface Materials.</p>

	Options	U.S. Price	Required to Specify
Surface Materials	Seat		
	• Fabric price group 1	No cost	Specify fabric color number.
	• Fabric price group 2	+\$ 193	Specify fabric color number.
	• Fabric price group 3	+\$ 390	Specify fabric color number.
	• Fabric price group 4	+\$ 655	Specify fabric color number.
	• Fabric price group 5	+\$1089	Specify fabric color number.
	• Fabric price group 6	+\$1522	Specify fabric color number.
	• Fabric price group 7	+\$2080	Specify fabric color number.
	• Fabric price group 8	+\$2576	Specify fabric color number.
	• Fabric price group 9	+\$3009	Specify fabric color number.
• Fabric price group 10	+\$3583	Specify fabric color number.	
	Backrest outer		
	• Fabric price group 1	No cost	Specify fabric color number.
	• Fabric price group 2	+\$ 241	Specify fabric color number.
	• Fabric price group 3	+\$ 485	Specify fabric color number.
	• Fabric price group 4	+\$ 820	Specify fabric color number.
	• Fabric price group 5	+\$1359	Specify fabric color number.
	• Fabric price group 6	+\$1898	Specify fabric color number.
	• Fabric price group 7	+\$2593	Specify fabric color number.
	• Fabric price group 8	+\$3208	Specify fabric color number.
	• Fabric price group 9	+\$3748	Specify fabric color number.
• Fabric price group 10	+\$4464	Specify fabric color number.	
	Backrest inner		
	• Fabric price group 1	No cost	Specify fabric color number.
	• Fabric price group 2	+\$ 130	Specify fabric color number.
	• Fabric price group 3	+\$ 265	Specify fabric color number.
	• Fabric price group 4	+\$ 445	Specify fabric color number.
	• Fabric price group 5	+\$ 737	Specify fabric color number.
	• Fabric price group 6	+\$1032	Specify fabric color number.
	• Fabric price group 7	+\$1409	Specify fabric color number.
	• Fabric price group 8	+\$1744	Specify fabric color number.
	• Fabric price group 9	+\$2037	Specify fabric color number.
• Fabric price group 10	+\$2424	Specify fabric color number.	
	Tablet top		
	• High-Pressure Laminate price group 1	No cost	Specify laminate color number.
	• High-Pressure Laminate price group 2	+\$ 445	Specify laminate color number.
	• High-Pressure Laminate price group 3	+\$ 926	Specify laminate color number.
	• Open Line laminate (OLL)	+\$ 111 plus cost of laminate	▶ See <i>Surface Materials Reference Manual</i> .
	Leg/foot scheme		
	• Black foot and column	No cost	Specify with <i>black foot and column</i> .
	• Silver foot and column	No cost	Specify with <i>silver foot and column</i> .
	• Black foot and chrome column	+\$ 187	Specify with <i>black foot and chrome column</i> .

▶ Options, continued on next page



For Canadian Pricing
Multiply U.S. Price by the Canadian price factor.
▶ See page 1 for details.

► Options, continued from previous page

Tip: Select paint when specifying power.

Options	U.S. Price	Required to Specify
Top Power/ Data Axil <ul style="list-style-type: none"> No power/data 4 duplex outlets 2 outlets with CAT6 and HDMI ports 2 outlets with 2 CAT6 data ports 2 outlets with CAT6 and USB data port 	No cost +\$592 +\$677 +\$683 +\$703	Specify with no power/data. Specify with 4 duplex outlets. Specify with 2 outlets with CAT6 and HDMI ports. Specify with 2 outlets with CAT6 data ports. Specify with 2 outlets with CAT6 and USB data port.
Monitor Bracket <ul style="list-style-type: none"> No monitor bracket Tilting monitor bracket 	No cost +\$337	Specify with no monitor bracket. Specify with tilting monitor bracket.

Specification Information

Style Number	U.S. Base Prices									
	Screen Fabric Groups									
	1	2	3	4	5	6	7	8	9	10
OBAD85	\$33,592	\$33,807	\$34,029	\$34,329	\$34,817	\$35,303	\$35,928	\$36,485	\$36,970	\$37,615

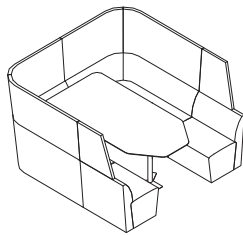

Specifying

 **For Canadian Pricing**
Multiply U.S. Price by the Canadian price factor.
► See page 1 for details.

Away from the Desk Enclosed Media Den, Four to Six People

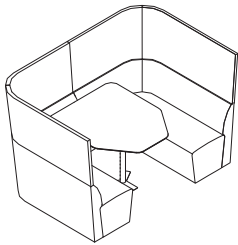

Tip: Customer's Own Material (COM) is available at a price group 1.

	Standard Includes	Required to Specify
▶ Need help? Product details, page 46	<ul style="list-style-type: none"> Fully upholstered booth: fabric price group 1 1" thick table top with tapered edge: <ul style="list-style-type: none"> High-Pressure Laminate price group 1 Fixed 3 mm edgeband: plastic price group 1 Single table leg with foot Adjustable glides: black Linking brackets 	<ol style="list-style-type: none"> Style number Fabric color number for seat Laminate color number for table top Plastic color number for edgeband Options, if selected (see below) <p>▶ See Product Understanding for Surface Materials.</p>

	Options	U.S. Price	Required to Specify
Surface Materials	Seat		
	• Fabric price group 1	No cost	Specify fabric color number.
	• Fabric price group 2	+\$ 114	Specify fabric color number.
	• Fabric price group 3	+\$ 228	Specify fabric color number.
	• Fabric price group 4	+\$ 385	Specify fabric color number.
	• Fabric price group 5	+\$ 638	Specify fabric color number.
	• Fabric price group 6	+\$ 891	Specify fabric color number.
	• Fabric price group 7	+\$1217	Specify fabric color number.
	• Fabric price group 8	+\$1507	Specify fabric color number.
	• Fabric price group 9	+\$1758	Specify fabric color number.
• Fabric price group 10	+\$2093	Specify fabric color number.	
	Backrest outer		
	• Fabric price group 1	No cost	Specify fabric color number.
	• Fabric price group 2	+\$ 172	Specify fabric color number.
	• Fabric price group 3	+\$ 349	Specify fabric color number.
	• Fabric price group 4	+\$ 587	Specify fabric color number.
	• Fabric price group 5	+\$ 972	Specify fabric color number.
	• Fabric price group 6	+\$1359	Specify fabric color number.
	• Fabric price group 7	+\$1858	Specify fabric color number.
	• Fabric price group 8	+\$2299	Specify fabric color number.
	• Fabric price group 9	+\$2686	Specify fabric color number.
• Fabric price group 10	+\$3197	Specify fabric color number.	
	Backrest inner		
	• Fabric price group 1	No cost	Specify fabric color number.
	• Fabric price group 2	+\$ 104	Specify fabric color number.
	• Fabric price group 3	+\$ 211	Specify fabric color number.
	• Fabric price group 4	+\$ 354	Specify fabric color number.
	• Fabric price group 5	+\$ 588	Specify fabric color number.
	• Fabric price group 6	+\$ 821	Specify fabric color number.
	• Fabric price group 7	+\$1120	Specify fabric color number.
	• Fabric price group 8	+\$1387	Specify fabric color number.
	• Fabric price group 9	+\$1620	Specify fabric color number.
• Fabric price group 10	+\$1929	Specify fabric color number.	
	Tablet top		
	• High-Pressure Laminate price group 1	No cost	Specify laminate color number.
	• High-Pressure Laminate price group 2	+\$ 265	Specify laminate color number.
	• High-Pressure Laminate price group 3	+\$ 550	Specify laminate color number.
	• Open Line laminate (OLL)	+\$ 111 plus cost of laminate	▶ See <i>Surface Materials Reference Manual</i> .
	Leg/foot scheme		
	• Black foot and column	No cost	Specify with black foot and column.
	• Silver foot and column	No cost	Specify with silver foot and column.
	• Black foot and chrome column	+\$ 187	Specify with black foot and chrome column.

▶ Options, continued on next page



For Canadian Pricing
Multiply U.S. Price by the Canadian price factor.
▶ See page 1 for details.

► Options, continued from previous page

Tip: Select paint when specifying power.

Options	U.S. Price	Required to Specify
Top Power/Data Axil <ul style="list-style-type: none"> No power/data 4 duplex outlets 2 outlets with CAT6 and HDMI ports 2 outlets with 2 CAT6 data ports 2 outlets with CAT6 and USB data port 	No cost +\$592 +\$677 +\$683 +\$703	Specify with no power/data. Specify with 4 duplex outlets. Specify with 2 outlets with CAT6 and HDMI ports. Specify with 2 outlets with CAT6 data ports. Specify with 2 outlets with CAT6 and USB data port.
Monitor Bracket <ul style="list-style-type: none"> No monitor bracket Tilting monitor bracket 	No cost +\$337	Specify with no monitor bracket. Specify with tilting monitor bracket.

Specification Information

Style Number	U.S. Base Prices									
	Screen Fabric Groups									
	1	2	3	4	5	6	7	8	9	10
OBAD85A	\$20,362	\$20,545	\$20,733	\$20,987	\$21,401	\$21,815	\$22,348	\$22,817	\$23,231	\$23,778

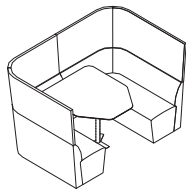

Specifying

 **For Canadian Pricing**
Multiply U.S. Price by the Canadian price factor.
► See page 1 for details.

Cubb Armless Chair with Wood Legs

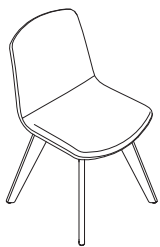

Tip: When two toned upholstered (contrasting) is selected, both seat finish and outer seat finish will need to be specified. Only a single price grade upcharge will be applied. The highest price group upcharge will be applied if multiple price groups are selected.

Standard Includes		Required to Specify
<ul style="list-style-type: none"> ▶ Need help? Product details, page 50 • Upholstered seating unit in one fabric: fabric price group 1 • Frame: paint price group 1 • Solid oak legs: wood group 1 • Glides • Shipped fully assembled 		<ol style="list-style-type: none"> 1 Style number 2 Fabric color number for chair 3 Paint color number for chassis 4 Wood color number for legs 5 Options, if selected (see below) <ul style="list-style-type: none"> ▶ See Product Understanding for Surface Materials.

Configuration	Options	U.S. Price	Required to Specify
	<ul style="list-style-type: none"> • Upholstered • Two toned upholstered 	<ul style="list-style-type: none"> No cost +\$ 44 	<ul style="list-style-type: none"> Specify with upholstered. Specify with two toned upholstered.
Surface Materials	Seat		
	<ul style="list-style-type: none"> • Customer's Own Leather (COL) No cost • Customer's Own Material (COM) No cost • Fabric price group 1 No cost • Fabric price group 2 +\$ 31 • Vinyl price group 2 +\$ 31 • Fabric price group 3 +\$ 63 • Fabric price group 4 +\$109 • Fabric price group 5 +\$175 • Fabric price group 6 +\$247 • Fabric price group 7 +\$339 • Fabric price group 8 +\$417 • Fabric price group 9 +\$488 • Fabric price group 10 +\$579 • Leather price group 1 +\$119 • Leather price group 2 +\$239 		<ul style="list-style-type: none"> ▶ See Surface Materials Reference Manual. ▶ See Surface Materials Reference Manual. Specify fabric color number. Specify fabric color number. Specify vinyl color number. Specify fabric color number. Specify fabric color number. Specify fabric color number. Specify fabric color number. Specify fabric color number. Specify fabric color number. Specify fabric color number. Specify fabric color number. Specify leather color number. Specify leather color number.
	Outer seat		
	<ul style="list-style-type: none"> • Customer's Own Leather (COL) No cost • Customer's Own Material (COM) No cost • Fabric price group 1 No cost • Fabric price group 2 +\$ 31 • Vinyl price group 2 +\$ 31 • Fabric price group 3 +\$ 63 • Fabric price group 4 +\$109 • Fabric price group 5 +\$175 • Fabric price group 6 +\$247 • Fabric price group 7 +\$339 • Fabric price group 8 +\$417 • Fabric price group 9 +\$488 • Fabric price group 10 +\$579 • Leather price group 1 +\$ 60 • Leather price group 2 +\$119 		<ul style="list-style-type: none"> ▶ See Surface Materials Reference Manual. ▶ See Surface Materials Reference Manual. Specify fabric color number. Specify fabric color number. Specify vinyl color number. Specify fabric color number. Specify fabric color number. Specify fabric color number. Specify fabric color number. Specify fabric color number. Specify fabric color number. Specify fabric color number. Specify fabric color number. Specify leather color number. Specify leather color number.
	Frame		
	<ul style="list-style-type: none"> • Paint price group 1 No cost • Paint price group 2 +\$ 30 • Paint price group 3 +\$ 47 		<ul style="list-style-type: none"> Specify paint color number. Specify paint color number. Specify paint color number.

Specification Information	
Style Number	U.S. Base Price
OBCUBB01	\$1022

 **For Canadian Pricing**
 Multiply U.S. Price by the Canadian price factor.
 ▶ See page 1 for details.

Cubb Upholstered Arm Chair with Wood Legs

Cubb Upholstered Arm Chair with Wood Legs



Tip: When two toned upholstered (contrasting) is selected, both seat finish and outer seat finish will need to be specified. Only a single price grade upcharge will be applied. The highest price group upcharge will be applied if multiple price groups are selected.

Standard Includes		Required to Specify
▶ Need help? Product details, page 50	<ul style="list-style-type: none"> Upholstered seating unit in one fabric: fabric price group 1 Frame: paint price group 1 Solid oak legs: wood group 1 Glides Shipped fully assembled 	<ol style="list-style-type: none"> Style number Fabric color number for chair Paint color number for chassis Wood color number for legs Options, if selected (see below) <p>▶ See Product Understanding for Surface Materials</p>

Configuration	Options	U.S. Price	Required to Specify
	<ul style="list-style-type: none"> Upholstered Two toned upholstered 	<ul style="list-style-type: none"> No cost +\$ 44 	<ul style="list-style-type: none"> Specify with <i>upholstered</i>. Specify with <i>two toned upholstered</i>.
Surface Materials	Seat		
	<ul style="list-style-type: none"> Customer's Own Leather (COL) No cost Customer's Own Material (COM) No cost Fabric price group 1 No cost Fabric price group 2 +\$ 31 Vinyl price group 2 +\$ 31 Fabric price group 3 +\$ 65 Fabric price group 4 +\$110 Fabric price group 5 +\$179 Fabric price group 6 +\$253 Fabric price group 7 +\$344 Fabric price group 8 +\$425 Fabric price group 9 +\$498 Fabric price group 10 +\$592 Leather price group 1 +\$186 Leather price group 2 +\$371 		<ul style="list-style-type: none"> ▶ See <i>Surface Materials Reference Manual</i>. ▶ See <i>Surface Materials Reference Manual</i>. Specify fabric color number. Specify fabric color number. Specify vinyl color number. Specify fabric color number. Specify fabric color number. Specify fabric color number. Specify fabric color number. Specify fabric color number. Specify fabric color number. Specify fabric color number. Specify fabric color number. Specify leather color number. Specify leather color number.
	Outer seat		
	<ul style="list-style-type: none"> Customer's Own Leather (COL) No cost Customer's Own Material (COM) No cost Fabric price group 1 No cost Fabric price group 2 +\$ 31 Vinyl price group 2 +\$ 31 Fabric price group 3 +\$ 65 Fabric price group 4 +\$110 Fabric price group 5 +\$179 Fabric price group 6 +\$253 Fabric price group 7 +\$344 Fabric price group 8 +\$425 Fabric price group 9 +\$498 Fabric price group 10 +\$592 Leather price group 1 +\$119 Leather price group 2 +\$239 		<ul style="list-style-type: none"> ▶ See <i>Surface Materials Reference Manual</i>. ▶ See <i>Surface Materials Reference Manual</i>. Specify fabric color number. Specify fabric color number. Specify vinyl color number. Specify fabric color number. Specify fabric color number. Specify fabric color number. Specify fabric color number. Specify fabric color number. Specify fabric color number. Specify fabric color number. Specify fabric color number. Specify leather color number. Specify leather color number.
	Frame		
	<ul style="list-style-type: none"> Paint price group 1 No cost Paint price group 2 +\$ 30 Paint price group 3 +\$ 47 		<ul style="list-style-type: none"> Specify paint color number. Specify paint color number. Specify paint color number.

Specification Information	
Style Number	U.S. Base Price
OBCUBB02	\$1304

 **For Canadian Pricing**
 Multiply U.S. Price by the Canadian price factor.
 ▶ See page 1 for details.

Specifying

Cubb Wire Arm Chair with Wood Legs



Tip: When two toned upholstered (contrasting) is selected, both seat finish and outer seat finish will need to be specified. Only a single price grade upcharge will be applied. The highest price group upcharge will be applied if multiple price groups are selected.

Standard Includes		Required to Specify
▶ Need help? Product details, page 50	<ul style="list-style-type: none"> Upholstered seating unit in one fabric: fabric price group 1 Wire arms: match frame Frame: paint price group 1 Solid oak legs: wood group 1 Glides Shipped fully assembled 	<ol style="list-style-type: none"> Style number Fabric color number for chair Paint color number for chassis Wood color number for legs Options, if selected (see below) <p>▶ See Product Understanding for Surface Materials.</p>

Configuration	Options	U.S. Price	Required to Specify
	<ul style="list-style-type: none"> Upholstered Two toned upholstered 	<ul style="list-style-type: none"> No cost +\$ 44 	<ul style="list-style-type: none"> Specify with <i>upholstered</i>. Specify with <i>two toned upholstered</i>.
Surface Materials	Seat	<ul style="list-style-type: none"> Customer's Own Leather (COL) No cost Customer's Own Material (COM) No cost Fabric price group 1 No cost Fabric price group 2 +\$ 31 Vinyl price group 2 +\$ 31 Fabric price group 3 +\$ 63 Fabric price group 4 +\$109 Fabric price group 5 +\$175 Fabric price group 6 +\$247 Fabric price group 7 +\$339 Fabric price group 8 +\$417 Fabric price group 9 +\$488 Fabric price group 10 +\$579 Leather price group 1 +\$119 Leather price group 2 +\$239 	<ul style="list-style-type: none"> ▶ See <i>Surface Materials Reference Manual</i>. ▶ See <i>Surface Materials Reference Manual</i>. Specify fabric color number. Specify fabric color number. Specify vinyl color number. Specify fabric color number. Specify fabric color number. Specify fabric color number. Specify fabric color number. Specify fabric color number. Specify fabric color number. Specify fabric color number. Specify leather color number. Specify leather color number.
	Outer seat	<ul style="list-style-type: none"> Customer's Own Leather (COL) No cost Customer's Own Material (COM) No cost Fabric price group 1 No cost Fabric price group 2 +\$ 31 Vinyl price group 2 +\$ 31 Fabric price group 3 +\$ 63 Fabric price group 4 +\$109 Fabric price group 5 +\$175 Fabric price group 6 +\$247 Fabric price group 7 +\$339 Fabric price group 8 +\$417 Fabric price group 9 +\$488 Fabric price group 10 +\$579 Leather price group 1 +\$ 60 Leather price group 2 +\$119 	<ul style="list-style-type: none"> ▶ See <i>Surface Materials Reference Manual</i>. ▶ See <i>Surface Materials Reference Manual</i>. Specify fabric color number. Specify fabric color number. Specify vinyl color number. Specify fabric color number. Specify fabric color number. Specify fabric color number. Specify fabric color number. Specify fabric color number. Specify fabric color number. Specify fabric color number. Specify leather color number. Specify leather color number.
	Frame	<ul style="list-style-type: none"> Paint price group 1 No cost Paint price group 2 +\$ 30 Paint price group 3 +\$ 47 	<ul style="list-style-type: none"> Specify paint color number. Specify paint color number. Specify paint color number.
	Arms	<ul style="list-style-type: none"> Match frame No cost Polished chrome +\$ 54 	<ul style="list-style-type: none"> Specify with <i>arms to match frame</i>. Specify with <i>polished chrome arms</i>.

Specification Information	
Style Number	U.S. Base Price
OBCUBB03	\$1143

 **For Canadian Pricing**
 Multiply U.S. Price by the Canadian price factor.
 ▶ See page 1 for details.

Cubb Armless Chair on 4-Star Trestle Base

Cubb Armless Chair on
4-Star Trestle Base



Tip: When two toned upholstered (contrasting) is selected, both seat finish and outer seat finish will need to be specified. Only a single price grade upcharge will be applied. The highest price group upcharge will be applied if multiple price groups are selected.

Standard Includes		Required to Specify
<ul style="list-style-type: none"> ▶ Need help? Product details, page 50 	<ul style="list-style-type: none"> • Upholstered seating unit in one fabric: fabric price group 1 • 4-star trestle base: <ul style="list-style-type: none"> – black – polished aluminum • Glides • Shipped fully assembled 	<ol style="list-style-type: none"> 1 Style number 2 Fabric color number for chair 3 Color number for base 4 Options, if selected (see below) <ul style="list-style-type: none"> ▶ See Product Understanding for Surface Materials.

Configuration	Options	U.S. Price	Required to Specify
	<ul style="list-style-type: none"> • Upholstered • Two toned upholstered 	<ul style="list-style-type: none"> No cost +\$ 44 	<ul style="list-style-type: none"> Specify with <i>upholstered</i>. Specify with <i>two toned upholstered</i>.
Surface Materials	<p>Seat</p> <ul style="list-style-type: none"> • Customer's Own Leather (COL) No cost • Customer's Own Material (COM) No cost • Fabric price group 1 No cost • Fabric price group 2 +\$ 31 • Vinyl price group 2 +\$ 31 • Fabric price group 3 +\$ 63 • Fabric price group 4 +\$109 • Fabric price group 5 +\$175 • Fabric price group 6 +\$247 • Fabric price group 7 +\$339 • Fabric price group 8 +\$417 • Fabric price group 9 +\$488 • Fabric price group 10 +\$579 • Leather price group 1 +\$119 • Leather price group 2 +\$239 <p>Outer seat</p> <ul style="list-style-type: none"> • Customer's Own Leather (COL) No cost • Customer's Own Material (COM) No cost • Fabric price group 1 No cost • Fabric price group 2 +\$ 31 • Vinyl price group 2 +\$ 31 • Fabric price group 3 +\$ 63 • Fabric price group 4 +\$109 • Fabric price group 5 +\$175 • Fabric price group 6 +\$247 • Fabric price group 7 +\$339 • Fabric price group 8 +\$417 • Fabric price group 9 +\$488 • Fabric price group 10 +\$579 • Leather price group 1 +\$ 60 • Leather price group 2 +\$119 		<ul style="list-style-type: none"> ▶ See <i>Surface Materials Reference Manual</i>. ▶ See <i>Surface Materials Reference Manual</i>. Specify fabric color number. Specify fabric color number. Specify vinyl color number. Specify fabric color number. Specify fabric color number. Specify fabric color number. Specify fabric color number. Specify fabric color number. Specify fabric color number. Specify fabric color number. Specify fabric color number. Specify fabric color number. Specify leather color number. Specify leather color number.
Glides	<ul style="list-style-type: none"> • Standard glides • Soft glides 	<ul style="list-style-type: none"> No cost +\$ 5 	<ul style="list-style-type: none"> Specify with <i>standard glides</i>. Specify with <i>soft glides</i>.

Specification Information	
Style Number	U.S. Base Price
OBCUBB04	\$1163

 **For Canadian Pricing**
Multiply U.S. Price by the Canadian price factor.
▶ See page 1 for details.

Specifying

Cubb Wire Arm Chair on 4-Star Trestle Base

Cubb Wire Arm Chair on
4-Star Trestle Base



Tip: When two toned upholstered (contrasting) is selected, both seat finish and outer seat finish will need to be specified. Only a single price grade upcharge will be applied. The highest price group upcharge will be applied if multiple price groups are selected.

Standard Includes		Required to Specify
▶ Need help? Product details, page 50	<ul style="list-style-type: none"> Upholstered seating unit in one fabric: fabric price group 1 Wire arms: match base 4-star trestle base: <ul style="list-style-type: none"> – black – polished aluminum Glides Shipped fully assembled 	1 Style number 2 Fabric color number for chair 3 Color number for base 4 Options, if selected (see below) ▶ See Product Understanding for Surface Materials.

Configuration	Options	U.S. Price	Required to Specify
	• Upholstered	No cost	Specify <i>with upholstered</i> .
	• Two toned upholstered	+\$ 44	Specify <i>with two toned upholstered</i> .

Surface Materials	Seat	U.S. Price	Required to Specify
	• Customer's Own Leather (COL)	No cost	▶ See <i>Surface Materials Reference Manual</i> .
	• Customer's Own Material (COM)	No cost	
	• Fabric price group 1	No cost	
	• Fabric price group 2	+\$ 31	
	• Vinyl price group 2	+\$ 31	
	• Fabric price group 3	+\$ 63	
	• Fabric price group 4	+\$109	
	• Fabric price group 5	+\$175	
	• Fabric price group 6	+\$247	
	• Fabric price group 7	+\$339	
	• Fabric price group 8	+\$417	▶ See <i>Surface Materials Reference Manual</i> . Specify fabric color number.
	• Fabric price group 9	+\$488	
	• Fabric price group 10	+\$579	
	• Leather price group 1	+\$119	
	• Leather price group 2	+\$239	

Outer seat	U.S. Price	Required to Specify
• Customer's Own Leather (COL)	No cost	▶ See <i>Surface Materials Reference Manual</i> .
• Customer's Own Material (COM)	No cost	
• Fabric price group 1	No cost	
• Fabric price group 2	+\$ 31	
• Vinyl price group 2	+\$ 31	
• Fabric price group 3	+\$ 63	
• Fabric price group 4	+\$109	
• Fabric price group 5	+\$175	
• Fabric price group 6	+\$247	
• Fabric price group 7	+\$339	
• Fabric price group 8	+\$417	▶ See <i>Surface Materials Reference Manual</i> . Specify fabric color number.
• Fabric price group 9	+\$488	
• Fabric price group 10	+\$579	
• Leather price group 1	+\$ 60	
• Leather price group 2	+\$119	

Glides	Options	U.S. Price	Required to Specify
	• Standard glides	No cost	Specify <i>with standard glides</i> .
	• Soft glides	+\$ 5	Specify <i>with soft glides</i> .

Specification Information

Style Number	U.S. Base Price
OBCUBB06	\$1200

 **For Canadian Pricing**
Multiply U.S. Price by the Canadian price factor.
▶ See page 1 for details.

Cubb Armless Chair with Wire Frame Base

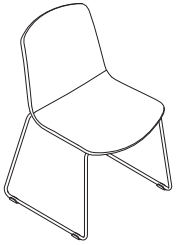

Tip: When two toned upholstered (contrasting) is selected, both seat finish and outer seat finish will need to be specified. Only a single price grade upcharge will be applied. The highest price group upcharge will be applied if multiple price groups are selected.

Standard Includes		Required to Specify
▶ Need help? Product details, page 50	<ul style="list-style-type: none"> Upholstered seating unit in one fabric: fabric price group 1 Wire frame base: paint price group 1 Glides Shipped fully assembled 	<ol style="list-style-type: none"> Style number Fabric color number for chair Paint color number for base Options, if selected (see below) <p>▶ See Product Understanding for Surface Materials.</p>

Configuration	Options	U.S. Price	Required to Specify
	<ul style="list-style-type: none"> Upholstered Two toned upholstered 	<ul style="list-style-type: none"> No cost +\$ 44 	<ul style="list-style-type: none"> Specify <i>with upholstered</i>. Specify <i>with two toned upholstered</i>.

Surface Materials	Seat	U.S. Price	Required to Specify
	<ul style="list-style-type: none"> Customer's Own Leather (COL) Customer's Own Material (COM) Fabric price group 1 Fabric price group 2 Vinyl price group 2 Fabric price group 3 Fabric price group 4 Fabric price group 5 Fabric price group 6 Fabric price group 7 Fabric price group 8 Fabric price group 9 Fabric price group 10 Leather price group 1 Leather price group 2 	<ul style="list-style-type: none"> No cost No cost No cost +\$ 31 +\$ 31 +\$ 63 +\$109 +\$175 +\$247 +\$339 +\$417 +\$488 +\$579 +\$119 +\$239 	<ul style="list-style-type: none"> ▶ See <i>Surface Materials Reference Manual</i>. ▶ See <i>Surface Materials Reference Manual</i>. Specify fabric color number. Specify fabric color number. Specify vinyl color number. Specify fabric color number. Specify fabric color number. Specify fabric color number. Specify fabric color number. Specify fabric color number. Specify fabric color number. Specify fabric color number. Specify fabric color number. Specify leather color number. Specify leather color number.

Outer seat	U.S. Price	Required to Specify
<ul style="list-style-type: none"> Customer's Own Leather (COL) Customer's Own Material (COM) Fabric price group 1 Fabric price group 2 Vinyl price group 2 Fabric price group 3 Fabric price group 4 Fabric price group 5 Fabric price group 6 Fabric price group 7 Fabric price group 8 Fabric price group 9 Fabric price group 10 Leather price group 1 Leather price group 2 	<ul style="list-style-type: none"> No cost No cost No cost +\$ 31 +\$ 31 +\$ 63 +\$109 +\$175 +\$247 +\$339 +\$417 +\$488 +\$579 +\$ 60 +\$119 	<ul style="list-style-type: none"> ▶ See <i>Surface Materials Reference Manual</i>. ▶ See <i>Surface Materials Reference Manual</i>. Specify fabric color number. Specify fabric color number. Specify vinyl color number. Specify fabric color number. Specify fabric color number. Specify fabric color number. Specify fabric color number. Specify fabric color number. Specify fabric color number. Specify fabric color number. Specify fabric color number. Specify leather color number. Specify leather color number.

Frame	U.S. Price	Required to Specify
<ul style="list-style-type: none"> Paint price group 1 Paint price group 2 Paint price group 3 Polished chrome 	<ul style="list-style-type: none"> No cost +\$ 57 +\$ 90 +\$118 	<ul style="list-style-type: none"> Specify paint color number. Specify paint color number. Specify paint color number. Specify <i>with polished chrome</i>.

Specification Information	
Style Number	U.S. Base Price
OBCUBB07	\$897



For Canadian Pricing
Multiply U.S. Price by the Canadian price factor.
▶ See page 1 for details.

Cubb Upholstered Arm Chair with Wire Frame Base

Cubb Upholstered Arm Chair with Wire Frame Base

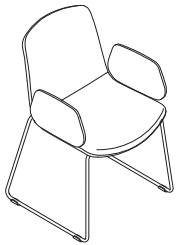

Tip: When two toned upholstered (contrasting) is selected, both seat finish and outer seat finish will need to be specified. Only a single price grade upcharge will be applied. The highest price group upcharge will be applied if multiple price groups are selected.

Standard Includes		Required to Specify
▶ Need help? Product details, page 50	<ul style="list-style-type: none"> Upholstered seating unit in one fabric: fabric price group 1 Wire frame base: paint price group 1 Glides Shipped fully assembled 	<ol style="list-style-type: none"> Style number Fabric color number for chair Paint color number for base Options, if selected (see below) <p>▶ See Product Understanding for Surface Materials.</p>

Options	U.S. Price	Required to Specify
Configuration		
• Upholstered	No cost	Specify <i>with upholstered</i> .
• Two toned upholstered	+\$ 44	Specify <i>with two toned upholstered</i> .

Surface Materials	Seat	U.S. Price	Required to Specify
	• Customer's Own Leather (COL)	No cost	▶ See <i>Surface Materials Reference Manual</i> .
	• Customer's Own Material (COM)	No cost	
	• Fabric price group 1	No cost	
	• Fabric price group 2	+\$ 31	
	• Vinyl price group 2	+\$ 31	
	• Fabric price group 3	+\$ 65	
	• Fabric price group 4	+\$110	
	• Fabric price group 5	+\$179	
	• Fabric price group 6	+\$253	
	• Fabric price group 7	+\$344	
	• Fabric price group 8	+\$425	▶ See <i>Surface Materials Reference Manual</i> . ▶ See <i>Surface Materials Reference Manual</i> . Specify fabric color number. Specify fabric color number. Specify vinyl color number. Specify fabric color number. Specify fabric color number. Specify fabric color number. Specify fabric color number. Specify fabric color number. Specify fabric color number. Specify fabric color number. Specify fabric color number. Specify leather color number. Specify leather color number.
	• Fabric price group 9	+\$498	
	• Fabric price group 10	+\$592	
	• Leather price group 1	+\$186	
	• Leather price group 2	+\$371	

Outer seat	U.S. Price	Required to Specify
• Customer's Own Leather (COL)	No cost	▶ See <i>Surface Materials Reference Manual</i> . ▶ See <i>Surface Materials Reference Manual</i> . Specify fabric color number. Specify fabric color number. Specify vinyl color number. Specify fabric color number. Specify fabric color number. Specify fabric color number. Specify fabric color number. Specify fabric color number. Specify fabric color number. Specify fabric color number. Specify fabric color number. Specify leather color number. Specify leather color number.
• Customer's Own Material (COM)	No cost	
• Fabric price group 1	No cost	
• Fabric price group 2	+\$ 31	
• Vinyl price group 2	+\$ 31	
• Fabric price group 3	+\$ 65	
• Fabric price group 4	+\$110	
• Fabric price group 5	+\$179	
• Fabric price group 6	+\$253	
• Fabric price group 7	+\$344	
• Fabric price group 8	+\$425	Specify paint color number. Specify paint color number. Specify paint color number. Specify <i>with polished chrome</i> .
• Fabric price group 9	+\$498	
• Fabric price group 10	+\$592	
• Leather price group 1	+\$119	
• Leather price group 2	+\$239	

Frame	U.S. Price	Required to Specify
• Paint price group 1	No cost	Specify paint color number.
• Paint price group 2	+\$ 57	Specify paint color number.
• Paint price group 3	+\$ 90	Specify paint color number.
• Polished chrome	+\$118	Specify <i>with polished chrome</i> .

Specification Information	
Style Number	U.S. Base Price
OBCUBB08	\$1181

 **For Canadian Pricing**
Multiply U.S. Price by the Canadian price factor.
▶ See page 1 for details.

Specifying

Cubb Wire Arm Chair with Wire Frame Base

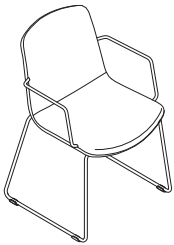

Tip: When two toned upholstered (contrasting) is selected, both seat finish and outer seat finish will need to be specified. Only a single price grade upcharge will be applied. The highest price group upcharge will be applied if multiple price groups are selected.

Standard Includes		Required to Specify
▶ Need help? Product details, page 50	<ul style="list-style-type: none"> Upholstered seating unit in one fabric: fabric price group 1 Wire arms: match base Wire frame base: paint price group 1 Glides Shipped fully assembled 	<ol style="list-style-type: none"> Style number Fabric color number for chair Paint color number for base Options, if selected (see below) <p>▶ See Product Understanding for Surface Materials.</p>

Configuration	Options	U.S. Price	Required to Specify
	<ul style="list-style-type: none"> Upholstered Two toned upholstered 	<ul style="list-style-type: none"> No cost +\$ 44 	<ul style="list-style-type: none"> Specify with upholstered. Specify with two toned upholstered.

Surface Materials	Seat	U.S. Price	Required to Specify
	<ul style="list-style-type: none"> Customer's Own Leather (COL) Customer's Own Material (COM) Fabric price group 1 Fabric price group 2 Vinyl price group 2 Fabric price group 3 Fabric price group 4 Fabric price group 5 Fabric price group 6 Fabric price group 7 Fabric price group 8 Fabric price group 9 Fabric price group 10 Leather price group 1 Leather price group 2 	<ul style="list-style-type: none"> No cost No cost No cost +\$ 31 +\$ 31 +\$ 63 +\$109 +\$175 +\$247 +\$339 +\$417 +\$488 +\$579 +\$119 +\$239 	<ul style="list-style-type: none"> ▶ See Surface Materials Reference Manual. ▶ See Surface Materials Reference Manual. Specify fabric color number. Specify fabric color number. Specify vinyl color number. Specify fabric color number. Specify fabric color number. Specify fabric color number. Specify fabric color number. Specify fabric color number. Specify fabric color number. Specify fabric color number. Specify fabric color number. Specify leather color number. Specify leather color number.

Outer seat	U.S. Price	Required to Specify
<ul style="list-style-type: none"> Customer's Own Leather (COL) Customer's Own Material (COM) Fabric price group 1 Fabric price group 2 Vinyl price group 2 Fabric price group 3 Fabric price group 4 Fabric price group 5 Fabric price group 6 Fabric price group 7 Fabric price group 8 Fabric price group 9 Fabric price group 10 Leather price group 1 Leather price group 2 	<ul style="list-style-type: none"> No cost No cost No cost +\$ 31 +\$ 31 +\$ 63 +\$109 +\$175 +\$247 +\$339 +\$417 +\$488 +\$579 +\$ 60 +\$119 	<ul style="list-style-type: none"> ▶ See Surface Materials Reference Manual. ▶ See Surface Materials Reference Manual. Specify fabric color number. Specify fabric color number. Specify vinyl color number. Specify fabric color number. Specify fabric color number. Specify fabric color number. Specify fabric color number. Specify fabric color number. Specify fabric color number. Specify fabric color number. Specify fabric color number. Specify leather color number. Specify leather color number.

Frame	U.S. Price	Required to Specify
<ul style="list-style-type: none"> Paint price group 1 Paint price group 2 Paint price group 3 Polished chrome 	<ul style="list-style-type: none"> No cost +\$ 57 +\$ 90 +\$118 	<ul style="list-style-type: none"> Specify paint color number. Specify paint color number. Specify paint color number. Specify with polished chrome.

Specification Information	
Style Number	U.S. Base Price
OBCUBB09	\$1021

 **For Canadian Pricing**
 Multiply U.S. Price by the Canadian price factor.
 ▶ See page 1 for details.

Cubb Armless Chair on 5-Star Base

Cubb Armless Chair on
5-Star Base



Tip: When two toned upholstered (contrasting) is selected, both seat finish and outer seat finish will need to be specified. Only a single price grade upcharge will be applied. The highest price group upcharge will be applied if multiple price groups are selected.

Standard Includes		Required to Specify
<ul style="list-style-type: none"> ▶ Need help? Product details, page 50 	<ul style="list-style-type: none"> Upholstered seating unit in one fabric: fabric price group 1 5-star base: <ul style="list-style-type: none"> – black – polished aluminum Hard casters: black Pneumatic seat height Shipped fully assembled 	<ol style="list-style-type: none"> Style number Fabric color number for chair Color number for base Options, if selected (see below) <ul style="list-style-type: none"> ▶ See Product Understanding for Surface Materials.

Configuration	Options	U.S. Price	Required to Specify
	<ul style="list-style-type: none"> Upholstered Two toned upholstered 	<ul style="list-style-type: none"> No cost +\$ 44 	<ul style="list-style-type: none"> Specify with <i>upholstered</i>. Specify with <i>two toned upholstered</i>.
Surface Materials	<p>Seat</p> <ul style="list-style-type: none"> Customer's Own Leather (COL) No cost Customer's Own Material (COM) No cost Fabric price group 1 No cost Fabric price group 2 +\$ 31 Vinyl price group 2 +\$ 31 Fabric price group 3 +\$ 63 Fabric price group 4 +\$109 Fabric price group 5 +\$175 Fabric price group 6 +\$247 Fabric price group 7 +\$339 Fabric price group 8 +\$417 Fabric price group 9 +\$488 Fabric price group 10 +\$579 Leather price group 1 +\$119 Leather price group 2 +\$239 <p>Outer seat</p> <ul style="list-style-type: none"> Customer's Own Leather (COL) No cost Customer's Own Material (COM) No cost Fabric price group 1 No cost Fabric price group 2 +\$ 31 Vinyl price group 2 +\$ 31 Fabric price group 3 +\$ 63 Fabric price group 4 +\$109 Fabric price group 5 +\$175 Fabric price group 6 +\$247 Fabric price group 7 +\$339 Fabric price group 8 +\$417 Fabric price group 9 +\$488 Fabric price group 10 +\$579 Leather price group 1 +\$ 60 Leather price group 2 +\$119 		<ul style="list-style-type: none"> ▶ See <i>Surface Materials Reference Manual</i>. ▶ See <i>Surface Materials Reference Manual</i>. Specify fabric color number. Specify fabric color number. Specify vinyl color number. Specify fabric color number. Specify fabric color number. Specify fabric color number. Specify fabric color number. Specify fabric color number. Specify fabric color number. Specify fabric color number. Specify fabric color number. Specify fabric color number. Specify leather color number. Specify leather color number.
Caster	<ul style="list-style-type: none"> Hard black casters Soft black casters 	<ul style="list-style-type: none"> No cost +\$ 43 	<ul style="list-style-type: none"> Specify with <i>hard black casters</i>. Specify with <i>soft black casters</i>.

Specification Information	
Style Number	U.S. Base Price
OBCUBB10	\$1101

Specifying

 **For Canadian Pricing**
Multiply U.S. Price by the Canadian price factor.
▶ See page 1 for details.

Cubb Upholstered Arm Chair on 5-Star Base



Tip: When two toned upholstered (contrasting) is selected, both seat finish and outer seat finish will need to be specified. Only a single price grade upcharge will be applied. The highest price group upcharge will be applied if multiple price groups are selected.

	Standard Includes	Required to Specify
▶ Need help? Product details, page 50	<ul style="list-style-type: none"> Upholstered seating unit in one fabric: fabric price group 1 5-star base: <ul style="list-style-type: none"> – black – polished aluminum Hard casters: black Pneumatic seat height Shipped fully assembled 	<ol style="list-style-type: none"> Style number Fabric color number for chair Color number for base Options, if selected (see below) <p>▶ See Product Understanding for Surface Materials.</p>

	Options	U.S. Price	Required to Specify
Configuration	<ul style="list-style-type: none"> Upholstered Two toned upholstered 	<ul style="list-style-type: none"> No cost +\$ 44 	<ul style="list-style-type: none"> Specify with upholstered. Specify with two toned upholstered.
Surface Materials	<p>Seat</p> <ul style="list-style-type: none"> Customer's Own Leather (COL) No cost Customer's Own Material (COM) No cost Fabric price group 1 No cost Fabric price group 2 +\$ 31 Vinyl price group 2 +\$ 31 Fabric price group 3 +\$ 65 Fabric price group 4 +\$110 Fabric price group 5 +\$179 Fabric price group 6 +\$253 Fabric price group 7 +\$344 Fabric price group 8 +\$425 Fabric price group 9 +\$498 Fabric price group 10 +\$592 Leather price group 1 +\$186 Leather price group 2 +\$371 <p>Outer seat</p> <ul style="list-style-type: none"> Customer's Own Leather (COL) No cost Customer's Own Material (COM) No cost Fabric price group 1 No cost Fabric price group 2 +\$ 31 Vinyl price group 2 +\$ 31 Fabric price group 3 +\$ 65 Fabric price group 4 +\$110 Fabric price group 5 +\$179 Fabric price group 6 +\$253 Fabric price group 7 +\$344 Fabric price group 8 +\$425 Fabric price group 9 +\$498 Fabric price group 10 +\$592 Leather price group 1 +\$119 Leather price group 2 +\$239 		<ul style="list-style-type: none"> ▶ See Surface Materials Reference Manual. ▶ See Surface Materials Reference Manual. Specify fabric color number. Specify vinyl color number. Specify fabric color number. Specify fabric color number. Specify fabric color number. Specify fabric color number. Specify fabric color number. Specify fabric color number. Specify fabric color number. Specify leather color number. Specify leather color number.
Caster	<ul style="list-style-type: none"> Hard black casters Soft black casters 	<ul style="list-style-type: none"> No cost +\$ 43 	<ul style="list-style-type: none"> Specify with hard black casters. Specify with soft black casters.

Specification Information	
Style Number	U.S. Base Price
OBCUBB11	\$1384

 **For Canadian Pricing**
 Multiply U.S. Price by the Canadian price factor.
 ▶ See page 1 for details.

Cubb Wire Arm Chair on 5-Star Base

Cubb Wire Arm Chair on
5-Star Base

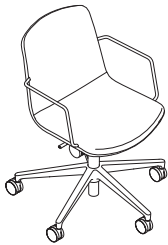

Tip: When two toned upholstered (contrasting) is selected, both seat finish and outer seat finish will need to be specified. Only a single price grade upcharge will be applied. The highest price group upcharge will be applied if multiple price groups are selected.

Standard Includes		Required to Specify
▶ Need help? Product details, page 50	<ul style="list-style-type: none"> Upholstered seating unit in one fabric: fabric price group 1 Wire arms: match base 5-star base: <ul style="list-style-type: none"> – black – polished aluminum Hard casters: black Pneumatic seat height Shipped fully assembled 	<ol style="list-style-type: none"> Style number Fabric color number for chair Color number for base Options, if selected (see below) <p>▶ See Product Understanding for Surface Materials.</p>

Options	U.S. Price	Required to Specify
Configuration	<ul style="list-style-type: none"> Upholstered No cost Two toned upholstered +\$ 44 	<p>Specify with upholstered.</p> <p>Specify with two toned upholstered.</p>
Surface Materials	<p>Seat</p> <ul style="list-style-type: none"> Customer's Own Leather (COL) No cost Customer's Own Material (COM) No cost Fabric price group 1 No cost Fabric price group 2 +\$ 31 Vinyl price group 2 +\$ 31 Fabric price group 3 +\$ 63 Fabric price group 4 +\$109 Fabric price group 5 +\$175 Fabric price group 6 +\$247 Fabric price group 7 +\$339 Fabric price group 8 +\$417 Fabric price group 9 +\$488 Fabric price group 10 +\$579 Leather price group 1 +\$119 Leather price group 2 +\$239 <p>Outer seat</p> <ul style="list-style-type: none"> Customer's Own Leather (COL) No cost Customer's Own Material (COM) No cost Fabric price group 1 No cost Fabric price group 2 +\$ 31 Vinyl price group 2 +\$ 31 Fabric price group 3 +\$ 63 Fabric price group 4 +\$109 Fabric price group 5 +\$175 Fabric price group 6 +\$247 Fabric price group 7 +\$339 Fabric price group 8 +\$417 Fabric price group 9 +\$488 Fabric price group 10 +\$579 Leather price group 1 +\$ 60 Leather price group 2 +\$119 	<p>▶ See Surface Materials Reference Manual.</p> <p>▶ See Surface Materials Reference Manual.</p> <p>Specify fabric color number.</p> <p>Specify vinyl color number.</p> <p>Specify fabric color number.</p> <p>Specify fabric color number.</p> <p>Specify fabric color number.</p> <p>Specify fabric color number.</p> <p>Specify fabric color number.</p> <p>Specify fabric color number.</p> <p>Specify fabric color number.</p> <p>Specify fabric color number.</p> <p>Specify leather color number.</p> <p>Specify leather color number.</p>
Caster	<ul style="list-style-type: none"> Hard black casters No cost Soft black casters +\$ 43 	<p>Specify with hard black casters.</p> <p>Specify with soft black casters.</p>

Specification Information	
Style Number	U.S. Base Price
OBCUBB12	\$1229

Specifying

 **For Canadian Pricing**
Multiply U.S. Price by the Canadian price factor.
▶ See page 1 for details.

Cubb Barstool with Oak Base

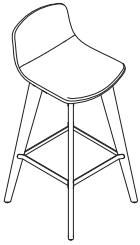

Tip: When two toned upholstered (contrasting) is selected, both seat finish and outer seat finish will need to be specified. Only a single price grade upcharge will be applied. The highest price group upcharge will be applied if multiple price groups are selected.

Standard Includes		Required to Specify
<ul style="list-style-type: none"> ▶ Need help? Product details, page 50 Upholstered seating unit in one fabric: fabric price group 1 Solid oak legs: wood group 1 Metal chassis: paint price group 1 Glides Shipped fully assembled 		<ol style="list-style-type: none"> Style number Fabric color number for chair Paint color number for chassis Wood color number for legs Options, if selected (see below) <ul style="list-style-type: none"> ▶ See Product Understanding for Surface Materials.

Configuration	Options	U.S. Price	Required to Specify
	<ul style="list-style-type: none"> Upholstered Two toned upholstered 	<ul style="list-style-type: none"> No cost +\$ 44 	<ul style="list-style-type: none"> Specify with upholstered. Specify with two toned upholstered.

Surface Materials	Seat	U.S. Price	Required to Specify
	<ul style="list-style-type: none"> Customer's Own Leather (COL) Customer's Own Material (COM) Fabric price group 1 Fabric price group 2 Vinyl price group 2 Fabric price group 3 Fabric price group 4 Fabric price group 5 Fabric price group 6 Fabric price group 7 Fabric price group 8 Fabric price group 9 Fabric price group 10 Leather price group 1 Leather price group 2 	<ul style="list-style-type: none"> No cost No cost No cost +\$ 26 +\$ 26 +\$ 51 +\$ 88 +\$145 +\$202 +\$274 +\$342 +\$398 +\$474 +\$ 90 +\$179 	<ul style="list-style-type: none"> ▶ See Surface Materials Reference Manual. ▶ See Surface Materials Reference Manual. Specify fabric color number. Specify fabric color number. Specify vinyl color number. Specify fabric color number. Specify fabric color number. Specify fabric color number. Specify fabric color number. Specify fabric color number. Specify fabric color number. Specify fabric color number. Specify fabric color number. Specify leather color number. Specify leather color number.

Outer seat	U.S. Price	Required to Specify
<ul style="list-style-type: none"> Customer's Own Leather (COL) Customer's Own Material (COM) Fabric price group 1 Fabric price group 2 Vinyl price group 2 Fabric price group 3 Fabric price group 4 Fabric price group 5 Fabric price group 6 Fabric price group 7 Fabric price group 8 Fabric price group 9 Fabric price group 10 Leather price group 1 Leather price group 2 	<ul style="list-style-type: none"> No cost No cost No cost +\$ 26 +\$ 26 +\$ 51 +\$ 88 +\$145 +\$202 +\$274 +\$342 +\$398 +\$474 +\$ 90 +\$179 	<ul style="list-style-type: none"> ▶ See Surface Materials Reference Manual. ▶ See Surface Materials Reference Manual. Specify fabric color number. Specify fabric color number. Specify vinyl color number. Specify fabric color number. Specify fabric color number. Specify fabric color number. Specify fabric color number. Specify fabric color number. Specify fabric color number. Specify fabric color number. Specify fabric color number. Specify leather color number. Specify leather color number.

Frame	U.S. Price	Required to Specify
<ul style="list-style-type: none"> Paint price group 1 Paint price group 2 Paint price group 3 	<ul style="list-style-type: none"> No cost +\$ 30 +\$ 47 	<ul style="list-style-type: none"> Specify paint color number. Specify paint color number. Specify paint color number.

Specification Information	
Style Number	U.S. Base Price
OBCUBB13	\$1193



For Canadian Pricing
Multiply U.S. Price by the Canadian price factor.
▶ See page 1 for details.

Cubb Barstool with Wire Frame Base

Cubb Barstool with Wire
Frame Base

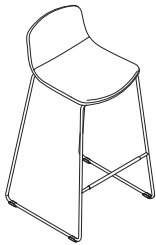

Tip: When two toned upholstered (contrasting) is selected, both seat finish and outer seat finish will need to be specified. Only a single price grade upcharge will be applied. The highest price group upcharge will be applied if multiple price groups are selected.

Standard Includes		Required to Specify
▶ Need help? Product details, page 50	<ul style="list-style-type: none"> Upholstered seating unit in one fabric: fabric price group 1 No foot rail cover Wire frame base: paint price group 1 Glides Shipped fully assembled 	<ol style="list-style-type: none"> Style number Fabric color number for barstool Paint color number for frame Options, if selected (see below) <p>▶ See Product Understanding for Surface Materials.</p>

Options	U.S. Price	Required to Specify
Configuration		
• Upholstered	No cost	Specify <i>with upholstered</i> .
• Two toned upholstered	+\$ 44	Specify <i>with two toned upholstered</i> .

Surface Materials	Seat	U.S. Price	Required to Specify
	• Customer's Own Leather (COL)	No cost	▶ See <i>Surface Materials Reference Manual</i> .
	• Customer's Own Material (COM)	No cost	▶ See <i>Surface Materials Reference Manual</i> .
	• Fabric price group 1	No cost	Specify fabric color number.
	• Fabric price group 2	+\$ 26	Specify fabric color number.
	• Vinyl price group 2	+\$ 26	Specify vinyl color number.
	• Fabric price group 3	+\$ 51	Specify fabric color number.
	• Fabric price group 4	+\$ 88	Specify fabric color number.
	• Fabric price group 5	+\$145	Specify fabric color number.
	• Fabric price group 6	+\$202	Specify fabric color number.
	• Fabric price group 7	+\$274	Specify fabric color number.
	• Fabric price group 8	+\$342	Specify fabric color number.
	• Fabric price group 9	+\$398	Specify fabric color number.
	• Fabric price group 10	+\$474	Specify fabric color number.
	• Leather price group 1	+\$ 90	Specify leather color number.
	• Leather price group 2	+\$179	Specify leather color number.

Outer seat

• Customer's Own Leather (COL)	No cost	▶ See <i>Surface Materials Reference Manual</i> .
• Customer's Own Material (COM)	No cost	▶ See <i>Surface Materials Reference Manual</i> .
• Fabric price group 1	No cost	Specify fabric color number.
• Fabric price group 2	+\$ 26	Specify fabric color number.
• Vinyl price group 2	+\$ 26	Specify vinyl color number.
• Fabric price group 3	+\$ 51	Specify fabric color number.
• Fabric price group 4	+\$ 88	Specify fabric color number.
• Fabric price group 5	+\$145	Specify fabric color number.
• Fabric price group 6	+\$202	Specify fabric color number.
• Fabric price group 7	+\$274	Specify fabric color number.
• Fabric price group 8	+\$342	Specify fabric color number.
• Fabric price group 9	+\$398	Specify fabric color number.
• Fabric price group 10	+\$474	Specify fabric color number.
• Leather price group 1	+\$ 90	Specify leather color number.
• Leather price group 2	+\$179	Specify leather color number.

Frame

• Paint price group 1	No cost	Specify paint color number.
• Paint price group 2	+\$ 57	Specify paint color number.
• Paint price group 3	+\$ 90	Specify paint color number.
• Polished chrome	+\$118	Specify <i>with polished chrome</i> .

Footrail Cover	• No footrail cover	No cost	Specify <i>with no footrail cover</i> .
	• With footrail cover	+\$ 5	Specify <i>with footrail cover</i> .

Specification Information

Style Number	U.S. Base Price
OBCUBB14	\$932



For Canadian Pricing

Multiply U.S. Price by the Canadian price factor.

▶ See page 1 for details.

Cubb Occasional Stool with Oak Base



	Standard Includes	Required to Specify
▶ Need help? Product details, page 52	<ul style="list-style-type: none"> Fully upholstered occasional stool: fabric price group 1 Solid oak legs: wood group 1 Metal chassis: paint price group 1 Glides Shipped fully assembled 	<ol style="list-style-type: none"> Style number Fabric color number for stool Paint color number for chassis Wood color number for legs Options, if selected (see below) <p>▶ See Product Understanding for Surface Materials.</p>

	Options	U.S. Price	Required to Specify
Surface Materials	Seat		
	• Customer's Own Leather (COL)	No cost	▶ See <i>Surface Materials Reference Manual</i> .
	• Customer's Own Material (COM)	No cost	▶ See <i>Surface Materials Reference Manual</i> .
	• Fabric price group 1	No cost	Specify fabric color number.
	• Fabric price group 2	+\$ 12	Specify fabric color number.
	• Vinyl price group 2	+\$ 12	Specify vinyl color number.
	• Fabric price group 3	+\$ 28	Specify fabric color number.
	• Fabric price group 4	+\$ 49	Specify fabric color number.
	• Fabric price group 5	+\$ 81	Specify fabric color number.
	• Fabric price group 6	+\$114	Specify fabric color number.
	• Fabric price group 7	+\$153	Specify fabric color number.
	• Fabric price group 8	+\$188	Specify fabric color number.
	• Fabric price group 9	+\$222	Specify fabric color number.
	• Fabric price group 10	+\$263	Specify fabric color number.
	• Leather price group 1	+\$244	Specify leather color number.
• Leather price group 2	+\$488	Specify leather color number.	
	Frame		
	• Paint price group 1	No cost	Specify paint color number.
	• Paint price group 2	+\$ 30	Specify paint color number.
	• Paint price group 3	+\$ 47	Specify paint color number.

Specification Information	
• Style Number	• U.S. Base Price
•	•
•	•
•	•
OBCUBB15	\$652
•	•
•	•

 **For Canadian Pricing**
Multiply U.S. Price by the Canadian price factor.
▶ See page 1 for details.

Cubb Two Seat Bench

Cubb Two Seat Bench

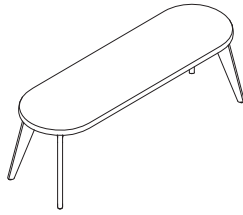

Standard Includes		Required to Specify
<ul style="list-style-type: none"> ▶ Need help? Product details, page 52 	<ul style="list-style-type: none"> Fully upholstered bench: fabric price group 1 Solid oak legs: wood group 1 Metal chassis: paint price group 1 Glides Shipped fully assembled 	<ol style="list-style-type: none"> Style number Fabric color number for bench Paint color number for chassis Wood color number for legs Options, if selected (see below) <ul style="list-style-type: none"> ▶ See Product Understanding for Surface Materials.

Options	U.S. Price	Required to Specify
<p>Surface Materials</p> <ul style="list-style-type: none"> Customer's Own Leather (COL) Customer's Own Material (COM) Fabric price group 1 Fabric price group 2 Vinyl price group 2 Fabric price group 3 Fabric price group 4 Fabric price group 5 Fabric price group 6 Fabric price group 7 Fabric price group 8 Fabric price group 9 Fabric price group 10 Leather price group 1 Leather price group 2 	<p>Seat</p> <ul style="list-style-type: none"> No cost No cost No cost +\$ 24 +\$ 24 +\$ 47 +\$ 79 +\$128 +\$178 +\$246 +\$302 +\$354 +\$420 +\$184 +\$368 	<ul style="list-style-type: none"> ▶ See <i>Surface Materials Reference Manual</i>. ▶ See <i>Surface Materials Reference Manual</i>. Specify fabric color number. Specify fabric color number. Specify vinyl color number. Specify fabric color number. Specify fabric color number. Specify fabric color number. Specify fabric color number. Specify fabric color number. Specify fabric color number. Specify fabric color number. Specify fabric color number. Specify leather color number. Specify leather color number.
<p>Frame</p> <ul style="list-style-type: none"> Paint price group 1 Paint price group 2 Paint price group 3 	<ul style="list-style-type: none"> No cost +\$ 30 +\$ 47 	<ul style="list-style-type: none"> Specify paint color number. Specify paint color number. Specify paint color number.

Specification Information	
Style Number	U.S. Base Price
OBCUBB19	\$1443
:	:
:	:

Specifying

 **For Canadian Pricing**
 Multiply U.S. Price by the Canadian price factor.
 ▶ See page 1 for details.

Cubb Four Person Round Meeting Table



	Standard Includes	Required to Specify
▶ Need help? Product details, page 52	<ul style="list-style-type: none"> 1" thick table top: Low-Pressure Laminate price group 1 3 mm edgeband: plastic price group 1 Solid oak legs: wood group 1 Cable management channel with rubber riser inset per leg: black Metal chassis: paint price group 1 Glides 	<ol style="list-style-type: none"> Style number Low-Pressure Laminate color number for table top Plastic color number for edgeband Wood color number for legs Paint color number for metal chassis Options, if selected (see below) <p>▶ See Product Understanding for Surface Materials.</p>

	Options	U.S. Price	Required to Specify
Surface Materials	Top		
	<ul style="list-style-type: none"> Low-Pressure Laminate price group 1 High-Pressure Laminate price group 1 High-Pressure Laminate price group 2 High-Pressure Laminate price group 3 Open Line laminate (OLL) 	<ul style="list-style-type: none"> No cost +\$ 520 +\$ 859 +\$1511 +\$ 111 plus cost of laminate 	<ul style="list-style-type: none"> Specify laminate color number. Specify laminate color number. Specify laminate color number. Specify laminate color number. ▶ See <i>Surface Materials Reference Manual</i>.
	Frame		
	<ul style="list-style-type: none"> Paint price group 1 Paint price group 2 Paint price group 3 	<ul style="list-style-type: none"> No cost +\$ 59 +\$ 120 	<ul style="list-style-type: none"> Specify paint color number. Specify paint color number. Specify paint color number.
Power	<ul style="list-style-type: none"> No power Node 201 - 2 power Node 204 - 1 power, 1 USB A+C 	<ul style="list-style-type: none"> No cost +\$ 296 +\$ 405 	<ul style="list-style-type: none"> Specify <i>with no power</i>. Specify <i>with Node 201, 2 power</i>. Specify <i>with Node 204, 1 power, 1 USB A+C</i>.
Plug or Hardwire	<ul style="list-style-type: none"> Hardwire Plug 	<ul style="list-style-type: none"> No cost No cost 	<ul style="list-style-type: none"> Specify <i>with hardwire</i>. Specify <i>with plug</i>.
Cable Clips	<ul style="list-style-type: none"> No cable clips Cable clips 	<ul style="list-style-type: none"> No cost +\$ 53 	<ul style="list-style-type: none"> Specify <i>with no cable clips</i>. Specify <i>with cable clips</i>.

Tip: If power is selected it will be located in the center.

Tip: Select paint when specifying power.

Specification Information	
Style Number	U.S. Base Price
OBCUBBRDM01	\$2617



For Canadian Pricing
 Multiply U.S. Price by the Canadian price factor.
 ▶ See page 1 for details.

Cubb Six Person Round Meeting Table

Cubb Six Person Round Meeting Table



Standard Includes		Required to Specify
<ul style="list-style-type: none"> ▶ Need help? Product details, page 52 	<ul style="list-style-type: none"> 1" thick table top: Low-Pressure Laminate price group 1 3 mm edgeband: plastic price group 1 Solid oak legs: wood group 1 Cable management channel with rubber riser inset per leg: black Metal chassis: paint price group 1 Glides 	<ol style="list-style-type: none"> 1 Style number 2 Low-Pressure Laminate color number for table top 3 Plastic color number for edgeband 4 Wood color number for legs 5 Paint color number for metal chassis 6 Options, if selected (see below) <ul style="list-style-type: none"> ▶ See Product Understanding for Surface Materials.

	Options	U.S. Price	Required to Specify
Surface Materials	Top		
	• Low-Pressure Laminate price group 1	No cost	Specify laminate color number.
	• High-Pressure Laminate price group 1	+\$ 546	Specify laminate color number.
	• High-Pressure Laminate price group 2	+\$ 900	Specify laminate color number.
	• High-Pressure Laminate price group 3	+\$1584	Specify laminate color number.
	• Open Line laminate (OLL)	+\$ 111 plus cost of laminate	▶ See <i>Surface Materials Reference Manual</i> .
	Frame		
	• Paint price group 1	No cost	Specify paint color number.
	• Paint price group 2	+\$ 59	Specify paint color number.
	• Paint price group 3	+\$ 120	Specify paint color number.
Power	• No power	No cost	Specify <i>with no power</i> .
	• Node 201 - 2 power	+\$ 296	Specify <i>with Node 201, 2 power</i> .
	• Node 204 - 1 power, 1 USB A+C	+\$ 405	Specify <i>with Node 204, 1 power, 1 USB A+C</i> .
Plug or Hardwire	• Hardwire	No cost	Specify <i>with hardwire</i> .
	• Plug	No cost	Specify <i>with plug</i> .
Cable Clips	• No cable clips	No cost	Specify <i>with no cable clips</i> .
	• Cable clips	+\$ 53	Specify <i>with cable clips</i> .

Tip: If power is selected it will be located in the center.

Tip: Select paint when specifying power.

Specification Information

Style Number	U.S. Base Price
OBCUBBRDM02	\$2745

 **For Canadian Pricing**
 Multiply U.S. Price by the Canadian price factor.
 ▶ See page 1 for details.

Cubb Seven Person Round Meeting Table



	Standard Includes	Required to Specify
▶ Need help? Product details, page 52	<ul style="list-style-type: none"> 1" thick table top: Low-Pressure Laminate price group 1 3 mm edgeband: plastic price group 1 Solid oak legs: wood group 1 Cable management channel with rubber riser inset per leg: black Metal chassis: paint price group 1 Glides 	<ol style="list-style-type: none"> Style number Low-Pressure Laminate color number for table top Plastic color number for edgeband Wood color number for legs Paint color number for metal chassis Options, if selected (see below) <p>▶ See Product Understanding for Surface Materials.</p>

	Options	U.S. Price	Required to Specify
Surface Materials	Top		
	• Low-Pressure Laminate price group 1	No cost	Specify laminate color number.
	• High-Pressure Laminate price group 1	+\$ 633	Specify laminate color number.
	• High-Pressure Laminate price group 2	+\$1042	Specify laminate color number.
	• High-Pressure Laminate price group 3	+\$1835	Specify laminate color number.
	• Open Line laminate (OLL)	+\$ 111 plus cost of laminate	▶ See <i>Surface Materials Reference Manual</i> .
	Frame		
	• Paint price group 1	No cost	Specify paint color number.
	• Paint price group 2	+\$ 59	Specify paint color number.
Power	• Paint price group 3	+\$ 120	Specify paint color number.
	• No power	No cost	Specify <i>with no power</i> .
	• Node 201 - 2 power	+\$ 296	Specify <i>with Node 201, 2 power</i> .
	• Node 204 - 1 power, 1 USB A+C	+\$ 405	Specify <i>with Node 204, 1 power, 1 USB A+C</i> .
Plug or Hardwire	• Hardwire	No cost	Specify <i>with hardwire</i> .
	• Plug	No cost	Specify <i>with plug</i> .
Cable Clips	• No cable clips	No cost	Specify <i>with no cable clips</i> .
	• Cable clips	+\$ 53	Specify <i>with cable clips</i> .

Tip: If power is selected it will be located in the center.

Tip: Select paint when specifying power.

Specification Information	
• Style Number	• U.S. Base Price
OBCUBBRDM03	\$3177



For Canadian Pricing
Multiply U.S. Price by the Canadian price factor.
▶ See page 1 for details.

Cubb Eight Person Round Meeting Table

Cubb Eight Person Round Meeting Table

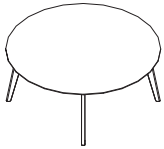

	Standard Includes	Required to Specify
▶ Need help? Product details, page 52	<ul style="list-style-type: none"> 1" thick table top: Low-Pressure Laminate price group 1 3 mm edgeband: plastic price group 1 Solid oak legs: wood group 1 Cable management channel with rubber riser inset per leg: black Metal chassis: paint price group 1 Glides 	<ol style="list-style-type: none"> Style number Low-Pressure Laminate color number for table top Plastic color number for edgeband Wood color number for legs Paint color number for metal chassis Options, if selected (see below) <p>▶ See Product Understanding for Surface Materials.</p>

	Options	U.S. Price	Required to Specify
Surface Materials	Top		
	• Low-Pressure Laminate price group 1	No cost	Specify laminate color number.
	• High-Pressure Laminate price group 1	+\$ 637	Specify laminate color number.
	• High-Pressure Laminate price group 2	+\$1049	Specify laminate color number.
	• High-Pressure Laminate price group 3	+\$1846	Specify laminate color number.
	• Open Line laminate (OLL)	+\$ 111 plus cost of laminate	▶ See Surface Materials Reference Manual.
	Frame		
	• Paint price group 1	No cost	Specify paint color number.
	• Paint price group 2	+\$ 59	Specify paint color number.
	• Paint price group 3	+\$ 120	Specify paint color number.
	Power		
	• No power	No cost	Specify with no power.
	• Node 201 - 2 power	+\$ 296	Specify with Node 201, 2 power.
	• Node 204 - 1 power, 1 USB A+C	+\$ 405	Specify with Node 204, 1 power, 1 USB A+C.
	Plug or Hardwire		
	• Hardwire	No cost	Specify with hardwire.
	• Plug	No cost	Specify with plug.
	Cable Clips		
	• No cable clips	No cost	Specify with no cable clips.
	• Cable clips	+\$ 53	Specify with cable clips.

Tip: If power is selected it will be located in the center.

Tip: Select paint when specifying power.

Specification Information

Style Number	U.S. Base Price
OBCUBBRDM04	\$3204

Specifying

 **For Canadian Pricing**
 Multiply U.S. Price by the Canadian price factor.
 ▶ See page 1 for details.

Cubb Four Person Square Meeting Table



Standard Includes	Required to Specify
<ul style="list-style-type: none"> ▶ Need help? Product details, page 52 • 1" thick table top: Low-Pressure Laminate price group 1 • 3 mm edgeband: plastic price group 1 • Solid oak legs: wood group 1 • Cable management channel with rubber riser inset per leg: black • Metal chassis: paint price group 1 • Glides 	<ol style="list-style-type: none"> 1 Style number 2 Low-Pressure Laminate color number for table top 3 Plastic color number for edgeband 4 Wood color number for legs 5 Paint color number for metal chassis 6 Options, if selected (see below) <p>▶ See Product Understanding for Surface Materials.</p>

Options	U.S. Price	Required to Specify
Surface Materials		
Top		
• Low-Pressure Laminate price group 1	No cost	Specify laminate color number.
• High-Pressure Laminate price group 1	+\$ 499	Specify laminate color number.
• High-Pressure Laminate price group 2	+\$ 824	Specify laminate color number.
• High-Pressure Laminate price group 3	+\$1451	Specify laminate color number.
• Open Line laminate (OLL)	+\$ 111 plus cost of laminate	▶ See <i>Surface Materials Reference Manual</i> .
Frame		
• Paint price group 1	No cost	Specify paint color number.
• Paint price group 2	+\$ 59	Specify paint color number.
• Paint price group 3	+\$ 120	Specify paint color number.
Power		
• No power	No cost	Specify <i>with no power</i> .
• Dean Z 201 - 2 power	+\$ 304	Specify <i>with Dean Z 201, 2 power</i> .
• Dean Z 202 - 1 power, 1 USB A+C	+\$ 423	Specify <i>with Dean Z 202, 1 power, 1 USB A+C</i> .
• Node 204 - 1 power, 1 USB A+C	+\$ 405	Specify <i>with Node 204 - 1 power, 1 USB A+C</i> .
Plug or Hardwire		
• Hardwire	No cost	Specify <i>with hardwire</i> .
• Plug	No cost	Specify <i>with plug</i> .
Cable Clips		
• No cable clips	No cost	Specify <i>with no cable clips</i> .
• Cable clips	+\$ 53	Specify <i>with cable clips</i> .

Tip: If power is selected it will be located in the center.

Tip: Select paint when specifying power.

Specification Information	
Style Number	U.S. Base Price
OBCUBBSQM01	\$2512



For Canadian Pricing
 Multiply U.S. Price by the Canadian price factor.
 ▶ See page 1 for details.

Cubb Four Person Square Meeting Table with Softened Corners

Cubb Four Person Square Meeting Table with Softened Corners



Standard Includes		Required to Specify
<ul style="list-style-type: none"> ▶ Need help? Product details, page 52 	<ul style="list-style-type: none"> 1" thick table top: Low-Pressure Laminate price group 1 3 mm edgeband: plastic price group 1 Solid oak legs: wood group 1 Cable management channel with rubber riser inset per leg: black Metal chassis: paint price group 1 Glides 	<ol style="list-style-type: none"> 1 Style number 2 Low-Pressure Laminate color number for table top 3 Plastic color number for edgeband 4 Wood color number for legs 5 Paint color number for metal chassis 6 Options, if selected (see below) <ul style="list-style-type: none"> ▶ See Product Understanding for Surface Materials.

Options	U.S. Price	Required to Specify
Surface Materials		
Top		
• Low-Pressure Laminate price group 1	No cost	Specify laminate color number.
• High-Pressure Laminate price group 1	+\$ 505	Specify laminate color number.
• High-Pressure Laminate price group 2	+\$ 837	Specify laminate color number.
• High-Pressure Laminate price group 3	+\$1471	Specify laminate color number.
• Open Line laminate (OLL)	+\$ 111 plus cost of laminate	▶ See <i>Surface Materials Reference Manual</i> .
Frame		
• Paint price group 1	No cost	Specify paint color number.
• Paint price group 2	+\$ 59	Specify paint color number.
• Paint price group 3	+\$ 120	Specify paint color number.
Power		
• No power	No cost	Specify <i>with no power</i> .
• Dean Z 201 - 2 power	+\$ 304	Specify <i>with Dean Z 201, 2 power</i> .
• Dean Z 202 - 1 power, 1 USB A+C	+\$ 423	Specify <i>with Dean Z 202, 1 power, 1 USB A+C</i> .
Plug or Hardwire		
• Hardwire	No cost	Specify <i>with hardwire</i> .
• Plug	No cost	Specify <i>with plug</i> .
Cable Clips		
• No cable clips	No cost	Specify <i>with no cable clips</i> .
• Cable clips	+\$ 53	Specify <i>with cable clips</i> .

Tip: If power is selected it will be located in the center.

Tip: Select paint when specifying power.

Specifying

Specification Information	
Style Number	U.S. Base Price
OBCUBBSSM01	\$2552

 **For Canadian Pricing**
 Multiply U.S. Price by the Canadian price factor.
 ▶ See page 1 for details.

Cubb Four Person Rectangle Meeting Table



	Standard Includes	Required to Specify
▶ Need help? Product details, page 52	<ul style="list-style-type: none"> 1" thick table top: Low-Pressure Laminate price group 1 3 mm edgeband: plastic price group 1 Solid oak legs: wood group 1 Cable management channel with rubber riser inset per leg: black Metal chassis: paint price group 1 Glides 	<ol style="list-style-type: none"> Style number Low-Pressure Laminate color number for table top Plastic color number for edgeband Wood color number for legs Paint color number for metal chassis Options, if selected (see below) <p>▶ See Product Understanding for Surface Materials.</p>

	Options	U.S. Price	Required to Specify
Surface Materials	Top		
	<ul style="list-style-type: none"> Low-Pressure Laminate price group 1 High-Pressure Laminate price group 1 High-Pressure Laminate price group 2 High-Pressure Laminate price group 3 Open Line laminate (OLL) 	<ul style="list-style-type: none"> No cost +\$ 496 +\$ 817 +\$1437 +\$ 111 plus cost of laminate 	<ul style="list-style-type: none"> Specify laminate color number. Specify laminate color number. Specify laminate color number. Specify laminate color number. ▶ See <i>Surface Materials Reference Manual</i>.
	Frame		
	<ul style="list-style-type: none"> Paint price group 1 Paint price group 2 Paint price group 3 	<ul style="list-style-type: none"> No cost +\$ 59 +\$ 120 	<ul style="list-style-type: none"> Specify paint color number. Specify paint color number. Specify paint color number.
	Power		
	<ul style="list-style-type: none"> No power Dean Z 201 - 2 power Dean Z 202 - 1 power, 1 USB A+C Dean Z 401 - 3 power, 1 USB A+C Dean Z 402 - 2 power, 2 USB A+C Dean Z 501 - 3 power, 1 USB-C, 100W 	<ul style="list-style-type: none"> No cost +\$ 304 +\$ 423 +\$ 473 +\$ 589 +\$ 725 	<ul style="list-style-type: none"> Specify with <i>no power</i>. Specify with <i>Dean Z 201, 2 power</i>. Specify with <i>Dean Z 202, 1 power, 1 USB A+C</i>. Specify with <i>Dean Z 401, 3 power, 1 USB A+C</i>. Specify with <i>Dean Z 402, 2 power, 2 USB A+C</i>. Specify with <i>Dean Z 501, 3 power, 1 USB-C, 100W</i>.
	Plug or Hardwire		
	<ul style="list-style-type: none"> Hardwire Plug 	<ul style="list-style-type: none"> No cost No cost 	<ul style="list-style-type: none"> Specify with <i>hardwire</i>. Specify with <i>plug</i>.
	Cable Clips		
	<ul style="list-style-type: none"> No cable clips Cable clips 	<ul style="list-style-type: none"> No cost +\$ 53 	<ul style="list-style-type: none"> Specify with <i>no cable clips</i>. Specify with <i>cable clips</i>.

Tip: If power is selected it will be located in the center.

Tip: Select paint when specifying power.

Specification Information	
Style Number	U.S. Base Price
OBCUBRCM01	\$2493



For Canadian Pricing
Multiply U.S. Price by the Canadian price factor.
▶ See page 1 for details.

Cubb Four to Six Person Rectangle Meeting Table

Cubb Four to Six Person
Rectangle Meeting Table

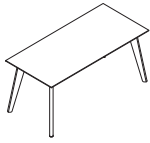

Standard Includes	Required to Specify
<p>▶ Need help? Product details, page 52</p> <ul style="list-style-type: none"> 1" thick table top: Low-Pressure Laminate price group 1 3 mm edgeband: plastic price group 1 Solid oak legs: wood group 1 Cable management channel with rubber riser inset per leg: black Metal chassis: paint price group 1 Glides 	<ol style="list-style-type: none"> Style number Low-Pressure Laminate color number for table top Plastic color number for edgeband Wood color number for legs Paint color number for metal chassis Options, if selected (see below) <p>▶ See Product Understanding for Surface Materials.</p>

Options	U.S. Price	Required to Specify
Surface Materials		
Top		
• Low-Pressure Laminate price group 1	No cost	Specify laminate color number.
• High-Pressure Laminate price group 1	+\$ 514	Specify laminate color number.
• High-Pressure Laminate price group 2	+\$ 848	Specify laminate color number.
• High-Pressure Laminate price group 3	+\$1493	Specify laminate color number.
• Open Line laminate (OLL)	+\$ 111 plus cost of laminate	▶ See <i>Surface Materials Reference Manual</i> .
Frame		
• Paint price group 1	No cost	Specify paint color number.
• Paint price group 2	+\$ 59	Specify paint color number.
• Paint price group 3	+\$ 120	Specify paint color number.
Power		
• No power	No cost	Specify <i>with no power</i> .
• Dean Z 201 - 2 power	+\$ 304	Specify <i>with Dean Z 201, 2 power</i> .
• Dean Z 202 - 1 power, 1 USB A+C	+\$ 423	Specify <i>with Dean Z 202, 1 power, 1 USB A+C</i> .
• Dean Z 401 - 3 power, 1 USB A+C	+\$ 473	Specify <i>with Dean Z 401, 3 power, 1 USB A+C</i> .
• Dean Z 402 - 2 power, 2 USB A+C	+\$ 589	Specify <i>with Dean Z 402, 2 power, 2 USB A+C</i> .
• Dean Z 501 - 3 power, 1 USB-C, 100W	+\$ 725	Specify <i>with Dean Z 501, 3 power, 1 USB-C, 100W</i> .
Plug or Hardwire		
• Hardwire	No cost	Specify <i>with hardwire</i> .
• Plug	No cost	Specify <i>with plug</i> .
Cable Clips		
• No cable clips	No cost	Specify <i>with no cable clips</i> .
• Cable clips	+\$ 53	Specify <i>with cable clips</i> .

Tip: If power is selected it will be located in the center.

Tip: Select paint when specifying power.

Specifying

Specification Information	
Style Number	U.S. Base Price
OBCUBRCM02	\$2582

For Canadian Pricing
Multiply U.S. Price by the Canadian price factor.
▶ See page 1 for details.

Cubb Six to Eight Person Rectangle Meeting Table

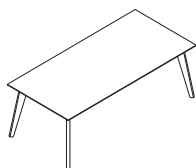

	Standard Includes	Required to Specify
▶ Need help? Product details, page 52	<ul style="list-style-type: none"> 1" thick table top: Low-Pressure Laminate price group 1 3 mm edgeband: plastic price group 1 Solid oak legs: wood group 1 Cable management channel with rubber riser inset per leg: black Metal chassis: paint price group 1 Glides 	<ol style="list-style-type: none"> Style number Low-Pressure Laminate color number for table top Plastic color number for edgeband Wood color number for legs Paint color number for metal chassis Options, if selected (see below) <p>▶ See Product Understanding for Surface Materials.</p>

	Options	U.S. Price	Required to Specify
Surface Materials	Top		
	<ul style="list-style-type: none"> Low-Pressure Laminate price group 1 High-Pressure Laminate price group 1 High-Pressure Laminate price group 2 High-Pressure Laminate price group 3 Open Line laminate (OLL) 	<ul style="list-style-type: none"> No cost +\$ 556 +\$ 919 +\$1618 +\$ 111 plus cost of laminate 	<ul style="list-style-type: none"> Specify laminate color number. Specify laminate color number. Specify laminate color number. Specify laminate color number. <p>▶ See <i>Surface Materials Reference Manual</i>.</p>
	Frame		
	<ul style="list-style-type: none"> Paint price group 1 Paint price group 2 Paint price group 3 	<ul style="list-style-type: none"> No cost +\$ 59 +\$ 120 	<ul style="list-style-type: none"> Specify paint color number. Specify paint color number. Specify paint color number.
Power	<ul style="list-style-type: none"> No power Dean Z 201 - 2 power Dean Z 202 - 1 power, 1 USB A+C Dean Z 401 - 3 power, 1 USB A+C Dean Z 402 - 2 power, 2 USB A+C Dean Z 501 - 3 power, 1 USB-C, 100W 	<ul style="list-style-type: none"> No cost +\$ 304 +\$ 423 +\$ 473 +\$ 589 +\$ 725 	<ul style="list-style-type: none"> Specify with <i>no power</i>. Specify with <i>Dean Z 201, 2 power</i>. Specify with <i>Dean Z 202, 1 power, 1 USB A+C</i>. Specify with <i>Dean Z 401, 3 power, 1 USB A+C</i>. Specify with <i>Dean Z 402, 2 power, 2 USB A+C</i>. Specify with <i>Dean Z 501, 3 power, 1 USB-C, 100W</i>.
Power Location	<ul style="list-style-type: none"> Center only Left and right Left only Left and center Left, right, and center Right only Right and center 	<ul style="list-style-type: none"> No cost No cost No cost No cost No cost No cost No cost 	<ul style="list-style-type: none"> Specify with <i>center only</i>. Specify with <i>left and right</i>. Specify with <i>left only</i>. Specify with <i>left and center</i>. Specify with <i>left, right, and center</i>. Specify with <i>right only</i>. Specify with <i>right and center</i>.
Plug or Hardwire	<ul style="list-style-type: none"> Hardwire Plug 	<ul style="list-style-type: none"> No cost No cost 	<ul style="list-style-type: none"> Specify with <i>hardwire</i>. Specify with <i>plug</i>.
Cable Clips	<ul style="list-style-type: none"> No cable clips Cable clips 	<ul style="list-style-type: none"> No cost +\$ 53 	<ul style="list-style-type: none"> Specify with <i>no cable clips</i>. Specify with <i>cable clips</i>.

Tip: Select paint when specifying power.

Specification Information	
Style Number	U.S. Base Price
OBCUBRCM03	\$2803

 **For Canadian Pricing**
 Multiply U.S. Price by the Canadian price factor.
 ▶ See page 1 for details.

Cubb Eight Person Rectangle Meeting Table

Cubb Eight Person
Rectangle Meeting Table

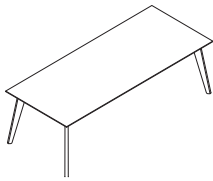

Standard Includes	Required to Specify
<ul style="list-style-type: none"> ▶ Need help? Product details, page 52 • 1" thick table top: Low-Pressure Laminate price group 1 • 3 mm edgeband: plastic price group 1 • Solid oak legs: wood group 1 • Cable management channel with rubber riser inset per leg: black • Metal chassis: paint price group 1 • Glides 	<ol style="list-style-type: none"> 1 Style number 2 Low-Pressure Laminate color number for table top 3 Plastic color number for edgeband 4 Wood color number for legs 5 Paint color number for metal chassis 6 Options, if selected (see below) <p>▶ See Product Understanding for Surface Materials.</p>

Options	U.S. Price	Required to Specify
Surface Materials		
Top		
• Low-Pressure Laminate price group 1	No cost	Specify laminate color number.
• High-Pressure Laminate price group 1	+\$ 577	Specify laminate color number.
• High-Pressure Laminate price group 2	+\$ 947	Specify laminate color number.
• High-Pressure Laminate price group 3	+\$1668	Specify laminate color number.
• Open Line laminate (OLL)	+\$ 111 plus cost of laminate	▶ See <i>Surface Materials Reference Manual</i> .
Frame		
• Paint price group 1	No cost	Specify paint color number.
• Paint price group 2	+\$ 59	Specify paint color number.
• Paint price group 3	+\$ 120	Specify paint color number.
Power		
• No power	No cost	Specify with <i>no power</i> .
• Dean Z 201 - 2 power	+\$ 304	Specify with <i>Dean Z 201, 2 power</i> .
• Dean Z 202 - 1 power, 1 USB A+C	+\$ 423	Specify with <i>Dean Z 202, 1 power, 1 USB A+C</i> .
• Dean Z 401 - 3 power, 1 USB A+C	+\$ 473	Specify with <i>Dean Z 401, 3 power, 1 USB A+C</i> .
• Dean Z 402 - 2 power, 2 USB A+C	+\$ 589	Specify with <i>Dean Z 402, 2 power, 2 USB A+C</i> .
• Dean Z 501 - 3 power, 1 USB-C, 100W	+\$ 725	Specify with <i>Dean Z 501, 3 power, 1 USB-C, 100W</i> .
Power Location		
• Center only	No cost	Specify with <i>center only</i> .
• Left and right	No cost	Specify with <i>left and right</i> .
• Left only	No cost	Specify with <i>left only</i> .
• Left and center	No cost	Specify with <i>left and center</i> .
• Left, right, and center	No cost	Specify with <i>left, right, and center</i> .
• Right only	No cost	Specify with <i>right only</i> .
• Right and center	No cost	Specify with <i>right and center</i> .
Plug or Hardwire		
• Hardwire	No cost	Specify with <i>hardwire</i> .
• Plug	No cost	Specify with <i>plug</i> .
Cable Clips		
• No cable clips	No cost	Specify with <i>no cable clips</i> .
• Cable clips	+\$ 53	Specify with <i>cable clips</i> .

Tip: Select paint when specifying power.

Specifying

Specification Information	
Style Number	U.S. Base Price
OBCUBRCM04	\$2890

For Canadian Pricing
Multiply U.S. Price by the Canadian price factor.
▶ See page 1 for details.

Cubb 47"D Eight to Ten Person Rectangle Meeting Table

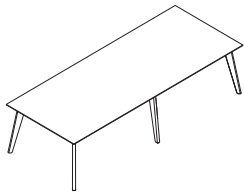

► Need help? Product details, page 52

Standard Includes

- 1" thick table top: Low-Pressure Laminate price group 1
- 3 mm edgeband: plastic price group 1
- Solid oak legs: wood group 1
- Cable management channel with rubber riser inset per leg: black
- Metal chassis: paint price group 1
- Glides

Required to Specify

- 1 Style number
 - 2 Low-Pressure Laminate color number for table top
 - 3 Plastic color number for edgeband
 - 4 Wood color number for legs
 - 5 Paint color number for metal chassis
 - 6 Options, if selected (see below)
- See Product Understanding for Surface Materials.

	Options	U.S. Price	Required to Specify
Surface Materials	Top		
	• Low-Pressure Laminate price group 1	No cost	Specify laminate color number.
	• High-Pressure Laminate price group 1	+\$1025	Specify laminate color number.
	• High-Pressure Laminate price group 2	+\$1692	Specify laminate color number.
	• High-Pressure Laminate price group 3	+\$2978	Specify laminate color number.
	• Open Line laminate (OLL)	+\$ 111 plus cost of laminate	► See <i>Surface Materials Reference Manual</i> .
	Frame		
• Paint price group 1	No cost	Specify paint color number.	
• Paint price group 2	+\$ 59	Specify paint color number.	
• Paint price group 3	+\$ 120	Specify paint color number.	
Power	• No power	No cost	Specify <i>with no power</i> .
	• Dean Z 201 - 2 power	+\$ 304	Specify <i>with Dean Z 201, 2 power</i> .
	• Dean Z 202 - 1 power, 1 USB A+C	+\$ 423	Specify <i>with Dean Z 202, 1 power, 1 USB A+C</i> .
	• Dean Z 401 - 3 power, 1 USB A+C	+\$ 473	Specify <i>with Dean Z 401, 3 power, 1 USB A+C</i> .
	• Dean Z 402 - 2 power, 2 USB A+C	+\$ 589	Specify <i>with Dean Z 402, 2 power, 2 USB A+C</i> .
	• Dean Z 501 - 3 power, 1 USB-C, 100W	+\$ 725	Specify <i>with Dean Z 501, 3 power, 1 USB-C, 100W</i> .
Power Location	• Left and right	No cost	Specify <i>with left and right</i> .
	• Left only	No cost	Specify <i>with left only</i> .
	• Right only	No cost	Specify <i>with right only</i> .
Plug or Hardwire	• Hardwire	No cost	Specify <i>with hardwire</i> .
	• Plug	No cost	Specify <i>with plug</i> .
Cable Clips	• No cable clips	No cost	Specify <i>with no cable clips</i> .
	• Cable clips	+\$ 53	Specify <i>with cable clips</i> .

Tip: Select paint when specifying power.

Specification Information

• Style Number	• U.S. Base Price
OBCUBBRM05	\$5162



For Canadian Pricing

Multiply U.S. Price by the Canadian price factor.

► See page 1 for details.

Cubb 47"D 12 to 14 Person Rectangle Meeting Table

Cubb 47"D 12 to 14 Person Rectangle Meeting Table

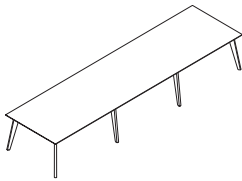

▶ Need help? Product details, page 52

Standard Includes

- 1" thick table top: Low-Pressure Laminate price group 1
- 3 mm edgeband: plastic price group 1
- Solid oak legs: wood group 1
- Cable management channel with rubber riser inset per leg: black
- Metal chassis: paint price group 1
- Glides

Required to Specify

- 1 Style number
 - 2 Low-Pressure Laminate color number for table top
 - 3 Plastic color number for edgeband
 - 4 Wood color number for legs
 - 5 Paint color number for metal chassis
 - 6 Options, if selected (see below)
- ▶ See Product Understanding for Surface Materials.

	Options	U.S. Price	Required to Specify
Surface Materials	Top		
	<ul style="list-style-type: none"> • Low-Pressure Laminate price group 1 • High-Pressure Laminate price group 1 • High-Pressure Laminate price group 2 • High-Pressure Laminate price group 3 • Open Line laminate (OLL) 	<ul style="list-style-type: none"> No cost +\$1477 +\$2434 +\$4288 +\$ 111 plus cost of laminate 	<ul style="list-style-type: none"> Specify laminate color number. Specify laminate color number. Specify laminate color number. Specify laminate color number. ▶ See <i>Surface Materials Reference Manual</i>.
	Frame		
	<ul style="list-style-type: none"> • Paint price group 1 • Paint price group 2 • Paint price group 3 	<ul style="list-style-type: none"> No cost +\$ 59 +\$ 120 	<ul style="list-style-type: none"> Specify paint color number. Specify paint color number. Specify paint color number.
Power	<ul style="list-style-type: none"> • No power • Dean Z 201 - 2 power • Dean Z 202 - 1 power, 1 USB A+C • Dean Z 401 - 3 power, 1 USB A+C • Dean Z 402 - 2 power, 2 USB A+C • Dean Z 501 - 3 power, 1 USB-C, 100W 	<ul style="list-style-type: none"> No cost +\$ 304 +\$ 423 +\$ 473 +\$ 589 +\$ 725 	<ul style="list-style-type: none"> Specify with <i>no power</i>. Specify with <i>Dean Z 201, 2 power</i>. Specify with <i>Dean Z 202, 1 power, 1 USB A+C</i>. Specify with <i>Dean Z 401, 3 power, 1 USB A+C</i>. Specify with <i>Dean Z 402, 2 power, 2 USB A+C</i>. Specify with <i>Dean Z 501, 3 power, 1 USB-C, 100W</i>.
Power Location	<ul style="list-style-type: none"> • Center only • Left and right • Left only • Left and center • Left, right, and center • Right only • Right and center 	<ul style="list-style-type: none"> No cost No cost No cost No cost No cost No cost No cost 	<ul style="list-style-type: none"> Specify with <i>center only</i>. Specify with <i>left and right</i>. Specify with <i>left only</i>. Specify with <i>left and center</i>. Specify with <i>left, right, and center</i>. Specify with <i>right only</i>. Specify with <i>right and center</i>.
Plug or Hardwire	<ul style="list-style-type: none"> • Hardwire • Plug 	<ul style="list-style-type: none"> No cost No cost 	<ul style="list-style-type: none"> Specify with <i>hardwire</i>. Specify with <i>plug</i>.
Cable Clips	<ul style="list-style-type: none"> • No cable clips • Cable clips 	<ul style="list-style-type: none"> No cost +\$ 53 	<ul style="list-style-type: none"> Specify with <i>no cable clips</i>. Specify with <i>cable clips</i>.

Tip: Select paint when specifying power.

Specifying

Specification Information	
Style Number	U.S. Base Price
OBCUBBRM07	\$7429

 **For Canadian Pricing**
 Multiply U.S. Price by the Canadian price factor.
 ▶ See page 1 for details.

Cubb 55"D Eight to Ten Person Rectangle Meeting Table

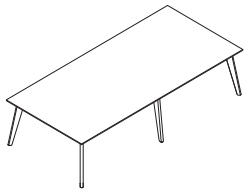

► Need help? Product details, page 52

Standard Includes

- 1" thick table top: Low-Pressure Laminate price group 1
- 3 mm edgeband: plastic price group 1
- Solid oak legs: wood group 1
- Cable management channel with rubber riser inset per leg: black
- Metal chassis: paint price group 1
- Glides

Required to Specify

- 1 Style number
 - 2 Low-Pressure Laminate color number for table top
 - 3 Plastic color number for edgeband
 - 4 Wood color number for legs
 - 5 Paint color number for metal chassis
 - 6 Options, if selected (see below)
- See Product Understanding for Surface Materials.

	Options	U.S. Price	Required to Specify
Surface Materials	Top		
	• Low-Pressure Laminate price group 1	No cost	Specify laminate color number.
	• High-Pressure Laminate price group 1	+\$1114	Specify laminate color number.
	• High-Pressure Laminate price group 2	+\$1840	Specify laminate color number.
	• High-Pressure Laminate price group 3	+\$3237	Specify laminate color number.
	• Open Line laminate (OLL)	+\$ 111 plus cost of laminate	► See <i>Surface Materials Reference Manual</i> .
	Frame		
• Paint price group 1	No cost	Specify paint color number.	
• Paint price group 2	+\$ 59	Specify paint color number.	
• Paint price group 3	+\$ 120	Specify paint color number.	
Power	• No power	No cost	Specify <i>with no power</i> .
	• Dean Z 201 - 2 power	+\$ 304	Specify <i>with Dean Z 201, 2 power</i> .
	• Dean Z 202 - 1 power, 1 USB A+C	+\$ 423	Specify <i>with Dean Z 202, 1 power, 1 USB A+C</i> .
	• Dean Z 401 - 3 power, 1 USB A+C	+\$ 473	Specify <i>with Dean Z 401, 3 power, 1 USB A+C</i> .
	• Dean Z 402 - 2 power, 2 USB A+C	+\$ 589	Specify <i>with Dean Z 402, 2 power, 2 USB A+C</i> .
	• Dean Z 501 - 3 power, 1 USB-C, 100W	+\$ 725	Specify <i>with Dean Z 501, 3 power, 1 USB-C, 100W</i> .
Power Location	• Left and right	No cost	Specify <i>with left and right</i> .
	• Left only	No cost	Specify <i>with left only</i> .
	• Right only	No cost	Specify <i>with right only</i> .
Plug or Hardwire	• Hardwire	No cost	Specify <i>with hardwire</i> .
	• Plug	No cost	Specify <i>with plug</i> .
Cable Clips	• No cable clips	No cost	Specify <i>with no cable clips</i> .
	• Cable clips	+\$ 53	Specify <i>with cable clips</i> .

Tip: Select paint when specifying power.

Specification Information

• Style Number	• U.S. Base Price
OBCUBBRM09	\$5612



For Canadian Pricing

Multiply U.S. Price by the Canadian price factor.

► See page 1 for details.

Cubb 55"D 12 to 14 Person Rectangle Meeting Table

Cubb 55"D 12 to 14 Person Rectangle Meeting Table

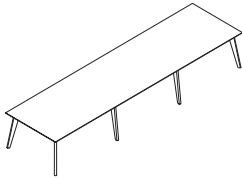

▶ Need help? Product details, page 52

Standard Includes

- 1" thick table top: Low-Pressure Laminate price group 1
- 3 mm edgeband: plastic price group 1
- Solid oak legs: wood group 1
- Cable management channel with rubber riser inset per leg: black
- Metal chassis: paint price group 1
- Glides

Required to Specify

- 1 Style number
 - 2 Low-Pressure Laminate color number for table top
 - 3 Plastic color number for edgeband
 - 4 Wood color number for legs
 - 5 Paint color number for metal chassis
 - 6 Options, if selected (see below)
- ▶ See Product Understanding for Surface Materials.

	Options	U.S. Price	Required to Specify
Surface Materials	Top		
	<ul style="list-style-type: none"> • Low-Pressure Laminate price group 1 • High-Pressure Laminate price group 1 • High-Pressure Laminate price group 2 • High-Pressure Laminate price group 3 • Open Line laminate (OLL) 	<ul style="list-style-type: none"> No cost +\$1568 +\$2586 +\$4549 +\$ 111 plus cost of laminate 	<ul style="list-style-type: none"> Specify laminate color number. Specify laminate color number. Specify laminate color number. Specify laminate color number. ▶ See <i>Surface Materials Reference Manual</i>.
	Frame		
	<ul style="list-style-type: none"> • Paint price group 1 • Paint price group 2 • Paint price group 3 	<ul style="list-style-type: none"> No cost +\$ 59 +\$ 120 	<ul style="list-style-type: none"> Specify paint color number. Specify paint color number. Specify paint color number.
Power	<ul style="list-style-type: none"> • No power • Dean Z 201 - 2 power • Dean Z 202 - 1 power, 1 USB A+C • Dean Z 401 - 3 power, 1 USB A+C • Dean Z 402 - 2 power, 2 USB A+C • Dean Z 501 - 3 power, 1 USB-C, 100W 	<ul style="list-style-type: none"> No cost +\$ 304 +\$ 423 +\$ 473 +\$ 589 +\$ 725 	<ul style="list-style-type: none"> Specify with <i>no power</i>. Specify with <i>Dean Z 201, 2 power</i>. Specify with <i>Dean Z 202, 1 power, 1 USB A+C</i>. Specify with <i>Dean Z 401, 3 power, 1 USB A+C</i>. Specify with <i>Dean Z 402, 2 power, 2 USB A+C</i>. Specify with <i>Dean Z 501, 3 power, 1 USB-C, 100W</i>.
Power Location	<ul style="list-style-type: none"> • Center only • Left and right • Left only • Left and center • Left, right, and center • Right only • Right and center 	<ul style="list-style-type: none"> No cost No cost No cost No cost No cost No cost No cost 	<ul style="list-style-type: none"> Specify with <i>center only</i>. Specify with <i>left and right</i>. Specify with <i>left only</i>. Specify with <i>left and center</i>. Specify with <i>left, right, and center</i>. Specify with <i>right only</i>. Specify with <i>right and center</i>.
Plug or Hardwire	<ul style="list-style-type: none"> • Hardwire • Plug 	<ul style="list-style-type: none"> No cost No cost 	<ul style="list-style-type: none"> Specify with <i>hardwire</i>. Specify with <i>plug</i>.
Cable Clips	<ul style="list-style-type: none"> • No cable clips • Cable clips 	<ul style="list-style-type: none"> No cost +\$ 53 	<ul style="list-style-type: none"> Specify with <i>no cable clips</i>. Specify with <i>cable clips</i>.

Tip: Select paint when specifying power.

Specifying

Specification Information

Style Number	U.S. Base Price
OBCUBBRM11	\$7896



For Canadian Pricing
Multiply U.S. Price by the Canadian price factor.
▶ See page 1 for details.

Cubb Four to Six Person Standing Height Project Table



	Standard Includes	Required to Specify
▶ Need help? Product details, page 52	<ul style="list-style-type: none"> 1" thick table top: Low-Pressure Laminate price group 1 3 mm edgeband: plastic price group 1 Solid oak legs: wood group 1 Cable management channel with rubber riser inset per leg: black Metal chassis and beam: paint price group 1 Two structural cable attachments with hardware Glides 	<ol style="list-style-type: none"> Style number Low-Pressure Laminate color number for table top Plastic color number for edgeband Wood color number for legs Paint color number for metal chassis Options, if selected (see below) <p>▶ See Product Understanding for Surface Materials.</p>

	Options	U.S. Price	Required to Specify
Surface Materials	Top		
	• Low-Pressure Laminate price group 1	No cost	Specify laminate color number.
	• High-Pressure Laminate price group 1	+\$ 889	Specify laminate color number.
	• High-Pressure Laminate price group 2	+\$1468	Specify laminate color number.
	• High-Pressure Laminate price group 3	+\$2589	Specify laminate color number.
	• Open Line laminate (OLL)	+\$ 111 plus cost of laminate	▶ See <i>Surface Materials Reference Manual</i> .
	Frame		
	• Paint price group 1	No cost	Specify paint color number.
	• Paint price group 2	+\$ 120	Specify paint color number.
Power	• Paint price group 3	+\$ 241	Specify paint color number.
	• No power	No cost	Specify with <i>no power</i> .
	• Dean Z 201 - 2 power	+\$ 304	Specify with <i>Dean Z 201, 2 power</i> .
	• Dean Z 202 - 1 power, 1 USB A+C	+\$ 423	Specify with <i>Dean Z 202, 1 power, 1 USB A+C</i> .
	• Dean Z 401 - 3 power, 1 USB A+C	+\$ 473	Specify with <i>Dean Z 401, 3 power, 1 USB A+C</i> .
	• Dean Z 402 - 2 power, 2 USB A+C	+\$ 589	Specify with <i>Dean Z 402, 2 power, 2 USB A+C</i> .
Power Location	• Dean Z 501 - 3 power, 1 USB-C, 100W	+\$ 725	Specify with <i>Dean Z 501, 3 power, 1 USB-C, 100W</i> .
	• Left and right	No cost	Specify with <i>left and right</i> .
	• Left only	No cost	Specify with <i>left only</i> .
Plug or Hardwire	• Right only	No cost	Specify with <i>right only</i> .
	• Hardwire	No cost	Specify with <i>hardwire</i> .
Cable Clips	• Plug	No cost	Specify with <i>plug</i> .
	• No cable clips	No cost	Specify with <i>no cable clips</i> .
	• Cable clips	+\$ 53	Specify with <i>cable clips</i> .

Tip: Select paint when specifying power.

Specification Information	
• Style Number	• U.S. Base Price
OBCUBBRCP01	\$4477



For Canadian Pricing
Multiply U.S. Price by the Canadian price factor.
▶ See page 1 for details.

Cubb Six to Eight Person Standing Height Project Table

Cubb Six to Eight Person
Standing Height
Project Table



Standard Includes	Required to Specify
<p>▶ Need help? Product details, page 52</p> <ul style="list-style-type: none"> 1" thick table top: Low-Pressure Laminate price group 1 3 mm edgeband: plastic price group 1 Solid oak legs: wood group 1 Cable management channel with rubber riser inset per leg: black Metal chassis and beam: paint price group 1 Two structural cable attachments with hardware Glides 	<ol style="list-style-type: none"> Style number Low-Pressure Laminate color number for table top Plastic color number for edgeband Wood color number for legs Paint color number for metal chassis Options, if selected (see below) <p>▶ See Product Understanding for Surface Materials.</p>

Options	U.S. Price	Required to Specify
Surface Materials		
Top		
• Low-Pressure Laminate price group 1	No cost	Specify laminate color number.
• High-Pressure Laminate price group 1	+\$ 926	Specify laminate color number.
• High-Pressure Laminate price group 2	+\$1529	Specify laminate color number.
• High-Pressure Laminate price group 3	+\$2690	Specify laminate color number.
• Open Line laminate (OLL)	+\$ 111 plus cost of laminate	▶ See <i>Surface Materials Reference Manual</i> .
Frame		
• Paint price group 1	No cost	Specify paint color number.
• Paint price group 2	+\$ 120	Specify paint color number.
• Paint price group 3	+\$ 241	Specify paint color number.
Power		
• No power	No cost	Specify with <i>no power</i> .
• Dean Z 201 - 2 power	+\$ 304	Specify with <i>Dean Z 201, 2 power</i> .
• Dean Z 202 - 1 power, 1 USB A+C	+\$ 423	Specify with <i>Dean Z 202, 1 power, 1 USB A+C</i> .
• Dean Z 401 - 3 power, 1 USB A+C	+\$ 473	Specify with <i>Dean Z 401, 3 power, 1 USB A+C</i> .
• Dean Z 402 - 2 power, 2 USB A+C	+\$ 589	Specify with <i>Dean Z 402, 2 power, 2 USB A+C</i> .
• Dean Z 501 - 3 power, 1 USB-C, 100W	+\$ 725	Specify with <i>Dean Z 501, 3 power, 1 USB-C, 100W</i> .
Power Location		
• Center only	No cost	Specify with <i>center only</i> .
• Left and right	No cost	Specify with <i>left and right</i> .
• Left only	No cost	Specify with <i>left only</i> .
• Left and center	No cost	Specify with <i>left and center</i> .
• Left, right, and center	No cost	Specify with <i>left, right, and center</i> .
• Right only	No cost	Specify with <i>right only</i> .
• Right and center	No cost	Specify with <i>right and center</i> .
Plug or Hardwire		
• Hardwire	No cost	Specify with <i>hardwire</i> .
• Plug	No cost	Specify with <i>plug</i> .
Cable Clips		
• No cable clips	No cost	Specify with <i>no cable clips</i> .
• Cable clips	+\$ 53	Specify with <i>cable clips</i> .

Tip: Select paint when specifying power.

Specifying

Specification Information

Style Number	U.S. Base Price
OBCUBBRCP02	\$4661



For Canadian Pricing
Multiply U.S. Price by the Canadian price factor.
▶ See page 1 for details.

Cubb Eight to Ten Person Standing Height Project Table

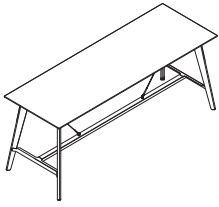

Standard Includes	Required to Specify
<p>▶ Need help? Product details, page 52</p> <ul style="list-style-type: none"> 1" thick table top: Low-Pressure Laminate price group 1 3 mm edgeband: plastic price group 1 Solid oak legs: wood group 1 Cable management channel with rubber riser inset per leg: black Metal chassis and beam: paint price group 1 Two structural cable attachments with hardware Glides 	<ol style="list-style-type: none"> Style number Low-Pressure Laminate color number for table top Plastic color number for edgeband Wood color number for legs Paint color number for metal chassis Options, if selected (see below) <p>▶ See Product Understanding for Surface Materials.</p>

Options	U.S. Price	Required to Specify
<p>Surface Materials</p> <p>Top</p> <ul style="list-style-type: none"> Low-Pressure Laminate price group 1 High-Pressure Laminate price group 1 High-Pressure Laminate price group 2 High-Pressure Laminate price group 3 Open Line laminate (OLL) <p>Frame</p> <ul style="list-style-type: none"> Paint price group 1 Paint price group 2 Paint price group 3 	<p>No cost</p> <p>+\$ 954</p> <p>+\$1575</p> <p>+\$2775</p> <p>+\$ 111 plus cost of laminate</p> <p>No cost</p> <p>+\$ 120</p> <p>+\$ 241</p>	<p>Specify laminate color number.</p> <p>Specify laminate color number.</p> <p>Specify laminate color number.</p> <p>Specify laminate color number.</p> <p>▶ See <i>Surface Materials Reference Manual</i>.</p> <p>Specify paint color number</p> <p>Specify paint color number.</p> <p>Specify paint color number.</p>
<p>Power</p> <ul style="list-style-type: none"> No power Dean Z 201 - 2 power Dean Z 202 - 1 power, 1 USB A+C Dean Z 401 - 3 power, 1 USB A+C Dean Z 402 - 2 power, 2 USB A+C Dean Z 501 - 3 power, 1 USB-C, 100W 	<p>No cost</p> <p>+\$ 304</p> <p>+\$ 423</p> <p>+\$ 473</p> <p>+\$ 589</p> <p>+\$ 725</p>	<p>Specify with <i>no power</i>.</p> <p>Specify with <i>Dean Z 201, 2 power</i>.</p> <p>Specify with <i>Dean Z 202, 1 power, 1 USB A+C</i>.</p> <p>Specify with <i>Dean Z 401, 3 power, 1 USB A+C</i>.</p> <p>Specify with <i>Dean Z 402, 2 power, 2 USB A+C</i>.</p> <p>Specify with <i>Dean Z 501, 3 power, 1 USB-C, 100W</i>.</p>
<p>Power Location</p> <ul style="list-style-type: none"> Center only Left and right Left only Left and center Left, right, and center Right only Right and center 	<p>No cost</p> <p>No cost</p> <p>No cost</p> <p>No cost</p> <p>No cost</p> <p>No cost</p> <p>No cost</p>	<p>Specify with <i>center only</i>.</p> <p>Specify with <i>left and right</i>.</p> <p>Specify with <i>left only</i>.</p> <p>Specify with <i>left and center</i>.</p> <p>Specify with <i>left, right, and center</i>.</p> <p>Specify with <i>right only</i>.</p> <p>Specify with <i>right and center</i>.</p>
<p>Plug or Hardwire</p> <ul style="list-style-type: none"> Hardwire Plug 	<p>No cost</p> <p>No cost</p>	<p>Specify with <i>hardwire</i>.</p> <p>Specify with <i>plug</i>.</p>
<p>Cable Clips</p> <ul style="list-style-type: none"> No cable clips Cable clips 	<p>No cost</p> <p>+\$ 53</p>	<p>Specify with <i>no cable clips</i>.</p> <p>Specify with <i>cable clips</i>.</p>

Tip: Select paint when specifying power.

Specification Information	
Style Number	U.S. Base Price
OBCUBBRCP03	\$4803

 **For Canadian Pricing**
 Multiply U.S. Price by the Canadian price factor.
 ▶ See page 1 for details.

Cubb 23⁵/₈"W Round Occasional Table

Cubb 23⁵/₈"W Round Occasional Table



	Standard Includes	Required to Specify
▶ Need help? Product details, page 52	<ul style="list-style-type: none"> 1" thick table top: Low-Pressure Laminate price group 1 3 mm edgeband: plastic price group 1 Solid oak legs: wood group 1 Metal chassis: paint price group 1 Glides 	<ol style="list-style-type: none"> Style number Low-Pressure Laminate color number for table top Plastic color number for edgeband Wood color number for legs Paint color number for metal chassis Options, if selected (see below) <p>▶ See Product Understanding for Surface Materials.</p>

	Options	U.S. Price	Required to Specify
Surface Materials	Top		
	• Low-Pressure Laminate price group 1	No cost	Specify laminate color number.
	• High-Pressure Laminate price group 1	+\$339	Specify laminate color number.
	• High-Pressure Laminate price group 2	+\$555	Specify laminate color number.
	• High-Pressure Laminate price group 3	+\$975	Specify laminate color number.
	• Open Line laminate (OLL)	+\$111 plus cost of laminate	▶ See <i>Surface Materials Reference Manual</i> .
	Frame		
• Paint price group 1	No cost	Specify paint color number.	
• Paint price group 2	+\$ 59	Specify paint color number.	
• Paint price group 3	+\$120	Specify paint color number.	

Specification Information	
Style Number	U.S. Base Price
OBCUBBRD001	\$1696

Specifying

 **For Canadian Pricing**
 Multiply U.S. Price by the Canadian price factor.
 ▶ See page 1 for details.

Cubb 31"W Round Occasional Table



	Standard Includes	Required to Specify
▶ Need help? Product details, page 52	<ul style="list-style-type: none"> 1" thick table top: Low-Pressure Laminate price group 1 3 mm edgeband: plastic price group 1 Solid oak legs: wood group 1 Metal chassis: paint price group 1 Glides 	<ol style="list-style-type: none"> Style number Low-Pressure Laminate color number for table top Plastic color number for edgeband Wood color number for legs Paint color number for metal chassis Options, if selected (see below) <p>▶ See Product Understanding for Surface Materials.</p>

	Options	U.S. Price	Required to Specify
Surface Materials	Top		
	<ul style="list-style-type: none"> Low-Pressure Laminate price group 1 High-Pressure Laminate price group 1 High-Pressure Laminate price group 2 High-Pressure Laminate price group 3 Open Line laminate (OLL) 	<p>No cost</p> <p>+\$ 388</p> <p>+\$ 640</p> <p>+\$1126</p> <p>+\$ 111 plus cost of laminate</p>	<p>Specify laminate color number.</p> <p>Specify laminate color number.</p> <p>Specify laminate color number.</p> <p>Specify laminate color number.</p> <p>▶ See <i>Surface Materials Reference Manual</i>.</p>
	Frame		
	<ul style="list-style-type: none"> Paint price group 1 Paint price group 2 Paint price group 3 	<p>No cost</p> <p>+\$ 59</p> <p>+\$ 120</p>	<p>Specify paint color number.</p> <p>Specify paint color number.</p> <p>Specify paint color number.</p>

Specification Information	
Style Number	U.S. Base Price
OBCUBBRD002	\$1951



For Canadian Pricing
 Multiply U.S. Price by the Canadian price factor.
 ▶ See page 1 for details.

Cubb Rectangle Occasional Table

Cubb Rectangle
Occasional Table

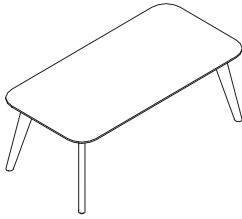

Standard Includes	Required to Specify
<p>▶ Need help? Product details, page 52</p> <ul style="list-style-type: none"> 1" thick table top: Low-Pressure Laminate price group 1 3 mm edgeband: plastic price group 1 Solid oak legs: wood group 1 Metal chassis: paint price group 1 Glides 	<ol style="list-style-type: none"> Style number Low-Pressure Laminate color number for table top Plastic color number for edgeband Wood color number for legs Paint color number for metal chassis Options, if selected (see below) <p>▶ See Product Understanding for Surface Materials.</p>

Options	U.S. Price	Required to Specify
Surface Materials		
Top		
• Low-Pressure Laminate price group 1	No cost	Specify laminate color number.
• High-Pressure Laminate price group 1	+\$ 411	Specify laminate color number.
• High-Pressure Laminate price group 2	+\$ 679	Specify laminate color number.
• High-Pressure Laminate price group 3	+\$1197	Specify laminate color number.
• Open Line laminate (OLL)	+\$ 111 plus cost of laminate	▶ See <i>Surface Materials Reference Manual</i> .
Frame		
• Paint price group 1	No cost	Specify paint color number.
• Paint price group 2	+\$ 59	Specify paint color number.
• Paint price group 3	+\$ 120	Specify paint color number.

Specification Information	
Style Number	U.S. Base Price
OBCUBBRC001	\$2079

Specifying

 **For Canadian Pricing**
Multiply U.S. Price by the Canadian price factor.
▶ See page 1 for details.

Cubb Square Occasional Table



Standard Includes	Required to Specify
<ul style="list-style-type: none"> ▶ Need help? Product details, page 52 • 1" thick table top: Low-Pressure Laminate price group 1 • 3 mm edgeband: plastic price group 1 • Solid oak legs: wood group 1 • Metal chassis: paint price group 1 • Glides 	<ol style="list-style-type: none"> 1 Style number 2 Low-Pressure Laminate color number for table top 3 Plastic color number for edgeband 4 Wood color number for legs 5 Paint color number for metal chassis 6 Options, if selected (see below) <ul style="list-style-type: none"> ▶ See Product Understanding for Surface Materials.

	Options	U.S. Price	Required to Specify
Surface Materials	Top		
	• Low-Pressure Laminate price group 1	No cost	Specify laminate color number.
	• High-Pressure Laminate price group 1	+\$ 346	Specify laminate color number.
	• High-Pressure Laminate price group 2	+\$ 573	Specify laminate color number.
	• High-Pressure Laminate price group 3	+\$1005	Specify laminate color number.
	• Open Line laminate (OLL)	+\$ 111 plus cost of laminate	▶ See <i>Surface Materials Reference Manual</i> .
	Frame		
• Paint price group 1	No cost	Specify paint color number.	
• Paint price group 2	+\$ 59	Specify paint color number.	
• Paint price group 3	+\$ 120	Specify paint color number.	

Specification Information	
• Style Number	• U.S. Base Price
OBCUBBSQ001	\$1746



For Canadian Pricing
 Multiply U.S. Price by the Canadian price factor.
 ▶ See page 1 for details.



Tip: Vertical cable carrier is recommended for use with height-adjustable worksurfaces.

Tip: Vertical cable carrier affixes under the worksurface and has a weighted base to hold it in place.

Standard Includes		Required to Specify
▶ Need help? Product details, page 54	<ul style="list-style-type: none"> • Cable carrier: 6688 Steel • Attachment hardware 	Style number

Specification Information			
• Dimensions		• Style	• U.S.
W	H	Number	Price
2 1/2"	52"	AHCC	\$251

Specifying



For Canadian Pricing
 Multiply U.S. Price by the Canadian price factor.
 ▶ See page 1 for details.

Style Number Index

Style Number	Page	Description
AHCC	285	Vertical Cable Carrier
OB1AIR23	57	Air ³ ; Half-Sq, Opening roof
OB1AIR25	59	Air ³ ; Sq, Opening roof
OB1AIR27	61	Air ³ ; Rect, Opening roof
OB1AIR30	62	Air ³ ; Pod table-Small
OB1AIR35	63	Air ³ ; Pod table-Short, Str
OB1AIRGA151	64	Magnetic-Whiteboard, Glass, Str
OB1AIRGA153US	64	Monitor bracket-Hoop mounted
OB1AIRGA174US	64	Monitor bracket-Over upholster
OB1AIRGA176	65	Air25 Pod Seismic Kit
OB1AIRGA180	65	Air23 Pod Seismic Kit
OB1AIRGA181	65	Air27 Pod Seismic Kit
OB1AIRGA204	65	Air29 Pod Seismic Kit
OB1AIRINSTALL1	65	Air ³ Installation Training-1 to 5 units
OB1AIRINSTALL2	65	Air ³ Installation Training-6 to 10 units
OB1AIRINSTALL3	65	Air ³ Installation Training-11+ units
OB1AW01	132	88" Awning
OB1AW02	133	115" Awning
OB1CD02BLS	71	C&D Glass Front and Rear Camper LH
OB1CD02BRS	71	C&D Glass Front and Rear Camper RH
OB1CD02CLS	84	C&D Corner Glass Camper LH
OB1CD02CRS	100	C&D Corner Glass Camper RH
OB1CD02DLS	116	C&D Glass Front Camper LH
OB1CD02DRS	116	C&D Glass Front Camper RH
OB1CD05BLS	77	115" x 119" Glass Front & Rear LH
OB1CD05BLSNB	77	115" x 119" Glass Front & Rear (with infill) LH
OB1CD05BRS	77	115" x 119" Glass Front & Rear RH
OB1CD05BRSNB	77	115" x 119" Glass Front & Rear (with infill) RH
OB1CD05CLS	92	115" x 119" Corner Glass Front LH
OB1CD05CLS NB	92	115" x 119" Corner Glass Front (with infill) LH
OB1CD05CRS	108	115" x 119" Corner Glass Front RH
OB1CD05CRS NB	108	115" x 119" Corner Glass Front (with infill) RH
OB1CD05DLS	124	115" x 119" Glass Front LH
OB1CD05DLSNB	125	115" x 119" Glass Front (with infill) LH
OB1CD05DRS	124	115" x 119" Glass Front RH
OB1CD05DRS NB	125	115" x 119" Glass Front (with infill) RH
OB1CDC01	130	C&D Cabin
OB1CDC02	131	115" Cabin
OB1CDFHMB	138	C&D Off Hoop Mounted Monitor Bracket
OB1CDHMMBS	138	C&D Hoop Mounted Monitor Bracket
OB1CDHSMB	139	C&D Hoop or Seam Mntd Conf Device Bracket
OB1CDK01L	127	C&D Kink, Left
OB1CDK01R	127	C&D Kink, Right
OB1CDK02L	129	115" Kink, Left
OB1CDK02R	129	115" Kink, Right
OB1CDPSMB	139	C&D Panel Seam Mounted Monitor Bracket
OB1CDSBK	138	C&D CD Seismic/Bracing Kit
OB1CDSPRNK	139	C&D CD Sprinkler Kit
OB1CDUS01	140	C&D Upholstered Seat, Single
OB1CDUS02	141	C&D Upholstered Seat, Double
OB1CDWT01	137	C&D Small Table
OB1CDWT02	137	C&D Medium Table
OB1HACK08	134	C&D Hacking, Up to Corner
OB1HACK09	134	C&D Hacking, Full Depth
OB1HACK10	135	C&D Hacking, Around Corner

Style Number	Page	Description
OB1HACK11	135	119" Up to Corner, Wood Slat
OB1HACK12	136	119" Full Depth, Wood Slat
OB1HACK13	136	119" Around Corner, Wood Slat
OB1QT01	144	Short Angled Phone Booth, LH
OB1QT02	144	Short Angled Phone Booth, RH
OB1QT03	148	Tall Angled Phone Booth, LH
OB1QT04	148	Tall Angled Phone Booth, RH
OB1QTF01	151	Furniture Seat, LH
OB1QTF02	151	Furniture Seat, RH
OBAD01	184	Str Seat-Mod, 31½"W
OBAD02	187	Str Seat-Mod, Back, 31½"W
OBAD03	190	Str Seat-Mod, Back, Scr, 31½"W
OBAD03LC	190	Str seat-Back, LH, Tprd Scr, 31½"W
OBAD03RC	190	Str seat-Back, RH, Tprd Scr, 31½"W
OBAD101	239	Sgl seat-Det, Unit
OBAD101LT	239	Sgl seat-Det, Unit, Int tablet, LH
OBAD101RT	239	Sgl seat-Det, Unit, Int tablet, RH
OBAD102	241	Sgl seat-Det, Unit, Scr
OBAD102LT	241	Sgl seat-Det, Unit, Scr, Int tablet, LH
OBAD102RT	241	Sgl seat-Det, Unit, Scr, Int tablet, RH
OBAD103	242	Three seat-Det, Unit
OBAD11	192	Str Seat-Mod, 70⅞"W
OBAD12	195	Str Seat-Mod, Back, 70⅞"W
OBAD13	197	Str Seat-Mod, Back, Scr, 70⅞"W
OBAD21	199	Seat-Mod, 120°
OBAD22	202	Seat-Ext back, 120°, Mod
OBAD23	207	Seat-Ext back, 120°, Scr, Mod
OBAD23LC	207	Seat-Ext back, 120°, LH, Tprd Scr, Mod
OBAD23RC	207	Seat-Ext back, 120°, RH, Tprd Scr, Mod
OBAD24	209	Seat-Intl back, 120°, Mod
OBAD25	211	Seat-Intl back, 120°, Scr, Mod
OBAD31	213	Tri Seat-Mod, 120°
OBAD32	216	Tri seat-Intl back, 120°, Mod
OBAD33	220	Tri seat-Intl back, 120°, Scr, Mod
OBAD42	224	Seat-Back, 90°, Mod
OBAD43	228	Seat-Back, 90°, Scr, Mod
OBAD52	231	Curved seat-Back, 90°, Mod
OBAD53	233	Curved seat-Back, 90°, Scr, Mod
OBAD64SRO	234	Lrg Uph Tprd base-Round top, Small, Mod
OBAD81DS	235	Media unit-Low, Top, D shaped
OBAD85	245	Media den-Enclosed
OBAD85A	247	Media den-Enclosed, 4 to 6 ppl
OBAD91LRO	237	Huddle buddle-Group working table, 55⅞ dia
OBAD91SRO	236	Huddle buddle-Group working table, 47¼ dia
OBASPECT07HB	153	Aspect; Work unit with curved arm-1 seat
OBASPECT08HB	155	Aspect; Work unit with curved arm-2 seat
OBASPECT09HB	157	Aspect; Work unit with curved arm-3 seat
OBASPECT57HB	161	Aspect; Work Scred unit with fixed table-2 seat
OBASPECT58HB	165	Aspect; Work Scred unit with fixed table-4 seat
OBASPECT59HB	169	Aspect; Work Scred unit with fixed table-6 seat
OBORDER01	177	Border; 1 seat-Low,Tbl, 32 dia
OBORDER02	179	Border; 2 seat-Low,Tbl, 32 dia
OBORDER03	181	Border; 1 seat-Hi,LH,Tbl, 32 dia
OBORDER04	181	Border; 1 seat-Hi,RH,Tbl, 32 dia
OBORDER05	183	Border; 2 seat-Hi,Tbl, 32 dia

Style Number	Page	Description
OBCUBB01	248	Cubb; Chair-Armless, Wood legs
OBCUBB02	249	Cubb; Chair-Uph arm, Wood legs
OBCUBB03	250	Cubb; Chair-Wire arm, Wood legs
OBCUBB04	251	Cubb; Chair-Armless, Trestle base, 4 star
OBCUBB05	252	Cubb; Chair-Uph arm, Trestle base, 4 star
OBCUBB06	253	Cubb; Chair-Wire arm, Trestle base, 4 star
OBCUBB07	254	Cubb; Chair-Armless, Wire frame base
OBCUBB08	255	Cubb; Chair-Uph arm, Wire frame base
OBCUBB09	256	Cubb; Chair-Wire arm, Wire frame base
OBCUBB10	257	Cubb; Chair-Armless, Base, 5 star
OBCUBB11	258	Cubb; Chair-Uph arm, Base, 5 star
OBCUBB12	259	Cubb; Chair-Wire arm, Base, 5 star
OBCUBB13	260	Cubb; Barstool-Base, Oak
OBCUBB14	261	Cubb; Barstool-Wire frame base
OBCUBB15	262	Cubb; Stool-Occasional, Base, Oak
OBCUBB19	263	Cubb; Bench-2 seat
OBCUBBRM01	270	Cubb; Table-Mtg, 4 pers, Rect
OBCUBBRM02	271	Cubb; Table-Mtg, 4-6 ppl, Rect
OBCUBBRM03	272	Cubb; Table-Mtg, 6-8 ppl, Rect
OBCUBBRM04	273	Cubb; Table-Mtg, 8 pers, Rect
OBCUBBRM05	274	Cubb; Table-Mtg, Rect, 8-10 ppl, 47"D
OBCUBBRM07	275	Cubb; Table-Mtg, Rect, 12-14 ppl, 47"D
OBCUBBRM09	276	Cubb; Table-Mtg, Rect, 8-10 ppl, 55"D
OBCUBBRM11	277	Cubb; Table-Mtg, Rect, 12-14 ppl, 55"D
OBCUBBRM001	283	Cubb; Table-Rect, Occasional
OBCUBBRCP01	278	Cubb; Table-Project, 4-6 ppl, Standing height
OBCUBBRCP02	279	Cubb; Table-Project, 6-8 ppl, Standing height
OBCUBBRCP03	280	Cubb; Table-Project, 8-10 ppl, Standing height
OBCUBBRDM01	264	Cubb; Table-Mtg, 4 pers, Round
OBCUBBRDM02	265	Cubb; Table-Mtg, 6 pers, Round
OBCUBBRDM03	266	Cubb; Table-Mtg, 7 pers, Round
OBCUBBRDM04	267	Cubb; Table-Mtg, 8 pers, Round
OBCUBBRDO01	281	Cubb; Table-Round, Occasional, 23 ⁵ / ₈ "W
OBCUBBRDO02	282	Cubb; Table-Round, Occasional, 31"W
OBCUBBSQM01	268	Cubb; Table-Mtg, 4 pers, Sq
OBCUBBSQO01	284	Cubb; Table-Sq, Occasional
OBCUBBSSM01	269	Cubb; Table-Mtg, 4 pers, Sq, Softened corners
OBSRAMSEY01	175	Ramsey; Chair-Work,Uph
OBSSKOMER01	173	Skomer; Arm chair-Uph
OBSSULLY01	170	Sully; Stool-Uph

Trademark List

™/® The following is a non-exhaustive list of trademarks and registered trademarks for products of Steelcase Inc. or one of its related corporate entities: Agree, Airtouch, Aisla, Alight, Amia, Answer, Apprise, Aspekt, Avenir, Await, B-Free, Ballet, Bassline, Bindu, Bivi, Bix, Bottomline, Brody, Buoy, Cachet, Campfire, Capa, CF Series, CG_1, Chord, Circa, Clipper, Cobi, Collaboration, Convene, Coupe, Cura, Currency, dash, Divisio, Duo, E-Table 2, Edge Series, Elbrook, Elective Elements, Embold, Empath, Everwall, Exponents, Folio, FrameOne, Gesture, Groupwork, Host, Hosu, i2i, Jenny, Kart, Kathryn, Kick, Lagunitas, Leap, Leela, LessThanFive, LiveBack, LiveSeat, Mackinac, Marien152, Max-Stacker, media:scape, Migration, Millbrae, Mineral, Mitra, Montage, Montara650, MoreThanFive, Move, Node, Ocular, Ology, Opus, Paperflo, Passerelle, Player, Pocket, Potrero415, QiVi, Radia, Regard, Relay, Reply, Ripple, Roam, Sarto, Scoop, Sebastopol, Senti Series, Senza, Shortcut, Sidewalk, Siento, Sieste, SILQ, Soffio, Sorrel, SOTO, Steelcase Eclipse, Steelcase Flex, Steelcase Karman, Steelcase Relay, Steelcase Rise, Steelcase Series, Surround, SW_1, Switch, Sync, Tava, Tenor, Think, Thoughtful, Thread, Together, Train, Trees, Turnstone, Umami, Underscore, V.I.A., Verb, Verge, Verlay, Victor2, Visalia, WorkValet, and X-tenz.

™/® The following are trademarks or registered trademarks of AMQ Solutions, LLC: 3F, Activ, Amobi, Bixby, Bodi, Cluvo, Concur, Embank, FL-X, Iline, Jaku, Kinex, Personality Plus, Revi, S-Series, Siya, Tektis, Tizu, Uptake, and Zilo.

™/® The following are trademarks or registered trademarks of Orangebox Ltd., Cardiff, UK: Air3, Aspect, Avi, Away from the Desk, Border, Campers & Dens, Coppice, Cubb, Kirm, On the QT, Ramsey, Skomer, Sully, Track-B, and Vale.

™/® The following are trademarks or registered trademarks of Viccarbe Habitat, S.L.: Aleta, Cambio, Designed in The Sun, Foro, Funda, Holy Day, Kelly, Last Minute, Noha, Savina, Sistema, Sistema, Viable, and Wrapp.

® The following are registered brands of Steelcase Inc. and its family of companies: Steelcase, AMQ, Coalesse, Designtex, Halcon, Orangebox, Smith System, and Viccarbe.

® The following registered trademarks are under license from AWI Licensing Company, Dover, DE: SoundScapes, DuraBrite, BioBlock, and Armstrong.

® The following registered trademarks are under license from Byrne Electrical, Rockford, MI: Interport, Mini-Port, Axil Z, and Ellora.

® The following is a registered trademark of DuPont, Wilmington, DE: Corian.

® The following is a registered trademark of Genlyte Thomas Company, Louisville, KY: Lightolier.

® The following is a registered trademark of Hilti Corporation, FL-9494 Schaan, Principality of Liechtenstein: Hilti.

® The following is a registered trademark of Leviton Manufacturing Company, Little Neck, NY: Decora.

® The following is a registered trademark of Mechanical Plastics Corp, Elmsford, NY: Toggler.

® The following is a registered trademark of Microsoft Corporation, Redmond, WA: Microsoft.

® The following are registered trademarks of Orangebox Ltd., Cardiff, UK: Orangebox.

® The following is a registered trademark of Panduit Corporation, Lockport, IL: Panduit.

® The following is a registered trademark of Trav (Press), Cuneo, Italy: Assisa.

® The following is a registered trademark of Virtual Ink, Boston, MA: mimioActive.

® The following registered trademarks are under license from Wilkhahn Furniture Products: Avera, Senzo, Versal, and Wilkhahn FS.

® The following are registered trademarks of Polyvision Corp: Flow, Motif, Polyvision, Sans, and Serif.

® The following is a registered trademark of Wilsonart International, Temple, TX: Chemsurf.

® The following is a registered trademark of Wiremold, West Hartford, CT: Wiremold.

® The following is a registered trademark of EMU Group S.P.A., Perugia, Italy: EMU.

® The following is a registered trademark of Security People, Inc.: Digilock.

® The following are registered trademarks of Natural Capital Partners Europe Limited: CarbonNeutral and the CarbonNeutral Certified logo.

™ The following is a trademark of Microsoft Corporation, Redmond, WA: Windows.

™ The following is a trademark of Rodman Industries, Inc., Oconomowoc, WI: ResinCore1.

™ The following is a trademark of Ultrafabrics, LLC, Elmsford, NY: Ultraleather.

™ The following trademarks are under license from Wilkhahn Furniture products: Cana, Linus, Logon, Picto, Range, Stitz, Thema, Timetable, and Tubis.

™ The following trademarks are under license from Walter Knoll: Andoo, Bob, Lazlo, Lox, Ribbon, and Together.

™ The following trademarks are under license from PP Mobler: Bar and Flag Halyard.

™ The following trademarks are under license from Carl Hansen: Elbow, Paddle, Shell, Wing, and Wishbone.

™ The following trademarks are under license from Cambridge Sound Management, LLC Cambridge, MA: QtPro Soundmasking, Qt Quiet Technology, and Sonet Qt.

™ The following is a trademark of Electri-Cable Assemblies, Shelton, CT: Interact.

™ The following is a trademark of Clestra Hauserman: IRYS.

™ The following is a trademark of Wiesner-Hager Möbel GmbH: Nooi.

™ The following are trademarks of Polyvision: Accord, a3, e3, Boundri, and Nota.

™ The following is a trademark of Bostock Company, Inc: SnapCab.

™ The following is a trademark of Williams-Sonoma, Inc: West Elm.

™ The following is a trademark of Elena Marquina Testor: nanimarquina.

™ The following is a trademark of Forbo International SA: Forbo.

Trademarks used herein are the property of Steelcase Inc. or their respective owners.