



Height-Adjustable Desks Specification Guide

Availability

Electronic price list updated with release 204.C (U.S.) and 158.C (Canada), dated June 15, 2026.

All specifications subject to change without notice. Reference the electronic catalog/Hedberg for current pricing.

Transitional products in this specification guide are **maintained for existing customers only** and are likely to be phased out over time. These products are indicated with a . Products that are scheduled to be culled are indicated with an , followed by the last order entry date.

Surface Materials

The surface materials team has announced the launch of the Finish Library, found at www.steelcase.com/finishlibrary/.

► For a list of all trademarks, refer to the last page of this specification guide. © 2026 Steelcase Inc.

Working With This Specification Guide

Ten Tips: How to Get the Most Out of This Book	2
Additional Resources	4

Statement of Line

6

Workstation Design Guidelines and Requirements

32

How to Calculate Power Needs

34

Basics of Ergonomic Seating

35

Basics of Standing and Monitor Arm Positioning

36

Worksurface Shape Overview

37

Worksurface Edge Options

38

Height-Adjustable Desks Comparison Chart

40

Worktools Compatibility Charts

48

Steelcase Monitor Arm Guidelines

58

CarbonNeutral Product Certification

60

Ology

63

Steelcase Flex Collection

149

Migration Desking Collection

179

Currency for Use with Ology and Migration SE

277

Airtouch

285

Screens, Cable and Power Management

295

Surface Materials

361

Resources

373



For Canadian Pricing

Canadian factor can be found at www.steelcase.com/CADpricing/.

Calculate in the following order to avoid rounding errors:

- Multiply the base price and each option by the Canadian factor.
- Round each to the nearest dollar.
- Add base and options for total list price.

Ten Tips: How to Get the Most Out of This Book

Tip 1

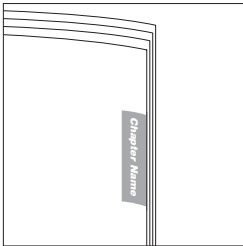

Watch the tabs on the right-hand edges of the pages. They'll always indicate which chapter you are in.

Tip 2

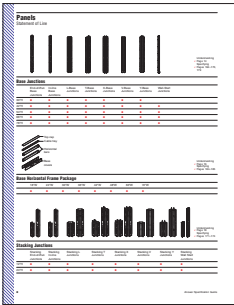

Use the Statement of Line pages for an overview of the available components, their sizes, and page references for additional information. Each *Understanding* chapter includes a statement of line after the table of contents.

Tip 3



Find cross references by looking for page numbers flagged with an arrow.

Tip 4

Study the product detail pages in the *Understanding* section to learn everything an expert knows about specific products. Each product detail page in this section contains the following features, where applicable:

- Product Drawing
- Actual Dimensions
- Product Details
- Connections
- Wiring and Cabling
- Surface Materials
- Application Topics

Product Drawing shows you what the product looks like and points out important features.

Product Details gives specific information on the product and how it is used.

Connections describes how the product is assembled or how it attaches to another product.

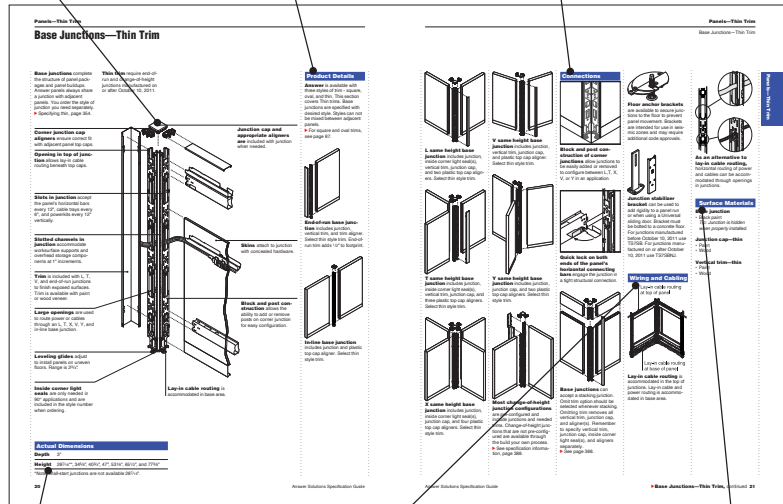

Actual Dimensions table lists the dimensions of the product.

Wiring and Cabling details the power and cable-management and cable routing capabilities of the product.

Surface Materials lists what material is used for each part of the product.

Tip 5

Refer to the specifying pages for all the information needed to order a product. Each product specifying page contains a variety of elements to help you complete a specification:

- Product Drawing
- Standard Includes
- Required to Specify
- Options
- Related Products
- Specification Information
 - Dimensions
 - Style Number
 - Price

Standard Includes (under the red or dark grey band) provides a list of what comes standard with the product.

Required to Specify (under the red or dark grey band) itemizes the information that you must provide to order the standard product and the preferred sequence for specification.

Specification Information (under the teal or light grey band) provides product dimensions, style numbers, and prices for the standard product and any surface material choices that are available.

Product Drawing shows you what the product looks like.

Standard Includes		Required to Specify	
• Standard height (see table)	• 1/8" AIA	• 1/8" AIA	• 1/8" AIA
• Base trim with no backboard (see 1/8" AIA)	• 1/8" AIA	• 1/8" AIA	• 1/8" AIA
• Base trim with backboard (see 1/8" AIA)	• 1/8" AIA	• 1/8" AIA	• 1/8" AIA
• Backboard (see 1/8" AIA)	• 1/8" AIA	• 1/8" AIA	• 1/8" AIA
• 1/8" AIA	• 1/8" AIA	• 1/8" AIA	• 1/8" AIA

Options	Qty.	Price	Required to Specify
• 1/8" AIA	1	10.00	Specify with 1/8" AIA
• 1/8" AIA	1	10.00	Specify with 1/8" AIA
• 1/8" AIA	1	10.00	Specify with 1/8" AIA
• 1/8" AIA	1	10.00	Specify with 1/8" AIA

Style Number	Price
100	100.00
101	101.00
102	102.00
103	103.00
104	104.00
105	105.00
106	106.00
107	107.00
108	108.00
109	109.00
110	110.00

Options (under the black band) lists all the options that apply to the product, their price, and what is required to specify.

Related Products provide specification information for products that are directly related.

Tip 6

Required to Specify

Specify with *Customiz Stain*

Italic typeface on specifying pages usually identifies wording that you should use in your order.

i

Tip 7

To determine how many skins are needed to complete a panel, consult the table at the right.
Tip: Remember to order skins for both sides of the panel buildup.

Watch for tips throughout the text that give you explanations and helpful instructions.

Tip 8

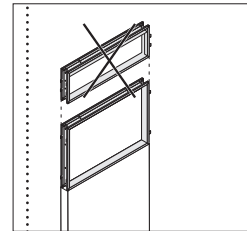

Learn what you cannot do by looking for drawings crossed out with an "X."

Tip 9

Use the surface materials listings in the Surface Materials section of this book to find surface material color numbers.

Tip 10

Style Number	Page
TS7042BL	131
TS7042S	130
TS7048BL	131
TS7048S	130
TS7060BL	131
TS7060S	130
TS7072BL	131

Refer to the style number index when you know a style number and you need to find the page that has more details about the product.

Additional Resources

Product brochures and planning tools can be ordered through your Steelcase area office by calling 1.800.784.0358 or through the Marketing Resources website at village.steelcase.com.

This specification guide contains multiple Steelcase product lines which are designed into one specification guide for your convenience.

Additional storage products can be found in the *Storage Specification Guide*.

Printed Materials

Express Program Specification Guide
This specification guide describes all Steelcase and Coalesse products including the finishes and options that are available as Express orders - manufactured and shipped within 7 business days.

Surface Materials Reference Manual

This publication provides:

- An explanation of the surface materials
- "Available on" matrices
- Vertical surface fabric and seating upholstery selection listing
- Technical data for surface materials
- Surface material care and cleaning instructions

Computer Tools

Electronic Catalog
Accurate sales quotations and purchase orders for Steelcase products are created with specification software that uses Steelcase Electronic Catalog data. Use the data to specify and price style numbers and options for every Steelcase product. The data is updated bimonthly by Steelcase and provided to software programs including: the Hedberg Business System, SmartTools – Steelcase's design and specification software (for more information on SmartTools, please email SmartTools@steelcase.com), the ProjectMatrix Project-Symbols libraries, as well as 20-20 CAP Studio.

Furniture Symbol Graphic Data

Steelcase creates 2D and 3D furniture symbols (with attributes) for planning and initially specifying Steelcase products. This data is incorporated into several add-on software packages that work in either a Microstation or an AutoCAD drafting environment.

Digital Publications

You can access these digital publications at www.steelcase.com or village.steelcase.com.

Planning Ideas

Planning ideas are available to help inspire, envision, and plan great solutions. 2D and 3D AutoCAD drawings, Sketch-Up files, and SmartTools drawings are available on the Planning Ideas site: www.steelcase.com/planningideas.

Support

Steelcase Capabilities
Steelcase products are distributed, installed, and serviced through a network of more than 600 dealers worldwide. Steelcase is also represented with offices and corporate showrooms in 26 U.S. cities, 4 Canadian cities, and in France, Germany, Great Britain, and Japan. Every Steelcase product meets our exceptionally high standards of quality and durability and comes with the Steelcase assurance of excellence in service.

For ordering or product assistance, call your local dealer, the Steelcase Solutions Resource Team, or the Steelcase Solutions Fulfillment Team at 1.888.STEELCASE (1.888.783.3522) or send an e-mail to lineone@steelcase.com.

Call the Steelcase Solutions Resource Team prior to placing an order, when working on a bid, or when you need information about product applications and specifications.

Call the Steelcase Solutions Fulfillment Team if you have submitted an order to Steelcase and you need to speak to your Solutions Fulfillment Team Representative about the order. Also call if you have any post-shipment quality concerns or service parts questions.

For warranty information, please go to <http://www.steelcase.com/warranty/>.

Outside the U.S.A., Canada, Mexico, Puerto Rico, and the U.S. Virgin Islands, call 1.616.247.2500.

Related Products

Steelcase worktools include a full line of ergonomically designed products that enhances and improves the work setting. Product platforms include computer support tools, organizational worktools, and personal lighting.

► For additional information, refer to *Steelcase Worktools Specification Guide*.

Sustainability

At Steelcase, we believe business can be a force for good. We create long-lasting products that are better for people and better for the planet. Our products and operations use life cycle thinking to meet our commitment to reducing climate change. This commitment is reinforced by practices such as designing to minimize global warming and other life cycle impacts, ensuring material health, and enabling end-of-use strategies. To learn more at a corporate level, visit: www.steelcase.com/discover/steelcase/esg-overview/environmental/ProductEnvironmentalProfiles, which provide key environmental attributes such as recycled content, embodied carbon and recyclability, as well as product certifications can be found by searching for Steelcase at Origin.build.

Statement of Line

Ology Height-Adjustable Desks

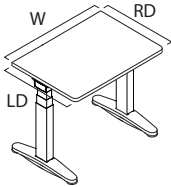

- Understanding
- ▶ Page 64
- Specifying
- ▶ Page 98

Rectangular Desks

	34"	40"	46"	52"	58"	64"	70"	76"
23" or 24"D	[]	[]	[]	[]	[]	[]	[]	[]
29" or 30"D	[]	[]	[]	[]	[]	[]	[]	[]
35" or 36"D	[]	[]	[]	[]	[]	[]	[]	[]

Tip: Widths are available parametrically in 1/16" increments from 34"–78".

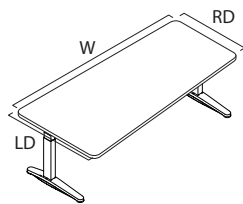

- Understanding
- ▶ Page 64
- Specifying
- ▶ Page 102

Tapered Desks*

29" or 30"	[58"]	23" or 24"	29" or 30"	[64"]	23" or 24"
29" or 30"	[70"]	23" or 24"	29" or 30"	[76"]	23" or 24"

*Left-hand units shown. Right-hand units available.

Tip: Widths are available parametrically in 1/16" increments from 58"W–78"W.

Ology Height-Adjustable Desks, continued

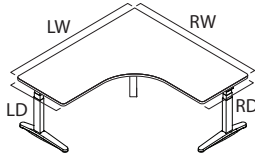

Understanding
 ▶ Page 64
 Specifying
 ▶ Page 106

90° Equal Corner 3-Leg Desks

	52"W	58"W	64"W	70"W	76"W
23"D or 24"D	●	●	●	●	●
29"D or 30"D	●	●	●	●	●

*Tip: Widths are available parametrically in 1/16" increments from 52"W–78"W.
 Tip: 64"W, 70"W, and 76"W 90° equal worksurfaces ship in two pieces.*

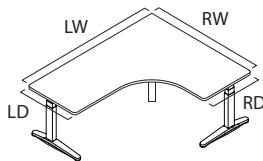

Understanding
 ▶ Page 64
 Specifying
 ▶ Page 106

90° Extended Corner 3-Leg Desks*

	40"W	46"W	52"W	58"W	64"W	70"W	76"W
23"D or 24"D	●	●	●	●	●	●	●
29"D or 30"D	●	●	●	●	●	●	●

**Left-hand units shown. Right-hand units available.
 Tip: Widths are available parametrically in 1/16" increments from 40"W–78"W.*

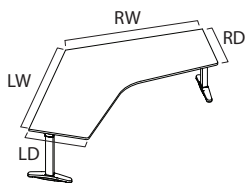

Understanding
 ▶ Page 64
 Specifying
 ▶ Page 106

120° Equal Corner 3-Leg Desks

	34"W	40"W	46"W	52"W	58"W	64"W
23"D or 24"D	●	●	●	●	●	●
29"D or 30"D	●	●	●	●	●	●

Tip: Widths are available parametrically in 1/16" increments from 34"W–66"W.

Ology Height-Adjustable Desks, continued

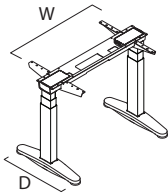

Understanding
 ▶ Page 64
 Specifying
 ▶ Page 124

Rectangular Bases

	34"W	40"W	46"W	52"W	58"W	64"W	70"W	76"W
23"D or 24"D	●	●	●	●	●	●	●	●
29"D or 30"D	●	●	●	●	●	●	●	●
35"D or 36"D	●	●	●	●	●	●	●	●

Tip: Widths are available parametrically in 1/16" increments from 34"W–78"W.

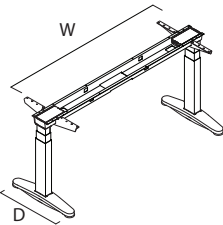

Understanding
 ▶ Page 64
 Specifying
 ▶ Page 124

Tapered Bases*

	58"W	64"W	70"W	76"W
23"D/29"D or 24"D/30"D	●	●	●	●

*Left-hand units shown. Right-hand units available.

Tip: Widths are available parametrically in 1/16" increments from 58"W–78"W.

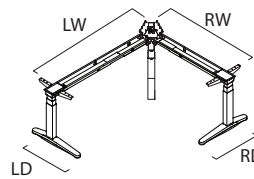

Understanding
 ▶ Page 64
 Specifying
 ▶ Page 124

90° Equal Corner 3-Leg Bases

	52"W	58"W	64"W	70"W	76"W
23"D or 24"D	●	●	●	●	●
29"D or 30"D	●	●	●	●	●

Tip: Widths are available parametrically in 1/16" increments from 52"W–78"W.

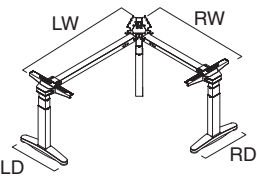

Understanding
 ▶ Page 64
 Specifying
 ▶ Page 124

90° Extended Corner 3-Leg Bases*

	40"W	46"W	52"W	58"W	64"W	70"W	76"W
23"D or 24"D	●	●	●	●	●	●	●
29"D or 30"D	●	●	●	●	●	●	●

*Left-hand units shown. Right-hand units available.

Tip: Widths are available parametrically in 1/16" increments from 40"W–78"W.

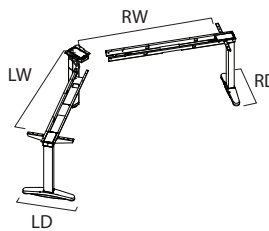

Understanding
 ▶ Page 64
 Specifying
 ▶ Page 124

120° Equal Corner 3-Leg Bases

	34"W	40"W	46"W	52"W	58"W	64"W
23"D or 24"D	●	●	●	●	●	●
29"D or 30"D	●	●	●	●	●	●

Tip: Widths are available parametrically in 1/16" increments from 34"W–66"W.

Modesty Panels and Fixed Personal/Modesty Screens

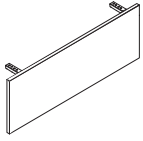

Understanding
 ▶ Page 92
 Specifying
 ▶ Page 134

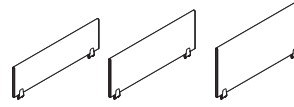

Understanding
 ▶ Page 313
 Specifying
 ▶ Page 344

Ology Modesty Panels

	34"W	40"W	46"W	58"W	64"W	70"W	76"W
14 $\frac{3}{8}$ "H	●	●	●	●	●	●	●

Tip: Widths are available parametrically in 1/16" increments from 34"W–78"W.

Tip: Both modular and parametric are undersized by 2 1/2" for square corner and radius corner options. Verify in SmartTools the manufactured width vs modular or parametric widths.

Fixed Personal/Modesty Screens

	30"W	36"W	42"W	48"W
12"H	●	●	●	●
19 1/2"H	●	●	●	●
24"H	●	●	●	●

Tip: 19 1/2"H and 24"H are for privacy use only.

Ology Cable and Power Management



Cable Riser-Leg Connection

Understanding
 ▶ Page 66
 Specifying
 ▶ Page 135

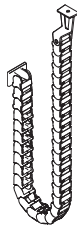

Cable Riser-Fence Connection

Understanding
 ▶ Page 67
 Specifying
 ▶ Page 135

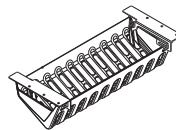

Cable Basket

Understanding
 ▶ Page 67
 Specifying
 ▶ Page 135



Cable Brackets

Understanding
 ▶ Page 67
 Specifying
 ▶ Page 135

Ology Integrated Storage

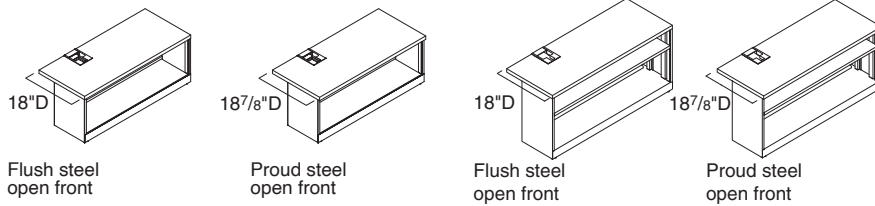

Understanding
 ▶ Page 94
 Specifying
 ▶ Page 138

Universal Steel One-High and 1.5-High Open Laterals for Ology Application*

	30"W	36"W	42"W
16"H	●	●	●
22"H	●	●	●

*Right-hand application shown. Left-hand application available.

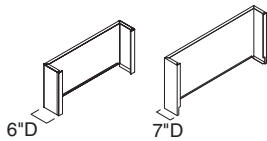

Understanding
 ▶ Page 94
 Specifying
 ▶ Page 140

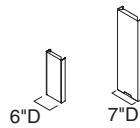

Understanding
 ▶ Page 94
 Specifying
 ▶ Page 141

Universal Shrouds

Universal Filler

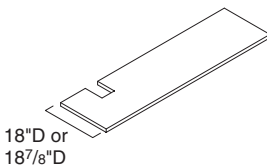

Understanding
 ▶ Page 96
 Specifying
 ▶ Page 142

Universal Common Tops for Ology Application*

60"W	66"W	72"W	78"W	84"W	90"W	96"W	108"W
●	●	●	●	●	●	●	●

*Right-hand application shown. Left-hand application available.

Ology Integrated Storage, continued

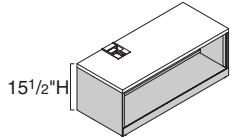

Understanding
▶ Page 96
Specifying
▶ Page 144

Elective Elements One-High Open Plinth Base Pedestals for Ology Application*

	24"W	30"W	36"W	42"W
17 1/4"D	●	●	●	●

*Right-hand application shown. Left-hand application available.

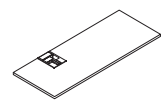

Understanding
▶ Page 96
Specifying
▶ Page 146

Elective Elements Common Tops for Ology Application*

	24"W	30"W	36"W	42"W	48"W	54"W	60"W	66"W	72"W	78"W	84"W	90"W
18"D	●	●	●	●	●	●	●	●	●	●	●	●
	96"W	102"W	108"W	114"W	120"W							
18"D	●	●	●	●	●							

*Right-hand application shown. Left-hand application available.

Rectangle Steelcase Flex Collection

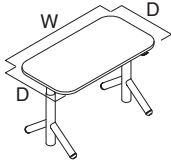

Understanding
 ▶ Page 150
 Specifying
 ▶ Page 162

Rectangle Height-Adjustable Desks

	46"W	58"W	70"W
23"D or 24"D	●	●	●
29"D or 30"D	●	●	●

Tip: Widths are available parametrically in 1/16" increments from 46"–72".

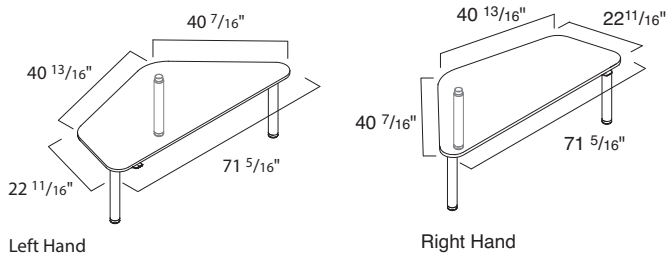

Understanding
 ▶ Page 154
 Specifying
 ▶ Page 168

120° Straight Height-Adjustable Desks

	Depth Left	Depth Right	Width Back	Width Front
Left-Hand	22 ¹¹ / ₁₆ "	40 ⁷ / ₁₆ "	40 ¹³ / ₁₆ "	71 ⁵ / ₁₆ "
Right-Hand	40 ⁷ / ₁₆ "	22 ¹¹ / ₁₆ "	40 ¹³ / ₁₆ "	71 ⁵ / ₁₆ "

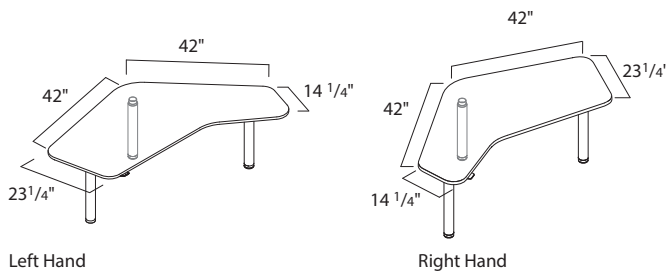

Understanding
 ▶ Page 154
 Specifying
 ▶ Page 170

120° Corner Height-Adjustable Desks

	Depth Left	Depth Right	Width Back	Width Front
Left-Hand	23 ¹ / ₄ "	14 ¹ / ₄ "	42"	42"
Right-Hand	14 ¹ / ₄ "	23 ¹ / ₄ "	42"	42"

Steelcase Flex Collection, continued



Understanding
 ▶ Page 150
 Specifying
 ▶ Page 166

Rectangle Height-Adjustable Bases

	46"W	58"W	70"W
23"D or 24"D	●	●	●
29"D or 30"D	●	●	●

Tip: Widths are available parametrically in 1/16" increments from 46"–72".

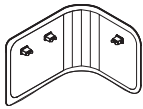

Understanding
 ▶ Page 157
 Specifying
 ▶ Page 172

Curved Screens

	46"W	58"W	70"W
18"H	●	●	●

Personal Spaces Privacy Wraps

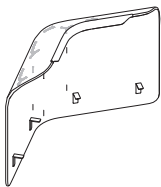

120° Desk Mount Privacy Wrap

Understanding
 ▶ Page 158
 Specifying
 ▶ Page 173

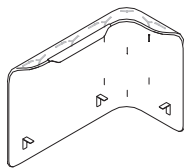

90° Desk Mount Privacy Wrap

Understanding
 ▶ Page 158
 Specifying
 ▶ Page 174

Accessories



Power Hanger

Understanding
▶ Page 160
Specifying
▶ Page 175

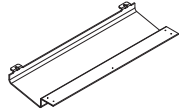

Cable Tray for Flex Rectangle Height-Adjustable Desks

Understanding
▶ Page 151
Specifying
▶ Page 175

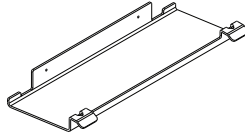

Cable Tray for 120° Flex Height-Adjustable Desks

Understanding
▶ Page 155
Specifying
▶ Page 176

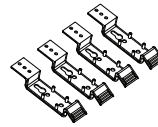

Cable Brackets

Understanding
▶ Page 152
Specifying
▶ Page 177

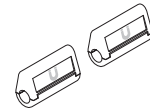

Magnetic Cable Clips

Understanding
▶ Page 160
Specifying
▶ Page 176

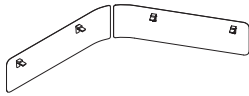

Modesty Panel for 120° Height-Adjustable and 120° Straight Work Table

Understanding
▶ Page 155
Specifying
▶ Page 178

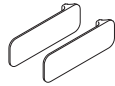

Magnetic Name Tag

Understanding
▶ Page 160
Specifying
▶ Page 178

Migration Pro Height-Adjustable Desks

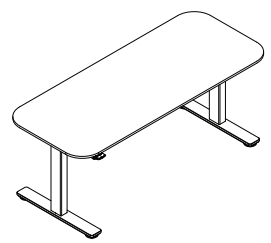

Understanding
 ▶ Page 186
 Specifying
 ▶ Page 220

Rectangular Desks, T-Leg

	40"W	46"W	52"W	58"W	64"W	70"W	76"W	82"W	88"W	94"W
23"D or 24"D	●	●	●	●	●	●	●	●	●	●
28"D, 29"D, or 30"D	●	●	●	●	●	●	●	●	●	●

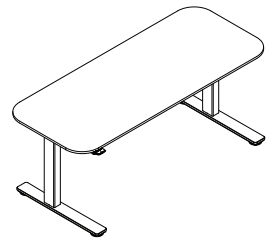

Understanding
 ▶ Page 186
 Specifying
 ▶ Page 220

Rectangular Desks, C-Leg

	40"W	46"W	52"W	58"W	64"W	70"W	76"W	82"W	88"W	94"W
28"D, 29"D, or 30"D	●	●	●	●	●	●	●	N.A.	N.A.	N.A.

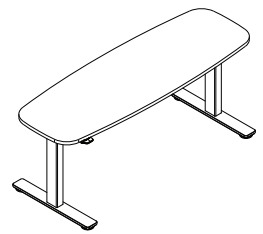

Understanding
 ▶ Page 186
 Specifying
 ▶ Page 224

Organic Desks, T-Leg

	40"W	46"W	52"W	58"W	64"W	70"W	76"W	82"W	88"W	94"W
23"D or 24"D	●	●	●	●	●	●	●	●	●	●
28"D, 29"D, or 30"D	●	●	●	●	●	●	●	●	●	●

Migration Pro Height-Adjustable Desks, continued

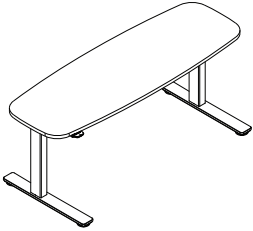

Understanding
 ▶ Page 186
 Specifying
 ▶ Page 224

Organic Desks, C-Leg

	40"W	46"W	52"W	58"W	64"W	70"W	76"W	82"W	88"W	94"W
28"D, 29"D, or 30"D	●	●	●	●	●	●	●	N.A.	N.A.	N.A.

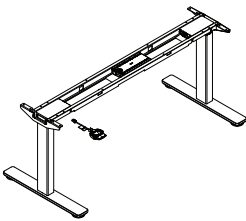

Understanding
 ▶ Page 198
 Specifying
 ▶ Page 228

Rectangular Bases, T-Leg

	40"W	46"W	52"W	58"W	64"W	70"W	76"W	82"W	88"W	94"W
23"D or 24"D	●	●	●	●	●	●	●	●	●	●
28"D, 29"D, or 30"D	●	●	●	●	●	●	●	●	●	●

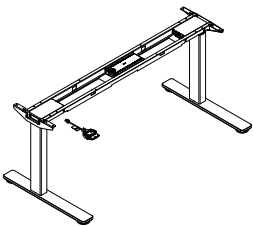

Understanding
 ▶ Page 186
 Specifying
 ▶ Page 228

Rectangular Bases, C-Leg

	40"W	46"W	52"W	58"W	64"W	70"W	76"W	82"W	88"W	94"W
28"D, 29"D, or 30"D	●	●	●	●	●	●	●	N.A.	N.A.	N.A.

Migration Pro with Boost High-Speed Height-Adjustable Desks

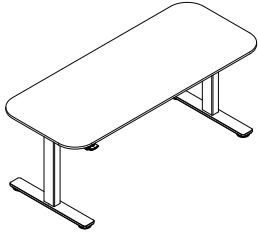

Understanding
 ▶ Page 192
 Specifying
 ▶ Page 230

Rectangular Desks

	40"W	46"W	52"W	58"W	64"W	70"W	76"W
23"D or 24"D	●	●	●	●	●	●	●
28"D, 29"D, or 30"D	●	●	●	●	●	●	●

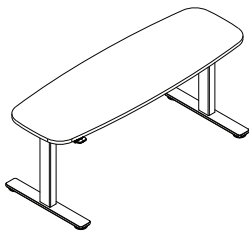

Understanding
 ▶ Page 192
 Specifying
 ▶ Page 234

Organic Desks

	40"W	46"W	52"W	58"W	64"W	70"W	76"W
23"D or 24"D	●	●	●	●	●	●	●
28"D, 29"D, or 30"D	●	●	●	●	●	●	●

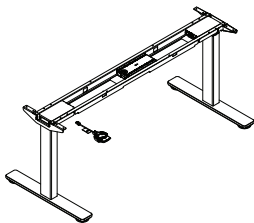

Understanding
 ▶ Page 194
 Specifying
 ▶ Page 237

Rectangular Bases

	40"W	46"W	52"W	58"W	64"W	70"W	76"W
23"D or 24"D	●	●	●	●	●	●	●
28"D, 29"D, or 30"D	●	●	●	●	●	●	●

Migration Intro Height-Adjustable Desks

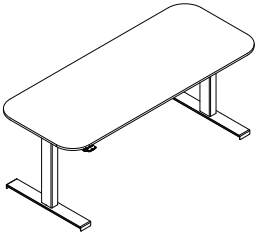

Understanding
 ▶ Page 198
 Specifying
 ▶ Page 238

Rectangular Desks

	40"W	46"W	52"W	58"W	64"W	70"W	76"W
23"D or 24"D	●	●	●	●	●	●	●
28"D, 29"D, or 30"D	●	●	●	●	●	●	●

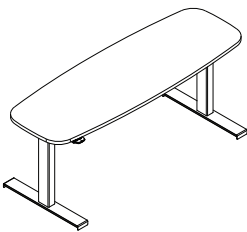

Understanding
 ▶ Page 198
 Specifying
 ▶ Page 240

Organic Desks

	40"W	46"W	52"W	58"W	64"W	70"W	76"W
23"D or 24"D	●	●	●	●	●	●	●
28"D, 29"D, or 30"D	●	●	●	●	●	●	●

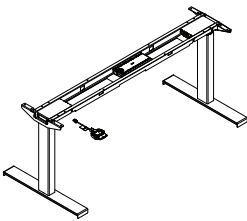

Understanding
 ▶ Page 198
 Specifying
 ▶ Page 242

Rectangular Bases

	40"W	46"W	52"W	58"W	64"W	70"W	76"W
23"D or 24"D	●	●	●	●	●	●	●
28"D, 29"D, or 30"D	●	●	●	●	●	●	●

Migration Intro and Pro Accessories

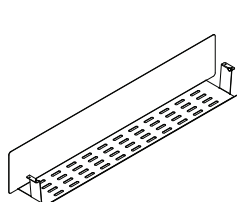

Metal Cable Tray
Understanding
▶ Page 204
Specifying
▶ Page 243

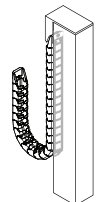

Cable Riser
Understanding
▶ Page 204
Specifying
▶ Page 244



Small Cable Brackets
Understanding
▶ Page 204
Specifying
▶ Page 245

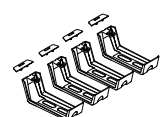

Large Cable Brackets
Understanding
▶ Page 204
Specifying
▶ Page 245

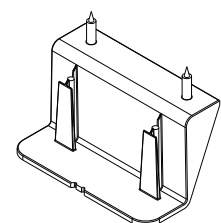

Utility Power Mounting Brackets
Understanding
▶ Page 189
Specifying
▶ Page 246

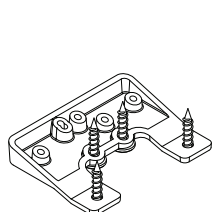

Side Screen Knife Edge Adapter Bracket
Understanding
▶ Page 189
Specifying
▶ Page 246

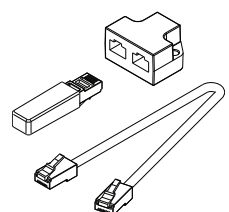

Obstruction Detection Kit
Understanding
▶ Page 189
Specifying
▶ Page 247

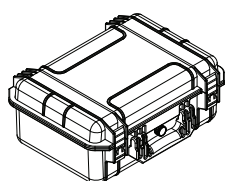

Maintenance Kit
Understanding
▶ Page 189
Specifying
▶ Page 247

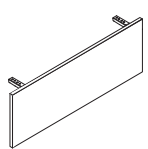

Understanding
▶ Page 206
Specifying
▶ Page 248

Modesty Panel

40"W	46"W	52"W	58"W	64"W	70"W	76"W	82"W	88"W	94"W
●	●	●	●	●	●	●	●	●	●

Migration SE Height-Adjustable Desks

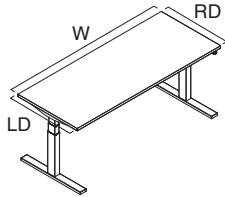

Understanding
 ▶ Page 208
 Specifying
 ▶ Page 250

Rectangular Desks, T-Leg

	46"	52"	58"	64"	70"	76"
23" or 24"D	<input type="checkbox"/>	<input type="checkbox"/>	<input type="checkbox"/>	<input type="checkbox"/>	<input type="checkbox"/>	<input type="checkbox"/>
	46"	52"	58"	64"	70"	76"
28", 29", or 30"D	<input type="checkbox"/>	<input type="checkbox"/>	<input type="checkbox"/>	<input type="checkbox"/>	<input type="checkbox"/>	<input type="checkbox"/>
	46"	52"	58"	64"	70"	76"
35" or 36"D	<input type="checkbox"/>	<input type="checkbox"/>	<input type="checkbox"/>	<input type="checkbox"/>	<input type="checkbox"/>	<input type="checkbox"/>

Tip: Widths are available parametrically in 1/16" increments from 46"–76".

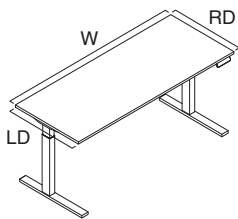

Understanding
 ▶ Page 208
 Specifying
 ▶ Page 252

Rectangular Desks, C-Leg

	46"	52"	58"	64"	70"	76"
29" or 30"D	<input type="checkbox"/>	<input type="checkbox"/>	<input type="checkbox"/>	<input type="checkbox"/>	<input type="checkbox"/>	<input type="checkbox"/>

Tip: Widths are available parametrically in 1/16" increments from 46"–76".

Migration SE Height-Adjustable Desks, continued

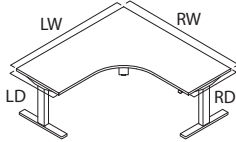

Understanding
 ▶ Page 208
 Specifying
 ▶ Page 254

90° Equal Corner 3-Leg Desks

	52"W	58"W
23"D or 24"D	●	●
29"D or 30"D	●	●

Tip: Widths are parametric by $\frac{1}{16}$ " from 52"W–60"W.

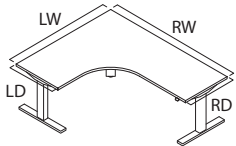

Understanding
 ▶ Page 208
 Specifying
 ▶ Page 254

90° Extended Corner 3-Leg Desks*

	46"W	52"W	58"W	64"W	70"W	76"W
23"D or 24"D	●	●	●	●	●	●
29"D or 30"D	●	●	●	●	●	●

*Left-hand units shown. Right-hand units available.

Tip: Widths are parametric by $\frac{1}{16}$ " from 46"W–76"W.

Tip: For modular sized desks, if width left or right is greater or equal to 64"W, then opposite side width must be less than or equal to 58"W.

Tip: For parametric sized desks, if width left or right is greater than 60"W, then opposite side width must be less than or equal to 60"W.

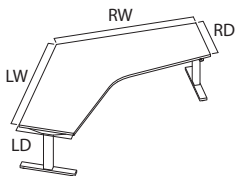

Understanding
 ▶ Page 208
 Specifying
 ▶ Page 254

120° Equal Corner 3-Leg Desks

	46"W	52"W	58"W	64"W
23"D or 24"D	●	●	●	●

Tip: Widths are parametric by $\frac{1}{16}$ " from 46"W–66"W.

Migration SE Height-Adjustable Desks, continued

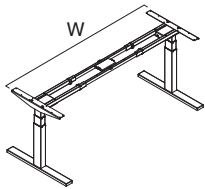

Understanding
 ▶ Page 208
 Specifying
 ▶ Page 265

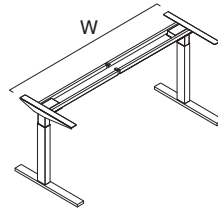

Understanding
 ▶ Page 208
 Specifying
 ▶ Page 266

Rectangular Bases, T-Leg

	46"W	52"W	58"W	64"W	70"W	76"W
23"D or 24"D	●	●	●	●	●	●
28"D, 29"D, or 30"D	●	●	●	●	●	●
35"D or 36"D	●	●	●	●	●	●

Rectangular Bases, C-Leg

	46"W	52"W	58"W	64"W	70"W	76"W
29"D or 30"D	●	●	●	●	●	●

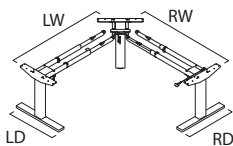

Understanding
 ▶ Page 208
 Specifying
 ▶ Page 267

90° Equal Corner 3-Leg Bases

	52"W	58"W
23"D or 24"D	●	●
29"D or 30"D	●	●

Tip: Widths are parametric by 1/16" from 52"W–60"W.

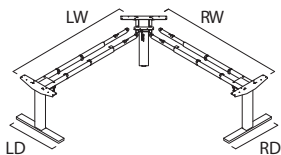

Understanding
 ▶ Page 208
 Specifying
 ▶ Page 267

90° Extended Corner 3-Leg Bases*

	46"W	52"W	58"W	64"W	70"W	76"W
23"D or 24"D	●	●	●	●	●	●
29"D or 30"D	●	●	●	●	●	●

*Left-hand units shown. Right-hand units available.

Tip: Widths are parametric by 1/16" from 46"W–76"W.

Tip: For modular sized desks, if width left or right is greater or equal to 64"W, then opposite side width must be less than or equal to 58"W.

Tip: For parametric sized desks, if width left or right is greater than 60"W, then opposite side width must be less than or equal to 60"W.

Migration SE Height-Adjustable Desks, continued

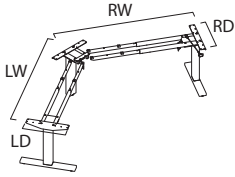

Understanding
 ▶ Page 208
 Specifying
 ▶ Page 267

120° Equal Corner 3-Leg Bases

	46"W	52"W	58"W	64"W
23"D or 24"D	●	●	●	●

Tip: Widths are parametric by 1/16" from 46"W–76"W.

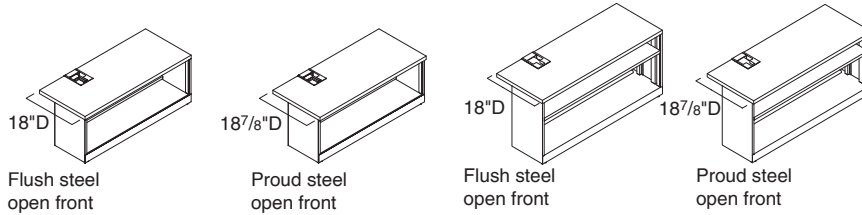

Understanding
 ▶ Page 218
 Specifying
 ▶ Page 268

Universal One-High and 1.5-High Open Laterals*

For Migration SE Application

	30"W	36"W	42"W
16"H	●	●	●
22"H	●	●	●

*Right-hand application shown. Left-hand application available.

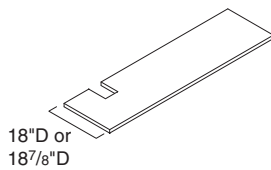

Understanding
 ▶ Page 218
 Specifying
 ▶ Page 270

Universal Common Tops*

For Migration SE Application

60"W	66"W	72"W	78"W	84"W	90"W	96"W	108"W
●	●	●	●	●	●	●	●

*Right-hand application shown. Left-hand application available.

Migration SE Height-Adjustable Desks, continued

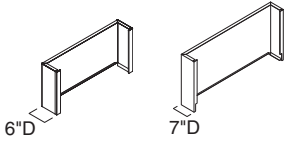

Understanding
 ▶ Page 218
 Specifying
 ▶ Page 272

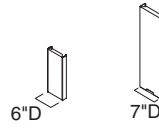

Understanding
 ▶ Page 218
 Specifying
 ▶ Page 273

Shrouds

For Migration SE Application

	30"W	36"W	42"W
16"H	●	●	●
22"H	●	●	●

Filler

For Migration SE Application

16"H	●
22"H	●

Migration SE Cable and Power Management



Cable Riser-Leg Connection
 Understanding
 ▶ Page 210
 Specifying
 ▶ Page 274



Cable Riser-Fence Connection
 Understanding
 ▶ Page 210
 Specifying
 ▶ Page 274

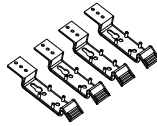

Cable Brackets
 Understanding
 ▶ Page 210
 Specifying
 ▶ Page 274

Currency

for Use with Ology and Migration SE

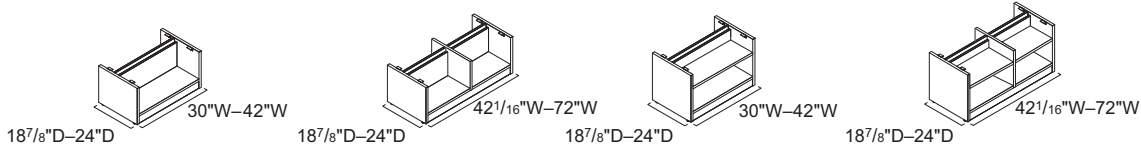

Understanding
 ▶ Page 278
 Specifying
 ▶ Page 282

One-High and 1.5-High Storage for Ology and Migration SE Applications

	30"W	36"W	42"W	48"W	60"W	72"W
15 3/8"H	●	●	●	●	●	●
21 3/8"H	●	●	●	●	●	●

Tip: Parametric depth (18 7/8"D–24"D) is available in 1/16" increments.
 Tip: Parametric width (30"W–72"W) is available in 1/16" increments.

Airtouch Height-Adjustable Worksurfaces

Universal Tables

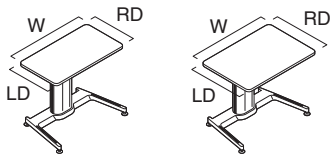

Understanding
 ▶ Page 286
 Specifying
 ▶ Page 290

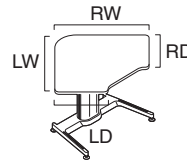

Understanding
 ▶ Page 286
 Specifying
 ▶ Page 290

Rectangular Worksurfaces

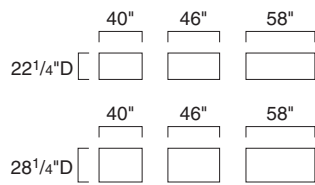

90° Corner Worksurfaces

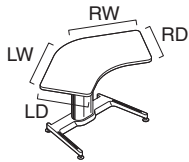
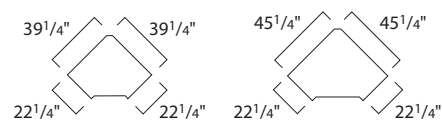

Understanding
 ▶ Page 286
 Specifying
 ▶ Page 290

120° Equal Worksurfaces

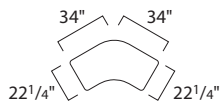

Airtouch Height-Adjustable Worksurfaces

For Use with Universal Systems

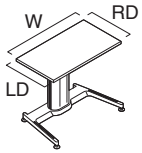

Understanding
▶ Page 286
Specifying
▶ Page 292

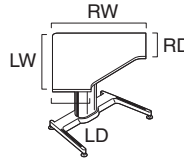

Understanding
▶ Page 286
Specifying
▶ Page 292

Rectangular Worksurfaces

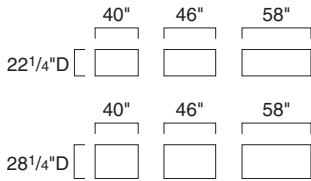

90° Corner Worksurfaces

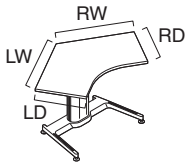
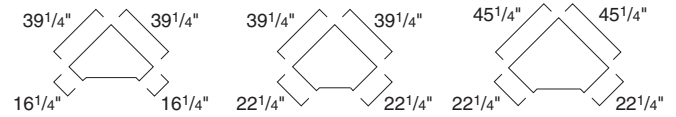

Understanding
▶ Page 286
Specifying
▶ Page 292

120° Equal Worksurfaces

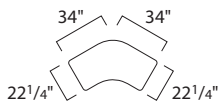

Screens

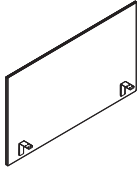

Understanding
▶ Page 296
Specifying
▶ Page 330

Universal Privacy/Modesty Screens

	Height Above Worksurface	42"W	48"W	54"W	60"W	66"W
Privacy Mount Height*	19½"H	●	●	●	●	●
Privacy/Modesty Mount Height*	13"H	●	●	●	●	●

*Privacy mount height measures 48" from the floor to the top of the screen and privacy/modesty mount height measures 42" from the floor to the top of the screen.

Tip: Overall screen height is 25⁷/₁₀"H.

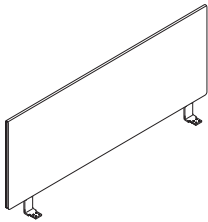

Understanding
▶ Page 300
Specifying
▶ Page 332

Universal Privacy Screens

	24"W	30"W	36"W	42"W	48"W	54"W	60"W	66"W	72"W	78"W	84"W	90"W	96"W
13½"H	●	●	●	●	●	●	●	●	●	●	●	●	●
19½"H	●	●	●	●	●	●	●	●	●	●	●	●	●

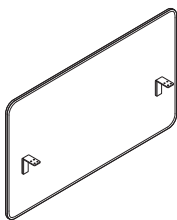

Understanding
▶ Page 302
Specifying
▶ Page 334

Sarto Privacy/Modesty Screens

	24"W	29"W	42"W	46"W	48"W	54"W	58"W	60"W	66"W	70"W
24"H	●	●	●	●	●	●	●	●	●	●
30"H	●	●	●	●	●	●	●	●	●	●

Screens, continued

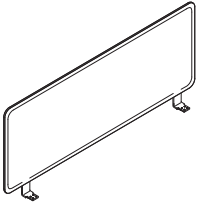

Understanding
 ▶ Page 306
 Specifying
 ▶ Page 336

Sarto Privacy Screens

	24"W	29"W	30"W	36"W	42"W	46"W	48"W	54"W	58"W	60"W	66"W	70"W	72"W	78"W	84"W	90"W	96"W
13 1/2"H	●	●	●	●	●	●	●	●	●	●	●	●	●	●	●	●	●
19 1/2"H	●	●	●	●	●	●	●	●	●	●	●	●	●	●	●	●	●
24"H	●	●	●	●	●	●	●	●	●	●	●	●	●	●	●	●	●
36"H	●	●	●	●	●	●	●	●	●	●	●	●	●	●	●	●	●

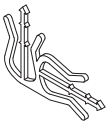

Understanding
 ▶ Page 306
 Specifying
 ▶ Page 338

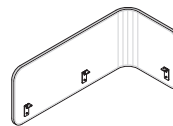

Understanding
 ▶ Page 308
 Specifying
 ▶ Page 340

Sarto Alignment Bracket

Sarto Curved Screens, L-Screen

23"–46"W

18 1/2"–24"H	●
--------------	---

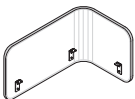

Understanding
 ▶ Page 308
 Specifying
 ▶ Page 342

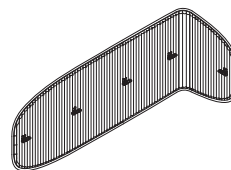

Understanding
 ▶ Page 312
 Specifying
 ▶ Page 343

Sarto Curved Screens, Half Desk-Screen

23"–46"W

18 1/2"–24"H	●
--------------	---

Soffio Screen

56"W 68"W 80"W

26"H	●	●	●
------	---	---	---

Screens, continued

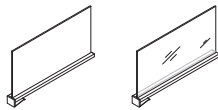

Understanding
▶ Page 314
Specifying
▶ Pages 346–348

Worksurface Side Screens

	22"W	23 1/2"W	24"W	28"W	29 1/2"W	30"W
12"H	●	●	●	●	●	●
19 1/2"H	●	●	●	●	●	●



Understanding
▶ Page 316
Specifying
▶ Page 350

Acrylic Privacy Screens

	22"W	28"W	34"W	40"W	46"W	52"W	58"W	64"W
22"H	●	●	●	●	●	●	●	●



Understanding
▶ Page 317
Specifying
▶ Page 350

Acrylic Modesty Screens

	22"W	28"W	34"W	40"W	46"W	52"W	58"W	64"W
14"H	●	●	●	●	●	●	●	●

Cable and Power Management



Vertical Cable Carrier

Understanding
▶ Page 318
Specifying
▶ Page 351

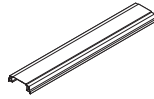

6\"D Wire Manager

Understanding
▶ Page 318
Specifying
▶ Page 351

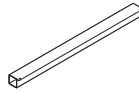

1 3/4\"D Wire Manager

Understanding
▶ Page 318
Specifying
▶ Page 352

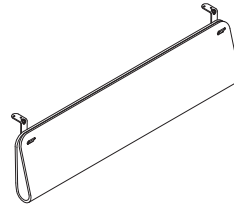

Soft Cable Drop

Understanding
▶ Page 318
Specifying
▶ Page 352



Utility Hook

Understanding
▶ Page 318
Specifying
▶ Page 353

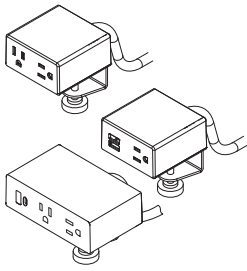

Powerstrip Intro

Understanding
▶ Page 319
Specifying
▶ Page 354



Powerstrip Plus

Understanding
▶ Page 323
Specifying
▶ Page 356

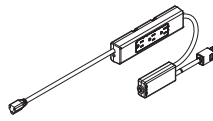

Under Worksurface Utility Power

Understanding
▶ Page 326
Specifying
▶ Page 358

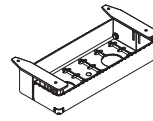

Universal Cable Management Kit, Small

Understanding
▶ Page 328
Specifying
▶ Page 359

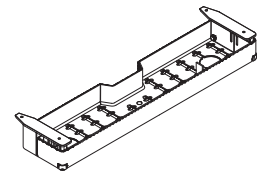

Universal Cable Management Kit, Large

Understanding
▶ Page 328
Specifying
▶ Page 359

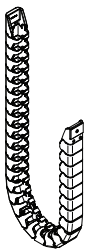

High-Capacity Cable Riser

Understanding
▶ Page 329
Specifying
▶ Page 360

Workstation Design Guidelines and Requirements

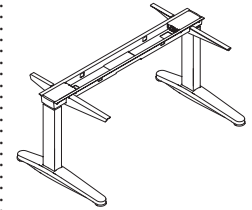
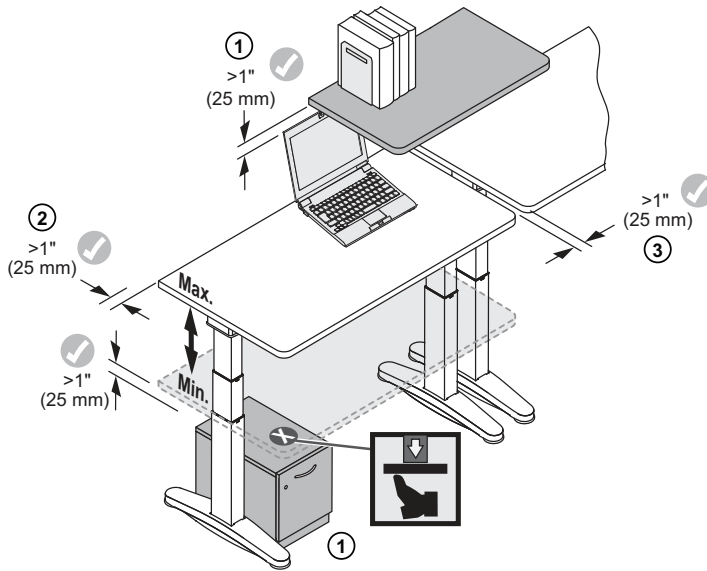

WARNING

Risk of serious injury.

Bases-only warranty limitations and potential for injury: The use of worksurfaces that do not comply with the Steelcase defined criteria and limitations could cause personal injury or property damage due to pinch points, instability, or other problems, and voids all Steelcase Warranties, expressed or implied.

Potential for non-compliance: The use of worksurfaces that do not comply with Steelcase criteria voids any Steelcase claims of compliance with ANSI/BIFMA, UL, LEED, or other applicable requirements. The use of non-Steelcase worksurfaces on Steelcase adjustable-height bases may not be accepted as compliant to municipal electrical codes or OSHA federal workplace standards, because this use does not create an NRTL (UL, ETL, etc.) listed product. Steelcase is not responsible for the ultimate determinations of compliance for height-adjustable bases with non-Steelcase worksurface, and assumes no liability for their compliance with standards when height adjustable bases are used without a Steelcase worksurface as intended.

Overview

Designed for movement with dynamic seating, adjustable worktools and height-adjustable desks are important for today's office workers.

To determine the best height-adjustable solution, consider these four criteria:

1. **Adjustability Needed:**
What is the height range requirement? (seated or sit-to-stand)
2. **Worksurface Size Needed:**
What does the physical space look like? (worksurface configuration)
3. **Equipment/Tools Used:**
What type of computer equipment and other worktools are being used on the worksurface? (load capacity)
4. **Use:**
What is the height-adjustable desk being used for (individual or shared, touchdown space or full workstation, sit-to-stand or seated)?

WARNING

Risk of Serious Injury. If not used as intended, moving worksurfaces can pinch or injure people, or damage property. Always follow these Instructions:

1. Keep height-adjustment range free from obstructions above and below the worksurface.
2. Plan for a minimum 1" gap against a panel or wall.
3. Plan for a minimum 1" gap to adjacent furniture.

Tips

Obstructions

Moving worksurfaces can collide with other objects. Do not install overhead storage, stationary pedestals or components in the path of height-adjustable desks.

Weight

The maximum allowable load (varies by height-adjustable desk) should be evenly distributed and must not be exceeded.

Width

Specify a minimum 1" gap to adjacent furniture. This minimizes any pinch points between a height-adjustable desk and a fixed object.

Depth

When placing a height-adjustable desk against a panel or wall specify the worksurface depth shorter to provide a minimum 1" gap. This minimizes pinch points and adds clearances for cable access.

Managing Technology

Design workstations with computer equipment in mind so that the height-adjustment range of the height-adjustable desk is not impeded because of cables. Consider the addition of a cable riser or cable basket to help harness these wires and cables.

Power

Plan easy and unobstructed access to electrical outlets for computer equipment and height-adjustable desks (when applicable).

Worksurface Criteria and Limitations

The use of non-Steelcase worksurfaces is not recommended. Any use of a non-Steelcase worksurface requires additional investigation by the customer regarding the appropriateness for use. It is the sole responsibility of the customer to determine the suitability and safety of the selected worksurface construction and attachment means.

The following information is provided as a guideline, but does not address all potential issues. Customers should seek professional guidance as to the appropriateness of their chosen worksurface.

Mandatory Requirements

- Height-adjustable bases** include fasteners intended for use with Steelcase worksurfaces. These fasteners may be suitable for worksurfaces meeting the following criteria:
- Medium-density or higher particleboard or fiberboard cores, with High- or Low-Pressure Laminates and backers.
 - Thickness of 1" or greater (Ology, Flex, and Migration SE)
 - Thickness of 13/16" or greater
 - Fasteners located a minimum distance of 1" from any edge

Any other worksurface construction will require different and/or additional fastening means and these means must be determined by the project's designer, architect, or engineer. For example, solid-surface materials should use appropriate threaded inserts and corresponding fasteners or similar attachment means.

In all cases, all fastener locations provided in the base attachment features must be used (e.g. if attachment plate has six screw holes, all six holes must be used for attachment).

Flammability: Any work-surface or similar large part >10ft ^ 2 must have a flame spread <200 and a smoke developed index <450 when tested per UL 723.

Sharp edges: All accessible edges of the worksurface must meet 1439 test for sharp edges.

Dimensional limitations: Rectangle worksurface depth 23", 24", 28", 29", or 30". Worksurface width for Migration Intro (HA1 styles) not to exceed 78".

How to Calculate Power Needs

Use This to Determine How Many Power-Ins You'll Need

When planning a power network, you must calculate the amperage requirements of all your electrical components so you can provide sufficient electricity to power them.

If your usage is not known in advance: The National Electrical Code (NEC) allows a maximum of 13 receptacles on each 20-amp circuit. This provides up to 30 receptacles for each 3-circuit power-in.

If your usage is known in advance:

Add up the amperage used by each piece of equipment in the workstation. Whenever you reach 60 amps (20 amps times 3 circuits) from items that are likely to be used at the same time, you have reached the limit for a single power-in. Specify another power-in and continue until all equipment is powered.

If the circuits will normally be subject to a continuous load (three or more hours of continuous use, such as lights or computers), the NEC requires that circuit capacity be "de-rated" by 20 percent. Therefore, treat circuits used for continuous loads as if they were rated at 16 amps instead of the regular 20 amps.

Try to anticipate future increases in power requirements and build some excess capacity into your plan.

▶ See table at right for typical and actual amperage usages for components.

To calculate amperage when the wattage of a device is known, divide watts by 120.

Some appliances, such as large copiers, coffee makers, or space heaters require most of the current available on a 20-amp circuit. It is recommended that such devices be supplied with their own receptacle/circuit, directly from the building. This leaves the capacity of the furniture circuits available for the more dynamic requirements of the office equipment.

Local electrical codes vary. Consult a qualified electrical contractor or engineer for the proper planning of electrical circuits in your locale.

Approximate power consumption for common devices

• Device	• Wattage	• Amperage	• Voltage	• Number of Devices Supported on Single 20 Amp Circuit
Laptop (Low)	30	0.25	120	64
Laptop (High)	100	0.83	120	19
CPU/Desktop Computer (Low)	65	0.54	120	30
CPU/Desktop Computer (High)	150	1.25	120	13
Monitor (Low)	15	0.13	120	128
Monitor (High)	80	0.67	120	24
Phone	5	0.04	120	384
High Power Tablet	10	0.08	120	192
Lower Power Tablet	45	0.38	120	43
Desktop Printer	40	0.33	120	48
42" LCD Screen	120	1.00	120	16
Projector (Small)	50	0.42	120	38
Projector (Medium)	250	2.08	120	8
Projector (Large)	800	6.67	120	2
Desktop Lamp	20	0.17	120	96
Large Printer/Copier	1600	13.33	120	1
Small Printer/Copier	800	6.67	120	2
Paper Shredder (Small)	250	2.08	120	8
Paper Shredder (Large)	800	6.67	120	2
Desktop Fan	25	0.21	120	77
Standing Fan	125	1.04	120	15
Coffee Maker (Low)	500	4.17	120	4
Coffee Maker (High)	1500	12.50	120	1
Microwave (Low)	600	5.00	120	3
Microwave (High)	1000	8.33	120	2
Refrigerator (Low)	200	1.67	120	10
Refrigerator (High)	1500	12.50	120	1
Vacuum (Low)	200	1.67	120	10
Vacuum (High)	1500	12.50	120	1
Space Heater (Low)	400	3.33	120	5
Space Heater (High)	1500	12.50	120	1
Height-Adjustable Desk (Low Power Consumption)*	200	1.67	120	10
Height-Adjustable Desk (High Power Consumption)*	550	4.58	120	3

Tip: These calculations are estimations and are meant solely for informational purposes. It is important to conduct proper power planning for each installation to prevent overloading a circuit.

* Refer to the Height-Adjustable Desks Specification Guide for specific product information.

Basics of Ergonomic Seating

A well-designed, ergonomically advanced chair that allows a full range of healthy postures throughout the day and can contribute to worker wellness and productivity.

Neck is straight or slightly forward.

Shoulders are relaxed so arms hang naturally.

Back has full contact with the backrest (sit all the way back in your chair).

Elbows and forearms can rest comfortably on the arms of your chair, or on worksurfaces.

Lower back fits into curved lumbar support.

Tension is adjusted so backrest reclines easily, yet provides smooth, even support, and encourages postural change.

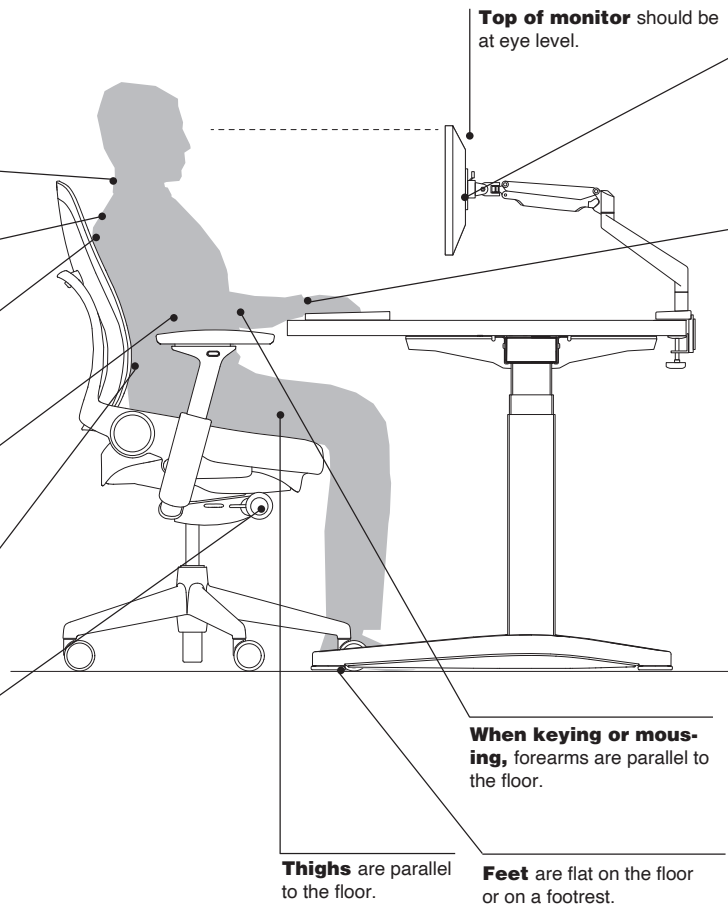

Top of monitor should be at eye level.

Screen is 20 to 30 inches from the eyes. Screen is at eye level slightly lower and directly in front of worker so head is not turned.

Wrists should be straight when keying or mousing, not bent up or down.

When keying or mousing, forearms are parallel to the floor.

Thighs are parallel to the floor.

Feet are flat on the floor or on a footrest.

Basics of Standing and Monitor Arm Positioning

Height-adjustable desks, when combined with monitor arms, allow a full range of healthy postures throughout the day and can contribute to worker wellbeing and productivity.

Top of monitor should be 0° to 20° below horizontal line of sight.

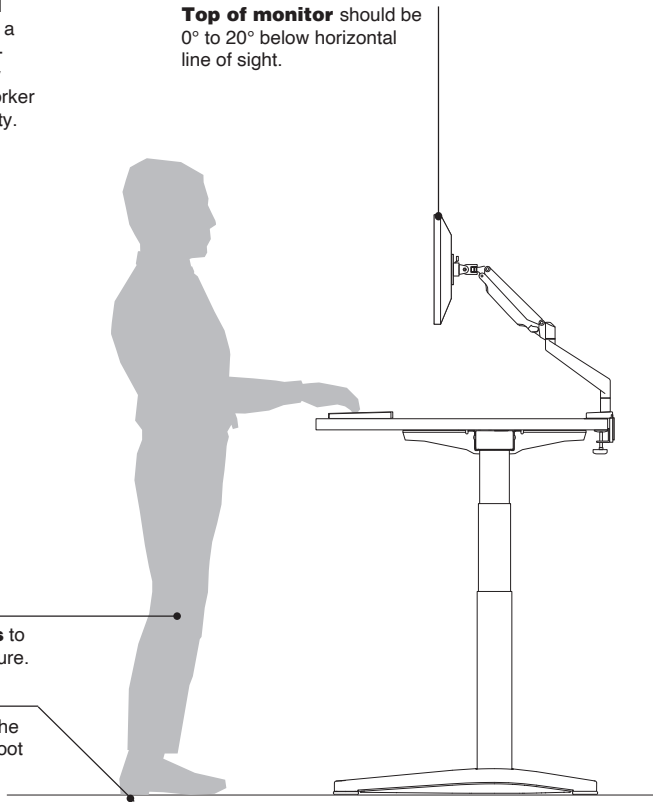

Avoid locking knees to help maintain good posture.

Feet should be flat on the floor or use foot rest or foot pad.

Height

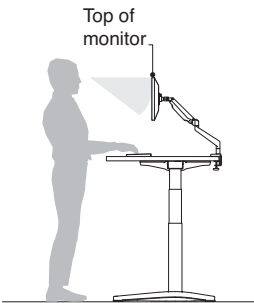

Top of the monitor should be positioned at or slightly below eye level.

Distance

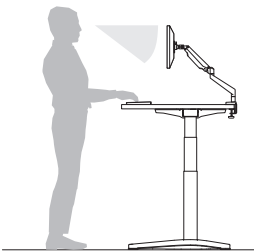

Monitor should be 20" to 30" from the eyes or approximately an arm's length away.

Worksurface Shape Overview

Extensive worksurface shape and size offering allows designers to meet a variety of planning applications and footprints.



Rectangular
Ology
Migration Pro
Migration Pro High-Speed
Migration Intro
Migration SE
Airtouch



Rectangular with 2" Radius Corners
Ology**
Migration Pro
Migration Pro High-Speed
Migration Intro
Migration SE

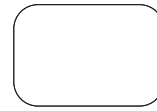

Rectangular with 5" Radius Corners
Rectangle Flex Desk
Migration Pro
Migration Pro High-Speed
Migration Intro
Migration SE

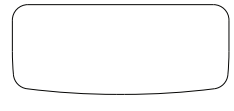

Organic Bow Front
Migration Pro
Migration Pro High-Speed
Migration Intro



Organic Bow Front and Back
Migration Pro
Migration Pro High-Speed
Migration Intro



Tapered
Ology

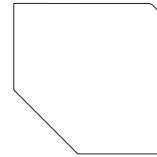

90° Corner
Airtouch

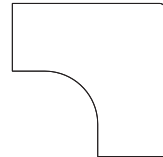

90° Equal
Ology
Migration SE

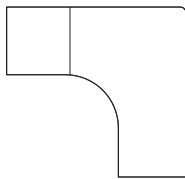

90° Equal *
Ology



90° Extended
Ology
Migration SE

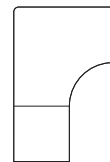

90° Extended *
Ology

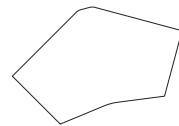

120° Equal
Ology 120° Extended through parametrics
Airtouch
Migration SE



120° Straight Desk
120° Flex Desk

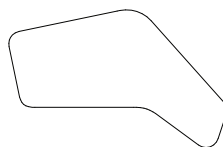

120° Corner Desk
120° Flex Desk

*Worksurfaces equal to and wider than 60 1/16" x 60 1/16" ship in two pieces.

** Ology radius corners are 1 1/4".

Worksurface Edge Options

High-Pressure Laminate Worksurfaces

Front (user's) edge profile is available with a 3 mm edge profile.

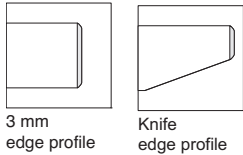

PVC-free, 3 mm edge profiles are proprietary polyolefin blend for all solid colors and seven woodgrain finishes. Matching 1 mm side and back edges are also PVC-free.

▶ See *Surface Materials* in this book for specific PVC-free availability, page 362.
Tip: Universal Tables (rounded corners) have a continuous 3 mm edge.

Edge profile finishes are specified separately from laminate color.

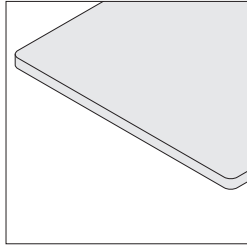

Radius corners have rounded corners on all four sides with a continuous user edge. Radius corners eliminate sharp edges and are appropriate for freestanding furniture.

Tip: Ology, when optioned with rounded corners and with integrated rail, will have 1/4" radius corners on the two front (user's) corners and 90° corners on the rear two corners.

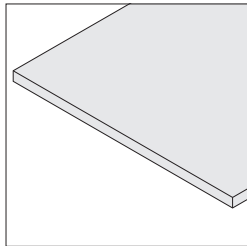

Square corners and wood veneer worksurfaces have 90° corner on all four sides with a front user's edge.

Tip: Flex rectangle and 120° corner desk wood veneer worksurfaces have radius corners on all four sides.

Wood Veneer Worksurfaces

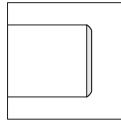

Front (user's) edge profile is wood veneer with a square (3 mm) radius. Back edge and edge that joins to adjacent worksurfaces are flat. Wood edge color matches finish specified for worksurface.

Tip: Wood veneer worksurfaces are available on Airtouch through specials.

Radius Corner Edge Profiles



Rectangular



Rectangular with 2" Radius Corners



Rectangular with 5" Radius Corners



Organic Bow Front



Organic Bow Front and Back



Tapered

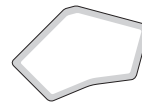

120° Equal

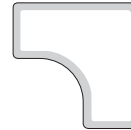

90° Equal



90° Extended



120° Straight Desk



120° Corner Desk

Square Corner and Wood Edge Profiles



Rectangular



Tapered



120° Equal

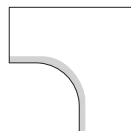

90° Equal



90° Extended

Height-Adjustable Desks Comparison Chart

Height-adjustable desks transform to meet the needs of someone 5' to 6'4" tall. Adjustables offer several selections; Ology, Flex, Migration SE, and Airtouch.

The chart below will help you determine which product line best meets your needs.

Ology

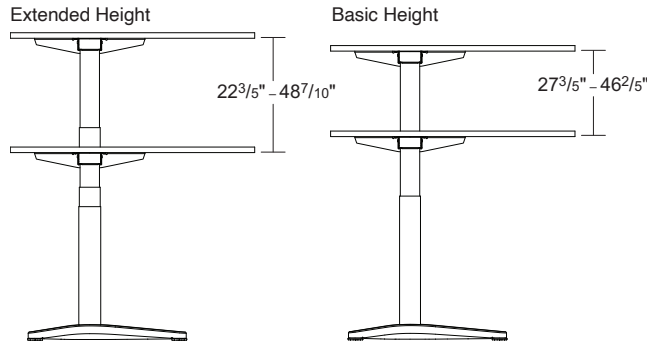

Enhanced sit-to-stand height-adjustability

A push button delivers electric adjustability at 1½" per second. Includes three controller options:

- Simple touch
- Active touch
- 4 Pre-sets

Weight capacity of 360 pounds (2-leg) to 500 pounds (3-leg).

Tip: When calculating lifting capacity, subtract the weight of the worksurface, understructure, and options selected.

Tip: 2-leg desks that have an overhang, or are 35"D or 36"D will have a distributed weight capacity of 300 pounds (136.1 kg).

▶ See page 70 for worksurface weights.

Adjustables Comparison Chart

	Ology Sit-to-Stand
Range of Adjustment	Extended height: 22 ³ / ₅ " – 48 ⁷ / ₁₀ " Basic height: 27 ³ / ₅ " – 46 ² / ₅ "
Type of Adjustment	Electric
Distributed Weight Capacity	360 pounds (2-leg) 500 pounds (3-leg) <i>Tip: 2-leg desks that have an overhang, or are 35"D or 36"D will have a distributed weight capacity of 300 pounds (136.1 kg).</i>
Worksurface Weight	▶ See page 70 for worksurface weights
Worksurface Thickness	1"
Controller	Simple touch, Active touch, 4 Pre-sets
Integrated Rail	Yes
Knife Edge	No
Integrated Soft Edge	Yes
Integrated Power	Yes
Motor	Enclosed
Decibel Rating	< 50 dBA
Volts	2-leg: 120v AC/ 3-leg: 100-240v AC
Input Amps	2-leg: 2.5A/ 3-leg: 3.75A
Watts	2-leg: 300W/ 3-leg: 450W
Standby Power	0.1W
Frequency and Phase	2-leg: 60 Hz Single Phase/ 3-leg: 50-60Hz
Adjustability Speed	1½" per second
Stretcher or Understructure Design	Fixed
Base Only Availability	Yes
ANSI/BIFMA (29"D Knee depth requirement for worksurface)	Meet or Exceed

Flex Rectangle Height-Adjustable Desks

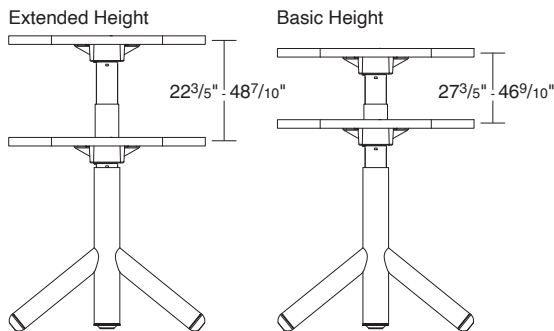

Enhanced sit-to-stand height-adjustability

A push button delivers electric adjustability up to 1¹/₂" per second. Includes two controller options:

- Simple touch
- Active touch

	Weight Capacity
Flex Rectangle	360 pounds

Tip: When calculating lifting capacity, subtract the weight of the worksurface, understructure, and options selected.

▶ See *Storage Specification Guide* for worksurface weights.

Adjustables Comparison Chart

	Flex Rectangle Sit-to-Stand
Range of Adjustment	Extended height: 22 ³ / ₅ " – 48 ⁷ / ₁₀ " Basic height: 27 ³ / ₅ " – 46 ⁹ / ₁₀ "
Type of Adjustment	Electric
Distributed Weight Capacity	360 pounds
Worksurface Weight	See page 153 for worksurface weights
Worksurface Thickness	1"
Controller	Simple touch, Active touch
Integrated Rail	No
Knife Edge	No
Integrated Soft Edge	No
Integrated Power	Yes
Motor	Enclosed
Decibel Rating	< 45 dBA
Volts	120v AC
Input Amps	2.5A
Watts	300W
Standby Power	0.1W
Frequency and Phase	60 Hz Single Phase
Adjustability Speed	1 ¹ / ₂ " per second
Stretcher or Understructure Design	Fixed
Base Only Availability	Yes
ANSI/BIFMA (29"D Knee depth requirement for worksurface)	Meet or Exceed

Height-Adjustable Desks Comparison Chart, continued

Flex 120° Height-Adjustable Desks

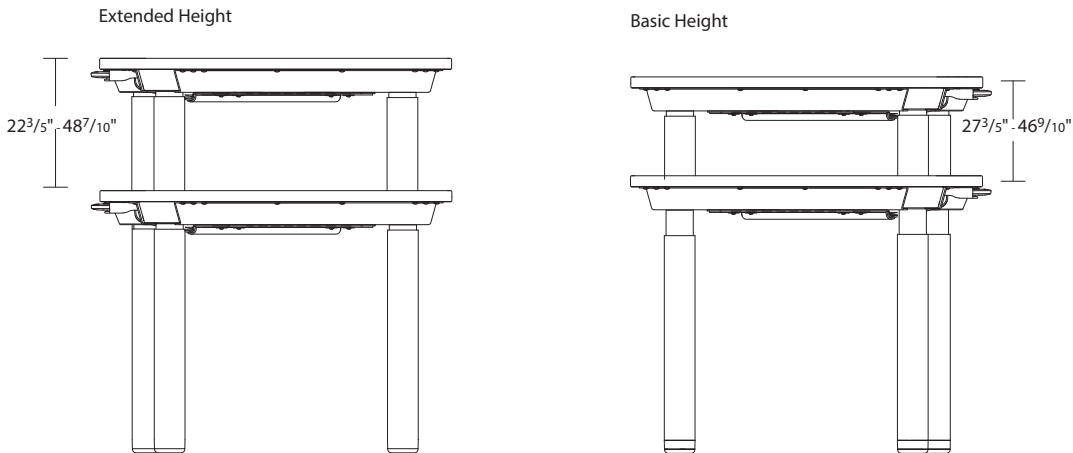

Enhanced sit-to-stand height-adjustability

A push button delivers electric adjustability up to 1 1/2" per second. Includes two controller options:

- Simple touch
- Active touch

	Weight Capacity
Flex 120° Straight and Flex 120° Corner	540 pounds

Tip: When calculating lifting capacity, subtract the weight of the worksurface, understructure, and options selected.

▶ See *Storage Specification Guide* for worksurface weights.

Adjustables Comparison Chart

	Flex 120° Straight and Flex 120° Corner Sit-to-Stand
Range of Adjustment	Extended height: 22 ³ / ₅ " – 48 ⁷ / ₁₀ " Basic height: 27 ³ / ₅ " – 46 ⁹ / ₁₀ "
Type of Adjustment	Electric
Distributed Weight Capacity	540 pounds
Worksurface Weight	See page 153 for worksurface weights
Worksurface Thickness	1"
Controller	Simple touch, Active touch
Integrated Rail	No
Knife Edge	No
Integrated Soft Edge	No
Integrated Power	Yes
Motor	Partially enclosed
Decibel Rating	< 45 dBA
Volts	100v-240v AC
Input Amps	3.75A
Watts	450W
Standby Power	0.1W
Frequency and Phase	60 Hz Single Phase
Adjustability Speed	1 1/2" per second
Stretcher or Understructure Design	Fixed
Base Only Availability	No
ANSI/BIFMA (29"D Knee depth requirement for worksurface)	Meet or Exceed

Height-Adjustable Desks Comparison Chart, continued

Migration Intro and Pro Height-Adjustable Desks

Migration Pro and Pro High-Speed – Extended

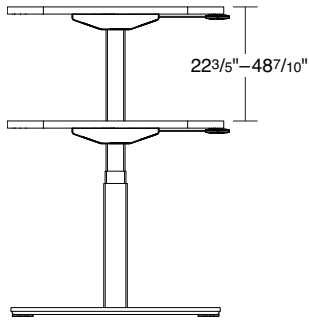

Migration Pro – Basic

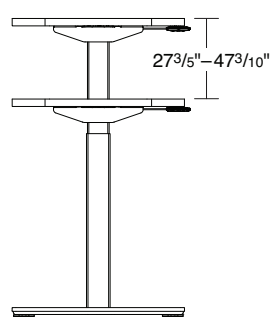

Migration Pro Enhanced sit-to-stand height-adjustability

Controller adjusts the height of the desk at a rate of 1¹/₂" per second. Includes three options:

- Simple touch
- Active touch
- 3-Preset

Migration Pro with Boost High-Speed Fast sit-to-stand height-adjustability

Controller adjusts the height of the desk at a rate of 3¹/₁₀" per second. Includes three options:

- Simple touch
- Active touch
- 3-Preset

Adjustables Comparison Chart

	Migration Pro Sit-to-Stand	Migration Pro with Boost Sit-to-Stand
Range of Adjustment	Extended height: 22 ³ / ₅ " – 48 ⁷ / ₁₀ " Basic height: 27 ³ / ₅ " – 47 ³ / ₁₀ "	Extended height: 22 ³ / ₅ " – 48 ⁷ / ₁₀ "
Type of Adjustment	Electric	Electric
Distributed Weight Capacity	360 pounds	270 pounds
Worksurface Weight	▶ See page 211 for worksurface weights	▶ See page 211 for worksurface weights
Worksurface Thickness	1"	1"
Controller	Simple touch, Active touch, 3-Preset	Simple touch, Active touch, 3-Preset
Integrated Rail	No	No
Knife Edge	Yes	Yes
Integrated Soft Edge	Yes	Yes
Integrated Power	Yes	Yes
Motor	Enclosed	Enclosed
Decibel Rating	< 39 dBA	< 45 dBA
Volts	120V AC	100V-240V AC
Input Amps	2.5A	3.75A
Watts	300W	450W
Standby Power	0.1W	0.1W
Frequency and Phase	60 HZ Single Phase	60 HZ Single Phase
Adjustability Speed	1 ¹ / ₂ " per second	3 ¹ / ₁₀ " per second
Stretcher or Understructure Design	Fixed	Fixed
Base Only Availability	Yes	Yes
ANSI/BIFMA (29"D Knee depth requirement for worksurface)	Meet or Exceed	Meet or Exceed

Migration Intro and Pro Height-Adjustable Desks

Migration Intro – Extended

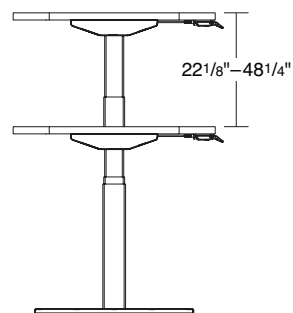

Migration Intro – Basic

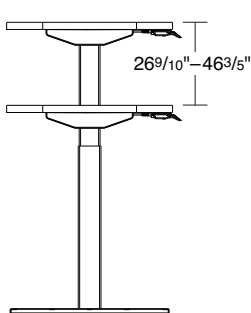

Migration Intro Easy sit-to-stand height-adjustability

Controller adjusts the height of the desk at a rate of 1 1/5" per second. Includes two options:

- Basic
- Active touch

	Weight Capacity
Migration Pro	360 pounds
Migration Pro with Boost High-Speed	270 pounds
Migration Intro	270 pounds

Tip: When calculating lifting capacity, subtract the weight of the worksurface, channel, and options selected.

▶ See page 211 for worksurface weights

Adjustables Comparison Chart

	Migration Intro Sit-to-Stand
Range of Adjustment	Extended height: 22 1/8" – 48 1/4" Basic height: 26 9/10" – 46 3/5"
Type of Adjustment	Electric
Distributed Weight Capacity	270 pounds
Worksurface Weight	▶ See page 211 for worksurface weights
Worksurface Thickness	1"
Controller	Basic, Active touch
Integrated Rail	No
Knife Edge	No
Integrated Soft Edge	No
Integrated Power	No
Motor	Enclosed
Decibel Rating	< 45 dBA
Volts	120V AC
Input Amps	4.0A
Watts	480W
Standby Power	0.1W
Frequency and Phase	50-60 HZ Single Phase
Adjustability Speed	1 1/5" per second
Stretcher or Understructure Design	Fixed
Base Only Availability	Yes
ANSI/BIFMA (29"D Knee depth requirement for worksurface)	Meet or Exceed

Height-Adjustable Desks Comparison Chart, continued

Migration SE Height-Adjustable Desks

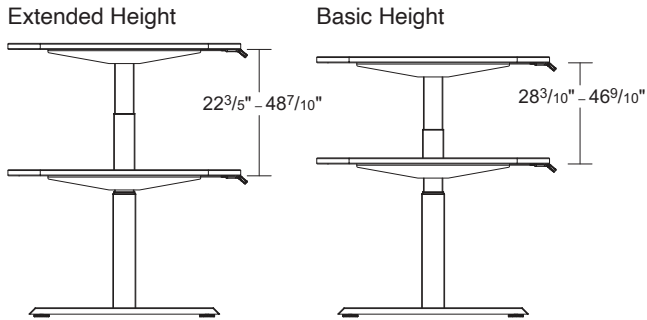

Simple sit-to-stand height-adjustability

Controller adjusts the height of the desk at a rate of 13/10" per second. Includes two options:

- Up/down
- 4-Preset

Weight capacity of 250 pounds (2-leg) and 300 pounds (3-leg).

Tip: When calculating lifting capacity, subtract the weight of the worksurface, channel, and options selected.

▶ See page 211 for worksurface weights

Adjustables Comparison Chart

	Migration SE
Range of Adjustment	Extended height: 22 ³ / ₅ "–48 ⁷ / ₁₀ " Basic height: 28 ³ / ₁₀ "–46 ⁹ / ₁₀ "
Type of Adjustment	Electric
Distributed Weight Capacity	250 pounds (2-leg) 330 pounds (3-leg)
Worksurface Weight	▶ See page 211 for worksurface weights
Worksurface Thickness	1"
Controller	Up/Down, Digital Pre-set
Integrated Rail	No
Knife Edge	No
Integrated Soft Edge	No
Integrated Power	No
Motor	Enclosed
Decibel Rating	< 47 dBA
Volts	100-127v AC, 220-240v AC
Input Amps	5A max for 100–127v AC, 2A max for 220–240v AC
Watts	540W
Standby Power	0.3W
Frequency and Phase	60 Hz (100–127v AC) 50Hz (220–240v AC) Single Phase
Adjustability Speed	1 ³ / ₁₀ " per second
Stretcher or Understructure Design	Telescoping understructure for both T- and C-leg
Base Only Availability	Yes
ANSI/BIFMA (29"D Knee depth requirement for worksurface)	Meet or Exceed

Airtouch

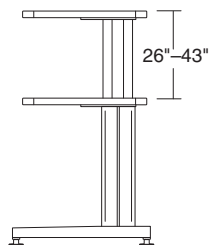

Collaborative height-adjustability

Weight capacity of 150 pounds.

Tip: When calculating lifting capacity, subtract the weight of the worksurface.

▶ See page 289 for worksurface weights.

*Small configurations only.

** 29"D knee depth requirement for worksurface

Adjustables Comparison Chart

	Airtouch Sit-to-Stand
Range of Adjustment	26" – 43"
Type of Adjustment	Counterforce Mechanism
Distributed Weight Capacity	150 pounds
Worksurface Weight	▶ See page 289 for worksurface weights
Worksurface Thickness	1 ³ / ₁₆ "
Controller	Paddle
Integrated Rail	No
Knife Edge	No
Integrated Soft Edge	No
Integrated Power	No
Motor	N.A.
Decibel Rating	N.A.
Volts	N.A.
Input Amps	N.A.
Watts	N.A.
Standby Power	N.A.
Frequency and Phase	N.A.
Adjustability Speed	User speed (1 second)
Stretcher or Under-structure Design	N.A.
Base Only Availability	No
ANSI/BIFMA **	Meet or Exceed

Worktools Compatibility Charts

To determine worksurface compatibility with acrylic privacy/modesty screens, SOTO rail, and SlatRail worktools for each configuration and shape, see compatibility chart below.

Tip: The Ology integrated rail option does not apply to these rules because the rail matches the worksurface width.

Tip: Slatwall stanchions are not applicable because they allow Slatwall to overhang mounting area.

Tip: SlatRail stanchions do not work with the same size screen or SOTO rail, (e.g. 48"W SlatRail will not work with 52"W screens) because of clamp location. Specify the SlatRail one size smaller or larger when using in combination (if applicable).

▶ See page 316

Ology Desks

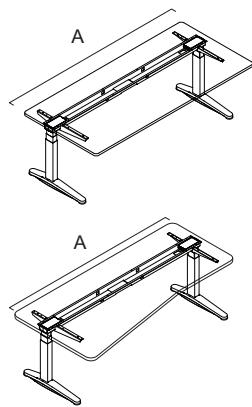

Rectangular and Tapered

Side **A** width

Acrylic Privacy/Modesty/SOTO Rail

Worksurfaces	28"W	34"W	40"W	46"W	52"W	58"W	64"W
34"W	■						
40"W		■					
46"W			■				
52"W				■			
58"W					■		
64"W						■	
70"W							■
76"W							

Side **A** width

SlatRail

Worksurfaces	24"W	30"W	36"W	42"W	48"W	60"W
34"W	■	■				
40"W		■	■			
46"W			■	■		
52"W				■	■	
58"W					■	■
64"W						■
70"W						
76"W						

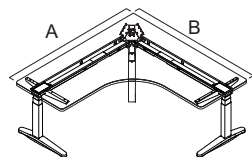

90° Equal 3-Leg

Side **A** width

Acrylic Privacy/Modesty/SOTO Rail

Worksurfaces	28"W	34"W	40"W	46"W	52"W	58"W	64"W
52"W	■	■	■	■			
58"W		■	■	■	■		
64"W			■	■	■	■	
70"W				■	■	■	■
76"W					■	■	■

Side **B** width

Acrylic Privacy/Modesty/SOTO Rail

Worksurfaces	28"W	34"W	40"W	46"W	52"W	58"W	64"W
52"W	■	■	■	■			
58"W		■	■	■	■		
64"W			■	■	■	■	
70"W				■	■	■	■
76"W					■	■	■

Side **A** width

SlatRail

Worksurfaces	24"W	30"W	36"W	42"W	48"W	60"W
52"W	■	■	■	■	■	
58"W		■	■	■	■	
64"W			■	■	■	■
70"W				■	■	■
76"W					■	■

Side **B** width

SlatRail

Worksurfaces	24"W	30"W	36"W	42"W	48"W	60"W
52"W	■	■	■	■	■	
58"W		■	■	■	■	
64"W			■	■	■	■
70"W				■	■	■
76"W					■	■

Ology Desks, continued

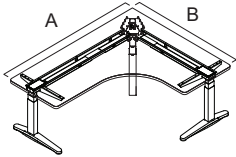

90° Extended 3-Leg

Side A width

Acrylic Privacy/Modesty/SOTO Rail

Worksurfaces	Side A width						
	28"W	34"W	40"W	46"W	52"W	58"W	64"W
40"W							
46"W							
58"W	■	■	■	■	■		
64"W	■	■	■	■	■	■	
70"W	■	■	■	■	■	■	■
76"W	■	■	■	■	■	■	■

Side B width

Acrylic Privacy/Modesty/SOTO Rail

Worksurfaces	Side B width						
	28"W	34"W	40"W	46"W	52"W	58"W	64"W
40"W	■	■					
46"W	■	■	■				
58"W	■	■	■	■	■		
64"W							
70"W							
76"W							

Side A width

SlatRail

Worksurfaces	Side A width					
	24"W	30"W	36"W	42"W	48"W	60"W
40"W						
46"W						
58"W	■	■	■	■	■	
64"W	■	■	■	■	■	
70"W	■	■	■	■	■	■
76"W	■	■	■	■	■	■

Side B width

SlatRail

Worksurfaces	Side B width					
	24"W	30"W	36"W	42"W	48"W	60"W
40"W	■	■	■			
46"W	■	■	■	■		
58"W	■	■	■	■	■	
64"W						
70"W						
76"W						

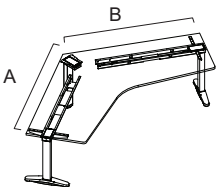

120° Equal

Side A width

Acrylic Privacy/Modesty/SOTO Rail

Worksurfaces	Side A width						
	28"W	34"W	40"W	46"W	52"W	58"W	64"W
34"W	■						
40"W	■	■					
46"W	■	■	■				
52"W	■	■	■	■			
58"W	■	■	■	■	■		
64"W	■	■	■	■	■	■	

Side B width

Acrylic Privacy/Modesty/SOTO Rail

Worksurfaces	Side B width						
	28"W	34"W	40"W	46"W	52"W	58"W	64"W
34"W	■						
40"W	■	■					
46"W	■	■	■				
52"W	■	■	■	■			
58"W	■	■	■	■	■		
64"W	■	■	■	■	■	■	■

Side A width

SlatRail

Worksurfaces	Side A width					
	24"W	30"W	36"W	42"W	48"W	60"W
34"W	■	■				
40"W	■	■	■			
46"W	■	■	■	■		
52"W	■	■	■	■	■	
58"W	■	■	■	■	■	
64"W	■	■	■	■	■	■

Side B width

SlatRail

Worksurfaces	Side B width					
	24"W	30"W	36"W	42"W	48"W	60"W
34"W	■	■				
40"W	■	■	■			
46"W	■	■	■	■		
52"W	■	■	■	■	■	
58"W	■	■	■	■	■	
64"W	■	■	■	■	■	■

Ology Desks, continued

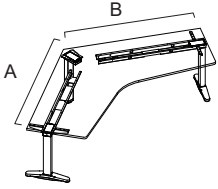

120° Equal 3-Leg

Worksurfaces	Side A width							Side B width						
	28"W	34"W	40"W	46"W	52"W	58"W	64"W	28"W	34"W	40"W	46"W	52"W	58"W	64"W
Acrylic Privacy/Modesty/SOTO Rail														
34"W	■							■						
40"W	■	■						■	■					
46"W	■	■	■					■	■	■				
52"W	■	■	■	■				■	■	■	■			
58"W	■	■	■	■	■			■	■	■	■	■		
64"W	■	■	■	■	■	■		■	■	■	■	■	■	

Worksurfaces	Side A width						Side B width					
	24"W	30"W	36"W	42"W	48"W	60"W	24"W	30"W	36"W	42"W	48"W	60"W
SlatRail												
34"W	■	■					■	■				
40"W	■	■	■				■	■	■			
46"W	■	■	■	■			■	■	■	■		
52"W	■	■	■	■	■		■	■	■	■	■	
58"W	■	■	■	■	■		■	■	■	■	■	
64"W	■	■	■	■	■	■	■	■	■	■	■	■

Steelcase Flex Height-Adjustable Desks



Rectangular

Worksurfaces	Side A width						Side A width				
	28"W	34"W	40"W	46"W	52"W	58"W	24"W	30"W	36"W	42"W	48"W
Acrylic Privacy/Modesty/SOTO Rail											
46"W	■	■					■	■	■		
58"W	■	■	■	■			■	■	■	■	
70"W	■	■	■	■	■	■	■	■	■	■	■

Migration SE Desks

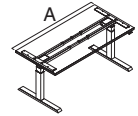

Rectangular

Side **A** width

Acrylic Privacy/Modesty/SOTO Rail

Worksurfaces	Side A width						
	28"W	34"W	40"W	46"W	52"W	58"W	64"W
46"W	■	■	■				
52"W	■	■	■	■			
58"W	■	■	■	■	■		
64"W	■	■	■	■	■	■	
70"W	■	■	■	■	■	■	■
76"W	■	■	■	■	■	■	■

Side **A** width

SlatRail

Worksurfaces	Side A width					
	24"W	30"W	36"W	42"W	48"W	60"W
46"W	■	■	■			
52"W	■	■	■	■		
58"W	■	■	■	■	■	
64"W	■	■	■	■	■	■
70"W	■	■	■	■	■	■
76"W	■	■	■	■	■	■

Tip: Migration SE 90° and 120° corner desks are not available with acrylic privacy/modesty screens, SOTO rail, and SlatRail.

Airtouch Worksurfaces

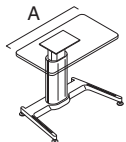

Rectangular and Rectangular Bi-level

Worksurfaces	Side A width							Side A width					
	Acrylic Privacy/Modesty/SOTO Rail							SlatRail					
	28"W	34"W	40"W	46"W	52"W	58"W	64"W	24"W	30"W	36"W	42"W	48"W	60"W
40"W	■	■						■	■	■			
46"W	■	■	■					■	■	■	■		
58"W	■	■	■	■	■			■	■	■	■	■	

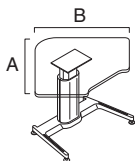

90° Corner and 90° Corner Bi-Level

Worksurfaces	Side A width							Side B width							
	Acrylic Privacy/Modesty/SOTO Rail							Acrylic Privacy/Modesty/SOTO Rail							
	28"W	34"W	40"W	46"W	52"W	58"W	64"W	28"W	34"W	40"W	46"W	52"W	58"W	64"W	
39 1/4"W	■	■						■	■						
45 1/4"W	■	■	■					■	■	■					

Worksurfaces	Side A width						Side B width					
	SlatRail						SlatRail					
	24"W	30"W	36"W	42"W	48"W	60"W	24"W	30"W	36"W	42"W	48"W	60"W
39 1/4"W	■	■	■				■	■	■			
45 1/4"W	■	■	■	■			■	■	■	■		

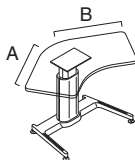

120° Equal

Worksurfaces	Side A width							Side B width						
	Acrylic Privacy/Modesty/SOTO Rail							Acrylic Privacy/Modesty/SOTO Rail						
	28"W	34"W	40"W	46"W	52"W	58"W	64"W	28"W	34"W	40"W	46"W	52"W	58"W	64"W
34"W	■							■						

Worksurfaces	Side A width						Side B width					
	SlatRail						SlatRail					
	24"W	30"W	36"W	42"W	48"W	60"W	24"W	30"W	36"W	42"W	48"W	60"W
34"W	■	■					■	■				

Steelcase Monitor Arm Guidelines

Application Guidelines for Migration Pro, Migration Pro with Boost High-Speed, and Migration Intro



Rules:

- Single monitor arm and monitor requires a minimum worksurface size of 23/24"D x 46"W
- Dual and triple monitor arms and monitors require a minimum worksurface size of 28/29/30"D x 58"W
- Up to three single monitor arms with maximum monitor weight of 15 lbs. each
- Maximum of six tiered monitors with a maximum monitor weight of 10 lbs. each (60 lbs. in total)

Tip: Attached monitor arms on freestanding desks must not extend beyond the perimeter of the desk. This includes the front, sides, and back edge of the work-surface.

Dynamic adjustment: Up to three single arms with maximum 15 lbs. each monitor (45 lbs. total)

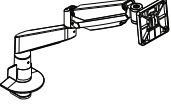
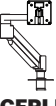
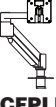
- **CFINTRO** – 20 lbs.
- **CFPLUS** – 17 lbs.
- **CFPLUSHD** – 28 lbs.
- **CFMAX** – 40 lbs.
- **CFINTROSLIDE** – 20 lbs.
- **CFSTDDUALBAR** – 28 lbs.

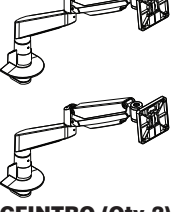
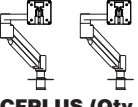
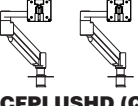

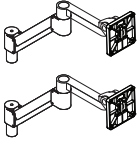
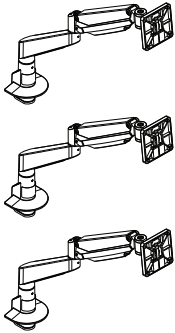
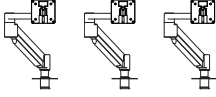
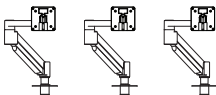
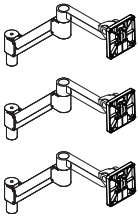
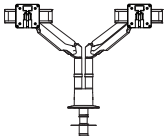
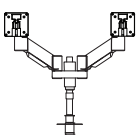
Monitor Arm Assemblies	Migration Pro (HA2)	Migration Pro with Boost High-Speed (HA3)	Migration Intro (HA1)
 <p>CFINTRO</p>  <p>CFPLUS—Single</p>	Yes, allowed with modesty panel or cable tray	Yes, allowed with modesty panel or cable tray	Yes, allowed with modesty panel or cable tray
 <p>CFPLUSHD—Single</p>	Yes, allowed with modesty panel or cable tray	Yes, allowed with modesty panel or cable tray	Yes, allowed with modesty panel or cable tray
 <p>CFMAX</p>	Yes, with exceptions. Monitor arm C-clamp does not allow modesty panel or cable tray use	Yes, with exceptions. Monitor arm C-clamp does not allow modesty panel or cable tray use	No
 <p>CFINTRO (Qty 2)</p>	Yes, allowed with modesty panel or cable tray	Yes, allowed with modesty panel or cable tray	Yes, with exceptions. Modesty panel and cable tray are not allowed.
 <p>CFPLUS (Qty 2)</p>	Yes, allowed with modesty panel or cable tray	Yes, allowed with modesty panel or cable tray	Yes, allowed with modesty panel or cable tray
 <p>CFPLUSHD (Qty 2)</p>	Yes, allowed with modesty panel or cable tray	Yes, allowed with modesty panel or cable tray	No

Monitor Arm Assemblies	Migration Pro (HA2)	Migration Pro with Boost High-Speed (HA3)	Migration Intro (HA1)
 <p>CFMAX (Qty 2)</p>	No	No	No
 <p>CFINTRO (Qty 3)</p>	Yes, allowed with modesty panel or cable tray	Yes, allowed with modesty panel or cable tray	No
 <p>CFPLUS (Qty 3)</p>	Yes, allowed with modesty panel or cable tray	Yes, allowed with modesty panel or cable tray	No
 <p>CFPLUSHD (Qty 3)</p>	No	No	No
 <p>CFMAX (Qty 3)</p>	No	No	No
 <p>CFINTROSLIDE</p>	Yes, allowed with modesty panel or cable tray	Yes, allowed with modesty panel or cable tray	Yes, allowed with modesty panel or cable tray
 <p>CFPLUS—Dual</p>	Yes, allowed with modesty panel or cable tray	Yes, allowed with modesty panel or cable tray	Yes, with exceptions. Modesty panel is not allowed.

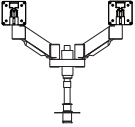
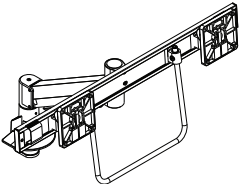
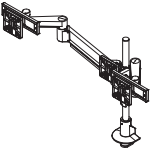
Steelcase Monitor Arm Guidelines, Application Guidelines for Migration Pro, Migration Pro with Boost High-Speed, and Migration Intro, continued

Monitor Arm Assemblies	Migration Pro (HA2)	Migration Pro with Boost High-Speed (HA3)	Migration Intro (HA1)
 <p>CFPLUSHD—Dual</p>	Yes, allowed with modesty panel or cable tray	Yes, allowed with modesty panel or cable tray	No
 <p>CFSTDUALBAR</p>	Yes, allowed with modesty panel or cable tray	Yes, allowed with modesty panel or cable tray	Yes, with exceptions. Modesty panel is not allowed.
 <p>CFPLUSHD—Triple</p>	Yes, allowed with modesty panel or cable tray	Yes, allowed with modesty panel or cable tray	No

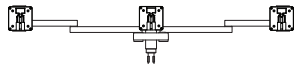
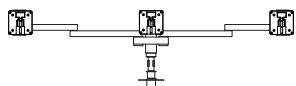
- **Static adjustment:** Up to six tiered monitors with maximum 10 lbs. each monitor (60 lbs. total)
- **CFSTATIC** – Single up to 30 lbs.
- **CFSTATIC** – Triple up to 15 lbs.
- **CFSTATIC** – Triple wide up to 15 lbs.

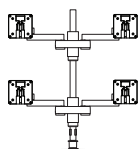
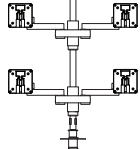
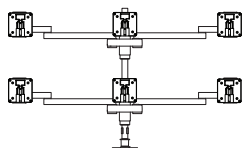
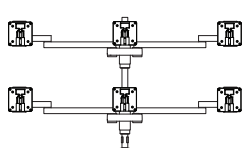
Monitor Arm Assemblies	Migration Pro (HA2)	Migration Pro with Boost High-Speed (HA3)	Migration Intro (HA1)
 <p>CFSTATIC—Single</p>	Yes, with exceptions. Monitor arm C-clamp does not allow modesty panel or cable tray use	Yes, with exceptions. Monitor arm C-clamp does not allow modesty panel or cable tray use	Yes, with exceptions. Monitor arm C-clamp does not allow modesty panel or cable tray use
 <p>CFSTATIC—Triple</p>	Yes, with exceptions. Monitor arm C-clamp does not allow modesty panel or cable tray use	Yes, with exceptions. Monitor arm C-clamp does not allow modesty panel or cable tray use	Yes, with exceptions. Monitor arm C-clamp does not allow modesty panel or cable tray use
 <p>CFSTATIC—Triple Wide</p>	No	No	No
 <p>CFSTATIC—1 over 1</p>	Yes, with exceptions. Monitor arm C-clamp does not allow modesty panel or cable tray use	Yes, with exceptions. Monitor arm C-clamp does not allow modesty panel or cable tray use	Yes, with exceptions. Monitor arm C-clamp does not allow modesty panel or cable tray use
 <p>CFSTATIC—2 over 2</p>	Yes, with exceptions. Monitor arm C-clamp does not allow modesty panel or cable tray use	Yes, with exceptions. Monitor arm C-clamp does not allow modesty panel or cable tray use	No
 <p>CFSTATIC—2 over 2 Wide</p>	No	No	No
 <p>CFSTATIC—3 over 3</p>	Yes, with exceptions. Monitor arm C-clamp does not allow modesty panel or cable tray use	Yes, with exceptions. Monitor arm C-clamp does not allow modesty panel or cable tray use	No
 <p>CFSTATIC—3 over 3 Wide</p>	No	No	No

Steelcase Monitor Arm Guidelines

Application Guidelines for Single, Dual, and Triple Monitor Arm Applications on 2-Leg Height-Adjustable Desks

Rules:

- Single monitor arm and monitor requires a minimum worksurface size of 23/24"D x 46"W
- Dual and triple monitor arms and monitors require a minimum worksurface size of 29/30"D x 58"W
- Monitor arms are not permitted on two leg desks with casters

Monitor Arm Assemblies	Migration SE C-Leg	Migration SE T-Leg	Ology	Flex
Single Dynamic/Single Static Monitor Arm	Yes	Yes	Yes	Yes
Dual Dynamic/Dual Static Monitor Arm	Yes	Yes	Yes	Yes
Triple Dynamic/Triple Static Monitor Arm	Static only	Yes	Yes	Static only

Tip: For other height-adjustable desks, please see their respective product catalogs for further information.

Tip: When using 3-leg Ology and Migration SE applications, total weight of monitors and assemblies must be distributed evenly across the application.

Tip: Attached monitor arms on freestanding tables must not extend beyond the perimeter of the desk. This includes the front, sides, and back edge of the worksurface.

Steelcase Monitor Arm Guidelines

Application Guidelines for Tiered Monitor Arm Applications on 2-Leg Height-Adjustable Desks

Rules:

- Minimum worksurface size of 29/30"D x 58"W required for multiple monitors
- Six monitors maximum permitted on a 2-leg desk
- 60 pounds total maximum monitor weight per 2-leg desk
- Monitor arm applications are not permitted on 2-leg desks with casters
- When calculating height-adjustable desk lifting capacity, subtract the weight of the worksurface, understructure, options, and add-on products (e.g. flat panel monitor arm, monitors, and CPUs)

Monitor Arm Assemblies	Migration SE C-Leg	Migration SE T-Leg	Ology	Flex
One over One Static Monitor Arm	No	Yes	Yes	No
Two over Two Static/Wide Static Monitor Arm	No	Yes	Yes	No
Three over Three Static/Wide Static Monitor Arm	No	Yes	Yes	No

Tip: Attached monitor arms on freestanding tables must not extend beyond the perimeter of the desk. This includes the front, sides, and back edge of the worksurface.

CarbonNeutral Product Certification



CarbonNeutral.com

To be a CarbonNeutral product, the emissions of each desk are measured, calculated and third-party verified across every stage of the desk's lifecycle. The amount of carbon emissions from manufacturing that can't be avoided are offset by investing in trusted projects that focus on emissions avoidance and removal, and social good. Through the investment of these projects, the carbon emissions of these desk options equal zero.

The following style numbers have CarbonNeutral product certification options:

Ology

- **OLSLRQCN**
- **OLELRQCN**
- **OLSL3CN**
- **OLELL3CN**

Migration SE

- **MGSLTRQCN**
- **MGELTRQCN**
- **MGSLCRQCN**
- **MGELCRQCN**

Exceptions:

- Stand alone add on accessories are not available with CarbonNeutral product certification.

: Desks that are FSC Mix credit help organizations meet their sustainability goals. Worksurfaces are made with a mixture of materials from FSC-certified forests, recycled materials, and/or FSC-controlled wood.

: The following style numbers are FSC Mix credit:

: Migration Pro

- **HA2ERFSC**
- **HA2EOFSC**

: Migration Pro with Boost High-Speed

- **HA3ERFSC**
- **HA3EOFSC**

: Migration Intro

- **HA1ERFSC**
- **HA1EOFSC**

: Migration Pro and Intro Modesty Panel

- **HAMPFSC**



Ology

Understanding

Ology Height-Adjustable Desks	64
Ology Corner Desks and Bases Size Restrictions	84
Ology Options Availability Chart	90
Ology Modesty Panels	92
Universal Steel One-High and 1.5-High Open Laterals	94
Elective Elements One-High Open Plinth Base Pedestals and Common Tops	96

Specifying

Ology Height-Adjustable Rectangular Desks	98
Ology Height-Adjustable Tapered Desks	102
Ology Height-Adjustable 3-Leg Corner Desks	106
Ology Height-Adjustable Bases	124
Ology Modesty Panels	134
Ology Cable and Power Management	135
Active Touch Controller Kit	136
Universal Steel One-High and 1.5-High Open Laterals	138
Universal Shrouds	140
Universal Filler	141
Universal Common Tops	142
Elective Elements One-High Open Plinth Base Pedestals	144
Elective Elements Common Tops	146

Ology Height-Adjustable Desks

Ology brings together physiology and biology to support wellbeing at work. It allows users to quickly, quietly, and intuitively change posture without disrupting their coworkers. Ology offers a one button solution for quick eye-to-eye collaboration. The integrated rail offers today's workers a range of ergonomic tools. Ology provides Bactiblock, an antimicrobial additive, can be molded into the most frequently touched components.
 ▶ Specifying, page 98.

Desk has a wood core with a High-Pressure Laminate or wood veneer surface and is 1" thick.

Lifting column is controlled by central control box for synchronization. Columns are precision balanced to minimize surface vibrations.

Access door and tray with power provides user access to 120V and USB A+C 20W power and data as well as cord management. Available as an option.

Integrated rail, available as an option, supports space division, lighting, or worktools to give users choice and control for their physical wellbeing.

Extended height-adjustable base adjusts from 22³/₈"H to 48⁷/₁₀"H in any increment.

Basic height-adjustable base adjusts from 27³/₈"H–46²/₅"H in any increment.

Leveling glides adjust 1/2" to install desk on uneven floors. 1" adjustable glides are available as an option.

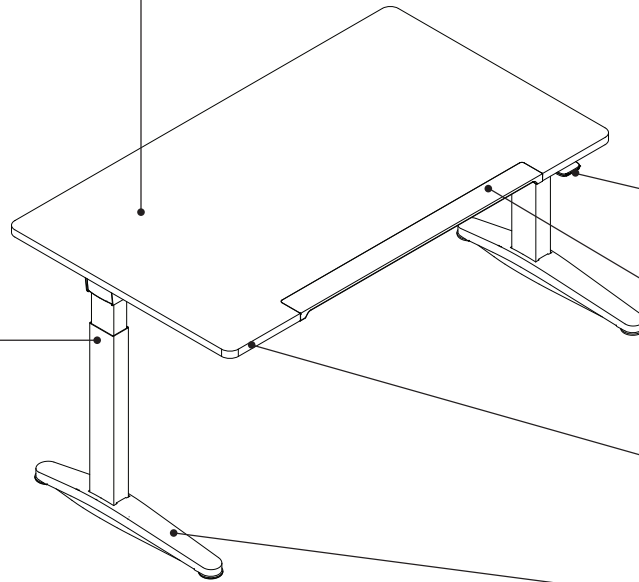

CarbonNeutral.com

Now available as a CarbonNeutral product, making sure our commitment to a more sustainable future helps yours too.

Push button simple touch controller adjusts height at a rate of 1 1/2" per second.

Soft edge, available as option, reduces unhealthy pressure on forearms, as well as feelings of shoulder and neck fatigue. Soft edge is 36"W.

Edge is available in 3 mm edge profile for radius corner and square corner is 3 mm on the user's edge and 1 mm sides and back.

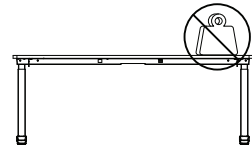

Distribute weight evenly. **Base** supports a maximum distributed weight load of 360 pounds (2-leg) and 500 pounds (3-leg).
Tip: 2-leg desks that have an overhang, or are 35"D or 36"D will have a distributed weight capacity of 300 pounds (136.1 kg).

Tip: When calculating lifting capacity, subtract the weight of the worksurface, understructure, and options selected.
 ▶ See page 70 for worksurface weights.

Active touch controller is Bluetooth-enabled and includes digital display, two preset buttons, double-tap automatic drive, and active motion posture reminders.
Tip: Active touch controller is standard.
Tip: Steelcase Rise mobile app is available that pairs with any active touch controller to support preferences, presets, and activity tracking.

Product Details

High-Pressure Laminate Desks

Front (user's) edge profile is available in 3 mm edge profile.

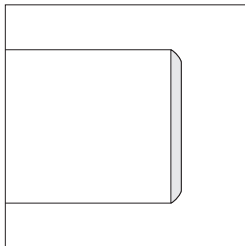

PVC-free, 3 mm edge profiles are proprietary polyolefin blend for all solid colors and seven woodgrain finishes. Matching 1 mm side and back edges are also PVC-free.

► See *Surface Materials* in this book for specific PVC-free availability, page 362.

Edge profile finishes are specified separately from laminate color.

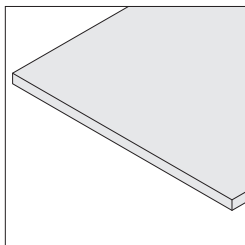

Square corners, available as an option, have 90° corners on all four sides with a front user's edge.

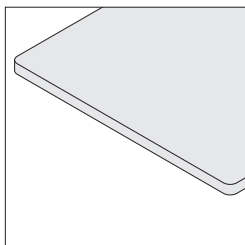

Radius corners, available as an option, have 1¼" radius on all four sides with a continuous user's edge. Radius corners eliminate sharp edges and are appropriate for freestanding furniture.

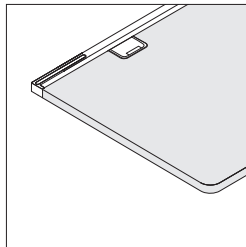

When radius corners are specified in applications with integrated rail, the front corners of the desk will be radius and the back corners will be square.

Wood Veneer Desks

Front (user's) edge profile is wood veneer with a square (3 mm) radius.

Side and back edges are flat. Wood edge color matches finish specified for desk. Corner style for wood veneer desks are square corners.

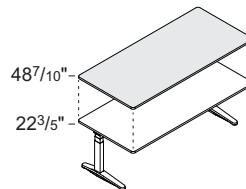

Extended ology desks adjust 22¾"H to 48 7/10"H in any increment. Basic height-adjustable base adjusts from 27¾"H–46¾"H in any increment.

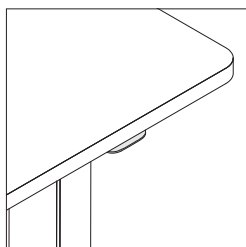

Simple touch controller is available as an option and easily adjusts height of desk, at a rate of 1½" per second, by lifting or pressing down on the controller.

Tip: Optional antimicrobial additive available.

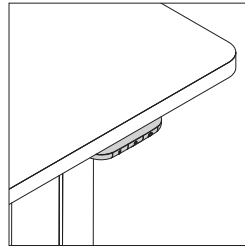

Active touch controller is Bluetooth-enabled and is standard and includes digital display, two preset buttons, double-tap automatic drive, and active motion posture reminders.

Tip: Steelcase Rise mobile app is available that pairs with any active touch controller to support preferences, presets, and activity tracking.

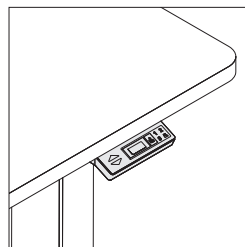

4 pre-set programmable controller is available as an option. It allows users to set the seated and standing height positions or pre-set heights for multiple users. The collaboration button can be programmed to raise the desk to an average standing height for shoulder to shoulder/dyadic collaboration. Digital display will show the height of the desk when adjusting and at rest before it enters sleep mode.

Gyroscopic obstruction sensing technology is standard with all Ology desks. The worksurface will backtrack when it makes contact with an object or detects tilt.

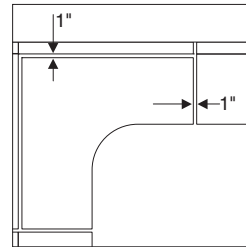

Desk sizes are listed in actual dimensions to allow for 1" gap to adjacent furniture eliminating any pinch points.

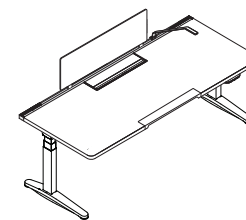

Integrated rail, available as an option, allows for the mounting of personal/modesty screens, lights, power strips, and other worktools.

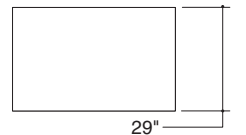

The overall dimension of the worksurface is 23"D, 29"D, or 35"D. If full depth worksurfaces are desired, add 1" to each depth.

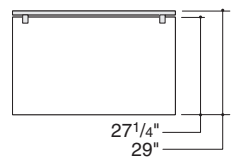

Integrated rail is optional and must be specified on initial order. It cannot be added after install. Worksurface depth is shortened by 1¾" to accommodate the integrated rail so the overall footprint remains the same.

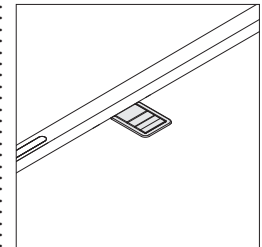

Cord drop is standard when rail is specified and power door or grommets are not optioned to allow for cords to drop below the surface. Corner desks will have a cord drop on opposite side when power door or grommets are specified on a single side.



Desk overhang for CPU holder or layering of low storage and pedestals is available as an option on rectangular desks. The overhang is 9" and available on 64"W or larger desks. Desk widths 70"W or larger allow for single or dual overhang.

Tip: Overhang not available on 35"D or 36"D.

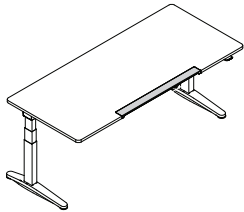

Soft edge, available as an option, is polyurthane and is offered with Bactiblock, an antimicrobial additive. Soft edge is available on rectangular and tapered desks that are 58"W or wider without overhang. With a left or right overhang, soft edge is available on 70"W and 76"W only. Soft edge cannot be used on desks that have overhang on both left and right.

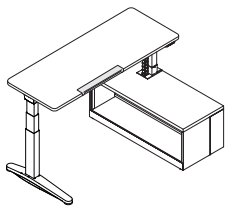

Soft edge can be positioned left or right on desks that are 64"W or wider for use with integrated storage. *Tip: Soft edge is shifted 3" on 64"W, 6" on 70"W, and 9" on 76"W, without overhang.*

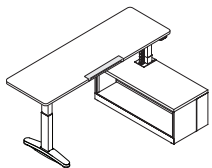

Worksurface overhang can be positioned left or right on desks that are 70" wide or wider for use with integrated storage. *Tip: Overhang not available on 35"D or 36"D.*

Ology desk with integrated storage must be specified with modular widths only. When opting for parametric widths, integrated storage is not available.

Steelcase guidance for height adjustment obstruction sensing technology (OST):

- Always read and follow all instructions and safety messages before positioning and using powered, height-adjustable products. Obstruction Sensing Technology (OST) is primarily intended to protect internal mechanisms and is only one part of the overall product system.
- OST is intended to detect hard, immovable objects that contact the desk during raising or lowering.
- OST may not detect soft and/or flexible objects such as padded arm caps, compliant seating surfaces, and cushion tops of peds.
- OST may not detect dynamic and/or articulating objects such as adjustable chair backs and chair arms.
- Different Steelcase height adjustable desks and benches have different types of OST that does not all behave the same.
- OST is disabled during the recalibration/synchronization process, but the unit moves at a much slower speed.

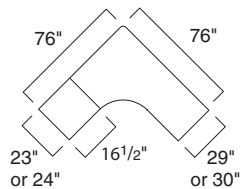

90° desks, 60¹/₁₆" x 60¹/₁₆" and wider, are manufactured in two pieces due to laminate sheet size. Flush mounted desk bracing is provided. The desk split is located on the left side if an equal corner is specified. The split is located on the longest side if an extended corner is specified.

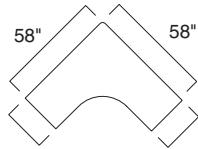

90° desks can be specified 23", 24", 29", or 30" deep. Right- and left-hand depths are not required to match.

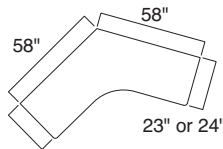

120° desks can be specified 23", 24", 29", or 30" deep. Right- and left-hand depths must match.



CarbonNeutral.com
CarbonNeutral product in the Ology portfolio helps organizations achieve their carbon emissions goals. Order **OLSLRQCN, OLELRQCN, OLSLL3CN, or OLELL3CN** to specify Ology with CarbonNeutral product certification.

Wiring and Cabling

Low surge electric motor with quiet operation adjusts at 1 1/2" per second. Motor is 110V and includes a 10⁴/₅' power cord. Motor has 0.1W standby power.

Chicago requires that desks shipping into Illinois ship with a 9' power cord.

Ology desks are NRTL listed, and the Ology base is NRTL listed when constructed in accordance with the assembly directions.

Controller may be placed on either the left or right side of the desk.

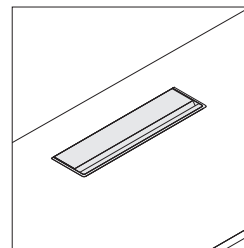

Power and data access door and tray with USB A+C 20W is available as an option. The door is 16 1/2"W and centered on the surface, can be off set starting at 64"W providing user access to power, data, and USB A+C 20W, as well as cord management. Corner desks can support the access door on either side of the desk or on both sides and will have a cord drop on opposite side when an integrated rail is specified.

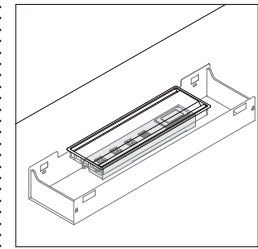

Power strip, located in tray, includes three outlets and easy access to two USB A+C 20W charging ports. Cord length is 10'. Data can be terminated and accessed in the tray, and it is positioned to the right. Both modular furniture and NEMA faceplates can be used. Chicago and California have special requirements. Desks shipping to Illinois and California with the power access door option have a powerstrip with overcurrent protection.

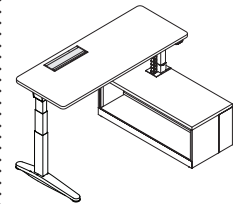

Power and data access door and tray can be positioned left or right on desks that are 64"W or wider for use with integrated storage. *Tip: Power and data access door and tray is shifted 3" on 64"W, 6" on 70"W, and 9" on 76"W, without overhang.*

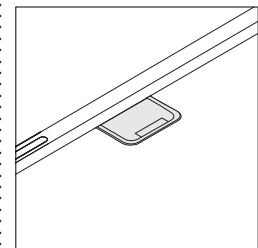

Grommets, available as an option, help manage cable/cords going from the top of desk to the underside. Grommet inside dimensions are 3 1/4"W X 3 3/4"D.

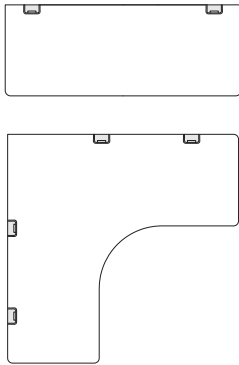

Grommets come in pairs. 90° and 120° corners offer pairs of grommets on the left side, right side, or both sides. 90° widths smaller than 58"W and 120° widths smaller than 40"W have a single grommet.
Tip: When grommet is optional, power and data access door cannot be applied on the same side of the worksurface.

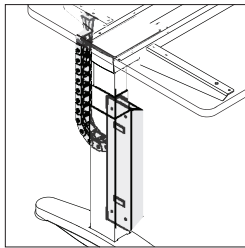

Cable riser supports cable management vertically between the floor and the underside of the desk. It is available in 6527 Merle and is specified separately.
▶ Specifying, page 135

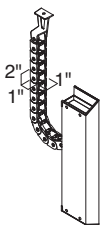

Cable riser, with leg connection, inside dimensions are 1"D x 1"W to accommodate a variety of cord sizes. Overall depth is 2".

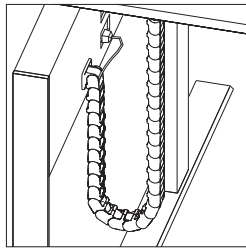

Cable riser, with fence connection, inside dimensions are 1"D x 1"W to accommodate a variety of cord sizes. Overall depth is 2".

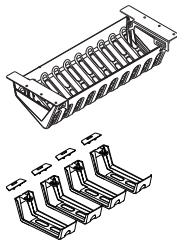

Cable basket and cable brackets, ordered separately, support horizontal cable management below the worksurface.
▶ Specifying, page 135

Cable baskets are available on rectangular, tapered, and 90° corner desks 46 1/16"W or larger, and 120° corner desks 40"W or larger.

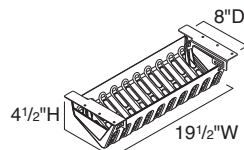

Cable baskets inside dimensions are 6"D x 17 3/4"W x 4 1/4"H and the overall dimensions are 8"D x 19 1/2"W x 4 1/2"H.

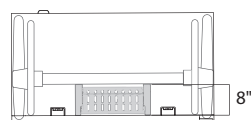

Cable basket requires 8"D of clearance to install. The cable basket bracket is universal which allows for front or back facing orientation. Front access only when used with integrated rail.



Inside dimensions of cable brackets are 6"D x 2"H.

Surface Materials

High-Pressure Laminate Desk

- Laminate
▶ See *Surface Materials*, page 362
- Open Line laminate (option)
A program including non-Steelcase laminates which are suitable for use on Steelcase products.
▶ See *Surface Materials Reference Manual*.

3 mm edge profile

- Plastic

Wood Veneer Desk

- Wood veneer (standard)
- Customiz stain (option)

Square 3 mm edge profile

- Wood veneer to match desk

Height-adjustable base

- 4799 Platinum Metallic
- 7207 Black
- 7241 Arctic White
- 7360 Merle

Soft edge and grommet

- 6527 Merle

Power and Data Access Door and Tray

Door

- Paint
- Anodized Aluminum

Door bezel

- 6527 Merle

Application Topics

Moving desks can collide with other components. Do not install overhead storage, desk-height power, or desk accessories in the path of height-adjustable desks.
▶ See page 32

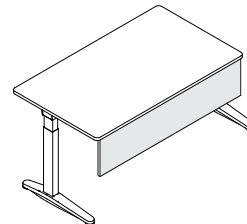

Modesty panels, available in laminate and wood veneer, attach to the understructure of the desk. It is parametric in width from 1/16". Width of modesty panel can be equal to or less than the width of the desk.

Tip: Full-width modesty panels cannot be used on desks with integrated rail. To use with the integrated rail, the modesty panel must be undersized by a minimum of 20" (rectangular and tapered), or 19" (90°), and 16" (120°) and inset from the edge of the worksurface.

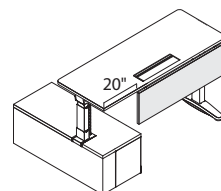

When using modesty panels with integrated storage, modesty panels must be specified 20" smaller than the width of the desk.

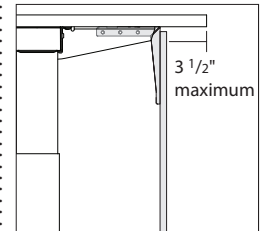

Modesty panels may be inset a maximum of 3 1/2" from the back of the worksurface to allow for c-clamping.
Tip: Inset modesty panels do not work with the power access door option or the cable basket and cable brackets.

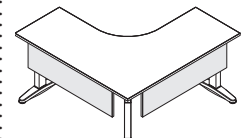

In order to inset, modesty panels must be specified a minimum of 16" or less (rectangular and tapered) or 14" or less (90°) and 10" or less (120°) than the width of the desk understructure.

Tip: Inset modesty panels do not work with the power access door option or the cable basket and cable brackets.

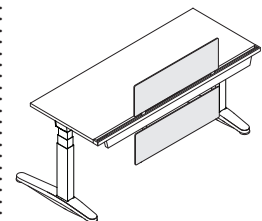

Fixed privacy/modesty screens mount on the integrated rail above for privacy and below for modesty.
Tip: 19 1/2"H and 24"H are for privacy use only.

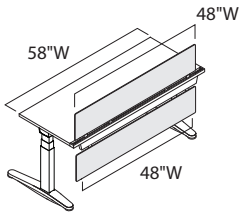

When using fixed screens in the modesty position, the desk must be at least 10" wider than the width of the screen.

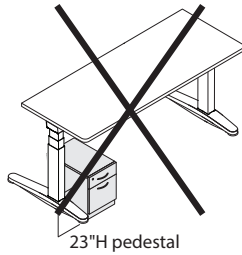

On extended height desks, any storage higher than 18" will impede the height range of the desk. On basic height desks, any storage higher than 23" will impede the height range of the desk.
Tip: Do not place storage underneath controller.

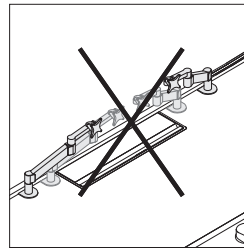
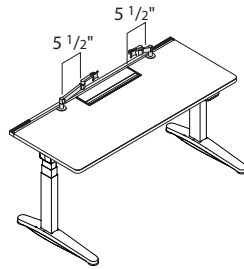

When optioning both the integrated rail and power access door, monitor arms cannot be c-clamped 5 1/2" on either side of the power door.

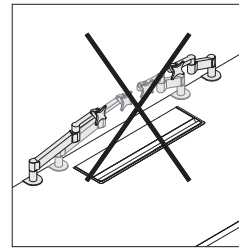
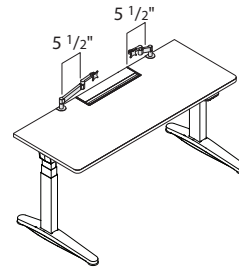

When optioning the power access door only, monitor arms cannot be c-clamped behind the power door or within 5 1/2" to either side.

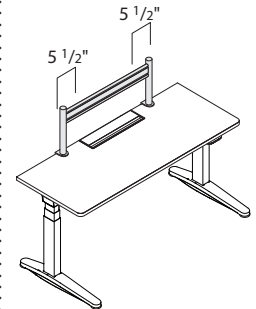

When installing SlatRail with a power door only, do not c-clamp the stanchions within 5 1/2" on either side of the power door.

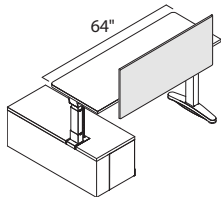

When mounting Universal privacy/modesty screens with One-High integrated storage, desks must be 64"W and wider.

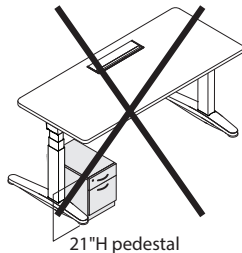

When the power access door is optioned, on extended height desks any storage taller than 15 1/2"H will impede the height range of the desk. On basic height desks, any storage taller than 20 1/2"H will impede the height range of the desk.
Tip: Do not place storage underneath controller.

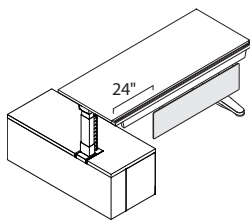

When using fixed screens in the modesty position with One-High integrated storage, the desk must be at least 24" wider than the width of the screen.

Monitor arms cannot be rail mounted.
▶ See page 58 for *Steelcase Monitor Arm Guidelines*.

When optioning the integrated rail and using a cable basket, there will not be enough room to C-clamp behind the basket.

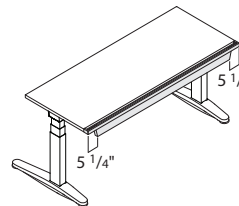

When attaching lighting to the integrated rail, there is a 5 1/4" mounting free zone on each end of the rail.

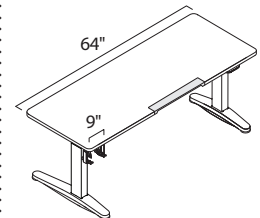

When mounting CPU holders, specify the overhang option.
Tip: CPU holders that require less than 12"D clearance may be mounted inboard of legs.

Tip: Maximum CPU weight capacity is 40 lbs.

Tip: Only standard Stella or 5" lift and lock mechanisms should be used.

Tip: CPU holders are not allowed on 35"D or 36"D worksurfaces.

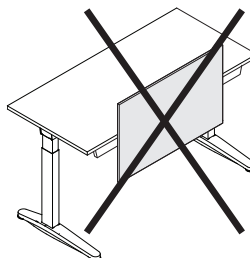

Universal boundary screens are not permitted on height-adjustable desks, as they do not pass minimum safety requirements which could result in the desk tipping over.

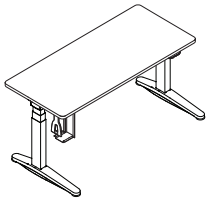

On extended height desks, CPUs installed in a CPU holder should not be installed over the foot or exceed 16" high, or it will impede the height range of the desk.

All assemblies meet or exceed ANSI/BIFMA standards.



Read base only warranty limitations.

► See page 32 for *Workstation Design Guidelines and Requirements*.

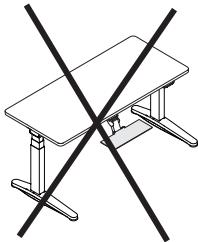

Keyboard assemblies are not allowed on rectangle or tapered 24"D or smaller and smaller than 46"W height-adjustable desks. They do not meet minimum safety requirements.

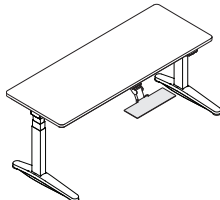

Steelcase keyboard assemblies can be installed on rectangle or tapered 29"/30"D Ology. Specify desks 46"W and wider and with an 11" track.

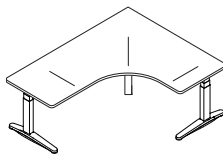

For rectangle and tapered desks:

- 23"D/24"D - keyboard not allowed
- 29"D/30"D and 46"W or wider - specify 11" track
- 35"D/36"D - specify up to 17" track

For 90°/120° desks (keyboard mounted on sides):

- 23"D/24"D - keyboard not allowed
- 29"D/30"D - specify 11" track

For 90° desks (keyboard mounted on corner):

- Specify up to 20" track

For 120° desks (keyboard mounted on corner):

- Specify up to 17" track

Ology Height-Adjustable Desks, continued

Installation

Desks ship with pre-drilled holes for mounting bases.

Two-piece tops ship with flush mounted desk bracing.

Height-adjustable base requires attachment to the worksurface.

Base supports a maximum distributed weight capacity of 360 pounds (2-leg) and 500 pounds (3-leg).

Tip: 2-leg desks that have an overhang, or are 35"D or 36"D will have a distributed weight capacity of 300 pounds (136.1 kg).

Tip: When calculating lifting capacity, subtract the weight of the worksurface, understructure and options (i.e. integrated rail, power and data access door or soft edge).

Tip: A label applied to the underside of the worksurface will include the load-capacity for each desk.

Worksurface Weight

Worksurface Shape **W** **LD** **RD** **Worksurface Weight**

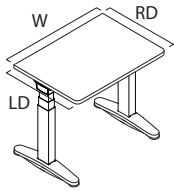

				23"D	24"D
Rectangular	34"	23" or 24"	23" or 24"	20 lb	21 lb
	40"	23" or 24"	23" or 24"	24 lb	25 lb
	46"	23" or 24"	23" or 24"	27 lb	29 lb
	52"	23" or 24"	23" or 24"	31 lb	32 lb
	58"	23" or 24"	23" or 24"	35 lb	36 lb
	64"	23" or 24"	23" or 24"	39 lb	40 lb
	70"	23" or 24"	23" or 24"	42 lb	43 lb
	76"	23" or 24"	23" or 24"	46 lb	47 lb
				29"D	30"D
	34"	29" or 30"	29" or 30"	26 lb	27 lb
	40"	29" or 30"	29" or 30"	30 lb	31 lb
	46"	29" or 30"	29" or 30"	34 lb	36 lb
	52"	29" or 30"	29" or 30"	39 lb	41 lb
	58"	29" or 30"	29" or 30"	43 lb	45 lb
	64"	29" or 30"	29" or 30"	48 lb	50 lb
	70"	29" or 30"	29" or 30"	52 lb	54 lb
	76"	29" or 30"	29" or 30"	56 lb	59 lb
				35"D	36"D
	34"	35" or 36"	35" or 36"	31 lb	32 lb
	40"	35" or 36"	35" or 36"	36 lb	37 lb
	46"	35" or 36"	35" or 36"	42 lb	43 lb
	52"	35" or 36"	35" or 36"	47 lb	48 lb
	58"	35" or 36"	35" or 36"	52 lb	54 lb
	64"	35" or 36"	35" or 36"	58 lb	60 lb
	70"	35" or 36"	35" or 36"	63 lb	65 lb
	76"	35" or 36"	35" or 36"	69 lb	71 lb

Understructure Weight	Options		Power and Data Access Door Weight	Soft Edge Weight	Accessory
	Integrated Rail Weight				Modesty Panel Weight*
7.8 lb	5.1 lb		N.A.	N.A.	15.2 lb
9.0 lb	5.8 lb		6.9 lb	N.A.	17.6 lb
10.1 lb	6.6 lb		6.9 lb	N.A.	20.0 lb
11.3 lb	7.3 lb		6.9 lb	N.A.	22.4 lb
12.4 lb	8.0 lb		6.9 lb	2.6 lb	24.8 lb
13.6 lb	8.8 lb		6.9 lb	2.6 lb	27.3 lb
14.8 lb	9.5 lb		6.9 lb	2.6 lb	29.7 lb
15.9 lb	10.2 lb		6.9 lb	2.6 lb	32.1 lb
7.8 lb	5.1 lb		N.A.	N.A.	15.2 lb
9.0 lb	5.8 lb		6.9 lb	N.A.	17.6 lb
10.1 lb	6.6 lb		6.9 lb	N.A.	20.0 lb
11.3 lb	7.3 lb		6.9 lb	N.A.	22.4 lb
12.4 lb	8.0 lb		6.9 lb	2.6 lb	24.8 lb
13.6 lb	8.8 lb		6.9 lb	2.6 lb	27.3 lb
14.8 lb	9.5 lb		6.9 lb	2.6 lb	29.7 lb
15.9 lb	10.2 lb		6.9 lb	2.6 lb	32.1 lb
8.9 lb	5.1 lb		N.A.	N.A.	15.2 lb
10.1 lb	5.8 lb		6.9 lb	N.A.	17.6 lb
11.1 lb	6.6 lb		6.9 lb	N.A.	20.0 lb
12.3 lb	7.3 lb		6.9 lb	N.A.	22.4 lb
13.5 lb	8.0 lb		6.9 lb	2.6 lb	24.8 lb
14.6 lb	8.8 lb		6.9 lb	2.6 lb	27.3 lb
15.8 lb	9.5 lb		6.9 lb	2.6 lb	29.7 lb
17.0 lb	10.2 lb		6.9 lb	2.6 lb	32.1 lb

*For detailed modesty panel information, see page 92

Ology Height-Adjustable Desks, continued

Base supports a maximum distributed weight capacity of 360 pounds (2-leg) and 500 pounds (3-leg).

Tip: 2-leg desks that have an overhang, or are 35"D or 36"D will have a distributed weight capacity of 300 pounds (136.1 kg).

Tip: When calculating lifting capacity, subtract the weight of the worksurface, understructure and options (i.e. integrated rail, power and data access door or soft edge).

Tip: A label applied to the underside of the worksurface will include the load-capacity for each desk.

Worksurface Weight, continued

Worksurface Shape	W	LD	RD	Worksurface Weight	
				23"D/29"D	24"D/30"D

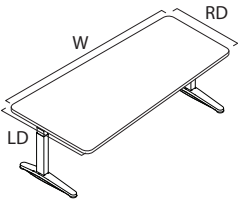

Tapered	58"	29" or 30"	23" or 24"	39 lb	40 lb
	64"	29" or 30"	23" or 24"	43 lb	45 lb
	70"	29" or 30"	23" or 24"	47 lb	49 lb
	76"	29" or 30"	23" or 24"	51 lb	53 lb
	58"	23" or 24"	29" or 30"	39 lb	40 lb
	64"	23" or 24"	29" or 30"	43 lb	45 lb
	70"	23" or 24"	29" or 30"	47 lb	49 lb
	76"	23" or 24"	29" or 30"	51 lb	53 lb

Worksurface Shape	LW	LD	RW	RD	Worksurface Weight	
					23"D	24"D

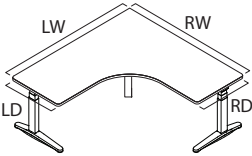

90° Equal 3-Leg	52"	23" or 24"	52"	23" or 24"	58.2 lb	59.2 lb
	58"	23" or 24"	58"	23" or 24"	66.6 lb	67.6 lb
	64"	23" or 24"	64"	23" or 24"	75.0 lb	77.0 lb
	70"	23" or 24"	70"	23" or 24"	83.4 lb	85.4 lb
	76"	23" or 24"	76"	23" or 24"	91.8 lb	94.8 lb

• Understructure Weight	• Options			• Soft Edge Weight	• Accessory
	• Integrated Rail Weight	• Power and Data Access Door Weight			• Modesty Panel Weight*
12.4 lb	8.0 lb	6.9 lb		2.6 lb	24.8 lb
13.6 lb	8.8 lb	6.9 lb		2.6 lb	27.3 lb
14.8 lb	9.5 lb	6.9 lb		2.6 lb	29.7 lb
15.9 lb	10.2 lb	6.9 lb		2.6 lb	32.1 lb
12.4 lb	8.0 lb	6.9 lb		2.6 lb	24.8 lb
13.6 lb	8.8 lb	6.9 lb		2.6 lb	27.3 lb
14.8 lb	9.5 lb	6.9 lb		2.6 lb	29.7 lb
15.9 lb	10.2 lb	6.9 lb		2.6 lb	32.1 lb

• Understructure Weight	• Options			• Soft Edge Weight
	• Integrated Rail Weight	• Power and Data Access Door Weight		
15.1 lb	15.8 lb	N.A.		N.A.
17.5 lb	17.3 lb	6.9 lb each		N.A.
19.6 lb	18.7 lb	6.9 lb each		N.A.
22.0 lb	20.2 lb	6.9 lb each		N.A.
24.3 lb	21.7 lb	6.9 lb each		N.A.

*For detailed modesty panel information, see page 92

Ology Height-Adjustable Desks, continued

Base supports a maximum distributed weight capacity of 360 pounds (2-leg) and 500 pounds (3-leg).

Tip: 2-leg desks that have an overhang, or are 35"D or 36"D will have a distributed weight capacity of 300 pounds (136.1 kg).

Tip: When calculating lifting capacity, subtract the weight of the worksurface, understructure and options (i.e. integrated rail, power and data access door or soft edge).

Tip: A label applied to the underside of the worksurface will include the load-capacity for each desk.

Worksurface Weight, continued

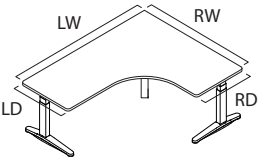
Worksurface Shape	LW	LD	RW	RD	Worksurface Weight	
					23"D/23"D	24"D/24"D
	40"	23" or 24"	52"	23" or 24"	49.8 lb	50.8 lb
	40"	23" or 24"	58"	23" or 24"	54.1 lb	55.1 lb
	40"	23" or 24"	64"	23" or 24"	58.2 lb	59.2 lb
	40"	23" or 24"	70"	23" or 24"	62.4 lb	63.4 lb
	40"	23" or 24"	76"	23" or 24"	66.6 lb	67.6 lb
	46"	23" or 24"	52"	23" or 24"	54.0 lb	55.0 lb
	46"	23" or 24"	58"	23" or 24"	58.2 lb	59.2 lb
	46"	23" or 24"	64"	23" or 24"	62.4 lb	64.4 lb
	46"	23" or 24"	70"	23" or 24"	66.6 lb	68.6 lb
	46"	23" or 24"	76"	23" or 24"	70.8 lb	72.8 lb
	52"	23" or 24"	40"	23" or 24"	49.8 lb	50.8 lb
	52"	23" or 24"	46"	23" or 24"	54.0 lb	55.0 lb
	52"	23" or 24"	58"	23" or 24"	62.4 lb	63.4 lb
	52"	23" or 24"	64"	23" or 24"	66.6 lb	67.6 lb
	52"	23" or 24"	70"	23" or 24"	70.8 lb	72.8 lb
	52"	23" or 24"	76"	23" or 24"	75.0 lb	77.0 lb
	58"	23" or 24"	40"	23" or 24"	54.1 lb	55.1 lb
	58"	23" or 24"	46"	23" or 24"	58.2 lb	59.2 lb
	58"	23" or 24"	52"	23" or 24"	62.4 lb	63.4 lb
	58"	23" or 24"	64"	23" or 24"	70.8 lb	72.8 lb
58"	23" or 24"	70"	23" or 24"	75.0 lb	77.0 lb	
58"	23" or 24"	76"	23" or 24"	79.2 lb	81.2 lb	
64"	23" or 24"	40"	23" or 24"	58.2 lb	59.2 lb	
64"	23" or 24"	46"	23" or 24"	62.4 lb	64.4 lb	
64"	23" or 24"	52"	23" or 24"	66.6 lb	67.6 lb	
64"	23" or 24"	58"	23" or 24"	70.8 lb	72.8 lb	
64"	23" or 24"	70"	23" or 24"	79.2 lb	82.2 lb	
64"	23" or 24"	76"	23" or 24"	83.4 lb	86.4 lb	

Understructure Weight	Options		
	Integrated Rail Weight	Power and Data Access Door Weight	Soft Edge Weight
13.5 lb	18.8 lb	6.9 lb each	N.A.
14.6 lb	19.9 lb	6.9 lb each	N.A.
15.7 lb	20.9 lb	6.9 lb each	N.A.
16.9 lb	21.9 lb	6.9 lb each	N.A.
18.0 lb	23.0 lb	6.9 lb each	N.A.
14.7 lb	19.9 lb	6.9 lb each	N.A.
15.8 lb	20.9 lb	6.9 lb each	N.A.
16.9 lb	21.9 lb	6.9 lb each	N.A.
18.1 lb	23.0 lb	6.9 lb each	N.A.
19.2 lb	24.0 lb	6.9 lb each	N.A.
13.5 lb	18.8 lb	6.9 lb each	N.A.
14.7 lb	19.9 lb	6.9 lb each	N.A.
16.3 lb	21.9 lb	6.9 lb each	N.A.
17.4 lb	23.0 lb	6.9 lb each	N.A.
18.5 lb	24.0 lb	6.9 lb each	N.A.
19.7 lb	25.1 lb	6.9 lb each	N.A.
14.6 lb	19.9 lb	6.9 lb each	N.A.
15.8 lb	20.9 lb	6.9 lb each	N.A.
16.3 lb	21.9 lb	6.9 lb each	N.A.
18.5 lb	24.0 lb	6.9 lb each	N.A.
19.7 lb	25.1 lb	6.9 lb each	N.A.
20.9 lb	26.1 lb	6.9 lb each	N.A.
15.7 lb	20.9 lb	6.9 lb each	N.A.
16.9 lb	21.9 lb	6.9 lb each	N.A.
17.4 lb	23.0 lb	6.9 lb each	N.A.
18.5 lb	24.0 lb	6.9 lb each	N.A.
20.8 lb	26.1 lb	6.9 lb each	N.A.
22.0 lb	27.1 lb	6.9 lb each	N.A.

Ology Height-Adjustable Desks, continued

Base supports a maximum distributed weight capacity of 360 pounds (2-leg) and 500 pounds (3-leg).

Tip: 2-leg desks that have an overhang, or are 35"D or 36"D will have a distributed weight capacity of 300 pounds (136.1 kg).

Tip: When calculating lifting capacity, subtract the weight of the worksurface, under-structure and options (i.e. integrated rail, power and data access door or soft edge).

Tip: A label applied to the underside of the worksurface will include the load-capacity for each desk.

Worksurface Weight, continued

Worksurface Shape	LW	LD	RW	RD	Worksurface Weight	
					23"D	24"D

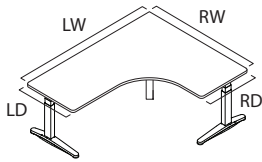

90° Extended 3-Leg, continued	70"	23" or 24"	40"	23" or 24"	62.4 lb	63.4 lb
	70"	23" or 24"	46"	23" or 24"	66.6 lb	68.6 lb
	70"	23" or 24"	52"	23" or 24"	70.8 lb	72.8 lb
	70"	23" or 24"	58"	23" or 24"	75.0 lb	77.0 lb
	70"	23" or 24"	64"	23" or 24"	79.2 lb	82.2 lb
	70"	23" or 24"	76"	23" or 24"	87.6 lb	90.6 lb
	76"	23" or 24"	40"	23" or 24"	66.6 lb	67.6 lb
	76"	23" or 24"	46"	23" or 24"	70.8 lb	72.8 lb
	76"	23" or 24"	52"	23" or 24"	75.0 lb	77.0 lb
	76"	23" or 24"	58"	23" or 24"	79.2 lb	81.2 lb
	76"	23" or 24"	64"	23" or 24"	83.4 lb	86.4 lb
	76"	23" or 24"	70"	23" or 24"	87.6 lb	90.6 lb

• Understructure Weight	• Options		
	• Integrated Rail Weight	• Power and Data Access Door Weight	• Soft Edge Weight
16.9 lb	21.9 lb	6.9 lb each	N.A.
18.1 lb	23.0 lb	6.9 lb each	N.A.
18.5 lb	24.0 lb	6.9 lb each	N.A.
19.7 lb	25.1 lb	6.9 lb each	N.A.
20.8 lb	26.1 lb	6.9 lb each	N.A.
23.1 lb	28.2 lb	6.9 lb each	N.A.
18.0 lb	23.0 lb	6.9 lb each	N.A.
19.2 lb	24.0 lb	6.9 lb each	N.A.
19.7 lb	25.1 lb	6.9 lb each	N.A.
20.9 lb	26.1 lb	6.9 lb each	N.A.
22.0 lb	27.1 lb	6.9 lb each	N.A.
23.1 lb	28.2 lb	6.9 lb each	N.A.

Ology Height-Adjustable Desks, continued

Base supports a maximum distributed weight capacity of 360 pounds (2-leg) and 500 pounds (3-leg).

Tip: 2-leg desks that have an overhang, or are 35"D or 36"D will have a distributed weight capacity of 300 pounds (136.1 kg).

Tip: When calculating lifting capacity, subtract the weight of the worksurface, under-structure and options (i.e. integrated rail, power and data access door or soft edge).

Tip: A label applied to the underside of the worksurface will include the load-capacity for each desk.

Worksurface Weight, continued

Worksurface Shape	LW	RW	Worksurface Weight	Worksurface Weight	Worksurface Weight
			LD and RD	LD and RD	LD and RD
			23"D/29"D	23"D/30"D	24"D/29"D

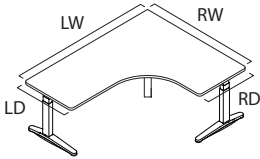

90° Extended 3-Leg	46"	40"	48.8 lb	49.3 lb	49.3 lb
	46"	52"	59.3 lb	60.2 lb	59.9 lb
	46"	58"	64.6 lb	65.7 lb	65.2 lb
	46"	64"	69.9 lb	71.2 lb	70.4 lb
	46"	70"	75.2 lb	76.6 lb	75.7 lb
	46"	76"	80.5 lb	82.1 lb	81.0 lb
	46"	78"	82.3 lb	83.9 lb	82.8 lb
	52"	40"	53.0 lb	53.5 lb	53.7 lb
	52"	46"	58.3 lb	59.0 lb	59.0 lb
	52"	58"	68.8 lb	69.9 lb	69.5 lb
	52"	64"	74.1 lb	75.4 lb	74.8 lb
	52"	70"	79.4 lb	80.8 lb	80.1 lb
	52"	76"	84.7 lb	86.3 lb	85.4 lb
	52"	78"	86.5 lb	88.1 lb	87.2 lb
	58"	40"	57.2 lb	57.7 lb	58.0 lb
	58"	46"	62.4 lb	63.1 lb	63.3 lb
	58"	52"	67.7 lb	68.6 lb	68.6 lb
	58"	64"	78.3 lb	79.6 lb	79.2 lb
	58"	70"	83.6 lb	85.0 lb	84.5 lb
	58"	76"	88.9 lb	90.5 lb	89.8 lb
	58"	78"	90.7 lb	92.3 lb	91.5 lb
	64"	40"	61.4 lb	61.9 lb	62.4 lb
	64"	46"	66.6 lb	67.3 lb	67.7 lb
	64"	52"	71.9 lb	72.8 lb	73.0 lb
	64"	58"	77.2 lb	78.3 lb	78.3 lb
	64"	70"	87.8 lb	89.2 lb	88.9 lb
	64"	76"	93.1 lb	94.7 lb	94.2 lb
	64"	78"	94.9 lb	96.5 lb	95.9 lb

•Worksurface Weight LD and RD	•Worksurface Weight LD and RD	•Worksurface Weight LD and RD	•Worksurface Weight LD and RD
24"D/30"D	29"D/29"D	29"D/30"D	30"D/30"D
49.8 lb	N.A.	N.A.	N.A.
60.7 lb	62.4 lb	63.1 lb	63.6 lb
66.2 lb	67.7 lb	68.6 lb	69.1 lb
71.7 lb	73.0 lb	74.1 lb	74.6 lb
77.1 lb	78.3 lb	79.6 lb	80.0 lb
82.6 lb	83.6 lb	85.0 lb	85.5 lb
84.4 lb	85.4 lb	86.9 lb	87.3 lb
54.1 lb	N.A.	N.A.	N.A.
59.6 lb	62.4 lb	63.0 lb	63.6 lb
70.6 lb	73.0 lb	73.9 lb	74.6 lb
76.0 lb	78.3 lb	79.4 lb	80.0 lb
81.5 lb	83.6 lb	84.9 lb	85.5 lb
87.0 lb	88.9 lb	90.3 lb	91.0 lb
88.8 lb	90.7 lb	92.1 lb	92.8 lb
58.5 lb	N.A.	N.A.	N.A.
64.0 lb	67.7 lb	68.3 lb	69.1 lb
69.5 lb	73.0 lb	73.7 lb	74.6 lb
80.4 lb	83.6 lb	84.7 lb	85.5 lb
85.9 lb	88.9 lb	90.1 lb	91.0 lb
91.4 lb	94.2 lb	95.6 lb	96.5 lb
93.2 lb	95.9 lb	97.4 lb	98.3 lb
62.9 lb	N.A.	N.A.	N.A.
68.4 lb	73.0 lb	73.5 lb	74.6 lb
73.8 lb	78.3 lb	79.0 lb	80.0 lb
79.3 lb	83.6 lb	84.5 lb	85.5 lb
90.3 lb	94.2 lb	95.4 lb	96.5 lb
95.7 lb	99.5 lb	100.9 lb	101.9 lb
97.6 lb	101.2 lb	102.7 lb	103.8 lb

Ology Height-Adjustable Desks, continued

Base supports a maximum distributed weight capacity of 360 pounds (2-leg) and 500 pounds (3-leg).

Tip: 2-leg desks that have an overhang, or are 35"D or 36"D will have a distributed weight capacity of 300 pounds (136.1 kg).

Tip: When calculating lifting capacity, subtract the weight of the worksurface, under-structure and options (i.e. integrated rail, power and data access door or soft edge).

Tip: A label applied to the underside of the worksurface will include the load-capacity for each desk.

Worksurface Weight, continued

Worksurface Shape	LW	RW	Worksurface Weight	Worksurface Weight	Worksurface Weight
			LD and RD	LD and RD	LD and RD
			23"D/29"D	23"D/30"D	24"D/29"D

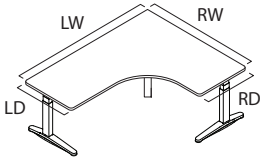

90° Extended 3-Leg	70"	40"	65.5 lb	66.1 lb	66.8 lb
	70"	46"	70.8 lb	71.5 lb	72.1 lb
	70"	52"	76.1 lb	77.0 lb	77.4 lb
	70"	58"	81.4 lb	82.5 lb	82.7 lb
	70"	64"	86.7 lb	88.0 lb	88.0 lb
	70"	76"	97.3 lb	98.9 lb	98.5 lb
	70"	78"	99.0 lb	100.7 lb	100.3 lb
	76"	40"	69.7 lb	70.3 lb	71.2 lb
	76"	46"	75.0 lb	75.7 lb	76.5 lb
	76"	52"	80.3 lb	81.2 lb	81.8 lb
	76"	58"	85.6 lb	86.7 lb	87.0 lb
	76"	64"	90.9 lb	92.1 lb	92.3 lb
	76"	70"	96.2 lb	97.6 lb	97.6 lb
	76"	78"	103.2 lb	104.9 lb	104.7 lb

Worksurface Weight LD and RD	Worksurface Weight LD and RD	Worksurface Weight LD and RD	Worksurface Weight LD and RD
24"D/30"D	29"D/29"D	29"D/30"D	30"D/30"D
67.3 lb	N.A.	N.A.	N.A.
72.8 lb	78.3 lb	78.8 lb	80.0 lb
78.2 lb	83.6 lb	84.3 lb	85.5 lb
83.7 lb	88.9 lb	89.8 lb	91.0 lb
89.2 lb	94.2 lb	95.2 lb	96.5 lb
100.1 lb	104.8 lb	106.2 lb	107.4 lb
101.9 lb	106.5 lb	108.0 lb	109.2 lb
71.7 lb	N.A.	N.A.	N.A.
77.1 lb	83.6 lb	84.1 lb	85.5 lb
82.6 lb	88.9 lb	89.6 lb	91.0 lb
88.1 lb	94.2 lb	95.1 lb	96.5 lb
93.5 lb	99.5 lb	100.5 lb	101.9 lb
99.0 lb	104.8 lb	106.0 lb	107.4 lb
106.3 lb	111.8 lb	113.3 lb	114.7 lb

Ology Height-Adjustable Desks, continued

Base supports a maximum distributed weight capacity of 360 pounds (2-leg) and 500 pounds (3-leg).

Tip: 2-leg desks that have an overhang, or are 35"D or 36"D will have a distributed weight capacity of 300 pounds (136.1 kg).

Tip: When calculating lifting capacity, subtract the weight of the worksurface, under-structure and options (i.e. integrated rail, power and data access door or soft edge).

Tip: A label applied to the underside of the worksurface will include the load-capacity for each desk.

Worksurface Weight, continued

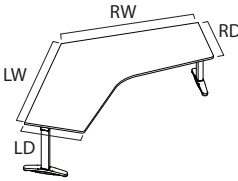
Worksurface Shape	LW	LD	RW	RD	Worksurface Weight			
					23"D	24"D	29"D	30"D
	34"	23", 24", 29" or 30"	34"	23", 24", 29" or 30"	38.7 lb	39.7 lb	38.9 lb	39.6 lb
	40"	23", 24", 29" or 30"	40"	23", 24", 29" or 30"	47.1 lb	48.1 lb	47.9 lb	48.9 lb
	46"	23", 24", 29" or 30"	46"	23", 24", 29" or 30"	55.5 lb	56.5 lb	57.3 lb	58.5 lb
	52"	23", 24", 29" or 30"	52"	23", 24", 29" or 30"	63.9 lb	65.9 lb	62.7 lb	64.2 lb
	58"	23", 24", 29" or 30"	58"	23", 24", 29" or 30"	72.3 lb	74.3 lb	72.0 lb	73.8 lb
	64"	23", 24", 29" or 30"	64"	23", 24", 29" or 30"	80.7 lb	82.7 lb	81.4 lb	83.5 lb

Tip: Right- and left-hand depths must match.

• Understructure Weight	• Integrated Rail Weight	• Power and Data Access Door Weight	• Soft Edge Weight
11.8 lb	11.5 lb	N.A.	N.A.
14.2 lb	13.0 lb	N.A.	N.A.
15.1 lb	14.5 lb	N.A.	N.A.
17.5 lb	15.9 lb	6.9 lb each	N.A.
19.6 lb	17.4 lb	6.9 lb each	N.A.
22.0 lb	18.9 lb	6.9 lb each	N.A.

Ology Corner Desks and Bases Size Restrictions

Style	Desks Specified as	Base Price	Desks Specified as	Base Price
90° Corner Desks — Extended Height (Different Depth Opposite Ends 23"/24" Right/Left and 29"/30" Left/Right)				
High-Pressure Laminate Desks				
OLELL3	40WL x 23DL x 52WR x 29DR	N.A.	40WL x 29DL x 52WR x 23DR	\$4160
	40WL x 24DL x 52WR x 29DR	N.A.	40WL x 29DL x 52WR x 24DR	\$4160
	40WL x 23DL x 58WR x 29DR	N.A.	40WL x 29DL x 58WR x 23DR	\$4298
	40WL x 24DL x 58WR x 29DR	N.A.	40WL x 29DL x 58WR x 24DR	\$4298
	40WL x 23DL x 64WR x 29DR	N.A.	40WL x 29DL x 64WR x 23DR	\$4437
	40WL x 24DL x 64WR x 29DR	N.A.	40WL x 29DL x 64WR x 24DR	\$4437
	40WL x 23DL x 70WR x 29DR	N.A.	40WL x 29DL x 70WR x 23DR	\$4573
	40WL x 24DL x 70WR x 29DR	N.A.	40WL x 29DL x 70WR x 24DR	\$4573
	40WL x 23DL x 76WR x 29DR	N.A.	40WL x 29DL x 76WR x 23DR	\$4714
	40WL x 24DL x 76WR x 29DR	N.A.	40WL x 29DL x 76WR x 24DR	\$4714
	40WL x 23DL x 52WR x 30DR	N.A.	40WL x 30DL x 52WR x 23DR	\$4160
	40WL x 24DL x 52WR x 30DR	N.A.	40WL x 30DL x 52WR x 24DR	\$4160
	40WL x 23DL x 58WR x 30DR	N.A.	40WL x 30DL x 58WR x 23DR	\$4298
	40WL x 24DL x 58WR x 30DR	N.A.	40WL x 30DL x 58WR x 24DR	\$4298
	40WL x 23DL x 64WR x 30DR	N.A.	40WL x 30DL x 64WR x 23DR	\$4437
	40WL x 24DL x 64WR x 30DR	N.A.	40WL x 30DL x 64WR x 24DR	\$4437
	40WL x 23DL x 70WR x 30DR	N.A.	40WL x 30DL x 70WR x 23DR	\$4573
	40WL x 24DL x 70WR x 30DR	N.A.	40WL x 30DL x 70WR x 24DR	\$4573
	40WL x 23DL x 76WR x 30DR	N.A.	40WL x 30DL x 76WR x 23DR	\$4714
	40WL x 24DL x 76WR x 30DR	N.A.	40WL x 30DL x 76WR x 24DR	\$4714
	52WL x 29DL x 40WR x 23DR	N.A.	52WL x 23DL x 40WR x 29DR	\$4160
	52WL x 29DL x 40WR x 24DR	N.A.	52WL x 24DL x 40WR x 29DR	\$4160
	52WL x 30DL x 40WR x 23DR	N.A.	52WL x 23DL x 40WR x 30DR	\$4160
	52WL x 30DL x 40WR x 24DR	N.A.	52WL x 24DL x 40WR x 30DR	\$4160

Tip: When the 90° desk width is 40"-42" and 23"/24" deep on one end AND the opposite end is 29"/30" deep, product size limits apply. The width must be increased to 46"W or greater.

Tip: When specifying 3-leg 90° equal corners the smallest width available is 52" x 52", regardless of depth.

Tip: When specifying 3-leg 90° extended corners the smallest width available is 40" x 52", when 23"/24" deep is selected on both ends.

Tip: When specifying 3-leg 90° extended corners the smallest width available is 46" x 52", when 29"/30" deep is selected on both ends.



For Canadian Pricing

Multiply U.S. Price by the Canadian price factor.

▶ See page 1 for details.

• Style	• Desks Specified as	• Base Price	• Desks Specified as	• Base Price
90° Corner Desks — Extended Height (Different Depth Opposite Ends 23"/24" Right/Left and 29"/30" Left/Right)				
Wood Veneer Desks				
OLELL3	40WL x 23DL x 52WR x 29DR	N.A.	40WL x 29DL x 52WR x 23DR	\$5654
	40WL x 24DL x 52WR x 29DR	N.A.	40WL x 29DL x 52WR x 24DR	\$5654
	40WL x 23DL x 58WR x 29DR	N.A.	40WL x 29DL x 58WR x 23DR	\$5814
	40WL x 24DL x 58WR x 29DR	N.A.	40WL x 29DL x 58WR x 24DR	\$5814
	40WL x 23DL x 64WR x 29DR	N.A.	40WL x 29DL x 64WR x 23DR	\$5975
	40WL x 24DL x 64WR x 29DR	N.A.	40WL x 29DL x 64WR x 24DR	\$5975
	40WL x 23DL x 70WR x 29DR	N.A.	40WL x 29DL x 70WR x 23DR	\$6130
	40WL x 24DL x 70WR x 29DR	N.A.	40WL x 29DL x 70WR x 24DR	\$6130
	40WL x 23DL x 76WR x 29DR	N.A.	40WL x 29DL x 76WR x 23DR	\$6301
	40WL x 24DL x 76WR x 29DR	N.A.	40WL x 29DL x 76WR x 24DR	\$6301
	40WL x 23DL x 52WR x 30DR	N.A.	40WL x 30DL x 52WR x 23DR	\$5654
	40WL x 24DL x 52WR x 30DR	N.A.	40WL x 30DL x 52WR x 24DR	\$5654
	40WL x 23DL x 58WR x 30DR	N.A.	40WL x 30DL x 58WR x 23DR	\$5814
	40WL x 24DL x 58WR x 30DR	N.A.	40WL x 30DL x 58WR x 24DR	\$5814
	40WL x 23DL x 64WR x 30DR	N.A.	40WL x 30DL x 64WR x 23DR	\$5975
	40WL x 24DL x 64WR x 30DR	N.A.	40WL x 30DL x 64WR x 24DR	\$5975
	40WL x 23DL x 70WR x 30DR	N.A.	40WL x 30DL x 70WR x 23DR	\$6130
	40WL x 24DL x 70WR x 30DR	N.A.	40WL x 30DL x 70WR x 24DR	\$6130
	40WL x 23DL x 76WR x 30DR	N.A.	40WL x 30DL x 76WR x 23DR	\$6301
	40WL x 24DL x 76WR x 30DR	N.A.	40WL x 30DL x 76WR x 24DR	\$6301
	52WL x 29DL x 40WR x 23DR	N.A.	52WL x 23DL x 40WR x 29DR	\$5654
	52WL x 29DL x 40WR x 24DR	N.A.	52WL x 24DL x 40WR x 29DR	\$5654
	52WL x 30DL x 40WR x 23DR	N.A.	52WL x 23DL x 40WR x 30DR	\$5654
	52WL x 30DL x 40WR x 24DR	N.A.	52WL x 24DL x 40WR x 30DR	\$5654

Tip: When the 90° desk width is 40"-42" and 23"/24" deep on one end AND the opposite end is 29"/30" deep, product size limits apply. The width must be increased to 46"W or greater.

Tip: When specifying 3-leg 90° equal corners the smallest width available is 52" x 52", regardless of depth.

Tip: When specifying 3-leg 90° extended corners the smallest width available is 40" x 52", when 23"/24" deep is selected on both ends.

Tip: When specifying 3-leg 90° extended corners the smallest width available is 46" x 52", when 29"/30" deep is selected on both ends.



For Canadian Pricing

Multiply U.S. Price by the Canadian price factor.

▶ See page 1 for details.

Ology Corner Desks and Bases Size Restrictions, continued

Style	Desks Specified as	Base Price	Desks Specified as	Base Price
90° Corner Desks — Basic Height (Different Depth Opposite Ends 23"/24" Right/Left and 29"/30" Left/Right)				
High-Pressure Laminate Desks				
OLSL3	40WL x 23DL x 52WR x 29DR	N.A.	40WL x 29DL x 52WR x 23DR	\$3835
	40WL x 24DL x 52WR x 29DR	N.A.	40WL x 29DL x 52WR x 24DR	\$3835
	40WL x 23DL x 58WR x 29DR	N.A.	40WL x 29DL x 58WR x 23DR	\$3959
	40WL x 24DL x 58WR x 29DR	N.A.	40WL x 29DL x 58WR x 24DR	\$3959
	40WL x 23DL x 64WR x 29DR	N.A.	40WL x 29DL x 64WR x 23DR	\$4088
	40WL x 24DL x 64WR x 29DR	N.A.	40WL x 29DL x 64WR x 24DR	\$4088
	40WL x 23DL x 70WR x 29DR	N.A.	40WL x 29DL x 70WR x 23DR	\$4216
	40WL x 24DL x 70WR x 29DR	N.A.	40WL x 29DL x 70WR x 24DR	\$4216
	40WL x 23DL x 76WR x 29DR	N.A.	40WL x 29DL x 76WR x 23DR	\$4341
	40WL x 24DL x 76WR x 29DR	N.A.	40WL x 29DL x 76WR x 24DR	\$4341
	40WL x 23DL x 52WR x 30DR	N.A.	40WL x 30DL x 52WR x 23DR	\$3835
	40WL x 24DL x 52WR x 30DR	N.A.	40WL x 30DL x 52WR x 24DR	\$3835
	40WL x 23DL x 58WR x 30DR	N.A.	40WL x 30DL x 58WR x 23DR	\$3959
	40WL x 24DL x 58WR x 30DR	N.A.	40WL x 30DL x 58WR x 24DR	\$3959
	40WL x 23DL x 64WR x 30DR	N.A.	40WL x 30DL x 64WR x 23DR	\$4088
	40WL x 24DL x 64WR x 30DR	N.A.	40WL x 30DL x 64WR x 24DR	\$4088
	40WL x 23DL x 70WR x 30DR	N.A.	40WL x 30DL x 70WR x 23DR	\$4216
	40WL x 24DL x 70WR x 30DR	N.A.	40WL x 30DL x 70WR x 24DR	\$4216
	40WL x 23DL x 76WR x 30DR	N.A.	40WL x 30DL x 76WR x 23DR	\$4341
	40WL x 24DL x 76WR x 30DR	N.A.	40WL x 30DL x 76WR x 24DR	\$4341
	52WL x 29DL x 40WR x 23DR	N.A.	52WL x 23DL x 40WR x 29DR	\$3835
	52WL x 29DL x 40WR x 24DR	N.A.	52WL x 24DL x 40WR x 29DR	\$3835
	52WL x 30DL x 40WR x 23DR	N.A.	52WL x 23DL x 40WR x 30DR	\$3835
	52WL x 30DL x 40WR x 24DR	N.A.	52WL x 24DL x 40WR x 30DR	\$3835

Tip: When the 90° desk width is 40"-42" and 23"/24" deep on one end AND the opposite end is 29"/30" deep, product size limits apply. The width must be increased to 46"W or greater.

Tip: When specifying 3-leg 90° equal corners the smallest width available is 52" x 52", regardless of depth.

Tip: When specifying 3-leg 90° extended corners the smallest width available is 40" x 52", when 23"/24" deep is selected on both ends.

Tip: When specifying 3-leg 90° extended corners the smallest width available is 46" x 52", when 29"/30" deep is selected on both ends.



For Canadian Pricing

Multiply U.S. Price by the Canadian price factor.

▶ See page 1 for details.

• Style	• Desks Specified as	• Base Price	• Desks Specified as	• Base Price
90° Corner Desks — Basic Height (Different Depth Opposite Ends 23"/24" Right/Left and 29"/30" Left/Right)				
Wood Veneer Desks				
OLSL3	40WL x 23DL x 52WR x 29DR	N.A.	40WL x 29DL x 52WR x 23DR	\$5334
	40WL x 24DL x 52WR x 29DR	N.A.	40WL x 29DL x 52WR x 24DR	\$5334
	40WL x 23DL x 58WR x 29DR	N.A.	40WL x 29DL x 58WR x 23DR	\$5476
	40WL x 24DL x 58WR x 29DR	N.A.	40WL x 29DL x 58WR x 24DR	\$5476
	40WL x 23DL x 64WR x 29DR	N.A.	40WL x 29DL x 64WR x 23DR	\$5626
	40WL x 24DL x 64WR x 29DR	N.A.	40WL x 29DL x 64WR x 24DR	\$5626
	40WL x 23DL x 70WR x 29DR	N.A.	40WL x 29DL x 70WR x 23DR	\$5773
	40WL x 24DL x 70WR x 29DR	N.A.	40WL x 29DL x 70WR x 24DR	\$5773
	40WL x 23DL x 76WR x 29DR	N.A.	40WL x 29DL x 76WR x 23DR	\$5928
	40WL x 24DL x 76WR x 29DR	N.A.	40WL x 29DL x 76WR x 24DR	\$5928
	40WL x 23DL x 52WR x 30DR	N.A.	40WL x 30DL x 52WR x 23DR	\$5334
	40WL x 24DL x 52WR x 30DR	N.A.	40WL x 30DL x 52WR x 24DR	\$5334
	40WL x 23DL x 58WR x 30DR	N.A.	40WL x 30DL x 58WR x 23DR	\$5476
	40WL x 24DL x 58WR x 30DR	N.A.	40WL x 30DL x 58WR x 24DR	\$5476
	40WL x 23DL x 64WR x 30DR	N.A.	40WL x 30DL x 64WR x 23DR	\$5626
	40WL x 24DL x 64WR x 30DR	N.A.	40WL x 30DL x 64WR x 24DR	\$5626
	40WL x 23DL x 70WR x 30DR	N.A.	40WL x 30DL x 70WR x 23DR	\$5773
	40WL x 24DL x 70WR x 30DR	N.A.	40WL x 30DL x 70WR x 24DR	\$5773
	40WL x 23DL x 76WR x 30DR	N.A.	40WL x 30DL x 76WR x 23DR	\$5928
	40WL x 24DL x 76WR x 30DR	N.A.	40WL x 30DL x 76WR x 24DR	\$5928
	52WL x 29DL x 40WR x 23DR	N.A.	52WL x 23DL x 40WR x 29DR	\$5334
	52WL x 29DL x 40WR x 24DR	N.A.	52WL x 24DL x 40WR x 29DR	\$5334
	52WL x 30DL x 40WR x 23DR	N.A.	52WL x 23DL x 40WR x 30DR	\$5334
	52WL x 30DL x 40WR x 24DR	N.A.	52WL x 24DL x 40WR x 30DR	\$5334

Tip: When the 90° desk width is 40"-42" and 23"/24" deep on one end AND the opposite end is 29"/30" deep, product size limits apply. The width must be increased to 46"W or greater.

Tip: When specifying 3-leg 90° equal corners the smallest width available is 52" x 52", regardless of depth.

Tip: When specifying 3-leg 90° extended corners the smallest width available is 40" x 52", when 23"/24" deep is selected on both ends.

Tip: When specifying 3-leg 90° extended corners the smallest width available is 46" x 52", when 29"/30" deep is selected on both ends.



For Canadian Pricing

Multiply U.S. Price by the Canadian price factor.

▶ See page 1 for details.

Ologer Corner Desks and Bases Size Restrictions, continued

• Style	• Desks Specified as	• Base Price	• Desks Specified as	• Base Price
90° Corner Base — Extended Height (Different Depth Opposite Ends 23"/24" Right/Left and 29"/30" Left/Right)				
OLELL3B	40WL x 23DL x 52WR x 29DR	N.A.	40WL x 29DL x 52WR x 23DR	\$3998
	40WL x 24DL x 52WR x 29DR	N.A.	40WL x 29DL x 52WR x 24DR	\$3998
	40WL x 23DL x 58WR x 29DR	N.A.	40WL x 29DL x 58WR x 23DR	\$4059
	40WL x 24DL x 58WR x 29DR	N.A.	40WL x 29DL x 58WR x 24DR	\$4059
	40WL x 23DL x 64WR x 29DR	N.A.	40WL x 29DL x 64WR x 23DR	\$4123
	40WL x 24DL x 64WR x 29DR	N.A.	40WL x 29DL x 64WR x 24DR	\$4123
	40WL x 23DL x 70WR x 29DR	N.A.	40WL x 29DL x 70WR x 23DR	\$4183
	40WL x 24DL x 70WR x 29DR	N.A.	40WL x 29DL x 70WR x 24DR	\$4183
	40WL x 23DL x 76WR x 29DR	N.A.	40WL x 29DL x 76WR x 23DR	\$4244
	40WL x 24DL x 76WR x 29DR	N.A.	40WL x 29DL x 76WR x 24DR	\$4244
	40WL x 23DL x 52WR x 30DR	N.A.	40WL x 30DL x 52WR x 23DR	\$3998
	40WL x 24DL x 52WR x 30DR	N.A.	40WL x 30DL x 52WR x 24DR	\$3998
	40WL x 23DL x 58WR x 30DR	N.A.	40WL x 30DL x 58WR x 23DR	\$4059
	40WL x 24DL x 58WR x 30DR	N.A.	40WL x 30DL x 58WR x 24DR	\$4059
	40WL x 23DL x 64WR x 30DR	N.A.	40WL x 30DL x 64WR x 23DR	\$4123
	40WL x 24DL x 64WR x 30DR	N.A.	40WL x 30DL x 64WR x 24DR	\$4123
	40WL x 23DL x 70WR x 30DR	N.A.	40WL x 30DL x 70WR x 23DR	\$4183
	40WL x 24DL x 70WR x 30DR	N.A.	40WL x 30DL x 70WR x 24DR	\$4183
	40WL x 23DL x 76WR x 30DR	N.A.	40WL x 30DL x 76WR x 23DR	\$4244
	40WL x 24DL x 76WR x 30DR	N.A.	40WL x 30DL x 76WR x 24DR	\$4244
	52WL x 29DL x 40WR x 23DR	N.A.	52WL x 23DL x 40WR x 29DR	\$3998
	52WL x 29DL x 40WR x 24DR	N.A.	52WL x 24DL x 40WR x 29DR	\$3998
	52WL x 30DL x 40WR x 23DR	N.A.	52WL x 23DL x 40WR x 30DR	\$3998
	52WL x 30DL x 40WR x 24DR	N.A.	52WL x 24DL x 40WR x 30DR	\$3998

Tip: When the 90° desk width is 40"-42" and 23"/24" deep on one end AND the opposite end is 29"/30" deep, product size limits apply. The width must be increased to 46"W or greater.

Tip: When specifying 3-leg 90° equal corners the smallest width available is 52" x 52", regardless of depth.

Tip: When specifying 3-leg 90° extended corners the smallest width available is 40" x 52", when 23"/24" deep is selected on both ends.

Tip: When specifying 3-leg 90° extended corners the smallest width available is 46" x 52", when 29"/30" deep is selected on both ends.



For Canadian Pricing

Multiply U.S. Price by the Canadian price factor.

▶ See page 1 for details.

• Style	• Desks Specified as	• Base Price	• Desks Specified as	• Base Price
90° Corner Base — Basic Height (Different Depth Opposite Ends 23"/24" Right/Left and 29"/30" Left/Right)				
OLSL3B	40WL x 23DL x 52WR x 29DR	N.A.	40WL x 29DL x 52WR x 23DR	\$3682
	40WL x 24DL x 52WR x 29DR	N.A.	40WL x 29DL x 52WR x 24DR	\$3682
	40WL x 23DL x 58WR x 29DR	N.A.	40WL x 29DL x 58WR x 23DR	\$3741
	40WL x 24DL x 58WR x 29DR	N.A.	40WL x 29DL x 58WR x 24DR	\$3741
	40WL x 23DL x 64WR x 29DR	N.A.	40WL x 29DL x 64WR x 23DR	\$3795
	40WL x 24DL x 64WR x 29DR	N.A.	40WL x 29DL x 64WR x 24DR	\$3795
	40WL x 23DL x 70WR x 29DR	N.A.	40WL x 29DL x 70WR x 23DR	\$3854
	40WL x 24DL x 70WR x 29DR	N.A.	40WL x 29DL x 70WR x 24DR	\$3854
	40WL x 23DL x 76WR x 29DR	N.A.	40WL x 29DL x 76WR x 23DR	\$3909
	40WL x 24DL x 76WR x 29DR	N.A.	40WL x 29DL x 76WR x 24DR	\$3909
	40WL x 23DL x 52WR x 30DR	N.A.	40WL x 30DL x 52WR x 23DR	\$3682
	40WL x 24DL x 52WR x 30DR	N.A.	40WL x 30DL x 52WR x 24DR	\$3682
	40WL x 23DL x 58WR x 30DR	N.A.	40WL x 30DL x 58WR x 23DR	\$3741
	40WL x 24DL x 58WR x 30DR	N.A.	40WL x 30DL x 58WR x 24DR	\$3741
	40WL x 23DL x 64WR x 30DR	N.A.	40WL x 30DL x 64WR x 23DR	\$3795
	40WL x 24DL x 64WR x 30DR	N.A.	40WL x 30DL x 64WR x 24DR	\$3795
	40WL x 23DL x 70WR x 30DR	N.A.	40WL x 30DL x 70WR x 23DR	\$3854
	40WL x 24DL x 70WR x 30DR	N.A.	40WL x 30DL x 70WR x 24DR	\$3854
	40WL x 23DL x 76WR x 30DR	N.A.	40WL x 30DL x 76WR x 23DR	\$3909
	40WL x 24DL x 76WR x 30DR	N.A.	40WL x 30DL x 76WR x 24DR	\$3909
	52WL x 29DL x 40WR x 23DR	N.A.	52WL x 23DL x 40WR x 29DR	\$3682
	52WL x 29DL x 40WR x 24DR	N.A.	52WL x 24DL x 40WR x 29DR	\$3682
	52WL x 30DL x 40WR x 23DR	N.A.	52WL x 23DL x 40WR x 30DR	\$3682
	52WL x 30DL x 40WR x 24DR	N.A.	52WL x 24DL x 40WR x 30DR	\$3682

Tip: When the 90° desk width is 40"-42" and 23"/24" deep on one end AND the opposite end is 29"/30" deep, product size limits apply. The width must be increased to 46"W or greater.

Tip: When specifying 3-leg 90° equal corners the smallest width available is 52" x 52", regardless of depth.

Tip: When specifying 3-leg 90° extended corners the smallest width available is 40" x 52", when 23"/24" deep is selected on both ends.

Tip: When specifying 3-leg 90° extended corners the smallest width available is 46" x 52", when 29"/30" deep is selected on both ends.



For Canadian Pricing

Multiply U.S. Price by the Canadian price factor.

▶ See page 1 for details.

Ology Options Availability Chart

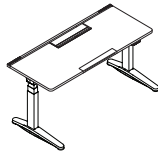

	Rectangular							
	34"W	40"W	46"W	52"W	58"W	64"W	70"W	76"W
Grommet	Available	Available	Available	Available	Available	Available	Available	Available
Integrated Rail	Available	Available	Available	Available	Available	Available	Available	Available
Overhang	Not available	Not available	Not available	Not available	Not available	Left or Right	Left or Right or Left and Right	Left or Right or Left and Right
Overhang + Power Door	Not available	Not available	Not available	Not available	Not available	Center	Center	Center
Overhang + Soft Edge	Not available	Not available	Not available	Not available	Not available	Not available	Center	Center
Power Door	Not available	Center	Center	Center	Center	Left, Right, or Center	Left, Right, or Center	Left, Right, or Center
Soft Edge	Not available	Not available	Not available	Not available	Center	Left, Right, or Center	Left, Right, or Center	Left, Right, or Center

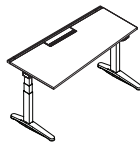

	Tapered			
	58"W	64"W	70"W	76"W
Grommet	Available	Available	Available	Available
Integrated Rail	Available	Available	Available	Available
Power Door	Center	Left, Right or Center	Left, Right or Center	Left, Right or Center
Soft Edge	Center	Left, Right or Center	Left, Right or Center	Left, Right or Center

Tip: When integrated storage is present, power door and soft edge can be positioned left or right on desks that are 64"W or wider. Position must shift away from the storage.

Tip: Overhang can be positioned left or right on desks that are 70" wide or wider when used with integrated storage.

Tip: Overhang not available on 35"D or 36"D.

Tip: When choosing location of power door and soft edge, both will be on the same side.

Tip: 70"W or wider with double overhang does not allow soft edge.

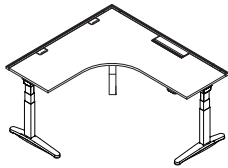

	90°						
	40"W	46"W	52"W	58"W	64"W	70"W	76"W
Grommet	Available	Available	Available	Available	Available	Available	Available
Integrated Rail	Available	Available	Available	Available	Available	Available	Available
Overhang	Not available	Not available	Not available	Not available	Not available	Not available	Not available
Power Door	Not available	Not available	Not available	One or Both Sides	One or Both Sides	One or Both Sides	One or Both Sides
Soft Edge	Not available	Not available	Not available	Not available	Not available	Not available	Not available

Tip: Integrated storage can be used on 90° Ology desks that are 70" wide or wider.

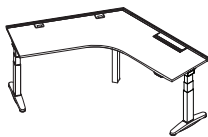

	120°					
	34"W	40"W	46"W	52"W	58"W	64"W
Grommet	Available	Available	Available	Available	Available	Available
Integrated Rail	Available	Available	Available	Available	Available	Available
Power Door	Not available	Not available	Not available	One or Both Sides	One or Both Sides	One or Both Sides
Soft Edge	Not available	Not available	Not available	Not available	Not available	Not available

Tip: Integrated storage can be used on 120° Ology desks that are 52" wide or wider.

Ology Modesty Panels

Modesty panels provide modesty when needed. Modesty panels, available in laminate and veneer, connect to the desk frame.

- Specifying, page 134

Brackets are attached to the panel.

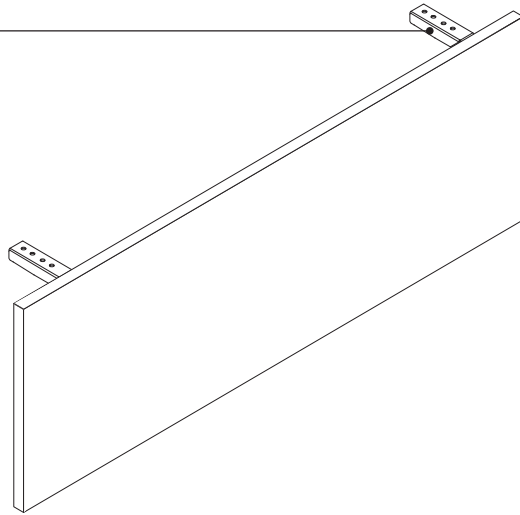

Product Details

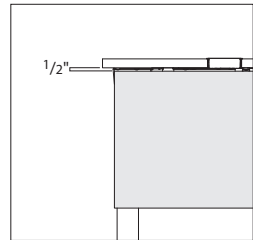

Gap is $\frac{1}{2}$ " between underside of the worksurface and top of modesty panel. Panel can be flush to the worksurface or inset.

Modesty panels, both modular and parametric, are undersized $2\frac{1}{2}$ " for square corner or radius corner options. If planning for full width on square corner, add $2\frac{1}{2}$ ". Verify in SmartTools the manufactured width vs modular or parametric widths.

C-clamp mounting is not allowed with flush mount. C-clamp mount when panel is inset.

Modesty panels are defaulted in the horizontal grain direction for both laminate and wood veneer. Optional vertical grain direction can be specified, however, laminate specification is only allowed up to 60" wide.

Actual Dimensions

Modular Modesty Panels

Width	31 $\frac{1}{2}$ ", 37 $\frac{1}{2}$ ", 43 $\frac{1}{2}$ ", 49 $\frac{1}{2}$ ", 54 $\frac{1}{2}$ ", 61 $\frac{1}{2}$ ", 67 $\frac{1}{2}$ ", or 73 $\frac{1}{2}$ "
Height	14 $\frac{3}{8}$ "
Overall height	14 $\frac{7}{8}$ "
Thickness	$\frac{3}{4}$ "

Tip: Overall height is measured from bottom of mounting surface to the bottom of the screen.

Tip: Parametric modesty panel widths can be specified from 34"–78"W in $\frac{1}{16}$ " increments.

Tip: Verify in SmartTools the manufactured width vs modular or parametric widths, that are undersized by $2\frac{1}{2}$ ".

Surface Materials

High-Pressure Laminate Panel

- Laminate
- ▶ See *Surface Materials*, page 362
- Open Line laminate (option)
- A program including non-Steelcase laminates which are suitable for use on Steelcase products.
- ▶ See *Surface Materials Reference Manual*.

3 mm edge profile

- Plastic

Wood veneer panel

- Wood veneer (standard)
- Customiz stain (option)

Square 3 mm edge profile

- Wood veneer to match panel

Bracket

- 7360 Merle

Application Topics

Modesty panels are parametric in width from 34"W to 78"W in 1/16" increments. Modesty panel can be equal to the width of the desk or shorter.

Tip: When using a modesty panel on straight and taper parametric sized desks, modesty panel width must be verified in CET to avoid interference.

When used with integrated storage, modesty panel must be a minimum of 20" shorter than worksurface width to allow for pinch point clearances.

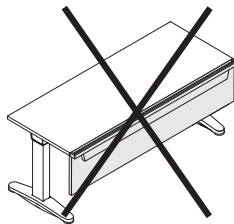

Full width modesty panels cannot be used on desks with integrated rail.

Tip: To use with the integrated rail, the modesty panel must be undersized by a minimum of 20" (rectangular and tapered) or 19" or less (90°) and 16" or less (120°) than the width of the desk understructure.

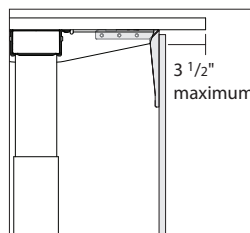

Modesty panels may be inset a maximum of 3 1/2" from the back of the worksurface to allow for c-clamping.

Tip: Inset modesty panels do not work with the power access door option or the cable basket and cable brackets.

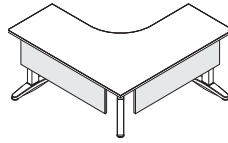

In order to inset, modesty panels must be specified a minimum of 16" or less (rectangular and tapered) or 14" or less (90°) and 10" or less (120°) than the width of the desk understructure. Utilize the mounting plates and screws to attach the modesty panel to the underside of the worksurface.

Tip: Inset modesty panels do not work with the power access door option or the cable basket and cable brackets.

Universal or Sarto privacy/modesty screens cannot be used with Ology modesty panels.

When using a modesty panel with Universal or Sarto privacy screens, verify placement in CET to avoid interference.

Universal Steel One-High and 1.5-High Open Laterals

For Ology Application

Universal One-High and 1.5-High open laterals for Ology application seamlessly integrates the Ology desk leg into universal storage. It provides a clean aesthetic with an efficient footprint. Ease of access to your items under the desk is convenient with this open storage configuration.
 ▶ Specifying, page 138

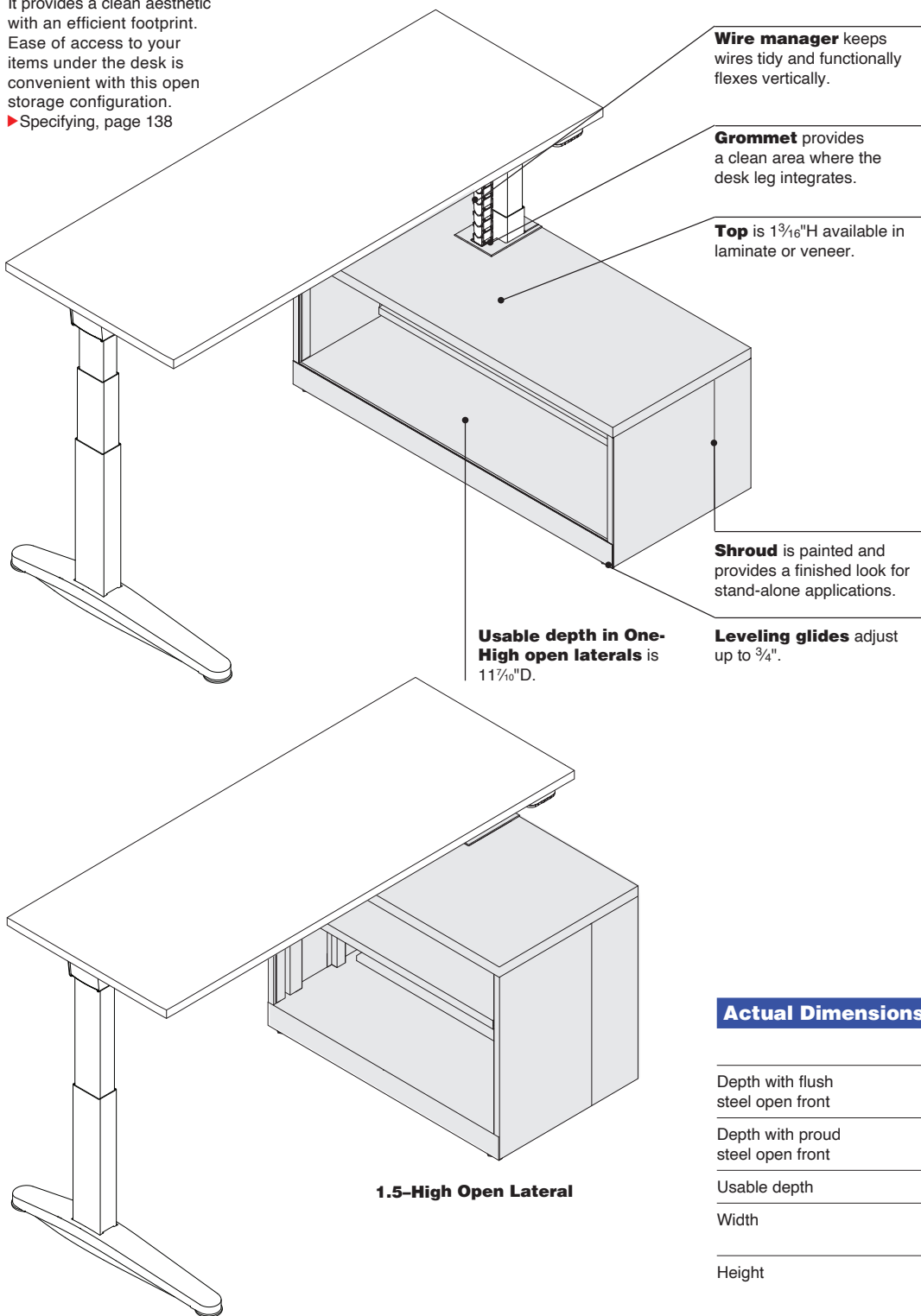

Product Details

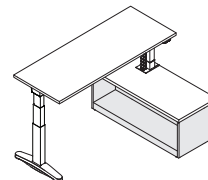

One-High storage can be used with Ology extended range desks or basic range desks.

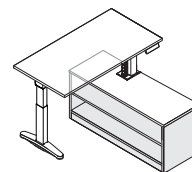

1.5-High storage can only be used with Ology basic range desks.

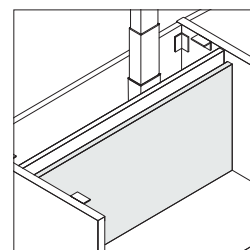

One-High and 1.5-High storage for Ology application have a removable interior back panel to allow access to the Ology base.

Ology desk with integrated storage must be specified with modular widths only. When opting for parametric widths, integrated storage is not available.

Actual Dimensions

	One-High	1.5-High
Depth with flush steel open front	18"	18"
Depth with proud steel open front	18 ⁷ / ₈ "	18 ⁷ / ₈ "
Usable depth	11 ⁷ / ₁₀ "	11 ⁷ / ₁₀ "
Width	30", 36", and 42"	30", 36", and 42"
Height	16"	22"

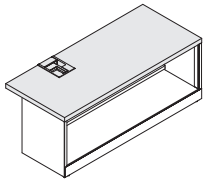

Laminate and wood veneer tops with square edge profile are available. Tops are 1³/₁₆"H.

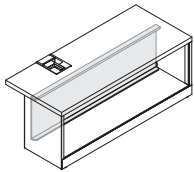

Removable interior cover provides access to power outlets that can be located in the panel behind storage unit.

Case Widths and Ology Foot Dimensions

30"W Ology open laterals can house Ology legs of 24" or 30" in length. 36"W and 42"W units can house Ology legs with feet of 24", 30", or 36" in length.

Integrated leg options apply to One-High and 1.5-High units only and are meant for use with Ology height-adjustable desks only.

Application Topics

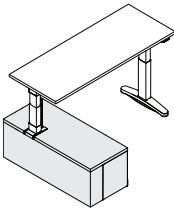

Application: Ology left

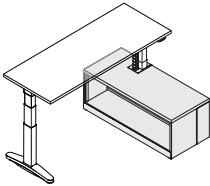

Application: Ology right

Application is determined by which leg of the Ology desk is located inside the storage.

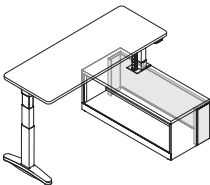

Shroud is used to finish off the back of the storage when application is used as stand-alone unit.

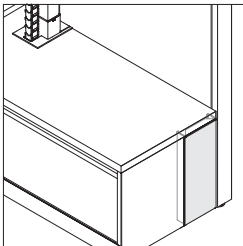

Filler is used in end-of-run applications where end of storage unit will be visible.

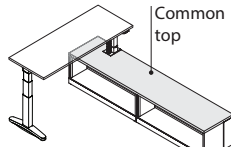

No top option on lateral file is available for use with a Universal common top shared with an adjacent lateral.

Universal common top for Ology application, ordered separately, is available in laminate or veneer. Cut-out for Ology leg is available on the left side or the right side of the Universal common top. Ology desk cannot be placed in the middle of the Universal common top.

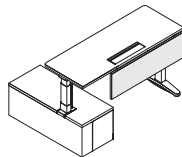

Ology modesty panel or fixed personal/modesty screens must be undersized and justified to the outside when used with One-High and 1.5-High storage units. Only one open lateral file is permitted on Ology 90° corner desks.

When used with One-High and 1.5-High integrated storage, screens used in the modesty position must be a minimum of 18" shorter than worksurface width to allow for pinch point clearances.

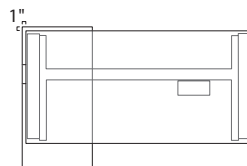

To help avoid pinch points, the Universal One-High and 1.5-High open laterals for Ology application extends 1" past the back of the Ology worksurface.

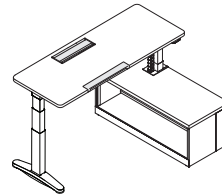

Soft edge and power and data access door can be positioned left or right on Ology desks that are 64"W or wider for use with One-High and 1.5-High integrated storage.

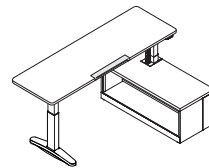

Worksurface overhang can be positioned left or right on desks that are 70" wide or wider.
Tip: Overhang not available on 35"D or 36"D.

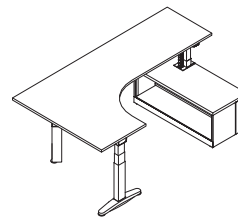

Ology 90° corners that are 70" wide and wider can be used with One-High and 1.5-High storage units.

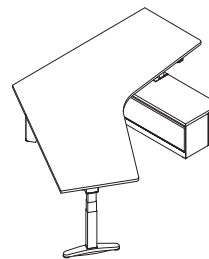

Ology 120° corners that are 52" wide and wider can be used with One-High and 1.5-High storage units. Only one open lateral file is permitted on Ology 120° corner desks.

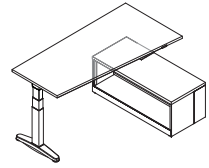

Tapered desks that are 70" wide and wider can be used with One-High and 1.5-High storage units.

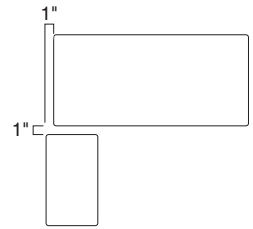

When specifying One-High and 1.5-High storage that matches the worksurface depth, only One-High storage should be placed adjacent to the desk.

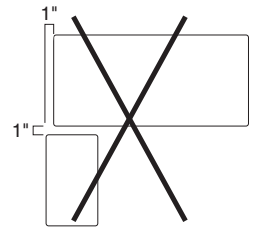

Pinch point clearances are not maintained when 1.5-High or taller storage is used adjacent to One-High integrated storage that matches the worksurface depth.

Surface Materials

Lateral case

- Paint

Laminate top

- Laminate
- Open Line laminate (option)

Edge on laminate top

- Plastic

Wood veneer top

- Wood veneer—open pore finishes
- Full-fill (option) is available on wood veneer tops only.

Shroud and filler

- Paint

Elective Elements One-High Open Plinth Base Pedestals and Common Tops

For Ology Application

One-High open plinth base pedestal and common top for Ology application seamlessly integrate the Ology desk into Elective Elements. They provide a clean aesthetic with an efficient footprint. Ease of access to your items under the desk is convenient with this open storage configuration.

► Specifying, pages 144 and 146.

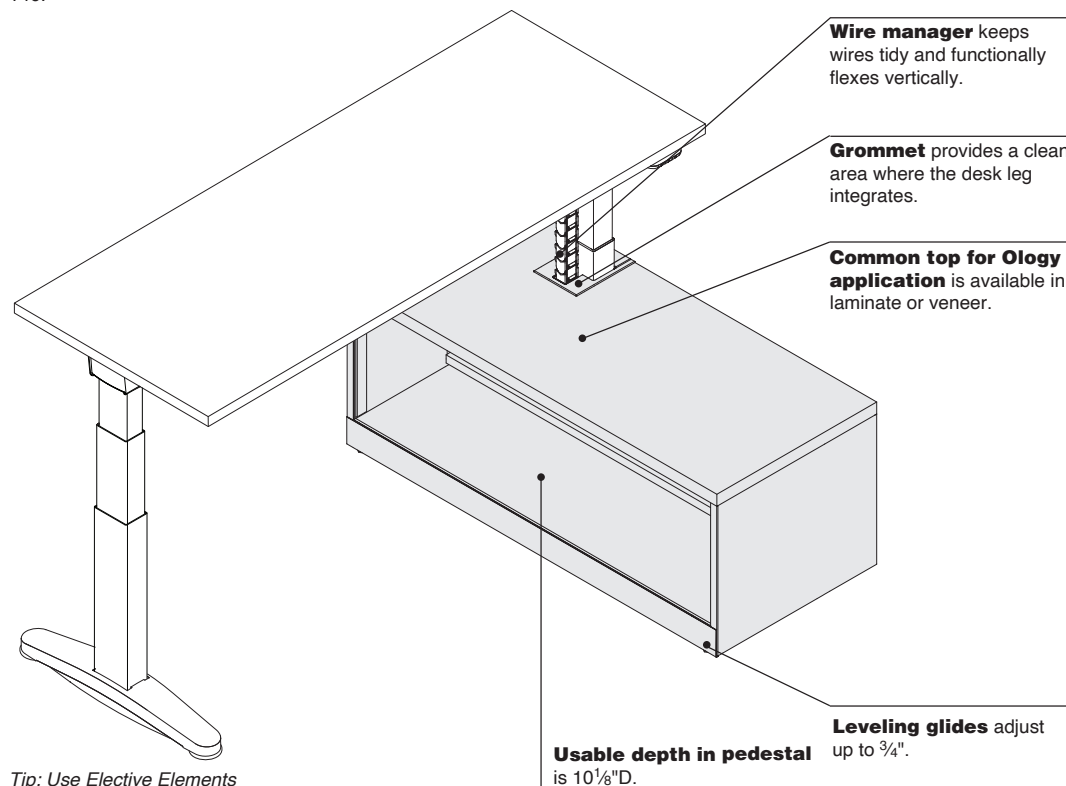

Tip: Use Elective Elements common tops with Ology base to create an Elective Elements height adjustable desk.

Actual Dimensions

One-High Open Plinth Base Pedestal

Depth	17 $\frac{1}{4}$ "
Width	24", 30", 36", and 42"
Height	15 $\frac{1}{2}$ "

Common Top

Depth	18"
Width	24", 30", 36", 42", 48", 54", 60", 66", 72", 78", 84", 90", 96", 102", 108", 114", and 120"
Height	N.A.

Product Details

Pedestal Base

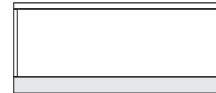

3" Base

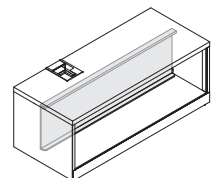

Removable interior cover provides access to power outlets that can be located in the panel behind storage unit.

Base widths and Ology foot:

- 24"W Ology base units can house Ology legs 24" in length.
- 30"W Ology base units can house Ology legs of 24" or 30" in length.
- 36"W and 42"W units can house Ology legs of 24", 30", or 36" in length.

Ology desk with integrated storage must be specified with modular widths only. When opting for parametric widths, integrated storage is not available.

Surface Materials

Pedestal case

- Veneer
- Laminate

Laminate top on pedestal and common top

- Laminate
- Open Line laminate (option)

Edges on pedestal and common top

- Wood veneer
- Plastic

Wood veneer top on pedestal and common top

- Wood veneer—open pore finishes
- Full-fill (option) is available on wood veneer tops only.

Application Topics

Storage

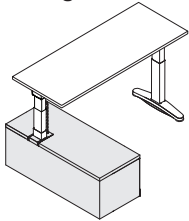

Application: Ology left

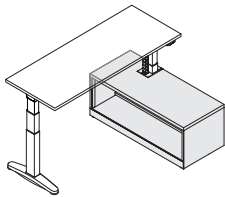

Application: Ology right

Application is determined by which leg of the Ology base is located inside the pedestal.

Common tops for Ology application can be used with two units side-by-side when one storage unit is required for Ology leg integration.

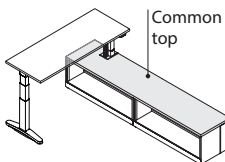

Common top for Ology application, ordered separately, is available in laminate or veneer. Cut-out for Ology leg is available on the left side or the right side of the common top. Ology desk cannot be placed in the middle of the common top.

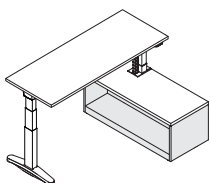

Common tops for Ology application are available when ganging Ology base units to other Elective Elements pedestals of the same height.

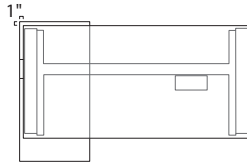

To help avoid pinch points, the pedestal for Ology application extends 1" past the back of the common top.

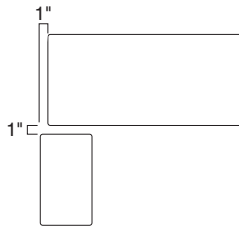

When specifying One-High storage that matches the worksurface depth, only One-High storage should be placed adjacent to the desk.

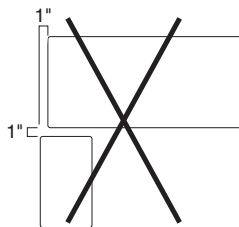

Pinch point clearances are not maintained when 1.5-High or taller storage is used adjacent to One-High integrated storage that matches the worksurface depth.

Desk

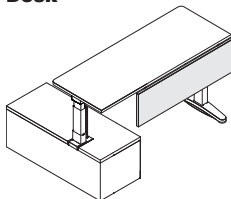

Modesty panel or fixed personal/modesty screens must be under-sized and justified to the outside of the common top when used with pedestal.

When used with One-High integrated storage, screens used in the modesty position must be a minimum of 18" shorter than worksurface width to allow for pinch point clearances.

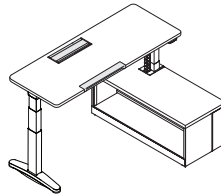

Soft edge and power and data access door can be positioned left or right on Ology desks that are 64"W or wider for use with One-High integrated storage.

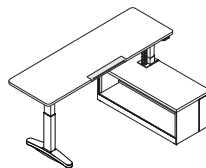

Workspace overhang can be positioned left or right on desks that are 70" wide or wider.
Tip: Overhang not available on 35"D or 36"D.

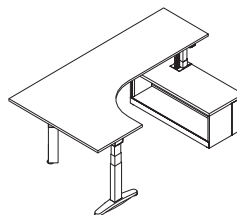

Ology 90° corners that are 70" wide and wider can be used with One-High storage unit.

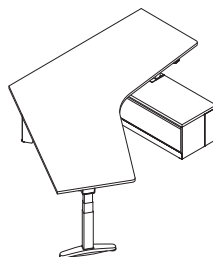

Ology 120° corners that are 52" wide and wider can be used with One-High storage unit.

Ology Height-Adjustable Rectangular Desks

High-Pressure Laminate or Composite Veneer

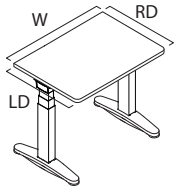

Tip: On extended height desks, any storage higher than 18", or 15½" if the power access door is optioned, will impede lowest height range of worksurface. On basic height desks, any storage higher than 23", or 20½" if the power access door is optioned, will impede lowest height range of worksurface. Do not place storage underneath controller.

Tip: One single monitor is allowed on desks 23"D or deeper and 46"W and wider.
▶ See page 58 for *Steelcase Monitor Arm Guidelines*.

Tip: Dual monitors are allowed on 29"D or deeper and 58"W and wider.
▶ See page 58, *Steelcase Monitor Arm Guidelines*.

Tip: Base supports a maximum distributed weight capacity of 360 pounds (2-leg) and 500 pounds (3-leg). When calculating lifting capacity, subtract the weight of the worksurface, understructure, and options selected.

Tip: 2-leg desks that have an overhang, or are 35"D or 36"D will have a distributed weight capacity of 300 pounds (136.1 kg).
▶ See page 70 for *worksurface weights*.

Tip: Antimicrobial additives can be specified only when specifying simple touch controller and/or soft edge.

For laminate group 2 and 3 pricing, please refer to the electronic catalog or SmartTools.



For Canadian Pricing
Multiply U.S. Price by the Canadian price factor.
▶ See page 1 for details.

	Standard Includes	Required to Specify
▶ Need help? Product details, page 64	<ul style="list-style-type: none"> • Worksurface: High-Pressure Laminate price group 1 with 3 mm plastic edge or composite veneer group 1 • Electric height-adjustable sit-to-stand base: paint • Active touch controller • Modular widths: 34"—76" • ½" adjustable glides • Power cord: 10½' • Attachment hardware 	<ol style="list-style-type: none"> 1 Style number 2 Desk depth 3 Desk width 4 High-Pressure Laminate or composite veneer for worksurface 5 Plastic color number for profile edge on laminate worksurface, if selected 6 Desk corner style, if laminate desk selected (see below under Required Selections) 7 Paint color number for base: 4799 Platinum Metallic 7207 Black 7241 Arctic White 7360 Merle 8 Integrated rail (see below under Required Selections) 9 Antimicrobial or non-antimicrobial components, if simple touch controller selected (see below under Required Selections) 10 Options, if selected (see below) <p>▶ See <i>Surface Materials</i>, page 362</p>

	Required Selections	U.S. Price	Required to Specify
Desk Corner Style (Laminate Desks Only)	<ul style="list-style-type: none"> • Square corners • Radius corners 	No cost +\$ 98	Specify <i>with square corners</i> . Specify <i>with radius corners</i> .
Integrated Rail	<ul style="list-style-type: none"> • Without integrated rail • With integrated rail 	No cost +\$485	Specify <i>without integrated rail</i> . Specify <i>with integrated rail</i> .
Antimicrobial Components	<ul style="list-style-type: none"> • Non-antimicrobial components • Antimicrobial components 	No cost No cost	Specify <i>with non-antimicrobial components</i> . Specify <i>with antimicrobial components</i> .

	Options	U.S. Price	Required to Specify
Surface Materials	High-Pressure Laminate desks		
	<ul style="list-style-type: none"> • Laminate price group 2 • Laminate price group 3 • Open Line laminate 	See information at left See information at left +\$111 plus cost of laminate	Specify laminate color number. Specify laminate color number. ▶ See <i>Surface Materials Reference Manual</i> .
	Composite veneer desks		
	<ul style="list-style-type: none"> • Composite veneer group 1 • Composite veneer group 2 	Prices at right +\$108	Specify composite veneer color number. Specify composite veneer color number.
	Wood veneer desks		
	<ul style="list-style-type: none"> • Wood group 1 • Wood group 2 • Wood group 3 • Customiz stain 	Prices at right +\$118 +\$417 No cost	Specify wood color number. Specify wood color number. Specify wood color number. Specify <i>with customiz stain</i> . ▶ See <i>Surface Materials Reference Manual</i> .
	Base		
	<ul style="list-style-type: none"> • Paint price group 1 • Paint price group 2 	No cost +\$ 48	Specify paint color number. Specify paint color number. ▶ See <i>Surface Materials</i> , page 362.
Desk Type	<ul style="list-style-type: none"> • Parametric width desk 	No cost	Specify <i>with parametric desk type</i> .

▶ Options, continued on next page

► Options, continued from previous page

Options	U.S. Price	Required to Specify
Overhang	<ul style="list-style-type: none"> • Desk overhang on left No cost • Desk overhang on right No cost • Desk overhang left and right No cost 	<ul style="list-style-type: none"> Specify with desk overhang left. Specify with desk overhang right. Specify with desk overhang left and right.
Controller	<ul style="list-style-type: none"> • Simple touch controller –\$ 78 • 4 Pre-set controller +\$ 188 	<ul style="list-style-type: none"> Specify with simple touch controller. Specify with 4 pre-set controller.
Soft Edge	<ul style="list-style-type: none"> • With soft edge +\$ 346 	Specify with soft edge.
Power and Data Access Door, Tray and USB A+C 20W	<ul style="list-style-type: none"> • Power and data access door, tray and USB A+C 20W: paint group 1 or 2 +\$1219 • Power and data access door, tray and USB A+C 20W: anodized aluminum +\$1236 	<ul style="list-style-type: none"> Specify with power and data access door and select paint color number. Specify with power and data access door and select anodized aluminum.
Power and Data Access Door and Soft Edge Position	<ul style="list-style-type: none"> • Centered No cost • Left No cost • Right No cost 	<ul style="list-style-type: none"> Specify with centered position. Specify with left position. Specify with right position.
Grommet	<ul style="list-style-type: none"> • Grommet +\$ 66 	Specify with grommet.
Glides	<ul style="list-style-type: none"> • 1" adjustable glides +\$ 50 	Specify with 1" glides.
CarbonNeutral Product	<ul style="list-style-type: none"> • CarbonNeutral product certification +\$ 49 	Add suffix CN to the end of the style number.
Related Products	<ul style="list-style-type: none"> • Modesty panels • Fixed personal/modesty screens • Cable and power management 	<ul style="list-style-type: none"> ► Page 134 ► Page 344 ► Page 135

► Specification Information, on next page

Tip: Overhang not available on 35"D or 36"D.

Tip: 9" overhang is available on desks 64"W and larger. Overhang on both sides is available on 70"W and larger.

Tip: The standard active touch controller is Bluetooth-enabled to allow pairing with the Steelcase Rise app.

Tip: Soft edge is available on desks 58"W and larger. If overhang left or overhang right is selected, soft edge is available on desks 70"W or 76"W. Soft edge cannot be specified on desks that have overhang on both sides.

Tip: Power and data access door is available on desks 40"W or greater.

Tip: Power access door and soft edge can be positioned left or right on desks that are 64"W or wider for use with One-High integrated storage.

Tip: Rectangular desks accommodate either power and data access door or grommet, but not both.



For Canadian Pricing

Multiply U.S. Price by the Canadian price factor.

► See page 1 for details.

Ology Height-Adjustable Rectangular Desks, High-Pressure Laminate or Composite Veneer, continued

► Options, on previous page

Specification Information

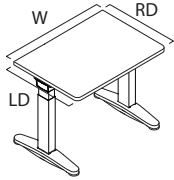

U.S. Base Prices

• Style Number	• Dimensions D	• Desk Type	U.S. Base Prices							
			34"W	40"W	46"W	52"W	58"W	64"W	70"W	76"W
		Modular	34"W	40"W	46"W	52"W	58"W	64"W	70"W	76"W
		Parametric	34"W -36"W	36 ¹ / ₁₆ "W -42"W	42 ¹ / ₁₆ "W -48"W	48 ¹ / ₁₆ "W -54"W	54 ¹ / ₁₆ "W -60"W	60 ¹ / ₁₆ "W -66"W	66 ¹ / ₁₆ "W -72"W	72 ¹ / ₁₆ "W -78"W

High-Pressure Laminate Desks — Extended Height

OLELRQ	23" or 24"	29" or 30"	35" or 36"	34"W	40"W	46"W	52"W	58"W	64"W	70"W	76"W
				\$2655	\$2740	\$2821	\$2906	\$2995	\$3089	\$3180	\$3276
				\$2979	\$3070	\$3163	\$3261	\$3360	\$3462	\$3566	\$3674
				\$3304	\$3403	\$3508	\$3614	\$3728	\$3836	\$3954	\$4080

Composite Veneer Desks — Extended Height

OLELRQ	23" or 24"	29" or 30"	35" or 36"	34"W	40"W	46"W	52"W	58"W	64"W	70"W	76"W
				\$3482	\$3582	\$3672	\$3771	\$3874	\$3984	\$4085	\$4199
				\$3840	\$3947	\$4052	\$4163	\$4273	\$4394	\$4506	\$4632
				\$4199	\$4310	\$4432	\$4551	\$4676	\$4803	\$4930	\$5070

Wood Veneer Desks — Extended Height

OLELRQ	23" or 24"	29" or 30"	35" or 36"	34"W	40"W	46"W	52"W	58"W	64"W	70"W	76"W
				\$3564	\$3666	\$3758	\$3858	\$3961	\$4073	\$4176	\$4292
				\$3926	\$4034	\$4141	\$4254	\$4364	\$4486	\$4600	\$4728
				\$4288	\$4401	\$4525	\$4645	\$4771	\$4900	\$5028	\$5169

High-Pressure Laminate Desks — Basic Height

OLSLRQ	23" or 24"	29" or 30"	35" or 36"	34"W	40"W	46"W	52"W	58"W	64"W	70"W	76"W
				\$2451	\$2525	\$2599	\$2680	\$2760	\$2847	\$2934	\$3021
				\$2747	\$2834	\$2915	\$3008	\$3097	\$3191	\$3289	\$3389
				\$3046	\$3140	\$3234	\$3333	\$3436	\$3535	\$3646	\$3758

Composite Veneer Desks — Basic Height

OLSLRQ	23" or 24"	29" or 30"	35" or 36"	34"W	40"W	46"W	52"W	58"W	64"W	70"W	76"W
				\$3278	\$3367	\$3450	\$3545	\$3639	\$3742	\$3839	\$3944
				\$3608	\$3711	\$3804	\$3910	\$4010	\$4123	\$4229	\$4347
				\$3941	\$4047	\$4158	\$4270	\$4384	\$4502	\$4622	\$4748

Wood Veneer Desks — Basic Height

OLSLRQ	23" or 24"	29" or 30"	35" or 36"	34"W	40"W	46"W	52"W	58"W	64"W	70"W	76"W
				\$3360	\$3451	\$3536	\$3632	\$3726	\$3831	\$3930	\$4037
				\$3694	\$3798	\$3893	\$4001	\$4101	\$4215	\$4323	\$4443
				\$4030	\$4138	\$4251	\$4364	\$4479	\$4599	\$4720	\$4847



Ology Height-Adjustable Tapered Desks

High-Pressure Laminate or Composite Veneer

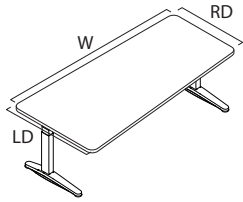

Tip: On extended height desks, any storage higher than 18"H, or 15½"H if the power access door is optional, will impede lowest height range of worksurface. On basic height desks, any storage higher than 23"H, or 20½"H if the power access door is optional, will impede lowest height range of worksurface. Do not place storage underneath controller.

Tip: One single monitor is allowed on desks 23"D or deeper and 46"W and wider. ▶ See *Steelcase Worktools Specification Guide*.

Tip: Dual monitors allowed on 29"D or deeper and 58"W and wider. ▶ See page 58, *Steelcase Monitor Arm Guidelines*.

Tip: Base supports a maximum distributed weight capacity of 360 pounds (2-leg) and 500 pounds (3-leg). When calculating lifting capacity, subtract the weight of the worksurface, understructure, and options selected. ▶ See page 70 for worksurface weights.

Tip: Antimicrobial additives can be specified only when specifying simple touch controller and/or soft edge.

For laminate group 2 and 3 pricing, please refer to the electronic catalog or SmartTools.

Tip: Soft edge is available on desks 58"W and larger.

Tip: Power access door and soft edge can be positioned left or right on desks that are 64"W or wider for use with One-High integrated storage.



For Canadian Pricing
Multiply U.S. Price by the Canadian price factor.
▶ See page 1 for details.

	Standard Includes	Required to Specify
▶ Need help? Product details, page 64	<ul style="list-style-type: none"> • Worksurface: High-Pressure Laminate price group 1 with 3 mm plastic edge or composite veneer group 1 • Electric height-adjustable sit-to-stand base: paint • Active touch controller • Modular widths: 58"-76" • ½" adjustable glides • Power cord: 10⁴/₅' • Attachment hardware 	<ol style="list-style-type: none"> 1 Style number 2 Desk depth 3 Desk width 4 High-Pressure Laminate or composite veneer for worksurface 5 Plastic color number for profile edge on laminate worksurface, if selected 6 Desk corner style, if laminate desk selected (see below under Required Selections) 7 Paint color number for base 4799 Platinum Metallic 7207 Black 7241 Arctic White 7360 Merle 8 Integrated rail (see below under Required Selections) 9 Antimicrobial or non-antimicrobial components, if simple touch controller selected (see below under Required Selections) 10 Options, if selected (see below) <p>▶ See <i>Surface Materials</i>, page 362</p>

	Required Selections	U.S. Price	Required to Specify
Desk Corner Style (Laminate Desks Only)	<ul style="list-style-type: none"> • Square corners • Radius corners 	No cost +\$ 98	Specify with square corners. Specify with radius corners.
Integrated Rail	<ul style="list-style-type: none"> • Without integrated rail • With integrated rail 	No cost +\$485	Specify without integrated rail. Specify with integrated rail.
Antimicrobial Components	<ul style="list-style-type: none"> • Non-antimicrobial components • Antimicrobial components 	No cost No cost	Specify with non-antimicrobial components. Specify with antimicrobial components.

	Options	U.S. Price	Required to Specify
Surface Materials	High-Pressure Laminate desks		
	<ul style="list-style-type: none"> • Laminate price group 2 • Laminate price group 3 • Open Line laminate 	See information at left See information at left +\$111 plus cost of laminate	Specify laminate color number. Specify laminate color number. ▶ See <i>Surface Materials Reference Manual</i> .
	Composite veneer desks		
	<ul style="list-style-type: none"> • Composite veneer group 1 • Composite veneer group 2 	Prices at right +\$108	Specify composite veneer color number. Specify composite veneer color number.
	Wood veneer desks		
	<ul style="list-style-type: none"> • Wood group 1 • Wood group 2 • Wood group 3 • Customiz stain 	Prices at right +\$118 +\$417 No cost	Specify wood color number. Specify wood color number. Specify wood color number. Specify with customiz stain. ▶ See <i>Surface Materials Reference Manual</i> .
	Base		
	<ul style="list-style-type: none"> • Paint price group 1 • Paint price group 2 	No cost +\$ 48	Specify paint color number. Specify paint color number. ▶ See <i>Surface Materials</i> , page 362.
Desk Type	<ul style="list-style-type: none"> • Parametric width desk 	No cost	Specify with parametric desk type.
Soft Edge	<ul style="list-style-type: none"> • With soft edge 	+\$346	Specify with soft edge.

▶ Options, continued on next page

► Options, continued from previous page

Options	U.S. Price	Required to Specify
Power and Data Access Door, Tray and USB A+C 20W	<ul style="list-style-type: none"> Power and data access door, tray and USB A+C 20W: paint group 1 or 2 +\$1219 Power and data access door, tray and USB A+C 20W: anodized aluminum +\$1236 	<p>Specify with power and data access door and select paint color number.</p> <p>Specify with power and data access door and select anodized aluminum.</p>
Controller	<ul style="list-style-type: none"> Simple touch controller -\$ 78 4 Pre-set controller +\$ 188 	<p>Specify with simple touch controller.</p> <p>Specify with 4 pre-set controller.</p>
Power and Data Access Door and Soft Edge Position	<ul style="list-style-type: none"> Centered No cost Left No cost Right No cost 	<p>Specify with centered position.</p> <p>Specify with left position.</p> <p>Specify with right position.</p>
Grommet	<ul style="list-style-type: none"> Grommet +\$ 66 	Specify with grommet.
Glides	<ul style="list-style-type: none"> 1" adjustable glides +\$ 50 	Specify with 1" glides.
Related Products	<ul style="list-style-type: none"> Modesty panels Fixed personal/modesty screens Cable and power management 	<ul style="list-style-type: none"> ► Page 134 ► Page 344 ► Page 135

Tip: The standard active touch controller is Bluetooth-enabled to allow pairing with the Steelcase Rise app.

Tip: Tapered desks accommodate either power and data access door or grommet, but not both.

Specification Information

Style Number	Dimensions		Desk Type	U.S. Base Prices			
	LD	RD		58"W	64"W	70"W	76"W
			Modular				
			Parametric	58 ¹ / ₁₆ "W-60"W	60 ¹ / ₁₆ "W-66"W	66 ¹ / ₁₆ "W-72"W	72 ¹ / ₁₆ "W-78"W

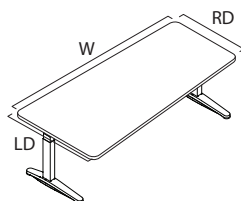

High-Pressure Laminate Desks — Extended Height

OLELRT	23" or 24"	29" or 30"	\$3360	\$3462	\$3566	\$3674
	29" or 30"	23" or 24"	\$3360	\$3462	\$3566	\$3674

Composite Veneer Desks — Extended Height

OLELRT	23" or 24"	29" or 30"	\$4273	\$4394	\$4506	\$4632
	29" or 30"	23" or 24"	\$4273	\$4394	\$4506	\$4632

Wood Veneer Desks — Extended Height

OLELRT	23" or 24"	29" or 30"	\$4364	\$4486	\$4600	\$4728
	29" or 30"	23" or 24"	\$4364	\$4486	\$4600	\$4728

► Specification Information, continued on next page



For Canadian Pricing

Multiply U.S. Price by the Canadian price factor.

► See page 1 for details.

Ology Height-Adjustable Tapered Desks, High-Pressure Laminate or Composite Veneer, continued

► **Specification Information, continued from previous page**

Specification Information

• Style Number	• Dimensions		• Desk Type	• U.S. Base Prices			
	LD	RD		58"W	64"W	70"W	76"W
			Modular				
			Parametric	58 ¹ / ₁₆ "W-60"W	60 ¹ / ₁₆ "W-66"W	66 ¹ / ₁₆ "W-72"W	72 ¹ / ₁₆ "W-78"W

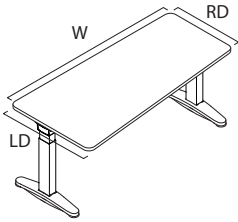

High-Pressure Laminate Desks — Basic Height

OLSLRT	23" or 24"	29" or 30"	\$3097	\$3191	\$3289	\$3389
	29" or 30"	23" or 24"	\$3097	\$3191	\$3289	\$3389

Composite Veneer Desks — Basic Height

OLSLRT	23" or 24"	29" or 30"	\$4010	\$4123	\$4229	\$4347
	29" or 30"	23" or 24"	\$4010	\$4123	\$4229	\$4347

Wood Veneer Desks — Basic Height

OLSLRT	23" or 24"	29" or 30"	\$4101	\$4215	\$4323	\$4443
	29" or 30"	23" or 24"	\$4101	\$4215	\$4323	\$4443



For Canadian Pricing

Multiply U.S. Price by the Canadian price factor.

► See page 1 for details.

Ology Height-Adjustable 3-Leg Corner Desks

High-Pressure Laminate or Composite Veneer

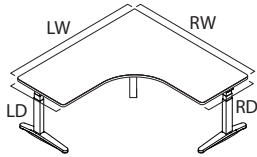

Tip: On extended height desks, any storage higher than 18"H, or 15½"H if the power access door is optional, will impede lowest height range of worksurface. On basic height desks, any storage higher than 23"H, or 20½"H if the power access door is optional, will impede lowest height range of work-surface. Do not place stor-age underneath controller.

Tip: Base supports a maximum distributed weight capacity of 500 pounds (3-leg). When calculating lifting capacity, subtract the weight of the worksurface, understructure and options selected.

▶ See page 70 for worksur-face weights.

Tip: Antimicrobial additives can be specified only when specifying simple touch controller

For laminate price group 2 and 3 pricing, please refer to the electronic catalog or SmartTools.

Tip: For a conversion chart of old to new 3-leg corner style numbers refer to page 374.

Tip: The standard active touch controller is Bluetooth-enabled to allow pairing with the Steelcase Rise app.

Standard Includes	Required to Specify
<p>▶ Need help? Product details, page 64</p> <ul style="list-style-type: none"> • Worksurface: High-Pressure Laminate price group 1 with 3 mm plastic edge or composite veneer group 1 • Electric height-adjustable sit-to-stand base: paint • Active touch controller • Modular widths: <ul style="list-style-type: none"> – 90° equal corner: 52"–76" – 90° extended corner: 40"–76" – 120° equal corner: 34"–64" • ½" adjustable glides • Power cord: 10^{5/8}' • Attachment hardware 	<ol style="list-style-type: none"> 1 Style number 2 Desk depth 3 Desk width 4 High-Pressure Laminate or composite veneer for worksurface 5 Plastic color number for profile edge on laminate worksurface, if selected 6 Desk corner style, if laminate desk selected (see below under Required Selections) 7 Paint color number for base <ul style="list-style-type: none"> 4799 Platinum Metallic 7207 Black 7241 Arctic White 7360 Merle 8 Integrated rail (see below under Required Selections) 9 Antimicrobial or non-antimicrobial components, if simple touch controller selected (see below under Required Selections) 10 Options, if selected (see below) <ul style="list-style-type: none"> ▶ See <i>Surface Materials</i>, page 362

Required Selections	U.S. Price	Required to Specify
Desk Corner Style (Laminate Desks Only) <ul style="list-style-type: none"> • Square corners • Radius corners 	No cost +\$ 98	Specify <i>with square corners</i> . Specify <i>with radius corners</i> .
Integrated Rail <ul style="list-style-type: none"> • Without integrated rail • With integrated rail 	No cost +\$970	Specify <i>without integrated rail</i> . Specify <i>with integrated rail</i> .
Antimicrobial Components <ul style="list-style-type: none"> • Non-antimicrobial components • Antimicrobial components 	No cost No cost	Specify <i>with non-antimicrobial components</i> . Specify <i>with antimicrobial components</i> .

Options	U.S. Price	Required to Specify
Surface Materials <ul style="list-style-type: none"> • High-Pressure Laminate desks <ul style="list-style-type: none"> • Laminate price group 2 • Laminate price group 3 • Open Line laminate 	See information at left See information at left +\$111 plus cost of laminate	Specify laminate color number. Specify laminate color number. ▶ See <i>Surface Materials Reference Manual</i> .
<ul style="list-style-type: none"> • Composite veneer desks <ul style="list-style-type: none"> • Composite veneer group 1 • Composite veneer group 2 	Prices at right +\$108	Specify composite veneer color number. Specify composite veneer color number.
<ul style="list-style-type: none"> • Wood veneer desks <ul style="list-style-type: none"> • Wood group 1 • Wood group 2 • Wood group 3 • Customiz stain 	Prices at right +\$118 +\$417 No cost	Specify wood color number. Specify wood color number. Specify wood color number. Specify <i>with customiz stain</i> . ▶ See <i>Surface Materials Reference Manual</i> .
Base <ul style="list-style-type: none"> • Paint price group 1 • Paint price group 2 	No cost +\$ 72	Specify paint color number. Specify paint color number. ▶ See <i>Surface Materials</i> , page 362.
Desk Type <ul style="list-style-type: none"> • Modular width desk • Parametric width desk 	No cost No cost	Specify <i>with modular desk type</i> . Specify <i>with parametric desk type</i> .
Controller <ul style="list-style-type: none"> • Simple touch controller • 4 Pre-set controller 	–\$ 78 +\$188	Specify <i>with simple touch controller</i> . Specify <i>with 4 pre-set controller</i> .

▶ Options, continued on next page

► Options, continued from previous page

Tip: Power and data access door and grommet cannot be located on the same side of the desk.

Tip: Power and data access door is available on desks 58"W or greater.

Tip: When selecting power and data access door or grommet on one side, a cord drop will be standard on opposite side if integrated rail is present.

Tip: CarbonNeutral option is not available for 120° corner desks.

Options	U.S. Price	Required to Specify
Power and Data Access Door, Tray and USB A+C 20W	<ul style="list-style-type: none"> Power and data access door on left or right: paint group 1 or 2 +\$1219 Power and data access door on left or right: anodized aluminum +\$1236 Power and data access door on left and right: paint group 1 or 2 +\$2438 Power and data access door on left and right: anodized aluminum +\$2472 	<ul style="list-style-type: none"> Specify with power and data access door on left or right and select paint color number. Specify with power and data access door on left or right and select anodized aluminum. Specify with power and data access door on left and right and select paint color number. Specify with power and data access door on left and right and select anodized aluminum.
Grommet	<ul style="list-style-type: none"> Grommet on left- or right-hand side. +\$ 66 Grommet on left- and right-hand side. +\$ 132 	<ul style="list-style-type: none"> Specify with grommet and select left- or right-hand sides. Specify with grommet and select left- and right-hand sides.
Glides	<ul style="list-style-type: none"> 1" adjustable glides +\$ 75 	Specify with 1" glides.
CarbonNeutral Product	CarbonNeutral product certification +\$ 49	Add suffix CN to the end of the style number.
Related Products	<ul style="list-style-type: none"> Modesty panels Fixed personal/modesty screens Cable and power management 	<ul style="list-style-type: none"> ► Page 134 ► Page 344 ► Page 135

Ology

Specification Information

Style Number	Dimensions D	Modular Left Width	Parametric Left Width	Modular Right Width	Parametric Right Width	U.S. Base Prices												
						40"W	46"W	52"W	58"W	64"W	70"W	76"W						
						40"W—42"W	42 ¹ / ₁₆ "W—48"W	48 ¹ / ₁₆ "W—54"W	54 ¹ / ₁₆ "W—60"W	60 ¹ / ₁₆ "W—66"W	66 ¹ / ₁₆ "W—72"W	72 ¹ / ₁₆ "W—78"W						

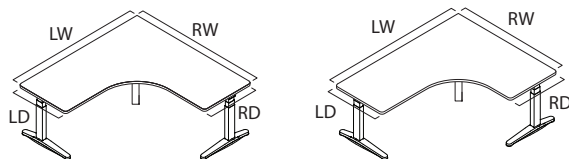

90° 3-Leg Corner Desks — Extended Height (Same Depth Both Ends 23"/24")

High-Pressure Laminate Desks

OLELL3	23" or 24"	40"W	40"W—42"W	N.A.	N.A.	\$4047	\$4175	\$4304	\$4435	\$4568
	23" or 24"	46"W	42 ¹ / ₁₆ "W—48"W	N.A.	N.A.	\$4175	\$4304	\$4435	\$4568	\$4713
	23" or 24"	52"W	48 ¹ / ₁₆ "W—54"W	\$4047	\$4175	\$4304	\$4435	\$4568	\$4713	\$4857
	23" or 24"	58"W	54 ¹ / ₁₆ "W—60"W	\$4175	\$4304	\$4435	\$4568	\$4713	\$4857	\$5006
	23" or 24"	64"W	60 ¹ / ₁₆ "W—66"W	\$4304	\$4435	\$4568	\$4713	\$4857	\$5006	\$5161
	23" or 24"	70"W	66 ¹ / ₁₆ "W—72"W	\$4435	\$4568	\$4713	\$4857	\$5006	\$5161	\$5326
	23" or 24"	76"W	72 ¹ / ₁₆ "W—78"W	\$4568	\$4713	\$4857	\$5006	\$5161	\$5326	\$5485

Tip: At least one side must be 52"W or greater.

Tip: Equal corner widths are parametric to 1/16" from 52"W—78"W.

Tip: 90° desks, 60¹/₁₆"W x 60¹/₁₆"W and wider, are manufactured in two pieces. The worksurface split is located on the left side of an equal corner and on the longest side of an extended corner.

► Specification Information, continued on next page

Ology Height-Adjustable 3-Leg Corner Desks, High-Pressure Laminate or Composite Veneer, continued

► Specification Information, continued from previous page

Specification Information													
Style Number	Dimensions				U.S. Base Prices								
	D		Modular Left Width	Parametric Left Width	Modular Right Width	Parametric Right Width	40"W	46"W	52"W	58"W	64"W	70"W	76"W
						40"W—42"W	42 ¹ / ₁₆ "W—48"W	48 ¹ / ₁₆ "W—54"W	54 ¹ / ₁₆ "W—60"W	60 ¹ / ₁₆ "W—66"W	66 ¹ / ₁₆ "W—72"W	72 ¹ / ₁₆ "W—78"W	

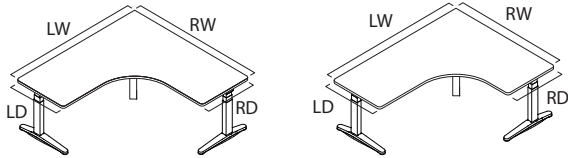

90° 3-Leg Corner Desks — Extended Height (Different Depth Opposite Ends 23"/24" Right/Left and 29"/30" Left/Right)

High-Pressure Laminate Desks

OLELL3	23" or 24" R/L	29" or 30" L/R	40"W	40"W—42"W	N.A.	N.A.	► See page 84	► See page 84	► See page 84	► See page 84	► See page 84
	23" or 24" R/L	29" or 30" L/R	46"W	42 ¹ / ₁₆ "W—48"W	N.A.	N.A.	\$4298	\$4437	\$4573	\$4714	\$4859
	23" or 24" R/L	29" or 30" L/R	52"W	48 ¹ / ₁₆ "W—54"W	► See page 84	\$4298	\$4437	\$4573	\$4714	\$4859	\$5011
	23" or 24" R/L	29" or 30" L/R	58"W	54 ¹ / ₁₆ "W—60"W	\$4298	\$4437	\$4573	\$4714	\$4859	\$5011	\$5160
	23" or 24" R/L	29" or 30" L/R	64"W	60 ¹ / ₁₆ "W—66"W	\$4437	\$4573	\$4714	\$4859	\$5011	\$5160	\$5319
	23" or 24" R/L	29" or 30" L/R	70"W	66 ¹ / ₁₆ "W—72"W	\$4573	\$4714	\$4859	\$5011	\$5160	\$5319	\$5486
	23" or 24" R/L	29" or 30" L/R	76"W	72 ¹ / ₁₆ "W—78"W	\$4714	\$4859	\$5011	\$5160	\$5319	\$5486	\$5642

Tip: At least one side must be 52"W or greater.

Tip: Equal corner widths are parametric to ¹/₁₆" from 52"W—78"W.

Tip: 90° desks, 60¹/₁₆"W x 60¹/₁₆"W and wider, are manufactured in two pieces. The work surface split is located on the left side of an equal corner and on the longest side of an extended corner.

► Specification Information, continued on next page



For Canadian Pricing

Multiply U.S. Price by the Canadian price factor.

► See page 1 for details.

► **Specification Information, continued from previous page**

Specification Information												
Style Number	Dimensions D			U.S. Base Prices								
		Modular Left Width	Parametric Left Width	Modular Right Width	Parametric Right Width	40"W	46"W	52"W	58"W	64"W	70"W	76"W
						40"W	42 ¹ / ₁₆ "W	48 ¹ / ₁₆ "W	54 ¹ / ₁₆ "W	60 ¹ / ₁₆ "W	66 ¹ / ₁₆ "W	72 ¹ / ₁₆ "W
						42"W	48"W	54"W	60"W	66"W	72"W	78"W

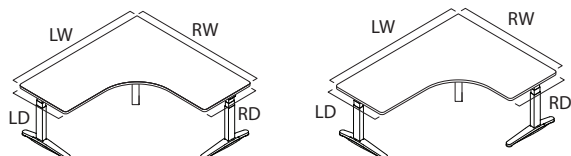

90° 3-Leg Corner Desks — Extended Height (Same Depth Both Ends 29"/30")

High-Pressure Laminate Desks

OLELL3	29" or 30"	40"W	40"W-42"W	N.A.	N.A.	N.A.	N.A.	N.A.	N.A.	N.A.
	29" or 30"	46"W	42 ¹ / ₁₆ "W-48"W	N.A.	N.A.	\$4419	\$4568	\$4717	\$4857	\$5006
	29" or 30"	52"W	48 ¹ / ₁₆ "W-54"W	N.A.	\$4419	\$4568	\$4717	\$4857	\$5006	\$5161
	29" or 30"	58"W	54 ¹ / ₁₆ "W-60"W	N.A.	\$4568	\$4717	\$4857	\$5006	\$5161	\$5318
	29" or 30"	64"W	60 ¹ / ₁₆ "W-66"W	N.A.	\$4717	\$4857	\$5006	\$5161	\$5318	\$5475
	29" or 30"	70"W	66 ¹ / ₁₆ "W-72"W	N.A.	\$4857	\$5006	\$5161	\$5318	\$5475	\$5643
	29" or 30"	76"W	72 ¹ / ₁₆ "W-78"W	N.A.	\$5006	\$5161	\$5318	\$5475	\$5643	\$5801

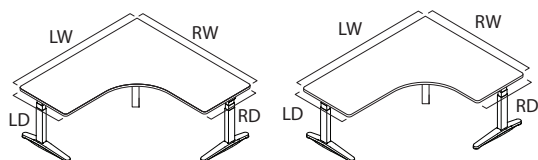

90° 3-Leg Corner Desks — Extended Height (Same Depth Both Ends 23"/24")

Composite Veneer Desks

OLELL3	23" or 24"	40"W	40"W-42"W	N.A.	N.A.	\$5405	\$5553	\$5702	\$5851	\$6010
	23" or 24"	46"W	42 ¹ / ₁₆ "W-48"W	N.A.	N.A.	\$5553	\$5702	\$5851	\$6010	\$6175
	23" or 24"	52"W	48 ¹ / ₁₆ "W-54"W	\$5405	\$5553	\$5702	\$5833	\$6010	\$6175	\$6340
	23" or 24"	58"W	54 ¹ / ₁₆ "W-60"W	\$5553	\$5702	\$5833	\$6010	\$6175	\$6340	\$6510
	23" or 24"	64"W	60 ¹ / ₁₆ "W-66"W	\$5702	\$5851	\$6010	\$6175	\$6340	\$6510	\$6687
	23" or 24"	70"W	66 ¹ / ₁₆ "W-72"W	\$5851	\$6010	\$6175	\$6340	\$6510	\$6672	\$6868
	23" or 24"	76"W	72 ¹ / ₁₆ "W-78"W	\$6010	\$6175	\$6340	\$6510	\$6687	\$6868	\$7064

Tip: At least one side must be 52"W or greater.

Tip: Equal corner widths are parametric to 1/16" from 52"W-78"W.

Tip: 90° desks, 60¹/₁₆"W x 60¹/₁₆"W and wider, are manufactured in two pieces. The worksurface split is located on the left side of an equal corner and on the longest side of an extended corner.

► **Specification Information, continued on next page**

Ology Height-Adjustable 3-Leg Corner Desks, High-Pressure Laminate or Composite Veneer, continued

► **Specification Information, continued from previous page**

Specification Information												
• Style Number	• Dimensions			• U.S. Base Prices								
	D	• Modular Left Width	• Parametric Left Width	• Modular Right Width	• Parametric Right Width	40"W	46"W	52"W	58"W	64"W	70"W	76"W
						40"W—42"W	42 ¹ / ₁₆ "W—48"W	48 ¹ / ₁₆ "W—54"W	54 ¹ / ₁₆ "W—60"W	60 ¹ / ₁₆ "W—66"W	66 ¹ / ₁₆ "W—72"W	72 ¹ / ₁₆ "W—78"W

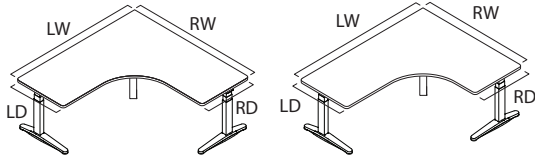

90° 3-Leg Corner Desks — Extended Height (Same Depth Both Ends 23"/24"), continued

Wood Veneer Desks

OLELL3	23" or 24"	40"W	40"W—42"W	N.A.	N.A.	\$5541	\$5691	\$5842	\$5992	\$6155
	23" or 24"	46"W	42 ¹ / ₁₆ "W—48"W	N.A.	N.A.	\$5691	\$5842	\$5992	\$6155	\$6322
	23" or 24"	52"W	48 ¹ / ₁₆ "W—54"W	\$5541	\$5691	\$5842	\$5973	\$6155	\$6322	\$6489
	23" or 24"	58"W	54 ¹ / ₁₆ "W—60"W	\$5691	\$5842	\$5973	\$6155	\$6322	\$6489	\$6661
	23" or 24"	64"W	60 ¹ / ₁₆ "W—66"W	\$5842	\$5992	\$6155	\$6322	\$6489	\$6661	\$6840
	23" or 24"	70"W	66 ¹ / ₁₆ "W—72"W	\$5992	\$6155	\$6322	\$6489	\$6661	\$6823	\$7022
	23" or 24"	76"W	72 ¹ / ₁₆ "W—78"W	\$6155	\$6322	\$6489	\$6661	\$6840	\$7022	\$7223

Tip: At least one side must be 52"W or greater.

Tip: Equal corner widths are parametric to 1/16" from 52"W—78"W.

Tip: 90° desks, 60¹/₁₆"W x 60¹/₁₆"W and wider, are manufactured in two pieces. The worksurface split is located on the left side of an equal corner and on the longest side of an extended corner.

► **Specification Information, continued on next page**



For Canadian Pricing

Multiply U.S. Price by the Canadian price factor.

► See page 1 for details.

► Specification Information, continued from previous page

Specification Information												
Style Number	Dimensions				U.S. Base Prices							
	D		Modular Left Width	Parametric Left Width	Modular Right Width	40"W	46"W	52"W	58"W	64"W	70"W	76"W
					Parametric Right Width	40"W—42"W	42 ¹ / ₁₆ "W—48"W	48 ¹ / ₁₆ "W—54"W	54 ¹ / ₁₆ "W—60"W	60 ¹ / ₁₆ "W—66"W	66 ¹ / ₁₆ "W—72"W	72 ¹ / ₁₆ "W—78"W

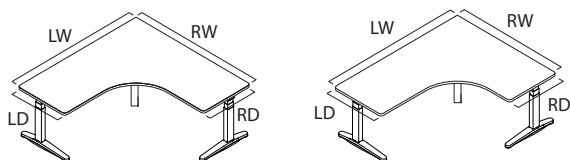

90° 3-Leg Corner Desks — Extended Height (Different Depth Opposite Ends 23"/24" Right/Left and 29"/30" Left/Right)

Composite Veneer Desks											
OLELL3	23" or 24" R/L	29" or 30" L/R	40"W	40"W–42"W	N.A.	N.A.	► See page 85	► See page 85	► See page 85	► See page 85	► See page 85
	23" or 24" R/L	29" or 30" L/R	46"W	42 ¹ / ₁₆ "W–48"W	N.A.	N.A.	\$5676	\$5835	\$5989	\$6156	\$6320
	23" or 24" R/L	29" or 30" L/R	52"W	48 ¹ / ₁₆ "W–54"W	► See page 85	\$5676	\$5835	\$5989	\$6156	\$6320	\$6495
	23" or 24" R/L	29" or 30" L/R	58"W	54 ¹ / ₁₆ "W–60"W	\$5676	\$5835	\$5989	\$6156	\$6320	\$6495	\$6664
	23" or 24" R/L	29" or 30" L/R	64"W	60 ¹ / ₁₆ "W–66"W	\$5835	\$5989	\$6156	\$6320	\$6495	\$6664	\$6847
	23" or 24" R/L	29" or 30" L/R	70"W	66 ¹ / ₁₆ "W–72"W	\$5989	\$6156	\$6320	\$6495	\$6664	\$6847	\$7029
	23" or 24" R/L	29" or 30" L/R	76"W	72 ¹ / ₁₆ "W–78"W	\$6156	\$6320	\$6495	\$6664	\$6847	\$7029	\$7221

Wood Veneer Desks											
OLELL3	23" or 24" R/L	29" or 30" L/R	40"W	40"W–42"W	N.A.	N.A.	► See page 85	► See page 85	► See page 85	► See page 85	► See page 85
	23" or 24" R/L	29" or 30" L/R	46"W	42 ¹ / ₁₆ "W–48"W	N.A.	N.A.	\$5814	\$5975	\$6130	\$6301	\$6467
	23" or 24" R/L	29" or 30" L/R	52"W	48 ¹ / ₁₆ "W–54"W	► See page 85	\$5814	\$5975	\$6130	\$6301	\$6467	\$6643
	23" or 24" R/L	29" or 30" L/R	58"W	54 ¹ / ₁₆ "W–60"W	\$5814	\$5975	\$6130	\$6301	\$6467	\$6643	\$6815
	23" or 24" R/L	29" or 30" L/R	64"W	60 ¹ / ₁₆ "W–66"W	\$5975	\$6130	\$6301	\$6467	\$6643	\$6815	\$7000
	23" or 24" R/L	29" or 30" L/R	70"W	66 ¹ / ₁₆ "W–72"W	\$6130	\$6301	\$6467	\$6643	\$6815	\$7000	\$7183
	23" or 24" R/L	29" or 30" L/R	76"W	72 ¹ / ₁₆ "W–78"W	\$6301	\$6467	\$6643	\$6815	\$7000	\$7183	\$7380

Tip: At least one side must be 52"W or greater.

Tip: Equal corner widths are parametric to 1/16" from 52"W–78"W.

Tip: 90° desks, 60¹/₁₆"W x 60¹/₁₆"W and wider, are manufactured in two pieces. The work surface split is located on the left side of an equal corner and on the longest side of an extended corner.

► Specification Information, continued on next page

Ology Height-Adjustable 3-Leg Corner Desks, High-Pressure Laminate or Composite Veneer, continued

► **Specification Information, continued from previous page**

Specification Information											
Style Number	Dimensions			Modular Right Width	U.S. Base Prices						
	Modular Left Width	Parametric Left Width	Parametric Right Width		40"W	46"W	52"W	58"W	64"W	70"W	76"W
					40"W	42 ¹ / ₁₆ "W	48 ¹ / ₁₆ "W	54 ¹ / ₁₆ "W	60 ¹ / ₁₆ "W	66 ¹ / ₁₆ "W	72 ¹ / ₁₆ "W
					42"W	48"W	54"W	60"W	66"W	72"W	78"W

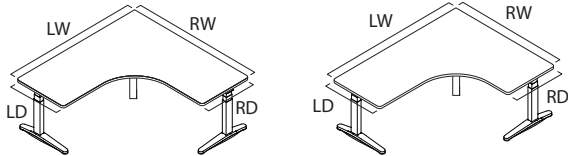

90° 3-Leg Corner Desks — Extended Height (Same Depth Both Ends 29"/30")

Composite Veneer Desks

OLELL3	29" or 30"	40"W	40"W–42"W	N.A.	N.A.	N.A.	N.A.	N.A.	N.A.	N.A.
	29" or 30"	46"W	42 ¹ / ₁₆ "W–48"W	N.A.	N.A.	\$5797	\$5966	\$6132	\$6299	\$6468
	29" or 30"	52"W	48 ¹ / ₁₆ "W–54"W	N.A.	\$5797	\$5966	\$6132	\$6299	\$6468	\$6644
	29" or 30"	58"W	54 ¹ / ₁₆ "W–60"W	N.A.	\$5966	\$6132	\$6299	\$6468	\$6644	\$6822
	29" or 30"	64"W	60 ¹ / ₁₆ "W–66"W	N.A.	\$6132	\$6299	\$6468	\$6644	\$6822	\$7001
	29" or 30"	70"W	66 ¹ / ₁₆ "W–72"W	N.A.	\$6299	\$6468	\$6644	\$6822	\$7001	\$7186
	29" or 30"	76"W	72 ¹ / ₁₆ "W–78"W	N.A.	\$6468	\$6644	\$6822	\$7001	\$7186	\$7380

Wood Veneer Desks

OLELL3	29" or 30"	40"W	40"W–42"W	N.A.	N.A.	N.A.	N.A.	N.A.	N.A.	N.A.
	29" or 30"	46"W	42 ¹ / ₁₆ "W–48"W	N.A.	N.A.	\$5935	\$6106	\$6273	\$6444	\$6615
	29" or 30"	52"W	48 ¹ / ₁₆ "W–54"W	N.A.	\$5935	\$6106	\$6273	\$6444	\$6615	\$6793
	29" or 30"	58"W	54 ¹ / ₁₆ "W–60"W	N.A.	\$6106	\$6273	\$6444	\$6615	\$6793	\$6973
	29" or 30"	64"W	60 ¹ / ₁₆ "W–66"W	N.A.	\$6273	\$6444	\$6615	\$6793	\$6973	\$7154
	29" or 30"	70"W	66 ¹ / ₁₆ "W–72"W	N.A.	\$6444	\$6615	\$6793	\$6973	\$7154	\$7340
	29" or 30"	76"W	72 ¹ / ₁₆ "W–78"W	N.A.	\$6615	\$6793	\$6973	\$7154	\$7340	\$7539

Tip: At least one side must be 52"W or greater.

Tip: Equal corner widths are parametric to ¹/₁₆" from 52"W–78"W.

Tip: 90° desks, 60¹/₁₆"W x 60¹/₁₆"W and wider, are manufactured in two pieces. The worksurface split is located on the left side of an equal corner and on the longest side of an extended corner.

► **Specification Information, continued on next page**



For Canadian Pricing

Multiply U.S. Price by the Canadian price factor.

► See page 1 for details.

► **Specification Information, continued from previous page**

Specification Information											
• Style Number	• Dimensions D			• U.S. Base Prices							
	• Modular Left Width	• Parametric Left Width	• Parametric Right Width	• Modular Right Width	40"W	46"W	52"W	58"W	64"W	70"W	76"W
					40"W	42 ¹ / ₁₆ "W	48 ¹ / ₁₆ "W	54 ¹ / ₁₆ "W	60 ¹ / ₁₆ "W	66 ¹ / ₁₆ "W	72 ¹ / ₁₆ "W
					42"W	48"W	54"W	60"W	66"W	72"W	78"W

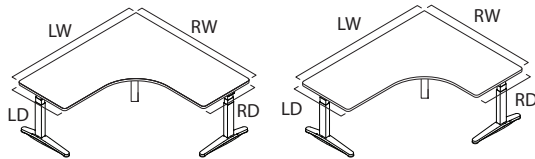

90° 3-Leg Corner Desks — Basic Height (Same Depth Both Ends 23"/24")

High-Pressure Laminate Desks

OLSL3	23" or 24"	40"W	40"W–42"W	N.A.	N.A.	\$3728	\$3850	\$3969	\$4086	\$4211
	23" or 24"	46"W	42 ¹ / ₁₆ "W–48"W	N.A.	N.A.	\$3850	\$3969	\$4086	\$4211	\$4340
	23" or 24"	52"W	48 ¹ / ₁₆ "W–54"W	\$3728	\$3850	\$3969	\$4086	\$4211	\$4340	\$4475
	23" or 24"	58"W	54 ¹ / ₁₆ "W–60"W	\$3850	\$3969	\$4086	\$4211	\$4340	\$4475	\$4611
	23" or 24"	64"W	60 ¹ / ₁₆ "W–66"W	\$3969	\$4086	\$4211	\$4340	\$4475	\$4611	\$4754
	23" or 24"	70"W	66 ¹ / ₁₆ "W–72"W	\$4086	\$4211	\$4340	\$4475	\$4611	\$4754	\$4906
	23" or 24"	76"W	72 ¹ / ₁₆ "W–78"W	\$4211	\$4340	\$4475	\$4611	\$4754	\$4906	\$5050

Tip: At least one side must be 52"W or greater.

Tip: Equal corner widths are parametric to 1/16" from 52"W–78"W.

Tip: 90° desks, 60¹/₁₆"W x 60¹/₁₆"W and wider, are manufactured in two pieces. The worksurface split is located on the left side of an equal corner and on the longest side of an extended corner.

► **Specification Information, continued on next page**

For Canadian Pricing
Multiply U.S. Price by the
Canadian price factor.
► See page 1 for details.

► **Specification Information, continued from previous page**

Specification Information												
Style Number	Dimensions			U.S. Base Prices								
	D	Modular Left Width	Parametric Left Width	Modular Right Width	Parametric Right Width	40"W	46"W	52"W	58"W	64"W	70"W	76"W
						40"W—	42 ¹ / ₁₆ "W—	48 ¹ / ₁₆ "W—	54 ¹ / ₁₆ "W—	60 ¹ / ₁₆ "W—	66 ¹ / ₁₆ "W—	72 ¹ / ₁₆ "W—
						42"W	48"W	54"W	60"W	66"W	72"W	78"W

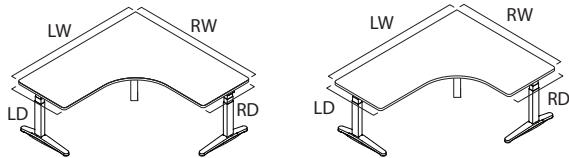

90° 3-Leg Corner Desks — Basic Height (Different Depth Opposite Ends 23"/24" Right/Left and 29"/30" Left/Right)

High-Pressure Laminate Desks

OLSL3	23" or 24" R/L	29" or 30" L/R	40"W	40"W–42"W	N.A.	N.A.	► See page 86	► See page 84	► See page 84	► See page 84	► See page 84
	23" or 24" R/L	29" or 30" L/R	46"W	42 ¹ / ₁₆ "W–48"W	N.A.	N.A.	\$3959	\$4088	\$4216	\$4341	\$4478
	23" or 24" R/L	29" or 30" L/R	52"W	48 ¹ / ₁₆ "W–54"W	► See page 84	\$3959	\$4088	\$4216	\$4341	\$4478	\$4617
	23" or 24" R/L	29" or 30" L/R	58"W	54 ¹ / ₁₆ "W–60"W	\$3959	\$4088	\$4216	\$4341	\$4478	\$4617	\$4754
	23" or 24" R/L	29" or 30" L/R	64"W	60 ¹ / ₁₆ "W–66"W	\$4088	\$4216	\$4341	\$4478	\$4617	\$4754	\$4899
	23" or 24" R/L	29" or 30" L/R	70"W	66 ¹ / ₁₆ "W–72"W	\$4216	\$4341	\$4478	\$4617	\$4754	\$4899	\$5046
	23" or 24" R/L	29" or 30" L/R	76"W	72 ¹ / ₁₆ "W–78"W	\$4341	\$4478	\$4617	\$4754	\$4899	\$5046	\$5197

Tip: At least one side must be 52"W or greater.

Tip: Equal corner widths are parametric to 1/16" from 52"W–78"W.

Tip: 90° desks, 60¹/₁₆"W x 60¹/₁₆"W and wider, are manufactured in two pieces. The worksurface split is located on the left side of an equal corner and on the longest side of an extended corner.

► **Specification Information, continued on next page**

 **For Canadian Pricing**
 Multiply U.S. Price by the Canadian price factor.
 ► See page 1 for details.

► **Specification Information, continued from previous page**

Specification Information										
• Style Number	• Dimensions D			• U.S. Base Prices						
	• Modular Left Width	• Parametric Left Width	• Modular Right Width	40"W	46"W	52"W	58"W	64"W	70"W	76"W
			• Parametric Right Width	40"W	42 ¹ / ₁₆ "W	48 ¹ / ₁₆ "W	54 ¹ / ₁₆ "W	60 ¹ / ₁₆ "W	66 ¹ / ₁₆ "W	72 ¹ / ₁₆ "W
				42"W	48"W	54"W	60"W	66"W	72"W	78"W

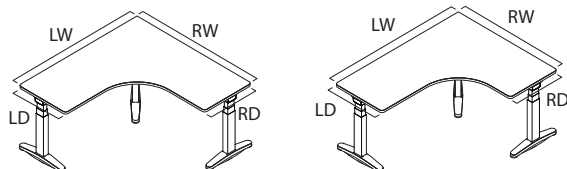

90° 3-Leg Corner Desks — Basic Height (Same Depth Both Ends 29"/30")

High-Pressure Laminate Desks

OLSL3	29" or 30"	40"W	40"W–42"W	N.A.	N.A.	N.A.	N.A.	N.A.	N.A.	N.A.
	29" or 30"	46"W	42 ¹ / ₁₆ "W–48"W	N.A.	N.A.	\$4072	\$4211	\$4342	\$4475	\$4611
	29" or 30"	52"W	48 ¹ / ₁₆ "W–54"W	N.A.	\$4072	\$4211	\$4342	\$4475	\$4611	\$4754
	29" or 30"	58"W	54 ¹ / ₁₆ "W–60"W	N.A.	\$4211	\$4342	\$4475	\$4611	\$4754	\$4897
	29" or 30"	64"W	60 ¹ / ₁₆ "W–66"W	N.A.	\$4342	\$4475	\$4611	\$4754	\$4897	\$5044
	29" or 30"	70"W	66 ¹ / ₁₆ "W–72"W	N.A.	\$4475	\$4611	\$4754	\$4897	\$5044	\$5198
	29" or 30"	76"W	72 ¹ / ₁₆ "W–78"W	N.A.	\$4611	\$4754	\$4897	\$5044	\$5198	\$5344

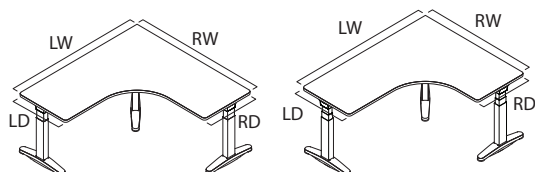

90° 3-Leg Corner Desks — Basic Height (Same Depth Both Ends 23"/24")

Composite Veneer Desks

OLSL3	23" or 24"	40"W	40"W–42"W	N.A.	N.A.	\$5086	\$5228	\$5367	\$5502	\$5653
	23" or 24"	46"W	42 ¹ / ₁₆ "W–48"W	N.A.	N.A.	\$5228	\$5367	\$5502	\$5653	\$5802
	23" or 24"	52"W	48 ¹ / ₁₆ "W–54"W	\$5086	\$5228	\$5367	\$5484	\$5653	\$5802	\$5958
	23" or 24"	58"W	54 ¹ / ₁₆ "W–60"W	\$5228	\$5367	\$5484	\$5653	\$5802	\$5958	\$6115
	23" or 24"	64"W	60 ¹ / ₁₆ "W–66"W	\$5367	\$5502	\$5653	\$5802	\$5958	\$6115	\$6280
	23" or 24"	70"W	66 ¹ / ₁₆ "W–72"W	\$5502	\$5653	\$5802	\$5958	\$6115	\$6280	\$6447
	23" or 24"	76"W	72 ¹ / ₁₆ "W–78"W	\$5653	\$5802	\$5958	\$6115	\$6280	\$6447	\$6629

Tip: At least one side must be 52"W or greater.

Tip: Equal corner widths are parametric to 1/16" from 52"W–78"W.

Tip: 90° desks, 60¹/₁₆"W x 60¹/₁₆"W and wider, are manufactured in two pieces. The work surface split is located on the left side of an equal corner and on the right side of an extended corner.

► **Specification Information, continued on next page**

Ology Height-Adjustable 3-Leg Corner Desks, High-Pressure Laminate or Composite Veneer, continued

► **Specification Information, continued from previous page**

Specification Information											
Style Number	Dimensions D		Modular Right Width	U.S. Base Prices							
	Modular Left Width	Parametric Left Width		40"W	46"W	52"W	58"W	64"W	70"W	76"W	
			Parametric Right Width	40"W	42 ¹ / ₁₆ "W	48 ¹ / ₁₆ "W	54 ¹ / ₁₆ "W	60 ¹ / ₁₆ "W	66 ¹ / ₁₆ "W	72 ¹ / ₁₆ "W	78"W

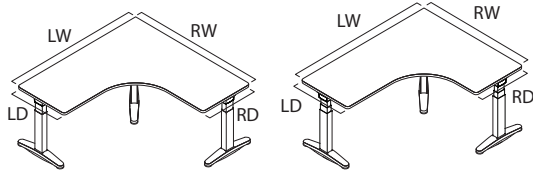

90° 3-Leg Corner Desks — Basic Height (Same Depth Both Ends 23"/24"), continued

Wood Veneer Desks

OLSL3	23" or 24"	40"W	40"W-42"W	N.A.	N.A.	\$5222	\$5366	\$5507	\$5643	\$5798
	23" or 24"	46"W	42 ¹ / ₁₆ "W-48"W	N.A.	N.A.	\$5366	\$5507	\$5643	\$5798	\$5949
	23" or 24"	52"W	48 ¹ / ₁₆ "W-54"W	\$5222	\$5366	\$5507	\$5624	\$5798	\$5949	\$6107
	23" or 24"	58"W	54 ¹ / ₁₆ "W-60"W	\$5366	\$5507	\$5624	\$5798	\$5949	\$6107	\$6266
	23" or 24"	64"W	60 ¹ / ₁₆ "W-66"W	\$5507	\$5643	\$5798	\$5949	\$6107	\$6266	\$6433
	23" or 24"	70"W	66 ¹ / ₁₆ "W-72"W	\$5643	\$5798	\$5949	\$6107	\$6266	\$6433	\$6601
	23" or 24"	76"W	72 ¹ / ₁₆ "W-78"W	\$5798	\$5949	\$6107	\$6266	\$6433	\$6601	\$6788

Tip: At least one side must be 52"W or greater.

Tip: Equal corner widths are parametric to 1/16" from 52"W-78"W.

Tip: 90° desks, 60¹/₁₆"W x 60¹/₁₆"W and wider, are manufactured in two pieces. The worksurface split is located on the left side of an equal corner and on the longest side of an extended corner.

► **Specification Information, continued on next page**

 **For Canadian Pricing**
 Multiply U.S. Price by the Canadian price factor.
 ► See page 1 for details.

► Specification Information, continued from previous page

Specification Information											
Style Number	Dimensions			U.S. Base Prices							
	D	Modular Left Width	Parametric Left Width	Modular Right Width	40"W	46"W	52"W	58"W	64"W	70"W	76"W
				Parametric Right Width	40"W—42"W	42 ¹ / ₁₆ "W—48"W	48 ¹ / ₁₆ "W—54"W	54 ¹ / ₁₆ "W—60"W	60 ¹ / ₁₆ "W—66"W	66 ¹ / ₁₆ "W—72"W	72 ¹ / ₁₆ "W—78"W

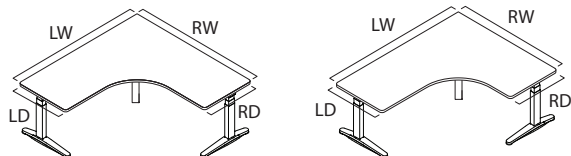

90° 3-Leg Corner Desks — Basic Height (Different Depth Opposite Ends 23"/24" Right/Left and 29"/30" Left/Right)

Composite Veneer Desks

Style Number	Right Depth	Left Depth	Modular Right Width	Parametric Right Width	40"W	46"W	52"W	58"W	64"W	70"W	76"W
OLSLL3	23" or 24" R/L	29" or 30" L/R	40"W	40"W—42"W	N.A.	N.A.	► See page 87	► See page 87	► See page 87	► See page 87	► See page 87
	23" or 24" R/L	29" or 30" L/R	46"W	42 ¹ / ₁₆ "W—48"W	N.A.	N.A.	\$5338	\$5486	\$5632	\$5783	\$5940
	23" or 24" R/L	29" or 30" L/R	52"W	48 ¹ / ₁₆ "W—54"W	► See page 87	\$5338	\$5486	\$5632	\$5783	\$5940	\$6100
	23" or 24" R/L	29" or 30" L/R	58"W	54 ¹ / ₁₆ "W—60"W	\$5338	\$5486	\$5632	\$5783	\$5940	\$6100	\$6258
	23" or 24" R/L	29" or 30" L/R	64"W	60 ¹ / ₁₆ "W—66"W	\$5486	\$5632	\$5783	\$5940	\$6100	\$6258	\$6427
	23" or 24" R/L	29" or 30" L/R	70"W	66 ¹ / ₁₆ "W—72"W	\$5632	\$5783	\$5940	\$6100	\$6258	\$6427	\$6596
	23" or 24" R/L	29" or 30" L/R	76"W	72 ¹ / ₁₆ "W—78"W	\$5783	\$5940	\$6100	\$6258	\$6427	\$6596	\$6776

Wood Veneer Desks

Style Number	Right Depth	Left Depth	Modular Right Width	Parametric Right Width	40"W	46"W	52"W	58"W	64"W	70"W	76"W
OLSLL3	23" or 24" R/L	29" or 30" L/R	40"W	40"W—42"W	N.A.	N.A.	► See page 87	► See page 87	► See page 87	► See page 87	► See page 87
	23" or 24" R/L	29" or 30" L/R	46"W	42 ¹ / ₁₆ "W—48"W	N.A.	N.A.	\$5476	\$5626	\$5773	\$5928	\$6087
	23" or 24" R/L	29" or 30" L/R	52"W	48 ¹ / ₁₆ "W—54"W	► See page 87	\$5476	\$5626	\$5773	\$5928	\$6087	\$6249
	23" or 24" R/L	29" or 30" L/R	58"W	54 ¹ / ₁₆ "W—60"W	\$5476	\$5626	\$5773	\$5928	\$6087	\$6249	\$6409
	23" or 24" R/L	29" or 30" L/R	64"W	60 ¹ / ₁₆ "W—66"W	\$5626	\$5773	\$5928	\$6087	\$6249	\$6409	\$6580
	23" or 24" R/L	29" or 30" L/R	70"W	66 ¹ / ₁₆ "W—72"W	\$5773	\$5928	\$6087	\$6249	\$6409	\$6580	\$6751
	23" or 24" R/L	29" or 30" L/R	76"W	72 ¹ / ₁₆ "W—78"W	\$5928	\$6087	\$6249	\$6409	\$6580	\$6751	\$6935

Tip: At least one side must be 52"W or greater.

Tip: Equal corner widths are parametric to 1/16" from 52"W—78"W.

Tip: 90° desks, 60¹/₁₆"W x 60¹/₁₆"W and wider, are manufactured in two pieces. The worksurface split is located on the left side of an equal corner and on the longest side of an extended corner.

► Specification Information, continued on next page

Ology Height-Adjustable 3-Leg Corner Desks, High-Pressure Laminate or Composite Veneer, continued

► **Specification Information, continued from previous page**

Specification Information											
Style Number	Dimensions			Modular Right Width	U.S. Base Prices						
	Modular Left Width	Parametric Left Width	Parametric Right Width		40"W	46"W	52"W	58"W	64"W	70"W	76"W
					40"W—42"W	42 ¹ / ₁₆ "W—48"W	48 ¹ / ₁₆ "W—54"W	54 ¹ / ₁₆ "W—60"W	60 ¹ / ₁₆ "W—66"W	66 ¹ / ₁₆ "W—72"W	72 ¹ / ₁₆ "W—78"W

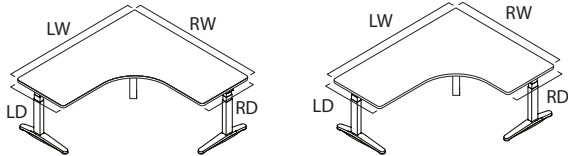

90° 3-Leg Corner Desks — Basic Height (Same Depth Both Ends 29"/30")

Composite Veneer Desks											
Style Number	Depth	Modular Left Width	Parametric Left Width	Modular Right Width	40"W	46"W	52"W	58"W	64"W	70"W	76"W
OLSLL3	29" or 30"	40"W	40"W—42"W		N.A.	N.A.	N.A.	N.A.	N.A.	N.A.	N.A.
	29" or 30"	46"W	42 ¹ / ₁₆ "W—48"W		N.A.	N.A.	\$5450	\$5609	\$5758	\$5917	\$6073
	29" or 30"	52"W	48 ¹ / ₁₆ "W—54"W		N.A.	\$5450	\$5609	\$5758	\$5917	\$6073	\$6237
	29" or 30"	58"W	54 ¹ / ₁₆ "W—60"W		N.A.	\$5609	\$5758	\$5917	\$6073	\$6237	\$6401
	29" or 30"	64"W	60 ¹ / ₁₆ "W—66"W		N.A.	\$5758	\$5917	\$6073	\$6237	\$6401	\$6570
	29" or 30"	70"W	66 ¹ / ₁₆ "W—72"W		N.A.	\$5917	\$6073	\$6237	\$6401	\$6570	\$6739
	29" or 30"	76"W	72 ¹ / ₁₆ "W—78"W		N.A.	\$6073	\$6237	\$6401	\$6570	\$6739	\$6923
Wood Veneer Desks											
Style Number	Depth	Modular Left Width	Parametric Left Width	Modular Right Width	40"W	46"W	52"W	58"W	64"W	70"W	76"W
OLSLL3	29" or 30"	40"W	40"W—42"W		N.A.	N.A.	N.A.	N.A.	N.A.	N.A.	N.A.
	29" or 30"	46"W	42 ¹ / ₁₆ "W—48"W		N.A.	N.A.	\$5588	\$5749	\$5899	\$6062	\$6220
	29" or 30"	52"W	48 ¹ / ₁₆ "W—54"W		N.A.	\$5588	\$5749	\$5899	\$6062	\$6220	\$6386
	29" or 30"	58"W	54 ¹ / ₁₆ "W—60"W		N.A.	\$5749	\$5899	\$6062	\$6220	\$6386	\$6552
	29" or 30"	64"W	60 ¹ / ₁₆ "W—66"W		N.A.	\$5899	\$6062	\$6220	\$6386	\$6552	\$6723
	29" or 30"	70"W	66 ¹ / ₁₆ "W—72"W		N.A.	\$6062	\$6220	\$6386	\$6552	\$6723	\$6893
	29" or 30"	76"W	72 ¹ / ₁₆ "W—78"W		N.A.	\$6220	\$6386	\$6552	\$6723	\$6893	\$7082

Tip: At least one side must be 52"W or greater.

Tip: Equal corner widths are parametric to ¹/₁₆" from 52"W—78"W.

Tip: 90° desks, 60¹/₁₆"W x 60¹/₁₆"W and wider, are manufactured in two pieces. The worksurface split is located on the left side of an equal corner and on the longest side of an extended corner.

► **Specification Information, continued on next page**



For Canadian Pricing

Multiply U.S. Price by the Canadian price factor.

► See page 1 for details.

► Specification Information, continued from previous page

Specification Information										
Style Number	Dimensions D			U.S. Base Prices						
	Modular Left Width	Parametric Left Width	Modular Right Width	Parametric Right Width	34"W	40"W	46"W	52"W	58"W	64"W
					34"W—	36 ¹ / ₁₆ "W—	42 ¹ / ₁₆ "W—	48 ¹ / ₁₆ "W—	54 ¹ / ₁₆ "W—	60 ¹ / ₁₆ "W—
					36"W	42"W	48"W	54"W	60"W	66"W

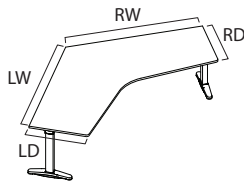

120° 3-Leg Corner Desks — Extended Height

High-Pressure Laminate Desks

OLELW3	23" or 24"	34"W	34"W–36"W	\$3728	\$3856	\$3980	\$4107	\$4234	\$4366
	23" or 24"	40"W	36 ¹ / ₁₆ "W–42"W	\$3856	\$3980	\$4107	\$4234	\$4366	\$4500
	23" or 24"	46"W	42 ¹ / ₁₆ "W–48"W	\$3980	\$4107	\$4234	\$4366	\$4500	\$4638
	23" or 24"	52"W	48 ¹ / ₁₆ "W–54"W	\$4107	\$4234	\$4366	\$4500	\$4638	\$4780
	23" or 24"	58"W	54 ¹ / ₁₆ "W–60"W	\$4234	\$4366	\$4500	\$4638	\$4780	\$4924
	23" or 24"	64"W	60 ¹ / ₁₆ "W–66"W	\$4366	\$4500	\$4638	\$4780	\$4924	\$5069

Composite Veneer Desks

OLELW3	23" or 24"	34"W	34"W–36"W	\$4810	\$5265	\$5425	\$5552	\$5679	\$5830
	23" or 24"	40"W	36 ¹ / ₁₆ "W–42"W	\$5265	\$5389	\$5552	\$5698	\$5830	\$5985
	23" or 24"	46"W	42 ¹ / ₁₆ "W–48"W	\$5425	\$5552	\$5679	\$5851	\$5985	\$6147
	23" or 24"	52"W	48 ¹ / ₁₆ "W–54"W	\$5552	\$5698	\$5851	\$5985	\$6150	\$6292
	23" or 24"	58"W	54 ¹ / ₁₆ "W–60"W	\$5679	\$5830	\$5985	\$6150	\$6292	\$6455
	23" or 24"	64"W	60 ¹ / ₁₆ "W–66"W	\$5830	\$5985	\$6146	\$6292	\$6455	\$6623

Wood Veneer Desks

OLELW3	23" or 24"	34"W	34"W–36"W	\$4919	\$5407	\$5554	\$5697	\$5845	\$6000
	23" or 24"	40"W	36 ¹ / ₁₆ "W–42"W	\$5407	\$5554	\$5697	\$5845	\$6000	\$6148
	23" or 24"	46"W	42 ¹ / ₁₆ "W–48"W	\$5554	\$5697	\$5845	\$6000	\$6148	\$6301
	23" or 24"	52"W	48 ¹ / ₁₆ "W–54"W	\$5697	\$5845	\$6000	\$6148	\$6301	\$6464
	23" or 24"	58"W	54 ¹ / ₁₆ "W–60"W	\$5845	\$6000	\$6148	\$6301	\$6464	\$6633
	23" or 24"	64"W	60 ¹ / ₁₆ "W–66"W	\$6000	\$6148	\$6301	\$6464	\$6633	\$6804

► Specification Information, continued on next page

 **For Canadian Pricing**
Multiply U.S. Price by the Canadian price factor.
► See page 1 for details.

Ology Height-Adjustable 3-Leg Corner Desks, High-Pressure Laminate or Composite Veneer, continued

► Specification Information, continued from previous page

Specification Information									
Style Number	Dimensions D			U.S. Base Prices					
	Modular Left Width	Parametric Left Width	Modular Right Width	34"W	40"W	46"W	52"W	58"W	64"W
			Parametric Right Width	34"W—	36 ¹ / ₁₆ "W—	42 ¹ / ₁₆ "W—	48 ¹ / ₁₆ "W—	54 ¹ / ₁₆ "W—	60 ¹ / ₁₆ "W—
				36"W	42"W	48"W	54"W	60"W	66"W

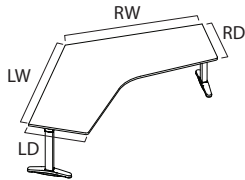

120° 3-Leg Corner Desks — Extended Height

High-Pressure Laminate Desks

OLELW3	29" or 30"	34"W	34"W–36"W	\$4052	\$4182	\$4305	\$4432	\$4559	\$4687
	29" or 30"	40"W	36 ¹ / ₁₆ "W–42"W	\$4182	\$4305	\$4432	\$4559	\$4687	\$4822
	29" or 30"	46"W	42 ¹ / ₁₆ "W–48"W	\$4305	\$4432	\$4559	\$4687	\$4822	\$4963
	29" or 30"	52"W	48 ¹ / ₁₆ "W–54"W	\$4432	\$4559	\$4687	\$4822	\$4963	\$5107
	29" or 30"	58"W	54 ¹ / ₁₆ "W–60"W	\$4559	\$4687	\$4822	\$4963	\$5107	\$5248
	29" or 30"	64"W	60 ¹ / ₁₆ "W–66"W	\$4687	\$4822	\$4963	\$5107	\$5248	\$5393

Composite Veneer Desks

OLELW3	29" or 30"	34"W	34"W–36"W	\$5461	\$5613	\$5750	\$5896	\$6044	\$6185
	29" or 30"	40"W	36 ¹ / ₁₆ "W–42"W	\$5613	\$5750	\$5896	\$6044	\$6185	\$6334
	29" or 30"	46"W	42 ¹ / ₁₆ "W–48"W	\$5750	\$5896	\$6044	\$6185	\$6334	\$6494
	29" or 30"	52"W	48 ¹ / ₁₆ "W–54"W	\$5896	\$6044	\$6185	\$6334	\$6494	\$6661
	29" or 30"	58"W	54 ¹ / ₁₆ "W–60"W	\$6044	\$6185	\$6334	\$6494	\$6661	\$6825
	29" or 30"	64"W	60 ¹ / ₁₆ "W–66"W	\$6185	\$6334	\$6494	\$6661	\$6825	\$6990

Wood Veneer Desks

OLELW3	29" or 30"	34"W	34"W–36"W	\$5603	\$5756	\$5895	\$6043	\$6193	\$6335
	29" or 30"	40"W	36 ¹ / ₁₆ "W–42"W	\$5756	\$5895	\$6043	\$6193	\$6335	\$6485
	29" or 30"	46"W	42 ¹ / ₁₆ "W–48"W	\$5895	\$6043	\$6193	\$6335	\$6485	\$6647
	29" or 30"	52"W	48 ¹ / ₁₆ "W–54"W	\$6043	\$6193	\$6335	\$6485	\$6647	\$6816
	29" or 30"	58"W	54 ¹ / ₁₆ "W–60"W	\$6193	\$6335	\$6485	\$6647	\$6816	\$6983
	29" or 30"	64"W	60 ¹ / ₁₆ "W–66"W	\$6335	\$6485	\$6647	\$6816	\$6983	\$7150

► Specification Information, continued on next page



For Canadian Pricing

Multiply U.S. Price by the Canadian price factor.

► See page 1 for details.

► Specification Information, continued from previous page

Specification Information											
Style Number	Dimensions D			U.S. Base Prices							
	Modular Left Width	Parametric Left Width		Modular Right Width	Parametric Right Width	34"W	40"W	46"W	52"W	58"W	64"W
						34"W—	36 ¹ / ₁₆ "W—	42 ¹ / ₁₆ "W—	48 ¹ / ₁₆ "W—	54 ¹ / ₁₆ "W—	60 ¹ / ₁₆ "W—
						36"W	42"W	48"W	54"W	60"W	66"W

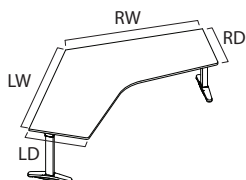

120° 3-Leg Corner Desks — Basic Height

High-Pressure Laminate Desks

OLSLW3	23" or 24"	34"W	34"W–36"W	\$3435	\$3553	\$3669	\$3785	\$3900	\$4019
	23" or 24"	40"W	36 ¹ / ₁₆ "W–42"W	\$3553	\$3669	\$3785	\$3900	\$4019	\$4145
	23" or 24"	46"W	42 ¹ / ₁₆ "W–48"W	\$3669	\$3785	\$3900	\$4019	\$4145	\$4275
	23" or 24"	52"W	48 ¹ / ₁₆ "W–54"W	\$3785	\$3900	\$4019	\$4145	\$4275	\$4408
	23" or 24"	58"W	54 ¹ / ₁₆ "W–60"W	\$3900	\$4019	\$4145	\$4275	\$4408	\$4537
	23" or 24"	64"W	60 ¹ / ₁₆ "W–66"W	\$4019	\$4145	\$4275	\$4408	\$4537	\$4674

Composite Veneer Desks

OLSLW3	23" or 24"	34"W	34"W–36"W	\$4517	\$4962	\$5114	\$5230	\$5345	\$5483
	23" or 24"	40"W	36 ¹ / ₁₆ "W–42"W	\$4962	\$5078	\$5230	\$5364	\$5483	\$5630
	23" or 24"	46"W	42 ¹ / ₁₆ "W–48"W	\$5114	\$5230	\$5345	\$5504	\$5630	\$5784
	23" or 24"	52"W	48 ¹ / ₁₆ "W–54"W	\$5230	\$5364	\$5504	\$5630	\$5787	\$5920
	23" or 24"	58"W	54 ¹ / ₁₆ "W–60"W	\$5345	\$5483	\$5630	\$5787	\$5920	\$6068
	23" or 24"	64"W	60 ¹ / ₁₆ "W–66"W	\$5483	\$5630	\$5784	\$5920	\$6068	\$6228

Wood Veneer Desks

OLSLW3	23" or 24"	34"W	34"W–36"W	\$4626	\$5104	\$5243	\$5375	\$5511	\$5653
	23" or 24"	40"W	36 ¹ / ₁₆ "W–42"W	\$5104	\$5243	\$5375	\$5511	\$5653	\$5793
	23" or 24"	46"W	42 ¹ / ₁₆ "W–48"W	\$5243	\$5375	\$5511	\$5653	\$5793	\$5938
	23" or 24"	52"W	48 ¹ / ₁₆ "W–54"W	\$5375	\$5511	\$5653	\$5793	\$5938	\$6092
	23" or 24"	58"W	54 ¹ / ₁₆ "W–60"W	\$5511	\$5653	\$5793	\$5938	\$6092	\$6246
	23" or 24"	64"W	60 ¹ / ₁₆ "W–66"W	\$5653	\$5793	\$5938	\$6092	\$6246	\$6409

► Specification Information, continued on next page

 **For Canadian Pricing**
Multiply U.S. Price by the Canadian price factor.
► See page 1 for details.

Ology Height-Adjustable 3-Leg Corner Desks, High-Pressure Laminate or Composite Veneer, continued

► **Specification Information, continued from previous page**

Specification Information											
Style Number	Dimensions D			U.S. Base Prices							
	Modular Left Width	Parametric Left Width		Modular Right Width	Parametric Right Width	34"W	40"W	46"W	52"W	58"W	64"W
						34"W	40"W	46"W	52"W	58"W	64"W
						34"W—	36 ¹ / ₁₆ "W—	42 ¹ / ₁₆ "W—	48 ¹ / ₁₆ "W—	54 ¹ / ₁₆ "W—	60 ¹ / ₁₆ "W—
						36"W	42"W	48"W	54"W	60"W	66"W

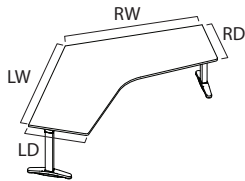

120° 3-Leg Corner Desks — Basic Height

High Pressure Laminate Desks

OLSLW3	29" or 30"	34"W	34"W–36"W	\$3734	\$3852	\$3968	\$4083	\$4199	\$4317
	29" or 30"	40"W	36 ¹ / ₁₆ "W–42"W	\$3852	\$3968	\$4083	\$4199	\$4317	\$4443
	29" or 30"	46"W	42 ¹ / ₁₆ "W–48"W	\$3968	\$4083	\$4199	\$4317	\$4443	\$4570
	29" or 30"	52"W	48 ¹ / ₁₆ "W–54"W	\$4083	\$4199	\$4317	\$4443	\$4570	\$4703
	29" or 30"	58"W	54 ¹ / ₁₆ "W–60"W	\$4199	\$4317	\$4443	\$4570	\$4703	\$4834
	29" or 30"	64"W	60 ¹ / ₁₆ "W–66"W	\$4317	\$4443	\$4570	\$4703	\$4834	\$4969

Composite Veneer Desks

OLSLW3	29" or 30"	34"W	34"W–36"W	\$5143	\$5283	\$5413	\$5547	\$5684	\$5815
	29" or 30"	40"W	36 ¹ / ₁₆ "W–42"W	\$5283	\$5413	\$5547	\$5684	\$5815	\$5955
	29" or 30"	46"W	42 ¹ / ₁₆ "W–48"W	\$5413	\$5547	\$5684	\$5815	\$5955	\$6101
	29" or 30"	52"W	48 ¹ / ₁₆ "W–54"W	\$5547	\$5684	\$5815	\$5955	\$6101	\$6257
	29" or 30"	58"W	54 ¹ / ₁₆ "W–60"W	\$5684	\$5815	\$5955	\$6101	\$6257	\$6411
	29" or 30"	64"W	60 ¹ / ₁₆ "W–66"W	\$5815	\$5955	\$6101	\$6257	\$6411	\$6566

Wood Veneer Desks

OLSLW3	29" or 30"	34"W	34"W–36"W	\$5285	\$5426	\$5558	\$5694	\$5833	\$5965
	29" or 30"	40"W	36 ¹ / ₁₆ "W–42"W	\$5426	\$5558	\$5694	\$5833	\$5965	\$6106
	29" or 30"	46"W	42 ¹ / ₁₆ "W–48"W	\$5558	\$5694	\$5833	\$5965	\$6106	\$6254
	29" or 30"	52"W	48 ¹ / ₁₆ "W–54"W	\$5694	\$5833	\$5965	\$6106	\$6254	\$6412
	29" or 30"	58"W	54 ¹ / ₁₆ "W–60"W	\$5833	\$5965	\$6106	\$6254	\$6412	\$6569
	29" or 30"	64"W	60 ¹ / ₁₆ "W–66"W	\$5965	\$6106	\$6254	\$6412	\$6569	\$6726



For Canadian Pricing

Multiply U.S. Price by the Canadian price factor.

► See page 1 for details.



Ology Height-Adjustable Bases

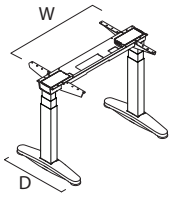

Tip: Any storage higher than 18"H will impede lowest height range of worksurface. On basic height desks, any storage higher than 23"H will impede lowest height range of worksurface. Do not place storage underneath controller.

Tip: One single monitor is allowed on desks 23"D or deeper, and 46"W and wider.

▶ See page 58 for *Steelcase Monitor Arm Guidelines*.

Tip: Dual monitors allowed on 29"D or deeper, and 58"W and wider.

▶ See page 58, *Steelcase Monitor Arm Guidelines*.

Tip: Base supports a maximum distributed weight capacity of 360 pounds (2-leg). When calculating lifting capacity, subtract the weight of the worksurface and understructure.

Tip: 2-leg desks that have an overhang, or are 35"D or 36"D will have a distributed weight capacity of 300 pounds (136.1 kg).

▶ See page 70 for understructure weights.

Tip: Antimicrobial additives can be specified only when specifying simple touch controller.

Tip: Attachment hardware is intended for worksurfaces 1" thick only.

Tip: 9" overhang is available on desks 64"W and larger. Overhang on both sides is available on 70"W and 76"W only.

Tip: Overhang not available on 35"D or 36"D.

Tip: Overhang is available on rectangular bases only.

Standard Includes		Required to Specify
▶ Need help? Product details, page 64	<ul style="list-style-type: none"> • Electric height-adjustable sit-to-stand base: paint • Active touch controller • Modular width: <ul style="list-style-type: none"> – Rectangular base: 34"–76" – Tapered base: 58"–76" – 90° equal corner base: 52"–76" – 90° extended corner base: 40"–76" – 120° equal corner base: 34"–64" • ½" adjustable glides • Power cord: 10⁴/₅' • Attachment hardware 	<ol style="list-style-type: none"> 1 Style number 2 Desk depth 3 Desk width 4 Paint color number for base: <ul style="list-style-type: none"> 4799 Platinum Metallic 7207 Black 7241 Arctic White 7360 Merle 5 Antimicrobial or non-antimicrobial components, if simple touch controller selected (see below under Required Selections) 6 Options, if selected (see below) <p>▶ See <i>Surface Materials</i>, page 362.</p>

Required Selections	U.S. Price	Required to Specify
Antimicrobial Components	<ul style="list-style-type: none"> • Non-antimicrobial components No cost • Antimicrobial components No cost 	<p>Specify with <i>non-antimicrobial components</i>.</p> <p>Specify with <i>antimicrobial components</i>.</p>

Options	U.S. Price	Required to Specify
Surface Materials	<p>Bases</p> <ul style="list-style-type: none"> • Paint price group 1 No cost • Paint price group 2 for rectangular and tapered bases +\$ 48 • Paint price group 2 for corner bases +\$ 72 	<p>Specify paint color number.</p> <p>Specify paint color number.</p> <p>Specify paint color number.</p> <p>▶ See <i>Surface Materials</i>, page 362.</p>

Desk Type	<ul style="list-style-type: none"> • Parametric width desk No cost 	Specify with <i>parametric desk type</i> .
Overhang	<ul style="list-style-type: none"> • Desk overhang on left No cost • Desk overhang on right No cost • Desk overhang left and right No cost 	<p>Specify with <i>desk overhang left</i>.</p> <p>Specify with <i>desk overhang right</i>.</p> <p>Specify with <i>desk overhang left and right</i>.</p>
Glides	<ul style="list-style-type: none"> • 1" adjustable glides +\$ 25 per glide 	Specify with <i>1" glides</i> .
Controller	<ul style="list-style-type: none"> • Simple touch controller –\$ 78 • 4 pre-set controller +\$188 	<p>Specify with <i>simple touch controller</i>.</p> <p>Specify with <i>4 pre-set controller</i>.</p>

Tip: The standard active touch controller is Bluetooth-enabled to allow pairing with the *Steelcase Rise* app.



WARNING
Read base only warranty limitations.
▶ See page 32 for *Workstation Design Guidelines and Requirements*.

Specification Information

Style Number	Dimension D	Desk Type	U.S. Base Prices							
			34"W	40"W	46"W	52"W	58"W	64"W	70"W	76"W
		Modular	34"W	40"W	46"W	52"W	58"W	64"W	70"W	76"W
		Parametric	34"W	36 ¹ / ₁₆ "W	42 ¹ / ₁₆ "W	48 ¹ / ₁₆ "W	54 ¹ / ₁₆ "W	60 ¹ / ₁₆ "W	66 ¹ / ₁₆ "W	72 ¹ / ₁₆ "W
			36"W	42"W	48"W	54"W	60"W	66"W	72"W	78"W

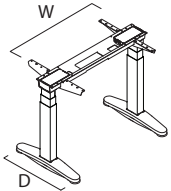

Rectangular Bases — Extended Height

OLELRQB	23" or 24"	\$2505	\$2585	\$2667	\$2753	\$2838	\$2935	\$3029	\$3122
	29" or 30"	\$2822	\$2912	\$3005	\$3101	\$3138	\$3188	\$3218	\$3238
	35" or 36"	\$3101	\$3128	\$3162	\$3178	\$3206	\$3252	\$3266	\$3271

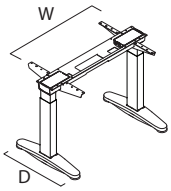

Rectangular Bases — Basic Height

OLSLRQB	23" or 24"	\$2309	\$2382	\$2459	\$2538	\$2618	\$2708	\$2791	\$2879
	29" or 30"	\$2602	\$2685	\$2769	\$2861	\$2890	\$2941	\$2968	\$2985
	35" or 36"	\$2861	\$2886	\$2916	\$2928	\$2957	\$2997	\$3009	\$3016

► Specification Information, continued on next page



For Canadian Pricing
Multiply U.S. Price by the Canadian price factor.
► See page 1 for details.

Ology Height-Adjustable Bases, continued

► Specification Information, continued from previous page

Specification Information

• Style Number	• Dimensions		• Desk Type	• U.S. Base Prices			
	LD	RD					
			Modular	58"W	64"W	70"W	76"W
			Parametric	58 ¹ / ₁₆ "W–60"W	60 ¹ / ₁₆ "W–66"W	66 ¹ / ₁₆ "W–72"W	72 ¹ / ₁₆ "W–78"W

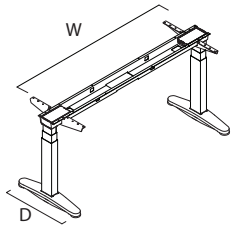

Tapered Bases — Extended Height

OLELRTB	23" or 24"	29" or 30"	\$3138	\$3188	\$3218	\$3238
	29" or 30"	23" or 24"	\$3138	\$3188	\$3218	\$3238

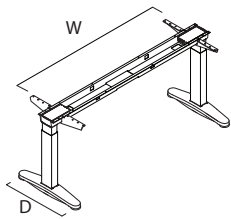

Tapered Bases — Basic Height

OLSLRTB	23" or 24"	29" or 30"	\$2890	\$2941	\$2968	\$2985
	29" or 30"	23" or 24"	\$2890	\$2941	\$2968	\$2985

► Specification Information, continued on next page



For Canadian Pricing

Multiply U.S. Price by the Canadian price factor.

► See page 1 for details.

► **Specification Information, continued from previous page**

Specification Information										
Style Number	Dimensions		U.S. Base Prices							
	Modular Left Width	Parametric Left Width	Modular Right Width	40"W	46"W	52"W	58"W	64"W	70"W	76"W
			Parametric Right Width	40"W	42 ¹ / ₁₆ "W	48 ¹ / ₁₆ "W	54 ¹ / ₁₆ "W	60 ¹ / ₁₆ "W	66 ¹ / ₁₆ "W	72 ¹ / ₁₆ "W
				42"W	48"W	54"W	60"W	66"W	72"W	78"W

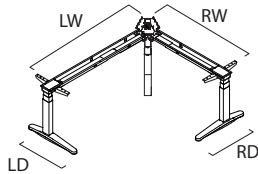

90° Corner 3-Leg Bases — Extended Height (Same Depth Both Ends 23"/24")

OLELL3B	23" or 24"	40"W	40"W—42"W	N.A.	N.A.	\$3831	\$3891	\$3951	\$4012	\$4073
	23" or 24"	46"W	42 ¹ / ₁₆ "W—48"W	N.A.	N.A.	\$3891	\$3951	\$4012	\$4073	\$4136
	23" or 24"	52"W	48 ¹ / ₁₆ "W—54"W	\$3831	\$3891	\$3951	\$4012	\$4073	\$4136	\$4196
	23" or 24"	58"W	54 ¹ / ₁₆ "W—60"W	\$3891	\$3951	\$4012	\$4073	\$4136	\$4196	\$4257
	23" or 24"	64"W	60 ¹ / ₁₆ "W—66"W	\$3951	\$4012	\$4073	\$4136	\$4196	\$4257	\$4317
	23" or 24"	70"W	66 ¹ / ₁₆ "W—72"W	\$4012	\$4073	\$4136	\$4196	\$4257	\$4317	\$4380
	23" or 24"	76"W	72 ¹ / ₁₆ "W—76"W	\$4073	\$4136	\$4196	\$4257	\$4317	\$4380	\$4445

Tip: At least one side must be 52"W or greater.

► **Specification Information, continued on next page**

 **For Canadian Pricing**
Multiply U.S. Price by the Canadian price factor.
► See page 1 for details.

Ology Height-Adjustable Bases, continued

► Specification Information, continued from previous page

Specification Information											
Style Number	Dimensions D			U.S. Base Prices							
	Modular Left Width	Parametric Left Width	Modular Right Width	40"W	46"W	52"W	58"W	64"W	70"W	76"W	
			Modular Right Width	40"W—	42 ¹ / ₁₆ "W—	48 ¹ / ₁₆ "W—	54 ¹ / ₁₆ "W—	60 ¹ / ₁₆ "W—	66 ¹ / ₁₆ "W—	72 ¹ / ₁₆ "W—	
			Parametric Right Width	42"W	48"W	54"W	60"W	66"W	72"W	78"W	

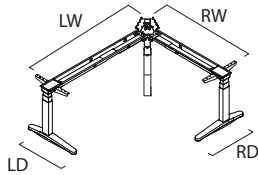

90° Corner 3-Leg Bases — Extended Height (Different Depth Opposite Ends 23"/24" Right/Left and 29"/30" Left/Right)

OLELL3B	23" or 24" R/L	29" or 30" L/R	40"W	40"W—42"W	N.A.	N.A.	► See page 88	► See page 88	► See page 88	► See page 88	► See page 88
	23" or 24" R/L	29" or 30" L/R	46"W	42 ¹ / ₁₆ "W—48"W	N.A.	N.A.	\$4059	\$4123	\$4183	\$4244	\$4304
	23" or 24" R/L	29" or 30" L/R	52"W	48 ¹ / ₁₆ "W—54"W	► See page 88	\$4059	\$4123	\$4183	\$4244	\$4304	\$4367
	23" or 24" R/L	29" or 30" L/R	58"W	54 ¹ / ₁₆ "W—60"W	\$4059	\$4123	\$4183	\$4244	\$4304	\$4367	\$4427
	23" or 24" R/L	29" or 30" L/R	64"W	60 ¹ / ₁₆ "W—66"W	\$4123	\$4183	\$4244	\$4304	\$4367	\$4427	\$4489
	23" or 24" R/L	29" or 30" L/R	70"W	66 ¹ / ₁₆ "W—72"W	\$4183	\$4244	\$4304	\$4367	\$4427	\$4489	\$4549
	23" or 24" R/L	29" or 30" L/R	76"W	72 ¹ / ₁₆ "W—78"W	\$4244	\$4304	\$4367	\$4427	\$4489	\$4549	\$4616

Tip: At least one side must be 52"W or greater.

► Specification Information, continued on next page



For Canadian Pricing
 Multiply U.S. Price by the Canadian price factor.
 ► See page 1 for details.

► **Specification Information, continued from previous page**

Specification Information										
Style Number	Dimensions		U.S. Base Prices							
	Modular Left Width	Parametric Left Width	Modular Right Width	40"W	46"W	52"W	58"W	64"W	70"W	76"W
			Parametric Right Width	40"W	42 ¹ / ₁₆ "W	48 ¹ / ₁₆ "W	54 ¹ / ₁₆ "W	60 ¹ / ₁₆ "W	66 ¹ / ₁₆ "W	72 ¹ / ₁₆ "W
				42"W	48"W	54"W	60"W	66"W	72"W	78"W

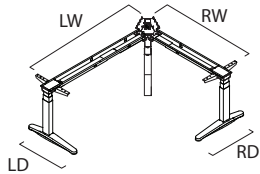

90° Corner 3-Leg Bases — Extended Height (Same Depth Both Ends 29"/30")

OLELL3B	29" or 30"	40"W	40"W—42"W	N.A.	N.A.	N.A.	N.A.	N.A.	N.A.	N.A.
	29" or 30"	46"W	42 ¹ / ₁₆ "W—48"W	N.A.	N.A.	\$4226	\$4289	\$4352	\$4412	\$4474
	29" or 30"	52"W	48 ¹ / ₁₆ "W—54"W	N.A.	\$4226	\$4289	\$4352	\$4412	\$4474	\$4533
	29" or 30"	58"W	54 ¹ / ₁₆ "W—60"W	N.A.	\$4289	\$4352	\$4412	\$4474	\$4533	\$4597
	29" or 30"	64"W	60 ¹ / ₁₆ "W—66"W	N.A.	\$4352	\$4412	\$4474	\$4533	\$4597	\$4657
	29" or 30"	70"W	66 ¹ / ₁₆ "W—72"W	N.A.	\$4412	\$4474	\$4533	\$4597	\$4657	\$4718
	29" or 30"	76"W	72 ¹ / ₁₆ "W—78"W	N.A.	\$4474	\$4533	\$4597	\$4657	\$4718	\$4780

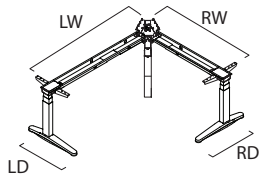

90° Corner 3-Leg Bases — Basic Height (Same Depth Both Ends 23"/24")

OLSL3B	23" or 24"	40"W	40"W—42"W	N.A.	N.A.	\$3530	\$3586	\$3641	\$3700	\$3754
	23" or 24"	46"W	42 ¹ / ₁₆ "W—48"W	N.A.	N.A.	\$3586	\$3641	\$3700	\$3754	\$3810
	23" or 24"	52"W	48 ¹ / ₁₆ "W—54"W	\$3530	\$3586	\$3641	\$3700	\$3754	\$3810	\$3867
	23" or 24"	58"W	54 ¹ / ₁₆ "W—60"W	\$3586	\$3641	\$3700	\$3754	\$3810	\$3867	\$3923
	23" or 24"	64"W	60 ¹ / ₁₆ "W—66"W	\$3641	\$3700	\$3754	\$3810	\$3867	\$3923	\$3979
	23" or 24"	70"W	66 ¹ / ₁₆ "W—72"W	\$3700	\$3754	\$3810	\$3867	\$3923	\$3979	\$4034
	23" or 24"	76"W	72 ¹ / ₁₆ "W—78"W	\$3754	\$3810	\$3867	\$3923	\$3979	\$4034	\$4096

Tip: At least one side must be 52"W or greater.

► **Specification Information, continued on next page**



For Canadian Pricing

Multiply U.S. Price by the Canadian price factor.

► See page 1 for details.

Ology Height-Adjustable Bases, continued

► Specification Information, continued from previous page

Specification Information											
Style Number	Dimensions			U.S. Base Prices							
	D			Modular Right Width	40"W	46"W	52"W	58"W	64"W	70"W	76"W
		Modular Left Width	Parametric Left Width	Parametric Right Width	40"W—42"W	42 ¹ / ₁₆ "W—48"W	48 ¹ / ₁₆ "W—54"W	54 ¹ / ₁₆ "W—60"W	60 ¹ / ₁₆ "W—66"W	66 ¹ / ₁₆ "W—72"W	72 ¹ / ₁₆ "W—78"W

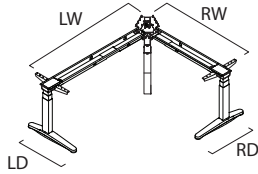

90° Corner 3-Leg Bases — Basic Height (Different Depth Opposite Ends 23"/24" Right/Left and 29"/30" Left/Right)

OLSL3B	23" or 24" R/L	29" or 30" L/R	40"W	40"W—42"W	N.A.	N.A.	► See page 89	► See page 89	► See page 89	► See page 89	► See page 89
	23" or 24" R/L	29" or 30" L/R	46"W	42 ¹ / ₁₆ "W—48"W	N.A.	N.A.	\$3741	\$3795	\$3854	\$3909	\$3968
	23" or 24" R/L	29" or 30" L/R	52"W	48 ¹ / ₁₆ "W—54"W	► See page 89	\$3741	\$3795	\$3854	\$3909	\$3968	\$4022
	23" or 24" R/L	29" or 30" L/R	58"W	54 ¹ / ₁₆ "W—60"W	\$3741	\$3795	\$3854	\$3909	\$3968	\$4022	\$4078
	23" or 24" R/L	29" or 30" L/R	64"W	60 ¹ / ₁₆ "W—66"W	\$3795	\$3854	\$3909	\$3968	\$4022	\$4078	\$4134
	23" or 24" R/L	29" or 30" L/R	70"W	66 ¹ / ₁₆ "W—72"W	\$3854	\$3909	\$3968	\$4022	\$4078	\$4134	\$4189
	23" or 24" R/L	29" or 30" L/R	76"W	72 ¹ / ₁₆ "W—78"W	\$3909	\$3968	\$4022	\$4078	\$4134	\$4189	\$4252

Tip: At least one side must be 52"W or greater.

► Specification Information, continued on next page



For Canadian Pricing
 Multiply U.S. Price by the Canadian price factor.
 ► See page 1 for details.

► **Specification Information, continued from previous page**

Specification Information										
Style Number	Dimensions		U.S. Base Prices							
	Modular Left Width	Parametric Left Width	Modular Right Width	40"W	46"W	52"W	58"W	64"W	70"W	76"W
			Parametric Right Width	40"W	42 ¹ / ₁₆ "W	48 ¹ / ₁₆ "W	54 ¹ / ₁₆ "W	60 ¹ / ₁₆ "W	66 ¹ / ₁₆ "W	72 ¹ / ₁₆ "W
				42"W	48"W	54"W	60"W	66"W	72"W	78"W

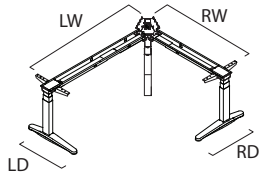

90° Corner 3-Leg Base — Basic Height (Same Depth Both Ends 29"/30")

OLSL3B	29" or 30"	40"W	40"W—42"W	N.A.	N.A.	N.A.	N.A.	N.A.	N.A.	N.A.
	29" or 30"	46"W	42 ¹ / ₁₆ "W—48"W	N.A.	N.A.	\$3896	\$3951	\$4008	\$4064	\$4123
	29" or 30"	52"W	48 ¹ / ₁₆ "W—54"W	N.A.	\$3896	\$3951	\$4008	\$4064	\$4123	\$4176
	29" or 30"	58"W	54 ¹ / ₁₆ "W—60"W	N.A.	\$3951	\$4008	\$4064	\$4123	\$4176	\$4234
	29" or 30"	64"W	60 ¹ / ₁₆ "W—66"W	N.A.	\$4008	\$4064	\$4123	\$4176	\$4234	\$4289
	29" or 30"	70"W	66 ¹ / ₁₆ "W—72"W	N.A.	\$4064	\$4123	\$4176	\$4234	\$4289	\$4347
	29" or 30"	76"W	72 ¹ / ₁₆ "W—78"W	N.A.	\$4123	\$4176	\$4234	\$4289	\$4347	\$4407

Tip: At least one side must be 52"W or greater.

► **Specification Information, continued on next page**

 **For Canadian Pricing**
Multiply U.S. Price by the Canadian price factor.
► See page 1 for details.

Ology Height-Adjustable Bases, continued

► Specification Information, continued from previous page

• Style Number		• Dimensions D			• U.S. Base Prices						
					• Modular Right Width	34"W	40"W	46"W	52"W	58"W	64"W
		• Modular Left Width	• Parametric Left Width		• Parametric Right Width	34"W	36 ¹ / ₁₆ "W	42 ¹ / ₁₆ "W	48 ¹ / ₁₆ "W	54 ¹ / ₁₆ "W	60 ¹ / ₁₆ "W
						36"W	42"W	48"W	54"W	60"W	66"W

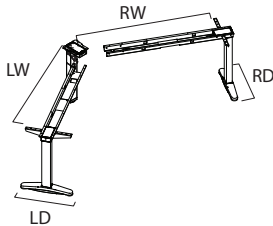

120° 3-Leg Corner Bases — Extended Height

OLELW3B	23" or 24"	34"W	34"W—36"W	\$3631	\$3689	\$3746	\$3805	\$3864	\$3923
		40"W	36 ¹ / ₁₆ "W—42"W	\$3689	\$3746	\$3805	\$3864	\$3923	\$3982
		46"W	42 ¹ / ₁₆ "W—48"W	\$3746	\$3805	\$3864	\$3923	\$3982	\$4042
		52"W	48 ¹ / ₁₆ "W—54"W	\$3805	\$3864	\$3923	\$3982	\$4042	\$4101
		58"W	54 ¹ / ₁₆ "W—60"W	\$3864	\$3923	\$3982	\$4042	\$4101	\$4160
		64"W	60 ¹ / ₁₆ "W—66"W	\$3923	\$3982	\$4042	\$4101	\$4160	\$4218

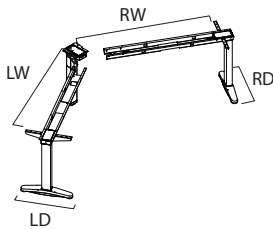

120° 3-Leg Corner Bases — Extended Height

OLELW3B	29" or 30"	34"W	34"W—36"W	\$3791	\$3851	\$3909	\$3969	\$4027	\$4085
		40"W	36 ¹ / ₁₆ "W—42"W	\$3851	\$3909	\$3969	\$4027	\$4085	\$4144
		46"W	42 ¹ / ₁₆ "W—48"W	\$3909	\$3969	\$4027	\$4085	\$4144	\$4202
		52"W	48 ¹ / ₁₆ "W—54"W	\$3969	\$4027	\$4085	\$4144	\$4202	\$4261
		58"W	54 ¹ / ₁₆ "W—60"W	\$4027	\$4085	\$4144	\$4202	\$4261	\$4320
		64"W	60 ¹ / ₁₆ "W—66"W	\$4085	\$4144	\$4202	\$4261	\$4320	\$4380

► Specification Information, continued on next page



For Canadian Pricing

Multiply U.S. Price by the Canadian price factor.

► See page 1 for details.

► Specification Information, continued from previous page

Specification Information

• Style Number	• Dimensions D	• U.S. Base Prices					
		• Modular Right Width	• Parametric Left Width	• Modular Right Width	• Parametric Left Width	• Modular Right Width	• Parametric Left Width
		34"W	40"W	46"W	52"W	58"W	64"W
		34"W	36 ¹ / ₁₆ "W	42 ¹ / ₁₆ "W	48 ¹ / ₁₆ "W	54 ¹ / ₁₆ "W	60 ¹ / ₁₆ "W
		36"W	42"W	48"W	54"W	60"W	66"W

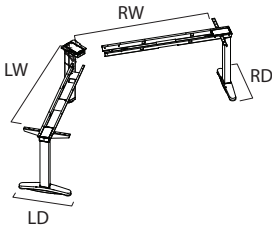

120° Corner 3-Leg Bases — Basic Height

OLSLW3B	23" or 24"	34"W	34"W—36"W	\$3334	\$3388	\$3440	\$3497	\$3552	\$3608
		40"W	36 ¹ / ₁₆ "W—42"W	\$3388	\$3440	\$3497	\$3552	\$3608	\$3662
		46"W	42 ¹ / ₁₆ "W—48"W	\$3440	\$3497	\$3552	\$3608	\$3662	\$3716
		52"W	48 ¹ / ₁₆ "W—54"W	\$3497	\$3552	\$3608	\$3662	\$3716	\$3769
		58"W	54 ¹ / ₁₆ "W—60"W	\$3552	\$3608	\$3662	\$3716	\$3769	\$3823
		64"W	60 ¹ / ₁₆ "W—66"W	\$3608	\$3662	\$3716	\$3769	\$3823	\$3879

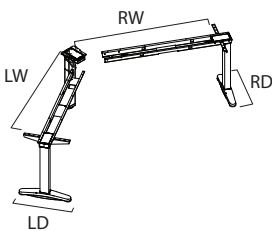

120° 3-Leg Corner Bases — Basic Height

OLSLW3B	29" or 30"	34"W	34"W—36"W	\$3494	\$3549	\$3605	\$3660	\$3711	\$3765
		40"W	36 ¹ / ₁₆ "W—42"W	\$3549	\$3605	\$3660	\$3711	\$3765	\$3819
		46"W	42 ¹ / ₁₆ "W—48"W	\$3605	\$3660	\$3711	\$3765	\$3819	\$3873
		52"W	48 ¹ / ₁₆ "W—54"W	\$3660	\$3711	\$3765	\$3819	\$3873	\$3927
		58"W	54 ¹ / ₁₆ "W—60"W	\$3711	\$3765	\$3819	\$3873	\$3927	\$3980
		64"W	60 ¹ / ₁₆ "W—66"W	\$3765	\$3819	\$3873	\$3927	\$3980	\$4034

 **For Canadian Pricing**
Multiply U.S. Price by the Canadian price factor.
► See page 1 for details.

Ology Modesty Panels

High-Pressure Laminate or Composite Veneer

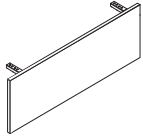

Tip: Full width modesty panels cannot be used on desks with integrated rail. To use with the integrated rail, the modesty panel must be undersized by a minimum of 20" (rectangular and tapered) or 19" (90°) and 16" (120°), and inset from the edge of the worksurface.

For laminate price group 2 and 3 pricing, please refer to the electronic catalog or SmartTools.

Tip: Modular and parametric modesty panels are undersized 2 1/2" to account for desks with radius corners.

Modular and parametric modesty panels are undersized by 2 1/2" for square corner and radius corner options to account for desks with radius corners.

Tip: When using a modesty panel on straight and taper parametric sized desks, modesty panel width must be verified in CET to avoid interference.

Tip: Modesty panels are defaulted in the horizontal grain direction for both laminate and wood veneer. Optional vertical grain direction can be specified, however, laminate specification is only allowed up to 60" wide.

Standard Includes		Required to Specify
<ul style="list-style-type: none"> ▶ Need help? Product details, page 92 	<ul style="list-style-type: none"> • Panel: High-Pressure Laminate price group 1 or composite veneer group 1 • Modular widths: 34"–76" • Attachment hardware 	<ol style="list-style-type: none"> 1 Style number 2 Panel type (see below under Required Selections) 3 Panel width 4 High-Pressure Laminate or composite veneer for panel 5 Options, if selected (see below) <ul style="list-style-type: none"> ▶ See <i>Surface Materials</i>, page 362.

	Required Selections	U.S. Price	Required to Specify
Panel Type	<ul style="list-style-type: none"> • Modular width panel • Parametric width panel 	No cost No cost	Specify with <i>modular panel type</i> . Specify with <i>parametric panel type</i> .

	Options	U.S. Price	Required to Specify
Surface Materials	High-Pressure Laminate		
	<ul style="list-style-type: none"> • Laminate price group 2 • Laminate price group 3 • Open Line laminate 	See information at left See information at left +\$111 plus cost of laminate	Specify laminate color number. Specify laminate color number. ▶ See <i>Surface Materials Reference Manual</i> .
	Composite veneer		
	<ul style="list-style-type: none"> • Composite veneer group 1 • Composite veneer group 2 	Prices below +\$108	Specify composite veneer color number. Specify composite veneer color number.
	Wood veneer		
	<ul style="list-style-type: none"> • Wood group 1 • Wood group 2 • Wood group 3 • Customiz stain 	Prices below +\$118 +\$417 No cost	Specify wood color number. Specify wood color number. Specify wood color number. Specify with <i>customiz stain</i> . ▶ See <i>Surface Materials Reference Manual</i> .
	Grain direction		
	<ul style="list-style-type: none"> • Horizontal grain direction • Vertical grain direction 	No cost No cost	Specify with <i>horizontal grain direction</i> . Specify with <i>vertical grain direction</i> .

Specification Information									
Style Number	Panel Type	U.S. Base Prices							
	Modular	34"W	40"W	46"W	52"W	58"W	64"W	70"W	76"W
	Parametric	34"W	36 1/16"W	42 1/16"W	48 1/16"W	54 1/16"W	60 1/16"W	66 1/16"W	72 1/16"W
		36"W	42"W	48"W	54"W	60"W	66"W	72"W	78"W
	Weight	15.2 lb	17.6 lb	20.0 lb	22.4 lb	24.8 lb	27.3 lb	29.7 lb	32.1 lb

High-Pressure Laminate

OLMP	34"	40"	46"	52"	58"	64"	70"	76"
	\$312	\$313	\$320	\$326	\$330	\$341	\$349	\$358

Composite Veneer

OLMP	34"	40"	46"	52"	58"	64"	70"	76"
	\$388	\$393	\$402	\$408	\$412	\$425	\$436	\$448

Wood Veneer

OLMP	34"	40"	46"	52"	58"	64"	70"	76"
	\$395	\$402	\$411	\$417	\$421	\$434	\$444	\$457



For Canadian Pricing
Multiply U.S. Price by the Canadian price factor.
▶ See page 1 for details.

Cable Riser

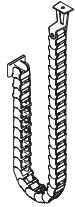

Fence connection



Leg connection

Tip: Cable riser leg connection is not compatible with the Flex height adjustable desk.

Standard Includes		Required to Specify
▶ Need help? Product details, page 66	<ul style="list-style-type: none"> Cable riser with fence connection: 7360 Merle paint Attachment hardware 	1 Style number 2 Options, if selected (see below)

Options	U.S. Price	Required to Specify
Connection		
<ul style="list-style-type: none"> Fence Leg 	No cost +\$165	Specify with <i>fence connection</i> . Specify with <i>leg connection</i> .

Specification Information	
• Style Number	• U.S. Base Price
.....
OLCR	\$113
.....

Cable Basket

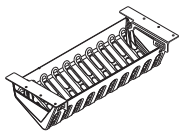

Tip: Cable baskets are compatible with rectangular, tapered, or 90° corner desks 46 1/8"W or larger and 120° corner desks 40"W or larger.

Tip: Cable basket attaches to the worksurface with brackets, which requires an 8" depth clearance to mount.

Standard Includes		Required to Specify
▶ Need help? Product details, page 66	<ul style="list-style-type: none"> Cable basket: 6527 Merle plastic 	Style number

Specification Information					
• Dimensions			• Style	• Weight	• U.S.
D	W	H	Number		Price
8"	18"	4 1/2"	OLCB	1.0 lb	\$89
.....

Cable Brackets

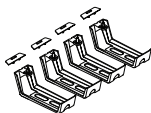

For Canadian Pricing
 Multiply U.S. Price by the Canadian price factor.
 ▶ See page 1 for details.

Standard Includes		Required to Specify
▶ Need help? Product details, page 66	<ul style="list-style-type: none"> Cable brackets, quantity of four: 6527 Merle plastic 	Style number

Specification Information				
• Dimensions		• Style	• Weight	• U.S.
D	H	Number		Price
6"	2"	OLCBK4	0.5 lb	\$53
.....

Active Touch Controller Kit

For Ology Desks

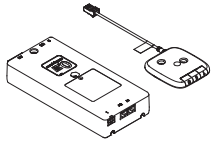

Tip: Active touch controller kit can upgrade any existing Ology desk or base as a replacement to the up/down or 4-preset programmable controller.

Tip: Tapered and rectangle Ology desks require the standard 2-leg application; corner Ology desks require 3-leg application.

Tip: The standard active touch controller is Bluetooth-enabled to allow pairing with the Steelcase Rise app.

Standard Includes		Required to Specify
-------------------	--	---------------------

- Active touch controller
- 2-leg application

- 1 Style number
- 2 Options, if selected (see below)

Options	U.S. Price	Required to Specify
---------	------------	---------------------

Leg Application

- 3-leg

+\$211

Specify with 3-leg.

Specification Information

Style Number	U.S. Base Price
OLATKT	\$421



For Canadian Pricing

Multiply U.S. Price by the Canadian price factor.

▶ See page 1 for details.

Universal Steel One-High and 1.5-High Open Laterals

For Ology Application

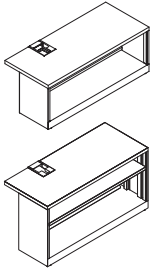

Drawings show right-hand application, left hand is also available.

Tip: Right-hand or left-hand application is determined by which leg of the Ology desk is located inside the storage.

Tip: Only available for Ology desks specified with modular widths.

For laminate group 2 and 3 pricing, please refer to the electronic catalog or SmartTools.

 **For Canadian Pricing**
Multiply U.S. Price by the Canadian price factor.
▶ See page 1 for details.

	Standard Includes	Required to Specify
▶ Need help? Product details, page 94	<ul style="list-style-type: none"> Lateral case: paint price group 1 1³/₁₆"H top: laminate price group 1, if selected <ul style="list-style-type: none"> – Edge: plastic 1³/₁₆"H top: composite veneer group 1, if selected Four adjustable leveling glides Grommet Wire manager Ganging hardware 	<ol style="list-style-type: none"> Style number Paint color number for lateral case Width (see below under Required Selections) Laminate color number for top, if laminate top selected Plastic color number for edge, if laminate top selected Composite veneer color number for top, if composite veneer selected Front style (see below under Required Selections) Application (see below under Required Selections) Options, if selected (see below) <p>▶ See <i>Surface Materials</i>, page 362.</p>

	Required Selections	U.S. Price	Required to Specify
Width	<ul style="list-style-type: none"> 30"W 36"W 42"W 	Prices at right Prices at right Prices at right	Specify with 30" width. Specify with 36" width. Specify with 42" width.
Front Style	<ul style="list-style-type: none"> Flush steel front Proud steel front 	Prices at right Prices at right	Specify with flush steel front. Specify with proud steel front.
Application	<ul style="list-style-type: none"> Right hand Left hand 	No cost No cost	Specify with right-hand application. Specify with left-hand application.

	Options	U.S. Price	Required to Specify
Surface Materials	<ul style="list-style-type: none"> Paint price group 1 Paint price group 2 Paint price group 3 	No cost +\$120 +\$208	Specify paint color number. Specify paint color number. Specify paint color number.
Tops	<p>No top</p> <ul style="list-style-type: none"> For use beneath a Universal common top <p>Laminate top</p> <ul style="list-style-type: none"> Laminate price group 2 Laminate price group 3 Open Line laminate <p>Composite veneer top</p> <ul style="list-style-type: none"> Composite veneer group 1 Composite veneer group 2 <p>Wood veneer top</p> <ul style="list-style-type: none"> Wood group 1 Wood group 2 Wood group 3 Customiz stain 	–\$161 See information at left See information at left +\$111 plus cost of laminate +\$653 +\$696 +\$718 +\$765 +\$878 No cost	Specify with no top. Specify laminate color number. Specify laminate color number. ▶ See <i>Surface Materials Reference Manual</i> . Specify with composite veneer top and indicate composite veneer color number. Specify with composite veneer top and indicate composite veneer color number. Specify with wood veneer top and indicate wood color number. Specify with wood veneer top and indicate wood color number. Specify with wood veneer top and indicate wood color number. Specify with customiz stain. ▶ See <i>Surface Materials Reference Manual</i> .

Related Products		
	<ul style="list-style-type: none"> Universal common tops Universal shrouds Universal filler 	<ul style="list-style-type: none"> ▶ Page 142 ▶ Page 140 ▶ Page 141

Specification Information

Style Number	Dimensions			U.S. Base Prices	
	D	W	H	Flush Steel Front	Proud Steel Front

One-High Open Lateral

RSCHAD	Dimensions		W	H	U.S. Base Prices	
	D	D			Flush Steel Front	Proud Steel Front
	18"	18 ⁷ / ₈ "	30"	16"	\$1660	\$1756
	18"	18 ⁷ / ₈ "	36"	16"	\$1833	\$1951
	18"	18 ⁷ / ₈ "	42"	16"	\$1996	\$2125

1.5-High Open Lateral

RSCBHD	Dimensions		W	H	U.S. Base Prices	
	D	D			Flush Steel Front	Proud Steel Front
	18"	18 ⁷ / ₈ "	30"	22"	\$2022	\$2140
	18"	18 ⁷ / ₈ "	36"	22"	\$2233	\$2378
	18"	18 ⁷ / ₈ "	42"	22"	\$2435	\$2592

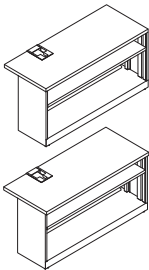
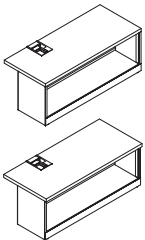

 **For Canadian Pricing**
Multiply U.S. Price by the
Canadian price factor.
▶ See page 1 for details.

Universal Shrouds

For Use with Universal Steel One-High and 1.5-High Open Laterals, Ology Application

Tip: Universal shroud width must match width of the universal Steel One-High or 1.5-High open lateral for Ology applications.

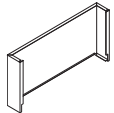
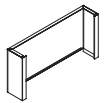

Standard Includes		Required to Specify
<ul style="list-style-type: none"> ▶ Need help? Product details, page 94 	<ul style="list-style-type: none"> • Shroud: paint price group 1 • Attachment hardware 	<ol style="list-style-type: none"> 1 Style number 2 Width (see below under Required Selections) 3 Paint color number for shroud 4 Options, if selected (see below) <ul style="list-style-type: none"> ▶ See <i>Surface Materials</i>, page 362.

	Required Selections	U.S. Price	Required to Specify
Width	<ul style="list-style-type: none"> • 30"W • 36"W • 42"W 	<ul style="list-style-type: none"> No cost No cost No cost 	<ul style="list-style-type: none"> Specify with 30" width. Specify with 36" width. Specify with 42" width.

	Options	U.S. Price	Required to Specify
Surface Materials	<ul style="list-style-type: none"> • Paint price group 1 • Paint price group 2 • Paint price group 3 	<ul style="list-style-type: none"> No cost +\$49 +\$80 	<ul style="list-style-type: none"> Specify paint color number. Specify paint color number. Specify paint color number.

Related Products	<ul style="list-style-type: none"> • Universal Steel One-High and 1.5-High open lateral files for Ology application 	▶ Page 138
-------------------------	--	------------

Specification Information

Dimensions		Style	U.S.
D	H	Number	Base Price
:	:	:	:
:	:	:	:

One-High Shroud

6"	16"	RPXSHAD	\$126
:	:	:	:

1.5-High Shroud

6"	22"	RPXSBHAD	\$141
:	:	:	:



For Canadian Pricing

Multiply U.S. Price by the Canadian price factor.

▶ See page 1 for details.

Universal Filler

For Use with Universal Steel One-High and 1.5-High Open Laterals, Ology Application

Standard Includes		Required to Specify
▶ Need help? Product details, page 94	<ul style="list-style-type: none"> • Filler: paint • Attachment hardware 	1 Style number 2 Paint color number for filler ▶ See <i>Surface Materials</i> , page 362.

Related Products	
<ul style="list-style-type: none"> • Universal Steel One-High and 1.5-High open lateral files for Ology applications 	▶ Page 138

Specification Information

Dimensions		Style	U.S.
D	H	Number	Price

One-High Filler

6"	16"	RPXFHAD	\$ 89
:	:	:	:

1.5-High Filler

6"	22"	RPXFBHAD	\$111
:	:	:	:



Ology

 **For Canadian Pricing**
 Multiply U.S. Price by the
 Canadian price factor.
 ▶ See page 1 for details.

Universal Common Tops

For Use with Universal Steel One-High and 1.5-High Open Laterals and Credenzas, Ology Application

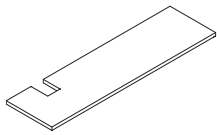

Drawing shows right-hand application, left hand is also available.

Standard Includes	Required to Specify
<ul style="list-style-type: none"> ▶ Need help? Product details, page 96 • 1$\frac{3}{16}$"H top: laminate price group 1, if selected <ul style="list-style-type: none"> – Edge: plastic • 1$\frac{3}{16}$"H top: composite veneer group 1, if selected 	<ol style="list-style-type: none"> 1 Style number 2 Width (see below under Required Selections) 3 Laminate color number for top, if laminate top selected 4 Plastic color number for edge, if laminate top selected 5 Composite veneer color number for top, if composite veneer selected 6 Front style (see below under Required Selections) 7 Application (see below under Required Selections) 8 Options, if selected (see below) <p>▶ See <i>Surface Materials</i>, page 362.</p>

Required Selections	U.S. Price	Required to Specify
Width	<ul style="list-style-type: none"> • 60"W Prices at right • 66"W Prices at right • 72"W Prices at right • 78"W Prices at right • 84"W Prices at right • 90"W Prices at right • 96"W Prices at right • 108"W Prices at right 	<p>Specify with 60" width.</p> <p>Specify with 66" width.</p> <p>Specify with 72" width.</p> <p>Specify with 78" width.</p> <p>Specify with 84" width.</p> <p>Specify with 90" width.</p> <p>Specify with 96" width.</p> <p>Specify with 108" width.</p>
Front Style	<ul style="list-style-type: none"> • Flush front No cost • Proud front No cost 	<p>Specify with flush front.</p> <p>Specify with proud front.</p>
Application	<ul style="list-style-type: none"> • Right hand No cost • Left hand No cost 	<p>Specify with right-hand application.</p> <p>Specify with left-hand application.</p>

Tip: Right-hand or left-hand application is determined by which leg of the Ology desk is located inside the storage.

For composite veneers, wood and laminate group 2 and 3 pricing, please refer to the electronic catalog or SmartTools.

Options	U.S. Price	Required to Specify
Surface Materials	<p>Laminate top</p> <ul style="list-style-type: none"> • Laminate price group 2 See information at left • Laminate price group 3 See information at left • Open Line laminate +\$111 plus cost of laminate 	<p>Specify laminate color number.</p> <p>Specify laminate color number.</p> <p>▶ See <i>Surface Materials Reference Manual</i>.</p>
	<p>Composite veneer top</p> <ul style="list-style-type: none"> • Composite veneer group 1 Prices at right • Composite veneer group 2 See information at left 	<p>Specify with composite veneer top and indicate composite veneer color number.</p> <p>Specify with composite veneer top and indicate composite veneer color number.</p>
	<p>Wood veneer top</p> <ul style="list-style-type: none"> • Wood group 1 Prices at right • Wood group 2 See information at left • Wood group 3 See information at left • Customiz stain No cost 	<p>Specify with wood veneer top and indicate wood color number.</p> <p>Specify with wood veneer top and indicate wood color number.</p> <p>Specify with wood veneer top and indicate wood color number.</p> <p>Specify with customiz stain.</p> <p>▶ See <i>Surface Materials Reference Manual</i>.</p>
Related Products	<ul style="list-style-type: none"> • Universal Steel One-High and 1.5-High open lateral files for Ology application • Universal shrouds • Universal filler 	<p>▶ Page 138</p> <p>▶ Page 140</p> <p>▶ Page 141</p>



For Canadian Pricing
Multiply U.S. Price by the Canadian price factor.
▶ See page 1 for details.

Specification Information

Style Number	Dimensions		W	U.S. Base Prices		
	Flush Front	Proud Front		Laminate Price Group 1	Composite Veneer Group 1	Wood Group 1
RATCTHAD	18"	18 ⁷ / ₈ "	60"	\$ 510	\$1144	\$1207
	18"	18 ⁷ / ₈ "	66"	\$ 588	\$1207	\$1270
	18"	18 ⁷ / ₈ "	72"	\$ 664	\$1265	\$1328
	18"	18 ⁷ / ₈ "	78"	\$ 839	\$1513	\$1576
	18"	18 ⁷ / ₈ "	84"	\$ 948	\$1722	\$1801
	18"	18 ⁷ / ₈ "	90"	\$1056	\$1820	\$1899
	18"	18 ⁷ / ₈ "	96"	\$1165	\$2008	\$2087
	18"	18 ⁷ / ₈ "	108"	\$1399	N.A.	N.A.

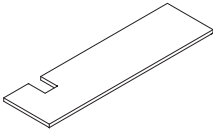

Tip: Can not order veneer on 108"W Universal common top.



 **For Canadian Pricing**
 Multiply U.S. Price by the Canadian price factor.
 ▶ See page 1 for details.

Elective Elements One-High Open Plinth Base Pedestals

For Ology Application

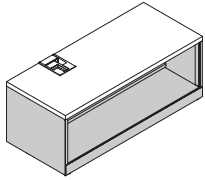

Tip: Ships without top. Picture shows fully assembled product. To specify a top, see style number **E6WSHAD**.
▶ Page 146

Tip: Leveling glides adjust up to 3/4".

For laminate price group 2 and 3 pricing, please refer to the electronic catalog or SmartTools.

Tip: Only available for Ology desks specified with modular widths.

Standard Includes		Required to Specify
▶ Need help? Product details, page 96	<ul style="list-style-type: none"> Case with back panel: composite veneer group 1 Grommet in top of case Removable interior cover Skeleton bone wire manager 	1 Style number 2 Width (see below under Required Selections) 3 Composite veneer number for case 4 Options, if selected (see below) ▶ See <i>Surface Materials</i> , page 362.

Required Selections	U.S. Price	Required to Specify
Width		
• 24"W	Price below	Specify with 24"W.
• 30"W	Price below	Specify with 30"W.
• 36"W	Price below	Specify with 36"W.
• 42"W	Price below	Specify with 42"W.

Options	U.S. Price	Required to Specify
Surface Materials		
Case		
• Laminate price group 1	-\$232	Specify laminate color number.
• Laminate price group 2	See information at left	Specify laminate color number.
• Laminate price group 3	See information at left	Specify laminate color number.
• Open Line laminate	-\$196 plus cost of laminate	▶ See <i>Surface Materials Reference Manual</i> .
• Composite veneer group 1	Prices below	Specify composite veneer color number.
• Composite veneer group 2	+\$ 65	Specify composite veneer color number.
• Wood group 1	+\$ 54	Specify wood color number.
• Wood group 2	+\$ 72	Specify wood color number.
• Wood group 3	+\$257	Specify wood color number.
• Customiz stain	No cost	Specify with <i>Customiz stain</i> .
Grain Direction		
• No grain direction	No cost	Specify with <i>no grain direction</i> .
• Vertical	No cost	Specify with <i>vertical grain direction</i> .
• Horizontal	No cost	Specify with <i>horizontal grain direction</i> .
Related Products		
• Common top for Ology application		▶ Page 146
• Ology height-adjustable desks		▶ Page 98

Specification Information					
Style Number	Dimensions			U.S. Base Price	Option (Add \$ to Base Price)
	D	H	W		
E6PDHAD	17¼"	15½"	24"	\$2404	-\$188
	17¼"	15½"	30"	\$2566	-\$215
	17¼"	15½"	36"	\$2725	-\$239
	17¼"	15½"	42"	\$2890	-\$268



For Canadian Pricing
Multiply U.S. Price by the Canadian price factor.
▶ See page 1 for details.

Elective Elements Common Tops

For Ology Application

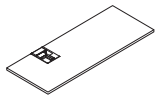

Tip: Drawings show right-hand application, left hand is also available.

Standard Includes	Required to Specify
<ul style="list-style-type: none"> ▶ Need help? Product details, page 96 • Tops: composite veneer group 1 veneer or laminate price group 1 • Composite veneer tops with wood edge: <ul style="list-style-type: none"> – 3 mm wood square profile on user side – 0.5 mm veneer on other sides • Laminate tops with plastic edge: <ul style="list-style-type: none"> – 3 mm plastic edge on user's side – 1 mm plastic edge on other sides, plastic default to match user's side • Laminate tops with wood edge: <ul style="list-style-type: none"> – Solid wood edge on user's side – 1 mm plastic edge on other sides, plastic default to match worksurface 	<ol style="list-style-type: none"> 1 Style number 2 Width (see below under Required Selections) 3 Composite veneer or laminate color number 4 Wood edge color number for all sides on wood worksurfaces, if selected 5 Plastic edge color number for all sides on laminate worksurfaces, if selected 6 Tops profile (see below under Required Selections) 7 Application (see below under Required Selections) 8 Options, if selected (see below) <p>▶ See <i>Surface Materials</i>, page 362.</p>

Width	Required Selections	U.S. Price	Required to Specify
	• 24"W	Prices at right	Specify with 24"W.
	• 30"W	Prices at right	Specify with 30"W.
	• 36"W	Prices at right	Specify with 36"W.
	• 42"W	Prices at right	Specify with 42"W.
	• 48"W	Prices at right	Specify with 48"W.
	• 54"W	Prices at right	Specify with 54"W.
	• 60"W	Prices at right	Specify with 60"W.
	• 66"W	Prices at right	Specify with 66"W.
	• 72"W	Prices at right	Specify with 72"W.
	• 78"W	Prices at right	Specify with 78"W.
	• 84"W	Prices at right	Specify with 84"W.
	• 90"W	Prices at right	Specify with 90"W.
	• 96"W	Prices at right	Specify with 96"W.
	• 102"W	Prices at right	Specify with 102"W.
	• 108"W	Prices at right	Specify with 108"W.
	• 114"W	Prices at right	Specify with 114"W.
	• 120"W	Prices at right	Specify with 120"W.

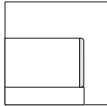
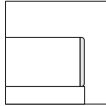
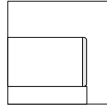
Wood Common Top Edge Profile	Laminate Common Top Edge Profile	Prices at right
 <p>Wood Square Profile</p>	 <p>Plastic Square Profile</p>	 <p>Wood Square Profile</p>

Application	<ul style="list-style-type: none"> • Left-hand application • Right-hand application 	<p>No cost</p> <p>No cost</p>	<p>Specify with <i>Ology left-hand application</i>.</p> <p>Specify with <i>Ology right-hand application</i>.</p>
--------------------	---	-------------------------------	--

Surface Materials	Options	U.S. Price	Required to Specify
	<p>Composite veneer common top</p> <ul style="list-style-type: none"> • Composite veneer group 1 • Composite veneer group 2 	<p>Prices at right</p> <p>Prices at right</p>	<p>Specify composite veneer color number.</p> <p>Specify composite veneer color number.</p>
	<p>Wood veneer common top</p> <ul style="list-style-type: none"> • Wood group 1 • Wood group 2 • Wood group 3 • Customiz stain 	<p>Prices at right</p> <p>Prices at right</p> <p>Prices at right</p> <p>No cost</p>	<p>Specify wood color number.</p> <p>Specify wood color number.</p> <p>Specify wood color number.</p> <p>Specify with <i>Customiz stain</i>.</p>

▶ **Specification Information, continued on next page**



For Canadian Pricing

Multiply U.S. Price by the Canadian price factor.

▶ See page 1 for details.

► **Specification Information, continued from previous page**

For laminate group 2 and 3 pricing, please refer to the electronic catalog or SmartTools.

Tip: Shroud top surface follows worksurface grain direction.

Tip: Short grain on laminate tops is only available on 60"W.

	Options	U.S. Price	Required to Specify
Surface Materials, continued	Laminate common top <ul style="list-style-type: none"> Laminate price group 1 Laminate price group 2 Laminate price group 3 Open Line laminate 	Prices below See information at left See information at left Prices below plus cost of laminate	Specify laminate color number. Specify laminate color number. Specify laminate color number. ► See <i>Surface Materials Reference Manual</i> .
Grain Direction	Veneer tops <ul style="list-style-type: none"> Long grain Short grain 	No cost No cost	Specify <i>with long grain</i> . Specify <i>with short grain</i> .
	Laminate tops <ul style="list-style-type: none"> No grain direction Long grain Short grain (on 60"W) 	No cost No cost No cost	Specify <i>with no grain direction</i> . Specify <i>with long grain</i> . Specify <i>with short grain</i> .
Related Products	<ul style="list-style-type: none"> Elective Elements One-High open plinth base pedestals for Ology application Ology modesty panels Fixed personal/modesty screens Ology height-adjustable desks 		► Page 144 ► Page 134 ► Page 344 ► Page 98

Ology

Specification Information

Style Number	Dimensions		U.S. Base Prices					Options (Add \$ to Base Price)					
	D	W	Composite Veneer Group 1	Wood Group 1	Laminate Group 1	Composite Veneer Square Edge	Wood Square Edge	3 mm Plastic Square Edge	Composite Veneer Square Edge	Wood Square Edge	Composite Veneer Group 2	Wood Group 2	Wood Group 3

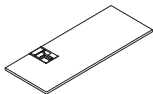

E6WSHAD	18"	24"	\$ 784	\$ 892	\$ 321	\$ 668	\$ 668	+\$ 43	+\$ 47	+\$160	-\$353
	18"	30"	\$ 832	\$ 940	\$ 369	\$ 716	\$ 716	+\$ 43	+\$ 47	+\$160	-\$353
	18"	36"	\$ 853	\$ 961	\$ 390	\$ 737	\$ 737	+\$ 73	+\$ 80	+\$279	-\$353
	18"	42"	\$ 945	\$1065	\$ 424	\$ 823	\$ 823	+\$ 73	+\$ 80	+\$279	-\$409
	18"	48"	\$1020	\$1140	\$ 499	\$ 898	\$ 898	+\$ 73	+\$ 80	+\$279	-\$409
	18"	54"	\$1055	\$1175	\$ 534	\$ 933	\$ 933	+\$ 73	+\$ 80	+\$279	-\$409
	18"	60"	\$1150	\$1285	\$ 569	\$1013	\$1013	+\$108	+\$118	+\$416	-\$471
	18"	66"	\$1223	\$1358	\$ 642	\$1086	\$1086	+\$108	+\$118	+\$416	-\$471
	18"	72"	\$1307	\$1442	\$ 726	\$1170	\$1170	+\$108	+\$118	+\$416	-\$471
	18"	78"	\$1377	\$1512	\$ 796	\$1240	\$1240	+\$108	+\$118	+\$416	-\$471
	18"	84"	\$1672	\$1807	\$1091	\$1535	\$1535	+\$108	+\$118	+\$416	-\$471
	18"	90"	\$1952	\$2087	\$1371	\$1815	\$1815	+\$108	+\$118	+\$416	-\$471
	18"	96"	\$2245	\$2380	\$1664	\$2108	\$2108	+\$108	+\$118	+\$416	-\$471
	18"	102"	\$2581	\$2730	\$1941	\$2434	\$2434	+\$149	+\$164	+\$572	-\$528
	18"	108"	\$2966	\$3115	\$2326	\$2819	\$2819	+\$149	+\$164	+\$572	-\$528
	18"	114"	\$3413	\$3562	\$2773	\$3266	\$3266	+\$149	+\$164	+\$572	-\$528
	18"	120"	\$3924	\$4073	\$3284	\$3777	\$3777	+\$149	+\$164	+\$572	-\$528



Steelcase Flex Collection

Understanding

Height-Adjustable Desks and Bases	150
120° Height-Adjustable Desks	154
Curved Screens	157
Personal Spaces	158
Accessories	160

Specifying

Rectangle Height-Adjustable Desks and Bases	162
120° Height-Adjustable Desks	168
Curved Screens	172
Personal Spaces	173
Accessories	175

Flex Rectangle Height-Adjustable Desks and Bases

Height-adjustable

desks bring mobility and wellbeing, allowing users to change posture and location to suit their work needs. Optional integrated power includes a single power cord that comes out of the desk for ease of movement.

► Specifying, pages 162–166

Desk has a wood core with a High-Pressure Laminate or wood veneer surface, and is 1" thick.

Edge is available in 3 mm edge profile, when High-Pressure Laminate is selected.

Square edge is available in 3 mm edge profile, when wood veneer is selected.

Basic height-adjustable base adjusts from 27³/₈"H–46⁷/₁₀"H in any increment.

Extended height-adjustable base adjusts from 22³/₈"H to 48⁷/₁₀"H in any increment.

Brakes are available as an option or can be specified separately. Brake can be activated by the user to fix the mobile desk into place and is engaged by spinning the ring to the floor.

Tip: Brake is recommend for use on hard floors.

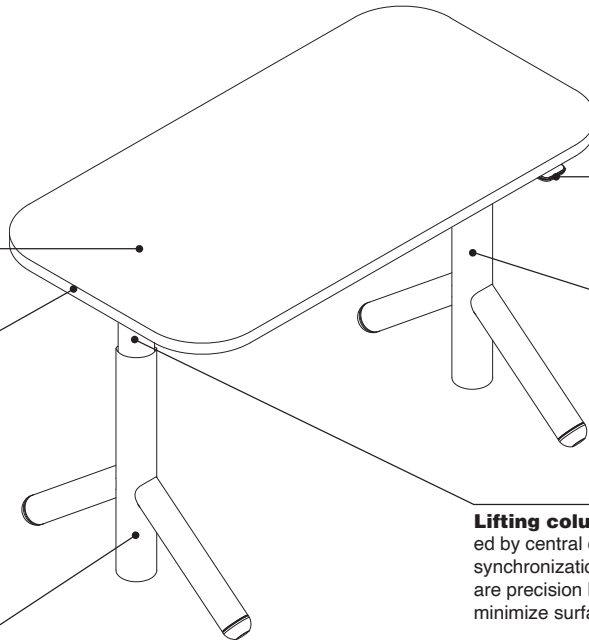

Push button simple touch controller adjusts height at a rate of 1¹/₂" per second.

Base supports a maximum distributed weight load of 360 pounds (2-leg).
Tip: When calculating lifting capacity, subtract the weight of the worksurface, understructure, and options selected.
► See page 153 for worksurface weights.

Lifting column is controlled by central control box for synchronization. Columns are precision balanced to minimize surface vibrations.

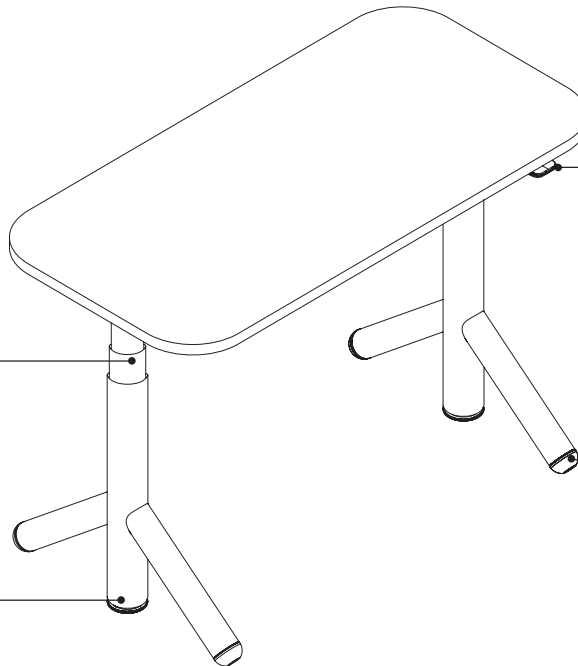

Active touch controller is Bluetooth-enabled and is standard and includes digital display, two preset buttons, double-tap automatic drive, and active motion posture reminders.
Tip: Steelcase Rise mobile app is available that pairs with any active touch controller to support preferences, presets, and activity tracking.

Directional rollers provide intentional user mobility.

Product Details

High-Pressure Laminate Desks

Edge profile is available in 3 mm edge profile.

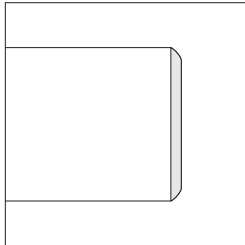

PVC-free, 3 mm edge profiles are proprietary polyolefin blend for all solid colors and woodgrain finishes.

Edge profile finishes are specified separately from laminate color.

Radius corners are standard and have a 5" radius on all four sides with a continuous user edge. Radius corners eliminate sharp edges and are appropriate for mobile furniture.

Wood Veneer Desks

Edge profile is wood veneer with a square (3 mm) radius.

Simple touch controller is available as an option and easily adjusts height of desk, at a rate of 1½" per second, by lifting or pressing down on the controller.

Tip: Available with an antimicrobial option.

Active touch controller is Bluetooth-enabled and is standard and includes digital display, two preset buttons, double-tap automatic drive, and active motion posture reminders.

Tip: Mobile app is available that pairs with any active touch controller to support preferences, presets, and activity tracking.

Obstruction sensing technology is standard with all Flex desks. The worksurface will backtrack when it makes contact with an object.

The overall depth of the worksurface is 23"D, 24"D, 29"D, or 30"D.

Desk overhang for CPU holder or layering of low storage and pedestals is available as an option. The overhang is 9" and available on 58"W or larger desks. Desk widths 70"W or larger allow for single or dual overhang.

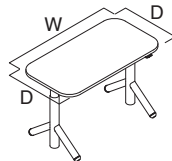

Extended height Flex desks adjust 22¾"H to 48⅞"H in any increment. Basic height-adjustable base adjusts from 27¾"H–46⅞"H in any increment.

Wiring and Cabling

Low surge electric motor with quiet operation adjusts at 1½" per second. Motor is 110V and includes a 10' power cord. Motor has 0.1W standby power.

Chicago requires that desks shipping into Illinois ship with a 9' power cord.

Flex desks and bases are listed by ETL.

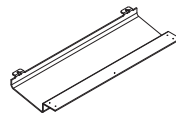

Cable trays are available as an option or can be ordered separately. 46"W–57½"W desks use the 28" cable tray. 58"W–72"W desks use the 40"W cable tray. When specifying a desk overhang, see the chart below for additional guidelines.

Overhang	Worksurface Width			
	46"W–57½"W	58"W–65½"W	66"W–69½"W	70"W–72"W
None	28"W Cable Tray	40"W Cable Tray		
Left or Right		28"W Cable Tray	40"W Cable Tray	
Left and Right				28"W Cable Tray

Integrated power is optional and is located in the understructure of a desk. Integrated power consolidates technology to provide one cord out of the desk for convenience to the user. Two versions are available: underworksurface only and underworksurface plus worksurface clamp on convenience power. Worksurface power has two power outlet options, either dual USB-A or USB-C. Desks 57½"W and under receive three power outlets in the understructure and desks 58"W and above receive five power outlets. Over-current power protection is standard on the integrated power option. If the over-current protection trips, reset by pushing the button located on the face of the understructure.

Integrated power is standard with a 10' standard black power cord. A 20' cord option is available if additional length is needed. For extra color, braided cord option is available.

Integrated power is available with either a standard three prong NEMA plug for use with standard receptacles or with Steelcase's proprietary thread low-profile plug for use with one-door and two-door low-profile connectors.

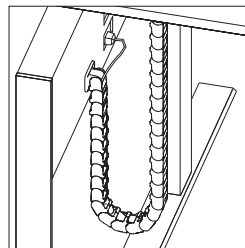

Cable riser, with fence connection, inside dimensions are 1"D x 1"W to accommodate a variety of cord sizes. Overall depth is 2".

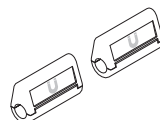

Magnetic cable clips are optimized for the Flex braided one-cord out solution. However, the magnetic cable clips will work on Ology, Migration SE, and the standard Flex power cords. The clips are used to manage power cords out of the users way. Orderable as a separate style number.

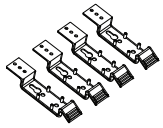

Cable brackets, ordered separately, support horizontal cable management below the worksurface.
 ▶ Specifying, page 177



Inside dimensions of cable brackets are 6"D x 2¼"W x ½"H.

Surface Materials

High-Pressure Laminate Desk

- Laminate
- ▶ See *Surface Materials*, page 362
- Open Line laminate (option)
 A program including non-Steelcase laminates which are suitable for use on Steelcase products.
- ▶ See *Surface Materials Reference Manual*.

3 mm edge profile

- Plastic

Wood Veneer Desk

- Wood veneer (standard)
- Customiz stain (option)

Square 3 mm edge profile

- Wood veneer to match desk

Height-adjustable base

- 4799 Platinum Metallic
- 7207 Black
- 7243 Seagull
- 7360 Merle

Foot

- Paint

Rollers

- 6053 Seagull
- 6205 Black
- 6249 Platinum Solid
- 6527 Merle

Brake

- 6527 Merle

Braided Cord Color Matrix

Braided cord samples are not available to order. Use matrix below that compares the braided cord finish to the nearest Steelcase finish or Pantone color for color reference purposes.

Tip: Braided cord color is defaulted to 9007 Sterling.

Finish	Similar Steelcase Color
9003 Fuchsia	PerfectMatch
9004 Marlin	4AZ5 Marlin
9006 Chili	6338 Chili
9007 Sterling*	6059 Sterling Dark Solid
9008 Honey	4CZ5 Honey
9009 Black	0835 Black
9010 Light Peacock	4CZ8 Light Peacock
9011 Seagull	4858 Seagull

*Default finish on integrated power.

Application Topics

Moving desks can collide with other components. Do not install overhead storage, desk-height power, or desk accessories in the path of height-adjustable desks.

Universal boundary screens are not permitted on height-adjustable desks, as they do not pass minimum safety requirements which could result in the desk tipping over.

On extended height desks, any storage higher than 19" will impede the height range of the desk. On basic height desks, any storage higher than 23⁷/₁₀" will impede the height range of the desk.

Tip: Do not place storage underneath controller.

When mounting CPU holders, specify the overhang option.

Tip: CPU holders that require less than 12"D clearance may be mounted inboard of legs.

All assemblies meet or exceed ANSI/BIFMA standards.



Read base only warranty limitations.

▶ See page 153 for *Workstation Design Guidelines and Requirements*.

Keyboard assemblies are not allowed for use on height-adjustable desks. They do not meet minimum safety requirements.

Installation

Desks ship with pre-drilled holes for mounting bases.

Height-adjustable base requires attachment to the worksurface.

Base supports a maximum distributed weight capacity of 360 pounds.

Tip: When calculating lifting capacity, subtract the weight of the worksurface, understructure, and options.

Tip: A label applied to the underside of the worksurface will include the load-capacity for each desk.

Tip: Flex 90° desk mounted wraps will work on Flex rectangular height-adjustable desks 23"D x 52"W and above.

Worksurface Weight

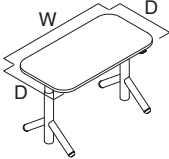
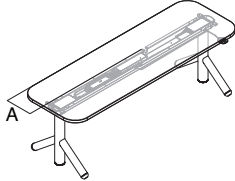
Worksurface Shape	W	D	Worksurface Weight		Understructure Weight	Leg Clearance (A)	Options	Accessory		
			23"D	24"D			Integrated Power Weight	Desk Mounted Wrap	Curved Screen*	
	46"	23" or 24"	27 lb	29 lb	7.1 lb	9½"	5.0 lb	29 lb	1.9 lb	
			29 lb	36 lb						9.4 lb
			42 lb	43 lb						11.7 lb
	58"	23" or 24"	35 lb	36 lb	9.4 lb	9½"	5.0 lb	29 lb	3.7 lb	
			42 lb	43 lb						11.7 lb
			52 lb	54 lb						11.7 lb
	70"	23" or 24"	42 lb	43 lb	11.7 lb	9½"	5.0 lb	29 lb	5.5 lb	
			49 lb	50 lb						
			56 lb	57 lb						
	46"	29" or 30"	34 lb	36 lb	7.1 lb	12½"	5.0 lb	29 lb	1.9 lb	
			41 lb	43 lb						9.4 lb
			48 lb	50 lb						11.7 lb
58"	29" or 30"	43 lb	45 lb	9.4 lb	12½"	5.0 lb	29 lb	3.7 lb		
		50 lb	52 lb							
		57 lb	59 lb							
70"	29" or 30"	52 lb	54 lb	11.7 lb	12½"	5.0 lb	29 lb	5.5 lb		
		59 lb	61 lb							
		66 lb	68 lb							

*For detailed curved screen information, see page 157.

120° Height-Adjustable Desks

120° height-adjustable desks bring mobility and wellbeing, allowing users to change posture and location to suit their work needs. Optional integrated power includes a single power cord that comes out of the desk for ease of movement.
 ▶ Specifying, pages 168–170

Edge is available in 3 mm edge profile, when High-Pressure Laminate is selected.

Desk has a wood core with a High-Pressure Laminate or wood veneer surface, and is 1" thick.

Base is available in extended or basic height: extended height-adjustable base adjusts from 22³/₅"H to 48⁷/₁₀"H in any increment.

Base supports a maximum distributed weight load of 540 pounds (3-leg).
Tip: When calculating lifting capacity, subtract the weight of the worksurface, understructure, and options selected.

Basic height-adjustable base adjusts from 27³/₅"H–46⁹/₁₀"H in any increment.

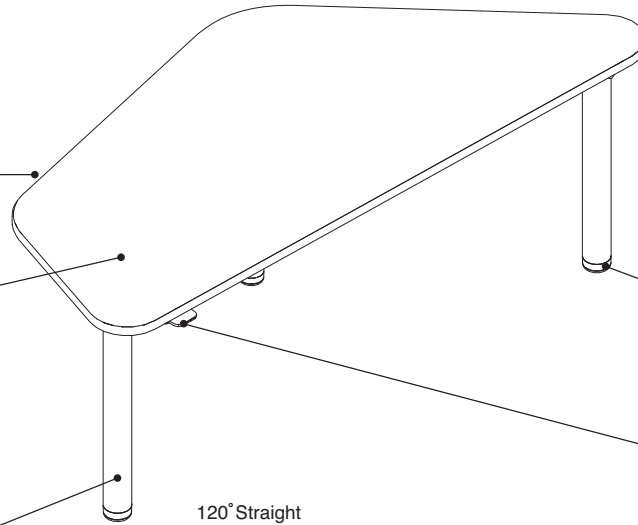

120° Straight

Lifting columns are controlled by a central control box for synchronization. Columns are precision balanced to minimize surface vibrations.

Push button simple touch controller adjusts height at a rate of 1½" per second.

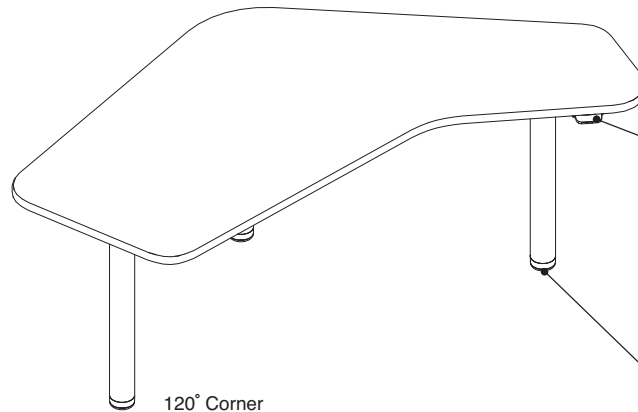

120° Corner

Active touch controller is Bluetooth-enabled; is standard and includes digital display, two preset buttons, double-tap automatic drive, and active motion posture reminders.

Tip: Steelcase Rise mobile app is available that pairs with any active touch controller to support preferences, presets, and activity tracking.

Slide glide on 120° height-adjustable desks provides intentional user mobility.

Product Details

High-Pressure Laminate Desks

Edge profile is available in 3 mm edge profile.

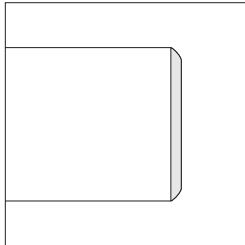

PVC-free, 3 mm edge profiles are proprietary polyolefin blend for all solid colors and woodgrain finishes.

Edge profile finishes are specified separately from laminate color.

Radius corners are standard with a continuous user edge. Radius corners eliminate sharp edges and are appropriate for mobile furniture.

Wood Veneer Desks

Edge profile is wood veneer with a square (3 mm) radius.

Simple touch controller is available as an option and easily adjusts height of desk, at a rate of 1½" per second, by lifting or pressing down on the controller.

Tip: Available with an antimicrobial option.

Active touch controller is standard and includes digital display, two preset buttons, double-tap automatic drive, and active motion posture reminders. *Tip: Mobile app is available that pairs with any active touch controller to support preferences, presets, and activity tracking.*

Obstruction sensing technology is standard with all Flex desks. The worksurface will backtrack when it makes contact with an object.

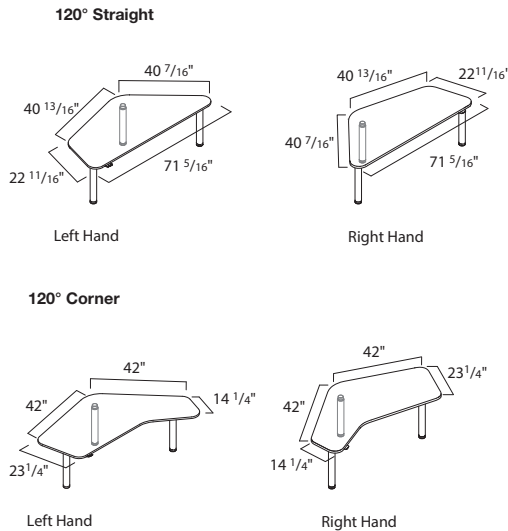

Extended height Flex desks adjust 22¾"H to 487/10"H in any increment.

Basic height-adjustable base adjusts from 27¾"H–469/10"H in any increment.

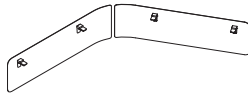

Modesty panels are available on the 120° height-adjustable desks as an option, or can be ordered separately. The two piece design provides modesty for the user, and attachment for the magnetic cable clips to keep the height-adjustable power cord out of the users way.

Steelcase guidance for height adjustment obstruction sensing technology (OST):

- Always read and follow all instructions and safety messages before positioning and using powered, height-adjustable products. Obstruction Sensing Technology (OST) is primarily intended to protect internal mechanisms and is only one part of the overall product system.
- OST is intended to detect hard, immovable objects that contact the desk during raising or lowering.
- OST may not detect soft and/or flexible objects such as padded arm caps, compliant seating surfaces, and cushion tops of peds.
- OST may not detect dynamic and/or articulating objects such as adjustable chair backs and chair arms.
- Different Steelcase height adjustable desks and benches have different types of OST that does not all behave the same.
- OST is disabled during the recalibration/synchronization process, but the unit moves at a much slower speed.

Monitor arms approved for use with Flex 120° height-adjustable desks are: **CSFSTDDUALBAR**, **CFINTROSLIDE**, **CFINTRO**.

Wiring and Cabling

Low surge electric motor with quiet operation adjusts at 1½" per second. Motor is 110V and includes a 10' power cord. Motor has 0.1W standby power.

Chicago requires that desks shipping into Illinois ship with a 9' power cord.

Flex desks and bases are listed by ETL.

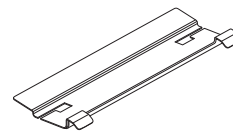

120° cable tray is available on the 120° height-adjustable desks as an option, or can be ordered separately.

Integrated power is optional and is located in the understructure of a desk. Integrated power consolidates technology to provide one cord out of the desk for convenience to the user. Two versions are available: underworksurface only and underworksurface plus worksurface clamp on convenience power. Worksurface power has two power outlet options, either dual USB-A or USB-C. Desks receive five power outlets. Over-current power protection is standard on the integrated power option. If the over-current protection trips, reset by pushing the button located on the face of the understructure.

Integrated power is standard with a 10' standard black power cord. A 20' cord option is available if additional length is needed. For extra color, a braided cord option is available. Curly cord is also available for extra cord management.

Integrated power is available with either a standard three prong NEMA plug for use with standard receptacles or with Steelcase's proprietary thread low-profile plug for use with one-door and two-door low-profile connectors.

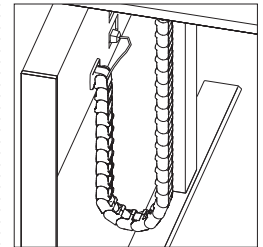

Cable riser, with fence connection, inside dimensions are 1"D x 1"W to accommodate a variety of cord sizes. Overall depth is 2".

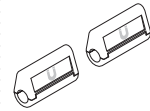

Magnetic cable clips are optimized for the Flex braided one-cord out solution. However, the magnetic cable clips will work on Ology, Migration SE, and the standard Flex power cords. The clips are used to manage power cords out of the users way. Orderable as a option on the 120° Flex height-adjustable desks, or as a separate style number.

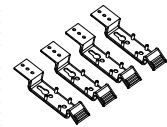

Cable brackets, ordered separately, support horizontal cable management below the worksurface. **► Specifying, page 177**



Inside dimensions of cable brackets are 6"D x 2¼"W x ½"H.

Surface Materials

High-Pressure Laminate Desk

- Laminate
- ▶ See *Surface Materials*, page 362
- Open Line laminate (option)
A program including non-Steelcase laminates which are suitable for use on Steelcase products.
- ▶ See *Surface Materials Reference Manual*.

3 mm edge profile

- Plastic

Wood Veneer Desk

- Wood veneer (standard)
- Customiz stain (option)

Square 3 mm edge profile

- Wood veneer to match desk

Height-adjustable base

- 4799 Platinum Metallic
- 7207 Black
- 7243 Seagull
- 7360 Merle

Desk slide glide

- 6527 Merle

Modesty panel

- Paint

Modesty panel bracket

- 6527 Merle

Magnetic cable clips

- 6053 Seagull

Braided Cord Color Matrix

Braided cord samples are not available to order. Use matrix below that compares the braided cord finish to the nearest Steelcase finish color for color reference purposes.
Tip: Braided cord color is defaulted to 9007 Sterling.

Finish	Similar Steelcase Color
9003 Fuchsia	PerfectMatch
9004 Marlin	4AZ5 Marlin
9006 Chili	6338 Chili
9007 Sterling*	6059 Sterling Dark Solid
9008 Honey	4CZ5 Honey
9009 Black	0835 Black
9010 Light Peacock	4CZ8 Light Peacock
9011 Seagull	4858 Seagull

*Default finish on integrated power.

Application Topics

Moving desks can collide with other components. Do not install overhead storage, desk-height power, or desk accessories in the path of height-adjustable desks.

Universal boundary screens are not permitted on height-adjustable desks, as they do not pass minimum safety requirements which could result in the desk tipping over.

On extended height desks, any storage higher than 19" will impede the height range of the desk. On basic height desks, any storage higher than 23⁷/₁₆" will impede the height range of the desk.
Tip: Do not place storage underneath controller.

All assemblies meet or exceed ANSI/BIFMA standards.



Read base only warranty limitations.

Keyboard assemblies are not allowed for use on height-adjustable desks. They do not meet minimum safety requirements.

Curved screens provide user adjustable privacy and modesty for height-adjustable desks and work tables.

► Specifying, page 172

Curved screens are attached to the worksurface with magnetic brackets allowing for user adjustability between privacy and modesty modes.

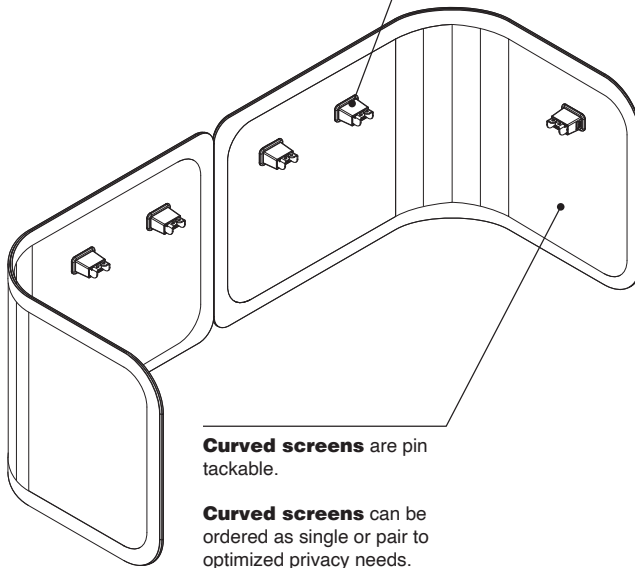

Curved screens are pin tackable.

Curved screens can be ordered as single or pair to optimized privacy needs.

Product Details

Curved screens perform to an NRC rating of 0.45.

Application Topics

Curved screens are sized to work with modular size desks. Mounting a pair of screens on a parametric sized desk will create a gap between screens.

Tip: It is recommended that CET SmartTools be used to evaluate the gap on the desk.

Curved screen is mounted with a 5/8" cord drop.

Fabric is applied in a warp horizontal direction. Due to the size of the screens, fabric is unable to be applied in a warp vertical direction.

Privacy configuration provides 11½" of screen above the worksurface and 5½" of screen below the worksurface. The height is measured from the top of the mounting surface to the top of the screen, and from the bottom of the mounting surface to the bottom of the screen. Screens are meant to be handled by the user. Choose fabrics colors that will wear well over time.

Modesty configuration provides 3½" of screen above the worksurface and 13½" of screen below the worksurface. The height is measured from the top of the mounting surface to the top of the screen, and from the bottom of the mounting surface to the bottom of the screen.

When ordering a single screen, selecting the correct hand is important. Handedness is assigned from the user position when the curved screen is mounted in privacy mode.

Single curved screens

mounted to a modular size desk will cover half the width of the desk. If more coverage is desired, order the next size larger of screens. *Tip: It is recommended that CET SmartTools be used to evaluate the placement of the screen on the desk.*

Curved screens are allowed on rectangular 5" radius and organic bow front worksurfaces from Migration Pro, Migration Pro High-Speed, and Migration Intro. *Tip: Screens are not allowed with the knife edge option.*

Surface Materials

Screen

- Fabric

Tip: Some thin, light colored fabrics are not available on these screens. Please see Surface Materials for available fabric finishes.

► Page 368

Brackets

- 6527 Merle

Actual Dimensions

Width	46", 58", or 70"
Height	18"
Weight	1.9 lb, 3.7 lb, 5.5 lb
Depth	½"

Personal Spaces

Desk Mount Privacy Wraps

Tackable acoustic privacy wraps offer acoustic privacy and personalization for the user.

► Specifying, pages 173–174

Upholstery details continue the curvature of the wrap.

120° desk mount privacy wraps are attached via brackets to the 120° straight and 120° corner height-adjustable desks.

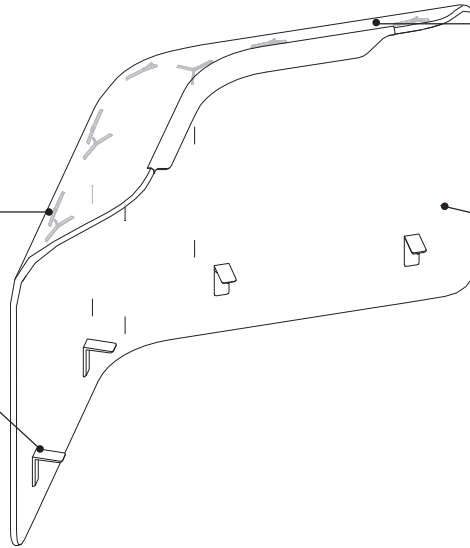

Integrated light option minimizes shadows under privacy wrap, and enhances backdrop for video calls.

Wrap knit covers the entire frame creating a warm and enclosed privacy element.

Actual Dimensions

120° Privacy Wrap

Width Left 40⁹/₁₀"

Width Right 40⁹/₁₀"

Height 45¹/₄"

Integrated light option minimizes shadows under privacy wrap, and enhances backdrop for video calls.

90° desk mount privacy wrap attaches to Flex rectangular height-adjustable desks and worksurfaces that offer a 5" radius corner.

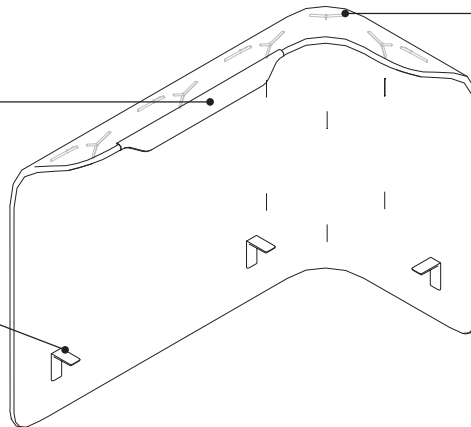

Upholstery details continue the curvature of the wrap.

Frame can accept magnetic name tag or Flex freestanding screens to add personalization and privacy to the workstation.

Actual Dimensions

90° Privacy Wrap

Depth 25⁴/₅"

Width 52⁹/₁₀"

Height 45¹/₄"

Wrap Knit and Light Finish Matrix

Wrap Finish Name	Wrap Finish Code	Light Finish Name	Light Finish Code
Dark Grey/ Merle	5KJ1	Merle	6527
Blue	5KJ2	Seagull	6053
Light Grey/ Platinum	5KJ3	Seagull	6053
Light Brown/ Beige	5KJ4	Milk	6052

Application Topics

90° desk mount privacy wraps are allowed on rectangular 5" radius and 28/29/30"D organic bow front work-surfaces from Migration Pro, Migration Pro High-Speed, and Migration Intro.

Tip: Privacy wrap is not allowed with the following worksurface options: knife edge profile, 23"D, mounted on the same side as an overhang.

Tip: Desks must be 52"W and wider.

Accessories

Flex accessories can be used across the collection to provide functionality and personalization.

► Specifying, pages 175–178

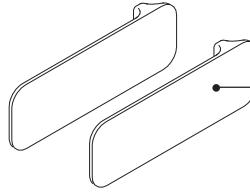

Magnetic name tag attaches to all privacy wraps for personal notes in the workstation. Name tags have an erasable finish and are sold in packages of two or ten.

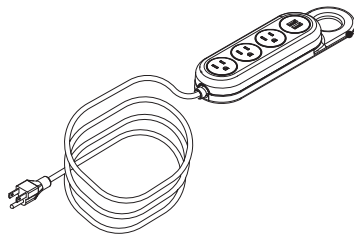

Power hangers are available in two configurations: four power and three power with USB.

Power hangers hang from the pegs on work tables.

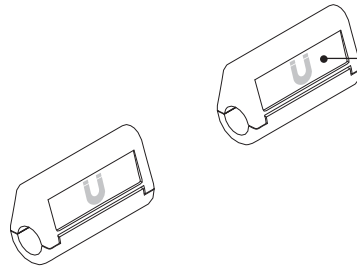

Magnetic cable clips manage the height adjustable power cord. Cable clips are sold in packages of two or ten.

Braided Cord Color Matrix

Braided cord samples are not available to order. Use matrix below that compares the braided cord finish to the nearest Steelcase finish or Pantone color for color reference purposes.

Finish	Similar Steelcase Color
9003 Fuchsia	PerfectMatch
9004 Marlin	4AZ5 Marlin
9006 Chili	6338 Chili
9007 Sterling	6059 Sterling Dark Solid
9008 Honey	4CZ5 Honey
9009 Black	0835 Black
9010 Light Peacock	4CZ8 Light Peacock
9011 Seagull	4858 Seagull

Tip: Braided cord color is defaulted to cover finish but can be changed if desired.

Actual Dimensions

	Depth	Width	Height
Power Hanger	2 ³ / ₁₀ "	10"	1 ³ / ₈ "

Product Details

Power hangers are standard with a 10' standard black power cord. A 20' cord option is available if additional length is needed. For extra color, braided cord option is available.

Power hangers are available with either a standard three prong NEMA plug for use with standard receptacles or with Steelcase's proprietary thread low-profile plug for use with one-door and two-door low-profile connectors.

Power hangers are weighted and have a rubberized back to allow them to sit firmly on the worksurface.

Power cords should not be routed in walkways or where subject to damage.

Over-current protection is standard on power hangers. The reset button is located on the side of the power hanger. If the over-current protection trips, reset by pushing the button back into place.

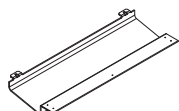

Rectangular cable trays are available as an option or can be ordered separately. 46"W–57¹⁵/₁₆"W desks use the 28"W cable tray. 58"W–72"W desks use the 40"W cable tray. When specifying a desk overhang, see additional cable tray specifying details chart on page 175.

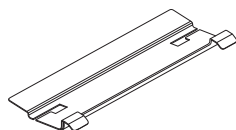

120° cable tray is available on the 120° height-adjustable desks as an option, or can be ordered separately.

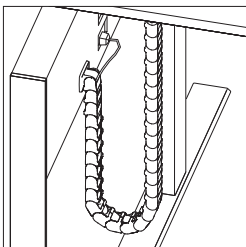

Cable riser, with fence connection, inside dimensions are 1"D x 1"W to accommodate a variety of cord sizes. Overall depth is 2".

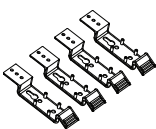

Cable brackets, ordered separately, support horizontal cable management below the worksurface.

► Specifying, page 177



Inside dimensions of cable brackets are 6"D x 2¹/₄"W x 1¹/₂"H.

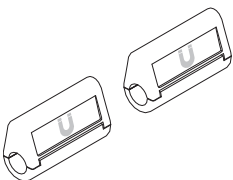

Magnetic cable clips are finished in 6053 Seagull with a 6527 Merle magnet logo.

Surface Materials

Power hangers

- 4AY2 Chili
- 4AZ5 Marlin
- 4BQ7 Fuchsia
- 4CZ8 Light Peacock
- 7243 Seagull
- 7360 Merle

Rectangular and 120° cable trays

- P631 Dark Heather Grey

Cable bracket

- 6527 Merle

Cable riser

- 7360 Merle

Cable catch

- P630 Medium Heather Grey
- P631 Dark Heather Grey

Magnetic cable clips

- 6053 Seagull with 6527 Merle magnet symbol

Magnetic name tag

- 6009 Arctic White (erasable)

Rectangle Height-Adjustable Desks

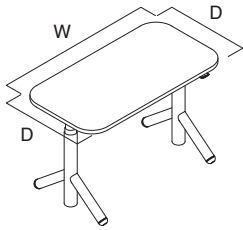

Tip: Height-adjustable desks shipping to Illinois will receive 9' power cord.

Tip: Attachment hardware is intended for worksurfaces 1" thick only.

Tip: Composite veneer group 2 upcharge is in addition to the composite veneer group 1 cost.

Tip: Veneer group 3 upcharge is in addition to the veneer group 1 cost.

Tip: The 9" overhang is available on 58"W or larger desks.

Tip: Desks 70"W or larger allow for single or dual overhang.

Tip: When specifying a desk overhang, see understanding for additional cable tray specifying details.

▶ See page 161

Standard Includes	Required to Specify
<ul style="list-style-type: none"> ▶ Need help? Product details, page 150 • Worksurface: <ul style="list-style-type: none"> – High-Pressure Laminate price group 1 with 3 mm plastic edge – Composite veneer price group 1 with matching 3 mm square edge, if selected • Electric height-adjustable sit-to-stand base: paint price group 1 • Active touch controller • Foot: paint price group 1 • Roller: plastic • Modular widths: 46", 58", or 70" • Attachment hardware • No overhang on worksurface • Power cord: 10' with standard plug 	<ol style="list-style-type: none"> 1 Style number 2 Desk depth 3 Desk width 4 High-Pressure Laminate or composite veneer color number for worksurface 5 Plastic color number for edge on laminate worksurface, if selected 6 Paint color number for base 7 Paint color number for foot 8 Plastic color number for roller 9 Options, if selected (see below) <p>▶ See <i>Surface Materials</i>, page 362.</p>

Surface Materials	Options	U.S. Price	Required to Specify
	Top		
	• High-Pressure Laminate price group 1	Prices at right	Specify laminate color number.
	• High-Pressure Laminate price group 2		
	– 46"W–54"W	+\$ 27	Specify laminate color number.
	– 54 ¹ / ₁₆ "W–72"W	+\$ 36	Specify laminate color number.
	• High-Pressure Laminate price group 3		
	– 46"W–54"W	+\$ 53	Specify laminate color number.
	– 54 ¹ / ₁₆ "W–72"W	+\$ 71	Specify laminate color number.
	• Open Line laminate	+\$111 plus cost of laminate	▶ See <i>Surface Materials Reference Manual</i> .
	• Composite veneer price group 1	Prices at right	Specify composite veneer color number.
	• Composite veneer price group 2	+\$108	Specify composite veneer color number.
	• Veneer price group 1	Prices at right	Specify veneer color number.
	• Veneer price group 3	+\$417	Specify veneer color number.
	• Customiz stain	No cost	Specify <i>with customiz stain</i> .
	Base		
	• Paint price group 1	No cost	Specify paint color number.
	• Paint price group 2	+\$ 24	Specify paint color number.
	Foot		
	• Paint price group 1	No cost	Specify paint color number.
	• Paint price group 2	+\$ 24	Specify paint color number.
	• Paint price group 3	+\$ 44	Specify paint color number.
	Size		
	• Modular	No cost	Specify modular.
	• Parametric	No cost	Specify parametric.
	Overhang		
	• No overhang	No cost	Specify <i>with no overhang</i> .
	• Overhang—left	No cost	Specify <i>with overhang left</i> .
	• Overhang—left and right	No cost	Specify <i>with overhang left and right</i> .
	• Overhang—right	No cost	Specify <i>with overhang right</i> .

▶ Options, continued on next page



For Canadian Pricing

Multiply U.S. Price by the Canadian price factor.

▶ See page 1 for details.

► Options, continued from previous page

	Options	U.S. Price	Required to Specify
Power Configuration	• No under worksurface power	No cost	Specify with no under worksurface power.
	• Under worksurface only		
	– 46"W–57 ¹⁵ / ₁₆ "W	+\$ 516	Specify with under worksurface power.
	– 58"W–72"W	+\$ 551	Specify with under worksurface power.
	• Under worksurface clamp with USB A+C 20W		
	– 46"W–57 ¹⁵ / ₁₆ "W	+\$ 868	Specify with under worksurface clamp with USB A+C 20W.
	– 58"W–72"W	+\$ 904	Specify with under worksurface clamp with USB A+C 20W.
	• Under worksurface clamp with USB-C		
	– 46"W–57 ¹⁵ / ₁₆ "W	+\$1216	Specify with under worksurface clamp with USB-C.
	– 58"W–72"W	+\$1250	Specify with under worksurface clamp with USB-C.
Power Cord	• 10' standard cord	No cost	Specify with 10' standard cord.
	• 10' braided cord	+\$ 80	Specify with 10' braided cord.
	• 20' standard cord	+\$ 80	Specify with 20' standard cord.
	• 20' braided cord	+\$ 238	Specify with 20' braided cord.
	• 8' curly cord	+\$ 346	Specify with 8' curly cord.
Power Plug Type	• Standard NEMA 5-15 3-prong	No cost	Specify with standard NEMA 5-15 3-prong.
	• Thread low profile plug	+\$ 43	Specify with thread low profile plug.
PVC	• With PVC	No cost	Specify with PVC.
	• Non PVC	+\$ 37	Specify with non PVC.
Cable Tray	• No cable tray	No cost	Specify with no cable tray.
	• With cable tray	Price below	Specify with cable tray.
Controller	• Active touch controller	No cost	Specify with active touch controller.
	• Simple touch controller	–\$ 78	Specify with simple touch controller.
Antimicrobial	• Non-antimicrobial	No cost	Specify with non-antimicrobial.
	• With antimicrobial	No cost	Specify with antimicrobial.
Brake	• No brake	No cost	Specify with no brake.
	• With brake	+\$ 75	Specify with brake.

Tip: On 23"/24"D and less than 58"W desks, only single and dual flat panel monitor arm applications are permitted for use.

► See Steelcase Worktools Specification Guide.

Tip: For desks 29"/30"D x 58"W and greater additional monitor arm configurations are allowed.

► See Steelcase Worktools Specification Guide.

Tip: Standard plug is a NEMA 5-15 3-prong plug.

Tip: The standard active touch controller is Bluetooth enabled to allow pairing with the Steelcase Rise app.

Tip: Antimicrobial can be specified only when specifying simple touch controller.

► Specification Information, on next page



For Canadian Pricing
Multiply U.S. Price by the Canadian price factor.
► See page 1 for details.

Rectangle Height-Adjustable Desks, continued

► Options, on previous page

Specification Information

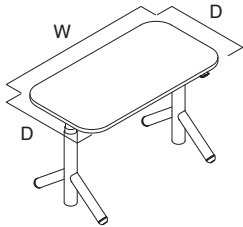
Style Number	Depth	U.S. Base Prices						Option
		Modular	Width		N.A.		70"W	
			46"W	N.A.	58"W	N.A.	70"W	(Add \$ to Base Price)
		Parametric	46"W-	48 ¹ / ₁₆ "W-	54 ¹ / ₁₆ "W-	60 ¹ / ₁₆ "W-	66 ¹ / ₁₆ "W-	Cable Tray
			48"W	54"W	60"W	66"W	72"W	



Rectangle Height-Adjustable Desks

High-Pressure Laminate Price Group 1—Basic Height

FLXSRQ	Depth	46"W	54"W	60"W	66"W	72"W	Option
	23" or 24"	\$2599	\$2680	\$2760	\$2847	\$2934	+\$198
	29" or 30"	\$2915	\$3008	\$3097	\$3191	\$3289	+\$223

Composite Veneer Price Group 1—Basic Height

FLXSRQ	Depth	46"W	54"W	60"W	66"W	72"W	Option
	23" or 24"	\$3450	\$3545	\$3639	\$3742	\$3839	+\$198
	29" or 30"	\$3804	\$3910	\$4010	\$4123	\$4229	+\$223

Veneer Price Group 1—Basic Height

FLXSRQ	Depth	46"W	54"W	60"W	66"W	72"W	Option
	23" or 24"	\$3536	\$3632	\$3726	\$3831	\$3930	+\$198
	29" or 30"	\$3893	\$4001	\$4101	\$4215	\$4323	+\$223

High-Pressure Laminate Price Group 1—Extended Height

FLXERQ	Depth	46"W	54"W	60"W	66"W	72"W	Option
	23" or 24"	\$2821	\$2906	\$2995	\$3089	\$3180	+\$198
	29" or 30"	\$3163	\$3261	\$3360	\$3462	\$3566	+\$223

Composite Veneer Price Group 1—Extended Height

FLXERQ	Depth	46"W	54"W	60"W	66"W	72"W	Option
	23" or 24"	\$3672	\$3771	\$3874	\$3984	\$4085	+\$198
	29" or 30"	\$4052	\$4163	\$4273	\$4394	\$4506	+\$223

Veneer Price Group 1—Extended Height

FLXERQ	Depth	46"W	54"W	60"W	66"W	72"W	Option
	23" or 24"	\$3758	\$3858	\$3961	\$4073	\$4176	+\$198
	29" or 30"	\$4141	\$4254	\$4364	\$4486	\$4600	+\$223



For Canadian Pricing

Multiply U.S. Price by the Canadian price factor.

► See page 1 for details.

Rectangle Height-Adjustable Bases

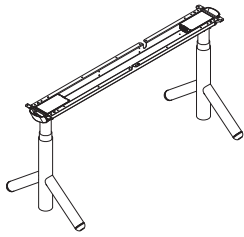

Tip: Attachment hardware is intended for worksurfaces 1" thick only.

Tip: The 9" overhang is available on 58"W or larger desks.

Tip: Desks 70"W or larger allow for single or dual overhang.

Tip: When specifying a desk overhang, see understanding for additional cable tray specifying details.

► See page 161.

Tip: Standard plug is a NEMA 5-15 3-prong plug.

Tip: On 23"/24"D and less than 58"W desks, only single and dual flat panel monitor arm applications are permitted for use.

► See *Steelcase Worktools Specification Guide*.

Tip: For desks 29"/30"D x 58"W and greater additional monitor arm configurations are allowed.

► See *Steelcase Worktools Specification Guide*.

Tip: The standard active touch controller is Bluetooth enabled to allow pairing with the *Steelcase Rise* app.

Tip: Antimicrobial can be specified only when specifying simple touch controller.

Standard Includes	Required to Specify
<ul style="list-style-type: none"> ► Need help? Product details, page 150 • Electric height-adjustable sit-to-stand base: paint price group 1 • Foot: paint price group 1 • Roller: plastic • Active touch controller • Modular widths: 46", 58", or 70" • Attachment hardware • No overhang on worksurface • Power cord: 10' with standard plug 	<ol style="list-style-type: none"> 1 Style number 2 Base depth 3 Base width 4 Paint color number for base 5 Paint color number for foot 6 Plastic color number for roller 7 Options, if selected (see below) <p>► See <i>Surface Materials</i>, page 362.</p>

Options	U.S. Price	Required to Specify
Surface Materials <ul style="list-style-type: none"> • Paint price group 1 • Paint price group 2 	No cost +\$ 24	Specify paint color number. Specify paint color number.
Foot <ul style="list-style-type: none"> • Paint price group 1 • Paint price group 2 • Paint price group 3 	No cost +\$ 24 +\$ 44	Specify paint color number. Specify paint color number. Specify paint color number.
Size <ul style="list-style-type: none"> • Modular • Parametric 	No cost No cost	Specify modular. Specify parametric.
Overhang <ul style="list-style-type: none"> • No overhang • Overhang—left • Overhang—left and right • Overhang—right 	No cost No cost No cost No cost	Specify <i>with no overhang</i> . Specify <i>with overhang left</i> . Specify <i>with overhang left and right</i> . Specify <i>with overhang right</i> .
Power Configuration <ul style="list-style-type: none"> • No under worksurface power • Under worksurface only <ul style="list-style-type: none"> – 46"W–57¹⁵/₁₆"W – 58"W–72"W • Under worksurface clamp with USB A+C 20W <ul style="list-style-type: none"> – 46"W–57¹⁵/₁₆"W – 58"W–72"W • Under worksurface clamp with USB-C <ul style="list-style-type: none"> – 46"W–57¹⁵/₁₆"W – 58"W–72"W 	No cost +\$ 516 +\$ 551 +\$ 868 +\$ 904 +\$1216 +\$1250	Specify <i>with no under worksurface power</i> . Specify <i>with under worksurface power</i> . Specify <i>with under worksurface power</i> . Specify <i>with under worksurface clamp with USB A+C 20W</i> . Specify <i>with under worksurface clamp with USB A+C 20W</i> . Specify <i>with under worksurface clamp with USB-C</i> . Specify <i>with under worksurface clamp with USB-C</i> .
Power Cord <ul style="list-style-type: none"> • 10' standard cord • 10' braided cord • 20' standard cord • 20' braided cord • 8' curly cord 	No cost +\$ 80 +\$ 80 +\$ 238 +\$ 346	Specify <i>with 10' standard cord</i> . Specify <i>with 10' braided cord</i> . Specify <i>with 20' standard cord</i> . Specify <i>with 20' braided cord</i> . Specify <i>with 8' curly cord</i> .
Power Plug Type <ul style="list-style-type: none"> • Standard NEMA 5-15 3-prong • Thread low profile plug 	No cost +\$ 43	Specify <i>with standard NEMA 5-15 3-prong</i> . Specify <i>with thread low profile plug</i> .
PVC <ul style="list-style-type: none"> • With PVC • Non PVC 	No cost +\$ 37	Specify <i>with PVC</i> . Specify <i>with non PVC</i> .
Cable Tray <ul style="list-style-type: none"> • No cable tray • With cable tray 	No cost Price at right	Specify <i>with no cable tray</i> . Specify <i>with cable tray</i> .
Controller <ul style="list-style-type: none"> • Active touch controller • Simple touch controller 	No cost –\$ 78	Specify <i>with active touch controller</i> . Specify <i>with simple touch controller</i> .
Antimicrobial <ul style="list-style-type: none"> • Non-antimicrobial • With antimicrobial 	No cost No cost	Specify <i>with non-antimicrobial</i> . Specify <i>with antimicrobial</i> .
Brake <ul style="list-style-type: none"> • No brake • With brake 	No cost +\$ 75	Specify <i>with no brake</i> . Specify <i>with brake</i> .

Specification Information

Style Number	Depth	Modular Parametric	U.S. Base Prices						Option (Add \$ to Base Price) Cable Tray
			46"W	N.A.	58"W	N.A.	70"W	72"W	
			46"W	48 1/16"W	54 1/16"W	60 1/16"W	66 1/16"W	72"W	

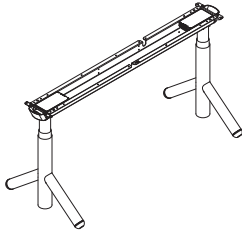

Rectangle Height-Adjustable Bases

Basic Height

FLXSRQB	23" or 24"	29" or 30"	23" or 24"	29" or 30"	23" or 24"	29" or 30"	23" or 24"	29" or 30"
	\$2459	\$2538	\$2618	\$2708	\$2791	+\$198		
	\$2769	\$2861	\$2890	\$2941	\$2968	+\$223		

Extended Height

FLXERQB	23" or 24"	29" or 30"	23" or 24"	29" or 30"	23" or 24"	29" or 30"	23" or 24"	29" or 30"
	\$2667	\$2753	\$2838	\$2935	\$3029	+\$198		
	\$3005	\$3101	\$3138	\$3188	\$3218	+\$223		

 **For Canadian Pricing**
Multiply U.S. Price by the
Canadian price factor.
▶ See page 1 for details.

120° Height-Adjustable Desks

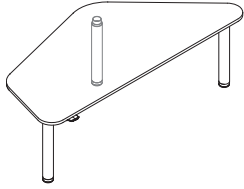

Tip: Height-adjustable desks shipping to Illinois will receive 9' power cord.

Tip: Attachment hardware is intended for worksurfaces 1" thick only.

Tip: Composite veneer group 2 upcharge is in addition to the composite veneer group 1 cost.

Tip: Veneer group 2 and veneer group 3 upcharge is in addition to the veneer group 1 cost.

Standard Includes		Required to Specify	
<ul style="list-style-type: none"> ▶ Need help? Product details, page 154 	<ul style="list-style-type: none"> • Worksurface: <ul style="list-style-type: none"> – High-Pressure Laminate price group 1 with 3 mm plastic edge – Composite veneer price group 1 with matching 3 mm square edge, if selected • Electric height-adjustable sit-to-stand base: paint price group 1 • Active touch controller • Power cord: 10' with standard plug • Slide glide: plastic • Attachment hardware 	<ol style="list-style-type: none"> 1 Style number 2 Desk depth 3 Desk width 4 High-Pressure Laminate or composite veneer color number for worksurface 5 Plastic color number for edge on laminate worksurface, if selected 6 Paint color number for base 7 Plastic color number for glide 8 Options, if selected (see below) 	<ul style="list-style-type: none"> ▶ See <i>Surface Materials</i>, page 362.

Surface Materials	Options	U.S. Price	Required to Specify
	Top		
	• High-Pressure Laminate price group 1	Prices at right	Specify laminate color number.
	• High-Pressure Laminate price group 2	+\$ 36	Specify laminate color number.
	• High-Pressure Laminate price group 3	+\$ 69	Specify laminate color number.
	• Open Line laminate	+\$ 111 plus cost of laminate	▶ See <i>Surface Materials Reference Manual</i> .
	• Composite veneer price group 1	+\$ 785	Specify composite veneer color number.
	• Composite veneer price group 2	+\$ 108	Specify composite veneer color number.
	• Veneer price group 1	+\$ 863	Specify veneer color number.
	• Veneer price group 2	+\$ 118	Specify veneer color number.
	• Veneer price group 3	+\$ 417	Specify veneer color number.
	• Customiz stain	No cost	Specify <i>with customiz stain</i> .
	Base		
	• Paint price group 1	No cost	Specify paint color number.
	• Paint price group 2	+\$ 24	Specify paint color number.
	Modesty panel		
	• Paint price group 1	No cost	Specify paint color number.
	• Paint price group 2	+\$ 22	Specify paint color number.
	• Paint price group 3	+\$ 40	Specify paint color number.
Handedness	• Left hand	No cost	Specify left hand.
	• Right hand	No cost	Specify right hand.
Depth—Left	• 22 ¹ / ₁₆ "	No cost	Specify 22 ¹ / ₁₆ "D left.
	• 40 ⁷ / ₁₆ "	No cost	Specify 40 ⁷ / ₁₆ "D left.
Depth—Right	• 22 ¹ / ₁₆ "	No cost	Specify 22 ¹ / ₁₆ "D right.
	• 40 ⁷ / ₁₆ "	No cost	Specify 40 ⁷ / ₁₆ "D right.
Power Configuration	• No under worksurface power	No cost	Specify <i>with no under worksurface power</i> .
	• Under worksurface only	+\$ 551	Specify <i>with under worksurface power</i> .
	• Under worksurface clamp with USB A+C 20W	+\$ 904	Specify <i>with under worksurface clamp with USB A+C 20W</i> .
	• Under worksurface clamp with USB-C	+\$1250	Specify <i>with under worksurface clamp with USB-C</i> .
Power Cord	• 10' standard cord	No cost	Specify <i>with 10' standard cord</i> .
	• 10' braided cord	+\$ 80	Specify <i>with 10' braided cord</i> .
	• 20' standard cord	+\$ 80	Specify <i>with 20' standard cord</i> .
	• 20' braided cord	+\$ 238	Specify <i>with 20' braided cord</i> .
	• 8' curly cord	+\$ 346	Specify <i>with 8' curly cord</i> .

▶ Options, continued on next page



For Canadian Pricing

Multiply U.S. Price by the Canadian price factor.

▶ See page 1 for details.

► **Options, continued from previous page**

	Options	U.S. Price	Required to Specify
Power Plug Type	• Standard NEMA 5-15 3-prong	No cost	Specify with standard NEMA 5-15 3-prong.
	• Thread low profile plug	+\$ 43	Specify with thread low profile plug.
PVC	• With PVC	No cost	Specify with PVC.
	• Non PVC	+\$ 37	Specify with non PVC.
Controller	• Active touch controller	No cost	Specify with active touch controller.
	• Simple touch controller	-\$ 78	Specify with simple touch controller.
Antimicrobial	• Non-antimicrobial	No cost	Specify with non-antimicrobial.
	• With antimicrobial	No cost	Specify with antimicrobial.
Magnetic Cable Clips	• No magnetic cable clips	No cost	Specify with no magnetic cable clips.
	• With magnetic cable clips	+\$103	Specify with magnetic cable clips.
Cable Tray	• No cable tray	No cost	Specify with no cable tray.
	• With cable tray	+\$198	Specify with cable tray.
Modesty Panel	• No modesty panel	No cost	Specify with no modesty panel.
	• Modesty panel	+\$705	Specify with modesty panel.

Tip: Standard plug is a NEMA 5-15 3-prong plug.

Tip: The standard active touch controller is Bluetooth enabled to allow pairing with the Steelcase Rise app.

Tip: Antimicrobial can be specified only when specifying simple touch controller.

Tip: Magnetic cable clips come in a pack of two when ordered with the height-adjustable desk style number.

Specification Information

Style Number	U.S. Base Price

120° Straight Desk Height-Adjustable, Basic Height

FLXSWS3 \$3364

120° Straight Desk Height-Adjustable, Extended Height

FLXEWS3 \$3652

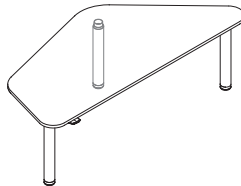

 **For Canadian Pricing**
Multiply U.S. Price by the Canadian price factor.
► See page 1 for details.

120° Height-Adjustable Corner Desks

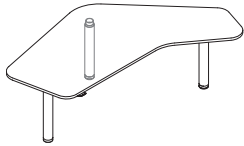

Tip: Height-adjustable desks shipping to Illinois will receive 9' power cord.

Tip: Attachment hardware is intended for worksurfaces 1" thick only.

Tip: Composite veneer group 2 upcharge is in addition to the composite veneer group 1 cost.

Tip: Veneer group 2 and veneer group 3 upcharge is in addition to the veneer group 1 cost.

Tip: Standard plug is a NEMA 5-15 3-prong plug.



For Canadian Pricing
Multiply U.S. Price by the Canadian price factor.

▶ See page 1 for details.

Standard Includes	Required to Specify
<ul style="list-style-type: none"> ▶ Need help? Product details, page 154 • Worksurface: <ul style="list-style-type: none"> – High-Pressure Laminate price group 1 with 3 mm plastic edge – Composite veneer price group 1 with matching 3 mm square edge, if selected • Electric height-adjustable sit-to-stand base: paint price group 1 • Active touch controller • Power cord: 10' with standard plug • Slide glide: plastic • Attachment hardware 	<ol style="list-style-type: none"> 1 Style number 2 Desk depth 3 Desk width 4 High-Pressure Laminate or composite veneer color number for worksurface 5 Plastic color number for edge on laminate worksurface, if selected 6 Paint color number for base 7 Plastic color number for glide 8 Options, if selected (see below) <p>▶ See <i>Surface Materials</i>, page 362.</p>

Surface Materials	Options	U.S. Price	Required to Specify
	Top		
	• High-Pressure Laminate price group 1	Prices at right	Specify laminate color number.
	• High-Pressure Laminate price group 2	+\$ 36	Specify laminate color number.
	• High-Pressure Laminate price group 3	+\$ 69	Specify laminate color number.
	• Open Line laminate	+\$ 111 plus cost of laminate	▶ See <i>Surface Materials Reference Manual</i> .
	• Composite veneer price group 1	+\$ 785	Specify composite veneer color number.
	• Composite veneer price group 2	+\$ 108	Specify composite veneer color number.
	• Veneer price group 1	+\$ 863	Specify veneer color number.
	• Veneer price group 2	+\$ 118	Specify veneer color number.
	• Veneer price group 3	+\$ 417	Specify veneer color number.
	• Customiz stain	No cost	Specify <i>with customiz stain</i> .
	Base		
	• Paint price group 1	No cost	Specify paint color number.
	• Paint price group 2	+\$ 24	Specify paint color number.
	Modesty panel		
	• Paint price group 1	No cost	Specify paint color number.
	• Paint price group 2	+\$ 22	Specify paint color number.
	• Paint price group 3	+\$ 40	Specify paint color number.
	Handedness		
	• Left hand	No cost	Specify left hand.
	• Right hand	No cost	Specify right hand.
	Depth—Left		
	• 14¼"	No cost	Specify 14¼"D left.
	• 23¼"	No cost	Specify 23¼"D left.
	Depth—Right		
	• 14¼"	No cost	Specify 14¼"D right.
	• 23¼"	No cost	Specify 23¼"D right.
	Power Configuration		
	• No under worksurface power	No cost	Specify <i>with no under worksurface power</i> .
	• Under worksurface only	+\$ 551	Specify <i>with under worksurface power</i> .
	• Under worksurface clamp with USB A+C 20W	+\$ 904	Specify <i>with under worksurface clamp with USB A+C 20W</i> .
	• Under worksurface clamp with USB-C	+\$1250	Specify <i>with under worksurface clamp with USB-C</i> .
	Power Cord		
	• 10' standard cord	No cost	Specify <i>with 10' standard cord</i> .
	• 10' braided cord	+\$ 80	Specify <i>with 10' braided cord</i> .
	• 20' standard cord	+\$ 80	Specify <i>with 20' standard cord</i> .
	• 20' braided cord	+\$ 238	Specify <i>with 20' braided cord</i> .
	• 8' curly cord	+\$ 346	Specify <i>with 8' curly cord</i> .
	Power Plug Type		
	• Standard NEMA 5-15 3-prong	No cost	Specify <i>with standard NEMA 5-15 3-prong</i> .
	• Thread low profile plug	+\$ 43	Specify <i>with thread low profile plug</i> .
	PVC		
	• With PVC	No cost	Specify <i>with PVC</i> .
	• Non PVC	+\$ 37	Specify <i>with non PVC</i> .

▶ **Options, continued on next page**

► **Options, continued from previous page**

Options	U.S. Price	Required to Specify
Controller	<ul style="list-style-type: none"> Active touch controller Simple touch controller 	No cost -\$ 78
Antimicrobial	<ul style="list-style-type: none"> Non-antimicrobial With antimicrobial 	No cost No cost
Magnetic Cable Clips	<ul style="list-style-type: none"> No magnetic cable clips With magnetic cable clips 	No cost +\$103
Cable Tray	<ul style="list-style-type: none"> No cable tray With cable tray 	No cost +\$198
Modesty Panel	<ul style="list-style-type: none"> No modesty panel Modesty panel 	No cost +\$705

Tip: The standard active touch controller is Bluetooth enabled to allow pairing with the Steelcase Rise app.

Tip: Antimicrobial can be specified only when specifying simple touch controller.

Tip: Magnetic cable clips come in a pack of two when ordered with the height-adjustable desk style number.

Specification Information

Style Number	U.S. Base Price
--------------	-----------------

120° Corner Desk Height-Adjustable, Basic Height

FLXSWC3 \$3398

120° Corner Desk Height-Adjustable, Extended Height

FLXEWC3 \$3687

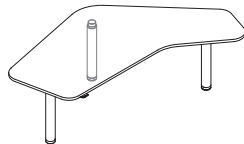

 **For Canadian Pricing**
Multiply U.S. Price by the Canadian price factor.
► See page 1 for details.

Curved Screens

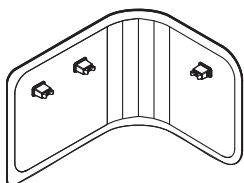

Tip: Fabric is applied in a warp horizontal direction. Due to the size of the screens, fabric is unable to be applied in a warp vertical direction.

Tip: When choosing contrasting fabrics, outside and inside screen fabric must stay within same fabric family.

Tip: Handedness is only needed to specify when ordering single curved screen.

Standard Includes

- ▶ Need help? Product details, page 157
- Curved desk screen: fabric price group A or 1
- Magnet attachment housing: 6527 Merle
- Attachment hardware

Required to Specify

- 1 Style number
 - 2 Fabric color number for screen
 - 3 Options, if selected (see below)
- ▶ See *Surface Materials*, page 362.

Options

Surface Materials	Options	U.S. Price	Required to Specify	
Inside screen	• Fabric price group 1	No cost	Specify fabric color number.	
	• Fabric price group A	No cost	Specify fabric color number.	
	• Fabric price group 2	+\$ 27	Specify fabric color number.	
	• Fabric price group 3	+\$ 71	Specify fabric color number.	
	• Fabric price group 4	+\$ 90	Specify fabric color number.	
	• Fabric price group 5	+\$111	Specify fabric color number.	
	• Fabric price group 6	+\$128	Specify fabric color number.	
	• Fabric price group 7	+\$147	Specify fabric color number.	
	• Fabric price group 8	+\$167	Specify fabric color number.	
	• Fabric price group 9	+\$186	Specify fabric color number.	
	• Fabric price group 10	+\$205	Specify fabric color number.	
	• Customer's Own Material (COM)	+\$ 9	▶ See <i>Surface Materials Reference Manual</i> .	
	Outside screen	• Fabric price group 1	No cost	Specify fabric color number.
		• Fabric price group A	No cost	Specify fabric color number.
		• Fabric price group 2	+\$ 27	Specify fabric color number.
		• Fabric price group 3	+\$ 71	Specify fabric color number.
• Fabric price group 4		+\$ 90	Specify fabric color number.	
• Fabric price group 5		+\$111	Specify fabric color number.	
• Fabric price group 6		+\$128	Specify fabric color number.	
• Fabric price group 7		+\$147	Specify fabric color number.	
• Fabric price group 8		+\$167	Specify fabric color number.	
• Fabric price group 9		+\$186	Specify fabric color number.	
• Fabric price group 10	+\$205	Specify fabric color number.		
• Customer's Own Material (COM)	+\$ 9	▶ See <i>Surface Materials Reference Manual</i> .		
Handedness	• Left hand privacy/ right hand modesty	No cost	Specify with <i>left hand privacy/ right hand modesty</i> .	
	• Right hand privacy/ left hand modesty	No cost	Specify with <i>right hand privacy/ left hand modesty</i> .	

Specification Information

• Dimensions		• Style Number	• U.S. Base Prices		
D	H		Desk Width		
			46"W	58"W	70"W
Single					
1/2"	18"	FLXCS	\$ 735	\$ 848	\$ 960
Pair					
1/2"	18"	FLXCSP	\$1470	\$1696	\$1920



For Canadian Pricing
Multiply U.S. Price by the Canadian price factor.
▶ See page 1 for details.

Personal Spaces

120° Desk Mount Privacy Wraps

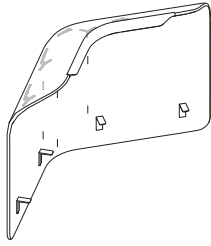

Tip: To coordinate the wrap knit finish and light finish see Wrap Knit and Light Finish Matrix for Personal Spaces. See page 159.

Tip: 120° desk mounted privacy wrap is optimized for use with the 120° straight and 120° corner height-adjustable tables.

Standard Includes		Required to Specify
<ul style="list-style-type: none"> ▶ Need help? Product details, page 158 	<ul style="list-style-type: none"> • 45 1/4" H wrap: knit <ul style="list-style-type: none"> – 5KJ1 Merle – 5KJ2 Cloud – 5KJ3 Fog – 5KJ4 Sand • Light, if selected: plastic <ul style="list-style-type: none"> – 6052 Milk – 6053 Seagull – 6527 Merle 	<ul style="list-style-type: none"> 1 Style number 2 Fabric color number for wrap 3 Plastic color number for light, if selected 4 Options, if selected (see below) ▶ See <i>Surface Materials</i>, page 362.

Options	U.S. Price	Required to Specify
Light <ul style="list-style-type: none"> • No light • With light <ul style="list-style-type: none"> – 10 pack 	No cost +\$ 898 +\$8980	Specify <i>with no light</i> . Specify <i>with light</i> . Specify <i>with light pack</i> .

Specification Information	
• Style Number	• U.S. Base Price
:	:
:	:
:	:

Quantity 1	
FLXDWW	\$ 2487
:	:

Quantity 10	
FLXDWW10	\$23,291
:	:

Steelcase
Flex Collection

 **For Canadian Pricing**
 Multiply U.S. Price by the Canadian price factor.
 ▶ See page 1 for details.

Personal Spaces

90° Desk Mount Privacy Wraps

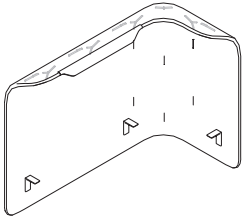

Tip: To coordinate the wrap knit finish and light finish see Wrap Knit and Light Finish Matrix for Personal Spaces. ▶ See page 159.

Standard Includes		Required to Specify
▶ Need help? Product details, page 158	<ul style="list-style-type: none"> 45¼"H wrap: knit <ul style="list-style-type: none"> – 5KJ1 Merle – 5KJ2 Cloud – 5KJ3 Fog – 5KJ4 Sand Light, if selected: plastic <ul style="list-style-type: none"> – 6052 Milk – 6053 Seagull – 6527 Merle 	<ol style="list-style-type: none"> Style number Fabric color number for wrap Plastic color number for light, if selected Options, if selected (see below) ▶ See <i>Surface Materials</i> , page 362.

	Options	U.S. Price	Required to Specify
Handedness	<ul style="list-style-type: none"> Left hand Right hand 	No cost No cost	Select left hand. Select right hand.
Light	<ul style="list-style-type: none"> No light With light <ul style="list-style-type: none"> – 10 pack 	No cost +\$ 898 +\$8980	Specify <i>with no light</i> . Specify <i>with light</i> . Specify <i>with light pack</i> .

Specification Information	
• Style Number	• U.S. Base Price
.....

Quantity 1

FLXDWR \$ 2487

Quantity 10

FLXDWR10 \$23,291



For Canadian Pricing
Multiply U.S. Price by the Canadian price factor.
▶ See page 1 for details.

Power Hanger

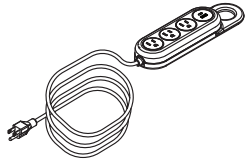

Tip: Power hangers shipping to Illinois will receive 9' power cord.

Tip: Each USB port can utilize up to 2.1 amps. Each port is independent of the other.

Tip: Braided cord color is defaulted to cover finish but can be changed if desired.

Tip: Standard plug is a NEMA 5-15 3-prong plug.

	Standard Includes	Required to Specify
▶ Need help? Product details, page 160	<ul style="list-style-type: none"> Rubberized hanger back: 7360 Merle paint Cover: <ul style="list-style-type: none"> 4AY2 Chili 4AZ5 Marlin 4BQ7 Fuchsia 4CZ8 Light Peacock 7243 Seagull 7360 Merle Power cord: 10' with standard plug 	<ol style="list-style-type: none"> Style number Plastic color number for cover Options, if selected (see below)

	Options	U.S. Price	Required to Specify
Power Configuration	<ul style="list-style-type: none"> 4 power 3 power 1 USB A+C 	No cost +\$129	Specify with 4 power. Specify with 4 power 1 USB A+C.
Power Cord	<ul style="list-style-type: none"> 10' standard cord 10' braided cord 20' standard cord 20' braided cord 	No cost +\$ 80 +\$ 80 +\$238	Specify with 10' standard cord. Specify with 10' braided cord. Specify with 20' standard cord. Specify with 20' braided cord.
Power Plug Type	<ul style="list-style-type: none"> Standard NEMA 5-15 3-prong Thread low profile plug 	No cost +\$ 43	Specify with standard NEMA 5-15 3-prong. Specify with thread low profile plug.
PVC	<ul style="list-style-type: none"> With PVC Non PVC 	No cost +\$ 37	Specify with PVC. Specify with non PVC.

Specification Information	
Style Number	U.S. Base Price
FLXPH	\$583

Steelcase
Flex Collection

Cable Tray for Rectangle Height-Adjustable Desks

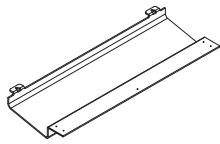

Tip: 46"W–57¹⁵/₁₆"W desks use the 28"W cable tray. 58"W–72"W desks use the 48"W cable tray. ▶ See page 161.

Tip: When specifying a desk overhang, see understanding for additional cable tray specifying details.

 **For Canadian Pricing**
Multiply U.S. Price by the Canadian price factor.
▶ See page 1 for details.

	Standard Includes	Required to Specify
▶ Need help? Product details, page 160	<ul style="list-style-type: none"> Cable tray: P631 Dark Heather Grey molded PET felt Attachment hardware 28"W cable tray, if 46"W–57¹⁵/₁₆"W worksurface selected 40"W cable tray, if 58"W–72"W worksurface selected 	<ol style="list-style-type: none"> Style number Options, if selected (see below)

	Options	U.S. Price	Required to Specify
Worksurface Depth	<ul style="list-style-type: none"> 23" 24" 29" 30" 	Prices below Prices below Prices below Prices below	Specify 23" depth. Specify 24" depth. Specify 29" depth. Specify 30" depth.

Specification Information	
Style Number	U.S. Prices Worksurface Depth
FLXCT	\$198 \$223

Cable Tray for 120° Height-Adjustable Desks

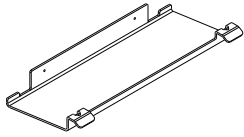

Tip: Flex 120° cable tray can be used with the Flex 120° straight and Flex 120° corner height-adjustable desks.

Standard Includes	Required to Specify
-------------------	---------------------

- | | | |
|--|---|--|
| <ul style="list-style-type: none"> ▶ Need help? Product details, page 160 | <ul style="list-style-type: none"> • Cable tray: P631 Dark Heather Grey molded PET felt • Attachment hardware | <ul style="list-style-type: none"> Style number |
|--|---|--|

Specification Information	
Style Number	U.S. Price

FLXWCT	\$198
:	:
:	:

Magnetic Cable Clips

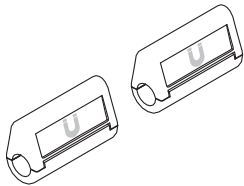

Standard Includes	Required to Specify
-------------------	---------------------

- | | | |
|--|--|--|
| <ul style="list-style-type: none"> ▶ Need help? Product details, page 160 | <ul style="list-style-type: none"> • Magnetic clips: 6053 Seagull | <ul style="list-style-type: none"> Style number |
|--|--|--|

Specification Information	
Style Number	U.S. Price

:	:
:	:

Magnetic Cable Clips, Quantity 2

FLXMCC2	\$106
:	:

Magnetic Cable Clips, Quantity 10

FLXMCC10	\$418
:	:



For Canadian Pricing

Multiply U.S. Price by the Canadian price factor.

▶ See page 1 for details.

Cable Brackets

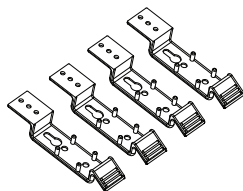

Tip: Cable brackets can be used instead of cable trays or will fit inside footprint of 29"/30"D cable trays.

Standard Includes	Required to Specify
<ul style="list-style-type: none"> ▶ Need help? Product details, page 160 • Cable brackets, quantity of four: 6527 Merle 	<ul style="list-style-type: none"> Style number

Specification Information

• Style Number	• U.S. Price
FLXCBK4	\$51
:	:

Cable Riser

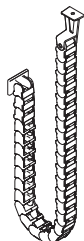

Tip: Cable riser leg connection is not compatible with the Flex height-adjustable desk.

Standard Includes	Required to Specify
<ul style="list-style-type: none"> ▶ Need help? Product details, page 160 • Cable riser with fence connection: 7360 Merle paint • Attachment hardware 	<ul style="list-style-type: none"> Style number

Specification Information

• Style Number	• U.S. Price
OLCR	\$113
:	:

Brakes for Rectangle Height-Adjustable Desks

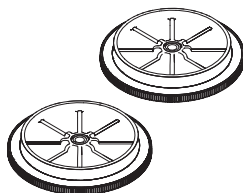

Standard Includes	Required to Specify
<ul style="list-style-type: none"> ▶ Need help? Product details, page 160 • Two brakes: 6527 Merle • Attachment hardware 	<ul style="list-style-type: none"> Style number

Specification Information

• Style Number	• U.S. Price
FLXBRK	\$75
:	:



For Canadian Pricing
Multiply U.S. Price by the Canadian price factor.
▶ See page 1 for details.

120° Modesty Panel

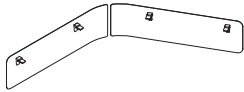

Tip: Modesty panel can be used with 120° straight and corner height-adjustable desks and 120° straight seated height work table.

Standard Includes		Required to Specify
<ul style="list-style-type: none"> ▶ Need help? Product details, page 160 	<ul style="list-style-type: none"> • Modesty panel: paint price group 1 	<ul style="list-style-type: none"> 1 Style number 2 Paint color number for modesty panel 3 Options, if selected (see below) ▶ See <i>Surface Materials</i>, page 362.

Options	U.S. Price	Required to Specify
Surface Materials	<ul style="list-style-type: none"> • Paint price group 1 • Paint price group 2 • Paint price group 3 	<ul style="list-style-type: none"> No cost +\$22 +\$40
		<ul style="list-style-type: none"> Specify paint color number. Specify paint color number. Specify paint color number.

Specification Information	
• Style Number	• U.S. Base Price
FLXWMP	\$717
:	:

Magnetic Name Tags

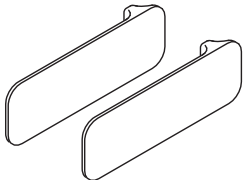

Tip: Magnetic name tags work on the privacy wraps.

Standard Includes		Required to Specify
<ul style="list-style-type: none"> ▶ Need help? Product details, page 160 	<ul style="list-style-type: none"> • Name tags: 6009 Arctic White 	<ul style="list-style-type: none"> Style number

Specification Information	
• Style Number	• U.S. Price
FLXMNT2	\$ 170
:	:

Quantity 2

FLXMNT2	\$ 170
:	:

Quantity 10

FLXMNT10	\$1101
:	:



For Canadian Pricing
 Multiply U.S. Price by the Canadian price factor.
 ▶ See page 1 for details.

Migration Desking Collection

Understanding

Migration Desking Collection Comparison Chart	180
Migration Desking Collection Options Availability Chart	181
Migration Pro Height-Adjustable Desks and Bases	186
Migration Pro with Boost High-Speed Height-Adjustable Desks and Bases	192
Migration Intro Height-Adjustable Desks and Bases	198
Migration Pro and Intro Cable Management	204
Migration Pro and Intro Modesty Panels	206
Migration SE Height-Adjustable Desks and Bases	208
Universal One-High and 1.5-High Open Laterals for Migration SE	218

Specifying

Migration Pro Height-Adjustable Desks	220
Migration Pro Height-Adjustable Bases	228
Migration Pro with Boost High-Speed Height-Adjustable Desks	230
Migration Pro with Boost High-Speed Height-Adjustable Bases	237
Migration Intro Height-Adjustable Desks	238
Migration Intro Height-Adjustable Bases	242
Migration Intro and Pro Accessories	243
Migration SE Height Adjustable Desks	250
Migration SE Height Adjustable Bases	252
Universal One-High and 1.5-High Open Laterals for Migration SE	268
Universal Common Tops for Migration SE	270
Universal Shrouds for Migration SE	272
Universal Fillers for Migration SE	273
Migration SE Cable Management	274
Migration SE Accessories	275

Migration Desking Collection Comparison Chart

Desk Type	Migration SE	Migration Intro	Migration Pro	Migration Pro with Boost High-Speed
Style Number Prefix	MG	HA1	HA2	HA3
Design				
Worksurface Shapes	Rectangular 90° 120°	Rectangular Organic	Rectangular Organic	Rectangular Organic
Column Shape	Rectangular	Rectangular	Rectangular Round	Rectangular
Worksurface Edge	Flat	Flat	Flat, knife edge, soft edge	Flat, knife edge, soft edge
Integrated Power	None	None	Flush mount, pop-up	Flush mount, pop-up
Understructure	Telescopic	Fixed	Fixed	Fixed
Cable Management	Cable brackets, riser	Cable brackets, riser, tray, grommets	Cable brackets, riser, tray, grommets	Cable brackets, riser, tray, grommets
Sustainability Styles	Carbon Neutral	FSC Mix*	FSC Mix*	FSC Mix*
Worksurface Finishes	Laminate Veneer	Laminate	Laminate Veneer	Laminate Veneer
Base Finishes	4	3	24	24
Performance				
Range of Adjustment	Extended height: 22 ³ / ₅ " – 48 ⁷ / ₁₀ " Basic height: 28³/₁₀" – 46⁹/₁₀"	Extended height: 22 ¹ / ₈ " – 48 ¹ / ₄ " Basic height: 26 ⁹ / ₁₀ " – 46 ³ / ₅ "	Extended height: 22 ³ / ₅ " – 48 ⁷ / ₁₀ " Basic height: 27 ³ / ₅ " – 47 ³ / ₁₀ "	Extended height: 22 ³ / ₅ " – 48 ⁷ / ₁₀ "
Controller	Up/Down, 4 Preset	Basic, Active Touch	Simple Touch, Active Touch , 3-Preset	Simple Touch, Active Touch , 3-Preset
Distributed Weight Capacity	250 pounds	270 pounds	360 pounds	270 pounds
Adjustability Speed	1 ³ / ₁₀ " per second	1 ¹ / ₅ " per second	1 ¹ / ₂ " per second	3¹/₁₀" per second
Decibel Rating	< 47 dBA	< 45 dBA	< 39 dBA	< 45 dBA

Tip: Bolded text indicated product differentiators.

* FSC Mix - The product is made with a mixture of materials from FSC-certified forests, recycled materials, and/or FSC-controlled wood.

Migration Desking Collection Options Availability Chart

Migration Pro (HA2) Options Availability Chart

Rectangular and Organic	Desk Widths									
	40"W	46"W	52"W	58"W	64"W	70"W	76"W	82"W	88"W	94"W
Options:	40" – 45 ¹⁵ / ₁₆ "	46" – 51 ¹⁵ / ₁₆ "	52" – 57 ¹⁵ / ₁₆ "	58" – 63 ¹⁵ / ₁₆ "	64" – 69 ¹⁵ / ₁₆ "	70" – 75 ¹⁵ / ₁₆ "	76" – 81 ¹⁵ / ₁₆ "	82" – 87 ¹⁵ / ₁₆ "	88" – 93 ¹⁵ / ₁₆ "	94" – 96 ¹⁵ / ₁₆ "
Knife Edge*										
Grommets	Left, Right, or Center	Left, Right, or Center	Left, Right, or Center	Left, Right, or Center	Left, Right, or Center	Left, Right, or Center	Left, Right, or Center	Left, Right, or Center	Left, Right, or Center	Left, Right, or Center
No Overhang										
No Overhang + Flush or Pop-Up Power	Center	Center	Center	Left, Right, or Center	Left, Right, or Center	Left, Right, or Center	Left, Right, or Center	Left, Right, or Center	Left, Right, or Center	Left, Right, or Center
No Overhang + Soft Edge**					Starts at 64"W w/ 3-preset controller					
No Overhang + Cable Tray	Small	Small	Small	Medium	Medium	Large	Large	Large	Large	Large
1 Overhang										
1 Overhang + Flush or Pop-Up Power				Center	Left, Right, or Center	Left, Right, or Center	Left, Right, or Center	Left, Right, or Center	Left, Right, or Center	Left, Right, or Center
1 Overhang + Soft Edge**						Starts at 70"W w/ 3-preset controller				
1 Overhang + Cable Tray				Small	Medium	Medium	Large	Large	Large	Large
2 Overhangs										
2 Overhangs + Flush and Pop-Up Power					Center	Left, Right, or Center	Left, Right, or Center	Left, Right, or Center	Left, Right, or Center	Left, Right, or Center
2 Overhangs + Soft Edge**							Starts at 76"W w/ 3-preset controller			
2 Overhangs + Cable Tray					Small	Medium	Medium	Large	Large	Large
Rectangular Column										
Round Column										
T-Leg										
C-Leg***										
1" Spacer										
Slide Glide										

Available
Not Available

- * Knife edge is only available on laminate worksurfaces.
- ** Soft edge is only available on rectangular laminate worksurfaces. Soft edge is centered between the cantilevers. If one overhang is selected, the soft edge will be off-center on the worksurface. Soft edge cannot be specified on a knife edge worksurface.
- *** C-leg is only available with rectangular columns and is only available in 28", 29", or 30" depths.
- Tip: Grommets can be specified left, right, and/or center. When overhang is also specified, grommet positions will match the understructure width, not the worksurface width.
- Tip: Metal cable trays are not available on organic bow front and back worksurfaces.
- Tip: Flush and pop-up power can be specified on center. Left or right positions availability depend on width and overhang conditions. Only one integrated power feature can be specified per desk.
- Tip: Metal cable trays are available in three widths: 30", 42", and 52".
- Tip: See the Migration Pro understanding pages for detailed information on worksurface overhang(s).
- Tip: Overhang not available on basic height Migration Pro desks.

Migration Pro with Boost High-Speed (HA3) Options Availability Chart

Rectangular and Organic	Desk Widths						
	40"W	46"W	52"W	58"W	64"W	70"W	76"W
Options:	40" – 45 ¹⁵ / ₁₆ "	46" – 51 ¹⁵ / ₁₆ "	52" – 57 ¹⁵ / ₁₆ "	58" – 63 ¹⁵ / ₁₆ "	64" – 69 ¹⁵ / ₁₆ "	70" – 75 ¹⁵ / ₁₆ "	76" – 78"
Knife Edge*							
Grommets	Left, Right, or Center	Left, Right, or Center	Left, Right, or Center	Left, Right, or Center	Left, Right, or Center	Left, Right, or Center	Left, Right, or Center
Flush or Pop-Up Power	Center	Center	Center	Left, Right, or Center	Left, Right, or Center	Left, Right, or Center	Left, Right, or Center
Soft Edge**					Starts at 64"W w/ 3-preset controller		
Metal Cable Tray	Small	Small	Small	Medium	Medium	Large	Large
1" Spacer							
Slide Glide							

Available
Not Available

* Knife edge is only available on laminate worksurfaces.

** Soft edge is only available on rectangular laminate worksurfaces.

Tip: Metal cable trays are not available on organic bow front and back worksurfaces.

Tip: Flush and pop-up power can be specified on center. Left or right positions availability depend on width and overhang conditions. Only one integrated power feature can be specified per desk.

Tip: Metal cable trays are available in three widths: 30", 42", and 52".

Tip: Modular widths have a standard 3" overhang on both sides. Parametric width overhangs will vary. Use the SmartTools dimension tool to determine exact overhang.

Migration Intro (HA1) Options Availability Chart

Rectangular and Organic	Desk Widths						
	40"W	46"W	52"W	58"W	64"W	70"W	76"W
Options:	40" – 45 ¹⁵ / ₁₆ "	46" – 51 ¹⁵ / ₁₆ "	52" – 57 ¹⁵ / ₁₆ "	58" – 63 ¹⁵ / ₁₆ "	64" – 69 ¹⁵ / ₁₆ "	70" – 75 ¹⁵ / ₁₆ "	76" – 78 ¹⁵ / ₁₆ "
Grommets	Left, Right, or Center	Left, Right, or Center	Left, Right, or Center	Left, Right, or Center	Left, Right, or Center	Left, Right, or Center	Left, Right, or Center
Metal Cable Tray	Small	Small	Small	Medium	Medium	Large	Large

Available
Not Available

Tip: Grommets can be specified left, center, and/or right.

Tip: Metal cable trays are not available on organic bow front and back worksurfaces.

Tip: Metal cable trays are available in three widths: 30", 42", and 52".

Tip: Modular widths have a standard 3" overhang on both sides. Parametric width overhangs will vary. Use the SmartTools dimension tool to determine exact overhang.

Migration Desking Collection Options Availability Chart, continued

Migration SE (MG) Options Availability Chart

Rectangular	Desk Widths					
	46"W	52"W	58"W	64"W	70"W	76"W
Options:	46" – 51 ¹⁵ / ₁₆ "	52" – 57 ¹⁵ / ₁₆ "	58" – 63 ¹⁵ / ₁₆ "	64" – 69 ¹⁵ / ₁₆ "	70" – 75 ¹⁵ / ₁₆ "	76"
No Overhang						
1 Overhang			3", 6"	3", 6", 9", 12"	3", 6", 9", 12"	6", 9", 12"
1 Overhang + Height-Saver Foot						
T-Leg						
C-Leg*						
Miter Foot						
Height-Saver Foot**						

Available
Not Available

* C-leg is only available in 29" or 30" depths.
 ** Height-saver foot is only available in 29" or 30" deep, T-leg desk configurations.
 Tip: 76" wide worksurfaces have a standard 4" overhang on both sides.
 Tip: Modular and parametric widths have a standard 1" overhang on both sides.

Maximum Rear Screen Sizes Based on Worksurface Edge Types on Migration Intro, Migration Pro, and Pro with Boost High-Speed

Screen Type	Desk Without Knife Edge		Desk With Knife Edge*	
	Square or 2" Radius	5" Radius	Square or 2" Radius	5" Radius
Universal Privacy Screen (UFPS)	Max Screen Width = Width of Desk	Max Screen Width = Width of Desk Minus 3"	N.A.	N.A.
Universal Privacy/Modesty Screen (UFPM)	Max Screen Width = Width of Desk	Max Screen Width = Width of Desk Minus 3"	Max Screen Width = Depth of Desk	Max Screen Width = Depth of Desk Minus 4"
Sarto Privacy Screen (PSPS)	Max Screen Width = Width of Desk	Max Screen Width = Width of Desk Minus 3"	Max Screen Width = Depth of Desk	Max Screen Width = Depth of Desk Minus 4"
Sarto Privacy/Modesty Screen (PSPM)	Max Screen Width = Width of Desk	Max Screen Width = Width of Desk Minus 2 1/2"	Max Screen Width = Depth of Desk	N.A.

Tip: Measurements provided do not include cutouts and overhang rules.
Tip: Rear screens are not compatible with Migration Pro and Intro organic bow front and back shape.

Maximum Side Screen Sizes Based on Worksurface Edge Types on Migration Intro, Migration Pro, and Pro with Boost High-Speed

Screen Type	Desk Without Knife Edge		Desk With Knife Edge*	
	Square or 2" Radius	5" Radius	Square or 2" Radius	5" Radius
Universal Privacy Screen (UFPS)	Max Screen Width = Depth of Desk	Max Screen Width = Depth of Desk Minus 3"	N.A.	N.A.
Sarto Privacy Screen (PSPS) with Option SIDESCEN Selected	Max Screen Width = Depth of Desk	Max Screen Width = Depth of Desk Minus 4"	Max Screen Width = Depth of Desk	Max Screen Width = Depth of Desk Minus 4"
Sarto Privacy/Modesty Screen (PSPM) with Option SIDE-SCN Selected	Max Screen Width = Depth of Desk	N.A.	Max Screen Width = Depth of Desk	N.A.

* Knife edge is an option on Migration Pro.
Tip: Measurements provided do not include cutouts and overhang rules.
Tip: Side screens are not compatible with Migration Pro and Intro organic bow front and back shape.
Tip: To add a side screen to a Migration Pro knife edge desk, option Sarto side screen and Migration side knife attachment brackets.
Tip: Sarto curved screens, Flex curved, and Flex privacy wrap are not allowed on Migration Pro desks with side knife edge.

Migration Pro Height-Adjustable Desks and Bases

Migration Pro is a high-performance height-adjustable desk that is designed and engineered to match the unique needs of users.

► Specifying, pages 220, 224, and 224

Available as a FSC Mix product, the worksurface is made with a mixture of materials from FSC-certified forests, recycled materials, and/or FSC-controlled wood. The FSC Mix credit claim number is published on the customer invoice.

Rectangular worksurfaces are available with square or radius corner options. The radius corner option can be specified with 2" or 5" radius.

Lifting column is controlled by a central box for synchronization. Columns are precision balanced to minimize surface vibrations.

Rectangular columns are offered in both T- and C-leg configurations.

Edge is available in 3 mm edge profile.

Organic worksurfaces are available in bow front or bow front and back options. Bow front has 5" radius corners at the back.

Round columns are offered in T-leg configurations.

Active touch controller is Bluetooth-enabled and includes digital display, two preset buttons, double-tap automatic drive, and active motion posture reminders.
Tip: Steelcase Rise mobile app is available for download on Apple and Google Play stores. Pair to any active touch controller to access preferences, presets, and posture activity tracking.

Worksurface has a wood core with a High-Pressure Laminate or wood veneer surface and is 1" thick.

Controller adjusts the height of the desk at a rate of 1 $\frac{1}{2}$ " per second. Three options are available - active touch, simple touch, and 3-preset with digital display.

Soft edge, available as an option, reduces unhealthy pressure on forearms, as well as feelings of shoulder and neck fatigue. Soft edge is 36"W.

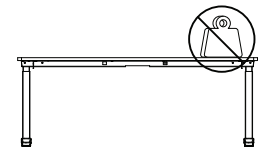

Distribute weight evenly

Base supports a maximum distributed weight capacity of 360 pounds.

Tip: When calculating lifting capacity, subtract the weight of the worksurface, channel, and options selected.

► See page 211 for worksurface weights.

Extended height-adjustable base adjusts from 22 $\frac{3}{5}$ "–48 $\frac{7}{10}$ " in any increment.

Basic height-adjustable base adjusts from 27 $\frac{3}{5}$ " – 47 $\frac{3}{10}$ " in any increment.

Leveling glides adjust $\frac{1}{2}$ " to install desk on uneven floors. Slide glides and 1" adjustable spacers are available as an option.

Knife edge, available as an option, is a thin profile worksurface edge that wraps three sides of the desk.

Product Details

High-Pressure Laminate Desks

Front (user's) edge profile is available in 3 mm edge profile.

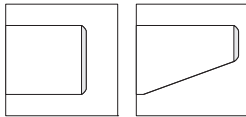

3 mm plastic edge profile Knife edge profile

PVC-free, 3 mm edge profiles are proprietary polyolefin blend for all solid colors and three woodgrain finishes. Matching 1 mm side and back edges are also PVC-free.

▶ See *Surface Materials* in this book for specific PVC-free availability, page 362.

Edge profile finishes are specified separately from laminate color.

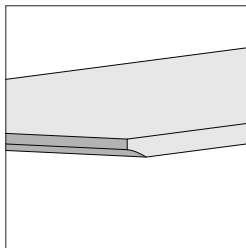

Knife edge with 3 mm user and side edges is available on rectangular and organic worksurfaces as an option. On radius corners the knife edge wraps to the back of the worksurface.

Tip: Knife edge is available on laminate worksurfaces only.

Tip: Knife edge and soft edge cannot be specified together.

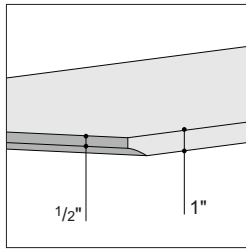

Knife edge is 15° and edge profile is 1/2". Overall thickness of worksurface is 1".

Tip: The sloping underside of the edge is finished to match the backer on the underside of worksurface.

Tip: Monitor arms and power strips can still be c-clamped at the back of the worksurface.

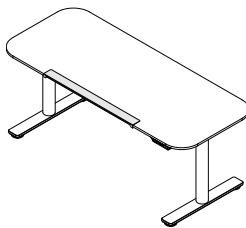

Soft edge, available as an option, is made of polyurethane and is offered on rectangular worksurfaces 58"W or wider without overhang. When specified with a left or right overhang, soft edge availability varies.

▶ See *Migration Pro Options Availability Chart*, page 181.

Tip: Soft edge is available on laminate worksurfaces only.

Tip: Soft edge is available as non-antimicrobial only.

Tip: Soft edge and knife edge cannot be specified together.

Tip: Soft edge, when specified with 3-preset controller, has additional width limitations due to the size of the controller.

Wood Veneer Desks

Front (user's) edge profile is wood veneer with a square 3 mm radius.

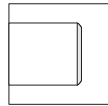

3 mm wood square profile



Rectangular worksurfaces are available with square or radius corners.

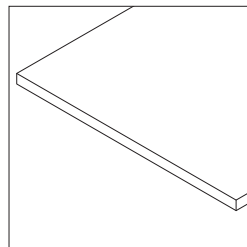

Square corners are standard on rectangular desks and have 90° corners on all four sides.

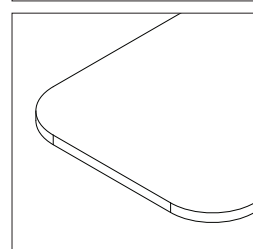
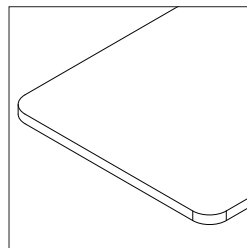

Radius corners, available as an option on rectangular desks, have 2" or 5" radius on all four sides with a continuous 3 mm user's edge. Radius corners eliminate sharp edges suitable for freestanding desks.

Tip: Wood veneer worksurfaces are available with a 5" radius only.

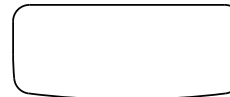

Organic worksurfaces are available in two shapes: bow front or bow front and back.

Tip: Side screens are not allowed on organic worksurface shapes.

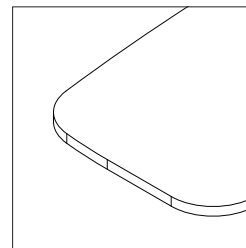

Organic bow front worksurfaces have a 5" radius on the back corners.

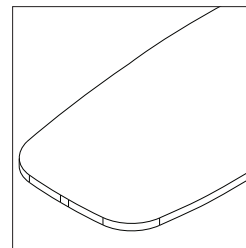

Organic bow front and back worksurfaces are symmetric.

Tip: Organic bow front and back worksurfaces work with Soffio screens only.

Tip: Metal cable tray cannot be specified with organic bow front and back worksurfaces.

Desks that are FSC Mix credit help organizations meet their sustainability goals. Order **HA2ERFSC** or **HA2EOFSC** to specify Migration Pro with FSC product certification.

Tip: Product is not labeled. The FSC Mix credit claim number is published on the customer invoice.

Tip: FSC worksurfaces have minimal worksurface finish limitations.

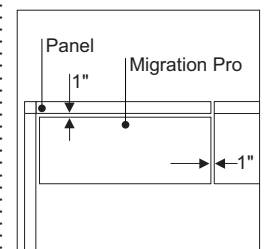

Rectangular and organic worksurface sizes

are listed in actual dimensions to allow for 1" gap to adjacent furniture, eliminating any pinch points.

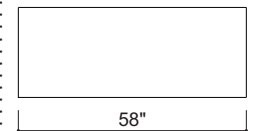

The overall width of the worksurface is 40"W–96"W. Modular widths account for 1" pinch point on each side. Parametric widths are available in 1/16" increments.

Worksurfaces 78" and wider may have different configuration and application rules.

▶ See *Migration Pro Options Availability Chart*, page 181

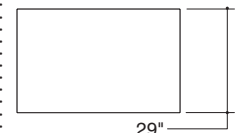

The overall depth of the worksurface is 23", 24", 28", 29", or 30". Modular depths account for a 1" pinch point clearance at the back or full depth is available.

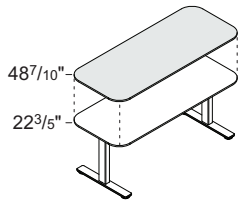

Extended height desks adjust 22³/₅"H to 48⁷/₁₀"H in any increment.

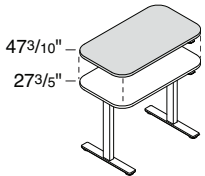

Basic height desks adjust from 27³/₅"H to 47³/₁₀"H in any increment.

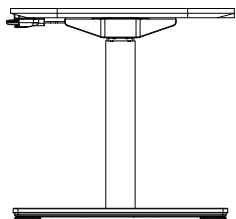

T-leg configuration with round or rectangular columns is an option for 23", 24", 28", 29", and 30" depth options. All worksurface widths are available with this option.

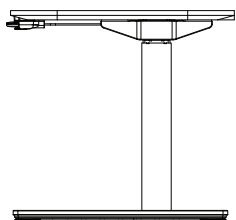

C-leg rectangular column configuration is an option for 28", 29", and 30" depth options, maximizing user knee depth clearance below the desk. Worksurfaces up to 78"W are available with this option.
Tip: Round columns are not available as a C-leg configuration.

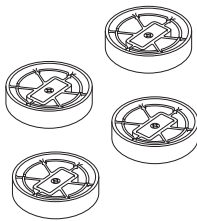

1" glide spacer is available as an option. Added to the existing glide, it raises the overall height of the glide by 1/2" for uneven floors.

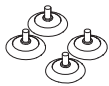

Slide guides are available as an option to aid in user-controlled mobility within the workstation.
Tip: Overall height of desk is increased by 1/2".

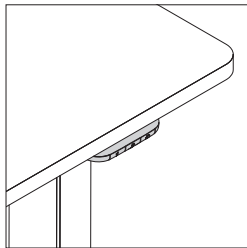

Active touch controller is standard, Bluetooth-enabled, and includes digital display, two preset buttons, double-tap automatic drive, and active motion posture reminders.
Tip: Steelcase Rise mobile app is available for download on Apple and Google Play stores. Pair to any active touch controller to access preferences, presets, and posture activity tracking.

Tip: When specified on knife edge worksurfaces, a knife edge adapter is shipped with the controller.

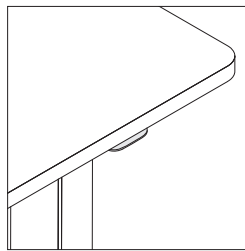

Simple touch controller is available as an option and easily adjusts the desk by lifting up or pressing down on the controller.
Tip: Simple touch is available as non-antimicrobial only.

Tip: When specified on knife edge worksurfaces, a knife edge adapter is shipped with the controller.

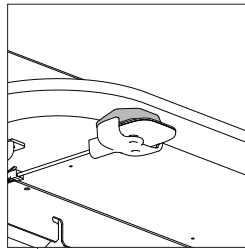

When knife edge is specified, an adapter is shipped with active touch and simple touch controllers for ease of use.

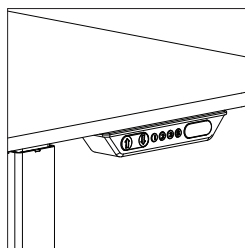

Three preset controller with digital display is available as an option and easily adjusts the desk by pushing the up and down arrows. It allows users to set the seated and standing height positions. Digital display will show the height of the desk when adjusting and at rest before it enters sleep mode.

Tip: Does not use a knife edge adapter bracket. The controller is not mounted flush to front of worksurface, it is inset mounted underneath the desk at the knife edge transition.

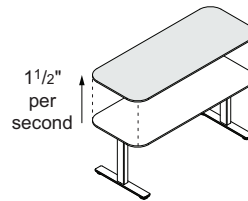

Desks adjust at a rate of 1¹/₂" per second.

Gyroscopic obstruction sensing technology is standard with all Migration Pro desks. The worksurface will backtrack when it contacts an object or detects tilt.
Tip: Desks greater than 78"W ship with two obstruction sensing dongles.

Steelcase guidance for height adjustment obstruction sensing technology (OST):

- Always read and follow all instructions and safety messages before positioning and using powered, height-adjustable products. Obstruction Sensing Technology (OST) is primarily intended to protect internal mechanisms and is only one part of the overall product system.
- OST is intended to detect hard, immovable objects that contact the desk during raising or lowering.
- OST may not detect soft and/or flexible objects such as padded arm caps, compliant seating surfaces, and cushion tops of peds.
- OST may not detect dynamic and/or articulating objects such as adjustable chair backs and chair arms.
- Different Steelcase height adjustable desks and benches have different types of OST that does not all behave the same.
- OST is disabled during the recalibration/synchronization process, but the unit moves at a much slower speed.

Wiring and Cabling

Low surge electric motor with quiet operation adjusts at 1¹/₂" per second. Motor is 110V and includes a 10¹/₂' power cord. Motor has 0.1W standby power.

Ships with 10¹/₂' power cord. To meet Chicago power cord requirements, refer to the Migration Pro assembly directions.
Tip: If specifying flush mount or pop-up power with utility power the desk power cord is 4'. Utility power cord is available in three options: standard smooth straight, braided, or curly. Standard and braided cords are 10'. Curly cord is 163".

Underwriters Laboratory (UL) Listed. Migration Pro desks are designed to meet U.S. and Canadian national electrical and energy codes and most local building codes. Height-adjustable base is UL listed when constructed in accordance with assembly directions. Local electrical codes vary; consult the local authority having jurisdiction to verify the product as installed is compliant with local code.

Round grommets, available as an option, help manage cable and cords routing from above to below the desk.
Tip: Grommets are centered between the base, not the worksurface, when overhang is specified.

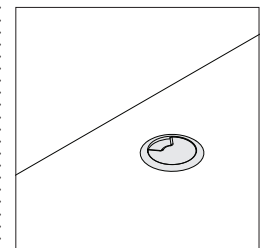

Round grommet inside dimension is 2".

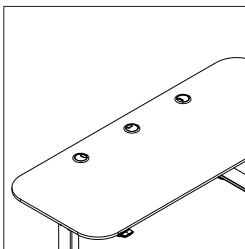

Grommets can be specified left, right, and/or center on the worksurface.

Tip: Grommets are centered between the base, not the worksurface, when overhang is specified.

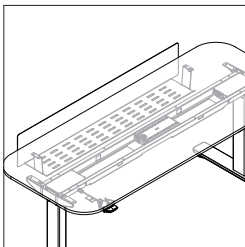

Metal cable tray, available as an option, manages cables and disguises clamps and power strips at the worksurface for a clean aesthetic.

Tip: Metal cable tray is not available as an option on organic bow front and back worksurfaces.

*Tip: Worktools smart straps **DSBULKSTRP**, can be ordered separately to manage bundled cables in the tray.*

Tip: Metal cable tray can be ordered separately; however, pilot holes will not be provided.

► Specifying, page 243

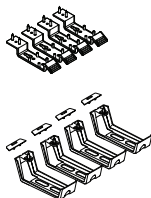

Small and large cable brackets, ordered separately, support horizontal cable management below the worksurface.

► Understanding, page 204

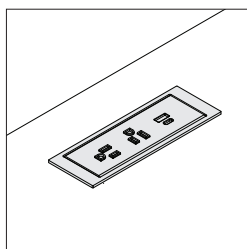

Flush and pop-up power strips are available as an option and can be specified left, right or center depending on the worksurface width.

Tip: Only one integrated power feature can be specified per desk.

► See Migration Pro Options Availability Chart, page 181.

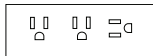

3 power

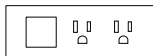

2 Power
1 Data

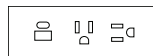

2 power
1 USB A+C 20W



1 Power
1 USB-C 100W

Flush and pop-up power are available in four power configurations:

Hedberg Option Code	Power Configuration
3P	3 power
2P1D	2 power, 1 data
2P1AC20	2 power, 1 USB A+C 20W
1P1C100	1 power, 1 USB-C 100W

Flush and pop-up options:

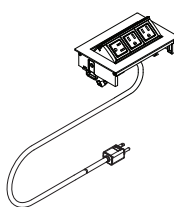

Without overcurrent protection

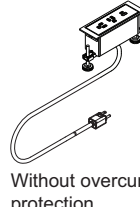

Without overcurrent protection

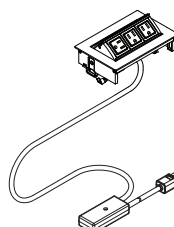

With overcurrent protection

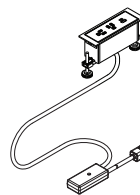

With overcurrent protection

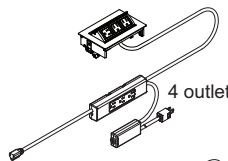

4 outlet

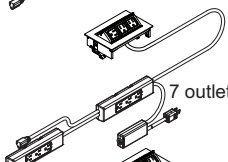

7 outlet

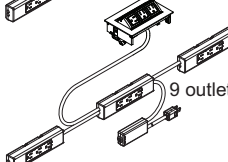

9 outlet

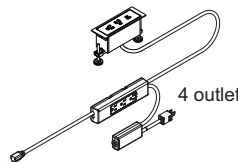

4 outlet

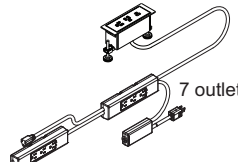

7 outlet

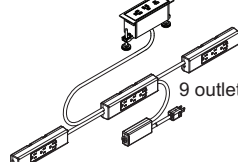

9 outlet

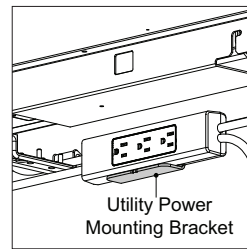

Utility Power
Mounting Bracket

Flush and pop-up power strips with utility power optioned ship with worksurface mounting brackets. Can be used in conjunction with metal cable tray or small and large cable brackets.

USB A+C 20W 

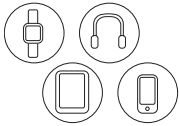

Flush and pop-up powerstrips USB A+C 20W recommended for charging cell phones, tablets, headphones, wearable fitness trackers, or other small electronic devices.

Dual 45W or 100W USB-C 



USB-C 100W recommended for all the above and compact laptops.
Tip: For USB-C 100W port, use USB-C charging cable rated for 100W use for full charging benefits. Charging cables not included.

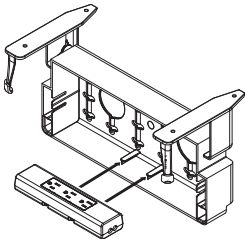

Universal cable management kit, ordered separately, is designed to mount the utility power and mounting brackets would be unused.

Tip: The flush and pop-up powerstrip should not be enclosed within the universal cable management tray because the tray will not fully open. The tray should be mounted to the side.

Optional data port adapter information chart.

(Coupler/jack not included)

Note: Please verify fit of jack in adapter before ordering large quantities as manufacturer designs may change without notice.

Adapter	Manufacturer
BBB	L-Com Keystone Modular
BBB	NETCONNECT, and 110 Connect Series Modular Jack
BBB	Siemon ZMAX Style
BBB	Allen Tel Versa Tap Series
BBB	Leviton Quick Port Series
BBB	Belden REVConnect
BBB	HDMI Adapter Cable
CCC	Hubbell Nextspeed Keystone Series
CCC	ADC Truernet series
DDD	Blank (no coupler/jack)
EEE	Ortronics TracJack Series
FFF	Panduit Mini-Com Series
HHH	Video Monitor Jack/DB-15, panel mount solder style

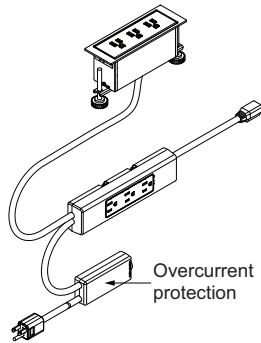

Overcurrent protection is included as standard with flush or pop-up power with utility power configurations with more than three outlets and is an option on configurations with less than four outlets. Check with your local authorities having jurisdiction to see if overcurrent protection is required for assemblies with less than four outlets.

Overcurrent protection via circuit breaker prevents the powerstrip from drawing more than 15 amps of power.

Flush or pop-up power plug options are:

- Standard NEMA 5-15, 3 prong
- 90° NEMA 5-15, 3 prong
- Thread low profile plug

Powerstrips with C-clamp or front edge mount are field-installed and provide users with convenient power access and/or utility power beneath the worksurface.

▶ See page 243 for *Migration Pro and Intro Cable Management*.

Surface Materials

High-Pressure Laminate Desks

- Laminate
- ▶ See page 362
- Open Line laminate (option)

A program including non-Steelcase laminates which are suitable for use on Steelcase products.

▶ See *Surface Materials Reference Manual*.
Tip: FSC worksurfaces and modesty panels are not available with an OLL option.

3 mm edge profile

- Plastic

Wood Veneer Desk

- Wood veneer (standard)
- Customiz stain (option)

3 mm square edge profile

- Wood veneer to match desk

Height-Adjustable Base

- Paint

Soft edge and utility power mounting bracket

- 6527 Merle

Round grommet, and controller knife edge adapters

- 6000 Black

Flush mount frame and faceplate

- 6000 Black
- 6009 Arctic White
- 6053 Seagull
- 6527 Merle

Pop-up powerstrip frame/lid and faceplate

- 0835 Black
- 4799 Platinum Metallic
- 7241 Arctic White
- 7243 Seagull
- 7360 Merle

Tip: When selecting 4799 Platinum Metallic on the pop-up powerstrip, the faceplate will be 7360 Merle.

Flush mount and pop-up power cord finishes

Standard smooth straight and curly cord

- Black
- White
- Braided cord
- 9009 Black
- 9011 Seagull

Metal cable tray

- Paint

Application Topics

Moving desks can collide with other components. Do not install overhead storage, desk-height power, or desk accessories in the path of height-adjustable desks.

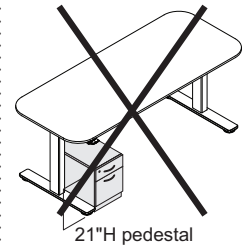

21"H pedestal

On extended height desks, any storage higher than 18 1/2" will impede the height range of the desk.
Tip: Do not place storage underneath controller.

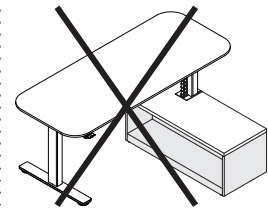

Integrated storage, designed for Migration SE, cannot be used with Migration Pro.

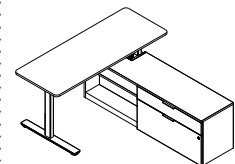

Migration Pro basic height desks can be integrated with Aisla HIU storage.

▶ See Aisla HIU Low Storage in *Aisla Specification Guide*.

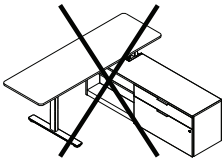

Overhang is not available on Migration basic desks that integrate with storage.

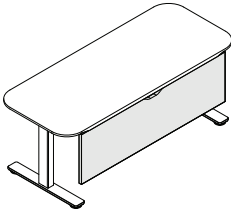

Modesty panels, ordered separately, are parametric in $\frac{1}{16}$ " increments from 40"-96". Modesty panels are specified to match the desk options. Widths will vary depending on if knife edge, square or radius corners are specified.

► Specifying, page 248

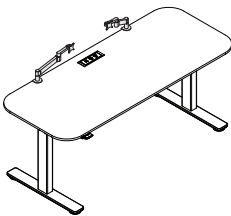

When optioning either flush or pop-up power, flat panel monitor arms cannot be c-clamped behind the power. Install arm to the side.

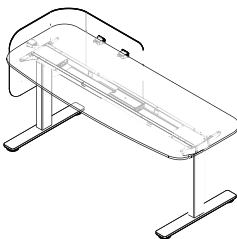

5" radius corners, optioned on rectangular and standard on organic bow front worksurfaces, ship with pilot holes for Flex curved screens (**FLXCS**), and Flex 90° desk mount privacy wrap (**FLXDWR**).

Tip: Flex screens and wraps are not allowed on knife edge worksurfaces.

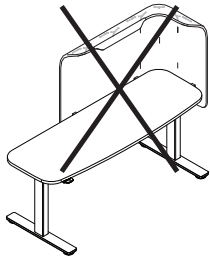

When attaching 90° desk mount privacy wrap (FLXDWR) to 5" radius corners or organic bow front worksurfaces, a worksurface overhang is not allowed on the same side the wrap is mounting.

Tip: A worksurface overhang can be specified on the opposite side as the wrap is mounted.

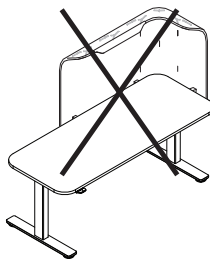

Flex privacy wrap (FLXDWR) is not allowed on 23"D worksurfaces or 24"D bow front worksurfaces.

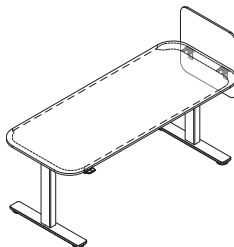

When attaching Sarto privacy/modesty screens to the side of a knife edge worksurface, select Migration side knife attachment bracket option for the screen to receive the knife edge adapter brackets.

Tip: Standard attachment brackets will be sent with both "no brackets" and "Migration side knife attachment bracket" options.

Tip: Sarto privacy and Sarto privacy/modesty side screens are not allowed with organic bow front and back worksurfaces.

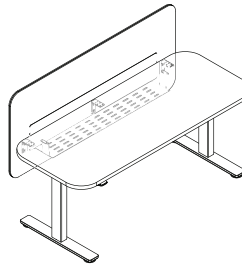

Universal and Sarto privacy/modesty screens can be installed with the metal cable tray.

Tip: When specifying a Sarto privacy/modesty screen equal to or greater than 60"W to use with the cable tray, select the with metal cable tray application option.

Tip: Screen width must be 10 1/2" wider than metal cable tray.

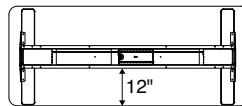

CPU holders that require less than 12"D clearance on T-leg desks, and 15"D on C-leg desks may be mounted inboard of legs.

Tip: Maximum total weight of CPU holder and CPU is 40 pounds. CPU weight should not exceed 25 pounds.

Tip: CPU holders are not intended for use on 23" or 24" deep desks without specifying worksurface overhang.

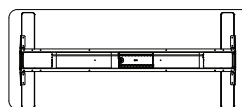

When no overhang is specified up to 76"W, modular widths have a standard 3" overhang on both sides.

Tip: Parametric width overhangs will vary. Use the SmartTools dimension tool to determine exact overhang.

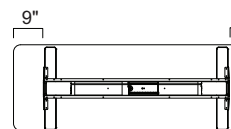
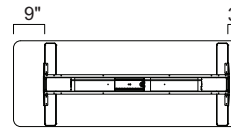
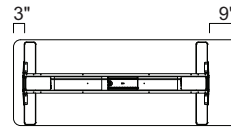

Desk overhang for CPU holder or layering of low storage and pedestals is available as an option. The overhang is 9" and available on 58"W or wider desks. Desk widths 64"W or larger allow for single or dual overhang.

► See Migration Pro Options Availability Chart, page 181.

Tip: When specifying parametric width and left or right overhang, the overhang on the opposite side will vary. When dual overhangs are selected, both overhangs will match. Use the SmartTools dimension tool to determine exact overhang.

Tip: Desks 82"-87 15/16"W may be specified with single or dual overhang. Desks 88"W and wider will have dual overhang.

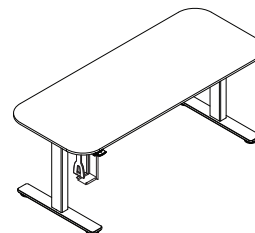

On extended height desks, CPUs installed in a CPU holder should not be installed over the foot or exceed 15 3/4" high, or it will impede the height range of the desk.

*Tip: Vertical locking and non-locking CPU cradles **CPRCCL** and **CPRCCN** are not allowed on extended height desks.*

All assemblies meet or exceed ANSI/BIFMA standards.

Desks ship with pre-drilled holes for mounting bases.

Height-adjustable base requires attachment to the worksurface.

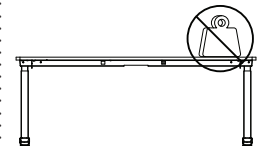

Distribute weight evenly

Height-adjustable base supports a maximum distributed weight capacity of 360 pounds.

Tip: When calculating lifting capacity, subtract the weight of the worksurface, channel, and options selected.

► See page 211 for worksurface weights.

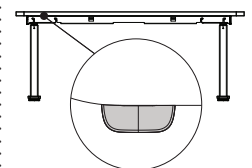
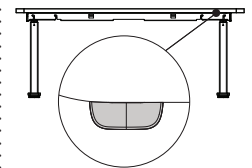

Controllers can be mounted on either the left- or right-hand side of the desk.

Migration Pro with Boost High-Speed Height-Adjustable Desks and Bases

Migration Pro with boost high-speed is a height-adjustable desk equipped with advanced technology that enriches the user experience allowing for quick posture changes.

► Specifying, pages 230, 234, and 237

Available as a FSC Mix product, the worksurface is made with a mixture of materials from FSC-certified forests, recycled materials, and/or FSC-controlled wood. The FSC Mix credit claim number is published on the customer invoice.

Soft edge, available as an option, reduces unhealthy pressure on forearms, as well as feelings of shoulder and neck fatigue. Soft edge is 36"W.

Controller adjusts the height of the desk at a rate of $3\frac{1}{10}$ " per second. Three options are available - active touch, simple touch, and 3-preset with digital display.

Lifting column is controlled by a central box for synchronization. Columns are precision balanced to minimize surface vibrations.

Edge is available in 3 mm edge profile.

Organic worksurfaces are available in bow front or bow front and back options. Bow front has 5" radius corners at the back.

Active touch controller is Bluetooth-enabled and includes digital display, two preset buttons, double-tap automatic drive, and active motion posture reminders.
Tip: Steelcase Rise mobile app is available for download on Apple and Google Play stores. Pair to any active touch controller to access preferences, presets, and posture activity tracking.

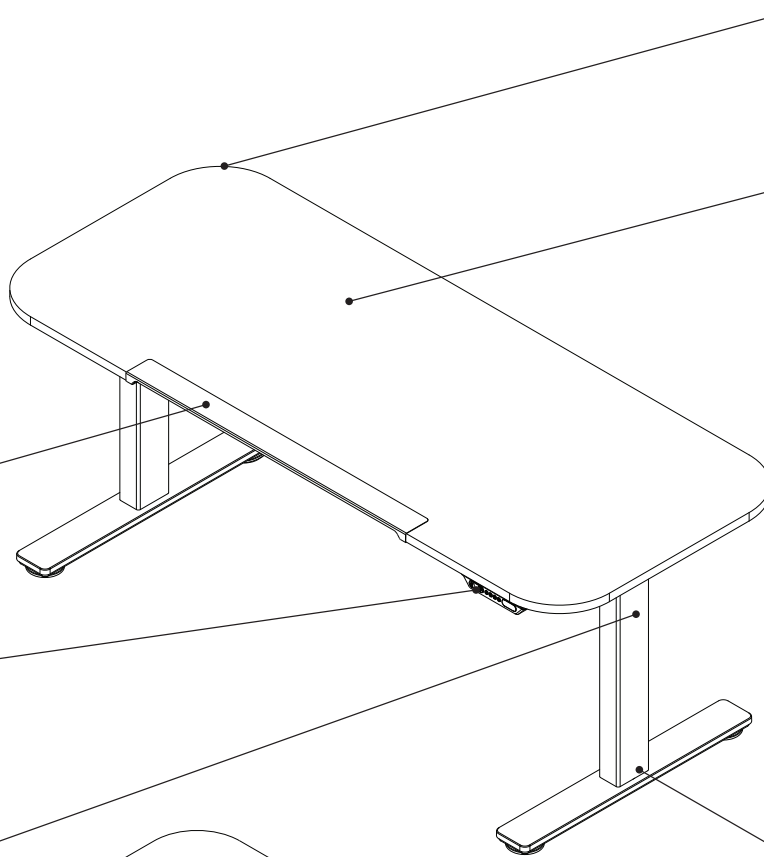

Rectangular worksurfaces are available with square or radius corner options. The radius corner option can be specified with 2" or 5" radius.

Worksurface has a wood core with a High-Pressure Laminate or wood veneer surface and is 1" thick.

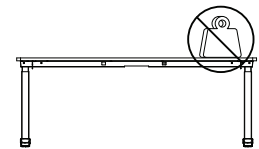

Distribute weight evenly

Base supports a maximum distributed weight capacity of 270 pounds.
Tip: When calculating lifting capacity, subtract the weight of the worksurface, channel, and options selected.
 ► See page 211 for worksurface weights.

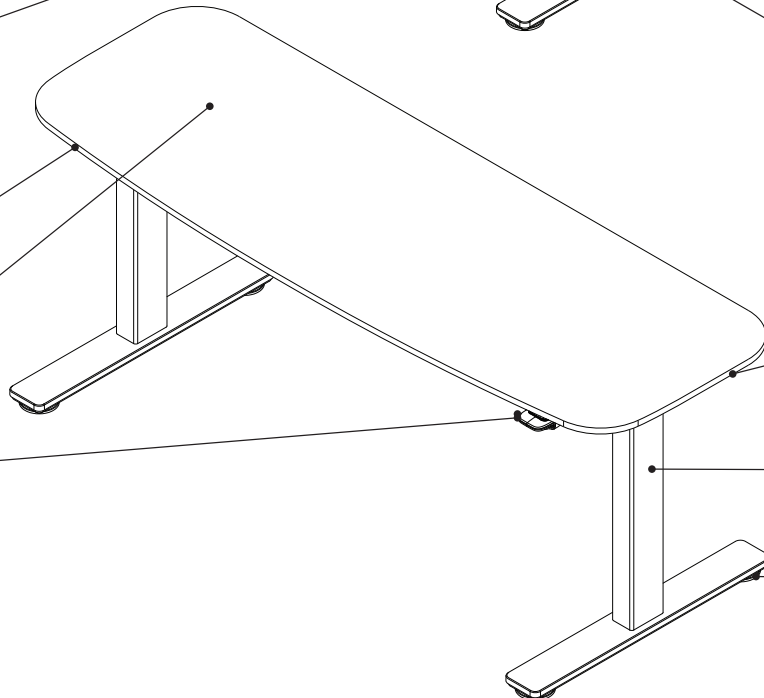

Extended height-adjustable base adjusts from $22\frac{3}{5}$ "– $48\frac{7}{10}$ " in any increment.

Knife edge, available as an option, is a thin profile worksurface edge that wraps three sides of the desk.

Columns are rectangular shaped and are available as a T-leg configuration.

Leveling glides adjust $\frac{1}{2}$ " to install desk on uneven floors. Slide glides and 1" adjustable spacers are available as an option.

Product Details

High-Pressure Laminate Desks

Front (user's) edge profile is available in 3 mm edge profile.

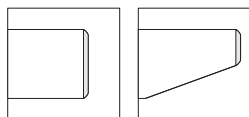

3 mm plastic edge profile

Knife edge profile

PVC-free, 3 mm edge profiles are proprietary polyolefin blend for all solid colors and three woodgrain finishes. Matching 1 mm side and back edges are also PVC-free.

► See *Surface Materials* in this book for specific PVC-free availability, page 362.

Edge profile finishes are specified separately from laminate color.

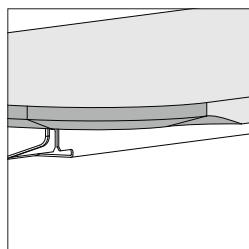

Knife edge with 3 mm user and side edges is available on rectangular and organic worksurfaces as an option. On radius corners the knife edge wraps to the back of the worksurface.
Tip: Knife edge is available on laminate worksurfaces only.

Tip: Knife edge and soft edge cannot be specified together.

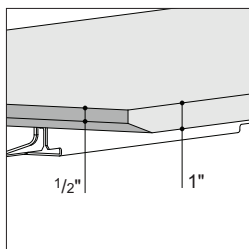

Knife edge is 15° and edge profile is 1/2". Overall thickness of worksurface is 1".

Tip: The sloping underside of the edge is finished to match the backer on the underside of worksurface.

Tip: Monitor arms and power strips can still be c-clamped at the back of the worksurface.

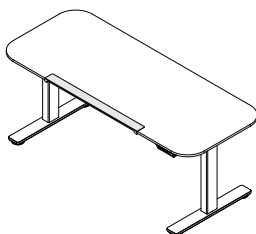

Soft edge, available as an option, is made of polyurethane and is offered on rectangular worksurfaces 58"W or wider without overhang.

► See *Migration Pro with Boost High-Speed Options Availability Chart*, page 181

Tip: Soft edge is available on laminate worksurfaces only.

Tip: Soft edge is available as non-antimicrobial only.

Tip: Soft edge and knife edge cannot be specified together.

Tip: Soft edge, when specified with 3-preset controller, has additional width limitations due to the size of the controller.

Wood Veneer Desks

Front (user's) edge profile is wood veneer with a square 3 mm radius.

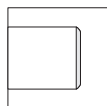

3 mm wood square profile



Rectangular worksurfaces are available with square or radius corners.

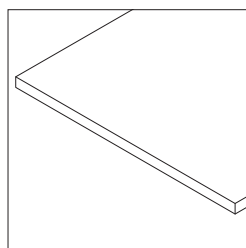

Square corners are standard on rectangular desks and have 90° corners on all four sides.

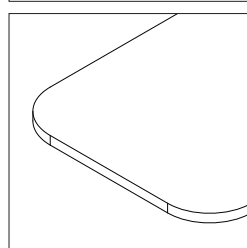
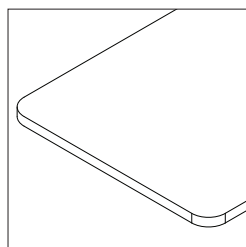

Radius corners, available as an option on rectangular desks, have 2" or 5" radius on all four sides with a continuous 3 mm user's edge. Radius corners eliminate sharp edges suitable for freestanding desks.

Tip: Wood veneer worksurfaces are available with a 5" radius only.

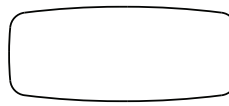

Organic worksurfaces

are available in two shapes: bow front or bow front and back.

Tip: Side screens are not allowed on organic worksurface shapes.

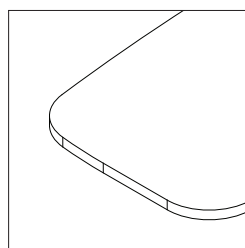

Organic bow front worksurfaces have a 5" radius on the back corners.

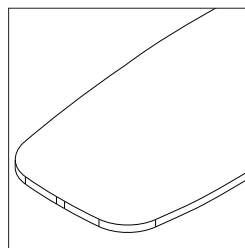

Organic bow front and back worksurfaces are symmetric.

Tip: Organic bow front and back worksurfaces work with Soffio screens only.

Tip: Metal cable tray cannot be specified with organic bow front and back worksurfaces.

Desks that are FSC Mix credit help organizations meet their sustainability goals. Order **HA3ERFSC** or **HA3EOFSC** to specify Migration Pro with FSC product certification.

Tip: Product is not labeled. The FSC Mix credit claim number is published on the customer invoice.

Tip: FSC worksurfaces have minimal worksurface finish limitations.

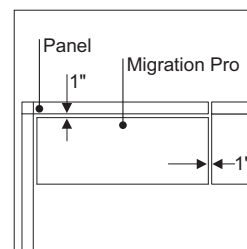

Rectangular and organic worksurface sizes

are listed in actual dimensions to allow for 1" gap to adjacent furniture, eliminating any pinch points.



The overall width of the worksurface is 40"W-78"W. Modular widths account for 1" pinch point on each side. Parametric widths are available in 1/16" increments.

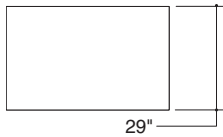

The overall depth of the worksurface is 23", 24", 28", 29", or 30". Modular depths account for a 1" pinch point clearance at the back or full depth is available.

Tip: Sarto privacy and Sarto privacy/modesty side screens are not allowed with rectangular 5" radius corners or organic bow front and bow front and back worksurfaces.

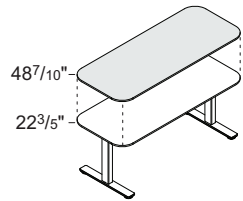

Extended height desks adjust 22³/₅" to 48⁷/₁₀" in any increment.

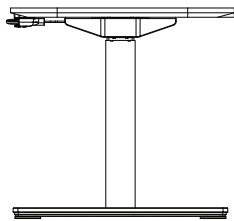

T-leg rectangular column configuration is standard for 23", 24", 28", 29", and 30" depth options.

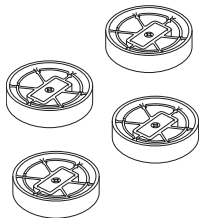

1" glide spacer is available as an option. Added to the existing glide, it raises the overall height of the glide by 1/2" for uneven floors.

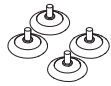

Slide glides are available as an option to aid in user-controlled mobility within the workstation.

Tip: Overall height of desk is increased by 1/2".

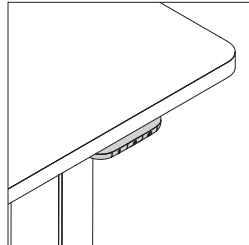

Active touch controller is standard, Bluetooth-enabled, and includes digital display, two preset buttons, double-tap automatic drive, and active motion posture reminders.

Tip: Steelcase Rise mobile app is available for download on Apple and Google Play stores. Pair to any active touch controller to access preferences, presets, and posture activity tracking.

Tip: When specified on knife edge worksurfaces, a knife edge adapter is shipped with the controller.

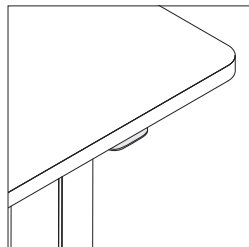

Simple touch controller is available as an option and easily adjusts the desk by lifting up or pressing down on the controller.

Tip: Simple touch is available as non-antimicrobial only.

Tip: When specified on knife edge worksurfaces, a knife edge adapter is shipped with the controller.

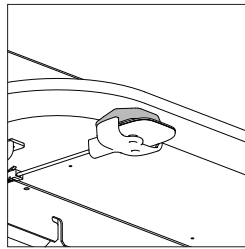

When knife edge is specified, an adapter is shipped with active touch and simple touch controllers for ease of use.

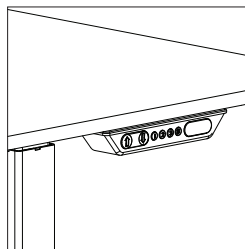

Three preset controller with digital display is available as an option and easily adjusts the desk by pushing the up and down arrows. It allows users to set the seated and standing height positions. Digital display will show the height of the desk when adjusting and at rest before it enters sleep mode.

Tip: Does not use a knife edge adapter bracket. The controller is not mounted flush to front of worksurface, it is inset mounted underneath the desk at the knife edge transition.

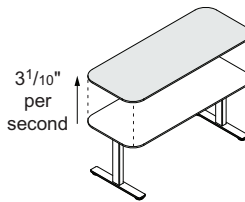

Desks adjust at a rate of 3¹/₁₀" per second.

Gyroscopic obstruction sensing technology is standard with all Migration Pro desks. The worksurface will backtrack when it contacts an object or detects tilt.

Steelcase guidance for height adjustment obstruction sensing technology (OST):

- Always read and follow all instructions and safety messages before positioning and using powered, height-adjustable products. Obstruction Sensing Technology (OST) is primarily intended to protect internal mechanisms and is only one part of the overall product system.
- OST is intended to detect hard, immovable objects that contact the desk during raising or lowering.
- OST may not detect soft and/or flexible objects such as padded arm caps, compliant seating surfaces, and cushion tops of peds.
- OST may not detect dynamic and/or articulating objects such as adjustable chair backs and chair arms.
- Different Steelcase height adjustable desks and benches have different types of OST that does not all behave the same.
- OST is disabled during the recalibration/synchronization process, but the unit moves at a much slower speed.

Wiring and Cabling

Low surge electric motor with quiet operation adjusts at 3¹/₁₀" per second. Motor is 110V and includes a 10¹/₂' power cord. Motor has 0.1W standby power.

Ships with 10¹/₂' power cord. To meet Chicago power cord requirements, refer to the Migration Pro assembly directions.

Tip: If specifying flush mount or pop-up power with utility power the desk power cord is 4'. Utility power cord is available in three options: standard smooth straight, braided, or curly. Standard and braided cords are 10'. Curly cord is 163".

Underwriters Laboratory (UL) Listed.

Migration Pro desks are designed to meet U.S. and Canadian national electrical and energy codes and most local building codes. Height-adjustable base is UL listed when constructed in accordance with assembly directions. Local electrical codes vary; consult the local authority having jurisdiction to verify the product as installed is compliant with local code.

Round grommets, available as an option, help manage cable and cords routing from above to below the desk.

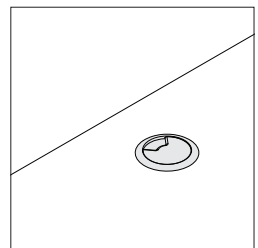

Round grommet inside dimension is 2".

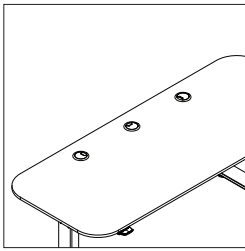

Grommets can be specified left, right, and/or center on the worksurface.

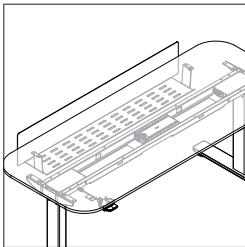

Metal cable tray, available as an option, manages cables and disguises clamps and power strips at the worksurface for a clean aesthetic.

Tip: Metal cable tray is not available as an option on organic bow front and back worksurfaces.

*Tip: Worktools smart straps **DSBULKSTRP**, can be ordered separately to manage bundled cables in the tray.*

Tip: Metal cable tray can be ordered separately; however, pilot holes will not be provided.

► Specifying, page 243

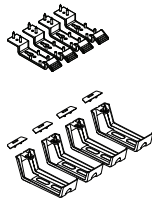

Small and large cable brackets, ordered separately, support horizontal cable management below the worksurface.

► Understanding, page 204.

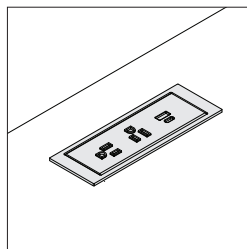

Flush and pop-up power strips are available as an option and can be specified left, right, or center depending on the worksurface width.

Tip: Only one integrated power feature can be specified per desk.

► See Migration Pro with Boost High-Speed Options Availability Chart, page 181.

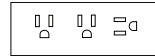

3 power

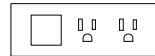

2 Power
1 Data

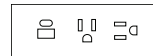

2 power
1 USB A+C 20W

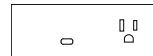

1 Power
1 USB-C 100W

Flush and pop-up power are available in four power configurations:

Hedberg Option Code	Power Configuration
3P	3 power
2P1D	2 power, 1 data
2P1AC20	2 power, 1 USB A+C 20W
1P1C100	1 power, 1 USB-C 100W

Pop-up and flush options:

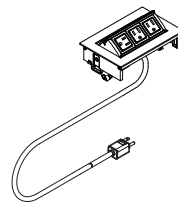

Without overcurrent protection

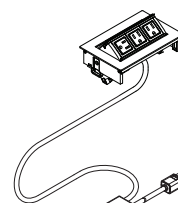

With overcurrent protection

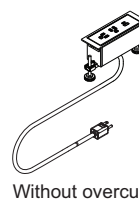

Without overcurrent protection

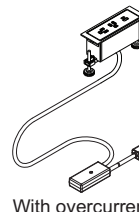

With overcurrent protection

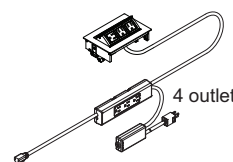

4 outlet

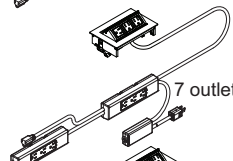

7 outlet

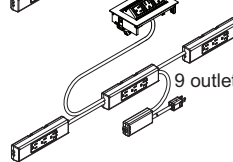

9 outlet

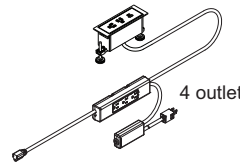

4 outlet

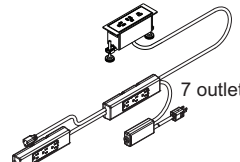

7 outlet

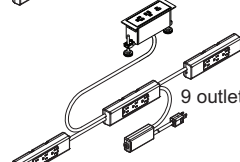

9 outlet

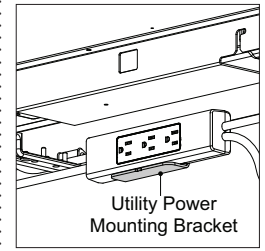

Utility Power
Mounting Bracket

Flush and pop-up power strips with utility power optioned ship with worksurface mounting brackets. Can be used in conjunction with metal cable tray or small and large cable brackets.

USB A+C 20W

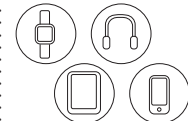

Flush and pop-up power strips USB A+C 20W recommended for charging cell phones, tablets, headphones, wearable fitness trackers, or other small electronic devices.

Dual 45W
or
100W USB-C



USB-C 100W recommended for all the above and compact laptops.

Tip: For USB-C 100W port, use USB-C charging cable rated for 100W use for full charging benefits. Charging cables not included.

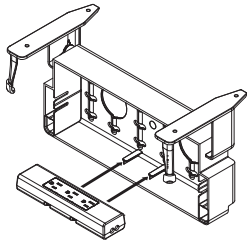

Universal cable management kit, ordered separately, is designed to mount the utility power and mounting brackets would be unused.

Tip: The flush and pop-up powerstrip should not be enclosed within the universal cable management tray because the tray will not fully open. The tray should be mounted to the side.

Optional data port adapter information chart.

(Coupler/jack not included)

Note: Please verify fit of jack in adapter before ordering large quantities as manufacturer designs may change without notice.

Adapter	Manufacturer
BBB	L-Com Keystone Modular
BBB	NETCONNECT, and 110 Connect Series Modular Jack
BBB	Siemon ZMAX Style
BBB	Allen Tel Versa Tap Series
BBB	Leviton Quick Port Series
BBB	Belden REVConnect
BBB	HDMI Adapter Cable
CCC	Hubbell Nextspeed Keystone Series
CCC	ADC Truenet series
DDD	Blank (no coupler/jack)
EEE	Ortronics TracJack Series
FFF	Panduit Mini-Com Series
HHH	Video Monitor Jack/DB-15, panel mount solder style

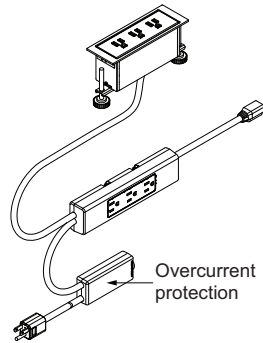

Overcurrent protection is included as standard with flush or pop-up power with utility power configurations with more than three outlets and is an option on configurations with less than four outlets. Check with your local authorities having jurisdiction to see if overcurrent protection is required for assemblies with less than four outlets.

Overcurrent protection via circuit breaker prevents the powerstrip from drawing more than 15 amps of power.

Flush or pop-up power plug options are:

- Standard NEMA 5-15, 3 prong
- 90° NEMA 5-15, 3 prong
- Thread low profile plug

Powerstrips with C-clamp or front edge mount are field-installed and provide users with convenient power access and/or utility power beneath the worksurface.

▶ See page 243 for *Migration Pro and Intro Cable Management*.

Surface Materials

High-Pressure Laminate Desks

- Laminate
 - ▶ See page 362
 - Open Line laminate (option)
- A program including non-Steelcase laminates which are suitable for use on Steelcase products.
- ▶ See *Surface Materials Reference Manual*.
- Tip: FSC worksurfaces and modesty panels are not available with an OLL option.*

3 mm edge profile

- Plastic

Wood Veneer Desk

- Wood veneer (standard)
- Customiz stain (option)

3 mm square edge profile

- Wood veneer to match desk

Height-Adjustable Base

- Paint

Soft edge and utility power mounting bracket

- 6527 Merle

Round grommet and controller knife edge adapters

- 6000 Black

Flush mount frame and faceplate

- 6000 Black
- 6009 Arctic White
- 6053 Seagull
- 6527 Merle

Pop-up powerstrip frame/lid and faceplate

- 0835 Black
- 4799 Platinum Metallic
- 7241 Arctic White
- 7243 Seagull
- 7360 Merle

Tip: When selecting 4799 Platinum Metallic on the pop-up powerstrip, the faceplate will be 7360 Merle.

Flush mount and pop-up power cord finishes

- Standard smooth straight and curly cord
- Black
 - White
- Braided cord
- 9009 Black
 - 9011 Seagull

Metal cable tray

- Paint

Application Topics

Moving desks can collide with other components. Do not install overhead storage, desk-height power, or desk accessories in the path of height-adjustable desks.

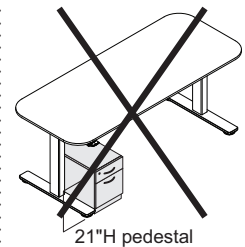

On extended height desks, any storage higher than 18 1/2" will impede the height range of the desk.

Tip: Do not place storage underneath controller.

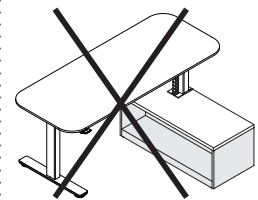

Integrated storage, designed for Migration SE, cannot be used with Migration Pro with boost high-speed.

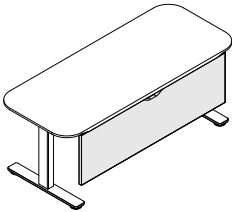

Modesty panels, ordered separately, are parametric in 1/16" increments from 40"–96". Modesty panels are specified to match the desk options. Widths will vary depending on if knife edge, square or radius corners are specified.
► Specifying, page 248

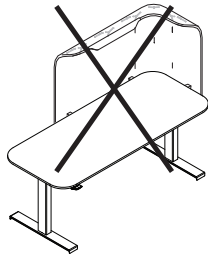

Flex privacy wrap (FLXDWR) is not allowed on 23"D worksurfaces or 24"D bow front worksurfaces.

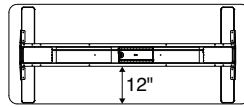

CPU holders that require less than 12"D clearance on T-leg desks may be mounted inboard of legs.

Tip: Maximum total weight of CPU holder and CPU is 40 pounds. CPU weight should not exceed 25 pounds.

Tip: CPU holders are not intended for use on 23" or 24" deep desks.

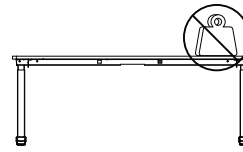

Distribute weight evenly

Height-adjustable base supports a maximum distributed weight capacity of 270 pounds.

Tip: When calculating lifting capacity, subtract the weight of the worksurface, channel, and options selected.

► See page 211 for worksurface weights.

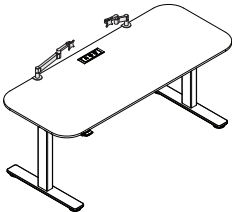

When optioning either flush or pop-up power, flat panel monitor arms cannot be c-clamped behind the power. Install arm to the side.

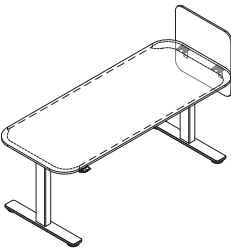

When attaching Sarto privacy or privacy/modesty screens to the side of a knife edge worksurface,

select Migration side knife attachment bracket option for the screen to receive the knife edge adapter brackets.

Tip: Sarto privacy and Sarto privacy/modesty side screens are not allowed with rectangular 5" radius corners or organic bow front and bow front and back worksurfaces.

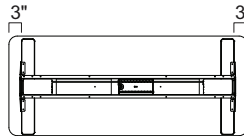

Modular widths have a standard 3" overhang on both sides.

Tip: Parametric width overhangs will vary. Use the SmartTools dimension tool to determine exact overhang.

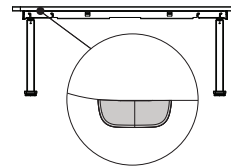
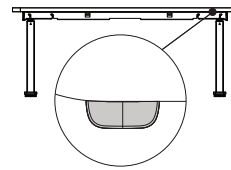

Controllers can be mounted on either the left- or right-hand side of the desk.

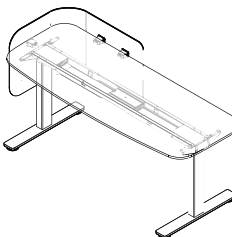

5" radius corners, optioned on rectangular and standard on organic bow front worksurfaces, ship with pilot holes for Flex curved screens (**FLXCS**), and Flex 90° desk mount privacy wrap (**FLXDWR**).

Tip: Flex screens and wraps are not allowed on knife edge worksurfaces.

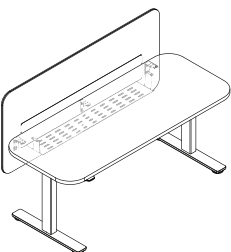

Universal and Sarto privacy/modesty screens can be installed with the metal cable tray.

Tip: When specifying a Sarto privacy/modesty screen equal to or greater than 60"W to use with the cable tray, select the with metal cable tray application option.

Tip: Screen width must be 10 1/2" wider than metal cable tray.

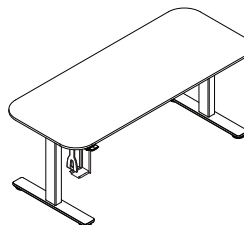

On extended height desks, CPUs installed in a CPU holder should not be installed over the foot or exceed 15 3/4" high, or it will impede the height range of the desk.

*Tip: Vertical locking and non-locking CPU cradles **CPRCCL** and **CPRCCN** are not allowed on extended height desks.*

All assemblies meet or exceed ANSI/BIFMA standards.

Desks ship with pre-drilled holes for mounting bases.

Height-adjustable base requires attachment to the worksurface.

Migration Intro Height-Adjustable Desks and Bases

Migration Intro is a simply designed height-adjustable desk complete with the essential features that support the posture needs of users.

► Specifying, page 220

Available as a FSC Mix product, the worksurface is made with a mixture of materials from FSC-certified forests, recycled materials, and/or FSC-controlled wood. The FSC Mix credit claim number is published on the customer invoice.

Worksurface has a wood core with a High-Pressure Laminate surface and is 1" thick.

Edge is available in 3 mm edge profile.

Paddle controllers adjust the height of the desk at a rate of 1¹/₅" per second. Two options are available—basic or active touch.

Primary column with integrated control PCB connects to the secondary column via a motor cable and is run by an external power supply.

Organic worksurfaces are available in bow front or bow front and back options. Bow front has 5" radius corners at the back.

Leveling glides adjust 1/2" to install desk on uneven floors.

Rectangular worksurfaces are available with square or radius corner options. The radius corner option can be specified with 2" or 5" radius.

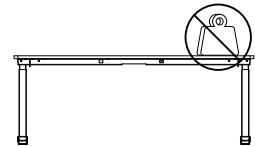

Distribute weight evenly

Base supports a maximum distributed weight capacity of 270 pounds.
Tip: When calculating lifting capacity, subtract the weight of the worksurface, channel, and options selected.
 ► See page 211 for worksurface weights.

Extended height-adjustable base adjusts from 22¹/₈"–48¹/₄" in any increment.

Columns are rectangular shaped and are available as a T-leg configuration.

Basic height-adjustable base adjusts from 26⁹/₁₀"–46³/₅" in any increment.

Active touch controller is Bluetooth-enabled and includes digital display, two preset buttons, double-tap automatic drive, and active motion posture reminders.
Tip: Steelcase Rise mobile app is available for download on Apple and Google Play stores. Pair to any active touch controller to access preferences, presets, and posture activity tracking.

Product Details

High-Pressure Laminate Desks

Front (user's) edge profile is available in 3 mm edge profile.

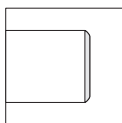

3 mm plastic edge profile

PVC-free, 3 mm edge profiles

are proprietary polyolefin blend for all solid colors and three woodgrain finishes. Matching 1 mm side and back edges are also PVC-free.

▶ See *Surface Materials* in this book for specific PVC-free availability, page 362.

Edge profile finishes

are specified separately from laminate color.



Rectangular work surfaces are available with square or radius corners.

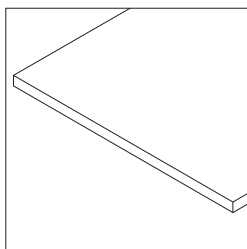

Square corners are standard on rectangular desks and have 90° corners on all four sides.

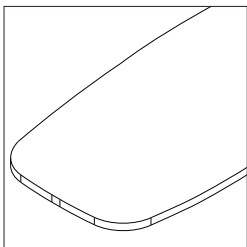
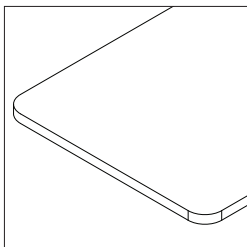

Organic bow front and back work surfaces are symmetric.

Tip: Organic bow front and back work surfaces work with Soffio screens only.

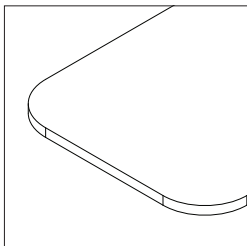

Tip: Metal cable tray cannot be specified with organic bow front and back work surfaces.

Desks that are FSC Mix Credit help organizations meet their sustainability goals. Order **HA1ERFSC** or **HA1EOFSC** to specify Migration Intro with FSC product certification.

Tip: Product is not labeled. The FSC Mix credit claim number is published on the customer invoice.

Tip: FSC work surfaces have minimal work surface finish limitations.

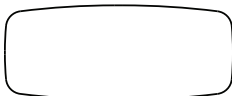

Radius corners, available as an option on rectangular desks, have 2" or 5" radius on all four sides with a continuous 3 mm user's edge. Radius corners eliminate sharp edges suitable for freestanding desks.

Organic work surfaces are available in two shapes: bow front or bow front and back.

Tip: Side screens are not allowed on organic work surface shapes.

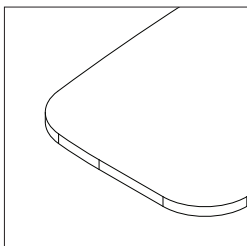

Organic bow front work surfaces have a 5" radius on the back corners.

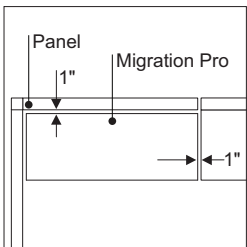

Rectangular and organic work surface sizes are listed in actual dimensions to allow for 1" gap to adjacent furniture, eliminating any pinch points.

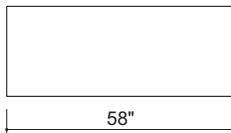

The overall width of the work surface is 40"W–78"W. Modular widths account for 1" pinch point on each side. Parametric widths are available in 1/16" increments.

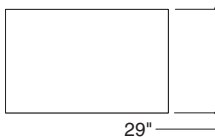

The overall depth of the work surface is 23", 24", 28", 29", or 30". Modular depths account for a 1" pinch point clearance at the back, or full depth is available.

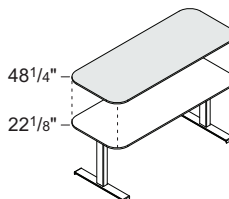

Extended height desks adjust 22 1/8"H to 48 1/4"H in any increment.

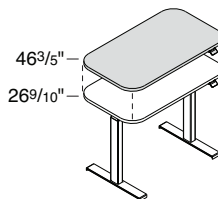

Basic height desks adjust from 26 9/10"H to 46 3/5"H in any increment.

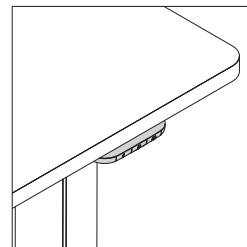

Active touch controller, available as an option, is Bluetooth-enabled and includes digital display, two preset buttons, double-tap automatic drive, and active motion posture reminders.

Tip: Steelcase Rise mobile app is available for download on Apple and Google Play stores. Pair to any active touch controller to access preferences, presets, and posture activity tracking.

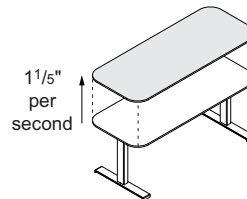

Desks adjust at a rate of 1 1/5" per second.

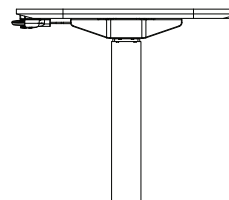

T-leg rectangular column configuration is standard for 23", 24", 28", 29", and 30" depth options.

Gyroscopic obstruction sensing technology

is standard with all Migration Intro desks. The work surface will backtrack when it contacts an object or detects tilt.

Tip: Desks greater than 72"W ship with a secondary obstruction sensing dongle.

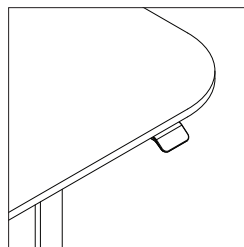

Basic controller is standard and easily adjusts the desk by lifting up or pressing down on the controller.

Steelcase guidance for height adjustment obstruction sensing technology (OST):

- Always read and follow all instructions and safety messages before positioning and using powered, height-adjustable products. Obstruction Sensing Technology (OST) is primarily intended to protect internal mechanisms and is only one part of the overall product system.
- OST is intended to detect hard, immovable objects that contact the desk during raising or lowering.
- OST may not detect soft and/or flexible objects such as padded arm caps, compliant seating surfaces, and cushion tops of peds.
- OST may not detect dynamic and/or articulating objects such as adjustable chair backs and chair arms.
- Different Steelcase height adjustable desks and benches have different types of OST that does not all behave the same.
- OST is disabled during the recalibration/synchronization process, but the unit moves at a much slower speed.

Wiring and Cabling

Primary and secondary electric columns operate quietly and adjust at 1¹/₅" per second.

External power supply is 110V and has 0.1W standby power.

Ships with 10¹/₂" power cord. To meet Chicago power cord requirements, refer to the Migration Intro assembly directions.

Underwriters Laboratory (UL) Listed.

Migration Intro desks are designed to meet U.S. and Canadian national electrical and energy codes and most local building codes. Height-adjustable base is UL listed when constructed in accordance with assembly directions. Local electrical codes vary; consult the local authority having jurisdiction to verify the product as installed is compliant with local code.

Round grommets, available as an option, help manage cable and cords routing from above to below the desk.

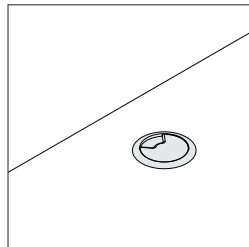

Round grommet inside dimension is 2".

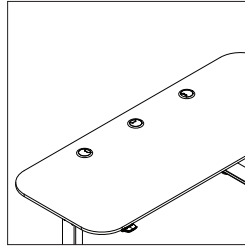

Grommets can be specified left, right, and/or center on the worksurface.

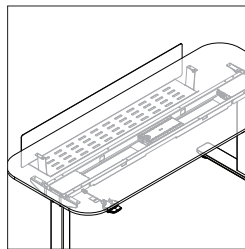

Metal cable tray, available as an option, manages cables and disguises clamps and power strips at the worksurface for a clean aesthetic.

Tip: Metal cable tray is not available as an option on organic bow front and back worksurfaces.

Tip: Worktools smart straps (DSBULKSTRP) can be ordered separately to manage bundled cables in the tray.

Tip: Metal cable tray can be ordered separately; however, pilot holes will not be provided.

► Specifying, page 243

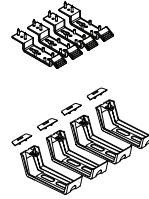

Small and large cable brackets, ordered separately, support horizontal cable management below the worksurface.

► Understanding, page 204

Power strips with C-clamp or front edge mount

are field-installed and provide users with convenient power access and/or utility power beneath the worksurface.

► See page 204 for Migration Pro and Intro Cable Management.

Surface Materials

High-Pressure Laminate Desks

- Laminate
- See page 362
- Open Line laminate (option)

A program including non-Steelcase laminates which are suitable for use on Steelcase products.

► See Surface Materials Reference Manual.

Tip: FSC worksurfaces and modesty panels are not available with an OLL option.

3 mm edge profile

- Plastic

Height-adjustable base

- 0835 Black
- 4231 Arctic White
- 4243 Merle
- 4799 Platinum Metallic

Round grommet

- 6000 Black

Metal cable tray

- Paint

Application Topics

Moving desks can collide with other components. Do not install overhead storage, desk-height power, or desk accessories in the path of height-adjustable desks.

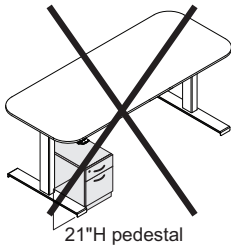

21"H pedestal

On extended height desks, any storage higher than 17³/₄" will impede the height range of the desk.
Tip: Do not place storage underneath controller.

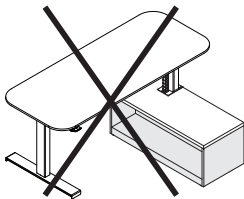

Integrated storage, designed for Migration SE, cannot be used with Migration Intro.

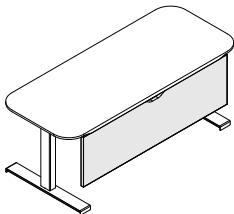

Modesty panels, ordered separately, are parametric in 1/16" increments from 40"—96". Modesty panels are specified to match the desk options. Widths will vary depending on whether square or radius corners are specified.
▶ Specifying, page 248

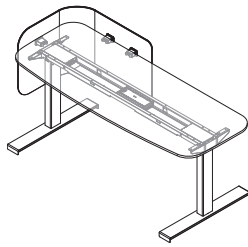

5" radius corners, optioned on rectangular and standard on organic bow front worksurfaces, ship with pilot holes for Flex curved screens (**FLXCS**), and Flex 90° desk mount privacy wrap (**FLXDWR**).

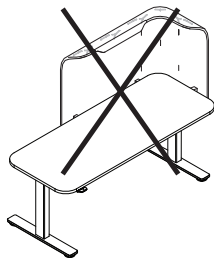

Flex privacy wrap (FLXDWR) is not allowed on 23"D worksurfaces or 24"D bow front worksurfaces.

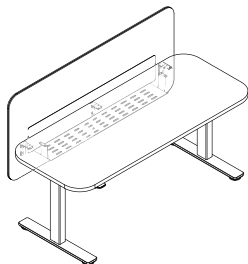

Universal and Sarto privacy/modesty screens can be installed with the metal cable tray.
Tip: When specifying a Sarto privacy/modesty screen equal to or greater than 60"W to use with the cable tray, select the with metal cable tray application option.

Tip: Screen width must be 10¹/₂" wider than the metal cable tray.

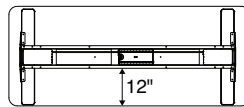

CPU holders that require less than 12"D clearance may be mounted inboard of legs.
Tip: Maximum total weight of CPU holder and CPU is 40 pounds. CPU weight should not exceed 25 pounds.

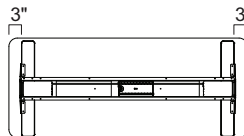

Modular widths have a standard 3" overhang on both sides.
Tip: Parametric width overhangs will vary. Use the SmartTools dimension tool to determine exact overhang.

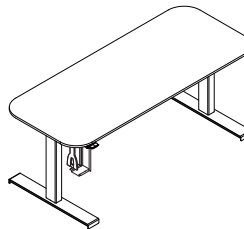

On extended height desks, CPUs installed in a CPU holder should not be installed over the foot or exceed 15" high, or it will impede the height range of the desk.

*Tip: Vertical locking and non-locking CPU cradles **CPRCCL** and **CPRCCN** are not allowed on extended height desks.*

All assemblies meet or exceed ANSI/BIFMA standards.

Desks ship with pre-drilled holes for mounting bases.

Height-adjustable base requires attachment to the worksurface.

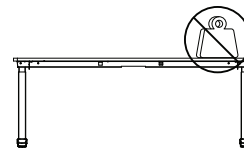

Distribute weight evenly

Height-adjustable base supports a maximum distributed weight capacity of 270 pounds.

Tip: When calculating lifting capacity, subtract the weight of the worksurface, channel, and options selected.

▶ See page 211 for worksurface weights.

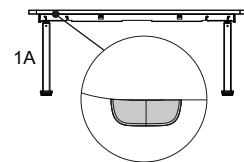
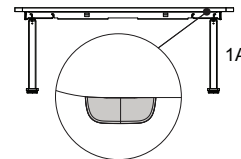

Controllers can be mounted on either the left- or right-hand side of the desk.

Tip: Controller must be located next to the primary leg, which is labeled 1A on the part label.

Migration Intro Height-Adjustable Desks and Bases, continued

Installation

Migration Pro (HA2) bases support a maximum distributed weight capacity of 360 pounds.

Migration Pro with boost high-speed (HA3) bases support a maximum distributed weight capacity of 270 pounds.

Migration Intro (HA1) bases support a maximum distributed weight capacity of 270 pounds.

Tip: When calculating lifting capacity, subtract the weight of the worksurface, understructure, and options (i.e., integrated power, soft edge, or cable tray).

Worksurface Weight

Worksurface W Shape	D	Worksurface Weight	Options					Accessory Modesty Panel Weight
			Understructure Weight*	Flush and Pop-Up Power**	Soft Edge Weight	Cable Tray Weight		

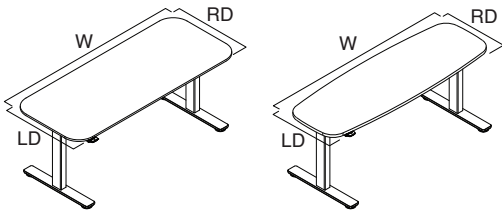

Rectangular	W	D	Worksurface Weight					Understructure Weight*	Flush and Pop-Up Power**	Soft Edge Weight	Cable Tray Weight	Accessory Modesty Panel Weight
			23"D	24"D	28"D	29"D	30"D					
	40"	23", 24", 28", 29", or 30"	26 lb	27 lb	32 lb	33 lb	34 lb	5.6 lb	4.0 lb	N.A.	6.6 lb	12.3 lb
	46"	23", 24", 28", 29", or 30"	30 lb	32 lb	37 lb	38 lb	39 lb	6.8 lb	4.0 lb	N.A.	6.6 lb	14.1 lb
	52"	23", 24", 28", 29", or 30"	34 lb	36 lb	42 lb	43 lb	45 lb	7.8 lb	4.0 lb	N.A.	6.6 lb	16.0 lb
	58"	23", 24", 28", 29", or 30"	38 lb	40 lb	46 lb	48 lb	50 lb	9.0 lb	4.0 lb	2.6 lb	9.1 lb	17.8 lb
	64"	23", 24", 28", 29", or 30"	42 lb	44 lb	51 lb	53 lb	55 lb	10.1 lb	4.0 lb	2.6 lb	9.1 lb	19.7 lb
	70"	23", 24", 28", 29", or 30"	46 lb	48 lb	56 lb	58 lb	60 lb	11.2 lb	4.0 lb	2.6 lb	11.5 lb	21.5 lb
	76"	23", 24", 28", 29", or 30"	50 lb	52 lb	61 lb	63 lb	65 lb	12.4 lb	4.0 lb	2.6 lb	11.5 lb	23.4 lb
	82"	23", 24", 28", 29", or 30"	54 lb	56 lb	66 lb	68 lb	70 lb	12.4 lb	4.0 lb	2.6 lb	11.5 lb	25.2 lb
	88"	23", 24", 28", 29", or 30"	58 lb	60 lb	70 lb	73 lb	76 lb	12.4 lb	4.0 lb	2.6 lb	11.5 lb	27.1 lb
	94"	23", 24", 28", 29", or 30"	62 lb	65 lb	75 lb	78 lb	81 lb	12.4 lb	4.0 lb	2.6 lb	11.5 lb	28.9 lb

*Understructure weight is without optional worksurface overhang (available on Migration Pro only).

** Flush and pop-up power weights include two utility power options. Without utility power, the weight is two pounds.

Tip: Not all worksurface widths and options are available on all desks. See options availability chart for each product (prefixes HA1, HA2, and HA3).

Migration Pro and Intro Cable Management

Both vertical and horizontal cable management are important elements for cleaning up the cords that exists beneath today's height-adjustable desks.

Metal cable tray manages cables and power at worksurface height for a clean aesthetic. Available as an option or can be ordered separately.

► Specifying, page 243

Small and large cable brackets, ordered separately, manage cables and cords horizontally under the worksurface.

► Specifying, page 245

Universal cable management kit, ordered separately, provides easy management and access to cords, cables, and utility power under the desk.

► Specifying, page 246

Cable riser, ordered separately, supports high-capacity cable management vertically from the floor to the underside of the desk. Leg attachment is available in 24 paint finishes. Chain is available in 6527 Merle or 6053 Seagull.

► Specifying, page 244

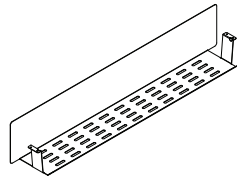

Metal cable tray

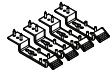

Small cable brackets

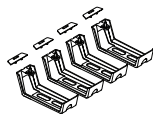

Large cable brackets

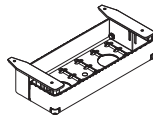

Universal cable management kit

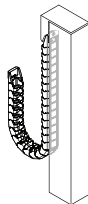

Migration Pro and Intro cable riser

Product Details

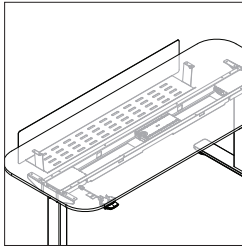

Metal cable tray, available as an option, manages cables and disguises clamps and power strips at the worksurface for a clean aesthetic.

Tip: Metal cable tray is not available as an option on organic bow front and back worksurfaces.

Tip: Metal cable tray can be ordered separately; however, pilot holes will not be provided.

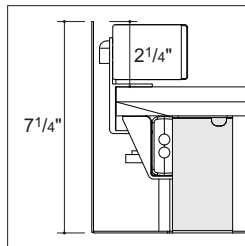

Metal cable tray is a fixed height 2¹/₄" above the worksurface. The overall height of the tray is 7¹/₄".

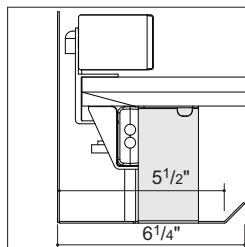

Inside dimension of the metal cable tray is 5¹/₂". The overall depth of the tray is 6¹/₄".

Tip: CF maximum-duty arm bracket (CFSPSGLBASE), does not fit within the metal cable tray.

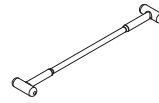

Smart straps are available in a bulk pack of 100 straps, **DSBULKSTRP**.

Tip: Smart straps can be used to manage bundled cables in the metal cable tray.

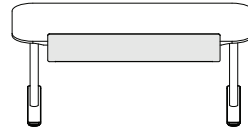

Metal cable tray, when optioned, is sized to not interfere with grommet locations and work with Universal and Sarto privacy/modesty screens.

Tip: If ordered separately, the mounting brackets require under worksurface clearance that is 1¹/₂" shorter than the metal cable tray width.

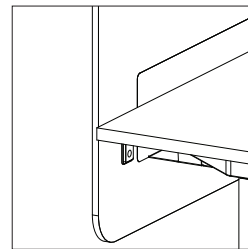

Metal cable tray can be installed with Sarto and Universal privacy/modesty screens. When specifying a Sarto screen equal to or greater than 60"W to use with the cable tray, select **WTRAYAPP** option.

Tip: Screen width must be 10¹/₂" wider than metal cable tray.

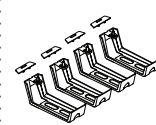

Small and large cable brackets, ordered separately, support horizontal cable management below the worksurface.



Inside dimensions of the small cable brackets are 3⁵/₈"D x 1³/₈"W x 1³/₁₆"H.



Inside dimensions of the large cable bracket are 6"D x 2¹/₄"W x 1¹/₂"H.

	Metal Tray Width	Minimum Allowed Desk Width	Minimum Allowed Screen Width
Small	30"W	40"W	41 ¹ / ₂ "W
Medium	41 ¹ / ₂ "W	48"W	52"W
Large	52"W	58"W	63 ¹ / ₂ "W

Tip: Follow the minimum width rules when mounting a metal cable tray only or when used in combination with Sarto or Universal privacy/modesty screens.

Tip: When specifying separately from the desk, verify fit in the field to ensure it is mounted free from interferences with worksurface options (i.e. integrated flush or pop-up power, grommets, etc.).

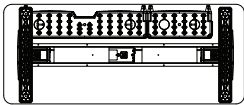

Universal cable management tray is designed to fit behind the understructure on Migration Pro and Intro for both T- and C-leg configurations.

Tip: On C-leg desks, universal cable management tray and modesty panel cannot be used together.

Tip: Universal cable management trays and flush mount power option will not fit on 23/24"D T-leg or 28/29/30"D C-leg desks because of interference.

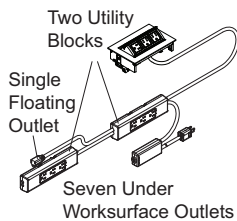

Universal cable management tray - small tray, **DSMTRAYSM**, holds four outlets and large tray, **DSTRAYLG**, holds seven outlets under worksurface utility power.

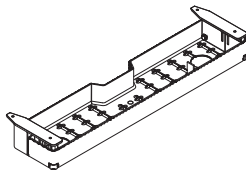
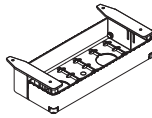

Universal cable management tray is available in two sizes: small and large.

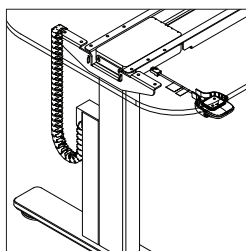

Cable riser connects to the back of the leg. The inside dimensions of the high-capacity chain are 1¹/₄"D x 1⁷/₁₆"W to accommodate a variety of cord sizes. Overall depth of chain is 1⁷/₁₆".

Tip: Select the rectangular column shape to work with Migration Intro and Migration Pro with boost high-speed.

Tip: Migration Pro is available with a rectangular or round column option.

Surface Materials

Metal cable tray

- Paint

Cable brackets and universal cable management kit

- 6527 Merle

Cable riser

Leg connection

- Paint
- Chain
- 6053 Seagull
- 6527 Merle

Desk Width	Maximum Allowed Universal Tray Size
40"W–45 ¹⁵ / ₁₆ "W	Small
46"W–51 ¹⁵ / ₁₆ "W	Small
52"W–57 ¹⁵ / ₁₆ "W	Small
58"W–63 ¹⁵ / ₁₆ "W	Large
64"W–69 ¹⁵ / ₁₆ "W	Large and Small
70"W–75 ¹⁵ / ₁₆ "W	Large and Small
76"W–96"W	Two Large

Tip: If optioning integrated flush or pop-up power, grommets, or mounting screens, the universal cable management tray size recommendations may not apply. Fit should be verified in the field.

Migration Pro and Intro Modesty Panels

Modesty panels provide modesty when applications require this aesthetic. Modesty panels, available in laminate and veneer, attach to the worksurface.

► Specifying, page 248

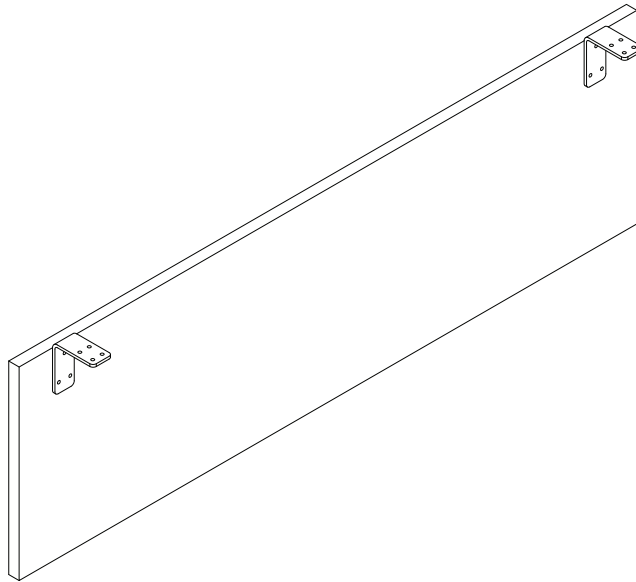

Product Details

Modesty panels are parametric in width from 40"W to 96"W in 1/16" increments. To specify modesty panel, desk width, worksurface shape, and knife edge condition must be selected to provide full width modesty.

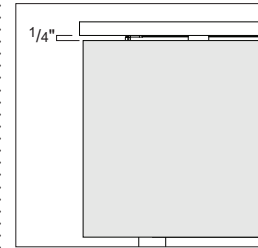

Gap is 1/4" between underside of worksurface and top of modesty panel. Panel can be flush to the worksurface or inset.

Tip: CF C-clamp,

CFSERIESCC, fits with the modesty panel with or without scallop.

Tip: CF maximum-duty arm C-clamp, CFSPSGLBASE, does not fit with the modesty panel in any condition.

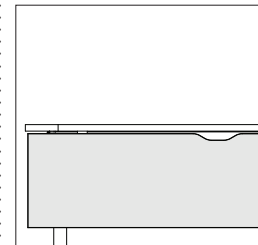

Modesty panel can be optioned with a scallop on laminate panels only.

Modesty panels are defaulted in the horizontal grain direction for both laminate and wood veneer. Optional vertical grain direction can be specified. Grain direction specification is only allowed up to 60" wide.

Actual Dimensions

	Modesty Panel Widths (Flush to back of worksurface)	
	Without Knife Edge	With Knife Edge*
Rectangular worksurface with square corners	1/8" shorter than desk width	4" shorter than desk width
Rectangular worksurface with 2" radius corners	4" shorter than desk width	11" shorter than desk width
Rectangular worksurface with 5" radius corners	10" shorter than desk width	11" shorter than desk width
Organic bow front worksurface	10" shorter than desk width	11" shorter than desk width
Organic bow front and back worksurface	Inset only	Inset only
Height	14 ³ / ₈ "	14 ³ / ₈ "
Overall height	14 ⁷ / ₈ "	14 ⁷ / ₈ "
Thickness	3/4"	3/4"

* Modesty panel will align with the knife edge transition at the back of the worksurface.

Tip: Size determined by desk width, corner type, and knife edge condition.

Tip: Overall height is measured from bottom of worksurface to bottom of panel.

Tip: Parametric modesty panel widths can be specified from 40"W to 96"W in 1/16" increments.

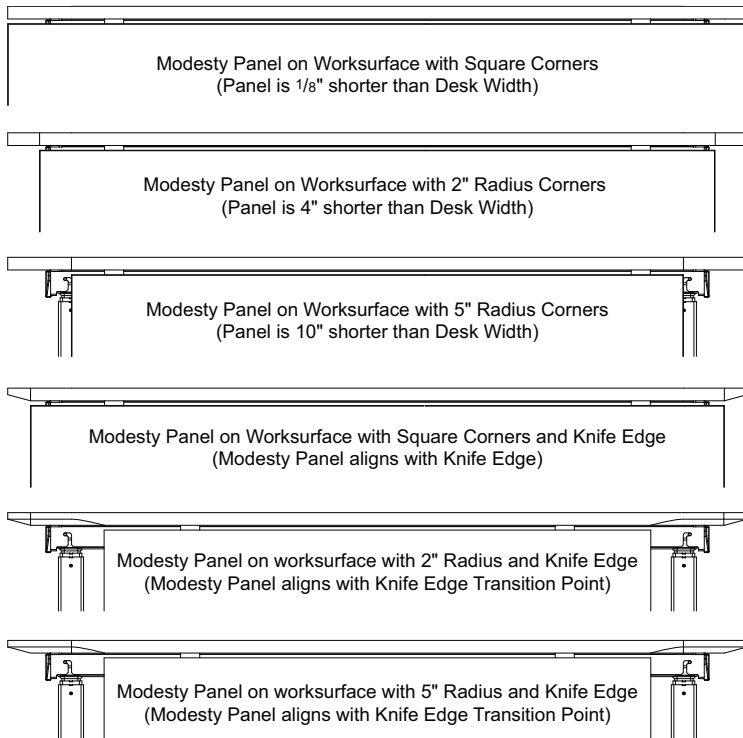

Surface Materials

High-Pressure Laminate Panel

- Laminate
 - ▶ See page 362
 - Open Line laminate (option)
- A program including non-Steelcase laminates which are suitable for use on Steelcase products.
- ▶ See *Surface Materials Reference Manual*.
- Tip: FSC worksurfaces and modesty panels are not available with an OLL option.*

3 mm edge profile

- Plastic

Wood Veneer Panel

- Wood veneer (standard)
- Customiz stain (option)

3 mm edge profile

- Wood veneer to match panel

Bracket

- 7360 Merle

Application Topics

When specifying a modesty panel, consider flush or pop-up power and/or grommets to cleanly manage cables below the desk.

Tip: If specifying veneer modesty panel, the scallop is not an option, so a grommet is recommended.

Tip: On C-leg desk configurations, universal cable management tray and modesty panel cannot be used together.

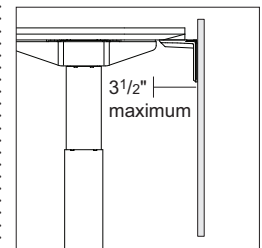

Modesty panels may be inset a maximum of 3 1/2" from the back of the work surface on C-leg desks. On T-leg desks the maximum inset varies by worksurface depth; 23"D maximum is 4 1/2" and 30"D is 8".

Tip: Inset modesty panels do not work with pop-up power on 23" or 24"D T-leg or C-leg desks. Flush power, round grommets, and cable brackets do not work on C-leg desks.

Privacy/modesty, curved, or wrap screens cannot be used with a modesty panel.

When using a modesty panel with Universal or Sarto privacy screens verify placement in CET to avoid interference.

Migration SE Height-Adjustable Desks and Bases

Migration SE supports wellbeing at work by allowing users to move between seated and standing postures throughout the workday.
 ▶ Specifying, page 250



CarbonNeutral.com

Now available as a CarbonNeutral product, making sure our commitment to a more sustainable future helps yours too.

Corners are available in both square or radius options. The radius corner option offers both a 2" and 5" radius.

Push button controller adjusts height at a rate of 1 $\frac{3}{10}$ " per second. Two options are available—up/down or 4 pre-set.

Base supports a maximum distributed weight capacity of 250 pounds (2-leg) and 330 pounds (3-leg).
Tip: When calculating lifting capacity, subtract the weight of the worksurface.
 ▶ See page 211 for worksurface weights.

Edge is available in 3 mm edge profile.

Desk foot is available in square, mitered edge, or height saver foot with casters.

The extended height adjustable base adjusts from 22 $\frac{2}{5}$ "-48 $\frac{7}{10}$ " in any increment.

Migration SE offers both T- and C-leg configurations on rectangle desks, and T-leg configurations on 3-leg corner desks.

Desk has a wood core with a High-Pressure Laminate or wood veneer surface and is 1" thick.

Internal motors with electronic synchronization drive.

The basic height adjustable base adjusts from 28 $\frac{3}{10}$ "-46 $\frac{9}{10}$ " in any increment.

Leveling glides adjust $\frac{1}{2}$ " to install desk on uneven floors.

Migration SE desks are available in 90° and 120° 3-leg configurations.

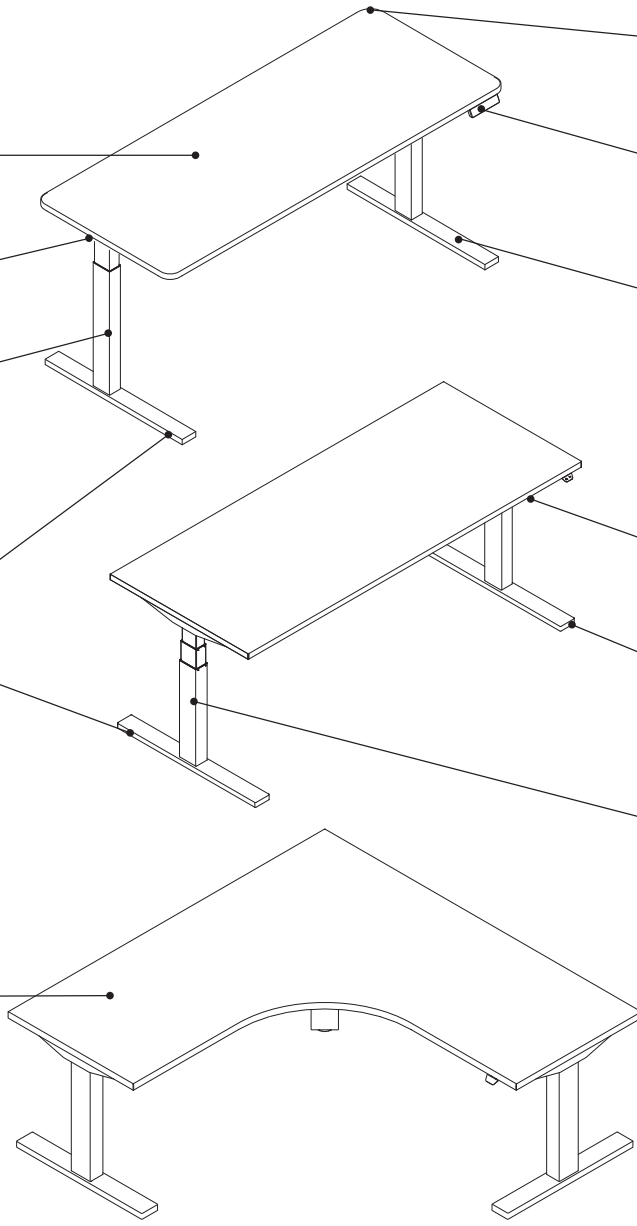

Product Details

High-Pressure Laminate Desks

Front (user's) edge profile is available in 3 mm edge profile.

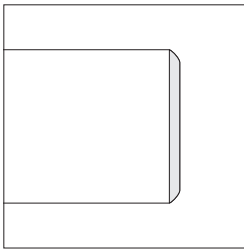

PVC-free, 3 mm edge profiles are proprietary polyolefin blend for all solid colors and three woodgrain finishes. Matching 1 mm side and back edges are also PVC-free.

► See *Surface Materials* in this book for specific PVC-free availability, page 362.

Edge profile finishes are specified separately from laminate color.

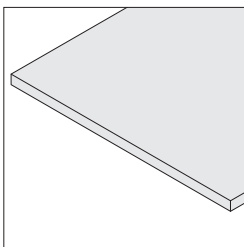

Square corners are standard and have 90° corners on all four sides.

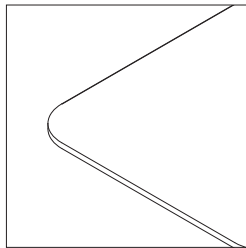
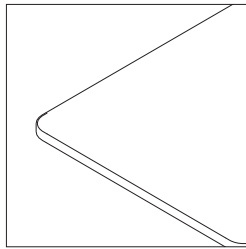

Radius corners are available as an option on rectangle desks with 2" radius or 5" radius on all four corners and will include 3 mm edge profile on all sides.

Tip: Radius corners are not available on 90° and 120° corner desks.

Wood Veneer Desks

Front (user's) edge profile is wood veneer with a square (3 mm) radius.

Side and back edges are flat. Wood edge color matches finish specified for desk.

Overhang is available as an option. The maximum overhang available as a standard option is 12"W.

Tip: 76"W rectangle desks come with a 4" overhang on each side.

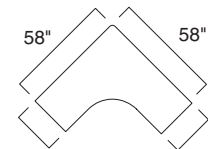

23", 24", 29", or 30" 23", 24", 29", or 30"

90° corner desks can be specified 23", 24", 29", or 30" deep. Right- and left-hand depths are not required to match. Right- and left-hand widths are not required to match.

Tip: If left or right width is greater than 60"W, then the opposite side width must be less than or equal to 60"W.

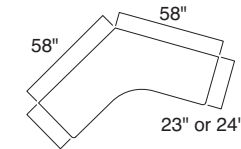

23" or 24"

120° corner desks can be specified 23" or 24" deep. Right- and left-hand depths must match and right- and left-hand widths must match.

Overhangs on 90° corner desks are allowed on one side only. Overhangs on 120° corner desks are not allowed.

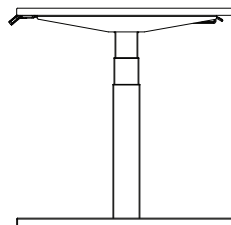

T-leg configuration is available on rectangle and corner desks. Rectangle T-leg desks are available in 23"/24", 28"/29"/30", and 35"/36" depth options. Corner T-leg desks are available in 23", 24", 29", and 30" depth options.

Corner desks are 3-leg desks and are available in a T-leg configuration.

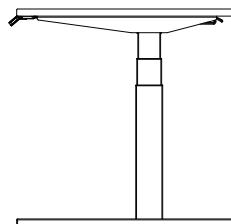

C-leg configuration is available on rectangle desks only in a 29"/30" depth option to maximize leg clearance below.

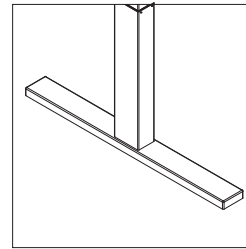

Squared-edge foot offers a squared front and back edge flush to the floor. The glide adjustments on this foot are 1/2".

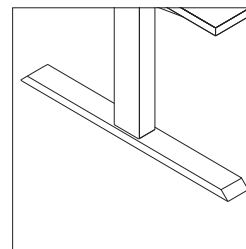

Mitered-edge foot is available as an option on rectangle desks. This style of foot offers a mitered front and back edge flush to the floor. The glide adjustments on this foot are 1/2".

Tip: Mitered-edge foot is only available on rectangle desks.

Slide glides are available and can be added for user mobility.

► See page 275

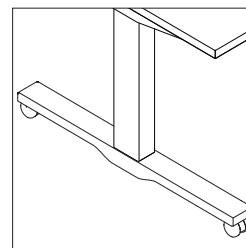

Height saver foot is available as an option on T-leg rectangle desks. This style foot offers 50 mm casters without changing the height range of the desk. The front two casters lock while the back two casters do not lock.

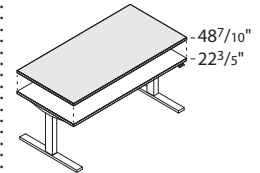

Migration SE extended height adjustable desk adjusts from 22³/₅"–48⁷/₁₀" in any increment. The basic height adjustable desk adjusts from 28³/₁₀"–46⁹/₁₀" in any increment.

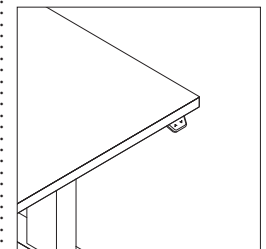

Up/down controller is available as an option and easily adjusts height of desk, at a rate of 1³/₁₀" per second, by simply pushing the up and down arrows.

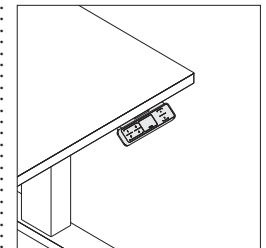

4 pre-set programmable controller is available as an option. It allows users to set the seated and standing height positions or pre-set heights for multiple users. When activated, the digital display will show the height of desk.

Obstruction sensing technology is standard with all Migration SE desks. The worksurface will back-track when it makes contact with an object.

Steelcase guidance for height adjustment obstruction sensing technology (OST):

- Always read and follow all instructions and safety messages before positioning and using powered, height-adjustable products. Obstruction Sensing Technology (OST) is primarily intended to protect internal mechanisms and is only one part of the overall product system.
- OST is intended to detect hard, immovable objects that contact the desk during raising or lowering.
- OST may not detect soft and/or flexible objects such as padded arm caps, compliant seating surfaces, and cushion tops of peds.
- OST may not detect dynamic and/or articulating objects such as adjustable chair backs and chair arms.
- Different Steelcase height adjustable desks and benches have different types of OST that does not all behave the same.
- OST is disabled during the recalibration/synchronization process, but the unit moves at a much slower speed.

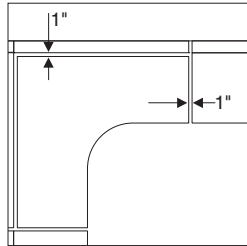
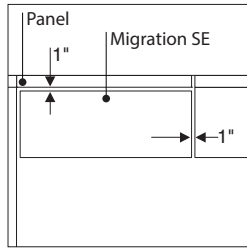

Rectangle and corner desk sizes are listed in actual dimensions to allow for 1" gap to adjacent furniture eliminating any pinch points.



CarbonNeutral.com
CarbonNeutral product in the Migration SE portfolio helps organizations achieve their carbon emissions goals. Order **MGSLTRQCN**, **MGELTRQCN**, **MGSLCRQCN**, or **MGELCRQCN** to specify Migration SE with CarbonNeutral product certification.

Wiring and Cabling

Electric motor with whisper quiet operation adjusts at 1 $\frac{3}{10}$ " per second. Motor is 24V DC and includes a 9' power cord. Motor for 2-leg desk has a 0.3W standby power and 3-leg desk has a 0.1W standby power.

Migration SE desks and bases are listed by ETL.
Tip: Migration SE base only is ETL recognized because alternative worksurfaces do not create an ETL listed product.
▶ See page 32

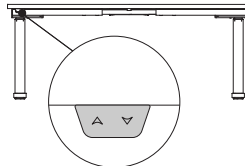
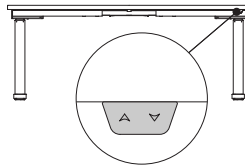

Controller can be mounted on either the left- or right-hand side of the top and is field-installed.

Power and data strips are field-installed on either a SOTO rail or worksurface. Specify appropriate attachment bracket depending on application.
▶ See page 318 for *Cable and Power Management*.

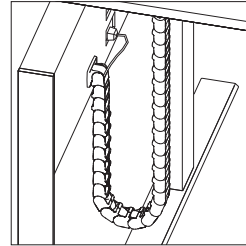
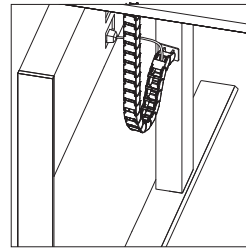

Cable riser-fence connections inside dimensions are 1"D x 1"W to accommodate a variety of cord sizes. The fence connection can go to the leg or the fence. Overall depth is 2".

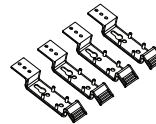

Cable brackets, ordered separately, support horizontal cable management below the worksurface.
▶ Specifying, page 274



Inside dimensions of cable brackets are 3 $\frac{5}{8}$ "D x 1 $\frac{3}{8}$ "W x 1 $\frac{1}{16}$ "H.

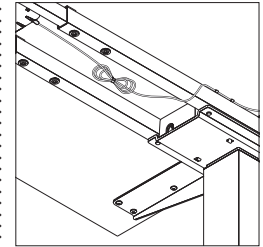

Cable management includes two cable clips and two ties to help manage desk cables.

Surface Materials

High-Pressure Laminate Desk

- Laminate
- ▶ See page 362
- Open Line laminate (option)
- A program including non-Steelcase laminates which are suitable for use on Steelcase products.
- ▶ See *Surface Materials Reference Manual*.

3 mm edge profile

- Plastic

Wood Veneer Desk

- Wood veneer (standard)
- Customiz stain (option)

Square 3 mm edge profile

- Wood veneer to match desk

Height-adjustable base

- 4799 Platinum Metallic
- 7207 Black
- 7241 Arctic White
- 7360 Merle
- *Tip: 2-leg understructure will always be 7207 Black.*

Application Topics

Moving desks can collide with other components. Do not install overhead storage, desk-height power, or desk accessories in the path of height-adjustable desks.

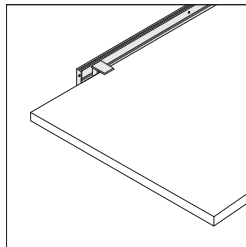

SOTO rail and SlatRail mount to desks to support worktools, freeing up desk space.

- ▶ See *Steelcase Worktools Specification Guide*.

Integrated storage is allowed on Migration SE rectangle and corner desks. Two storage units may be used on one rectangle desk, however, user space will be limited. Only one storage unit can be used on corner desks.

76"W Migration SE desks ship standard with a 4" overhang, which only allows it to be used with integrated storage in a stand-alone application. The desk extends past the integrated storage below.

Integrated storage on Migration SE corner desks cannot be used if the desk has an overhang.

Migration SE 90° corners with one side that is 70"W and wider can be used with integrated storage.

Migration SE 120° corners that are 52"W or wider can be used with integrated storage.

Integrated storage cannot be used on Migration SE desk with 5" radius corners.

When attaching 90° desk mount privacy wrap to the Migration SE worksurface with radius corners, a worksurface overhang is not allowed on either side of the worksurface.

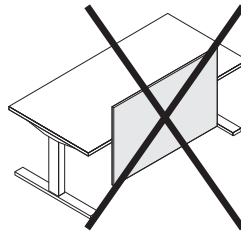

Universal boundary screens are not permitted on height-adjustable desks, as they do not pass minimum safety requirements which could result in the desk tipping over.

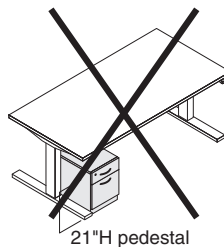

On extended height desks, any storage higher than 18³/₄" will impede height range of desk. On basic height desks, any storage higher than 24" will impede the height range of the desk.

All assemblies meet or exceed ANSI/BIFMA standards.

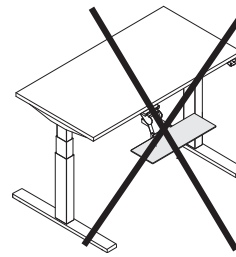

Keyboard assemblies are not allowed on 23"D or smaller than 46"W height-adjustable desks. They do not meet minimum safety requirements.

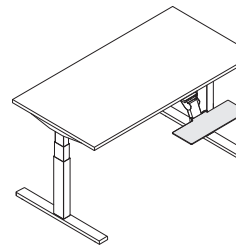

Steelcase keyboard assemblies can be installed on 29"/30"D Migration SE. Specify with an 11" track.

WARNING

Read base only warranty limitations.

- ▶ See page 32 for *Workstation Design Guidelines and Requirements*.

Installation

Desks ship with pre-drilled holes for mounting bases.

Height-adjustable base requires attachment to the worksurface.

Base supports a maximum of distributed weight capacity of 250 pounds (2-leg rectangle) and 330 pounds (3-leg corner).

Tip: When calculating lifting capacity of rectangle desks, subtract the weight of the worksurface (see below) and the weight of the understructure (18.2 pounds).

Tip: When calculating lifting capacity of corner desks, subtract the weight of the worksurface (see below) and the weight of the understructure (27.8 pounds).

Migration SE Height-Adjustable Desks and Bases, continued

Base supports a maximum distributed weight capacity of 250 pounds (2-leg) and 330 pounds (3-leg).
 Tip: When calculating lifting capacity, subtract the weight of the worksurface and understructure.

Desk Weight

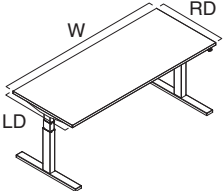
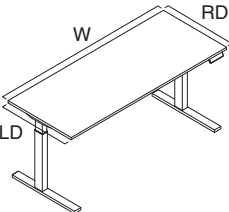
Worksurface Shape	W	LD	RD	Worksurface Weight
Rectangle Desk				
T-Leg	C-Leg			
				
Rectangular— 23" or 24"D	46"	23" or 24"	23" or 24"	30 lb
	52"	23" or 24"	23" or 24"	34 lb
	58"	23" or 24"	23" or 24"	38 lb
	64"	23" or 24"	23" or 24"	42 lb
	70"	23" or 24"	23" or 24"	46 lb
	76"	23" or 24"	23" or 24"	51.8 lb
Rectangular— 28", 29", or 30"D	46"	29" or 30"	29" or 30"	38 lb
	52"	29" or 30"	29" or 30"	43 lb
	58"	29" or 30"	29" or 30"	48 lb
	64"	29" or 30"	29" or 30"	53 lb
	70"	29" or 30"	29" or 30"	58 lb
	76"	29" or 30"	29" or 30"	62.6 lb
Rectangular— 35" or 36"D	46"	35" or 36"	35" or 36"	46 lb
	52"	35" or 36"	35" or 36"	52 lb
	58"	35" or 36"	35" or 36"	58 lb
	64"	35" or 36"	35" or 36"	64 lb
	70"	35" or 36"	35" or 36"	70 lb
	76"	35" or 36"	35" or 36"	75.5 lb

Tip: C-leg is available in 29" and 30" depth only.

Desk Weight

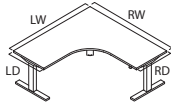
Worksurface Shape	Worksurface Weight					
	LW	RW	LD and RD 23"D/23"D	LD and RD 23"D/24"D	LD and RD 23"D/29"D	LD and RD 23"D/30"D
	46"	52"	49.5 lb	50.3 lb	54.4 lb	55.3 lb
	46"	58"	53.4 lb	54.4 lb	59.4 lb	60.4 lb
	46"	64"	57.3 lb	58.5 lb	64.3 lb	65.5 lb
	46"	70"	61.2 lb	62.6 lb	69.3 lb	70.6 lb
	46"	76"	65.2 lb	66.7 lb	74.2 lb	75.7 lb
	52"	46"	49.5 lb	50.1 lb	53.4 lb	54.1 lb
	52"	52"	54.4 lb	55.2 lb	59.4 lb	60.2 lb
	52"	58"	58.3 lb	59.3 lb	64.3 lb	65.3 lb
	52"	64"	62.3 lb	63.4 lb	69.2 lb	70.4 lb
	52"	70"	66.2 lb	67.5 lb	74.2 lb	75.5 lb
	52"	76"	70.1 lb	71.6 lb	79.1 lb	80.6 lb
	58"	46"	53.4 lb	54.1 lb	57.3 lb	58 lb
	58"	52"	58.3 lb	59.2 lb	63.3 lb	64.1 lb
	58"	58"	62.3 lb	63.3 lb	68.2 lb	69.2 lb
	58"	64"	66.2 lb	67.3 lb	73.2 lb	74.3 lb
	58"	70"	70.1 lb	71.4 lb	78.1 lb	79.4 lb
	58"	76"	74 lb	75.5 lb	83 lb	84.6 lb
	64"	46"	57.3 lb	58 lb	61.2 lb	61.9 lb
	64"	52"	62.3 lb	63.1 lb	67.2 lb	68 lb
	64"	58"	66.2 lb	67.2 lb	72.1 lb	73.1 lb
70"	46"	61.2 lb	61.9 lb	65.2 lb	65.8 lb	
70"	52"	66.2 lb	67 lb	71.1 lb	71.9 lb	
70"	58"	70.1 lb	71.1 lb	76.1 lb	77.1 lb	
76"	46"	65.2 lb	65.8 lb	69.1 lb	69.7 lb	
76"	52"	70.1 lb	70.9 lb	75 lb	75.9 lb	
76"	58"	74 lb	75 lb	80 lb	81 lb	

Migration SE

Migration SE Height-Adjustable Desks and Bases, continued

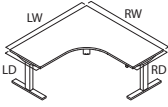
Desk Weight					
Worksurface Shape	Worksurface Weight				
	LW	RW	LD and RD 24"D/24"D	LD and RD 24"D/29"D	LD and RD 24"D/30"D
	46"	52"	50.9 lb	54.9 lb	55.7 lb
	46"	58"	55 lb	59.9 lb	60.8 lb
	46"	64"	59.1 lb	64.8 lb	65.9 lb
	46"	70"	63.2 lb	69.7 lb	71 lb
	46"	76"	67.3 lb	74.7 lb	76.2 lb
	52"	46"	50.9 lb	54.1 lb	54.7 lb
	52"	52"	56 lb	60 lb	60.8 lb
	52"	58"	60.1 lb	65 lb	65.9 lb
	52"	64"	64.2 lb	69.9 lb	71 lb
	52"	70"	68.3 lb	74.8 lb	76.1 lb
	52"	76"	72.4 lb	79.8 lb	81.3 lb
	58"	46"	55 lb	58.2 lb	58.8 lb
	58"	52"	60.1 lb	64.1 lb	64.9 lb
	58"	58"	64.2 lb	69 lb	70 lb
	58"	64"	68.3 lb	74 lb	75.1 lb
	58"	70"	72.4 lb	78.9 lb	80.2 lb
	58"	76"	76.5 lb	83.9 lb	85.3 lb
	64"	46"	59.1 lb	62.2 lb	62.9 lb
	64"	52"	64.2 lb	68.2 lb	69 lb
	64"	58"	68.3 lb	73.1 lb	74.1 lb
70"	46"	63.2 lb	66.3 lb	67 lb	
70"	52"	68.3 lb	72.3 lb	73.1 lb	
70"	58"	72.4 lb	77.2 lb	78.2 lb	
76"	46"	67.3 lb	70.4 lb	71 lb	
76"	52"	72.4 lb	76.4 lb	77.2 lb	
76"	58"	76.2 lb	81.3 lb	82.3 lb	

Desk Weight

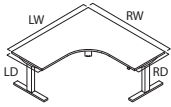
Worksurface Shape	Worksurface Weight					
	LW	RW	LD and RD 29"D/29"D	LD and RD 29"D/30"D	LD and RD 30"D/30"D	
	90° Corner 3-Leg	46"	52"	57.3 lb	58 lb	58.4 lb
		46"	58"	62.3 lb	63.1 lb	63.5 lb
		46"	64"	67.2 lb	68.2 lb	68.7 lb
		46"	70"	72.2 lb	73.3 lb	73.8 lb
		46"	76"	77.1 lb	78.4 lb	78.9 lb
		52"	46"	57.3 lb	57.8 lb	58.4 lb
		52"	52"	63.3 lb	63.9 lb	64.6 lb
		52"	58"	68.2 lb	69 lb	69.7 lb
		52"	64"	73.2 lb	74.2 lb	74.8 lb
		52"	70"	78.1 lb	79.3 lb	79.9 lb
		52"	76"	83 lb	84.4 lb	85 lb
		58"	46"	62.3 lb	62.8 lb	63.5 lb
		58"	52"	68.2 lb	68.9 lb	69.7 lb
		58"	58"	73.2 lb	74 lb	74.8 lb
		58"	64"	78.1 lb	79.1 lb	79.9 lb
		58"	70"	83 lb	84.2 lb	85 lb
		58"	76"	88 lb	89.3 lb	90.1 lb
		64"	46"	67.2 lb	67.7 lb	68.7 lb
		64"	52"	73.2 lb	73.8 lb	74.8 lb
		64"	58"	78.1 lb	78.9 lb	79.9 lb
	70"	46"	72.2 lb	72.6 lb	73.8 lb	
	70"	52"	78.1 lb	78.8 lb	79.9 lb	
	70"	58"	83 lb	83.9 lb	85 lb	
	76"	46"	77.1 lb	77.6 lb	78.9 lb	
	76"	52"	83 lb	83.7 lb	85 lb	
	76"	58"	88 lb	88.8 lb	90.1 lb	

Migration SE Height-Adjustable Desks and Bases, continued

Desk Weight

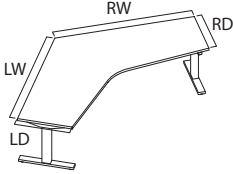
Worksurface Shape	Worksurface Weight			
	LW	RW	LD and RD 23"D/23"D	LD and RD 24"D/24"D
	46"	46"	58 lb	59.7 lb
	52"	52"	66.9 lb	68.9 lb
	58"	58"	75.9 lb	46.8 lb
	64"	64"	84.8 lb	46.8 lb

Overhang

Rectangle Desk	Overhang				
	3"W	4"W	6"W	9"W	12"W
Desk Width 46"–57.9"	N.A.	N.A.	N.A.	N.A.	N.A.
58"–63.9"	•	N.A.	•	N.A.	N.A.
64"–70"	•	N.A.	•	•	•
70.06"–75.9"	N.A.	N.A.	•	•	•
76"*	N.A.	•	•	•	•

*Tip: 76"W has a standard 4" overhang on both sides.

90° 3-Leg Corner Desk Overhang

Desk Width	Overhang			
	3"W	6"W	9"W	12"W
46"–57.9"	N.A.	N.A.	N.A.	N.A.
58"–63.9"	•	•	•	•
64"–69.9"	•	•	•	•
70"–75.9"	•	•	•	•
76"	•	•	•	•

Tip: Overhangs are allowed on one side only.

Tip: 120° corner desks do not allow overhangs.

Universal One-High and 1.5-High Open Laterals

For Migration SE Application

Universal One-High and 1.5-High open laterals for Migration SE application seamlessly integrates the Migration SE T-leg into universal storage. It provides a clean aesthetic with an efficient footprint. Ease of access to your items under the desk is convenient with this open storage configuration.
 ▶ Specifying, page 268

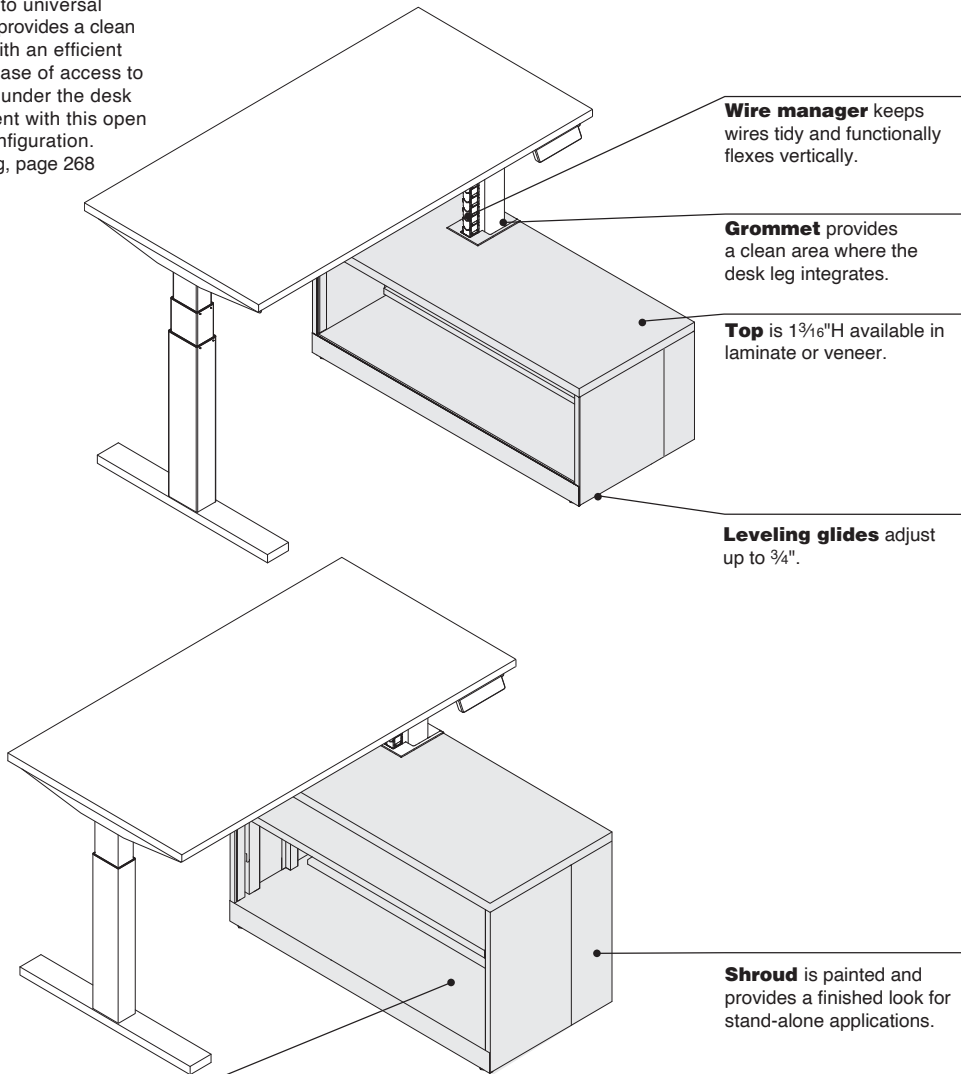

Usable depth in One-High and 1.5-High open laterals is 10 $\frac{7}{10}$ "D.

Actual Dimensions

	One-High	1.5-High
Depth with flush steel open front	18"	18"
Depth with proud steel open front	18 $\frac{7}{8}$ "	18 $\frac{7}{8}$ "
Usable Depth	10 $\frac{7}{10}$ "	10 $\frac{7}{10}$ "
Width	30", 36", and 42"	30", 36", and 42"
Height	16"	22"

Product Details

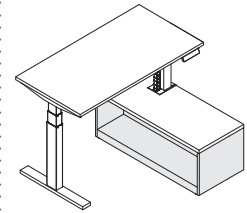

One-High storage can be used with Migration SE with T-leg extended range desks or basic range desks.

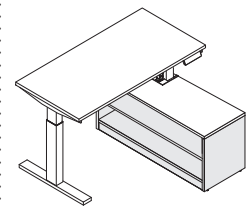

1.5-High storage can only be used with Migration SE with T-leg basic range desks.

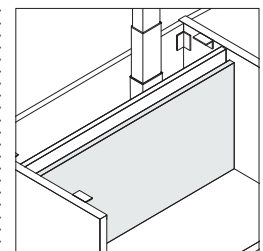

One-High and 1.5-High storage for Migration SE with T-leg application have a removeable interior back panel to allow access to the Migration SE with T-leg base.

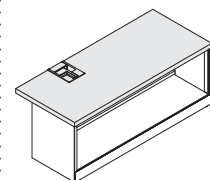

Laminate and wood veneer tops with square edge profile are available. Tops are 1 $\frac{3}{16}$ "H.

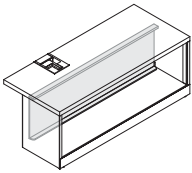

Removable interior cover provides access to power outlets that can be located in the panel behind storage unit.

Integrated open laterals do not accommodate 24"D, 30"D, or 36"D Migration SE workspaces.

Case Widths and Migration SE Foot Dimensions

		Migration SE Worksurface Depth		
		23"	29"	35"
Migration SE Open Lateral Width	30"	•	N.A.	N.A.
	36"	•	•	•
	42"	•	•	•

30"W Migration SE open laterals are not permitted with 29"D or 35"D Migration SE desks due to the size of the desk foot. All other integrated storage widths are permitted with all Migration SE desk depths.

Integrated leg options apply to One-High and 1.5-High units only and are meant for use with Migration SE T-leg height-adjustable rectangle and corner desks.

Application Topics

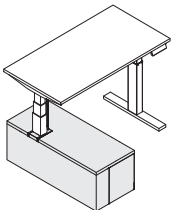

Application: Migration SE left

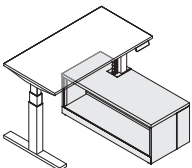

Application: Migration SE right

Application is determined by which leg of the Migration SE desk is located inside the storage.

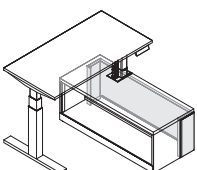

Shroud is used to finish off the back of the storage when application is used as stand-alone unit.

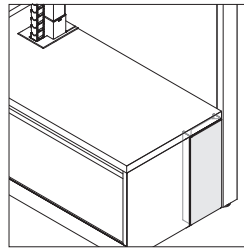

Filler is used in end-of-run applications where end of storage unit will be visible.

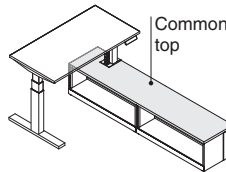

No top option on lateral file is available for use with a Universal common top shared with an adjacent lateral.

Universal common top for Migration SE application, ordered separately, is available in laminate or veneer. Cut-out for Migration SE T-leg is available on the left side or the right side of the Universal common top. Migration SE desk cannot be placed in the middle of the Universal common top.

76"W Migration SE desks ship standard with a 4" overhang, which only allows it to be used with integrated storage in a stand-alone application. The desk extends past the Universal One-High and 1.5-High open lateral storage below.

Integrated storage on Migration SE corner desks cannot be used if the desk has an overhang.

Migration SE 90° corners with one side that is 70"W and wider can be used with integrated storage.

Migration SE 120° corners that are 52"W or wider can be used with integrated storage.

Integrated storage cannot be used on Migration SE rectangle desk with 5" radius corners.

Universal privacy/modesty or Sarto privacy/modesty screens must be undersized and justified to the outside when used with One-High and 1.5-High storage units.

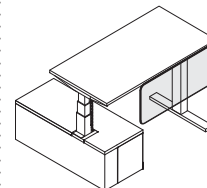

When used with One-High and 1.5-High integrated storage, screens used in the modesty position must be a minimum of 18" shorter than worksurface width to allow for pinch point clearances.

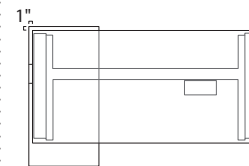

To help avoid pinch points, the Universal One-High and 1.5-High open laterals for Migration SE application extend 1" past the back of the Migration SE worksurface. Open laterals for Migration SE are only available on Migration SE T-leg desks 23"D, 29"D, and 35"D.

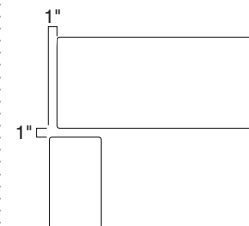

When specifying One-High and 1.5-High storage that matches the worksurface depth, only One-High storage should be placed adjacent to the desk.

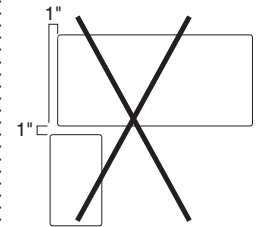

Pinch point clearances are not maintained when 1.5-High or taller storage is used adjacent to One-High integrated storage that matches the worksurface depth.

Universal One-High and 1.5-High open laterals for Migration SE application can only be used with Migration SE T-leg desks.

Surface Materials

Lateral case

- Paint

Laminate top

- Laminate
- Open Line laminate (option)

Edge on laminate top

- Plastic

Wood veneer top

- Wood veneer—open pore finishes
- Full-fill (option) is available on wood veneer tops only.

Shroud and filler

- Paint

Migration Pro Height-Adjustable Desks

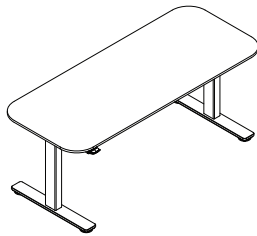

Rectangle Column Shape Shown

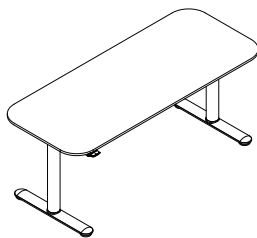

Round Column Shape Shown

Tip: C-leg is only available with rectangle columns and is only available in 28", 29", or 30" depths.

Tip: Knife edge is only available on laminate worksurfaces.

Tip: Overhang not available on basic height Migration Pro desks.

Tip: Soft edge cannot be specified on a knife edge worksurface.

Tip: Soft edge is only available on rectangular laminate worksurface, and centered between the cantilevers. If one overhang is selected, the soft edge will be off-center on the worksurface.

Standard Includes	Required to Specify
<p>► Need help? Product details, page 186</p> <ul style="list-style-type: none"> • Worksurface: High-Pressure Laminate price group 1 with 3 mm plastic edge • Electric height-adjustable sit-to-stand base: paint • Active touch controller • Square corners, if selected • Depth: 23", 24", 28", 29", or 30" • Modular width: 40", 46", 52", 58", 64", 70", 76", 82", 88", or 94" • 1/2" glide • Power cord: 10¹/₂' • Attachment hardware 	<ol style="list-style-type: none"> 1 Style number 2 Desk depth 3 Desk width 4 Column shape (see below under Required Selections) 5 Leg type (see below under Required Selections) 6 Corner (see below under Required Selections) 7 Edge profile (see below under Required Selections) 8 Overhang and overhang width, if selected (see below under Required Selections) 9 Glides (see below under Required Selections) 10 Controller (see below under Required Selections) 11 High-Pressure Laminate, composite veneer, or wood color for worksurface 12 Plastic color number for profile edge on laminate worksurface 13 Paint color number for lower base 14 Options, if selected (see below) <p>► See <i>Surface Materials</i>, page 362</p>

	Required Selections	U.S. Price	Required to Specify
Column Shape	<ul style="list-style-type: none"> • Rectangle • Round 	No cost No cost	Specify with <i>rectangle column</i> . Specify with <i>round column</i> .
Leg Type	<ul style="list-style-type: none"> • T-leg configuration • C-leg configuration 	No cost No cost	Specify with <i>T-leg configuration</i> . Specify with <i>C-leg configuration</i> .
Corner	<ul style="list-style-type: none"> • Square corner • Radius 2" corner • Radius 5" corner 	No cost +\$ 98 +\$ 98	Specify with <i>square corner</i> . Specify with <i>radius 2" corner</i> . Specify with <i>radius 5" corner</i> .
Edge Profile	<ul style="list-style-type: none"> • 3 mm plastic edge • 3 mm wood edge • Knife edge 	No cost No cost +\$174	Specify with <i>3 mm plastic edge</i> . Specify with <i>3 mm wood edge</i> . Specify with <i>knife edge</i> .
Overhang	<ul style="list-style-type: none"> • No overhang • Left overhang • Right overhang • Left and right overhang 	No cost No cost No cost No cost	Specify with <i>no overhang</i> . Specify with <i>left overhang</i> . Specify with <i>right overhang</i> . Specify with <i>left and right overhang</i> .
	Overhang width		
	<ul style="list-style-type: none"> • 9"W 	No cost	Specify with <i>9"W overhang</i> .
Glides	<ul style="list-style-type: none"> • 1/2" glide • Slide glide • 1" adjustable spacer 	No cost +\$ 34 +\$ 49	Specify with <i>1/2" glide</i> . Specify with <i>slide glide</i> . Specify with <i>1" adjustable spacer</i> .
Controller	<ul style="list-style-type: none"> • Active touch controller • Simple touch controller • 3-preset controller 	No cost -\$ 78 +\$131	Specify with <i>active touch controller</i> . Specify with <i>simple touch controller</i> . Specify with <i>3-preset controller</i> .

► **Options, on next page**



For Canadian Pricing

Multiply U.S. Price by the Canadian price factor.

► See page 1 for details.

► **Required Selections, on previous page**

	Options	U.S. Price	Required to Specify	
Size Option	• Modular width desk	No cost	Specify <i>with modular width desk</i> .	
	• Parametric width desk	No cost	Specify <i>with parametric width desk</i> .	
Soft Edge	• Soft edge	+\$346	Specify <i>with soft edge</i> .	
Surface Materials	High-Pressure Laminate desk			
	<ul style="list-style-type: none"> • Laminate price group 2 • Laminate price group 3 • Open Line laminate (OLL) 	See information at left See information at left +\$111 plus cost of laminate	Specify laminate color number. Specify laminate color number. ► See <i>Surface Materials Reference Manual</i> .	
	Wood veneer desk			
	• Composite veneer group 1	Prices at right	Specify composite veneer color number.	
	• Composite veneer group 2	+\$108	Specify composite veneer color number.	
	• Wood group 1	Prices at right	Specify wood color number.	
	• Wood group 2	+\$118	Specify wood color number.	
	• Wood group 3	+\$417	Specify wood color number.	
• Customiz stain	No cost	Specify <i>with customiz stain</i> . ► See <i>Surface Materials Reference Manual</i> .		
	Height-adjustable base			
	• Base lower paint group 2	+\$ 24	Specify paint color number.	
	• Base upper paint group 2	+\$ 24	Specify paint color number.	
	• Base lower paint group 3	+\$ 44	Specify paint color number.	
	• Base upper paint group 3	+\$ 44	Specify paint color number. ► See <i>Surface Materials</i> , page 362	
	Metal cable tray			
	• Paint price group 1	No cost	Specify paint color number.	
	• Paint price group 2	+\$ 16	Specify paint color number.	
	• Paint price group 3	+\$ 28	Specify paint color number. ► See <i>Surface Materials</i> , page 362	
Grommet and Integrated Power – Left Position	• None	No cost	Specify <i>with none</i> .	
	• Round grommet	+\$ 32	Specify <i>with round grommet on left</i> .	
	• Flush power	+\$519	Specify <i>with flush power on left</i> and specify plastic color number.	
	• Pop-up power	+\$519	Specify <i>with pop-up power on left</i> and specify paint color number.	
	Grommet and Integrated Power – Center Position	• None	No cost	Specify <i>with none</i> .
		• Round grommet	+\$ 32	Specify <i>with round grommet on center</i> .
• Flush power		+\$519	Specify <i>with flush power on center</i> and specify plastic color number.	
• Pop-up power		+\$519	Specify <i>with pop-up power on center</i> and specify paint color number.	
Grommet and Integrated Power – Right Position	• None	No cost	Specify <i>with none</i> .	
	• Round grommet	+\$ 32	Specify <i>with round grommet on right</i> .	
	• Flush power	+\$519	Specify <i>with flush power on right</i> and specify plastic color number.	
	• Pop-up power	+\$519	Specify <i>with pop-up power on right</i> and specify paint color number.	
Height-Adjustable Base Power Cord	• 10' standard cord	No cost	Specify <i>with 10' standard cord</i> .	
	• 4' standard cord	No cost	Specify <i>with 4' standard cord</i> .	

For laminate group 2 and 3 pricing, please refer to the electronic catalog or SmartTools.

Tip: Base upper paint finish defaults to match base lower paint finish.

Tip: Only one flush or pop-up integrated power can be specified per desk.

Tip: When overhang is also specified, left, right, and/or center grommet positions will match the understructure width, not the worksurface width.

Tip: When flush or pop-up power is specified with utility power, a 4' height-adjustable base power cord is automatically shipped.

*Tip: Height-adjustable base must be specified with 10¹/₂' power cord unless utility power is optioned. When selecting 4' cord to minimize cable management, **DSPINTRO** or **DSPower** with utility power is required.*

► **Options, continued on next page**

For Canadian Pricing
Multiply U.S. Price by the Canadian price factor.
► See page 1 for details.

Migration Pro Height-Adjustable Desks, continued

► Options, continued from previous page

	Options	U.S. Price	Required to Specify
Flush and Pop-Up Power Configuration	• 3 power	No cost	Specify with 3 power.
	• 2 power 1 data	No cost	Specify with 2 power 1 data.
	• 2 power 1 USB A+C 20W	+\$ 85	Specify with 2 power 1 USB A+C 20W.
	• 1 power, 1 USB C 100W	+\$335	Specify with 1 power, 1 USB C 100W.
Flush and Pop-Up Utility Power Configuration	• No utility	No cost	Specify with no utility.
	• No utility with overcurrent protection	+\$ 70	Specify with no utility w/OCP.
	• 1 utility, 1 female plug, tray	+\$173	Specify with 1 utility, 1 female plug, tray.
	• 2 utility, 1 female plug, tray	+\$346	Specify with 2 utility, 1 female plug, tray.
	• 3 utility, tray mount	+\$519	Specify with 3 utility, tray mount.
Flush and Pop-Up Power Cord	• 10' standard cord	No cost	Specify with 10' standard cord.
	• 10' braided cord	+\$276	Specify with 10' braided cord.
	• 163" curly cord	+\$391	Specify with 163" curly cord.
Flush and Pop-Up Power Plug Type	• Standard NEMA 3-prong	No cost	Specify with standard NEMA 3-prong.
	• 90° NEMA	+\$ 49	Specify with 90° NEMA.
	• Thread low profile plug	+\$ 54	Specify with thread low profile plug.
Flush and Pop-Up Power Cord Color	Standard and curly cord		
	• Black	No cost	Specify with black cord.
	• White	No cost	Specify with white cord.
	Braided cord		
	• 9009 Black	No cost	Specify with 9009 Black cord.
	• 9011 Seagull	No cost	Specify with 9011 Seagull cord.
FSC Worksurface	• FSC Mix credit product	+\$ 42	Add suffix FSC to the end of the style number.
Metal Cable Tray	• No cable tray	No cost	Specify with no cable tray.
	• Metal tray		
	– 30"W	+\$237	Specify with metal tray.
	– 42"W	+\$290	Specify with metal tray.
	– 52"W	+\$343	Specify with metal tray.
Related Products	• Cable brackets		► Page 245
	• Modesty panel		► Page 248
	• Maintenance kit		► Page 247

Tip: FSC worksurface is only available for extended height desks.

Tip: Actual width of 42"W cable tray is 41½".

Tip: Metal cable tray dimension will be automatically determined based on desk dimensions and overhang, if selected.



For Canadian Pricing

Multiply U.S. Price by the Canadian price factor.

► See page 1 for details.

Specification Information

Style Number	Dimensions Depth	Desk Type	U.S. Base Prices									
			40"W	46"W	52"W	58"W	64"W	70"W	76"W	82"W	88"W	94"W
		Modular	40 ¹ / ₁₆ "W	42 ¹ / ₁₆ "W	48 ¹ / ₁₆ "W	54 ¹ / ₁₆ "W	60 ¹ / ₁₆ "W	66 ¹ / ₁₆ "W	72 ¹ / ₁₆ "W	78 ¹ / ₁₆ "W	84 ¹ / ₁₆ "W	90 ¹ / ₁₆ "W
		Parametric	42"W	48"W	54"W	60"W	66"W	72"W	78"W	84"W	90"W	96"W

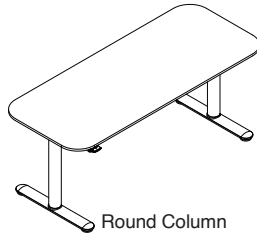
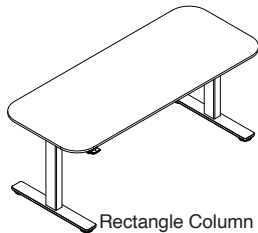

High-Pressure Laminate Pro Desk—Extended

HA2ER	23" or 24"	\$2425	\$2457	\$2489	\$2532	\$2575	\$2618	\$2661	\$2762	\$2805	\$2848
	28", 29", or 30"	\$2462	\$2494	\$2526	\$2569	\$2612	\$2655	\$2698	\$2799	\$2842	\$2885

Composite Veneer Group 1 Pro Desk—Extended

HA2ER	23" or 24"	\$3247	\$3295	\$3343	\$3402	\$3461	\$3520	\$3579	\$3696	\$3755	\$3814
	28", 29", or 30"	\$3322	\$3370	\$3418	\$3477	\$3536	\$3595	\$3654	\$3771	\$3830	\$3889

Wood Group 1 Pro Desk—Extended

HA2ER	23" or 24"	\$3247	\$3295	\$3343	\$3402	\$3461	\$3520	\$3579	\$3696	\$3755	\$3814
	28", 29", or 30"	\$3322	\$3370	\$3418	\$3477	\$3536	\$3595	\$3654	\$3771	\$3830	\$3889

High-Pressure Laminate Pro Desk—Basic

HA2SRQ	23" or 24"	\$2183	\$2215	\$2247	\$2290	\$2333	\$2376	\$2419	\$2520	\$2563	\$2606
	28", 29", or 30"	\$2220	\$2252	\$2284	\$2327	\$2370	\$2413	\$2456	\$2557	\$2600	\$2643

Composite Veneer Group 1 Pro Desk—Basic

HA2SRQ	23" or 24"	\$3005	\$3053	\$3101	\$3160	\$3219	\$3278	\$3337	\$3454	\$3513	\$3572
	28", 29", or 30"	\$3080	\$3128	\$3176	\$3235	\$3294	\$3353	\$3412	\$3529	\$3588	\$3647

Wood Group 1 Pro Desk—Basic

HA2SRQ	23" or 24"	\$3005	\$3053	\$3101	\$3160	\$3219	\$3278	\$3337	\$3454	\$3513	\$3572
	28", 29", or 30"	\$3080	\$3128	\$3176	\$3235	\$3294	\$3353	\$3412	\$3529	\$3588	\$3647



For Canadian Pricing

Multiply U.S. Price by the Canadian price factor.

► See page 1 for details.

Migration Pro Height-Adjustable Desks

Organic Desks

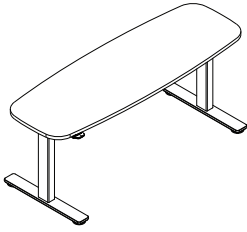

Rectangle Column Shape Shown

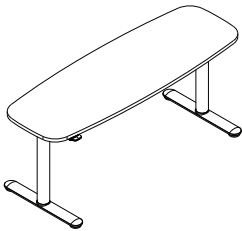

Round Column Shape Shown

Tip: C-leg is only available with rectangle columns and is only available in 28", 29", or 30" depths.

Tip: Knife edge is only available on laminate worksurfaces.

Tip: Soft edge cannot be specified on a knife edge worksurface.

Tip: Soft edge is only available on rectangular laminate worksurface, and centered between the cantilevers. If one overhang is selected, the soft edge will be off-center on the worksurface.

Standard Includes	Required to Specify
<ul style="list-style-type: none"> ▶ Need help? Product details, page 186 • Worksurface: High-Pressure Laminate price group 1 with 3 mm plastic edge • Organic worksurface: bow front or bow front and back • Electric height-adjustable sit-to-stand base: paint • Active touch controller • Depth: 23", 24", 28", 29", or 30" • Modular width: 40", 46", 52", 58", 64", 70", 76", 82", 88", or 94" • 1/2" glide • Power cord: 10¹/₂' • Attachment hardware 	<ol style="list-style-type: none"> 1 Style number 2 Desk depth 3 Desk width 4 Column shape (see below under Required Selections) 5 Leg type (see below under Required Selections) 6 Shape type (see below under Required Selections) 7 Edge profile (see below under Required Selections) 8 Overhang and overhang width, if selected (see below under Required Selections) 9 Glides (see below under Required Selections) 10 Controller (see below under Required Selections) 11 High-Pressure Laminate, composite veneer, or wood color for worksurface 12 Plastic color number for profile edge on laminate worksurface 13 Paint color number for lower base 14 Options, if selected (see below) <p>▶ See <i>Surface Materials</i>, page 362</p>

	Required Selections	U.S. Price	Required to Specify
Column Shape	<ul style="list-style-type: none"> • Rectangle • Round 	No cost No cost	Specify with <i>rectangle column</i> . Specify with <i>round column</i> .
Leg Type	<ul style="list-style-type: none"> • T-leg configuration • C-leg configuration 	No cost No cost	Specify with <i>T-leg configuration</i> . Specify with <i>C-leg configuration</i> .
Shape type	<ul style="list-style-type: none"> • Bow front • Bow front and back 	No cost No cost	Specify with <i>bow front</i> . Specify with <i>bow front and back</i> .
Edge Profile	<ul style="list-style-type: none"> • 3 mm plastic edge • 3 mm wood edge • Knife edge 	No cost No cost +\$174	Specify with <i>3 mm plastic edge</i> . Specify with <i>3 mm wood edge</i> . Specify with <i>knife edge</i> .
Overhang	<ul style="list-style-type: none"> • No overhang • Left overhang • Right overhang • Left and right overhang 	No cost No cost No cost No cost	Specify with <i>no overhang</i> . Specify with <i>left overhang</i> . Specify with <i>right overhang</i> . Specify with <i>left and right overhang</i> .
	Overhang width		
	<ul style="list-style-type: none"> • 9"W 	No cost	Specify with <i>9"W overhang</i> .
Glides	<ul style="list-style-type: none"> • 1/2" glide • Slide glide • 1" adjustable spacer 	No cost +\$ 34 +\$ 49	Specify with <i>1/2" glide</i> . Specify with <i>slide glide</i> . Specify with <i>1" adjustable spacer</i> .
Controller	<ul style="list-style-type: none"> • Active touch controller • Simple touch controller • 3-preset controller 	No cost -\$ 78 +\$131	Specify with <i>active touch controller</i> . Specify with <i>simple touch controller</i> . Specify with <i>3-preset controller</i> .

▶ **Options, on next page**



For Canadian Pricing

Multiply U.S. Price by the Canadian price factor.

▶ See page 1 for details.

► **Required Selections, on previous page**

	Options	U.S. Price	Required to Specify
Size Option	• Modular width desk	No cost	Specify with modular width desk.
	• Parametric width desk	No cost	Specify with parametric width desk.
Surface Materials	High-Pressure Laminate desk		
	• Laminate price group 2	See information at left	Specify laminate color number.
	• Laminate price group 3	See information at left	Specify laminate color number.
	• Open Line laminate (OLL)	+\$111 plus cost of laminate	► See <i>Surface Materials Reference Manual</i> .
	Wood veneer desk		
	• Composite veneer group 1	Prices at right	Specify composite veneer color number.
	• Composite veneer group 2	+\$108	Specify composite veneer color number.
	• Wood group 1	Prices at right	Specify wood color number.
	• Wood group 2	+\$118	Specify wood color number.
	• Wood group 3	+\$417	Specify wood color number.
	• Customiz stain	No cost	Specify with customiz stain. ► See <i>Surface Materials Reference Manual</i> .
	Height-adjustable base		
• Base lower paint group 2	+\$ 24	Specify paint color number.	
• Base upper paint group 2	+\$ 24	Specify paint color number.	
• Base lower paint group 3	+\$ 44	Specify paint color number.	
• Base upper paint group 3	+\$ 44	Specify paint color number. ► See <i>Surface Materials</i> , page 362	
Metal cable tray			
• Paint price group 1	No cost	Specify paint color number.	
• Paint price group 2	+\$ 16	Specify paint color number.	
• Paint price group 3	+\$ 28	Specify paint color number. ► See <i>Surface Materials</i> , page 362	
Grommet and Integrated Power – Left Position	• None	No cost	Specify with none.
	• Round grommet	+\$ 32	Specify with round grommet on left.
	• Flush power	+\$519	Specify with flush power on left and specify plastic color number.
	• Pop-up power	+\$519	Specify with pop-up power on left and specify paint color number.
Grommet and Integrated Power – Center Position	• None	No cost	Specify with none.
	• Round grommet	+\$ 32	Specify with round grommet on center.
	• Flush power	+\$519	Specify with flush power on center and specify plastic color number.
	• Pop-up power	+\$519	Specify with pop-up power on center and specify paint color number.
Grommet and Integrated Power – Right Position	• None	No cost	Specify with none.
	• Round grommet	+\$ 32	Specify with round grommet on right.
	• Flush power	+\$519	Specify with flush power on right and specify plastic color number.
	• Pop-up power	+\$519	Specify with pop-up power on right and specify paint color number.
Height-Adjustable Base Power Cord	• 10' standard cord	No cost	Specify with 10' standard cord.
	• 4' standard cord	No cost	Specify with 4' standard cord.
Flush and Pop-Up Power Configuration	• 3 power	No cost	Specify with 3 power.
	• 2 power 1 data	No cost	Specify with 2 power 1 data.
	• 2 power 1 USB A+C 20W	+\$ 85	Specify with 2 power 1 USB A+C 20W.
	• 1 power, 1 USB C 100W	+\$335	Specify with 1 power, 1 USB C 100W.

► **Options, continued on next page**

For laminate group 2 and 3 pricing, please refer to the electronic catalog or SmartTools.

Tip: Base upper paint finish defaults to match base lower paint finish.

Tip: Only one flush or pop-up integrated power can be specified per desk.

Tip: When overhang is also specified, left, right, and/or center grommet positions will match the understructure width, not the worksurface width.

Tip: When flush or pop-up power is specified with utility power, a 4' height-adjustable base power cord is automatically shipped.

*Tip: Height-adjustable base must be specified with 10 1/2' power cord unless utility power is optional. When selecting 4' cord to minimize cable management, **DSPINTRO** or **DSPOWER** with utility power is required.*

Migration Pro Height-Adjustable Desks, Organic Desks, continued

► Options, continued from previous page

	Options	U.S. Price	Required to Specify
Flush and Pop-Up Utility Power Configuration	• No utility	No cost	Specify with no utility.
	• No utility with overcurrent protection	+\$ 70	Specify with no utility w/OCP.
	• 1 utility, 1 female plug, tray	+\$173	Specify with 1 utility, 1 female plug, tray.
	• 2 utility, 1 female plug, tray	+\$346	Specify with 2 utility, 1 female plug, tray.
	• 3 utility, tray mount	+\$519	Specify with 3 utility, tray mount.
Flush and Pop-Up Power Cord	• 10' standard cord	No cost	Specify with 10' standard cord.
	• 10' braided cord	+\$276	Specify with 10' braided cord.
	• 163" curly cord	+\$391	Specify with 163" curly cord.
Flush and Pop-Up Power Plug Type	• Standard NEMA 3-prong	No cost	Specify with standard NEMA 3-prong.
	• 90° NEMA	+\$ 49	Specify with 90° NEMA.
	• Thread low profile plug	+\$ 54	Specify with thread low profile plug.
Flush and Pop-Up Power Cord Color	Standard and curly cord		
	• Black	No cost	Specify with black cord.
	• White	No cost	Specify with white cord.
	Braided cord		
	• 9009 Black	No cost	Specify with 9009 Black cord.
	• 9011 Seagull	No cost	Specify with 9011 Seagull cord.
FSC Worksurface	• FSC Mix credit product	+\$ 42	Add suffix FSC to the end of the style number.
Metal Cable Tray	• No cable tray	No cost	Specify with no cable tray.
	• Metal tray		
	– 30"W	+\$237	Specify with metal tray.
	– 42"W	+\$290	Specify with metal tray.
	– 52"W	+\$343	Specify with metal tray.
Related Products	• Cable brackets		► Page 245
	• Modesty panel		► Page 248
	• Maintenance kit		► Page 247

Tip: Actual width of 42"W cable tray is 41½".

Tip: Metal cable tray is not available as an option on organic bow front and back worksurfaces.

Tip: Metal cable tray dimension will be automatically determined based on desk dimensions and overhang, if selected.



For Canadian Pricing

Multiply U.S. Price by the Canadian price factor.

► See page 1 for details.

Specification Information

Style Number	Dimensions Depth	Desk Type	U.S. Base Prices										
			40"W	46"W	52"W	58"W	64"W	70"W	76"W	82"W	88"W	94"W	
		Modular	40 ¹ / ₁₆ "W	42 ¹ / ₁₆ "W	44 ¹ / ₁₆ "W	46 ¹ / ₁₆ "W	48 ¹ / ₁₆ "W	50 ¹ / ₁₆ "W	52 ¹ / ₁₆ "W	54 ¹ / ₁₆ "W	56 ¹ / ₁₆ "W	58 ¹ / ₁₆ "W	60 ¹ / ₁₆ "W
		Parametric	40"W	42"W	44"W	46"W	48"W	50"W	52"W	54"W	56"W	58"W	60"W

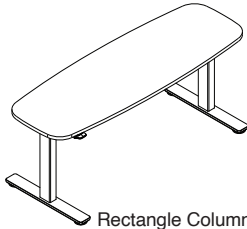

Rectangle Column

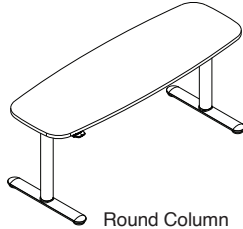

Round Column

High-Pressure Laminate Pro Organic Desk—Extended

HA2EO	23" or 24"	\$2523	\$2555	\$2587	\$2630	\$2673	\$2716	\$2759	\$2860	\$2903	\$2946
	28", 29", or 30"	\$2560	\$2592	\$2624	\$2667	\$2710	\$2753	\$2796	\$2897	\$2940	\$2983

Composite Veneer Group 1 Pro Organic Desk—Extended

HA2EO	23" or 24"	\$3345	\$3393	\$3441	\$3500	\$3559	\$3618	\$3677	\$3794	\$3853	\$3912
	28", 29", or 30"	\$3420	\$3468	\$3516	\$3575	\$3634	\$3693	\$3752	\$3869	\$3928	\$3987

Wood Group 1 Pro Organic Desk—Extended

HA2EO	23" or 24"	\$3345	\$3393	\$3441	\$3500	\$3559	\$3618	\$3677	\$3794	\$3853	\$3912
	28", 29", or 30"	\$3420	\$3468	\$3516	\$3575	\$3634	\$3693	\$3752	\$3869	\$3928	\$3987



For Canadian Pricing

Multiply U.S. Price by the Canadian price factor.

► See page 1 for details.

Migration Pro Height-Adjustable Bases

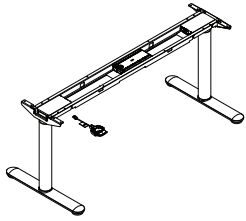

Rectangle Column Shape Shown

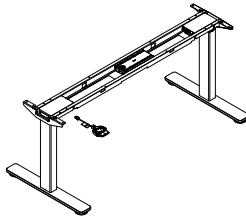

Round Column Shape Shown

Tip: C-leg is only available with rectangular columns and is only available in 28", 29", or 30" depths.

Tip: Overhang not available on basic height Migration Pro bases.

Tip: Base upper paint finish defaults to match base lower paint finish.

*Tip: Height-adjustable base must be specified with 10' 1/2' power cord unless utility power is optioned. When selecting 4' cord to minimize cable management, **DSPINPRO** or **DSPower** with utility power is required.*



For Canadian Pricing
Multiply U.S. Price by the Canadian price factor.

▶ See page 1 for details.

Standard Includes	Required to Specify
<ul style="list-style-type: none"> ▶ Need help? Product details, page 186 • Electric height-adjustable sit-to-stand base: paint • Active touch controller • Depth: 23", 24", 28", 29", or 30" • Modular width: 40", 46", 52", 58", 64", 70", 76", 82", 88", or 94" • 1/2" glide • Power cord: 10' 1/2' • Attachment hardware 	<ol style="list-style-type: none"> 1 Style number 2 Base depth 3 Base width 4 Column shape (see below under Required Selections) 5 Leg type (see below under Required Selections) 6 Overhang and overhang width, if selected (see below under Required Selections) 7 Glides (see below under Required Selections) 8 Controller (see below under Required Selections) 9 Paint color number for lower base 10 Options, if selected (see below) <p>▶ See <i>Surface Materials</i>, page 362</p>

Required Selections	U.S. Price	Required to Specify
Column Shape <ul style="list-style-type: none"> • Rectangle • Round 	No cost No cost	Specify with <i>rectangle column</i> . Specify with <i>round column</i> .
Leg Type <ul style="list-style-type: none"> • T-leg configuration • C-leg configuration 	No cost No cost	Specify with <i>T-leg configuration</i> . Specify with <i>C-leg configuration</i> .
Overhang <ul style="list-style-type: none"> • No overhang • Left overhang • Right overhang • Left and right overhang 	No cost No cost No cost No cost	Specify with <i>no overhang</i> . Specify with <i>left overhang</i> . Specify with <i>right overhang</i> . Specify with <i>left and right overhang</i> .
Overhang width <ul style="list-style-type: none"> • 9"W 	No cost	Specify with <i>9"W overhang</i> .
Glides <ul style="list-style-type: none"> • 1/2" glide • Slide glide • 1" adjustable spacer 	No cost +\$ 34 +\$ 49	Specify with <i>1/2" glide</i> . Specify with <i>slide glide</i> . Specify with <i>1" adjustable spacer</i> .
Controller <ul style="list-style-type: none"> • Active touch controller • Simple touch controller • 3-preset controller 	No cost -\$ 78 +\$131	Specify with <i>active touch controller</i> . Specify with <i>simple touch controller</i> . Specify with <i>3-preset controller</i> .

Options	U.S. Price	Required to Specify
Size Option <ul style="list-style-type: none"> • Modular width • Parametric width 	No cost No cost	Specify with <i>modular width</i> . Specify with <i>parametric width</i> .
Surface Materials <ul style="list-style-type: none"> • Base lower paint group 2 • Base upper paint group 2 • Base lower paint group 3 • Base upper paint group 3 	+\$ 24 +\$ 24 +\$ 44 +\$ 44	Specify paint color number. Specify paint color number. Specify paint color number. Specify paint color number. ▶ See <i>Surface Materials</i> , page 362
Height-Adjustable Base Power Cord <ul style="list-style-type: none"> • 10' standard cord • 4' standard cord 	No cost No cost	Specify with <i>10' standard cord</i> . Specify with <i>4' standard cord</i> .
Related Products <ul style="list-style-type: none"> • Cable brackets • Modesty panel • Maintenance kit 		▶ Page 245 ▶ Page 248 ▶ Page 247

Specification Information

Style Number	Dimensions Depth	Desk Type	U.S. Base Prices											
			40"W	46"W	52"W	58"W	64"W	70"W	76"W	82"W	88"W	94"W		
		Modular												
		Parametric	40 ¹ / ₁₆ "W	42 ¹ / ₁₆ "W	48 ¹ / ₁₆ "W	54 ¹ / ₁₆ "W	60 ¹ / ₁₆ "W	66 ¹ / ₁₆ "W	72 ¹ / ₁₆ "W	78 ¹ / ₁₆ "W	84 ¹ / ₁₆ "W	90 ¹ / ₁₆ "W		
			– 42"W	– 48"W	– 54"W	– 60"W	– 66"W	– 72"W	– 78"W	– 84"W	– 90"W	– 96"W		

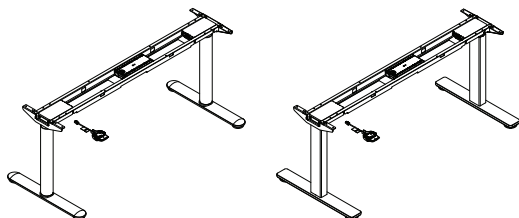

Pro Rectangular Base—Extended

HA2ERB	Dimensions Depth	40"W	46"W	52"W	58"W	64"W	70"W	76"W	82"W	88"W	94"W
	23" or 24"	\$2172	\$2188	\$2204	\$2220	\$2236	\$2252	\$2268	\$2342	\$2358	\$2374
	28", 29", or 30"	\$2193	\$2209	\$2225	\$2241	\$2257	\$2273	\$2289	\$2363	\$2379	\$2395

Pro Rectangular Base—Basic

HA2SRB	Dimensions Depth	40"W	46"W	52"W	58"W	64"W	70"W	76"W	82"W	88"W	94"W
	23" or 24"	\$1930	\$1946	\$1962	\$1978	\$1994	\$2010	\$2026	\$2100	\$2116	\$2132
	28", 29", or 30"	\$1951	\$1967	\$1983	\$1999	\$2015	\$2031	\$2047	\$2121	\$2137	\$2153



For Canadian Pricing

Multiply U.S. Price by the Canadian price factor.

► See page 1 for details.

Migration Pro with Boost High-Speed Height-Adjustable Desks

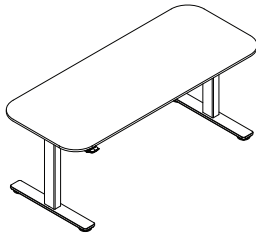

▶ Need help?
Product details,
page 192

Standard Includes

- Worksurface: High-Pressure Laminate price group 1 with 3 mm plastic edge
- Electric height-adjustable sit-to-stand base: paint
- Column shape: rectangle
- T-leg configuration
- Active touch controller
- Square corners, if selected
- Depth: 23", 24", 28", 29", or 30"
- Modular width: 40", 46", 52", 58", 64", 70", or 76"
- 1/2" glide
- Power cord: 10 1/2'
- Attachment hardware

Required to Specify

- 1 Style number
 - 2 Desk depth
 - 3 Desk width
 - 4 Corner (see below under Required Selections)
 - 5 Edge profile (see below under Required Selections)
 - 6 Glides (see below under Required Selections)
 - 7 Controller (see below under Required Selections)
 - 8 High-Pressure Laminate, composite veneer, or wood color for worksurface
 - 9 Plastic color number for profile edge on laminate worksurface
 - 10 Paint color number for lower base
 - 11 Options, if selected (see below)
- ▶ See *Surface Materials*, page 362

Tip: Knife edge is only available on laminate worksurfaces.

Tip: Soft edge cannot be specified on a knife edge worksurface.

Tip: Soft edge is only available on rectangular laminate worksurface, and centered between the cantilevers. If one overhang is selected, the soft edge will be off-center on the worksurface.

For laminate group 2 and 3 pricing, please refer to the electronic catalog or SmartTools.

	Required Selections	U.S. Price	Required to Specify
Corner	<ul style="list-style-type: none"> • Square corner • Radius 2" corner • Radius 5" corner 	No cost +\$ 98 +\$ 98	Specify <i>with square corner</i> . Specify <i>with radius 2" corner</i> . Specify <i>with radius 5" corner</i> .

Edge Profile	<ul style="list-style-type: none"> • 3 mm plastic edge • 3 mm wood edge • Knife edge 	No cost No cost +\$174	Specify <i>with 3 mm plastic edge</i> . Specify <i>with 3 mm wood edge</i> . Specify <i>with knife edge</i> .
---------------------	---	------------------------------	---

Glides	<ul style="list-style-type: none"> • 1/2" glide • Slide glide • 1" adjustable spacer 	No cost +\$ 34 +\$ 49	Specify <i>with 1/2" glide</i> . Specify <i>with slide glide</i> . Specify <i>with 1" adjustable spacer</i> .
---------------	---	-----------------------------	---

Controller	<ul style="list-style-type: none"> • Active touch controller • Simple touch controller • 3-preset controller 	No cost -\$ 78 +\$131	Specify <i>with active touch controller</i> . Specify <i>with simple touch controller</i> . Specify <i>with 3-preset controller</i> .
-------------------	---	-----------------------------	---

	Options	U.S. Price	Required to Specify
Size Option	<ul style="list-style-type: none"> • Modular width desk • Parametric width desk 	No cost No cost	Specify <i>with modular width desk</i> . Specify <i>with parametric width desk</i> .

Soft Edge	<ul style="list-style-type: none"> • Soft edge 	+\$346	Specify <i>with soft edge</i> .
------------------	---	--------	---------------------------------

Surface Materials	High-Pressure Laminate desk		Required to Specify
	<ul style="list-style-type: none"> • Laminate price group 2 • Laminate price group 3 • Open Line laminate (OLL) 	See information at left See information at left +\$111 plus cost of laminate	

Wood veneer desk

- Composite veneer group 1
 - Composite veneer group 2
 - Wood group 1
 - Wood group 2
 - Wood group 3
 - Customiz stain
- Prices at right
 +\$108
 Prices at right
 +\$118
 +\$417
 No cost

- Specify composite veneer color number.
 Specify composite veneer color number.
 Specify wood color number.
 Specify wood color number.
 Specify wood color number.
 Specify *with customiz stain*.
 ▶ See *Surface Materials Reference Manual*.

▶ Options, continued on next page



For Canadian Pricing

Multiply U.S. Price by the Canadian price factor.

▶ See page 1 for details.

► Options, continued from previous page

	Options	U.S. Price	Required to Specify
Surface Materials, continued	Height-adjustable base		
	<ul style="list-style-type: none"> • Base lower paint group 2 +\$ 24 • Base upper paint group 2 +\$ 24 • Base lower paint group 3 +\$ 44 • Base upper paint group 3 +\$ 44 		Specify paint color number. Specify paint color number. Specify paint color number. Specify paint color number. ► See <i>Surface Materials</i> , page 362
	Metal cable tray		
	<ul style="list-style-type: none"> • Paint price group 1 No cost • Paint price group 2 +\$ 16 • Paint price group 3 +\$ 28 		Specify paint color number. Specify paint color number. Specify paint color number. ► See <i>Surface Materials</i> , page 362
Grommet and Integrated Power – Left Position	<ul style="list-style-type: none"> • None No cost • Round grommet +\$ 32 • Flush power +\$519 		Specify with <i>none</i> . Specify with <i>round grommet on left</i> . Specify with <i>flush power on left</i> and specify plastic color number. Specify with <i>pop-up power on left</i> and specify paint color number.
	<ul style="list-style-type: none"> • Pop-up power +\$519 		
Grommet and Integrated Power – Center Position	<ul style="list-style-type: none"> • None No cost • Round grommet +\$ 32 • Flush power +\$519 		Specify with <i>none</i> . Specify with <i>round grommet on center</i> . Specify with <i>flush power on center</i> and specify plastic color number. Specify with <i>pop-up power on center</i> and specify paint color number.
	<ul style="list-style-type: none"> • Pop-up power +\$519 		
Grommet and Integrated Power – Right Position	<ul style="list-style-type: none"> • None No cost • Round grommet +\$ 32 • Flush power +\$519 		Specify with <i>none</i> . Specify with <i>round grommet on right</i> . Specify with <i>flush power on right</i> and specify plastic color number. Specify with <i>pop-up power on right</i> and specify paint color number.
	<ul style="list-style-type: none"> • Pop-up power +\$519 		
Height-Adjustable Base Power Cord	<ul style="list-style-type: none"> • 10' standard cord No cost • 4' standard cord No cost 		Specify with <i>10' standard cord</i> . Specify with <i>4' standard cord</i> .
	Flush and Pop-Up Power Configuration	<ul style="list-style-type: none"> • 3 power No cost • 2 power 1 data No cost • 2 power 1 USB A+C 20W +\$ 85 • 1 power, 1 USB C 100W +\$335 	Specify with <i>3 power</i> . Specify with <i>2 power 1 data</i> . Specify with <i>2 power 1 USB A+C 20W</i> . Specify with <i>1 power, 1 USB C 100W</i> .
Flush and Pop-Up Utility Power Configuration	<ul style="list-style-type: none"> • No utility No cost • No utility with overcurrent protection +\$ 70 		Specify with <i>no utility</i> . Specify with <i>no utility w/OCP</i> .
	<ul style="list-style-type: none"> • 1 utility, 1 female plug, tray +\$173 • 2 utility, 1 female plug, tray +\$346 • 3 utility, tray mount +\$519 		Specify with <i>1 utility, 1 female plug, tray</i> . Specify with <i>2 utility, 1 female plug, tray</i> . Specify with <i>3 utility, tray mount</i> .
Flush and Pop-Up Power Cord	<ul style="list-style-type: none"> • 10' standard cord No cost • 10' braided cord +\$276 • 163" curly cord +\$391 		Specify with <i>10' standard cord</i> . Specify with <i>10' braided cord</i> . Specify with <i>163" curly cord</i> .
	Flush and Pop-Up Power Plug Type	<ul style="list-style-type: none"> • Standard NEMA 3-prong No cost • 90° NEMA +\$ 49 • Thread low profile plug +\$ 54 	Specify with <i>standard NEMA 3-prong</i> . Specify with <i>90° NEMA</i> . Specify with <i>thread low profile plug</i> .

► Options, continued on next page

Tip: Base upper paint finish defaults to match base lower paint finish.

Tip: Only one flush or pop-up integrated power can be specified per desk.

Tip: When flush or pop-up power is specified with utility power, a 4' height-adjustable base power cord is automatically shipped.

Tip: Height-adjustable base must be specified with 10 1/2' power cord unless utility power is optioned. When selecting 4' cord to minimize cable management, **DSPINTRO** or **DSPower** with utility power is required.



For Canadian Pricing

Multiply U.S. Price by the Canadian price factor.

► See page 1 for details.

Migration Pro with Boost High-Speed Height-Adjustable Desks, continued

► Options, continued from previous page

Options	U.S. Price	Required to Specify	
Flush and Pop-Up Power Cord Color			
Standard and curly cord			
• Black	No cost	Specify with <i>black cord</i> .	
• White	No cost	Specify with <i>white cord</i> .	
Braided cord			
• 9009 Black	No cost	Specify with <i>9009 Black cord</i> .	
• 9011 Seagull	No cost	Specify with <i>9011 Seagull cord</i> .	
FSC Worksurface	• FSC Mix credit product	+\$ 42	Add suffix FSC to the end of the style number.
Metal Cable Tray	• No cable tray	No cost	Specify with <i>no cable tray</i> .
	• Metal tray		
	– 30"W	+\$237	Specify with <i>metal tray</i> .
	– 42"W	+\$290	Specify with <i>metal tray</i> .
	– 52"W	+\$343	Specify with <i>metal tray</i> .
Related Products	• Cable brackets		► Page 245
	• Modesty panel		► Page 248
	• Maintenance kit		► Page 247

Tip: Actual width of 42"W cable tray is 41½".

Tip: Metal cable tray dimension will be automatically determined based on desk dimensions.

Specification Information

Style Number	Dimensions Depth	Desk Type	U.S. Base Prices						
			40"W	46"W	52"W	58"W	64"W	70"W	76"W
		Modular	40"W	46"W	52"W	58"W	64"W	70"W	76"W
		Parametric	40½"W	42½"W	48½"W	54½"W	60½"W	66½"W	72½"W
			– 42"W	– 48"W	– 54"W	– 60"W	– 66"W	– 72"W	– 78"W

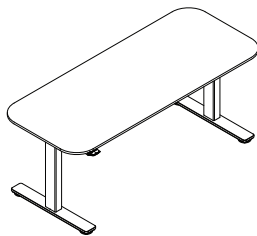

High-Pressure Laminate Pro High-Speed Desk—Extended

HA3ER	23" or 24"	\$2773	\$2805	\$2837	\$2880	\$2923	\$2966	\$3009
	28", 29", or 30"	\$2810	\$2842	\$2874	\$2917	\$2960	\$3003	\$3046

Composite Veneer Group 1 Pro High-Speed Desk—Extended

HA3ER	23" or 24"	\$3595	\$3643	\$3691	\$3750	\$3809	\$3868	\$3927
	28", 29", or 30"	\$3670	\$3718	\$3766	\$3825	\$3884	\$3943	\$4002

Wood Group 1 Pro High-Speed Desk—Extended

HA3ER	23" or 24"	\$3595	\$3643	\$3691	\$3750	\$3809	\$3868	\$3927
	28", 29", or 30"	\$3670	\$3718	\$3766	\$3825	\$3884	\$3943	\$4002



For Canadian Pricing

Multiply U.S. Price by the Canadian price factor.

► See page 1 for details.

Migration Pro with Boost High-Speed Height-Adjustable Desks

Organic Desks

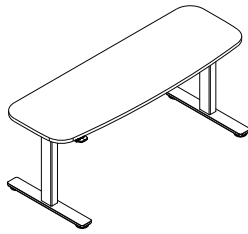

► Need help? Product details, page 192

Standard Includes

- Worksurface: High-Pressure Laminate price group 1 with 3 mm plastic edge
- Electric height-adjustable sit-to-stand base: paint
- Column shape: rectangle
- T-leg configuration
- Active touch controller
- Depth: 23", 24", 28", 29", or 30"
- Modular width: 40", 46", 52", 58", 64", 70", or 76"
- 1/2" glide
- Power cord: 10 1/2'
- Attachment hardware

Required to Specify

- 1 Style number
 - 2 Desk depth
 - 3 Desk width
 - 4 Shape type (see below under Required Selections)
 - 5 Edge profile (see below under Required Selections)
 - 6 Glides (see below under Required Selections)
 - 7 Controller (see below under Required Selections)
 - 8 High-Pressure Laminate, composite veneer, or wood color for worksurface
 - 9 Plastic color number for profile edge on laminate worksurface
 - 10 Paint color number for lower base
 - 11 Options, if selected (see below)
- See *Surface Materials*, page 362

Tip: Knife edge is only available on laminate worksurfaces.

	Required Selections	U.S. Price	Required to Specify
Shape Type	<ul style="list-style-type: none"> • Bow front • Bow front and back 	<p>No cost</p> <p>No cost</p>	<p>Specify <i>with bow front</i>.</p> <p>Specify <i>with bow front and back</i>.</p>
Edge Profile	<ul style="list-style-type: none"> • 3 mm plastic edge • 3 mm wood edge • Knife edge 	<p>No cost</p> <p>No cost</p> <p>+\$174</p>	<p>Specify <i>with 3 mm plastic edge</i>.</p> <p>Specify <i>with 3 mm wood edge</i>.</p> <p>Specify <i>with knife edge</i>.</p>
Glides	<ul style="list-style-type: none"> • 1/2" glide • Slide glide • 1" adjustable spacer 	<p>No cost</p> <p>+\$ 34</p> <p>+\$ 49</p>	<p>Specify <i>with 1/2" glide</i>.</p> <p>Specify <i>with slide glide</i>.</p> <p>Specify <i>with 1" adjustable spacer</i>.</p>
Controller	<ul style="list-style-type: none"> • Active touch controller • Simple touch controller • 3-preset controller 	<p>No cost</p> <p>-\$ 78</p> <p>+\$131</p>	<p>Specify <i>with active touch controller</i>.</p> <p>Specify <i>with simple touch controller</i>.</p> <p>Specify <i>with 3-preset controller</i>.</p>

	Options	U.S. Price	Required to Specify
Size Option	<ul style="list-style-type: none"> • Modular width desk • Parametric width desk 	<p>No cost</p> <p>No cost</p>	<p>Specify <i>with modular width desk</i>.</p> <p>Specify <i>with parametric width desk</i>.</p>
Surface Materials	<p>High-Pressure Laminate desk</p> <ul style="list-style-type: none"> • Laminate price group 2 • Laminate price group 3 • Open Line laminate (OLL) <p>Wood veneer desk</p> <ul style="list-style-type: none"> • Composite veneer group 1 • Composite veneer group 2 • Wood group 1 • Wood group 2 • Wood group 3 • Customiz stain 	<p>See information at left</p> <p>See information at left</p> <p>+\$111 plus cost of laminate</p> <p>Prices at right</p> <p>+\$108</p> <p>Prices at right</p> <p>+\$118</p> <p>+\$417</p> <p>No cost</p>	<p>Specify laminate color number.</p> <p>Specify laminate color number.</p> <p>► See <i>Surface Materials Reference Manual</i>.</p> <p>Specify composite veneer color number.</p> <p>Specify composite veneer color number.</p> <p>Specify wood color number.</p> <p>Specify wood color number.</p> <p>Specify wood color number.</p> <p>Specify <i>with customiz stain</i>.</p> <p>► See <i>Surface Materials Reference Manual</i>.</p>

► Options, continued on next page

For laminate group 2 and 3 pricing, please refer to the electronic catalog or SmartTools.



For Canadian Pricing

Multiply U.S. Price by the Canadian price factor.

► See page 1 for details.

► Options, continued from previous page

	Options	U.S. Price	Required to Specify
Surface Materials, continued	Height-adjustable base		
	• Base lower paint group 2	+\$ 24	Specify paint color number.
	• Base upper paint group 2	+\$ 24	Specify paint color number.
	• Base lower paint group 3	+\$ 44	Specify paint color number.
	• Base upper paint group 3	+\$ 44	Specify paint color number.
			► See <i>Surface Materials</i> , page 362
	Metal cable tray		
	• Paint price group 1	No cost	Specify paint color number.
	• Paint price group 2	+\$ 16	Specify paint color number.
	• Paint price group 3	+\$ 28	Specify paint color number.
			► See <i>Surface Materials</i> , page 362
Grommet and Integrated Power – Left Position	• None	No cost	Specify <i>with none</i> .
	• Round grommet	+\$ 32	Specify <i>with round grommet on left</i> .
	• Flush power	+\$519	Specify <i>with flush power on left</i> and specify plastic color number.
	• Pop-up power	+\$519	Specify <i>with pop-up power on left</i> and specify paint color number.
Grommet and Integrated Power – Center Position	• None	No cost	Specify <i>with none</i> .
	• Round grommet	+\$ 32	Specify <i>with round grommet on center</i> .
	• Flush power	+\$519	Specify <i>with flush power on center</i> and specify plastic color number.
	• Pop-up power	+\$519	Specify <i>with pop-up power on center</i> and specify paint color number.
Grommet and Integrated Power – Right Position	• None	No cost	Specify <i>with none</i> .
	• Round grommet	+\$ 32	Specify <i>with round grommet on right</i> .
	• Flush power	+\$519	Specify <i>with flush power on right</i> and specify plastic color number.
	• Pop-up power	+\$519	Specify <i>with pop-up power on right</i> and specify paint color number.
Height-Adjustable Base Power Cord	• 10' standard cord	No cost	Specify <i>with 10' standard cord</i> .
	• 4' standard cord	No cost	Specify <i>with 4' standard cord</i> .
Flush and Pop-Up Power Configuration	• 3 power	No cost	Specify <i>with 3 power</i> .
	• 2 power 1 data	No cost	Specify <i>with 2 power 1 data</i> .
	• 2 power 1 USB A+C 20W	+\$ 85	Specify <i>with 2 power 1 USB A+C 20W</i> .
	• 1 power, 1 USB C 100W	+\$335	Specify <i>with 1 power, 1 USB C 100W</i> .
Flush and Pop-Up Utility Power Configuration	• No utility	No cost	Specify <i>with no utility</i> .
	• No utility with overcurrent protection	+\$ 70	Specify <i>with no utility w/OCP</i> .
	• 1 utility, 1 female plug, tray	+\$173	Specify <i>with 1 utility, 1 female plug, tray</i> .
	• 2 utility, 1 female plug, tray	+\$346	Specify <i>with 2 utility, 1 female plug, tray</i> .
	• 3 utility, tray mount	+\$519	Specify <i>with 3 utility, tray mount</i> .
Flush and Pop-Up Power Cord	• 10' standard cord	No cost	Specify <i>with 10' standard cord</i> .
	• 10' braided cord	+\$276	Specify <i>with 10' braided cord</i> .
	• 163" curly cord	+\$391	Specify <i>with 163" curly cord</i> .
Flush and Pop-Up Power Plug Type	• Standard NEMA 3-prong	No cost	Specify <i>with standard NEMA 3-prong</i> .
	• 90° NEMA	+\$ 49	Specify <i>with 90° NEMA</i> .
	• Thread low profile plug	+\$ 54	Specify <i>with thread low profile plug</i> .

► Options, continued on next page

Tip: Base upper paint finish defaults to match base lower paint finish.

Tip: Only one flush or pop-up integrated power can be specified per desk.

Tip: When flush or pop-up power is specified with utility power, a 4' height-adjustable base power cord is automatically shipped.

Tip: Height-adjustable base must be specified with 10 1/2' power cord unless utility power is optioned. When selecting 4' cord to minimize cable management, **DSPINTRO** or **DSPower** with utility power is required.



For Canadian Pricing

Multiply U.S. Price by the Canadian price factor.

► See page 1 for details.

Migration Pro with Boost High-Speed Height-Adjustable Desks, Organic Desks, continued

► **Options, continued from previous page**

Options	U.S. Price	Required to Specify	
Flush and Pop-Up Power Cord Color			
Standard and curly cord			
• Black	No cost	Specify with <i>black cord</i> .	
• White	No cost	Specify with <i>white cord</i> .	
Braided cord			
• 9009 Black	No cost	Specify with <i>9009 Black cord</i> .	
• 9011 Seagull	No cost	Specify with <i>9011 Seagull cord</i> .	
FSC Worksurface	• FSC Mix credit product	+\$ 42	Add suffix FSC to the end of the style number.
Metal Cable Tray	• No cable tray	No cost	Specify with <i>no cable tray</i> .
	• Metal tray		
	– 30"W	+\$237	Specify with <i>metal tray</i> .
	– 42"W	+\$290	Specify with <i>metal tray</i> .
	– 52"W	+\$343	Specify with <i>metal tray</i> .
Related Products	• Cable brackets		► Page 245
	• Modesty panel		► Page 248
	• Maintenance kit		► Page 247

Tip: Actual width of 42"W cable tray is 41½".

Tip: Metal cable tray dimension will be automatically determined based on desk dimensions.

Tip: Metal cable tray is not available as an option on organic bow front and back workspaces.

Specification Information

Style Number	Dimensions Depth	Desk Type	U.S. Base Prices						
			40"W	46"W	52"W	58"W	64"W	70"W	76"W
		Modular	40"W	46"W	52"W	58"W	64"W	70"W	76"W
		Parametric	40½"W	42½"W	48½"W	54½"W	60½"W	66½"W	72½"W
			– 42"W	– 48"W	– 54"W	– 60"W	– 66"W	– 72"W	– 78"W

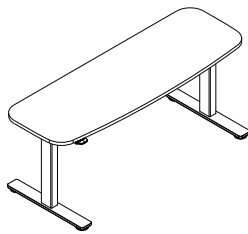

High-Pressure Laminate Pro High-Speed Organic Desk—Extended

HA3EO	23" or 24"	\$2871	\$2903	\$2935	\$2978	\$3021	\$3064	\$3107
	28", 29", or 30"	\$2908	\$2940	\$2972	\$3015	\$3058	\$3101	\$3144

Composite Veneer Group 1 Pro High-Speed Organic Desk—Extended

HA3EO	23" or 24"	\$3693	\$3741	\$3789	\$3848	\$3907	\$3966	\$4025
	28", 29", or 30"	\$3768	\$3816	\$3864	\$3923	\$3982	\$4041	\$4100

Wood Group 1 Pro High-Speed Organic Desk—Extended

HA3EO	23" or 24"	\$3693	\$3741	\$3789	\$3848	\$3907	\$3966	\$4025
	28", 29", or 30"	\$3768	\$3816	\$3864	\$3923	\$3982	\$4041	\$4100



For Canadian Pricing

Multiply U.S. Price by the Canadian price factor.

► See page 1 for details.

Migration Pro with Boost High-Speed Height-Adjustable Bases

Migration Pro with Boost High-Speed Height-Adjustable Bases

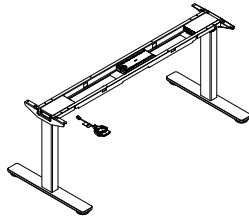

Standard Includes	Required to Specify
<ul style="list-style-type: none"> ▶ Need help? Product details, page 192 • Electric height-adjustable sit-to-stand base: paint • Active touch controller • Column shape: rectangle • T-leg configuration • Depth: 23", 24", 28", 29", or 30" • Modular width: 40", 46", 52", 58", 64", 70", 76" • 1/2" glide • Power cord: 10 1/2' • Attachment hardware 	<ol style="list-style-type: none"> Style number Base depth Base width Glides (see below under Required Selections) Controller (see below under Required Selections) Paint color number for lower base Options, if selected (see below) <p>▶ See <i>Surface Materials</i>, page 362</p>

Required Selections	U.S. Price	Required to Specify
Glides <ul style="list-style-type: none"> • 1/2" glide • Slide glide • 1" adjustable spacer 	No cost +\$ 34 +\$ 49	Specify with 1/2" glide. Specify with slide glide. Specify with 1" adjustable spacer.
Controller <ul style="list-style-type: none"> • Active touch controller • Simple touch controller • 3-preset controller 	No cost -\$ 78 +\$131	Specify with active touch controller. Specify with simple touch controller. Specify with 3-preset controller.

Options	U.S. Price	Required to Specify
Size Option <ul style="list-style-type: none"> • Modular width • Parametric width 	No cost No cost	Specify with modular width desk. Specify with parametric width desk.
Surface Materials <ul style="list-style-type: none"> • Base lower paint group 2 • Base upper paint group 2 • Base lower paint group 3 • Base upper paint group 3 	+\$ 24 +\$ 24 +\$ 44 +\$ 44	Specify paint color number. Specify paint color number. Specify paint color number. Specify paint color number. ▶ See <i>Surface Materials</i> , page 362

Tip: Base upper paint finish defaults to match base lower paint finish.

Tip: Height-adjustable base must be specified with 10 1/2' power cord unless utility power is optioned. When selecting 4' cord to minimize cable management, **DSPINTRO** or **DSPOWER** with utility power is required.

Height-Adjustable Base Power Cord <ul style="list-style-type: none"> • 10' standard cord • 4' standard cord 	No cost No cost	Specify with 10' standard cord. Specify with 4' standard cord.
Related Products <ul style="list-style-type: none"> • Cable brackets • Modesty panel • Maintenance kit 		▶ Page 245 ▶ Page 248 ▶ Page 247

Specification Information		U.S. Base Prices								
Style Number	Dimensions Depth	Desk Type	U.S. Base Prices							
			40"W	46"W	52"W	58"W	64"W	70"W	76"W	
		Modular	40"W	46"W	52"W	58"W	64"W	70"W	76"W	
		Parametric	40 1/16"W	42 1/16"W	48 1/16"W	54 1/16"W	60 1/16"W	66 1/16"W	72 1/16"W	
			42"W	48"W	54"W	60"W	66"W	72"W	78"W	

Pro High-Speed Rectangular Base—Extended								
Style	Dimensions	U.S. Price	U.S. Price	U.S. Price	U.S. Price	U.S. Price	U.S. Price	U.S. Price
HA3ERB	23" or 24"	\$2520	\$2536	\$2552	\$2568	\$2584	\$2600	\$2616
	28", 29", or 30"	\$2541	\$2557	\$2573	\$2589	\$2605	\$2621	\$2637

 **For Canadian Pricing**
 Multiply U.S. Price by the Canadian price factor.
 ▶ See page 1 for details.

Migration Intro Height-Adjustable Desks

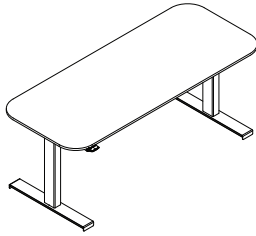

► Need help?
Product details,
page 198

Standard Includes

- Worksurface: High-Pressure Laminate price group 1 with 3 mm plastic edge
- Electric height-adjustable sit-to-stand base: paint
- Column shape: rectangle
- T-leg configuration
- Basic controller
- Square corners, if selected
- Depth: 23", 24", 28", 29", or 30"
- Modular width: 40", 46", 52", 58", 64", 70", or 76"
- 1/2" glide
- Power cord: 10'1/2'
- Attachment hardware

Required to Specify

- 1 Style number
 - 2 Desk depth
 - 3 Desk width
 - 4 Corner (see below under Required Selections)
 - 5 Controller (see below under Required Selections)
 - 6 High-Pressure Laminate, composite veneer, or wood color for worksurface
 - 7 Plastic color number for profile edge on laminate worksurface
 - 8 Paint color number for base
 - 9 Options, if selected (see below)
- See *Surface Materials*, page 362

	Required Selections	U.S. Price	Required to Specify
Corner	<ul style="list-style-type: none"> • Square corner • Radius 2" corner • Radius 5" corner 	No cost +\$ 98 +\$ 98	Specify <i>with square corner</i> . Specify <i>with radius 2" corner</i> . Specify <i>with radius 5" corner</i> .
Controller	<ul style="list-style-type: none"> • Basic controller • Active touch controller 	No cost +\$ 78	Specify <i>with basic controller</i> . Specify <i>with active touch controller</i> .
	Options	U.S. Price	Required to Specify
Size Option	<ul style="list-style-type: none"> • Modular width desk • Parametric width desk 	No cost No cost	Specify <i>with modular width desk</i> . Specify <i>with parametric width desk</i> .
Surface Materials	High-Pressure Laminate desk <ul style="list-style-type: none"> • Laminate price group 2 • Laminate price group 3 • Open Line laminate (OLL) 	See information at left See information at left +\$111 plus cost of laminate	Specify laminate color number. Specify laminate color number. ► See <i>Surface Materials Reference Manual</i> .
	Height-adjustable base <ul style="list-style-type: none"> • 0835 Black • 4231 Arctic White • 4243 Merle Smooth • 4799 Platinum Metallic 	No cost No cost No cost +\$ 48	Specify <i>with 0835 Black</i> . Specify <i>with 4231 Arctic White</i> . Specify <i>with 4243 Merle Smooth</i> . Specify <i>with 4799 Platinum Metallic</i> .
	Metal cable tray <ul style="list-style-type: none"> • Paint price group 1 • Paint price group 2 • Paint price group 3 	No cost +\$ 16 +\$ 28	Specify paint color number. Specify paint color number. Specify paint color number. ► See <i>Surface Materials</i> , page 362
Grommet – Left Position	<ul style="list-style-type: none"> • None • Round grommet 	No cost +\$ 32	Specify <i>with none</i> . Specify <i>with round grommet on left</i> .
Grommet – Center Position	<ul style="list-style-type: none"> • None • Round grommet 	No cost +\$ 32	Specify <i>with none</i> . Specify <i>with round grommet on center</i> .
Grommet – Right Position	<ul style="list-style-type: none"> • None • Round grommet 	No cost +\$ 32	Specify <i>with none</i> . Specify <i>with round grommet on right</i> .

► Options, continued on next page

For laminate group 2 and 3 pricing, please refer to the electronic catalog or SmartTools.



For Canadian Pricing

Multiply U.S. Price by the Canadian price factor.

► See page 1 for details.

► Options, continued from previous page

Tip: FSC worksurface is only available for extended height desks.

Tip: Actual width of 42"W cable tray is 41 1/2".

Tip: Metal cable tray dimension will be automatically determined based on desk dimensions.

Options	U.S. Price	Required to Specify
FSC Worksurface • FSC Mix credit product	+\$ 42	Add suffix FSC to the end of the style number.
Metal Cable Tray • No cable tray	No cost	Specify <i>with no cable tray</i> .
• Metal tray		
– 30"W	+\$237	Specify <i>with metal tray</i> .
– 42"W	+\$290	Specify <i>with metal tray</i> .
– 52"W	+\$343	Specify <i>with metal tray</i> .
Related Products • Cable brackets		► Page 245
• Modesty panel		► Page 248
• Maintenance kit		► Page 247

Specification Information

Style Number	Dimensions Depth	Desk Type	U.S. Base Prices						
			40"W	46"W	52"W	58"W	64"W	70"W	76"W
		Modular	40"W	46"W	52"W	58"W	64"W	70"W	76"W
		Parametric	40 1/16"W	42 1/16"W	48 1/16"W	54 1/16"W	60 1/16"W	66 1/16"W	72 1/16"W
			– 42"W	– 48"W	– 54"W	– 60"W	– 66"W	– 72"W	– 78"W

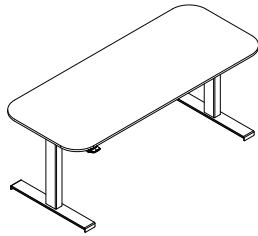

High-Pressure Laminate Intro Desk—Extended

HA1ER	23" or 24"	\$1804	\$1836	\$1868	\$1911	\$1954	\$1997	\$2098
	28", 29", or 30"	\$1841	\$1873	\$1905	\$1948	\$1991	\$2034	\$2135

High-Pressure Laminate Intro Desk—Basic

HA1SRQ	23" or 24"	\$1626	\$1658	\$1690	\$1733	\$1776	\$1819	\$1920
	28", 29", or 30"	\$1663	\$1695	\$1727	\$1770	\$1813	\$1856	\$1957



For Canadian Pricing
Multiply U.S. Price by the Canadian price factor.
► See page 1 for details.

Migration Intro Height-Adjustable Desks

Organic Desks

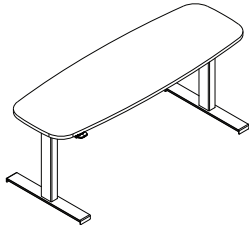

► Need help?
Product details,
page 198

Standard Includes

- Worksurface: High-Pressure Laminate price group 1 with 3 mm plastic edge
- Organic worksurface: bow front or bow front and back
- Electric height-adjustable sit-to-stand base: paint
- Column shape: rectangle
- T-leg configuration
- Basic controller
- Depth: 23", 24", 28", 29", or 30"
- Modular width: 40", 46", 52", 58", 64", 70", or 76"
- 1/2" glide
- Power cord: 10 1/2'
- Attachment hardware

Required to Specify

- 1 Style number
 - 2 Desk depth
 - 3 Desk width
 - 4 Shape type (see below under Required Selections)
 - 5 Controller (see below under Required Selections)
 - 6 High-Pressure Laminate, composite veneer, or wood color for worksurface
 - 7 Plastic color number for profile edge on laminate worksurface
 - 8 Paint color number for base
 - 9 Options, if selected (see below)
- See *Surface Materials*, page 362

	Required Selections	U.S. Price	Required to Specify
--	---------------------	------------	---------------------

Shape Type	<ul style="list-style-type: none"> • Bow front • Bow front and back 	No cost No cost	Specify <i>with bow front</i> . Specify <i>with bow front and back</i> .
Controller	<ul style="list-style-type: none"> • Basic controller • Active touch controller 	No cost +\$ 78	Specify <i>with basic controller</i> . Specify <i>with active touch controller</i> .

	Options	U.S. Price	Required to Specify
--	---------	------------	---------------------

Size Option	<ul style="list-style-type: none"> • Modular width desk • Parametric width desk 	No cost No cost	Specify <i>with modular width desk</i> . Specify <i>with parametric width desk</i> .
--------------------	---	--------------------	---

Surface Materials	High-Pressure Laminate desk		
	<ul style="list-style-type: none"> • Laminate price group 2 • Laminate price group 3 • Open Line laminate (OLL) 	See information at left See information at left +\$111 plus cost of laminate	Specify laminate color number. Specify laminate color number. ► See <i>Surface Materials Reference Manual</i> .

Height-adjustable base

- | | | |
|--------------------------|---------|--|
| • 4231 Arctic White | No cost | Specify <i>with 4231 Arctic White</i> . |
| • 4243 Merle Smooth | No cost | Specify <i>with 4243 Merle Smooth</i> . |
| • 4799 Platinum Metallic | No cost | Specify <i>with 4799 Platinum Metallic</i> . |

Metal cable tray

- | | | |
|-----------------------|---------|-----------------------------|
| • Paint price group 1 | No cost | Specify paint color number. |
| • Paint price group 2 | +\$ 16 | Specify paint color number. |
| • Paint price group 3 | +\$ 28 | Specify paint color number. |

► See *Surface Materials*, page 362

Grommet – Left Position	<ul style="list-style-type: none"> • None • Round grommet 	No cost +\$ 32	Specify <i>with none</i> . Specify <i>with round grommet on left</i> .
--------------------------------	---	-------------------	---

Grommet – Center Position	<ul style="list-style-type: none"> • None • Round grommet 	No cost +\$ 32	Specify <i>with none</i> . Specify <i>with round grommet on center</i> .
----------------------------------	---	-------------------	---

Grommet – Right Position	<ul style="list-style-type: none"> • None • Round grommet 	No cost +\$ 32	Specify <i>with none</i> . Specify <i>with round grommet on right</i> .
---------------------------------	---	-------------------	--

► Options, continued on next page

For laminate group 2 and 3 pricing, please refer to the electronic catalog or SmartTools.



For Canadian Pricing

Multiply U.S. Price by the Canadian price factor.

► See page 1 for details.

► Options, continued from previous page

Options	U.S. Price	Required to Specify
FSC Worksurface • FSC Mix credit product	+\$ 42	Add suffix FSC to the end of the style number.
Metal Cable Tray • No cable tray	No cost	Specify <i>with no cable tray</i> .
• Metal tray		
– 30"W	+\$237	Specify <i>with metal tray</i> .
– 42"W	+\$290	Specify <i>with metal tray</i> .
– 52"W	+\$343	Specify <i>with metal tray</i> .
Related Products • Cable brackets		► Page 245
• Modesty panel		► Page 248
• Maintenance kit		► Page 247

Tip: Actual width of 42"W cable tray is 41½".

Tip: Metal cable tray dimension will be automatically determined based on desk dimensions.

Tip: Metal cable tray is not available as an option on organic bow front and back worksurfaces.

Specification Information		U.S. Base Prices								
Style Number	Dimensions Depth	Desk Type	U.S. Base Prices							
			40"W	46"W	52"W	58"W	64"W	70"W	76"W	
		Modular	40"W	46"W	52"W	58"W	64"W	70"W	76"W	
		Parametric	40¼"W	42¼"W	48¼"W	54¼"W	60¼"W	66¼"W	72¼"W	
			42"W	48"W	54"W	60"W	66"W	72"W	78"W	

High-Pressure Laminate Intro Organic Desk—Extended

HA1EO	Dimensions Depth	U.S. Base Prices	U.S. Base Prices	U.S. Base Prices	U.S. Base Prices	U.S. Base Prices	U.S. Base Prices	U.S. Base Prices
	23" or 24"	\$1902	\$1934	\$1966	\$2009	\$2052	\$2095	\$2196
	28", 29", or 30"	\$1939	\$1971	\$2003	\$2046	\$2089	\$2132	\$2233

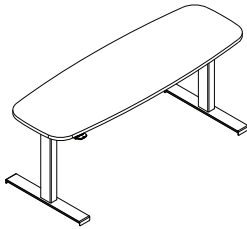

 **For Canadian Pricing**
Multiply U.S. Price by the Canadian price factor.
► See page 1 for details.

Migration Intro Height-Adjustable Bases

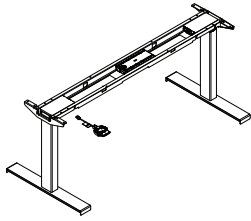

▶ Need help?
Product details,
page 198

Standard Includes	Required to Specify
<ul style="list-style-type: none"> • Electric height-adjustable sit-to-stand base: paint • Basic controller • Column shape: rectangle • T-leg configuration • Depth: 23", 24", 28", 29", or 30" • Modular width: 40", 46", 52", 58", 64", 70", or 76" • 1/2" glide • Power cord: 10 1/2' • Attachment hardware 	<ol style="list-style-type: none"> 1 Style number 2 Base depth 3 Base width 4 Controller (see below under Required Selections) 5 Paint color number for base base 6 Options, if selected (see below) <ul style="list-style-type: none"> ▶ See <i>Surface Materials</i>, page 362

Required Selections	U.S. Price	Required to Specify
Controller <ul style="list-style-type: none"> • Basic controller • Active touch controller 	No cost +\$78	Specify <i>with basic controller</i> . Specify <i>with active touch controller</i> .

Options	U.S. Price	Required to Specify
Size Option <ul style="list-style-type: none"> • Modular width • Parametric width 	No cost No cost	Specify <i>with modular width</i> . Specify <i>with parametric width</i> .
Surface Materials <ul style="list-style-type: none"> • 0835 Black • 4231 Arctic White • 4243 Merle Smooth • 4799 Platinum Metallic 	No cost No cost No cost +\$48	Specify <i>with 0835 Black</i> . Specify <i>with 4231 Arctic White</i> . Specify <i>with 4243 Merle Smooth</i> . Specify <i>with 4799 Platinum Metallic</i> .
Related Products <ul style="list-style-type: none"> • Cable brackets • Modesty panel • Maintenance kit 		▶ Page 245 ▶ Page 248 ▶ Page 247

Specification Information			U.S. Base Prices						
Style Number	Dimensions Depth	Desk Type	U.S. Base Prices						
			40"W	46"W	52"W	58"W	64"W	70"W	76"W
		Modular	40"W	46"W	52"W	58"W	64"W	70"W	76"W
		Parametric	40 1/16"W	42 1/16"W	48 1/16"W	54 1/16"W	60 1/16"W	66 1/16"W	72 1/16"W
			42"W	48"W	54"W	60"W	66"W	72"W	78"W

Intro Rectangular Base—Extended								
Style Number	Dimensions Depth	U.S. Price	U.S. Price	U.S. Price	U.S. Price	U.S. Price	U.S. Price	U.S. Price
HA1ERB	23" or 24"	\$1551	\$1567	\$1583	\$1599	\$1615	\$1631	\$1705
	28", 29", or 30"	\$1572	\$1588	\$1604	\$1620	\$1636	\$1652	\$1726

Intro Rectangular Base—Basic								
Style Number	Dimensions Depth	U.S. Price	U.S. Price	U.S. Price	U.S. Price	U.S. Price	U.S. Price	U.S. Price
HA1SRB	23" or 24"	\$1373	\$1389	\$1405	\$1421	\$1437	\$1453	\$1527
	28", 29", or 30"	\$1394	\$1410	\$1426	\$1442	\$1458	\$1474	\$1548



For Canadian Pricing
Multiply U.S. Price by the
Canadian price factor.
▶ See page 1 for details.

Metal Cable Tray

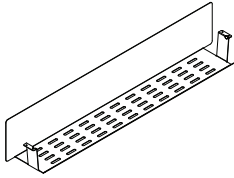

Standard Includes		Required to Specify
<ul style="list-style-type: none"> ▶ Need help? Product details, page 202 	<ul style="list-style-type: none"> • Cable tray: paint price group 1 • Attachment hardware 	<ol style="list-style-type: none"> 1 Style number 2 Tray width 3 Paint color number for tray <ul style="list-style-type: none"> ▶ See <i>Surface Materials</i>, page 362

Options	U.S. Price	Required to Specify
Surface Materials <ul style="list-style-type: none"> • Paint price group 1 • Paint price group 2 • Paint price group 3 	No cost +\$16 +\$28	Specify paint color number. Specify paint color number. Specify paint color number. ▶ See <i>Surface Materials</i> , page 362

Specification Information			
Style Number	Dimensions		U.S. Base Price
	W	H	
HACTM	30" (Small)	7"	\$237
	42" (Medium)	7"	\$290
	52" (Large)	7"	\$343

Tip: Actual width of 42"W cable tray is 41 1/2".

 **For Canadian Pricing**
 Multiply U.S. Price by the Canadian price factor.
 ▶ See page 1 for details.

Cable Riser

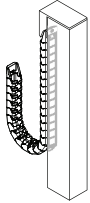

Standard Includes		Required to Specify
▶ Need help? Product details, page 202	<ul style="list-style-type: none"> • Cable riser: paint price group 1 • Chain: plastic price group 1 • Attachment hardware 	<ol style="list-style-type: none"> 1 Style number 2 Column shape 3 Paint color number for cable riser 4 Plastic color number for chain <p>▶ See <i>Surface Materials</i>, page 362</p>

Options	U.S. Price	Required to Specify
Column Shape <ul style="list-style-type: none"> • Rectangle column • Round column 	<p>No cost</p> <p>No cost</p>	<p>Specify <i>with rectangle column</i>.</p> <p>Specify <i>with round column</i>.</p>
Surface Materials	Cable riser <ul style="list-style-type: none"> • Paint price group 1 • Paint price group 2 • Paint price group 3 	<p>No cost</p> <p>+\$16</p> <p>+\$28</p> <p>Specify paint color number.</p> <p>Specify paint color number.</p> <p>Specify paint color number.</p> <p>▶ See <i>Surface Materials</i>, page 362</p>
	Chain <ul style="list-style-type: none"> • 6053 Seagull • 6527 Merle 	<p>No cost</p> <p>No cost</p> <p>Specify <i>with 6053 Seagull</i>.</p> <p>Specify <i>with 6527 Merle</i>.</p>

Specification Information	
Style Number	U.S. Base Price
HACR	\$343



For Canadian Pricing
 Multiply U.S. Price by the Canadian price factor.
 ▶ See page 1 for details.

Small Cable Brackets

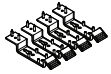

Standard Includes	Required to Specify
<ul style="list-style-type: none"> ▶ Need help? Product details, page 202 • Cable brackets, quantity of four: 6527 Merle plastic 	Style number

Specification Information

• Dimensions		• Style	• Weight	• U.S.
D	H	Number		Price
3 ⁵ / ₈ "	1 ³ / ₁₆ "	HACBKS4	0.5 lb	\$51
:	:	:	:	:

Large Cable Brackets

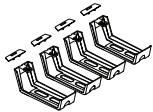

Standard Includes	Required to Specify
<ul style="list-style-type: none"> ▶ Need help? Product details, page 202 • Cable brackets, quantity of four: 6527 Merle plastic 	Style number

Specification Information

• Dimensions		• Style	• Weight	• U.S.
D	H	Number		Price
6"	2"	HACBKL4	0.5 lb	\$53
:	:	:	:	:



For Canadian Pricing

Multiply U.S. Price by the Canadian price factor.

▶ See page 1 for details.

Utility Power Mounting Brackets

For Powerstrip Intro, Powerstrip Plus, Flush Powerstrip, Pop-up Powerstrip, and Under Worksurface Utility Power

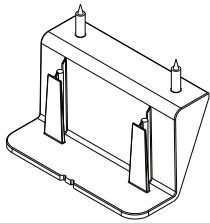

Standard Includes		Required to Specify
▶ Need help? Product details, page 189	• Mounting brackets quantity of 10: 6527 Merle Plastic	Style number

Specification Information

• Style • Number	• U.S. • Price
HAUPBK10	\$264

Side Screen Knife Edge Adapter Bracket for Migration Pro and Migration Pro High-Speed Desks

For Sarto Privacy and Sarto Privacy/Modesty Side Screens

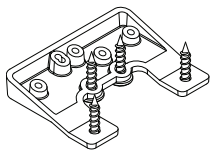

Standard Includes		Required to Specify
▶ Need help? Product details, page 189	• Knife edge adapter brackets for screens, quantity of 10: 6527 Merle plastic	Style number

Specification Information

• Style • Number	• U.S. • Price
HAKEBK10	\$158

Tip: To install Sarto privacy and Sarto privacy/modesty screens on a knife edge worksurface if the Migration side knife attachment bracket option was not selected when ordering.



For Canadian Pricing

Multiply U.S. Price by the Canadian price factor.

▶ See page 1 for details.

Obstruction Detection Kit

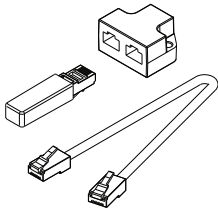

Tip: Desks are standard with obstruction sensing technology. Order kit for additional sensing technology.

Standard Includes	Required to Specify
<ul style="list-style-type: none"> ▶ Need help? Product details, page 189 • Obstruction detection sensor, quantity of 10 • T-splitter, quantity of 10 • Splitter cable, quantity of 10 • Attachment hardware 	<ul style="list-style-type: none"> Style number

Specification Information

Style Number	U.S. Price
HAODKT10	\$633

Maintenance Kit

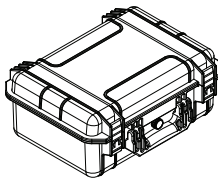

Tip: Includes electronic parts to aid in troubleshooting height-adjustable desks. Compatible with Migration Intro, Migration Pro, Ology, Flex, and Slim Leg HAD.

Standard Includes	Required to Specify
<ul style="list-style-type: none"> ▶ Need help? Product details, page 189 • Hard case with electrical components for Migration Pro and Intro 	<ul style="list-style-type: none"> Style number

Specification Information

Style Number	U.S. Price
HAMKT	\$1002



For Canadian Pricing

Multiply U.S. Price by the Canadian price factor.

▶ See page 1 for details.

Modesty Panel

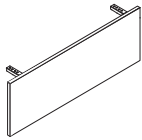

	Standard Includes	Required to Specify
▶ Need help? Product details, page 206	<ul style="list-style-type: none"> Modesty panel: High-Pressure Laminate price group 1 with 3 mm plastic edge Modular width: 40", 46", 52", 58", 64", 70", 76", 82", 88", or 94" Attachment hardware 	<ol style="list-style-type: none"> Style number Worksurface width Worksurface shape type (see below under Required Selections) Worksurface corner shape (see below under Required Selections) Worksurface edge profile (see below under Required Selections) High-Pressure Laminate, composite veneer, or wood color for panel Plastic color number for profile edge on laminate panel, if selected Options, if selected (see below) <p>▶ See <i>Surface Materials</i>, page 362</p>

Tip: Modesty panels are not allowed on organic bow front and back worksurfaces unless they are inset.

	Required Selections	U.S. Price	Required to Specify
Worksurface Shape Type	<ul style="list-style-type: none"> Rectangle Bow front 	No cost No cost	Specify with <i>rectangle shape</i> . Specify with <i>bow front shape</i> .
Worksurface Corner Shape	<ul style="list-style-type: none"> Square corner Radius 2" corner Radius 5" corner 	No cost No cost No cost	Specify with <i>square corner</i> . Specify with <i>radius 2" corner</i> . Specify with <i>radius 5" corner</i> .
Worksurface Edge Profile	<ul style="list-style-type: none"> No knife edge Knife edge 	No cost No cost	Specify with <i>no knife edge</i> . Specify with <i>knife edge</i> .

Tip: Scallop option is available on laminate only.

	Options	U.S. Price	Required to Specify
Size Option	<ul style="list-style-type: none"> Modular width desk Parametric width desk 	No cost No cost	Specify with <i>modular width desk</i> . Specify with <i>parametric width desk</i> .
Scallop	<ul style="list-style-type: none"> No scallop With scallop 	No cost +\$ 32	Specify with <i>no scallop</i> . Specify with <i>scallop</i> .

For laminate group 2 and 3 pricing, please refer to the electronic catalog or SmartTools.

	Surface Materials	U.S. Price	Required to Specify
	<ul style="list-style-type: none"> High-Pressure Laminate panel Laminate price group 2 Laminate price group 3 Open Line laminate (OLL) 	See information at left See information at left +\$111 plus cost of laminate	Specify laminate color number. Specify laminate color number. ▶ See <i>Surface Materials Reference Manual</i> .
	<ul style="list-style-type: none"> Wood veneer panel Composite veneer group 1 Composite veneer group 2 Wood group 1 Wood group 2 Wood group 3 Customiz stain 	Prices at right +\$108 Prices at right +\$118 +\$417 No cost	Specify composite veneer color number. Specify composite veneer color number. Specify wood color number. Specify wood color number. Specify wood color number. Specify with customiz stain. ▶ See <i>Surface Materials Reference Manual</i> .

Tip: Vertical grain direction is only allowed up to 60"W.

	Grain Direction	U.S. Price	Required to Specify
	<ul style="list-style-type: none"> No grain direction Vertical Horizontal 	No cost No cost No cost	Specify with <i>no grain direction</i> . Specify with <i>vertical grain direction</i> . Specify with <i>horizontal grain direction</i> .
	FSC Worksurface	<ul style="list-style-type: none"> FSC Mix credit product 	+\$ 42 Add suffix FSC to the end of the style number.



For Canadian Pricing
Multiply U.S. Price by the Canadian price factor.
▶ See page 1 for details.

Specification Information

Style Number	Panel Type	U.S. Base Prices									
		40"W	46"W	52"W	58"W	64"W	70"W	76"W	82"W	88"W	94"W
	Modular										
	Parametric	40 ¹ / ₁₆ "W	42 ¹ / ₁₆ "W	48 ¹ / ₁₆ "W	54 ¹ / ₁₆ "W	60 ¹ / ₁₆ "W	66 ¹ / ₁₆ "W	72 ¹ / ₁₆ "W	78 ¹ / ₁₆ "W	84 ¹ / ₁₆ "W	90 ¹ / ₁₆ "W
		- 42"W	- 48"W	- 54"W	- 60"W	- 66"W	- 72"W	- 78"W	- 84"W	- 90"W	- 96"W

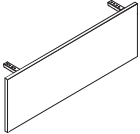

High-Pressure Laminate Panel

HAMP	\$290	\$301	\$312	\$323	\$334	\$345	\$356	\$367	\$378	\$389
-------------	-------	-------	-------	-------	-------	-------	-------	-------	-------	-------

Composite Veneer Group 1 Panel

HAMP	\$372	\$394	\$416	\$438	\$460	\$482	\$504	\$526	\$548	\$570
-------------	-------	-------	-------	-------	-------	-------	-------	-------	-------	-------

Wood Group 1 Panel

HAMP	\$372	\$394	\$416	\$438	\$460	\$482	\$504	\$526	\$548	\$570
-------------	-------	-------	-------	-------	-------	-------	-------	-------	-------	-------



For Canadian Pricing

Multiply U.S. Price by the Canadian price factor.

▶ See page 1 for details.

Migration SE Height-Adjustable Desks

T-Leg

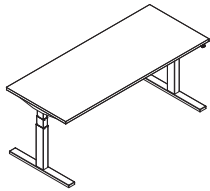

Tip: 76"W Migration SE desks ship standard with a 4" overhang on both sides.

Tip: The height saver with casters option is only available on 29"/30"D or 35"/36"D desks.

Tip: On extended height desks, any storage higher than 18³/₁₀" will impede height range of desk. On basic height desks, any storage higher than 24" will impede the height range of the desk.

▶ See page 211 for overhang rules.

Tip: 5" corner radius option available on desks 58"W or wider.

Tip: On 23"/24"D and less than 58"W desks, only single and dual flat panel monitor arm applications are permitted for use.

▶ See Steelcase Worktools Specification Guide.

Tip: For desks 29"/30"Dx58"W and greater additional monitor arm configurations are allowed.

▶ See page 58, Steelcase Monitor Arm Guidelines.



For Canadian Pricing
Multiply U.S. Price by the Canadian price factor.

▶ See page 1 for details.

	Standard Includes	Required to Specify
▶ Need help? Product details, page 208	<ul style="list-style-type: none"> • Worksurface with square corners: High-Pressure Laminate price group 1 with 3 mm plastic edge • Electric height-adjustable sit-to-stand base: paint • Square or radius (if selected) corners • Depth: 23", 24", 28", 29", 29", 30", 35", or 36" • Width: 46", 52", 58", 64", 70", or 76" • Power cord: 9' • ½" adjustable glides • Attachment hardware 	<ol style="list-style-type: none"> 1 Style number 2 Desk type (see below under Required Selections) 3 Overhang and overhang width, if selected (see below under Required Selections) 4 Controller (see below under Required Selections) 5 Foot (see below under Required Selections) 6 Corner (see below under Required Selections) 7 Desk depth 8 Desk width 9 High-Pressure Laminate, composite veneer, or wood color for worksurface 10 Plastic color number for profile edge, if selected 11 Paint color number for base: 4799 Platinum Metallic 7207 Black 7241 Arctic White 7360 Merle 12 Options, if selected (see below) <p>▶ See <i>Surface Materials</i>, page 362</p>

	Required Selections	U.S. Price	Required to Specify
Desk Type	<ul style="list-style-type: none"> • Parametric width desk • Modular width desk 	No cost No cost	Specify with <i>parametric desk type</i> . Specify with <i>modular desk type</i> .
Controller	<ul style="list-style-type: none"> • Up/down controller • 4 pre-set controller 	No cost +\$ 78	Specify with <i>up/down controller</i> . Specify with <i>4 pre-set controller</i> .
Foot	<ul style="list-style-type: none"> • Squared-edge foot • Mitered-edge foot • Height saver with casters 	No cost No cost +\$219	Specify with <i>squared-edge foot</i> . Specify with <i>mitered-edge foot</i> . Specify with <i>height saver with caster</i> .
Overhang	<ul style="list-style-type: none"> • No overhang • Left overhang • Right overhang 	No cost No cost No cost	Specify with <i>no overhang</i> . Specify with <i>left overhang</i> . Specify with <i>right overhang</i> .
	Overhang width		
	<ul style="list-style-type: none"> • 3"W • 6"W • 9"W • 12"W 	No cost No cost No cost No cost	Specify with <i>3"W overhang</i> . Specify with <i>6"W overhang</i> . Specify with <i>9"W overhang</i> . Specify with <i>12"W overhang</i> .
Corner	<ul style="list-style-type: none"> • Square corner • Radius corner 	No cost +\$ 98	Specify with <i>square corner</i> . Specify with <i>radius corner</i> .
	Corner radius		
	<ul style="list-style-type: none"> • 2" radius • 5" radius 	No cost No cost	Specify with <i>2" radius</i> . Specify with <i>5" radius</i> .

	Options	U.S. Price	Required to Specify
Surface Materials	Laminate desks		
	<ul style="list-style-type: none"> • Laminate price group 2 • Laminate price group 3 • Open Line laminate 	See information at left See information at left +\$111	Specify laminate color number. Specify laminate color number. ▶ See <i>Surface Materials Reference Manual</i> .
	Composite veneer desks		
	<ul style="list-style-type: none"> • Composite veneer group 1 • Composite veneer group 2 	Prices at right +\$108	Specify composite veneer color number. Specify composite veneer color number.

▶ Options, continued on next page

► Options, continued from previous page

Options	U.S. Price	Required to Specify
Surface Materials, continued		
Wood veneer desks		
• Wood group 1	Prices below	Specify wood color number.
• Wood group 2	+\$118	Specify wood color number.
• Wood group 3	+\$417	Specify wood color number.
• Customiz stain	No cost	Specify with customiz stain.
		► See <i>Surface Materials Reference Manual</i> .
Base		
• Paint price group 1	No cost	Specify paint color number.
• Paint price group 2	+\$ 47	Specify paint color number.
		► See <i>Surface Materials</i> , page 362
CarbonNeutral Product	CarbonNeutral product certification	+\$ 47
		Add suffix CN to the end of the style number.
Related Products	• Privacy/modesty screens	► Pages 330–332
	• Cable and power management	► Page 274

For laminate group 2 and 3 pricing, please refer to the electronic catalog or SmartTools.

Tip: Base supports a maximum distributed weight capacity of 250 pounds. When calculating lifting capacity, subtract the weight of the worksurface.

► See page 211 for worksurface weights.

Tip: CarbonNeutral option is not available for GSA styles MGLSTRQG and MGELTRQG.

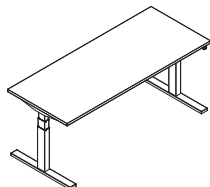

Tip: MGLSTRQG and MGELTRQG are for GSA use only.

Specification Information

Style Number	Dimensions Depth	Desk Type	U.S. Base Prices					
			46"W	52"W	58"W	64"W	70"W	76"W
		Modular	46"W	52"W	58"W	64"W	70"W	76"W
		Parametric	46"W	46½"W	52½"W	58½"W	64½"W	70½"W
			-52"W	-58"W	-64"W	-70"W	-76"W	

High-Pressure Laminate Desks—Basic Height

MGLSTRQ	23" or 24"	\$1820	\$1855	\$1893	\$1939	\$1987	\$2035
MGLSTRQG	28", 29", or 30"	\$1856	\$1894	\$1932	\$1977	\$2029	\$2078
	35" or 36"	\$1895	\$1933	\$1971	\$2029	\$2078	\$2129

Composite Veneer Group 1 Desks—Basic Height

MGLSTRQ	23" or 24"	\$2640	\$2685	\$2735	\$2797	\$2856	\$2918
MGLSTRQG	28", 29", or 30"	\$2711	\$2760	\$2810	\$2871	\$2931	\$2993
	35" or 36"	\$2779	\$2832	\$2886	\$2958	\$3015	\$3083

Wood Group 1 Desks—Basic Height

MGLSTRQ	23" or 24"	\$2722	\$2769	\$2819	\$2882	\$2943	\$3007
MGLSTRQG	28", 29", or 30"	\$2796	\$2847	\$2897	\$2960	\$3022	\$3084
	35" or 36"	\$2868	\$2922	\$2977	\$3051	\$3109	\$3178

High-Pressure Laminate Desks—Extended Height

MGELTRQ	23" or 24"	\$2006	\$2045	\$2084	\$2136	\$2189	\$2243
MGELTRQG	28", 29", or 30"	\$2047	\$2085	\$2127	\$2182	\$2237	\$2290
	35" or 36"	\$2090	\$2129	\$2172	\$2237	\$2290	\$2348

Composite Veneer Group 1 Desks—Extended Height

MGELTRQ	23" or 24"	\$2826	\$2875	\$2926	\$2994	\$3058	\$3126
MGELTRQG	28", 29", or 30"	\$2902	\$2951	\$3005	\$3076	\$3139	\$3205
	35" or 36"	\$2974	\$3028	\$3087	\$3166	\$3227	\$3302

Wood Group 1 Desks—Extended Height

MGELTRQ	23" or 24"	\$2908	\$2959	\$3010	\$3079	\$3145	\$3215
MGELTRQG	28", 29", or 30"	\$2987	\$3038	\$3092	\$3165	\$3230	\$3296
	35" or 36"	\$3063	\$3118	\$3178	\$3259	\$3321	\$3397

For Canadian Pricing
Multiply U.S. Price by the Canadian price factor.
► See page 1 for details.

Migration SE Height-Adjustable Desks

C-Leg

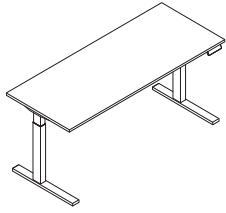

Standard Includes	Required to Specify
<ul style="list-style-type: none"> ▶ Need help? Product details, page 208 • Worksurface with square corners: High-Pressure Laminate price group 1 with 3 mm plastic edge • Electric height-adjustable sit-to-stand base: paint • Square corners • Depth: 29" or 30" • Width: 46", 52", 58", 64", 70", or 76" • Power cord: 9' • ½" adjustable glides • Attachment hardware 	<ol style="list-style-type: none"> 1 Style number 2 Desk type (see below under Required Selections) 3 Overhang and overhang width, if selected (see below under Required Selections) 4 Controller (see below under Required Selections) 5 Corner (see below under Required Selections) 6 Desk depth 7 Desk width 8 High-Pressure Laminate, composite veneer, or wood color for worksurface 9 Plastic color number for profile edge, if selected 10 Paint color number for base: <ul style="list-style-type: none"> 4799 Platinum Metallic 7207 Black 7241 Arctic White 7360 Merle 11 Options, if selected (see below) <ul style="list-style-type: none"> ▶ See <i>Surface Materials</i>, page 362

Tip: 76"W Migration SE desks ship standard with a 4" overhang on both sides.

Tip: On extended height desks, any storage higher than 18¾" will impede height range of desk. On basic height desks, any storage higher than 24" will impede the height range of the desk.

▶ See page 211 for overhang rules.

Tip: On 23"/24"D and less than 58"W desks, only single and dual flat panel monitor arm applications are permitted for use.

▶ See *Steelcase Worktools Specification Guide*.

Tip: For desks 29"/30"Dx58"W and greater additional monitor arm configurations are allowed.

▶ See page 58, *Steelcase Monitor Arm Guidelines*.

Tip: 5" corner radius option available on desks 58"W or wider.

For laminate group 2 and 3 pricing, please refer to the electronic catalog or SmartTools.



For Canadian Pricing
Multiply U.S. Price by the Canadian price factor.

▶ See page 1 for details.

	Required Selections	U.S. Price	Required to Specify
Desk Type	<ul style="list-style-type: none"> • Parametric width desk • Modular width desk 	No cost No cost	Specify with <i>parametric desk type</i> . Specify with <i>modular desk type</i> .
Controller	<ul style="list-style-type: none"> • Up/down controller • 4 pre-set controller 	No cost +\$ 78	Specify with <i>up/down controller</i> . Specify with <i>4 pre-set controller</i> .
Foot	<ul style="list-style-type: none"> • Squared-edge • Mitered-edge 	No cost No cost	Specify with <i>squared-edge foot</i> . Specify with <i>mitered-edge foot</i> .
Overhang	<ul style="list-style-type: none"> • No overhang • Left overhang • Right overhang 	No cost No cost No cost	Specify with <i>no overhang</i> . Specify with <i>left overhang</i> . Specify with <i>right overhang</i> .
	Overhang width		
	<ul style="list-style-type: none"> • 3"W • 6"W • 9"W • 12"W 	No cost No cost No cost No cost	Specify with <i>3"W overhang</i> . Specify with <i>6"W overhang</i> . Specify with <i>9"W overhang</i> . Specify with <i>12"W overhang</i> .
Corner	<ul style="list-style-type: none"> • Square corner • Radius corner 	No cost +\$ 98	Specify with <i>square corner</i> . Specify with <i>radius corner</i> .
	Corner radius		
	<ul style="list-style-type: none"> • 2" radius • 5" radius 	No cost No cost	Specify with <i>2" radius</i> . Specify with <i>5" radius</i> .

	Options	U.S. Price	Required to Specify
Surface Materials	Laminate desks		
	<ul style="list-style-type: none"> • Laminate price group 2 • Laminate price group 3 • Open Line laminate 	See information at left See information at left +\$111	Specify laminate color number. Specify laminate color number. ▶ See <i>Surface Materials Reference Manual</i> .
	Composite veneer desks		
	<ul style="list-style-type: none"> • Composite veneer group 1 • Composite veneer group 2 	Prices at right +\$108	Specify composite veneer color number. Specify composite veneer color number.

▶ Options, continued on next page

► Options, continued from previous page

Options	U.S. Price	Required to Specify
Surface Materials, continued		
Wood veneer desks		
• Wood group 1	Prices below	Specify wood color number.
• Wood group 2	+\$118	Specify wood color number.
• Wood group 3	+\$417	Specify wood color number.
• Customiz stain	No cost	Specify with customiz stain.
		► See <i>Surface Materials Reference Manual</i> .
Base		
• Paint price group 1	No cost	Specify paint color number.
• Paint price group 2	+\$ 47	Specify paint color number.
		► See <i>Surface Materials</i> , page 362
CarbonNeutral Product	CarbonNeutral product certification	+\$ 47
		Add suffix CN to the end of the style number.
Related Products	• Privacy/modesty screens	► Pages 330–332
	• Cable and power management	► Page 274

Tip: Base supports a maximum distributed weight capacity of 250 pounds. When calculating lifting capacity, subtract the weight of the worksurface and understructure.

► See page 211 for worksurface weights.

Tip: CarbonNeutral option is not available for GSA styles *MGSLCRQG* and *MGELCRQG*.

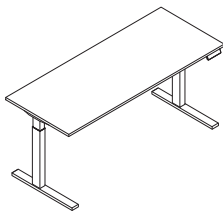

Tip: *MGSLCRQG* and *MGELCRQG* are for GSA use only.

Specification Information

Style Number	Dimensions Depth	Desk Type	U.S. Base Prices					
			46"W	52"W	58"W	64"W	70"W	76"W
		Modular	46"W	52"W	58"W	64"W	70"W	76"W
		Parametric	46"W	46 ¹ / ₁₆ "W	52 ¹ / ₁₆ "W	58 ¹ / ₁₆ "W	64 ¹ / ₁₆ "W	70 ¹ / ₁₆ "W
			-52"W	-58"W	-64"W	-70"W	-76"W	

High-Pressure Laminate Desks—Basic Height

Style Number	Dimensions	46"W	52"W	58"W	64"W	70"W	76"W
MGSLCRQ	29" or 30"	\$1856	\$1894	\$1932	\$1977	\$2029	\$2078
MGSLCRQG							

Composite Veneer Group 1 Desks—Basic Height

Style Number	Dimensions	46"W	52"W	58"W	64"W	70"W	76"W
MGSLCRQ	29" or 30"	\$2711	\$2760	\$2810	\$2871	\$2931	\$2993
MGSLCRQG							

Wood Group 1 Desks—Basic Height

Style Number	Dimensions	46"W	52"W	58"W	64"W	70"W	76"W
MGSLCRQ	29" or 30"	\$2796	\$2847	\$2897	\$2960	\$3022	\$3084
MGSLCRQG							

High-Pressure Laminate Desks—Extended Height

Style Number	Dimensions	46"W	52"W	58"W	64"W	70"W	76"W
MGELCRQ	29" or 30"	\$2047	\$2085	\$2127	\$2182	\$2237	\$2290
MGELCRQG							

Composite Veneer Group 1 Desks—Extended Height

Style Number	Dimensions	46"W	52"W	58"W	64"W	70"W	76"W
MGELCRQ	29" or 30"	\$2902	\$2951	\$3005	\$3076	\$3139	\$3205
MGELCRQG							

Wood Group 1 Desks—Extended Height

Style Number	Dimensions	46"W	52"W	58"W	64"W	70"W	76"W
MGELCRQ	29" or 30"	\$2987	\$3038	\$3092	\$3165	\$3230	\$3296
MGELCRQG							

 **For Canadian Pricing**
Multiply U.S. Price by the Canadian price factor.
► See page 1 for details.

Migration SE Height-Adjustable 3-Leg Corner Desk

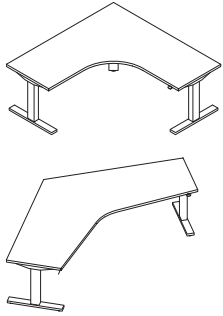

Tip: On extended height desks, any storage higher than 18³/₁₀" will impede the height range of the desk. On basic height desks, any storage higher than 24" will impede the height range of the desk. Do not place storage underneath controller.

Tip: Base supports a maximum distributed weight capacity of 330 pounds. When calculating lifting capacity, subtract the weight of the worksurface and understructure.

Tip: If left or right width is greater than 60"W, then the opposite side width must be less than or equal to 60"W.

Tip: Overhang is not allowed on 120° corner desks.

For laminate group 2 and 3 pricing, please refer to the electronic catalog or SmartTools.



For Canadian Pricing
Multiply U.S. Price by the Canadian price factor.
▶ See page 1 for details.

Standard Includes	Required to Specify
<ul style="list-style-type: none"> ▶ Need help? Product details, page 208 • Worksurface: High-Pressure Laminate price group 1 with 3 mm plastic edge or composite veneer group 1 • Electric height-adjustable sit-to-stand base: paint price group 1 • Up/down controller • Depth: <ul style="list-style-type: none"> – 90° equal corner: 23", 24", 29", 30" – 90° extended corner: 23", 24", 29", 30" – 120° equal corner: 23", 24" • Modular widths: <ul style="list-style-type: none"> – 90° corner: 46"–76" – 120° equal corner: 46"–64" • ½" adjustable glides • Power cord: 9' • Attachment hardware 	<ol style="list-style-type: none"> 1 Style number 2 Desk type (see below under Required Selections) 3 Overhang and overhang width, if selected (see below under Required Selections) 4 Controller (see below under Required Selections) 5 Desk depth 6 Desk width 7 High-Pressure Laminate or composite veneer for worksurface 8 Plastic color number for profile edge on laminate worksurface, if selected 9 Paint color number for base: <ul style="list-style-type: none"> 4799 Platinum Metallic 7207 Black 7241 Arctic White 7360 Merle 10 Options, if selected (see below) <ul style="list-style-type: none"> ▶ See <i>Surface Materials</i>, page 362

Required Selections	U.S. Price	Required to Specify
Desk Type <ul style="list-style-type: none"> • Parametric width desk • Modular width desk 	No cost No cost	Specify with <i>parametric desk type</i> . Specify with <i>modular desk type</i> .
Controller <ul style="list-style-type: none"> • Up/down controller • 4 pre-set controller 	No cost +\$ 78	Specify with <i>up/down controller</i> . Specify with <i>4 pre-set controller</i> .
Overhang <ul style="list-style-type: none"> • No overhang • Left overhang • Right overhang 	No cost No cost No cost	Specify with <i>no overhang</i> . Specify with <i>left overhang</i> . Specify with <i>right overhang</i> .
Overhang width <ul style="list-style-type: none"> • 3"W • 6"W • 9"W • 12"W 	No cost No cost No cost No cost	Specify with <i>3"W overhang</i> . Specify with <i>6"W overhang</i> . Specify with <i>9"W overhang</i> . Specify with <i>12"W overhang</i> .

Options	U.S. Price	Required to Specify
Surface Materials <ul style="list-style-type: none"> • Laminate desks <ul style="list-style-type: none"> • Laminate price group 2 • Laminate price group 3 • Open Line laminate • Composite veneer desks <ul style="list-style-type: none"> • Composite veneer group 1 • Composite veneer group 2 • Wood veneer desks <ul style="list-style-type: none"> • Wood group 1 • Wood group 2 • Wood group 3 • Customiz stain • Base <ul style="list-style-type: none"> • Paint price group 1 • Paint price group 2 	See information at left See information at left +\$111 No cost +\$108 Prices at right +\$118 +\$417 No cost No cost +\$ 72	Specify laminate color number. Specify laminate color number. ▶ See <i>Surface Materials Reference Manual</i> . Specify composite veneer color number. Specify composite veneer color number. Specify wood color number. Specify wood color number. Specify wood color number. Specify with <i>customiz stain</i> . ▶ See <i>Surface Materials Reference Manual</i> . Specify paint color number. Specify paint color number. ▶ See <i>Surface Materials</i> , page 362

Related Products	Required to Specify
<ul style="list-style-type: none"> • Privacy/modesty screens • Cable and power management 	<ul style="list-style-type: none"> ▶ Pages 330–332 ▶ Page 274

Specification Information

• Style Number	• Dimensions D		• Modular Right Width	• U.S. Base Prices					
	• Modular Left Width	• Parametric Left Width		• Parametric Right Width	46"W	52"W	58"W	64"W	70"W
				46"W	52"W	58"W	64"W	70"W	76"W
				46"W	46 ¹ / ₁₆ "W–52"W	52 ¹ / ₁₆ "W–58"W	58 ¹ / ₁₆ "W–64"W	64 ¹ / ₁₆ "W–70"W	70 ¹ / ₁₆ "W–76"W

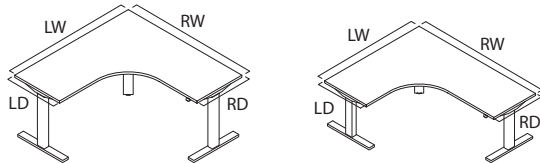

90° 3-Leg Corner Desks—Basic Height (Same Depth Both Ends 23"/24")

High-Pressure Laminate Desks										
MGSLTLC	23" or 24"	46"	46"	N.A.	\$2812	\$2896	\$2982	\$3072	\$3164	
MGSLTCG	23" or 24"	52"	46 ¹ / ₁₆ "–52"	\$2812	\$2896	\$2982	\$3072	\$3164	\$3259	
	23" or 24"	58"	52 ¹ / ₁₆ "–58"	\$2896	\$2982	\$3072	\$3164	\$3259	\$3357	
	23" or 24"	64"	58 ¹ / ₁₆ "–64"	\$2982	\$3072	\$3164	\$3259	\$3357	\$3457	
	23" or 24"	70"	64 ¹ / ₁₆ "–70"	\$3072	\$3164	\$3259	\$3357	N.A.	N.A.	
	23" or 24"	76"	70 ¹ / ₁₆ "–76"	\$3164	\$3259	\$3357	\$3457	N.A.	N.A.	

90° 3-Leg Corner Desks—Basic Height (Different Depth Opposite Ends 23"/24" Right/Left and 29"/30" Left/Right)

High-Pressure Laminate Desks										
MGSLTLC	23" or 24" R/L	29" or 30" L/R	46"	46"	N.A.	\$2866	\$2953	\$3042	\$3132	\$3226
	23" or 24" R/L	29" or 30" L/R	52"	46 ¹ / ₁₆ "–52"	\$2866	\$2953	\$3042	\$3132	\$3226	\$3323
	23" or 24" R/L	29" or 30" L/R	58"	52 ¹ / ₁₆ "–58"	\$2953	\$3042	\$3132	\$3226	\$3323	\$3423
	23" or 24" R/L	29" or 30" L/R	64"	58 ¹ / ₁₆ "–64"	\$3042	\$3132	\$3226	\$3323	\$3423	\$3526
	23" or 24" R/L	29" or 30" L/R	70"	64 ¹ / ₁₆ "–70"	\$3132	\$3226	\$3323	\$3423	N.A.	N.A.
	23" or 24" R/L	29" or 30" L/R	76"	70 ¹ / ₁₆ "–76"	\$3226	\$3323	\$3423	\$3526	N.A.	N.A.

Tip: **MGSLTCG** is for GSA use only.
 Tip: For modular sized desks, if width left or right is greater or equal to 64"W, then opposite side width must be less than or equal to 58"W. For parametric sized desks, if width left or right is greater than 60"W, then opposite side width must be less than or equal to 60"W.
 Tip: Widths are parametric in 1/16" increments.

► **Specification Information, continued on next page**



For Canadian Pricing
 Multiply U.S. Price by the Canadian price factor.
 ► See page 1 for details.

Migration SE Height-Adjustable 3-Leg Corner Desk, continued

► **Specification Information, continued from previous page**

Style Number		Dimensions D		U.S. Base Prices						
		Modular Left Width	Parametric Left Width	Modular Right Width	46"W	52"W	58"W	64"W	70"W	76"W
				Parametric Right Width	46"W	46 ¹ / ₁₆ "W-	52 ¹ / ₁₆ "W-	58 ¹ / ₁₆ "W-	64 ¹ / ₁₆ "W-	70 ¹ / ₁₆ "W-

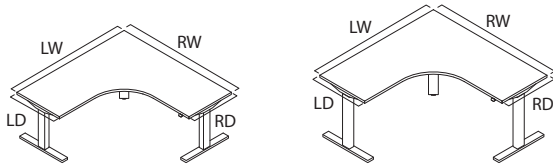

90° 3-Leg Corner Desks—Basic Height (Same Depth Both Ends 29"/30")

High-Pressure Laminate Desks

MGSLTLC	Style Number	Modular Left Width	Parametric Left Width	Modular Right Width	46"W	52"W	58"W	64"W	70"W	76"W
MGSLTLCG	29" or 30"	46"	46"	N.A.	\$2866	\$2953	\$3042	\$3132	\$3226	\$3226
	29" or 30"	52"	46 ¹ / ₁₆ "-52"	\$2866	\$2953	\$3042	\$3132	\$3226	\$3226	\$3323
	29" or 30"	58"	52 ¹ / ₁₆ "-58"	\$2953	\$3042	\$3132	\$3226	\$3323	\$3423	\$3423
	29" or 30"	64"	58 ¹ / ₁₆ "-64"	\$3042	\$3132	\$3226	\$3323	\$3423	\$3526	\$3526
	29" or 30"	70"	64 ¹ / ₁₆ "-70"	\$3132	\$3226	\$3323	\$3423	N.A.	N.A.	N.A.
	29" or 30"	76"	70 ¹ / ₁₆ "-76"	\$3226	\$3323	\$3423	\$3526	N.A.	N.A.	N.A.

90° 3-Leg Corner Desks—Basic Height (Same Depth Both Ends 23"/24")

Composite Veneer Desks

MGSLTLC	Style Number	Modular Left Width	Parametric Left Width	Modular Right Width	46"W	52"W	58"W	64"W	70"W	76"W
	23" or 24"	46"	46"	N.A.	\$4190	\$4294	\$4398	\$4514	\$4626	\$4626
	23" or 24"	52"	46 ¹ / ₁₆ "-52"	\$4190	\$4294	\$4398	\$4514	\$4626	\$4742	\$4742
	23" or 24"	58"	52 ¹ / ₁₆ "-58"	\$4294	\$4398	\$4514	\$4626	\$4742	\$4861	\$4861
	23" or 24"	64"	58 ¹ / ₁₆ "-64"	\$4398	\$4514	\$4626	\$4742	\$4861	\$4983	\$4983
	23" or 24"	70"	64 ¹ / ₁₆ "-70"	\$4514	\$4626	\$4742	\$4861	N.A.	N.A.	N.A.
	23" or 24"	76"	70 ¹ / ₁₆ "-76"	\$4626	\$4742	\$4861	\$4983	N.A.	N.A.	N.A.

Wood Veneer Desks

MGSLTLC	Style Number	Modular Left Width	Parametric Left Width	Modular Right Width	46"W	52"W	58"W	64"W	70"W	76"W
	23" or 24"	46"	46"	N.A.	\$4328	\$4434	\$4539	\$4659	\$4773	\$4773
	23" or 24"	52"	46 ¹ / ₁₆ "-52"	\$4328	\$4434	\$4539	\$4659	\$4773	\$4891	\$4891
	23" or 24"	58"	52 ¹ / ₁₆ "-58"	\$4434	\$4539	\$4659	\$4773	\$4891	\$5012	\$5012
	23" or 24"	64"	58 ¹ / ₁₆ "-64"	\$4539	\$4659	\$4773	\$4891	\$5012	\$5136	\$5136
	23" or 24"	70"	64 ¹ / ₁₆ "-70"	\$4659	\$4773	\$4891	\$5012	N.A.	N.A.	N.A.
	23" or 24"	76"	70 ¹ / ₁₆ "-76"	\$4773	\$4891	\$5012	\$5136	N.A.	N.A.	N.A.

Tip: **MGSLTLCG** is for GSA use only.

Tip: For modular sized desks, if width left or right is greater or equal to 64"W, then opposite side width must be less than or equal to 58"W.

For parametric sized desks, if width left or right is greater than 60"W, then opposite side width must be less than or equal to 60"W.

Tip: Widths are parametric in 1/16" increments.

► **Specification Information, continued on next page**

► **Specification Information, continued from previous page**

Specification Information										
Style Number	Dimensions				U.S. Base Prices					
	D		Modular Right Width	Parametric Right Width	46"W	52"W	58"W	64"W	70"W	76"W
	Modular Left Width	Parametric Left Width			46"W	46 ¹ / ₁₆ "W-	52 ¹ / ₁₆ "W-	58 ¹ / ₁₆ "W-	64 ¹ / ₁₆ "W-	70 ¹ / ₁₆ "W-
					52"W	58"W	64"W	70"W	76"W	

90° 3-Leg Corner Desks—Basic Height (Different Depth Opposite Ends 23"/24" Right/Left and 29"/30" Left/Right)

Composite Veneer Desks										
MGSLTLC	23" or 24" R/L	29" or 30" L/R	46"	46"	N.A.	\$4244	\$4351	\$4458	\$4574	\$4688
	23" or 24" R/L	29" or 30" L/R	52"	46 ¹ / ₁₆ "-52"	\$4244	\$4351	\$4458	\$4574	\$4688	\$4806
	23" or 24" R/L	29" or 30" L/R	58"	52 ¹ / ₁₆ "-58"	\$4351	\$4458	\$4574	\$4688	\$4806	\$4927
	23" or 24" R/L	29" or 30" L/R	64"	58 ¹ / ₁₆ "-64"	\$4458	\$4574	\$4688	\$4806	\$4927	\$5052
	23" or 24" R/L	29" or 30" L/R	70"	64 ¹ / ₁₆ "-70"	\$4574	\$4688	\$4806	\$4927	N.A.	N.A.
	23" or 24" R/L	29" or 30" L/R	76"	70 ¹ / ₁₆ "-76"	\$4688	\$4806	\$4927	\$5052	N.A.	N.A.
Wood Veneer Desks										
MGSLTLC	23" or 24" R/L	29" or 30" L/R	46"	46"	N.A.	\$4382	\$4491	\$4599	\$4719	\$4835
	23" or 24" R/L	29" or 30" L/R	52"	46 ¹ / ₁₆ "-52"	\$4382	\$4491	\$4599	\$4719	\$4835	\$4955
	23" or 24" R/L	29" or 30" L/R	58"	52 ¹ / ₁₆ "-58"	\$4491	\$4599	\$4719	\$4835	\$4955	\$5078
	23" or 24" R/L	29" or 30" L/R	64"	58 ¹ / ₁₆ "-64"	\$4599	\$4719	\$4835	\$4955	\$5078	\$5205
	23" or 24" R/L	29" or 30" L/R	70"	64 ¹ / ₁₆ "-70"	\$4719	\$4835	\$4955	\$5078	N.A.	N.A.
	23" or 24" R/L	29" or 30" L/R	76"	70 ¹ / ₁₆ "-76"	\$4835	\$4955	\$5078	\$5205	N.A.	N.A.

Tip: **MGSLTLCG** is for GSA use only.
 Tip: For modular sized desks, if width left or right is greater or equal to 64"W, then opposite side width must be less than or equal to 58"W. For parametric sized desks, if width left or right is greater than 60"W, then opposite side width must be less than or equal to 60"W.
 Tip: Widths are parametric in 1/16" increments.

► **Specification Information, continued on next page**

 **For Canadian Pricing**
 Multiply U.S. Price by the Canadian price factor.
 ► See page 1 for details.

Migration SE Height-Adjustable 3-Leg Corner Desk, continued

► Specification Information, continued from previous page

Specification Information										
Style Number	Dimensions			U.S. Base Prices						
	D	Modular Left Width	Parametric Left Width	Modular Right Width	46"W	52"W	58"W	64"W	70"W	76"W
				Parametric Right Width	46"W	46½"W	52½"W	58½"W	64½"W	70½"W

90° 3-Leg Corner Desks—Basic Height (Same Depth Both Ends 29"/30")

Composite Veneer Desks

Style	Depth	Modular Left Width	Parametric Left Width	Modular Right Width	46"W	52"W	58"W	64"W	70"W	76"W
MGSLTLC	29" or 30"	46"	46"		N.A.	\$4244	\$4351	\$4458	\$4574	\$4688
MGSLTCG	29" or 30"	52"	46½"—52"		\$4244	\$4351	\$4458	\$4574	\$4688	\$4806
	29" or 30"	58"	52½"—58"		\$4351	\$4458	\$4574	\$4688	\$4806	\$4927
	29" or 30"	64"	58½"—64"		\$4458	\$4574	\$4688	\$4806	\$4927	\$5052
	29" or 30"	70"	64½"—70"		\$4574	\$4688	\$4806	\$4927	N.A.	N.A.
	29" or 30"	76"	70½"—76"		\$4688	\$4806	\$4927	\$5052	N.A.	N.A.

Wood Veneer Desks

Style	Depth	Modular Left Width	Parametric Left Width	Modular Right Width	46"W	52"W	58"W	64"W	70"W	76"W
MGSLTLC	29" or 30"	46"	46"		N.A.	\$4382	\$4491	\$4599	\$4719	\$4835
MGSLTCG	29" or 30"	52"	46½"—52"		\$4382	\$4491	\$4599	\$4719	\$4835	\$4955
	29" or 30"	58"	52½"—58"		\$4491	\$4599	\$4719	\$4835	\$4955	\$5078
	29" or 30"	64"	58½"—64"		\$4599	\$4719	\$4835	\$4955	\$5078	\$5205
	29" or 30"	70"	64½"—70"		\$4719	\$4835	\$4955	\$5078	N.A.	N.A.
	29" or 30"	76"	70½"—76"		\$4835	\$4955	\$5078	\$5205	N.A.	N.A.

Tip: **MGSLTCG** is for GSA use only.

Tip: For modular sized desks, if width left or right is greater or equal to 64"W, then opposite side width must be less than or equal to 58"W. For parametric sized desks, if width left or right is greater than 60"W, then opposite side width must be less than or equal to 60"W.

Tip: Widths are parametric in ½" increments.

► Specification Information, continued on next page



For Canadian Pricing

Multiply U.S. Price by the Canadian price factor.

► See page 1 for details.

► Specification Information, continued from previous page

Specification Information									
Style Number	Dimensions		U.S. Base Prices						
	D		Modular Right Width	46"W	52"W	58"W	64"W	70"W	76"W
	Modular Left Width	Parametric Left Width	Parametric Right Width	46"W	46 ¹ / ₁₆ "W–52"W	52 ¹ / ₁₆ "W–58"W	58 ¹ / ₁₆ "W–64"W	64 ¹ / ₁₆ "W–70"W	70 ¹ / ₁₆ "W–76"W

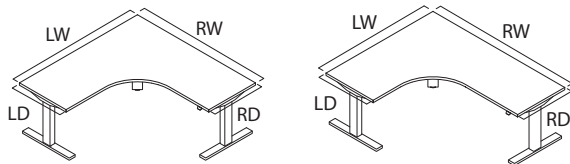

90° 3-Leg Corner Desks—Extended Height (Same Depth Both Ends 23"/24")

High-Pressure Laminate Desks

Model	Depth	Modular Left Width	Parametric Left Width	Modular Right Width	46"W	52"W	58"W	64"W	70"W	76"W
MGELTLC	23" or 24"	46"	46"	N.A.	\$3096	\$3189	\$3285	\$3383	\$3485	
MGELTLCG	23" or 24"	52"	46 ¹ / ₁₆ "–52"	\$3096	\$3189	\$3285	\$3383	\$3485	\$3589	
	23" or 24"	58"	52 ¹ / ₁₆ "–58"	\$3189	\$3285	\$3383	\$3485	\$3589	\$3697	
	23" or 24"	64"	58 ¹ / ₁₆ "–64"	\$3285	\$3383	\$3485	\$3589	\$3697	\$3807	
	23" or 24"	70"	64 ¹ / ₁₆ "–70"	\$3383	\$3485	\$3589	\$3697	N.A.	N.A.	
	23" or 24"	76"	70 ¹ / ₁₆ "–76"	\$3485	\$3589	\$3697	\$3807	N.A.	N.A.	

90° 3-Leg Corner Desks—Extended Height (Different Depth Opposite Ends 23"/24" Right/Left and 29"/30" Left/Right)

High-Pressure Laminate Desks

Model	Depth	Modular Left Width	Parametric Left Width	Modular Right Width	46"W	52"W	58"W	64"W	70"W	76"W
MGSLTLC	23" or 24" R/L	29" or 30" L/R	46"	46"	N.A.	\$2866	\$2953	\$3042	\$3132	\$3226
	23" or 24" R/L	29" or 30" L/R	52"	46 ¹ / ₁₆ "–52"	\$2866	\$2953	\$3042	\$3132	\$3226	\$3323
	23" or 24" R/L	29" or 30" L/R	58"	52 ¹ / ₁₆ "–58"	\$2953	\$3042	\$3132	\$3226	\$3323	\$3423
	23" or 24" R/L	29" or 30" L/R	64"	58 ¹ / ₁₆ "–64"	\$3042	\$3132	\$3226	\$3323	\$3423	\$3526
	23" or 24" R/L	29" or 30" L/R	70"	64 ¹ / ₁₆ "–70"	\$3132	\$3226	\$3323	\$3423	N.A.	N.A.
	23" or 24" R/L	29" or 30" L/R	76"	70 ¹ / ₁₆ "–76"	\$3226	\$3323	\$3423	\$3526	N.A.	N.A.

Tip: **MGELTLCG** is for GSA use only.

Tip: For modular sized desks, if width left or right is greater or equal to 64"W, then opposite side width must be less than or equal to 58"W.

For parametric sized desks, if width left or right is greater than 60"W, then opposite side width must be less than or equal to 60"W.

Tip: Widths are parametric in 1/16" increments.

► Specification Information, continued on next page



For Canadian Pricing

Multiply U.S. Price by the Canadian price factor.

► See page 1 for details.

Migration SE Height-Adjustable 3-Leg Corner Desk, continued

► Specification Information, continued from previous page

Specification Information										
Style Number	Dimensions D			Modular Right Width	U.S. Base Prices					
	Modular Left Width	Parametric Left Width	Parametric Right Width		46"W	52"W	58"W	64"W	70"W	76"W
					46"W	46 ¹ / ₁₆ "W-	52 ¹ / ₁₆ "W-	58 ¹ / ₁₆ "W-	64 ¹ / ₁₆ "W-	70 ¹ / ₁₆ "W-
						52"W	58"W	64"W	70"W	76"W

90° 3-Leg Corner Desks—Extended Height (Same Depth Both Ends 29"/30")

High-Pressure Laminate Desks

Style Number	Depth	Modular Left Width	Parametric Left Width	Parametric Right Width	46"W	52"W	58"W	64"W	70"W	76"W
MGELTLC	29" or 30"	46"	46"		N.A.	\$3160	\$3255	\$3353	\$3453	\$3556
MGELTLCG	29" or 30"	52"	46 ¹ / ₁₆ "-52"		\$3160	\$3255	\$3353	\$3453	\$3556	\$3663
	29" or 30"	58"	52 ¹ / ₁₆ "-58"		\$3255	\$3353	\$3453	\$3556	\$3663	\$3773
	29" or 30"	64"	58 ¹ / ₁₆ "-64"		\$3353	\$3453	\$3556	\$3663	\$3773	\$3886
	29" or 30"	70"	64 ¹ / ₁₆ "-70"		\$3453	\$3556	\$3663	\$3773	N.A.	N.A.
	29" or 30"	76"	70 ¹ / ₁₆ "-76"		\$3556	\$3663	\$3773	\$3886	N.A.	N.A.

90° 3-Leg Corner Desks—Extended Height (Same Depth Both Ends 23"/24")

Composite Veneer Desks

Style Number	Depth	Modular Left Width	Parametric Left Width	Parametric Right Width	46"W	52"W	58"W	64"W	70"W	76"W
MGELTLC	23" or 24"	46"	46"		N.A.	\$4474	\$4587	\$4701	\$4825	\$4947
MGELTLCG	23" or 24"	52"	46 ¹ / ₁₆ "-52"		\$4474	\$4587	\$4701	\$4825	\$4947	\$5072
	23" or 24"	58"	52 ¹ / ₁₆ "-58"		\$4587	\$4701	\$4825	\$4947	\$5072	\$5201
	23" or 24"	64"	58 ¹ / ₁₆ "-64"		\$4701	\$4825	\$4947	\$5072	\$5201	\$5333
	23" or 24"	70"	64 ¹ / ₁₆ "-70"		\$4825	\$4947	\$5072	\$5201	N.A.	N.A.
	23" or 24"	76"	70 ¹ / ₁₆ "-76"		\$4947	\$5072	\$5201	\$5333	N.A.	N.A.

Wood Veneer Desks

Style Number	Depth	Modular Left Width	Parametric Left Width	Parametric Right Width	46"W	52"W	58"W	64"W	70"W	76"W
MGELTLC	23" or 24"	46"	46"		N.A.	\$4612	\$4727	\$4842	\$4970	\$5094
MGELTLCG	23" or 24"	52"	46 ¹ / ₁₆ "-52"		\$4612	\$4727	\$4842	\$4970	\$5094	\$5221
	23" or 24"	58"	52 ¹ / ₁₆ "-58"		\$4727	\$4842	\$4970	\$5094	\$5221	\$5352
	23" or 24"	64"	58 ¹ / ₁₆ "-64"		\$4842	\$4970	\$5094	\$5221	\$5352	\$5486
	23" or 24"	70"	64 ¹ / ₁₆ "-70"		\$4970	\$5094	\$5221	\$5352	N.A.	N.A.
	23" or 24"	76"	70 ¹ / ₁₆ "-76"		\$5094	\$5221	\$5352	\$5486	N.A.	N.A.

Tip: **MGELTLCG** is for GSA use only.

Tip: For modular sized desks, if width left or right is greater or equal to 64"W, then opposite side width must be less than or equal to 58"W.

For parametric sized desks, if width left or right is greater than 60"W, then opposite side width must be less than or equal to 60"W.

Tip: Widths are parametric in ¹/₁₆" increments.

► Specification Information, continued on next page



For Canadian Pricing

Multiply U.S. Price by the Canadian price factor.

► See page 1 for details.

► **Specification Information, continued from previous page**

Specification Information										
Style Number	Dimensions				U.S. Base Prices					
	D		Modular Right Width	Parametric Right Width	46"W	52"W	58"W	64"W	70"W	76"W
	Modular Left Width	Parametric Left Width			46"W	46 ¹ / ₁₆ "W–52"W	52 ¹ / ₁₆ "W–58"W	58 ¹ / ₁₆ "W–64"W	64 ¹ / ₁₆ "W–70"W	70 ¹ / ₁₆ "W–76"W

90° 3-Leg Corner Desks—Extended Height (Different Depth Opposite Ends 23"/24" Right/Left and 29"/30" Left/Right)

Composite Veneer Desks

Style Number	Right Width	Left Width	Opposite Right Width	Opposite Left Width	46"W	52"W	58"W	64"W	70"W	76"W
MGSLTLC	23" or 24" R/L	29" or 30" L/R	46"	46"	N.A.	\$4244	\$4351	\$4458	\$4574	\$4688
	23" or 24" R/L	29" or 30" L/R	52"	46 ¹ / ₁₆ "–52"	\$4244	\$4351	\$4458	\$4574	\$4688	\$4806
	23" or 24" R/L	29" or 30" L/R	58"	52 ¹ / ₁₆ "–58"	\$4351	\$4458	\$4574	\$4688	\$4806	\$4927
	23" or 24" R/L	29" or 30" L/R	64"	58 ¹ / ₁₆ "–64"	\$4458	\$4574	\$4688	\$4806	\$4927	\$5052
	23" or 24" R/L	29" or 30" L/R	70"	64 ¹ / ₁₆ "–70"	\$4574	\$4688	\$4806	\$4927	N.A.	N.A.
	23" or 24" R/L	29" or 30" L/R	76"	70 ¹ / ₁₆ "–76"	\$4688	\$4806	\$4927	\$5052	N.A.	N.A.

Wood Veneer Desks

Style Number	Right Width	Left Width	Opposite Right Width	Opposite Left Width	46"W	52"W	58"W	64"W	70"W	76"W
MGSLTLC	23" or 24" R/L	29" or 30" L/R	46"	46"	N.A.	\$4382	\$4491	\$4599	\$4719	\$4835
	23" or 24" R/L	29" or 30" L/R	52"	46 ¹ / ₁₆ "–52"	\$4382	\$4491	\$4599	\$4719	\$4835	\$4955
	23" or 24" R/L	29" or 30" L/R	58"	52 ¹ / ₁₆ "–58"	\$4491	\$4599	\$4719	\$4835	\$4955	\$5078
	23" or 24" R/L	29" or 30" L/R	64"	58 ¹ / ₁₆ "–64"	\$4599	\$4719	\$4835	\$4955	\$5078	\$5205
	23" or 24" R/L	29" or 30" L/R	70"	64 ¹ / ₁₆ "–70"	\$4719	\$4835	\$4955	\$5078	N.A.	N.A.
	23" or 24" R/L	29" or 30" L/R	76"	70 ¹ / ₁₆ "–76"	\$4835	\$4955	\$5078	\$5205	N.A.	N.A.

Tip: **MGELTLCG** is for GSA use only.

Tip: For modular sized desks, if width left or right is greater or equal to 64"W, then opposite side width must be less than or equal to 58"W.

For parametric sized desks, if width left or right is greater than 60"W, then opposite side width must be less than or equal to 60"W."

Tip: Widths are parametric in 1/16" increments.

► **Specification Information, continued on next page**

 **For Canadian Pricing**
Multiply U.S. Price by the Canadian price factor.
► See page 1 for details.

Migration SE Height-Adjustable 3-Leg Corner Desk, continued

► Specification Information, continued from previous page

Specification Information										
Style Number	Dimensions			U.S. Base Prices						
	D	Modular Left Width	Parametric Left Width	Modular Right Width	46"W	52"W	58"W	64"W	70"W	76"W
				Parametric Right Width	46"W	46½"W-	52½"W-	58½"W-	64½"W-	70½"W-
						52"W	58"W	64"W	70"W	76"W

90° 3-Leg Corner Desks—Extended Height (Same Depth Both Ends 29"/30")

Composite Veneer Desks

Style	Depth	Modular Left Width	Parametric Left Width	Modular Right Width	46"W	52"W	58"W	64"W	70"W	76"W
MGELTLC	29" or 30"	46"	46"		N.A.	\$4538	\$4653	\$4769	\$4895	\$5018
MGELTCG	29" or 30"	52"	46½"W-52"		\$4538	\$4653	\$4769	\$4895	\$5018	\$5146
	29" or 30"	58"	52½"W-58"		\$4653	\$4769	\$4895	\$5018	\$5146	\$5277
	29" or 30"	64"	58½"W-64"		\$4769	\$4895	\$5018	\$5146	\$5277	\$5412
	29" or 30"	70"	64½"W-70"		\$4895	\$5018	\$5146	\$5277	N.A.	N.A.
	29" or 30"	76"	70½"W-76"		\$5018	\$5146	\$5277	\$5412	N.A.	N.A.

Wood Veneer Desks

Style	Depth	Modular Left Width	Parametric Left Width	Modular Right Width	46"W	52"W	58"W	64"W	70"W	76"W
MGELTLC	29" or 30"	46"	46"		N.A.	\$4676	\$4793	\$4910	\$5040	\$5165
MGELTCG	29" or 30"	52"	46½"W-52"		\$4676	\$4793	\$4910	\$5040	\$5165	\$5295
	29" or 30"	58"	52½"W-58"		\$4793	\$4910	\$5040	\$5165	\$5295	\$5428
	29" or 30"	64"	58½"W-64"		\$4910	\$5040	\$5165	\$5295	\$5428	\$5565
	29" or 30"	70"	64½"W-70"		\$5040	\$5165	\$5295	\$5428	N.A.	N.A.
	29" or 30"	76"	70½"W-76"		\$5165	\$5295	\$5428	\$5565	N.A.	N.A.

Tip: **MGELTCG** is for GSA use only.

Tip: For modular sized desks, if width left or right is greater or equal to 64"W, then opposite side width must be less than or equal to 58"W.

For parametric sized desks, if width left or right is greater than 60"W, then opposite side width must be less than or equal to 60"W.

Tip: Widths are parametric in ½" increments.

► Specification Information, continued on next page



For Canadian Pricing

Multiply U.S. Price by the Canadian price factor.

► See page 1 for details.

► **Specification Information, continued from previous page**

Specification Information										
Style Number	Dimensions			U.S. Base Prices						
	D	Modular Left Width	Parametric Left Width	Modular Right Width	46"W	52"W	58"W	64"W		
				Parametric Right Width	46"W	46½"W-	52½"W-	58½"W-	64½"W-	66"W

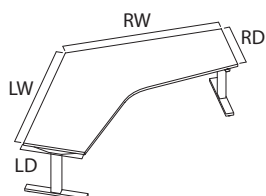

120° 3-Leg Corner Desks—Basic Height (Same Depth Both Ends 23"/24")

High-Pressure Laminate Desks

Style Number	D	Modular Left Width	Parametric Left Width	Modular Right Width	46"W	52"W	58"W	64"W	66"W
MGSLTWC	23" or 24"	46"	46"		\$2841	N.A.	N.A.	N.A.	N.A.
MGSLTWC	23" or 24"	52"	46½"-52"		N.A.	\$3039	N.A.	N.A.	N.A.
	23" or 24"	58"	52½"-58"		N.A.	N.A.	\$3223	N.A.	N.A.
	23" or 24"	64"	58½"-64"		N.A.	N.A.	N.A.	\$3419	N.A.
	23" or 24"		64½"-66"		N.A.	N.A.	N.A.	N.A.	\$3627

120° 3-Leg Corner Desks—Basic Height (Same Depth Both Ends 23"/24")

Composite Veneer Desks

Style Number	D	Modular Left Width	Parametric Left Width	Modular Right Width	46"W	52"W	58"W	64"W	66"W
MGSLTWC	23" or 24"	46"	46"		\$4286	N.A.	N.A.	N.A.	N.A.
MGSLTWC	23" or 24"	52"	46½"-52"		N.A.	\$4524	N.A.	N.A.	N.A.
	23" or 24"	58"	52½"-58"		N.A.	N.A.	\$4735	N.A.	N.A.
	23" or 24"	64"	58½"-64"		N.A.	N.A.	N.A.	\$4973	N.A.
	23" or 24"		64½"-66"		N.A.	N.A.	N.A.	N.A.	\$5181

Wood Veneer Desks

Style Number	D	Modular Left Width	Parametric Left Width	Modular Right Width	46"W	52"W	58"W	64"W	66"W
MGSLTWC	23" or 24"	46"	46"		\$4431	N.A.	N.A.	N.A.	N.A.
MGSLTWC	23" or 24"	52"	46½"-52"		N.A.	\$4673	N.A.	N.A.	N.A.
	23" or 24"	58"	52½"-58"		N.A.	N.A.	\$4886	N.A.	N.A.
	23" or 24"	64"	58½"-64"		N.A.	N.A.	N.A.	\$5128	N.A.
	23" or 24"		64½"-66"		N.A.	N.A.	N.A.	N.A.	\$5336

Tip: **MGSLTWC** is for GSA use only.
Tip: Width left and width right must match.
Tip: Widths are parametric by ½" from 46"-66".

► **Specification Information, continued on next page**

 **For Canadian Pricing**
Multiply U.S. Price by the Canadian price factor.
► See page 1 for details.

Migration SE Height-Adjustable 3-Leg Corner Desk, continued

► Specification Information, continued from previous page

Specification Information		U.S. Base Prices							
Style Number	Dimensions D			Modular Right Width	46"W	52"W	58"W	64"W	
		Modular Left Width	Parametric Left Width	Parametric Right Width	46"W	46½"W–52"W	52½"W–58"W	58½"W–64"W	64½"W–66"W

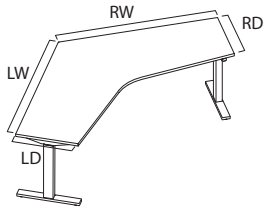

120° 3-Leg Corner Desks—Extended Height (Same Depth Both Ends 23"/24")

High-Pressure Laminate Desks

MGELTWC	MGELTWCG	23" or 24"	46"	46"	\$3070	N.A.	N.A.	N.A.	N.A.
		23" or 24"	52"	46½"–52"	N.A.	\$3281	N.A.	N.A.	N.A.
		23" or 24"	58"	52½"–58"	N.A.	N.A.	\$3479	N.A.	N.A.
		23" or 24"	64"	58½"–64"	N.A.	N.A.	N.A.	\$3695	N.A.
		23" or 24"		64½"–66"	N.A.	N.A.	N.A.	N.A.	\$3919

120° 3-Leg Corner Desks—Extended Height (Same Depth Both Ends 23"/24")

Composite Veneer Desks

MGELTWC	MGELTWCG	23" or 24"	46"	46"	\$4515	N.A.	N.A.	N.A.	N.A.
		23" or 24"	52"	46½"–52"	N.A.	\$4766	N.A.	N.A.	N.A.
		23" or 24"	58"	52½"–58"	N.A.	N.A.	\$4991	N.A.	N.A.
		23" or 24"	64"	58½"–64"	N.A.	N.A.	N.A.	\$5249	N.A.
		23" or 24"		64½"–66"	N.A.	N.A.	N.A.	N.A.	\$5473

Wood Veneer Desks

MGELTWC	MGELTWCG	23" or 24"	46"	46"	\$4660	N.A.	N.A.	N.A.	N.A.
		23" or 24"	52"	46½"–52"	N.A.	\$4915	N.A.	N.A.	N.A.
		23" or 24"	58"	52½"–58"	N.A.	N.A.	\$5142	N.A.	N.A.
		23" or 24"	64"	58½"–64"	N.A.	N.A.	N.A.	\$5404	N.A.
		23" or 24"		64½"–66"	N.A.	N.A.	N.A.	N.A.	\$5628

Tip: **MGELTWCG** is for GSA use only.

Tip: Width left and width right must match.

Tip: Widths are parametric by ½" from 46"-66".



For Canadian Pricing

Multiply U.S. Price by the Canadian price factor.

► See page 1 for details.

Migration SE Height-Adjustable Bases

T-Leg

Migration SE
Height-Adjustable
Bases

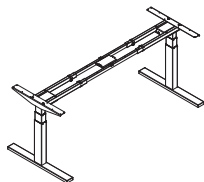

Tip: Attachment hardware is intended for desks 1" to 1 1/4" thick.

	Standard Includes	Required to Specify
▶ Need help? Product details, page 208	<ul style="list-style-type: none"> • Electric height-adjustable sit-to-stand base: paint price group 1 • Depth: 23", 24", 28", 29", 30", 35", or 36" • Power cord: 9' • 1/2" adjustable glides • Attachment hardware 	<ol style="list-style-type: none"> 1 Style number 2 Depth 3 Paint color number for base: <ul style="list-style-type: none"> 4799 Platinum Metallic 7241 Arctic White 7207 Black 7360 Merle 4 Controller (see below under Required Selections) 5 Foot (see below under Required Selections) 6 Options, if selected (see below)

Tip: The height saver with casters option is only available on 29/30"D or 35/36"D base.

Tip: Any storage higher than 20" will impede lowest height range of worksurface. Do not place storage underneath controller.

Tip: On 23"/24"D and less than 58"W desks, only single and dual flat panel monitor arm applications are permitted for use.

▶ See *Steelcase Worktools Specification Guide*.

Tip: For desks 29"/30"Dx58"W and greater additional monitor arm configurations are allowed.

▶ See page 58, *Steelcase Monitor Arm Guidelines*.

Tip: Base supports a maximum distributed weight capacity of 250 pounds. When calculating lifting capacity, subtract the weight of the worksurface.

Tip: Worksurface for use on this base needs to be 2" wider than the base.



WARNING
Read base only warranty limitations.
▶ See page 32 for *Workstation Design Guidelines and Requirements*.



For Canadian Pricing
Multiply U.S. Price by the Canadian price factor.
▶ See page 1 for details.

	Required Selections	U.S. Price	Required to Specify
Controller	<ul style="list-style-type: none"> • Up/down controller • 4 pre-set controller 	<p>No cost</p> <p>+\$ 78</p>	<p>Specify with <i>up/down controller</i>.</p> <p>Specify with <i>4 pre-set controller</i>.</p>

Foot	<ul style="list-style-type: none"> • Squared-edge foot • Mitered-edge foot • Height saver with casters 	<p>No cost</p> <p>No cost</p> <p>+\$219</p>	<p>Specify with <i>squared-edge foot</i>.</p> <p>Specify with <i>mitered-edge foot</i>.</p> <p>Specify with <i>height saver with caster</i>.</p>
-------------	---	---	--

	Options	U.S. Price	Required to Specify
Surface Materials	<p>Base</p> <ul style="list-style-type: none"> • Paint price group 1 • Paint price group 2 	<p>No cost</p> <p>+\$ 47</p>	<p>Specify paint color number.</p> <p>Specify paint color number.</p> <p>▶ See <i>Surface Materials</i>, page 362</p>

Related Products	<ul style="list-style-type: none"> • Privacy/modesty screens • Cable and power management 		<p>▶ Pages 330–332</p> <p>▶ Page 274</p>
-------------------------	---	--	--

Specification Information

Style Number	Depth	U.S. Base Price
--------------	-------	-----------------

Rectangular Base—Basic Height

MGSLTRQB	23" or 24"	\$1423
	28", 29", or 30"	\$1423
	35" or 36"	\$1423

Rectangular Base—Extended Height

MGELTRQB	23" or 24"	\$1586
	28", 29", or 30"	\$1586
	35" or 36"	\$1586

Migration SE Height-Adjustable Bases

C-Leg

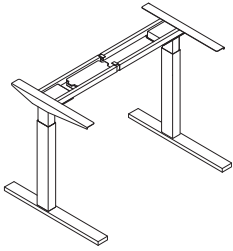

Tip: Attachment hardware is intended for desks 1" to 1 1/8" thick.

Tip: Any storage higher than 20" will impede lowest height range of worksurface. Do not place storage underneath controller.

Tip: On 23"/24"D and less than 58"W desks, only single and dual flat panel monitor arm applications are permitted for use.

▶ See *Steelcase Worktools Specification Guide*.

Tip: For desks 29"/30"Dx58"W and greater additional monitor arm configurations are allowed. ▶ See page 58, *Steelcase Monitor Arm Guidelines*.

Tip: Base supports a maximum distributed weight capacity of 250 pounds. When calculating lifting capacity, subtract the weight of the worksurface and understructure.

Tip: Worksurface for use on this base needs to be 2" wider than the base.



Read base only warranty limitations.

▶ See page 32 for *Workstation Design Guidelines and Requirements*.



For Canadian Pricing

Multiply U.S. Price by the Canadian price factor.

▶ See page 1 for details.

Standard Includes		Required to Specify
▶ Need help? Product details, page 208	<ul style="list-style-type: none"> • Electric height-adjustable sit-to-stand base: paint price group 1 • Depth: 29" or 30" • Power cord: 9' • 1/2" adjustable glides • Attachment hardware 	1 Style number 2 Depth 3 Paint color number for base: 4799 Platinum Metallic 7241 Arctic White 7207 Black 7360 Merle 4 Controller (see below under Required Selections) 5 Foot (see below under Required Selections) 6 Options, if selected (see below)

	Required Selections	U.S. Price	Required to Specify
Controller	<ul style="list-style-type: none"> • Up/down controller • 4 pre-set controller 	No cost +\$78	Specify with <i>up/down controller</i> . Specify with <i>4 pre-set controller</i> .
Foot	<ul style="list-style-type: none"> • Squared-edge • Mitered-edge 	No cost No cost	Specify with <i>squared-edge foot</i> . Specify with <i>mitered-edge foot</i> .

	Options	U.S. Price	Required to Specify
Surface Materials	Base <ul style="list-style-type: none"> • Paint price group 1 • Paint price group 2 	No cost +\$47	Specify paint color number. Specify paint color number. ▶ See <i>Surface Materials</i> , page 362
Related Products	<ul style="list-style-type: none"> • Privacy/modesty screens • Cable and power management 		▶ Pages 330–332 ▶ Page 274

Specification Information		
Style Number	Depth	U.S. Base Price
Rectangular Base—Basic Height		
MGSLCRQB	29" or 30"	\$1423
Rectangular Base—Extended Height		
MGELCRQB	29" or 30"	\$1586

Migration SE Height-Adjustable 3-Leg Corner Bases

Migration SE
Height-Adjustable
3-Leg Corner Bases

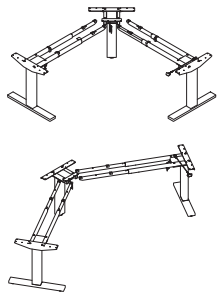

Tip: Attachment hardware is intended for desks 1" to 1 3/16" thick

Tip: On extended height desks, any storage higher than 18 3/10" will impede the height range of the desk. On basic height desks, any storage higher than 24" will impede the height range of the desk. Do not place storage underneath controller.

Tip: Base supports a maximum distributed weight capacity of 330 pounds. When calculating lifting capacity, subtract the weight of the worksurface and understructure.

	Standard Includes	Required to Specify
▶ Need help? Product details, page 208	<ul style="list-style-type: none"> • Electric height-adjustable sit-to-stand base: paint price group 1 • Up/down controller • Width: 46", 52", 58", 64", 70", or 76" • Depth: <ul style="list-style-type: none"> – 90° corner: 23", 24", 29", 30" – 120° corner: 23", 24" • 1/2" adjustable glides • Power cord: 9' • Attachment hardware 	<ol style="list-style-type: none"> 1 Style number 2 Desk depth 3 Controller (see below under Required Selections) 4 Paint color number for base: <ul style="list-style-type: none"> 4799 Platinum Metallic 7207 Black 7241 Arctic White 7360 Merle 5 Options, if selected (see below)

	Required Selections	U.S. Price	Required to Specify
Controller	<ul style="list-style-type: none"> • Up/down controller • 4 Pre-set controller 	No cost +\$78	Specify with up/down controller. Specify with 4 pre-set controller.

	Options	U.S. Price	Required to Specify
Surface Materials	<ul style="list-style-type: none"> • Paint price group 1 • Paint price group 2 	No cost +\$72	Specify paint color number. Specify paint color number. ▶ See <i>Surface Materials</i> , page 362

Related Products	<ul style="list-style-type: none"> • Privacy/modesty screens • Cable and power management 		▶ Pages 330–332 ▶ Page 274
-------------------------	---	--	-------------------------------

Specification Information		
Style Number	Depth	U.S. Base Price

90 3-Leg Corner Base—Basic Height		
MGSLTLCB	23" or 24"	\$2604
	29" or 30"	\$2604

90 3-Leg Corner Base—Extended Height		
MGELTLCB	23" or 24"	\$2815
	29" or 30"	\$2815

120 3-Leg Corner Base—Basic Height		
MGSLTWCB	23" or 24"	\$2604

120 3-Leg Corner Base—Extended Height		
MGELTWCB	23" or 24"	\$2815

 **For Canadian Pricing**
Multiply U.S. Price by the Canadian price factor.
▶ See page 1 for details.

Universal One-High and 1.5-High Open Laterals

for Migration SE Application

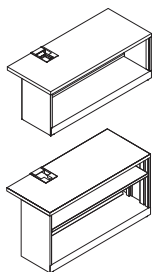

Drawings show right-hand application, left hand is also available.

Tip: Open laterals are only for Migration SE T-leg desks.

Tip: 30"W integrated storage is not permitted with 29"D and 35"D Migration SE worksurfaces due to the size of the desk foot. All other integrated storage widths are permitted with all Migration SE desk depths. ▶ See page 219 for chart showing restrictions

Tip: Migration SE desk depth is necessary in specification for integrated storage due to the placement of the Migration SE leg.

Tip: Right-hand or left-hand application is determined by which leg of the Migration SE desk is located inside the storage.

Tip: 76"W Migration SE desks ship standard with a 4" overhang, which only allows it to be used with integrated storage in a stand-alone application.



For Canadian Pricing

Multiply U.S. Price by the Canadian price factor.

▶ See page 1 for details.

Standard Includes		Required to Specify
▶ Need help? Product details, page 218	<ul style="list-style-type: none"> Lateral case: paint price group 1 1$\frac{3}{16}$"H top: laminate price group 1, if selected <ul style="list-style-type: none"> Edge: plastic 1$\frac{3}{16}$"H top: composite veneer group 1, if selected <ul style="list-style-type: none"> Four adjustable leveling glides Grommet Wire manager Ganging hardware 	<ol style="list-style-type: none"> Style number Paint color number for lateral case Width (see below under Required Selections) Migration SE desk depth (see below under Required Selections) Laminate color number for top, if laminate top selected Plastic color number for edge, if laminate top selected Composite veneer color number for top, if composite veneer top selected Front style (see below under Required Selections) Application (see below under Required Selections) Options, if selected (see below) <p>▶ See <i>Surface Materials</i>, page 362.</p>

	Required Selections	U.S. Price	Required to Specify
Width	<ul style="list-style-type: none"> 30"W 36"W 42"W 	Prices at right Prices at right Prices at right	Specify with 30"W. Specify with 36"W. Specify with 42"W.
Migration SE Desk Depth	<ul style="list-style-type: none"> 23"D 29"D 35"D 	No cost No cost No cost	Specify with 23"D. Specify with 29"D. Specify with 35"D.
Front Style	<ul style="list-style-type: none"> Flush steel front Proud steel front 	Prices at right Prices at right	Specify with <i>flush steel front</i> . Specify with <i>proud steel front</i> .
Application	<ul style="list-style-type: none"> Right hand Left hand 	No cost No cost	Specify with <i>right-hand application</i> . Specify with <i>left-hand application</i> .

	Options	U.S. Price	Required to Specify
Surface Materials	<ul style="list-style-type: none"> Paint price group 1 Paint price group 2 Paint price group 3 	No cost +\$120 +\$208	Specify paint color number. Specify paint color number. Specify paint color number.
Tops	<p>No top</p> <ul style="list-style-type: none"> For use beneath a Universal common top <p>Laminate top</p> <ul style="list-style-type: none"> High-Pressure Laminate price group 2 High-Pressure Laminate price group 3 Open Line laminate <p>Composite veneer top</p> <ul style="list-style-type: none"> Composite veneer group 1 top Composite veneer group 2 top <p>Wood veneer top</p> <ul style="list-style-type: none"> Wood group 1 veneer top Wood group 2 veneer top Wood group 3 veneer top Customiz stain 	-\$161 +\$ 18 +\$ 36 +\$111 plus cost of laminate +\$653 +\$696 +\$718 +\$765 +\$878 No cost	Specify with <i>no top</i> . Specify laminate color number. Specify laminate color number. ▶ See <i>Surface Materials Reference Manual</i> . Specify with <i>composite veneer top</i> and indicate composite veneer color number. Specify with <i>composite veneer top</i> and indicate composite veneer color number. Specify with <i>wood veneer top</i> and indicate wood color number. Specify with <i>wood veneer top</i> and indicate wood color number. Specify with <i>wood veneer top</i> and indicate wood color number. Specify with <i>Customiz stain</i> . ▶ See <i>Surface Materials Reference Manual</i> .

Related Products

- Universal common tops for Migration SE application ▶ Page 270
- Universal shrouds ▶ Page 272
- Universal filler ▶ Page 273

Specification Information

Style Number	Dimensions			U.S. Base Prices	
	D	W	H	Flush Steel Front	Proud Steel Front

One-High Open Lateral

RSCMHAD	18"	18 ⁷ / ₈ "	30"	16"	\$1660	\$1756
	18"	18 ⁷ / ₈ "	36"	16"	\$1833	\$1951
	18"	18 ⁷ / ₈ "	42"	16"	\$1996	\$2125

1.5-High Open Lateral

RSCMBHAD	18"	18 ⁷ / ₈ "	30"	22"	\$2022	\$2140
	18"	18 ⁷ / ₈ "	36"	22"	\$2233	\$2378
	18"	18 ⁷ / ₈ "	42"	22"	\$2435	\$2592

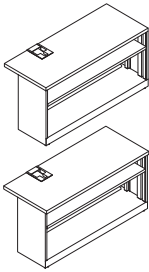
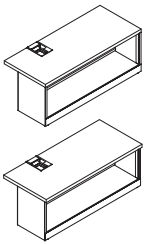

 **For Canadian Pricing**
Multiply U.S. Price by the
Canadian price factor.
▶ See page 1 for details.

Universal Common Tops

for Migration SE Application

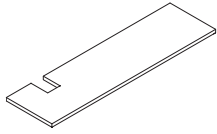

Drawing shows right-hand application, left hand is also available.

Tip: 76"W Migration SE desks ship standard with a 4" overhang, which only allows it to be used with integrated storage in a stand-alone application.

Tip: Right-hand or left-hand application is determined by which leg of the Migration SE desk is located inside the storage.

For composite veneers, wood and laminate group 2 and 3 pricing, please refer to the electronic catalog or SmartTools.



For Canadian Pricing

Multiply U.S. Price by the Canadian price factor.

▶ See page 1 for details.

Standard Includes		Required to Specify
▶ Need help? Product details, page 218	<ul style="list-style-type: none"> 1 3/16"H top: laminate price group 1, if selected – Edge: plastic 1 3/16"H top: composite veneer group 1, if selected 	<ol style="list-style-type: none"> Style number Width (see below under Required Selections) Migration SE desk depth (see below under Required Selections) Laminate color number for top, if laminate top selected Plastic color number for edge, if laminate top selected Composite veneer color number for top, if composite veneer top selected Front style (see below under Required Selections) Application (see below under Required Selections) Options, if selected (see below) <p>▶ See <i>Surface Materials</i>, page 362.</p>

	Required Selections	U.S. Price	Required to Specify
Width	<ul style="list-style-type: none"> 60"W 66"W 72"W 78"W 84"W 90"W 96"W 108"W 	Prices at right Prices at right Prices at right Prices at right Prices at right Prices at right Prices at right Prices at right	Specify with 60"W. Specify with 66"W. Specify with 72"W. Specify with 78"W. Specify with 84"W. Specify with 90"W. Specify with 96"W. Specify with 108"W.
Migration SE Desk Depth	<ul style="list-style-type: none"> 23"W 29"W 35"W 	No cost No cost No cost	Specify with 23"D. Specify with 29"D. Specify with 35"D.
Front Style	<ul style="list-style-type: none"> Flush front Proud front 	No cost No cost	Specify with flush front. Specify with proud front.
Application	<ul style="list-style-type: none"> Right hand Left hand 	No cost No cost	Specify with right-hand application. Specify with left-hand application.

	Options	U.S. Price	Required to Specify
Surface Materials	Laminate top		
	<ul style="list-style-type: none"> High-Pressure Laminate price group 2 High-Pressure Laminate price group 3 Open Line laminate 	See information at left See information at left +\$111 plus cost of laminate	Specify laminate color number. Specify laminate color number. ▶ See <i>Surface Materials Reference Manual</i> .
	Composite veneer top		
	<ul style="list-style-type: none"> Composite veneer group 1 Composite veneer group 2 	Prices at right See information at left	Specify with composite veneer top and indicate composite veneer color number. Specify with composite veneer top and indicate composite veneer color number.
	Wood veneer top		
	<ul style="list-style-type: none"> Wood group 1 Wood group 2 Wood group 3 Customiz stain 	Prices at right See information at left See information at left No cost	Specify with wood veneer top and indicate wood color number. Specify with wood veneer top and indicate wood color number. Specify with wood veneer top and indicate wood color number. Specify with Customiz stain. ▶ See <i>Surface Materials Reference Manual</i> .

Related Products

- Related Products**
- Universal One-High and open lateral 1.5-High for Migration SE application ▶ Page 268
 - Universal shrouds ▶ Page 272
 - Universal filler ▶ Page 273

Specification Information

Style Number	Dimensions			U.S. Base Prices		
	D	W		Laminate	Composite Veneer	Veneer
	Flush Front	Proud Front				
RATCTMHAD	18"	18 ⁷ / ₈ "	60"	\$ 505	\$1133	\$1196
	18"	18 ⁷ / ₈ "	66"	\$ 586	\$1194	\$1257
	18"	18 ⁷ / ₈ "	72"	\$ 654	\$1253	\$1316
	18"	18 ⁷ / ₈ "	78"	\$ 831	\$1501	\$1564
	18"	18 ⁷ / ₈ "	84"	\$ 940	\$1704	\$1783
	18"	18 ⁷ / ₈ "	90"	\$1049	\$1804	\$1883
	18"	18 ⁷ / ₈ "	96"	\$1154	\$1988	\$2067
	18"	18 ⁷ / ₈ "	108"	\$1388	N.A.	N.A.

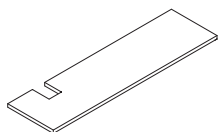

Tip: Can not order veneer on 108"W Universal common top.



For Canadian Pricing
 Multiply U.S. Price by the Canadian price factor.
 ▶ See page 1 for details.

Universal Shrouds

for Migration SE Application

Standard Includes		Required to Specify
<ul style="list-style-type: none"> ▶ Need help? Product details, page 218 	<ul style="list-style-type: none"> • Shroud: paint price group 1 • Attachment hardware 	<ol style="list-style-type: none"> 1 Style number 2 Width (see below under Required Selections) 3 Paint color number for shroud 4 Options, if selected (see below) <ul style="list-style-type: none"> ▶ See <i>Surface Materials</i>, page 362.

Tip: Shroud width must match width of the universal One-High or 1.5-High open lateral for Migration SE applications.

Required Selections	U.S. Price	Required to Specify
Width		
• 30"W	No cost	Specify with 30"W.
• 36"W	No cost	Specify with 36"W.
• 42"W	No cost	Specify with 42"W.

Options	U.S. Price	Required to Specify
Surface Materials		
• Paint price group 1	No cost	Specify paint color number.
• Paint price group 2	+\$49	Specify paint color number.
• Paint price group 3	+\$80	Specify paint color number.

Related Products	<ul style="list-style-type: none"> • Universal One-High and 1.5-High open lateral files for Migration SE application 	▶ Page 268
-------------------------	---	------------

Specification Information

Dimensions		Style Number	U.S. Base Price
D	H		
7"	16"	RPXSMHAD	\$126
7"	22"	RPXSMBHAD	\$141

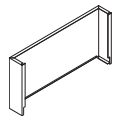
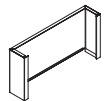

One-High Shroud			
7"	16"	RPXSMHAD	\$126
:	:	:	:

1.5-High Shroud			
7"	22"	RPXSMBHAD	\$141
:	:	:	:

 **For Canadian Pricing**
 Multiply U.S. Price by the Canadian price factor.
 ▶ See page 1 for details.

Universal Fillers

for Migration SE Application

Standard Includes	Required to Specify
<ul style="list-style-type: none"> ▶ Need help? Product details, page 218 • Filler: paint • Attachment hardware 	<ul style="list-style-type: none"> 1 Style number 2 Paint color number for filler ▶ See <i>Surface Materials</i>, page 362.

Related Products
<ul style="list-style-type: none"> • Universal One-High and 1.5-High open lateral files for Migration SE applications

Specification Information			
• Dimensions		• Style	• U.S.
D	H	Number	Price

One-High Filler			
7"	16"	RPXFMHAD	\$ 89
:	:	:	:

1.5-High Filler			
7"	22"	RPXFMBHAD	\$111
:	:	:	:



 **For Canadian Pricing**
 Multiply U.S. Price by the Canadian price factor.
 ▶ See page 1 for details.

Migration SE Cable and Power Management

Cable Riser

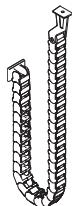

Fence connection



Leg connection

Standard Includes		Required to Specify
-------------------	--	---------------------

- | | | |
|--|--|--|
| <ul style="list-style-type: none"> ▶ Need help? Product details, page 210 | <ul style="list-style-type: none"> • Cable riser with fence connection: 7360 Merle paint • Attachment hardware | <ul style="list-style-type: none"> 1 Style number 2 Options, if selected (see below) |
|--|--|--|

Options	U.S. Price	Required to Specify
---------	------------	---------------------

- | | | |
|--|-------------------|--|
| Connection <ul style="list-style-type: none"> • Fence • Leg | No cost
+\$160 | Specify <i>with fence connection</i> .
Specify <i>with leg connection</i> . |
|--|-------------------|--|

Specification Information	
---------------------------	--

- | • Style Number | • U.S. Base Price |
|----------------|-------------------|
| MIGCR | \$116 |
| • | • |

Cable Brackets

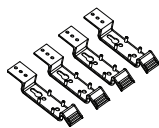

Standard Includes		Required to Specify
-------------------	--	---------------------

- | | | |
|--|--|--|
| <ul style="list-style-type: none"> ▶ Need help? Product details, page 210 | <ul style="list-style-type: none"> • Cable brackets, quantity of four: 6527 Merle plastic | <ul style="list-style-type: none"> Style number |
|--|--|--|

Specification Information		
---------------------------	--	--

- | • Style Number | • Weight | • U.S. Price |
|----------------|----------|--------------|
| MIGCBK4 | 0.5 lb | \$51 |
| • | • | • |



For Canadian Pricing

Multiply U.S. Price by the Canadian price factor.

▶ See page 1 for details.

Slide Glides

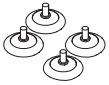

Standard Includes	Required to Specify
<ul style="list-style-type: none"> ▶ Need help? Product details, page 209 • Slide glides, quantity of four, basic or extended height range control box: black plastic 	<ul style="list-style-type: none"> • Style number

Specification Information	
Style Number	U.S. Price
MGSGLD	\$34

Desk and Bench Switch Kit

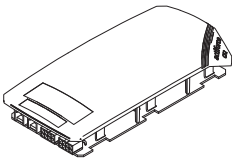

Standard Includes	Required to Specify
<ul style="list-style-type: none"> ▶ Need help? Product details, page 46 • Up/down controller, basic or extended height range control box: black plastic 	<ul style="list-style-type: none"> • 1 Style number • 2 Options, if selected (see below)

Options	U.S. Price	Required to Specify
Controller <ul style="list-style-type: none"> • Up/down controller • 4 pre-set controller 	<ul style="list-style-type: none"> No cost +\$78 	<ul style="list-style-type: none"> Specify with <i>up/down controller</i>. Specify with <i>4 pre-set controller</i>.
Height Range <ul style="list-style-type: none"> • Basic • Extended 	<ul style="list-style-type: none"> No cost No cost 	<ul style="list-style-type: none"> Specify with <i>basic range</i>. Specify with <i>extended range</i>.

Specification Information	
Style Number	U.S. Base Price
MGDSKT	\$305



For Canadian Pricing
 Multiply U.S. Price by the Canadian price factor.
 ▶ See page 1 for details.



Currency

Understanding

Universal One-High and 1.5-High Open Laterals **278**

Specifying

Universal One-High and 1.5-High Open Laterals **282**

One-High and 1.5-High Open Storage for Ology and Migration SE Applications

One-High and 1.5-High open storage are available with options to accommodate Ology and Migration SE integration. They provide a clean aesthetic with an efficient footprint. Ease of access to your items under the desk is convenient with the open storage configuration.

► Specifying, page 282

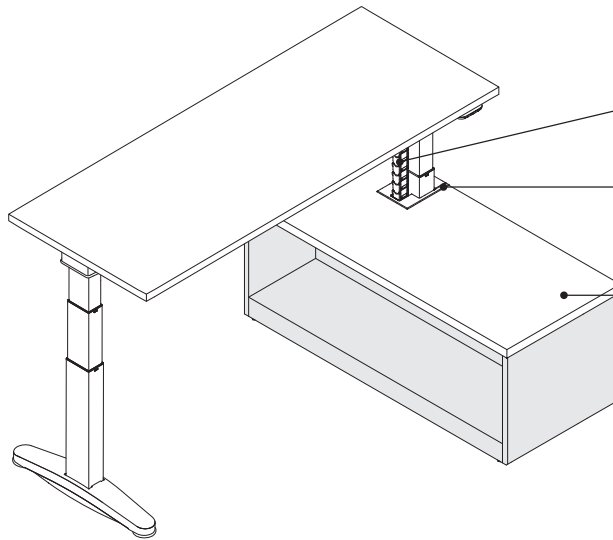

Wire manager keeps wires tidy and functionally flexes vertically.

Grommet provides a clean area where the desk leg integrates.

Units come without tops. Tops for Ology and Migration SE applications are ordered separately (style number **CRHADCT**).

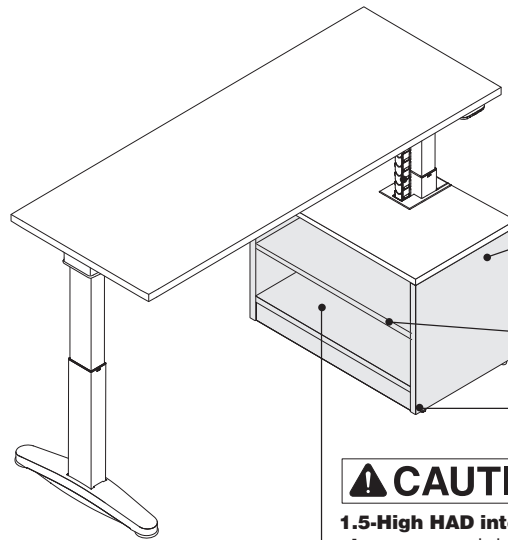

Usable depth in One-High and 1.5-High open storage is 10⁴/₅"D for Ology application and 9⁵/₈"D for Migration SE applications.

Shelf thickness is 3/4".

Leveling glides adjust to install on uneven floors and have a 1¹/₄" adjustable glide range.

CAUTION

1.5-High HAD integrated storage can only be used with basic height Ology and Migration SE.

Actual Dimensions

	One-High	1.5-High
Depth	18 ⁷ / ₈ "–24"	18 ⁷ / ₈ "–24"
Usable Depth for Ology application	10 ² / ₅ "*	10 ² / ₅ "*
Usable Depth for Migration SE application	9 ³ / ₁₀ "	9 ³ / ₁₀ "
Width	30"–72"	30"–72"
Height	15 ³ / ₈ "	21 ³ / ₈ "

* Top depth is 18⁷/₈", case depth is 18", to align with any other open low storage (example: open credenza).

* The case on One-High and 1.5-High open units is 18¹/₈"D. When top is added, the top matches the depth of units with drawers and doors.

Product Details

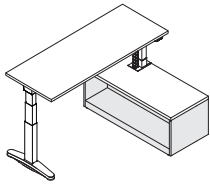

One-High open storage can be used with Ology extended range desks, Ology basic range desks and Migration SE extended range desks and Migration SE basic range desks.

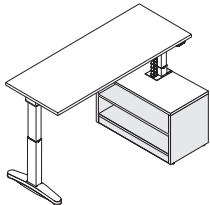

1.5-High open storage can be used with Ology basic range desks and Migration SE basic range desks.

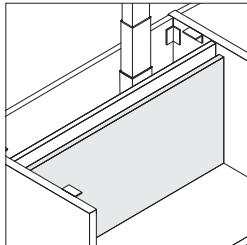

One-High and 1.5-High open storage have a merle painted steel, removable interior back panel to allow access to the base.

One-High and 1.5-High open storage cannot be interchanged. Use Ology open storage with Ology desk and Migration SE open storage with Migration SE desk.

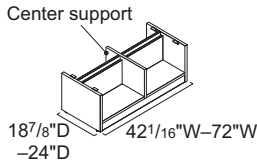
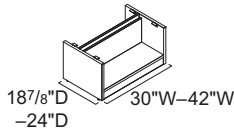

Units smaller than or equal to 42"W have one opening. Units 42¹/₁₆" and larger have a center support.

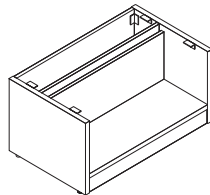
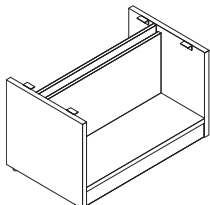

Ology and Migration SE open units offer an option of open back or a finished back for use in applications where the back of the unit is exposed, such as an aisle-way.

Tip: Units have removable back to allow access to desk leg and can be specified with open or finished back.

Ology desk with integrated storage must be specified with modular widths only. When opting for parametrics widths, integrated storage is not available.

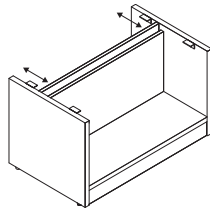

Open back units for Ology desks have 6" clearance. Open back units for Migration SE units have 7²/₂₅" clearance.

Integrated storage options that apply to One-High and 1.5-High units are only meant for use with the specified height-adjustable desk. For example, open storage specified for Migration SE cannot later be blended with Ology.

Integrated open laterals do not accommodate 24"D, 30"D, or 36"D Migration SE worksurfaces. See actual dimensions chart on next page.

Application Topics

Base units are non-handed. Handedness is identified in the specification of the tops, which are ordered separately.

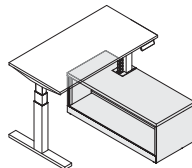
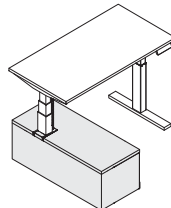

Application is determined by which leg of the desk is located inside the storage.

Location of the Ology and Migration SE port in tops is determined by the application orientation. If right leg is integrated into storage, it is a right application. Ology or Migration SE desks cannot be placed in the middle of the common top.

Tops for Ology and Migration SE application feature a cutout for legs and are used on individual storage units.

Common tops for Ology and Migration SE application can be used with two units side-by-side when one storage unit is required for leg integration.

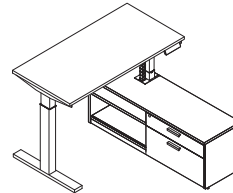

Common tops for Ology and Migration SE open units application are available when ganging height adjustable desk integrated storage units to other lower storage units of the same height and depth.

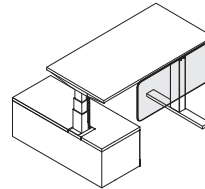

Universal privacy/modesty screens must be undersized and justified to the outside when used with a storage unit.

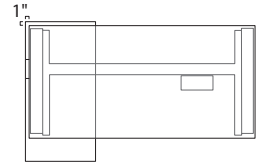

To help avoid pinch points, the One-High and 1.5-High lower storage for height-adjustable desk application extends 1" past the back of the height-adjustable desk worksurface.

Surface Materials

Case

- Low-Pressure Laminate
 - High-Pressure Laminate
- Tip: For more information on Low-Pressure and High-Pressure Laminate, please see Surface Materials.*
- ▶ Page 362

Wire manager

- Merle plastic

Grommet

- Merle paint

HAD Integrated Storage Case Widths and Desk Dimensions

Ology Desk Depth						
Case Width	23"	24"	29"	30"	35"	36"
30"–35¹⁵/₁₆"	●	●	●	●	N.A.	N.A.
36"–41¹⁵/₁₆"	●	●	●	●	●	●
42"–72"	●	●	●	●	●	●

Migration SE Desk Depth						
Case Width	23"	24"	29"	30"	35"	36"
30"–35¹⁵/₁₆"	●	N.A.	N.A.	N.A.	N.A.	N.A.
36"–41¹⁵/₁₆"	●	N.A.	●	N.A.	●	N.A.
42"–72"	●	N.A.	●	N.A.	●	N.A.

Tip: C-leg only available with HAD integrated storage when desk is 29"D.

One-High and 1.5-High Open Storage

For Ology and Migration SE Applications

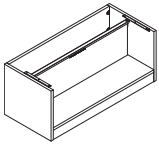

Tip: The actual thickness between Low-Pressure Laminate (LPL) and High-Pressure Laminate (HPL) worksurfaces is slightly different. It is recommended that only worksurfaces of the same type are specified in a given application. In addition, there may be sheen or texture differences when using LPL and HPL in adjacent applications.

	Standard Includes	Required to Specify
▶ Need help? Product details, page 278	<ul style="list-style-type: none"> Case, One-High and 1.5-High: <ul style="list-style-type: none"> – Low-Pressure Laminate price group 1 Removable interior cover Shelf, if 1.5-High unit is selected Grommet: merle paint Wire manager: merle plastic 1¼" adjustable leveling slides Shipped fully assembled 	<ol style="list-style-type: none"> Style number Size type (see below under Required Selections) Depth (see below under Required Selections) Width (see below under Required Selections) Desk type (see below under Required Selections) Low-Pressure Laminate color number for case Options, if selected (see below) <p>▶ See <i>Surface Materials</i>, page 362.</p>

	Required Selections	U.S. Price	Required to Specify
Size Type	<ul style="list-style-type: none"> Modular Parametric 	No cost No cost	Specify <i>with modular</i> . Specify <i>with parametric</i> .
Depth	<ul style="list-style-type: none"> 18⁷/₈"D 24"D 	Prices at right Prices at right	Specify 18 ⁷ / ₈ " depth. Specify 24" depth.
Width	<ul style="list-style-type: none"> 30"W 36"W 42"W 48"W 60"W 72"W 	Prices at right Prices at right Prices at right Prices at right Prices at right Prices at right	Specify 30" width. Specify 36" width. Specify 42" width. Specify 48" width. Specify 60" width. Specify 72" width.
Desk Type	<ul style="list-style-type: none"> Migration SE Ology 	No cost No cost	Specify <i>with Migration SE</i> . Specify <i>with Ology</i> .

	Options	U.S. Price	Required to Specify
Surface Materials	Case <ul style="list-style-type: none"> Low-Pressure Laminate (LPL) price group 1 High-Pressure Laminate (HPL) price group 1 High-Pressure Laminate (HPL) price group 2 High-Pressure Laminate (HPL) price group 3 Open Line laminate 	No cost Prices at right See information at left See information at left +\$111 plus cost of laminate	Specify laminate color number. Specify laminate color number. Specify laminate color number. Specify laminate color number. ▶ See <i>Surface Material Reference Manual</i> .
Back Panel	<ul style="list-style-type: none"> No back panel With a back panel 30"W–42"W With a back panel 42¹/₁₆"W–72"W 	No cost +\$191 +\$205	Specify <i>without back panel</i> . Specify <i>with back panel</i> . Specify <i>with back panel</i> .

For laminate price group 2 and higher pricing, please refer to the electronic catalog or SmartTools.



For Canadian Pricing
Multiply U.S. Price by the Canadian price factor.
▶ See page 1 for details.

Specification Information

Dimensions			Style Number	Modular Width	U.S. Base Prices					
					Modular Depth	Parametric Depth	Modular Height	30"	36"	42"
18 7/8"	N.A.	15 3/8"	CRHAD1H	30"	30 1/16"	36 1/16"	42 1/16"	48 1/16"	60 1/16"	72"
24"	18 15/16"-24"	15 3/8"	CRHAD1H	36"	36"	42"	48"	60"	72"	

One-High Open Storage for Ology and Migration SE Application

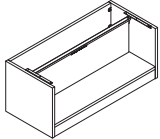

Low-Pressure Laminate

18 7/8"	N.A.	15 3/8"	CRHAD1H	\$ 933	\$ 933	\$ 940	\$ 970	\$ 999	\$1032
24"	18 15/16"-24"	15 3/8"	CRHAD1H	\$ 979	\$ 979	\$ 986	\$1019	\$1049	\$1083

High-Pressure Laminate

18 7/8"	N.A.	15 3/8"	CRHAD1H	\$1166	\$1166	\$1174	\$1214	\$1250	\$1289
24"	18 15/16"-24"	15 3/8"	CRHAD1H	\$1224	\$1224	\$1233	\$1273	\$1311	\$1353

1.5-High Open Storage for Ology and Migration SE Application

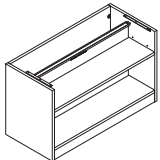

Low-Pressure Laminate

18 7/8"	N.A.	21 3/8"	CRHAD15H	\$ 971	\$ 971	\$ 980	\$1010	\$1039	\$1070
24"	18 15/16"-24"	21 3/8"	CRHAD15H	\$1020	\$1020	\$1029	\$1061	\$1091	\$1123

High-Pressure Laminate

18 7/8"	N.A.	21 3/8"	CRHAD15H	\$1215	\$1215	\$1225	\$1262	\$1299	\$1337
24"	18 15/16"-24"	21 3/8"	CRHAD15H	\$1274	\$1274	\$1285	\$1326	\$1363	\$1403



For Canadian Pricing

Multiply U.S. Price by the Canadian price factor.

► See page 1 for details.



Airtouch

Understanding

Height-Adjustable Worksurfaces	286
--------------------------------	------------

Height-Adjustable Worksurfaces

Universal Tables	290
------------------	------------

Universal Systems	292
-------------------	------------

Airtouch Height-Adjustable Worksurfaces

Airtouch worksurfaces

support computer-intensive users and mobile users in single occupant, multi-occupant, or high-churn environments. They allow users to quickly and effortlessly raise and lower their worksurfaces between seated and standing positions.

► Specifying, page 290

Worksurface has a wood core with a High-Pressure Laminate surface and is 1³/₁₆" thick.

Edge is available in 3 mm profile.

Base allows unique applications without having to tether any power cords.

Leveling glides adjust 1" to install unit on uneven floors.

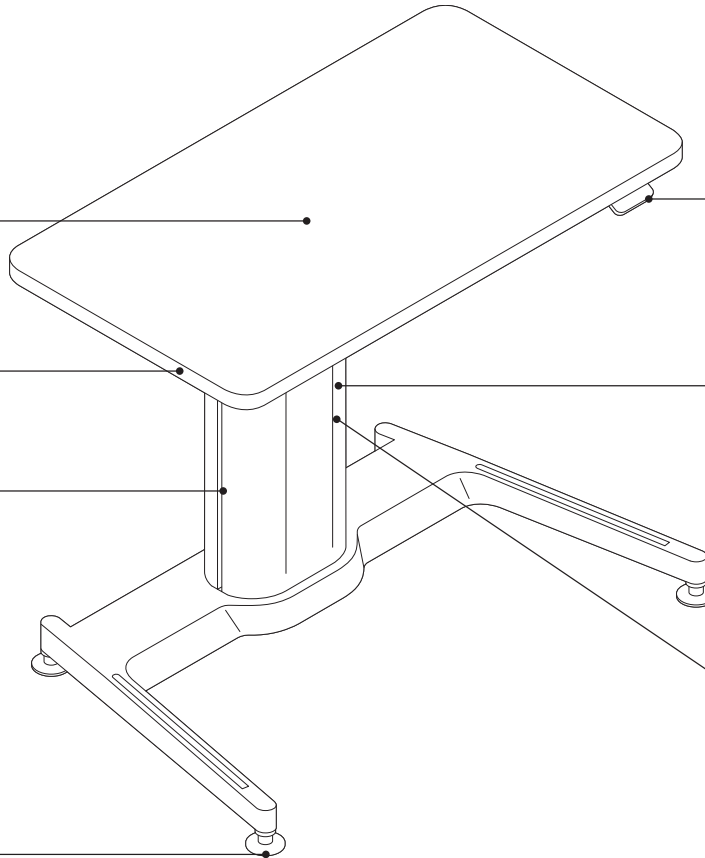

Ergonomic lift handle activates smooth, effortless height adjustments.

Airtouch has an adjustment feature on the column which allows the unit to function properly with any weight up to 150 pounds. *Tip: When calculating lifting capacity, subtract the weight of the worksurface.* ► See page 289 for worksurface weights.

Height-adjustable column adjusts from 26"H to 43"H in any increment.

Product Details

High-Pressure Laminate Worksurfaces

Front (user's) edge profile is available in 3 mm edge profile.

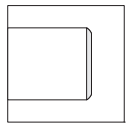

3 mm edge profile

PVC-free, 3 mm edge profiles are proprietary polyolefin blend for all solid colors and seven woodgrain finishes. Matching 1 mm side and back edges are also PVC-free. See surface material listing in this book for specific PVC-free availability.

Tip: Universal Tables have a continuous 3 mm edge.

Edge profile finishes are specified separately from laminate color.

Edge profile provides a flush interface with universal pedestals.

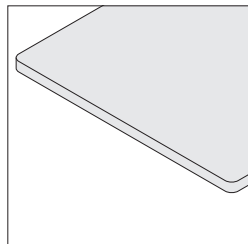

Universal tables have 2" radius corners on all four sides with a continuous user's edge. Radius corners eliminate sharp edges and are appropriate for free-standing furniture.

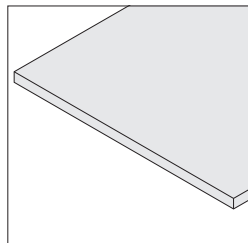

Universal Systems have 90° corners on all four sides with a front user's edge.

Airtouch height-adjustable tables are available in straight and corner shapes.

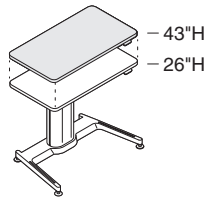

Airtouch worksurfaces adjust 26"H to 43"H in any increment.

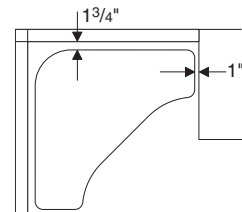

At least a 1 3/4" gap must separate backs of a table and panels to accommodate cables and prevent pinching. A 1" gap separates sides and adjacent furniture.

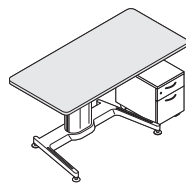

Worksurface overhang for pedestal storage varies by shape and size of worksurface.

Surface Materials

High-Pressure Laminate Tables

- Laminate
- ▶ See page 362
- Open Line laminate (option)

A program including non-Steelcase laminates which are suitable for use on Steelcase products.

▶ See *Surface Materials Reference Manual*.

3 mm

- Plastic

Height-adjustable base

- 4799 Platinum
- 7207 Black

Height-adjustable column

- 4799 Platinum paint

Application Topics

Moving tables can collide with other components. Do not install overhead storage, desk-height power, or desk accessories in the path of height-adjustable worksurfaces.

Airtouch is designed to support up to 150 pounds including the worksurface. An adjustable feature on the column allows the amount of lift assist to be set for various cargo loads.

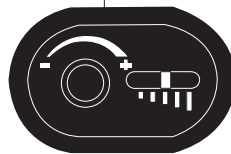
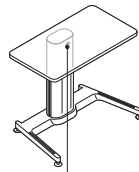

The gauge located near the top of the column

shows the amount of lift assist in use. The amount of lift assist can be dialed up for heavier loads and dialed down for lighter loads. If the unit is not moving smoothly, the lift assist mechanism needs to be adjusted. For example, if the top raises too fast, dial the lift assist down. If the top is difficult to raise, dial the lift assist up.

Typical workload weights are:

- Laptop 5–8 lb
- Small flat screen 10–16 lb
- Monitor arm 10–14 lb
- Desk lamp 5–10 lb
- Keyboard 2–3 lb
- Inch of paper 2 1/2 lb
- Desk phone 3–5 lb

Worksurface travels at the speed designated by the user. Users can adjust the table from seated to standing in one natural motion (approximately 1 second).

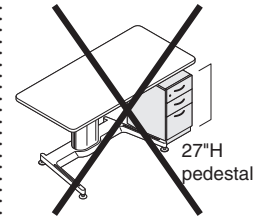
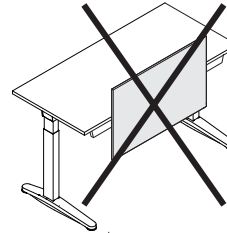

Any storage higher than 24 1/2" will impede the lower height range of worksurface.
Tip: Do not place storage underneath paddle.

Universal boundary screens are not permitted on height-adjustable desks, as they do not pass minimum safety requirements which could result in the desk tipping over.

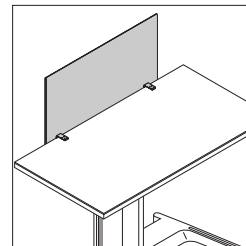

Screens mount to worksurfaces in privacy or below the worksurface for modesty.

▶ See *Worktools Compatibility Charts*, page 48, for help determining appropriate screen widths for each Airtouch worksurface size.

SOTO rail and SlatRail mount to worksurfaces to support worktools, freeing up worksurface space.

▶ See *Worktools Compatibility Charts*, page 48, for help determining appropriate SOTO rail and SlatRail widths for each Airtouch worksurface size.

Worksurface weight plates may be necessary to order if there is not enough weight on the worksurface. Applications using the smallest width worksurface without additional worktools (i.e. touch-down spaces) will require these counterweights (946900053SR).

All assemblies meet or exceed ANSI/BIFMA standards.

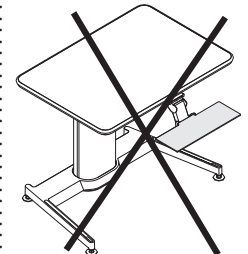

Keyboard assemblies are not allowed on height-adjustable desks. They do not meet minimum safety requirements.

Installation

Worksurfaces ship with pre-drilled holes for mounting bases.

Airtouch column requires attachment to the base and worksurface.

Airtouch Height-Adjustable Worksurfaces, continued

Base supports a maximum distributed weight capacity of 150 pounds.

Tip: When calculating lifting capacity, subtract the weight of the worksurface.

Worksurface Weight

Worksurface Shape	W	LD	RD	Style Number	Worksurface Weight
Universal Tables					
Rectangular – 22¼"D	40"	22¼"	22¼"	BAPSS2442	30.6 lb
	46"	22¼"	22¼"	BAPSS2448	35.0 lb
	58"	22¼"	22¼"	BAPSS2460	44.8 lb

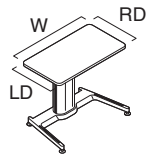

Rectangular – 28¼"D	40"	28¼"	28¼"	BAPSS3042	38.3 lb
	46"	28¼"	28¼"	BAPSS3048	44.8 lb
	58"	28¼"	28¼"	BAPSS3060	55.8 lb

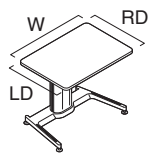

Worksurface Shape	LW	LD	RW	RD	Style Number	Worksurface Weight
90° Corner	39¼"	22¼"	39¼"	22¼"	BAPSC2442	45.9 lb
	45¼"	22¼"	45¼"	22¼"	BAPSC2448	59.0 lb

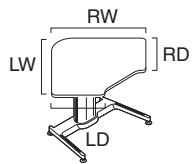

120° Equal	34"	22¼"	34"	22¼"	BAPB2436	55.8 lb
------------	-----	------	-----	------	----------	---------

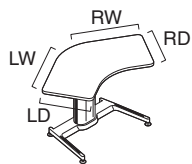

Worksurface Weight

Worksurface Shape	W	LD	RD	Style Number	Worksurface Weight
-------------------	---	----	----	--------------	--------------------

For use with Universal Systems

Rectangular – 22¼"D	40"	22¼"	22¼"	UAPSS2442	30.6 lb
	46"	22¼"	22¼"	UAPSS2448	35.0 lb
	58"	22¼"	22¼"	UAPSS2460	44.8 lb

Rectangular – 28¼"D	40"	28¼"	28¼"	UAPSS3042	38.3 lb
	46"	28¼"	28¼"	UAPSS3048	44.8 lb
	58"	28¼"	28¼"	UAPSS3060	55.8 lb

Worksurface Shape	LW	LD	RW	RD	Style Number	Worksurface Weight
-------------------	----	----	----	----	--------------	--------------------

90° Corner	39¼"	16¼"	39¼"	16¼"	UAPSC1842	30.6 lb
	39¼"	22¼"	39¼"	22¼"	UAPSC2442	45.9 lb
	45¼"	22¼"	45¼"	22¼"	UAPSC2448	59.0 lb

120° Equal	34"	22¼"	34"	22¼"	UAPB2436	55.8 lb
------------	-----	------	-----	------	----------	---------

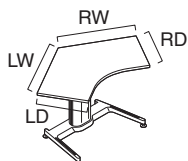
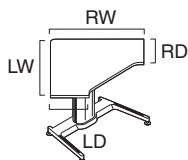
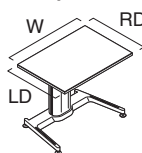
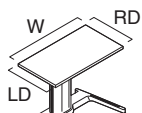

Airtouch Height-Adjustable Worksurfaces

High-Pressure Laminate Universal Tables

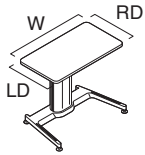

Tip: Airtouch height-adjustable base requires assembly and attachment to the worksurface.

Tip: Worksurfaces ship with pre-drilled holes for mounting bases.

Tip: Any storage higher than 24½" will impede the lower height range of the worksurface. Do not place storage underneath paddle.

For laminate group 2 and 3 pricing, please refer to the electronic catalog or SmartTools.

Tip: An adjustment feature on the column allows the unit to function properly with any load up to 150 pounds, including the worksurface.

Tip: Counterweights may be necessary to order if there is not enough load on the worksurface. Order service part (946900053SR).

Tip: For help determining privacy/modesty screen, SOTO rail, and SlatRail width compatibility, see Worktools Compatibility Charts, page 48.

Tip: Wood veneer worksurface options are available through specials.

Tip: Paint surface options apply to base only. Paint surface option does not apply to column.

Tip: Only single and dual flat panel monitor arm applications are permitted for use with single column height-adjustable tables.



For Canadian Pricing
Multiply U.S. Price by the Canadian price factor.
▶ See page 1 for details.

Standard Includes		Required to Specify
▶ Need help? Product details, page 286	<ul style="list-style-type: none"> High-Pressure Laminate price group 1 High-Pressure Laminate worksurface edge: plastic 3 mm edge Worksurface corners: radius Height-adjustable column mechanism: 4799 Platinum Height-adjustable mechanism base: paint Attachment hardware 	<ol style="list-style-type: none"> Style number High-Pressure Laminate color number for worksurface Plastic color number for profile edge on laminate worksurface Paint color number for base: 4799 Platinum Metallic 7207 Black Options, if selected (see below) <p>▶ See Surface Materials, page 362.</p>

Options	U.S. Price	Required to Specify
Surface Materials	<ul style="list-style-type: none"> Paint price group 1: No cost Paint price group 2: +\$ 61 Laminate price group 2: See information below Laminate price group 3: See information below Open Line laminate: +\$111 plus cost of laminate 	<ul style="list-style-type: none"> Specify paint color number. Specify paint color number. Specify laminate color number. Specify laminate color number. <p>▶ See <i>Surface Materials Reference Manual</i>.</p>
Related Products	<ul style="list-style-type: none"> Slatwall, SlatRail, and Freestanding Worktools SOTO rail Flat panel arms Privacy/modesty screens Acrylic screens Cable and power management 	<ul style="list-style-type: none"> ▶ See <i>Steelcase Worktools Specification Guide</i>. ▶ See <i>Steelcase Worktools Specification Guide</i>. ▶ See <i>Steelcase Worktools Specification Guide</i>. ▶ Pages 330–332 ▶ Page 316 ▶ Page 351

Specification Information

**U.S. Base Price
High-Pressure Laminate**



• Dimensions			• Style Number	• Plastic 3 mm Edge
W	LD	RD		

Rectangular Tables

22 1/4" D

40"	22 1/4"	22 1/4"	BAPSS2442	\$3814
46"	22 1/4"	22 1/4"	BAPSS2448	\$3868
58"	22 1/4"	22 1/4"	BAPSS2460	\$3988

28 1/4" D

40"	28 1/4"	28 1/4"	BAPSS3042	\$3969
46"	28 1/4"	28 1/4"	BAPSS3048	\$4029
58"	28 1/4"	28 1/4"	BAPSS3060	\$4154

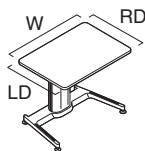
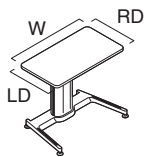

Tip: 58" privacy/modesty screens should not be specified with 22 1/4" D rectangular worksurfaces.

Tip: Base supports a maximum distributed weight capacity of 150 pounds. When calculating lifting capacity, subtract the weight of the worksurface.

▶ See page 289 worksurface weights.

Specification Information

**U.S. Base Price
High-Pressure Laminate**



• Dimensions				• Style Number	• Plastic 3 mm Edge
LW	LD	RW	RD		

90° Corner Tables

39 1/4"	22 1/4"	39 1/4"	22 1/4"	BAPSC2442	\$4174
45 1/4"	22 1/4"	45 1/4"	22 1/4"	BAPSC2448	\$4241

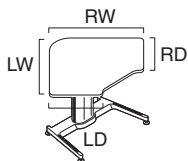

120° Equal Table

34"	22 1/4"	34"	22 1/4"	BAPB2436	\$4712
-----	---------	-----	---------	-----------------	--------

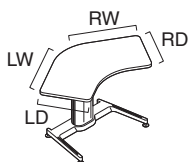

For Canadian Pricing

Multiply U.S. Price by the Canadian price factor.

▶ See page 1 for details.

Airtouch Height-Adjustable Worksurfaces

High-Pressure Laminate Universal Systems

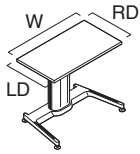

Tip: Airtouch height-adjustable base requires assembly and attachment to the worksurface.

Tip: Worksurfaces ship with pre-drilled holes for mounting bases.

Tip: An adjustment feature on the column allows the unit to function properly with any load up to 150 pounds, including the worksurface.

For laminate group 2 and 3 pricing, please refer to the electronic catalog or SmartTools.

Tip: Any storage higher than 24½" will impede the lower height range of the worksurface. Do not place storage underneath paddle.

Tip: Counterweights may be necessary to order if there is not enough load on the worksurface. Order service part (946900053SR).

Tip: For help determining privacy/modesty screen, SOTO rail, and SlatRail width compatibility, see Worktools Compatibility Charts, page 48.

Tip: Wood veneer worksurface options are available through specials.

Tip: Only single and dual flat panel monitor arm applications are permitted for use with single column height-adjustable tables.

Tip: Paint surface options apply to base only. Paint surface option does not apply to column.



For Canadian Pricing
Multiply U.S. Price by the Canadian price factor.
▶ See page 1 for details.

	Standard Includes	Required to Specify
▶ Need help? Product details, page 286	<ul style="list-style-type: none"> High-Pressure Laminate price group 1 High-Pressure Laminate worksurface edge: plastic 3 mm edge Worksurface corners: 90° Height-adjustable column mechanism: 4799 Platinum Height-adjustable mechanism base: paint Attachment hardware 	<ol style="list-style-type: none"> Style number High-Pressure Laminate color number for worksurface Plastic color number for profile edge on laminate worksurface Paint color number for base: 4799 Platinum Metallic 7207 Black Options, if selected (see below) <p>▶ See Surface Materials, page 362.</p>

	Options	U.S. Price	Required to Specify
Surface Materials	<ul style="list-style-type: none"> Paint price group 1 Paint price group 2 Laminate price group 2 Laminate price group 3 Open Line laminate 	<p>No cost</p> <p>+\$ 61</p> <p>See information below</p> <p>See information below</p> <p>+\$111 plus cost of laminate</p>	<p>Specify paint color number.</p> <p>Specify paint color number.</p> <p>Specify laminate color number.</p> <p>Specify laminate color number.</p> <p>▶ See <i>Surface Materials Reference Manual</i>.</p>
Related Products	<ul style="list-style-type: none"> Slatwall, SlatRail, and Freestanding Worktools SOTO rail Flat panel arms Privacy/modesty screens Acrylic screens Cable and power management 		<p>▶ See <i>Steelcase Worktools Specification Guide</i>.</p> <p>▶ See <i>Steelcase Worktools Specification Guide</i>.</p> <p>▶ See <i>Steelcase Worktools Specification Guide</i>.</p> <p>▶ Pages 330–332</p> <p>▶ Page 350</p> <p>▶ Page 351</p>

Tip: 58" privacy/modesty screens should not be specified with 22¹/₄"D rectangular worksurfaces.

Specification Information

Dimensions				Style Number	U.S. Base Price High-Pressure Laminate
W	LD	RD	Plastic 3 mm Edge		



Rectangular Worksurfaces

22 ¹ / ₄ "D					
W	LD	RD	Style Number	U.S. Base Price	Plastic 3 mm Edge
40"	22 ¹ / ₄ "	22 ¹ / ₄ "	UAPSS2442	\$3733	
46"	22 ¹ / ₄ "	22 ¹ / ₄ "	UAPSS2448	\$3786	
58"	22 ¹ / ₄ "	22 ¹ / ₄ "	UAPSS2460	\$3887	

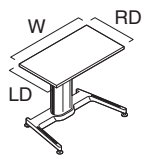

28 ¹ / ₄ "D					
W	LD	RD	Style Number	U.S. Base Price	Plastic 3 mm Edge
40"	28 ¹ / ₄ "	28 ¹ / ₄ "	UAPSS3042	\$3868	
46"	28 ¹ / ₄ "	28 ¹ / ₄ "	UAPSS3048	\$3927	
58"	28 ¹ / ₄ "	28 ¹ / ₄ "	UAPSS3060	\$4045	

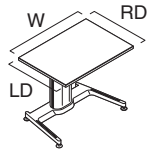

Specification Information

Dimensions					Style Number	U.S. Base Price High-Pressure Laminate
LW	LD	RW	RD	Plastic 3 mm Edge		



90° Corner Worksurfaces

LW	LD	RW	RD	Style Number	U.S. Base Price
39 ¹ / ₄ "	16 ¹ / ₄ "	39 ¹ / ₄ "	16 ¹ / ₄ "	UAPSC1842	\$4001
39 ¹ / ₄ "	22 ¹ / ₄ "	39 ¹ / ₄ "	22 ¹ / ₄ "	UAPSC2442	\$4027
45 ¹ / ₄ "	22 ¹ / ₄ "	45 ¹ / ₄ "	22 ¹ / ₄ "	UAPSC2448	\$4088

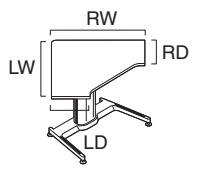

120° Equal Worksurface

LW	LD	RW	RD	Style Number	U.S. Base Price
34"	22 ¹ / ₄ "	34"	22 ¹ / ₄ "	UAPB2436	\$4551

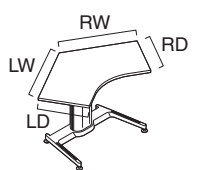

 **For Canadian Pricing**
Multiply U.S. Price by the Canadian price factor.
▶ See page 1 for details.



Screens, Cable and Power Management

Understanding

Universal Privacy/Modesty Screens	296
Universal Privacy Screens and Aligners	300
Sarto Privacy/Modesty Screens	302
Sarto Privacy Screens	306
Sarto Curved Screens	308
Universal and Sarto Screens Specific Guidelines	310
Soffio Screen	312
Fixed Personal/Modesty Screens	313
Worksurface Side Screens	314
Acrylic Screens	316
Cable and Power Management	318

Specifying

Universal Privacy/Modesty Screens	330
Universal Privacy Screens and Aligners	332
Sarto Privacy/Modesty Screens	334
Sarto Privacy Screens	336
Sarto Alignment Clip	338
Sarto Curved Screens	340
Soffio Screen	343
Fixed Personal/Modesty Screens	344
Worksurface Side Screens	346
Acrylic Screens	350
Cable and Power Management	351

Universal Privacy/Modesty Screens

Universal privacy/modesty screen provides a boundary element for height-adjustable desks and fixed worksurfaces. It can be used with Ology desk, Migration Desking Collection, Airtouch, Elective Elements, Universal tables, and Universal panel mount worksurfaces. Privacy/modesty screens are not to be used on height-adjustable benching.
▶ Specifying, page 330

Universal privacy/modesty screens are available in one height, 25⁷/₁₀" , with two mount location options to provide either privacy or privacy/modesty.

Universal privacy/modesty screens cannot be used on surfaces that have intergrated rails or an additive SOTO rail.

Universal privacy/modesty screen is pin tackable.

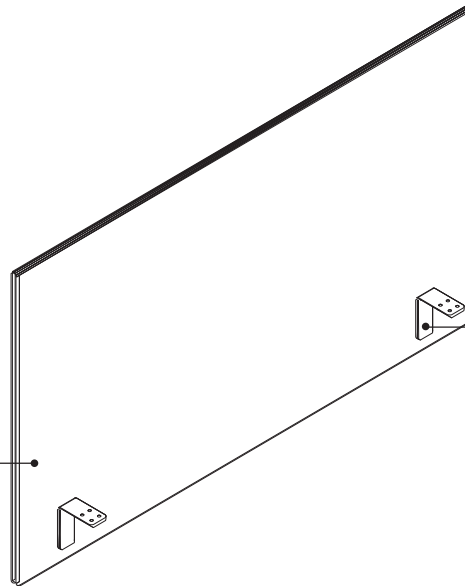

The screen is attached to the worksurface using simple L-brackets and 1" screws.

Actual Dimensions

Width	42", 48", 54", 60", or 66"
Height	25 ⁷ / ₁₀ "
Weight	9.79 lb, 10.315 lb, 10.84 lb, 11.365 lb, 11.89 lb
Thickness	3/4"

Product Details

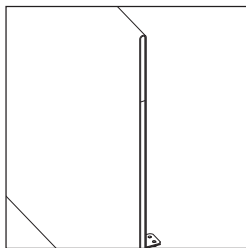

The edge of the screen is comprised of two different materials. The upper segment is merle plastic. The lower portion is PET which can be specified in medium heather grey to provide contrast or dark heather grey for a uniform visual.

The screen may be used on $\frac{3}{4}$ "– $1\frac{1}{2}$ " thick worksurfaces.

The width of the screen can be equal to or less than the width of the worksurface to which it will attach. Some restrictions apply due to location of worksurface legs and supports.

Surface Materials

Screen

- Fabric
- ▶ See *Surface Materials*, page 362.

Edge (upper segment)

- 7360 Merle

Edge (lower segment)

- P630 Medium Heather Grey PET
- P631 Dark Heather Grey PET

Brackets

- 7360 Merle

Application Topics

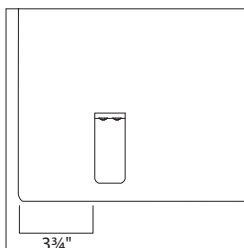

Universal privacy/modesty screen mounts to worksurfaces using simple L-brackets and screws. The brackets are positioned $3\frac{3}{4}$ " in from each side of the screen.

Tip: When specifying grommets on Ology, verify the position of the screen in CET SmartTools Planning.

Screen height attachment locations are determined when specifying privacy (top of screen will be at 48") or privacy/modesty (top of screen will be at 42"). The location cannot be changed in the field.

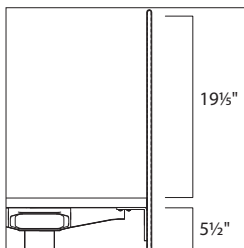

Privacy configuration provides $19\frac{1}{2}$ " of screen above the worksurface and $5\frac{1}{2}$ " of screen below the worksurface. The height is measured from the top of the mounting surface to the top of the screen, and from the bottom of the mounting surface to the bottom of the screen. The top of the screen will align with the bottom of the top trim on a 48"H Answer panel.

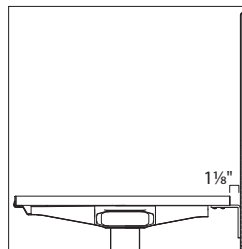

Screen can be mounted with a $\frac{1}{8}$ " cord drop or flush with no cord drop.

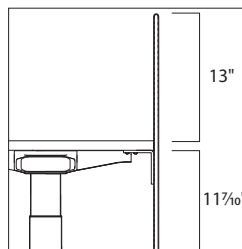

Privacy/modesty configuration provides 13" of screen above the worksurface and $11\frac{7}{10}$ " of screen below the worksurface. The height is measured from the top of the mounting surface to the top of the screen, and from the bottom of the mounting surface to the bottom of the screen. The top of the screen will align with the bottom of the top trim on a 42"H Answer panel.

Both the privacy and privacy/modesty configurations allow the height-adjustable desks to be lowered to the lowest position (22") while preserving pinch point gap. Privacy version will not interfere with integrated storage.

Privacy/modesty screens must never be wider than the surface to which they are attached.
Tip: It is recommended that CET SmartTools Planning aid be used to ensure proper application of screen to worksurface or tables.

Universal privacy/modesty screens cannot be used with 58"W Ology desks with leg integrated into storage. The smallest screen width is 42" which would collide with the storage. Must use a minimum 64"W desk when using storage and Universal privacy/modesty screens.

Universal privacy/modesty screens cannot be used with Ology and Migration Pro/Intro modesty panels.

When used with One-High integrated storage, Universal privacy/modesty screens must be a minimum of 18" shorter than worksurface width to allow for pinch point clearances.

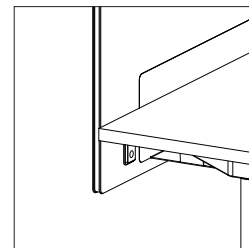

Universal privacy/modesty screen can be installed with the Migration metal cable tray. Tray can be optioned on the desk or ordered separately.
Tip: Screen width must be $10\frac{1}{2}$ " wider than metal cable tray.

Maximum Rear Screen Sizes Based on Worksurface Edge Types on Migration Intro, Migration Pro, and Pro with Boost High-Speed

Screen Type	Square or Square with Knife Edge or 2" Radius	5" Radius	2" Radius with Knife Edge or 5" Radius with Knife Edge
Universal Privacy Screen (UFPS)	Max Screen Width = Width of Desk	Max Screen Width = Width of Desk Minus 3"	Max Screen Width = Width of Desk Minus 5"
Universal Privacy/Modesty Screen (UFPM)	Max Screen Width = Width of Desk	Max Screen Width = Width of Desk Minus 3"	Max Screen Width = Width of Desk Minus 5"
Sarto Privacy Screen (PSPS)	Max Screen Width = Width of Desk	Max Screen Width = Width of Desk Minus 3"	Max Screen Width = Width of Desk Minus 5"
Sarto Privacy/Modesty Screen (PSPM)	Max Screen Width = Width of Desk	Max Screen Width = Width of Desk Minus 2 1/2"	Max Screen Width = Width of Desk Minus 5"

Tip: Measurements provided do not include cutouts and overhang rules.

Tip: Rear screens are not compatible with Migration Pro and Intro organic bow front and back shape.

Maximum Side Screen Sizes Based on Worksurface Edge Types on Migration Intro, Migration Pro, and Pro with Boost High-Speed

Screen Type	Square or 2" Radius without Knife Edge	Square or 2" Radius with Knife Edge	5" Radius without Knife Edge	5" Radius with Knife Edge
Universal Privacy Screen (UFPS)	Max Screen Width = Depth of Desk	N/A	Max Screen Width = Depth of Desk Minus 3"	N/A
Sarto Privacy Screen (PSPS) with Option SIDESCEN Selected	Max Screen Width = Depth of Desk	Max Screen Width = Depth of Desk	Max Screen Width = Depth of Desk Minus 4"	Max Screen Width = Depth of Desk Minus 4"
Sarto Privacy/Modesty Screen (PSPM) with Option SIDESCEN Selected	Max Screen Width = Depth of Desk	Max Screen Width = Depth of Desk	N/A	N/A

Tip: Measurements provided do not include cutouts and overhang rules.

Tip: Side screens are not compatible with Migration Pro and Intro organic bow front and back shape.

Universal Privacy Screens and Aligners

Universal privacy screens provide a boundary and privacy element for height adjustable desks and fixed worksurfaces. It can be used with Ology, Migration Desking Collection, Elective Elements, panel supported Universal worksurfaces, and TS Series worksurfaces.
 ▶ Specifying, page 332

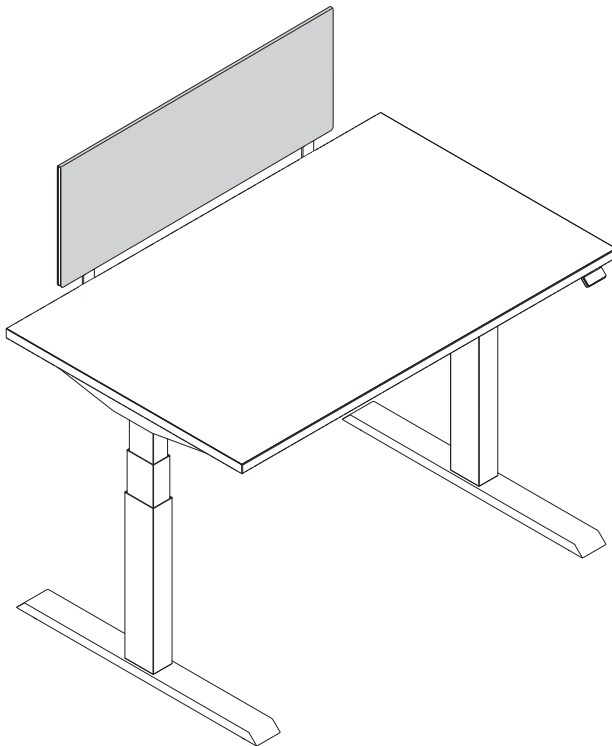

Actual Dimensions

Height	12½" or 18½"
Overall Height	13½" or 19½"
Width	24", 30", 36", 42", 48", 54", 60", 66", 72", 78", 84", 90", or 96"

Tip: Overall height is measured from top of mounting surface to the top of the screen.

Tip: 13½"H screen aligns with a 42" datum from the floor. 19½" screen aligns with a 48" datum from the floor.

Product Details

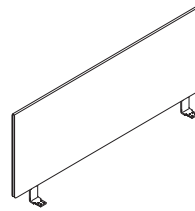

Universal privacy screens are tackable and available in 13½"H and 19½"H, and have widths from 24"W to 96"W.

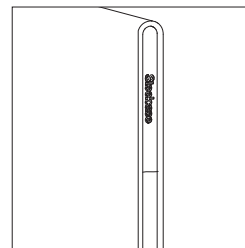

The edge of the screen is comprised of two different materials. The upper segment is merle plastic. The lower portion is PET which can be specified in medium heather grey to provide contrast or dark heather grey for a uniform visual.

The screen may be used on ¾"-1½" thick worksurface.

The width of the screen can be equal to or less than the width of the worksurface to which it will attach. Some restrictions apply due to location of worksurface legs and supports.

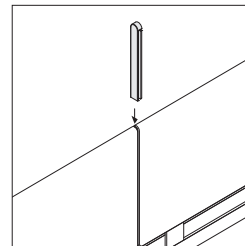

When fabric screens are placed directly adjacent to each other, a small aligner can be placed in between the screens at the top to connect them for planar alignment. Aligners are ordered separately in packages of 10.

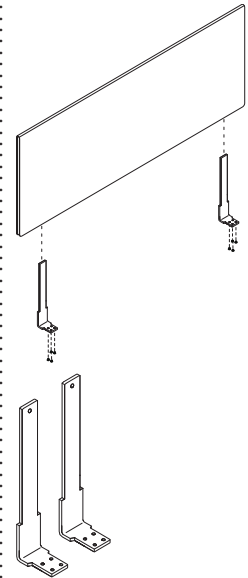

Brackets are included with screens. Two brackets are used on all screens.

Universal privacy screen slides onto brackets.

Surface Materials

Screen

- Fabric
- ▶ See *Surface Materials*, page 362.

Edge (upper segment)

- 7360 Merle

Edge (lower segment)

- P630 Medium Heather Grey PET
- P631 Dark Heather Grey PET

Brackets

- 7241 Textured Arctic White
- 7360 Textured Merle
- 4799 Platinum

Maximum Rear Screen Sizes Based on Worksurface Edge Types on Migration Intro, Migration Pro, and Pro with Boost High-Speed

Screen Type	Square or Square with Knife Edge or 2" Radius	5" Radius	2" Radius with Knife Edge or 5" Radius with Knife Edge
Universal Privacy Screen (UFPS)	Max Screen Width = Width of Desk	Max Screen Width = Width of Desk Minus 3"	Max Screen Width = Width of Desk Minus 5"
Universal Privacy/Modesty Screen (UFPM)	Max Screen Width = Width of Desk	Max Screen Width = Width of Desk Minus 3"	Max Screen Width = Width of Desk Minus 5"
Sarto Privacy Screen (PSPS)	Max Screen Width = Width of Desk	Max Screen Width = Width of Desk Minus 3"	Max Screen Width = Width of Desk Minus 5"
Sarto Privacy/Modesty Screen (PSPM)	Max Screen Width = Width of Desk	Max Screen Width = Width of Desk Minus 2 1/2"	Max Screen Width = Width of Desk Minus 5"

Tip: Measurements provided do not include cutouts and overhang rules.

Tip: Rear screens are not compatible with Migration Pro and Intro organic bow front and back shape.

Maximum Side Screen Sizes Based on Worksurface Edge Types on Migration Intro, Migration Pro, and Pro with Boost High-Speed

Screen Type	Square or 2" Radius without Knife Edge	Square or 2" Radius with Knife Edge	5" Radius without Knife Edge	5" Radius with Knife Edge
Universal Privacy Screen (UFPS)	Max Screen Width = Depth of Desk	N/A	Max Screen Width = Depth of Desk Minus 3"	N/A
Sarto Privacy Screen (PSPS) with Option SIDESCN Selected	Max Screen Width = Depth of Desk	Max Screen Width = Depth of Desk	Max Screen Width = Depth of Desk Minus 4"	Max Screen Width = Depth of Desk Minus 4"
Sarto Privacy/Modesty Screen (PSPM) with Option SIDESCN Selected	Max Screen Width = Depth of Desk	Max Screen Width = Depth of Desk	N/A	N/A

Tip: Measurements provided do not include cutouts and overhang rules.

Tip: Side screens are not compatible with Migration Pro and Intro organic bow front and back shape.

Sarto Privacy/Modesty Screens

Sarto privacy/modesty screen provides a boundary element for height-adjustable desks and fixed worksurfaces. It can be used with Ology desk, Migration Desking Collection, Airtouch, Elective Elements, Universal tables, and Universal panel mount worksurfaces. Sarto privacy/modesty screens are not to be used on height-adjustable benching.

► Specifying, page 334

Sarto privacy/modesty screens are available in overall heights from 24" to 30", with a privacy height option to provide varying levels of privacy and modesty.

Sarto privacy/modesty screen is pin tackable.

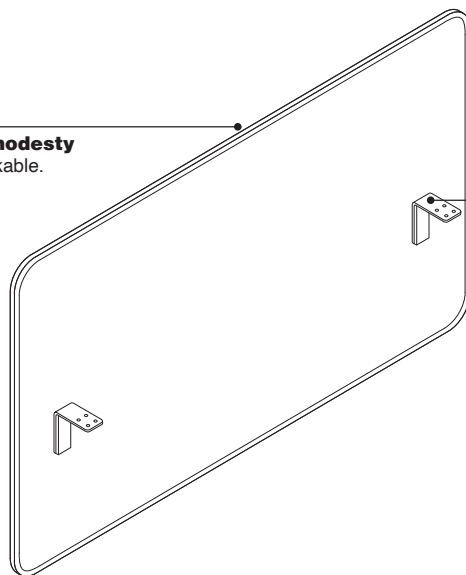

The screen is attached to the worksurface using simple L-brackets and 1" screws.

Actual Dimensions

Width 23"-70"

Height 24"-30"

Thickness 9/16"

Product Details

The screen may be used on 3/4"-1 1/2" thick worksurfaces.

Screens are available in modular or parametric sizes.

The width of the screen can be equal to or less than the width of the worksurface to which it will attach. Some restrictions apply due to location of worksurface legs and supports.

Weight of screens are calculated as follows:
Screen: 0.0044 pounds per inch² Bracket: 0.2 pounds per bracket.

Application Topics

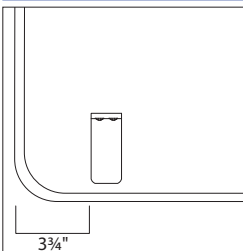

Sarto privacy/modesty screen mounts to worksurfaces using simple L-brackets and screws. The brackets are positioned 3 3/4" in from each side of the screen. Two L-brackets are included with screens narrower than 60"W. Three or four L-brackets are included on screens 60"W and wider.

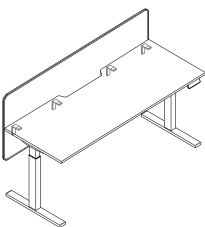

Worksurface type is available for screens 60" wide or wider, and allows the Sarto privacy/modesty screen to mount to a scalloped worksurface (for example Bivi Height-Adjustable Desk).

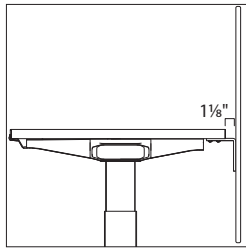

Screen can be mounted to the back edge of the worksurface with a 1 1/8" cord drop or flush with no cord drop.

Screens 36"W and narrower can be mounted as side screens, and are always mounted flush to the edge of the worksurface. This application grows the footprint of the workstation by 9/16" per screen.

Screens are specified with a privacy height above the worksurface. A 1" thick worksurface is assumed. This privacy height sets the position of the brackets and cannot be changed in the field.

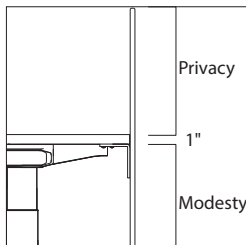

Screens are specified by first selecting an overall screen height (24"-30"), then specifying a privacy height. Privacy height is measured from the top of the worksurface. Allowable privacy height selection changes based on the specified overall height.

All privacy heights allow a height adjustable desk to be lowered to the lowest position (22") while preserving pinch point gap.

To match screens ordered on or before June 20, 2021, please consult the following information to determine proper privacy height.

- 24"H Screen, Privacy/Modesty Configuration – Privacy Height = 13 1/2"
- 24"H Screen, Privacy Configuration – Privacy Height = 16 1/2"
- 30"H Screen, Privacy Configuration – Privacy Height = 22 1/2"

Sarto privacy/modesty screens can be used with universal worksurfaces and tables where surface supports and leg brackets are not in same location of the screen L-bracket attachment points.

- Example 1 – Worksurfaces supported by a panel side bracket or cantilever can accept privacy/modesty screen placed 6" in from end with these brackets.
- Example 2 – Tables with cabby leg or double elliptical post C-legs can accept screens 6" shorter than total table width but not same width.

Sarto privacy/modesty screens cannot be used with Ology or Migration Pro/Intro modesty panels.

When a parametric Sarto screen is used on a parametric Ology desk, verify the screen width and placement in CET SmartTools planning to avoid interference.

Privacy/modesty screens can also be used with Elective Elements surfaces with some restrictions when combined with gate leg or the Elective Elements adjustable-height leg.

Privacy/modesty screens must never be wider than the surface to which they are attached.
Tip: It is recommended that CET SmartTools planning aid be used to ensure proper application of screen to worksurface or tables.

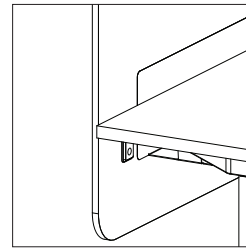

Sarto privacy/modesty screens can be installed with the Migration metal cable tray. When specifying a Sarto screen equal to or greater than 60"W to use with the cable tray, select the "with tray application" option. The metal tray is an option with the desk or can be ordered separately.
Tip: Screen width must be 10 1/2" wider than the metal cable tray.

Surface Materials

Screen

- Fabric
- ▶ See *Surface Materials*, page 362.

Brackets

- 7360 Merle

Maximum Rear Screen Sizes Based on Worksurface Edge Types on Migration Intro, Migration Pro, and Pro with Boost High-Speed

Screen Type	Square or Square with Knife Edge or 2" Radius	5" Radius	2" Radius with Knife Edge or 5" Radius with Knife Edge
Universal Privacy Screen (UFPS)	Max Screen Width = Width of Desk	Max Screen Width = Width of Desk Minus 3"	Max Screen Width = Width of Desk Minus 5"
Universal Privacy/Modesty Screen (UFPM)	Max Screen Width = Width of Desk	Max Screen Width = Width of Desk Minus 3"	Max Screen Width = Width of Desk Minus 5"
Sarto Privacy Screen (PSPS)	Max Screen Width = Width of Desk	Max Screen Width = Width of Desk Minus 3"	Max Screen Width = Width of Desk Minus 5"
Sarto Privacy/Modesty Screen (PSPM)	Max Screen Width = Width of Desk	Max Screen Width = Width of Desk Minus 2 1/2"	Max Screen Width = Width of Desk Minus 5"

Tip: Measurements provided do not include cutouts and overhang rules.

Tip: Rear screens are not compatible with Migration Pro and Intro organic bow front and back shape.

Maximum Side Screen Sizes Based on Worksurface Edge Types on Migration Intro, Migration Pro, and Pro with Boost High-Speed

Screen Type	Square or 2" Radius without Knife Edge	Square or 2" Radius with Knife Edge	5" Radius without Knife Edge	5" Radius with Knife Edge
Universal Privacy Screen (UFPS)	Max Screen Width = Depth of Desk	N/A	Max Screen Width = Depth of Desk Minus 3"	N/A
Sarto Privacy Screen (PSPS) with Option SIDESCEN Selected	Max Screen Width = Depth of Desk	Max Screen Width = Depth of Desk	Max Screen Width = Depth of Desk Minus 4"	Max Screen Width = Depth of Desk Minus 4"
Sarto Privacy/Modesty Screen (PSPM) with Option SIDESCEN Selected	Max Screen Width = Depth of Desk	Max Screen Width = Depth of Desk	N/A	N/A

Tip: Measurements provided do not include cutouts and overhang rules.

Tip: Side screens are not compatible with Migration Pro and Intro organic bow front and back shape.

Sarto Privacy Screens

Sarto privacy screens provide a light scale boundary and privacy element for height-adjustable desks and fixed worksurfaces. It can be used with Ology, Migration Desking Collection, Elective Elements, universal worksurfaces, and TS Series worksurfaces.

► Specifying, page 336

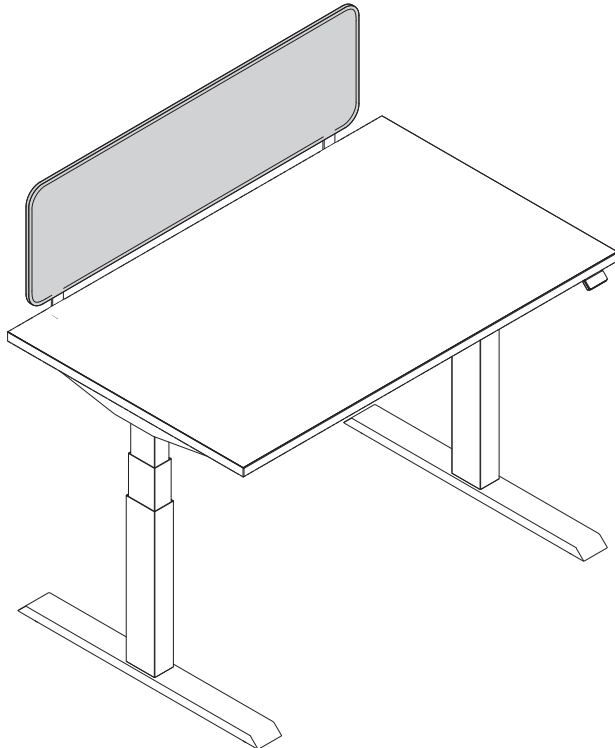

Actual Dimensions

Screen Height	12½"–34½"
Overall Height	13½"–25½"
Width	24"–96"

Tip: Overall height is measured from top of mounting surface to the top of the screen.

Product Details

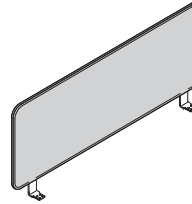

Sarto privacy screens are tackable. They are available in four modular heights, 13½"H, 19½"H, 23½"H, and 35½"H, and have widths ranging from 24"W to 96"W. Screens can also be specified parametrically.

The screen may be used on ¾"–1½" thick worksurfaces.

The width of the screen can be equal to or less than the width of the worksurface to which it will attach. Some restrictions apply due to location of worksurface legs and supports.

Tip: It is recommended that CET SmartTools planning aid be used to ensure proper application of screen to worksurface or tables.

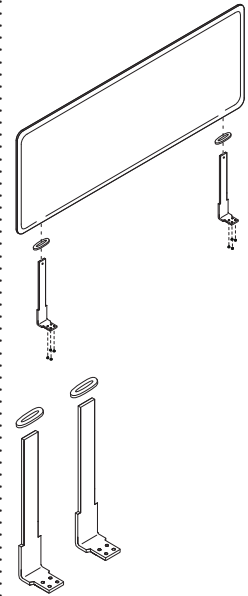

Brackets and hard stops are included with screens. Screens narrower than 60"W use two brackets, while screens 60"W and larger utilize three brackets. The third bracket is centered on the width of the screen.

Offset brackets are included with 29"W screens, to help maintain appropriate pinch points between the screen and adjacent objects. Side screen option is available for screens 36"W and narrower.

Sarto privacy screen slides onto brackets.

Alignment brackets are available to help eliminate gapping and misalignment between back and side screens. Alignment brackets are available as their own style (**PSCB**).

Weight of screens are calculated as follows: Screen: 0.0044 pounds per inch² Bracket: 1.2 pounds per bracket.

Surface Materials

Screen

- Fabric
- See *Surface Materials*, page 362.

Brackets and hard stops

- 7360 Merle

Maximum Rear Screen Sizes Based on Worksurface Edge Types on Migration Intro, Migration Pro, and Pro with Boost High-Speed

Screen Type	Square or Square with Knife Edge or 2" Radius	5" Radius	2" Radius with Knife Edge or 5" Radius with Knife Edge
Universal Privacy Screen (UFPS)	Max Screen Width = Width of Desk	Max Screen Width = Width of Desk Minus 3"	Max Screen Width = Width of Desk Minus 5"
Universal Privacy/Modesty Screen (UFPM)	Max Screen Width = Width of Desk	Max Screen Width = Width of Desk Minus 3"	Max Screen Width = Width of Desk Minus 5"
Sarto Privacy Screen (PSPS)	Max Screen Width = Width of Desk	Max Screen Width = Width of Desk Minus 3"	Max Screen Width = Width of Desk Minus 5"
Sarto Privacy/Modesty Screen (PSPM)	Max Screen Width = Width of Desk	Max Screen Width = Width of Desk Minus 2 1/2"	Max Screen Width = Width of Desk Minus 5"

Tip: Measurements provided do not include cutouts and overhang rules.

Tip: Rear screens are not compatible with Migration Pro and Intro organic bow front and back shape.

Maximum Side Screen Sizes Based on Worksurface Edge Types on Migration Intro, Migration Pro, and Pro with Boost High-Speed

Screen Type	Square or 2" Radius without Knife Edge	Square or 2" Radius with Knife Edge	5" Radius without Knife Edge	5" Radius with Knife Edge
Universal Privacy Screen (UFPS)	Max Screen Width = Depth of Desk	N/A	Max Screen Width = Depth of Desk Minus 3"	N/A
Sarto Privacy Screen (PSPS) with Option SIDESCEN Selected	Max Screen Width = Depth of Desk	Max Screen Width = Depth of Desk	Max Screen Width = Depth of Desk Minus 4"	Max Screen Width = Depth of Desk Minus 4"
Sarto Privacy/Modesty Screen (PSPM) with Option SIDESCEN Selected	Max Screen Width = Depth of Desk	Max Screen Width = Depth of Desk	N/A	N/A

Tip: Measurements provided do not include cutouts and overhang rules.

Tip: Side screens are not compatible with Migration Pro and Intro organic bow front and back shape.

Sarto Curved Screens

Sarto curved screens provide light scale privacy and modesty for height-adjustable desks and work tables.
 ▶ Specifying, pages 340–342

Curved screens are pin tackable.

Curved screens are attached to the worksurface with simple metal L-brackets.

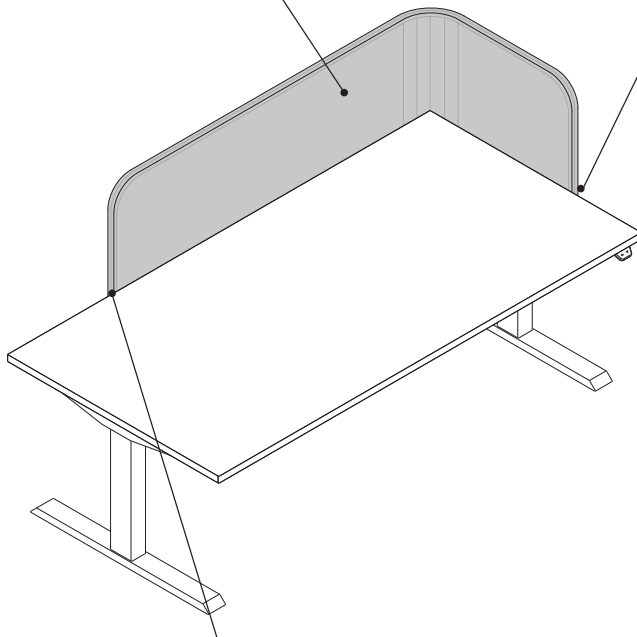

Sarto curved screens sit flush against the worksurface. If 1" cord drop is needed, please reach out to Specials for alternative bracket.

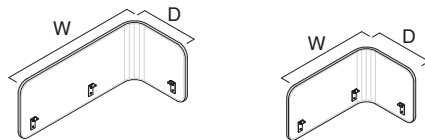

Actual Dimensions

	L-Screen	Half-Desk Screen
Overall Width	43"–66"	43", 49", or 55"
Depth	20"	20"
Width	23"–46"	23", 29", or 35"
Height	17.909", 18", or 24"	17.909", 18", or 24"
Thickness	7/8"	7/8"
Weight: 18"H	5.7 lb, 6.5 lb, 7.2 lb	5.0 lb, 5.6 lb, 6.2 lb
Weight: 24"H	7.3 lb, 8.4 lb, 9.4 lb	6.4 lb, 7.2 lb, 8.0 lb

Application Topics

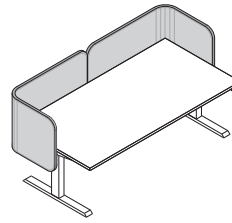

Half desk screens are sized to work with modular size desks. Mounting a pair of half desk screens on a parametric sized desk will create a gap between screens. Parametric width screens are available to create a full wrap of parametric worksurfaces.

Tip: It is recommended that CET SmartTools be used to evaluate the gap on the desk.

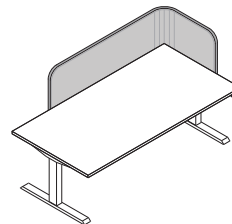

L-screens are sized to work with popular sized modular width desks. When mounted, the modular widths of the L-screen are designed to cover two thirds of the back of the worksurface.

Tip: It is recommended that CET SmartTools be used to evaluate the placement of the screen on the desk.

Fabric is applied in a warp horizontal direction. Due to the size of the screens, fabric is unable to be applied in a warp vertical direction.

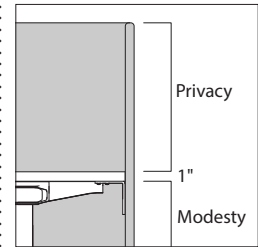

Screens are specified by first selecting an overall screen height (18"-24"), then specifying a privacy height. Privacy height is measured from the top of the screen to the top of the worksurface. Allowable privacy height selection changes based on the specified overall height.

All privacy heights allow a height-adjustable desk to be lowered to the lowest position (22") while preserving pinch point gap.

To match screens ordered on or before June 20, 2021, please consult the following information to determine proper privacy height.

- 24"H Screen, Privacy/Modesty Configuration – Privacy Height = 13½"
- 24"H Screen, Privacy Configuration – Privacy Height = 16½"

When ordering a single screen, selecting the correct hand is important. Handedness is assigned from the user position when the curved screen is mounted.

Screen is not applicable on shaped worksurface edges (knife edge, bullnose, P-edge, etc).

Surface Materials

Screen

• Fabric
Tip: Some thin, light colored fabrics are not available on these screens. Please see Surface Materials for available fabric finishes.

▶ Page 368

Brackets

- 6527 Merle

Universal and Sarto Screens Specific Guidelines

Migration SE Specific Guidelines

Rectangular 29"D and 35"D

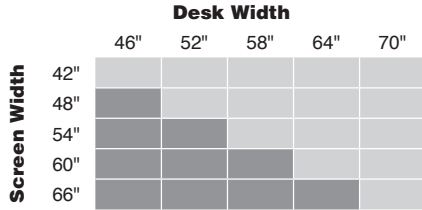

All guidelines assume the screen is centered on the desk.

Screens are sized to be a minimum of 4" smaller than worksurfaces. They can be placed anywhere along the back edge of a desk but cannot extend past the desk edge.

Ology Specific Guidelines

Rectangular 23"D, 29"D, and 35"D

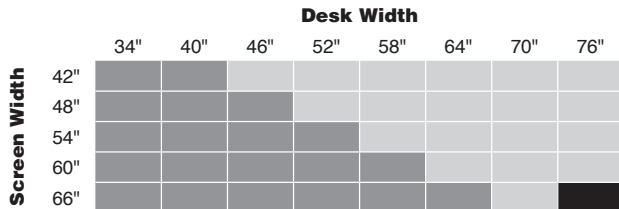

Tapered 23"D and 29"D

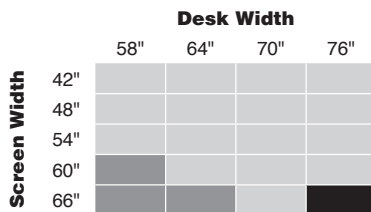

The screen can be placed on the back edge of an Ology without an integrated rail desk utilizing either the 1 1/8" cord drop or no cord drop placement. Screens are sized to be a minimum of 4" smaller than worksurfaces. Optional cable trays and grommets on Ology may cause some interference with screen mounting brackets.

Legend

No interference
Interference or cannot be used
Cannot specify a grommet

Ology Specific Guidelines, continued

90° Corner 23"D

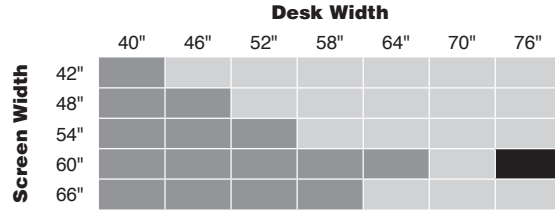

120° Corner 23"D

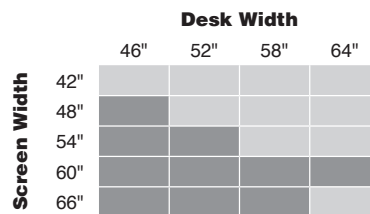

All guidelines assume the screen is centered on the desk.

When using the universal or sarto privacy/modesty screen on Ology with 1 1/8" cable drop, there are no limits on the horizontal placement of the cable tray beneath the desk.

The Universal and Sarto privacy/modesty screens can not be used with the Ology modesty panel without causing interference.

When a parametric Sarto screen is used on a parametric Ology desk, verify the screen width and placement in CET SmartTools planning to avoid interference.

The universal or sarto privacy/modesty screen can be used on either back edge of a 90° or 120° corner desk configuration.

Ology desks using an integrated storage leg may only mount the universal privacy/modesty screen in the privacy position and cannot use sarto screens due to interference. See SmartTools for more information.

The universal or sarto privacy/modesty screen does not mount to an Ology rail or into the Ology cantilevers.

If using overhangs, the leg must be at least 3 1/2" in from its standard position to avoid interference with the screen bracket.

Airtouch Specific Guidelines

Rectangular 22¹/₄"D and 28¹/₄"D

		Worksurface Width		
		40"	46"	58"
Screen Width	42"			
	48"			
	54"			
	60"			
	66"			

90° 22¹/₄"D

		Worksurface Width	
		39 ¹ / ₄ "	45 ¹ / ₄ "
Screen Width	42"		
	48"		
	54"		
	60"		
	66"		

120° 22¹/₄"D

		Worksurface Width
		34"
Screen Width	42"	
	48"	
	54"	
	60"	
	66"	

Universal or sarto privacy/modesty screen weight should be considered, along with other items to be used on Airtouch, so as not to exceed weight limit.

Universal or sarto privacy/modesty screens can be placed on the back edge of an Airtouch worksurface, utilizing either the 1¹/₈" cord drop or no cord drop placement without creating interference. The screen must be narrower than the width of the worksurface. Screen cannot exceed the width of table.

Legend

	No interference
	Interference or cannot be used
	Cannot specify a grommet

Soffio Screen

Soffio screen provides privacy and modesty in nearly infinite configurations for height-adjustable desks and fixed workspaces.

► Specifying, page 343

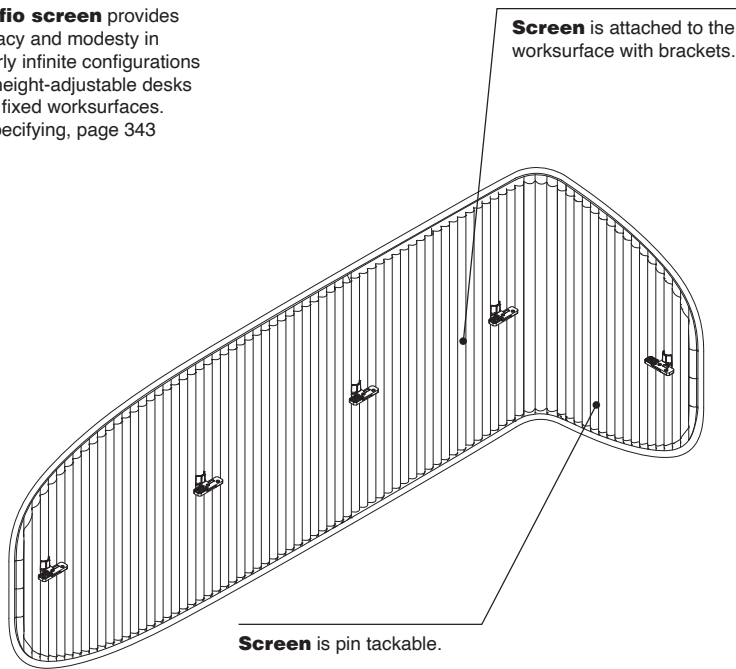

Screen is pin tackable.

Screen includes corrugations, allowing for the screen to curve at any point along the width.

Application Topics

Screen is available in three standard sizes, allowing for a variety of mounting configurations on desks of different sizes.

Tip: It is strongly recommended that CET SmartTools be used to evaluate the placement of the screen on the desk.

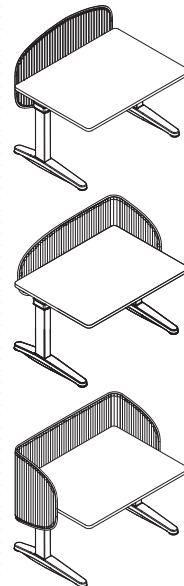

Fabric is applied in a warp horizontal direction. Due to the size of the screens, fabric is unable to be applied in a warp vertical direction.

Screen provides 13" of screen above the worksurface and 12" of screen below the worksurface. The height is measured from the top of the mounting surface to the top of the screen, and from the bottom of the mounting surface to the bottom of the screen.

Screen is not handed. The screen can be mounted in a right- or left-hand configuration.

Screen is not applicable on shaped worksurface edges (knife edge, bullnose, P-edge, etc).

Surface Materials

Screen

- Fabric

Brackets

- 6527 Merle

Actual Dimensions

Desk width	56", 68", or 80"
Height	26"
Weight	2.9 lb, 3.6 lb, 4.2 lb
Thickness	1"

Fixed Personal/Modesty Screens

Fixed Personal/
Modesty Screens

Personal screens are tackable and provide variable privacy when and where it is needed. The screens can be used on the Ology integrated rail and the SOTO rail. 19½"H and 24"H are not intended for use in modesty position when used with a height-adjustable desk.

► Specifying, page 344

Fixed personal screens are available in three heights; 12", 19½", and 24" - and four widths to accommodate varying levels of privacy. Height is measured from the top of the mounting surface to the top of the screen.

Brackets are attached to the screen.

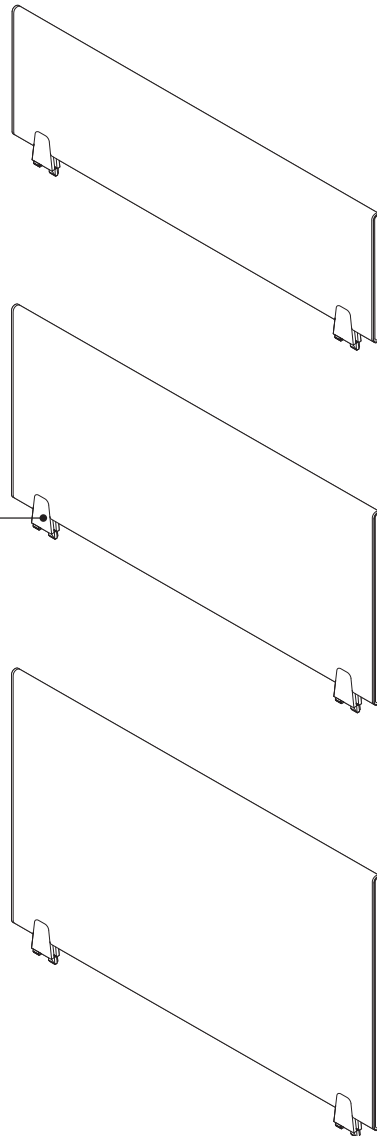

Actual Dimensions

Fixed Personal/Modesty Screens

	Fixed Personal/Modesty Screens
Width	30", 36", 42", or 48"
Height	11", 18½", or 23"
Overall height	12", 19½", or 24"
Thickness	¾"

Tip: Overall height is measured from top of mounting surface to the top of the screen.

Product Details

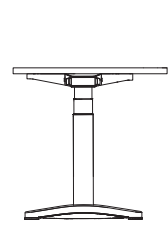

Personal screens can be mounted on the rail. The overall height from the floor will vary depending on the height of the adjustable worksurface.

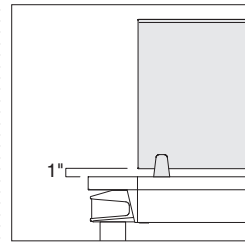

Gap is 1" between personal screen and rail.

Surface Materials

Infill

- Fabric

Brackets

- 4799 Platinum paint

front



back



Fabric without pattern is recommended when using a COM fabric to provide a consistent visual. Fabric with patterns could result in the above visual.

Application Topics

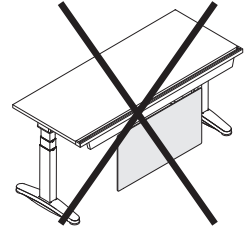

19½"H and 24"H personal screens cannot be used in the modesty position on Ology desks.

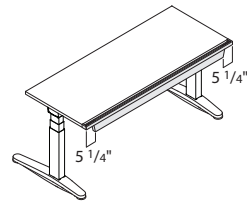

When attaching fixed personal/modesty screens to the Ology integrated rail, there is a 5¼" mounting free zone on each end of the rail.

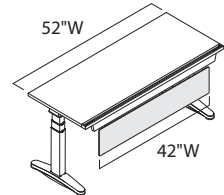

When using fixed screens in the modesty position, the desk must be at least 10" larger than the width of the screen.

When used with One-High integrated storage, fixed modesty screens must be a minimum of 24" shorter than worksurface width to allow for pinch point clearances.

Worksurface Side Screens

For Use on Desking, Benching, and Table Worksurfaces with Varying Thickness

Worksurface side screens provide a territorial boundary between users. Fabric, frosted glass, or clear glass screens are available for different levels of privacy. They are used on worksurfaces 0.808", 1", 1.185" and 1.5" thick. ▶ Specifying, pages 346–348

Worksurface bracket sits on the worksurface and allows the side screen to work on worksurfaces 22"D–30"D or deeper worksurfaces.

Worksurface side screen is available in fabric or glass. Fabric screen is pin tackable.

Worksurface bracket is powder coat paint.

Clamp at front of bracket attaches to the front edge of four specific worksurface thicknesses.

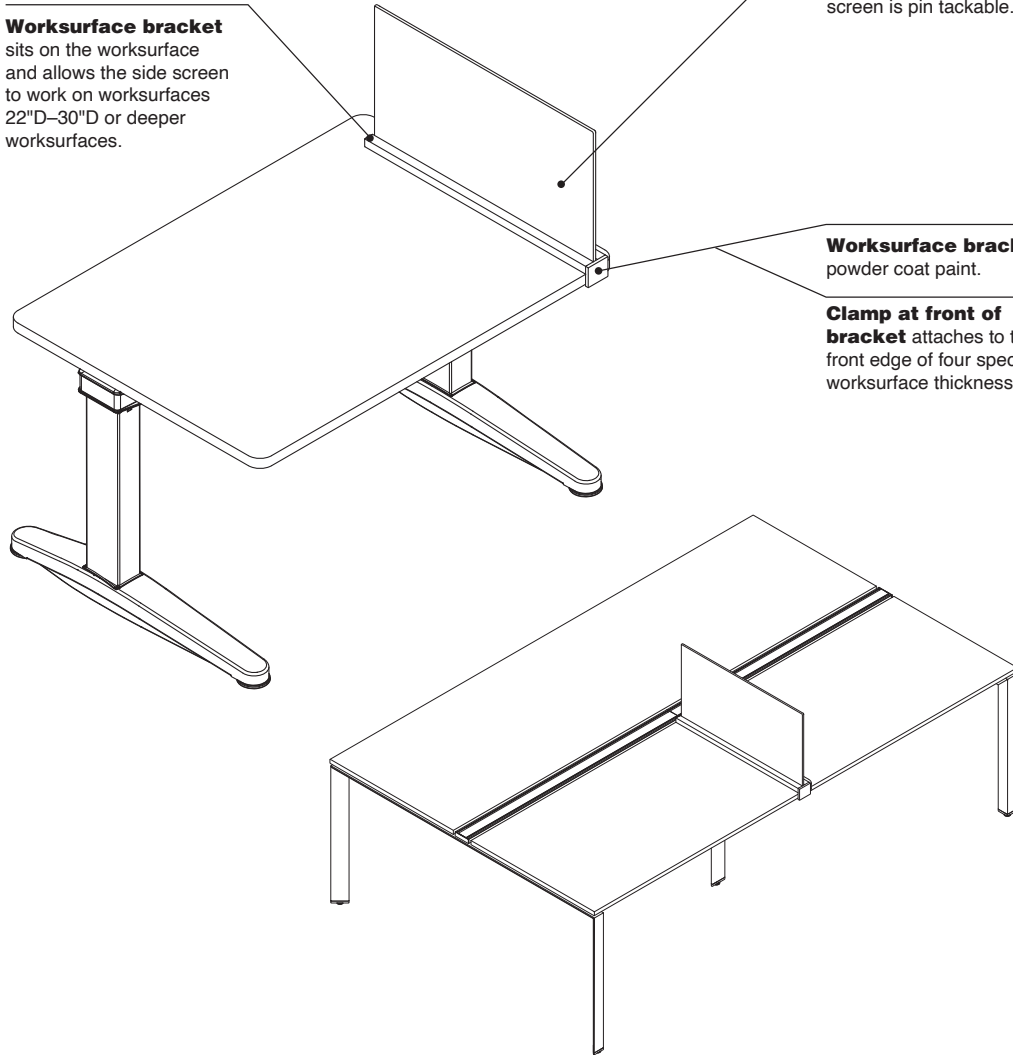

Actual Dimensions

	Fabric and Glass Screen	Application
Width	22" or 28" 24" or 30" 23½" or 29½"	FrameOne, Ology, Migration SE, and Flex worksurfaces Elective Elements and Universal worksurfaces Universal worksurfaces with cord drop
Height	12" or 19½"	
Fabric Screen Thickness	¾"	
Glass Thickness	¼"	
Worksurface Bracket Clamp	0.808" thickness 1" thickness 1.185" thickness 1.5" thickness	FrameOne worksurfaces Ology, Migration SE, and Flex worksurfaces Universal worksurfaces Elective Elements worksurfaces

Product Details

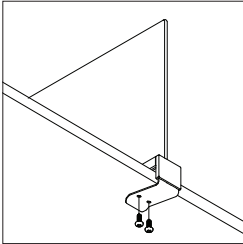

Worksurface side screens attach with two screws (#8 x 1/2" large buttonhead wood screws) through the clamp at the front on the underneath of the worksurface. The bracket clamp must be flush to the worksurface flat front edge.

Worksurfaces 0.808" thick utilize the smallest clamp at the front (FrameOne).

Worksurfaces 1" thick utilize a different clamp at the front (Ology, Migration SE, Flex).

Worksurfaces 1.185" thick utilize another clamp at the front (Universal).

Worksurfaces 1.5" thick utilize the largest clamp at the front (Elective Elements).
Tip: Worksurface bracket clamp must be used with the corresponding top thickness as noted above.

Application Topics

Side screens run parallel to the side (depth) of a worksurface only. They can attach anywhere along the front edge of a worksurface as long as the underworksurface clearance is free from any obstructions.

Worksurface side screen must be clear of any obstruction or interference on top of the worksurface.

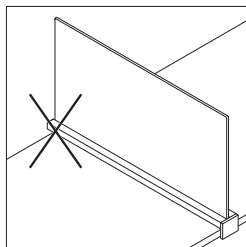

The width of screens can be equal to or less than the depth of the worksurface to which it will attach. No overhang is allowed. Some restrictions apply due to location of worksurface legs and supports.
Tip: Consult SmartTools for any application restrictions.

Surface Materials

Bracket

- 4799 Platinum Metallic
- 7207 Black
- 7241 Arctic White
- 7360 Merle

Screen

- 6500 Clear Glass
- 6530 Frosted Glass
- Fabric

▶ See *Surface Materials*, page 362.

Acrylic Screens

Acrylic Privacy Screens



► Specifying, page 350

Tip: Screen may need to be shorter than worksurface width. To determine screen and height-adjustable worksurface compatibility, see Worktools Compatibility Charts, page 48.

Product Details

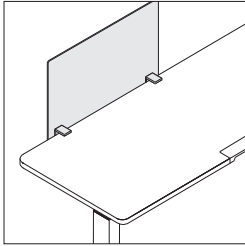

Privacy screen provides lightweight space division above worksurface.

Gap between worksurface and screen is 1" to allow for cable feed through.

Privacy screen top is a fixed height 19" above worksurface.

Privacy screen can be used in combination with modesty screen.

Privacy screen ships with Universal clamps for field installation.

Application Topics

Screen Width	SlatRail Width					
	24"	30"	36"	42"	48"	60"
22"	Light	Light	Light	Light	Light	Light
25"/28"	Dark	Light	Light	Light	Light	Light
31"/34"	Light	Dark	Light	Light	Light	Light
37"/40"	Light	Light	Dark	Light	Light	Light
43"/46"	Light	Light	Light	Dark	Light	Light
49"/52"	Light	Light	Light	Light	Dark	Light
55"/58"	Light	Light	Light	Light	Light	Dark
61"/64"	Light	Light	Light	Light	Light	Dark

SlatRail stanchions mount on the outside of the screen

SlatRail stanchions will not work with the screen

SlatRail stanchions mount on the inside of the screen

Tip: SlatRail does not overhang the SlatRail stanchions; therefore, it is important to order the appropriate SlatRail size when used in combination with screens.

Surface Materials

Screen
• 6544 Frost only

Universal clamp
• 0835 Black
• 4799 Platinum

Actual Dimensions

Depth 1/4"

Width 22", 28", 34", 40", 46", 52", 58", and 64"

Height 22"

Acrylic Modesty Screens



► Specifying, page 350

Tip: Screen may need to be shorter than worksurface width. To determine screen and height-adjustable worksurface compatibility, see Worktools Compatibility Charts, page 48.

Product Details

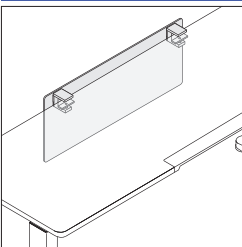

Modesty screen provides below worksurface modesty.

Gap between worksurface and screen/cable-way is 1" to allow for cable feed through.

Modesty screen top is a fixed height 1/4" above and 1 1/2" below worksurface.

Modesty screen can be used in combination with privacy screen.

Modesty screen ships with Universal clamps for field installation.

When used with One-High integrated storage, acrylic modesty screens must be a minimum of 18" shorter than worksurface width to allow for pinch point clearances.

Application Topics

		SlatRail Width					
		24"	30"	36"	42"	48"	60"
Screen Width	22"						
	25"/28"						
	31"/34"						
	37"/40"						
	43"/46"						
	49"/52"						
	55"/58"						
	61"/64"						

- SlatRail stanchions mount on the outside of the screen
- SlatRail stanchions will not work with the screen
- SlatRail stanchions mount on the inside of the screen

Tip: SlatRail does not overhang the SlatRail stanchions; therefore, it is important to order the appropriate SlatRail size when used in combination with screens.

Surface Materials

Screen

- 6544 Frost only

Universal clamp

- 0835 Black
- 4799 Platinum

Actual Dimensions

Depth	1/4"
Width	22", 28", 34", 40", 46", 52", 58", and 64"
Height	14"

Screens, Cable and Power Management

Cable and Power Management

Vertical Cable Carrier



► Specifying, page 351

Product Details

Vertical cable carrier has a 52" flexible spine with two management channels to manage cords from below worksurface to the floor.

Vertical cable carrier bracket attaches to the underside of the worksurface and weighted base sits on floor.

Surface Materials

Vertical cable carrier

- 6688 Steel

Actual Dimensions

Width 2½"

Height 52"

Weight 1 lb

6"D Wire Managers

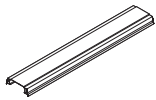

► Specifying, page 351

Product Details

Wire manager is flexible to manage cords underneath the worksurface.

PVC-free ABX material is resistant to fatigue and recyclable

Surface Materials

Wire manager

- 6000 Black
- 6249 Platinum

Actual Dimensions

Depth 6"

Width 30", 36", 42", 48", 54", and 60"

Height 1"

1¾"D Wire Managers

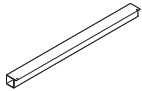

► Specifying, page 352

Product Details

Wire manager is flexible to manage cords underneath the worksurface.

PVC-free polypropylene material is resistant to fatigue and recyclable.

Surface Materials

Wire manager

- 6000 Black

Actual Dimensions

Depth 1¾"

Width 6", 12", 18", 23¼", 30", 35", 42", and 48"

Height 1¾"

Soft Cable Drop

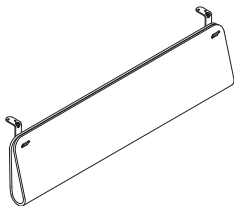

► Specifying, page 352

Product Details

Soft cable drop ships with two utility hooks that attach to the underside of the height-adjustable desk.

Soft cable drop comes in one size; 36"W x 11"H.

Soft cable drop is felted PET and will stretch and conform, dependent on the weight of the cords stored.

Surface Materials

Soft cable drop

- Soft PET in P631 Dark Heather Grey

Utility hooks

- Steel painted black

Actual Dimensions

Depth 36"

Height 11"

Utility Hook



► Specifying, page 353

Product Details

Utility hook installs underneath the height-adjustable desk on the right or left side of the user to hold laptop backs, backpacks, etc.

Utility hook has a weight limit of 20 pounds.

Surface Materials

Utility hooks

- Steel painted black

Actual Dimensions

Depth 3"

Width 1"

Height 3¼"

Powerstrip Intro

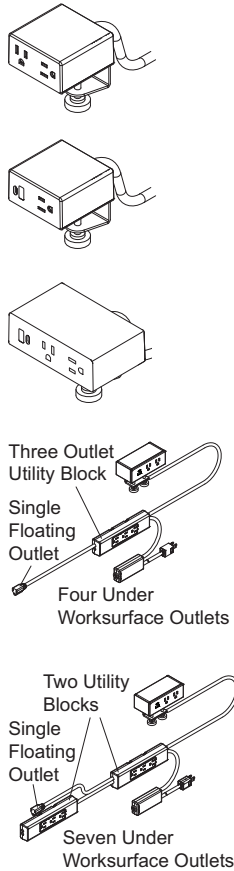

► Specifying, page 354

Product Details

Powerstrip intro offers desktop C-clamped powerstrips with combinations of power outlets, USB A+C 20W, and optional under worksurface utility power 4 or 7 power outlets.

Desktop power configuration options and specifications include:

- Two power
- One power and USB A+C 20W
- Two power and one USB-A+C 20W
- Power outlet is 15A, 120V, 60Hz
- Tamper resistant power outlets

Meets spill test criteria.

Two power with 20 watt intelligent USB A+C:

- If only USB-C in use: delivers what the device needs up to 20 watts
- If only USB-A in use, up to 10 watts
- If both USB A+C in use, USB-A delivers up to 10 watts and 10 watts to USB-C. If USB-A device needs less than 10W, the remainder up to 20 watts goes to the USB-C device
- USB-A watt/amp output (2 port) is 10W/2A per port with dedicated charging ports

C-clamp is designed to accommodate worksurfaces up to 1½" thick.

USB A+C 20W



Powerstrip intro USB ports are recommended for charging: cell phones, tablets, headphones, wearable fitness trackers, or other small electronic devices. Not recommended for devices needing higher output, more than 20-watts, like compact laptops. See Powerstrip Plus for higher output USB options.

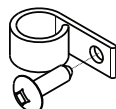
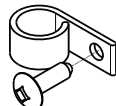

Cable management clips, 2-pack, comes standard with each powerstrip. Mounts under the worksurface to manage cords.

Tip: Cord clip screw length for minimum worksurface thickness of ¾".

Powerstrip intro without optional under worksurface utility power includes a 9-foot standard smooth cord with a diameter of 3/8".

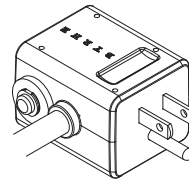

Powerstrip intro includes a standard straight 3-prong plug. An overcurrent protection (OCP) 90-degree plug is also an option. Check with your local authorities having jurisdiction to see if overcurrent protection is required.

Optional Under Worksurface Utility Power

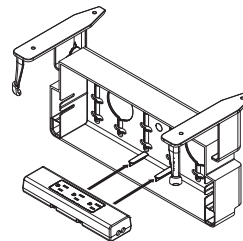
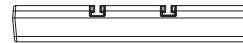
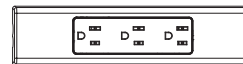

The bottom of each utility powerstrip block has slots. The slots allow the block to slide onto raised bars in the universal cable management trays, sold separately. These help keep the powerstrip in place when the tray is opened or closed.

Optional under worksurface utility power blocks do not ship with independent mounting hardware. They are designed to mount into the universal cable management kit without additional hardware. Kit sold separately.

Universal cable management tray - small tray, **DSTRAYSM**, holds four outlets and large tray, **DSTRAYLG**, holds seven outlets under worksurface utility power.

Overcurrent protection, OCP, via a circuit breaker prevents one powerstrip intro assembly from drawing more than 15 amps of power.

Overcurrent protection is included as standard with powerstrip intro configurations with more than three outlets and is an option on configurations with less than four outlets. Check with your local authorities having jurisdiction to see if overcurrent protection is required for assemblies with less than four outlets.

Overcurrent protection (OCP) includes a circuit breaker rated for 15 amps.

Powerstrip intro with optional under worksurface utility power comes standard with OCP inline box and optional 6-foot or 8-foot standard smooth power cord with a diameter of 3/8". Choice of standard straight or 90 degree NEMA 5-15 3-prong plug.

Surface Materials

Housing

- 6009 Arctic White
- 6527 Merle

Tip: Arctic white housing will have white cord and merle housing will have black cord.

Actual Dimensions

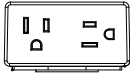

2 Port



3 Port

D	3 ¹ / ₁₆ "	3 ⁷ / ₁₆ "
W	3 ¹ / ₁₆ "	4 ¹¹ / ₁₆ "
H	1 ⁵ / ₈ "	1 ⁵ / ₈ "

Underwriters Laboratory (UL) Listed. These products have been designed to meet U.S. and Canadian national electrical and energy codes and most local building codes. Local electrical codes vary, so consult with your local authority having jurisdiction as they have final say if the products as installed are compliant with local code.

Certifications include:

- cULus



Power cord length

Nema 5-15 3 prong plug options

Overcurrent Protection (OCP)



	Without under worksurface utility power	With under worksurface utility power
Power cord length	9' or 163" curly cord	6' and 8' options or 163" curly cord
Nema 5-15 3 prong plug options	Standard Straight 1 ³ / ₈ " x 1" x 7 ⁷ / ₈ "	Standard Straight
Overcurrent Protection (OCP) in plug	90° with Overcurrent Protection (OCP) in plug 2 ¹ / ₁₆ " x 1 ⁵ / ₈ " x 1 ⁷ / ₁₆ "	Standard 90°
Overcurrent Protection (OCP)	90° OCP plug	Included with utility power as an inline box

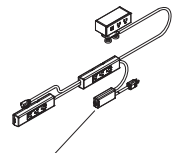
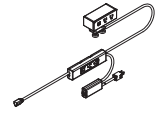

Standard 3-Prong Plug

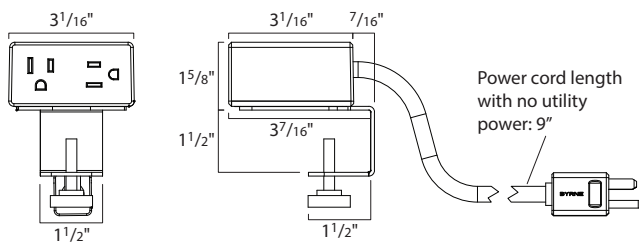
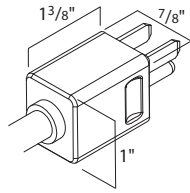

Overcurrent Protection (OCP) 90° Plug

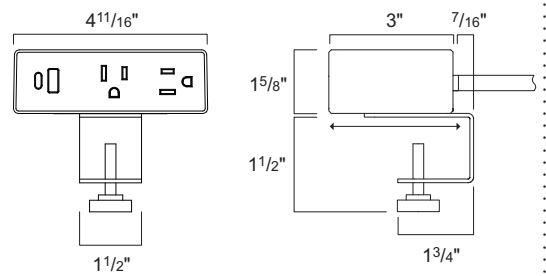
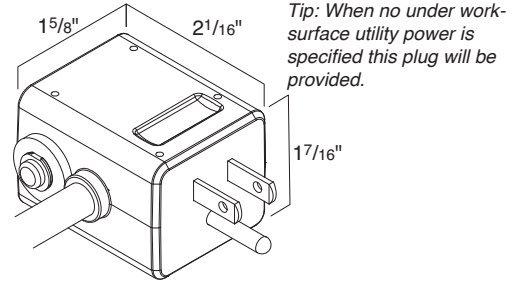

Optional Under Worksurface Utility Power

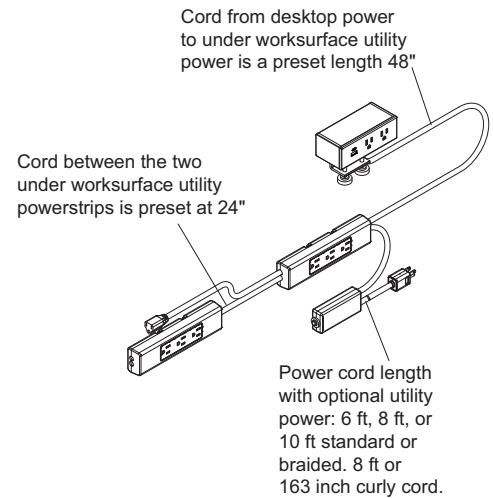
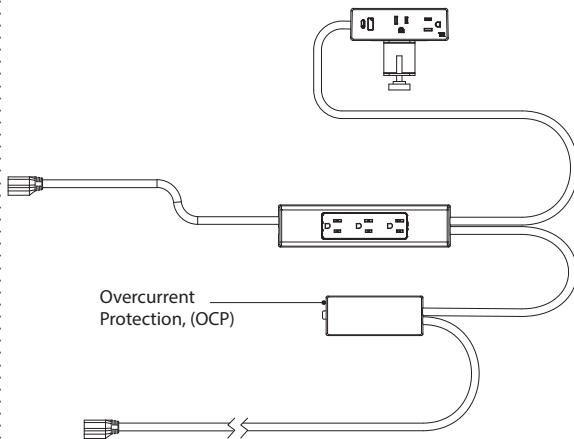

Powerstrip Intro vs. Powerstrip Plus		
Product Name	Power Strip Intro	Powerstrip Plus
Number of Worksurfaces Power Configurations	3 Power outlets and USB A+C 20W	12 Power outlets, USB A+C 20W, USB-C 45W or 100W and Data
20W USB A+C	Yes	Yes
45W or 100W USB-C	No	Yes
Mounting Options	C-Clamp	C-Clamp, Rail, Front Edge or Flush Mount
Under Worksurface Utility Power Options	4 Outlets or 7 Outlets	4 Outlets 7 Outlets or 9 Outlets
Overcurrent Protection (OCP)	Optional with no utility power Standard with more than three power outlets Standard with utility power	Optional with no utility power Standard with more than three power outlets Standard with utility power
Cord Options	Standard and Curly	Standard, Braided or Curly
Plug Options	Desktop powerstrip Standard NEMA or 90 Degree NEMA with overcurrent protection Desktop powerstrip with optional under worksurface utility powerstrip Standard NEMA 90 Degree NEMA *OCP is inline box with utility power.	Standard NEMA 90 Degree NEMA Thread Low Profile

Powerstrip Plus

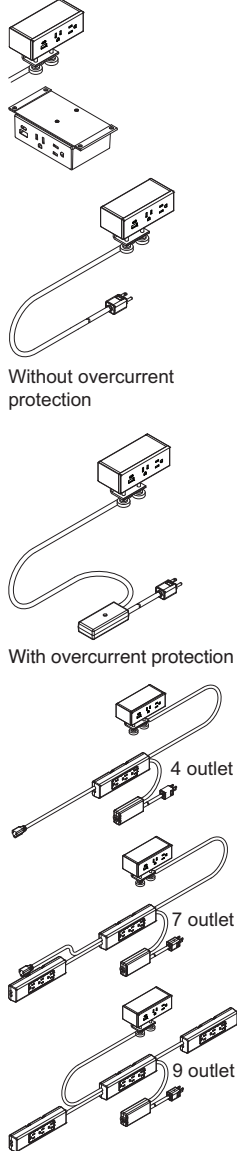

Without overcurrent protection

With overcurrent protection

► Specifying, page 356

Product Details

Desktop power offers multiple power, USB, and data options; and can be specified with a C-clamp, rail mount, or front edge mount. Meets spill test criteria.

C-clamp is designed to accommodate worksurfaces between 1/2" and 1 3/8" thick. Also available with rail mount or front edge mount.

Under worksurface optional utility power blocks do not ship with independent mounting hardware. They are designed to mount into the Universal cable management kit without additional hardware. Kit sold separately.

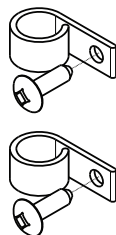

Cable management kit comes standard with each powerstrip. Mounts under the worksurface to manage cords.
Tip: Cord clip screw length for minimum worksurface thickness of 3/4".

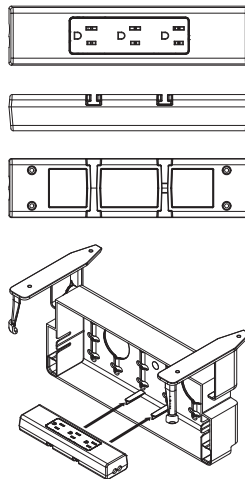

The bottom of each utility powerstrip block has slots. The slots allow the block to slide onto raised bars in the universal cable management kit. These help keep the powerstrip in place when the tray is opened or closed. Universal cable management kit sold separately.

USB A+C 20W

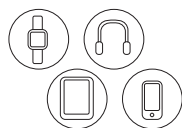

Powerstrip Plus's USB A+C 20W recommended for charging: cell phones, tablets, headphones, wearable fitness trackers, or other small electronic devices.

Dual 45W or 100W USB-C



USB-C 100W recommended for all of the above and compact laptops.

Overcurrent protection via a circuit breaker prevents one powerstrip plus assembly from drawing more than 15 amps of power.

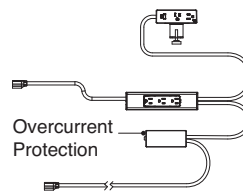

Overcurrent protection is included as standard with powerstrip plus configurations with more than three outlets and is an option on configurations with less than four outlets. Check with your local authorities having jurisdiction to see if overcurrent protection is required for assemblies with less than four outlets.

Power plug options:

- Standard NEMA 5-15 3 prong
- 90 degree NEMA 5-15 3 prong
- Thread low profile plug

Surface Materials

Desktop power

- 6000 Black
- 6009 Arctic White
- 6053 Seagull
- 6302 Baltic
- 6338 Chili
- 6527 Merle
- 6BD1 Aubergine
- 6BD2 Peacock
- 6BD5 Honey
- 6BD6 Lagoon
- 6BD7 Saffron
- 6BE2 Light Peacock

Power cord options and lengths:

- Smooth straight 6', 8', or 10': Black or White
- Braided 6', 8', or 10': Black or Seagull
- Curly cord 8' or 163": Black or White

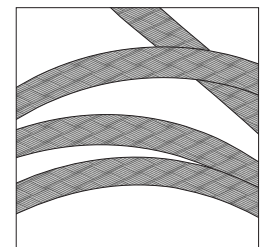

Braided cord

- 9009 Black
- 9011 Seagull

Actual Dimensions

Diameter of Powerstrip Plus power cords:

Standard	1/8"
Braided	3/8"

Curly 1/8" (coiled area 1 1/2" diameter)

Underwriters Laboratory (UL) Listed. These products have been designed to meet U.S. and Canadian national electrical and energy codes and most local building codes. Local electrical codes vary, so consult with your local authority having jurisdiction as they have final say if the products as installed are compliant with local code.

Power configurations options guide

Hedberg Option Code	Number per Powerstrip			Data
	Power Outlet	USB A+C/ Low Wattage	USB-C/ High Wattage	
3P	3			
2P1AC20	2	1 – 20W		
2P1AC1D	2	1 – 20W		1
2P1C100	2		1 –100W	
3P1AC	3	1 – 20W		
1P1AC1C100	1	1 – 20W	1 – 100W	
2P1AC1C100	2	1 – 20W	1 – 100W	
2P2AC	2	2 – 20W		
3P2AC20	3	2 – 20W		
3P1AC201D	3	1 – 20W		1
2P1ACC100D	2	1 – 20W	1 – 100W	1
2P2C45	2		2 – 45W	

Optional data port adapter information chart. (Coupler/jack not included)

Note: Please verify fit of jack in adapter before ordering large quantities as manufacturer designs may change without notice.

Adapter	Manufacturer
BBB	L-Com Keystone Modular
BBB	NETCONNECT, and 110 Connect Series Modular Jack
BBB	Siemon ZMAX Style
BBB	Allen Tel Versa Tap Series
BBB	Leviton Quick Port Series
BBB	Belden REVConnect
BBB	HDMI Adapter Cable
CCC	Hubbell Nextspeed Keystone Series
CCC	ADC Truenet series
DDD	Blank (no coupler/jack)
EEE	Ortronics TracJack Series
FFF	Panduit Mini-Com Series
HHH	Video Monitor Jack/DB-15, panel mount solder style

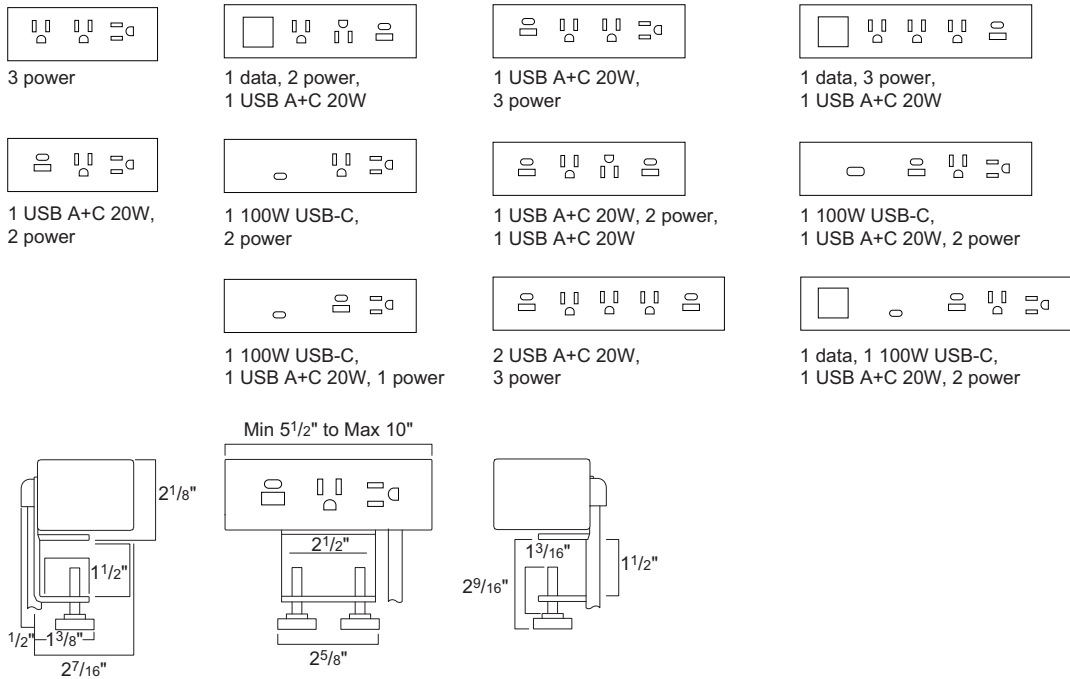

Optional Under Worksurface Utility Power Dimensions

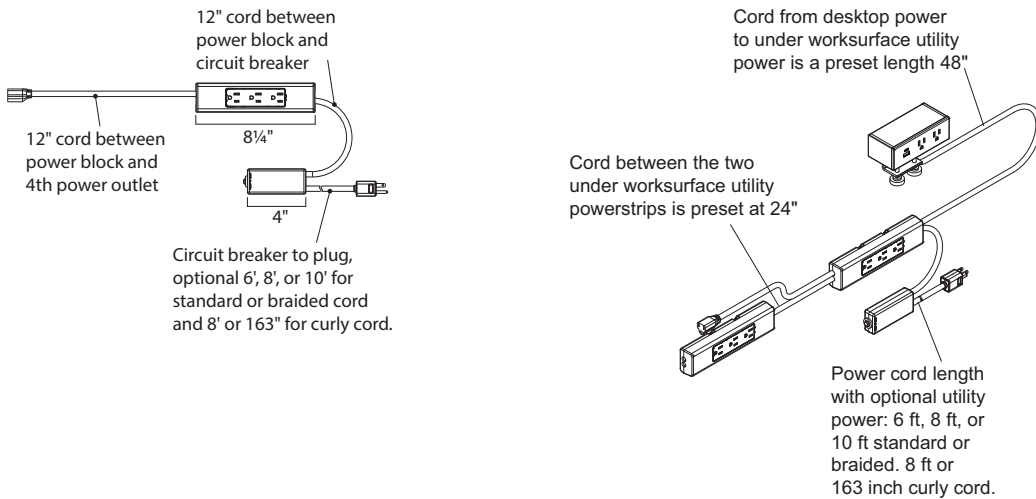

Under Worksurface Utility Power

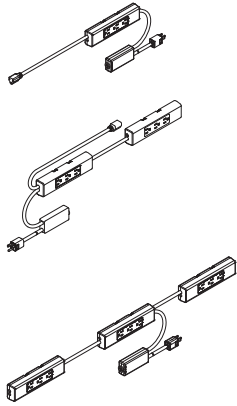

► Specifying, page 358

Product Details

Under worksurface utility power provides multiple power outlets for plugging in a height adjustable desk, computer, and desktop necessities with a one cord out solution.

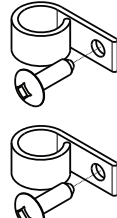

Cable management kit comes standard and mounts under the worksurface to manage cords.

Tip: Cord clip screw length for minimum worksurface thickness of 3/4".

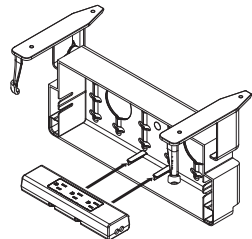

Under worksurface utility power does not ship with independent mounting hardware. The blocks are designed to mount into the universal cable management kit without additional hardware. Kit sold separately.

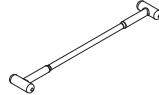
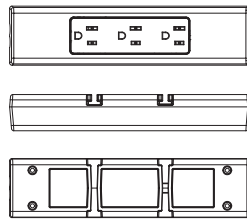

The bottom of each utility powerstrip block has slots. The slots allow the block to slide onto raised bars in the universal cable management kit trays. This design helps keep the powerstrip in place when the tray is opened or closed. Universal cable management kit's smart straps, if selected, are used to hold the power cord in place. ► See page 359 for universal cable management kit understanding content.

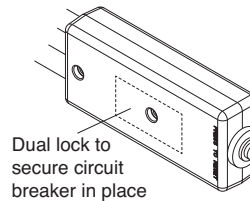
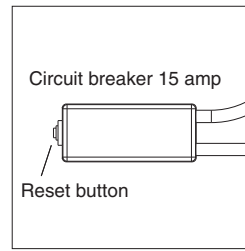

Overcurrent protection is required by UL on these products.

UL Listed: Utility power block outlets are hardwired together in a complete, UL listed assembly. *Tip: Underwriters laboratory (UL) listed. These products have been designed to meet U.S. and Canadian national electrical and energy codes and most local building codes. Local electrical codes vary, so consult with your local authority having jurisdiction as they have final say if the products as installed are compliant with local code.*

Power plug options:

- Standard NEMA 5-15 3 prong
- 90 degree NEMA 5-15 3 prong
- Thread low profile plug

Surface Materials

Power cord options and lengths:

- Smooth straight 6', 8', or 10': Black or White
- Braided 6', 8', or 10': Black or Seagull
- Curly cord 8' or 163": Black or White

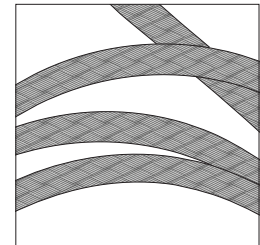

Braided cord

- 9009 Black
- 9011 Seagull

Actual Dimensions

Power blocks

Depth	2"
Width	8 1/4"
Thickness	1"

Four outlets total – One utility block, with three outlets each and one floating female outlet

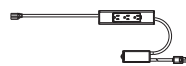

Seven outlets total – Two utility block, with three outlets each and one floating female outlet

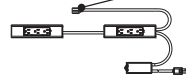

Nine outlets total – Three utility block, with three outlets each.

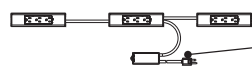

Floating female outlet for oversized plugs or power supplies.

Optional standard NEMA 3-prong plug, 90° or thread low profile plug.

Dimensions

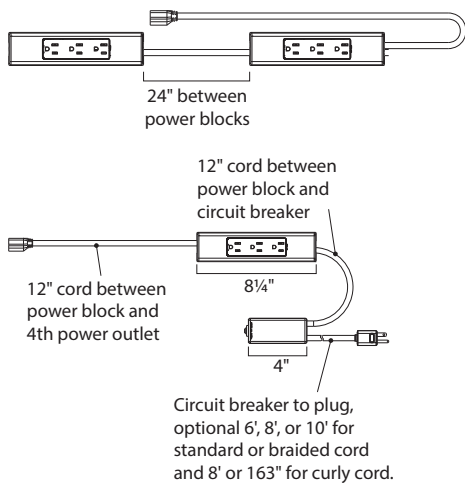

- Optional under worksurface utility power available with:
- NEMA 90°
 - Standard NEMA 5-15 3-prong
 - Thread low profile plug

Universal Cable Management Kit

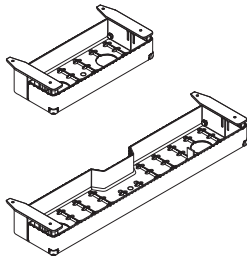

► Specifying, page 359

Product Details

Universal cable management kit provides easy management and access to cords, cables, and power blocks under a workstation.

Optional smart straps allow for easy management of cables and cords in the cable management tray. The large tray ships with 10 straps and the small tray ships with five straps. Straps are 5³/₄" long.

Cable management tray is designed to fit behind the stretcher bar and under-structure of most Steelcase height-adjustable tables. *Tip: Exceptions are Ology desks with integrated rail or modesty panel.*

Cable management tray provides tool-free and hardware-free mounting of under worksurface power from the powerstrip plus.

Cable management tray allows for a 1/8" gap around all four sides between the tray and the worksurface when mounted to allow for cable egress.

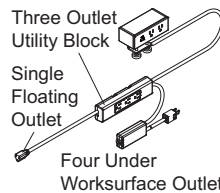
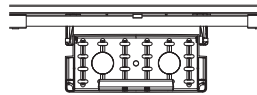

The small cable management tray is designed to hold one utility powerstrip and it has four outlets. The tray does not have the capacity to hold more than one utility powerstrip.

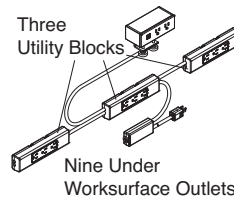
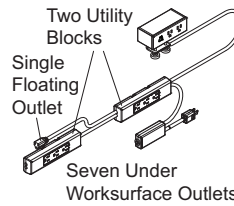
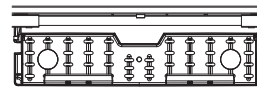

The large cable management tray holds two utility powerstrips in the raised bars section. There is capacity to add three utility powerstrips, two in the raised bar area and one more in the tray, strapped down.

Surface Materials

Cable tray
• 6205 Black

Actual Dimensions

Depth	6 ⁵ / ₁₆ " (7 ⁴ / ₈ " with bracket)
Width	15 ¹ / ₂ ", 30"
Height	2 ⁵ / ₈ " (3 ¹ / ₂ " when installed)

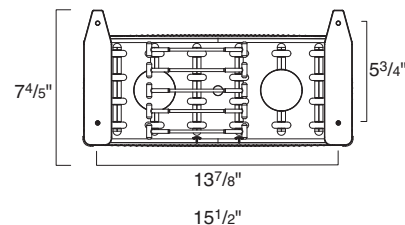
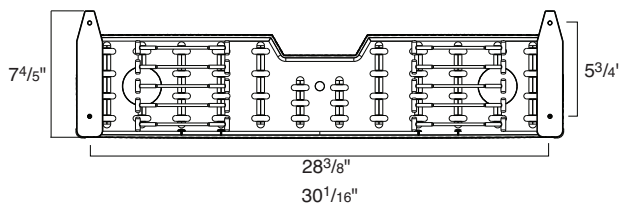

High-Capacity Cable Riser

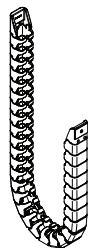

► Specifying, page 360

Product Details

High-capacity cable riser provides vertical cable management for multiple, heavy gauge cords; recommended for height-adjustable workspaces to a magnetic metal surface connection.

Easy cord installation and disassembly with a robust hold to keep cords in place.

Each link lays flat against the other to form a concealed front to hide cords and provide a clean aesthetic.

Links will move uniformly together keeping cables aligned and well managed.

Universal fit for most applications.

Application

Recommended for height-adjustable workspaces.

Attaches to the underside of the top along the back edge to route cords and cables from top to power source.

Tip: Do not use with standard integrated storage or within enclosed areas that would restrict the movement of the cable riser's links.

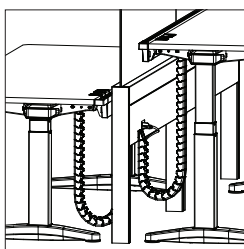

Top bracket can pivot to 90 degrees and attaches directly underneath the worksurface with screws.

Bottom bracket attaches to magnetic metal surfaces near a power receptacle via a rubber-coated magnet to avoid scratching.

Ideal for use with height-adjustable desks paired with Answer fence, beam, panel system, Bivi Slim Leg application, and benching applications.

Top bracket footprint needed: 2¹/₂"D by 2"W.

Top thickness – 1" plus with hardware included. If installing on less than 1" thick surface, shorter screw lengths must be obtained.

Screw length – 7/8"

Links can be rotated 180° degrees for customization.

Minimum bend radius is 1³/₁₆".

Surface Materials

Two choices for blending in with the furniture's palette aesthetic.

Cable Riser

- 6053 Seagull
- 6527 Merle

Actual Dimensions

Cable Riser Assembly

Depth 1⁷/₁₆"

Width 1³¹/₃₂"

Length 41⁵/₁₆" (including brackets and links)

Internal Cavity

Depth 1¹/₄"

Width 1⁷/₁₆"

Cable riser weight is 1.2 pounds (without cords).

Universal Privacy/Modesty Screens

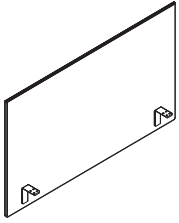

Tip: Universal privacy/modesty screens can be attached to 3/4"–1 1/2" thick worksurface, including height adjustable work-surfaces, universal work-surfaces, and Elective Elements work-surfaces.

Tip: The screens weigh between 9.79 pounds and 11.89 pounds. Take this into consideration when planning for use on height-adjustable work-surfaces.

Tip: The universal privacy/modesty screen is intended for use on the back of a worksurface.

Tip: Fabric is applied horizontally on the screen.

Tip: Screen allows for 1 1/8" cord drop or no cord drop. See understanding pages for product specific application guidelines.

Standard Includes	Required to Specify
-------------------	---------------------

- | | |
|---|---|
| <ul style="list-style-type: none"> ▶ Need help? Product details, page 296 • Screen: privacy or privacy/modesty: fabric price group 1 • Brackets: 7360 Merle • Edge: PET | <ol style="list-style-type: none"> 1 Style number 2 Width (see below under Required Selections) 3 Mount location (see below under Required Selections) 4 Fabric color number for screen 5 Edge color: <ul style="list-style-type: none"> P630 Medium Heather Grey PET P631 Dark Heather Grey PET 6 Options, if selected (see below) <ul style="list-style-type: none"> ▶ See <i>Surface Materials</i>, page 362. |
|---|---|

Width	Required Selections	U.S. Price	Required to Specify
-------	---------------------	------------	---------------------

Width	<ul style="list-style-type: none"> • 42"W • 48"W • 54"W • 60"W • 66"W 	<ul style="list-style-type: none"> Prices below Prices below Prices below Prices below Prices below 	<ul style="list-style-type: none"> Specify width. Specify width. Specify width. Specify width. Specify width.
--------------	--	--	--

Mount Location	Required Selections	U.S. Price	Required to Specify
----------------	---------------------	------------	---------------------

Mount Location	<ul style="list-style-type: none"> • Privacy (19 1/8" above the worksurface, 5 1/2" below the worksurface) • Privacy/modesty (13" above the worksurface, 11 7/16" below the worksurface) 	<ul style="list-style-type: none"> No cost No cost 	<ul style="list-style-type: none"> Specify with privacy application. Specify with privacy/modesty application.
-----------------------	--	--	--

Surface Materials	Options	U.S. Price	Required to Specify
-------------------	---------	------------	---------------------

Surface Materials	<ul style="list-style-type: none"> • Fabric price group 1 • Fabric price group 2 • Fabric price group 3 • Fabric price group 4 • Fabric price group 5 • Fabric price group 6 • Fabric price group 7 • Fabric price group 8 • Fabric price group 9 • Fabric price group 10 • Customer's Own Material (COM) 	<ul style="list-style-type: none"> No cost +\$ 61 +\$174 +\$222 +\$266 +\$311 +\$361 +\$405 +\$450 +\$496 +\$ 25 	<ul style="list-style-type: none"> Specify fabric color number. Specify fabric color number. Specify fabric color number. Specify fabric color number. Specify fabric color number. Specify fabric color number. Specify fabric color number. Specify fabric color number. Specify fabric color number. Specify fabric color number. ▶ See <i>Surface Materials Reference Manual</i>.
--------------------------	--	---	--

Specification Information					
Style Number	U.S. Base Prices				
	42"W	48"W	54"W	60"W	66"W

UFPM	\$734	\$780	\$829	\$880	\$929
------	-------	-------	-------	-------	-------



For Canadian Pricing
Multiply U.S. Price by the Canadian price factor.
▶ See page 1 for details.

Universal Privacy Screens and Aligners

Universal Privacy Screens

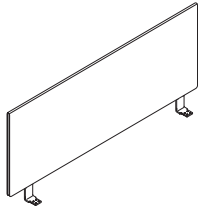

Standard Includes	Required to Specify
<ul style="list-style-type: none"> ▶ Need help? Product details, page 300 • Screen: fabric price group 1 • Brackets: paint price group 1 • Edge: PET 	<ol style="list-style-type: none"> 1 Style number 2 Width (see below under Required Selections) 3 Height (see below under Required Selections) 4 Fabric color number for screen 5 Bracket finish color number 6 Edge color: <ul style="list-style-type: none"> P630 Medium Heather Grey PET P631 Dark Heather Grey PET 7 Options, if selected (see below) <p>▶ See <i>Surface Materials</i>, page 362.</p>

Required Selections	U.S. Price	Required to Specify
Width		
• 24"W	Prices at right	Specify width.
• 30"W	Prices at right	Specify width.
• 36"W	Prices at right	Specify width.
• 42"W	Prices at right	Specify width.
• 48"W	Prices at right	Specify width.
• 54"W	Prices at right	Specify width.
• 60"W	Prices at right	Specify width.
• 66"W	Prices at right	Specify width.
• 72"W	Prices at right	Specify width.
• 78"W	Prices at right	Specify width.
• 84"W	Prices at right	Specify width.
• 90"W	Prices at right	Specify width.
• 96"W	Prices at right	Specify width.

Tip: 13½"H screen will align at a 42" datum. 19½"H screen will align at a 48" datum.

Height	<ul style="list-style-type: none"> • 13½"H • 19½"H 	Prices at right Prices at right	Specify height. Specify height.
---------------	--	------------------------------------	------------------------------------

Options	U.S. Price	Required to Specify
Surface Materials		
• Fabric price group 1	No cost	Specify fabric color number.
• Fabric price group 2	+\$ 53	Specify fabric color number.
• Fabric price group 3	+\$142	Specify fabric color number.
• Fabric price group 4	+\$178	Specify fabric color number.
• Fabric price group 5	+\$219	Specify fabric color number.
• Fabric price group 6	+\$256	Specify fabric color number.
• Fabric price group 7	+\$296	Specify fabric color number.
• Fabric price group 8	+\$332	Specify fabric color number.
• Fabric price group 9	+\$371	Specify fabric color number.
• Fabric price group 10	+\$408	Specify fabric color number.
• Customer's Own Material (COM)	+\$ 25	▶ See <i>Surface Materials Reference Manual</i> .
Bracket		
• Paint price group 1	No cost	Specify paint color number.
• Paint price group 2	+\$ 17	Specify paint color number.



For Canadian Pricing

Multiply U.S. Price by the Canadian price factor.

▶ See page 1 for details.

Specification Information									
Style Number	Height	U.S. Base Prices							
		24"W	30"W	36"W	42"W	48"W	54"W	60"W	66"W
UFPS	13½"	\$480	\$515	\$548	\$586	\$619	\$656	\$691	\$726
	19½"	\$548	\$603	\$659	\$713	\$773	\$827	\$882	\$935

► Specification Information, continued from above

Style Number	Height	U.S. Base Prices				
		72"W	78"W	84"W	90"W	96"W
UFPS	13½"	\$763	\$ 797	\$ 830	\$ 865	\$ 901
	19½"	\$992	\$1047	\$1099	\$1154	\$1206

Aligners



Tip: Aligners are for use with fabric screens only.

Standard Includes	Required to Specify
<p>► Need help? Product details, page 300</p> <ul style="list-style-type: none"> Aligner, package of 10: translucent plastic 	Style number

Specification Information	
Style Number	U.S. Price
UFAL	\$39

 **For Canadian Pricing**
Multiply U.S. Price by the
Canadian price factor.
► See page 1 for details.

Sarto Privacy/Modesty Screens

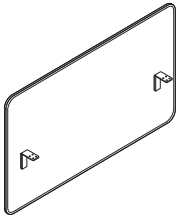

Tip: Sarto privacy/modesty screens can be attached to 3/4"-1 1/2" thick worksurface, including Ology, Migration SE, Elective Elements, universal tables, and universal panel-mount worksurfaces.

Tip: The screens weigh between 3.51 and 11.64 pounds. Take this into consideration when planning for use on height-adjustable worksurfaces. See understanding pages to calculate screen weight.

Tip: Worksurface type option adds a fourth worksurface bracket and repositions brackets to avoid worksurface scallops.

Tip: Side screen option changes standard brackets for smaller L-brackets and only mount flush to the side of the worksurface. Side screen option is only available on screens 36"W and narrower.

Standard Includes		Required to Specify
<ul style="list-style-type: none"> ▶ Need help? Product details, page 296 	<ul style="list-style-type: none"> • Screen: fabric price group 1 • Brackets: 7360 Merle 	<ol style="list-style-type: none"> 1 Style number 2 Size option (see below under Required Selections) 3 Width (see below under Required Selections) 4 Height (see below under Required Selections) 5 Privacy height (see below under Required Selections) 6 Worksurface type (see below under Required Selections) 7 Screen type (see below under Required Selections) 8 Fabric color number for screen 9 Options, if selected (see below) <p>▶ See <i>Surface Materials</i>, page 362.</p>

	Required Selections	U.S. Price	Required to Specify																																										
Size Option	<ul style="list-style-type: none"> • Modular • Parametric 	No cost No cost	Specify <i>with modular</i> . Specify <i>with parametric</i> .																																										
Width	<table border="1"> <thead> <tr> <th>Modular</th> <th>Parametric</th> </tr> </thead> <tbody> <tr><td>• N.A.</td><td>23"W–28¹⁵/₁₆"W</td></tr> <tr><td>• 24"W</td><td>N.A.</td></tr> <tr><td>• 29"W</td><td>29"W</td></tr> <tr><td>• N.A.</td><td>29¹/₁₆"W–36"W</td></tr> <tr><td>• 42"W</td><td>36¹/₁₆"W–42"W</td></tr> <tr><td>• 46"W</td><td>N.A.</td></tr> <tr><td>• 48"W</td><td>42¹/₁₆"W–48"W</td></tr> <tr><td>• 54"W</td><td>48¹/₁₆"W–54"W</td></tr> <tr><td>• 58"W</td><td>N.A.</td></tr> <tr><td>• 60"W</td><td>54¹/₁₆"W–60"W</td></tr> <tr><td>• 66"W</td><td>60¹/₁₆"W–66"W</td></tr> <tr><td>• 70"W</td><td>66¹/₁₆"W–70"W</td></tr> </tbody> </table>	Modular	Parametric	• N.A.	23"W–28 ¹⁵ / ₁₆ "W	• 24"W	N.A.	• 29"W	29"W	• N.A.	29 ¹ / ₁₆ "W–36"W	• 42"W	36 ¹ / ₁₆ "W–42"W	• 46"W	N.A.	• 48"W	42 ¹ / ₁₆ "W–48"W	• 54"W	48 ¹ / ₁₆ "W–54"W	• 58"W	N.A.	• 60"W	54 ¹ / ₁₆ "W–60"W	• 66"W	60 ¹ / ₁₆ "W–66"W	• 70"W	66 ¹ / ₁₆ "W–70"W	Prices at right Prices at right Prices at right Prices at right Prices at right Prices at right Prices at right Prices at right Prices at right Prices at right Prices at right Prices at right	Specify width. Specify width. Specify width. Specify width. Specify width. Specify width. Specify width. Specify width. Specify width. Specify width. Specify width. Specify width.																
Modular	Parametric																																												
• N.A.	23"W–28 ¹⁵ / ₁₆ "W																																												
• 24"W	N.A.																																												
• 29"W	29"W																																												
• N.A.	29 ¹ / ₁₆ "W–36"W																																												
• 42"W	36 ¹ / ₁₆ "W–42"W																																												
• 46"W	N.A.																																												
• 48"W	42 ¹ / ₁₆ "W–48"W																																												
• 54"W	48 ¹ / ₁₆ "W–54"W																																												
• 58"W	N.A.																																												
• 60"W	54 ¹ / ₁₆ "W–60"W																																												
• 66"W	60 ¹ / ₁₆ "W–66"W																																												
• 70"W	66 ¹ / ₁₆ "W–70"W																																												
Height	<table border="1"> <thead> <tr> <th>Modular</th> <th>Parametric</th> </tr> </thead> <tbody> <tr><td>• 24"H</td><td>24"H</td></tr> <tr><td>• 30"H</td><td>24¹/₂"H–30"H</td></tr> </tbody> </table>	Modular	Parametric	• 24"H	24"H	• 30"H	24 ¹ / ₂ "H–30"H	Prices at right Prices at right	Specify height. Specify height.																																				
Modular	Parametric																																												
• 24"H	24"H																																												
• 30"H	24 ¹ / ₂ "H–30"H																																												
Privacy Height	<table border="1"> <thead> <tr> <th>Screen Height</th> <th>Minimum Privacy Height</th> <th>Maximum Privacy Height</th> </tr> </thead> <tbody> <tr><td>• 24"H</td><td>9"H</td><td>16¹/₂"H</td></tr> <tr><td>• 24¹/₂"H</td><td>9¹/₂"H</td><td>17"H</td></tr> <tr><td>• 25"H</td><td>10"H</td><td>17¹/₂"H</td></tr> <tr><td>• 25¹/₂"H</td><td>10¹/₂"H</td><td>18"H</td></tr> <tr><td>• 26"H</td><td>11"H</td><td>18¹/₂"H</td></tr> <tr><td>• 26¹/₂"H</td><td>11¹/₂"H</td><td>19"H</td></tr> <tr><td>• 27"H</td><td>12"H</td><td>19¹/₂"H</td></tr> <tr><td>• 27¹/₂"H</td><td>12¹/₂"H</td><td>20"H</td></tr> <tr><td>• 28"H</td><td>13"H</td><td>20¹/₂"H</td></tr> <tr><td>• 28¹/₂"H</td><td>13¹/₂"H</td><td>21"H</td></tr> <tr><td>• 29"H</td><td>14"H</td><td>21¹/₂"H</td></tr> <tr><td>• 29¹/₂"H</td><td>14¹/₂"H</td><td>22"H</td></tr> <tr><td>• 30"H</td><td>15"H</td><td>22¹/₂"H</td></tr> </tbody> </table>	Screen Height	Minimum Privacy Height	Maximum Privacy Height	• 24"H	9"H	16 ¹ / ₂ "H	• 24 ¹ / ₂ "H	9 ¹ / ₂ "H	17"H	• 25"H	10"H	17 ¹ / ₂ "H	• 25 ¹ / ₂ "H	10 ¹ / ₂ "H	18"H	• 26"H	11"H	18 ¹ / ₂ "H	• 26 ¹ / ₂ "H	11 ¹ / ₂ "H	19"H	• 27"H	12"H	19 ¹ / ₂ "H	• 27 ¹ / ₂ "H	12 ¹ / ₂ "H	20"H	• 28"H	13"H	20 ¹ / ₂ "H	• 28 ¹ / ₂ "H	13 ¹ / ₂ "H	21"H	• 29"H	14"H	21 ¹ / ₂ "H	• 29 ¹ / ₂ "H	14 ¹ / ₂ "H	22"H	• 30"H	15"H	22 ¹ / ₂ "H	No cost No cost No cost No cost No cost No cost No cost No cost No cost No cost No cost No cost	Specify privacy height. Specify privacy height. Specify privacy height. Specify privacy height. Specify privacy height. Specify privacy height. Specify privacy height. Specify privacy height. Specify privacy height. Specify privacy height. Specify privacy height. Specify privacy height.
Screen Height	Minimum Privacy Height	Maximum Privacy Height																																											
• 24"H	9"H	16 ¹ / ₂ "H																																											
• 24 ¹ / ₂ "H	9 ¹ / ₂ "H	17"H																																											
• 25"H	10"H	17 ¹ / ₂ "H																																											
• 25 ¹ / ₂ "H	10 ¹ / ₂ "H	18"H																																											
• 26"H	11"H	18 ¹ / ₂ "H																																											
• 26 ¹ / ₂ "H	11 ¹ / ₂ "H	19"H																																											
• 27"H	12"H	19 ¹ / ₂ "H																																											
• 27 ¹ / ₂ "H	12 ¹ / ₂ "H	20"H																																											
• 28"H	13"H	20 ¹ / ₂ "H																																											
• 28 ¹ / ₂ "H	13 ¹ / ₂ "H	21"H																																											
• 29"H	14"H	21 ¹ / ₂ "H																																											
• 29 ¹ / ₂ "H	14 ¹ / ₂ "H	22"H																																											
• 30"H	15"H	22 ¹ / ₂ "H																																											
Worksurface Type	<ul style="list-style-type: none"> • For screens 60"W or greater • Without scallop • With scallop 	No cost +\$59	Specify <i>without scallop</i> . Specify <i>with scallop</i> .																																										
Screen Type	<ul style="list-style-type: none"> • Rear screen • Side screen 	No cost No cost	Specify <i>with rear screen</i> . Specify <i>with side screen</i> .																																										

Sarto Privacy Screens

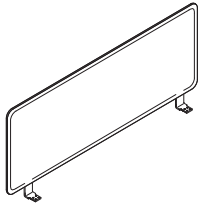

► Need help?
Product details,
page 306

Standard Includes

- Screen: fabric price group 1
- Brackets and hard stops: 7360 Merle

Required to Specify

- 1 Style number
 - 2 Size option (see below under Required Selections)
 - 3 Width (see below under Required Selections)
 - 4 Height (see below under Required Selections)
 - 5 Screen type (see below under Required Selections)
 - 6 Fabric color number for screen
 - 7 Options, if selected (see below)
- See *Surface Materials*, page 362.

	Required Selections	U.S. Price	Required to Specify
Size Options	<ul style="list-style-type: none"> • Modular • Parametric 	No cost No cost	Specify <i>with modular</i> . Specify <i>with parametric</i> .

Width	Modular	Parametric	U.S. Price	Required to Specify
	<ul style="list-style-type: none"> • 24"W • 29"W • 30"W • 36"W • 42"W • 46"W • 48"W • 54"W • 58"W • 60"W • 66"W • 70"W • 72"W • 78"W • 84"W • 90"W • 96"W 	<ul style="list-style-type: none"> 24"W N.A. 24¹/₁₆"W–30"W 30¹/₁₆"W–36"W 36¹/₁₆"W–42"W N.A. 42¹/₁₆"W–48"W 48¹/₁₆"W–54"W N.A. 54¹/₁₆"W–60"W 60¹/₁₆"W–66"W N.A. 66¹/₁₆"W–72"W 72¹/₁₆"W–78"W 78¹/₁₆"W–84"W 84¹/₁₆"W–90"W 90¹/₁₆"W–96"W 		

Height	Modular	Parametric	U.S. Price	Required to Specify
	<ul style="list-style-type: none"> • 13¹/₂"H • 19¹/₂"H • 23¹/₂"H • N.A. • 35¹/₂"H 	<ul style="list-style-type: none"> 13¹/₂"H 14"H–19¹/₂"H 20"H–24"H 24¹/₂"H–30"H 30¹/₂"H–35¹/₂"H 		

Screen Type	Required Selections	U.S. Price	Required to Specify
	<ul style="list-style-type: none"> • Rear screen • Side screen 	No cost No cost	Specify <i>with rear screen</i> . Specify <i>with side screen</i> .

	Options	U.S. Price	Required to Specify
Surface Materials	<ul style="list-style-type: none"> • Fabric price group 2 • Fabric price group 3 • Fabric price group 4 • Fabric price group 5 • Fabric price group 6 • Fabric price group 7 • Fabric price group 8 • Fabric price group 9 • Fabric price group 10 • Customer's Own Material (COM) 	<ul style="list-style-type: none"> +\$ 53 +\$142 +\$178 +\$219 +\$256 +\$296 +\$332 +\$371 +\$408 +\$ 25 	<ul style="list-style-type: none"> Specify fabric color number. Specify fabric color number. Specify fabric color number. Specify fabric color number. Specify fabric color number. Specify fabric color number. Specify fabric color number. Specify fabric color number. Specify fabric color number. Specify fabric color number. <p>► See <i>Surface Materials Reference Manual</i>.</p>

Attachment Brackets	Required Selections	U.S. Price	Required to Specify
	<ul style="list-style-type: none"> • No brackets • Migration side knife attachment bracket 	No cost +\$ 16	Specify <i>with no brackets</i> . Specify <i>with Migration side knife attachment bracket</i> .

Tip: Side screen option changes brackets smaller L-brackets and only mount flush to the side of the work surface. Side screen option is only available on screens 36"W and narrower.

Tip: To install 24"–30"W side screens on the Migration Pro desks (HA2 or HA3) with knife edge, the Migration side knife attachment bracket option must be specified.



For Canadian Pricing

Multiply U.S. Price by the Canadian price factor.

► See page 1 for details.

Specification Information

Style Number	Parametric Height	Modular Width	U.S. Base Prices												
			24"W	30"W	36"W	42"W	48"W	54"W	60"W	66"W	72"W	78"W	84"W	90"W	96"W
		Parametric Width	24"W	24 ¹ / ₁₆ "W	30 ¹ / ₁₆ "W	36 ¹ / ₁₆ "W	42 ¹ / ₁₆ "W	48 ¹ / ₁₆ "W	54 ¹ / ₁₆ "W	60 ¹ / ₁₆ "W	66 ¹ / ₁₆ "W	72 ¹ / ₁₆ "W	78 ¹ / ₁₆ "W	84 ¹ / ₁₆ "W	90 ¹ / ₁₆ "W
			-30"W	-36"W	-42"W	-48"W	-54"W	-60"W	-66"W	-72"W	-78"W	-84"W	-90"W	-96"W	

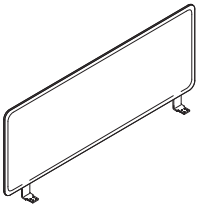

PSPS	Height	24"W	30"W	36"W	42"W	48"W	54"W	60"W	66"W	72"W	78"W	84"W	90"W	96"W
	13 ¹ / ₂ "H	\$348	\$373	\$400	\$424	\$450	\$479	\$504	\$530	\$ 556	\$ 601	\$ 626	\$ 653	\$ 678
	14"-19 ¹ / ₂ "	\$397	\$438	\$479	\$519	\$559	\$599	\$639	\$678	\$ 723	\$ 789	\$ 826	\$ 871	\$ 909
	20"-24"	\$485	\$519	\$554	\$587	\$620	\$656	\$691	\$728	\$ 763	\$ 807	\$ 850	\$ 894	\$ 937
	24 ¹ / ₂ "-30"	\$663	\$697	\$730	\$763	\$798	\$835	\$871	\$907	\$ 940	\$ 987	\$1041	\$1095	\$1159
	30 ¹ / ₂ "-35 ¹ / ₂ "	\$752	\$788	\$820	\$853	\$887	\$922	\$958	\$993	\$1031	\$1074	\$1121	\$1170	\$1219

Screens, Cable and Power Management

 **For Canadian Pricing**
 Multiply U.S. Price by the Canadian price factor.
 ▶ See page 1 for details.

Sarto Alignment Clip

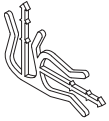

Tip: Alignment clip is for use with Sarto privacy or Sarto privacy/modesty screens.

Tip: Alignment clip is for Sarto screens in perpendicular applications.

Standard Includes	Required to Specify
-------------------	---------------------

- | | | |
|--|--|--|
| <ul style="list-style-type: none"> ▶ Need help? Product details, page 306 | <ul style="list-style-type: none"> • Alignment clip: 7360 Merle | <ul style="list-style-type: none"> Style number |
|--|--|--|

Specification Information	
---------------------------	--

• Style Number	• U.S. Price
----------------	--------------

PSCB	\$7
-------------	-----



For Canadian Pricing

Multiply U.S. Price by the Canadian price factor.

▶ See page 1 for details.

Sarto Curved Screens

L-Screen

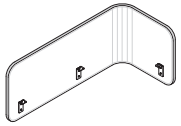

Tip: Sarto screens can be attached to 3/4" – 1 1/2" thick worksurfaces, including Ology, Migration SE, Elective Elements, Universal tables, and Universal panel-mount worksurfaces.

Tip: Screens weigh between 5.7 and 9 pounds. Take this into consideration when planning for use on height-adjustable worksurfaces.

Tip: Fabric is applied horizontally on the screen.

Tip: All Sarto curved screens have a 20" side leg depth.

Tip: Width refers to the distance from the corner of the worksurface to the edge of the screen when the screen is applied to the back of a worksurface.

Tip: Sarto curved screens sit flush against the work-surface. If 1" cord drop is needed, please reach out to Specials for alternative bracket.

Standard Includes		Required to Specify
<ul style="list-style-type: none"> ▶ Need help? Product details, page 308 	<ul style="list-style-type: none"> • Desk screen: fabric price group 1 • Brackets: 7360 Merle 	<ol style="list-style-type: none"> 1 Style number 2 Size option (see below under Required Selections) 3 Width (see below under Required Selections) 4 Height (see below under Required Selections) 5 Handedness (see below under Required Selections) 6 Privacy height (see below under Required Selections) 7 Fabric color number for screen 8 Options, if selected (see below) <p>▶ See <i>Surface Materials</i>, page 362.</p>

Size Options	Required Selections	U.S. Price	Required to Specify																																										
	<ul style="list-style-type: none"> • Modular • Parametric 	No cost No cost	Specify with <i>modular</i> . Specify with <i>parametric</i> .																																										
Width	<table border="1"> <thead> <tr> <th>Modular</th> <th>Parametric</th> </tr> </thead> <tbody> <tr> <td>• 23"W</td> <td>23"W</td> </tr> <tr> <td>• 29"W</td> <td>23 1/16"W–29"W</td> </tr> <tr> <td>• 35"W</td> <td>29 1/16"W–35"W</td> </tr> <tr> <td>• 41"W</td> <td>35 1/16"W–41"W</td> </tr> <tr> <td>• 46"W</td> <td>41 1/16"W–46"W</td> </tr> </tbody> </table>	Modular	Parametric	• 23"W	23"W	• 29"W	23 1/16"W–29"W	• 35"W	29 1/16"W–35"W	• 41"W	35 1/16"W–41"W	• 46"W	41 1/16"W–46"W	Prices at right Prices at right Prices at right Prices at right Prices at right	Specify width. Specify width. Specify width. Specify width. Specify width.																														
Modular	Parametric																																												
• 23"W	23"W																																												
• 29"W	23 1/16"W–29"W																																												
• 35"W	29 1/16"W–35"W																																												
• 41"W	35 1/16"W–41"W																																												
• 46"W	41 1/16"W–46"W																																												
Height	<table border="1"> <thead> <tr> <th>Modular</th> <th>Parametric</th> </tr> </thead> <tbody> <tr> <td>• 17.909"H</td> <td></td> </tr> <tr> <td>• 18"H</td> <td>18"H</td> </tr> <tr> <td>• 24"H</td> <td>18 1/2"H–24"H</td> </tr> </tbody> </table>	Modular	Parametric	• 17.909"H		• 18"H	18"H	• 24"H	18 1/2"H–24"H	No cost Prices at right Prices at right	Specify height. Specify height. Specify height.																																		
Modular	Parametric																																												
• 17.909"H																																													
• 18"H	18"H																																												
• 24"H	18 1/2"H–24"H																																												
Handedness	<ul style="list-style-type: none"> • Left-hand application • Right-hand application 	No cost No cost	Specify with <i>left-hand application</i> . Specify with <i>right-hand application</i> .																																										
Privacy Height	<table border="1"> <thead> <tr> <th>Screen Height</th> <th>Minimum Privacy Height</th> <th>Maximum Privacy Height</th> </tr> </thead> <tbody> <tr><td>• 18"H</td><td>7"H</td><td>10 1/2"H</td></tr> <tr><td>• 18 1/2"H</td><td>7"H</td><td>11"H</td></tr> <tr><td>• 19"H</td><td>7"H</td><td>11 1/2"H</td></tr> <tr><td>• 19 1/2"H</td><td>7"H</td><td>12"H</td></tr> <tr><td>• 20"H</td><td>7"H</td><td>12 1/2"H</td></tr> <tr><td>• 20 1/2"H</td><td>7"H</td><td>13"H</td></tr> <tr><td>• 21"H</td><td>7"H</td><td>13 1/2"H</td></tr> <tr><td>• 21 1/2"H</td><td>7"H</td><td>14"H</td></tr> <tr><td>• 22"H</td><td>7"H</td><td>14 1/2"H</td></tr> <tr><td>• 22 1/2"H</td><td>7 1/2"H</td><td>15"H</td></tr> <tr><td>• 23"H</td><td>8"H</td><td>15 1/2"H</td></tr> <tr><td>• 23 1/2"H</td><td>8 1/2"H</td><td>16"H</td></tr> <tr><td>• 24"H</td><td>9"H</td><td>16 1/2"H</td></tr> </tbody> </table>	Screen Height	Minimum Privacy Height	Maximum Privacy Height	• 18"H	7"H	10 1/2"H	• 18 1/2"H	7"H	11"H	• 19"H	7"H	11 1/2"H	• 19 1/2"H	7"H	12"H	• 20"H	7"H	12 1/2"H	• 20 1/2"H	7"H	13"H	• 21"H	7"H	13 1/2"H	• 21 1/2"H	7"H	14"H	• 22"H	7"H	14 1/2"H	• 22 1/2"H	7 1/2"H	15"H	• 23"H	8"H	15 1/2"H	• 23 1/2"H	8 1/2"H	16"H	• 24"H	9"H	16 1/2"H	No cost No cost No cost No cost No cost No cost No cost No cost No cost No cost No cost No cost	Specify privacy height. Specify privacy height. Specify privacy height. Specify privacy height. Specify privacy height. Specify privacy height. Specify privacy height. Specify privacy height. Specify privacy height. Specify privacy height. Specify privacy height. Specify privacy height.
Screen Height	Minimum Privacy Height	Maximum Privacy Height																																											
• 18"H	7"H	10 1/2"H																																											
• 18 1/2"H	7"H	11"H																																											
• 19"H	7"H	11 1/2"H																																											
• 19 1/2"H	7"H	12"H																																											
• 20"H	7"H	12 1/2"H																																											
• 20 1/2"H	7"H	13"H																																											
• 21"H	7"H	13 1/2"H																																											
• 21 1/2"H	7"H	14"H																																											
• 22"H	7"H	14 1/2"H																																											
• 22 1/2"H	7 1/2"H	15"H																																											
• 23"H	8"H	15 1/2"H																																											
• 23 1/2"H	8 1/2"H	16"H																																											
• 24"H	9"H	16 1/2"H																																											

Options	U.S. Price	Required to Specify
Surface Materials	<ul style="list-style-type: none"> • Fabric price group 2 +\$ 53 • Fabric price group 3 +\$142 • Fabric price group 4 +\$179 • Fabric price group 5 +\$220 • Fabric price group 6 +\$256 • Fabric price group 7 +\$296 • Fabric price group 8 +\$333 • Fabric price group 9 +\$372 • Fabric price group 10 +\$408 • Customer's Own Material (COM) +\$ 25 	Specify fabric color number. Specify fabric color number. Specify fabric color number. Specify fabric color number. Specify fabric color number. Specify fabric color number. Specify fabric color number. Specify fabric color number. Specify fabric color number. Specify fabric color number. ▶ See <i>Surface Materials Reference Manual</i> .



For Canadian Pricing
Multiply U.S. Price by the Canadian price factor.
▶ See page 1 for details.

Specification Information

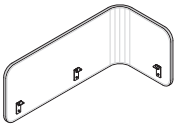

Style Number	Parametric Height	Modular Width Parametric Width	U.S. Base Prices				
			23"W	29"W	35"W	41"W	46"W
PLSCRN	18"H		\$629	\$696	\$761	\$824	\$890
	18½"-24"		\$650	\$717	\$782	\$845	\$911

Screens, Cable and Power Management

 **For Canadian Pricing**
 Multiply U.S. Price by the Canadian price factor.
 ▶ See page 1 for details.

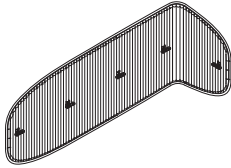

Tip: Soffio screens can be attached to 3/4" – 1 1/2" thick worksurfaces, including Ology, Migration SE, Elective Elements, Universal tables, and Universal panel-mount worksurfaces.

Tip: Screens weigh between 2.9 and 4.2 pounds. Take this into consideration when planning for use on height-adjustable worksurfaces.

Tip: Fabric is applied horizontally on the screen.

Standard Includes		Required to Specify
<ul style="list-style-type: none"> ▶ Need help? Product details, page 312 	<ul style="list-style-type: none"> • 26"H curved desk screen: fabric price group 3 • Brackets: 6527 Merle 	<ol style="list-style-type: none"> 1 Style number 2 Desk width (see below under Required Selections) 3 Fabric color number for screen <ul style="list-style-type: none"> ▶ See <i>Surface Materials</i>, page 362.

Required Selections	U.S. Price	Required to Specify
Width		
• 56"W	Price below	Specify with 56"W.
• 68"W	Price below	Specify with 68"W.
• 80"W	Price below	Specify with 80"W.

Options	U.S. Price	Required to Specify
Surface Materials		
• Fabric price group 3	No cost	Specify fabric color number.
• Fabric price group 4	+\$263	Specify fabric color number.

Specification Information			
Style Number	U.S. Base Prices		
	Desk Width		
	56"W	68"W	80"W
SSCRN	\$1154	\$1233	\$1308

Screens, Cable and Power Management

 **For Canadian Pricing**
 Multiply U.S. Price by the Canadian price factor.
 ▶ See page 1 for details.

Fixed Personal/Modesty Screens

Tip: Fixed personal/modesty screens are for use with Ology integrated rail and SOTO rail.

Tip: When using COM fabric, it is recommended that non-patterned fabric be used to provide a consistent visual between adjacent screens, and from one side to the other.

Tip: 19½"H and 24"H are for personal only.

Tip: 19½"H and 24"H screens are not intended for use in the modesty position when used with a height-adjustable desk.

Tip: For Ology desks 52"W and smaller, when using fixed screens in the modesty position, the screen must be sized 10" smaller than the width of the desk.

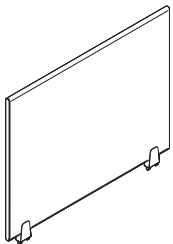
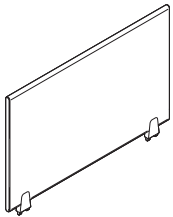
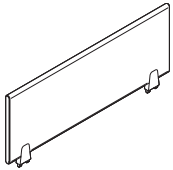

Standard Includes	Required to Specify
<ul style="list-style-type: none"> Need help? Product details, page 313 Personal/modesty screens: fabric price group 1 Brackets: 4799 Platinum 	<ol style="list-style-type: none"> Style number Fabric color number for screen Options, if selected (see below) <p>▶ See <i>Surface Materials</i>, page 362.</p>

Surface Materials	Options	U.S. Price			Required to Specify
		12"H	19½"H	24"H	
<ul style="list-style-type: none"> Fabric price group 1 Fabric price group 2 Fabric price group 3 Fabric price group 4 Customer's Own Material (COM) 	No cost	No cost	No cost	Specify fabric color number. Specify fabric color number. Specify fabric color number. Specify fabric color number. ▶ See <i>Surface Materials Reference Manual</i> .	
	+\$ 39	+\$ 53	+\$ 63		
	+\$104	+\$142	+\$178		
	+\$135	+\$178	+\$220		
	+\$ 25	+\$ 25	+\$ 25		

Specification Information			
Width	Weight	Style Number	U.S. Base Price

12"H Screens

30"	3.4 lb	CQSF3012	\$282
36"	3.9 lb	CQSF3612	\$331
42"	4.3 lb	CQSF4212	\$370
48"	4.7 lb	CQSF4812	\$419
:	:	:	:

19½"H Screens

30"	4.2 lb	CQSF3019	\$435
36"	4.7 lb	CQSF3619	\$483
42"	5.5 lb	CQSF4219	\$530
48"	6.5 lb	CQSF4819	\$571
:	:	:	:

24"H Screens

30"	4.9 lb	CQSF3024	\$584
36"	5.5 lb	CQSF3624	\$635
42"	6.1 lb	CQSF4224	\$680
48"	7.4 lb	CQSF4824	\$725
:	:	:	:



For Canadian Pricing
 Multiply U.S. Price by the Canadian price factor.
 ▶ See page 1 for details.

Worksurface Fabric Side Screens

For Use on Desking, Benching, and Table Worksurfaces with Varying Thickness

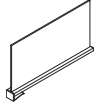

Tip: The worksurface side screen is intended to clamp to the front of a worksurface.

Tip: The worksurface side screen does not work on knife edge profiles.

Tip: Fabric is applied horizontally on the screen.

Standard Includes		Required to Specify
<ul style="list-style-type: none"> ▶ Need help? Product details, page 314 	<ul style="list-style-type: none"> • Screen: fabric price group 1 • Bracket with integrated worksurface clamp: paint price group 1 	<ol style="list-style-type: none"> 1 Style number 2 Height (see below under Required Selections) 3 Width (see below under Required Selections) 4 Options, if selected (see below) <ul style="list-style-type: none"> ▶ See <i>Surface Materials</i>, page 362.

	Required Selections	U.S. Price	Required to Specify
Height	<ul style="list-style-type: none"> • 12"H • 19½"H 	<ul style="list-style-type: none"> Prices below Prices below 	<ul style="list-style-type: none"> Specify with 12"H. Specify with 19½"H.
Width	<p>FrameOne, Ology, Migration SE, and Flex</p> <ul style="list-style-type: none"> • 22"W • 28"W <p>Elective Elements and Universal</p> <ul style="list-style-type: none"> • 24"W • 30"W <p>Universal with Cord Drop</p> <ul style="list-style-type: none"> • 23½"W • 29½"W 	<ul style="list-style-type: none"> Prices below Prices below Prices below Prices below Prices below Prices below 	<ul style="list-style-type: none"> Specify with 22"W. Specify with 28"W. Specify with 24"W. Specify with 30"W. Specify with 23½"W. Specify with 29½"W.

	Options	U.S. Price	Required to Specify
Bracket Finish	<ul style="list-style-type: none"> • Paint price group 1 • Paint price group 2 	<ul style="list-style-type: none"> No cost +\$ 17 	<ul style="list-style-type: none"> Specify paint color number. Specify paint color number.
Surface Materials	<ul style="list-style-type: none"> • Fabric price group 1 • Fabric price group 2 • Fabric price group 3 • Fabric price group 4 • Fabric price group 5 • Fabric price group 6 • Fabric price group 7 • Fabric price group 8 • Fabric price group 9 • Fabric price group 10 • Customer's Own Material (COM) 	<ul style="list-style-type: none"> No cost +\$ 41 +\$116 +\$145 +\$177 +\$207 +\$238 +\$270 +\$300 +\$330 +\$ 25 	<ul style="list-style-type: none"> Specify fabric color number. Specify fabric color number. Specify fabric color number. Specify fabric color number. Specify fabric color number. Specify fabric color number. Specify fabric color number. Specify fabric color number. Specify fabric color number. Specify fabric color number. ▶ See <i>Surface Materials Reference Manual</i>.

Specification Information			
Style Number	Dimensions		U.S. Base Prices
	H	W	
·	·	·	·
·	·	·	·

Fabric Side Screen for Use with FrameOne (0.808") Worksurface Thickness

WKSSFF	12"	22"	\$1081
	12"	28"	\$1165
	19½"	22"	\$1185
	19½"	28"	\$1269
·	·	·	·
·	·	·	·

▶ Specification Information, continued on next page



For Canadian Pricing

Multiply U.S. Price by the Canadian price factor.

▶ See page 1 for details.

► **Specification Information, continued from previous page**

Specification Information

• Style • Number	• Dimensions		• U.S. Base • Prices
	• H	• W	

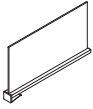

Fabric Side Screen for Use with Ology, Migration SE, and Flex (1") Worksurface Thicknesses

WKSSFHA	12"	22"	\$1081
	12"	28"	\$1165
	19 1/2"	22"	\$1185
	19 1/2"	28"	\$1269

Fabric Side Screen for Use with Universal (1.185") Worksurface Thickness

WKSSFU	12"	24"	\$1095
	12"	30"	\$1179
	19 1/2"	24"	\$1199
	19 1/2"	30"	\$1283

For Use with Cord Drop Worksurfaces

	12"	23 1/2"	\$1095
	12"	29 1/2"	\$1179
	19 1/2"	23 1/2"	\$1199
	19 1/2"	29 1/2"	\$1283

Fabric Side Screen for Use with Elective Elements (1.5") Worksurface Thickness

WKSSF E	12"	24"	\$1095
	12"	30"	\$1179
	19 1/2"	24"	\$1199
	19 1/2"	30"	\$1283



For Canadian Pricing

Multiply U.S. Price by the
Canadian price factor.

► See page 1 for details.

Worksurface Glass Side Screens

For Use on Desking, Benching, and Table Worksurfaces with Varying Thickness

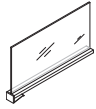

Tip: The worksurface side screen is intended to clamp to the front of a worksurface.

Tip: The worksurface side screen does not work on knife edge profiles.

Standard Includes		Required to Specify
<ul style="list-style-type: none"> ▶ Need help? Product details, page 314 	<ul style="list-style-type: none"> • Screen: 6500 Clear Glass • Bracket with integrated worksurface clamp: paint price group 1 	<ol style="list-style-type: none"> 1 Style number 2 Height (see below under Required Selections) 3 Width (see below under Required Selections) 4 Options, if selected (see below) <ul style="list-style-type: none"> ▶ See <i>Surface Materials</i>, page 362.

	Required Selections	U.S. Price	Required to Specify
Height	<ul style="list-style-type: none"> • 12"H • 19½"H 	<ul style="list-style-type: none"> Prices below Prices below 	<ul style="list-style-type: none"> Specify with 12"H. Specify with 19½"H.
Width	<p>FrameOne, Ology, Migration SE, and Flex</p> <ul style="list-style-type: none"> • 22"W • 28"W <p>Elective Elements and Universal</p> <ul style="list-style-type: none"> • 24"W • 30"W <p>Universal with Cord Drop</p> <ul style="list-style-type: none"> • 23½"W • 29½"W 	<ul style="list-style-type: none"> Prices below Prices below <p>Elective Elements and Universal</p> <ul style="list-style-type: none"> Prices below Prices below <p>Universal with Cord Drop</p> <ul style="list-style-type: none"> Prices below Prices below 	<ul style="list-style-type: none"> Specify with 22"W. Specify with 28"W. <p>Elective Elements and Universal</p> <ul style="list-style-type: none"> Specify with 24"W. Specify with 30"W. <p>Universal with Cord Drop</p> <ul style="list-style-type: none"> Specify with 23½"W. Specify with 29½"W.

	Options	U.S. Price	Required to Specify
Bracket Finish	<ul style="list-style-type: none"> • Paint price group 1 • Paint price group 2 	<ul style="list-style-type: none"> No cost +\$ 17 	<ul style="list-style-type: none"> Specify paint color number. Specify paint color number.
Surface Materials	<ul style="list-style-type: none"> • 6500 Clear Glass • 6530 Frosted Glass 	<ul style="list-style-type: none"> No cost +\$187 	<ul style="list-style-type: none"> Specify with 6500 Clear Glass. Specify with 6530 Frosted Glass.

Specification Information			
Style Number	Dimensions		U.S. Base Prices
	H	W	
.....

Glass Side Screen for Use with FrameOne (0.808") Worksurface Thickness

WKSSGF	12"	22"	\$742
	12"	28"	\$826
	19½"	22"	\$883
	19½"	28"	\$967
.....

Glass Side Screen for Use with Ology, Migration SE, and Flex (1") Worksurface Thicknesses

WKSSGHA	12"	22"	\$742
	12"	28"	\$826
	19½"	22"	\$883
	19½"	28"	\$967
.....

▶ Specification Information, continued on next page



For Canadian Pricing
Multiply U.S. Price by the Canadian price factor.
▶ See page 1 for details.

► **Specification Information, continued from previous page**

Specification Information

• Style • Number	• Dimensions		• U.S. Base • Prices
	• H	• W	

Glass Side Screen for Use with Universal (1.185") Worksurface Thickness

WKSSGU	12"	24"	\$771
	12"	30"	\$855
	19 1/2"	24"	\$912
	19 1/2"	30"	\$996

For use with Cord Drop Worksurfaces

	12"	23 1/2"	\$771
	12"	29 1/2"	\$855
	19 1/2"	23 1/2"	\$912
	19 1/2"	29 1/2"	\$996

Glass Side Screen for Use with Elective Elements (1.5") Worksurface Thickness

WKSSGE	12"	24"	\$771
	12"	30"	\$855
	19 1/2"	24"	\$912
	19 1/2"	30"	\$996

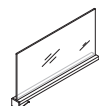

For Canadian Pricing

Multiply U.S. Price by the
Canadian price factor.

► See page 1 for details.

Acrylic Screens

Tip: Screen may need to be shorter than worksurface width. To determine screen and height-adjustable worksurface compatibility, see Worktools Compatibility Charts, page 48.

Tip: 58"W and 64"W screens are not recommended for use with 22¼"D rectangular worksurfaces.



Tip: 58"W and 64"W screens ship with three Universal clamps. All other screen widths ship with two Universal clamps.

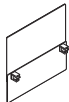

 **For Canadian Pricing**
Multiply U.S. Price by the Canadian price factor.
▶ See page 1 for details.

Standard Includes		Required to Specify
▶ Need help? Product details, page 316	<ul style="list-style-type: none"> • Screen: 6544 Frost only • Universal clamps: paint 	1 Style number 2 Paint color number for Universal clamp: 0835 Black 4799 Platinum

Specification Information			
• Screen Width	• Weight	• Style Number	• U.S. Price

Privacy Screens Only

22"	5.67 lb	AP22	\$ 543
28"	5.77 lb	AP28	\$ 569
34"	6.17 lb	AP34	\$ 601
40"	6.57 lb	AP40	\$ 629
46"	6.77 lb	AP46	\$ 663
52"	6.97 lb	AP52	\$ 693
58"	7.27 lb	AP58	\$ 775
64"	7.77 lb	AP64	\$ 803

Modesty Screens Only

22"	4.27 lb	AM22	\$ 495
28"	4.57 lb	AM28	\$ 528
34"	4.87 lb	AM34	\$ 556
40"	5.17 lb	AM40	\$ 583
46"	5.52 lb	AM46	\$ 616
52"	5.77 lb	AM52	\$ 646
58"	5.97 lb	AM58	\$ 726
64"	6.27 lb	AM64	\$ 749

Modesty and Privacy Screens

22"	8.07 lb	AMP22	\$ 884
28"	8.57 lb	AMP28	\$ 946
34"	9.27 lb	AMP34	\$1002
40"	9.97 lb	AMP40	\$1064
46"	10.52 lb	AMP46	\$1128
52"	10.97 lb	AMP52	\$1189
58"	11.47 lb	AMP58	\$1296
64"	12.27 lb	AMP64	\$1355

Vertical Cable Carrier



Tip: Vertical cable carrier is recommended for use with height-adjustable worksurfaces.

Tip: Vertical cable carrier affixes under the worksurface and has a weighted base to hold it in place.

Standard Includes		Required to Specify
<ul style="list-style-type: none"> ▶ Need help? Product details, page 318 	<ul style="list-style-type: none"> • Cable carrier: 6688 Steel • Attachment hardware 	Style number

Specification Information			
Dimensions		Style Number	U.S. Price
W	H		
2 1/2"	52"	AHCC	\$251

Screens, Cable and Power Management

6"D Wire Managers

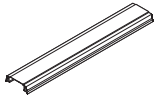

Tip: Wire manager attaches to a clip that is affixed to the underside of a worksurface.

Standard Includes		Required to Specify
<ul style="list-style-type: none"> ▶ Need help? Product details, page 318 	<ul style="list-style-type: none"> • Wire manager: 6000 Black or 6249 Platinum • Attachment hardware 	Style number

Specification Information					
Dimensions			Weight	Style Number	U.S. Price
D	W	H			
6"	30"	2"	0.13 lb	AWMXL30	\$110
6"	36"	2"	0.24 lb	AWMXL36	\$126
6"	42"	2"	0.34 lb	AWMXL42	\$143
6"	48"	2"	0.44 lb	AWMXL48	\$156
6"	54"	2"	0.56 lb	AWMXL54	\$175
6"	60"	2"	0.65 lb	AWMXL60	\$194



For Canadian Pricing
 Multiply U.S. Price by the Canadian price factor.
 ▶ See page 1 for details.

1 3/4"D Wire Managers

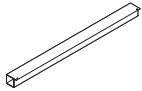

Standard Includes		Required to Specify
<ul style="list-style-type: none"> ▶ Need help? Product details, page 318 	<ul style="list-style-type: none"> • Wire manager: 6000 Black • Attachment hardware 	Style number

Specification Information					
Dimensions			Weight	Style Number	U.S. Price
D	W	H			
1 1/4"	6"	1 3/4"	0.13 lb	AWM06	\$ 38
1 1/4"	12"	1 3/4"	0.24 lb	AWM12	\$ 50
1 1/4"	18"	1 3/4"	0.34 lb	AWM18	\$ 57
1 1/4"	23"	1 3/4"	0.44 lb	AWM23	\$ 65
1 1/4"	30"	1 3/4"	0.56 lb	AWM30	\$ 76
1 1/4"	35"	1 3/4"	0.65 lb	AWM35	\$ 83
1 1/4"	42"	1 3/4"	0.77 lb	AWM42	\$ 92
1 1/4"	48"	1 3/4"	0.88 lb	AWM48	\$104

Tip: Actual width of AWM23 is 23 1/4".

Soft Cable Drop For Height-Adjustable Desk

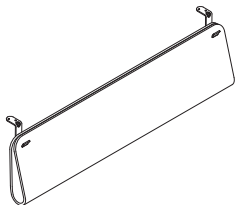

Standard Includes		Required to Specify
<ul style="list-style-type: none"> ▶ Need help? Product details, page 318 	<ul style="list-style-type: none"> • Cable management for Height-Adjustable Desks and bases: <ul style="list-style-type: none"> — Soft PET in P631 Dark Heather Grey • Attachment hardware 	Style number

Specification Information			
Dimensions		Style Number	U.S. Price
W	H		
36"	11"	TS8HADCBLD	\$331

Tip: This cable drop can be added to worksurfaces with a thickness of 1" or more (Examples are Migration SE and Ology).

Tip: In the ordering process, this should be added to your pick list in SmartTools as it will not automatically snap on non-Bivi product.



For Canadian Pricing
Multiply U.S. Price by the Canadian price factor.
▶ See page 1 for details.

Utility Hook For Height-Adjustable Desk



Tip: Weight limit is 20 pounds.

Tip: In the ordering process, this should be added to your pick list in SmartTools as it will not automatically snap on non-Bivi product.

Standard Includes	Required to Specify
<ul style="list-style-type: none"> Need help? Product details, page 318 Utility hook: steel painted black 	Style number

Specification Information				
Dimensions			Style	U.S.
D	W	H	Number	Price
3"	1"	3 1/4"	TS8HADUHK	\$22

 **For Canadian Pricing**
 Multiply U.S. Price by the Canadian price factor.
 ▶ See page 1 for details.

Powerstrip Intro

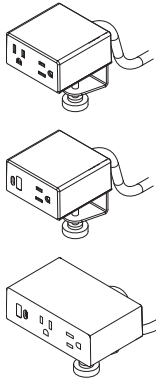

Tip: C-clamp is designed to accommodate worksurfaces up to 1 1/2" thick.

Tip: Overcurrent protection includes a 15 amp circuit breaker.

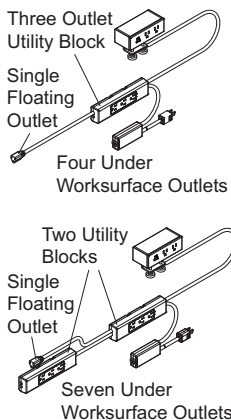

 **For Canadian Pricing**
 Multiply U.S. Price by the Canadian price factor.
 ▶ See page 1 for details.

Standard Includes	Required to Specify
<ul style="list-style-type: none"> ▶ Need help? Product details, page 319 • Powerstrip intro: plastic • Straight 3-prong plug • C-clamp mount 	<ol style="list-style-type: none"> 1 Style number 2 Desktop power configuration (see below under Required Selections) 3 Plastic color number for housing: 6009 Arctic White 6527 Merle 4 Options, (if selected) see below

Required Selections	U.S. Price	Required to Specify
Desktop Power Configuration <ul style="list-style-type: none"> • Two power outlets • One power outlet with one A+C 20W • Two power outlets with one USB A+C 20W 	No cost +\$ 43 +\$132	Specify with two power outlets. Specify with one power outlet with one A+C 20W. Specify with two power outlets with one USB A+C 20W.

Options	U.S. Price	Required to Specify
Power Plug Type <ul style="list-style-type: none"> • Standard NEMA 3-prong • 90° NEMA with overcurrent protection (OCP, used when desktop power only is specified, no utility power) • 90° NEMA (No OCP, used when utility power option is specified) 	No cost +\$ 56 +\$ 39	Specify with standard NEMA plug. Specify with 90° NEMA plug with overcurrent protection (OCP). Specify with 90° NEMA (no OCP).
Under Worksurface Utility Power Configuration <ul style="list-style-type: none"> • Four outlets total—one utility block, with three outlets each, and one floating female outlet • Seven outlets total—two utility blocks, with three outlets each, and one floating female outlet 	+\$139 +\$277	Specify with one utility and one female plug. Specify with two utility and one female plug.

Power Cord Lengths Without Under Worksurface Utility Power <ul style="list-style-type: none"> • 9' standard • 163" curly cord 	No cost +\$314	Specify with 9' standard cord. Specify with 163" curly cord.
--	-------------------	---

Power Cord Lengths With Under Worksurface Utility Power <ul style="list-style-type: none"> • 6' standard • 8' standard • 163" curly cord 	No cost +\$ 22 +\$314	Specify with 6' standard cord. Specify with 8' standard cord. Specify with 163" curly cord.
--	-----------------------------	---

Specification Information

Dimensions			Style	U.S. Base
D	W	H	Number	Price
3"	3"	3 1/8"	DSPINTRO	\$222

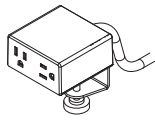

 **For Canadian Pricing**
 Multiply U.S. Price by the Canadian price factor.
 ▶ See page 1 for details.

Powerstrip Plus

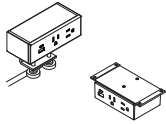

Standard Includes	Required to Specify
<ul style="list-style-type: none"> ▶ Need help? Product details, page 323 • Powerstrip plus: plastic price group 1 and group 2 • 8' standard power cord: black or white • C-clamp mount • Cord managers 	<ol style="list-style-type: none"> 1 Style number 2 Desktop power mount (see below under Required Selections) 3 Desktop power configuration (see below under Required Selections) 4 Plastic color number for powerstrip 5 Plastic color number for power cord 6 Options, (if selected) see below <ul style="list-style-type: none"> ▶ Surface Materials, see page 362.

Tip: C-clamp is designed to accommodate worksurfaces between 1/2" and 1 3/8" thick.

Tip: Desktop power cord exit extends 1/2" off of the back of the worksurface when C-clamped.

Tip: 20-watt USB-C provides wattage to charge cell phones and tablets. 100-watt USB-C is needed to charge larger devices like compact laptops.

Tip: Cord length between desktop power and under-worksurface power is 48" and length between under-worksurface blocks is 24".

Tip: Power cord 8' curly cannot be specified with power plug type thread low profile.

Tip: Cord clip screw length for minimum worksurface thickness of 3/4".

Tip: Flush mount requires top surface to be field cut. See assembly directions for details.

Tip: Flush mount faceplate mounts flat just above worksurface.

Tip: For USB-C 100W port, use USB-C charging cable rated for 100W use for full charging benefits. Charging cables not included.

Tip: For Bivi with a 1/2" thick top surface, a shorter screw length is needed.

Required Selections	U.S. Price	Required to Specify
Desktop Power Mount <ul style="list-style-type: none"> • C-clamp • Front edge under mount • Rail mount 	No cost +\$ 22 +\$ 35	Specify with C-clamp power mount. Specify with front-edge under mount. Specify with rail power mount.
Desktop Power Configuration <ul style="list-style-type: none"> • Three power outlets • Two power outlets with USB A+C 20-watt • Two power outlets with USB A+C 20W and open data port • Three power outlets with USB A+C 20W • Three power with dual USB A+C 20-watt and open data port • Two power outlets with dual 45W USB-C • Three power with two dual USB A+C 20-watt • Two power with USB A+C 20W • Two power outlets with 100-watt USB-C • One power outlet with USB A+C 20W and 100-watt USB-C • Two power outlets with USB A+C 20W and 100-watt USB-C • Two power outlets with dual 10-watt USB-A, 100-watt USB-C, and open data port 	No cost +\$ 69 +\$104 +\$104 +\$139 +\$161 +\$277 +\$347 +\$347 +\$484 +\$555 +\$622	Specify with three power outlets. Specify with two power outlets with USB A+C 20-watt. Specify with two power outlets with USB A+C 20W and open data port. Specify with three power outlets with USB A+C 20W. Specify with three power with dual USB A+C 20-watt and open data port. Specify with two power outlets with dual 45-watt USB-C. Specify with three power with two dual USB A+C 20-watt. Specify with two power with USB A+C 20W. Specify with two power outlets with 100-watt USB-C. Specify with one power outlet with USB A+C 20W and 100-watt USB-C. Specify with two power outlets with USB A+C 20W and 100-watt USB-C. Specify with two power outlets with USB A+C 20W, 100-watt USB-C, and open data port.
Flush Mount Only <ul style="list-style-type: none"> • Two power outlets and open data port • One power outlet with 100-watt USB-C 	No cost +\$269	Specify with two power outlets and open data port. Specify with one power outlet with 100-watt USB-C.

Options	U.S. Price	Required to Specify
Surface Materials <ul style="list-style-type: none"> • Plastic price groups 1 and 2 	No cost	Specify plastic color number.
Under Worksurface (Utility) Power Configuration <ul style="list-style-type: none"> • No under worksurface power • No under worksurface with overcurrent protection • Four outlets total—one utility block, with three outlets each, and one floating female outlet • Seven outlets total—two utility blocks, with three outlets each, and one floating female outlet • Nine outlets total—three utility blocks, with three outlets each 	No cost +\$ 56 +\$139 +\$277 +\$417	Specify with no utility. Specify with no utility and with overcurrent protection. Specify with one utility and one female plug. Specify with two utility and one female plug. Specify with three utility.

▶ Options, continued on next page

► Options, continued from previous page

	Options	U.S. Price	Required to Specify
Power Cord	• 6' standard cord	-\$ 22	Specify with 6' standard cord.
	• 8' standard cord	No cost	Specify with 8' standard cord.
	• 10' standard cord	No cost	Specify with 10' standard cord.
	• 6' braided cord	+\$ 74	Specify with 6' braided cord.
	• 8' braided cord	+\$222	Specify with 8' braided cord.
	• 10' braided cord	+\$222	Specify with 10' braided cord.
	• 8' curly cord	+\$277	Specify with 8' curly cord.
Power Cord Color	Standard and curly cord		
	• Black	No cost	Specify with black cord.
	• White	No cost	Specify with white cord.
	Braided cord		
	• Black	No cost	Specify with black braided cord.
	• Seagull	No cost	Specify with seagull braided cord.
Power Plug Type	• Standard NEMA 3-prong	No cost	Specify with standard NEMA plug.
	• 90° NEMA	+\$ 39	Specify with 90° NEMA plug.
	• Thread low profile	+\$ 43	Specify with Thread low profile plug.

Tip: Underworksurface power blocks do not ship with independent mounting hardware. They are designed to mount into the Universal cable management kit without additional hardware. Kit sold separately.

Tip: Overcurrent protection includes a 15 amp circuit breaker.

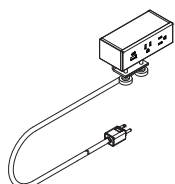

Without overcurrent protection

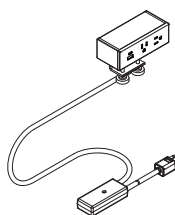

With overcurrent protection

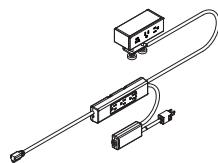

with optional under worksurface utility power with 4 outlets

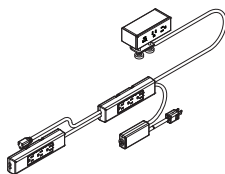

with optional under worksurface utility power with 7 outlets

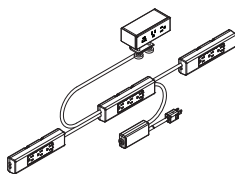

with optional under worksurface utility power with 9 outlets

Specification Information

Style Number	U.S. Base Price
DSPower	\$431

Tip: Configurations with outlets under the worksurface are standard with overcurrent protection.

Tip: Check with your local fire inspector and other authorities with jurisdiction, to understand if overcurrent protection is required for your municipality on units without under worksurface outlets.

Tip: Height adjustable desks can be plugged into powerstrip plus for a 'one cord down' solution.

Tip: When using powerstrip plus with nine outlets under worksurface utility power, specify one large and one small universal cable management kit.

Tip: Do not use a vertical cable manager with a curly cord or braided cord.

Tip: Curly power cord cannot be used with power plug type thread.

Tip: Specify 163" curly cord and 90° NEMA plug together and add additional cord management near the plug for a more secure power connection during desk movement.

Under Worksurface Utility Power

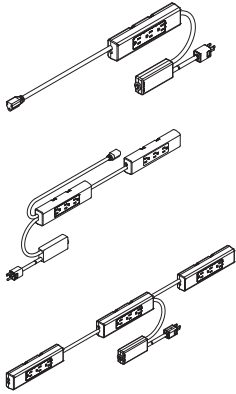

Tip: Underworksurface power blocks do not ship with independent mounting hardware. They are designed to mount into the universal cable management kit without additional hardware. Kit sold separately.

Tip: Overcurrent protection includes a 15 amp circuit breaker.

Tip: Do not use a vertical cable manager with a curly cord or braided cord.

Tip: Cord length between blocks is 24", if applicable.

Tip: Never plug a powerstrip into another powerstrip.

Tip: 4 outlet utility block fits in the small tray universal cable management kit, 7 outlet utility block fits in large tray universal cable management kit, and 9 outlets with three utility blocks, specify one large and one small universal cable management kit. Kit sold separately.

Tip: Power cord 8' curly cannot be specified with power plug type thread low profile.

Tip: Cord clip screw length for minimum worksurface thickness of 3/4".



For Canadian Pricing

Multiply U.S. Price by the Canadian price factor.

▶ See page 1 for details.

Standard Includes	Required to Specify
<ul style="list-style-type: none"> ▶ Need help? Product details, page 323 • Under worksurface utility power: 4 outlets • 8' standard cord: plastic • Circuit breaker • Cord managers • Power blocks in merle finish 	<ol style="list-style-type: none"> 1 Style number 2 Under worksurface utility power configuration (see below under Required Selections) 3 Options, (if selected) see below

Under Worksurface Utility Power Configuration	Required Selections	U.S. Price	Required to Specify
	• Four outlets total – one utility block, with three outlets each and one floating female outlet	No cost	Specify with one utility and one female plug.
	• Seven outlets total – two utility blocks, with three outlets each and one floating female outlet	+\$132	Specify with two utility and one female plug.
	• Nine outlets total – three utility blocks, with three outlets each	+\$264	Specify with three utility.

Options	U.S. Price	Required to Specify
Power Cord <ul style="list-style-type: none"> • 6' standard cord • 8' standard cord • 10' standard cord • 6' braided cord • 8' braided cord • 10' braided cord • 8' curly cord • 163" curly cord 	<ul style="list-style-type: none"> –\$ 22 No cost No cost +\$ 74 +\$222 +\$222 +\$277 +\$314 	<ul style="list-style-type: none"> Specify with 6' standard cord. Specify with 8' standard cord. Specify with 10' standard cord. Specify with 6' braided cord. Specify with 8' braided cord. Specify with 10' braided cord. Specify with 8' curly cord. Specify with 163" curly cord.
Power Cord Color <ul style="list-style-type: none"> • Standard and curly cord • Black • White 	<ul style="list-style-type: none"> No cost No cost 	<ul style="list-style-type: none"> Specify with black cord. Specify with white cord.
<ul style="list-style-type: none"> • Braided cord • Black • Seagull 	<ul style="list-style-type: none"> No cost No cost 	<ul style="list-style-type: none"> Specify with black braided cord. Specify with seagull braided cord.
Power Plug Type <ul style="list-style-type: none"> • Standard NEMA 3-prong • 90° NEMA • Thread low profile 	<ul style="list-style-type: none"> No cost +\$ 39 +\$ 43 	<ul style="list-style-type: none"> Specify with standard NEMA plug. Specify with 90° NEMA plug. Specify with Thread low profile plug.

Related Products <ul style="list-style-type: none"> • Universal cable management kits 	▶ Page 359
---	------------

Specification Information	
Style Number	U.S. Base Price
DSUP	\$198

Universal Cable Management Kit(s)

	Standard Includes	Required to Specify
▶ Need help? Product details, page 328	<ul style="list-style-type: none"> • Cable management tray: 6205 Black • Five red rubber: smart straps, if small cable management kit is selected • 10 red rubber: smart straps, if large cable management kit is selected • Attachment hardware 	<ul style="list-style-type: none"> 1 Style number 2 Options, if selected (see below)

	Options	U.S. Price	Required to Specify
Strap	• Smart straps	No cost	Specify <i>with smart straps</i> .

Specification Information				
Dimensions			Style	U.S.
D	W	H	Number	Price
.....

Tip: The weight limit of the 15½" tray is five pounds, while the weight limit of the 30" tray is 10 pounds.

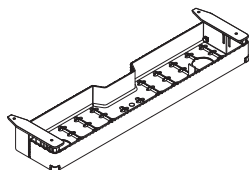
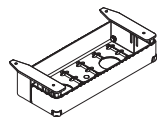

Small Cable Management Kit

6⅝"	15½"	3½"	DSTRAYSM	\$104
.....

Large Cable Management Kit

6⅝"	30"	3½"	DSTRAYLG	\$139
.....

Tip: When installed, tray provides ⅜" of clearance on all sides to allow for cable egress between the underside of the worksurface and the top of the tray.

Tip: Tray attachment hardware accommodates work-surfaces more than ¾" in thickness. Screws may pop through thinner worksurfaces.

 **For Canadian Pricing**
 Multiply U.S. Price by the Canadian price factor.
 ▶ See page 1 for details.

High-Capacity Cable Riser

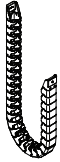

Tip: Screw attachment to the underside of the mounting surface.

Tip: Magnetic bottom bracket attaches to metal magnetic surface.

Tip: Do not use with integrated storage.

Tip: Do not use within an enclosed area that would restrict the movement of the cable riser's links.

Tip: Total weight is 1.2 pounds (without cords).

Standard Includes		Required to Specify
▶ Need help? Product details, page 329	<ul style="list-style-type: none"> High capacity vertical cable riser: plastic Attachment hardware for top bracket Magnetic bottom bracket 	1 Style number 2 Plastic color number for cable riser: 6053 Seagull 6527 Merle

Related Products	
<ul style="list-style-type: none"> Powerstrip Intro Powerstrip Plus 	<ul style="list-style-type: none"> ▶ Page 354 ▶ Page 356

Specification Information				
Dimensions			Style	U.S.
D	W	L	Number	Price
17/16"	13 ¹ / ₃₂ "	41 ⁵ / ₁₆ "	DSVCMHC	\$215
:	:	:	:	:



For Canadian Pricing
 Multiply U.S. Price by the Canadian price factor.
 ▶ See page 1 for details.

Surface Materials

Surface Materials	362
Directional Laminate Grain Directions	370
Wood Veneer Grain Directions	371

Surface Materials

This listing includes all the surface material choices that are available for the products in this specification guide.

Resources

For more information about surface materials, refer to the following resources:

Additional surface materials specification tools are available to assist you in the specification process—the Surface Materials Binders.

The global surface materials palette is a core collection of finishes that is available across multiple geographies (Americas/EMEA – Europe, Middle East, and Africa/ APAC – Asia Pacific) and on global product lines, where applicable. For a list of finishes included in the offering, see the Surface Materials Reference Manual. Additional details, like product approvals by geography and finish number conversions, can also be found in the Surface Materials Reference Manual or see steelcase.com/surface-materials.

Surface Materials Binders

include:

- Surface Materials Reference Manual
- A complete set of swatch cards for hard surfaces, vertical surface fabrics, and seating upholstery

Paint

Steelcase Surfaces

Applies to:

- USB powerstrip with clamp mount brackets

4140 Arctic White
4799 Platinum Metallic
7360 Merle

Applies to:

- USB powerstrip with rail mount brackets

4799 Platinum Metallic

Ⓔ = Excluded

Applies to:

- Ology bases
- Migration SE bases
- Flex height-adjustable desk lifting columns

Price Group 1

Textured Paint
7207 Black
7241 Arctic White
7360 Merle

Price Group 2

Smooth Metallic Paint
4799 Platinum Metallic

Applies to:

- Ology power and data access trays

Price Group 1

Textured Paint
7207 Black
7241 Arctic White
7360 Merle

Price Group 2

Smooth Metallic Paint
4799 Platinum Metallic

Metal and Accessory Paint

8043 Clear Anodized Aluminum

Applies to:

- Worksurface side screen bracket

Price Group 1

Textured Paint
7207 Black
7241 Arctic White
7360 Merle

Price Group 2

Smooth Metallic Paint
4799 Platinum Metallic

Applies to:

- Clamps for Privacy/Modesty Screens

Price Group 2

Smooth Metallic Paint
4799 Platinum Metallic

Smooth Paint
0835 Black

Applies to:

- Airtouch height-adjustable bases

Price Group 1

7207 Black

Price Group 2

4799 Platinum

Tip: Airtouch lifting column is available in 4799 Platinum only.

Applies to:

- Universal Steel One-High open lateral for Ology
- Universal shrouds for Ology
- Universal filler for Ology

Price Group 1

Smooth Paint
4238 Mocha
4239 Clay
4240 Chalk
4242 Milk

Textured Paint

7207 Black
7225 Sand
7237 Slate
7238 Fieldstone
7239 Midnight Ⓔ
7241 Arctic White
7243 Seagull
7278 Dark Bronze
7360 Merle

Price Group 2

Smooth Metallic Paint
4750 Champagne Metallic
4798 Sterling Metallic Ⓔ
4799 Platinum Metallic
4803 Near Black Metallic

Smooth Paint

4700 Warm White

Applies to:

- Universal privacy screens

Price Group 1

Textured Paint
7241 Arctic White
7360 Merle

Price Group 2

Smooth Metallic Paint
4799 Platinum Metallic

Applies to:

- Universal privacy/modesty screen brackets
- Sarto privacy/modesty screen brackets
- Sarto privacy screen brackets and hard stops
- Sarto curved screen brackets
- Soffio curved screen brackets

Price Group 1

Textured Paint
7360 Merle

Steelcase Surfaces

Applies to:

- Screen mounting brackets
- Slatwall screens

Price Group 1

7207 Black
7225 Sand
7241 Arctic White
7243 Seagull

Price Group 2

4750 Champagne Metallic
4798 Sterling Metallic Ⓔ
4799 Platinum Metallic

Applies to:

- Flex height-adjustable desk feet

Price Group 1

Smooth Paint
4238 Mocha
4239 Clay
4240 Chalk
4242 Milk
4710 Low Gloss Black*

Textured Paint

7207 Black
7225 Sand
7237 Slate
7238 Fieldstone
7239 Midnight Ⓔ
7241 Arctic White
7243 Seagull
7250 Sterling Dark Solid
7278 Dark Bronze
7360 Merle

Price Group 2

Smooth Metallic Paint
4750 Champagne Metallic
4798 Sterling Metallic Ⓔ
4799 Platinum Metallic
4803 Near Black Metallic

Smooth Paint

4700 Warm White

Applies to:

- Power hanger cover

4AY2 Chili
4AZ5 Marlin
4BQ7 Fuchsia
4CZ8 Light Peacock
7243 Seagull
7360 Merle

Applies to:

- Flex height-adjustable desk feet
- Privacy back wrap bracket
- Universal storage

Price Group 3

Accent Paint

1ATG Rose Quartz
4AV3 Blue Jay
4AV4 Baltic
4AX1 Citron
4AY2 Chili
4AZ5 Marlin
4CL7 Sandstone
4CL8 Smokey Plum
4CZ5 Honey
4CZ6 Lagoon
4CZ8 Light Peacock

Coatings

1ATT Cast Shadow

Lux Coatings

4B20 Obsidian
4B22 Matte Brass
4B23 Burnished Bronze
4B24 Night Bronze
4B25 Matte Copper
4B26 Smoked Mica
4B29 Cast Iron

Steelcase Surfaces

Applies to:

- Migration Intro bases

Price Group 1**Smooth Paint**

4231 Arctic White

Price Group 2**Smooth Metallic Paint**

4799 Platinum

Smooth Paint

4243 Merle

Applies to:

- Migration Pro bases
- Migration Pro High-Speed bases
- Cable tray
- Cable riser

Price Group 1**Smooth Paint**

4231 Arctic White

4238 Mocha

4239 Clay

4240 Chalk

4242 Milk

4858 Seagull

Price Group 2**Smooth Metallic Paint**

4799 Platinum Metallic

Smooth Paint

0835 Black

4243 Merle

4700 Warm White

Price Group 3**Accent Paint**

4AV4 Baltic

4AY2 Chili

4CL1 Dark Olivine

4CL4 Sea Glass

4CL6 Terra

4CL7 Sandstone

4CL8 Smokey Plum

4CZ5 Honey

Lux Coatings

4B20 Lux Obsidian

4B22 Matte Brass

4B23 Burnished Bronze

4B24 Night Bronze

4B25 Matte Copper

4B26 Smoked Mica

E = Excluded

Applies to:

- Pop-up power option on Migration Pro and Migration Pro High-Speed

Price Group 1**Textured Paint**

7241 Arctic White

7243 Seagull

7360 Merle

Price Group 2**Smooth Metallic Paint**

4799 Platinum Metallic

Smooth Paint

0835 Black

Custom Surfaces**Price Group 3****PerfectMatch**

PerfectMatch is a service that allows you to create your own paint color. Refer to the *Surface Materials Reference Manual* for more information about this program.

Tip: Price Group 3 paints are not available on height-adjustable bench bases.

Laminate

Tip: All products may not be available in all colors listed below.

Steelcase Surfaces**High-Pressure Laminate****Price Group 1**

Applies to:

- Ology desks
- Ology modesty panels
- Migration Pro desks
- Migration Pro High-Speed desks
- Migration Intro desks
- Migration Pro and Intro modesty panels
- Migration SE desks
- Airtouch worksurfaces
- Universal One-High open lateral tops for Ology
- Universal common tops for Ology
- Universal Steel One-High storage for Ology
- Universal tops and fillers for Ology
- Flex height-adjustable desk worksurface
- Currency

Fiber Laminate

2850 Vanadium Fiber

2852 Tungsten Fiber E

2854 Vellum Fiber E

2860 Granite Fiber

2862 Stucco Fiber E

Micro Laminate

2920 Marl Micro

2921 Gypsum Micro

2922 Clay Micro

Patina Laminate

2870 Blonde Bronze Patina

2873 Instant Iron Patina

Solid Laminate

2722 Cream E

2730 Arctic White

2746 Black

2759 Warm White

2811 Mist E

2883 Seagull

2884 Milk

2885 Dune

2HAA Persian Salt

2HAB Rose

2HAC Indigo

2HAD Green Citrine E

2HAE Dark Olivine

2HAF Cloudy

2HMG Merle

2HWU Clay

2HWV Chalk

Speckle Laminate

2820 Coffee Speckle E

2823 Driftwood Speckle

2824 Smoke Speckle

2825 Vanadium Speckle

Tip: Some wood veneer finishes and woodgrain laminates share the same name. Because of the difference in materials, veneers and laminates of the same name are not an exact match but do coordinate with each other.

Woodgrain Laminate

2406 Clear Cherry E

2409 Clear Maple

2410 Graphite Walnut

2412 Natural Cherry

2422 Medium Cherry E

2511 Winter on Maple E

2535 Virginia Walnut

2536 Blackwood

2538 Clear Walnut

2592 Blonde on Maple E

2714 Natural Walnut E

2HAK Clear Oak

2HAN Ash Noce

2HAT Acacia

2HAW Ash Wenge

2HBN Bisque Noce

2HBW Bisque Wenge

2HCN Clay Noce

2HCW Clay Wenge

2HSN Storm Noce

2HSW Storm Wenge

2HWA Grey Kingswood

2HWB Planked Walnut

2HWD Resolute Walnut

2HWE Natural Recon

2HWF Smoked Walnut E

2HZA Waxed Maple

2HZB Natural Ash

2HZC Aged Ash

2HZD Ashwood Oak

2HZE Ashwood Beige

2HZF White Washed Birchply

Tip: Woodgrain laminates and the turnstone laminate collection are not available as matched sets. The grain patterns will not align. These are not recommended for fully segmented skin applications.

Price Group 2

Textured Laminate

- 2TH2 Fawn Cypress
- 2TH4 Saddle Oak
- 2TH5 Veranda Teak
- 2TH7 Walnut Heights
- 2UH1 Reclaimed Aggregate
- 2UH2 Reclaimed Gravel
- 2UH4 Cement*
- 2UH6 Sheetrock

*2UH4 Cement has limited 90° corner parametric availability due to laminate sheet size.

Applies to:

- Universal One-High open lateral tops for Ology
- Universal common tops for Ology
- Flex height-adjustable desk worksurface
- Elective Elements common top
- Ology worksurfaces

Price Group 3

Solid Laminate

- 24H1 Satin White
- 24H2 Satin Black
- 24H3 Satin Stone
- 24H4 Satin Mocha

Steelcase Surfaces

Low-Pressure Laminate

Applies to:

- Currency

Fiber Laminate

- 2L50 Vanadium Fiber LPL

Solid Laminate

- 247L Black V2 LPL
- 2L30 Arctic White LPL
- 2L83 Seagull LPL
- 2L84 Milk LPL
- 2L85 Dune LPL
- 2LMG Merle LPL

Woodgrain Laminate

- 24L0 Graphite Walnut LPL
- 25L1 Winter on Maple LPL **E**
- 25L5 Virginia Walnut LPL
- 25L6 Blackwood LPL
- 25L8 Clear Walnut LPL
- 26L1 Natural Cherry V2 LPL
- 2L09 Clear Maple LPL
- 2LAK Clear Oak LPL
- 2LAN Ash Noce LPL
- 2LAT Acacia LPL
- 2LAW Ash Wenge LPL
- 2LBN Bisque Noce LPL
- 2LBW Bisque Wenge LPL
- 2LCN Clay Noce LPL
- 2LCW Clay Wenge LPL
- 2LSN Storm Noce LPL
- 2LSW Storm Wenge LPL
- 2LWA Grey Kingswood LPL
- 2LWB Planked Walnut LPL
- 2LWD Resolute Walnut LPL
- 2LWF Smoked Walnut LPL **E**
- 2LWG Natural Recon LPL
- 2TL2 Fawn Cypress LPL

E = Excluded

Custom Surfaces

Open Line Laminate (OLL)

This service allows you to order non-standard laminate at an additional processing fee of \$111 U.S. per unit, plus the cost of the laminate.

High-Pressure Laminate pricing does not include premium or digitally printed patterns from any suppliers. Laminate cost may also vary for basic or standard laminates from other suppliers. Please contact the OLL consultant at 616.475.2426 for pricing. The cost of the laminate will be added to your invoice as a separate line on the acknowledgement.

When processing orders for Open Line laminate on Ology desks, Universal One-High tops for use on Ology, and common tops for use on Ology, specify 2900 in the laminate finish field and enter the OLL manufacturer information. Enter the required edge finish as you would a standard laminate.

Tip: OLL is not available for specification with FSC Mix credit worksurfaces, style numbers ending in FSC.

Laminate Approval and Material Requirements

To confirm whether a particular laminate has already been tested for use on a specific Steelcase product or to determine material square foot requirements:

- Visit www.steelcase.com

For additional information, refer to the *Steelcase Surface Materials Reference Manual*.

Wood

Applies to:

- Ology desks
- Ology modesty panels
- Migration Pro desks
- Migration Pro High-Speed desks
- Migration Pro modesty panels
- Migration SE desks
- Universal One-High open lateral tops for Ology
- Universal common tops for Ology
- Flex height-adjustable desk worksurface

Steelcase carefully selects veneer and solid wood for consistent color and grain structure. Wood is a natural material and variations will occur in color, grain and texture. These variations are part of the inherent natural beauty of wood and are not considered defects.

All wood products will darken with age and exposure to ultraviolet light. This is especially apparent with cherry and maple veneer. We recommend that desk accessories be rearranged periodically to ensure even aging of wood surfaces.

When storing your wood furniture, please follow the following guidelines:

- Do not store products in trailers
- Store products in areas that simulate office temperatures (60°F to 90°F)
- Store products in areas that maintain constant, office-like humidity levels
- Keep product away from light. Cover products to make sure they are not exposed to light.

Steelcase Surfaces

Veneers are matched for proper balance and consistency. Veneers are available flat cut or quarter cut, except for Oak, which is rift cut. Refer to the *Surface Materials Reference Manual* for descriptions of each cut.

Open-pore finish is a medium gloss finish that leaves the wood grain texture visible to the eye and distinguishable to the touch.

Veneer**Wood Group 1****Flat-Cut Open-Pore**

- 3062 FC/OP Graphite Walnut
- 3402 FC/OP Clear Cherry (Aged)
- 3412 FC/OP Natural Cherry **E**
- 3422 FC/OP Medium Cherry
- 3522 FC/OP Clear Maple
- 3702 FC/OP Clear Walnut
- 3712 FC/OP Natural Walnut
- 3752 FC/OP Medium Walnut **E**
- 3762 FC/OP Dark Walnut
- 3772 FC/OP Medium Mahogany on Walnut

Flat-Cut Open-Pore, Natural Veneer

- 3342 FC/OP Black Walnut
- 35A2 FC/OP Blanch Maple
- 37A2 FC/OP Thunder Walnut

Quarter-Cut Open-Pore

- 3042 QC/OP Ash **E**
- 3222 QC/OP Clear Maple
- 3302 QC/OP Clear Walnut
- 3312 QC/OP Natural Walnut
- 3352 QC/OP Medium Walnut **E**
- 3362 QC/OP Dark Walnut
- 3372 QC/OP Medium Mahogany on Walnut
- 3382 QC/OP Graphite Walnut

Quarter-Cut Open-Pore, Natural Veneer

- 32A2 QC/OP Blanch Maple
- 33A2 QC/OP Thunder Walnut
- 3392 QC/OP Black Walnut

Rift-Cut Open-Pore

- 3602 RC/OP Desert Oak

Rift-Cut Open-Pore, Natural Veneer

- 36A2 RC/OP Volcanic Oak

Wood Group 3**Flat-Cut Open-Pore, Natural Veneer**

- 3082 FC/OP Washed Walnut

Wood Group 1**Open-Pore Planked Veneer**

- 3P41 OP Planked Cherry
- 3P51 OP Planked Maple
- 3P61 OP Planked Oak
- 3P71 OP Planked Walnut
- 3VFX OP Unmarked Oak

Tip: Known for its uniqueness, planked veneer has intentional and natural variations that include, but are not limited to: character marks, grain pattern, color, and natural color aging.

E = Excluded

Premium Veneers

A selection of Premium veneers in this collection are available on most Steelcase brand products. The collection will be available as close to standard leadtimes as possible. However, because adequate supplies of veneer and solids must be secured, all orders will be scheduled individually. Leadtimes will vary based on Premium veneer and Premium solids availability at the time the order is placed. The collection is available as Wood Group 3 as a part of our Select Surfaces program, and supported like standard veneers to make ordering easy. Please see the Steelcase surface materials section on village.steelcase.com for sample information and product line availability. All premium veneers are in clear-coat.

Wood Group 3**Quarter-Cut Open-Pore**

- 3832 QC/OP Figured Anegre

Select Surfaces

For information on products within Select Surfaces, including accent paints and fabrics from Designtex, Gabriel, Kvadrat, and Pollack, please refer to the *Surface Materials Reference Manual* or visit steelcase.com/surface-materials under the Select Surfaces section.

Composite Veneer

Composite veneers are an engineered wood intended to create specific grain patterns and characteristics. They are pre-stained and finished with Steelcase's Clarity water-borne UV topcoat, which protects the environment while providing durability and clarity. Only open-pore finishes are available on composite wood. Composite veneer and matching edge bands are available on most Steelcase brand products. Composites, for use as a solid nosing substitute, are not available. Steelcase does not recommend mixing composite veneers with natural solid nosings because composite and natural wood grain and color matching are rarely compatible. Composite veneers are Select Surfaces as Wood Group 1 pricing.

Composite Veneer Group 1**Composite Flat-Cut Open-Pore**

- 3JJX FC/OP Walnut Composite
- 3LAX FC/OP Graphite on Oak Composite
- 3LCX FC/OP Medium Cherry on Cherry Composite

Composite Quarter-Cut Open-Pore

- 3F8X QC/OP European Walnut Composite
- 3HGX QC/OP Oak Composite
- 3HVX QC/OP Walnut Composite
- 3LBX QC/OP Clear Walnut on Walnut Composite
- 3LDX QC/OP Natural Walnut on Walnut Composite

Composite Veneer Group 2**Composite Flat-Cut Open-Pore**

- 3LHX FC/OP Espresso on Walnut Composite

Composite Quarter-Cut Open-Pore

- 3LEX QC/OP Desert Oak on Oak Composite
- 3LGX QC/OP Chai on Walnut Composite
- 3LJX QC/OP Ebony on Walnut Composite

Custom Surfaces

Customiz stain is a service that allows you to create your own stain colors and finishes on standard veneer. Customiz stain color is available on all product lines that offer wood veneer.

A \$500 stain-matching fee applies on CUSTOMIZ requests (Exception: The \$500 fee does not apply on matches to Coalesse standard finishes or for a low-gloss finish request on a standard color). The \$500 fee covers the cost of formulating the Customiz color finish and applies regardless of whether or not an order for product is placed.

In addition, an approval form must be signed to indicate customer acceptance of Customiz match. A \$1,500 initiation fee will be charged prior to first order entry. This initiation fee activates the finish for unlimited use on any Steelcase product for an 18 month time period. After the 18 month time period has lapsed, the Customiz finish may be reactivated for another 18 months for a \$1,000 fee at any point within five years after the \$1,500 initiation fee was paid. If the finish is not reactivated within five years after the \$1,500 initiation fee was paid, the finish will be culled and the customer will need to pay the \$1,500 initiation fee again. All style number related Customiz charges products are no cost as of April 2014. The matching and initiation fees are not discountable.

Customiz stain takes 10 days to formulate. Consult the *Surface Materials Reference Manual* for more information. Custom veneers are also available and must be quoted by Steelcase specials group. Customiz stain on custom veneers takes 2 to 4 weeks to formulate.

Requirements and information on ordering a Customiz stain color are found in the *Surface Materials Reference Manual*.

Surface Materials, continued

Applies to:

- Flex Desk Mount Privacy Wraps

Wrap Knit

- 5KJ1 Merle
- 5KJ2 Cloud
- 5KJ3 Fog
- 5KJ4 Sand

Plastic

Steelcase Surfaces

Tip: Light color plastic edges are susceptible to degradation due to normal wear and tear. Staining (e.g., ball point pen or clothing dyes such as blue jeans) and dirt effects are more pronounced in light colors and are not considered defects.

Applies to:

- Cable clip

6053 Seagull

Applies to:

- Height-adjustable desk power

- 5U23 Blue Jay
- 6000 Black
- 6009 Arctic White
- 6053 Seagull
- 6249 Platinum Solid
- 6338 Chili
- 6527 Merle

Applies to:

- Wrap light

6052 Milk

6053 Seagull

6527 Merle

Applies to:

- Migration cable riser chain

6053 Seagull

6527 Merle

Applies to:

- Flush power option on Migration Pro and Migration Pro High-Speed

6000 Black

6009 Arctic White

6053 Seagull

6527 Merle

Applies to:

- 3 mm edge profile on Ology desks and modesty panels
- 3 mm edge profile on Migration Pro desks
- 3 mm edge profile on Migration Pro High-Speed desks
- 3 mm edge profile on Migration Intro desks
- 3 mm edge profile on Migration Pro and Intro modesty panels
- 3 mm edge profile on Migration SE desks
- Airtouch worksurfaces
- 1 mm square edge profile on Universal One-High open lateral laminate tops for Ology
- Universal common tops for Ology
- Universal tops for Ology
- Flex height-adjustable desk worksurface
- Currency

6000 Black

6009 Arctic White

6034 Natural Cherry

6036 Medium Cherry

6037 Winter on Maple

6038 Blonde on Maple **E**

6041 Natural Walnut **E**

6052 Milk

6053 Seagull

6169 Stone

6170 Mocha

61AA Persian Salt

61AB Rose

61AC Indigo

61AD Green Citrine **E**

61AE Dark Olivine

61AF Cloudy

6213 Acacia

6219 Clear Oak

6231 Graphite Walnut

6237 Clear Maple

6242 Virginia Walnut

6243 Blackwood

6245 Clear Walnut

6249 Platinum Solid

6271 Plywood

6527 Merle

6619 Ice **E**

6631 Cream **E**

6635 Dawn **E**

6636 Mist

6654 Sand

6655 Warm White

6695 Midnight

6697 Fog

6698 Fieldstone

66WA Grey Kingswood

66WB Planked Walnut

66WD Resolute Walnut

66WE Natural Recon

66WF Smoked Walnut

66WU Clay

66WV Chalk

6703 Ash Wenge

6704 Storm Wenge

6706 Clay Wenge

6707 Ash Noce

6708 Bisque Noce

6709 Clay Noce

6710 Storm Noce

6T02 Fawn Cypress

6T04 Saddle Oak

6T05 Veranda Teak

6T07 Walnut Heights

6T08 Aggregate

6T09 Gravel

6T10 Cement

6T12 Sheetrock

Tip: Plywood is a natural material and variations will occur in color, grain, and texture.

Applies to:

- USB powerstrip housing

6009 Arctic White

6527 Merle

Applies to:

- Flex height-adjustable desk rollers

6053 Seagull

6205 Black

6527 Merle

6249 Platinum Solid

6338 Chili

6527 Merle

6527 Merle

6527 Merle

Applies to:

- Translucent screens

6505 Frosted White

Applies to:

- Powerstrip plus

6000 Black

6009 Arctic White

6053 Seagull

6302 Baltic

6338 Chili

6527 Merle

6BD1 Aubergine

6BD2 Peacock

6BD5 Honey

6BD6 Lagoon

6BD7 Saffron

6BE2 Light Peacock

Acrylic

Applies to:

- Modesty and privacy screens

6544A Acrylic Frost

PET

Applies to:

- Flex cable catch

P630 Medium Heather Grey

P631 Dark Heather Grey

Applies to:

- Flex cable tray

P631 Dark Heather Grey

Glass

Applies to:

- Worksurface side screens

6500 Clear

6530 Frosted

E = Excluded

Upholstery

Applies to:
• Flex

Braided Cord Color Matrix

Braided cord samples are not available to order. Use matrix below that compares the braided cord finish to the nearest Steelcase finish or Pantone color for color reference purposes.

Tip: Braided cord color is defaulted to 9007 Sterling.

Finish	Pantone Color
9003 Fuchsia	4BQ7 Fuchsia
9004 Marlin	4AZ5 Marlin
9006 Chili	6338 Chili
9007 Sterling*	6059 Sterling Dark Solid
9008 Honey	4CZ5 Honey
9009 Black	0835 Black
9010 Light Peacock	4CZ8 Light Peacock
9011 Seagull	4858 Seagull

*Default finish on integrated power.

Applies to:
• Universal screens

Tip: Designtex: Gamut and Designtex: Crossweave are also available on Universal screens. Designtex: Gamut and Designtex: Crossweave are part of the Select Surfaces program.

► See Surface Materials Reference Manual for more information on the Select Surfaces program.

Steelcase Surfaces

Price Group 1

Abacus [ⓔ]

P123 Portico
P124 Opus
P125 Cusp
P126 Artifact

Buzz2

5F03 Tomato
5F04 Red [ⓔ]
5F05 Burgundy
5F06 Sky [ⓔ]
5F07 Blue
5F08 Navy
5F15 Stone
5F16 Grey
5F17 Black
5G50 Dunegrass
5G51 Sable
5G55 Pumpkin
5G57 Rouge
5G59 Meadow
5G61 Cyan
5G62 Atlantic
5G63 Crocus
5G64 Alpine
5G65 Tornado

[ⓔ] = Excluded

Price Group 2

Code

5FA1 Fossil
5FA2 Gabbro
5FA3 Reed
5FA4 Bluff
5FA5 Sea Salt
5FA6 Cannon
5FA7 Tussah
5FA9 Ecru
5FB1 Bamboo

Cogent: Connect

5S15 Coconut
5S16 Turmeric/Honey
5S17 Tangerine
5S18 Scarlet
5S19 Concord
5S21 Blue Jay
5S23 Wasabi
5S24 Nickel
5S25 Graphite
5S27 Malt
5S28 Root Beer
5S93 Indigo/Blueprint
5S94 Lizard/Jungle
5S95 Sailor
5S96 Quicksilver
5S99 Lipstick/Merlot
5SD0 Royal Blue
5SD1 Aubergine
5SD2 Peacock
5SD3 Lagoon
5SD4 Saffron
5SD5 Citrine
5SD6 Rose Quartz
5SD7 Sea Salt
5SF3 Storm Cloud
5SF4 Olivine

Dovetail by Designtex

5H39 Light Mocha
5H40 Pebble
5H41 Warm White
5H42 Sandstone
5H43 Honeycomb
5H44 Terra
5H45 Honeydew
5H46 Denim
5H47 Storm
5H48 Ice Blue
5H49 Aura
5H50 Darkest Grey

Intersection

P211 Summit
P212 Chalk
P213 Lace

Latch

P601 Clam
P602 Eggshell
P603 Zen
P604 Cool Gray
P605 Armor
P606 Sentinel
P608 Billow
P609 Nimbus

SoftNext

5H27 Obsidian
5H28 Foggy Night
5H29 Greystone
5H30 Mocha
5H31 Clay
5H32 Sandstone
5H33 Chalk
5H34 Midnight
5H35 Blue Mica
5H36 Jade
5H37 Burnt Umber
5H38 Cinnabar

Stencil

P455 Midnight
P456 Mulberry
P457 Cracked Pepper
P458 Denim
P459 Chartreuse
P460 Bittersweet
P461 Mauvelous
P462 Bermuda
P463 Concrete
P464 Orchid
P465 Parchment
P466 Silk
P467 Sea Salt
P468 Honeydew
P469 Sepia

Price Group 3

Billiard Multi-Use by Designtex

5H11 Poppy
5H12 Tangelo
5H13 Citrine/Citron
5H14 Avocado
5H16 Indigo
5H17 Mallard
5H18 Teak
5H19 Cumulus
5H20 Pewter
5H21 Gunmetal
5H22 Ink
5H23 Rose Quartz
5H24 Sea Salt
5H25 Storm Cloud
5H26 Olivine

Applies to:

- Sarto screens
- Flex curved screens
- Sarto curved screens
- Soffio curved screens

Tip: The following thin, light colored fabrics are not available on Sarto and Flex curved screens:

Abacus
P126 Artifact [ⓔ]
Alloy
P525 Polar
P526 Skim
P528 Tern
Charm
P505 Shell
P506 Mimosa
P508 Sparkle

Code
5FA5 Sea Salt

Latch
P601 Clam
P603 Zen

Optic
P541 Twinkle
P544 Shine

Flip: Orbit
5F91 Blizzard

Pianista
P420 Sand
P428 Flax

Sprite
5541 Snow

Price Group A

Sprite

Price Group 1

Abacus [ⓔ]
Alloy
Boccie
Buzz2
Charm
Link**
Optic
Pianista
Rhythm

Price Group 2

Bariolage
Cogent: Connect**
Dovetail by Designtex
Flip: Orbit
Flip: TexHex
Fresco
Intersection*
Latch
SoftNext
Stencil*

*Intersection and Stencil not available on Soffio curved screens.

**Cogent: Connect and Link are not available on Sarto curved screens or Flex curved screens.

Price Group 3

Billiard Multi-Use by Designtex

Applies to:
• Worksurface side screens

Price Group 1

Abacus **E**
Alloy
Boccie
Buzz2
Charm
Optic
Pianista
Rhythm
Tinsel

Price Group 2

Bariolage
Code
Cogent: Connect
Fresco
Intersection
Latch
Flip: Orbit
Stencil
Flip: TexHex

Price Group 3

Billiard Multi-Use by Designtex

Upholstery

Select Surfaces Program: Upholstery

Applies to:
• Soffio

A collection of textiles are available as part of a Select Surfaces Program. The collection from the leading suppliers in the market consists of high-performance textiles.

To order these fabrics, enter the finish code which corresponds with the fabric price group.

Price Group	Finish Code
4	59DD

Then enter the fabric information in the Special Fabric Information pop up window.

Applies to:
Worksurface side screens

Price Group	Finish Code
1	59DA
2	59DB
3	59DC
4	59DD
5	59DE
6	59DF
7	59DG
8	59DH
9	59DJ
10	59DK

Applies to:
• Flex curved screens
• Sarto screens
• Universal screens
• Worksurface side screens

Select Surfaces

For information on products within Select Surfaces,

To confirm whether a particular COM material has already been tested for use on a specific Steelcase product or to determine actual yardage requirements:
• Visit www.steelcase.com

For additional information regarding Customer's Own Material,

including accent paints, Signature plastics, and fabrics from Designtex, Gabriel, Kvadrat, and Pollack, please refer to the *Surface Materials Reference Manual* or visit steelcase.com/surface-materials under the Select Surfaces section.

Laminate and Edge Finishes

Applies to:
• Ology desks
• Ology modesty panels
• Migration SE desks
• Airtouch
• Universal One-High open lateral tops for Ology
• Universal common tops for Ology
• Flex height-adjustable worksurfaces
• Currency

Laminate Color Recommended 3 mm Edge Color

Fiber Laminate			
2850	Vanadium Fiber	6654	Sand
2852	Tungsten Fiber E	6636	Mist
2854	Vellum Fiber E	6655	Warm White
2860	Granite Fiber	6000	Black
2862	Stucco Fiber E	6053	Seagull

Micro Laminate			
2920	Marl Micro	6053	Seagull
2921	Gypsum Micro	6654	Sand
2922	Clay Micro	6654	Sand

Patina Laminate			
2870	Blonde Bronze Patina	6654	Sand
2873	Instant Iron Patina	6527	Merle

Solid Laminate			
24H1	Satin White	6009	Arctic White
24H2	Satin Black	6000	Black
24H3	Satin Stone	6169	Stone
24H4	Satin Mocha	6170	Mocha
2722	Cream E	6631	Cream E
2730	Arctic White	6009	Arctic White
2746	Black	6000	Black
2759	Warm White	6655	Warm White
2811	Mist E	6636	Mist
2883	Seagull	6053	Seagull
2884	Milk	6052	Milk
2885	Dune	6654	Sand
2HAA	Persian Salt	61AA	Persian Salt
2HAB	Rose	61AB	Rose
2HAC	Indigo	61AC	Indigo
2HAD	Green Citrine E	61AD	Green Citrine E
2HAE	Dark Olivine	61AE	Dark Olivine
2HAF	Cloudy	61AF	Cloudy
2HMG	Merle	6527	Merle
2HWU	Clay	66WU	Clay
2HWV	Chalk	66WV	Chalk

Speckle Laminate			
2820	Coffee Speckle E	6631	Cream E
2823	Driftwood Speckle	6631	Cream E
2824	Smoke Speckle	6636	Mist
2825	Vanadium Speckle	6619	Ice E

E = Excluded

Laminate and Edge Finishes, continued

Laminate Color	Recommended 3 mm Edge Color
Textured Laminate	
2TH2 Fawn Cypress	6T02 Fawn Cypress
2TH4 Saddle Oak	6T04 Saddle Oak
2TH5 Veranda Teak	6T05 Veranda Teak
2TH7 Walnut Heights	6T07 Walnut Heights
2UH1 Reclaimed Aggregate	6T08 Aggregate
2UH2 Reclaimed Gravel	6T09 Gravel
2UH4 Cement	6T10 Cement
2UH6 Sheetrock	6T12 Sheetrock
Woodgrain Laminate	
2406 Clear Cherry E	6234 Clear Cherry
2409 Clear Maple	6237 Clear Maple
2410 Graphite Walnut	6231 Graphite Walnut
2412 Natural Cherry	6034 Natural Cherry
2422 Medium Cherry E	6036 Medium Cherry
2511 Winter on Maple E	6037 Winter on Maple
2535 Virginia Walnut	6242 Virginia Walnut
2536 Blackwood	6243 Blackwood
2538 Clear Walnut	6245 Clear Walnut
2592 Blonde on Maple E	6038 Blonde on Maple E
2714 Natural Walnut E	6041 Natural Walnut E
2HAK Clear Oak	6219 Clear Oak
2HAN Ash Noce	6707 Ash Noce
2HAT Acacia	6213 Acacia
2HAW Ash Wenge	6703 Ash Wenge
2HBN Bisque Noce	6708 Bisque Noce
2HBW Bisque Wenge	6705 Bisque Wenge
2HCN Clay Noce	6707 Clay Noce
2HCW Clay Wenge	6706 Clay Wenge
2HSN Storm Noce	6709 Storm Noce
2HSW Storm Wenge	6704 Storm Wenge
2HWA Grey Kingswood	66WA Grey Kingswood
2HWB Planked Walnut	66WB Planked Walnut
2HWD Resolute Walnut	66WD Resolute Walnut
2HWE Natural Recon	66WE Natural Recon
2HWF Smoked Walnut E	66WF Smoked Walnut
2HZA Waxed Maple	6X50 Waxed Maple
2HZB Natural Ash	6X51 Natural Ash
2HZC Aged Ash	6X10 Aged Ash
2HZD Ashwood Oak	6X52 Ashwood Oak
2HZE Ashwood Beige	6X53 Ashwood Beige
2HZF White Washed Birchply	6X54 White Washed Birchply

Tip: Woodgrain laminates and the turnstone laminate collection are not available as matched sets. The grain patterns will not align.

E = Excluded

Custom Surfaces

Open Line Laminate (OLL)

This service allows you to order non-standard laminate at an additional processing fee of \$111 U.S. per unit, plus the cost of the laminate.

High-Pressure Laminate pricing does not include premium or digitally printed patterns from any suppliers. Laminate cost may also vary for basic or standard laminates from other suppliers. Please contact the OLL consultant at 616.475.2426 for pricing. The cost of the laminate will be added to your invoice as a separate line on the acknowledgement.

When processing orders for Open Line laminate on height-adjustable desks, specify 2900 in the laminate finish field and enter the OLL manufacturer information. Enter the required edge finish as you would a standard laminate.

Laminate Approval and Material Requirements

To confirm whether a particular laminate has already been tested for use on a specific Steelcase product or to determine material square foot requirements:

- Visit www.steelcase.com

For additional information, refer to the *Steelcase Surface Materials Reference Manual*.

Directional Laminate Grain Directions

Directional laminates are standard with the grain directions shown.

Worksurfaces—High-Pressure Laminate



Rectangular
Ology
Migration Pro
Migration Pro High-Speed
Migration Intro
Migration SE
Airtouch



Rectangular with 2" Radius Corners
Ology*
Migration Pro
Migration Pro High-Speed
Migration Intro
Migration SE



Rectangular with 5" Radius Corners
Rectangle Flex Desk
Migration Pro
Migration Pro High-Speed
Migration Intro
Migration SE



Organic Bow Front
Migration Pro
Migration Pro High-Speed
Migration Intro



Organic Bow Front and Back
Migration Pro
Migration Pro High-Speed
Migration Intro



Tapered
Ology

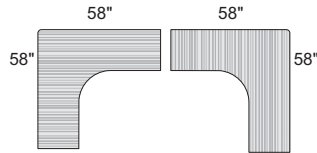

90° Equal
Migration SE
Ology

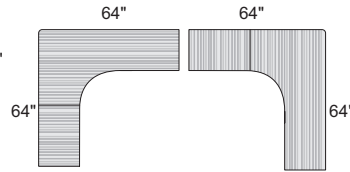

90° Equal 2 pc
Ology

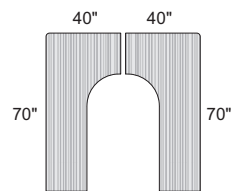

90° Extended
Migration SE
Ology

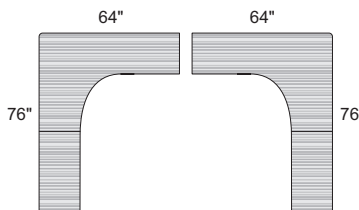

90° Extended 2 pc
Ology



90° Corner
Airtouch

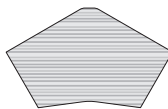

120° Equal
Migration SE
Ology



Modesty Panel
Ology
Migration Pro
Migration Pro High-Speed
Migration Intro



Tip: Modesty panels are defaulted in the horizontal grain direction for both laminate and wood veneer. Optional vertical grain direction can be specified; however, laminate specification is only allowed up to 60"W.

** Ology radius corners are 1/4".*

The appearance of wood veneer may change slightly depending on the angle from which it is viewed. This natural phenomenon is called polarization, and it can be seen on natural veneer, and to a lesser extent on composite veneer. Polarization is often noticed on worksurfaces installed at a 90° angle with each other. Please refer to the following illustrations for an understanding of grain direction on your installation.

Worksurfaces—Wood Veneer



Rectangular
Ology
Migration Pro
Migration Pro High-Speed
Migration SE

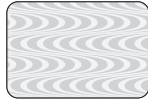

Rectangular with 2" Radius Corners
Ology*
Migration Pro
Migration Pro High-Speed
Migration SE



Rectangular with 5" Radius Corners
Rectangle Flex Desk
Migration Pro
Migration Pro High-Speed
Migration SE

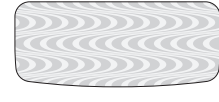

Organic Bow Front
Migration Pro
Migration Pro High-Speed

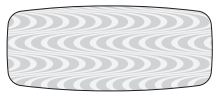

Organic Bow Front and Back
Migration Pro
Migration Pro High-Speed

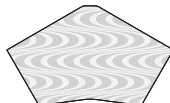

120° Equal
Ology
Migration SE

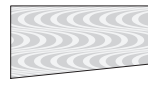

Tapered
Ology

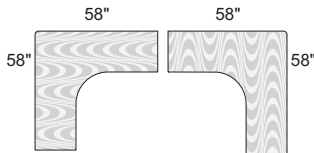

90° Equal
Migration SE
Ology

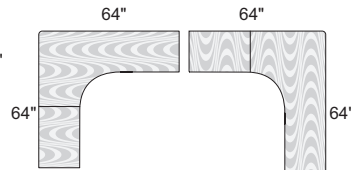

90° Equal 2 pc
Ology

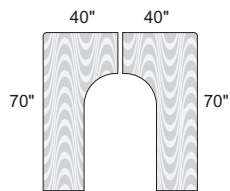

90° Extended
Migration SE
Ology

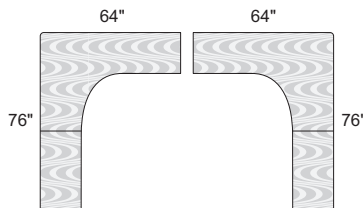

90° Extended 2 pc
Ology

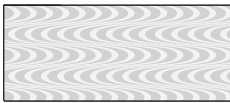

Modesty Panel Horizontal Grain Direction
Ology
Migration Pro
Migration Pro High-Speed
Migration Intro

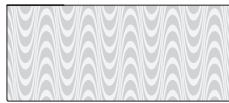

Modesty Panel Vertical Grain Direction
Ology
Migration Pro
Migration Pro High-Speed
Migration Intro

* Ology radius corners are 1/4".

Resources

Desking Products Style Number Conversion List	374
Style Number Index	376

Desking Products Style Number Conversion List

Ology Corner Desks

Old Style Number	New Style Number
90° Corner	
OLELLC	OLELL3
OLELLCB	OLELL3B
OLSLLC	OLSLL3
OLSLLCB	OLSLL3B
120° Corner	
OLELWC	OLELW3
OLELWCB	OLELW3B
OLSLWC	OLSLW3
OLSLWCB	OLSLW3B

Style Number Index

Style Number	Page	Description
AHCC	351	Vertical Cable Carrier
AM22	350	22" Modesty Screen
AM28	350	28" Modesty Screen
AM34	350	34" Modesty Screen
AM40	350	40" Modesty Screen
AM46	350	46" Modesty Screen
AM52	350	52" Modesty Screen
AM58	350	58" Modesty Screen
AM64	350	64" Modesty Screen
AMP22	350	22" Modesty and Privacy Screen
AMP28	350	28" Modesty and Privacy Screen
AMP34	350	34" Modesty and Privacy Screen
AMP40	350	40" Modesty and Privacy Screen
AMP46	350	46" Modesty and Privacy Screen
AMP52	350	52" Modesty and Privacy Screen
AMP58	350	58" Modesty and Privacy Screen
AMP64	350	64" Modesty and Privacy Screen
AP22	350	22" Privacy Screen
AP28	350	28" Privacy Screen
AP34	350	34" Privacy Screen
AP40	350	40" Privacy Screen
AP46	350	46" Privacy Screen
AP52	350	52" Privacy Screen
AP58	350	58" Privacy Screen
AP64	350	64" Privacy Screen
AWM06	352	6" Wire Manager
AWM12	352	12" Wire Manager
AWM18	352	18" Wire Manager
AWM23	352	23" Wire Manager
AWM30	352	30" Wire Manager
AWM35	352	35" Wire Manager
AWM42	352	42" Wire Manager
AWM48	352	48" Wire Manager
AWMXL30	351	6"D Wire Manager
AWMXL36	351	6"D Wire Manager
AWMXL42	351	6"D Wire Manager
AWMXL48	351	6"D Wire Manager
AWMXL54	351	6"D Wire Manager
AWMXL60	351	6"D Wire Manager
BAPB2436	291	Airtouch Hgt-Adj Wksf, 120° Equal
BAPSC2442	291	Airtouch Hgt-Adj Wksf, 90° Corner
BAPSC2448	291	Airtouch Hgt-Adj Wksf, 90° Corner
BAPSS2442	291	Airtouch Hgt-Adj Wksf, 22¼"D Rectangular
BAPSS2448	291	Airtouch Hgt-Adj Wksf, 22¼"D Rectangular
BAPSS2460	291	Airtouch Hgt-Adj Wksf, 22¼"D Rectangular
BAPSS3042	291	Airtouch Hgt-Adj Wksf, 28¼"D Rectangular
BAPSS3048	291	Airtouch Hgt-Adj Wksf, 28¼"D Rectangular
BAPSS3060	291	Airtouch Hgt-Adj Wksf, 28¼"D Rectangular
CQSF3012	344	12"H Fixed Personal/Modesty Screen
CQSF3019	344	19"H Fixed Personal/Modesty Screen
CQSF3024	344	24"H Fixed Personal/Modesty Screen
CQSF3612	344	12"H Fixed Personal/Modesty Screen
CQSF3619	344	19"H Fixed Personal/Modesty Screen
CQSF3624	344	24"H Fixed Personal/Modesty Screen
CQSF4212	344	12"H Fixed Personal/Modesty Screen

Style Number	Page	Description
CQSF4219	344	19"H Fixed Personal/Modesty Screen
CQSF4224	344	24"H Fixed Personal/Modesty Screen
CQSF4812	344	12"H Fixed Personal/Modesty Screen
CQSF4819	344	19"H Fixed Personal/Modesty Screen
CQSF4824	344	24"H Fixed Personal/Modesty Screen
CRHAD15H	283	Lower Storage, 1.5-High HAD
CRHAD1H	283	Lower Storage, One-High HAD
DSPINTRO	355	Powerstrip Intro
DSPOWER	357	Desktop Powerstrip Plus USB/Data
DSTRAYLG	359	Universal Cable Management Kit Large
DSTRAYSM	359	Universal Cable Management Kit Small
DSUP	358	Under Worksurface Utility Power
DSVCMHC	360	High-Capacity Cable Riser
E6PDHAD	144	Plnth Bs Ped Ology Ap
E6WSHAD	147	Ology Open Pedestal
FLXBRK	177	Flex, Brakes for Hgt-Adj Desks
FLXCBK4	177	Cable Brackets
FLXCS	172	Flex, Curved Screen
FLXCSP	172	Flex, Curved Screen, Pair
FLXCT	175	Flex, Cable Tray
FLXDWR	174	Desk Mount Privacy Wrap
FLXDWR10	174	Desk Mount Privacy Wrap
FLXDWW	173	Desk Mount Privacy Wrap
FLXDWW10	173	Desk Mount Privacy Wrap
FLXERQ	164	Flex, Hgt-Adj Desks, Ext Height
FLXERQB	167	Flex, Hgt-Adj Bases, Ext Height
FLXEWC3	171	120° Height-Adjustable Desk
FLXEW3	169	120° Height-Adjustable Desk
FLXMCC10	176	Magnetic Cable Clips
FLXMCC2	176	Magnetic Cable Clips
FLXMNT10	178	Magnetic Name Tag
FLXMNT2	178	Magnetic Name Tag
FLXPH	175	Flex, Power Hanger
FLXSRQ	164	Flex, Hgt-Adj Desks, Basic Height
FLXSRQB	167	Flex, Hgt-Adj Bases, Basic Height
FLXSWC3	171	120° Height-Adjustable Desk
FLXSW3	169	120° Height-Adjustable Desk, Cable Tray
FLXWCT	176	120° Height-Adjustable Desk
FLXWMP	178	120° Modesty Panel
HA1EO	241	Migration Intro Desk, Organic, Ext
HA1ER	239	Migration Intro Desk, Rectangular, Ext
HA1ERB	242	Migration Intro Base, Rectangular, Ext
HA1SRB	242	Migration Intro Base, Rectangular, Basic
HA1SRQ	239	Migration Intro Desk, Rectangular, Basic
HA2EO	227	Migration Pro Desk, Organic, Ext
HA2ER	223	Migration Pro Desk, Rectangular, Ext
HA2ERB	229	Migration Intro Base, Rectangular, Ext
HA2SRB	229	Migration Pro Base, Rectangular, Basic
HA2SRQ	223	Migration Pro Desk, Rectangular, Basic
HA3EO	236	Migration Pro High-Speed Desk, Org, Ext
HA3ER	232	Migration Pro High-Speed Desk, Rect, Ext
HA3ERB	237	Migration Pro High-Speed Base, Rect, Ext
HACBKL4	245	Migration Cable Brackets Large
HACBKS4	245	Migration Cable Brackets Small
HACR	244	Migration Cable Riser

Style Number	Page	Description	Style Number	Page	Description
HACTM	243	Migration Metal Cable Tray	PHSCRN	342	Sarto Curved Screen
HAKEBK10	246	Migration Knife Edge Adpt Brckt - Screen	PLSCRN	341	Sarto Curved Screen
HAMKT	247	Migration Maintenance Kit	PSCB	338	Sarto Alnmt Clip
HAMP	249	Migration Modesty Panel	PSPM	335	Sarto Privacy Screens
HAODKT10	247	Migration Obstruction Detection Kit	PSPS	337	Sarto Privacy Screens
HAUPBK10	246	Migration Mount Brackets – Utility Power	RATCTHAD	143	Common Top
MGDSKT	275	Desk and Bench Switch Kit	RATCTMHAD	271	Common Top
MGELCRQ	253	Migration SE Desk-Rect,C-Leg Ext Hgt	RPXFBHAD	141	Filler
MGELCRQB	266	Migration SE Base-Rect,C-Leg Ext Hgt	RPXFHAD	141	Filler
MGELCRQG	253	Migration SE Desk-Rect,C-Leg Ext Hgt GSA	RPXFBHAD	273	Filler
MGELTLC	259-260, 262	Migration SE Desk 90°, T-Leg Ext Hgt	RPXFMHAD	273	Filler
MGELTLCB	267	Migration SE Base 90°, T-Leg Ext Hgt	RPXSBHAD	140	Shroud
MGELTLCG	259-260, 262	Migration SE Desk 90°, T-Leg Ext Hgt GSA	RPXSHAD	140	Shroud
MGELTRQ	251	Migration SE,Desk-Rect, Ext hght	RPXSMBHAD	272	Shroud
MGELTRQB	265	Migration SE Base-Rect, T-Leg Ext Hgt	RPXSMHAD	272	Shroud
MGELTRQG	251	Migration SE Desk-Rect, T-Leg Ext Hgt GSA	RSCBHAD	139	Univ 1.5 High Open Lat
MGELTWC	264	Migration SE Desk 120°, T-Leg Ext Hgt	RSCHAD	139	Univ One-High Open Lat
MGELTWCB	267	Migration SE Base 120°, T-Leg Ext Hgt	RSCMBHAD	269	Univ 1.5 High Open Lat
MGELTWCG	264	Migration SE Desk 120°, T-Leg Ext Hgt GSA	RSCMHAD	269	Univ One-High Open Lat
MGSLD	275	Migration SE, Cable Bracket	SSCRN	343	Soffio Screen
MGSLCRQ	253	Migration SE Desk-Rect, C-Leg Bsc Hgt	TS8HADCBLD	352	Soft Cable Drop
MGSLCRQB	266	Migration SE Base-Rect, C-Leg Bsc Hgt	TS8HADUHK	353	Utility Hook
MGSLCRQG	253	Migration SE Desk-Rect, C-Leg Bsc Hgt GSA	UAPB2436	293	Airtouch Hgt-Adj Wksf, 120° Equal
MGSLTLC	255-259, 261	Migration SE Desk 90°, T-Leg Bsc Hgt	UAPSC1842	293	Airtouch Hgt-Adj Wksf, 90° Corner
MGSLTLCB	267	Migration SE Base 90°, T-Leg Bsc Hgt	UAPSC2442	293	Airtouch Hgt-Adj Wksf, 90° Corner
MGSLTLCG	255-256, 258	Migration SE Desk 90°, T-Leg Bsc Hgt GSA	UAPSC2448	293	Airtouch Hgt-Adj Wksf, 90° Corner
MGSLTRQ	251	Migration SE Desk-Rect, T-Leg Bsc Hgt	UAPSS2442	293	Airtouch Hgt-Adj Wksf, 22¼"D Rectangular
MGSLTRQB	265	Migration SE Base-Rect, T-Leg Bsc Hgt	UAPSS2448	293	Airtouch Hgt-Adj Wksf, 22¼"D Rectangular
MGSLTRQG	251	Migration SE Desk-Rect, T-Leg Bsc Hgt GSA	UAPSS2460	293	Airtouch Hgt-Adj Wksf, 22¼"D Rectangular
MGSLTWC	263	Migration SE Desk 120° T-Leg Bsc Hght	UAPSS3042	293	Airtouch Hgt-Adj Wksf, 28¼"D Rectangular
MGSLTWCB	267	Migration SE Base 120° T-Leg Bsc Hght	UAPSS3048	293	Airtouch Hgt-Adj Wksf, 28¼"D Rectangular
MGSLTWCG	263	Migration SE Desk 120° T-Leg Bsc Hght GSA	UAPSS3060	293	Airtouch Hgt-Adj Wksf, 28¼"D Rectangular
MIGCBK4	274	Migration, Cable Bracket	UFAL	333	Aligners
MIGCR	274	Migration, Cable Riser	UFPM	330	Uni Prv/ Mod Screen
OLATKT	136	Active Touch Kit	UFPS	333	Uni Prv Screen
OLCB	135	Ology, Cable Basket	WKSSFE	347	Fabric Side Scrn for 1.5" Wksf
OLCBK4	135	Ology, Cable Bracket	WKSSFF	346	Fabric Side Scrn for 0.808" Wksf
OLCR	135, 177	Cable Riser	WKSSFHA	347	Fabric Side Scrn for 1" Wksf
OLELL3	107-112	Ology, Hgt-Adj, 3-Leg Corner Desks	WKSSFU	347	Fabric Side Scrn for 1.185" Wksf
OLELL3B	127-129	Ology, Hgt-Adj Base, 90° 3-Leg Base	WKSSGE	349	Glass Side Scrn for 1.5" Wksf
OLELRQ	100	Ology, Hgt-Adj Desk, Rectangular	WKSSGF	348	Glass Side Scrn for 0.808" Wksf
OLELRQB	125	Ology, Hgt-Adj Desk, Rectangular	WKSSGHA	348	Glass Side Scrn for 1" Wksf
OLELRT	103	Ology, Hgt-Adj Desk, Tapered	WKSSGU	349	Glass Side Scrn for 1.185" Wksf
OLELRTB	126	Ology, Hgt-Adj Base, Tapered			
OLELW3	119-120	Ology, Hgt-Adj Base, 120° 3-Leg Corner Desk			
OLELW3B	132	Ology, Hgt-Adj Base, 120° 3-Leg Corner Base			
OLMP	134	Ology, Modesty Panels			
OLSLL3	113-118	Ology, 90° Corner Desk			
OLSLL3B	129-131	Ology, 90° Corner Base			
OLSLRQ	100	Ology, Hgt-Adj Desk, Rectangular			
OLSLRQB	125	Ology, Hgt-Adj Bases, Rectangular			
OLSLRT	104	Ology, Hgt-Adj Desk, Tapered			
OLSLRTB	126	Ology, Hgt-Adj Bases, Tapered			
OLSLW3	121-122	Ology, Hgt-Adj, 120° 3-Leg Corner Desk			
OLSLW3B	133	Ology, Hgt-Adj, 120° 3-Leg Corner Base			

Trademark List

™/® The following is a non-exhaustive list of trademarks and registered trademarks for products of Steelcase Inc. or one of its related corporate entities: Agree, Airtouch, Aisla, Alight, Amia, Answer, Apprise, Aspekt, Avenir, Await, B-Free, Ballet, Bassline, Bindu, Bivi, Bix, Bottomline, Brody, Buoy, Cachet, Campfire, Capa, CF Series, CG_1, Chord, Circa, Clipper, Cobi, Collaboration, Convene, Coupe, Cura, Currency, dash, Divisio, Duo, E-Table 2, Edge Series, Elbrook, Elective Elements, Embold, Empath, Everwall, Exponents, Folio, FrameOne, Gesture, Groupwork, Host, Hosu, i2i, Jenny, Kart, Kathryn, Kick, Lagunitas, Leap, Leela, LessThanFive, LiveBack, LiveSeat, Mackinac, Marien152, Max-Stacker, media:scape, Migration, Millbrae, Mineral, Mitra, Montage, Montara650, MoreThanFive, Move, Node, Ocular, Ology, Opus, Paperflo, Passerelle, Player, Pocket, Potrero415, QiVi, Radia, Regard, Relay, Reply, Ripple, Roam, Sarto, Scoop, Sebastopol, Senti Series, Senza, Shortcut, Sidewalk, Siento, Sieste, SILQ, Soffio, Sorrel, SOTO, Steelcase Eclipse, Steelcase Flex, Steelcase Karman, Steelcase Relay, Steelcase Rise, Steelcase Series, Surround, SW_1, Switch, Sync, Tava, Tenor, Think, Thoughtful, Thread, Together, Train, Trees, Turnstone, Umami, Underscore, V.I.A., Verb, Verge, Verlay, Victor2, Visalia, WorkValet, and X-tenz.

™/® The following are trademarks or registered trademarks of AMQ Solutions, LLC: 3F, Activ, Amobi, Bixby, Bodi, Cluvo, Concur, Embank, FL-X, Iline, Jaku, Kinex, Personality Plus, Revi, S-Series, Siya, Tektis, Tizu, Uptake, and Zilo.

™/® The following are trademarks or registered trademarks of Orangebox Ltd., Cardiff, UK: Air3, Aspect, Avi, Away from the Desk, Border, Campers & Dens, Coppice, Cubb, Kirm, On the QT, Ramsey, Skomer, Sully, Track-B, and Vale.

™/® The following are trademarks or registered trademarks of Viccarbe Habitat, S.L.: Aleta, Cambio, Designed in The Sun, Foro, Funda, Holy Day, Kelly, Last Minute, Noha, Savina, Sistema, Sistema, Viable, and Wrapp.

® The following are registered brands of Steelcase Inc. and its family of companies: Steelcase, AMQ, Coalesse, Designtex, Halcon, Orangebox, Smith System, and Viccarbe.

® The following registered trademarks are under license from AWI Licensing Company, Dover, DE: SoundScapes, DuraBrite, BioBlock, and Armstrong.

® The following registered trademarks are under license from Byrne Electrical, Rockford, MI: Interport, Mini-Port, Axil Z, and Ellora.

® The following is a registered trademark of DuPont, Wilmington, DE: Corian.

® The following is a registered trademark of Genlyte Thomas Company, Louisville, KY: Lightolier.

® The following is a registered trademark of Hilti Corporation, FL-9494 Schaan, Principality of Liechtenstein: Hilti.

® The following is a registered trademark of Leviton Manufacturing Company, Little Neck, NY: Decora.

® The following is a registered trademark of Mechanical Plastics Corp, Elmsford, NY: Toggler.

® The following is a registered trademark of Microsoft Corporation, Redmond, WA: Microsoft.

® The following are registered trademarks of Orangebox Ltd., Cardiff, UK: Orangebox.

® The following is a registered trademark of Panduit Corporation, Lockport, IL: Panduit.

® The following is a registered trademark of Trav (Press), Cuneo, Italy: Assisa.

® The following is a registered trademark of Virtual Ink, Boston, MA: mimioActive.

® The following registered trademarks are under license from Wilkhahn Furniture Products: Avera, Senzo, Versal, and Wilkhahn FS.

® The following are registered trademarks of Polyvision Corp: Flow, Motif, Polyvision, Sans, and Serif.

® The following is a registered trademark of Wilsonart International, Temple, TX: Chemsurf.

® The following is a registered trademark of Wiremold, West Hartford, CT: Wiremold.

® The following is a registered trademark of EMU Group S.P.A., Perugia, Italy: EMU.

® The following is a registered trademark of Security People, Inc.: Digilock.

® The following are registered trademarks of Natural Capital Partners Europe Limited: CarbonNeutral and the CarbonNeutral Certified logo.

™ The following is a trademark of Microsoft Corporation, Redmond, WA: Windows.

™ The following is a trademark of Rodman Industries, Inc., Oconomowoc, WI: ResinCore1.

™ The following is a trademark of Ultrafabrics, LLC, Elmsford, NY: Ultraleather.

™ The following trademarks are under license from Wilkhahn Furniture products: Cana, Linus, Logon, Picto, Range, Stitz, Thema, Timetable, and Tubis.

™ The following trademarks are under license from Walter Knoll: Andoo, Bob, Lazlo, Lox, Ribbon, and Together.

™ The following trademarks are under license from PP Mobler: Bar and Flag Halyard.

™ The following trademarks are under license from Carl Hansen: Elbow, Paddle, Shell, Wing, and Wishbone.

™ The following trademarks are under license from Cambridge Sound Management, LLC Cambridge, MA: QtPro Soundmasking, Qt Quiet Technology, and Sonet Qt.

™ The following is a trademark of Electri-Cable Assemblies, Shelton, CT: Interact.

™ The following is a trademark of Clestra Hauserman: IRYS.

™ The following is a trademark of Wiesner-Hager Möbel GmbH: Nooi.

™ The following are trademarks of Polyvision: Accord, a3, e3, Boundri, and Nota.

™ The following is a trademark of Bostock Company, Inc: SnapCab.

™ The following is a trademark of Williams-Sonoma, Inc: West Elm.

™ The following is a trademark of Elena Marquina Testor: nanimarquina.

™ The following is a trademark of Forbo International SA: Forbo.

Trademarks used herein are the property of Steelcase Inc. or their respective owners.