



Everwall Specification Guide

Availability

Electronic price list updated with release 204.C (U.S.) and 158.C (Canada), dated June 15, 2026.

All specifications subject to change without notice. Reference the electronic catalog/Hedberg for current pricing.

Transitional products in this specification guide are **maintained for existing customers only** and are likely to be phased out over time. These products are indicated with a . Products that are scheduled to be culled are indicated with an , followed by the last order entry date.

Surface Materials

The surface materials team has announced the launch of the Finish Library, found at www.steelcase.com/finishlibrary/.

► For a list of all trademarks, refer to the last page of this specification guide. © 2026 Steelcase Inc.



For Canadian Pricing

Canadian factor can be found at www.steelcase.com/CADpricing. Calculate in the following order to avoid rounding errors:

- Multiply the base price and each option by the Canadian factor.
- Round each to the nearest dollar.
- Add base and options for total list price.

Working With This Specification Guide

Ten Tips: How to Get the Most Out of This Book	4
Additional Resources	6

Statement of Line

8

Understanding

Structural Frame Components	22
Hang-on Components	25
Ceiling Clip Application	26
Skins	28
Unitized Glass	32
Glass Frame Kits	36
Swing Doors	38
Slider Doors	42
Door Pulls	46
Posts	50
Adapters	52
Vertical Transition to Lite Scale	54
Bypass	56
Cutable Ends	58
Mini End and Wall Start	60
Healthcare Applications	62
Electrical Components	64
Electrical Location	70
Electrical Wiring Schematics	73
How to Calculate Power Needs	74

► **Table of Contents, continued on next page**

► **Table of Contents, continued from previous page**

Specifying

Structural Frame Components	75
Hang-on Components	81
Skins	84
Unitized Glass	92
Glass Frame Kits	96
Swing Doors	98
Slider Doors	111
Door Pulls	116
Posts	119
Adapters	121
Bypass	124
Cutable Ends	125
Mini End and Wall Start	131
Healthcare Components	133
Electrical Components	134

Surface Materials **141**

Resources **147**

Style Number Index	148
--------------------	------------

Ten Tips: How to Get the Most Out of This Book

Tip 1

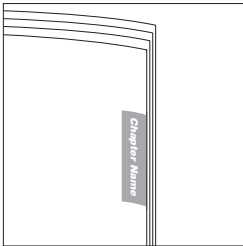

Watch the tabs on the right-hand edges of the pages. They'll always indicate which chapter you are in.

Tip 2

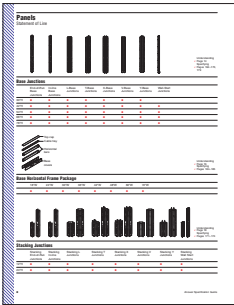

Use the Statement of Line pages for an overview of the available components, their sizes, and page references for additional information. Each *Understanding* chapter includes a statement of line after the table of contents.

Tip 3



Find cross references by looking for page numbers flagged with an arrow.

Tip 4

Study the product detail pages in the *Understanding* section to learn everything an expert knows about specific products. Each product detail page in this section contains the following features, where applicable:

- Product Drawing
- Actual Dimensions
- Product Details
- Connections
- Wiring and Cabling
- Surface Materials
- Application Topics

Product Drawing shows you what the product looks like and points out important features.

Product Details gives specific information on the product and how it is used.

Connections describes how the product is assembled or how it attaches to another product.

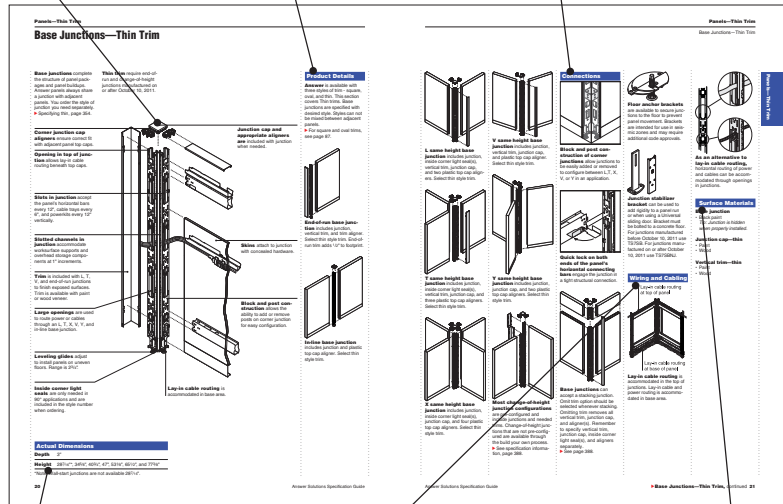

Actual Dimensions table lists the dimensions of the product.

Wiring and Cabling details the power and cable-management and cable routing capabilities of the product.

Surface Materials lists what material is used for each part of the product.

Tip 5

Refer to the specifying pages for all the information needed to order a product. Each product specifying page contains a variety of elements to help you complete a specification:

- Product Drawing
- Standard Includes
- Required to Specify
- Options
- Related Products
- Specification Information
- Dimensions
- Style Number
- Price

Standard Includes (under the red or dark grey band) provides a list of what comes standard with the product.

Required to Specify (under the red or dark grey band) itemizes the information that you must provide to order the standard product and the preferred sequence for specification.

Specification Information (under the teal or light grey band) provides product dimensions, style numbers, and prices for the standard product and any surface material choices that are available.

Product Drawing shows you what the product looks like.

The image shows two pages from a specification guide for 'Base Horizontal Frame Packages—Thin Trim'. The left page (page 296) contains sections for 'Standard Includes', 'Options', and 'Base Trim'. The right page (page 297) contains sections for 'Required to Specify', 'Specification Information', and 'Base Trim'. The 'Specification Information' section includes a table with columns for 'Width', 'Style Number', 'LWA', 'Price', and 'Option'. The 'Options' section lists various options with their LWA and Price. The 'Required to Specify' section lists items that must be specified for the product.

Options (under the black band) lists all the options that apply to the product, their price, and what is required to specify.

Related Products provide specification information for products that are directly related.

Tip 6

Required to Specify

Specify with *Customiz Stain*

Italic typeface on specifying pages usually identifies wording that you should use in your order.

i

Tip 7

To determine how many skins are needed to complete a panel, consult the table at the right.
Tip: Remember to order skins for both sides of the panel buildup.

Watch for tips throughout the text that give you explanations and helpful instructions.

Tip 8

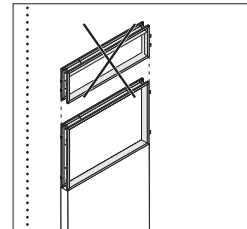

Learn what you cannot do by looking for drawings crossed out with an "X."

Tip 9

Use the surface materials listings in the Surface Materials section of this book to find surface material color numbers.

Tip 10

Style Number	Page
TS7042BL	131
TS7042S	130
TS7048BL	131
TS7048S	130
TS7060BL	131
TS7060S	130
TS7072BL	131

Refer to the style number index when you know a style number and you need to find the page that has more details about the product.

Additional Resources

Everwall is supported with informational materials, tools, and software to help you plan, specify, and order an installation efficiently.

Product brochures and planning tools can be ordered through your Steelcase area office by calling 1.800.784.0358 or through Marketing Resources web site at village.steelcase.com.

Printed Materials

Surface Materials Reference Manual

This publication provides:

- An explanation of the surface materials
- "Available on" matrices
- Vertical surface fabric and seating upholstery selection listing
- Technical data for surface materials
- Surface material care and cleaning instructions

Computer Tools

SmartTools

Everwall is designed and structured to offer the designer a broad range of dimensional and planning choices. By leveraging the parametric and functional options to best suit a given solution, a **Everwall** application can be as simple or intricate as the design criteria demands.

To help speed the product application process and ensure that product interfaces have been properly planned, all **Everwall** projects will be drawn using **SmartTools** in order to create a bill of material and then link to Hedberg.

All of the product logic and parametric values that are contained within this specification guide have been incorporated into **SmartTools** planning logic. This content is important in understanding overall product capabilities and performance. However, a full understanding is not required for planning with **Everwall**, as **SmartTools** will assist by offering the appropriate feedback and preventing any applications that don't comply with product logic.

Electronic Catalog

Accurate sales quotations and purchase orders for Steelcase products are created with specification software that uses Steelcase Electronic Catalog data. Use the data to specify and price style numbers and options for every Steelcase product. The data is updated bimonthly by Steelcase and provided to software programs including: the Hedberg Business System, **SmartTools**—Steelcase's design and specification software (for more information on **SmartTools**, please email SmartTools@steelcase.com), the ProjectMatrix ProjectSymbols libraries.

Digital Publications

You can access these digital publications at www.steelcase.com or village.steelcase.com.

Everwall Product Training

Basic training for the products included in the **Everwall** product portfolio is available on the Steelcase University website at village.steelcase.com.

Support

Steelcase Capabilities

Steelcase products are distributed, installed, and serviced through a network of more than 600 dealers worldwide. Steelcase is also represented with offices and corporate showrooms in 26 U.S. cities, 4 Canadian cities, and in France, Germany, Great Britain, and Japan. Every Steelcase product meets our exceptionally high standards of quality and durability and comes with the Steelcase assurance of excellence in service.

For ordering or product assistance,

please call line one at 1.888.STEELCASE (1.888.783.3522) or send an e-mail to lineone@steelcase.com for product application and specification assistance or contact your regional Architectural Dealer Sales Consultant.

Call the Steelcase Solutions Resource Team for assistance prior to placing an order or when working on a bid.

Call the Steelcase Solutions Fulfillment Team if you have submitted an order to Steelcase and you need to speak to your Solutions Fulfillment Team Representative about the order. Also call if you have any post shipment quality concerns or service parts questions.

For warranty information, please go to <http://www.steelcase.com/warranty/>.

Outside the U.S.A., Canada, Mexico, Puerto Rico, and the U.S. Virgin Islands, call 1.616.247.2500.

For information about Steelcase, the name of your nearest Steelcase dealer, or for product literature, call 1.800.333.9939, or visit our Web site: www.steelcase.com.

Statement of Line

Structural Frame Components

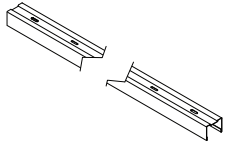

Understanding
▶ Page 22
Specifying
▶ Page 75



Understanding
▶ Page 22
Specifying
▶ Page 76

Ceiling Track

120" 144"



Structural Frame—Solid

84"H–120"H x 8"W–60"W



Understanding
▶ Page 22
Specifying
▶ Page 77



Understanding
▶ Page 22
Specifying
▶ Page 78

Frame Coupler

Ceiling Fastener

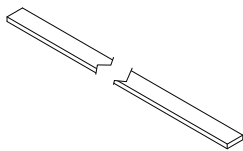

Understanding
▶ Page 22
Specifying
▶ Page 79

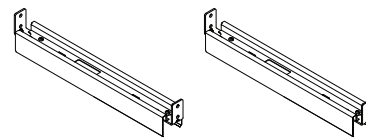

Understanding
▶ Page 23
Specifying
▶ Page 80

Floor Guide

Monitor Support Horizontals

24"W–60"W



Hang-on Components

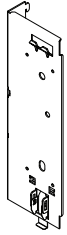

Understanding
▶ Page 25
Specifying
▶ Page 81

Elective Elements Storage Bracket

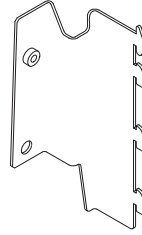

Understanding
▶ Page 25
Specifying
▶ Page 81

Elective Elements Organizer and Open Shelf Bracket



Understanding
▶ Page 25
Specifying
▶ Page 81

Universal Storage Bracket



Understanding
▶ Page 25
Specifying
▶ Page 82

Universal Vertical Off Module Bracket

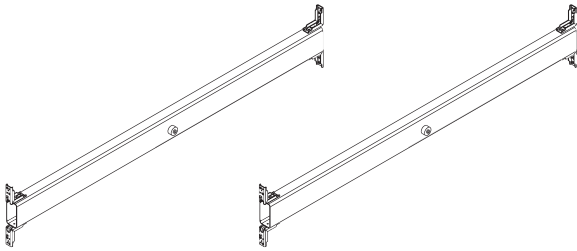

Understanding
▶ Page 25
Specifying
▶ Page 82

French Cleat Support

12"W-60"W



Hang-On Components, continued

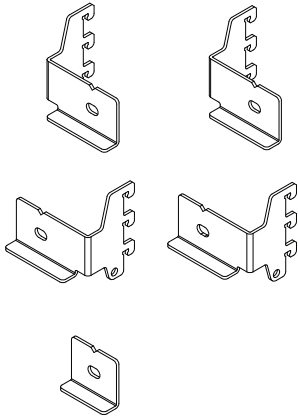

Understanding
▶ Page 25
Specifying
▶ Page 82

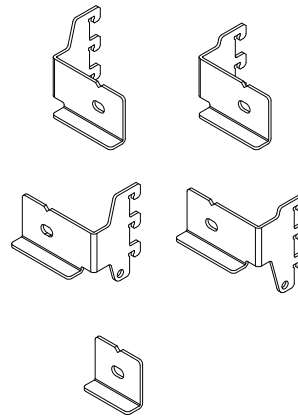

Understanding
▶ Page 25
Specifying
▶ Page 83

Flex Wall Rail Bracket, Portrait

Flex Wall Rail Bracket, Landscape

Skins

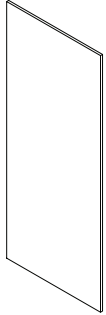

Understanding
▶ Page 28
Specifying
▶ Page 84



Understanding
▶ Page 28
Specifying
▶ Page 85

Solid Skin—Laminate

12"H–120"H x 8"W–120"W



Solid Skin—Laminate Markerboard

12"H–120"H x 8"W–120"W

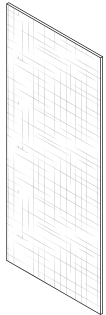

Understanding
▶ Page 28
Specifying
▶ Page 86

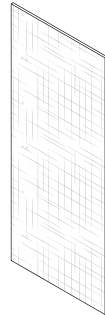

Understanding
▶ Page 28
Specifying
▶ Page 87

Solid Skin—Fabric

12"H–120"H x 8"W–120"W



Solid Skin—Steel, Fabric

12"H–120"H x 8"W–120"W

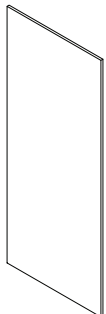

Understanding
▶ Page 28
Specifying
▶ Page 88



Understanding
▶ Page 28
Specifying
▶ Page 89

Solid Skin—Steel, Painted

12"H–120"H x 8"W–120"W



Solid Skin—Ceramic Markerboard

24"H–120"H x 24"W–120"W



Skins, continued

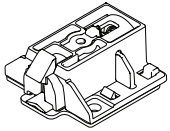

Understanding
▶ Page 28
Specifying
▶ Page 90

Solid Skin Latches

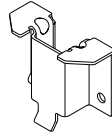

Understanding
▶ Page 28
Specifying
▶ Page 90

Solid Skin Brackets



Understanding
▶ Page 28
Specifying
▶ Page 90

Solid Skin Screw

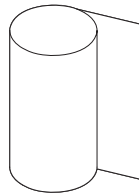

Understanding
▶ Page 28
Specifying
▶ Page 91

Acoustic Insulation

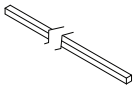

Understanding
▶ Page 28
Specifying
▶ Page 91

Acoustic Skin Seal—Small

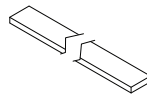

Understanding
▶ Page 28
Specifying
▶ Page 91

Acoustic Skin Seal—Large

Unitized Glass



Understanding
▶ Page 32
Specifying
▶ Page 92



Understanding
▶ Page 32
Specifying
▶ Page 94

Unitized Glass Panel

84"H–120"H x 12"W–60"W



Structural Frame—Clerestory

84"H–120"H x 12"W–60"W



Understanding
▶ Page 36
Specifying
▶ Page 96

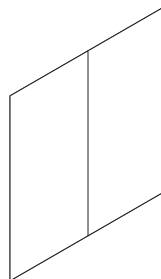

Understanding
▶ Page 36
Specifying
▶ Page 97

Frame Kit

84"H–120"H x 12"W–144"W



Glass Kit

84"H–120"H x 12"W–144"W



Glazing Tape—Clear

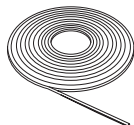

Understanding
▶ Page 37
Specifying
▶ Page 97

Swing Doors



Understanding
▶ Page 38
Specifying
▶ Page 98

Door Frame, Swing, Single

84"H-120"H x 28"W-48"W



Understanding
▶ Page 38
Specifying
▶ Page 99

Door Leaf, Swing, Solid

84"H-120"H x 28"W-48"W



Understanding
▶ Page 38
Specifying
▶ Page 100

Door Leaf, Swing, Polished Edge

84"H-120"H x 28"W-48"W



Door Hardware

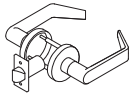

Cylindrical Latchset
 Understanding
 ▶ Page 38
 Specifying
 ▶ Page 102

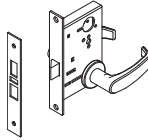

Mortise Latchset
 Understanding
 ▶ Page 38
 Specifying
 ▶ Page 103



Dome Style Floor Stop
 Understanding
 ▶ Page 38
 Specifying
 ▶ Page 104



Magnetic Wall Stop
 Understanding
 ▶ Page 38
 Specifying
 ▶ Page 105

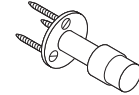

Screw In Base Stop
 Understanding
 ▶ Page 38
 Specifying
 ▶ Page 105

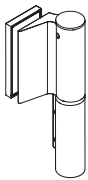

Slim Line Hinge
 Understanding
 ▶ Page 38
 Specifying
 ▶ Page 106

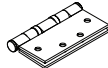

Butt Hinge
 Understanding
 ▶ Page 38
 Specifying
 ▶ Page 106

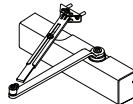

Closer
 Understanding
 ▶ Page 38
 Specifying
 ▶ Page 107

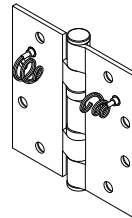

Electric Hinge
 Understanding
 ▶ Page 38
 Specifying
 ▶ Page 107



Roller Latch
 Understanding
 ▶ Page 38
 Specifying
 ▶ Page 108

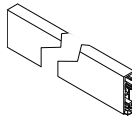

Drop Seal Assembly, Swing Door
 Understanding
 ▶ Page 38
 Specifying
 ▶ Page 108

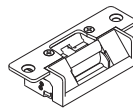

Electric Strike
 Understanding
 ▶ Page 41
 Specifying
 ▶ Page 109

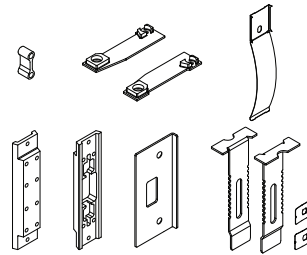

Assembly Hardware, Swing Door Frame
 Understanding
 ▶ Page 38
 Specifying
 ▶ Page 110

Slider Doors



Understanding
 ▶ Page 42
 Specifying
 ▶ Page 111

Door Frame, Slider, Single

84"H-120"H x 40"W-48"W

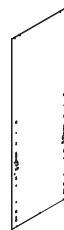

Understanding
 ▶ Page 42
 Specifying
 ▶ Page 112

Door Leaf, Slider, Polished Edge

84"H-120"H x 40"W-48"W

Slider Doors, continued

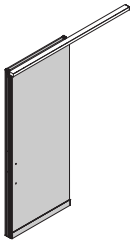

Understanding
▶ Page 42
Specifying
▶ Page 113

Door Track, Slider, Single

75"W–120"W

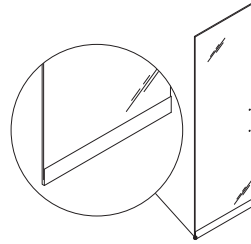

Understanding
▶ Page 42
Specifying
▶ Page 114

Slider Door-Drop Seal Housing

40"W–48"W

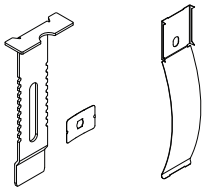

Understanding
▶ Page 42
Specifying
▶ Page 114

Assembly Hardware, Slider Door Frame

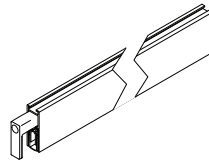

Understanding
▶ Page 42
Specifying
▶ Page 115

Slider Door Hardware—Drop Seal

40"W–48"W



Understanding
▶ Page 42
Specifying
▶ Page 115

Door Hardware—Slider Lever Lock



Door Pulls

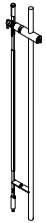

Understanding
 ▶ Page 46
 Specifying
 ▶ Page 116

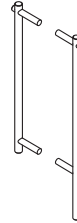

Understanding
 ▶ Page 46
 Specifying
 ▶ Page 117

Door Hardware—Ladder Pull, Aligned

Door Hardware—Ladder Pull, Offset

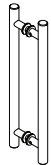

Understanding
 ▶ Page 46
 Specifying
 ▶ Page 118

Door Hardware—Push/Pull Handle

Posts



Understanding
 ▶ Page 50
 Specifying
 ▶ Page 119



Understanding
 ▶ Page 50
 Specifying
 ▶ Page 119

Post, Two-Way

Post, Three-Way

90° 120° 135° 180°
 ● ● ● ●

90° 120° 135°
 ● ● ●



Understanding
 ▶ Page 50
 Specifying
 ▶ Page 120



Understanding
 ▶ Page 52
 Specifying
 ▶ Page 121

Post, Four-Way

90° T/X Adapter

Adapters

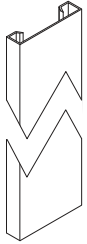

Understanding
▶ Page 52
Specifying
▶ Page 121



Understanding
▶ Page 52
Specifying
▶ Page 122

Finished End

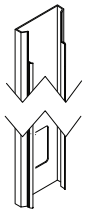

Understanding
▶ Page 52
Specifying
▶ Page 123

Utility Panel Frame

84"H–120"H



Understanding
▶ Page 52
Specifying
▶ See *Lite Scale Specification Guide*

Utility Panel Cover

84"H–120"H



Vertical Transition to Lite Scale



Understanding
▶ Page 52
Specifying
▶ Page 124

Bypass

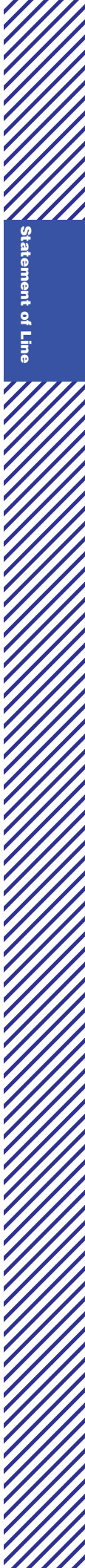

Cutable Ends

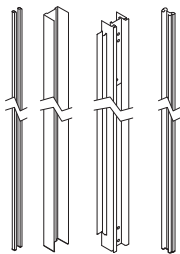

Understanding
 ▶ Page 58
 Specifying
 ▶ Page 125



Understanding
 ▶ Page 58
 Specifying
 ▶ Page 126

90° Cutable End Assembly

84"H–120"H



90° Cutable End Inner Channel

48"L 120"L



Understanding
 ▶ Page 58
 Specifying
 ▶ Page 127



Understanding
 ▶ Page 58
 Specifying
 ▶ Page 128

90° Cutable End Outer Channel

48"L 120"L



Cutable End Capture Trim

12.1"H–120"H



Understanding
 ▶ Page 58
 Specifying
 ▶ Page 129



Understanding
 ▶ Page 58
 Specifying
 ▶ Page 130

Cutable End Corner Angle

Cutable End Elbow

Mini End and Wall Start

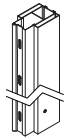

Understanding
▶ Page 60
Specifying
▶ Page 131



Understanding
▶ Page 60
Specifying
▶ Page 132

90° Adjustable Mini End

Medium
(2¼"H–37⁄8"H)

Large
(4¼"H–57⁄8"H)



Wall Start

Healthcare Components

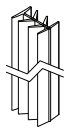

Flush Skin Seal

Understanding
▶ Page 62
Specifying
▶ Page 133



90° Inside Corner Flush Skin Seal

Understanding
▶ Page 62
Specifying
▶ Page 133

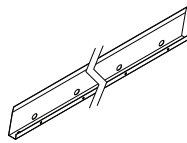

Cove Base Trim - Straight

Understanding
▶ Page 62
Specifying
▶ Page 133

Electrical Components

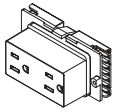

Receptacle
 Understanding
 ▶ Page 64
 Specifying
 ▶ Page 134

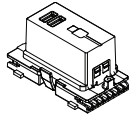

USB Receptacle
 Understanding
 ▶ Page 64
 Specifying
 ▶ Page 135

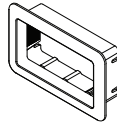

Power Receptacle Trim
 Understanding
 ▶ Page 64
 Specifying
 ▶ Page 135

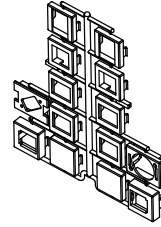
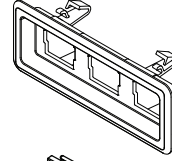

Modular Communication Faceplate
 Understanding
 ▶ Page 64
 Specifying
 ▶ Page 136



Hardwire

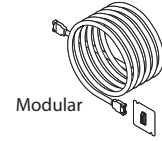

Modular

Multipurpose Infeed - 8 Wire
 Understanding
 ▶ Page 64
 Specifying
 ▶ Page 137

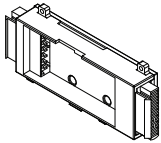

Power Block
 Understanding
 ▶ Page 64
 Specifying
 ▶ Page 137

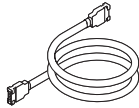

Modular Harness - 8 Wire
 Understanding
 ▶ Page 64
 Specifying
 ▶ Page 138



Harness-to-Harness Branching Connector
 Understanding
 ▶ Page 64
 Specifying
 ▶ Page 139

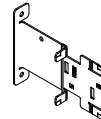

Electrical Mounting Bracket-Skin Modular
 Understanding
 ▶ Page 64
 Specifying
 ▶ Page 140

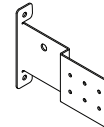

Electrical Mounting Bracket-Skin Hardwire
 Understanding
 ▶ Page 64
 Specifying
 ▶ Page 140

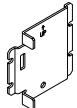

Modular



Hardwire

Electrical Mounting Bracket-Utility Panel
 Understanding
 ▶ Page 64
 Specifying
 ▶ Page 140

Structural Frame Components

Everwall's structural frame components

arrive on-site with all verticals, horizontals, and floor track assembled. Once the ceiling track is installed, the frame tilts into place.

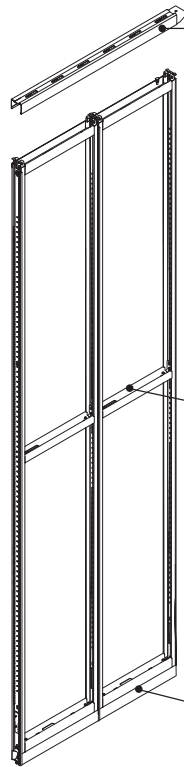

Ceiling track secures the top of the Everwall structural frame to the suspended ceiling grid. Allows plus/minus $\frac{1}{2}$ " of adjustment.

Intermediate horizontals are mounted between the floor and ceiling to support skin segmentation and electrical components.

Floor track is unitized to the structural frame as part of the manufacturing process.

Product Details

Structural frame components can be specified in sizes ranging from 84"H–120"H (ceiling height) and from 8"W–60"W in $\frac{1}{16}$ " increments.

Everwall finished wall thickness is 4".

For improved structural frame reconfigurability, pre-set widths are available: 8", 12", 18", 20", 24", 30", 36", 40", 42", 48", 54", and 60".

Frame couplers are used to join structural frame components once the skins are attached. Frame couplers are recessed and fit in between skins. They run to the top of the skin without overlapping the ceiling track and run to the floor, overlapping the floor track.

Acoustic seals are applied to the vertical and horizontal pieces of the structural frame components for improved acoustics. These seals are slightly visible when viewed from certain angles.

Large seals are for horizontals, small seals are for verticals.

There is a consistent 0.35 inch reveal between skins, junctions, and any other structural component.

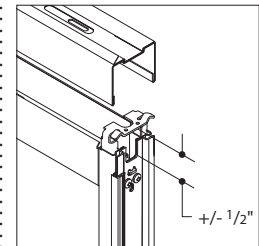

Ceiling track comes in 120" and 144" lengths; can be field cut on site. Allows plus/minus $\frac{1}{2}$ " of vertical adjustments to accommodate ceiling variation.

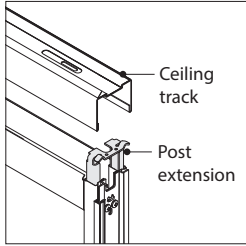

Structural frames include an adjustable post extension to ensure connection into the ceiling track.

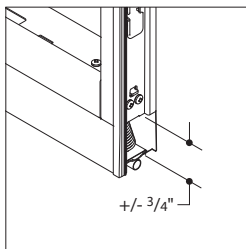

The floor track is factory assembled to the structural frame, and serves as the base trim as well. There is plus/minus 3/4" of adjustment to accommodate variations at the floor.

Springs are located between the floor track and structural horizontals to ensure continuous contact of the floor track with the floor.

Floor track sections that are 18"W or wider include cut-outs for routing cable through the floor.

Ceiling track seal can be specified from three color choices.

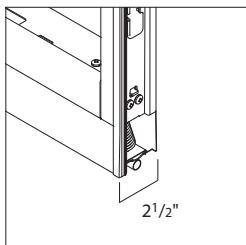

Structural frames are approximately 2 1/2" thick to accommodate an overall wall thickness of 4".

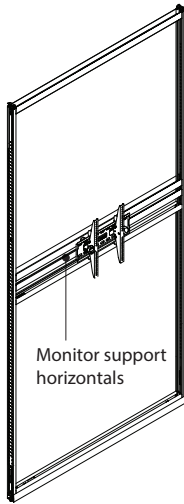

Monitor support horizontals come in sets of two and include hardware for anchoring the monitor mount bracket through the skin. Monitor support horizontals are installed on site. Each set has a maximum weight capacity of 200 pounds.

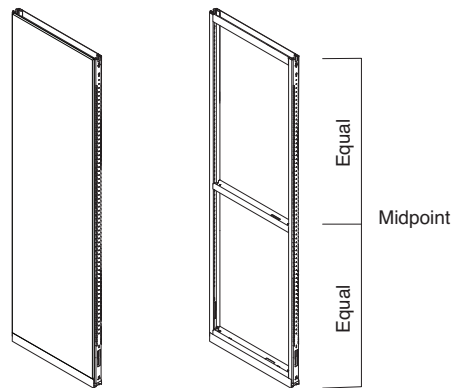

Monolithic Skin

To improve rigidity in shipping and handling, structural frames automatically include an intermediate horizontal at the midpoint of the frame.

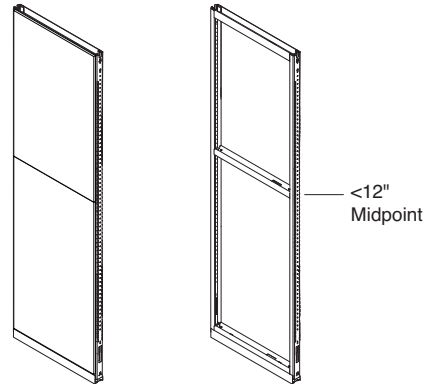

Segmented Skin

When a horizontal is added for segmentation or clerestory, and it is less than 12" from the center of the frame, that muntin will take the place of the shipping horizontal.

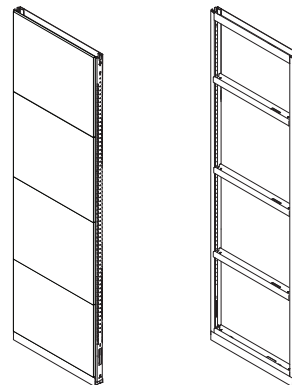

Segmented Skin

Intermediate horizontals are positioned according to skin configuration.

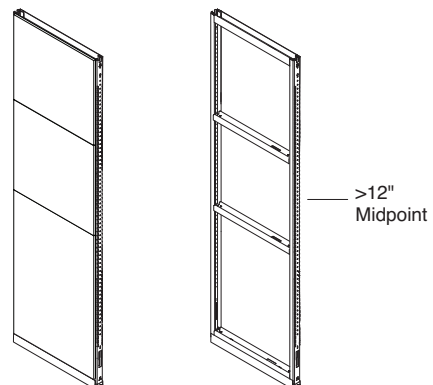

Segmented Skin

When horizontals are added for segmentation or clerestory, and the muntin is greater than 12" from the center of the frame, a shipping horizontal is still included.

Up to two cable access holes per intermediate horizontal allows for routing of power and communications cabling.

Power and communication mounting brackets are attached to verticals and intermediate horizontals for positioning modular and hardwire electrical components.

If mounted on a horizontal, brackets will be mounted horizontally. Please see electrical section for more details.

If mounted on a vertical, brackets will be mounted vertically.

Brackets can be mounted in three positions:

Low
Default height is ADA (17½")
Other options are: 10½" to 23½" in 1" increments.

Medium
Default height is Desk (34½")
Other options are: 24½" to 47½" in 1" increments.

High
Default height is Standing Monitor (49½")
Other options are: 47½" to 102½" in 1" increments.

Connections

Ceiling track fasteners secure the track to the suspended ceiling grid. Seven standard styles:

- 1"W exposed T
- ¾"W exposed T
- ¼" Donn fineline
- ⅛" Donn fineline
- 1" fluted runner ¼–20
- 1"W T for tegular ceiling tiles
- ¾"W T for tegular ceiling tiles

Spacers are included with fasteners for tegular ceiling tiles that allow adjustment for different tile edge depths.

Fasteners for other types of ceilings are purchased locally.

The building's designated design professional (architect or engineer) must verify that the ceiling grid is adequate to support the lateral loads imposed by ceiling supported walls. Local codes may require independent bracing.

Floor guides with simple option are positioned under verticals, and are required when installing Everwall on Underscore. They include material for gripping to hard surfaces and carpet.

Floor guides can also be specified for use in seismic design applications. Additional mechanical fasteners (not included with the floor guide) may be required as specified by the structural engineer.

Tip: Floor guides are cut in half when placed adjacent to posts and door frames.

When planning with Everwall on Underscore, do not position the wall directly above the edge trim, as this will create an unstable condition.

Wiring & Cabling

Power and data components are ordered separately. Standard access openings are available in the framing components. There is adequate space within the walls to feed the wires and cable needed for either modular or hardwire power and communication. ADA and desk height are the most common placements for power and communication. However, Everwall allows for power to be mounted on the verticals every 1", as long as it is above 15½" from the floor and more than 13½" from the ceiling. When mounting both modular and hardwired power horizontally, the structural frame must be at least 24" wide and the power must be mounted at center.

Surface Materials

Ceiling track

- 4799 Platinum Metallic
- 7241 Arctic White
- 7360 Merle

Floor track

- 7190 Platinum Solid
- 7360 Merle

Frame coupler

- 6249 Platinum Solid
- 6527 Merle

Acoustic seals

- 6249 Platinum Solid
- 6527 Merle

Surface Materials

Ceiling Clip Application
▶ See page 26



French Cleat Support

French cleat supports are used in sets of two to provide internal reinforcement in those applications where surface mounted storage is desired.

French cleat supports can hold a maximum of 700 pounds per side. Center of gravity of load must not exceed 7½" from the face of the skin.

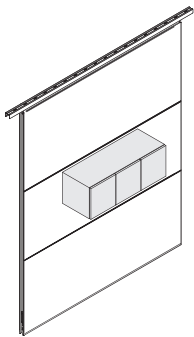

Storage hang-ons can be attached to slots in the solid panel and clerestory structural frames with brackets that interface with Elective Elements products. A maximum of two hang-on items can be hung per side of the panel frames.

In certain sizes and applications, items such as artwork or signage can be surface mounted directly to skins (steel or laminate) without the need for internal reinforcement. Surface mounting in this manner will result in holes in the skin. The following guidelines are based on an overall projection off the face of the wall of 4" or less with a maximum weight of 20 pounds.

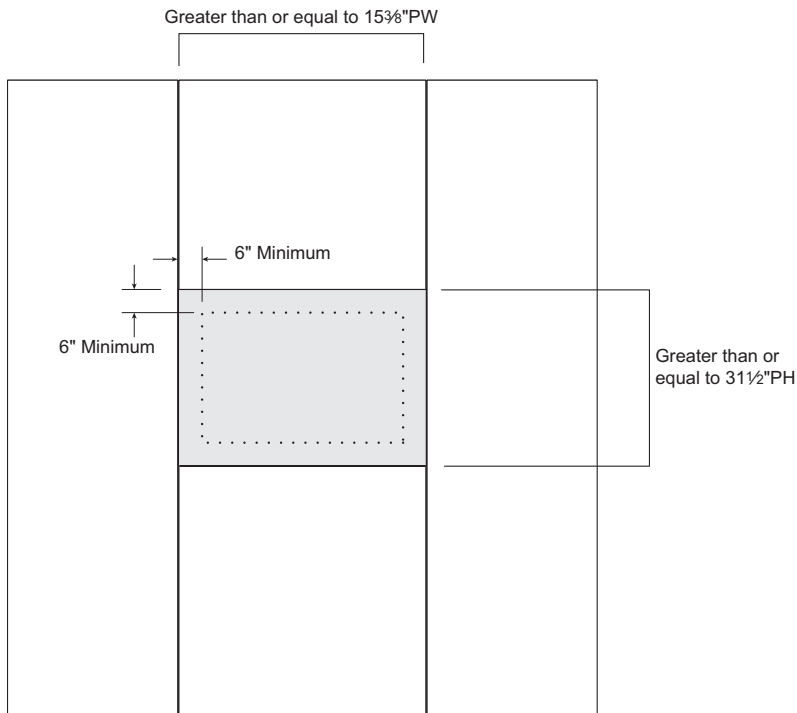

If skin planning height is greater than or equal to 31½" and skin planning width is greater than or equal to 15¾", surface mounting of up to 20 pounds is allowed. The item being mounted must project 4" or less from the surface of the skin. The mounting points of the item being hung must be at least 6" from the edges of the skin.

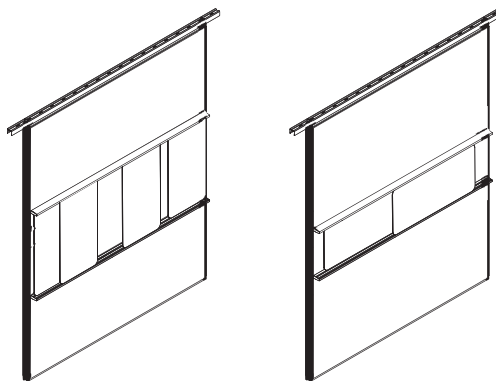

Flex wall rails can be installed using brackets engaged into the hanging slots of the Everwall structural frames.

Wall rails can be installed to allow for Flex markerboards to be installed in either portrait or landscape orientations.

Ceiling Clip Application

Tip: All planning and application guidelines contained in this section of the specification guide are based on the requirement that ceiling track is connected to a ceiling in order to properly install and align the wall components as shown. When any partition is fastened to a suspended ceiling grid, it may be necessary for an architect or engineer to verify that the grid can adequately support the partition. Local codes may require additional bracing.

T Grid Ceiling Fastener Kits

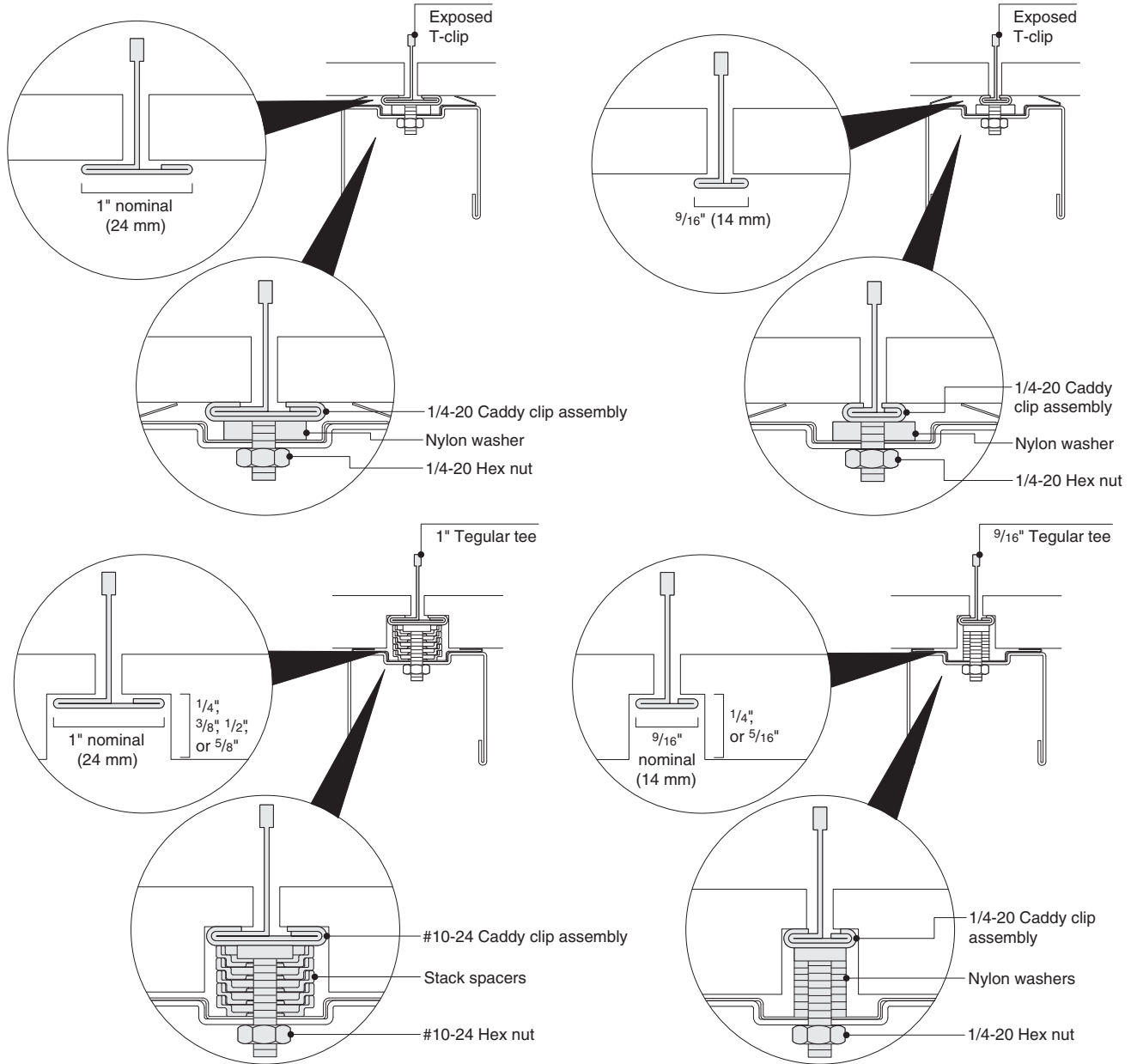

Bolt Slot Grids Ceiling Fastener Kits

Ceiling clips support the most common types of ceiling systems.

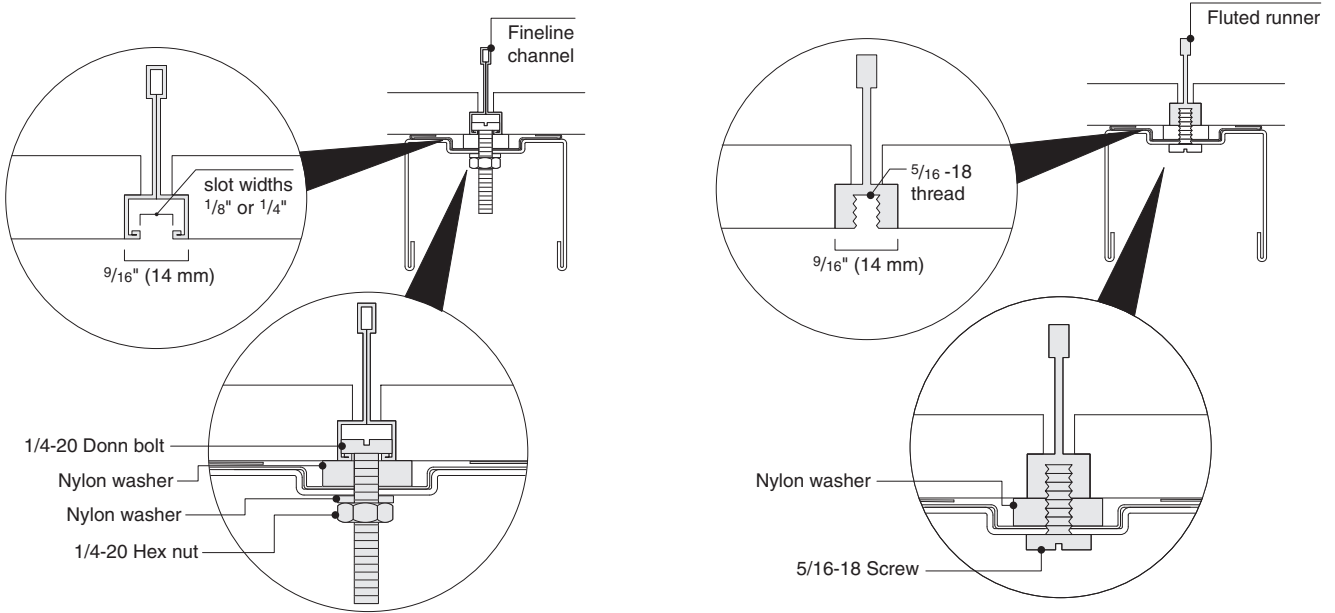

Concealed Grids – Field-Purchased Generic Fasteners

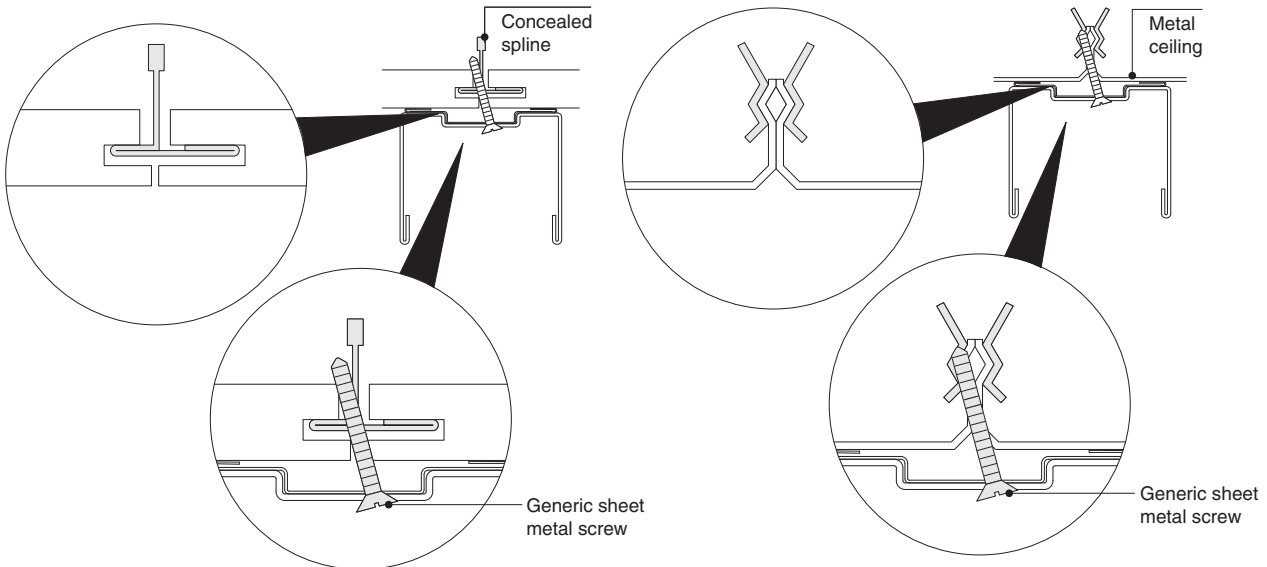

For these and other types of ceilings, the following fasteners can be sourced locally by the installer:

Concealed spline	#7 – 17 x 1 5/8" Bugle Head Self-Drilling Screws
Drywall	#14 – 1" Phillips Head SMS with plastic anchor
Plaster	1/4 – 20 Toggle Bolt
Concrete	Tapcon Anchor x 2"
Metal Pan	#7 – 17 x 1" Bugle Head Self-Drilling Screws

Skins

Everwall's skins can span up to four frames in either portrait or landscape orientation. A portrait skin is considered to be taller than it is wide and landscape skin is wider than it is tall.

Painted steel skins provide a simple and functional finish that is durable and easy to maintain. Surfaces support magnetic accessories. Skins can be combined with different acoustic accessories to achieve high STC levels.

Brackets, latches, and screws must be ordered separately. The brackets, latches, and screws are auto-calculated in SmartTools as these are skin size and orientation dependent. All brackets and latches are assembled with the screws to the back of the skin on site to enable the solid skin to attach to the frame.

Latches require two screws per latch.

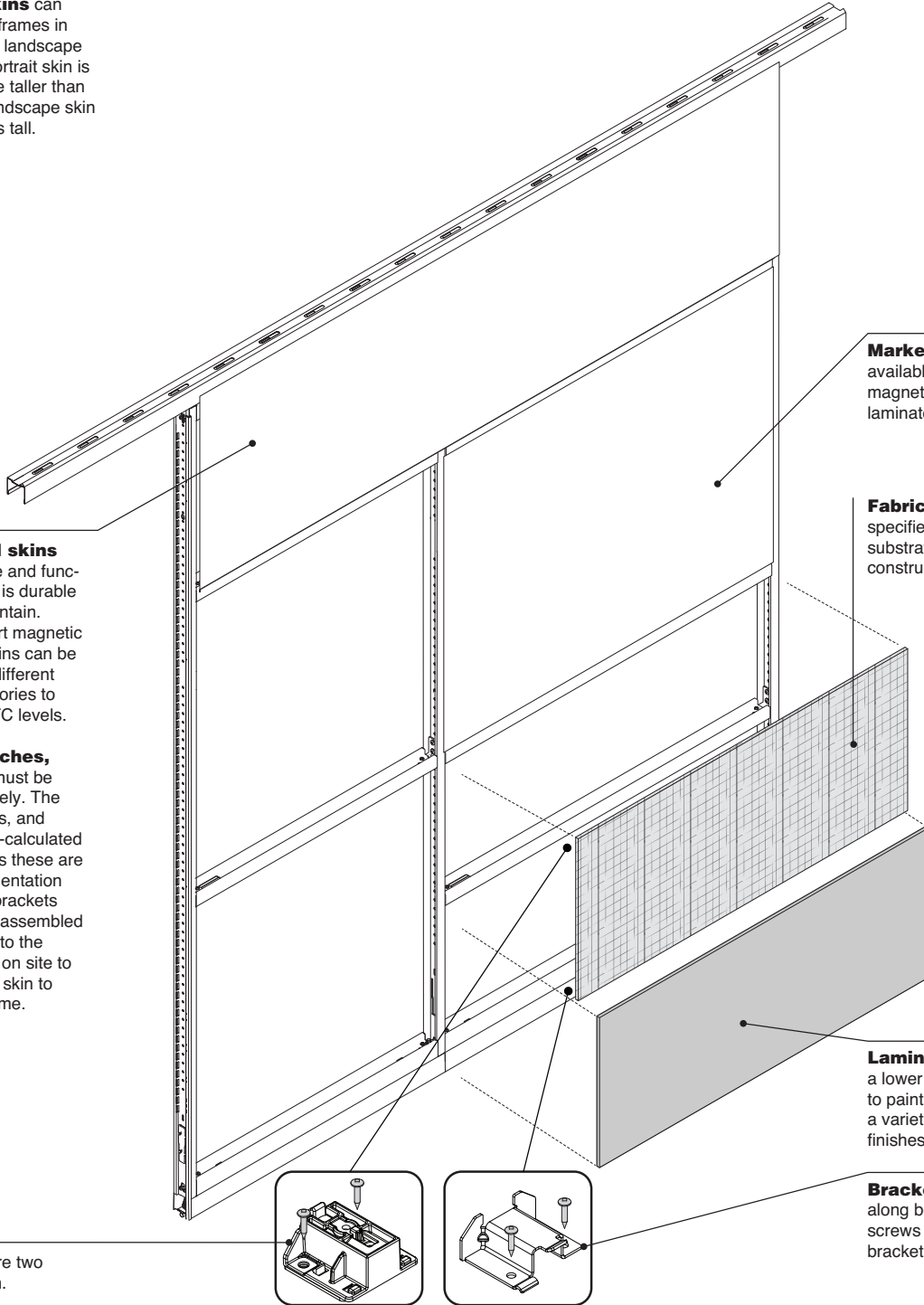

Markerboards are available in CeramicSteel magnetic and non-magnetic laminate.

Fabric skins can be specified with a laminate substrate or steel substrate construction.

Laminate skins provide a lower priced alternative to painted steel and offer a variety of colors and finishes.

Brackets are always along bottom of skin. Two screws are required per bracket.

Product Details

Solid skins can be specified in a range of sizes depending on material.

While skins can be specified in 1/16" increments, for improved solid skin reconfigurability, pre-set sized widths are available: 12", 18", 20", 24", 30", 36", 40", 42", 48", 54", and 60".

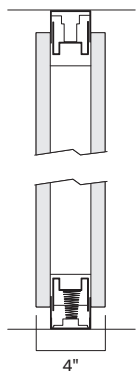

Everwall finished wall thickness is 4".

If plan height is greater than 60", the width cannot be greater than 60".

If plan width is greater than 60", plan height cannot exceed 60".

Solid skins, available with steel and laminate surfaces, form the visual and functional surface of the vertical plane that creates the desired environment and facilitates future change.

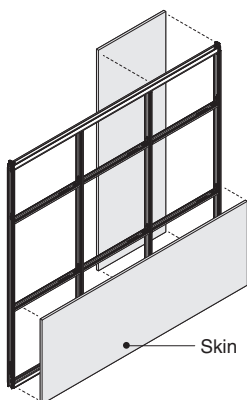

Skins can span up to four structural frames, and multiple intermediate horizontals. Different configurations are allowed on opposite sides of the wall.

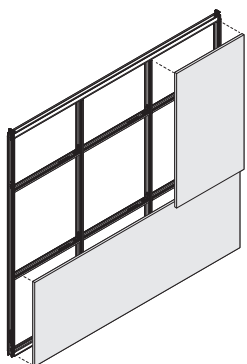

Skins can be oriented horizontally or vertically on the wall.

Solid skins install with brackets and latches assembled to the skin on site. Brackets, latches, and screws are ordered separately.

Skin brackets are positioned for mounting specifically in top, bottom, or intermediate positions.

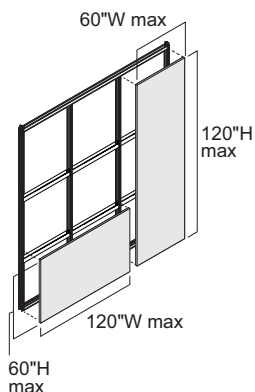

Steel painted, steel fabric, laminate, laminate markerboard, and fabric skins' maximum planning dimensions are 120"W by 60"H for landscape planning and 60"W by 120"H for portrait planning. Minimum planning dimensions are 8"W and 12"H.

When the width or height of the skin exceeds 60", the fabric warp direction will run parallel to the long dimension.

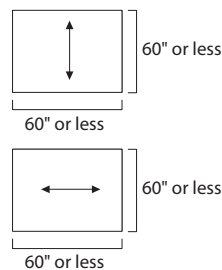

When the skin size is 60" or less in width and height, the fabric warp direction can be specified to run vertically or horizontally.

When the width or height of wood grain laminate skin exceeds 60", the grain pattern will run parallel to the long dimension.

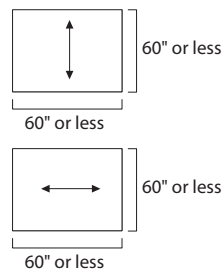

When the skin size is 60" or less in width and height, the grain pattern can be specified to run vertically or horizontally.

Ceramic Skins

CeramicSteel markerboard maximum planning dimensions are 120"W x 48"H for landscape planning and 48"W x 120"H for portrait planning. Minimum planning dimensions are 24"W and 24"H.

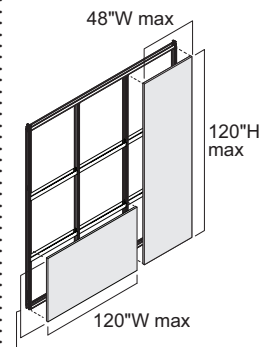

48"H max

Ceramic skins can be mounted in top, bottom, and intermediate positions and used in a single floor to ceiling application. There are no restrictions with the opposite side of the wall when using a ceramic skin.

Everwall ceramic skins incorporate the e³ environmental CeramicSteel surface.

Ceramic skins do not accommodate electrical cutouts.

CeramicSteel markerboards and laminate markerboards have different surface finishes. Ceramic markerboards have a smoother surface finish, laminate markerboards have a slightly textured or "orange peel" surface finish.

Acoustics

The STC performance levels can be improved by adding insulation to the wall cavity between the skins.

Insulation is provided in rolls that are 48"W x 174 feet long x 1" thick.

Flammability

Skins comply with ASTM E84 Surface Characteristics of Building Materials:

- Painted steel and fabric on steel—Class A (Type 1)
- Ceramic skins—Class A
- Laminate and fabric on laminate—Class C (Type 3)

Connections

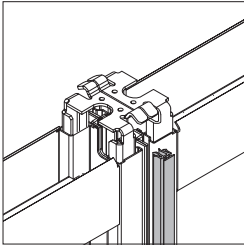

Frame couplers, ordered separately, join panels together. They prevent light and sound leaks and run from the top of the glass frame to the floor, overlapping the floor track.

Wiring & Cabling

Solid skins can be specified with electrical cut-outs to accommodate modular power, communications, and hardwire devices.

Electrical cut-outs can also be cut on site during installation.

ADA and desk height are the most common placements for power and communication. However, power can be placed at various heights. Please see Structural Frame Components for more information
 ▶ See page 22

Receptacles in walls can be specified in any combination of ADA, desk height, or other positions.

Hardwired switches and other electrical devices can also be located in the wall, but are not provided by Steelcase.

Electrical devices can be specified on either side or both sides of the wall. Components cannot be positioned back-to-back.

Surface Materials

Steel skins

- Fabric
 - Paint
- Tip: Metallic paint size restrictions = 36"W maximum width and 24 square feet.*

Laminate skins

- Low-Pressure Laminate
 - Open Line laminate
- Tip: Edge trim colors are pre-set for standard finishes.*

Open Line laminate can be applied with vertical grain direction only. Open Line laminates are not allowed on skins that are 60"W or wider. Open Line laminate is only available when specifying modular skins.

Directional and wood grain laminate can be applied horizontally on skins up to 96"W and vertically up to 60"W. Directional and wood grain laminate can only be applied vertically on skins.

Wood veneer grain direction can be specified horizontal or vertical for all skins.

Application Topics

- Electrical Components
- ▶ See page 64

Unitized Glass

Note: All planning and application guidelines contained in this section of the specification guide are based on the requirement that ceiling track is connected to a ceiling in order to properly support the wall components as shown.

Everwall unitized glass creates floor-to-ceiling walls, prefabricated to the height and width dimensions you specify. These panels can be easily relocated to respond to changing needs.

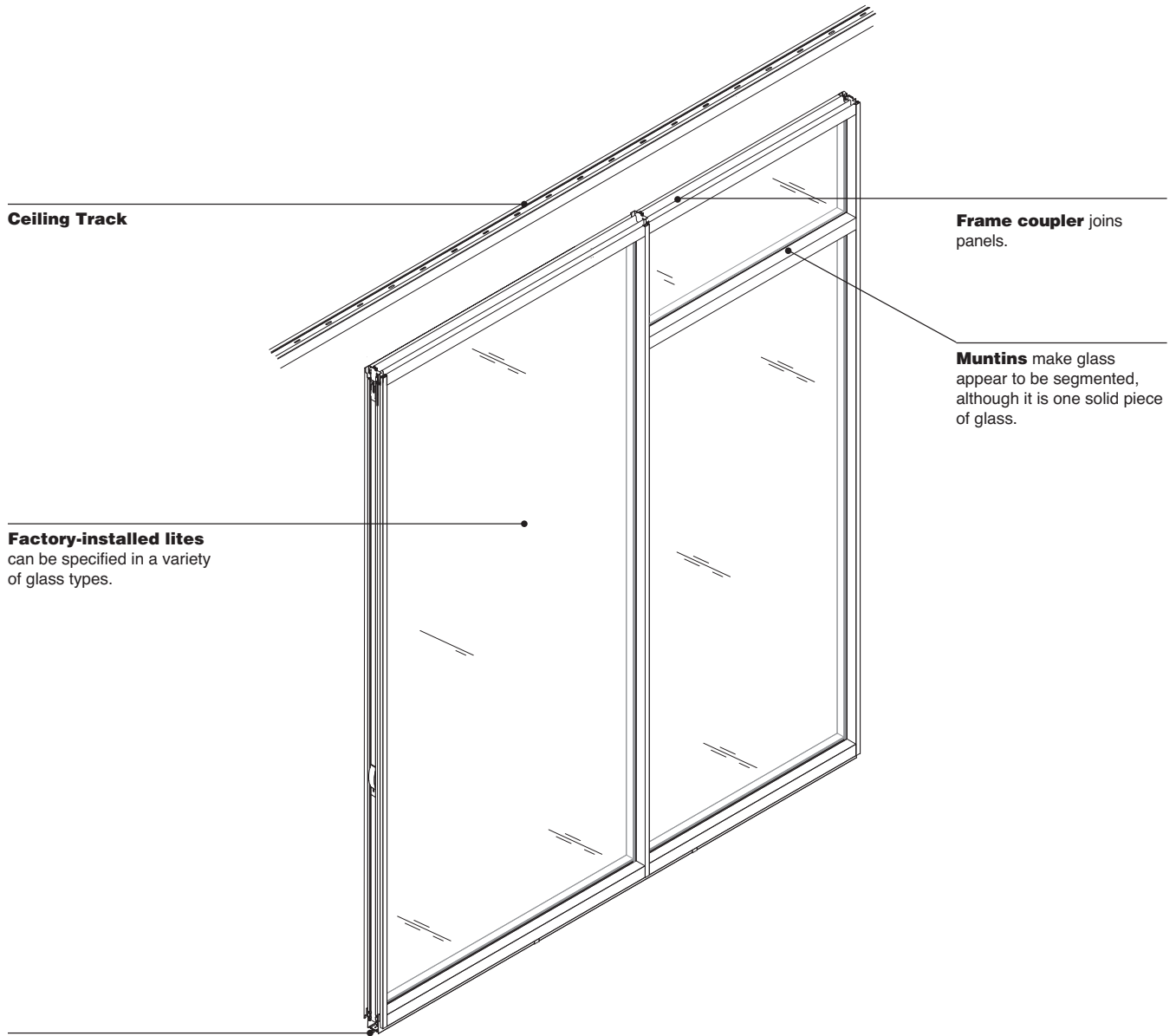

Ceiling Track

Frame coupler joins panels.

Muntins make glass appear to be segmented, although it is one solid piece of glass.

Factory-installed lites can be specified in a variety of glass types.

Adjustable glides allow panels to be installed on uneven floors.

Product Details

Unitized glass panels arrive on-site with glass, frame, and floor track pre-assembled.

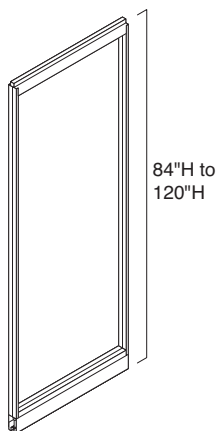

Panel height can be specified from 84"H–120"H at 1/16" increments.

For improved unitized glass reconfigurability, pre-set sized plan widths are available: 12", 18", 20", 24", 30", 36", 40", 42", 48", 54", and 60".

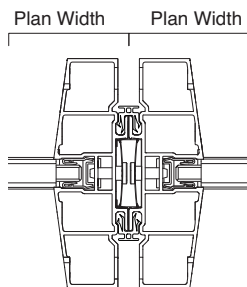

Plan width of panel is measured to center of joint between two panels.

Unitized glass can accommodate glass thickness of 1/4" or 3/8".

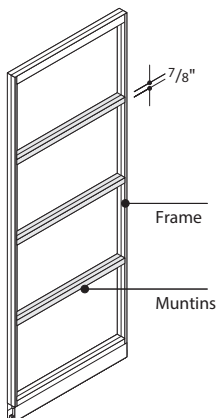

Muntins can be used to add visual segmentation to glass panels. Muntin positions can be specified in 1" increments.

Unitized glass frames maximum height is 120" and maximum width is 60". Minimum height and width is 84"H by 12"W.

Different types and thicknesses of glass may change the overall acoustic performance of a glass wall.

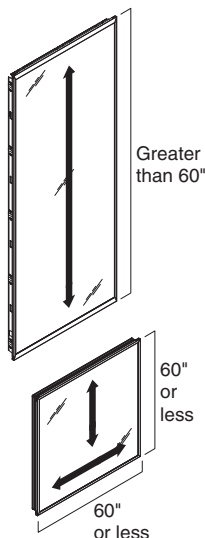

Certain glass patterns may have a linear pattern. When one of the glass frame dimensions is greater than 60", the linear direction will run parallel to the long dimension. When both frame dimensions are less than 60", the user can specify if the pattern is to run vertically or horizontally.

Certain etched or pattern glass types are polished on one face, and rough (etched or pattern) on the other. When defining the surface orientation of a glass frame, it is also important to consider the surface orientation of these types of glass. When planning with etched glass, the polished face of the glass is most often oriented to the corridor side of the wall to minimize the buildup of dirt on the etched face. Pattern glass is most often positioned with the patterned face oriented to the corridor, as the pattern face of the glass is considered the more attractive surface. Although these are the most common preferences for surface orientation, Everwall will allow for any relative position and orientation.

Connections

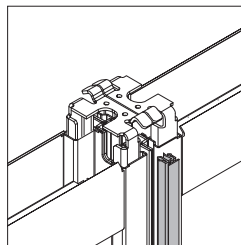

Frame couplers, ordered separately, join panels together. They prevent light and sound leaks and run from the top of the glass frame to the floor, overlapping the floor track.

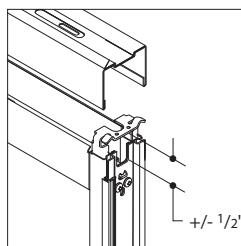

Ceiling track comes in 120" and 144" lengths; can be field cut on site. Allows plus/minus 1/2" of floating vertical adjustments to accommodate ceiling variation.

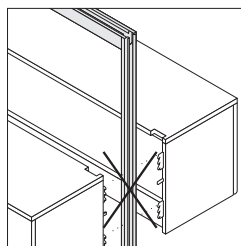

Panel-supported storage components cannot be attached to glass wall panels. Use solid wall or Clerestory panels instead.

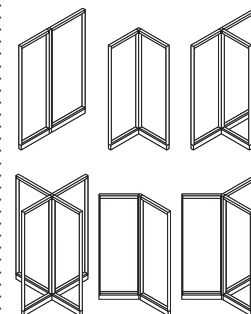

Posts join panels in in-line, L-, T-, X-, V-, and Y-configurations without blocking access to integral slotted verticals.

▶ Page 114

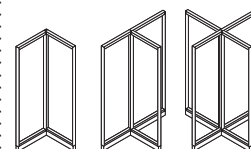

Adapters connect panels in L-, T-, and X-configurations without adding extra creep to panel dimension.

▶ Page 121

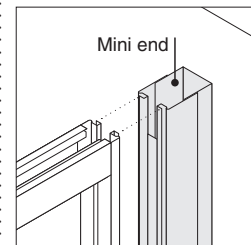

Mini end connects a panel or panel run to a perpendicular building wall.

▶ Page 126

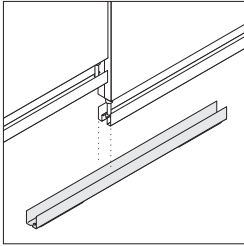

Floor grippers can be used to provide additional lateral support at the floor on carpet or hard surfaces, utilizing the simple option specification. They are required when used in active seismic zones as directed by the structural engineer of record, utilizing the seismic option specification.

Floor grippers are required when Everwall is installed on Underscore low profile floor. The simple gripper type option must be selected.

Wiring & Cabling

Unitized glass does not accommodate power or communication cabling.

Utility panels can be positioned adjacent to glass frames to facilitate cable routing and to introduce outlets, switches, and other electrical devices.

Surface Materials

Panel frame and muntins

- Paint

Anodized

- 8043 Clear Anodized Aluminum

Glass

- 1/4" thick
- 3/8" thick

Ceiling track

- 4799 Platinum Metallic
- 7241 Arctic White
- 7360 Merle

Frame coupler

- 6249 Platinum Solid
- 6527 Merle

Glass Frame Kits

Everwall glass frame kits allow for spans of uninterrupted glass and are assembled on-site.

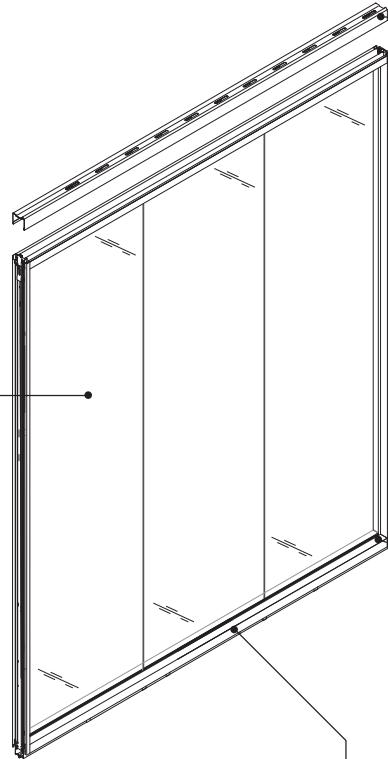

Frame kit and glass kit are assembled on site.

Ceiling track secures the top of the Everwall to the suspended ceiling grid. Allows plus/minus 1/2" of adjustment.

Glass frame kits allow for butt-glazing, creating uninterrupted spans of glass with butt glazing.

Floor track allows plus/minus 3/4" of vertical adjustment using floor glides to accommodate variations at the base of the wall.

Product Details

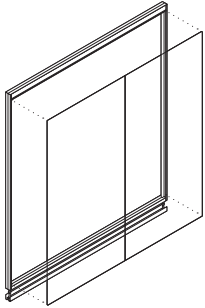

Everwall frame and glass kits are assembled in the field. Butt joints must be sealed with glazing tape.
Tip: COM glass for frame and glass kits must be $\frac{3}{8}$ " or $\frac{1}{2}$ " thick for structural integrity.

Glass frame kit can be specified from 12"W–144"W and 84"H–120"H at $\frac{1}{16}$ " increments.

For improved unitized glass reconfigurability, pre-set sized plan widths are available: 12", 18", 20", 24", 30", 36", 40", 42", 48", 54", 60", 72", 84", 96", 108", 120", 144".

Glass frame kits can accommodate glass thicknesses of $\frac{3}{8}$ " and $\frac{1}{2}$ ".

Different types and thicknesses of glass may change the overall acoustic performance of a glass wall.

Connections

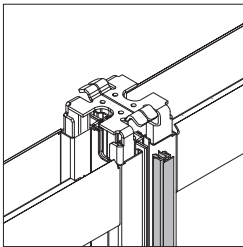

Frame couplers, ordered separately, join panels together. They prevent light and sound leaks and run from the top of the glass frame to the floor, overlapping the floor track.

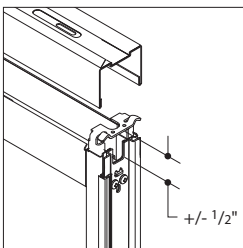

Ceiling track comes in 120" and 144" lengths; can be field cut on site. Allows plus/minus $\frac{1}{2}$ " of floating vertical adjustments to accommodate ceiling variation.

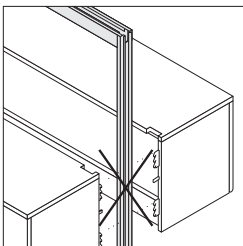

Panel-supported storage and work surface components cannot be attached to glass frame kits. Use solid wall or Clerestory panels instead.
▶ See page 25 for more information about hanging components.

Wiring and Cabling

Glass and frame kits do not accommodate power or communication cabling.

Utility panels can be positioned adjacent to glass frames to facilitate cable routing and to introduce outlets, switches, and other electrical devices.

Surface Materials

Glass Lite

- Glass
- Customer specified glass

Glass frames

- Paint
- 8043 Clear Anodized Aluminum

Swing Doors

Swing door units offer controlled access and privacy at door openings, and are available with options to accommodate specific functional requirements.

Doors and frames are available in full height applications in specifiable ceiling heights and are configured for single (non-pair) applications.

Door leaves are available as solid or polished edge glass and can be equipped with latchsets or door pulls.

Doors and frames are factory prepared for hardware as specified.

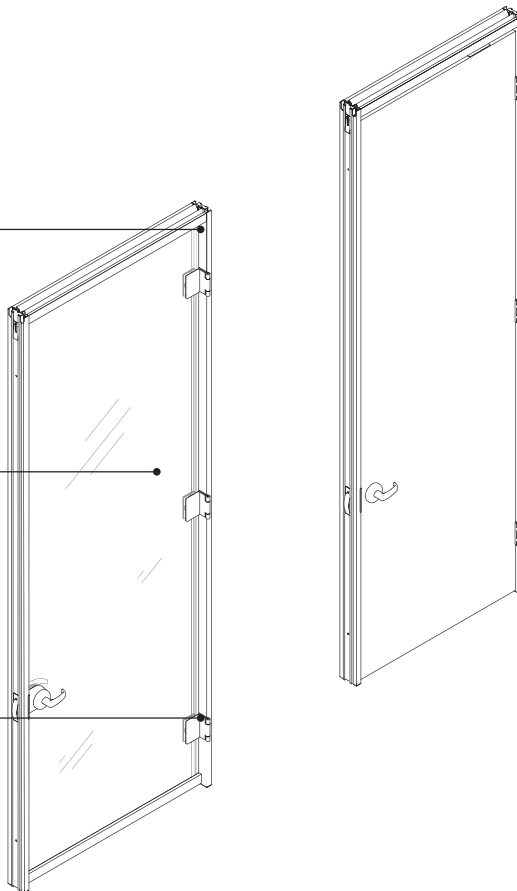

Product Details



Door frames are available in full height configurations. Height range: 84"–120" ceiling height. Heights are specifiable in $\frac{1}{16}$ " increments. Clear opening height = ceiling height minus $5\frac{3}{16}$ ".
Tip: Door unit ceiling heights less than $85\frac{1}{8}$ " will not meet criteria for an 80" clear opening height, which is a minimum requirement by code in most areas.

Door leaf planning widths range from 28"–48" and are specifiable in $\frac{1}{16}$ " increments. Overall door size cannot exceed 5,127 square inches based on planning width x ceiling height.

Pre-set planning widths for door frames and leaves are available at 36", 40", 42", 44", and 48" at a reduced price.

Industry standard tolerances for flatness for $\frac{3}{8}$ " thick glass may allow for gaps between the door surface and door frame seals. To minimize the potential for gaps, Steelcase recommends that door sizes for $\frac{3}{8}$ " thick doors do not exceed 108" ceiling height or 40" planning width.

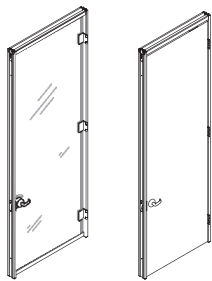

Door leaves can be specified as tempered glass with polished edges, or as solid core wood with veneer or painted MDO surfaces.

Polished edge door leaves are available in thicknesses of 1/2" or 3/8".

3/8" thick doors are available as a lower price alternative to 1/2" thick.

1/2" thick doors should be specified when acoustic performance is a priority.

Industry standard tolerances for flatness for 3/8" thick glass may allow for gaps between the door surface and door frame seals. To minimize the potential for gaps, Steelcase recommends that door sizes for 3/8" thick doors do not exceed 108" ceiling height or 40" planning width.

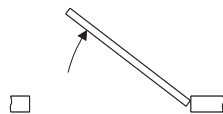

Right-hand

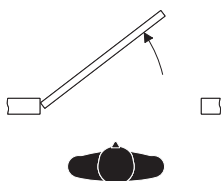

Left-hand

To determine door swing orientation: facing the door, so that the door swings away from you, the side that the hinges are on defines the handing of the door. Door frames are manufactured non-handed but become handed once hardware is installed.

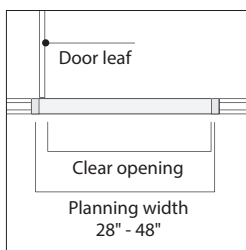

The handing of a door frame isn't set until it's installed.

Single door frame width is parametric, and can vary from 28" to 48" planning width in 1/16" increments. Planning width is measured to centerline of frame couplers. Steelcase recommends using a 40" wide door frame to maximize accessibility, maintain visual continuity, and simplify the planning process during reconfigurations.

Door frames and door leaves can be specified at pre-set planning widths at a lower price than other parametric sizes.

Pre-set planning widths for door frames are 36", 40", 42", 44", and 48".

Clear opening dimensions are as follows:
Solid door: PW minus 57/8"
Polished glass with slim line hinge: PW minus 67/16"
Polished glass with butt hinge: PW minus 61/16"

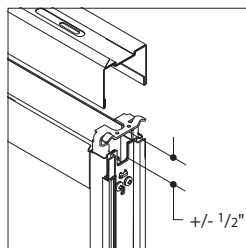

Ceiling track allows 1" of vertical adjustment (plus/minus 1/2"), to accommodate ceiling variation.



The door frame assembly is designed to allow for 1-12" of adjustment at the floor (plus/minus 3/4"), while maintaining a consistent 1/2" undercut.

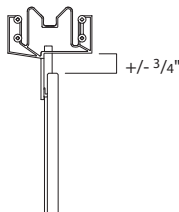

The visible margin between the top of the door leaf and door frame can vary by plus/minus 3/4" to accommodate floor variation.

Door frames are cut to finished height during installation. New door frames may be required when re-positioning door openings to an area with a taller ceiling height.

Door frames are provided with an assembly hardware kit, shipped separately, which includes parts, fittings and strike plate as required to assemble the door frame and hang the door.

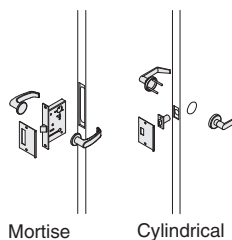

Mortise

Cylindrical

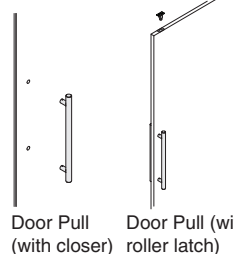

Door Pull (with closer)

Door Pull (with roller latch)

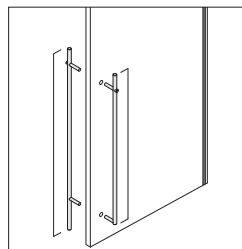

Latchsets can be either mortise or cylindrical types.

Tip: Doors that are specified with hardware prep for mortise locks will not have faces drilled for levers or cylinders, etc. All necessary holes in the face of the door must be drilled by the installer.

Mortise lock keying options:

- Random keyed with interchangeable core (SFIC).
- No cylinder (to allow customer to provide cylinders to specific keying requirements).

Cylindrical lock keying options:

- Random key with small format interchangeable core.
- No core (to allow customer to provide cores to specific keying requirements). For customers who require specific keying configurations and/or master key coordination, it is recommended to order locks without cylinders or cores. This will allow the customer to manage their keying requirements locally by securing cylinders or cores through their preferred security hardware provider.

The cylindrical lock set for swing doors can be specified in one of two ways:

1. With a random keyed, small format interchangeable core (SFIC).
2. Without a core, configured for a (SFIC).

Cylindrical lock sets

are compatible with six or seven pin cores (SFIC) as manufactured for Sargent, Best, or Schlage.



Mortise latchsets are available with three different lever styles.

Mortise latchsets can be specified without lever handles to allow for users to provide locally sourced handles.

The mortise lockset for swing doors can be specified in one of two ways:

1. With a random keyed lock cylinder configured for a small format interchangeable core (SFIC).
2. Without a core.

When ordering cylinders from other suppliers for use with the Everwall mortise locks, cylinders must be specified with a cam configuration that is compatible with a Sargent 8200 series lock set.

Locking ladder pull keying options:

- Random keyed with interchangeable core (SFIC)
- No cylinder (to allow customer to provide cylinders to specific keying)

Locking ladder pulls can accommodate SFIC cores (6 pin) as manufactured by Sargent, Schlage, Best, Medeco, Arrow, Yale, and Falcon.

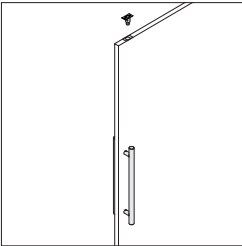

When specifying a solid door with push/pull or ladder pull, specify with either a roller latch or surface-mounted closer.

When specifying a polished edge door with push/pull or ladder pull, specify with either a roller latch or slim line hinges with self close feature.

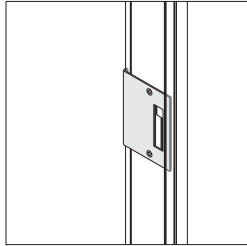

When specifying single door frames for use with mortise locks, the strike plate can be specified in either of two configurations. Strike plate type 1 is compatible with the standard Everwall lock, as well as Sargent, Corbin, Russwin, and Yale locks. Strike plate type 2 is compatible with mortise locks manufactured by Schlage and Lawrence. Strike plates are included as part of the assembly hardware kit.

Tip: If using mortise locks by other manufacturers than those mentioned above, check with the specials team for strike plate compatibility.

Tip: Doors that are specified with hardware prep for mortise locks will not have faces drilled for levers, cylinders, etc. All necessary holes in the face of the door must be drilled by the installer.

Tip: Swing door frames are not compatible with deadbolt locks.



Solid doors are equipped with butt hinges – 3 hinges per door opening.

Doors greater than 44" planning width are equipped with 4 hinges.



Butt Hinge



Slim Line Hinge

Polished edge doors can be equipped with slim line hinges or butt hinges. When butt hinges are specified, doors up to 44" planning width will be equipped with 3 hinges.

Doors that are greater than 44" wide will be equipped with 4 butt hinges. Slim line hinges will always be used in sets of two per door.

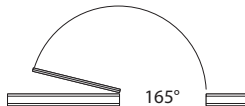
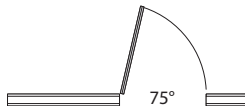

Slim line hinges can be specified with a self close feature. This functionality includes a hold-open feature that engages the door at approximately 75° (when 90° hinge is specified) or 165° (when 180° hinge is specified). The hinge includes an adjustable control for regulating the force of the closure and fine-tuning the braking control.

An electric hinge is required when equipping a solid door with an electric lock.

The electric hinge kit includes two or three additional butt hinges depending on door size.

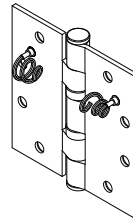

Electric hinge is equipped with four wire leads on each side.

The leads are a minimum 8" long to be connected to low voltage building source and electric lock.

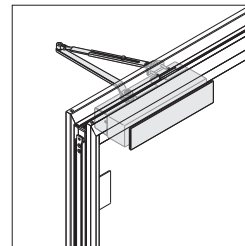

Door closers are available for use on solid and glass doors when the door must close automatically for safety and security reasons. *Tip: If self close functionality is required on polished edge doors, specify with slim line hinges.*

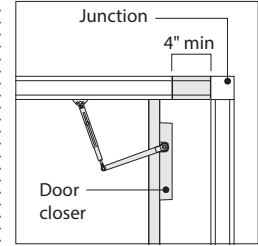

When mounting a closer on a door, and positioning the door at an inside corner, the door frame must be spaced at least 4" away from the adjacent surface.

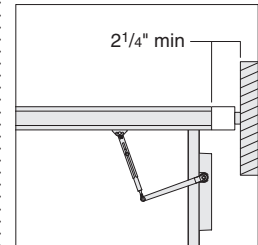

When mounting a closer on a door and positioning the door at a mini-end, the door frame must be spaced at least 2 1/4" away from the adjacent surface.

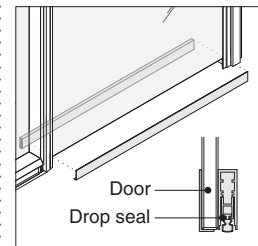

To enhance acoustical performance, an optional drop seal can be specified at the bottom of the door. The drop seal automatically deploys to block the gap under the door when the door is closed and retracts when the door is open.

Drop seals are not recommended for use on $\frac{3}{8}$ " polished edge doors that exceed 108" ceiling height or 40" planning width.

Tip: Polished glass doors with drop seals are compliant with ADA and California Title 24 guidelines.

Tip: Dome stops and base stops are not recommended when using polished glass doors with drop seals.

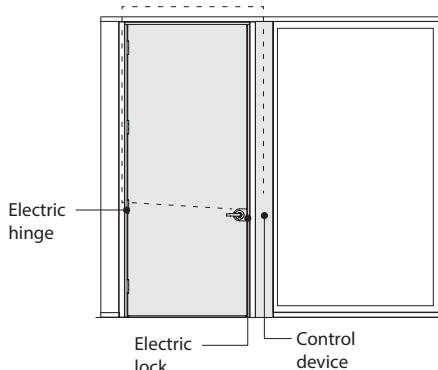

When door openings require an electronic security feature, solid doors can be equipped with an electric hinge. The electric hinge includes wire conductors that link an electric lock to the control device (card reader or keypad).

When specified, the solid door is constructed with an internal wireway to manage the wires from the hinge to the electric lock. Wires are routed from the hinge to the control device through the vertical door jamb as part of the installation process.

The wire conductors are 28 gauge and are suitable for low voltage current only (24 volt maximum). The lengths of the wires is 48" long (through the door) and 120" long (through the door jamb). The electric lock and the control device are not provided by Steelcase.

Door openings that require electronic security are typically equipped with closers in order to help maintain a secure opening. When mounting a closer on a door and positioning the door at an inside corner or mini-end, the door frame must be spaced at least 4" away from the adjacent surface.

Utility panels can be positioned adjacent to door frames to act as a mounting point for the control device. Electric hinges cannot be used with polished glass doors.

When electronic security is desired, as an alternative to electric locks, door frames can be specified for electric strikes. This is especially useful for door openings with polished glass doors.

When electric keeper strike is specified, additional parts are included in the door frame assembly kit to allow for the installation of the strike. The door frame is modified by the installer to accept the electric strike. The door frame is compatible with the following strikes from Rutherford Controls International as provided by Steelcase:

- Cylindrical locks: RCI L6504
- Mortise locks: RCI S6504

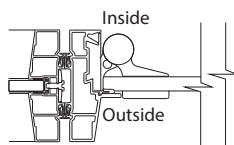

When specifying doors with etched glass, the etched surface can be oriented to either face of the door. Specify inside orientation when the polished face is oriented on the same side as the hinge knuckle. Specify outside orientation when polished edge is on the opposing face.

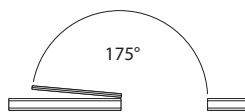

A swing door with butt hinge can swing open to a maximum of 175°.

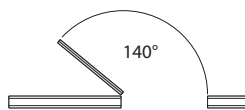

A swing door with butt hinge and closer can swing open to a maximum of 140°.

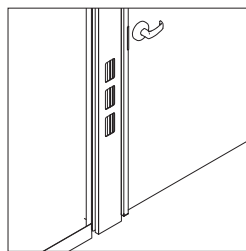

Utility panels can be positioned adjacent to door frames to accommodate switches, room schedulers, security control appliances, and other technology devices.



Magnetic wall stop



Dome-style floor stop



Screw-in base stop

Door stops can be ordered for use with doors. Magnetic wall stop, dome-style door stop, and screw-in base stop are available.

Magnetic wall stop is for use with painted steel skins.

Surface Materials

Door frame

- 8043 Clear Anodized Aluminum
- Paint

Solid door leaf

- Paint
- Wood veneer

Polished glass door

- Tempered Glass – Clear
- Tempered Glass – Satin

Latchset

- 9200 Satin Chrome
- 9201 Polished Chrome
- 4710 Black

Slim line hinges and butt hinges – solid

- 4710 Black
- 9200 Satin Chrome
- 9201 Polished Chrome

Butt hinges – polished edge

- 4710 Black
- 9200 Satin Chrome

Door pull (Push/pull handle)

- 4710 Black
- 8031 Brushed Stainless

Door closer

- 4710 Black
- 4799 Platinum

Roller latch

- 4710 Black
- 9200 Satin Chrome

Slider Doors

Slider door assemblies offer privacy and security with space savings at door openings, and are available with a variety of hardware options.

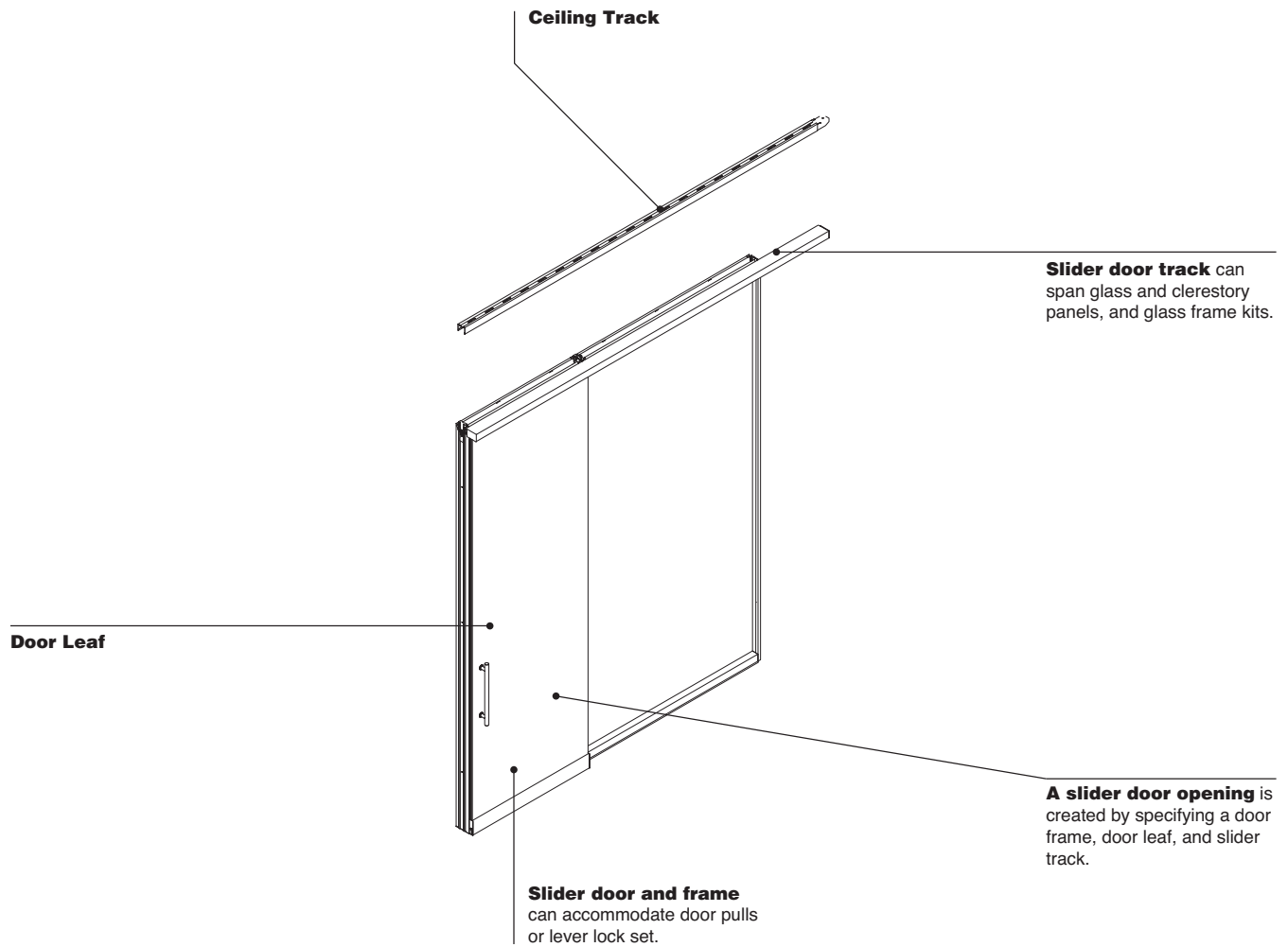

Product Details

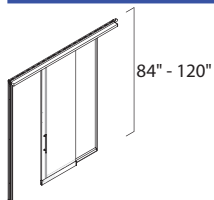

Door frames are available in full height configurations. Height range: 84"–120" ceiling height.

Heights are specifiable in 1/16" increments. Clear opening height = ceiling height minus 3 1/4". *Tip: Door unit ceiling heights less than 83 1/4" will not meet criteria for an 80" clear opening height, which is a minimum requirement by code in most areas.*

Door units are manufactured to specified slider orientation and cannot be altered.

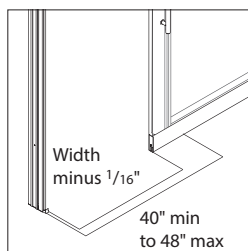

Door frames width is parametric and can vary from 40" to 48" planning width in 1/16" increments. Steelcase recommends using a 40" wide door frame to maximize accessibility, maintain visual continuity, and simplify the planning process during reconfigurations. Clear opening widths:

- With pull: planning width minus 8.
- With lever lock: planning width minus 8 15/16".

Tip: Door frames that are less than 40" planning width will not meet ADA guidelines for minimum clear opening (32").

Single door frame width is parametric, and can vary from 40" to 48" planning width in 1/16" increments. Planning width is measured to centerline of frame couplers. Steelcase recommends using a 40" wide door frame to maximize accessibility, maintain visual continuity, and simplify the planning process during reconfigurations.

Door frames and door leaves can be specified at pre-set planning widths at a lower price than other parametric sizes. Pre-set planning widths for door frames are 40", 42", and 48".

Ceiling track allows 1" of vertical adjustment (plus/minus 1/2"), to accommodate ceiling variation.

The door frame assembly is designed to allow for 1 1/2" of adjustment at the floor (plus/minus 3/4"), while maintaining a consistent 3/16" undercut between the bottom of the door and the floor.

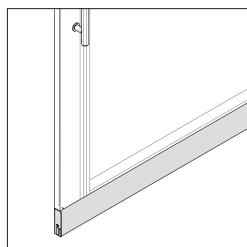

The polished edge door includes an adjustable aluminum bottom trim, which can be adjusted during installation to ensure a minimal and consistent clearance at the bottom of the door.

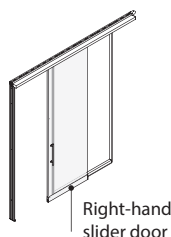

Right-hand slider door



Left-hand slider door

Door handing is determined by the direction in which the door travels when opening, as viewed from the face of the wall on which the door is mounted.

Doors can be oriented to either face of the wall to position the door on either the interior or exterior of a room.

Polished edge doors are available in thicknesses of 3/8" or 1/2".

Door frames are cut to finished height during installation. New door frames may be required when repositioning door openings to an area with a greater floor variation.

Door frames are provided with an assembly hardware kit, shipped separately, which includes parts and fittings as required to assemble the door frame and hang the door.

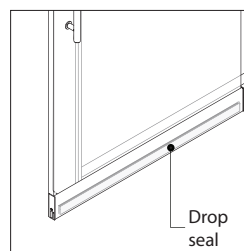

Drop seal

Slider door frames include static seals and gaskets to minimize potential sound paths around the door. Acoustic privacy can be enhanced by specifying the optional drop seal. The drop seal automatically deploys to block the gap under the door when the door is closed, and retracts when the door is open.

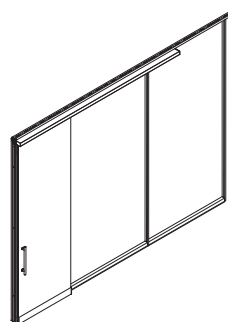

The slider door track spans the door frame and adjacent panel. The door track can be mounted to glass panel, clerestory panel, or frame kit.

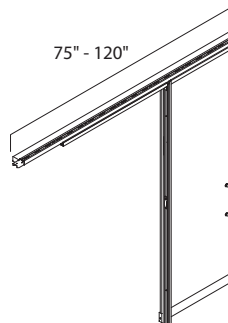

The slider track is available in width from 75" to 120", in 1/16" increments.

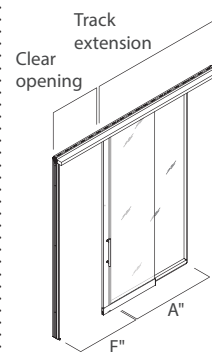

A must be > F-5"

The modules adjacent to the single door track on which the track is mounted must be at least as wide as the door frame minus 5" to allow for the door to travel the required distance to meet clear opening requirements.

The slider track can span two adjacent side panels or a frame kit, as long as the track length doesn't exceed 120".

The slider track cannot span an intersection or mini-end.

The slider track can span a utility panel when adjacent to a door frame on the trailing edge of the door.

Utility panels can be positioned adjacent to door frames to accommodate switches, room schedulers, security control appliances, and other technology devices.

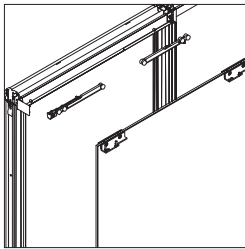

The slider track includes the sliding trolley hardware with close-assist functionality.

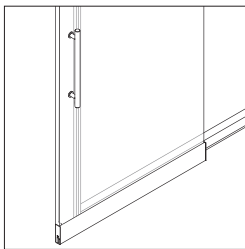

Slider doors can be equipped with push/pull handles, ladder pulls, or a lever lock set. See page 46 for a complete list of available pull options.

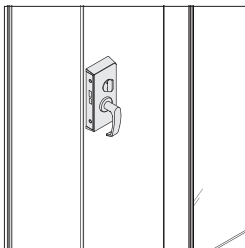

Lever locksets are available as an option on slider doors, and are equipped with an ADA compliant single action lock feature, allowing for the door to be unlocked and opened in a single motion.

Locksets can be provided in one of two configurations:

- Random key with standard cylinder
- No cylinder (to allow customer to provide cylinders to specific keying requirements)

Lever locksets are provided with a standard lever handle. Locksets can be provided without handles to allow for an easy substitution of another locally sourced style of lever.

Slider locksets are compatible with levers as manufactured by Schlage, Dorma, and Lawrence.

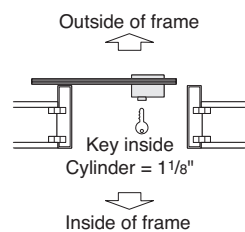
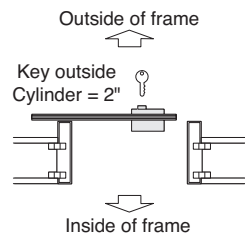

When ordering cylinders from other suppliers for use with the Everwall slider lever locksets, cylinders must be specified with a Schlage L cam configuration. When keyway and cylinder are oriented to the outside of the door frame, specify a 2" cylinder with a 7/16" trim ring. When keyway and cylinder are oriented to the inside of the door frame, specify a 1 1/8" cylinder with a 9/16" trim ring.

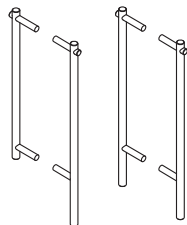

Locking functionality can also be addressed by specifying locking ladder pulls. ▶ See page 46 for more information.

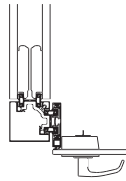

Two-Way 90°

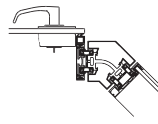

Two-Way 135°

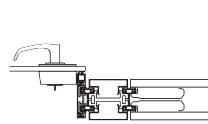

Utility Panel

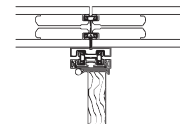

Adapter T on module

Door frames can be positioned adjacent to any post or utility panel or on-module T-adaptor.

Mini ends connect a door frame to perpendicular building wall.

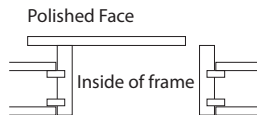

Polished Outside



Polished Inside

When specifying doors with etched glass, the etched surface can be oriented to either side of the wall to accommodate orientation relative to inside/outside of the room. Users often prefer to orient the polished surface of glass to the corridor side for ease of cleaning.

Surface Materials

Door frame

- 8043 Clear Anodized Aluminum
- Paint

Door frame seal

- 6000 Black
- 6249 Platinum Solid

Polished glass door

- Tempered Glass – Clear
- Tempered Glass – Satin

Lever lock

- 4710 Black
- 9200 Satin Chrome

Door bottom trim

- 8043 Clear Anodized
- Paint

Door Pulls

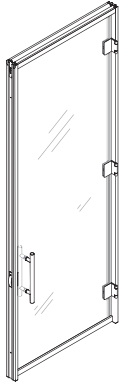

Push/Pull

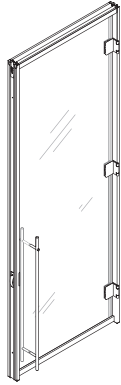

Locking Ladder Pull

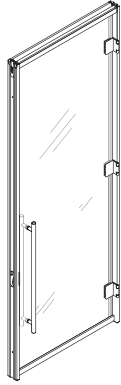

Ladder Pull

Product Details

Push/pulls and ladder pulls can be specified for use on both swing and slider doors, either solid or polished edge glass.

There are two versions of pulls available. The TCS pulls are a lower price alternative to PBA pulls.

▶ See page 47 for available sizes and functionality.

Keying options for locking ladder pulls:

- Random key with small format interchangeable core.
- No cylinder (to allow customer to provide housings and core to specific keying requirements). The no cylinder option is configured to receive a rim mounted cylinder. Recommended cylinder length:
PBA: 1 $\frac{3}{8}$ "
TCS: 1 $\frac{7}{16}$ "

Users can replace existing cores with other SFIC cores (6 pin) as manufactured by Sargent, Schlage, Best, Medeco, Arrow, Yale, and Falcon.

Locking ladder pulls are available in heights of 48", 53", or 60".

When specifying a door with push/pull handle or ladder pull, either a roller latch, closer or slim line hinge with self-close must be selected to ensure that the door remains in the closed position.

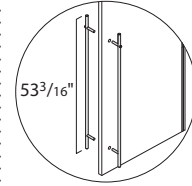

Aligned Pull

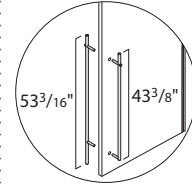

Offset Pull

When mounted on swing doors, offset pulls can be specified to provide clearance per ADA guidelines. Offset pulls can also be provided on slider doors when matching pulls are desired.

72" high ladder pulls will not be ADA compliant when mounted to swing doors.

Locking ladder pulls engage in the floor.

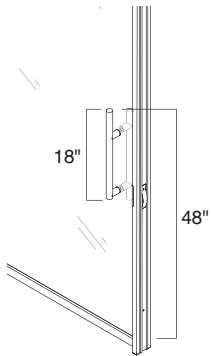

Push/Pull x 18" x 1.0"D

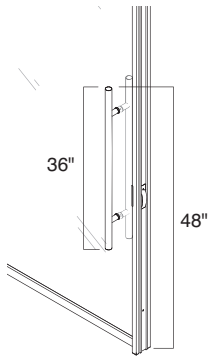

Ladder Pull x 36" x 1.0"D
Aligned TCS

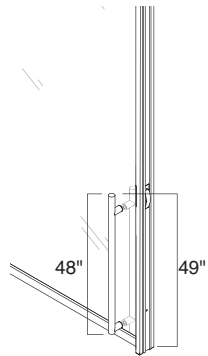

Ladder Pull x 48" x 1.38"D
Offset TCS
Locking

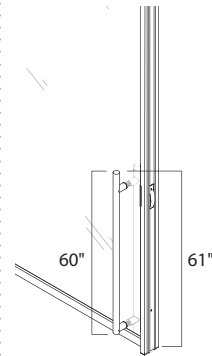

Ladder Pull x 60" x 1.38"D
Offset TCS
Locking

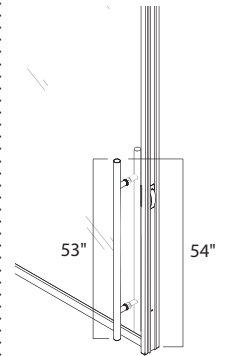

Ladder Pull x 53" x 1.0"D
Aligned PBA
Locking

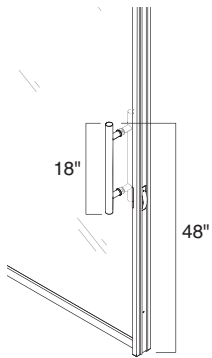

Ladder Pull x 18" x 1.0"D
Aligned TCS

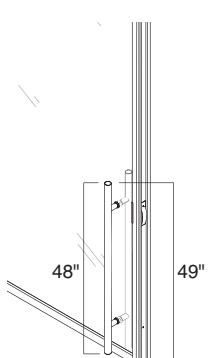

Ladder Pull x 48" x 1.0"D
Aligned TCS
Non-locking

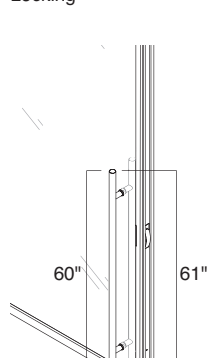

Ladder Pull x 60" x 1.0"D
Aligned TCS
Non-locking

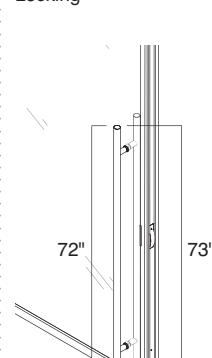

Ladder Pull x 72" x 1.0"D
Aligned TCS
Non-locking

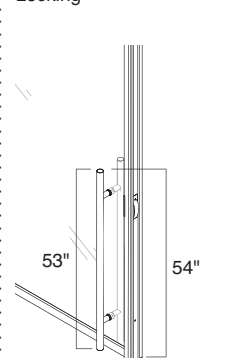

Ladder Pull x 53" x 1.0"D
Aligned PBA
Non-locking

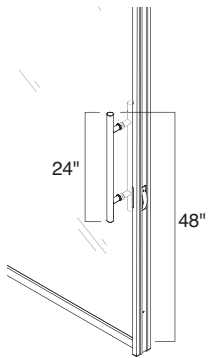

Ladder Pull x 24" x 1.0"D
Aligned TCS

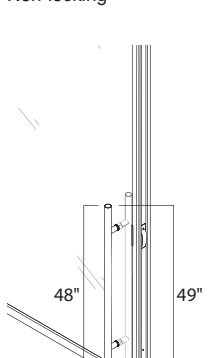

Ladder Pull x 48" x 1.0"D
Aligned TCS
Locking

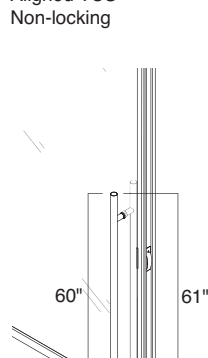

Ladder Pull x 60" x 1.0"D
Aligned TCS
Locking

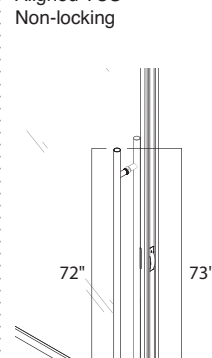

Ladder Pull x 72" x 1.0"D
Aligned TCS
Locking

Surface Materials

- 4710 Black
- 8031 Brushed Stainless

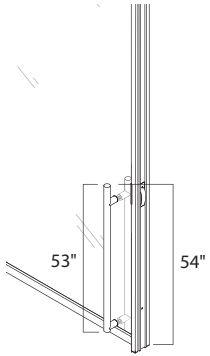

Ladder Pull x 53" x 1.4"D
Offset PBA
Locking

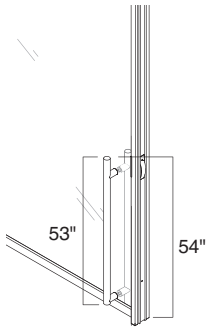

Ladder Pull x 53" x 1.4"D
Offset PBA
Non-locking

Posts

Note: All planning and application guidelines contained in this section of the specification guide are based on the requirement that ceiling track is connected to a ceiling in order to properly support the wall components as shown.

Posts join panels in a variety of configurations.

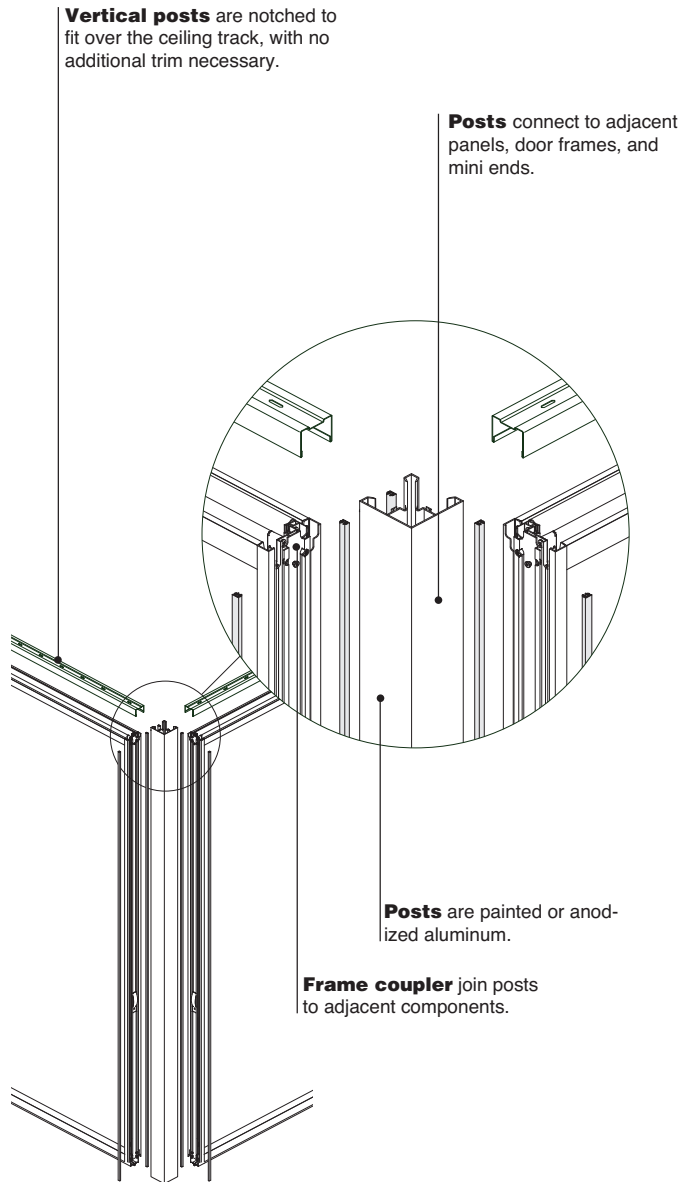

Product Details

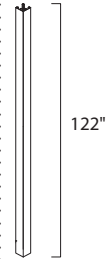

Posts are shipped in a standard height of 122" and are cut to fit in the field.

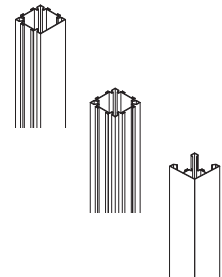

Posts span from finished floor to finished ceiling, and are cut to exact length by installer.

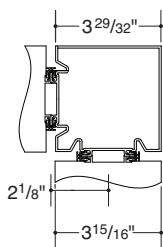

Two-Way 90°

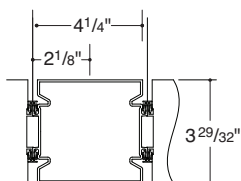

Two-Way 180°

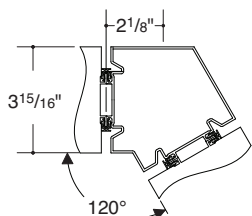

Two-Way 120°

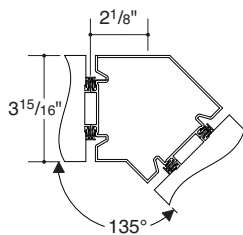

Two-Way 135°

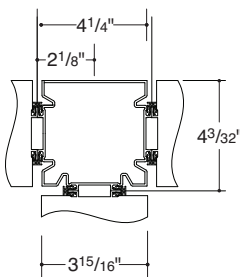

Three-Way 90°

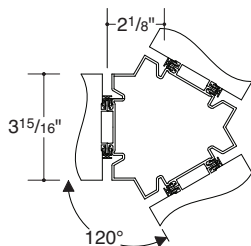

Three-Way 120°

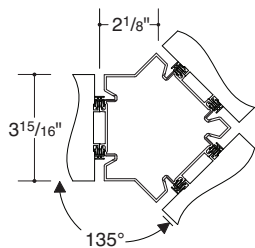

Three-Way 135°

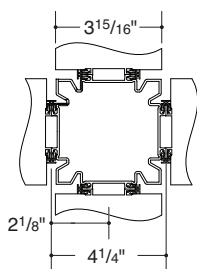

Four-Way°

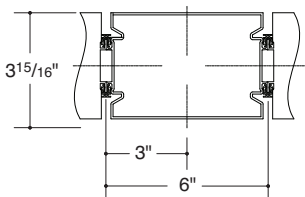

Bypass

Configurations for posts include two-way, three-way, and four-way.

Connections

Any panel, door frame, or mini end can be connected to a post.

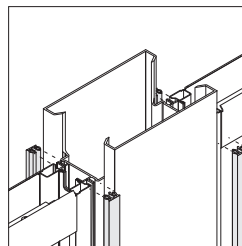

Frame couplers, ordered separately, join posts to panels and door frames. They prevent light and sound leaks and run from the top of the skin or glass frame to the floor, overlapping the floor track.

▶ Page 77

Posts are often more appropriate when planning with interior room dimensions.

Tip: Remember to allow for post dimensions when calculating the overall length of a wall.

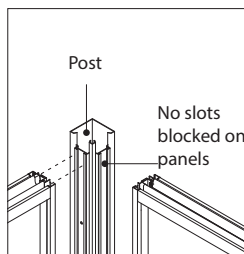

Slotted verticals are accessible when using posts.

Wiring & Cabling

Posts can be used to vertically route power and cable infeeds down from the ceiling or up from the floor.

Cutouts to run cabling horizontally through a post can be factory-supplied, or cut on-site during installation.

Surface Materials

- Post**
- Paint
 - Anodized aluminum

- Frame coupler**
- 6249 Platinum Solid
 - 6527 Merle

Adapters

Note: All planning and application guidelines contained in this section of the specification guide are based on the requirement that ceiling track is connected to a ceiling in order to properly support the wall components as shown.

Adapters engage the verticals on the edge of a panel to allow perpendicular panels to connect at T and X intersections.

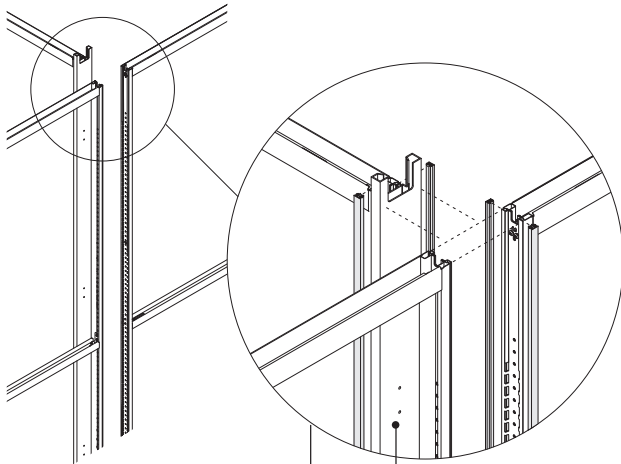

Surfaces of finished ends and T/X adapters are painted or anodized aluminum.

Frame couplers join adapters to adjacent components.

Product Details

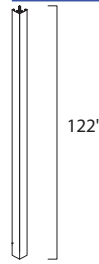

Adapters are shipped in a standard height of 122" and are cut to fit in the field.

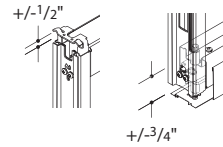

Ceiling track allows $1/2"$ of vertical adjustment to accommodate variations in field conditions. **Floor track** allows $3/4"$ of vertical adjustment to accommodate variations at base.

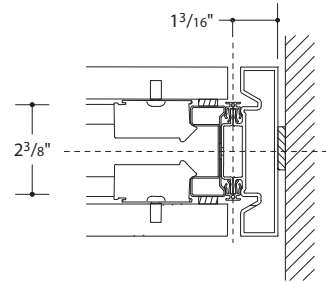

Finished-end adapter caps the exposed vertical edge of the last panel in a run. Surface of the adapter is painted or anodized aluminum. Finished-end adapter adds approximately $1\frac{1}{16}"$ to the length of the wall.

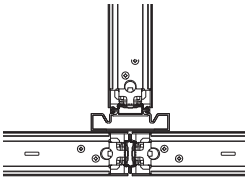

Adapter T on module

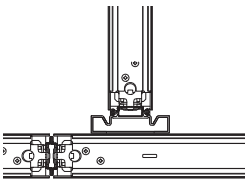

Adapter T off module

T adapter allows a perpendicular panel to join to a wall, either off-module or on-module.

Connections

Any panel, door frame, or mini end can be connected to an adapter.

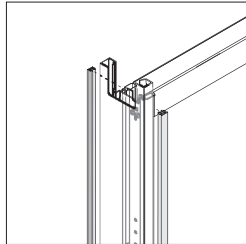

Frame couplers ordered separately, join panels and other components to adapters and prevent light and sound leaks. Frame couplers can be cut on site to provide access to the integral slotted verticals so that panel-supported components can be attached. To rearrange panels, frame couplers can be removed and reused.

▶ Page 77

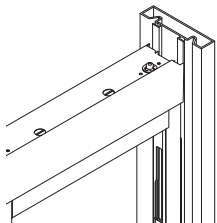

Finished end runs from the floor to ceiling, finishing the end of the ceiling track in the same way that the finished end adapter completes the exposed vertical edge of the last panel.

▶ Page 121

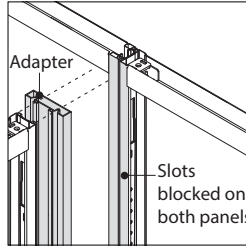

Blocked slots occur on the edges of some panels in configurations with adapters. This makes it impractical to attach panel-supported components at these points.

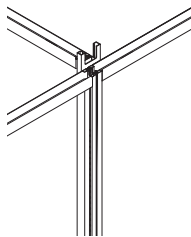
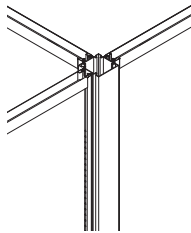

T-adapters, can present a cleaner visual than T-posts by presenting a single reveal and ceiling track continuity.

Wiring & Cabling

Adapters do not accommodate vertical wire and cable routing.

Surface Materials

Finished-end adapter and L-adapter

- Paint
- Anodized aluminum

Vertical Transition to Lite Scale

▶ See the *Lite Scale Specification Guide* for information regarding Everwall and Lite Scale.

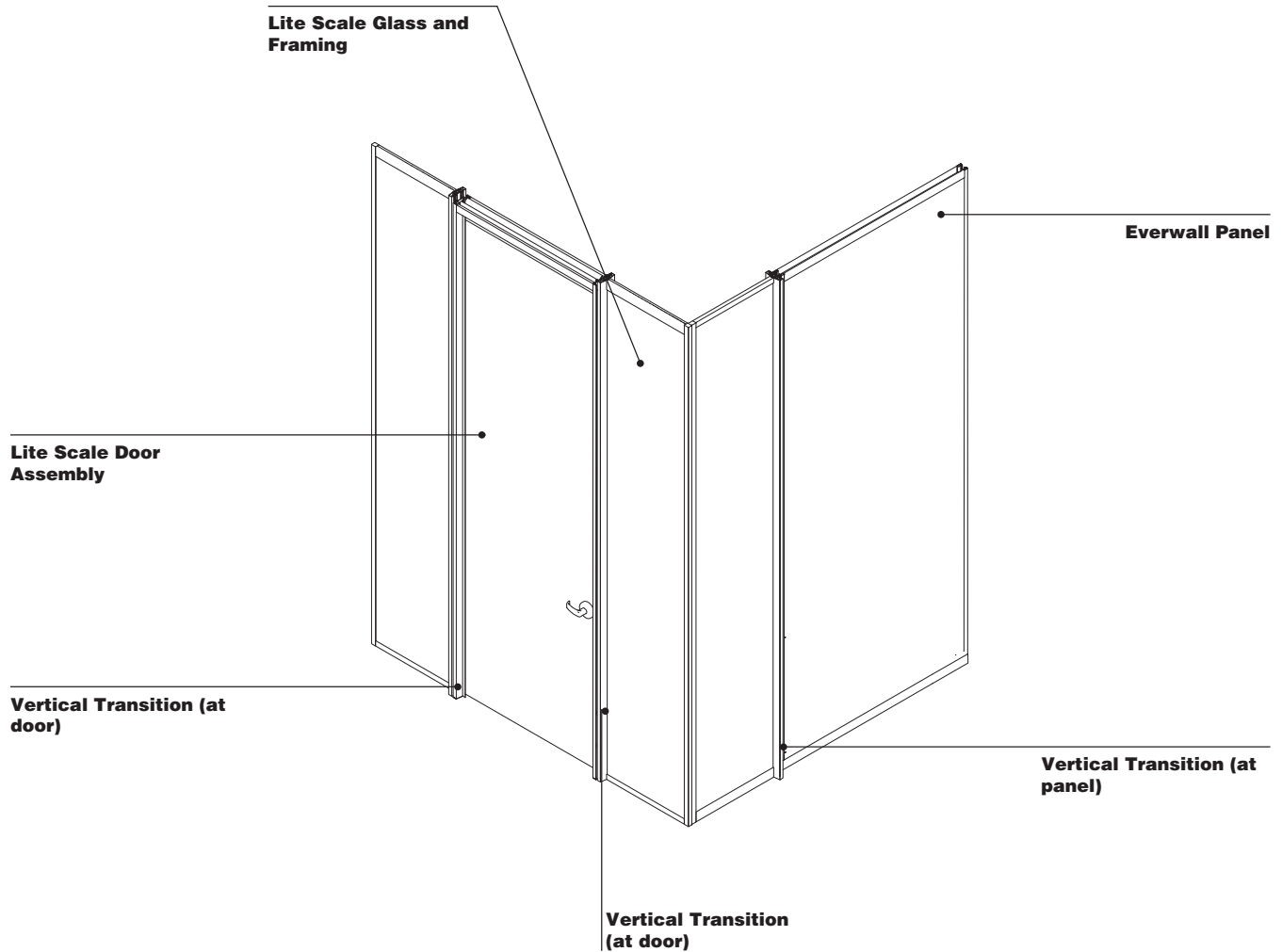

Bypass

When applying Everwall glass fronts with conventional fixed cross walls, it may be desirable to create an interface condition where the Everwall wall conceals the cross wall. The bypass assembly is designed so that it can be installed as a complete assembly and create an uninterrupted visual along a corridor.

Fixed Conventional Wall

Ceiling Track

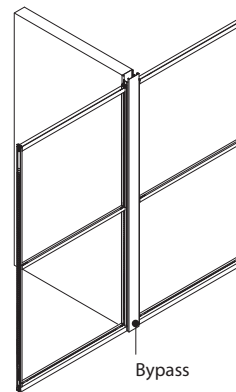
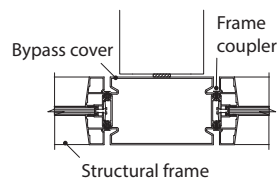
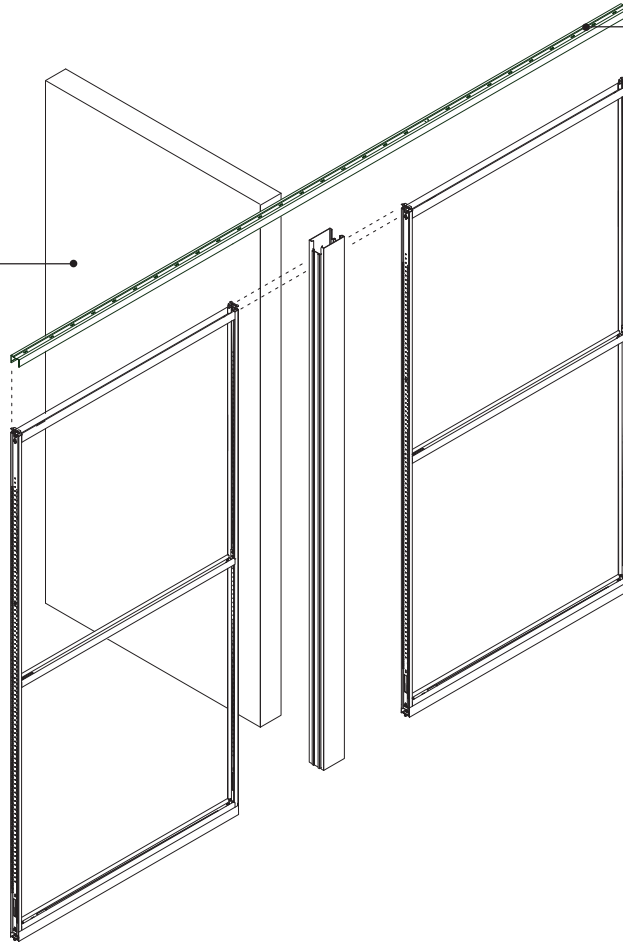

Product Details

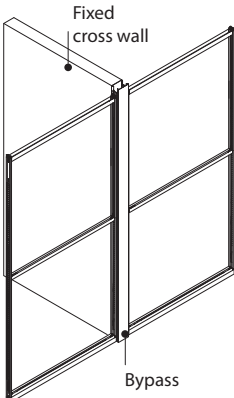

When applying Everwall glass fronts with conventional fixed cross walls, it may be desirable to create an interface condition where the Everwall wall conceals the cross wall. The bypass assembly is designed so that it can be installed as a complete assembly and create an uninterrupted visual along a corridor.

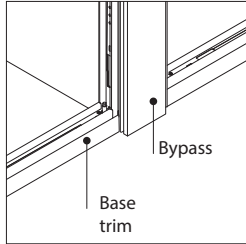

Bypass assemblies are designed to be used with base trim along the corridor side of the wall.

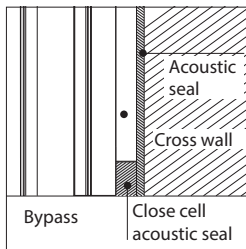

A close cell acoustic seal is included to close any gaps between the end of the cross wall and the face of the bypass cover.

Wiring & Cabling

Cutouts to run cabling horizontally through a bypass can be factory-supplied, or cut on-site during installation.

Surface Materials

- Bypass**
- 8043 Clear Anodized Aluminum
 - Paint

6"

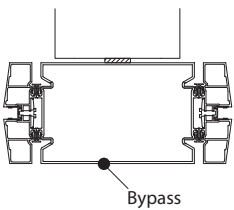

The planning width for a bypass assembly is 6".

Bypass surfaces can be painted or anodized aluminum.

Cutable Ends

Cutable ends can be field cut around irregular building surfaces.

Cutable ends can be used with a cut skin at a single flush cut.

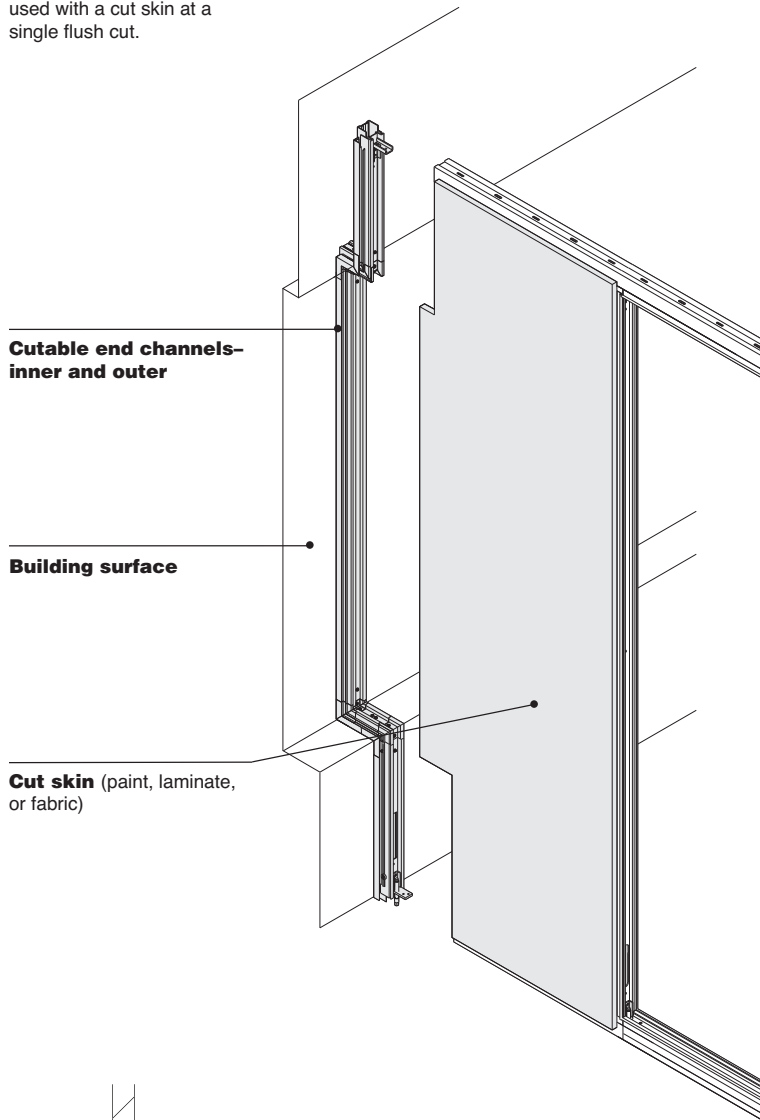

Cutable end channels—inner and outer

Building surface

Cut skin (paint, laminate, or fabric)

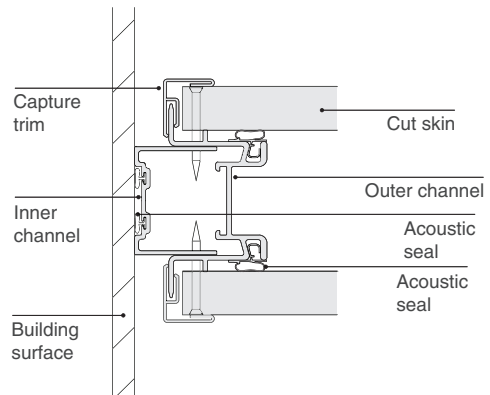

Capture trim

Cut skin

Inner channel

Outer channel

Acoustic seal

Acoustic seal

Building surface

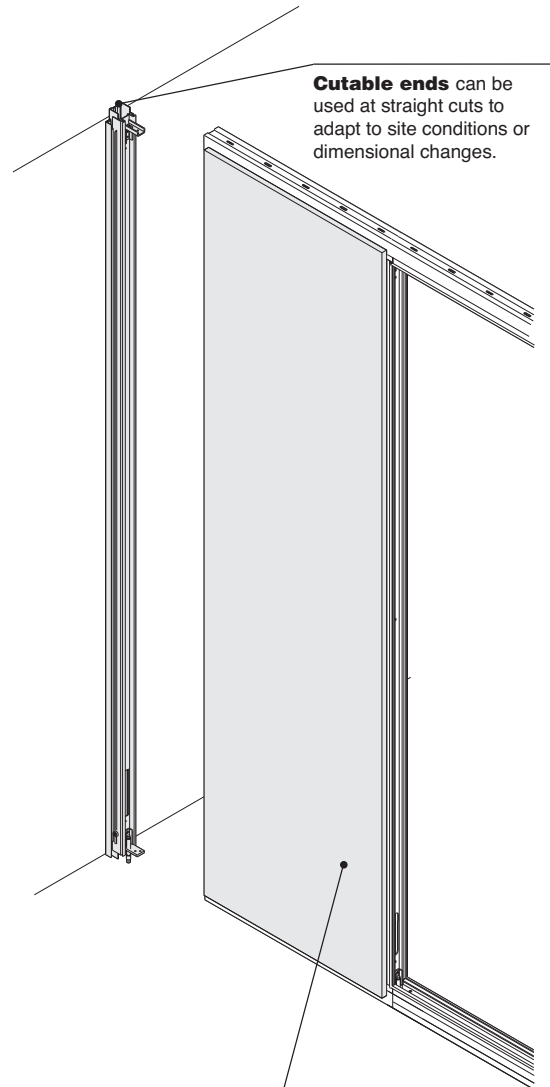

Cutable ends can be used at straight cuts to adapt to site conditions or dimensional changes.

Cut skin (paint, laminate, or fabric)

Product Details

Cutable ends are sometimes necessary for a field cut at a wall termination – either to allow for unknown dimension, or to trim around irregular building conditions.

Cutable ends are used with monolithic solid skins – paint, laminate or fabric.

Special skins are not required for field cutting.

Cutable ends are fastened to the adjacent building surface.

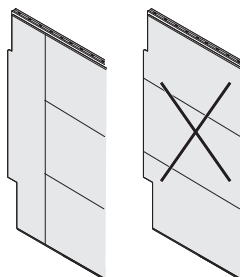

Cutable end assemblies do not accommodate intermediate horizontals or segmentation.

Cutable ends are not used with slatwall, lighting, ceramic skins, or monitor shrouds.

Electrical devices cannot be positioned in a cut skin.

Infeeds and cables can be routed behind a cut skin.

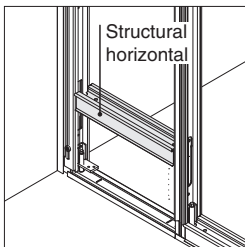

Structural horizontals that are positioned adjacent to cutable ends will be modified to ensure that cable cut-outs do not interfere with the bracket connection. These horizontals will receive one cut-out only when 22.61" long or greater. Structural horizontals that are less than 22.61" will not have any cable cut-outs.

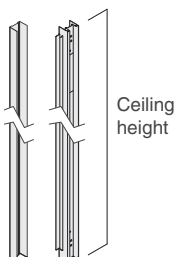

When intended for use with a single vertical cut, the inner and outer channel are ordered in lengths that correspond to ceiling height.

When intended for use with a single vertical cut, the inner and outer channel are combined into a single assembly.

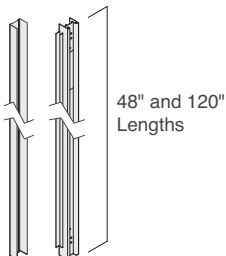

When intended for use with multiple cuts around sills and soffits, channel lengths can be specified in different lengths to minimize scrap.

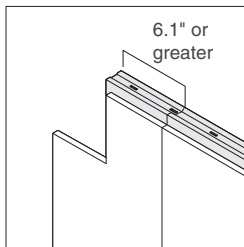

A skin cannot be cut to a dimension less than 6.1" (face of skin to centerline of post).

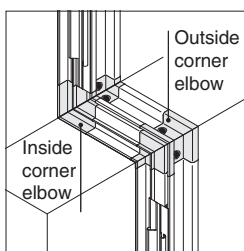

Cutable end assemblies can be combined with corner angles and elbows (inside and outside corner) to allow the installer to trim around unique end configurations.

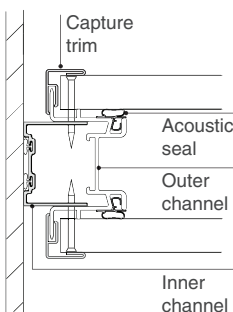

Inner channel can be specified in a different color than capture trim.

In some configurations, the outer channel seal may be visible and should be specified to be color matched to acoustic seals on adjacent posts and horizontals.

Capture trim paint color can differ from one side of wall to the other.

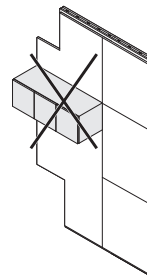

Cutable ends do not accommodate hang-on components.

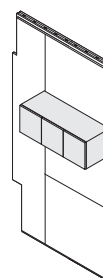

Hang-on storage components can be positioned adjacent to a cut condition.

Surface Materials

90° Cutable end assembly

- Paint (cutable end assembly)
- Plastic (seal)

90° Cutable end inner channel

- Paint (cutable end assembly)
- Plastic (seal)

Cutable end capture trim

- Paint

Mini End and Wall Start

Note: All planning and application guidelines contained in this section of the specification guide are based on the requirement that ceiling track is connected to a ceiling in order to properly support the wall components as shown.

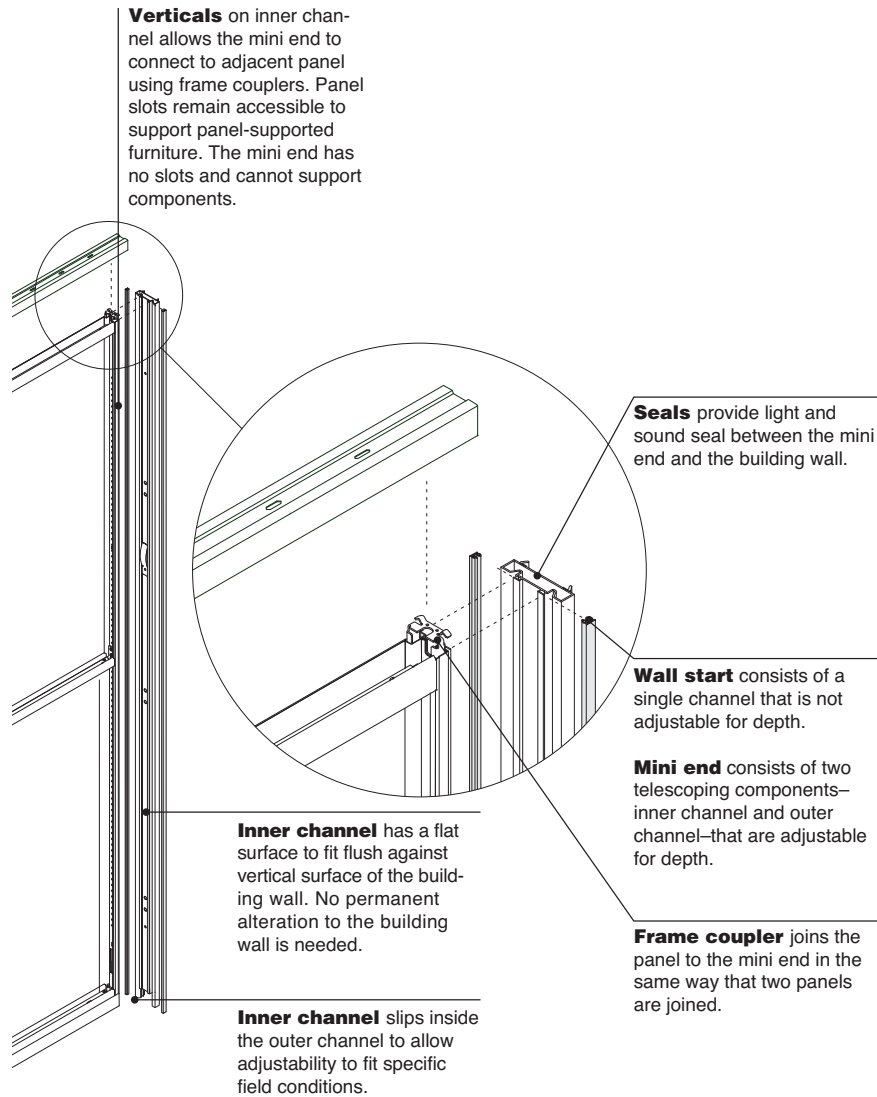

Product Details

Mini-ends and wall starts are shipped in a standard height of 122" and are cut to fit in the field to span from finished floor to finished ceiling.

1 3/16"

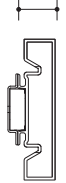

2 1/4" to 3 7/8"

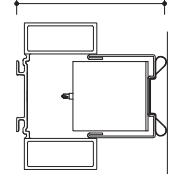

4 1/4" to 5 7/8"

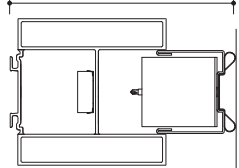

Two sizes of mini ends are available. Each telescopes to accommodate a different range of dimensions. For installations that require a dimension smaller than 1 1/2", use a wall start.
 ▶ Page 126

Wall starts present a more minimal visual than mini-ends. Because they are not adjustable, the interfacing surfaces must be precisely positioned, and be plumb and flat.
 ▶ Page 126

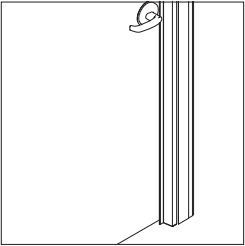
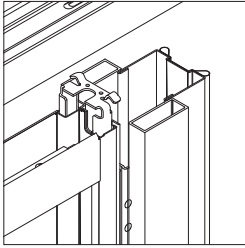

Mini ends always go to the floor and ceiling and are field-cut to the proper height.

Mini-ends and wall starts span from finished floor to finished ceiling, and are cut to exact length by installer.

Connections

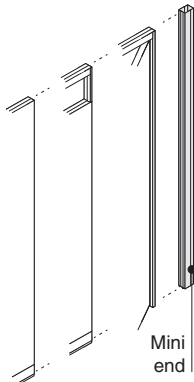

All panel types and door frames can connect to a mini end.

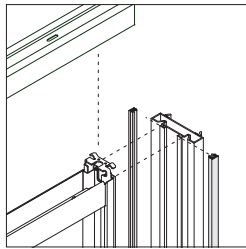

Adjacent panels connect to a mini end in the same way all panels connect. Frame couplers on both sides of the panel form a continuous link to the mini end by engaging the verticals of the mini end and the adjacent panel.

Physical connection to the building is not always needed. Mini ends are fitted with a continuous seal to prevent light and sound leaks.

Panel-supported components cannot be attached to a mini end. Use the adjacent panel to support storage components.

All wall types and door frames can connect to a mini end.

A screw connection to the building is not typically required. Mini end fits tightly against the building wall, and the contact points are sealed with a continuous polypropylene seal.

When routing cable through a medium mini-end, the inner channel will be screwed to the fixed wall.

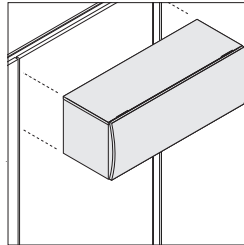

Solid panel adjacent to mini end can support hang-on storage.

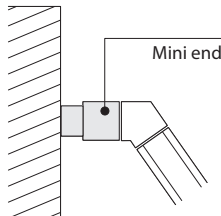

Mini ends can be positioned adjacent to an angled post to create an angled wall termination.

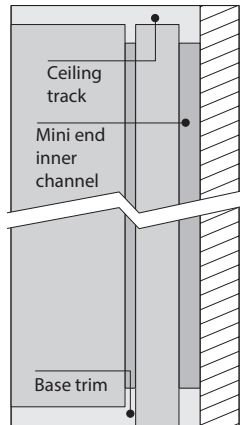

When making paint color selections, it is recommended to use the same color for ceiling track and mini end inner channel.

Wiring & Cabling

Wire and cable routing vertically through a mini end can be used to route power to adjacent clerestory or solid panels. Screws are needed when routing power in medium mini ends.

Cutouts to run cabling horizontally through a mini-end can be factory-supplied, or cut on-site during installation.

Surface Materials

Inner finish—mini end

- Paint

Outer finish—mini end

- Paint
- Anodized

Wall start

- Paint
- Anodized

Frame coupler

- 6249 Platinum Solid
- 6527 Merle

Healthcare Applications

In applications that require flush vertical surfaces to support infection prevention and improved cleanability, supplemental trims can be specified at skins and base trim.

High-Pressure Laminate skins or painted steel skins are recommended for use in healthcare settings. Low-Pressure Laminates are not ideal for these high impact locations.

In applications that require flush vertical surfaces to support infection prevention and improved cleanability, supplemental trims can be specified at skins and base trim.

Product Details

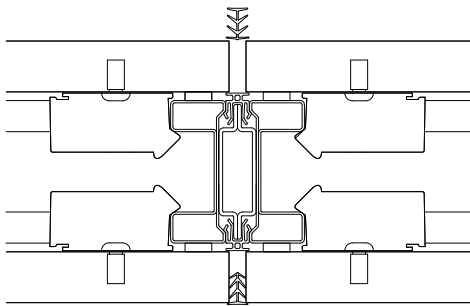

Flush skin seal

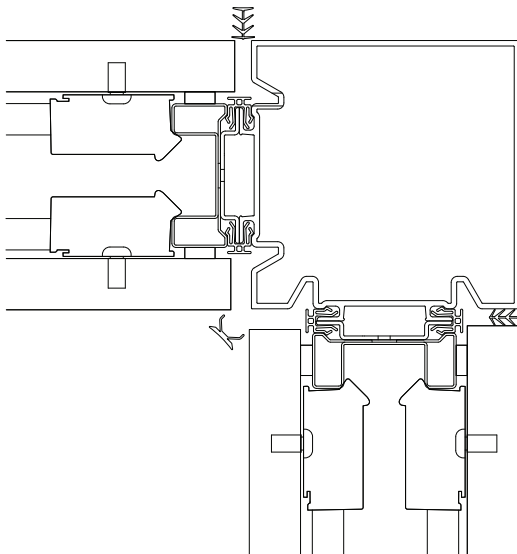
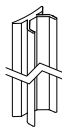

90° inside corner flush skin seal

Flush skin seals are available in a translucent finish.

Flush skin seals are inserted into the reveals between skins as part of the installation process. They are provided in 120" lengths, and cut to size by the installer.

Where vertical reveals run from top to bottom of wall, vertical seals are intended to be continuous, while the seals at the horizontal reveals are installed between the vertical seals.

Flush skin seals are positioned at inside corner reveals with 90° posts. They cannot be used at T/X adapters.

Flush skin seals are intended for use with paint, laminate, and ceramic skins. They are also inserted between skins and junction covers, or mini-ends and door frames. If desired, flush seals can also be used at fabric skins and glass panels.

When used with hang-on components, flush skin seals will be field notched to allow clearance for mounting brackets.

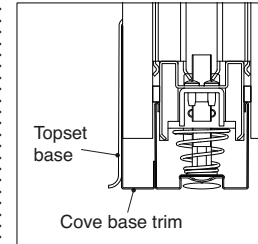
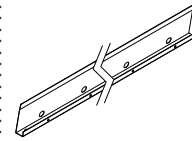

Additional base trim components can be specified for use with surface applied cove base. These additional V.I.A. base components are not the finished base material, but serve as surface to receive the adhesive for installation of the topset base material, as manufactured by commercial wall base suppliers. The same base trim components can also be used with applied cove flooring applications.

Cove base trims are provided in straight lengths, and cut to size by the installer.
Tip: When using surface applied base, skins are not removed and accessed as easily.

Tip: When using cove base, the bottom portion of the wall must be a solid skin.

Tip: Topset base is glued to cove base trim. It is not glued to skin.

Electrical Components

Field-installed electrical components are available to provide power, data, lighting control, or other types of devices. Power options include modular power or conventional hardwired devices.

Communication cabling is field installed.

Modular power components utilize modular connections to simplify power distribution and speed installation.

Electrical mounting brackets are supported by vertical structure or intermediate horizontals, and allow for either modular or hardwired components.

Framing components are pre-punched for cable routing.

Hardwire (power or communications)

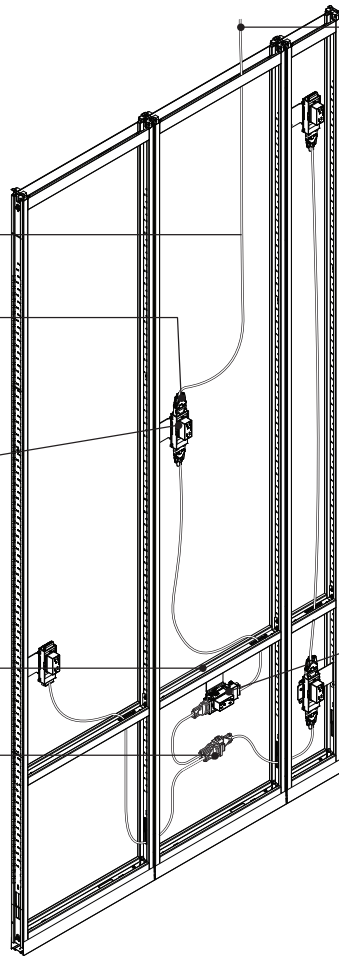

Infeeds can be routed through the ceiling or floor.

Modular harnesses connect power blocks.

Modular communications offer voice and data options consistent with design of modular power faceplate.

Electrical locations are parametric.

Electrical mounting brackets can be mounted to the underside of intermediate horizontals.

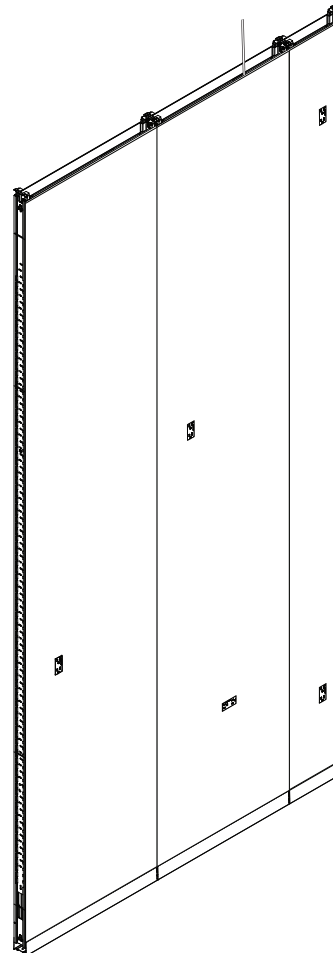

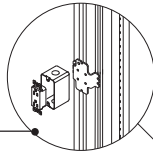

Electrical mounting brackets support hard-wired or modular power.

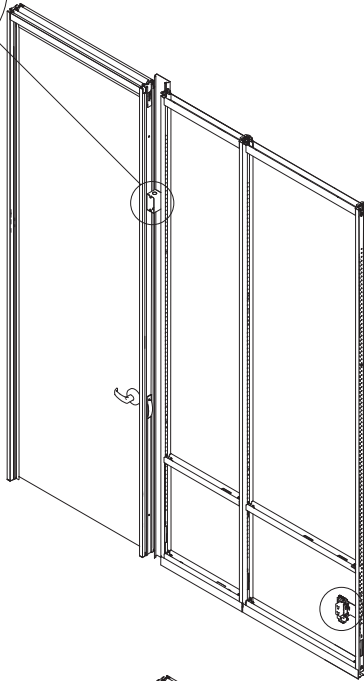

Electrical mount bracket at frame vertical.

Multipurpose infeed feeds from floor or ceiling.

Utility panels are factory cut for modular or hardwired power.

Utility panel houses electrical devices when cut-outs in skins are not available or desired.

Utility panel cover

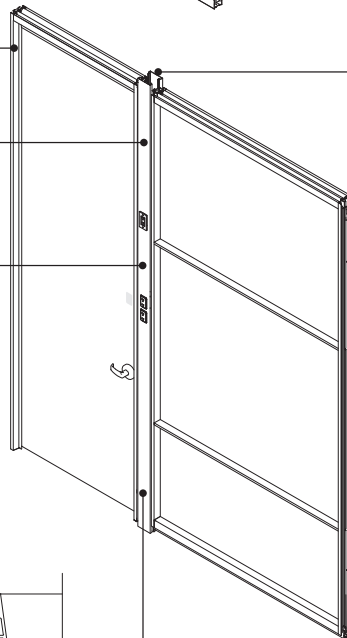

Utility panel frame

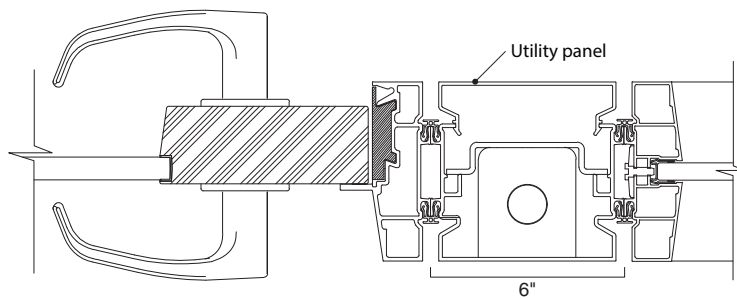

Product Details

Electrical devices can be positioned in solid skins or in utility panels.
 ▶ See Utility Panels on page 67

Modular power or hardwired electrical devices can be accommodated. Both types can be combined in the same application.

Receptacles mounted to verticals are parametric and can be positioned in 1" increments.
 ▶ See *SmartTools*

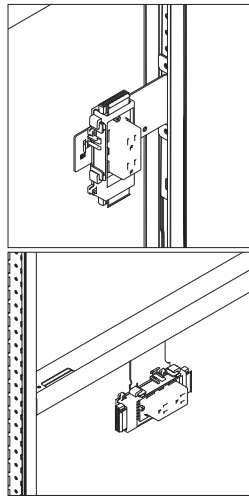

Electrical devices are held in place with mounting brackets, which are fastened to vertical structure or intermediate horizontals as part of the installation process.

Each structural frame vertical, structural horizontal and intermediate horizontal includes a cut-out for cabling routing. If required, additional cable routing holes can be cut during installation. Horizontals less than 10" wide do not have cutouts.

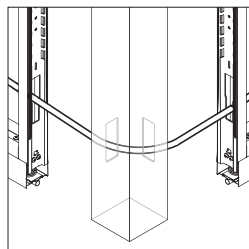

Infeeds and harnesses can be fed through posts and utility panels. Horizontal routing holes can be factory-supplied, or cut on-site during installation.

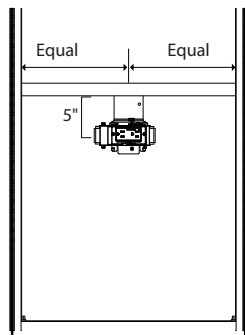

Receptacles mounted to horizontals are centered on the horizontal and mounted 5" below the centerline of the horizontal.

The maximum number of cut-outs per skin will vary depending on the size of the skin and overall skin geometry. The largest skin will allow for nine cut-outs. Electrical cut-outs can be specified for factory cutting, or can be cut on site.

A maximum of three devices can be located in a single utility panel.
 ▶ See Utility Panels on page 67

Modular Power in Skins

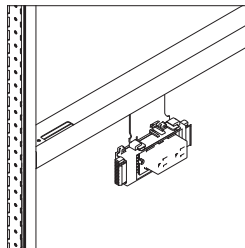

Modular power blocks are held in place with mounting brackets, which are fastened to structural frame components.

A multipurpose infeed brings power from the ceiling or floor to a power block in the wall.

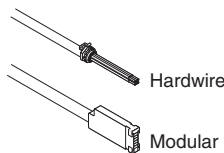

End of the power infeed can be hardwire or modular. Hardwire allows the electrician to make a conventional connection to the building's power inside a junction box. Modular allows the infeed to connect to any corresponding modular infeed cover. This is the same modular connector used by Answer, Montage, and Architectural Solutions modular power system.

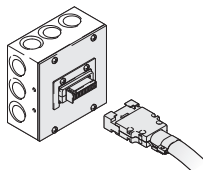

Modular infeed cover is included with modular multipurpose infeed to hardwire to a junction box. It allows modular connector on the infeed to snap easily into position. This allows infeeds to be quickly disconnected, moved, and reconnected later.

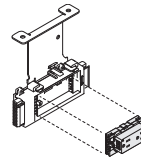

Receptacles are ordered separately and field installed in power blocks. Separate duplex receptacles are available to engage each of the different circuits that are possible in the electrical system. Receptacles are coded to indicate which circuit and type of ground they engage.

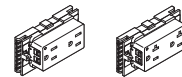

15 amp 20 amp
Receptacles can be specified as 15 amp or 20 amp rated.

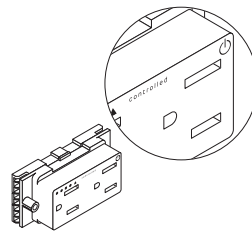

Modular receptacles are available with a power icon symbol, including the word "Controlled", when required as part of a controlled power system in compliance with the energy code.

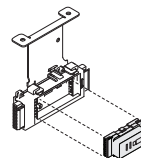

USB receptacles are available in three wiring schematics with multiple line options. USB receptacles offer easy access to two changing ports. Each port provides one amperage of output. USB receptacles conveniently charge a wide range of electronic devices. Some devices may not be compatible.

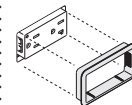

Receptacle trim is used with each receptacle to cover the edge of the cut-out and create a precise transition between the cut-out and the receptacle.

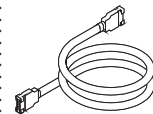

Modular harnesses connect power from one power block to another. Harnesses are available in lengths of 36", 72", and 144".

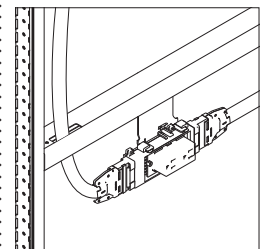

Each power block can receive a single harness at either end.

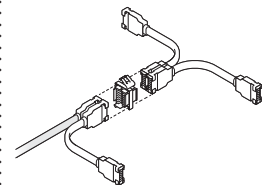

Harness-to-harness branching connector link harnesses. This allows multiple harnesses to connect at a single point to allow power networks to branch.

Harnesses cannot be routed in the base cavity or door frames.

Power harnesses can be routed behind solid skins or within posts, utility panels, and mini ends.

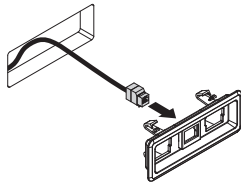

A modular communication faceplate can be used to create voice and data terminations using a design that is consistent with modular power receptacles.

Modular communication faceplates are not compatible with junction boxes. If junction boxes are desired at communication terminations, a conventional faceplate is required.

In some cities, like New York and Chicago, local electrical codes will not allow the use of modular power components in full height walls. When planning for power in these areas, use hardwire power components.

Hardwire in Skins

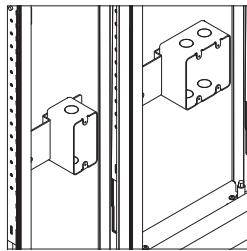

Junction boxes are held in place with mounting brackets, which are in turn fastened to structural frame components.

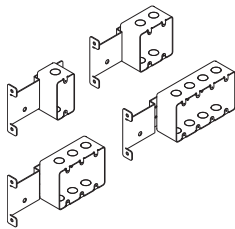

Mounting brackets can accommodate single gang, two gang, three gang, or four gang junction boxes. Mounting brackets are designed for use with 2 1/2" deep junction boxes as manufactured by Appleton. Single Gang – M1-250 Two Gang – M2-250 Three Gang – M3-250 Four Gang- M4-250 Partition – LVP250 Skins can be factory cut for any of these four sizes.

Junction boxes (and associated devices) and cover plates are purchased locally and are not part of the statement of line.

Conduit cannot be routed in the base cavity, or door frames.

Utility Panel

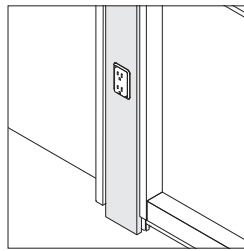

Utility panels are used to house electrical devices adjacent to glass panels and door frames, or when skin cut-outs are not desired.

Utility panels are made up of utility panel frame and cover.

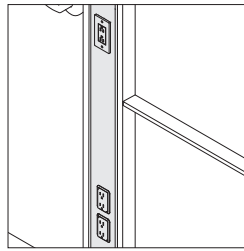

Utility panels can include as many as three electrical devices. One of these can be a modular power block. The three cut-outs can be located in one cover, or can be distributed between cover and panel (i.e. two cut-outs in the cover, one cut out in the panel). Utility panel frames and covers can be ordered with factory cut-outs.

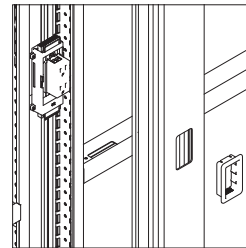
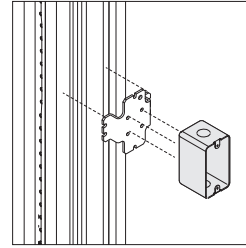

Electrical devices are held in place with mounting brackets, which are in turn fastened to utility panel verticals.

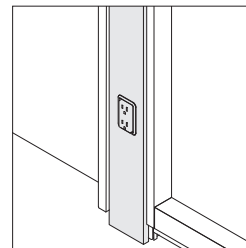

Modular power blocks are oriented vertically in the utility panel.

Utility panels can accommodate hardwired single gang 2" x 4" electrical boxes – 2 1/2" deep.

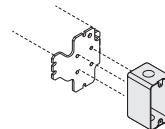

Hardwire box

Utility panel mounting brackets are designed for use with hardwired junction boxes as manufactured by Appleton. 2 1/2" deep: 4SSLD-1/2"

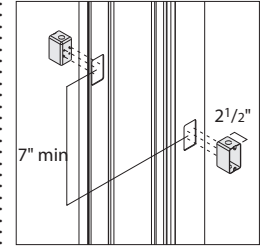

When hardwired devices using a 2 1/2" deep box are cut into both sides of the utility panel, they must be offset by a minimum of 7" (center to center).

There are two types of mounting brackets:

- hardwired 2 1/2" deep box
- modular power block

Modular communication covers cannot be located in a utility panel. Use industry standard communication faceplates.

Junction boxes (and associated devices) and cover plates are purchased locally and are not part of the statement of line.

Communications

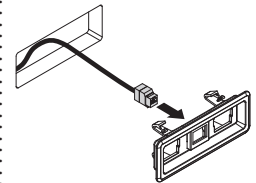

A modular communication faceplate can be used to create voice and data terminations using a design that is consistent with modular power receptacles.

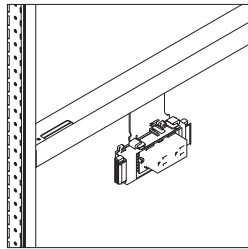

The modular communication faceplate snaps directly into a cutout in the skin.

The modular communication faceplate uses any combination of three adaptors from the provided data tree.

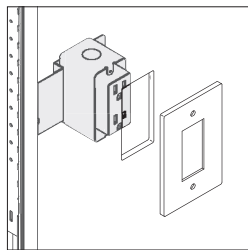

Conventional communication faceplates can be used with an electrical box, which is held in place with electrical mounting brackets.

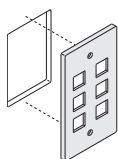

Cut-Outs

Cut-out locations are parametric, and are positioned as part of the design/planning process.
 ▶ Page 68 for more details related to cutout positions.

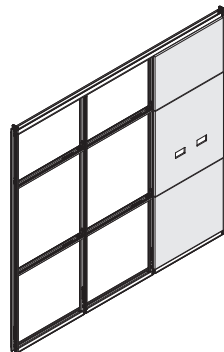

Electrical cut-outs can be specified for factory cutting or can be cut on site.

The maximum number of cut-outs per skin will vary depending on the size of the skin. The largest skin will allow for nine cut-outs.

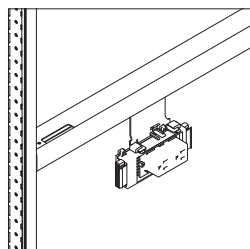

Modular Power (one cut-out for each receptacle)

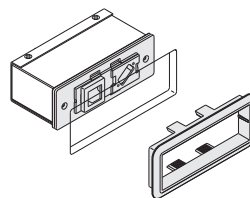

Modular Communications

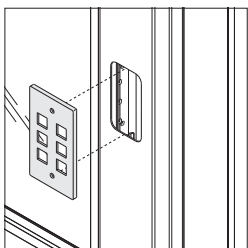

When an electrical box is not desired, communication faceplates can be fastened to the surface of the skin or utility panel.

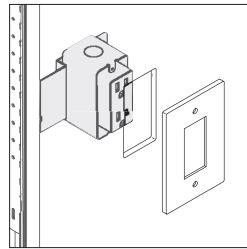

Hardwire Single

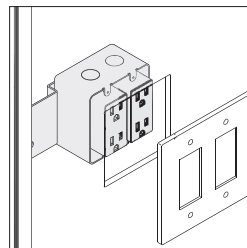

Hardwire Double

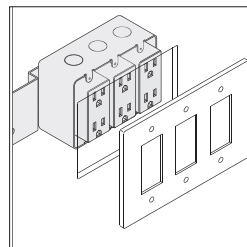

Hardwire Triple

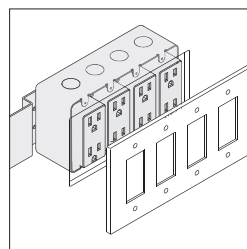

Hardwire Fourplex

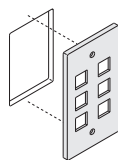

Communications - No Junction Box

Electrical cut-outs in skins are available in eight different configurations.

Brackets

Electrical mounting brackets for skins will fasten to intermediate or structural horizontals. They are available in two types:
 • Modular power
 • Hardwire

Two types of mounting brackets for utility panels:

- Hardwire 2 1/2" deep box
- Modular power block

All Everwall electrical components are listed by Underwriters Laboratory (UL) and certified by the Canadian Standards Association (CSA).

All Steelcase electrical systems are designed in compliance with the National Electrical Code (NEC) and Canadian Electrical Code (CEC) to function as a multi-wire branch circuit. Installations should be made in accordance with the NEC or CEC provisions for multi-wire branch circuits.

Local electrical codes vary. Consult a qualified electrical contractor or engineer for the proper installation of electrical equipment.

Surface Materials

Receptacle
 • Plastic

Power/communication receptacle trim
 • Plastic

Modular communication faceplate
 • Plastic

Utility panel cover
 • 8043 Clear Anodized Aluminum
 • Paint

Electrical Locations

Minimum Dimensions for Outlet Spacing
Modular Power and Communications with Bracket

All dimensions are to center of receptacle.

All dimensions are to centerline of reveal unless otherwise noted to floor/ceiling.

Electrical brackets do not attach to clerestory horizontals.

Minimum Skin Size - Mounted to Vertical

	Hardwire Single	Hardwire Double	Hardwire Triple	Hardwire Fourplex	Modular
Height	17"	17"	17"	17"	17"
Width	10"	12"	14"	16"	10"

Minimum Skin Size - Mounted to Horizontal

	Hardwire Single	Hardwire Double	Hardwire Triple	Hardwire Fourplex	Modular
Height	15"	15"	15"	15"	12"
Width	24"	24"	24"	24"	24"

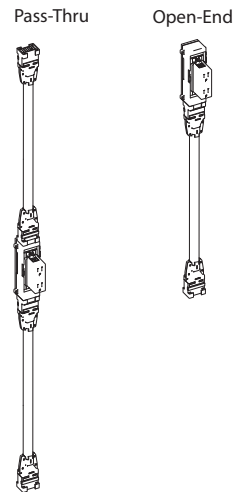
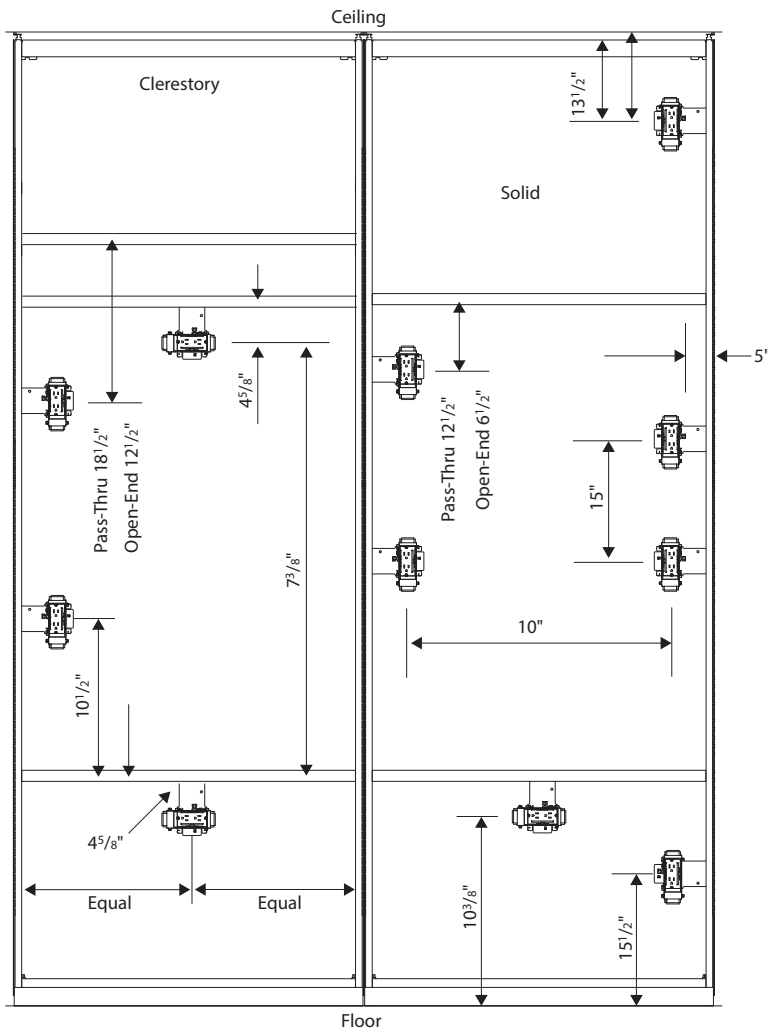

**Minimum Dimensions for Outlet Spacing
Hardwired Power and Communications
with Bracket**

A	Single Box	5"
	Double Box	6"
	Triple Box	7"
	Fourplex Box	8"
B	Single Box	10"
	Double Box	10"
	Triple Box	12"
	Fourplex Box	12"

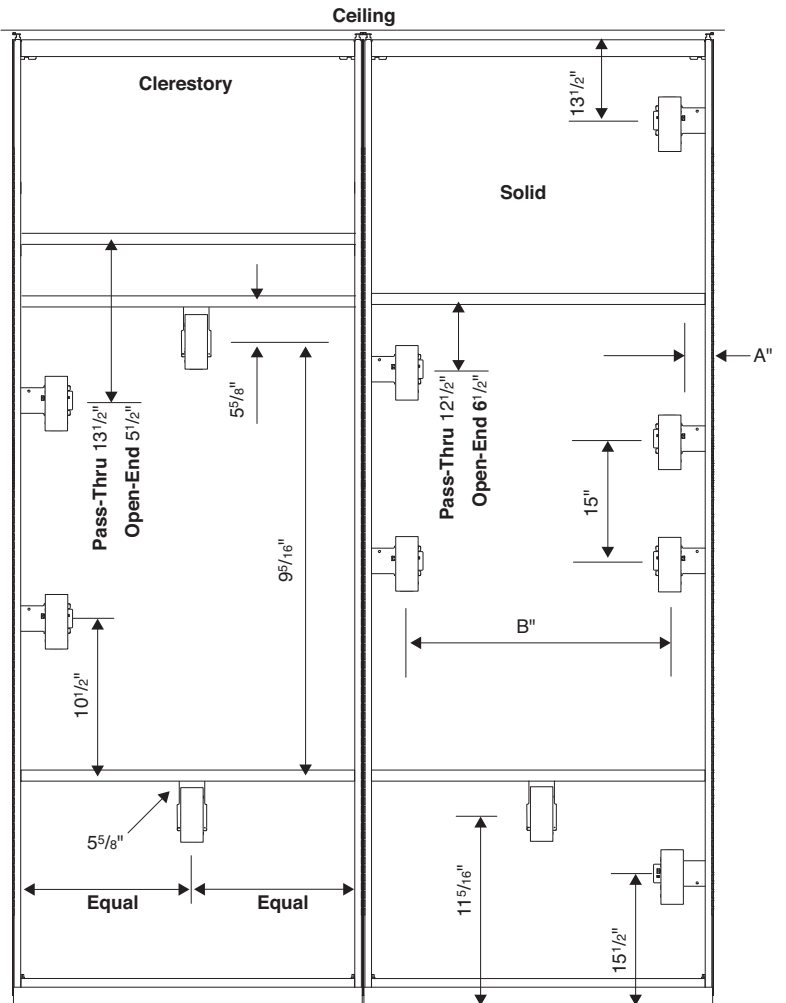

Electrical Locations, Minimum Dimensions for Outlet Spacing,
Modular Power and Communications with Bracket, continued

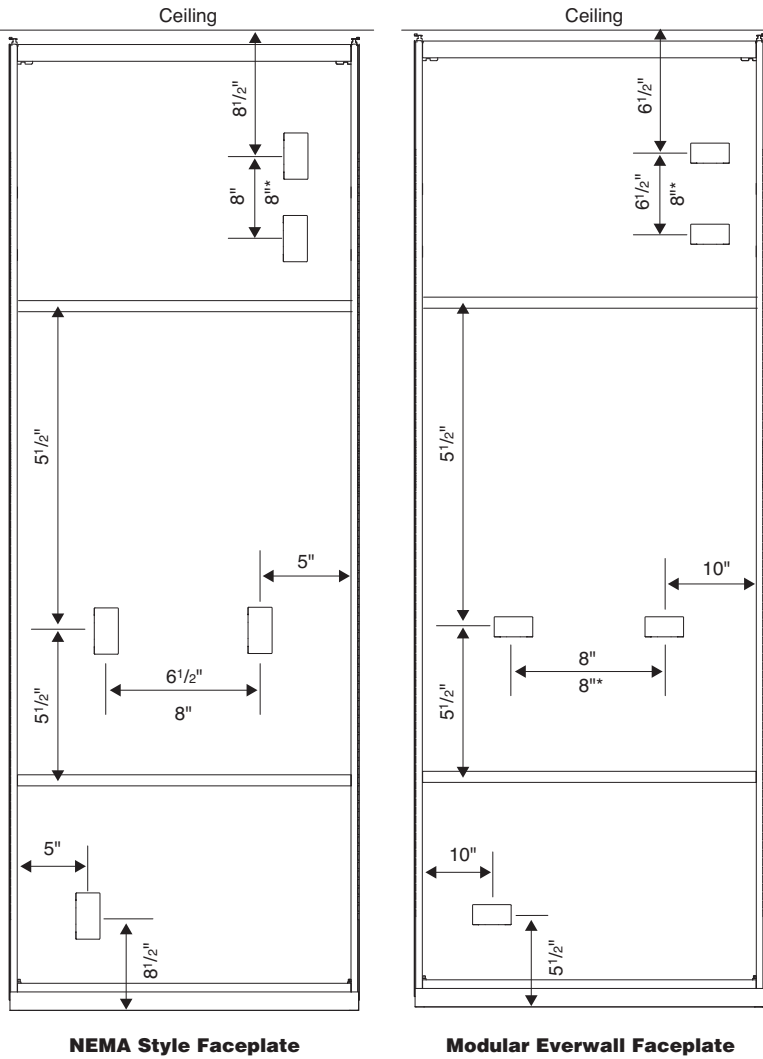

Communication Cutout Size

NEMA Cutouts	2 ⁴ / ₅ "H x 1 ³ / ₄ "W	
Modular Cutouts	1 ³ / ₄ "H x 5"W	
	Minimum Skin Size	
	NEMA	Modular
Height	12"	12"
Width	10"	12"

* Indicates minimum distance when combining modular and NEMA style cutouts.

Everwall modular power components are offered in three different wiring schematics to allow you to match your specific wiring strategy to any typical building wiring plan.

Tip: All the components in an electrical system must use the same wiring schematic. The components are color coded and keyed to make it impossible to connect mismatched parts.

Black = Four-circuit, 3+1

Brown = Four-circuit, 2+2

Rust = Three-circuit, separate neutrals

Shared neutral conductors = 10 gauge

Separate neutral conductors = 12 gauge

Hot conductors = 12 gauge

Grounding conductors = 12 gauge

Four-Circuit, 3+1

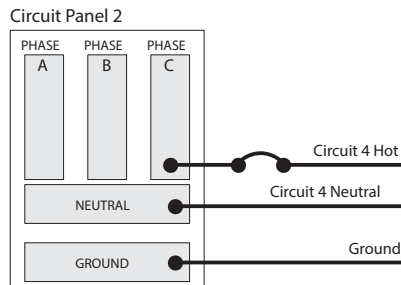
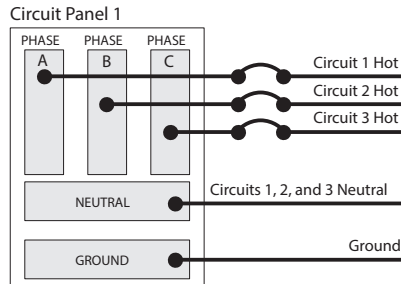

In the four-circuit 3+1 schematic, circuits 1, 2, and 3 are distributed from the first circuit panel and are supported with one shared neutral and one shared ground. Circuit 4 is distributed from a second circuit panel and is supported with a separate neutral and ground.

Single 3-Phase Circuit Panel

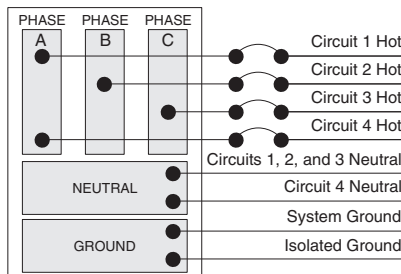

On a single 3-phase circuit panel, all four circuits are distributed as shown.

Four-Circuit, 2+2

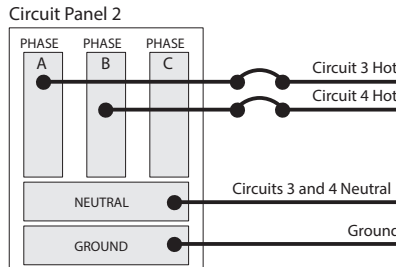
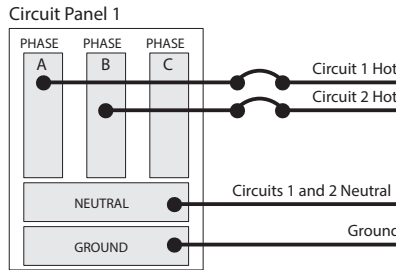

In the four-circuit 2+2 schematic, circuits 1 and 2 are distributed from two different phases from the first circuit panel and are supported with one shared neutral and one shared ground. Circuits 3 and 4 are distributed from a second circuit panel and supported by their own shared neutral and ground.

Single 3-Phase Circuit Panel

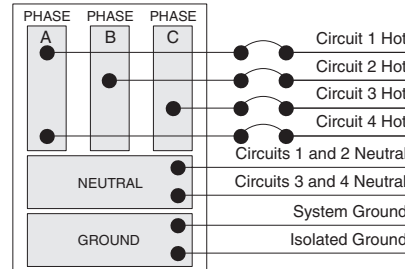

On a single 3-phase circuit panel, all four circuits are distributed as shown.

Split-Phase Circuit Panel

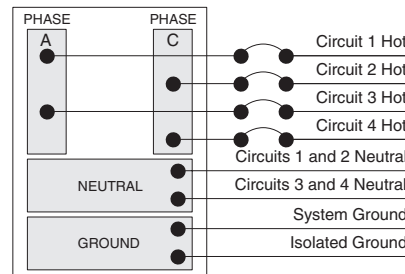

On a split-phase circuit panel, all four circuits are distributed as shown.

Three-Circuit, Separate Neutrals

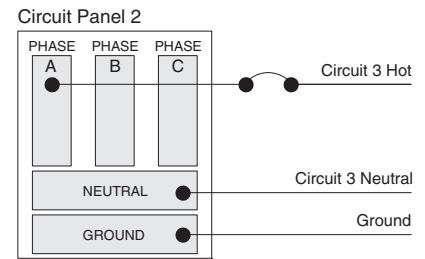
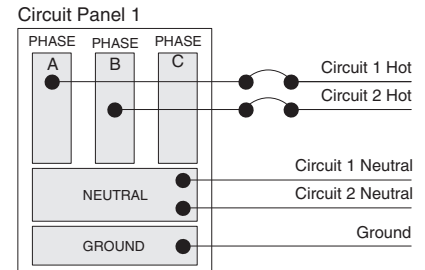

In the three-circuit, separate neutral schematic, circuits 1 and 2 are distributed from two different phases from the first circuit panel. Each circuit is supported with its own neutral and a common ground. Circuit 3 is distributed from the second circuit panel and is supported by its own neutral and ground.

Single 3-Phase Circuit Panel

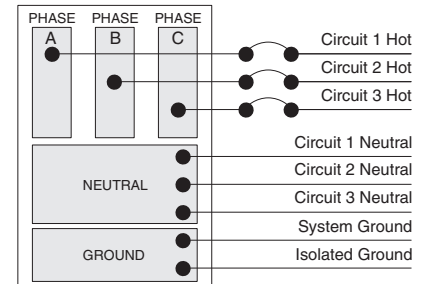

On a single 3-phase circuit panel, three circuits are distributed as shown.

Split-Phase Circuit Panel

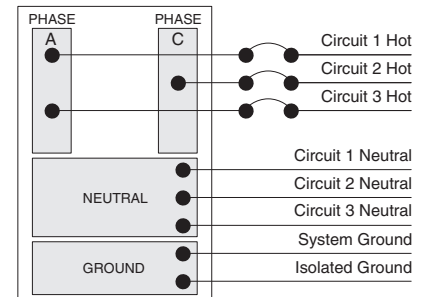

On a split-phase circuit panel, three circuits are distributed as shown.

How to Calculate Power Needs

Use This to Determine How Many Power-Ins You'll Need

When planning a power network, you must calculate the amperage requirements of all your electrical components so you can provide sufficient electricity to power them.

If your usage is not known in advance: The National Electrical Code (NEC) allows a maximum of 13 receptacles on each 20-amp circuit. This provides up to 30 receptacles for each 3-circuit power-in.

If your usage is known in advance:

Add up the amperage used by each piece of equipment in the workstation. Whenever you reach 60 amps (20 amps times 3 circuits) from items that are likely to be used at the same time, you have reached the limit for a single power-in. Specify another power-in and continue until all equipment is powered.

If the circuits will normally be subject to a continuous load (three or more hours of continuous use, such as lights or computers), the NEC requires that circuit capacity be "de-rated" by 20 percent. Therefore, treat circuits used for continuous loads as if they were rated at 16 amps instead of the regular 20 amps.

Try to anticipate future increases in power requirements and build some excess capacity into your plan.

▶ See table at right for typical and actual amperage usages for components.

To calculate amperage when the wattage of a device is known, divide watts by 120.

Some appliances, such as large copiers, coffee makers, or space heaters require most of the current available on a 20-amp circuit. It is recommended that such devices be supplied with their own receptacle/circuit, directly from the building. This leaves the capacity of the furniture circuits available for the more dynamic requirements of the office equipment.

Local electrical codes vary. Consult a qualified electrical contractor or engineer for the proper planning of electrical circuits in your locale.

Approximate power consumption for common devices

• Device	• Wattage	• Amperage	• Voltage	• Number of Devices Supported on Single 20 Amp Circuit
Laptop (Low)	30	0.25	120	64
Laptop (High)	100	0.83	120	19
CPU/Desktop Computer (Low)	65	0.54	120	30
CPU/Desktop Computer (High)	150	1.25	120	13
Monitor (Low)	15	0.13	120	128
Monitor (High)	80	0.67	120	24
Phone	5	0.04	120	384
High Power Tablet	10	0.08	120	192
Lower Power Tablet	45	0.38	120	43
Desktop Printer	40	0.33	120	48
42" LCD Screen	120	1.00	120	16
Projector (Small)	50	0.42	120	38
Projector (Medium)	250	2.08	120	8
Projector (Large)	800	6.67	120	2
Desktop Lamp	20	0.17	120	96
Large Printer/Copier	1600	13.33	120	1
Small Printer/Copier	800	6.67	120	2
Paper Shredder (Small)	250	2.08	120	8
Paper Shredder (Large)	800	6.67	120	2
Desktop Fan	25	0.21	120	77
Standing Fan	125	1.04	120	15
Coffee Maker (Low)	500	4.17	120	4
Coffee Maker (High)	1500	12.50	120	1
Microwave (Low)	600	5.00	120	3
Microwave (High)	1000	8.33	120	2
Refrigerator (Low)	200	1.67	120	10
Refrigerator (High)	1500	12.50	120	1
Vacuum (Low)	200	1.67	120	10
Vacuum (High)	1500	12.50	120	1
Space Heater (Low)	400	3.33	120	5
Space Heater (High)	1500	12.50	120	1
Height-Adjustable Desk (Low Power Consumption)*	200	1.67	120	10
Height-Adjustable Desk (High Power Consumption)*	550	4.58	120	3

Tip: These calculations are estimations and are meant solely for informational purposes. It is important to conduct proper power planning for each installation to prevent overloading a circuit.

** Refer to the Height-Adjustable Desks Specification Guide for specific product information.*

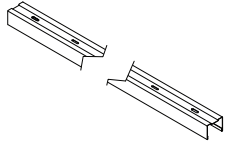

Standard Includes		Required to Specify
<ul style="list-style-type: none"> ▶ Need help? Product details, page 22 	<ul style="list-style-type: none"> • Ceiling track: paint price group 1 • Seal: plastic 	<ul style="list-style-type: none"> 1 Style number 2 Paint color number for track 3 Plastic color number for seal 4 Options, if selected (see below) ▶ See <i>Surface Materials</i>, page 142

Options	U.S. Price	Required to Specify
Length <ul style="list-style-type: none"> • 120" • 144" 	No cost +\$18.40	Specify <i>with 120"</i> . Specify <i>with 144"</i> .
Surface Materials <ul style="list-style-type: none"> • Paint price group 2 <ul style="list-style-type: none"> – 120" – 144" 	+\$36.01 +\$43.21	Specify paint color number. Specify paint color number.

Specification Information	
Style Number	U.S. Base Price
NECTS	\$213.89
.	.

Specifying

 **For Canadian Pricing**
 Multiply U.S. Price by the Canadian price factor.
 ▶ See page 1 for details.

Solid Structural Frame



Tip: When the standard pre-set widths are specified the list price will be reduced by 5% from the formula factors as shown above. This discount applies only to the base price per panel and the per square foot of panel add.

Standard Includes		Required to Specify
<ul style="list-style-type: none"> ▶ Need help? Product details, page 22 	<ul style="list-style-type: none"> • Frame • Width: 8"–60" • Height: 84"–120" • Floor track: <ul style="list-style-type: none"> – 7190 Platinum Solid – 7360 Merle • Seal: plastic 	<ul style="list-style-type: none"> 1 Style number 2 Frame width 3 Frame height 4 Paint color number for floor track 5 Options, if selected (see below) ▶ See <i>Surface Materials</i>, page 142

Options	U.S. Price	Required to Specify
Horizontal Count		
• 1	No cost	Specify with 1 horizontal.
• 2	+\$ 72.19	Specify with 2 horizontals.
• 3	+\$144.38	Specify with 3 horizontals.
• 4	+\$216.57	Specify with 4 horizontals.
• 5	+\$288.76	Specify with 5 horizontals.
• 6	+\$360.95	Specify with 6 horizontals.
• 7	+\$433.14	Specify with 7 horizontals.
• 8	+\$505.33	Specify with 8 horizontals.
• 9	+\$577.52	Specify with 9 horizontals.
• 10	+\$649.71	Specify with 10 horizontals.

Top Horizontal AFF	Horizontal Count 2-10	U.S. Price	Required to Specify
	• 15"–108"W	+\$ 0.40 per inch	Specify width.

Specification Information

Style Number	U.S. Base Price	
	Per Frame	Per Sq ft of Frame
NESFS	\$717.08	+\$2.63
:	:	:

Tip: Per sq. ft. of frame upcharge is based on height and width of the frame and is added to base price.



For Canadian Pricing
 Multiply U.S. Price by the Canadian price factor.
 ▶ See page 1 for details.

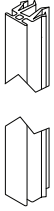

Standard Includes		Required to Specify
▶ Need help? Product details, page 22	<ul style="list-style-type: none"> • Frame coupler package of 26: <ul style="list-style-type: none"> – 6249 Platinum Solid – 6527 Merle • Seal: plastic 	<ul style="list-style-type: none"> 1 Style number 2 Plastic color number for frame coupler

Specification Information	
• Style • Number	• U.S. • Price
NEFC	\$1379.94

Specifying

 **For Canadian Pricing**
 Multiply U.S. Price by the
 Canadian price factor.
 ▶ See page 1 for details.

Ceiling Fastener



Tip: Order one ceiling fastener package per 10' of ceiling track.

Tip: Spacers are included with fasteners for regular ceiling tiles that allow adjustment for different tile edge depths.

Standard Includes	Required to Specify
-------------------	---------------------

- | | | |
|---|---|--|
| <ul style="list-style-type: none"> ▶ Need help? Product details, page 22 | <ul style="list-style-type: none"> • Fastener package of five • Spacers | <ul style="list-style-type: none"> 1 Style number 2 Options, if selected (see below) |
|---|---|--|

Options	U.S. Price	Required to Specify
---------	------------	---------------------

Fastener Type	<ul style="list-style-type: none"> • 1" fluted runner 1/4–20 • 1" tegular • 1" wide exposed T • 1/4" donn fineline • 1/8" donn fineline • 9/16" tegular • 9/16" wide exposed T 	<ul style="list-style-type: none"> No cost No cost No cost No cost No cost No cost No cost 	<ul style="list-style-type: none"> Specify with 1" fluted runner. Specify with 1" tegular. Specify with 1" wide exposed T. Specify with 1/4" donn fineline. Specify with 1/8" donn fineline. Specify with 9/16" tegular. Specify with 9/16" wide exposed T.
----------------------	---	---	--

Specification Information	
Style Number	U.S. Price

NECF	\$21.04
:	:
:	:



For Canadian Pricing

Multiply U.S. Price by the Canadian price factor.

▶ See page 1 for details.

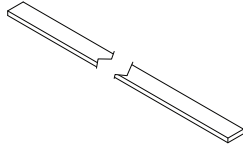

Tip: For seismic applications, additional mechanical fasteners, NOT included with the floor guide, may be required as specified by the structural engineer.

Standard Includes		Required to Specify
▶ Need help? Product details, page 22	<ul style="list-style-type: none"> • Seismic floor guide: floor guide only • Simple floor guide: floor guide, carpet gripper, and double-sided tape 	1 Style number 2 Options, if selected (see below)

Options	U.S. Price	Required to Specify
Gripper Type		
<ul style="list-style-type: none"> • Seismic • Simple 	No cost No cost	Specify with <i>seismic gripper</i> . Specify with <i>simple gripper</i> .

Specification Information	
Style Number	U.S. Price
NEFG	\$6.90
.	.

Specifying



For Canadian Pricing
 Multiply U.S. Price by the Canadian price factor.
 ▶ See page 1 for details.

Elective Elements Storage Bracket



Standard Includes		Required to Specify
<ul style="list-style-type: none"> ▶ Need help? Product details, page 25 	<ul style="list-style-type: none"> • Elective Elements storage bracket 	Style number
Specification Information		
• Style Number	• U.S. Price	
NEESB	\$32.82	

Elective Elements Organizer and Open Shelf Bracket

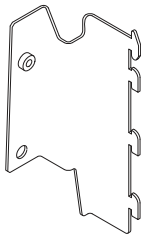

Standard Includes		Required to Specify
<ul style="list-style-type: none"> ▶ Need help? Product details, page 25 	<ul style="list-style-type: none"> • Elective Elements organizer and open shelf bracket 	Style number
Specification Information		
• Style Number	• U.S. Price	
NEESBO	\$156.98	

Specifying

Universal Storage Bracket



Standard Includes		Required to Specify
<ul style="list-style-type: none"> ▶ Need help? Product details, page 25 	<ul style="list-style-type: none"> • Universal storage bracket 	Style number
Specification Information		
• Style Number	• U.S. Price	
NEUSB	\$32.82	

 **For Canadian Pricing**
 Multiply U.S. Price by the Canadian price factor.
 ▶ See page 1 for details.

Universal Vertical Off Module Bracket



Standard Includes	Required to Specify
<ul style="list-style-type: none"> ▶ Need help? Product details, page 25 • Universal vertical off module bracket 	<ul style="list-style-type: none"> Style number

Specification Information

• Style Number	• U.S. Price
NERBKVOFM	\$174.23

French Cleat Support



Standard Includes	Required to Specify
<ul style="list-style-type: none"> ▶ Need help? Product details, page 25 • Two french cleat supports • Width: 12"–60" 	<ul style="list-style-type: none"> 1 Style number 2 Support width

Specification Information

• Style Number	• U.S. Base Price	
		Per Inch Width
NEFCS	\$878.93	+\$2.28

Flex Wall Rail Bracket, Portrait



Standard Includes	Required to Specify
<ul style="list-style-type: none"> ▶ Need help? Product details, page 25 • Top, bottom, and center brackets 	<ul style="list-style-type: none"> Style number

Specification Information

• Style Number	• U.S. Price
NEFWRBP	\$316.50

Tip: Portrait brackets can only be used on wall rails with markerboards installed in portrait orientation.

Flex Wall Rail Bracket, Landscape

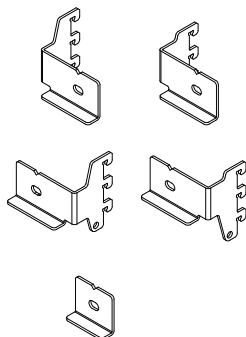

Tip: Landscape brackets can only be used on wall rails with markerboards installed in landscape orientation.

Standard Includes		Required to Specify
<ul style="list-style-type: none"> ▶ Need help? Product details, page 25 	<ul style="list-style-type: none"> • Top, bottom, and center brackets 	<ul style="list-style-type: none"> Style number
Specification Information		
Style Number	U.S. Price	
NEFWRBL	\$316.50	

Specifying

 **For Canadian Pricing**
 Multiply U.S. Price by the Canadian price factor.
 ▶ See page 1 for details.

Solid Skins—Laminate

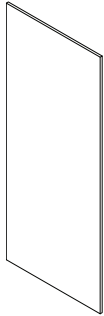

Tip: When the standard pre-set widths are specified the list price will be reduced by 5% from the formula factors as shown above. This discount applies only to the base price per panel and the per square foot of panel add.

Tip: Brackets, latches, and screws must be ordered separately. The brackets, latches, and screws are auto-calculated in SmartTools. All brackets and latches are assembled with the screws to the back of the skin on site.

Tip: Each cutout can be a different cutout type.

Tip: Per sq. ft. of skin upcharge is based on height and width of the skin and is in addition to the base price.



For Canadian Pricing
Multiply U.S. Price by the Canadian price factor.
▶ See page 1 for details.

Standard Includes		Required to Specify
▶ Need help? Product details, page 28	<ul style="list-style-type: none"> • Skin: Low-Pressure Laminate price group 1 with 1 mm plastic edge • Width: 8"–120" • Height: 12"–120" • Top mount • Bottom mount 	<ol style="list-style-type: none"> 1 Style number 2 Skin width 3 Skin height 4 Laminate color number for skin 5 Options, if selected (see below) <p>▶ See <i>Surface Materials</i>, page 142</p>

Options	U.S. Price	Required to Specify
Top Mount Type	<ul style="list-style-type: none"> • Ceiling mount No cost • Clerestory mount No cost • Intermediate mount No cost 	<ul style="list-style-type: none"> Specify with <i>ceiling mount</i>. Specify with <i>clerestory mount</i>. Specify with <i>intermediate mount</i>.
Bottom Mount Type	<ul style="list-style-type: none"> • Floor mount No cost • Intermediate mount No cost 	<ul style="list-style-type: none"> Specify with <i>floor mount</i>. Specify with <i>intermediate mount</i>.
Surface Materials	<p>Skin</p> <ul style="list-style-type: none"> • High-Pressure Laminate price group 1 <ul style="list-style-type: none"> – Per skin +\$226.89 – Per sq foot of skin +\$ 5.69 • High-Pressure Laminate price group 2 <ul style="list-style-type: none"> – Per skin +\$226.89 – Per sq foot of skin +\$ 9.74 • High-Pressure Laminate price group 3 <ul style="list-style-type: none"> – Per skin +\$226.89 – Per sq foot of skin +\$ 19.52 • Open Line laminate +\$110.78 plus cost of laminate 	<ul style="list-style-type: none"> Specify laminate color number. Specify laminate color number. Specify laminate color number. Specify laminate color number. Specify laminate color number. Specify laminate color number. ▶ See <i>Surface Materials Reference Manual</i>.
Grain Direction	<ul style="list-style-type: none"> • Horizontal No cost • No grain direction No cost • Vertical No cost 	<ul style="list-style-type: none"> Specify with <i>horizontal grain</i>. Specify with <i>no grain</i>. Specify with <i>vertical grain</i>.
Cutout Count	<ul style="list-style-type: none"> • No holes No cost • 1 hole +\$ 38.36 • 2 holes +\$ 76.72 • 3 holes +\$115.08 • 4 holes +\$153.44 • 5 holes +\$191.80 • 6 holes +\$230.16 • 7 holes +\$268.52 • 8 holes +\$306.88 • 9 holes +\$345.24 	<ul style="list-style-type: none"> Specify with <i>no holes</i>. Specify with <i>1 hole</i>. Specify with <i>2 holes</i>. Specify with <i>3 holes</i>. Specify with <i>4 holes</i>. Specify with <i>5 holes</i>. Specify with <i>6 holes</i>. Specify with <i>7 holes</i>. Specify with <i>8 holes</i>. Specify with <i>9 holes</i>.
Cutout Types (Per Cutout)	<ul style="list-style-type: none"> • Communication only no box No cost • Hardwire double No cost • Hardwire fourplex No cost • Hardwire single No cost • Hardwire triple No cost • Modular data No cost • Modular power horizontal No cost • Modular power vertical No cost 	<ul style="list-style-type: none"> Specify with <i>communication only no box</i>. Specify with <i>hardwire double</i>. Specify with <i>hardwire fourplex</i>. Specify with <i>hardwire single</i>. Specify with <i>hardwire triple</i>. Specify with <i>modular data</i>. Specify with <i>modular power horizontal</i>. Specify with <i>modular power vertical</i>.

Specification Information		
• Style Number	• U.S. Base Price	
	• Per	• Per sq ft
•	• Skin	• of Skin
•	•	•
•	•	•
NESSL	\$160.74	+\$21.10
•	•	•

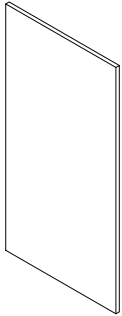

Tip: When the standard pre-set widths are specified the list price will be reduced by 5% from the formula factors as shown above. This discount applies only to the base price per panel and the per square foot of panel add.

Tip: Brackets, latches, and screws must be ordered separately. The brackets, latches, and screws are auto-calculated in SmartTools. All brackets and latches are assembled with the screws to the back of the skin on site.

Tip: Each cutout can be a different cutout type.

Tip: Per sq. ft. of skin upcharge is based on height and width of the skin and is in addition to the base price.

Standard Includes		Required to Specify
▶ Need help? Product details, page 28	<ul style="list-style-type: none"> • Skin with markerboard surface • Width: 8"–120" • Height: 12"–120" • Top mount • Bottom mount 	1 Style number 2 Skin width 3 Skin height 4 Options, if selected (see below) ▶ See <i>Surface Materials</i> , page 142

Options	U.S. Price	Required to Specify
Top Mount Type	<ul style="list-style-type: none"> • Ceiling mount • Clerestory mount • Intermediate mount 	No cost No cost No cost Specify with <i>ceiling mount</i> . Specify with <i>clerestory mount</i> . Specify with <i>intermediate mount</i> .
Bottom Mount Type	<ul style="list-style-type: none"> • Floor mount • Intermediate mount 	No cost No cost Specify with <i>floor mount</i> . Specify with <i>intermediate mount</i> .
Cutout Count	<ul style="list-style-type: none"> • No holes • 1 hole • 2 holes • 3 holes • 4 holes • 5 holes • 6 holes • 7 holes • 8 holes • 9 holes 	No cost +\$ 38.36 +\$ 76.72 +\$115.08 +\$153.44 +\$191.80 +\$230.16 +\$268.52 +\$306.88 +\$345.24 Specify with <i>no holes</i> . Specify with <i>1 hole</i> . Specify with <i>2 holes</i> . Specify with <i>3 holes</i> . Specify with <i>4 holes</i> . Specify with <i>5 holes</i> . Specify with <i>6 holes</i> . Specify with <i>7 holes</i> . Specify with <i>8 holes</i> . Specify with <i>9 holes</i> .
Cutout Types (Per Cutout)	<ul style="list-style-type: none"> • Communication only no box • Hardwire double • Hardwire fourplex • Hardwire single • Hardwire triple • Modular data • Modular power horizontal • Modular power vertical 	No cost No cost No cost No cost No cost No cost No cost No cost Specify with <i>communications only no box</i> . Specify with <i>hardwire double</i> . Specify with <i>hardwire fourplex</i> . Specify with <i>hardwire single</i> . Specify with <i>hardwire triple</i> . Specify with <i>modular data</i> . Specify with <i>modular power horizontal</i> . Specify with <i>modular power vertical</i> .

Specification Information		
• Style Number	• U.S. Base Price	
	Per Skin	Per sq ft of Skin
NESSLM	\$341.88	+\$18.73

Specifying

 **For Canadian Pricing**
 Multiply U.S. Price by the Canadian price factor.
 ▶ See page 1 for details.

Solid Skins—Fabric



Tip: When the standard pre-set widths are specified the list price will be reduced by 5% from the formula factors as shown above. This discount applies only to the base price per panel and the per square foot of panel add.

Tip: Brackets, latches, and screws must be ordered separately. The brackets, latches, and screws are auto-calculated in SmartTools. All brackets and latches are assembled with the screws to the back of the skin on site.

Tip: Each cutout can be a different cutout type.

Tip: Per sq. ft. of skin upcharge is based on height and width of the skin and is in addition to the base price.

Standard Includes		Required to Specify
▶ Need help? Product details, page 28	<ul style="list-style-type: none"> • Skin: fabric price group 1 • Width: 8"–120" • Height: 12"–120" • Top mount • Bottom mount 	<ol style="list-style-type: none"> 1 Style number 2 Skin width 3 Skin height 4 Fabric color number for skin 5 Options, if selected (see below) <p>▶ See <i>Surface Materials</i>, page 142</p>

Options		U.S. Price	Required to Specify
Top Mount Type	<ul style="list-style-type: none"> • Ceiling mount • Clerestory mount • Intermediate mount 	No cost No cost No cost	Specify with <i>ceiling mount</i> . Specify with <i>clerestory mount</i> . Specify with <i>intermediate mount</i> .
Bottom Mount Type	<ul style="list-style-type: none"> • Floor mount • Intermediate mount 	No cost No cost	Specify with <i>floor mount</i> . Specify with <i>intermediate mount</i> .
Surface Materials	Skin <ul style="list-style-type: none"> • Customer's Own Material (COM) • Fabric price group 1 • Fabric price group 2 • Fabric price group 3 • Fabric price group 4 • Fabric price group 5 • Fabric price group 6 • Fabric price group 7 • Fabric price group 8 • Fabric price group 9 • Fabric price group 10 	No cost No cost +\$ 8.80 per sq ft of skin +\$ 12.00 per sq ft of skin +\$ 16.05 per sq ft of skin +\$ 22.16 per sq ft of skin +\$ 29.72 per sq ft of skin +\$ 38.37 per sq ft of skin +\$ 47.55 per sq ft of skin +\$ 55.66 per sq ft of skin +\$ 64.31 per sq ft of skin	▶ See <i>Surface Materials Reference Manual</i> . Specify fabric color number. Specify fabric color number. Specify fabric color number. Specify fabric color number. Specify fabric color number. Specify fabric color number. Specify fabric color number. Specify fabric color number. Specify fabric color number. Specify fabric color number.
Fabric Direction	<ul style="list-style-type: none"> • Horizontal • Vertical 	No cost No cost	Specify with <i>horizontal fabric direction</i> . Specify with <i>vertical fabric direction</i> .
Cutout Count	<ul style="list-style-type: none"> • No holes • 1 hole • 2 holes • 3 holes • 4 holes • 5 holes • 6 holes • 7 holes • 8 holes • 9 holes 	No cost +\$ 25.37 +\$ 50.74 +\$ 76.11 +\$101.48 +\$126.85 +\$152.22 +\$177.59 +\$202.96 +\$228.33	Specify with <i>no holes</i> . Specify with <i>1 hole</i> . Specify with <i>2 holes</i> . Specify with <i>3 holes</i> . Specify with <i>4 holes</i> . Specify with <i>5 holes</i> . Specify with <i>6 holes</i> . Specify with <i>7 holes</i> . Specify with <i>8 holes</i> . Specify with <i>9 holes</i> .
Cutout Types (Per Cutout)	<ul style="list-style-type: none"> • Communication only no box • Hardwire double • Hardwire fourplex • Hardwire single • Hardwire triple • Modular data • Modular power horizontal • Modular power vertical 	No cost No cost No cost No cost No cost No cost No cost No cost	Specify with <i>communication only no box</i> . Specify with <i>hardwire double</i> . Specify with <i>hardwire fourplex</i> . Specify with <i>hardwire single</i> . Specify with <i>hardwire triple</i> . Specify with <i>modular data</i> . Specify with <i>modular power horizontal</i> . Specify with <i>modular power vertical</i> .

Specification Information

• Style Number	• U.S. Base Price	
	Per Skin	Per sq ft of Skin
NESSF	\$757.68	+\$27.34



Tip: When the standard pre-set widths are specified the list price will be reduced by 5% from the formula factors as shown above. This discount applies only to the base price per panel and the per square foot of panel add.

Tip: Brackets, latches, and screws must be ordered separately. The brackets, latches, and screws are auto-calculated in SmartTools. All brackets and latches are assembled with the screws to the back of the skin on site.

Tip: Each cutout can be a different cutout type.

Tip: Per sq. ft. of skin upcharge is based on height and width of the skin and is in addition to the base price.

Standard Includes		Required to Specify
▶ Need help? Product details, page 28	<ul style="list-style-type: none"> • Skin: fabric price group 1 • Width: 8"–120" • Height: 12"–120" • Top mount • Bottom mount 	<ol style="list-style-type: none"> 1 Style number 2 Skin width 3 Skin height 4 Fabric color number for skin 5 Options, if selected (see below) <p>▶ See <i>Surface Materials</i>, page 142</p>

Options		U.S. Price	Required to Specify
Top Mount Type	<ul style="list-style-type: none"> • Ceiling mount • Clerestory mount • Intermediate mount 	No cost No cost No cost	Specify with <i>ceiling mount</i> . Specify with <i>clerestory mount</i> . Specify with <i>intermediate mount</i> .
Bottom Mount Type	<ul style="list-style-type: none"> • Floor mount • Intermediate mount 	No cost No cost	Specify with <i>floor mount</i> . Specify with <i>intermediate mount</i> .
Surface Materials	Skin <ul style="list-style-type: none"> • Customer's Own Material (COM) • Fabric price group 1 • Fabric price group 2 • Fabric price group 3 • Fabric price group 4 • Fabric price group 5 • Fabric price group 6 • Fabric price group 7 • Fabric price group 8 • Fabric price group 9 • Fabric price group 10 	No cost +\$ 9.03 per sq ft of skin +\$ 12.30 per sq ft of skin +\$ 16.46 per sq ft of skin +\$ 22.72 per sq ft of skin +\$ 30.49 per sq ft of skin +\$ 39.35 per sq ft of skin +\$ 48.78 per sq ft of skin +\$ 57.10 per sq ft of skin +\$ 65.98 per sq ft of skin	▶ See <i>Surface Materials Reference Manual</i> . Specify fabric color number. Specify fabric color number. Specify fabric color number. Specify fabric color number. Specify fabric color number. Specify fabric color number. Specify fabric color number. Specify fabric color number. Specify fabric color number. Specify fabric color number.
Fabric Direction	<ul style="list-style-type: none"> • Horizontal • Vertical 	No cost No cost	Specify with <i>horizontal fabric direction</i> . Specify with <i>vertical fabric direction</i> .
Cutout Count	<ul style="list-style-type: none"> • No holes • 1 hole • 2 holes • 3 holes • 4 holes • 5 holes • 6 holes • 7 holes • 8 holes • 9 holes 	No cost +\$ 64.88 +\$129.76 +\$194.64 +\$259.52 +\$324.40 +\$389.28 +\$454.16 +\$519.04 +\$583.92	Specify with <i>no holes</i> . Specify with <i>1 hole</i> . Specify with <i>2 holes</i> . Specify with <i>3 holes</i> . Specify with <i>4 holes</i> . Specify with <i>5 holes</i> . Specify with <i>6 holes</i> . Specify with <i>7 holes</i> . Specify with <i>8 holes</i> . Specify with <i>9 holes</i> .
Cutout Types (Per Cutout)	<ul style="list-style-type: none"> • Communication only no box • Hardwire double • Hardwire fourplex • Hardwire single • Hardwire triple • Modular data • Modular power horizontal • Modular power vertical 	No cost No cost No cost No cost No cost No cost No cost	Specify with <i>communication only no box</i> . Specify with <i>hardwire double</i> . Specify with <i>hardwire fourplex</i> . Specify with <i>hardwire single</i> . Specify with <i>hardwire triple</i> . Specify with <i>modular data</i> . Specify with <i>modular power horizontal</i> . Specify with <i>modular power vertical</i> .

Specification Information

Style Number	U.S. Base Price	
	Per Skin	Per sq ft of Skin
NESSFSV2	\$901.00	+\$30.20

Specifying

Solid Steel Skins—Painted

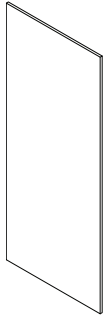

Tip: When the standard pre-set widths are specified the list price will be reduced by 5% from the formula factors as shown above. This discount applies only to the base price per panel and the per square foot of panel add.

Tip: Brackets, latches, and screws must be ordered separately. The brackets, latches, and screws are auto-calculated in SmartTools. All brackets and latches are assembled with the screws to the back of the skin on site.

Tip: Each cutout can be a different cutout type.

Tip: Per sq. ft. of skin upcharge is based on height and width of the skin and is in addition to the base price.

Standard Includes		Required to Specify
<ul style="list-style-type: none"> ▶ Need help? Product details, page 28 	<ul style="list-style-type: none"> • Skin: paint price group 1 • Width: 8"–120" • Height: 12"–120" • Top mount • Bottom mount 	<ol style="list-style-type: none"> 1 Style number 2 Skin width 3 Skin height 4 Paint color number for skin 5 Options, if selected (see below) <ul style="list-style-type: none"> ▶ See <i>Surface Materials</i>, page 142

Options	U.S. Price	Required to Specify
Top Mount Type <ul style="list-style-type: none"> • Ceiling mount • Clerestory mount • Intermediate mount 	No cost No cost No cost	Specify with ceiling mount. Specify with clerestory mount. Specify with intermediate mount.
Bottom Mount Type <ul style="list-style-type: none"> • Floor mount • Intermediate mount 	No cost No cost	Specify with floor mount. Specify with intermediate mount.
Surface Materials <ul style="list-style-type: none"> • Skin • Paint price group 1 • Paint price group 2 • Paint price group 3 	No cost +\$ 1.53 per sq ft of skin +\$ 6.28 per sq ft of skin	Specify paint color number. Specify paint color number. Specify paint color number.
Cutout Count <ul style="list-style-type: none"> • No holes • 1 hole • 2 holes • 3 holes • 4 holes • 5 holes • 6 holes • 7 holes • 8 holes • 9 holes 	No cost +\$ 77.87 +\$155.74 +\$233.61 +\$311.48 +\$389.35 +\$467.22 +\$545.09 +\$622.96 +\$700.83	Specify with no holes. Specify with 1 hole. Specify with 2 holes. Specify with 3 holes. Specify with 4 holes. Specify with 5 holes. Specify with 6 holes. Specify with 7 holes. Specify with 8 holes. Specify with 9 holes.
Cutout Types (Per Cutout) <ul style="list-style-type: none"> • Communication only no box • Hardwire double • Hardwire fourplex • Hardwire single • Hardwire triple • Modular data • Modular power horizontal • Modular power vertical 	No cost No cost No cost No cost No cost No cost No cost	Specify with communication only no box. Specify with hardwire double. Specify with hardwire fourplex. Specify with hardwire single. Specify with hardwire triple. Specify with modular data. Specify with modular power horizontal. Specify with modular power vertical.

Specification Information		
• Style Number	• U.S. Base Price	
	Per Skin	Per sq ft of Skin
NESSPSV2	\$553.43	+\$40.75

 **For Canadian Pricing**
 Multiply U.S. Price by the Canadian price factor.
 ▶ See page 1 for details.

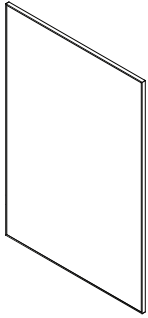

Tip: When the standard pre-set widths are specified the list price will be reduced by 5% from the formula factors as shown above. This discount applies only to the base price per panel and the per square foot of panel add.

Tip: Brackets, latches, and screws must be ordered separately. The brackets, latches, and screws are auto-calculated in SmartTools. All brackets and latches are assembled with the screws to the back of the skin on site.

Tip: Per sq. ft. of skin upcharge is based on height and width of the skin and is in addition to the base price.

Standard Includes		Required to Specify
<ul style="list-style-type: none"> ▶ Need help? Product details, page 28 	<ul style="list-style-type: none"> • Skin with ceramic markerboard surface • Width: 24"–120" • Height: 24"–120" • Top mount • Bottom mount 	<ul style="list-style-type: none"> 1 Style number 2 Skin width 3 Skin height 4 Options, if selected (see below) ▶ See <i>Surface Materials</i>, page 142

Options	U.S. Price	Required to Specify
Top Mount Type <ul style="list-style-type: none"> • Ceiling mount • Clerestory mount • Intermediate mount 	<ul style="list-style-type: none"> No cost No cost No cost 	<ul style="list-style-type: none"> Specify with <i>ceiling mount</i>. Specify with <i>clerestory mount</i>. Specify with <i>intermediate mount</i>.
Bottom Mount Type <ul style="list-style-type: none"> • Floor mount • Intermediate mount 	<ul style="list-style-type: none"> No cost No cost 	<ul style="list-style-type: none"> Specify with <i>floor mount</i>. Specify with <i>intermediate mount</i>.

Specification Information		
Style Number	U.S. Base Price	
	Per Skin	Per sq ft of Skin
NESC	\$657.58	+\$41.85

 **For Canadian Pricing**
Multiply U.S. Price by the Canadian price factor.
▶ See page 1 for details.

Skin Hardware

Solid Skin Latches

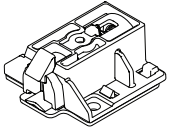

Tip: Latches are ordered separately and required for all solid skins.

Standard Includes		Required to Specify
<ul style="list-style-type: none"> ▶ Need help? Product details, page 28 	<ul style="list-style-type: none"> • Solid skin latches, quantity 200 	Style number
Specification Information		
• Style Number	• U.S. Price	
NESSC	\$1704.23	

Solid Skin Brackets

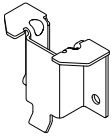

Tip: Brackets are ordered separately and required for all solid skins.

Standard Includes		Required to Specify
<ul style="list-style-type: none"> ▶ Need help? Product details, page 28 	<ul style="list-style-type: none"> • Solid skin brackets, quantity 100 	Style number
Specification Information		
• Style Number	• U.S. Price	
NESSB	\$646.50	

Solid Skin Screw



Tip: Two screws are required for each bracket or latch. Screws are ordered separately.

Standard Includes		Required to Specify
<ul style="list-style-type: none"> ▶ Need help? Product details, page 28 	<ul style="list-style-type: none"> • Solid skin screw, quantity 1 	Style number
Specification Information		
• Style Number	• U.S. Price	
NESSS	\$0.36	



For Canadian Pricing
 Multiply U.S. Price by the Canadian price factor.
 ▶ See page 1 for details.

Acoustic Insulation

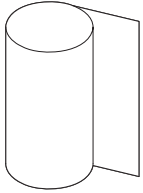

Standard Includes		Required to Specify
<ul style="list-style-type: none"> ▶ Need help? Product details, page 28 	<ul style="list-style-type: none"> • Acoustic insulation, 48"W x 87"L 2 ply 	<ul style="list-style-type: none"> Style number
Specification Information		
Style Number	U.S. Price	
NESIA	\$804.51	

Acoustic Skin Seal—Small

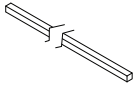

Standard Includes		Required to Specify
<ul style="list-style-type: none"> ▶ Need help? Product details, page 28 	<ul style="list-style-type: none"> • Seal: 50' roll, quantity of 4: <ul style="list-style-type: none"> – 6249 Platinum Solid – 6527 Merle 	<ul style="list-style-type: none"> 1 Style number 2 Plastic color number for seal
Specification Information		
Style Number	U.S. Price	
NEASSS	\$214.95	

Acoustic Skin Seal—Large

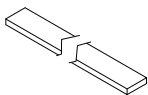

Standard Includes		Required to Specify
<ul style="list-style-type: none"> ▶ Need help? Product details, page 28 	<ul style="list-style-type: none"> • Seal: 50' roll, quantity of 1: <ul style="list-style-type: none"> – 6249 Platinum Solid – 6527 Merle 	<ul style="list-style-type: none"> 1 Style number 2 Plastic color number for seal
Specification Information		
Style Number	U.S. Price	
NEASSL	\$111.62	

 **For Canadian Pricing**
 Multiply U.S. Price by the Canadian price factor.
 ▶ See page 1 for details.

Unitized Glass Panel



Tip: When the standard pre-set widths are specified the list price will be reduced by 5% from the formula factors as shown above. This discount applies only to the base price per panel and the per square foot of panel add.

Tip: Muntin paint upcharge is based on the panel width per inch of muntin selected.

Tip: Per square feet of frame and glass upcharge is based on height and width of the frame and is in addition to the base price.

Tip: Muntin upcharge is based on the panel width per inch of muntin selected.

 **For Canadian Pricing**
Multiply U.S. Price by the Canadian price factor.
▶ See page 1 for details.

Standard Includes		Required to Specify
▶ Need help? Product details, page 32	<ul style="list-style-type: none"> • Frame: paint price group 1 or 8043 Clear Anodized Aluminum • 1/4" thick glass: glass price group 1 • Width: 12"-60" • Height: 84"-120" • Muntin height, if selected: 15"-108" • Floor track: <ul style="list-style-type: none"> – 7190 Platinum Solid – 7360 Merle 	<ol style="list-style-type: none"> 1 Style number 2 Panel width 3 Panel height 4 Paint or aluminum color number for frame 5 Glass color number for glass 6 Paint color number for floor track 7 Options, if selected (see below) <p>▶ See <i>Surface Materials</i>, page 142</p>

Options	U.S. Price	Required to Specify
Surface Materials		
Frame		
• Anodized aluminum	No cost	Specify with 8043 anodized aluminum.
• Paint price group 1	No cost	Specify paint color number.
• Paint price group 2		Specify paint color number.
– Width	+\$ 0.20 per inch	Specify paint color number.
– Height	+\$ 0.24 per inch	Specify paint color number.
• Paint price group 3		Specify paint color number.
– Width	+\$ 0.82 per inch	Specify paint color number.
– Height	+\$ 0.99 per inch	Specify paint color number.
Glass A		
• Glass price group 1	No cost	Specify glass color number.
• Glass price group 2		Specify glass color number.
– 1/4" thick	+\$ 20.21 per sq ft	Specify glass color number.
– 3/8" thick	+\$ 15.59 per sq ft	Specify glass color number.
• Glass price group 3		Specify glass color number.
– 1/4" thick	+\$ 8.81 per sq ft	Specify glass color number.
– 3/8" thick	+\$ 24.79 per sq ft	Specify glass color number.
• Glass price group 7		Specify glass color number.
– 1/4" thick	+\$ 30.87 per sq ft	Specify glass color number.
– 3/8" thick	+\$ 38.75 per sq ft	Specify glass color number.
Muntin		
• Paint price group 2	+\$ 0.40 per inch of muntin	Color based on frame finish.
• Paint price group 3	+\$ 1.66 per inch of muntin	Color based on frame finish.
Glass Thickness		
• 1/4"	No cost	Specify with 1/4" thick glass.
• 3/8"	+\$ 10.60 per sq ft	Specify with 3/8" thick glass.
Muntin Count		
• No muntin	No cost	Specify with no muntin.
• 1 muntin	+\$ 69.99	Specify with 1 muntin.
• 2 muntins	+\$139.98	Specify with 2 muntins.
• 3 muntins	+\$209.97	Specify with 3 muntins.
• 4 muntins	+\$279.96	Specify with 4 muntins.

Specification Information

• Style Number	• U.S. Base Price		• Options (Add \$ to Base Price)
	Per Panel	Per sq ft of Panel	
NEUGP	\$1188.09	+\$43.11	Muntin Width per Inch of Muntin

Unitized Glass Clerestory Frame



Tip: When the standard preset widths are specified the list price will be reduced by 5% from the formula factors as shown above. This discount applies only to the base price per panel and the per square foot of panel add.

Tip: Muntin paint upcharge is based on the panel width per inch of muntin selected.

Tip: Square feet for glass is calculated by height minus clerestory height multiplied by width.

Tip: Square feet for frame finish is clerestory height multiplied by width.

Tip: Muntin upcharge is based on the panel width per inch of muntin selected.

Standard Includes		Required to Specify
<ul style="list-style-type: none"> ▶ Need help? Product details, page 32 	<ul style="list-style-type: none"> • Frame with clerestory: paint price group 1 or 8043 Clear Anodized Aluminum • 1/4" thick glass: 6500 Clear glass • Width: 12"–60" • Height: 84"–120" • Clerestory height: 18"–108" • Muntin height, if selected: 30"–108" • Horizontal height, if selected: 15"–108" • Floor track: <ul style="list-style-type: none"> – 7190 Platinum Solid – 7360 Merle • Seal: plastic 	<ol style="list-style-type: none"> 1 Style number 2 Frame width 3 Frame height 4 Paint or aluminum color number for frame 5 Glass color number for glass 6 Paint color number for floor track 7 Options, if selected (see below) <p>▶ See <i>Surface Materials</i>, page 142</p>

Options	U.S. Price	Required to Specify
Surface Materials		
Glass A		
• Glass price group 1	No cost	Specify glass color number.
• Glass price group 2		
– 1/4" thick	+\$ 20.91 per sq ft	Specify glass color number.
– 3/8" thick	+\$ 16.13 per sq ft	Specify glass color number.
• Glass price group 3		
– 1/4" thick	+\$ 9.12 per sq ft	Specify glass color number.
– 3/8" thick	+\$ 25.65 per sq ft	Specify glass color number.
• Glass price group 7		
– 1/4" thick	+\$ 31.93 per sq ft	Specify glass color number.
– 3/8" thick	+\$ 40.09 per sq ft	Specify glass color number.
Frame		
• Paint price group 2		
– Width	+\$ 0.20 per inch	Specify paint color number.
– Height	+\$ 0.24 per inch	Specify paint color number.
• Paint price group 3		
– Width	+\$ 0.82 per inch	Specify paint color number.
– Height	+\$ 0.99 per inch	Specify paint color number.
Muntin		
• Paint price group 2	+\$ 0.40 per inch of muntin	Color based on frame finish.
• Paint price group 3	+\$ 1.66 per inch of muntin	Color based on frame finish.
Glass Thickness		
• 1/4"	No cost	Specify with 1/4" thick glass.
• 3/8"	+\$ 10.97 per sq ft	Specify with 3/8" thick glass.
Muntin Count		
• No muntin	No cost	Specify with no muntins.
• 1 muntin	+\$ 72.40	Specify with 1 muntin.
• 2 muntins	+\$144.80	Specify with 2 muntins.
• 3 muntins	+\$217.20	Specify with 3 muntins.
Top Horizontal AFF		
• 0	No cost	Specify with 0 horizontals.
• 1	No cost	Specify with 1 horizontal.
• 2	+\$ 72.19	Specify with 2 horizontals.
• 3	+\$144.38	Specify with 3 horizontals.
• 4	+\$216.57	Specify with 4 horizontals.
• 5	+\$288.76	Specify with 5 horizontals.
• 6	+\$360.95	Specify with 6 horizontals.
• 7	+\$433.14	Specify with 7 horizontals.
• 8	+\$505.33	Specify with 8 horizontals.
• 9	+\$577.52	Specify with 9 horizontals.
Top Horizontal AFF	Horizontal count 2-10	
	• 15"–108"W	+\$ 0.42 per inch
		Specify width.



For Canadian Pricing
Multiply U.S. Price by the Canadian price factor.
▶ See page 1 for details.

Tip: Square feet for frame is clerestory height multiplied by width. Square feet for glass is calculated by height minus clerestory height multiplied by width.



Specification Information

• Style Number	• U.S. Base Price			• Options (Add \$ to Base Price)
	Per Frame	Per sq ft of Frame	Per sq ft of Glass	
•	•	•	•	• Muntin Width per Inch of Muntin

Structural Frame—Clerestory

NESFC	\$1982.00	+\$2.75	+\$44.59	+\$2.96
•	•	•	•	•

Specifying

 **For Canadian Pricing**
Multiply U.S. Price by the Canadian price factor.
▶ See page 1 for details.

Glass Frame Kits

Accessories

Frame Kit



Tip: When the standard pre-set widths are specified the list price will be reduced by 5% from the formula factors as shown above. This discount applies only to the base price per panel and the per square foot of panel add.

Standard Includes	Required to Specify
<ul style="list-style-type: none"> ▶ Need help? Product details, page 36 • Frame: paint price group 1 or 8043 Clear Anodized Aluminum • Width: 12"–144" • Height: 84"–120" • 3/8" thick glass • Floor track: <ul style="list-style-type: none"> – 7190 Platinum Solid – 7360 Merle • Seal: plastic 	<ul style="list-style-type: none"> 1 Style number 2 Frame width 3 Frame height 4 Paint or aluminum color number for frame 5 Plastic color number for seal 6 Paint color number for floor track 7 Options, if selected (see below) ▶ See <i>Surface Materials</i>, page 142

Options	U.S. Price	Required to Specify
Surface Materials <ul style="list-style-type: none"> • Frame • Paint price group 2 <ul style="list-style-type: none"> – Width +\$0.30 per inch – Height +\$0.36 per inch • Paint price group 3 <ul style="list-style-type: none"> – Width +\$1.23 per inch – Height +\$1.47 per inch 		<ul style="list-style-type: none"> Specify paint color number. Specify paint color number. Specify paint color number. Specify paint color number.
Glass Thickness <ul style="list-style-type: none"> • 1/2" • 3/8" 	<ul style="list-style-type: none"> No cost No cost 	<ul style="list-style-type: none"> Specify with 1/2" thick glass. Specify with 3/8" thick glass.
Division Count <ul style="list-style-type: none"> • 1 • 2 • 3 	<ul style="list-style-type: none"> No cost No cost No cost 	<ul style="list-style-type: none"> Specify 1 division count. Specify 2 division count. Specify 3 division count.

Specification Information		
Style Number	U.S. Base Price	
:	: Per	: Per sq ft
:	: Frame	: of Opening
:	:	:
:	:	:
NEFK	\$2014.94	+\$16.96
:	:	:
:	:	:



For Canadian Pricing

Multiply U.S. Price by the Canadian price factor.

▶ See page 1 for details.

Glass Kit

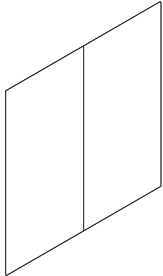

Tip: When the standard pre-set widths are specified the list price will be reduced by 5% from the formula factors as shown above. This discount applies only to the base price per panel and the per square foot of panel add.

Standard Includes		Required to Specify
▶ Need help? Product details, page 36	<ul style="list-style-type: none"> • 3/8" thick glass: 6500 Clear glass • Width: 12"-144" • Height: 84"-120" 	1 Style number 2 Glass width 3 Glass height 4 Glass color number for thick glass 5 Options, if selected (see below) ▶ See <i>Surface Materials</i> , page 142

Options	U.S. Price	Required to Specify
Surface Materials Glass A <ul style="list-style-type: none"> • Glass price group 1 – 1/2" thick only • Glass price group 2 – 3/8" thick only • Glass price group 3 – 1/2" thick only 	No cost +\$ 1.16 per sq ft +\$21.88 per sq ft +\$29.10 per sq ft	Specify glass color number. Specify glass color number. Specify glass color number. Specify glass color number.
Glass Thickness <ul style="list-style-type: none"> • 3/8" • 1/2" 	No cost +\$13.93 per sq ft	Specify with 3/8" thick glass. Specify with 1/2" thick glass.
Division Count <ul style="list-style-type: none"> • 1 • 2 • 3 	See below See below See below	Specify with 1 division. Specify with 2 divisions. Specify with 3 divisions.

Specification Information		
• Description	• (Add \$ to Base Price)	• (Add \$ to Base Price)

Division Count		
Division Count 1	+\$15.85	+\$0.79 per inch of height
Division Count 2	+\$31.70	+\$1.58 per inch of height
Division Count 3	+\$47.55	+\$2.37 per inch of height

Specification Information		
• Style Number	• U.S. Base Price	
	• Per Frame	• Per sq ft of Opening
NEGK	\$345.32	+\$24.23

Specifying

Glazing Tape—Clear



Standard Includes	Required to Specify
▶ Need help? Product details, page 37	55' glazing tape, clear

Specification Information	
• Style Number	• U.S. Price
NEGTC	\$129.07

Single Swing Door Frame



Tip: When the standard pre-set widths are specified the list price will be reduced by 5% from the formula factors as shown above. This discount applies only to the base price per panel and the per square foot of panel add.

Tip: If a solid door is used with a push/pull or ladder pull, choose a roller latch or surface-mounted closer to keep door closed.

Tip: If a polished edge door is used with a push/pull or ladder pull, choose a roller latch or slim line hinges with self close feature to keep door closed.

Standard Includes		Required to Specify
▶ Need help? Product details, page 38	<ul style="list-style-type: none"> Door frame: paint price group 1 or 8043 Clear Anodized Aluminum Width: 28"–48" Height: 84"–120" Seal: <ul style="list-style-type: none"> – 6000 Black – 6249 Platinum Solid 	<ol style="list-style-type: none"> Style number Frame width Frame height Plastic color number for seal Paint or aluminum color number for door frame Options, if selected (see below) <p>▶ See <i>Surface Materials</i>, page 142</p>

	Options	U.S. Price	Required to Specify
Surface Materials	Frame		
	• Paint price group 2		
	– Width	+\$0.15 per inch	Specify paint color number.
	– Height	+\$0.36 per inch	Specify paint color number.
Door Type	• Paint price group 3		
	– Width	+\$0.61 per inch	Specify paint color number.
	– Height	+\$1.47 per inch	Specify paint color number.
	• Polished edge	No cost	Specify with polished edge door.
Latch Prep	• Solid	No cost	Specify with solid door.
	• Custom pull	No cost	Specify with custom pull latch prep.
	• Cylindrical	No cost	Specify with cylindrical latch prep.
	• Mortise	No cost	Specify with mortise latch prep.
	• PBA ladder aligned locking	No cost	Specify with PBA ladder aligned locking latch prep.
	• PBA ladder aligned non-locking	No cost	Specify with PBA ladder aligned non-locking latch prep.
	• PBA ladder offset locking	No cost	Specify with PBA ladder offset locking latch prep.
	• PBA ladder offset non-locking	No cost	Specify with PBA ladder offset non-locking latch prep.
	• Pushpull	No cost	Specify with pushpull latch prep.
	• TCS ladder aligned locking	No cost	Specify with TCS ladder aligned locking latch prep.
	• TCS ladder aligned non-locking	No cost	Specify with TCS ladder aligned non-locking latch prep.
	• TCS ladder offset locking	No cost	Specify with TCS ladder offset locking latch prep.
	Roller Latch	• No roller latch	No cost
• Roller latch		No cost	Specify with roller latch.
Hinge Type	• Electric	No cost	Specify with electric hinge.
	• Polished edge butt	No cost	Specify with polished edge butt hinge.
	• Slim line	No cost	Specify with slim line hinge.
	• Solid butt	No cost	Specify with solid butt hinge.
Hinge Quantity	• 2	No cost	Specify with 2 hinges.
	• 3	No cost	Specify with 3 hinges.
	• 4	No cost	Specify with 4 hinges.
Electrification	• Electric strike	No cost	Specify with electric strike.
	• No electrification	No cost	Specify with no electrification.

Specification Information	
• Style Number	• U.S. Base Price
•	•
•	•
•	•
NEDFSWS	\$2287.49
•	•

 **For Canadian Pricing**
Multiply U.S. Price by the Canadian price factor.
▶ See page 1 for details.

Single Solid Swing Door Leaf

Single Solid Swing
Door Leaf



Tip: When the standard pre-set widths are specified the list price will be reduced by 5% from the formula factors as shown above. This discount applies only to the base price per panel and the per square foot of panel add.

Tip: If a pushpull or ladder pull is selected, choose a roller latch or self closing hinge to keep door closed.

Tip: Painted solid door leaf cannot ship to customer locations in Canada. Specify a veneer door leaf versus painted or source the door locally for shipments to Canada only.

Tip: Electrification option is only available when cylindrical or mortise latch prep is selected. Electrification is not available when push/pull handles are selected.

Tip: Stanchion upcharges are only applied if latch prep selection is custom pull.

Standard Includes		Required to Specify
▶ Need help? Product details, page 38	<ul style="list-style-type: none"> Door leaf: paint price group 1 or 2 Width: 28"–48" Height: 84"–120" 	1 Style number 2 Leaf width 3 Leaf height 4 Paint color number for door leaf 5 Options, if selected (see below) ▶ See <i>Surface Materials</i> , page 142

Options	U.S. Price	Required to Specify
Surface Materials <ul style="list-style-type: none"> Door <ul style="list-style-type: none"> Paint price group 1: No cost Paint price group 2: No cost Paint price group 3: +\$ 5.43 per sq ft Customiz stain: No cost Veneer price group 1: +\$ 26.72 per sq ft Veneer price group 3: +\$ 59.57 per sq ft 		Specify paint color number. Specify paint color number. Specify paint color number. Specify with <i>Customiz stain</i> . ▶ See <i>Surface Materials Reference Manual</i> . Specify veneer color number. Specify veneer color number.
Handedness <ul style="list-style-type: none"> Left hand: No cost Right hand: No cost 		Specify with <i>left-handed</i> . Specify with <i>right-handed</i> .
Latch Prep <ul style="list-style-type: none"> Custom pull: No cost Cylindrical: No cost Mortise: No cost No latch prep: No cost PBA ladder aligned locking: No cost PBA ladder aligned non-locking: No cost PBA ladder offset locking: No cost PBA ladder offset non-locking: No cost Pushpull: No cost TCS ladder aligned locking: No cost TCS ladder aligned non-locking: No cost TCS ladder offset locking: No cost 		Specify with <i>custom pull latch prep</i> . Specify with <i>cylindrical latch prep</i> . Specify with <i>mortise latch prep</i> . Specify with <i>no latch prep</i> . Specify with <i>PBA ladder aligned locking latch prep</i> . Specify with <i>PBA ladder aligned non-locking latch prep</i> . Specify with <i>PBA ladder offset locking latch prep</i> . Specify with <i>PBA ladder offset non-locking latch prep</i> . Specify with <i>pushpull latch prep</i> . Specify with <i>TCS ladder aligned locking latch prep</i> . Specify with <i>TCS ladder aligned non-locking latch prep</i> . Specify with <i>TCS ladder offset locking latch prep</i> .
Pull Size <ul style="list-style-type: none"> 18": No cost 24": No cost 36": No cost 48": No cost 60": No cost 72": No cost 		Specify with <i>18" pull</i> . Specify with <i>24" pull</i> . Specify with <i>36" pull</i> . Specify with <i>48" pull</i> . Specify with <i>60" pull</i> . Specify with <i>72" pull</i> .
Hinge Type <ul style="list-style-type: none"> Electric: No cost Solid butt: No cost 		Specify with <i>electric hinge</i> . Specify with <i>solid butt hinge</i> .
Hinge Quantity <ul style="list-style-type: none"> 3: No cost 4: No cost 		Specify with <i>3 hinges</i> . Specify with <i>4 hinges</i> .
Number of Stanchions <ul style="list-style-type: none"> 2: No cost 3: +\$ 60.38 4: +\$120.74 		Specify with <i>2 stanchions</i> . Specify with <i>3 stanchions</i> . Specify with <i>4 stanchions</i> .
Acoustic Seal <ul style="list-style-type: none"> Drop seal: No cost No seal: No cost 		Specify with <i>drop seal</i> . Specify with <i>no seal</i> .
Roller Latch <ul style="list-style-type: none"> No roller latch: No cost Roller latch: No cost 		Specify with <i>no roller latch</i> . Specify with <i>roller latch</i> .

Specification Information

Style Number	U.S. Base Price
NEDLSWS	\$162.30

For Canadian Pricing
 Multiply U.S. Price by the Canadian price factor.
 ▶ See page 1 for details.

Single Polished Edge Swing Door Leaf



Tip: When the standard pre-set widths are specified the list price will be reduced by 5% from the formula factors as shown above. This discount applies only to the base price per panel and the per square foot of panel add.

Tip: For Customer's Own Glass (COG) an engineering quote is required. Upcharges for latch prep, pull size, roller latch, hinge type, hinge quantity, and stanchions will be additional.

Tip: If a pushpull or ladder pull is selected, choose a roller latch or self closing hinge to keep door closed.

Tip: Stanchion upcharges are only applied if latch prep selection is custom pull.

 **For Canadian Pricing**
Multiply U.S. Price by the Canadian price factor.
▶ See page 1 for details.

Standard Includes		Required to Specify
▶ Need help? Product details, page 38	<ul style="list-style-type: none"> Door leaf: glass price group 1 or 2 Width: 28"–48" Height: 84"–120" 	1 Style number 2 Leaf width 3 Leaf height 4 Glass color number for door leaf 5 Options, if selected (see below) ▶ See <i>Surface Materials</i> , page 142

Options	U.S. Price	Required to Specify
Surface Materials	Glass <ul style="list-style-type: none"> Customer's Own Glass (COG) No cost Glass price group 3 <ul style="list-style-type: none"> – 1/2" +\$ 36.30 per sq ft – 3/8" +\$ 53.53 per sq ft 	▶ See <i>Surface Materials Reference Manual</i> . Specify glass color number. Specify glass color number.
Glass Thickness	<ul style="list-style-type: none"> 3/8" No cost 1/2" +\$ 19.29 per sq ft 	Specify with 3/8" thick glass. Specify with 1/2" thick glass.
Glass Surface Orientation	<ul style="list-style-type: none"> Polished to inside No cost Polished to outside No cost 	Specify with polished to inside. Specify with polished to outside.
Handedness	<ul style="list-style-type: none"> Left hand No cost Right hand No cost 	Specify with left-handed. Specify with right-handed.
Latch Prep	<ul style="list-style-type: none"> PBA ladder aligned locking +\$ 28.01 PBA ladder aligned non-locking +\$ 28.01 PBA ladder offset locking +\$ 28.01 PBA ladder offset non-locking +\$ 28.01 Pushpull +\$ 28.01 TCS ladder aligned locking +\$ 28.01 TCS ladder aligned non-locking +\$ 28.01 TCS ladder offset locking +\$ 28.01 Cylindrical +\$105.05 Mortise +\$105.05 	Specify with PBA ladder aligned locking latch prep. Specify with PBA ladder aligned non-locking latch prep. Specify with PBA ladder offset locking latch prep. Specify with PBA ladder offset non-locking latch prep. Specify with pushpull latch prep. Specify with TCS ladder aligned locking latch prep. Specify with TCS ladder aligned non-locking latch prep. Specify with TCS ladder offset locking latch prep. Specify with cylindrical latch prep. Specify with mortise latch prep.
Pull Size	<ul style="list-style-type: none"> 18" No cost 24" No cost 36" No cost 48" No cost 60" No cost 72" <ul style="list-style-type: none"> – TCS aligned locking +\$ 14.01 – TCS aligned non-locking +\$ 14.01 	Specify with 18" pull. Specify with 24" pull. Specify with 36" pull. Specify with 48" pull. Specify with 60" pull. Specify with 72" TCS aligned locking pull. Specify with 72" TCS aligned non-locking pull.
Hinge Type	<ul style="list-style-type: none"> Slim line +\$ 56.02 Polished edge butt +\$112.05 	Specify with slim line hinge. Specify with polished edge butt hinge.
Hinge Quantity	<ul style="list-style-type: none"> 2 No cost 3 +\$ 56.02 4 +\$112.05 	Specify with 2 hinges. Specify with 3 hinges. Specify with 4 hinges.
Number of Stanchions	<ul style="list-style-type: none"> 2 No cost 3 +\$ 60.38 4 +\$120.74 	Specify with 2 stanchions. Specify with 3 stanchions. Specify with 4 stanchions.
Roller Latch	<ul style="list-style-type: none"> No roller latch No cost Roller latch +\$105.08 	Specify with no roller latch. Specify with roller latch.

Tip: Base price is calculated based on customer selections per square foot.



Specification Information	
Style Number	U.S. Base Price
	Per sq ft of Leaf
NEDLSWPE	\$36.21

Specifying

 **For Canadian Pricing**
Multiply U.S. Price by the Canadian price factor.
▶ See page 1 for details.

Swing Door Hardware

Cylindrical Latchset

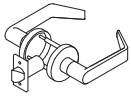

Cylindrical Latchset for Solid Door

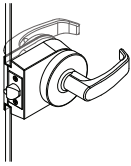

Cylindrical Latchset for Polished Edge Door

Tip: When the black finish is specified on latchsets, the strike plate on the frame will default to the satin chrome finish.

Standard Includes	Required to Specify
<ul style="list-style-type: none"> ▶ Need help? Product details, page 38 • Cylindrical latchset for solid door: 9200 Satin Chrome • Cylindrical latchset for polished edge door, includes latchset and cover assembly: 9200 Satin Chrome 	<ul style="list-style-type: none"> 1 Style number 2 Options, if selected (see below) ▶ See <i>Surface Materials</i>, page 142

Options	U.S. Price	Required to Specify
Surface Materials <ul style="list-style-type: none"> • Polished chrome—passage +\$ 55.19 • Paint price group 1—passage +\$734.41 		Specify with <i>polished chrome</i> . Specify paint color number.
Door Type <ul style="list-style-type: none"> • Solid No cost • Polished edge +\$484.26 		Specify with <i>solid door</i> . Specify with <i>polished edge door</i> .
Keying <ul style="list-style-type: none"> • Passage No cost • No core +\$166.87 • With core, random keyed +\$302.29 		Specify with <i>passage key</i> . Specify with <i>no core</i> . Specify with <i>core, random key</i> .

Specification Information	
• Style Number	• U.S. Base Price
•	•
•	•
•	•
NEDHCL	\$824.61
•	•
•	•

Cylindrical Latchset Housing for Everwall Polished Edge Doors with Locally Sourced Hardware

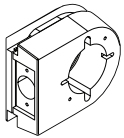

Cylindrical Latchset Housing for Polished Edge Door

Tip: Cylindrical latchset is not included.

Tip: When the black finish is specified on housings, the strike plate will default to the satin chrome finish.

Tip: For use only with polished edge doors, solid doors hardware is mounted directly on to the leaf.

Standard Includes	Required to Specify
<ul style="list-style-type: none"> ▶ Need help? Product details, page 38 • Cylindrical latchset housing for polished edge door: 9200 Satin Chrome 	<ul style="list-style-type: none"> 1 Style number 2 Options, if selected (see below) ▶ See <i>Surface Materials</i>, page 142

Options	U.S. Price	Required to Specify
Surface Materials <ul style="list-style-type: none"> • Paint price group 1 No cost • Polished chrome No cost 		Specify paint color number. Specify with <i>polished chrome</i> .

Specification Information	
• Style Number	• U.S. Price
•	•
•	•
NEDHCPH	\$484.26
•	•
•	•



For Canadian Pricing
Multiply U.S. Price by the Canadian price factor.
▶ See page 1 for details.

Mortise Latchset

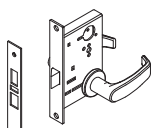

Mortise Latchset
for Solid Door



Mortise Latchset for
Polished Edge Door

Tip: When the black finish is specified on latchsets, the strike plate on the frame will default to the satin chrome finish.

Standard Includes		Required to Specify		
<ul style="list-style-type: none"> ▶ Need help? Product details, page 38 	<ul style="list-style-type: none"> • Mortise latchset for solid door: 9200 Satin Chrome • Mortise latchset for polished edge door, includes latchset and cover assembly: 9200 Satin Chrome 	<ul style="list-style-type: none"> 1 Style number 2 Options, if selected (see below) ▶ See <i>Surface Materials</i>, page 142 		
Options		U.S. Price	Required to Specify	
Surface Materials	• Polished chrome			
	– Passage	+\$ 55.19	Specify with <i>polished chrome</i> .	
	– No cylinder	+\$117.66	Specify with <i>polished chrome</i> .	
	– Random keyed	+\$117.66	Specify with <i>polished chrome</i> .	
	• Paint price group 1			
	– No cylinder	+\$117.66	Specify paint color number.	
	– Random keyed	+\$117.66	Specify paint color number.	
	– Passage	+\$220.85	Specify paint color number.	
Door Type	• Solid	No cost	Specify with <i>solid door</i> .	
	• Polished edge	+\$747.45	Specify with <i>polished edge door</i> .	
Keying	• Passage	No cost	Specify with <i>passage key</i> .	
	• No core	+\$135.42	Specify with <i>no core</i> .	
	• With core, random keyed	+\$270.84	Specify with <i>core, random key</i> .	
Lever	• L lever	No cost	Specify with <i>L lever</i> .	
	• No lever	–\$404.42	Specify with <i>no lever</i> .	
	• MB lever			
		– No cylinder	+\$436.82	Specify with <i>MB lever</i> .
		– Random keyed	+\$718.10	Specify with <i>MB lever</i> .
	• REM lever			
	– No cylinder	+\$805.38	Specify with <i>REM lever</i> .	
	– Random keyed	+\$992.24	Specify with <i>REM lever</i> .	

Specification Information

• Style • Number	• U.S. • Base • Price
NEDHML	\$1396.24
.	.



For Canadian Pricing

Multiply U.S. Price by the Canadian price factor.

▶ See page 1 for details.

Mortise Latchset Housing for Everwall Polished Edge Doors with Locally Sourced Hardware

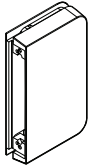

Mortise Latchset Housing for Polished Edge Door

Tip: Mortise latchset is not included.

Tip: When using mortise Latchsets, once a housing has been face drilled, it will not be reversible.

Tip: When the black finish is specified on latchsets, the strike plate will default to the satin chrome finish.

Tip: For use only with polished edge doors, solid doors hardware is mounted directly on to the leaf.

Standard Includes		Required to Specify
▶ Need help? Product details, page 38	• Mortise latchset housing for polished edge door: 9200 Satin Chrome	1 Style number 2 Options, if selected (see below) ▶ See <i>Surface Materials</i> , page 142

Options	U.S. Price	Required to Specify
Surface Materials	• Paint price group 1 • Polished chrome	No cost No cost
		Specify paint color number. Specify <i>with polished chrome</i> .

Specification Information	
• Style Number	• U.S. Price
NEDHMPH	\$747.45

Dome Style Floor Stop



Standard Includes		Required to Specify
▶ Need help? Product details, page 38	• Dome style floor stop: 9200 Satin Chrome	1 Style number 2 Options, if selected (see below) ▶ See <i>Surface Materials</i> , page 142

Options	U.S. Price	Required to Specify
Surface Materials	• Paint price group 1 • Polished chrome	+\$25.93 +\$38.90
		Specify paint color number. Specify <i>with polished chrome</i> .

Specification Information	
• Style Number	• U.S. Base Price
NEDDFS	\$27.83



For Canadian Pricing
Multiply U.S. Price by the Canadian price factor.
▶ See page 1 for details.

Magnetic Wall Stop



Standard Includes		Required to Specify	
▶ Need help? Product details, page 38	• Magnetic wall stop: 9200 Satin Chrome	1 Style number 2 Options, if selected (see below) ▶ See <i>Surface Materials</i> , page 142	
Options		U.S. Price	Required to Specify
Surface Materials	• Paint price group 1 • Polished chrome	+\$ 2.95 +\$38.90	Specify paint color number. Specify <i>with polished chrome</i> .
Specification Information			
• Style Number	• U.S. Base Price		
.....		
NEDMWS	\$61.98		
.....		

Screw In Base Stop

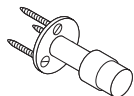

Standard Includes		Required to Specify	
▶ Need help? Product details, page 38	• Screw in base stop: 9200 Satin Chrome	1 Style number 2 Options, if selected (see below) ▶ See <i>Surface Materials</i> , page 142	
Options		U.S. Price	Required to Specify
Surface Materials	• Polished chrome • Paint price group 1	+\$38.90 +\$76.03	Specify <i>with polished chrome</i> . Specify paint color number.
Specification Information			
• Style Number	• U.S. Base Price		
.....		
NEDSBS	\$104.99		
.....		

 **For Canadian Pricing**
Multiply U.S. Price by the
Canadian price factor.
▶ See page 1 for details.

Slimline Hinge

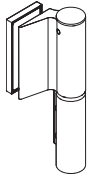

Standard Includes	Required to Specify
<ul style="list-style-type: none"> ▶ Need help? Product details, page 38 • Two free swinging slimline hinges: 9200 Satin Chrome 	<ul style="list-style-type: none"> 1 Style number 2 Options, if selected (see below) ▶ See <i>Surface Materials</i>, page 142

Options	U.S. Price	Required to Specify
Surface Materials <ul style="list-style-type: none"> • Polished chrome • Paint price group 1 	<ul style="list-style-type: none"> +\$ 92.06 +\$125.77 	Specify <i>with polished chrome</i> . Specify paint color number.
Handedness <ul style="list-style-type: none"> • Left hand • Right hand 	<ul style="list-style-type: none"> No cost No cost 	Specify <i>with left-handed</i> . Specify <i>with right-handed</i> .
Hinge Function <ul style="list-style-type: none"> • Free-swinging • Self-closing 180° • Self-closing 90° 	<ul style="list-style-type: none"> No cost +\$296.00 +\$296.00 	Specify <i>with free-swinging hinge</i> . Specify <i>with self-closing 180° hinge</i> . Specify <i>with self-closing 90° hinge</i> .

Specification Information	
Style Number	U.S. Base Price
NESWDHSH	\$2106.14

Butt Hinges

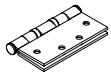

Standard Includes	Required to Specify
<ul style="list-style-type: none"> ▶ Need help? Product details, page 38 • Three butt hinges: 9200 Satin Chrome 	<ul style="list-style-type: none"> 1 Style number 2 Options, if selected (see below) ▶ See <i>Surface Materials</i>, page 142

Options	U.S. Price	Required to Specify
Surface Materials <ul style="list-style-type: none"> • Polished chrome • Paint price group 1 	<ul style="list-style-type: none"> +\$ 27.62 +\$ 56.32 	Specify <i>with polished chrome</i> . Specify paint color number.
Door Type <ul style="list-style-type: none"> • Polished edge • Solid <ul style="list-style-type: none"> – 3 hinges – 4 hinges 	<ul style="list-style-type: none"> No cost –\$1307.97 –\$1743.97 	Specify <i>with polished edge door</i> . Specify <i>with solid door</i> . Specify <i>with solid door</i> .
Handedness <ul style="list-style-type: none"> • Left hand • Right hand 	<ul style="list-style-type: none"> No cost No cost 	Specify <i>with left-handed</i> . Specify <i>with right-handed</i> .
Hinge Quantity <ul style="list-style-type: none"> • 3 • 4 	<ul style="list-style-type: none"> No cost +\$ 508.16 	Specify <i>with 3 hinges</i> . Specify <i>with 4 hinges</i> .

Specification Information	
Style Number	U.S. Base Price
NESWDHBH	\$1524.48



For Canadian Pricing
 Multiply U.S. Price by the Canadian price factor.
 ▶ See page 1 for details.

Door Closer

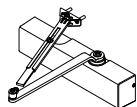

Standard Includes		Required to Specify
<ul style="list-style-type: none"> ▶ Need help? Product details, page 38 	<ul style="list-style-type: none"> • Surface mounted door closer: 4799 Platinum Metallic 	1 Style number 2 Options, if selected (see below)

Options	U.S. Price	Required to Specify
Surface Materials <ul style="list-style-type: none"> • 4710 Low Gloss Black 	+ \$117.76	Specify paint color number.

Specification Information	
• Style Number	• U.S. Base Price
NESWDHCLSR	\$1025.87
.....

Electric Hinge

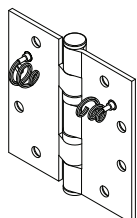

Standard Includes		Required to Specify
<ul style="list-style-type: none"> ▶ Need help? Product details, page 38 	<ul style="list-style-type: none"> • One electric hinge with wire conductors and two or three standard butt hinges: 9200 Satin Chrome 	1 Style number 2 Options, if selected (see below) ▶ See <i>Surface Materials</i> , page 142

Options	U.S. Price	Required to Specify
Surface Materials <ul style="list-style-type: none"> • Polished chrome • Paint price group 1 	+\$27.62 per hinge +\$56.32 per hinge	Specify <i>with polished chrome</i> . Specify paint color number.
Hinge Quantity <ul style="list-style-type: none"> • 3 • 4 	No cost	Specify <i>with 3 hinges</i> . Specify <i>with 4 hinges</i> .

Specification Information	
• Style Number	• U.S. Base Price
NESWDHELECHNG	\$1470.07
.....

 **For Canadian Pricing**
 Multiply U.S. Price by the Canadian price factor.
 ▶ See page 1 for details.

Roller Latch



Roller Latchset for Solid Door

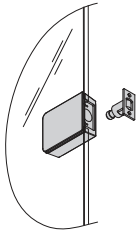

Roller Latchset for Polished Edge Door

Tip: When the black finish is specified on roller latches, the strike plate on the frame will default to the satin chrome finish.

	Standard Includes	Required to Specify
▶ Need help? Product details, page 38	<ul style="list-style-type: none"> Roller latch for solid door: 9200 Satin Chrome Roller latch for polished edge door, includes roller latch and housing: 9200 Satin Chrome 	1 Style number 2 Options, if selected (see below) ▶ See <i>Surface Materials</i> , page 142

	Options	U.S. Price	Required to Specify
Door Type	<ul style="list-style-type: none"> Solid Polished edge 	No cost +\$476.16	Specify with <i>solid door</i> . Specify with <i>polished edge door</i> .
Surface Materials	<ul style="list-style-type: none"> Paint price group 1 	+\$217.98	Specify paint color number.

Specification Information	
• Style Number	• U.S. Base Price
NESWDHRL	\$222.92
:	:

Drop Seal Assembly for Use with Swing Doors

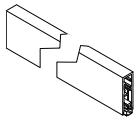

Tip: When the standard pre-set widths are specified the list price will be reduced by 5% from the formula factors as shown above. This discount applies only to the base price per panel and the per square foot of panel add.

	Standard Includes	Required to Specify
▶ Need help? Product details, page 38	<ul style="list-style-type: none"> Drop seal assembly: paint price group 1 or 8043 Clear Anodized Aluminum Width: 28"–48" 	1 Style number 2 Assembly width 3 Paint or aluminum color number for drop seal 4 Options, if selected (see below) ▶ See <i>Surface Materials</i> , page 142

	Options	U.S. Price	Required to Specify
Door Type	<ul style="list-style-type: none"> Polished edge Solid 	No cost No cost	Specify with <i>polished edge door</i> . Specify with <i>solid door</i> .
Surface Materials	Bottom trim <ul style="list-style-type: none"> Paint price group 2 Paint price group 3 	+\$0.15 per inch width +\$0.60 per inch width	Specify paint color number. Specify paint color number.

Specification Information	
• Style Number	• U.S. Base Price
NESWDSA	\$407.94
:	:



For Canadian Pricing
 Multiply U.S. Price by the Canadian price factor.
 ▶ See page 1 for details.

Electric Strike

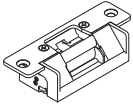

	Standard Includes	Required to Specify
▶ Need help? Product details, page 38	<ul style="list-style-type: none"> • Electric strike • Multi-voltage single solenoid • Selectable lock mode • Horizontal adjustment • Plug-in wire connectors 	1 Style number 2 Options, if selected (see below)

	Options	U.S. Price	Required to Specify
Latch Prep	<ul style="list-style-type: none"> • Cylindrical • Mortise 	No cost No cost	Specify with <i>cylindrical latch prep.</i> Specify with <i>mortise latch prep.</i>

Specification Information	
• Style Number	• U.S. Price
NESESTK	\$790.72
•	•

Specifying

 **For Canadian Pricing**
 Multiply U.S. Price by the
 Canadian price factor.
 ▶ See page 1 for details.

Assembly Hardware, Swing Door Frame

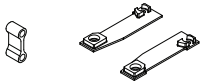

Crush Block Floor brackets

▶ Need help? Product details, page 38

Standard Includes

- Two hinge truck brackets and hardware for swing door frame: paint
- Strike bracket and hardware
- Strike plate and hardware: 9200 Satin Chrome
- Alignment clips
- Post extensions, clips, and hardware
- Floor brackets
- Crush block
- Height: 84"–120"

Required to Specify

- 1 Style number
 - 2 Frame height
 - 3 Paint color number for brackets and hardware
 - 4 Options, if selected (see below).
- ▶ See *Surface Materials*, page 142

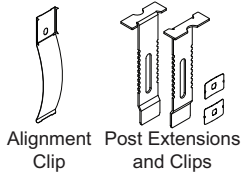

Alignment Clip Post Extensions and Clips

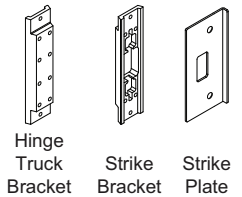

Hinge Truck Bracket Strike Bracket Strike Plate

Tip: Hardware offering will vary depending on the options that are specified.

Tip: If a pushpull or ladder pull is selected, choose a roller latch or self closing hinge to keep door closed.

Tip: Electrification is not available for a pushpull or ladder pull.

	Options	U.S. Price	Required to Specify
Door Type	<ul style="list-style-type: none"> • Polished edge • Solid 	No cost No cost	Specify with <i>polished edge door</i> . Specify with <i>solid door</i> .
Latch Prep	<ul style="list-style-type: none"> • Custom pull • Cylindrical • Mortise • PBA ladder aligned locking • PBA ladder aligned non-locking • PBA ladder offset locking • PBA ladder offset non-locking • Pushpull • TCS ladder aligned locking • TCS ladder aligned non-locking • TCS ladder offset locking 	No cost No cost No cost No cost No cost No cost No cost No cost No cost No cost	Specify with <i>custom pull latch prep</i> . Specify with <i>cylindrical latch prep</i> . Specify with <i>mortise latch prep</i> . Specify with <i>PBA ladder aligned locking latch prep</i> . Specify with <i>PBA ladder aligned non-locking latch prep</i> . Specify with <i>PBA ladder offset locking latch prep</i> . Specify with <i>PBA ladder offset non-locking latch prep</i> . Specify with <i>pushpull latch prep</i> . Specify with <i>TCS ladder aligned locking latch prep</i> . Specify with <i>TCS ladder aligned non-locking latch prep</i> . Specify with <i>TCS ladder offset locking latch prep</i> .
Roller Latch	<ul style="list-style-type: none"> • No roller latch • Roller latch 	No cost No cost	Specify with <i>no roller latch</i> . Specify with <i>roller latch</i> .
Hardware	<ul style="list-style-type: none"> • Satin chrome • Paint price group 1 	No cost +\$ 46.74	Specify with <i>satin chrome</i> . Specify paint color number.
Hinge Type	<ul style="list-style-type: none"> • Electric • Polished edge butt • Slim line • Solid butt 	No cost No cost No cost No cost	Specify with <i>electric hinge</i> . Specify with <i>polished edge butt hinge</i> . Specify with <i>slim line hinge</i> . Specify with <i>solid butt hinge</i> .
Hinge Quantity	<ul style="list-style-type: none"> • 2 • 3 • 4 	No cost +\$ 74.75 +\$149.49	Specify with <i>2 hinges</i> . Specify with <i>3 hinges</i> . Specify with <i>4 hinges</i> .
Electrification	<ul style="list-style-type: none"> • Electric strike • No electrification 	No cost No cost	Specify with <i>electric strike</i> . Specify with <i>no electrification</i> .
Strike Plate	<ul style="list-style-type: none"> • No strike plate • Type 1 • Type 2 	No cost No cost No cost	Specify with <i>no strike plate</i> . Specify with <i>type 1 strike plate</i> . Specify with <i>type 2 strike plate</i> .

Specification Information

Style Number	U.S. Base Price
NEAHSW	\$149.49



For Canadian Pricing
 Multiply U.S. Price by the Canadian price factor.
 ▶ See page 1 for details.



Standard Includes		Required to Specify
<ul style="list-style-type: none"> ▶ Need help? Product details, page 42 	<ul style="list-style-type: none"> • Door frame: paint price group 1 or 8043 Clear Anodized Aluminum • Width: 40"–48" • Height: 84"–120" • Seal: plastic 	<ol style="list-style-type: none"> 1 Style number 2 Frame width 3 Frame height 4 Paint or aluminum color number for door frame 5 Options, if selected (see below) <ul style="list-style-type: none"> ▶ See <i>Surface Materials</i>, page 142

Options	U.S. Price	Required to Specify
Surface Materials <ul style="list-style-type: none"> • Paint price group 2 <ul style="list-style-type: none"> – Width +\$0.15 per inch – Height +\$0.36 per inch • Paint price group 3 <ul style="list-style-type: none"> – Width +\$0.61 per inch – Height +\$1.47 per inch 		Specify paint color number. Specify paint color number. Specify paint color number. Specify paint color number.
Handedness <ul style="list-style-type: none"> • Left hand • Right hand 	No cost No cost	Specify <i>with left-handed</i> . Specify <i>with right-handed</i> .
Latch Prep <ul style="list-style-type: none"> • Lever lock • No latch prep 	No cost No cost	Specify <i>with lever lock latch prep</i> . Specify <i>with no latch prep</i> .

Specification Information	
Style Number	U.S. Base Price
NEDFSLS	\$1857.55

Specifying

 **For Canadian Pricing**
 Multiply U.S. Price by the Canadian price factor.
 ▶ See page 1 for details.

Single Polished Edge Slider Door Leaf

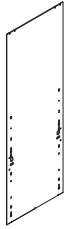

Tip: When the standard pre-set widths are specified the list price will be reduced by 5% from the formula factors as shown above. This discount applies only to the base price per panel and the per square foot of panel add.

Tip: For Customer's Own Glass (COG) an engineering quote is required. Upcharges for latch prep, pull size, roller latch, hinge type, hinge quantity, and stanchions will be additional.

Tip: Stanchion upcharges are only applied if latch prep selection is custom pull.

Standard Includes		Required to Specify
▶ Need help? Product details, page 42	<ul style="list-style-type: none"> • 3/8" thick glass door leaf: 6500 Clear glass • Width: 40"-48" • Height: 84"-120" 	<ol style="list-style-type: none"> 1 Style number 2 Leaf width 3 Leaf height 4 Glass color number for door leaf 5 Options, if selected (see below) <p>▶ See <i>Surface Materials</i>, page 142</p>

Options	U.S. Price	Required to Specify
Surface Materials	<ul style="list-style-type: none"> • Customer's Own Glass (COG) No cost • Glass price group 3 <ul style="list-style-type: none"> - 1/2" +\$ 53.65 per sq ft - 3/8" +\$ 79.11 per sq ft 	▶ See <i>Surface Materials Reference Manual</i> . Specify glass color number. Specify glass color number.
Glass Thickness	<ul style="list-style-type: none"> • 3/8" No cost • 1/2" +\$ 28.51 per sq ft 	Specify with 3/8" thick glass. Specify with 1/2" thick glass.
Glass Surface Orientation	<ul style="list-style-type: none"> • Polished to inside No cost • Polished to outside No cost 	Specify with polished to inside. Specify with polished to outside.
Handedness	<ul style="list-style-type: none"> • Left hand No cost • Right hand No cost 	Specify with left-handed. Specify with right-handed.
Latch Prep	<ul style="list-style-type: none"> • Custom pull No cost • PBA ladder aligned locking +\$ 41.40 • PBA ladder aligned non-locking +\$ 41.40 • PBA ladder offset locking +\$ 41.40 • PBA ladder offset non-locking +\$ 41.40 • Pushpull +\$ 41.40 • TCS ladder aligned locking +\$ 41.40 • TCS ladder aligned non-locking +\$ 41.40 • TCS ladder offset locking +\$ 41.40 • Lever lock +\$155.24 	Specify with custom pull latch prep. Specify with PBA ladder aligned locking latch prep. Specify with PBA ladder aligned non-locking latch prep. Specify with PBA ladder offset locking latch prep. Specify with PBA ladder offset non-locking latch prep. Specify with pushpull latch prep. Specify with TCS ladder aligned locking latch prep. Specify with TCS ladder aligned non-locking latch prep. Specify with TCS ladder offset locking latch prep. Specify lever lock latch prep.
Pull Size	<ul style="list-style-type: none"> • 18" No cost • 24" No cost • 36" No cost • 48" No cost • 60" No cost • 72" <ul style="list-style-type: none"> - TCS aligned locking +\$ 20.70 - TCS aligned non-locking +\$ 20.70 	Specify with 18" pull. Specify with 24" pull. Specify with 36" pull. Specify with 48" pull. Specify with 60" pull. Specify with 72" TCS aligned locking pull. Specify with 72" TCS aligned non-locking pull.
Number of Stanchions	<ul style="list-style-type: none"> • 2 No cost • 3 +\$ 60.38 • 4 +\$120.74 	Specify with 2 stanchions. Specify with 3 stanchions. Specify with 4 stanchions.

Specification Information		
Style Number	U.S. Base Price	
	Per Leaf	Per sq ft of Leaf
NEDLSLPE	\$310.49	+\$53.51

 **For Canadian Pricing**
Multiply U.S. Price by the Canadian price factor.
▶ See page 1 for details.



Tip: When the standard pre-set widths are specified the list price will be reduced by 5% from the formula factors as shown above. This discount applies only to the base price per panel and the per square foot of panel add.

Standard Includes		Required to Specify
▶ Need help? Product details, page 42	<ul style="list-style-type: none"> Door track: paint price group 1 or 8043 Clear Anodized Aluminum Width: 75"–120" 	<ol style="list-style-type: none"> Style number Track width Paint or aluminum color number for door track Options, if selected (see below) <p>▶ See <i>Surface Materials</i>, page 142</p>

Options	U.S. Price	Required to Specify
Surface Materials	<ul style="list-style-type: none"> Paint price group 2 +\$19.69 per sq ft Paint price group 3 +\$81.93 per sq ft 	Specify paint color number. Specify paint color number.
Glass Thickness	<ul style="list-style-type: none"> 1/2" No cost 3/8" No cost 	Specify with 1/2" thick glass. Specify with 3/8" thick glass.

Specification Information	
Style Number	U.S. Base Price
NEDTSL	\$2772.88
:	:

Specifying

 **For Canadian Pricing**
 Multiply U.S. Price by the Canadian price factor.
 ▶ See page 1 for details.

Slider Door Hardware

Drop Seal Housing for Use with Slider Doors

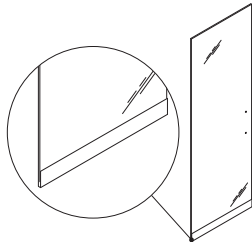

Tip: When the standard pre-set widths are specified the list price will be reduced by 5% from the formula factors as shown above. This discount applies only to the base price per panel and the per square foot of panel add.

Standard Includes		Required to Specify
<ul style="list-style-type: none"> ▶ Need help? Product details, page 42 	<ul style="list-style-type: none"> • Drop seal housing: paint price group 1 or 8043 Clear Anodized Aluminum • Width: 40"–48" 	<ol style="list-style-type: none"> 1 Style number 2 Housing width 3 Paint or aluminum color number for drop seal housing 4 Options, if selected (see below) <ul style="list-style-type: none"> ▶ See <i>Surface Materials</i>, page 142

Options	U.S. Price	Required to Specify
Surface Materials <ul style="list-style-type: none"> • Bottom trim • Paint price group 2 • Paint price group 3 	+\$.15 per sq ft +\$.61 per sq ft	Specify paint color number. Specify paint color number.
Glass Thickness <ul style="list-style-type: none"> • 1/2" • 3/8" 	No cost No cost	Specify with 1/2" thick glass. Specify with 3/8" thick glass.
Handedness <ul style="list-style-type: none"> • Left hand • Right hand 	No cost No cost	Specify with left-handed. Specify with right-handed.

Specification Information	
Style Number	U.S. Base Price
NELSH	\$758.03

Assembly Hardware—Slider Door Frame

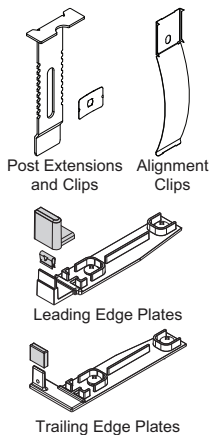

Standard Includes		Required to Specify
<ul style="list-style-type: none"> ▶ Need help? Product details, page 42 	<ul style="list-style-type: none"> • Assembly hardware for slider door frame • Two post extensions, clips, and hardware • Two alignment clips and hardware • Left- or right-hand leading edge plate and hardware • Left- or right-hand trailing edge plate and hardware 	<ol style="list-style-type: none"> 1 Style number 2 Options, if selected (see below)

Options	U.S. Price	Required to Specify
Handedness <ul style="list-style-type: none"> • Left hand • Right hand 	No cost No cost	Specify with left-handed. Specify with right-handed.

Specification Information	
Style Number	U.S. Price
NEAHS	\$92.88



For Canadian Pricing
 Multiply U.S. Price by the Canadian price factor.
 ▶ See page 1 for details.

Drop Seal

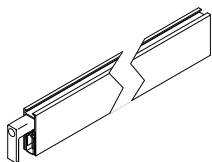

Tip: When the standard pre-set widths are specified the list price will be reduced by 5% from the formula factors as shown above. This discount applies only to the base price per panel and the per square foot of panel add.

Standard Includes	Required to Specify
<ul style="list-style-type: none"> ▶ Need help? Product details, page 42 • Drop seal for slider door • Width: 40"–48" 	<ul style="list-style-type: none"> 1 Style number 2 Seal width

Specification Information

Style Number	U.S. Price
NESLDHDS	\$377.09

Slider Lever Lock



Standard Includes	Required to Specify
<ul style="list-style-type: none"> ▶ Need help? Product details, page 42 • Slider lever lock: 4710 Low Gloss Black or 9200 Satin Chrome 	<ul style="list-style-type: none"> 1 Style number 2 Paint or aluminum color number for slider lever lock 3 Options, if selected (see below) ▶ See <i>Surface Materials</i>, page 142

Options	U.S. Price	Required to Specify
Key		
• No cylinder	No cost	Specify <i>with no cylinder</i> .
• With core, random keyed	No cost	Specify <i>with core, random keyed</i> .
Lever		
• L lever	No cost	Specify <i>with L lever</i> .
• No lever	–\$404.42	Specify <i>with no lever</i> .
• MB lever	+\$718.10	Specify <i>with MB lever</i> .
• REM lever	+\$992.24	Specify <i>with REM lever</i> .
Cylinder Orientation		
• Key inside	No cost	Specify <i>with key inside</i> .
• Key outside	No cost	Specify <i>with key outside</i> .

Specification Information

Style Number	U.S. Base Price
NEDHSSL	\$1467.56



For Canadian Pricing
 Multiply U.S. Price by the Canadian price factor.
 ▶ See page 1 for details.

Door Pulls

Ladder Pull, Aligned

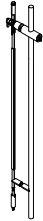

Tip: Latch prep with lockset includes cylinder with random keyed removable core.

Tip: Pull size finish pricing is for TCS ladder aligned nonlocking only.

Standard Includes		Required to Specify	
<ul style="list-style-type: none"> Need help? Product details, page 46 	<ul style="list-style-type: none"> Ladder pull, aligned: 4710 Low Gloss Black or 9200 Satin Chrome Solid door type 	<ol style="list-style-type: none"> Style number Paint or aluminum color number for ladder pull Options, if selected (see below) 	
Door Type	Options	U.S. Price	Required to Specify
	<ul style="list-style-type: none"> Polished edge Solid 	No cost No cost	Specify with polished edge door. Specify with solid door.
Latch Prep	<ul style="list-style-type: none"> PBA ladder aligned locking <ul style="list-style-type: none"> – 9200 +\$5434.82 – 4710 +\$6347.37 PBA ladder aligned non-locking <ul style="list-style-type: none"> – 9200 +\$2420.30 – 4710 +\$3082.95 TCS ladder aligned locking <ul style="list-style-type: none"> – 9200–48" +\$3722.88 – 4710–48" +\$4033.54 – 9200–60" +\$4328.40 – 4710–60" +\$4825.69 – 9200–72" +\$4680.06 – 4710–72" +\$5005.90 TCS ladder aligned non-locking 	See pull size below	Specify with PBA ladder aligned locking latch prep. Specify with PBA ladder aligned non-locking latch prep. Specify with TCS ladder aligned locking latch prep. Specify with TCS ladder aligned non-locking latch prep.
Pull Size	<ul style="list-style-type: none"> 18" <ul style="list-style-type: none"> – 9200 +\$ 651.16 – 4710 +\$ 949.78 24" <ul style="list-style-type: none"> – 9200 +\$ 838.69 – 4710 +\$1137.16 36" <ul style="list-style-type: none"> – 9200 +\$ 983.11 – 4710 +\$1280.97 48" <ul style="list-style-type: none"> – 9200 +\$1155.40 – 4710 +\$1452.29 60" <ul style="list-style-type: none"> – 9200 +\$1380.70 – 4710 +\$1665.94 72" <ul style="list-style-type: none"> – 9200 +\$2002.69 – 4710 +\$2302.48 		Specify with 18" pull. Specify with 24" pull. Specify with 36" pull. Specify with 48" pull. Specify with 60" pull. Specify with 72" pull.
Key	<ul style="list-style-type: none"> No keying option With core, random keyed No cylinder 	No cost No cost –\$ 135.42	Specify with no keying. Specify with core, random keyed. Specify with no cylinder.

Specification Information

Style Number	U.S. Base Price
NEDHLPA	\$333.47



For Canadian Pricing
 Multiply U.S. Price by the Canadian price factor.
 ▶ See page 1 for details.

Ladder Pull, Offset

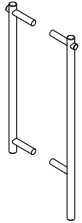

Standard Includes		Required to Specify
<ul style="list-style-type: none"> ▶ Need help? Product details, page 46 	<ul style="list-style-type: none"> Ladder pull, offset: 4710 Low Gloss Black or 9200 Satin Chrome Solid door type 	<ol style="list-style-type: none"> 1 Style number 2 Paint or chrome color number for ladder pull 3 Options, if selected (see below)

	Options	U.S. Price	Required to Specify
Door Type	<ul style="list-style-type: none"> Polished edge Solid 	No cost No cost	Specify with <i>polished edge door</i> . Specify with <i>solid door</i> .
Latch Prep	<ul style="list-style-type: none"> PBA ladder offset locking <ul style="list-style-type: none"> – 9200 +\$5434.82 – 4710 +\$6347.37 PBA ladder offset non-locking <ul style="list-style-type: none"> – 9200 +\$2972.30 – 4710 +\$3884.85 TCS ladder offset locking <ul style="list-style-type: none"> – 9200–48" +\$3737.74 – 4710–48" +\$4033.54 – 9200–60" +\$4328.40 – 4710–60" +\$4825.69 		Specify with <i>PBA ladder offset locking latch prep</i> . Specify with <i>PBA ladder aligned non-locking latch prep</i> . Specify with <i>TCS ladder aligned locking latch prep</i> .
Pull Size	<ul style="list-style-type: none"> 48" 60" 	See above See above	Specify with <i>48" pull</i> . Specify with <i>60" pull</i> .
Key	<ul style="list-style-type: none"> No keying option With core, random keyed No cylinder 	No cost No cost –\$ 135.42	Specify with <i>no keying</i> . Specify with <i>core, random keyed</i> . Specify with <i>no cylinder</i> .

Specification Information	
Style Number	U.S. Base Price
NEDHLPO	\$333.47

Specifying

 **For Canadian Pricing**
 Multiply U.S. Price by the Canadian price factor.
 ▶ See page 1 for details.

Pushpull Handle

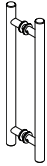

Standard Includes	Required to Specify
-------------------	---------------------

<ul style="list-style-type: none"> ▶ Need help? Product details, page 46 	<ul style="list-style-type: none"> • Pushpull handle: 9200 Satin Chrome 	<ul style="list-style-type: none"> 1 Style number 2 Options, if selected (see below)
---	--	--

Options	U.S. Price	Required to Specify
---------	------------	---------------------

Surface Materials <ul style="list-style-type: none"> • 4710 Low Gloss Black 	+\$46.95	Specify 4710 Low Gloss Black.
---	----------	-------------------------------

Specification Information	
---------------------------	--

<ul style="list-style-type: none"> • Style Number • • • 	<ul style="list-style-type: none"> • U.S. Base Price • • •
NEDHPPH	\$204.99
:	:



For Canadian Pricing
 Multiply U.S. Price by the Canadian price factor.
 ▶ See page 1 for details.

Post, Two-Way



Standard Includes		Required to Specify
<ul style="list-style-type: none"> ▶ Need help? Product details, page 50 	<ul style="list-style-type: none"> • Post: paint price group 1 or 8043 Clear Anodized Aluminum 	<ul style="list-style-type: none"> 1 Style number 2 Paint or aluminum color number for post 3 Options, if selected (see below) ▶ See <i>Surface Materials</i>, page 142

Options	U.S. Price	Required to Specify
Surface Materials <ul style="list-style-type: none"> • Paint price group 2 • Paint price group 3 	<ul style="list-style-type: none"> +\$ 25.90 +\$106.68 	<ul style="list-style-type: none"> Specify paint color number. Specify paint color number.
Angle <ul style="list-style-type: none"> • 90° • 120° • 180° • 135° 	<ul style="list-style-type: none"> No cost +\$ 18.36 +\$ 27.85 +\$255.29 	<ul style="list-style-type: none"> Specify with 90° angle. Specify with 120° angle. Specify with 180° angle. Specify with 135° angle.
Cable Routing Cutout <ul style="list-style-type: none"> • No cutout • Cutout 	<ul style="list-style-type: none"> No cost +\$ 63.30 	<ul style="list-style-type: none"> Specify with no cutout. Specify with cutout.

Specification Information	
Style Number	U.S. Base Price
NEP2	\$895.81

Specifying

Post, Three-Way



Standard Includes		Required to Specify
<ul style="list-style-type: none"> ▶ Need help? Product details, page 50 	<ul style="list-style-type: none"> • Post: paint price group 1 or 8043 Clear Anodized Aluminum 	<ul style="list-style-type: none"> 1 Style number 2 Paint or aluminum color number for post 3 Options, if selected (see below) ▶ See <i>Surface Materials</i>, page 142

Options	U.S. Price	Required to Specify
Surface Materials <ul style="list-style-type: none"> • Paint price group 2 • Paint price group 3 	<ul style="list-style-type: none"> +\$ 25.90 +\$106.68 	<ul style="list-style-type: none"> Specify paint color number. Specify paint color number.
Angle <ul style="list-style-type: none"> • 90° • 120° • 135° 	<ul style="list-style-type: none"> No cost No cost No cost 	<ul style="list-style-type: none"> Specify with 90° angle. Specify with 120° angle. Specify with 135° angle.
Cable Routing Cutout <ul style="list-style-type: none"> • No cutout • Cutout 	<ul style="list-style-type: none"> No cost +\$ 63.30 	<ul style="list-style-type: none"> Specify with no cutout. Specify with cutout.

Specification Information	
Style Number	U.S. Base Price
NEP3	\$1286.89

 **For Canadian Pricing**
 Multiply U.S. Price by the Canadian price factor.
 ▶ See page 1 for details.

Post, 4-Way



Standard Includes	Required to Specify
<ul style="list-style-type: none"> ▶ Need help? Product details, page 50 	<ul style="list-style-type: none"> • Post: paint price group 1 or 8043 Clear Anodized Aluminum 1 Style number 2 Paint or aluminum color number for post 3 Options, if selected (see below) ▶ See <i>Surface Materials</i>, page 142

	Options	U.S. Price	Required to Specify
Surface Materials	<ul style="list-style-type: none"> • Paint price group 2 • Paint price group 3 	<ul style="list-style-type: none"> +\$ 25.90 +\$106.68 	<ul style="list-style-type: none"> Specify paint color number. Specify paint color number.
Cable Routing Cutout	<ul style="list-style-type: none"> • No cutout • Cutout 	<ul style="list-style-type: none"> No cost +\$ 63.30 	<ul style="list-style-type: none"> Specify <i>with no cutout</i>. Specify <i>with cutout</i>.

Specification Information	
Style Number	U.S. Base Price
NEP4	\$1196.33
.	.



For Canadian Pricing
 Multiply U.S. Price by the Canadian price factor.
 ▶ See page 1 for details.

90° T/X Adapter

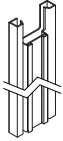

Standard Includes		Required to Specify
<ul style="list-style-type: none"> ▶ Need help? Product details, page 52 	<ul style="list-style-type: none"> • Adapter: paint price group 1 or 8043 Clear Anodized Aluminum 	<ol style="list-style-type: none"> 1 Style number 2 Paint or aluminum color number for adapter 3 Options, if selected (see below) <ul style="list-style-type: none"> ▶ See <i>Surface Materials</i>, page 142

Options	U.S. Price	Required to Specify
Surface Materials <ul style="list-style-type: none"> • Paint price group 2 • Paint price group 3 	+\$11.67 +\$48.08	Specify paint color number. Specify paint color number.
Modularity <ul style="list-style-type: none"> • Off mod • On mod 	No cost No cost	Specify <i>with off modular</i> . Specify <i>with on modular</i> .

Specification Information	
• Style Number	• U.S. Base Price
NEIA	\$793.93

Specifying

Finished End



Standard Includes		Required to Specify
<ul style="list-style-type: none"> ▶ Need help? Product details, page 52 	<ul style="list-style-type: none"> • Finished end: paint price group 1 or 8043 Clear Anodized Aluminum 	<ol style="list-style-type: none"> 1 Style number 2 Paint or aluminum color number for finished end 3 Options, if selected (see below) <ul style="list-style-type: none"> ▶ See <i>Surface Materials</i>, page 142

Options	U.S. Price	Required to Specify
Surface Materials <ul style="list-style-type: none"> • Paint price group 2 • Paint price group 3 	+\$10.14 +\$41.81	Specify paint color number. Specify paint color number.

Specification Information	
• Style Number	• U.S. Base Price
NEFEA	\$690.37

 **For Canadian Pricing**
 Multiply U.S. Price by the Canadian price factor.
 ▶ See page 1 for details.

Utility Panel, Frame



	Standard Includes	Required to Specify
▶ Need help? Product details, page 52	<ul style="list-style-type: none"> Trim: paint price group 1 or 8043 Clear Anodized Aluminum Ceiling height: 84"–120" 	<ol style="list-style-type: none"> Style number Ceiling height Paint or aluminum color number for trim Options, if selected (see below) <p>▶ See <i>Surface Materials</i>, page 142</p>

	Options	U.S. Price	Required to Specify
Surface Materials	<ul style="list-style-type: none"> Paint price group 2 Paint price group 3 	<p>+\$ 25.90</p> <p>+\$106.68</p>	<p>Specify paint color number.</p> <p>Specify paint color number.</p>
Cutout Count	<ul style="list-style-type: none"> No holes 1 hole 2 holes 3 holes 	<p>No cost</p> <p>+\$ 63.30</p> <p>+\$126.60</p> <p>+\$189.90</p>	<p>Specify <i>with no holes</i>.</p> <p>Specify <i>with 1 hole</i>.</p> <p>Specify <i>with 2 holes</i>.</p> <p>Specify <i>with 3 holes</i>.</p>
Cutout Type 1	<ul style="list-style-type: none"> Hardwire—2x4 rectangular Modular power 	<p>No cost</p> <p>No cost</p>	<p>Specify <i>with 2x4 rectangular hardwire</i>.</p> <p>Specify <i>with modular power</i>.</p>
Cutout Type 2	<ul style="list-style-type: none"> Hardwire—2x4 rectangular Modular power 	<p>No cost</p> <p>No cost</p>	<p>Specify <i>with 2x4 rectangular hardwire</i>.</p> <p>Specify <i>with modular power</i>.</p>
Cutout Type 3	<ul style="list-style-type: none"> Hardwire—2x4 rectangular Modular power 	<p>No cost</p> <p>No cost</p>	<p>Specify <i>with 2x4 rectangular hardwire</i>.</p> <p>Specify <i>with modular power</i>.</p>
Cable Routing Cutout	<ul style="list-style-type: none"> No cutout Cutout 	<p>No cost</p> <p>+\$ 63.30</p>	<p>Specify <i>with no cutout</i>.</p> <p>Specify <i>with cutout</i>.</p>

Specification Information	
Style Number	U.S. Base Price
NEUP	\$769.39
.	.



For Canadian Pricing
 Multiply U.S. Price by the
 Canadian price factor.
 ▶ See page 1 for details.

Utility Panel, Cover

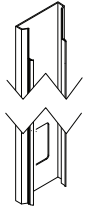

	Standard Includes	Required to Specify
▶ Need help? Product details, page 52	<ul style="list-style-type: none"> Trim: paint price group 1 or 8043 Clear Anodized Aluminum Ceiling height: 84"–120" 	<ol style="list-style-type: none"> Style number Ceiling height Paint or aluminum color number for trim Options, if selected (see below) ▶ See <i>Surface Materials</i> , page 142

	Options	U.S. Price	Required to Specify
Surface Materials	<ul style="list-style-type: none"> Paint price group 2 Paint price group 3 	+\$ 25.90 +\$106.68	Specify paint color number. Specify paint color number.
Cutout Count	<ul style="list-style-type: none"> No holes 1 hole 2 holes 3 holes 	No cost +\$ 63.30 +\$126.60 +\$189.90	Specify <i>with no holes</i> . Specify <i>with 1 hole</i> . Specify <i>with 2 holes</i> . Specify <i>with 3 holes</i> .
Cutout Type 1	<ul style="list-style-type: none"> Hardwire—2x4 rectangular Modular power 	No cost No cost	Specify <i>with 2x4 rectangular hardwire</i> . Specify <i>with modular power</i> .
Cutout Type 2	<ul style="list-style-type: none"> Hardwire—2x4 rectangular Modular power 	No cost No cost	Specify <i>with 2x4 rectangular hardwire</i> . Specify <i>with modular power</i> .
Cutout Type 3	<ul style="list-style-type: none"> Hardwire—2x4 rectangular Modular power 	No cost No cost	Specify <i>with 2x4 rectangular hardwire</i> . Specify <i>with modular power</i> .

Specification Information

Style Number	U.S. Base Price
NEUPC	\$579.97



For Canadian Pricing

Multiply U.S. Price by the Canadian price factor.

▶ See page 1 for details.

Bypass



Standard Includes		Required to Specify
<ul style="list-style-type: none"> ▶ Need help? Product details, page 56 	<ul style="list-style-type: none"> • Bypass: paint price group 1 or 8043 Clear Anodized Aluminum 	<ul style="list-style-type: none"> 1 Style number 2 Paint or aluminum color number for bypass 3 Options, if selected (see below) ▶ See <i>Surface Materials</i>, page 142

Options	U.S. Price	Required to Specify
Surface Materials <ul style="list-style-type: none"> • Paint price group 2 • Paint price group 3 	<ul style="list-style-type: none"> +\$ 25.90 +\$106.68 	<ul style="list-style-type: none"> Specify paint color number. Specify paint color number.
Cable Routing Cutout <ul style="list-style-type: none"> • No cutout • Cutout 	<ul style="list-style-type: none"> No cost +\$ 63.30 	<ul style="list-style-type: none"> Specify <i>with no cutout</i>. Specify <i>with cutout</i>.

Specification Information	
Style Number	U.S. Base Price
NEB	\$892.59



For Canadian Pricing
 Multiply U.S. Price by the Canadian price factor.
 ▶ See page 1 for details.

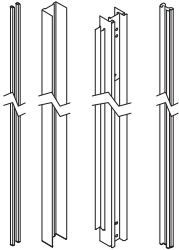

Standard Includes		Required to Specify
<ul style="list-style-type: none"> ▶ Need help? Product details, page 58 	<ul style="list-style-type: none"> • Cuttable end assembly: paint price group 1 • Ceiling height: 84"–120" 	<ul style="list-style-type: none"> 1 Style number 2 Ceiling height 3 Paint color number for cuttable end 4 Options, if selected (see below) ▶ See <i>Surface Materials</i>, page 142

Options	U.S. Price	Required to Specify
Surface Materials <ul style="list-style-type: none"> • Paint price group 2 • Paint price group 3 	<ul style="list-style-type: none"> + \$ 25.75 + \$107.18 	<ul style="list-style-type: none"> Specify paint color number. Specify paint color number.

Specification Information	
• Style Number	• U.S. Base Price
NEECEA	\$1450.59

Specifying

 **For Canadian Pricing**
 Multiply U.S. Price by the Canadian price factor.
 ▶ See page 1 for details.

90° Cuttable End Inner Channel



Standard Includes		Required to Specify
<ul style="list-style-type: none"> ▶ Need help? Product details, page 58 	<ul style="list-style-type: none"> • 48" cuttable end inner channel: paint price group 1 	<ul style="list-style-type: none"> 1 Style number 2 Paint color number for cuttable end 3 Options, if selected (see below) ▶ See <i>Surface Materials</i>, page 142

	Options	U.S. Price	Required to Specify
Length	<ul style="list-style-type: none"> • 48" • 120" 	<ul style="list-style-type: none"> No cost +\$ 87.77 	<ul style="list-style-type: none"> Specify length. Specify length.
Surface Materials	<ul style="list-style-type: none"> • Paint price group 2 • Paint price group 3 	<ul style="list-style-type: none"> +\$ 25.72 +\$107.14 	<ul style="list-style-type: none"> Specify paint color number. Specify paint color number.

Specification Information	
Style Number	U.S. Base Price
NEECEI	\$169.33



For Canadian Pricing
 Multiply U.S. Price by the Canadian price factor.
 ▶ See page 1 for details.



Standard Includes		Required to Specify	
-------------------	--	---------------------	--

▶ Need help? Product details, page 58	• 48" cuttable end outer channel	1 Style number	2 Options, if selected (see below)
---	----------------------------------	----------------	------------------------------------

Options	U.S. Price	Required to Specify
---------	------------	---------------------

Length	• 48" • 120"	No cost +\$87.75	Specify length. Specify length.
---------------	-----------------	---------------------	------------------------------------

Specification Information	
---------------------------	--

• Style Number	• U.S. Base Price
•	•
•	•
NEECEO	\$188.19
•	•

Specifying

 **For Canadian Pricing**
 Multiply U.S. Price by the Canadian price factor.
 ▶ See page 1 for details.

Cutable End Capture Trim



	Standard Includes	Required to Specify
▶ Need help? Product details, page 58	<ul style="list-style-type: none"> Cutable end capture trim: paint price group 1 Ceiling height 12.1"–120" 	<ol style="list-style-type: none"> Style number Ceiling height Paint color number for cutable end capture trim Options, if selected (see below) <p>▶ See <i>Surface Materials</i>, page 142</p>

	Options	U.S. Price	Required to Specify
Surface	• Paint price group 2	+\$12.06	Specify paint color number.
Materials	• Paint price group 3	+\$50.21	Specify paint color number.

Specification Information		
• Style Number	• U.S. Base Price	
•	• Per	• Per sq ft
•	• Capture	• of Height
•	• Trim	•
•	•	•
•	•	•
NEEECT	\$141.40	+\$0.16
•	•	•

 **For Canadian Pricing**
 Multiply U.S. Price by the Canadian price factor.
 ▶ See page 1 for details.



Standard Includes		Required to Specify
▶ Need help? Product details, page 58	• Cutable end corner angle	Style number

Specification Information	
• Style Number	• U.S. Price
NEECEAI	\$140.11

Specifying

 **For Canadian Pricing**
 Multiply U.S. Price by the
 Canadian price factor.
 ▶ See page 1 for details.

Cutable End Elbow



Standard Includes		Required to Specify
-------------------	--	---------------------

▶ Need help? Product details, page 58	• Cutable end elbow	1 Style number 2 Options, if selected (see below)
---	---------------------	--

Options	U.S. Price	Required to Specify
---------	------------	---------------------

Miter Configuration	• Inside corner • Outside corner	No cost No cost Specify <i>with inside corner.</i> Specify <i>with outside corner.</i>
----------------------------	-------------------------------------	---

Specification Information	
---------------------------	--

Style Number	U.S. Price
NEECEEO	\$296.08



For Canadian Pricing

Multiply U.S. Price by the Canadian price factor.

▶ See page 1 for details.

90° Adjustable Mini End

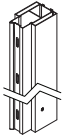

Standard Includes		Required to Specify
<ul style="list-style-type: none"> ▶ Need help? Product details, page 60 	<ul style="list-style-type: none"> • Medium adjustable mini end: paint price group 1 • Seal: <ul style="list-style-type: none"> – 6009 Arctic White – 6249 Platinum Solid – 6527 Merle 	<ol style="list-style-type: none"> 1 Style number 2 Plastic color number for seal 3 Finish for inner and outer 4 Options, if selected (see below) <ul style="list-style-type: none"> ▶ See <i>Surface Materials</i>, page 142

	Options	U.S. Price	Required to Specify
Size	<ul style="list-style-type: none"> • Large 	+\$340.44	Specify large size.
Surface Materials	Inner		
	<ul style="list-style-type: none"> • Paint price group 2 <ul style="list-style-type: none"> – Medium +\$ 20.16 – Large +\$ 27.93 • Paint price group 3 <ul style="list-style-type: none"> – Medium +\$ 82.95 – Large +\$114.97 		Specify paint color number. Specify paint color number. Specify paint color number. Specify paint color number.
	Outer		
	<ul style="list-style-type: none"> • Anodized aluminum No cost • Paint price group 1 No cost • Paint price group 2 <ul style="list-style-type: none"> – Medium +\$ 20.16 – Large +\$ 27.93 • Paint price group 3 <ul style="list-style-type: none"> – Medium +\$ 82.95 – Large +\$114.97 		Specify aluminum color number. Specify paint color number. Specify paint color number. Specify paint color number. Specify paint color number.
Cable Routing	<ul style="list-style-type: none"> • No cutout 	No cost	Specify <i>with no cutout</i> .
Cutout	<ul style="list-style-type: none"> • Cutout 	+\$ 63.30	Specify <i>with cutout</i> .

Specification Information	
• Style Number	• U.S. Base Price
NEEAM	\$748.62
:	:
:	:

Specifying

 **For Canadian Pricing**
 Multiply U.S. Price by the Canadian price factor.
 ▶ See page 1 for details.

Wall Start

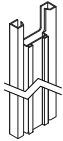

Standard Includes		Required to Specify
<ul style="list-style-type: none"> ▶ Need help? Product details, page 60 	<ul style="list-style-type: none"> • Wall start: paint price group 1 or 8043 Clear Anodized Aluminum 	<ul style="list-style-type: none"> 1 Style number 2 Color number for wall start 3 Options, if selected (see below) ▶ See <i>Surface Materials</i>, page 142

	Options	U.S. Price	Required to Specify
Surface	• Paint price group 2	+\$10.14	Specify paint color number.
Materials	• Paint price group 3	+\$41.81	Specify paint color number.

Specification Information	
• Style Number	• U.S. Base Price
NEWS	\$690.37
.	.



For Canadian Pricing
 Multiply U.S. Price by the Canadian price factor.
 ▶ See page 1 for details.

Flush Skin Seal



Standard Includes	Required to Specify
<ul style="list-style-type: none"> ▶ Need help? Product details, page 62 • Clear plastic • Flush skin seal, 120" long 	<ul style="list-style-type: none"> Style number

Specification Information

Style Number	U.S. Price
NESSFL	\$89.68
·	·

Flush Skin Seal, Inside Corner, 90°

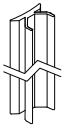

Standard Includes	Required to Specify
<ul style="list-style-type: none"> ▶ Need help? Product details, page 62 • Flush skin seal, inside corner, 90°, 120" long • Clear plastic 	<ul style="list-style-type: none"> Style number

Specification Information

Style Number	U.S. Price
NESSFIC90	\$105.50
·	·

Cove Base Trim, Straight

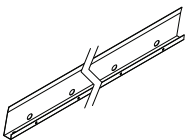

Standard Includes	Required to Specify
<ul style="list-style-type: none"> ▶ Need help? Product details, page 62 • Cove base trim, 75" long • Steel 	<ul style="list-style-type: none"> Style number

Specification Information

Style Number	U.S. Price
NEBTSC	\$126.60
·	·



For Canadian Pricing
 Multiply U.S. Price by the Canadian price factor.
 ▶ See page 1 for details.

Electrical Components

Receptacles

Receptacle

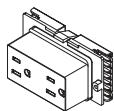

	Standard Includes	Required to Specify
▶ Need help? Product details, page 64	<ul style="list-style-type: none"> Receptacle: <ul style="list-style-type: none"> – 6009 Arctic White – 6249 Platinum Solid – 6527 Merle – 6B03 Red 	<ol style="list-style-type: none"> Style number Plastic color number for receptacle Options, if selected (see below)

	Options	U.S. Price	Required to Specify
Wiring Schematic	<ul style="list-style-type: none"> 2+2 3 separate neutrals 3+1 	<ul style="list-style-type: none"> No cost No cost No cost 	<ul style="list-style-type: none"> Specify with 2+2 wiring. Specify with 3 separate neutrals wiring. Specify with 3+1 wiring.
Line Number	<ul style="list-style-type: none"> Line 1 Line 2 Line 3 Line 4 	<ul style="list-style-type: none"> No cost No cost No cost No cost 	<ul style="list-style-type: none"> Specify with 1 line. Specify with 2 line. Specify with 3 line. Specify with 4 line.
Ground Type	<ul style="list-style-type: none"> Isolated System 	<ul style="list-style-type: none"> No cost No cost 	<ul style="list-style-type: none"> Specify with isolated grounding. Specify with system grounding.
Amp Type	<ul style="list-style-type: none"> 15 amp 20 amp 	<ul style="list-style-type: none"> No cost +\$12.92 	<ul style="list-style-type: none"> Specify with 15 amp. Specify with 20 amp.
Controlled Stamp	<ul style="list-style-type: none"> No stamp With controlled stamp 	<ul style="list-style-type: none"> No cost +\$ 2.58 	<ul style="list-style-type: none"> Specify with no stamp. Specify with controlled stamp.

Specification Information	
• Style Number	• U.S. Base Price
•	•
•	•
•	•
•	•
NEPRC	\$46.00
•	•

 **For Canadian Pricing**
 Multiply U.S. Price by the Canadian price factor.
 ▶ See page 1 for details.

USB Receptacle

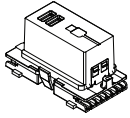

Standard Includes		Required to Specify
<ul style="list-style-type: none"> ▶ Need help? Product details, page 64 	<ul style="list-style-type: none"> • USB receptacle: <ul style="list-style-type: none"> – 6009 Arctic White – 6249 Platinum Solid – 6527 Merle 	<ul style="list-style-type: none"> 1 Style number 2 Plastic color number for receptacle 3 Options, if selected (see below)

Options	U.S. Price	Required to Specify
Wiring Schematic <ul style="list-style-type: none"> • 2+2 • 3 separate neutrals • 3+1 	<ul style="list-style-type: none"> No cost No cost No cost 	<ul style="list-style-type: none"> Specify with 2+2 wiring. Specify with 3 separate neutrals wiring. Specify with 3+1 wiring.
Line Number <ul style="list-style-type: none"> • Line 1 • Line 2 • Line 3 • Line 4 	<ul style="list-style-type: none"> No cost No cost No cost No cost 	<ul style="list-style-type: none"> Specify with 1 line. Specify with 2 line. Specify with 3 line. Specify with 4 line.

Specification Information	
Style Number	U.S. Price
NEPRCUSB	\$279.32
.	.

Specifying

Power Receptacle Trim

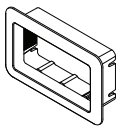

Standard Includes		Required to Specify
<ul style="list-style-type: none"> ▶ Need help? Product details, page 64 	<ul style="list-style-type: none"> • Power receptacle trim: <ul style="list-style-type: none"> – 6009 Arctic White – 6249 Platinum Solid – 6527 Merle 	<ul style="list-style-type: none"> 1 Style number 2 Plastic color number for power receptacle trim

Specification Information	
Style Number	U.S. Price
NEPRT	\$11.50
.	.

 **For Canadian Pricing**
 Multiply U.S. Price by the Canadian price factor.
 ▶ See page 1 for details.

Modular Communication Faceplate

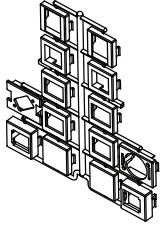
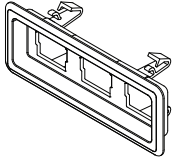

Standard Includes		Required to Specify
<ul style="list-style-type: none"> ▶ Need help? Product details, page 64 	<ul style="list-style-type: none"> • Modular communication faceplate: <ul style="list-style-type: none"> – 6009 Arctic White – 6249 Platinum Solid – 6527 Merle • Data adapter trims 	<ul style="list-style-type: none"> 1 Style number 2 Plastic color number for faceplate

Specification Information	
• Style Number	• U.S. Price
NEPFPC	\$46.00



For Canadian Pricing
 Multiply U.S. Price by the Canadian price factor.
 ▶ See page 1 for details.

Multipurpose Infeed and Power Block

Multipurpose Infeed
and Power Block

Multipurpose Infeed—8 Wire



Hardwire

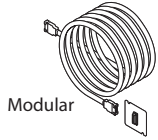

Modular

Standard Includes		Required to Specify
<ul style="list-style-type: none"> ▶ Need help? Product details, page 64 	<ul style="list-style-type: none"> • 24' long infeed • Junction box fittings • Conduit: metal 	<ul style="list-style-type: none"> 1 Style number 2 Options, if selected (see below)

	Options	U.S. Price	Required to Specify
Wiring Schematic	<ul style="list-style-type: none"> • 2+2 • 3 separate neutrals • 3+1 	<ul style="list-style-type: none"> No cost No cost No cost 	<ul style="list-style-type: none"> Specify with 2+2 wiring. Specify with 3 separate neutrals wiring. Specify with 3+1 wiring.
Building Connection	<ul style="list-style-type: none"> • Hardwire • Modular 	<ul style="list-style-type: none"> No cost +\$159.12 	<ul style="list-style-type: none"> Specify with hardwire connection. Specify with modular connection.

Specification Information	
Style Number	U.S. Base Price
NEPIMP8	\$766.74

Specifying

Power Block

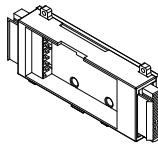

Standard Includes		Required to Specify
<ul style="list-style-type: none"> ▶ Need help? Product details, page 64 	<ul style="list-style-type: none"> • Power block 	<ul style="list-style-type: none"> 1 Style number 2 Options, if selected (see below)

	Options	U.S. Price	Required to Specify
Wiring Schematic	<ul style="list-style-type: none"> • 2+2 • 3 separate neutrals • 3+1 	<ul style="list-style-type: none"> No cost No cost No cost 	<ul style="list-style-type: none"> Specify with 2+2 wiring. Specify with 3 separate neutrals wiring. Specify with 3+1 wiring.

Specification Information	
Style Number	U.S. Price
NEPB	\$126.49

 **For Canadian Pricing**
Multiply U.S. Price by the Canadian price factor.
▶ See page 1 for details.

Modular Harness

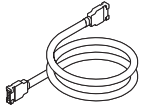

Standard Includes	Required to Specify
-------------------	---------------------

- | | | |
|---|---|--|
| <ul style="list-style-type: none"> ▶ Need help? Product details, page 64 | <ul style="list-style-type: none"> • Modular harness, 8-wire: 36" long | <ul style="list-style-type: none"> 1 Style number 2 Options, if selected (see below) |
|---|---|--|

Options	U.S. Price	Required to Specify
---------	------------	---------------------

Length	<ul style="list-style-type: none"> • 72" • 144" 	<ul style="list-style-type: none"> +\$ 89.40 +\$257.60 	<ul style="list-style-type: none"> Specify length. Specify length.
Wiring Schematic	<ul style="list-style-type: none"> • 2+2 • 3 separate neutrals • 3+1 	<ul style="list-style-type: none"> No cost No cost No cost 	<ul style="list-style-type: none"> Specify <i>with 2+2 wiring</i>. Specify <i>with 3 separate neutrals wiring</i>. Specify <i>with 3+1 wiring</i>.

Specification Information	
---------------------------	--

<ul style="list-style-type: none"> • Style Number • • • 	<ul style="list-style-type: none"> • U.S. Base Price • • •
NEPHN8	\$206.07
•	•



For Canadian Pricing
 Multiply U.S. Price by the Canadian price factor.
 ▶ See page 1 for details.

Harness-to-Harness Branching Connector

Harness-to-Harness
Branching Connector



Standard Includes		Required to Specify
▶ Need help? Product details, page 64	• Connector	1 Style number 2 Options, if selected (see below)

Options	U.S. Price	Required to Specify
Wiring	• 2+2 No cost	Specify with 2+2 wiring.
Schematic	• 3 separate neutrals No cost	Specify with 3 separate neutrals wiring.
	• 3+1 No cost	Specify with 3+1 wiring.

Specification Information	
• Style Number	• U.S. Price
NEPHNC	\$46.99
.	.

Specifying



For Canadian Pricing
Multiply U.S. Price by the
Canadian price factor.
▶ See page 1 for details.

Electrical Mounting Brackets

Bracket for Use with Modular Skin

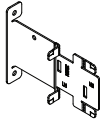

	Standard Includes	Required to Specify
▶ Need help? Product details, page 64	• Bracket: fire retardant polyurethane foam	Style number

Specification Information

• Style Number	• U.S. Price
NEPMBESM	\$48.14

Bracket for Use with Hardwire

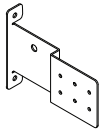

	Standard Includes	Required to Specify
▶ Need help? Product details, page 64	• Bracket: fire retardant polyurethane foam	Style number

Specification Information

• Style Number	• U.S. Price
NEPMBESH	\$108.14

Utility Panel



Modular



Hardwire

	Standard Includes	Required to Specify
▶ Need help? Product details, page 64	• Bracket: fire retardant polyurethane foam	1 Style number 2 Options, if selected (see below)

Devices	Options	U.S. Price	Required to Specify
	• Modular	No cost	Specify with modular device.
	• Hardwire single	+\$1.73	Specify with hardwire single device.

Specification Information

• Style Number	• U.S. Base Price
NEPMBEU	\$101.54



For Canadian Pricing

Multiply U.S. Price by the Canadian price factor.

▶ See page 1 for details.

Surface Materials

Surface Materials

142

Surface Materials

Surface Materials

This listing includes all the surface material choices that are available for the products in this specification guide.

Resources

For more information about surface materials, refer to the following resources:

Additional surface material specification tools are available to assist you in the specification process – the Surface Materials Binders.

The global surface materials palette is a core collection of finishes that is available across multiple geographies (Americas/EMEA – Europe, Middle East, and Africa/APAC – Asia Pacific) and on global product lines, where applicable. For a list of finishes included in the offering, see the *Surface Materials Reference Manual*. Additional details, like product approvals by geography and finish number conversions, can also be found in the *Surface Materials Reference Manual* or see steelcase.com/surface-materials.

Paint

Tip: All products may not be available in all colors listed below.

Price Group 1

Smooth Paint

- 4242 Milk Smooth
- 4710 Low Gloss Black
- 4843 Linen
- 4844 Glacier
- 4849 Vapor
- 4858 Seagull

Textured Paint

- 7190 Platinum Solid
- 7207 Black
- 7225 Sand
- 7237 Slate
- 7238 Fieldstone
- 7239 Midnight **E**
- 7241 Arctic White
- 7243 Seagull
- 7278 Dark Bronze
- 7360 Merle

Price Group 2

Smooth Metallic Paint

- 4750 Champagne Metallic
- 4798 Sterling Metallic **E**
- 4799 Platinum Metallic
- 4803 Near Black Metallic

Applies to:

- Ceiling track

Price Group 1

Textured Paint

- 7241 Arctic White
- 7360 Merle

Price Group 2

Smooth Metallic Paint

- 4799 Platinum Metallic

Custom Surfaces

Price Group 3

PerfectMatch

PerfectMatch is a service that allows you to create your own paint color. Refer to the *Surface Materials Reference Manual* for more information about this program.

Accent Paint

- 1ATG Rose Quartz
- 4AV4 Baltic
- 4CZ6 Lagoon
- 4CZ7 Saffron

Lux Coatings

- 4B22 Matte Brass
- 4B23 Burnished Bronze
- 4B24 Night Bronze
- 4B25 Matte Copper
- 4B26 Smoked Mica
- 4B29 Cast Iron

Accent Paint and Lux Coatings

will be added to products that receive the metal and accessories paint finishes.

Metal and Accessory Paint

Steelcase Surfaces

Applies to:

- Glass frames
- Bypass
- Adapter
- Finished end
- Utility panel cover and frame
- Door frames
- Slider door track
- Posts
- Vertical transition
- Wall start
- Drop seal assembly and housing

- 8043 Clear Anodized Aluminum

Laminate

Steelcase Surfaces

Low-Pressure Laminate

Price Group 1

Applies to:

- Laminate skins

Solid Laminate

- 247L Black V2 LPL
- 2L30 Arctic White LPL
- 2L83 Seagull LPL
- 2L84 Milk LPL
- 2L85 Dune LPL
- 2LMG Merle LPL

Woodgrain Laminate

- 24L0 Graphite Walnut LPL
- 25L1 Winter on Maple LPL **E**
- 25L5 Virginia Walnut LPL
- 25L6 Blackwood LPL
- 25L8 Clear Walnut LPL
- 265L Marbled Cherry LPL
- 26L1 Natural Cherry V2 LPL
- 2L09 Clear Maple LPL
- 2LAK Clear Oak LPL
- 2LAN Ash Noce LPL
- 2LAT Acacia LPL
- 2LAW Ash Wenge LPL
- 2LBN Bisque Noce LPL
- 2LBW Bisque Wenge LPL
- 2LCN Clay Noce LPL
- 2LCW Clay Wenge LPL
- 2LSN Storm Noce LPL
- 2LSW Storm Wenge LPL
- 2LWA Grey Kingswood LPL
- 2LWB Planked Walnut LPL
- 2LWD Resolute Walnut LPL
- 2LWF Smoked Walnut LPL **E**
- 2LWG Natural Recon LPL
- 2TL2 Fawn Cypress LPL

High-Pressure Laminate

Price Group 1

Applies to:

- Laminate skins

Fiber Laminate

- 2850 Vanadium Fiber HPL
- 2854 Vellum Fiber HPL **E**
- 2860 Granite Fiber HPL
- 2862 Stucco Fiber HPL **E**

Micro Laminate

- 2920 Marl Micro HPL
- 2921 Gypsum Micro HPL
- 2922 Clay Micro HPL

Patina Laminate

- 2870 Blonde Bronze Patina HPL
- 2873 Instant Iron Patina HPL

Solid Laminate

- 2722 Cream HPL **E**
- 2730 Arctic White HPL
- 2746 Black HPL
- 2759 Warm White
- 2811 Mist HPL **E**
- 2883 Seagull HPL
- 2884 Milk HPL
- 2885 Dune HPL
- 2HAA Persian Salt HPL
- 2HAB Rose HPL
- 2HAC Indigo HPL
- 2HAD Green Citrine HPL **E**
- 2HAE Dark Olivine HPL
- 2HAF Cloudy HPL
- 2HMG Merle HPL

Speckle Laminate

- 2820 Coffee Speckle HPL **E**
- 2823 Driftwood Speckle HPL
- 2824 Smoke Speckle HPL
- 2825 Vanadium Speckle HPL

E = Excluded

Woodgrain Laminate

2406	Clear Cherry HPL E
2409	Clear Maple HPL
2410	Graphite Walnut HPL
2412	Natural Cherry HPL
2422	Medium Cherry HPL E
2511	Winter on Maple HPL E
2535	Virginia Walnut HPL
2536	Blackwood HPL
2538	Clear Walnut HPL
2592	Blonde on Maple HPL E
2714	Natural Walnut HPL E
2HAK	Clear Oak HPL
2HAN	Ash Noce HPL
2HAT	Acacia HPL
2HAW	Ash Wenge HPL
2HBN	Bisque Noce HPL
2HBW	Bisque Wenge HPL
2HCN	Clay Noce HPL
2HCW	Clay Wenge HPL
2HSN	Storm Noce HPL
2HSW	Storm Wenge HPL
2HWA	Grey Kingswood HPL
2HWB	Planked Walnut HPL
2HWD	Resolute Walnut HPL
2HWE	Natural Recon HPL
2HWF	Smoked Walnut HPL E
2HWU	Clay
2HVV	Chalk

Price Group 2**Textured Laminate**

2TH2	Fawn Cypress HP
2TH4	Saddle Oak HPL
2TH5	Veranda Teak HPL
2TH7	Walnut Heights HPL
2UH1	Reclaimed Aggregate HPL
2UH2	Reclaimed Gravel HPL
2UH4	Cement HPL
2UH6	Sheetrock HPL

Price Group 3**Solid Laminate**

24H1	Satin White HPL
24H2	Satin Black HPL
24H3	Satin Stone HPL
24H4	Satin Mocha HPL

Plastic**Steelcase Surfaces**

Applies to:

- Receptacles
 - Receptacle trim
 - Modular communication faceplate
- | | |
|------|------------------------|
| 6009 | Arctic White |
| 6249 | Platinum Solid |
| 6527 | Merle |
| 6B03 | Red (receptacles only) |

E = Excluded

Applies to:

- Seals
- | | |
|------|----------------|
| 6249 | Platinum Solid |
| 6527 | Merle |

Applies to:

- Laminate skins
- | | |
|------|--------------------------|
| 6000 | Black |
| 6009 | Arctic White |
| 6034 | Natural Cherry |
| 6036 | Medium Cherry |
| 6037 | Winter on Maple |
| 6038 | Blonde on Maple E |
| 6041 | Natural Walnut E |
| 6052 | Milk |
| 6053 | Seagull |
| 6169 | Stone |
| 6170 | Mocha |
| 61AA | Persian Salt |
| 61AB | Rose |
| 61AC | Indigo |
| 61AD | Green Cintrine E |
| 61AE | Dark Olivine |
| 61AF | Cloudy |
| 6213 | Acacia |
| 6219 | Clear Oak |
| 6231 | Graphite Walnut |
| 6234 | Clear Cherry |
| 6237 | Clear Maple |
| 6242 | Virginia Walnut |
| 6243 | Blackwood |
| 6245 | Clear Walnut |
| 6249 | Platinum Solid |
| 6271 | Plywood |
| 6527 | Merle |
| 6615 | Grey V5 |
| 6619 | Ice E |
| 6631 | Cream E |
| 6636 | Mist |
| 6654 | Sand |
| 6655 | Warm White |
| 6676 | Marbled Maple |
| 6677 | Chocolate Walnut |
| 6678 | Marbled Cherry |
| 6697 | Fog |
| 6698 | Fieldstone |
| 66WA | Grey Kingswood |
| 66WB | Planked Walnut |
| 66WD | Resolute Walnut |
| 66WE | Natural Recon |
| 66WF | Smoked Walnut |
| 66WU | Clay |
| 66WV | Chalk |
| 6703 | Ash Wedge |
| 6704 | Storm Wedge |
| 6705 | Bisque Wedge |
| 6706 | Clay Wedge |
| 6707 | Ash Noce |
| 6708 | Bisque Noce |
| 6709 | Clay Noce |
| 6710 | Storm Noce |
| 6T02 | Fawn Cypress |
| 6T04 | Saddle Oak |
| 6T05 | Veranda Teak |
| 6T07 | Walnut Heights |
| 6T08 | Aggregate |
| 6T09 | Gravel |
| 6T10 | Cement |
| 6T12 | Sheetrock |

Custom Surfaces**Open Line Laminate (OLL)**

This service allows you to order non-standard laminate OLL at an additional processing fee, plus the cost of the laminate.

High-Pressure Laminate pricing does not include premium or digitally printed patterns from any suppliers. Laminate cost may also vary for basic or standard laminates from other suppliers. Please contact the OLL consultant at 616.475.2426 for pricing. The cost of the laminate will be added to your invoice as a separate line on the acknowledgement.

When processing orders for Open Line laminate on Everwall skins, specify 2900 in the laminate finish field and enter the OLL manufacturer information. Enter the required edge finish as you would a standard laminate.

Laminate Approval and Material Requirements

To confirm whether a particular laminate has already been tested for use on a specific Steelcase product or to determine material square requirements:

Visit www.steelcase.com

For additional information, refer to the *Steelcase Surface Materials Reference Manual*.

Glass**Steelcase Surfaces**

Applies to:

- Unitized glass panel
- Glass kit
- Structural frame - clerestory

Price Group 1

6500	Clear Glass
------	-------------

Price Group 2

6540	Clear Laminated
6541	White Laminated

Price Group 3

6501	Low Iron Clear
6542	Satin

Price Group 7

6504	Low Iron Clear Laminated
------	--------------------------

Plated Metal**Steelcase Surfaces**

Applies to:

- Push/pull handle
 - Hinges
 - Roller latch
 - Latchset
 - Wall stops
 - Floor stops
 - Ladder pulls
- | | |
|------|-------------------|
| 4710 | Low Gloss Black |
| 8031 | Brushed Stainless |
| 9200 | Satin Chrome |
| 9201 | Polished Chrome |

Vertical Surface Fabric**Steelcase Surfaces**

Applies to:

- Solid steel skins

Price Group 1**Abacus **E****

P123	Portico
P124	Opus
P125	Cusp
P126	Artifact

Boccie

P200	New Rice
P201	New Almond
P203	New Camel
P204	New Opal
P205	New Mist
P206	New Plum
P208	New Spearmint
P209	New Sky

Buzz2

5F03	Tomato
5F04	Red E
5F05	Burgundy
5F06	Sky E
5F07	Blue
5F08	Navy
5F15	Stone
5F16	Grey
5F17	Black
5G50	Dunegrass
5G51	Sable
5G55	Pumpkin
5G57	Rouge
5G59	Meadow
5G61	Cyan
5G62	Atlantic
5G63	Crocus
5G64	Alpine
5G65	Tornado

Charm

P505	Shell
P506	Mimosa
P507	Birch
P508	Sparkle
P510	Debut
P511	Clover
P513	Twilight

Optic

- P540 Hazel
- P541 Twinkle
- P542 Orion
- P547 Bath
- P551 Glimmer

Rhythm

- P555 Allegro
- P556 Tempo
- P557 Refrain
- P560 Melody
- P562 Opus

Tinsel

- P516 Lit
- P517 Ego
- P518 Fizz
- P519 Muse
- P520 Depth
- P521 Bliss
- P522 Grow
- P523 Dolce

Price Group 2

Bariolage

- G200 New Etude
- G201 New Andante **E**
- G202 New Cantata **E**
- G203 New Adagio
- G204 New Melody
- G205 New Ballata

Code

- 5FA1 Fossil
- 5FA2 Gabbro
- 5FA3 Reed
- 5FA4 Bluff
- 5FA5 Sea Salt
- 5FA6 Cannon
- 5FA7 Tussah
- 5FA9 Ecu
- 5FB1 Bamboo

Fresco

- G001 Sandrift
- G002 Mistiblu
- G003 Faon

Intersection

- P211 Summit
- P212 Chalk
- P213 Lace
- P214 Sea Salt
- P215 Lagoon
- P216 Electric Indigo
- P217 Indigo
- P218 Jungle
- P219 Green Citrine
- P220 Olivine
- P221 Rose Quartz
- P222 Mulberry
- P223 Tango
- P224 Scarlet
- P225 Saffron
- P226 Mousse

Latch

- P600 Seashell
- P601 Clam
- P602 Eggshell
- P603 Zen
- P604 Cool Gray
- P605 Armor
- P606 Sentinel
- P608 Billow
- P609 Nimbus

Stencil

- P455 Midnight
- P456 Mulberry
- P457 Cracked Pepper
- P458 Denim
- P459 Chartreuse
- P460 Bittersweet
- P461 Mauvelous
- P462 Bermuda
- P463 Concrete
- P464 Orchid
- P465 Parchment
- P466 Silk
- P467 Sea Salt
- P468 Honeydew
- P469 Sepia

Select Surfaces

For information on products within Select Surfaces, including accent paints and fabrics from Designtex, Gabriel, Kvadrat, and Pollack, please refer to the *Surface Materials Reference Manual* or visit steelcase.com/surface-materials under the Select Surfaces section.

Custom Surfaces

Price Group COM (Customer's Own Material)

Fabric Approval and Yardage

To confirm whether a particular COM material has already been tested for use on a specific Steelcase product or to determine actual yardage requirements:

- Visit www.steelcase.com

For additional information regarding Customer's Own Material, call 1.888.STEELCASE (1.888.783.3522) or send an e-mail to lineone@steelcase.com.

Wood

Applies to:

- Door leaf

Steelcase carefully selects veneer and solid wood for consistent color and grain structure. Wood is a natural material and variations will occur in color, grain, and texture. These variations are part of the inherent natural beauty of wood and are not considered defects.

All wood products will darken with age and exposure to ultraviolet light. This is especially apparent with cherry and maple veneer. We recommend that desk accessories be rearranged periodically to ensure even aging of wood surfaces.

When storing your wood furniture, please follow the following guidelines:

- Do not store products in trailers
- Store products in areas that simulate office temperatures (60°F to 90°F)
- Store products in areas that maintain constant, office-like humidity levels
- Keep product away from light. Cover products to make sure they are not exposed to light.

Steelcase Surfaces

Veneers are matched for proper balance and consistency. Veneers are available flat cut or quarter cut, except for Oak, which is rift cut. Refer to the *Surface Materials Reference Manual* for descriptions of each cut.

Open-pore finish is a medium gloss finish that leaves the wood grain texture visible to the eye and distinguishable to the touch.

Veneer

Wood Group 1

Flat-Cut Open-Pore

- 3062 FC/OP Graphite Walnut
- 3402 FC/OP Clear Cherry (Aged)
- 3412 FC/OP Natural Cherry **E**
- 3422 FC/OP Medium Cherry
- 3522 FC/OP Clear Maple
- 3592 FC/OP Blonde on Maple **E**
- 3702 FC/OP Clear Walnut
- 3712 FC/OP Natural Walnut
- 3752 FC/OP Medium Walnut **E**
- 3762 FC/OP Dark Walnut
- 3772 FC/OP Medium Mahogany on Walnut

Flat-Cut Open-Pore, Natural Veneer

- 3342 FC/OP Black Walnut
- 35A2 FC/OP Blanch Maple
- 37A2 FC/OP Thunder Walnut

Quarter-Cut Open-Pore

- 3042 QC/OP Ash **E**
- 3222 QC/OP Clear Maple
- 3292 QC/OP Blonde on Maple **E**

Quarter-Cut Open-Pore, Natural Veneer

- 32A2 QC/OP Blanch Maple
- 33A2 QC/OP Thunder Walnut
- 3392 QC/OP Black Walnut

Rift-Cut Open-Pore

- 3602 RC/OP Desert Oak

Rift-Cut Open-Pore, Natural Veneer

- 36A2 RC/OP Volcanic Oak

Wood Group 3

Flat-Cut Open-Pore, Natural Veneer

- 3082 FC/OP Washed Walnut

Wood Group 1

Open-Pore Planked Veneer

- 3P41 OP Planked Cherry
- 3P51 OP Planked Maple
- 3P61 OP Planked Oak
- 3P71 OP Planked Walnut
- 3VFX OP Unmarked Oak

Tip: Known for its uniqueness, planked veneer has intentional and natural variations that include, but are not limited to: character marks, grain pattern, color, and natural color aging.

Premium Veneers

A selection of Premium veneers in this collection are available on most Steelcase brand products. The collection will be available as close to standard leadtimes as possible. However, because adequate supplies of veneer and solids must be secured, all orders will be scheduled individually. Leadtimes will vary based on Premium veneer and Premium solids availability at the time the order is placed. The collection is available as Wood Group 3, as part of our Select Surfaces program and supported like standard veneers to make ordering easy. Please see the Steelcase surface materials section on village.steelcase.com for sample information and product line availability. All premium veneers are in clear-coat.

Wood Group 3

Quarter-Cut Open-Pore

- 3832 QC/OP Figured Anigre

Select Surfaces

For information on products within Select Surfaces, including accent paints and fabrics from Designtex, Gabriel, Kvadrat, and Pollack, please refer to the *Surface Materials Reference Manual* or visit steelcase.com/surface-materials under the Select Surfaces section.

E = Excluded

Custom Surfaces

Customiz stain is a service that allows you to create your own stain colors and finishes on standard veneer. Customiz stain color is available on all product lines that offer wood veneer.

A \$500 stain-matching fee applies on CUSTOMIZ requests (Exception: The \$500 fee does not apply on matches to Coalesse standard finishes or for a low-gloss finish request on a standard color). The \$500 fee covers the cost of formulating the Customiz color finish and applies regardless of whether or not an order for product is placed.

In addition, an approval form must be signed to indicate customer acceptance of Customiz match. A \$1,500 initiation fee will be charged prior to first order entry. This initiation fee activates the finish for unlimited use on any Steelcase product for an 18 month time period. After the 18 month time period has lapsed, the Customiz finish may be reactivated for another 18 months for a \$1,000 fee at any point within five years after the \$1,500 initiation was paid. If the finish is not reactivated within five years after the \$1,500 initiation fee was paid, the finish will be culled and the customer will need to pay the \$1,500 initiation fee again. All style number related Customiz charges products are no cost as of April 2014. The matching and initiation fee are not discountable.

Customiz stain takes 10 days to formulate. Consult the *Surface Materials Reference Manual* for more information. Custom veneers are also available and must be quoted by Steelcase specials group. Customiz stain on custom veneers takes 2 to 4 weeks to formulate.

Requirements and information on ordering a Customiz stain color are found in the *Surface Materials Reference Manual*.



Resources

Style Number Index

148

Style Number Index

Style Number	Page	Description
NEAHS�	114	Everwall, Slider Door Hardware
NEAHSW	110	Everwall, Swing Door Hardware
NEASSL	91	Everwall, Skin, Acoustic Product
NEASSS	91	Everwall, Skin, Acoustic Product
NEB	124	Everwall, Bypass
NEBTSC	133	Everwall, Cove Base Trim, Straight
NECF	78	Everwall, Ceiling Fastener
NECTS	75	Everwall, Ceiling Track
NEDDFS	104	Everwall, Swing Door Hardware
NEDFSL	111	Everwall, Slider Door Frame
NEDFSWS	98	Everwall, Swing Door Frame
NEDHCL	102	Everwall, Swing Door Hardware
NEDHCPH	102	Everwall, Swing Door Hardware
NEDHLPA	116	Everwall, Door Pull
NEDHLPO	117	Everwall, Door Pull
NEDHML	103	Everwall, Swing Door Hardware
NEDHMPH	104	Everwall, Swing Door Hardware
NEDHPPH	118	Everwall, Door Pull
NEDHSSL	115	Everwall, Slider Door Hardware
NEDLSLPE	112	Everwall, Slider Door Leaf, Polished Edge
NEDLSWPE	101	Everwall, Swing Door Leaf, Polished Edge
NEDLSWS	99	Everwall, Swing Door Leaf, Solid
NEDMWS	105	Everwall, Swing Door Hardware
NEDSBS	105	Everwall, Swing Door Hardware
NEDTSL	113	Everwall, Slider Door Track
NEEAM	131	Everwall, Mini End and Wall Start
NEECA	125	Everwall, 90° Cutable End Assembly
NEECEAI	129	Everwall, Cutable End Corner Angle
NEECECT	128	Everwall, Cutable End Capture Trim
NEECEEO	130	Everwall, Cutable End Elbow
NEECEI	126	Everwall, 90° Cutable End Inner Channel
NEECEO	127	Everwall, 90° Cutable End Outer Channel
NEEESB	81	Everwall, EE Strg Brckt
NEEESBO	81	Everwall, EE Org and Open Shelf Brkt
NEFC	77	Everwall, Frame Coupler
NEFCS	82	Everwall, French Cleat Support
NEFEA	121	Everwall, Finished End
NEFG	79	Everwall, Floor Guide
NEFK	96	Everwall, Frame Kit
NEFWRBL	83	Flex Wall Rail Bracket, Landscape
NEFWRBP	82	Flex Wall Rail Bracket, Portrait
NEGK	97	Everwall, Glass Kit
NEGTC	97	Everwall, Glazing Tape – Clear
NEIA	121	Everwall, 90° T/X Adapter
NEMH	80	Everwall, Monitor Support Horizontal
NEP2	119	Everwall, Post
NEP3	119	Everwall, Post
NEP4	120	Everwall, Post
NEPB	137	Everwall, Power Block
NEPFC	136	Everwall, Modular Communication Faceplate
NEPHN8	138	Everwall, Modular Harness
NEPHNC	139	Everwall, Harness-to-Harness Branching Conn
NEPIMP8	137	Everwall, Multipurpose Infeed
NEPMBESH	140	Everwall, Electrical Mounting Bracket
NEPMBESM	140	Everwall, Electrical Mounting Bracket

Style Number	Page	Description
NEPMBEU	140	Everwall, Electrical Mounting Bracket
NEPRC	134	Everwall, Receptacle
NEPRCUSB	135	Everwall, USB Receptacle
NEPRT	135	Everwall, Power Receptacle Trim
NERBKVOFM	82	Everwall, Univ Vertical Off Mod Brkt
NESC	89	Everwall, Solid Ceramic Skin - Markerboard
NESESTK	109	Everwall, Electric Strike
NEFC	95	Everwall, Structural Frame - Clerestory
NEFS	76	Everwall, Structural Frame
NESIA	91	Everwall, Acoustic Insulation
NESLDHDS	115	Everwall, Slider Door Hardware-Drop Seal
NESLSH	114	Everwall, Drop Seal Housing
NESSB	90	Everwall, Solid Skin Bracket
NESSC	90	Everwall, Solid Skin Latch
NESSF	86	Everwall, Solid Skin
NESSFIC90	133	Everwall, Flush Skin Seal, Inside Corner, 90°
NESSFL	133	Everwall, Flush Skin Seal
NESSFSV2	87	Everwall, Solid Steel Skin
NESSL	84	Everwall, Solid Skin
NESSLM	85	Everwall, Solid Skin - Laminate Markerboard
NESSPSV2	88	Everwall, Solid Steel Skin
NESSS	90	Everwall, Solid Skin Screw
NESWDHBH	106	Everwall, Butt Hinge
NESWDHCLSR	107	Everwall, Door Closer
NESWDHELECHNG	107	Everwall, Electric Hinge
NESWDHRL	108	Everwall, Roller Latch
NESWDHSH	106	Everwall, Drop Seal Assembly
NESWDSA	108	Everwall, Slimline Assembly
NEUGP	92	Everwall, Unitized Glass Panel
NEUP	122	Everwall, Utility Panel, Frame
NEUPC	123	Everwall, Utility Panel, Cover
NEUSB	81	Everwall, Universal Storage Bracket
NEWS	132	Everwall, Wall Start

Trademark List

™/® The following is a non-exhaustive list of trademarks and registered trademarks for products of Steelcase Inc. or one of its related corporate entities: Agree, Airtouch, Aisla, Alight, Amia, Answer, Apprise, Aspekt, Avenir, Await, B-Free, Ballet, Bassline, Bindu, Bivi, Bix, Bottomline, Brody, Buoy, Cachet, Campfire, Capa, CF Series, CG_1, Chord, Circa, Clipper, Cobi, Collaboration, Convene, Coupe, Cura, Currency, dash, Divisio, Duo, E-Table 2, Edge Series, Elbrook, Elective Elements, Embold, Empath, Everwall, Exponents, Folio, FrameOne, Gesture, Groupwork, Host, Hosu, i2i, Jenny, Kart, Kathryn, Kick, Lagunitas, Leap, Leela, LessThanFive, LiveBack, LiveSeat, Mackinac, Marien152, Max-Stacker, media:scape, Migration, Millbrae, Mineral, Mitra, Montage, Montara650, MoreThanFive, Move, Node, Ocular, Ology, Opus, Paperflo, Passerelle, Player, Pocket, Potrero415, QiVi, Radia, Regard, Relay, Reply, Ripple, Roam, Sarto, Scoop, Sebastopol, Senti Series, Senza, Shortcut, Sidewalk, Siento, Sieste, SILQ, Soffio, Sorrel, SOTO, Steelcase Eclipse, Steelcase Flex, Steelcase Karman, Steelcase Relay, Steelcase Rise, Steelcase Series, Surround, SW_1, Switch, Sync, Tava, Tenor, Think, Thoughtful, Thread, Together, Train, Trees, Turnstone, Umami, Underscore, V.I.A., Verb, Verge, Verlay, Victor2, Visalia, WorkValet, and X-tenz.

™/® The following are trademarks or registered trademarks of AMQ Solutions, LLC: 3F, Activ, Amobi, Bixby, Bodi, Cluvo, Concur, Embank, FL-X, Iline, Jaku, Kinex, Personality Plus, Revi, S-Series, Siya, Tektis, Tizu, Uptake, and Zilo.

™/® The following are trademarks or registered trademarks of Orangebox Ltd., Cardiff, UK: Air3, Aspect, Avi, Away from the Desk, Border, Campers & Dens, Coppice, Cubb, Kirm, On the QT, Ramsey, Skomer, Sully, Track-B, and Vale.

™/® The following are trademarks or registered trademarks of Viccarbe Habitat, S.L.: Aleta, Cambio, Designed in The Sun, Foro, Funda, Holy Day, Kelly, Last Minute, Noha, Savina, Sistema, Sistema, Viable, and Wrapp.

® The following are registered brands of Steelcase Inc. and its family of companies: Steelcase, AMQ, Coalesse, Designtex, Halcon, Orangebox, Smith System, and Viccarbe.

® The following registered trademarks are under license from AWI Licensing Company, Dover, DE: SoundScapes, DuraBrite, BioBlock, and Armstrong.

® The following registered trademarks are under license from Byrne Electrical, Rockford, MI: Interport, Mini-Port, Axil Z, and Ellora.

® The following is a registered trademark of DuPont, Wilmington, DE: Corian.

® The following is a registered trademark of Genlyte Thomas Company, Louisville, KY: Lightolier.

® The following is a registered trademark of Hilti Corporation, FL-9494 Schaan, Principality of Liechtenstein: Hilti.

® The following is a registered trademark of Leviton Manufacturing Company, Little Neck, NY: Decora.

® The following is a registered trademark of Mechanical Plastics Corp, Elmsford, NY: Toggler.

® The following is a registered trademark of Microsoft Corporation, Redmond, WA: Microsoft.

® The following are registered trademarks of Orangebox Ltd., Cardiff, UK: Orangebox.

® The following is a registered trademark of Panduit Corporation, Lockport, IL: Panduit.

® The following is a registered trademark of Trav (Press), Cuneo, Italy: Assisa.

® The following is a registered trademark of Virtual Ink, Boston, MA: mimioActive.

® The following registered trademarks are under license from Wilkhahn Furniture Products: Avera, Senzo, Versal, and Wilkhahn FS.

® The following are registered trademarks of Polyvision Corp: Flow, Motif, Polyvision, Sans, and Serif.

® The following is a registered trademark of Wilsonart International, Temple, TX: Chemsurf.

® The following is a registered trademark of Wiremold, West Hartford, CT: Wiremold.

® The following is a registered trademark of EMU Group S.P.A., Perugia, Italy: EMU.

® The following is a registered trademark of Security People, Inc.: Digilock.

® The following are registered trademarks of Natural Capital Partners Europe Limited: CarbonNeutral and the CarbonNeutral Certified logo.

™ The following is a trademark of Microsoft Corporation, Redmond, WA: Windows.

™ The following is a trademark of Rodman Industries, Inc., Oconomowoc, WI: ResinCore1.

™ The following is a trademark of Ultrafabrics, LLC, Elmsford, NY: Ultraleather.

™ The following trademarks are under license from Wilkhahn Furniture products: Cana, Linus, Logon, Picto, Range, Stitz, Thema, Timetable, and Tubis.

™ The following trademarks are under license from Walter Knoll: Andoo, Bob, Lazlo, Lox, Ribbon, and Together.

™ The following trademarks are under license from PP Mobler: Bar and Flag Halyard.

™ The following trademarks are under license from Carl Hansen: Elbow, Paddle, Shell, Wing, and Wishbone.

™ The following trademarks are under license from Cambridge Sound Management, LLC Cambridge, MA: QtPro Soundmasking, Qt Quiet Technology, and Sonet Qt.

™ The following is a trademark of Electri-Cable Assemblies, Shelton, CT: Interact.

™ The following is a trademark of Clestra Hauserman: IRYS.

™ The following is a trademark of Wiesner-Hager Möbel GmbH: Nooi.

™ The following are trademarks of Polyvision: Accord, a3, e3, Boundri, and Nota.

™ The following is a trademark of Bostock Company, Inc: SnapCab.

™ The following is a trademark of Williams-Sonoma, Inc: West Elm.

™ The following is a trademark of Elena Marquina Testor: nanimarquina.

™ The following is a trademark of Forbo International SA: Forbo.

Trademarks used herein are the property of Steelcase Inc. or their respective owners.