

---

# Coalesse Seating Specification Guide

## Availability

Electronic price list updated with release 204.C (U.S.) and 158.C (Canada), dated June 15, 2026.

All specifications subject to change without notice. Reference the electronic catalog/Hedberg for current pricing.

Transitional products in this specification guide are **maintained for existing customers only** and are likely to be phased out over time. These products are indicated with a **T**. Products that are scheduled to be culled are indicated with an **X**, followed by the last order entry date.

► For a list of all trademarks, refer to the last page of this specification guide. © 2026 Steelcase Inc.

## General Information

Ordering and Warranty	2
Sustainability	4
Collections	5

## Statement of Line

6

## Lounge Seating

27

## Collaboration Seating

289

## Guest Seating

317

## Stools

363

## Resources

409



### For Canadian Pricing

Canadian factor can be found at [steelcase.com/CADpricing](https://steelcase.com/CADpricing).

Calculate in the following order to avoid rounding errors:

- Multiply the base price and each option by the Canadian factor.
- Round each to the nearest dollar.
- Add base and options for total list price.

# Ordering and Warranty

## How to Order

Coalesse furniture is available through authorized dealers and retailers. Select products are available for order from our web site. The authorized dealer can help you with everything from surface material selection and order placement, to specialized services, such as space planning and design, delivery and installation. Best of all, they are part of your local community, providing expert advice with a thorough understanding of local needs. For more information and a listing of dealers and retailers, visit [www.coalesse.com](http://www.coalesse.com) or call 1.800.627.6770.

Coalesse reserves the right to limit distribution of any or all models.

MAIN TELEPHONE  
866.645.6952

CUSTOMER SERVICE  
1.800.627.6770

## Credit, Prices, and Terms

Credit may be established upon acceptance of satisfactory references. For payment terms, contact Coalesse's Credit Department. Coalesse may cancel or change credit terms at its discretion and may request advance payment at any time.

The order confirmation will be deemed by the customer and by Coalesse, as the final expression of agreement and will be deemed the exclusive statement of terms. The order confirmation supersedes all prior writings and may not be modified or rescinded, except by a revised Coalesse order confirmation signed by the customer. No changes are binding on Coalesse until delivery of the order confirmation. Any storage charges and applicable sales taxes are in addition to the prices shown for merchandise. Inside delivery, uncartoning and installation are customer's responsibility unless separately quoted. All list pricing shown includes freight prepaid to one destination for delivery in the 48 contiguous United States. Hawaii and Alaska are not included. We reserve the right to increase prices without notice due to increases in labor and material costs. If timely payment is not made, customer is liable for reasonable collection costs, including attorney's fees.

## Shipping and Storage

Coalesse reserves the right to select carrier and packaging method. Partial shipments may be delivered. Coalesse is not liable for delays or delivery failure due to strikes, lockouts, labor, or transportation difficulties, failure or delay of supply sources, accidents, fire, acts of God, or any other cause of like or unlike nature beyond Coalesse's control. Coalesse may transfer merchandise to storage if not accepted when shipment scheduled. Transfer and storage charges will be the customer's expense. Coalesse's invoice is payable upon transfer. If transfer is made prior to confirmed shipping date, storage expenses will be borne by customer.

Shipping charges MAY be calculated per order. Lead times vary by product. Coalesse reserves the right to select carrier. Partial shipments may be delivered. Coalesse will make every effort to provide current and accurate lead time information, however, Coalesse is not liable for delays or delivery failure due to strikes, lockouts, labor, or transportation difficulties, failure or delay of supply sources, accidents, fire, acts of God, or any other cause of like or unlike nature beyond Coalesse's control.

Freight is included on domestically manufactured products within the 48 contiguous states of the United States.

## Claims

Merchandise shipped from Coalesse is thoroughly inspected and properly packed before leaving the factory. Responsibility of its safe delivery is assumed by the carrier at the time of shipment. Customer must match the freight delivered with the bill of lading. Customer must examine packaging material upon delivery and note any damage on the carrier bill of lading. If there is damage to the packaging material, inspect the furniture immediately. If concealed damage is found, contact the carrier within 10 days of delivery date. Save all packaging materials until after inspection.

Freight damage and claims must be reported by the purchaser to the carrier. Coalesse is not responsible for freight claims. Claims for loss or damage must not be deducted from our invoice, nor payment withheld awaiting adjustment of such claims. Do not return any merchandise to Coalesse without a Return Authorization number. By following these procedures carefully, Coalesse guarantees our full support of your claims to protect you against loss or damages. All claims against Coalesse for errors or shortages must be made by customer in writing within fifteen (15) days after delivery. Failure to make claims within fifteen (15) days constitutes acceptance of merchandise and waives claims. Cutting of textiles deems acceptance of yardage and waives all defects, errors, and shortages. Coalesse is not liable for subsequent damages.

## Special/Custom Products

Coalesse prides itself on being responsive to our customer's needs. Contact our Customer Service team at 1.800.627.6770 to discuss a special opportunity. Due to product modifications and engineering time, special orders may not be cancelled. Charges will apply.

FOR MORE INFORMATION (on ordering our products) Please contact Coalesse Customer Service at: 1.800.627.6770.

# Ordering and Warranty

## Order Cancellations/Changes

All order change/cancellation requests must be submitted using the Coalesse order change/cancellation request form. Late changes could jeopardize the committed delivery of an order.

Coalesse Rapid10 programs no change or cancellations allowed.

### Coalesse Products:

- No charges will be assessed for change or cancellation 14 or more calendar days prior to the manufacturing completion date (excludes holidays and/or large quantity project size orders). For import products, charges may apply.
- No manufacturing changes are allowed 0-13 calendar days prior to the manufacturing completion date. Simple changes including shipping address changes are subject to approval but will be accommodated when possible.
- No cancellations or product changes will be accepted for express or special/custom product orders including special laminates. A cancellation fee will be applicable for any custom product and/or change may jeopardize lead time.
- If COM/COL has been received at time of change or cancellation, it is the dealer's responsibility to advise disposition or return of materials. Coalesse will not store materials after 30 days.

## Additional Charges

• Changes or cancellations that involve any of the following may be subject to a charge earlier and/or greater than shown above: Special engineering product, CSM, pre-ordered components, materials with extended lead times (e.g., veneers, special paint, etc.) or large quantities of standard materials.

- Use our Order Change/Cancellation Request Form for all order changes. It is Coalesse responsibility to accurately process change order requests. It is the dealer's responsibility to verify that we have accurately interpreted your change requests by checking the acknowledgment after the change has been made. If you do not use the web-based change order form process and an error occurs during our translation which cannot be corrected prior to ship, all costs will be shared on a 50/50 basis. Changing ship dates or adding product to your order is subject to the availability of manufacturing capacity.
- Cartoning changes and shipping address changes are subject to approval and to a change charge. Please consult your Customer Service for specific information pertaining to your order.

## Reserved Fabric Policy

Prior to order receipt, reserving textiles (COM/COL, Maharam, Designtex, and select Luna Select Surfaces) is the responsibility of the dealer. Coalesse cannot reserve textiles based on projected orders. Coalesse cannot guarantee Maharam or Designtex fabric availability. If dealer reserves Maharam or Designtex textiles, Coalesse will require the reserve number and zip code for locating purposes when ordering.

## Schedule Enhancements

Coalesse will entertain schedule enhancements on a case-by-case basis; however, please understand that we must receive complete information such as installation date, opening date in order to make informed scheduling decisions. No order move-ups or move-outs are allowed on any order that falls within the 15-working day period of its manufacturing completion date. If it is within the 15-working day period, Coalesse will invoice at shipment but may offer storage options at a charge for manufactured product.

## Express Program Specification Guide

This specification guide describes all Steelcase and Coalesse products including the finishes and options that are available as Express orders - manufactured and shipped within 7 business days.

## Warranty

For warranty information, please go to <http://www.coalesse.com/warranty/>.

# Sustainability

## Sustainability

At Steelcase, we believe business can be a force for good. We create long-lasting products that are better for people and better for the planet. Our products and operations use life cycle thinking to meet our commitment to reducing climate change. This commitment is reinforced by practices such as designing to minimize global warming and other life cycle impacts, ensuring material health, and enabling end-of-use strategies.

To learn more at a corporate level, visit: <https://www.steelcase.com/discover/steelcase/esg-overview/environmental/>

Product Environmental Profiles, which provide key environmental attributes such as recycled content, embodied carbon and recyclability, as well as product certifications can be found by searching for Steelcase at *Origin.build*.

# Collections

## Await Collection

- Occasional Tables ▶ See *Coalesse Tables, Storage, and Accessories Specification Guide*
- Lounge Seating ▶ See *Coalesse Seating Specification Guide*

## Bob Collection

- Collaborative and Conference Tables ▶ See *Coalesse Tables, Storage, and Accessories Specification Guide*
- Occasional Tables ▶ See *Coalesse Tables, Storage, and Accessories Specification Guide*
- Lounge Seating ▶ See *Coalesse Seating Specification Guide*
- Guest Seating ▶ See *Coalesse Seating Specification Guide*

## Circa Collection

- Occasional Tables ▶ See *Coalesse Seating Specification Guide*
- Lounge Seating ▶ See *Coalesse Seating Specification Guide*

## Enea Collection

- Guest Seating ▶ See *Coalesse Seating Specification Guide*
- Stools ▶ See *Coalesse Seating Specification Guide*

## Enea Lottus Collection

- Stools ▶ See *Coalesse Seating Specification Guide*

## Exponents Collection

- Storage ▶ See *Coalesse Tables, Storage, and Accessories Specification Guide*
- Accessories ▶ See *Coalesse Tables, Storage, and Accessories Specification Guide*
  - Lectern
  - Mobile Display Boards

## Host Collection

- Collaborative and Conference Tables ▶ See *Coalesse Tables, Storage, and Accessories Specification Guide*
- Storage ▶ See *Coalesse Tables, Storage, and Accessories Specification Guide*

## Lagunitas Collection

- Collaborative and Conference Tables ▶ See *Coalesse Tables, Storage, and Accessories Specification Guide*
- Occasional Tables ▶ See *Coalesse Tables, Storage, and Accessories Specification Guide*
- Lounge Seating ▶ See *Coalesse Seating Specification Guide*

## Massaud Collection

- Lounge Seating ▶ See *Coalesse Seating Specification Guide*
- Collaboration Seating ▶ See *Coalesse Seating Specification Guide*

## Millbrae Collection

- Occasional Tables ▶ See *Coalesse Tables, Storage, and Accessories Specification Guide*
- Lounge Seating ▶ See *Coalesse Seating Specification Guide*

## Montara650 Collection

- Café Tables ▶ See *Coalesse Tables, Storage, and Accessories Specification Guide*
- Occasional Tables ▶ See *Coalesse Tables, Storage, and Accessories Specification Guide*
- Guest Seating ▶ See *Coalesse Seating Specification Guide*
- Lounge Seating ▶ See *Coalesse Seating Specification Guide*
- Stools ▶ See *Coalesse Seating Specification Guide*

## Passerelle Collection

- Occasional Tables ▶ See *Coalesse Tables, Storage, and Accessories Specification Guide*
- Lounge Seating ▶ See *Coalesse Seating Specification Guide*

## Sidewalk Collection

- Lounge Seating ▶ See *Coalesse Seating Specification Guide*
- Collaboration Seating ▶ See *Coalesse Seating Specification Guide*

## Switch Collection

- Occasional Tables ▶ See *Coalesse Tables, Storage, and Accessories Specification Guide*
- Lounge Seating ▶ See *Coalesse Seating Specification Guide*
- Guest Seating ▶ See *Coalesse Seating Specification Guide*
- Stools ▶ See *Coalesse Seating Specification Guide*

## SW\_1 Collection

- Collaborative and Conference Tables ▶ See *Coalesse Tables, Storage, and Accessories Specification Guide*
- Occasional Tables ▶ See *Coalesse Tables, Storage, and Accessories Specification Guide*
- Lounge Seating ▶ See *Coalesse Seating Specification Guide*
- Collaboration Seating ▶ See *Coalesse Seating Specification Guide*

# Statement of Line

## Lounge Seating

### Await Lounge System

Understanding  
▶ Page 28  
Specifying  
▶ Page 30

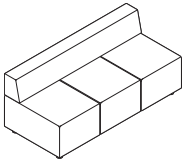

3-Seat Lounge

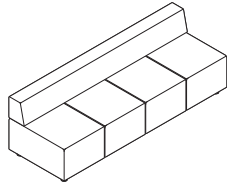

4-Seat Lounge

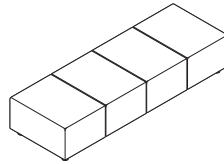

4-Seat Bench



Mobile Ottoman

### Await Lounge System Connector Benches and Tables

Understanding  
▶ Page 28  
Specifying  
▶ Pages 32 and 33

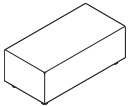

1-Section Connector Bench

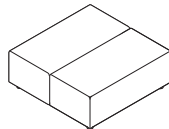

2-Section Connector Bench

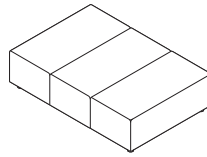

3-Section Connector Bench

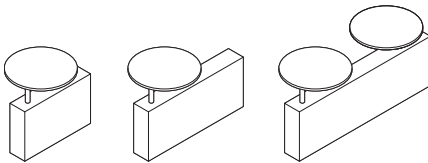

Connector Tables

### Bob Lounge Chairs

Understanding  
▶ Page 36  
Specifying  
▶ Page 38



Lounge Chair



Lounge Chair with Headrest

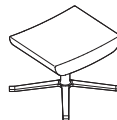

Ottoman

# Statement of Line

Lounge Seating, continued

## Circa Lounge System

Understanding  
 ▶ Page 42  
 Specifying  
 ▶ Page 48

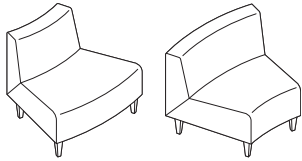

30° Outside/Inside Facing Wedge  
 1-Seat Lounge

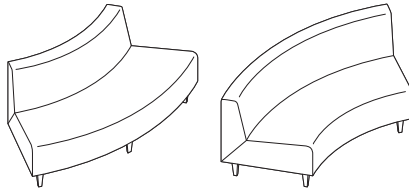

60° Wedge 2-Seat Lounge

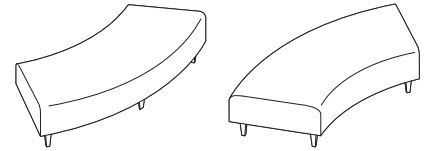

Wedge Bench

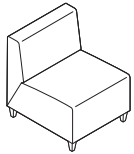

Straight 1-Seat  
 Lounge

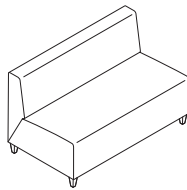

Straight 2-Seat  
 Lounge

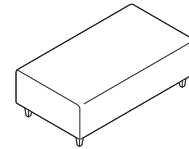

Straight Bench

## Circa Lounge System Upholstered Modular Arm Rests and Ottoman

Understanding  
 ▶ Page 42  
 Specifying  
 ▶ Page 52



Straight Armrest  
 Intermediate without  
 Legs



Straight Armrest  
 End-of-Run with Two Legs



15° Inside Armrest  
 Intermediate without Legs



15° Inside Armrest  
 End-of-Run with Two Legs



15° Outside Armrest  
 Intermediate without Legs



15° Outside Armrest  
 End-of-Run with Two Legs

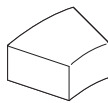

30° Inside Armrest  
 Intermediate without Legs

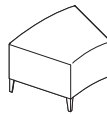

30° Inside Armrest  
 End-of-Run with Two Legs

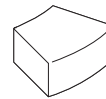

30° Outside Armrest  
 Intermediate without Legs

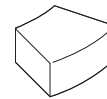

30° Outside Armrest  
 End-of-Run with Two Legs

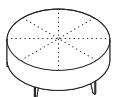

Round Ottoman

# Statement of Line *continued*

## Lounge Seating, continued

### Circa Lounge System Ganging and Occasional Tables

Understanding  
▶ Page 42  
Specifying  
▶ Page 56

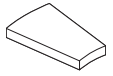

15° Low Wedge Table, Ganging

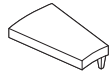

15° Low Wedge Table, End-of-Run, Two Legs

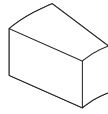

15° High Wedge Table, Ganging

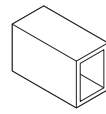

Straight High Table, Ganging

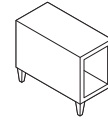

Straight High Table, End-of-Run, Two Legs

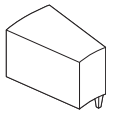

15° High Wedge Table, End-of-Run, Two Legs

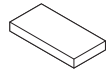

Straight Low Table, Ganging

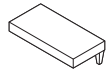

Straight Low Table, End-of-Run, Two Legs

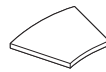

30° Low Wedge Table, Ganging



30° Low Wedge Table, End-of-Run, Two Legs



30° End-of-Run with One Leg

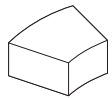

30° High Wedge Table, Ganging

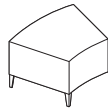

30° High Wedge Table, End-of-Run, Two Legs

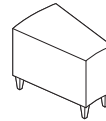

High Wedge

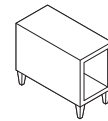

High Straight

### Circa Lounge System Freestanding Round Table

Understanding  
▶ Page 42  
Specifying  
▶ Page 59

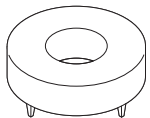

Round

# Statement of Line

Lounge Seating, continued

## Coalesse Ensemble Standalone Lounge *(feet included; armrest(s) available as an option)*

Understanding  
 ▶ Page 62  
 Specifying  
 ▶ Page 76

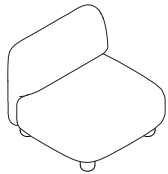

1-Seat Fixed Lounge

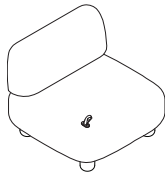

1-Seat Performance Lounge

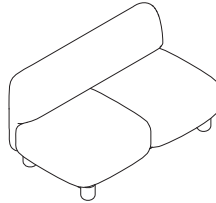

2-Seat Lounge

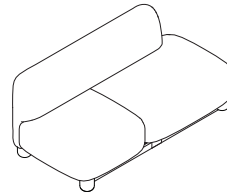

2-Seat Chaise

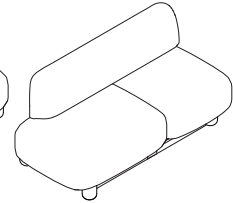

## Coalesse Ensemble Modular Lounge System *(feet specified separately)*

Understanding  
 ▶ Page 62  
 Specifying  
 ▶ Pages 80–89

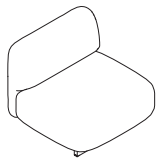

1-Seat Fixed Lounge

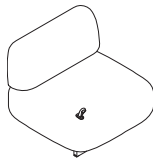

1-Seat Performance Lounge

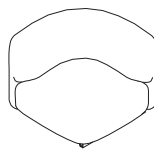

1-Seat Corner Lounge

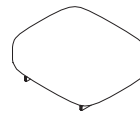

Backless Bench

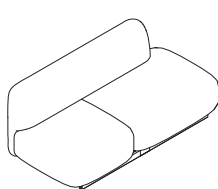

2-Seat Chaise

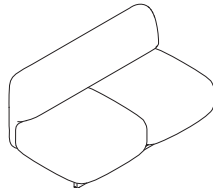
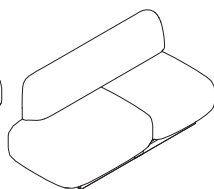

2-Seat Lounge

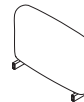

End Armrest



End Feet



Middle Feet

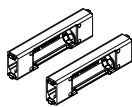

Connector Kit

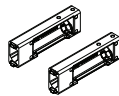

Armrest End Connector

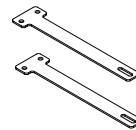

Corner Ganging Kit



Lounge Power Module



In-Line Rectangular Table

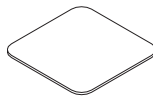

In-Line Square Table

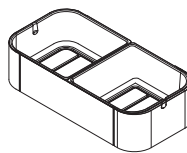

Planter

# Statement of Line *continued*

## Lounge Seating, continued

### Coalesse Ensemble Freestanding Screens

Understanding  
▶ Page 68  
Specifying  
▶ Page 90

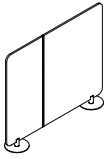

Low Straight Screen

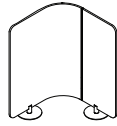

Low Corner Screen

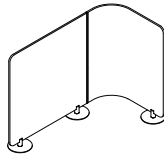

Low J Screen—Left

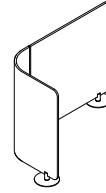

Low J Screen—Right

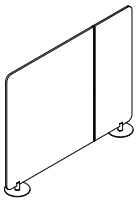

Medium Straight Screen

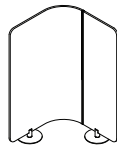

Medium Corner Screen

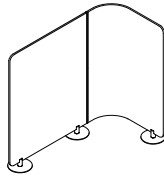

Medium J Screen—Left

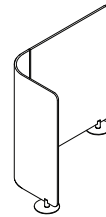

Medium J Screen —Right

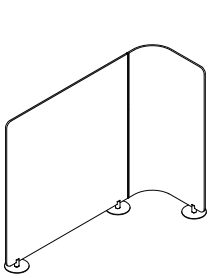

High J Screen—Left

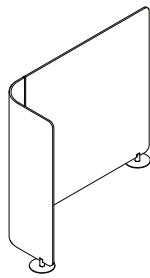

High J Screen—Right



Nesting Base



Standalone Base

### Coupe Lounge System

Understanding  
▶ Page 94  
Specifying  
▶ Page 95

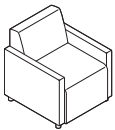

Lounge Chair

### Coupe Grande/Mobile Lounge Seating

Understanding  
▶ Page 94  
Specifying  
▶ Page 96

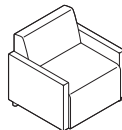

Grande Lounge Chair

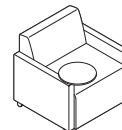

Grande Mobile Lounge Chair

# Statement of Line

## Lounge Seating, continued

### Davos Lounge Seating

Understanding  
▶ Page 97  
Specifying  
▶ Page 98

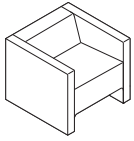

Lounge Chair

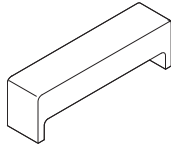

Large Bench

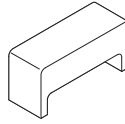

Medium Bench



Small Bench

### Hosu Lounge Seating

Understanding  
▶ Page 101  
Specifying  
▶ Page 102

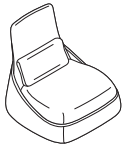

Lounge Chair with Lumbar Pillow

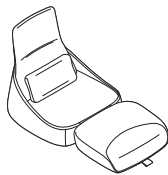

Lounge Chair with Ottoman and Lumbar Pillow

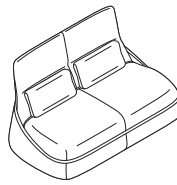

2-Seat Lounge with Two Lumbar Pillows

### Jean Nouvel Seating Collection

Understanding  
▶ Page 106  
Specifying  
▶ Page 108

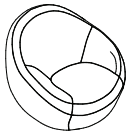

Lounge



Ottoman

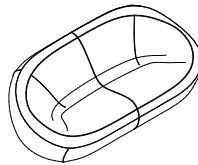

Sofa

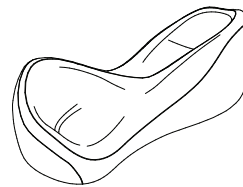

Tête-à-tête

### Joel Lounge Chair

Understanding  
▶ Page 110  
Specifying  
▶ Page 111



# Statement of Line *continued*

## Lounge Seating, continued

### Lagunitas Lounge System

Understanding  
▶ Page 114  
Specifying  
▶ Pages 134–163

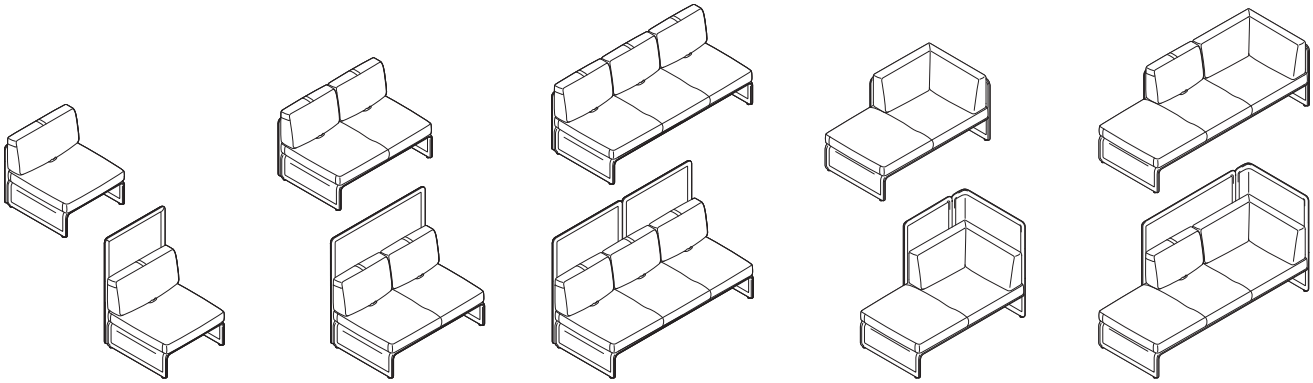

1-Seat Lounges

2-Seat Lounges

3-Seat Lounges

2-Seat Chaises

3-Seat Chaises

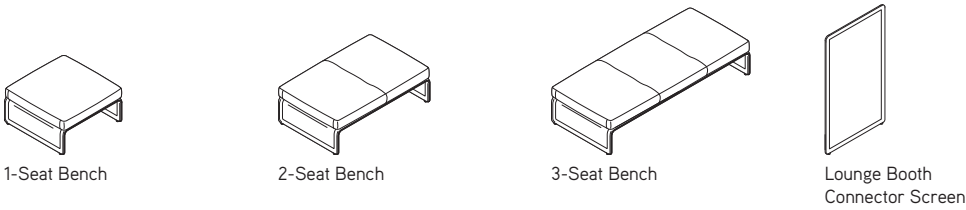

1-Seat Bench

2-Seat Bench

3-Seat Bench

Lounge Booth  
Connector Screen

### Lagunitas Focus Nook

Understanding  
▶ Page 164  
Specifying  
▶ Page 166

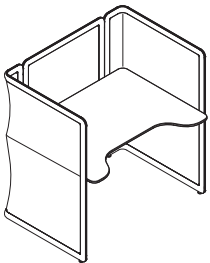

### LessThanFive Lounge

Understanding  
▶ Page 168  
Specifying  
▶ Page 169

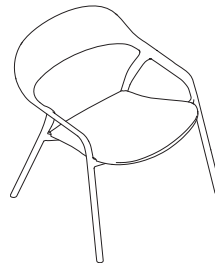

# Statement of Line

## Lounge Seating, continued

### Marien152 Lounge Seating

- Understanding
- ▶ Page 170
- Specifying
- ▶ Page 172

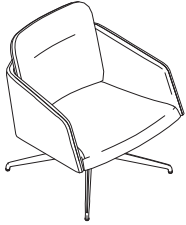

Metal Base Lounge

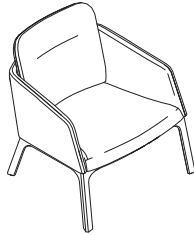

Wood Base Lounge

### Massaud Lounge Seating

- Understanding
- ▶ Page 176
- Specifying
- ▶ Page 178



Lounge



Work Lounge



Ottoman

### Medici Lounge Chair

- Understanding
- ▶ Page 181
- Specifying
- ▶ Page 182

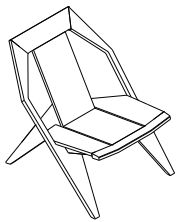

### Millbrae Lifestyle Lounge Seating

- Understanding
- ▶ Page 184
- Specifying
- ▶ Page 188

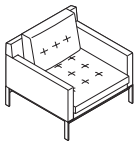

Lounge

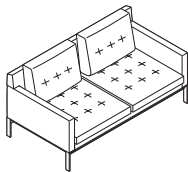

2-Seat Lounge

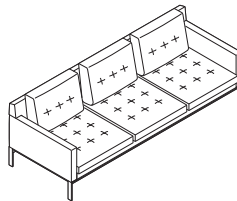

3-Seat Lounge



Round Arm Bolster



Square Arm Bolster

## Lounge Seating, continued

### Millbrae Contract Lounge Seating

Understanding  
▶ Page 186  
Specifying  
▶ Page 188

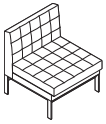

Lounge  
without Arms

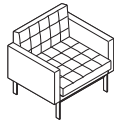

Lounge  
with Arms

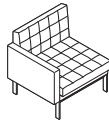

Lounge  
with Left Arm Facing

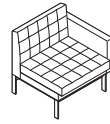

Lounge  
with Right Arm Facing

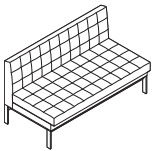

2-Seat Lounge  
without Arms

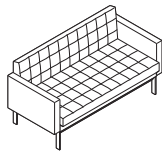

2-Seat Lounge with  
Arms

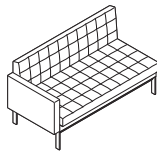

2-Seat Lounge  
with Left Arm Facing

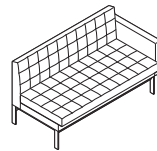

2-Seat Lounge  
with Right Arm Facing

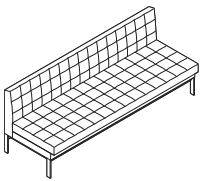

3-Seat Lounge  
without Arms

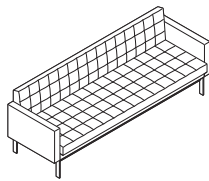

3-Seat Lounge  
with Arms

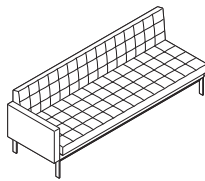

3-Seat Lounge  
with Left Arm Facing

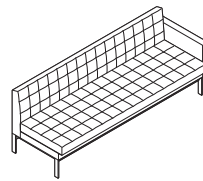

3-Seat Lounge  
with Right Arm Facing

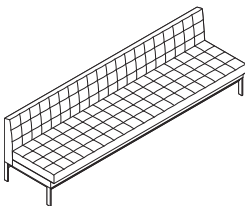

4-Seat Lounge  
without Arms

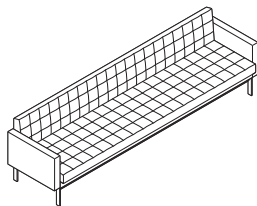

4-Seat Lounge  
with Arms

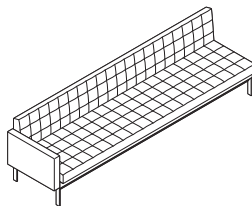

4-Seat Lounge  
with Left Arm Facing

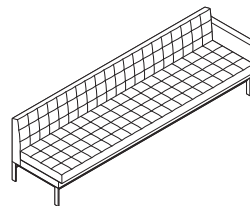

4-Seat Lounge  
with Right Arm Facing

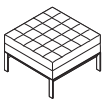

1-Seat  
Bench

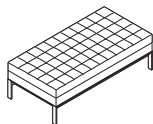

2-Seat Bench

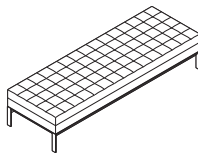

3-Seat Bench

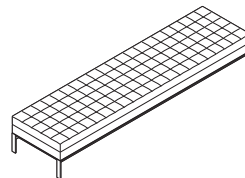

4-Seat Bench

# Statement of Line

## Lounge Seating, continued

### Montara650 Lounge Chair

- Understanding
  - ▶ Page 198
  - Specifying
    - ▶ Page 200



Wood Shell with Upholstered Seat,  
Wood Shell with ¾ Upholstery,  
and Fully Upholstered

### Montara650 Rocker

- Understanding
  - ▶ Page 202
  - Specifying
    - ▶ Page 204



Wood Shell with Upholstered Seat,  
Wood Shell with ¾ Upholstery,  
and Fully Upholstered

## Passerelle Lounge Seating

- Understanding
  - ▶ Page 208
  - Specifying
    - ▶ Pages 210–212

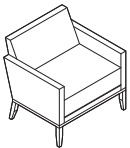

Lounge Chair

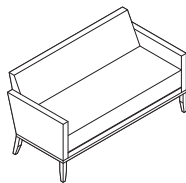

2-Seat Lounge

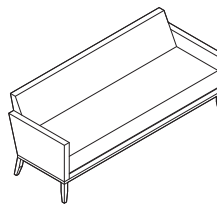

3-Seat Lounge



Arm Bolster

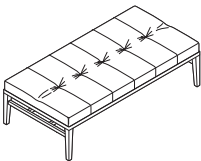

Benches

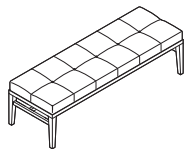

## Ripple Benches

- Understanding
  - ▶ Page 214
  - Specifying
    - ▶ Page 216

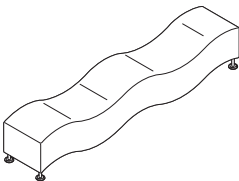

Upholstered  
Wave Seat

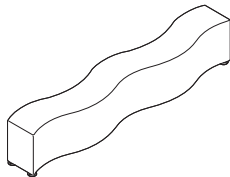

Upholstered  
Flat Seat

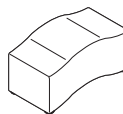

Little Ripple  
Wave Seat

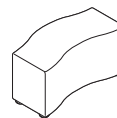

Little Ripple  
Flat Seat

# Statement of Line *continued*

## Lounge Seating, continued

### Sidewalk Lounge Seating

Understanding  
▶ Page 220  
Specifying  
▶ Page 222

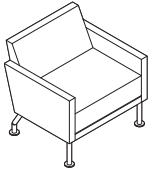

Low-Back Lounge Chair

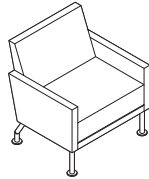

High-Back Lounge Chair

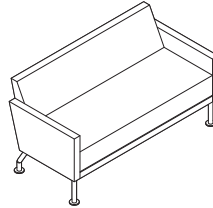

2-Seat Lounge

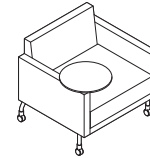

Mobile Low-Back Lounge Chair with Tablet

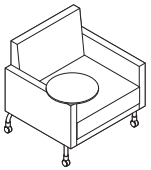

Mobile High-Back Lounge Chair with Tablet



Arm Bolster

### Sidewalk Collaborative Lounge Seating

Understanding  
▶ Page 226  
Specifying  
▶ Page 227

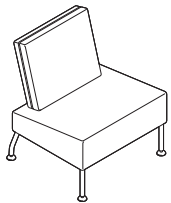

Lounge Chair

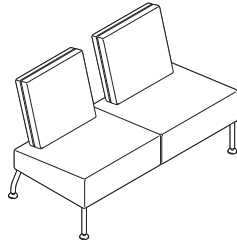

2-Seat Lounge

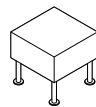

Ottoman

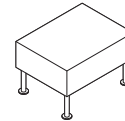
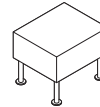

### Sidewalk Lounge Seating Ottoman/Benches

Understanding  
▶ Page 226  
Specifying  
▶ Page 228

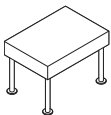

Bench

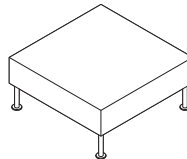
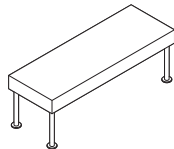
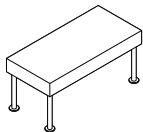

Ottoman

# Statement of Line

## Lounge Seating, continued

### Sistema Lounge System, Leg Base

Understanding  
▶ Pages 230-232  
Specifying  
▶ Pages 236-242

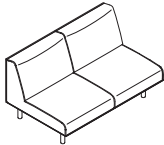

2-Seat Lounge

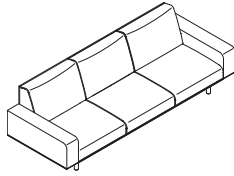

3-Seat Lounge



End Legs



Connector Frame With Legs

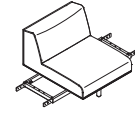

1-Seat Connector Lounge

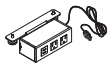

Power Module

*Tip: Legs are not included with 2- and 3-seat lounges and must be ordered separately.*

### Sistema Lounge System, Fully Upholstered Base

Understanding  
▶ Page 234  
Specifying  
▶ Page 244

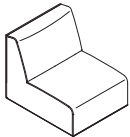

Lounge Chair, Armless

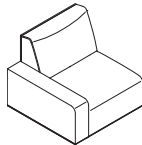

Lounge Chair, Right Arm

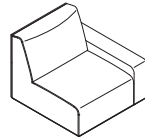

Lounge Chair, Left Arm

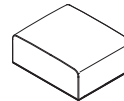

Backless Bench Lounge

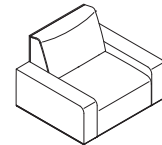

Lounge Chair, With Arms

### Sistema Lounge System Accessories

Understanding  
▶ Page 235  
Specifying  
▶ Pages 248-251



Round Ottoman

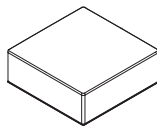

Square Ottoman



Arm Bolster, Moveable



Moveable Table



Square Pillow



Lumbar Pillow

# Statement of Line *continued*

## Lounge Seating, continued

### SW\_1 Lounge Seating

Understanding  
▶ Page 254  
Specifying  
▶ Page 256



Low-Back Collaborative Lounge Chair



High-Back Collaborative Lounge Chair



Ottoman

### Switch Lounge Seating

Understanding  
▶ Page 260  
Specifying  
▶ Page 262

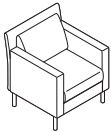

Lounge Chair

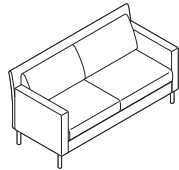

2-Seat Lounge

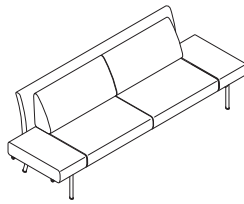

2-Seat Lounge with Extensions

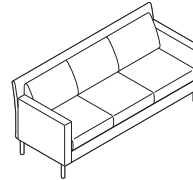

3-Seat Lounge



Arm Bolster

### Thoughtful Lounge Seating

Understanding  
▶ Page 266  
Specifying  
▶ Page 268

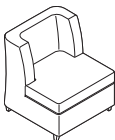

Lounge Chair

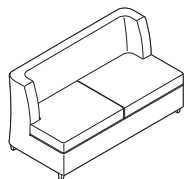

Small Lounge

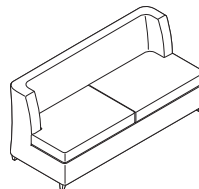

Medium Lounge

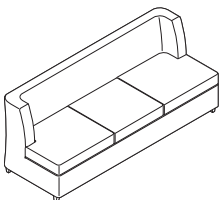

Long Lounge

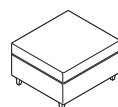

Ottoman

# Statement of Line

## Lounge Seating, continued

### Together Benches

Understanding  
▶ Page 272  
Specifying  
▶ Page 274

70½"D 96¼"W 31"H

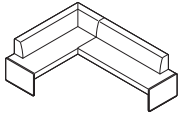

Left Corner with Back 8" Offset

97¼"D 96¼"W 31"H

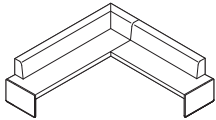

70½"D 123"W 31"H

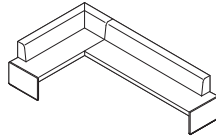

97¼"D 123"W 31"H

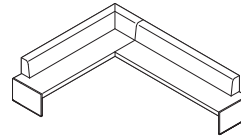

70½"D 96¼"W 31"H

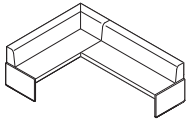

Left Corner with Back 1½" Offset

97¼"D 96¼"W 31"H

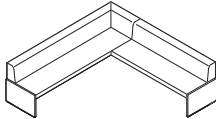

70½"D 123"W 31"H

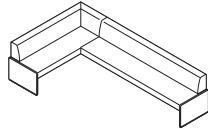

97¼"D 123"W 31"H

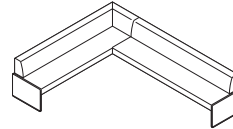

70½"D 96¼"W 31"H

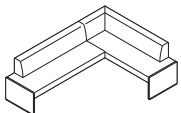

Right Corner with Back 8" Offset

97¼"D 96¼"W 31"H

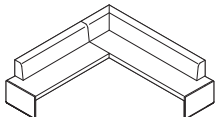

70½"D 123"W 31"H

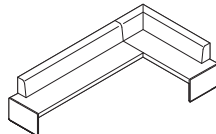

97¼"D 123"W 31"H

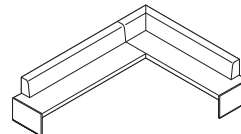

70½"D 96¼"W 31"H

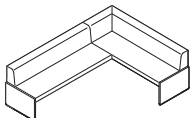

Right Corner with Back 1.5" Offset

97¼"D 96¼"W 31"H

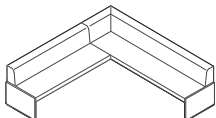

70½"D 123"W 31"H

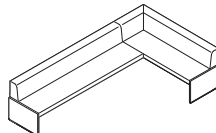

97¼"D 123"W 31"H

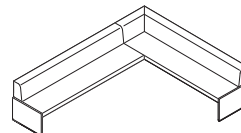

26¾"D 71"W 31"H

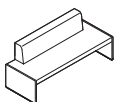

Straight with 8" Offset Back

26¾"D 97¾"W 31"H

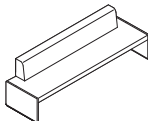

26¾"D 71"W 31"H

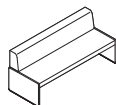

Straight with 1.5" Offset Back

26¾"D 97¾"W 31"H

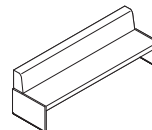

26¾"D 71"W 18½"H

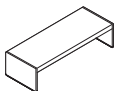

Straight without Back

26¾"D 97¾"W 18½"H

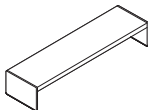

# Statement of Line *continued*

## Lounge Seating, continued

### Visalia Lounge Seating

Understanding  
▶ Page 282  
Specifying  
▶ Page 284

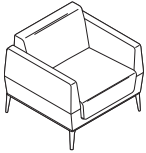

Lounge Chair

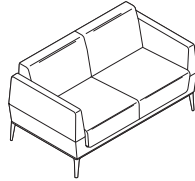

2-Seat Lounge

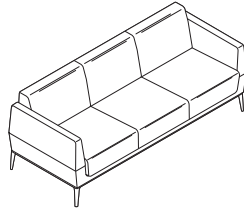

3-Seat Lounge

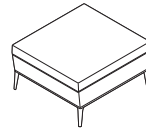

Ottoman

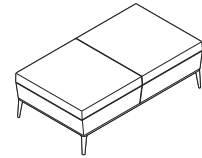

Bench

## Collaboration Seating

### Bindu Conference Seating

Understanding  
▶ Page 290  
Specifying  
▶ Page 292



Mid-Back Conference Chair



High-Back Conference Chair

### Chord Conference Seating

Understanding  
▶ Page 294  
Specifying  
▶ Page 296



Conference Narrow



Mid-Back



High-Back Narrow



High-Back/Large Scale

# Statement of Line

## Collaboration Seating, continued

### Marien152 Conference Seating

Understanding  
▶ Page 298  
Specifying  
▶ Page 300



4-Star Conference Chair



5-Star Conference Chair

### Lox Seating

Understanding  
▶ Page 303  
Specifying  
▶ Page 304



4-Star Base Chair with Upholstered Seat



4-Star Base Chair with Upholstered Seat and Back



5-Star Base Chair with Upholstered Seat



5-Star Base Chair with Upholstered Seat and Back

### Massaud Conference Seating

Understanding  
▶ Page 306  
Specifying  
▶ Page 308

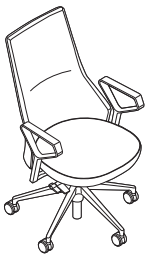

Mid-Back Conference Chair with Loop Arm



Mid-Back Duvet Conference Chair with Loop Arm



Low-Back Conference Chair with Integrated Arm



Low-Back Duvet Conference Chair with Integrated Arm



Mid-Back Conference Chair with Integrated Arm

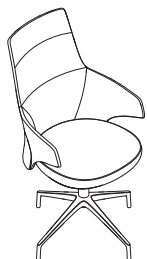

Mid-Back Duvet Conference Chair with Integrated Arm

# Statement of Line *continued*

## Collaboration Seating, continued

### SW\_1 Conference Seating

Understanding  
▶ Page 313  
Specifying  
▶ Page 314



Conference Chair  
with 4-Star Base



Conference Chair  
with 5-Star Base

## Guest Seating

### Bindu Chairs

Understanding  
▶ Page 318  
Specifying  
▶ Page 319



Low-Back Chair



Mid-Back Chair

### Bob Chair

Understanding  
▶ Page 320  
Specifying  
▶ Page 321



Guest Chair

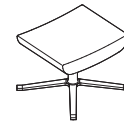

Ottoman

### Branca Chair

Understanding  
▶ Page 323  
Specifying  
▶ Page 324



### Capa Chair

Understanding  
▶ Page 325  
Specifying  
▶ Page 326



### Enea Lottus Chairs

Understanding  
▶ Page 328  
Specifying  
▶ Pages 330-333



Armless Chair



Cantilever Arm  
Chair



Aluminum Loop  
Arm Chair

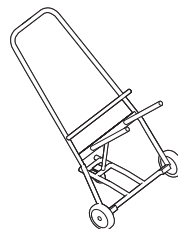

Dolly

# Statement of Line

## Guest Seating, continued

### Enea Altzo943 Chairs

Understanding  
▶ Page 334  
Specifying  
▶ Pages 335



Armless Chair



Armless Chair with Upholstered Cushion Insert

### Kathryn Chairs

Understanding  
▶ Page 336  
Specifying  
▶ Page 338

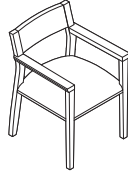

Open Wood Back

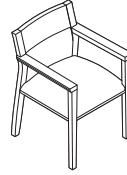

Upholstered Wood Back Panel

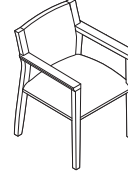

Fully Upholstered Back

### LessThanFive Chairs

Understanding  
▶ Page 340  
Specifying  
▶ Page 341



### Leva Chair

Understanding  
▶ Page 342  
Specifying  
▶ Page 343



### Marien152 Guest Seating

Understanding  
▶ Page 344  
Specifying  
▶ Pages 345-346



Wood Base Chair



Metal Base Chair

### Montara650 Chairs

Understanding  
▶ Page 348  
Specifying  
▶ Page 350



Wood Shell, Wood Shell with Upholstered Seat, Wood Shell with 3/4 Upholstery, and Fully Upholstered

### Round Outdoor Chairs

Understanding  
▶ Page 353  
Specifying  
▶ Page 354



Arm



Armless

### Seta Chair

Understanding  
▶ Page 355  
Specifying  
▶ Page 356



# Statement of Line *continued*

## Guest Seating, continued

### She Said Chair

- Understanding
- ▶ Page 357
- Specifying
- ▶ Page 358



### Switch Chairs

- Understanding
- ▶ Page 359
- Specifying
- ▶ Page 360

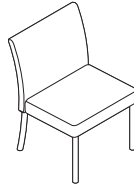

Armless Chair

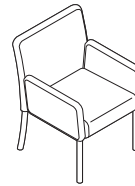

Arm Chair

## Wrapp Chairs

- Understanding
- ▶ Page 361
- Specifying
- ▶ Page 362



4-Leg Chair

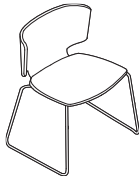

Sled-Base Chair

## Stools

### Branca Stools

- Understanding
- ▶ Pages 364 and 366
- Specifying
- ▶ Pages 365 and 367



Barstool

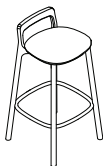

Counter Stool

### Cugino Stool

- Understanding
- ▶ Page 368
- Specifying
- ▶ Page 369

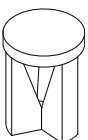

### Cugino Soft Stool

- Understanding
- ▶ Page 370
- Specifying
- ▶ Page 371

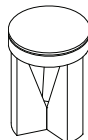

# Statement of Line

## Stools, continued

### Enea Café Wood Stools

Understanding  
▶ Page 372  
Specifying  
▶ Page 374



Café Wood Counter-Height Stool Upholstered Seat



Café Wood Bar-Height Stool Upholstered Seat



Café Wood Counter-Height Stool



Café Wood Bar-Height Stool

### Enea Lottus Stools

Understanding  
▶ Pages 376 and 380  
Specifying  
▶ Pages 378 and 382

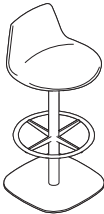

Counter-Height Post Base Stool

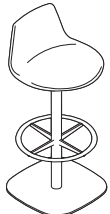

Bar-Height Post Base Stool



Counter-Height Sled Base Stool



Bar-Height Sled Base Stool

### Enea Altzo943 Stools

Understanding  
▶ Page 384  
Specifying  
▶ Page 386



Counter-Height Stool



Bar-Height Stool



Counter-Height Stool with Upholstered Cushion Insert



Bar-Height Stool with Upholstered Cushion Insert

### LessThanFive Stool

Understanding  
▶ Page 388  
Specifying  
▶ Page 389



### Medici Stool

Understanding  
▶ Page 397  
Specifying  
▶ Page 398



# Statement of Line *continued*

## Stools, continued

### Marien152 Stools

Understanding  
▶ Page 390  
Specifying  
▶ Page 392

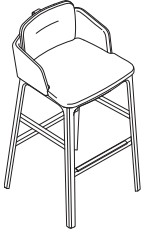

Metal Base Bar Stool

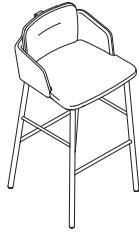

Wood Base Bar Stool



Metal Base Counter Stool



Wood Base Counter Stool

### Montara650 Stools

Understanding  
▶ Page 400  
Specifying  
▶ Page 402



Counter-Height or Bar-Height Stool: Wood Shell, Wood Shell with Upholstered Seat, and Fully Upholstered

### Round Outdoor Stool

Understanding  
▶ Page 404  
Specifying  
▶ Page 405

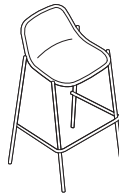

### Switch Stools

Understanding  
▶ Page 406  
Specifying  
▶ Page 407

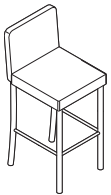

Counter-Height Stools

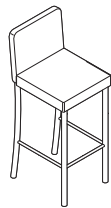

Bar-Height Stools

# Lounge Seating

\*These product lines are collections and will be found in multiple locations in this specification guide and/or *Coalesse Tables, Storage, and Accessories Specification Guide*.  
 ▶ See *Collections*, page 5

Await Lounge System*	28
Bob Lounge Chairs*	36
Circa Lounge System*	42
Coalesse Ensemble Lounge System	62
Coalesse Ensemble Freestanding Screens	68
Coupe/Coupe Grande/Mobile Lounge Seating	94
Davos Lounge Seating	97
Hosu Lounge Seating	101
Jean Nouvel Seating Collection	106
Joel Lounge Chair	110
Lagunitas Lounge System*	114
Lagunitas Focus Nook	164
LessThanFive Lounge	168
Marien152 Lounge Seating*	170
Massaud Lounge Seating*	176
Medici Lounge Chair	181
Millbrae Lifestyle/Contract Lounge Seating*	184
Montara650 Lounge Chair*	198
Montara650 Rocker*	202
Passerelle Lounge Seating*	208
Ripple Benches	214
Sidewalk Lounge Seating	220
Sidewalk Collaborative Lounge Seating	226
Systema Lounge System	230
SW_1 Lounge Seating*	254
Switch Lounge Seating*	260
Thoughtful Lounge Seating	266
Together Benches	272
Visalia Lounge Seating	282

# Await Lounge System

DESIGN E00S

**The Await lounge system** is the perfect solution for a variety of settings. Its staggered ganging capabilities offer versatility and functionality in transforming spaces.

*Tip: This product line is a collection and will be found in multiple locations in this specification guide and/or Coalesse Tables, Storage, and Accessories Specification Guide.*

► See *Collections*, page 5.

**Upholstery** features a topstitch detail.

**Legs** are black, high-density polyurethane resin with non-adjustable glides. Floor mount legs available.

**Freestanding tables and connector tables** feature a High-Pressure Laminate top with a 3 mm edge band. ½" thick glass top with radiused edges is also available.

**Seat** features multiple densities of polyurethane foam and spring packs for added comfort.

**Casters** are standard on ottoman and are non-locking.

**Connector tables** attach to seating units with ¼" ganging plates. Power/data modules are also available.

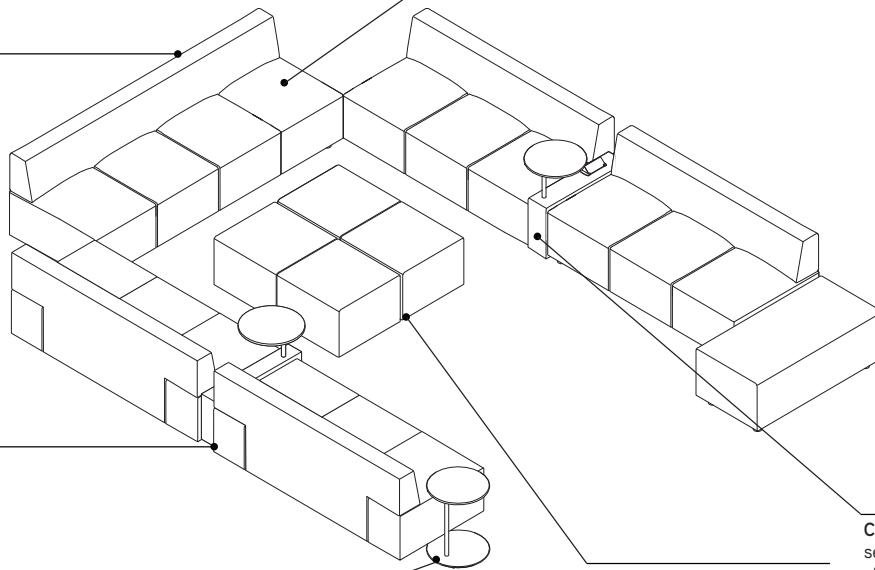

# Await Lounge System

DESIGN EOOS

## Product Details

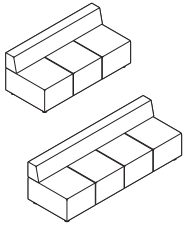

**Lounge** is available in 3- or 4-seat.

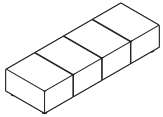

**4-seater bench** provides a backless seating option.

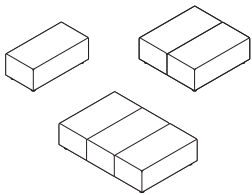

**Connector benches** are available in 1-, 2-, and 3-sections and feature a fixed seat with top and double needle stitching on seams. Ganging kit is available.

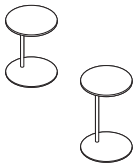

**Freestanding tables** are 15 $\frac{3}{4}$ " diameter, and available in two heights: 19"H and 25"H. Standard with silver frame.  
 ▶ See *Coalesse Tables, Storage, and Accessories Specification Guide*.

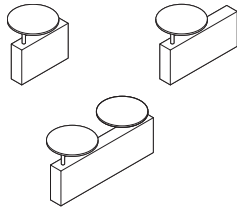

**Connector tables** are 4 $\frac{1}{2}$ "W and comes in three diameters: 20"D, 28"D, and 42"D; and in two heights: 15 $\frac{3}{4}$ "H and 25 $\frac{3}{8}$ "H. The tablet is 15 $\frac{3}{4}$ " diameter and  $\frac{1}{4}$ " thick. Bottom connecting ganging plate is standard. Power/data module is available. Panels are available in black, white, or gray.  
*Tip: Connector tables are not made for ganging to Await mobile ottoman.*

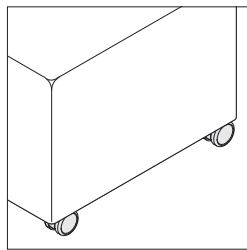

**Ottoman** standard with non-locking casters.

## Surface Materials

▶ See *Coalesse Surface Materials Reference Guide* for further information.

### Upholstery

- Fabric
- Leather

### Table/Tablet Top

- Laminate
- Glass

## Program and Services

**Customer's Own Material/Leather (COM/COL) Program** is available.

▶ See *Coalesse Surface Materials Reference Guide* for additional information.

# Await Lounge System

DESIGN E00S

*Tip: Recommended leathers are Elmosoft group 1 and Elmorustical group 2.*

*Tip: Special color match, consult Customer Service.*

*Tip: For Customer's Own Material or Leather, see necessary requirements, important processing instructions, and ordering information*  
**▶ See Coalesse Surface Materials Reference Guide.**

*Tip: Contrasting option available only on lounges.*

*Tip: Please include sketch for ganging.*

*Tip: Fabrics and leathers will appear loose with comfort wrinkles when upholstered.*

Standard Includes		Required to Specify	
<ul style="list-style-type: none"> <li>▶ Need help? Product details, page 28</li> </ul>	<ul style="list-style-type: none"> <li>• Frame: unibody construction with finger-jointed plywood</li> <li>• Multiple densities of polyurethane foam and polyester foam and polyester fiber</li> <li>• Lounge:                             <ul style="list-style-type: none"> <li>- Seat and back: fabric or leather</li> <li>- Legs: black high-density polyurethane resin</li> <li>- Glides: non-adjustable</li> </ul> </li> <li>• Ottoman:                             <ul style="list-style-type: none"> <li>- Seat: fabric or leather</li> <li>- Casters: non-locking</li> </ul> </li> </ul>	<ol style="list-style-type: none"> <li>1 Style number</li> <li>2 Number of fabrics if contrasting fabric style number is selected</li> <li>3 Fabric or leather color number for upholstery on seat and back</li> <li>4 Options, if selected (see below)</li> </ol>	<p>▶ See <i>Coalesse Surface Materials Reference Guide.</i></p>
Options		U.S. Price	Required to Specify
<b>Surface Materials</b>	<ul style="list-style-type: none"> <li>• Contrasting fabric</li> </ul>	+\$192 per fabric	Add suffix K to the style number and select fabric color number.
	<b>Acrylic backer</b>		
	• 3-seat lounge	+\$ 89	Specify with acrylic backer.
	• 4-seat lounge	+\$ 111	Specify with acrylic backer.
	• 4-seat bench	+\$ 78	Specify with acrylic backer.
	• Ottoman	+\$ 25	Specify with acrylic backer.
			▶ See <i>Coalesse Surface Materials Reference Guide.</i>
<b>Floor Mount Legs</b>	• Floor mount legs	+\$207 per unit	Specify with floor mount legs.
<b>Related Products</b>	<ul style="list-style-type: none"> <li>• Connector benches and tables</li> <li>• Occasional tables</li> </ul>		<p>▶ Pages 32 and 33</p> <p>▶ See <i>Coalesse Tables, Storage, and Accessories Specification Guide.</i></p>

## Specification Information

Style Number	U.S. Base Prices										Leather Groups:			
	Fabric Groups:											COL	1	2
	COM	1	2	3	4	5	6	7	8	9	10			

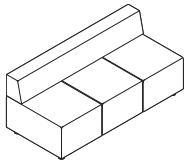

Overall: 30"D 66"W 27"H  
 Inside: 22"D 66"W 27"H  
 Seat: 16½"H  
 Arm: 10½"H

### 3-Seat Lounge

460-3	\$5665	\$5665	\$5843	\$5992	\$6168	\$6435	\$6765	\$7143	\$7544	\$7897	\$ 8275	\$6141	\$ 9853	\$10,582
-------	--------	--------	--------	--------	--------	--------	--------	--------	--------	--------	---------	--------	---------	----------

COM/yds = 5¾, COL/sq ft = 147

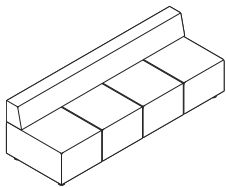

Overall: 30"D 88"W 27"H  
 Inside: 22"D 88"W 27"H  
 Seat: 16½"H  
 Arm: 10½"H

### 4-Seat Lounge

460-4	\$6981	\$6981	\$7207	\$7394	\$7616	\$7953	\$8369	\$8845	\$9351	\$9796	\$10,273	\$7457	\$12,166	\$13,075
-------	--------	--------	--------	--------	--------	--------	--------	--------	--------	--------	----------	--------	----------	----------

COM/yds = 7¼, COL/sq ft = 185

▶ Specification Information, continued on next page

# Await Lounge System

DESIGN EOOS

► Specification Information, continued from previous page

## Specification Information

Style Number	U.S. Base Prices										Leather Groups:		
	Fabric Groups:										COL		
	COM	1	2	3	4	5	6	7	8	9	10	1	2

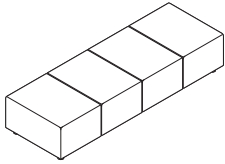

Overall: 30"D 88"W 16½"H  
Seat: 16½"H

### 4-Seat Bench

460-4B	\$5117	\$5117	\$5289	\$5430	\$5599	\$5854	\$6171	\$6532	\$6915	\$7252	\$7614	\$5593	\$9144	\$9833
--------	--------	--------	--------	--------	--------	--------	--------	--------	--------	--------	--------	--------	--------	--------

COM/yds = 5½, COL/sq ft = 100



Overall: 22"D 22"W 16½"H

### Mobile Ottoman

460-H	\$1248	\$1248	\$1296	\$1333	\$1380	\$1450	\$1536	\$1634	\$1739	\$1830	\$1930	\$1724	\$2632	\$2814
-------	--------	--------	--------	--------	--------	--------	--------	--------	--------	--------	--------	--------	--------	--------

COM/yds = 1½, COL/sq ft = 33

Lounge Seating

 **For Canadian Pricing**  
Multiply U.S. Price by the  
Canadian price factor.  
► See page 1 for details.

# Await Lounge System Connector Benches

DESIGN E00S

*Tip: Recommended leathers are Elmosoft group 1 and Elmorustical group 2.*

*Tip: Special color match, consult Customer Service.*

*Tip: For Customer's Own Material or Leather, see necessary requirements, important processing instructions, and ordering information*  
 ▶ See *Coalesse Surface Materials Reference Guide*.

*Tip: Please include sketch for ganging.*

*Tip: Fabrics and leathers will appear loose with comfort wrinkles when upholstered.*

Standard Includes		Required to Specify	
▶ Need help? Product details, page 29	<ul style="list-style-type: none"> <li>Bench: fabric or leather</li> <li>Frame: unibody construction with finger-jointed plywood</li> <li>Multiple densities of polyurethane foam</li> <li>Fixed seat</li> <li>Top and double needle stitching on seams</li> <li>Legs: black high-density polyurethane resin</li> <li>Glides</li> </ul>	1 Style number	2 Fabric or leather color number for upholstery on bench
		3 Options, if selected (see below)	▶ See <i>Coalesse Surface Materials Reference Guide</i> .
Options		U.S. Price	Required to Specify
<b>Surface Materials</b>	<b>Acrylic backer</b>		
	• 1-section connector bench	+\$ 36	Specify with acrylic backer.
	• 2-section connector bench	+\$ 53	Specify with acrylic backer.
	• 3-section connector bench	+\$ 80	▶ See <i>Coalesse Surface Materials Reference Guide</i> .
<b>Floor Mount Legs</b>	• Field-installed Floor mount legs	+\$207 per unit	Specify with floor mount legs.
<b>Related Products</b>	• Occasional tables		▶ See <i>Coalesse Tables, Storage, and Accessories Specification Guide</i> .
	• Lounge seating		▶ Page 30

## Specification Information

Style Number	U.S. Base Prices										Leather Groups:			
	Fabric Groups:													
	COM	1	2	3	4	5	6	7	8	9	10	COL	1	2

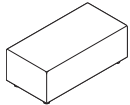

Overall: 44"D 22"W 16½"H

### 1-Section Connector Bench

461-1B	\$2307	\$2307	\$2379	\$2436	\$2505	\$2610	\$2740	\$2886	\$3043	\$3181	\$3329	\$2783	\$4190	\$4463
--------	--------	--------	--------	--------	--------	--------	--------	--------	--------	--------	--------	--------	--------	--------

COM/yds = 2¼, COL/sq ft = 53

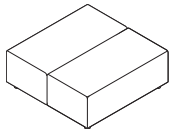

Overall: 44"D 44"W 16½"H

### 2-Section Connector Bench

461-2B	\$3548	\$3548	\$3668	\$3763	\$3879	\$4053	\$4270	\$4513	\$4776	\$5004	\$5252	\$4024	\$6413	\$6883
--------	--------	--------	--------	--------	--------	--------	--------	--------	--------	--------	--------	--------	--------	--------

COM/yds = 3¾, COL/sq ft = 83

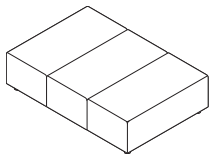

Overall: 44"D 66"W 16½"H

### 3-Section Connector Bench

461-3B	\$4950	\$4950	\$5110	\$5237	\$5392	\$5624	\$5912	\$6237	\$6587	\$6891	\$7222	\$5426	\$8798	\$9455
--------	--------	--------	--------	--------	--------	--------	--------	--------	--------	--------	--------	--------	--------	--------

COM/yds = 5, COL/sq ft = 110

### Ganging Kit

460-GANGPKG	\$ 79
-------------	-------

# Await Lounge System Connector Tables

DESIGN EOOS

*Tip: Await connector tables are not recommended to be used in end-of-run applications.*

*Tip: Await connector tables are not made for ganging to Await mobile ottoman.*

Standard Includes	Required to Specify
<ul style="list-style-type: none"> <li>▶ Need help? Product details, page 29</li> <li>• Connector table frame: panels are black, white, or gray</li> <li>• Top: High-Pressure Laminate top with matching 3 mm edge band</li> <li>• Glass top (tablet):                             <ul style="list-style-type: none"> <li>- 1/2" thick</li> <li>- Radiused edges</li> </ul> </li> <li>• Ganging plate: 1/4" thick ganging plates attach to the bottom of units to the seating unit plates</li> </ul>	<ol style="list-style-type: none"> <li>1 Style number</li> <li>2 Laminate top and tablets, if selected:                             <ul style="list-style-type: none"> <li>2746 Black</li> <li>2730 Arctic White</li> <li>290N North Sea</li> </ul> </li> <li>3 Glass color number for top, if selected</li> </ol> <p>▶ See <i>Coalesse Surface Materials Reference Guide</i>.</p>

Related Products
<ul style="list-style-type: none"> <li>• Occasional tables</li> <li>• Lounge seating</li> </ul>

▶ See *Coalesse Tables, Storage, and Accessories Specification Guide*.  
▶ Page 30

### Specification Information

Style Number	U.S. Prices			Glass Tablet:					
	Laminate Top:		Power/Data	Clear Green/	Clear Green/	Acid Etched 6511 Glass Tablet	Acid Etched 6511 Tablet and Power/Data	Back-Painted Glass Tablet	Back-Painted Tablet and Power/Data
No Tablet	Tablet	Clear Green/Frosted Glass Tablet		Clear Green/Frosted Tablet and Power/Data					
460-SE22	\$1063	\$2441	N.A.	\$2527	N.A.	\$2561	N.A.	\$2823	N.A.
460-SE22PD	N.A.	N.A.	\$2898	N.A.	\$3069	N.A.	\$3103	N.A.	\$3365
460-SE30	\$1216	\$2594	N.A.	\$2680	N.A.	\$2723	N.A.	\$2976	N.A.
460-SE30PD	N.A.	N.A.	\$3063	N.A.	\$3234	N.A.	\$3268	N.A.	\$3530
460-SE44	\$1494	\$4250	N.A.	\$4297	N.A.	\$4372	N.A.	\$4887	N.A.
460-SE44PD	N.A.	N.A.	\$4701	N.A.	\$4925	N.A.	\$4999	N.A.	\$5522

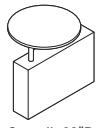

Overall: 20"D 4 1/2"W 15 3/4"H  
With Tablet: 15 3/4" Dia. and 25 3/8"H

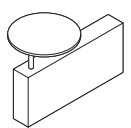

Overall: 28"D 4 1/2"W 15 3/4"H  
With Tablet: 15 3/4" Dia. and 25 3/8"H

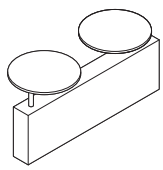

Overall: 42"D 4 1/2"W 25 3/8"H  
With Tablets: 15 3/4" Dia. and 25 3/8"H

 **For Canadian Pricing**  
Multiply U.S. Price by the Canadian price factor.  
▶ See page 1 for details.

# Await Lounge System Ganging Diagrams by Model (Underside View)

DESIGN E00S

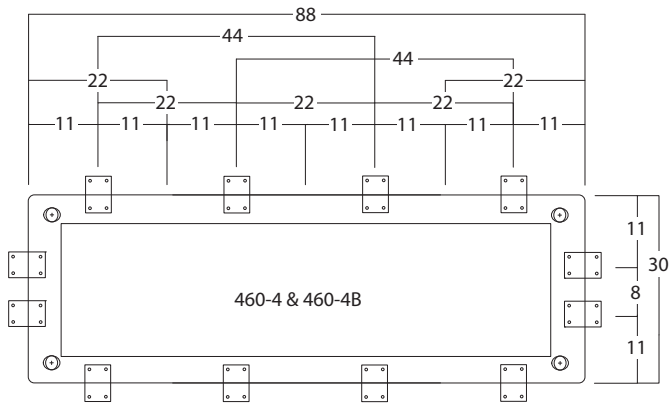
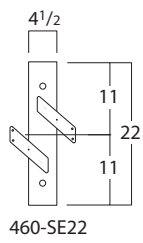
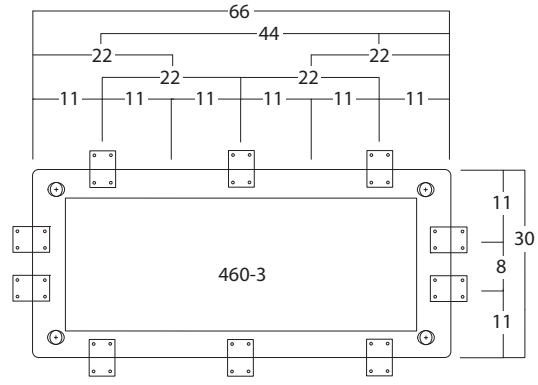
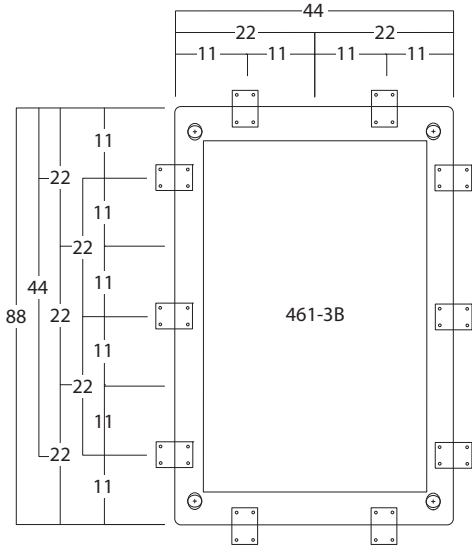
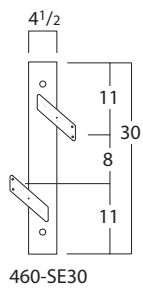
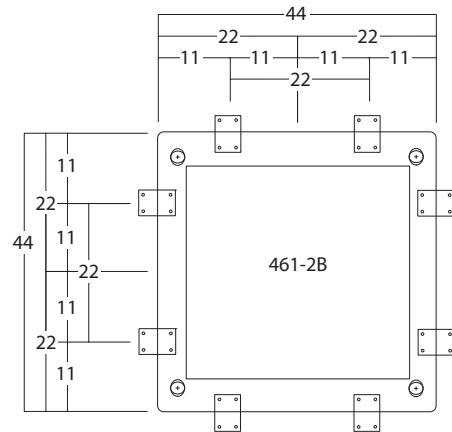
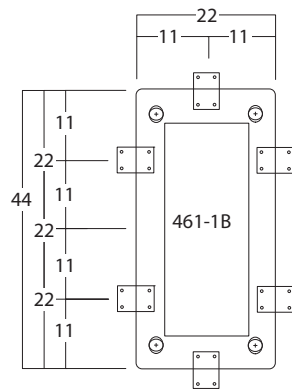
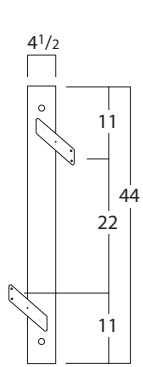

# Await Lounge System Multi-Fabric Diagram

DESIGN E00S

TO: \_\_\_\_\_

FROM: \_\_\_\_\_

DATE: \_\_\_\_\_

FAX....888.413.5161

**A** Seat (upholstery selections default for entire unit if B is not selected):

\_\_\_\_\_  
\_\_\_\_\_

**B** Back: \_\_\_\_\_

\_\_\_\_\_

*See specifying for contrasting fabric upcharge. List price based on highest fabric group usage.*

Specify Model below:

460-3K

460-4K

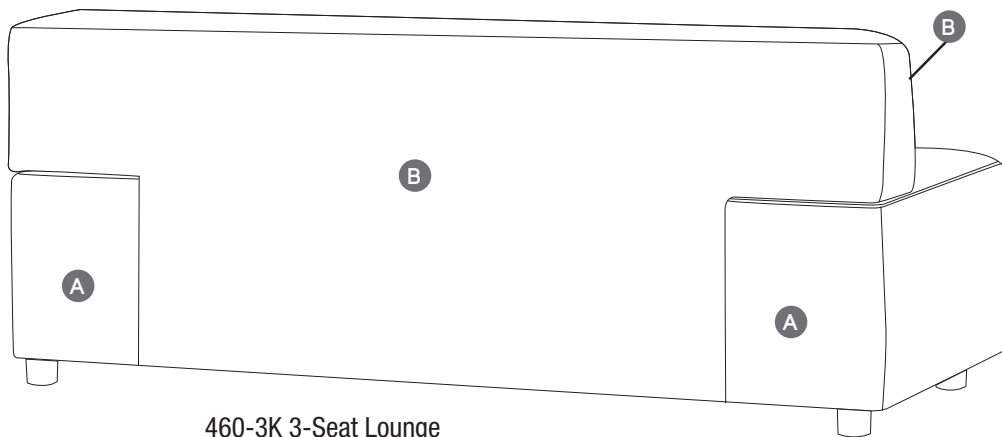
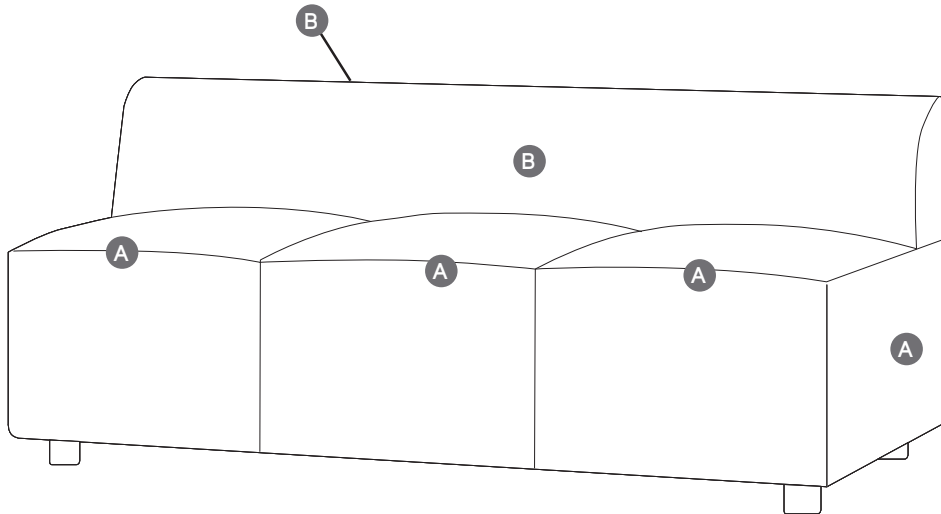

460-3K 3-Seat Lounge

# Bob Lounge Chairs by Walter Knoll

DESIGN PEARSON LLOYD

**Bob lounge chair** is well-suited to any professional space with its flared arms, aluminum base (painted or polished), and a coordinating ottoman.

*Tip: This product line is part of a collection and will be found in multiple locations in this specification guide and/or Coalesse Tables, Storage, and Accessories Specification Guide.*

► See *Collections*, page 5.

**Adjustable headrest** has a 2<sup>3</sup>/<sub>4</sub>" range; also available without headrest.

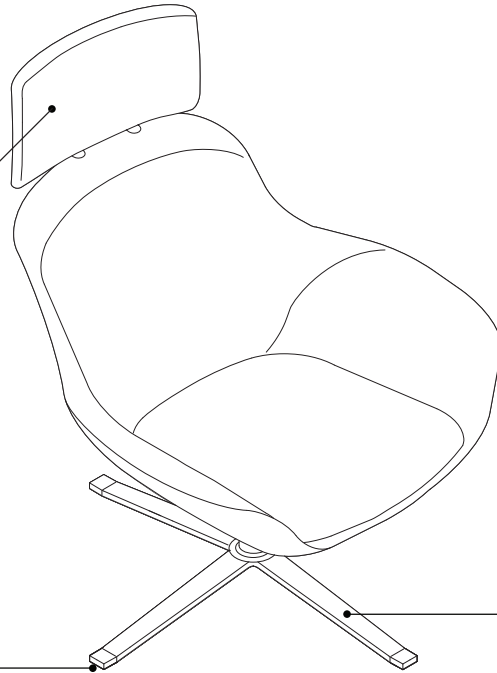

**Glides** are a non-marring, black polymer. Optional soft felt glides can be used on non-carpeted surfaces.

**4-leg base** comes standard with a swivel mechanism. An optional return swivel mechanism is available.

## Product Details



**Bob Lounge** is available without adjustable headrest.

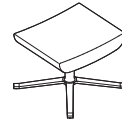

**Ottoman** is available in matching upholstery.

## Surface Materials

► See *Coalesse Surface Materials Reference Guide* for further information.

**Upholstery** (contrasting fabric available on lounge chairs)

- Fabric
- Leather

## Base

- Aluminum matte polished
- Painted aluminum (available on swivel base only)

## Program and Services

**Customer's Own Material/Leather (COM/COL) Program** is available.

► See *Coalesse Surface Materials Reference Guide* for additional information.

Coalesse

# Bob Lounge Chairs by Walter Knoll

DESIGN PEARSON LLOYD

# Bob Lounge Chairs by Walter Knoll

DESIGN PEARSON LLOYD

*Tip: For Customer's Own Material or Leather, see necessary requirements, important processing instructions, and ordering information*  
 ▶ See *Coalesse Surface Materials Reference Guide*.

*Tip: Fabrics and leathers will appear loose with comfort wrinkles when upholstered.*

Standard Includes		Required to Specify			
▶ Need help? Product details, page 36	<ul style="list-style-type: none"> <li>• Base: 8040 Aluminum Matte Polished or group 1 paint</li> <li>• Swivel base for lounge chairs, if selected</li> <li>• Upholstery for chair: fabric or leather</li> <li>• Glides</li> </ul>	1 Style number	2 Number of fabrics, if contrasting fabric style number is selected		
		3 Fabric or leather color number for upholstery	4 Options, if selected (see below)		
		▶ See <i>Coalesse Surface Materials Reference Guide</i> .			
Options		U.S. Price		Required to Specify	
<b>Surface Materials</b>	<ul style="list-style-type: none"> <li>• Contrasting fabric</li> </ul>	+\$192 per fabric		Add suffix K to the style number and select fabric color number.	
	<b>Acrylic backer</b>			Specify with <i>acrylic backer</i> .	
	• Lounge chair		+\$ 50	Specify with <i>acrylic backer</i> .	
	• Lounge chair with headrest		+\$ 53	Specify with <i>acrylic backer</i> .	
	• Ottoman		+\$ 13	▶ See <i>Coalesse Surface Materials Reference Guide</i> .	
<b>Base</b>	<b>Lounge chair with standard swivel mechanism</b>			Specify with <i>standard swivel</i> and select aluminum matte polished.	
	• Aluminum matte polished		No cost	Specify with <i>standard swivel</i> and select paint color number.	
	• Group 1 paint		No cost	Specify with <i>standard swivel</i> and select paint color number.	
	• Group 3 paint		+\$114	Specify with <i>standard swivel</i> and select paint color number.	
	<b>Lounge chair with return swivel mechanism</b>			Specify with <i>return swivel</i> and select aluminum matte polished.	
	• Aluminum matte polished		+\$380		
<b>Glides</b>	• Felted glides		+\$ 23	Specify with <i>felted glides</i> .	
<b>Related Products</b>	<ul style="list-style-type: none"> <li>• Guest seating</li> <li>• Occasional tables</li> </ul>			▶ Page 321	
				▶ See <i>Coalesse Tables, Storage, and Accessories Specification Guide</i> .	
	• Collaborative and conference tables			▶ See <i>Coalesse Tables, Storage, and Accessories Specification Guide</i> .	

## Specification Information

Style Number	U.S. Base Prices										Leather Groups:		
	Fabric Groups:											COL	1
COM	1	2	3	4	5	6	7	8	9	10			



Overall: 34¼"D 35"W 31¾"H  
 Inside: 21¾"D 20"W 17¼"H  
 Seat: 17"H  
 Arm: 21¾"H

## Lounge Chair

216	\$3615	\$3615	\$3717	\$3802	\$3903	\$4055	\$4244	\$4459	\$4688	\$4890	\$5106	\$4075	\$5866	\$6224
-----	--------	--------	--------	--------	--------	--------	--------	--------	--------	--------	--------	--------	--------	--------

COM/yds = 3, COL/sq ft = 72

▶ Specification Information, continued on next page



**For Canadian Pricing**  
 Multiply U.S. Price by the Canadian price factor.  
 ▶ See page 1 for details.

# Bob Lounge Chairs by Walter Knoll

DESIGN PEARSON LLOYD

► Specification Information, continued from previous page

## Specification Information

Style Number	U.S. Base Prices										Leather Groups:			
	Fabric Groups:										COL	1	2	
	COM	1	2	3	4	5	6	7	8	9	10			



Overall: 34¼"D 35"W 41¼"H  
Inside: 21¾"D 20"W 17½"H

### Lounge Chair with Headrest

221	\$4284	\$4284	\$4404	\$4502	\$4621	\$4798	\$5018	\$5269	\$5536	\$5773	\$6024	\$4744	\$6844	\$7261
-----	--------	--------	--------	--------	--------	--------	--------	--------	--------	--------	--------	--------	--------	--------

COM/yds = 3½, COL/sq ft = 77



Overall: 18½"D 19¾"W 15¼"H

### Ottoman

221-H	\$1321	\$1321	\$1356	\$1384	\$1418	\$1469	\$1531	\$1603	\$1680	\$1747	\$1819	\$1781	\$2316	\$2433
-------	--------	--------	--------	--------	--------	--------	--------	--------	--------	--------	--------	--------	--------	--------

COM/yds = 1, COL/sq ft = 22

Lounge Seating

 **For Canadian Pricing**  
Multiply U.S. Price by the  
Canadian price factor.  
► See page 1 for details.

# Bob Lounge Chairs Multi-Fabric Diagram

DESIGN PEARSON LLOYD

TO: \_\_\_\_\_

FROM: \_\_\_\_\_

DATE: \_\_\_\_\_

FAX...888.413.5161

**A** Seat (upholstery selections default for entire unit if B is not selected): \_\_\_\_\_

**B** Back and Arms: \_\_\_\_\_  
*Headrest available for 221 model only.*

Specify Model below:

216K

221K

221-HK

*See specifying for contrasting fabric upcharge. List price based on highest fabric group usage.*

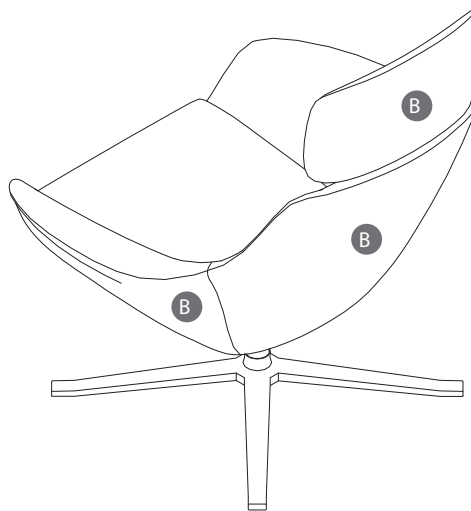
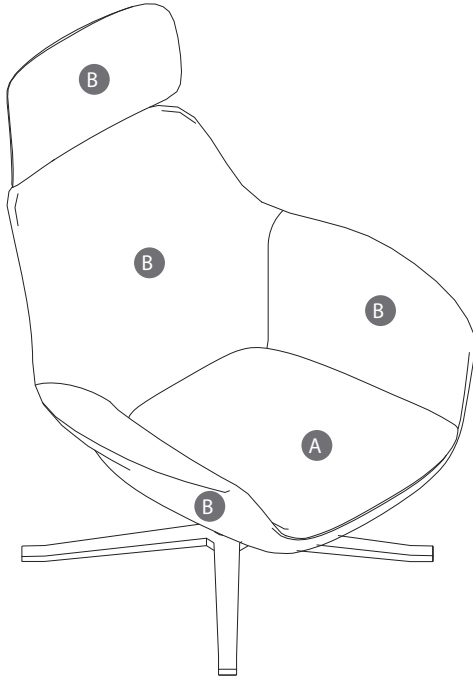

Coalesse

# Bob Lounge Chairs Multi-Fabric Diagram

DESIGN PEARSON LLOYD

# Circa Lounge System

DESIGN ALISON SPEAR, AIA

Circa lounge system offers a dramatic, creative palette for configuring signature spaces with a wide array of large and small application expressions, from straight to curvilinear modular lounges and ganging or freestanding tables.

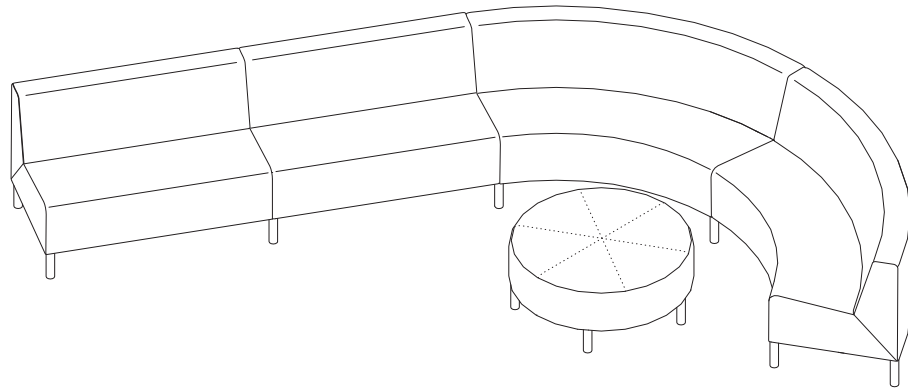

Intermediate tables are available in laminate (with self-edge) or veneer. Tables come with ganging brackets to attach to seating units. Shared application is an option.

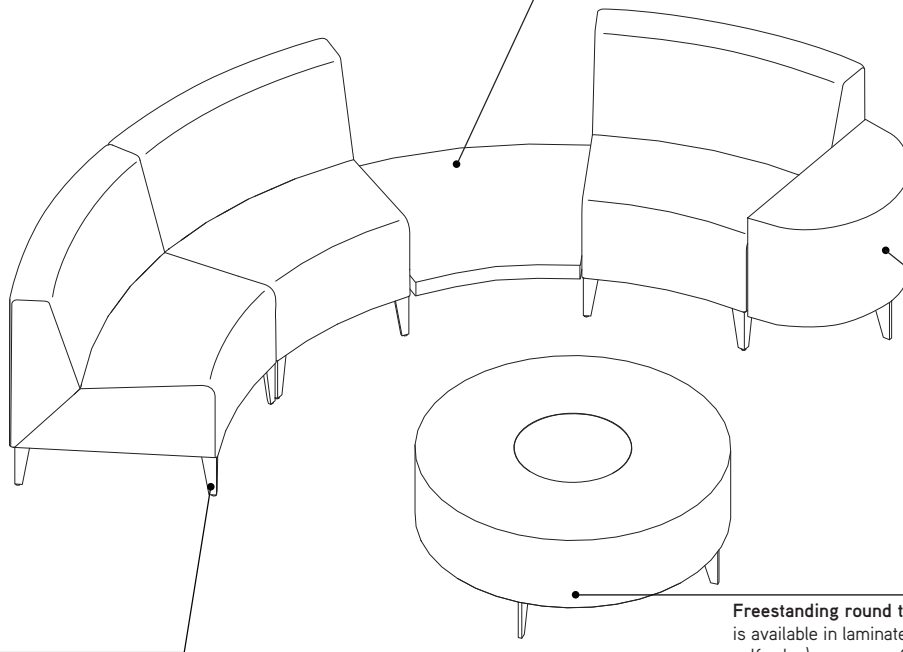

End-of-run tables are available in laminate (with self-edge) or veneer. Tables come with ganging brackets to attach to seating unit.

Freestanding round table is available in laminate (with self-edge) or veneer. Optional center inserts are available: green tinted glass or power/data module (available in black anodized aluminum or silver anodized aluminum).

Tapered legs are available in solid wood or metal. Solid wood legs are maple or walnut. Metal legs are offered in optional powder coat paint finishes. Tapered legs on lounge pieces support freestanding applications, allowing units to be easily rearranged.

Ganging kit is available to connect units together and maintain alignment.

# Circa Lounge System

DESIGN ALISON SPEAR, AIA

## Product Details

**Cylinder legs** are solid oak. Legs can be specified to be shared between adjacent lounge units, minimizing leg locations and ganging units together, as shown. Legs can also be specified freestanding, supporting individual units that can be easily rearranged.

**Modern metal legs** are available in powder coat paints. Legs can be specified to be shared between adjacent lounge units, minimizing leg locations and ganging units together, as shown. Legs can also be specified freestanding, supporting individual units that can be easily rearranged.

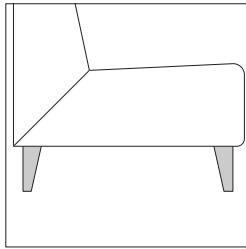

**Tapered legs** are available in solid maple or walnut, as well as optional metal in powder coat paints. Tapered legs on lounge units support freestanding applications, allowing units to be easily rearranged.

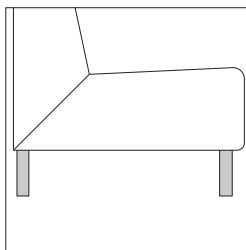

**Cylinder legs** are solid oak and are optional. Legs can be specified to be shared between adjacent lounge units or freestanding application, allowing units to be easily rearranged.

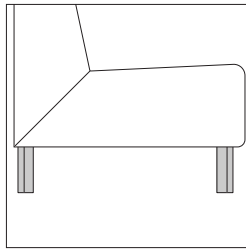

**Modern metal legs** are optional and are available in powder coat paints. Legs can be specified to be shared between adjacent lounge units or freestanding application, allowing units to be easily rearranged.

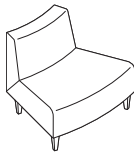

**30° wedge seat** is available outside facing or inside facing.

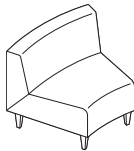

**60° wedge seat** is available outside facing or inside facing.

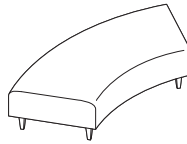
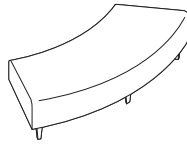
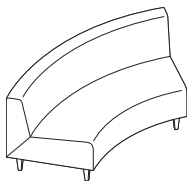
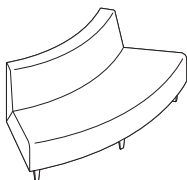

**60° wedge bench** is available and can be used in outside or inside facing applications.

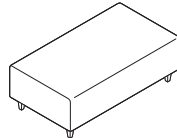
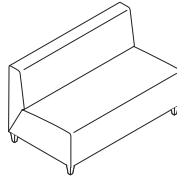
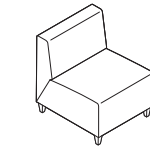

**Straight seating** available as 1-seat lounge, 2-seat lounge, or bench.

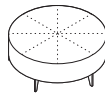

**Round ottoman** has five legs and is upholstered. Measures 42" diameter and 17"H. Tapered legs have a thin blade aesthetic and are available in solid maple and walnut, as well as optional metal in powder coat paints. Cylinder wood leg and modern metal leg are also available.

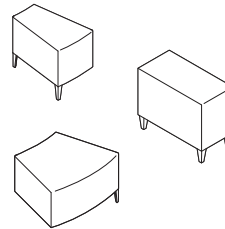

**Straight, inside, or outside (15° or 30°) armrests** can be specified without legs (intermediate) and ganged to adjacent lounge units. Or in end-of-run position, on left or right side.

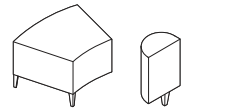
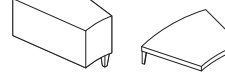
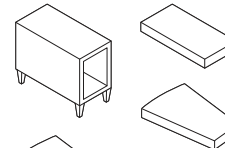

**High and low ganging tables** are available in three sizes: straight, 15° wedge, or 30° wedge. Tables can be specified without legs (intermediate) and ganged to adjacent lounge units or in end-of-run position, on left or right side.

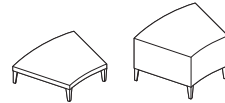
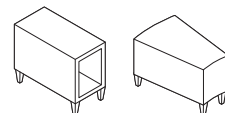

**High and low freestanding tables** are available straight, 15° wedge, or 30° wedge.

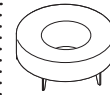

**Freestanding round table** is available in one size, 42" diameter, 15¾"H. Power/data module option available in black anodized aluminum or silver anodized aluminum. The round plate that houses the power module is powder coated to complement the module. Glass insert is available as an option.

## Surface Materials

► See *Coalesse Surface Materials Reference Guide* for further information.

**Upholstery** (contrasting fabric available)

- Fabric
- Leather

## Table tops

- Laminate with self edge (option)
- Veneer
  - Maple veneer (quarter cut, high and low sheen)
  - Walnut veneer (quarter cut, high and low sheen)
  - Oak veneer (rift cut, high and low sheen)

## Tapered legs

- Solid maple (quarter cut, high and low sheen)
- Solid walnut (quarter cut, high and low sheen)
- Painted steel

*Tip: Group 3 paints are not available on tables.*

## Cylinder wood legs

- Solid oak (rift cut, high and low sheen)

## Modern metal legs

- Painted steel
- Tip: Group 3 paints are not available on tables.*

## Program and Services

**Customer's Own Material/Leather (COM/COL) Program** is available.

► See *Coalesse Surface Materials Reference Guide* for additional information.

# Circa Lounge System Thought Starters and Applications

DESIGN ALISON SPEAR, AIA

## Modern Metal Legs, Shared Application

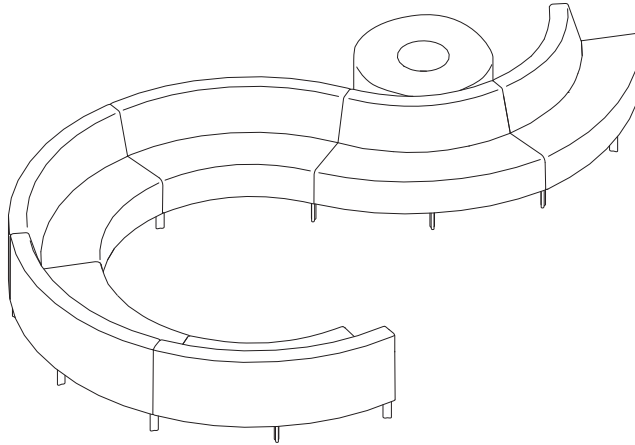

Quantity	Style Number	Description	Options
1	451-7460FI	60° Inside Wedge 2-Seat Lounge	5 Leg
3	451-7460FI	60° Inside Wedge 2-Seat Lounge	3 Leg (Shared)
2	451-7460FO	60° Outside Wedge 2-Seat Lounge	3 Leg (Shared)
1	45-T42RD	Freestanding Round Table	

# Circa Lounge System Thought Starters and Applications

DESIGN ALISON SPEAR, AIA

## Cylinder Wood Legs, Shared Application

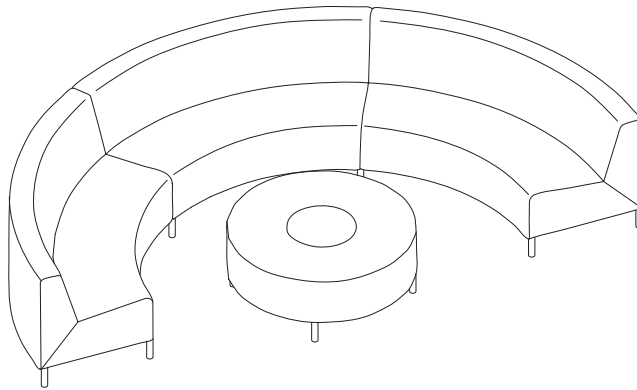

Lounge Seating

Quantity	Style Number	Description	Options
1	451-7460FI	60° Inside Wedge 2-Seat Lounge	5 Leg
2	451-7460FI	60° Inside Wedge 2-Seat Lounge	3 Leg (Shared)
1	45-T42RD	Freestanding Round Table	

# Circa Lounge System Thought Starters and Applications *continued*

DESIGN ALISON SPEAR, AIA

## Tapered Metal Legs, Non-Shared Application

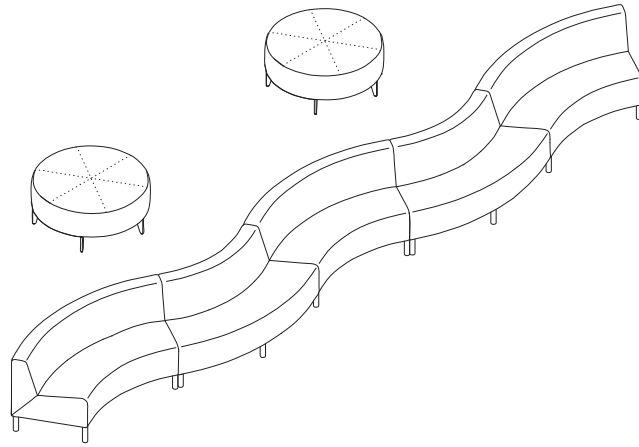

Quantity	Style Number	Description
3	451-7460FI	60° Inside Wedge 2-Seat Lounge
2	451-7460FO	60° Outside Wedge 2-Seat Lounge
2	451-B42RD	Freestanding Round Ottoman

# Circa Lounge System Thought Starters and Applications

DESIGN ALISON SPEAR, AIA

## Cylinder Wood Legs, Shared Application

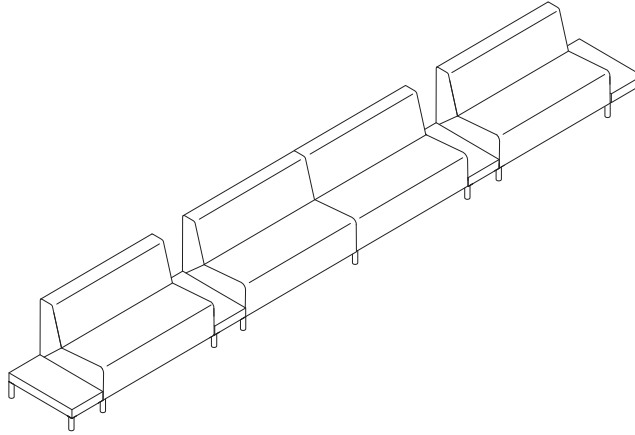

Lounge Seating

Quantity	Style Number	Description	Options
3	451-5000	Straight 2-Seat Lounge	4 Leg
1	451-5000	Straight 2-Seat Lounge	2 Leg (Shared)
2	45-T1300LG	Straight Low Table, Ganging	
2	45-T1300LER	Straight Low Table, End-of-Run	

# Circa Lounge System Upholstered Individual Lounge Units

DESIGN ALISON SPEAR, AIA

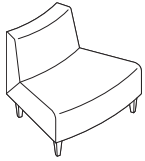

*Tip: Fabrics and leathers will appear loose with comfort wrinkles when upholstered.*

*Tip: For contrasting fabric, pricing is based on highest group textile specified.*

*Tip: For Customer's Own Material or Leather, see necessary requirements, important processing instructions, and ordering information*  
 ► See *Coalesse Surface Materials Reference Guide*.

*Tip: Benches are flat and 1-seat and 2-seat lounges are angled; therefore, seat angles will not be aligned when placed next to each other. A table is recommended between the units to minimize the difference.*

*Tip: All legs measure 6½" in height.*

*Tip: The 60° inside and outside wedge lounges and benches have five legs (if not sharing legs). If metal legs are selected, the upcharge is per leg.*

Standard Includes		Required to Specify	
► Need help? Product details, page 42	<ul style="list-style-type: none"> <li>• Frame: unibody construction of hardwood plywood utilizing box joinery</li> <li>• Upholstery: multiple densities of polyurethane foam fixed seat and back with top stitch on seams</li> <li>• Legs:                             <ul style="list-style-type: none"> <li>- Tapered leg, if selected: solid maple or walnut</li> <li>- Cylinder leg, if selected: solid oak</li> </ul> </li> </ul>	<ol style="list-style-type: none"> <li>1 Style number</li> <li>2 Number of fabrics if contrasting fabric style number is selected</li> <li>3 Fabric or leather color number for upholstery on seat and back</li> <li>4 Wood leg type</li> <li>5 Wood color number for legs</li> <li>6 Options, if selected (see below)</li> </ol> ► See <i>Coalesse Surface Materials Reference Guide</i> .	
Options		U.S. Price	Required to Specify
<b>Surface Materials</b>	<ul style="list-style-type: none"> <li>• Contrasting fabric</li> </ul>	+\$192 per fabric	Add suffix K to the style number and select fabric color number.
	<b>Acrylic backer</b>		
	<ul style="list-style-type: none"> <li>• 30° outside facing wedge 1-seat lounge</li> <li>• 30° inside facing wedge seat 1-seat lounge</li> <li>• 60° outside and inside wedge 2-seat lounge</li> <li>• 60° benches</li> <li>• Straight 1-seat lounge</li> <li>• Straight 2-seat lounge</li> <li>• Straight bench</li> </ul>	+\$ 52 +\$ 53 +\$ 93 +\$ 63 +\$ 36 +\$ 78 +\$ 50	Specify with acrylic backer. Specify with acrylic backer. Specify with acrylic backer. Specify with acrylic backer. Specify with acrylic backer. Specify with acrylic backer. Specify with acrylic backer. Specify with acrylic backer.
<b>Shared Leg Application</b>	<ul style="list-style-type: none"> <li>• Cylinder wood legs</li> <li>• Modern metal legs</li> </ul>	-\$292 -\$292	Specify with cylinder wood legs. Specify with modern metal legs.
<b>Metal Legs</b>	<b>Tapered legs</b>		
	<ul style="list-style-type: none"> <li>• Group 1 paint</li> <li>• Group 3 paint</li> </ul>	+\$220 per leg +\$250 per leg	Specify with tapered metal legs and select paint color number. ► See <i>Coalesse Surface Materials Reference Guide</i> . Specify with tapered metal legs and select paint color number. ► See <i>Coalesse Surface Materials Reference Guide</i> .
	<b>Modern legs</b>		
	<ul style="list-style-type: none"> <li>• Group 1 paint</li> <li>• Group 3 paint</li> </ul>	+\$220 per leg +\$250 per leg	Specify with modern metal legs and select paint color number. ► See <i>Coalesse Surface Materials Reference Guide</i> . Specify with modern metal legs and select paint color number. ► See <i>Coalesse Surface Materials Reference Guide</i> .
<b>Related Products</b>	<ul style="list-style-type: none"> <li>• Modular tables</li> </ul>		► Page 56

 **For Canadian Pricing**  
 Multiply U.S. Price by the Canadian price factor.  
 ► See page 1 for details.

# Circa Lounge System Upholstered Individual Lounge Units

DESIGN ALISON SPEAR, AIA

**Specification Information**

Style Number	U.S. Base Prices										Leather Groups:		
	Fabric Groups:										COL		
	COM	1	2	3	4	5	6	7	8	9	10	1	2

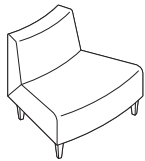

Overall: 28"D 36¾"W 29½"H  
 Inside: 20"D 36¾"W 12¼"H  
 Seat: 17¼"H  
 Angle Degree: 30°

### 30° Outside Facing Wedge 1-Seat Lounge

451-3730FO	\$2253	\$2253	\$2357	\$2444	\$2545	\$2700	\$2892	\$3112	\$3345	\$3550	\$3769	\$2781	\$5046	\$5496
------------	--------	--------	--------	--------	--------	--------	--------	--------	--------	--------	--------	--------	--------	--------

COM/yds = 3¼, COL/sq ft = 72

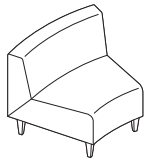

Overall: 28"D 38"W 29½"H  
 Inside: 20"D 36¾"W 12¼"H  
 Seat: 17¼"H  
 Angle Degree: 30°

### 30° Inside Facing Wedge 1-Seat Lounge

451-3730FI	\$2253	\$2253	\$2357	\$2444	\$2545	\$2700	\$2892	\$3112	\$3345	\$3550	\$3769	\$2781	\$5046	\$5496
------------	--------	--------	--------	--------	--------	--------	--------	--------	--------	--------	--------	--------	--------	--------

COM/yds = 3¼, COL/sq ft = 72

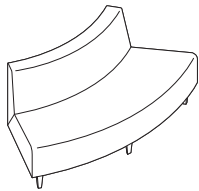

Overall: 28"D 71"W 29½"H  
 Inside: 20"D 71"W 12¼"H  
 Seat: 17¼"H  
 Angle Degree: 60°

### 60° Outside Wedge 2-Seat Lounge

451-7460FO	\$3776	\$3776	\$3929	\$4056	\$4203	\$4430	\$4711	\$5031	\$5372	\$5671	\$5992	\$4290	\$8915	\$9810
------------	--------	--------	--------	--------	--------	--------	--------	--------	--------	--------	--------	--------	--------	--------

COM/yds = 4½, COL/sq ft = 99

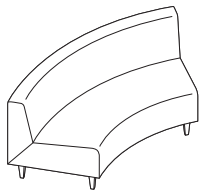

Overall: 28"D 71"W 29½"H  
 Inside: 20"D 71"W 12¼"H  
 Seat: 17¼"H  
 Angle Degree: 60°

### 60° Inside Wedge 2-Seat Lounge

451-7460FI	\$3702	\$3702	\$3855	\$3982	\$4129	\$4356	\$4637	\$4957	\$5298	\$5597	\$5918	\$4216	\$8841	\$9736
------------	--------	--------	--------	--------	--------	--------	--------	--------	--------	--------	--------	--------	--------	--------

COM/yds = 4¾, COL/sq ft = 105

► Specification Information, continued on next page



**For Canadian Pricing**  
 Multiply U.S. Price by the Canadian price factor.  
 ► See page 1 for details.

# Circa Lounge System Upholstered Individual Lounge Units *continued*

DESIGN ALISON SPEAR, AIA

► Specification Information, continued from previous page

## Specification Information

Style Number	U.S. Base Prices										Leather Groups:			
	Fabric Groups:										COL	1	2	
	COM	1	2	3	4	5	6	7	8	9	10			

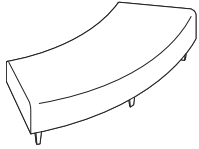

Overall: 28"D 71"W 17¼"H  
 Seat: 17¼"H  
 Angle Degree: 60°

### 60° Outside Wedge Bench

451-B7460FO	\$2843	\$2843	\$2940	\$3019	\$3113	\$3257	\$3434	\$3636	\$3852	\$4039	\$4242	\$3364	\$5449	\$5871
-------------	--------	--------	--------	--------	--------	--------	--------	--------	--------	--------	--------	--------	--------	--------

COM/yds = 3, COL/sq ft = 66

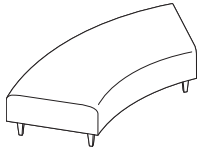

Overall: 28"D 71"W 17¼"H  
 Seat: 17¼"H  
 Angle Degree: 60°

### 60° Inside Wedge Bench

451-B7460FI	\$2843	\$2843	\$2940	\$3019	\$3113	\$3257	\$3434	\$3636	\$3852	\$4039	\$4242	\$3364	\$5449	\$5871
-------------	--------	--------	--------	--------	--------	--------	--------	--------	--------	--------	--------	--------	--------	--------

COM/yds = 3, COL/sq ft = 66

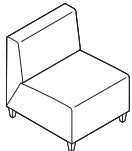

Overall: 28"D 25"W 29½"H  
 Inside: 20"D 25"W 12¼"H  
 Seat: 17¼"H  
 Angle Degree: 0°

### Straight 1-Seat Lounge

451-2500	\$2027	\$2027	\$2107	\$2174	\$2252	\$2371	\$2519	\$2687	\$2867	\$3024	\$3193	\$2548	\$4263	\$4608
----------	--------	--------	--------	--------	--------	--------	--------	--------	--------	--------	--------	--------	--------	--------

COM/yds = 2½, COL/sq ft = 55

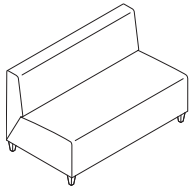

Overall: 28"D 50"W 29½"H  
 Inside: 20"D 50"W 12¼"H  
 Seat: 17¼"H  
 Angle Degree: 0°

### Straight 2-Seat Lounge

451-5000	\$2998	\$2998	\$3127	\$3233	\$3358	\$3549	\$3785	\$4055	\$4342	\$4593	\$4863	\$3519	\$7053	\$7742
----------	--------	--------	--------	--------	--------	--------	--------	--------	--------	--------	--------	--------	--------	--------

COM/yds = 4, COL/sq ft = 83

► Specification Information, continued on next page



**For Canadian Pricing**  
 Multiply U.S. Price by the  
 Canadian price factor.  
 ► See page 1 for details.

# Circa Lounge System Upholstered Individual Lounge Units

DESIGN ALISON SPEAR, AIA

► Specification Information, continued from previous page

**Specification Information**

Style Number	U.S. Base Prices										Leather Groups:		
	Fabric Groups:										COL		
	COM	1	2	3	4	5	6	7	8	9	10	1	2

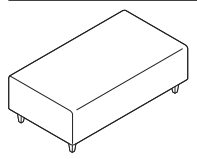

Overall: 28"D 50"W 17¼"H  
 Seat: 17¼"H  
 Angle Degree: 0°

## Straight Bench

451-B5000	\$2589	\$2589	\$2686	\$2765	\$2859	\$3003	\$3180	\$3382	\$3598	\$3785	\$3988	\$3103	\$5202	\$5603
-----------	--------	--------	--------	--------	--------	--------	--------	--------	--------	--------	--------	--------	--------	--------

COM/yds = 3, COL/sq ft = 66

## Ganging Kit

451-GANGPKG	\$ 61	N.A.	N.A.	N.A.	N.A.	N.A.	N.A.	N.A.	N.A.	N.A.	N.A.	N.A.	N.A.	N.A.
-------------	-------	------	------	------	------	------	------	------	------	------	------	------	------	------

*Tip: Please submit sketch for modular application. One kit is required per two chairs.*

Lounge Seating

**For Canadian Pricing**  
 Multiply U.S. Price by the Canadian price factor.  
 ► See page 1 for details.

# Circa Lounge System Upholstered Modular Arm Rests—Straight, 15°, 30°, and Ottoman

DESIGN ALISON SPEAR, AIA

*Tip: Fabrics and leathers will appear loose with comfort wrinkles when upholstered.*

*Tip: Cylinder wood and modern metal legs cannot be in shared position with armrests. The legs will always be on the lounge side.*

*Tip: For Customer's Own Material or Leather, see necessary requirements, important processing instructions, and ordering information*  
 ▶ See *Coalesse Surface Materials Reference Guide*.

*Tip: All legs measure 6½" in height.*

*Tip: The round ottoman has five legs. If metal legs are selected, the upcharge is per leg.*

Standard Includes	Required to Specify
▶ Need help? Product details, page 42 • Frame: hardwood panels • Upholstery: multiple densities of polyurethane • Top stitch on seams • Legs: – Tapered leg, if selected: solid maple or walnut – Cylinder leg, if selected: solid oak	1 Style number 2 Fabric or leather color number for arm rests 3 Wood leg type 4 Wood color number for legs 5 Options, if selected (see below) ▶ See <i>Coalesse Surface Materials Reference Guide</i> .

Options	U.S. Price	Required to Specify
<b>Surface Materials</b> • Contrasting fabric on ottoman	+\$192	Add suffix K to the style number and select fabric color number.
<b>Acrylic backer</b> • Straight armrests and 15° armrests • 30° armrests and ottoman	+\$ 30 +\$ 52	Specify with acrylic backer. ▶ See <i>Coalesse Surface Materials Reference Guide</i> . Specify with acrylic backer. ▶ See <i>Coalesse Surface Materials Reference Guide</i> .
<b>Metal Legs</b> <b>Tapered legs</b> • Group 1 paint • Group 3 paint <b>Modern legs</b> • Group 1 paint • Group 3 paint	+\$220 per leg +\$250 per leg +\$220 per leg +\$250 per leg	Specify with tapered metal legs and select paint color number. ▶ See <i>Coalesse Surface Materials Reference Guide</i> . Specify with tapered metal legs and select paint color number. ▶ See <i>Coalesse Surface Materials Reference Guide</i> . Specify with modern metal legs and select paint color number. ▶ See <i>Coalesse Surface Materials Reference Guide</i> . Specify with modern metal legs and select paint color number. ▶ See <i>Coalesse Surface Materials Reference Guide</i> .
<b>Related Products</b> • Modular tables		▶ Page 56

## Specification Information

Style Number	U.S. Base Prices										Leather Groups:		
	Fabric Groups:										COL	1	2
COM	1	2	3	4	5	6	7	8	9	10			



Overall: 28"D 18½"W 17"H

### Straight Armrest—Intermediate without Legs

451-A1800G	\$1248	\$1248	\$1321	\$1381	\$1451	\$1558	\$1691	\$1843	\$2004	\$2146	\$2298	\$1708	\$3031	\$3298
------------	--------	--------	--------	--------	--------	--------	--------	--------	--------	--------	--------	--------	--------	--------

COM/yds = 2¼, COL/sq ft = 50



Overall: 28"D 18½"W 23½"H  
 Tip: Specify left or right facing.

### Straight Armrest—End-of-Run with Two Legs

451-A1800ER	\$1446	\$1446	\$1519	\$1579	\$1649	\$1756	\$1889	\$2041	\$2202	\$2344	\$2496	\$1906	\$3229	\$3496
-------------	--------	--------	--------	--------	--------	--------	--------	--------	--------	--------	--------	--------	--------	--------

COM/yds = 2¼, COL/sq ft = 50

▶ Specification Information, continued on next page

# Circa Lounge System Upholstered Modular Arm Rests—Straight, 15°, 30°, and Ottoman

DESIGN ALISON SPEAR, AIA

► Specification Information, continued from previous page

## Specification Information

Style Number	U.S. Base Prices										Leather Groups:		
	Fabric Groups:										COL		
	COM	1	2	3	4	5	6	7	8	9	10	1	2



Overall: 28<sup>3</sup>/<sub>8</sub>"D 18<sup>1</sup>/<sub>2</sub>"W 17"H

### 15° Inside Armrest—Intermediate without Legs

451-A1815FIG	\$1238	\$1238	\$1302	\$1356	\$1418	\$1513	\$1632	\$1767	\$1910	\$2036	\$2171	\$1698	\$2862	\$3095
--------------	--------	--------	--------	--------	--------	--------	--------	--------	--------	--------	--------	--------	--------	--------

COM/yds = 2, COL/sq ft = 44

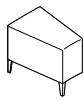

Overall: 28<sup>3</sup>/<sub>8</sub>"D 18<sup>1</sup>/<sub>2</sub>"W 23<sup>1</sup>/<sub>2</sub>"H  
 Tip: Specify left or right facing.

### 15° Inside Armrest—End-of-Run with Two Legs

451-A1815FIER	\$1520	\$1520	\$1584	\$1638	\$1700	\$1795	\$1914	\$2049	\$2192	\$2318	\$2453	\$1980	\$3144	\$3377
---------------	--------	--------	--------	--------	--------	--------	--------	--------	--------	--------	--------	--------	--------	--------

COM/yds = 2, COL/sq ft = 44

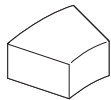

Overall: 29<sup>1</sup>/<sub>2</sub>"D 36<sup>3</sup>/<sub>4</sub>"W 17"H

### 30° Inside Arm Rest—Intermediate without Legs

451-A3730FIG	\$1765	\$1765	\$1862	\$1941	\$2035	\$2179	\$2356	\$2558	\$2774	\$2961	\$3164	\$2225	\$4016	\$4374
--------------	--------	--------	--------	--------	--------	--------	--------	--------	--------	--------	--------	--------	--------	--------

COM/yds = 3, COL/sq ft = 66

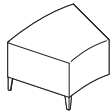

Overall: 29<sup>1</sup>/<sub>2</sub>"D 36<sup>3</sup>/<sub>4</sub>"W 23<sup>1</sup>/<sub>2</sub>"H  
 Tip: Specify left or right facing.

### 30° Inside Arm Rest—End-of-Run with Two Legs

451-A3730FIER	\$1980	\$1980	\$2077	\$2156	\$2250	\$2394	\$2571	\$2773	\$2989	\$3176	\$3379	\$2440	\$4231	\$4589
---------------	--------	--------	--------	--------	--------	--------	--------	--------	--------	--------	--------	--------	--------	--------

COM/yds = 3, COL/sq ft = 66



Overall: 28<sup>3</sup>/<sub>8</sub>"D 18<sup>1</sup>/<sub>2</sub>"W 17"H

### 15° Outside Armrest—Intermediate without Legs

451-A1815FOG	\$1238	\$1238	\$1302	\$1356	\$1418	\$1513	\$1632	\$1767	\$1910	\$2036	\$2171	\$1698	\$2862	\$3095
--------------	--------	--------	--------	--------	--------	--------	--------	--------	--------	--------	--------	--------	--------	--------

COM/yds = 2, COL/sq ft = 44

► Specification Information, continued on next page



**For Canadian Pricing**  
 Multiply U.S. Price by the Canadian price factor.  
 ► See page 1 for details.

# Circa Lounge System Upholstered Modular Arm Rests—Straight, 15°, 30°, and Ottoman *continued*

DESIGN ALISON SPEAR, AIA

► Specification Information, continued from previous page

## Specification Information

Style Number	U.S. Base Prices										Leather Groups:	
	Fabric Groups:										COL	
COM	1	2	3	4	5	6	7	8	9	10	1	2



Overall: 28¾"D 18½"W 23½"H  
Tip: Specify left or right facing.

### 15° Outside Armrest—End-of-Run with Two Legs

451-A1815FOER	\$1520	\$1520	\$1584	\$1638	\$1700	\$1795	\$1914	\$2049	\$2192	\$2318	\$2453	\$1980	\$3144	\$3377
---------------	--------	--------	--------	--------	--------	--------	--------	--------	--------	--------	--------	--------	--------	--------

COM/yds = 2, COL/sq ft = 44

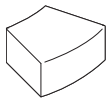

Overall: 29½"D 36¾"W 17"H

### 30° Outside Arm Rest—Intermediate without Legs

451-A3730FOG	\$1765	\$1765	\$1862	\$1941	\$2035	\$2179	\$2356	\$2558	\$2774	\$2961	\$3164	\$2225	\$4016	\$4374
--------------	--------	--------	--------	--------	--------	--------	--------	--------	--------	--------	--------	--------	--------	--------

COM/yds = 3, COL/sq ft = 66

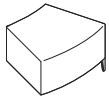

Overall: 29½"D 36¾"W 23½"H  
Tip: Specify left or right facing.

### 30° Outside Arm Rest—End-of-Run with Two Legs

451-A3730FOER	\$1980	\$1980	\$2077	\$2156	\$2250	\$2394	\$2571	\$2773	\$2989	\$3176	\$3379	\$2440	\$4231	\$4589
---------------	--------	--------	--------	--------	--------	--------	--------	--------	--------	--------	--------	--------	--------	--------

COM/yds = 3, COL/sq ft = 66

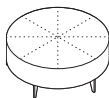

Overall: 42" Dia. 17"H

### Round Ottoman with Five Legs

451-B42RD	\$2700	\$2700	\$2804	\$2891	\$2992	\$3147	\$3339	\$3559	\$3792	\$3997	\$4216	\$3160	\$5116	\$5496
-----------	--------	--------	--------	--------	--------	--------	--------	--------	--------	--------	--------	--------	--------	--------

COM/yds = 3¼, COL/sq ft = 72

### Ganging Kit

451-GANGPKG	\$ 61	N.A.	N.A.	N.A.	N.A.	N.A.	N.A.	N.A.	N.A.	N.A.	N.A.	N.A.	N.A.	N.A.
-------------	-------	------	------	------	------	------	------	------	------	------	------	------	------	------

Tip: Please submit sketch for modular application. One kit is required per two chairs.



**For Canadian Pricing**  
Multiply U.S. Price by the Canadian price factor.

► See page 1 for details.

Coalesse

# Circa Lounge System Upholstered Modular Arm Rests—Straight, 15°, 30°, and Ottoman

DESIGN ALISON SPEAR, AIA

# Circa Lounge System Modular Tables

DESIGN ALISON SPEAR, AIA

	Standard Includes	Required to Specify
<p>► Need help? Product details, page 42</p>	<ul style="list-style-type: none"> <li>• Table: hardwood veneer</li> <li>• Legs:                             <ul style="list-style-type: none"> <li>- Tapered leg, if selected: solid maple or walnut</li> <li>- Cylinder leg, if selected: solid oak</li> </ul> </li> <li>• Brackets and hardware, if ganging or end-of-run tables selected</li> </ul>	<ol style="list-style-type: none"> <li>1 Style number</li> <li>2 Wood veneer color number for table</li> <li>3 Wood leg type</li> <li>4 Wood color number for legs</li> <li>5 Options, if selected (see below)</li> </ol> <p>► See <i>Coalesse Surface Materials Reference Guide</i>.</p>

	Options	U.S. Price	Required to Specify
<b>Surface Materials</b>	<p><b>Table</b></p> <ul style="list-style-type: none"> <li>• Laminate with self edge</li> </ul>	Prices below	<p>Specify <i>with laminate</i> and select laminate color number.</p> <p>► See <i>Coalesse Surface Materials Reference Guide</i>.</p>
<b>Metal Legs</b>	<p><b>Tapered legs</b></p> <ul style="list-style-type: none"> <li>• Group 1 paint</li> </ul>	+\$220 per leg	<p>Specify <i>with tapered metal legs</i> and select paint color number.</p> <p>► See <i>Coalesse Surface Materials Reference Guide</i>.</p>
	<p><b>Modern legs</b></p> <ul style="list-style-type: none"> <li>• Group 1 paint</li> </ul>	+\$220 per leg	<p>Specify <i>with modern metal legs</i> and select paint color number.</p> <p>► See <i>Coalesse Surface Materials Reference Guide</i>.</p>
<b>Related Products</b>	<ul style="list-style-type: none"> <li>• Lounge seating</li> </ul>		► Pages 48-52

*Tip: All legs measure 6 1/2" in height.*

Specification Information		
Style Number	U.S. Base Prices	
	Laminate	Wood Veneer

## 15° Low Wedge Table, Ganging

45-T1815LG	\$1911	\$2199
------------	--------	--------

## 15° Low Wedge Table, End-of-Run, Two Legs

45-T1815LER	\$2048	\$2495
-------------	--------	--------

## 15° High Wedge Table, Ganging

45-T1815HG	\$2425	\$3035
------------	--------	--------

## 15° High Wedge Table, End-of-Run, Two Legs

45-T1815HER	\$2558	\$3318
-------------	--------	--------

► Specification Information, continued on next page

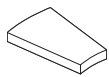

Overall: 28"D 18 1/2"W 8 1/2"H  
Angle Degree: 15°

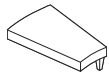

Overall: 28"D 18 1/2"W 8 1/2"H  
Angle Degree: 15°

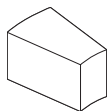

Overall: 28"D 18 1/2"W 22 1/2"H  
Angle Degree: 15°

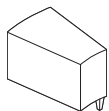

Overall: 28"D 18 1/2"W 22 1/2"H  
Angle Degree: 15°



**For Canadian Pricing**  
Multiply U.S. Price by the Canadian price factor.  
► See page 1 for details.

# Circa Lounge System Modular Tables

DESIGN ALISON SPEAR, AIA

► Specification Information, continued from previous page

## Specification Information

Style Number	U.S. Base Prices	
	Laminate	Wood Veneer

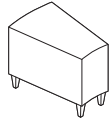

Overall: 28"D 18½"W 22½"H  
Angle Degree: 15°

### 15° High Wedge Table, Freestanding, Four Legs

45-T1815H	\$2693	\$3620
-----------	--------	--------

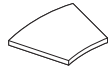

Overall: 29"D 36⅝"W 2"H  
(8½" from floor once assembled)

### 30° Low Wedge Table, Ganging

45-T3730LG	\$2394	\$2692
------------	--------	--------

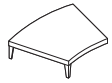

Overall: 29"D 36⅝"W 8½"H

### 30° Low Wedge Table, End-of-Run, Two Legs

45-T3730LER	\$2532	\$3012
-------------	--------	--------

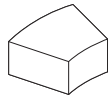

Overall: 29"D 36⅝"W 16"H

### 30° High Wedge Table, Ganging

45-T3730HG	\$3363	\$3837
------------	--------	--------

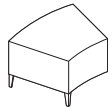

Overall: 29"D 36⅝"W 22½"H

### 30° High Wedge Table, End-of-Run, Two Legs

45-T3730HER	\$3499	\$4149
-------------	--------	--------

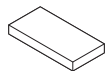

Overall: 27½"D 13½"W 8½"H  
Angle Degree: 0°

### Straight Low Table, Ganging

45-T1300LG	\$1907	\$2148
------------	--------	--------

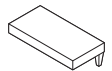

Overall: 27½"D 13½"W 8½"H  
Angle Degree: 0°

### Straight Low Table, End-of-Run, Two Legs

45-T1300LER	\$2048	\$2495
-------------	--------	--------

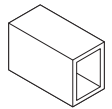

Overall: 27½"D 13½"W 22½"H  
Angle Degree: 0°

### Straight High Table, Ganging

45-T1300HG	\$2806	\$3440
------------	--------	--------

► Specification Information, continued on next page



**For Canadian Pricing**  
Multiply U.S. Price by the Canadian price factor.  
► See page 1 for details.

# Circa Lounge System Modular Tables *continued*

DESIGN ALISON SPEAR, AIA

► Specification Information, continued from previous page

## Specification Information

Style Number	U.S. Base Prices	
	Laminate	Wood Veneer

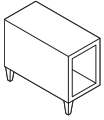

Overall: 27½"D 13½"W 22½"H  
Angle Degree: 0°

### Straight High Table, End-of-Run, Two Legs

45-T1300HER	\$3180	\$4028
-------------	--------	--------

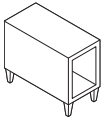

Overall: 27½"D 13½"W 22½"H  
Angle Degree: 0°

### Straight High Table, Freestanding, Four Legs

45-T1300H	\$3314	\$4269
-----------	--------	--------



Overall: 13¾"D 27½"W 22¼"H  
(8½" from floor once assembled)  
Tip: Model 45-T28HER has only a single width tapered leg, no corner.

### 30° End-of-Run, One Leg

45-T28HER	\$2639	\$3252
-----------	--------	--------

#### Options for Creating 90° Applications:

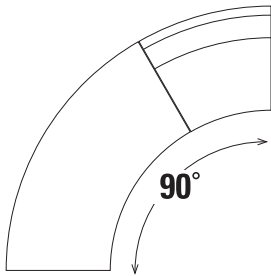

- (1) 30° Outside or Inside Facing Wedge Seat
- (1) 60° Wedge Bench

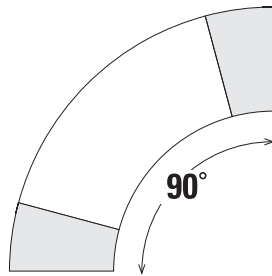

- (2) 15° Wedge Tables
- (1) 60° Wedge Bench

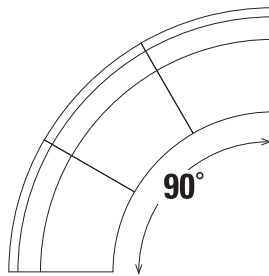

- (3) 30° Outside or Inside Facing Wedge Seats

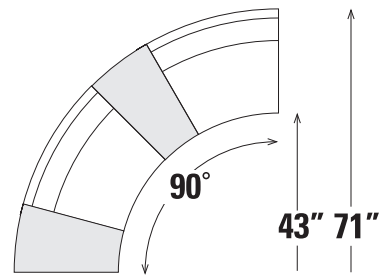

- (2) 30° Outside or Inside Facing Wedge Seats
- (2) 15° Wedge Tables



**For Canadian Pricing**  
Multiply U.S. Price by the Canadian price factor.  
► See page 1 for details.

# Circa Lounge System Freestanding Round Table

DESIGN ALISON SPEAR, AIA

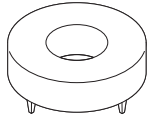

*Tip: All legs measure 6½" in height.*

*Tip: The round plate that houses the power/data module is powder coated to complement the power/data module finish. For the black anodized aluminum module, the round plate will be painted in 4710 Low Gloss Black. For the silver anodized aluminum module, the round plate will be painted 4799 Platinum.*

**Overall:** 42" dia. 15¾"H

*Tip: Tapered wood and metal legs have a thin, blade aesthetic.*

Standard Includes	Required to Specify
<ul style="list-style-type: none"> <li>▶ Need help? Product details, page 42</li> <li>• Table: laminate</li> <li>• Legs:                             <ul style="list-style-type: none"> <li>- Tapered leg, if selected: solid maple or walnut</li> <li>- Cylinder leg, if selected: solid oak</li> </ul> </li> </ul>	<ol style="list-style-type: none"> <li>1 Style number</li> <li>2 Laminate color number for table</li> <li>3 Wood leg type</li> <li>4 Wood color number for legs</li> <li>5 Options, if selected (see below)</li> </ol> ▶ See <i>Coalesse Surface Materials Reference Guide</i> .

	Options	U.S. Price	Required to Specify
<b>Surface Materials</b>	<b>Table</b> <ul style="list-style-type: none"> <li>• Wood veneer</li> </ul>	Price below	Specify <i>with wood veneer</i> and select wood color number. ▶ See <i>Coalesse Surface Materials Reference Guide</i> .
	<ul style="list-style-type: none"> <li>• Sunburst wood veneer</li> </ul>	Price below	Specify <i>with sunburst wood veneer</i> and select wood color number. ▶ See <i>Coalesse Surface Materials Reference Guide</i> .
<b>Metal Legs</b>	<b>Tapered legs</b> <ul style="list-style-type: none"> <li>• Group 1 paint</li> </ul>	+\$220 per leg	Specify <i>with tapered metal legs</i> and select paint color number. ▶ See <i>Coalesse Surface Materials Reference Guide</i> .
	<b>Modern legs</b> <ul style="list-style-type: none"> <li>• Group 1 paint</li> </ul>	+\$220 per leg	Specify <i>with modern metal legs</i> and select paint color number. ▶ See <i>Coalesse Surface Materials Reference Guide</i> .
<b>Glass Insert</b>	<ul style="list-style-type: none"> <li>• Green tinted glass insert ¾" thick with white enamel bottom square edge detail</li> </ul>	+\$431	Specify <i>with glass insert</i> .
<b>Power/Data Module</b>	<ul style="list-style-type: none"> <li>• Two power/two data ports black anodized aluminum or silver anodized aluminum</li> </ul>	+\$640	Specify finish color number.
<b>Related Products</b>	<ul style="list-style-type: none"> <li>• Lounge seating</li> </ul>		▶ Pages 48-52

Specification Information			
Style Number	U.S. Base Prices		
	Laminate	Wood Veneer	Sunburst Wood Veneer
<b>Round Table, Freestanding, Four Legs</b>			
45-T42RD	\$4541	\$6045	\$6511

 **For Canadian Pricing**  
Multiply U.S. Price by the Canadian price factor.  
▶ See page 1 for details.

# Circa Lounge System Multi-Fabric Diagram

DESIGN ALISON SPEAR, AIA

Applies to all Circa models including: Straight 1-Seat Lounge, Wedge, and Straight 2-Seat Lounge

TO: \_\_\_\_\_

FROM: \_\_\_\_\_

DATE: \_\_\_\_\_

FAX....888.413.5161

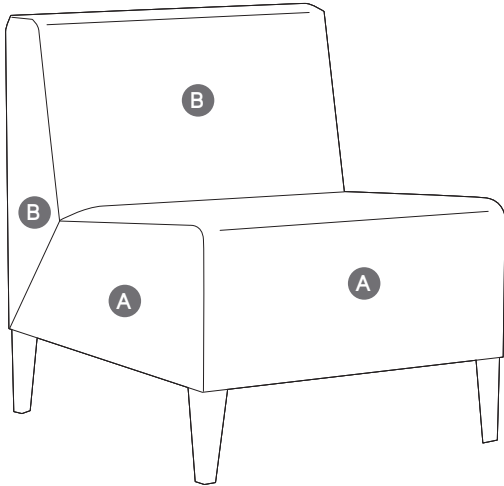

**A** Upholstery Selection (default for entire unit if B is not selected):

\_\_\_\_\_  
\_\_\_\_\_

**B** Back: \_\_\_\_\_

\_\_\_\_\_

Specify model below:

451-7460FOK Outside Facing

451-7460FIK Inside Facing

451-5000K

451-2500K

451-3730FOK Outside Facing

451-3730FIK Inside Facing

*See specifying for contrasting fabric upcharge. List price based on highest fabric group usage.*

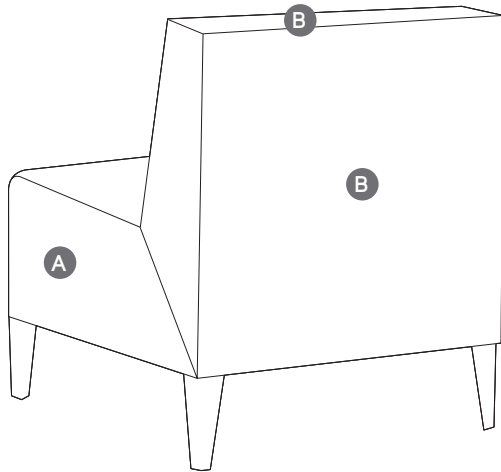

Coalesse

# Circa Lounge System Multi-Fabric Diagram

DESIGN ALISON SPEAR, AIA

# Coalesse Ensemble General Overview

DESIGN COALESSE DESIGN GROUP

**Designed for gathering that really works.** Coalesse Ensemble is a fluid, modular lounge system featuring an ingenious, intuitive performance back, proximity to power and companion screens for privacy, and infinite design expression with color, materials, and organic shapes.

**Individual modular lounges** are available as 1- and 2-seat units that can be ganged together for endless straight-run configurations by using the lounge connector kit. Personalize the lounge with an end of run armrest, metal or wood feet, varying in-line tables and planters, and power.

**Standalone lounges** are available as 1- and 2-seat units and come preassembled with choice of metal or wood feet. These styles can be specified armless, right or left arm, or with two arms.

**Freestanding screens** are available in three heights. Low screens are 51<sup>2</sup>/<sub>5</sub>"H, medium screens are 62<sup>7</sup>/<sub>10</sub>"H, and high screens are 78<sup>1</sup>/<sub>2</sub>"H. Screens are available in straight, corner, and J shapes.

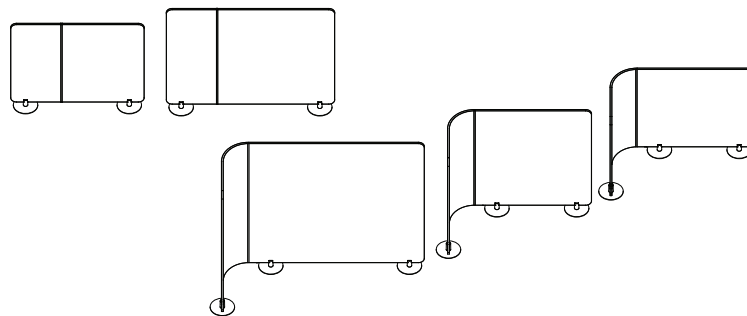
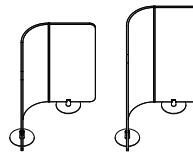
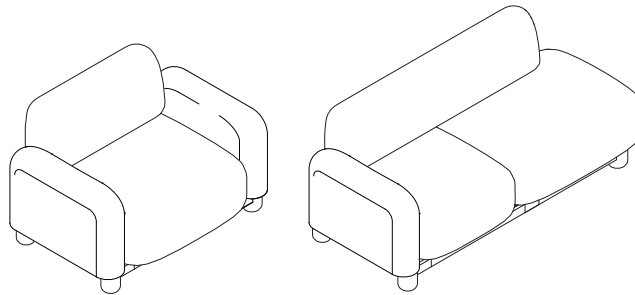
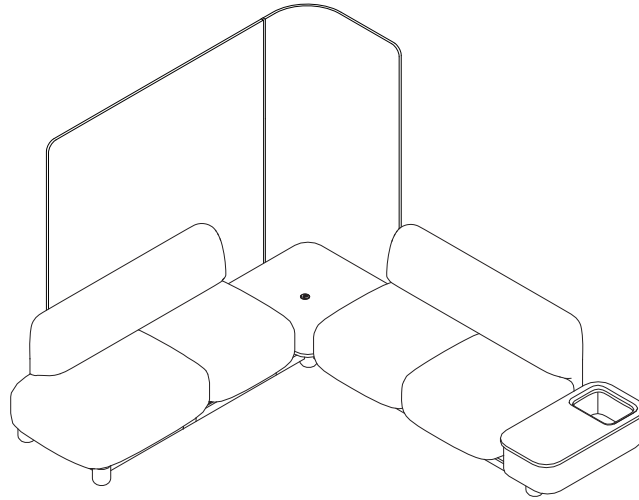

# Coalesse Ensemble General Overview

DESIGN COALESSE DESIGN GROUP

- **Modular design** allows individual components to be easily reconfigured by an installer.
- **Modular lounges** can be specified armless, right or left arm, or with two arms.

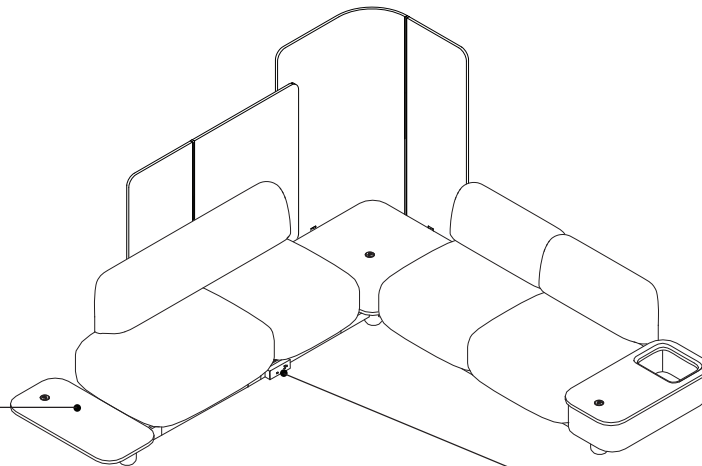

**Contrasting fabric** is available on seat and back cushions. If armrest(s) are selected, they will match the seat cushion. Note, to have the armrest(s) to match the seat back, or contrast the lounge unit all together, order the end armrest separately (COENLEA).

**In-line tables** are offered in two shapes: rectangular and square. Tables are standard in High-Pressure Laminate with 3/16 mm plastic edge and veneer. Optional power module can be specified as a one power or one USB A/C configuration.

**Lounge power module** is ordered separately and can be positioned anywhere along the attachment rail underneath the front lounge seat.

**Armrest** can be specified in end positions only, when next to a lounge unit. An exception is made for an in-line table or planter, which may be specified on the outside of an armrest. An armrest cannot be specified between two lounge units.

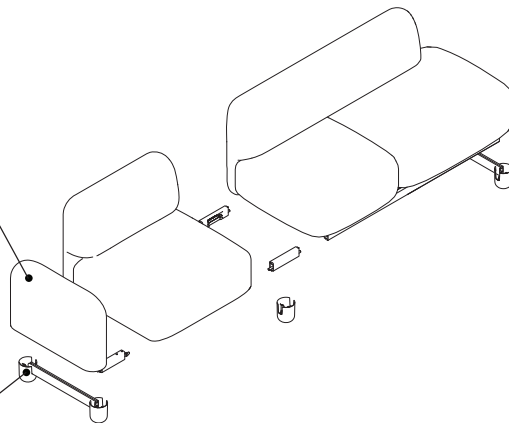

**Armrests** are fully upholstered and 23 1/4" H, from floor to top of armrest.

**Performance lounge seat back** allows user to change from a lounge position to a more upright task position within the same unit. An integrated pull strap is located on the top of the seat cushion. A simple pull activates the movement of the backrest. Release the pull strap to lock the backrest, when your desired comfort level is reached.

**Feet** are available in metal or wood choices. Feet are not included in the modular lounge styles and must be ordered separately.

**Adjustable glides** are standard on the lounge units. Each glide adjusts 1/2".

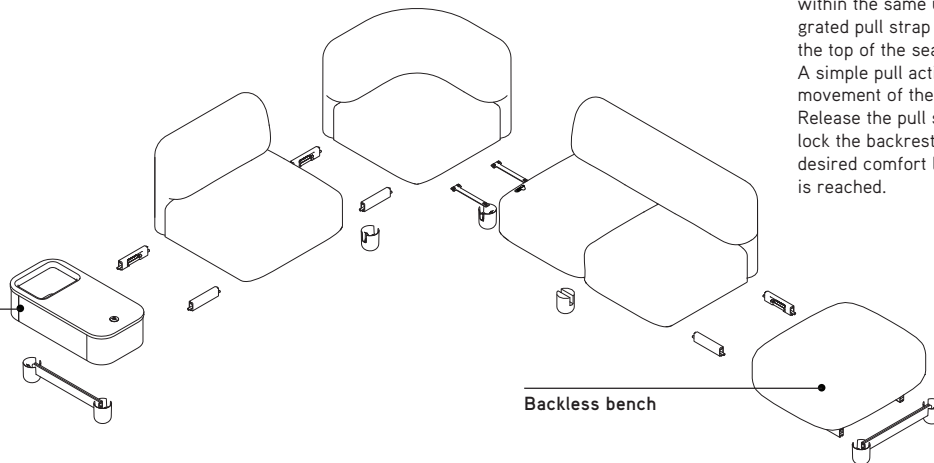

**Planter** is available with two liner inserts for hosting plants, or with one liner insert set within a laminate or veneer surface. Optional power module can be specified as a one power or one USB A/C configuration.

# Coalesse Ensemble General Overview *continued*

DESIGN COALESSE DESIGN GROUP

**Standalone lounges** are available as 1- and 2-seat units and come pre-assembled with choice of metal or wood feet.

**Lounges** can be specified armless, right or left arm, or with two arms.

**Armrests** are fully upholstered and 23¼"H, from floor to top of armrest.

**Adjustable glides** are standard on lounge units. Each glide can adjust ½" for uneven floors.

**Performance lounge seat back** allows user to change from a lounge position to a more upright task position within the same unit. An integrated pull strap is located on the top of the seat cushion. A simple pull activates the movement of the backrest. Release the pull strap to lock the backrest when desired comfort level is reached.

**Power module** is ordered separately and can be positioned anywhere along the attachment rail beneath the lounge seat.

**Contrasting fabric** is available on seat and back cushions. If arms are specified, they will match the seat cushion.

**Connectors (ganging kit)** are available and work on both modular lounge and standalone styles. Specify the modular lounge styles when looking to connect more than one module together.

**Feet** are available in metal or wood choices.

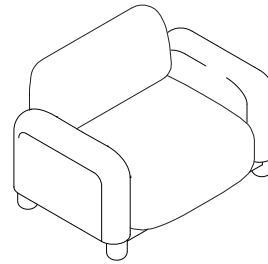
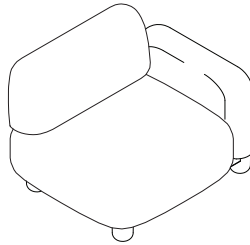
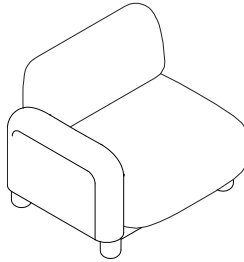
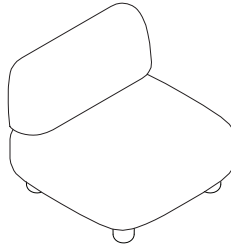

# Coalesse Ensemble General Overview

DESIGN COALESSE DESIGN GROUP

## Product Details

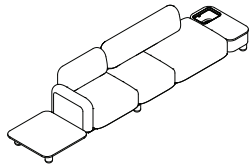

**Modular design** allows each component to be personalized with varying lounge and table choices. Create endless straight runs and gang them to create non-linear configurations. Individual components are assembled to a steel frame and connect to one another using steel connectors.



**Overall depth of each lounge unit, in-line table, and planter** is the same due to its modular design, allowing units to easily be reconfigured. Overall depth is 32 1/4".

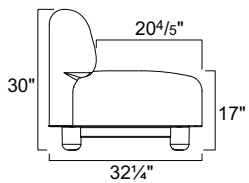

**17" seat height** is standard on all seating and benches and pairs with the Lagunitas 26"H work table height.

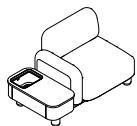

**Armrest** can be specified in end positions only, when next to a lounge unit. An exception is made for an in-line table or planter, which may be specified on the outside of an armrest. The armrest extends the overall width of the lounge by 6".

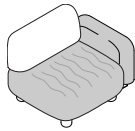

**Comfort wrinkles** are intended to occur over time to increase the comfort of Ensemble. Very little maintenance is required to reduce the definition; smooth the cushion fabric with a spreading/wiping motion.

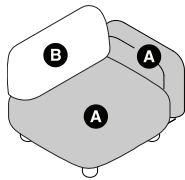

**Contrasting fabric** is available on seat, back, and arm cushions. When selecting contrasting fabric on a single unit with an armrest, the armrest will match the seat. Note, to have the armrest(s) match the seat back, or contrast the lounge unit all together, order the end armrest separately (COENLEA).

**Corner and chaise lounge units** are handed. Handedness is determined while in the seated position.

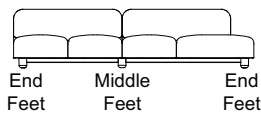

**Feet** are available in solid oak or painted and are specified separately based on desired configuration. Feet are required every 78". It is highly recommended to use CET SmartTools to confirm feet location before ordering.

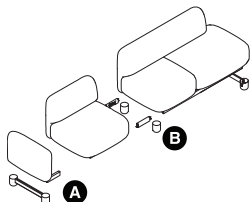

**End feet (A)** are specified at the end positions of each configuration.

**Middle feet (B)** are required for runs that span more than 78".

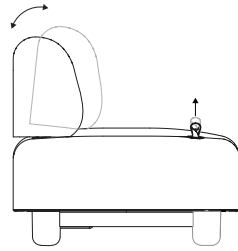

**Performance lounge seat** is activated by pulling up on the nylon pull strap. This strap is not specifiable and available only in black nylon.

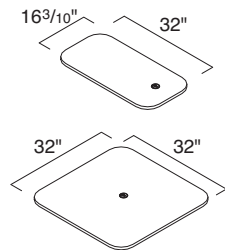

**In-line tables** are available in two sizes, 16 9/10"D x 32"W and 32"D x 32"W. The table surface comes standard in laminate with matching 0.6 mm flat edge band profile or wood veneer with matching 1 mm flat wood edge band.

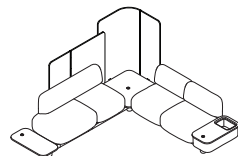

**The square in-line table** can be specified as a corner module in an "L" configuration. To achieve this, one (1) connector kit and one (1) corner ganging kit is needed.

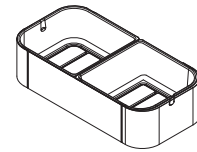
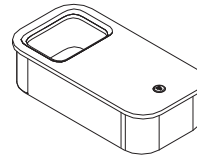

**Planters** are available and must be specified with one or two liner inserts. An optional top, available in laminate or veneer, is available with or without power.

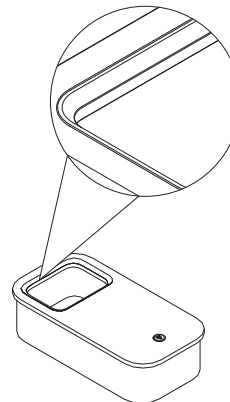

**The bezel** is found on the planter lid when specifying one insert. The bezel is available in milk, black, or graphite.

**Planters and in-line tables** can be specified at end of run, or in-line to create purposeful separation between lounge units.

**Clearance between the floor and rail** is 3".

## Connections

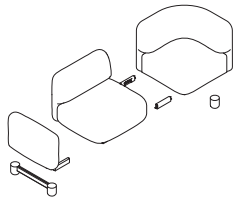

**The connector kit** gangs individual lounge, lounge to table, and lounge to planter units together.

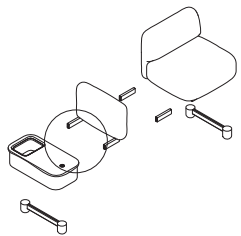

**Armrest end connector** is required only when connecting an in-line table or planter to an armrest. When connecting an armrest to a lounge unit, no additional connectors are needed.

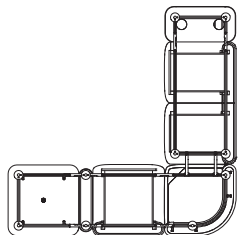

**Corner ganging kit** is required to create an "L" shaped configuration.

# Coalesse Ensemble General Overview *continued*

DESIGN COALESSE DESIGN GROUP

## Wiring & Cabling

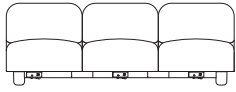

Lounge power modules are ordered separately and can be positioned anywhere along the attachment rail underneath the front of the lounge seat.

- Configurations available:
- 2 power, (1) USB A + (1) USB-C
  - 1 power, (1) USB C single 60W

Lounge power module is available in black.

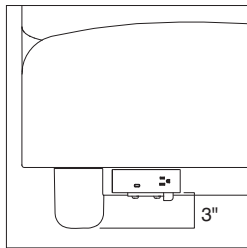

The power and USB power module options are located 3" from the floor.

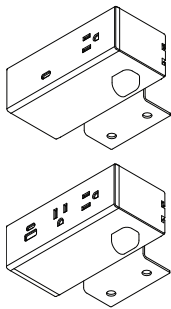

Lounge power modules have a 72"L cord with a 15-amp plug and contain wire manager clips to route cord under seat when desired. USB C single 60W can charge tablets and laptops.

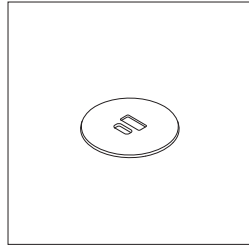
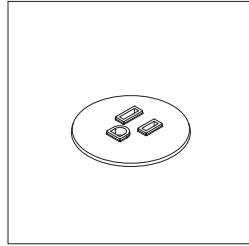

Single power or USB power module are available and can be specified with in-line tables and the planter. It comes with a 120"L power cord with 15-amp plug. The USB module has one USB A and one USB C 5V charging port. If a single USB module is specified, the 15-amp plug includes a built-in transformer measuring 2 1/8"D x 1 1/4"W x 3 1/2"H. The power modules are available in milk, black, or graphite.

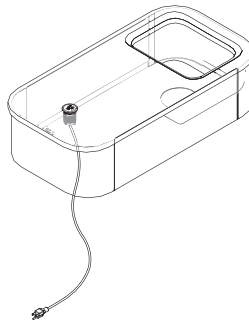

Planters route cables and cords from the table surface through the metal structure, and out through the planter base. Cords can be concealed in the planter base.

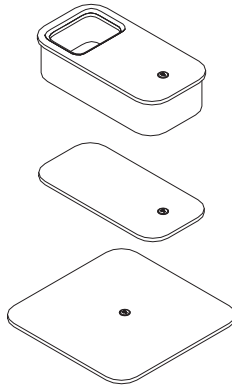

Power location on the rectangular in-line table and planter is 7 1/2" from the front edge of the table surface. When power is specified on the square in-line table, the power module is located in the center of the table.

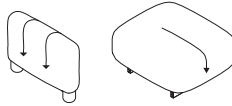

The direction of the fabric or pattern always cuts in the across roll (horizontal) direction. The exception is the armrest, which is always upholstered in a down roll (vertical) direction.

## Surface Materials

### Upholstery

- Fabric
- \* Note, leather/COL is not supported on Coalesse Ensemble at this time.

### Legs

- Metal, painted aluminum
- Wood, solid oak

### Frame

- Paint

### Performance strap

- Black nylon

### Connectors

- Paint

### Lounge power module

- Black powder paint with black receptacles

### In-line table and planter power module

- 6000 Black
- 6052 Milk
- 6D03 Graphite

### In-line table top and planter cover

- Laminate with matching or complementing 0.6 mm plastic edgeband
- Wood veneer with matching 1 mm wood edge

### Planter insert bezel

- 4180 Graphite Matte
- 4242 Milk Smooth
- 4710 Low Gloss Black

### Planter base

- Paint

Coalesse

# Coalesse Ensemble General Overview

DESIGN COALESSE DESIGN GROUP

# Coalesse Ensemble Freestanding Screens

DESIGN COALESSE DESIGN GROUP

**Freestanding screens** are available in three heights, 51<sup>2</sup>/<sub>5</sub>"H, 62<sup>7</sup>/<sub>10</sub>"H, and 78<sup>1</sup>/<sub>2</sub>"H. Screens offer privacy, reduce visual distraction, and provide purposeful space division and shielding in the open plan.

**Screens** are available in straight, corner, and J shapes.

**Screens** are sized to work best when paired with Ensemble Lounge, but can be paired with other products.

**Screen heights** are optimized for various applications: 51<sup>2</sup>/<sub>5</sub>"H works best with lounge-height seating, 62<sup>7</sup>/<sub>10</sub>"H works best with standard seated-height tables and seating, and 78<sup>1</sup>/<sub>2</sub>"H is best paired with standing-height tables and stools.

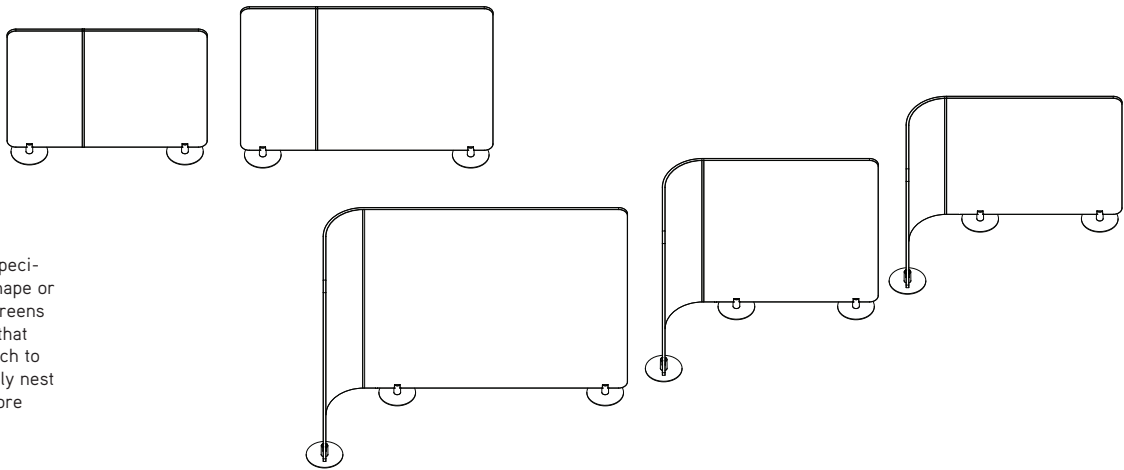
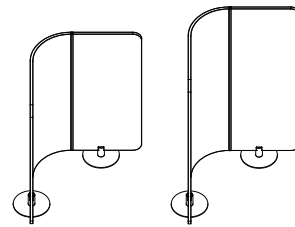

**Nesting base** can be specified with any screen shape or size and allows two screens to nest together. Note that the bases **DO NOT** attach to one another; they simply nest together to create a more streamlined look.

**Glides on bottom of freestanding screen** are non-adjustable.

# Coalesse Ensemble Freestanding Screens

DESIGN COALESSE DESIGN GROUP

## Product Details

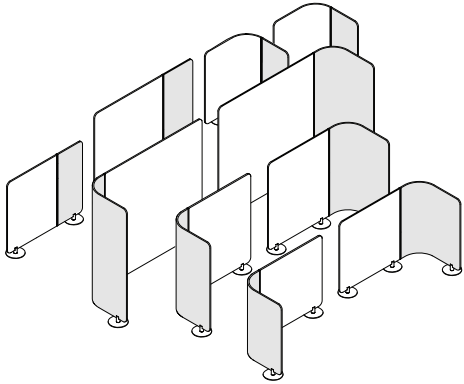

**Contrasting fabric** is available. The primary panel is identified as the larger panel; the secondary panel is identified as the smaller panel. On the J and corner screens, the primary panel will always be the straight section of the screen.

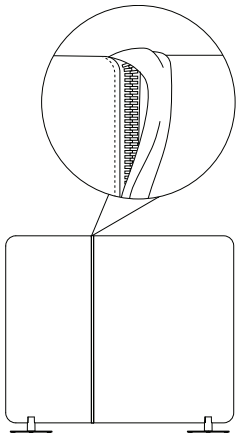

**Fabric panels** are joined together by a zipper, concealed behind fabric. This zipper color is not specifiable and is available only in black.

**Fabric** is applied in an across roll/vertical direction. Due to the size of the screens, fabric is unable to be applied in a down roll/horizontal direction.

**Ensemble screens** were designed for stationary use. The screens may be moved when lifted and carried; they are not designed to be dragged. Excessive handling may result in the fabric panel(s) becoming loose around the frame, resulting in wrinkles.

## Surface Materials

### Screen

- Fabric

### Approved fabrics include:

- Designtex Billiard Panel
- Designtex Mateo
- Designtex Rocket
- Steelcase Billiard Multi-Use by Designtex
- Steelcase Dovetail by Designtex
- Steelcase SoftNext

Fabrics can mix and match with the exception of Designtex Mateo. If specifying Designtex Mateo for the primary or secondary panel, the opposite panel must also be specified Designtex Mateo. Do note that a change in colorway is acceptable.

### Base

- Metal, painted steel

### Zipper

- Black

# Coalesse Ensemble Thought Starters and Applications

DESIGN COALESSE DESIGN GROUP

## Nest

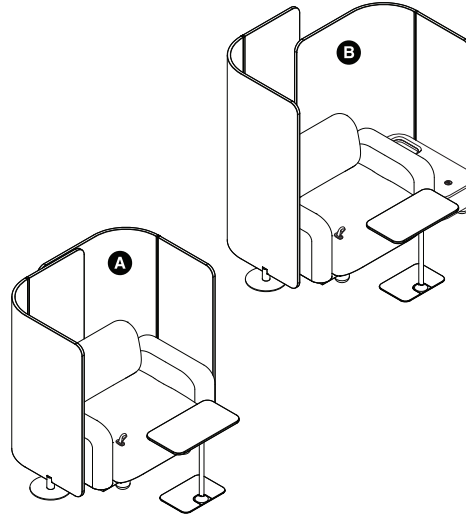

Quantity	Style Number	Description	Components
<b>Nest One (A)</b>			
1	COENLPLC	Coalesse Ensemble Standalone 1-Seat Performance Lounge <i>Shown with options: (2) Armrests</i>	Seating
1	COENLPWR	Coalesse Ensemble Lounge Power Module	Power
2	COENSLC	Coalesse Ensemble Low Corner Screen	Screen
1	COLAGTP	Lagunitas Personal Table	Table
<b>Nest Two (B)</b>			
1	COENLPL1	Coalesse Ensemble Modular 1-Seat Performance Lounge <i>Shown with options: (2) Armrests</i>	Seating
1	COENLCNTNR	Coalesse Ensemble Planter <i>Shown with options: 1 Liner, Cover with Cutout, Power</i>	Planter
1	COENLCF	Coalesse Ensemble Connector Kit	Ganging Kit
1	COENLLE	Coalesse Ensemble End Feet	Feet
1	COENSLC	Coalesse Ensemble Low Corner Screen	Screen
1	COENSMC	Coalesse Ensemble Medium Corner Screen	Screen
1	COLAGTP	Lagunitas Personal Table	Table

# Coalesse Ensemble Thought Starters and Applications

DESIGN COALESSE DESIGN GROUP

## Booth Setting

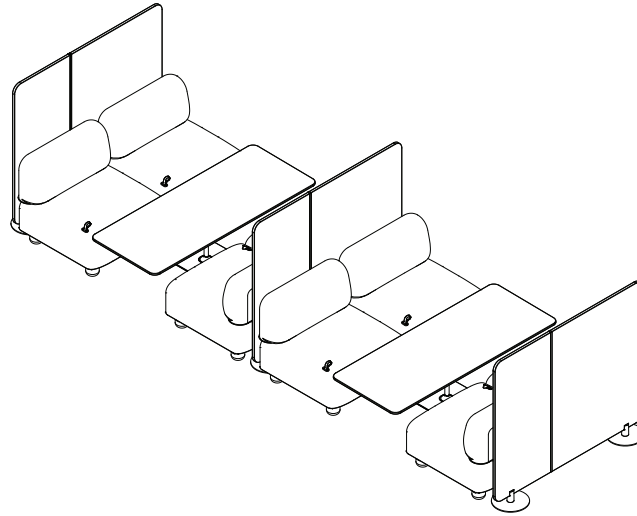

Lounge Seating

Quantity	Style Number	Description	Components
8	COENLPL1	Coalesse Ensemble Modular 1-Seat Performance Lounge	Seating
8	COENLLE	Coalesse Ensemble End Feet	Feet
4	COENLCF	Coalesse Ensemble Connector Kit	Ganging Kit
4	COENLPWR	Coalesse Ensemble Lounge Power Module	Power
3	COENSL5	Coalesse Ensemble Low Straight Screen	Screen
2	COLAGTRECT	Lagunitas Work Height Table, 26"H	Table

# Coalesse Ensemble Thought Starters and Applications *continued*

DESIGN COALESSE DESIGN GROUP

## Open Living Room

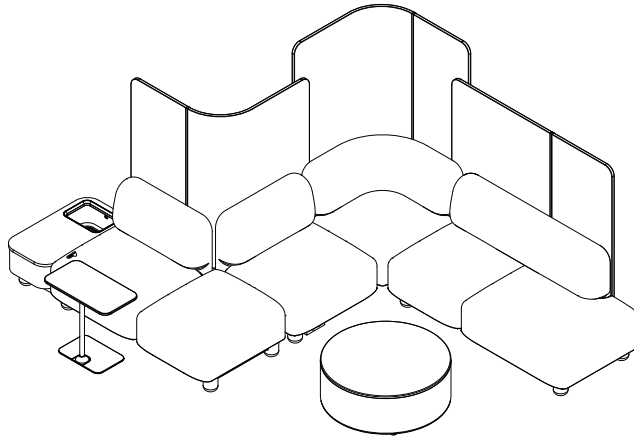

Quantity	Style Number	Description	Components
1	COENLCH2	Coalesse Ensemble Modular 2-Seat Chaise (Left-Handed)	Seating
1	COENLCL1	Coalesse Ensemble Modular 1-Seat Corner Lounge	Seating
1	COENLFL1	Coalesse Ensemble Modular 1-Seat Fixed Lounge	Seating
1	COENLBB	Coalesse Ensemble Backless Bench	Seating
1	COENLPL1	Coalesse Ensemble Modular 1-Seat Performance Lounge	Seating
1	COENLCNTNR	Coalesse Ensemble Planter <i>Shown with options: 1 Liner, Cover with Cutout</i>	Planter
3	COENLCF	Coalesse Ensemble Connector Kit	Ganging Kit
2	COENLCG	Coalesse Ensemble Corner Ganging Kit	Ganging Kit
4	COENLLE	Coalesse Ensemble End Feet	Feet
2	COENLPWR	Coalesse Ensemble Lounge Power Module	Power
1	COENSL5	Coalesse Ensemble Low Straight Screen	Screen
1	COENSMC	Coalesse Ensemble Medium Corner Screen	Screen
1	COENSLC	Coalesse Ensemble Low Corner Screen	Screen
1	COLAGTP	Lagunitas Personal Table	Table
1	COSISOR	Sistema Ottoman	Ottoman

# Coalesse Ensemble Thought Starters and Applications

DESIGN COALESSE DESIGN GROUP

## Small Den

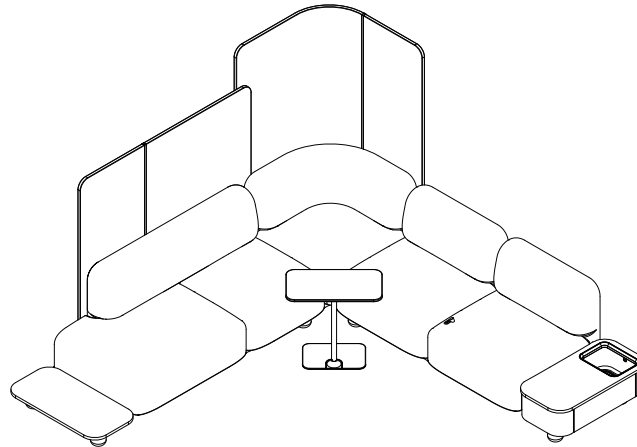

Lounge Seating

Quantity	Style Number	Description	Components
1	COENLCH2	Coalesse Ensemble Modular 2-Seat Chaise (Right-Handed)	Seating
1	COENLCL1	Coalesse Ensemble Modular 1-Seat Corner Lounge	Seating
1	COENLFL1	Coalesse Ensemble Modular 1-Seat Fixed Lounge	Seating
1	COENLPL1	Coalesse Ensemble Modular 1-Seat Performance Lounge	Seating
1	COENLCNTNR	Coalesse Ensemble Planter <i>Shown with options: 1 Liner, Cover with Cutout</i>	Planter
1	COENLRT	Coalesse Ensemble In-line Rectangular Table	Table
3	COENLCF	Coalesse Ensemble Connector Kit	Ganging Kit
1	COENLCG	Coalesse Ensemble Corner Ganging Kit	Ganging Kit
3	COENLLE	Coalesse Ensemble End Feet	Feet
1	COENLLM	Coalesse Ensemble Middle Feet	Feet
1	COENSLS	Coalesse Ensemble Low Straight Screen	Screen
1	COENSMC	Coalesse Ensemble Medium Corner Screen	Screen
1	COLAGTP	Lagunitas Personal Table	Table

# Coalesse Ensemble Thought Starters and Applications *continued*

DESIGN COALESSE DESIGN GROUP

## Collaborative Standing Height

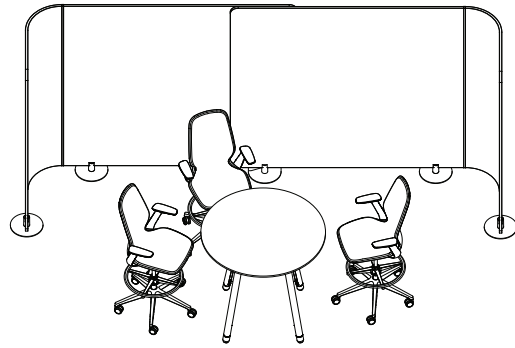

Quantity	Style Number	Description	Components
2	COENSHJ	Coalesse Ensemble High J-Screen <i>Shown with Option: Nesting Base</i>	Screen
1	COFOFLRDST	Potrero415 Standing-Height Round Light Table, Metal Legs	Table

Coalesse

# Coalesse Ensemble Thought Starters and Applications

DESIGN COALESSE DESIGN GROUP

# Coalesse Ensemble Lounge System Standalone Lounge

DESIGN COALESSE DESIGN STUDIO

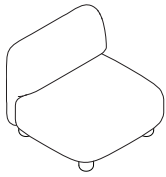

	Standard Includes	Required to Specify
<p>► Need help? Product details, page 62</p>	<ul style="list-style-type: none"> <li>Lounge: constructed with finger-jointed plywood</li> <li>Multiple densities of polyurethane foam and polyester fiber on seat and back</li> <li>Non-contrasting fabric</li> <li>Rail: group 1 paint</li> <li>Armless</li> <li>Metal feet: group 1 paint to match rail</li> <li>Glides: 1/2" of adjustment</li> <li>Ships assembled</li> </ul>	<ol style="list-style-type: none"> <li>Style number</li> <li>Fabric color number for seat and back</li> <li>Paint color number for rail</li> <li>Options, if selected (see below)</li> </ol> <p>► See <i>Coalesse Surface Materials Reference Guide</i>.</p>

*Tip: When selecting contrasting fabrics with one or two arms, arm finish will match seat finish.*

*Tip: Comfort wrinkles are intended to occur over time with upholstered fabrics.*

*Tip: If metal feet are selected, feet finish will match the rail finish.*

*Tip: Handedness is determined while in the seated position.*

	Options	U.S. Price	Required to Specify
<b>Surface Materials</b>	• Contrasting fabric	+\$192	Specify with <i>contrasting fabric</i> and select fabric color number.
	• Customer's Own Material (COM)	Prices at right	Specify with <i>COM</i> and select fabric color number.
	• Fabric upcharges	Prices at right	► See <i>Coalesse Surface Materials Reference Guide</i> .
	<b>Acrylic backer</b>		
	• Standalone 1-seat performance lounge	+\$ 46	Specify with <i>acrylic backer</i> .
	• Standalone 1-seat fixed lounge	+\$ 46	Specify with <i>acrylic backer</i> .
	• Standalone 2-seat lounge	+\$ 82	Specify with <i>acrylic backer</i> .
	• Standalone 2-seat chaise	+\$108	Specify with <i>acrylic backer</i> .
<b>Rail</b>	<b>1-seat lounge</b>		
	• Group 2 paint	+\$234	Select paint color number.
	• Group 3 paint	+\$322	Select paint color number.
	<b>2-seat lounge and chaise</b>		
	• Group 2 paint	+\$287	Select paint color number.
	• Group 3 paint	+\$437	Select paint color number.
<b>Feet</b>	<b>Wood feet</b>		
	• Wood group 1	+\$422	Specify with <i>wood</i> and select wood veneer group 1 color number.
<b>Armrest</b>	• Armless	No cost	Specify with <i>no arms</i> .
	• With left arm	+\$486	Specify with <i>left arm</i> and select fabric color number.
	• With right arm	+\$486	Specify with <i>right arm</i> and select fabric color number.
	• With two arms	+\$973	Specify with <i>two arms</i> and select fabric color number.
<b>Related Products</b>	• Modular lounge		► Page 80
	• Freestanding screens		► Page 90



**For Canadian Pricing**  
Multiply U.S. Price by the Canadian price factor.  
► See page 1 for details.

# Coalesse Ensemble Lounge System Standalone Lounge

DESIGN COALESSE DESIGN STUDIO

Tip: Performance seat strap is not specifiable and is only available in black.

## Specification Information

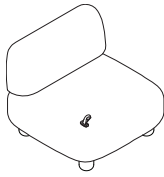

Overall:  
32<sup>1</sup>/<sub>10</sub>"D x 32<sup>3</sup>/<sub>10</sub>"W x 27<sup>1</sup>/<sub>5</sub>"H  
Seat height: 17"  
Seat depth: 20<sup>4</sup>/<sub>5</sub>"

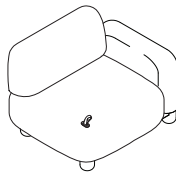

Overall:  
32<sup>1</sup>/<sub>10</sub>"D x 38<sup>3</sup>/<sub>10</sub>"W x 29<sup>1</sup>/<sub>5</sub>"H  
Seat height: 17"  
Seat depth: 20<sup>4</sup>/<sub>5</sub>"

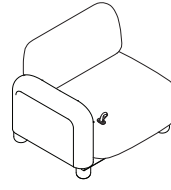

Overall:  
32<sup>1</sup>/<sub>10</sub>"D x 38<sup>3</sup>/<sub>10</sub>"W x 29<sup>1</sup>/<sub>5</sub>"H  
Seat height: 17"  
Seat depth: 20<sup>4</sup>/<sub>5</sub>"

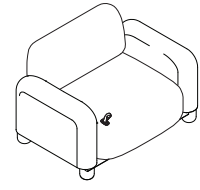

Overall:  
38<sup>1</sup>/<sub>10</sub>"D x 38<sup>3</sup>/<sub>10</sub>"W x 29<sup>1</sup>/<sub>5</sub>"H  
Seat height: 17"  
Seat depth: 20<sup>4</sup>/<sub>5</sub>"

Style Number	U.S. Base Price
--------------	-----------------

### 1-Seat Performance Lounge

COENLPLC \$2737

#### Fabric Upcharges

	Fabric Groups:										
	COM	1	2	3	4	5	6	7	8	9	10
Seat Cushion	No cost	No cost	+\$80	+\$148	+\$227	+\$347	+\$495	+\$665	+\$845	+\$1004	+\$1174
Back Cushion	No cost	No cost	+\$58	+\$107	+\$164	+\$250	+\$357	+\$479	+\$609	+\$ 724	+\$ 846
Armrest	No cost	No cost	+\$58	+\$107	+\$164	+\$250	+\$357	+\$479	+\$609	+\$ 724	+\$ 846

Tip: For upholstered arm fabric group pricing, add upcharge to arm option per arm.

COM: Seat Cushion: 2.50 yards, Back Cushion: 1.80 yards, Upholstered Arm: 1.80 yards (per arm)

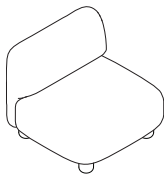

Overall:  
32<sup>3</sup>/<sub>10</sub>"D x 38<sup>3</sup>/<sub>10</sub>"W x 29<sup>1</sup>/<sub>5</sub>"H  
Seat height: 17"  
Seat depth: 20<sup>4</sup>/<sub>5</sub>"

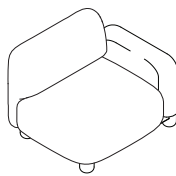

Overall:  
32<sup>3</sup>/<sub>10</sub>"D x 38<sup>3</sup>/<sub>10</sub>"W x 29<sup>1</sup>/<sub>5</sub>"H  
Seat height: 17"  
Seat depth: 20<sup>4</sup>/<sub>5</sub>"

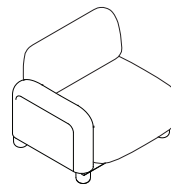

Overall:  
32<sup>3</sup>/<sub>10</sub>"D x 38<sup>3</sup>/<sub>10</sub>"W x 29<sup>1</sup>/<sub>5</sub>"H  
Seat height: 17"  
Seat depth: 20<sup>4</sup>/<sub>5</sub>"

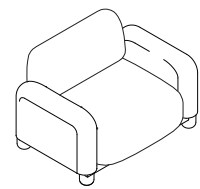

Overall:  
32<sup>3</sup>/<sub>10</sub>"D x 38<sup>3</sup>/<sub>10</sub>"W x 29<sup>1</sup>/<sub>5</sub>"H  
Seat height: 17"  
Seat depth: 20<sup>4</sup>/<sub>5</sub>"

Style Number	U.S. Base Price
--------------	-----------------

### 1-Seat Fixed Lounge

COENLFLC \$2463

#### Fabric Upcharges

	Fabric Groups:										
	COM	1	2	3	4	5	6	7	8	9	10
Seat Cushion	No cost	No cost	+\$72	+\$131	+\$200	+\$306	+\$437	+\$586	+\$745	+\$885	+\$1035
Back Cushion	No cost	No cost	+\$78	+\$142	+\$218	+\$333	+\$476	+\$639	+\$812	+\$965	+\$ 1129
Armrest	No cost	No cost	+\$58	+\$107	+\$164	+\$250	+\$357	+\$479	+\$609	+\$724	+\$ 846

COM: Seat Cushion: 2.20 yards, Back Cushion: 2.40 yards, Upholstered Arm: 1.80 yards (per arm)

► Specification Information, continued on next page

 **For Canadian Pricing**  
Multiply U.S. Price by the Canadian price factor.  
► See page 1 for details.

# Coalesse Ensemble Lounge System Standalone Lounge *continued*

DESIGN COALESSE DESIGN STUDIO

► Specification Information, continued from previous page

## Specification Information

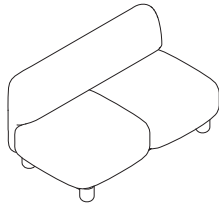

Overall:  
32<sup>3</sup>/<sub>10</sub>"D x 51<sup>1</sup>/<sub>10</sub>"W x 29<sup>9</sup>/<sub>10</sub>"H  
Seat height: 17"  
Seat depth: 20<sup>4</sup>/<sub>5</sub>"

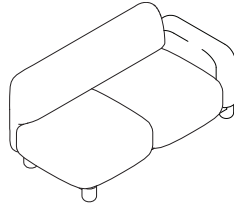

Overall:  
32<sup>3</sup>/<sub>10</sub>"D x 61<sup>1</sup>/<sub>10</sub>"W x 29<sup>9</sup>/<sub>10</sub>"H  
Seat height: 17"  
Seat depth: 20<sup>4</sup>/<sub>5</sub>"

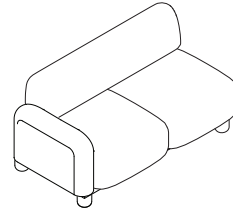

Overall:  
32<sup>3</sup>/<sub>10</sub>"D x 61<sup>1</sup>/<sub>10</sub>"W x 29<sup>9</sup>/<sub>10</sub>"H  
Seat height: 17"  
Seat depth: 20<sup>4</sup>/<sub>5</sub>"

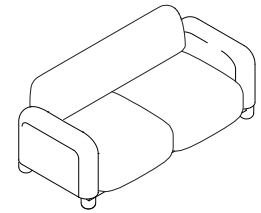

Overall:  
32<sup>3</sup>/<sub>10</sub>"D x 67<sup>1</sup>/<sub>10</sub>"W x 29<sup>9</sup>/<sub>10</sub>"H  
Seat height: 17"  
Seat depth: 20<sup>4</sup>/<sub>5</sub>"

Style Number	U.S. Base Price
--------------	-----------------

## 2-Seat Lounge

COENFLC2	\$4928
----------	--------

### Fabric Upcharges

	Fabric Groups:										
	COM	1	2	3	4	5	6	7	8	9	10
Seat Cushion	No cost	No cost	+\$130	+\$237	+\$364	+\$556	+\$793	+\$1064	+\$1354	+\$1609	+\$1881
Back Cushion	No cost	No cost	+\$ 97	+\$178	+\$273	+\$417	+\$595	+\$ 799	+\$1015	+\$1207	+\$1411
Armrest	No cost	No cost	+\$ 58	+\$107	+\$164	+\$250	+\$357	+\$ 479	+\$ 609	+\$ 724	+\$ 846

**COM:** Seat Cushion: 4.00 yards, Back Cushion: 3.00 yards, Upholstered Arm: 1.80 yards (per arm)

*Tip: When a 2-seat chaise is selected, only one armrest may be specified.*

► Specification Information, continued on next page



**For Canadian Pricing**  
Multiply U.S. Price by the  
Canadian price factor.  
► See page 1 for details.

# Coalesse Ensemble Lounge System Standalone Lounge

DESIGN COALESSE DESIGN STUDIO

► Specification Information, continued from previous page

## Specification Information

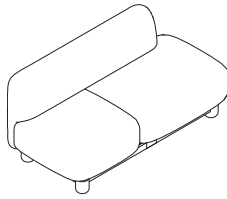

Overall:  
32<sup>3</sup>/<sub>10</sub>"D x 66<sup>9</sup>/<sub>10</sub>"W x 29<sup>9</sup>/<sub>10</sub>"H  
Seat height: 17"  
Seat depth: 20<sup>4</sup>/<sub>5</sub>"  
**Left-handed chaise**

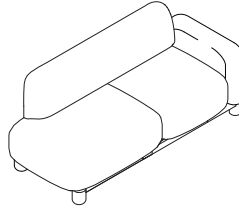

Overall:  
32<sup>3</sup>/<sub>10</sub>"D x 72<sup>9</sup>/<sub>10</sub>"W x 29<sup>9</sup>/<sub>10</sub>"H  
Seat height: 17"  
Seat depth: 20<sup>4</sup>/<sub>5</sub>"  
**Right-handed chaise**

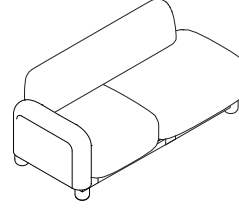

Overall:  
32<sup>3</sup>/<sub>10</sub>"D x 72<sup>9</sup>/<sub>10</sub>"W x 29<sup>9</sup>/<sub>10</sub>"H  
Seat height: 17"  
Seat depth: 20<sup>4</sup>/<sub>5</sub>"  
**Left-handed chaise**

*Tip: Two arms are not available on chaise units. A right-handed 2-seat chaise can only be specified with one left-handed arm. A left-handed 2-seat chaise can only be specified with one right-handed arm.*

Style Number	U.S. Base Price
--------------	-----------------

### 2-Seat Chaise

COENLHC2 \$5835

### Fabric Upcharges

	Fabric Groups:										
	COM	1	2	3	4	5	6	7	8	9	10
Seat Cushion	No cost	No cost	+\$127	+\$232	+\$356	+\$542	+\$774	+\$1039	+\$1320	+\$1570	+\$1835
Back Cushion	No cost	No cost	+\$ 97	+\$178	+\$273	+\$417	+\$595	+\$ 799	+\$1015	+\$1207	+\$1411
Armrest	No cost	No cost	+\$ 58	+\$107	+\$164	+\$250	+\$357	+\$ 479	+\$ 609	+\$ 724	+\$ 846

**COM:** Seat Cushion: 3.90 yards, Back Cushion: 3.00 yards, Upholstered Arm: 1.80 yards

 **For Canadian Pricing**  
Multiply U.S. Price by the  
Canadian price factor.  
► See page 1 for details.

# Coalesse Ensemble Lounge System Modular Lounge

DESIGN COALESSE DESIGN STUDIO

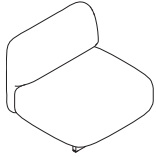

	Standard Includes	Required to Specify
<p>► Need help? Product details, page 62</p>	<ul style="list-style-type: none"> <li>Lounge: constructed with finger-jointed plywood</li> <li>Multiple densities of polyurethane foam and polyester fiber on seat and back</li> <li>Non-contrasting fabric</li> <li>Steel frame/rail: group 1 paint</li> <li>Armless</li> <li>Glides: 1/2" of adjustment</li> <li>Ships ready to assemble</li> </ul>	<ol style="list-style-type: none"> <li>Style number</li> <li>Fabric color number for seat and back or armrest</li> <li>Paint color number for frame/rail</li> <li>Options, if selected (see below)</li> </ol> <p>► See <i>Coalesse Surface Materials Reference Guide</i>.</p>

	Options	U.S. Price	Required to Specify
<b>Surface Materials</b>	<ul style="list-style-type: none"> <li>Contrasting fabric</li> <li>Customer's Own Material (COM)</li> <li>Fabric upcharges</li> </ul>	<p>+\$192</p> <p>Prices at right</p> <p>Prices at right</p>	<p>Specify <i>with contrasting fabric</i> and select fabric color number.</p> <p>Specify <i>with COM</i> and select fabric color number.</p> <p>► See <i>Coalesse Surface Materials Reference Guide</i>.</p>
	<b>Acrylic backer</b>		
	<ul style="list-style-type: none"> <li>Standalone 1-seat performance lounge</li> <li>Standalone 1-seat fixed and corner lounge</li> <li>Standalone 2-seat lounge</li> <li>Standalone 2-seat chaise</li> </ul>	<p>+\$ 46</p> <p>+\$ 46</p> <p>+\$ 82</p> <p>+\$108</p>	<p>Specify <i>with acrylic backer</i>.</p> <p>Specify <i>with acrylic backer</i>.</p> <p>Specify <i>with acrylic backer</i>.</p> <p>Specify <i>with acrylic backer</i>.</p>
	<b>Steel Frame/Rail</b>		
	<b>1-seat lounges and backless bench</b>		
	<ul style="list-style-type: none"> <li>Group 2 paint</li> <li>Group 3 paint</li> </ul>	<p>+\$ 80</p> <p>+\$168</p>	<p>Select paint color number.</p> <p>Select paint color number.</p>
	<b>2-seat lounge and chaise</b>		
	<ul style="list-style-type: none"> <li>Group 2 paint</li> <li>Group 3 paint</li> </ul>	<p>+\$133</p> <p>+\$283</p>	<p>Select paint color number.</p> <p>Select paint color number.</p>
	<b>1-seat corner lounge</b>		
	<ul style="list-style-type: none"> <li>Group 2 paint</li> <li>Group 3 paint</li> </ul>	<p>+\$196</p> <p>+\$284</p>	<p>Select paint color number.</p> <p>Select paint color number.</p>
	<b>End armrest</b>		
	<ul style="list-style-type: none"> <li>Group 2 paint</li> <li>Group 3 paint</li> </ul>	<p>+\$ 40</p> <p>+\$ 84</p>	<p>Select paint color number.</p> <p>Select paint color number.</p>
	<b>Feet</b>		
	<b>Wood foot (corner lounge)</b>		
	<ul style="list-style-type: none"> <li>Wood group 1</li> </ul>	<p>+\$317</p>	<p>Specify <i>with wood</i> and select wood veneer group 1 color number.</p>
	<b>Armrest</b>		
	<ul style="list-style-type: none"> <li>Armless</li> <li>With left arm</li> <li>With right arm</li> <li>With two arms</li> </ul>	<p>No cost</p> <p>+\$486</p> <p>+\$486</p> <p>+\$973</p>	<p>Specify <i>with no arms</i>.</p> <p>Specify <i>with left arm</i> and select fabric color number.</p> <p>Specify <i>with right arm</i> and select fabric color number.</p> <p>Specify <i>with two arms</i> and select fabric color number.</p>
	<b>Related Products</b>		
	<ul style="list-style-type: none"> <li>Standalone lounge</li> <li>Freestanding screens</li> </ul>		<p>► Page 76</p> <p>► Page 90</p>

Tip: Comfort wrinkles are intended to occur over time with upholstered fabrics.

Tip: Lounge units ship installed to frame.

Tip: Armrest can be specified in end positions only, when next to a lounge unit. An exception is made for an in-line table or planter, which may be specified on the outside of an armrest.

Tip: Handedness is determined while in the seated position.

Tip: Middle and end feet must be specified separately. Feet are required every 78".



**For Canadian Pricing**  
Multiply U.S. Price by the Canadian price factor.  
► See page 1 for details.

# Coalesse Ensemble Lounge System Modular Lounge

DESIGN COALESSE DESIGN STUDIO

*Tip: Performance seat strap is not specifiable and is only available in black.*

## Specification Information

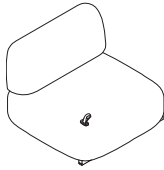

Overall: 32<sup>3</sup>/<sub>10</sub>"D x 32<sup>3</sup>/<sub>10</sub>"W x 27<sup>1</sup>/<sub>5</sub>"H  
 Seat height: 17", when feet are attached  
 Seat depth: 20<sup>4</sup>/<sub>5</sub>"

Style Number U.S. Base Price

### Modular 1-Seat Performance Lounge

COENLPL1 \$2148

#### Fabric Upcharges

	Fabric Groups:										
	COM	1	2	3	4	5	6	7	8	9	10
Seat Cushion	No cost	No cost	+\$80	+\$148	+\$227	+\$347	+\$495	+\$665	+\$845	+\$1004	+\$1174
Back Cushion	No cost	No cost	+\$58	+\$107	+\$164	+\$250	+\$357	+\$479	+\$609	+\$ 724	+\$ 846
Armrest	No cost	No cost	+\$58	+\$107	+\$164	+\$250	+\$357	+\$479	+\$609	+\$ 724	+\$ 846

COM: Seat Cushion: 2.50 yards, Back Cushion: 1.80 yards, Upholstered Arm: 1.80 yards (per arm)

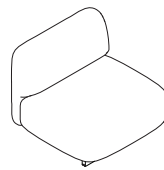

Overall: 32<sup>3</sup>/<sub>10</sub>"D x 32<sup>3</sup>/<sub>10</sub>"W x 27<sup>1</sup>/<sub>5</sub>"H  
 Seat height: 17", when feet are attached  
 Seat depth: 20<sup>4</sup>/<sub>5</sub>"

Style Number U.S. Base Price

### Modular 1-Seat Fixed Lounge

COENLFL1 \$1875

#### Fabric Upcharges

	Fabric Groups:										
	COM	1	2	3	4	5	6	7	8	9	10
Seat Cushion	No cost	No cost	+\$72	+\$131	+\$200	+\$306	+\$437	+\$586	+\$745	+\$885	+\$1035
Back Cushion	No cost	No cost	+\$78	+\$142	+\$218	+\$333	+\$476	+\$639	+\$812	+\$965	+\$ 1129
Armrest	No cost	No cost	+\$58	+\$107	+\$164	+\$250	+\$357	+\$479	+\$609	+\$724	+\$ 846

COM: Seat Cushion: 2.20 yards, Back Cushion: 2.40 yards, Upholstered Arm: 1.80 yards (per arm)

► Specification Information, continued on next page

 **For Canadian Pricing**  
 Multiply U.S. Price by the Canadian price factor.  
 ► See page 1 for details.

# Coalesse Ensemble Lounge System Modular Lounge *continued*

DESIGN COALESSE DESIGN STUDIO

► Specification Information, continued from previous page

## Specification Information

*Tip: Modular 1-seat corner lounge always comes with feet, they do not need to be specified.*

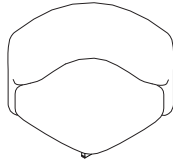

Overall: 32<sup>3</sup>/<sub>10</sub>"D x 32<sup>3</sup>/<sub>10</sub>"W x 27<sup>1</sup>/<sub>5</sub>"H  
 Seat height: 17"  
 Seat depth: 20<sup>4</sup>/<sub>5</sub>"

Style Number	U.S. Base Price
--------------	-----------------

### Modular 1-Seat Corner Lounge

COENLCL1	\$2587
----------	--------

#### Fabric Upcharges

	Fabric Groups:										
	COM	1	2	3	4	5	6	7	8	9	10
Seat Cushion	No cost	No cost	+\$50	+\$ 90	+\$137	+\$209	+\$298	+\$400	+\$509	+\$ 603	+\$ 706
Back Cushion	No cost	No cost	+\$81	+\$149	+\$228	+\$348	+\$496	+\$666	+\$846	+\$1005	+\$1175

**COM:** Seat Cushion: 1.50 yards, Back Cushion: 2.50 yards

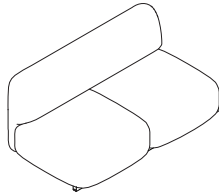

Overall: 32<sup>3</sup>/<sub>10</sub>"D x 55<sup>1</sup>/<sub>10</sub>"W x 27<sup>1</sup>/<sub>5</sub>"H  
 Seat height: 17", when feet are attached  
 Seat depth: 20<sup>4</sup>/<sub>5</sub>"

Style Number	U.S. Base Price
--------------	-----------------

### Modular 2-Seat Lounge

COENLFL2	\$4339
----------	--------

#### Fabric Upcharges

	Fabric Groups:										
	COM	1	2	3	4	5	6	7	8	9	10
Seat Cushion	No cost	No cost	+\$130	+\$237	+\$364	+\$556	+\$793	+\$1064	+\$1354	+\$1609	+\$1881
Back Cushion	No cost	No cost	+\$ 97	+\$178	+\$273	+\$417	+\$595	+\$ 799	+\$1015	+\$1207	+\$1411
Armrest	No cost	No cost	+\$ 58	+\$107	+\$164	+\$250	+\$357	+\$ 479	+\$ 609	+\$ 724	+\$ 846

**COM:** Seat Cushion: 4.00 yards, Back Cushion: 3.00 yards, Upholstered Arm: 1.80 yards (per arm)

► Specification Information, continued on next page



**For Canadian Pricing**  
 Multiply U.S. Price by the Canadian price factor.  
 ► See page 1 for details.

# Coalesse Ensemble Lounge System Modular Lounge

DESIGN COALESSE DESIGN STUDIO

► Specification Information, continued from previous page

## Specification Information

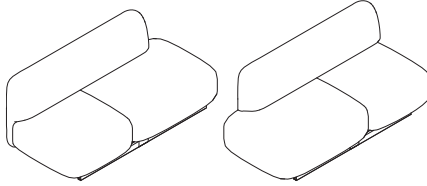

Left-handed

Right-handed

Overall: 32<sup>3</sup>/<sub>10</sub>"D x 66<sup>1</sup>/<sub>9</sub>"W x 27<sup>1</sup>/<sub>2</sub>"H  
 Seat height: 17", when feet are attached  
 Seat depth: 20<sup>4</sup>/<sub>5</sub>"

Style Number	U.S. Base Price
--------------	-----------------

### Modular 2-Seat Chaise

COENLCH2 \$5247

#### Fabric Upcharges

	Fabric Groups:										
	COM	1	2	3	4	5	6	7	8	9	10
Seat Cushion	No cost	No cost	+\$127	+\$232	+\$356	+\$542	+\$774	+\$1039	+\$1320	+\$1570	+\$1835
Back Cushion	No cost	No cost	+\$ 97	+\$178	+\$273	+\$417	+\$595	+\$ 799	+\$1015	+\$1207	+\$1411
Armrest	No cost	No cost	+\$ 58	+\$107	+\$164	+\$250	+\$357	+\$ 479	+\$ 609	+\$ 724	+\$ 846

COM: Seat Cushion: 3.90 yards, Back Cushion: 3.00 yards, Upholstered Arm: 1.80 yards

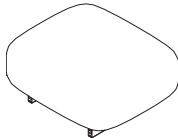

Overall: 32<sup>3</sup>/<sub>10</sub>"D x 27<sup>3</sup>/<sub>5</sub>"W  
 Seat height: 17", when feet are attached  
 Seat depth: 20<sup>4</sup>/<sub>5</sub>"

Style Number	U.S. Base Price
--------------	-----------------

### Modular Backless Bench

COENLBB \$1505

#### Fabric Upcharges

	Fabric Groups:										
	COM	1	2	3	4	5	6	7	8	9	10
Seat Cushion	No cost	No cost	+\$69	+\$124	+\$191	+\$292	+\$417	+\$559	+\$711	+\$845	+\$987

COM: Seat Cushion: 2.10 yards

► Specification Information, continued on next page

 **For Canadian Pricing**  
 Multiply U.S. Price by the Canadian price factor.  
 ► See page 1 for details.

# Coalesse Ensemble Lounge System Modular Lounge *continued*

DESIGN COALESSE DESIGN STUDIO

► Specification Information, continued from previous page

## Specification Information

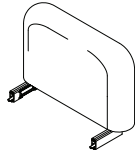

Overall: 10<sup>3</sup>/<sub>5</sub>"W x 28"D x 20<sup>1</sup>/<sub>2</sub>"H

Style Number	U.S. Base Price
--------------	-----------------

### End Armrest

COENLEA	\$559
---------	-------

### Fabric Upcharges

	Fabric Groups:										
	COM	1	2	3	4	5	6	7	8	9	10
Armrest	No cost	No cost	+\$58	+\$107	+\$164	+\$250	+\$357	+\$479	+\$609	+\$724	+\$846

COM: Upholstered Arm: 1.80 yards (per arm)



**For Canadian Pricing**  
 Multiply U.S. Price by the  
 Canadian price factor.  
 ► See page 1 for details.

# Coalesse Ensemble Lounge System Modular Lounge Connector Kits

DESIGN COALESSE DESIGN STUDIO

Standard Includes		Required to Specify
<ul style="list-style-type: none"> <li>▶ Need help? Product details, page 62</li> </ul>	<ul style="list-style-type: none"> <li>• Connector kit for ganging modular styles</li> <li>• Group 1 paint</li> </ul>	<ul style="list-style-type: none"> <li>1 Style number</li> <li>2 Paint color number for connector</li> <li>3 Options, if selected (see below)</li> <li>▶ See <i>Coalesse Surface Materials Reference Guide</i>.</li> </ul>

Options	U.S. Price	Required to Specify
<b>Paint Finishes</b> <ul style="list-style-type: none"> <li>• Connector kit</li> <li>• Group 2 paint</li> <li>• Group 3 paint</li> </ul>	<ul style="list-style-type: none"> <li>+\$20</li> <li>+\$42</li> </ul>	<ul style="list-style-type: none"> <li>Select paint color number.</li> <li>Select paint color number.</li> </ul>
<ul style="list-style-type: none"> <li>• Armrest end connector</li> <li>• Group 2 paint</li> <li>• Group 3 paint</li> </ul>	<ul style="list-style-type: none"> <li>+\$20</li> <li>+\$42</li> </ul>	<ul style="list-style-type: none"> <li>Select paint color number.</li> <li>Select paint color number.</li> </ul>
<b>Related Products</b> <ul style="list-style-type: none"> <li>• Standalone lounge</li> <li>• Freestanding screens</li> </ul>		<ul style="list-style-type: none"> <li>▶ Page 76</li> <li>▶ Page 90</li> </ul>

Specification Information	
Style Number	U.S. Base Price

Connector Kit	
COENLCF	\$226

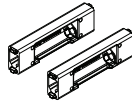

*Tip: Connector kit works on both modular and standalone styles. The connector kit gangs individual lounge, lounge to table, and lounge to planter units together.*

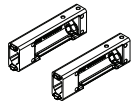

*Tip: Armrest end connector is required only when connecting an in-line table or planter to an armrest. When connecting an armrest to a lounge unit, no additional connectors are needed.*

Armrest End Connector	
COENLCFE	\$226



*Tip: Corner ganging kit is required to create non-linear or "L" shaped configurations.*  
*Tip: Corner ganging kit is not a visible part; paint color is black and is not specifiable.*

Corner Ganging Kit	
COENLCG	\$ 83

 **For Canadian Pricing**  
 Multiply U.S. Price by the Canadian price factor.  
 ▶ See page 1 for details.

# Coalesse Ensemble Lounge System Modular Lounge Feet

DESIGN COALESSE DESIGN STUDIO

*Tip: End feet include a painted rail; paint color is specifiable when selecting wood feet. If selecting metal feet, the rail and feet will match.*

	Standard Includes	Required to Specify
► Need help? Product details, page 62	<ul style="list-style-type: none"> <li>• Metal feet: group 1 paint</li> <li>• Rail: group 1 paint (end feet only)</li> <li>• Glides: 1/2" of adjustment</li> </ul>	1 Style number 2 Paint color number for feet 3 Options, if selected (see below) ► See <i>Coalesse Surface Materials Reference Guide</i> .

*Tip: Feet are needed every 78"*

	Options	U.S. Price	Required to Specify
<b>Paint</b>	<b>End rail (end feet only)</b> <ul style="list-style-type: none"> <li>• Group 2 paint</li> <li>• Group 3 paint</li> </ul>	+\$ 20 +\$ 42	Select paint color number. Select paint color number.
<b>Feet Type</b>	<b>Metal feet (middle feet only)</b> <ul style="list-style-type: none"> <li>• Group 2 paint</li> <li>• Group 3 paint</li> </ul> <b>Wood feet</b>	+\$ 77 +\$165  +\$211	Select paint color number. Select paint color number.  Specify <i>with wood</i> and select wood veneer color number.
<b>Related Products</b>	<ul style="list-style-type: none"> <li>• Standalone lounge</li> <li>• Freestanding screens</li> </ul>		► Page 76 ► Page 90

### Specification Information

Style Number	U.S. Base Price
--------------	-----------------

### End Feet

COENLLE	\$294
---------	-------

### Middle Feet

COENLLM	\$158
---------	-------

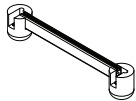

 **For Canadian Pricing**  
 Multiply U.S. Price by the Canadian price factor.  
 ► See page 1 for details.

# Coalesse Ensemble Lounge System Lounge Power Module

DESIGN COALESSE DESIGN STUDIO

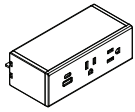

*Tip: Power module can be installed anywhere along the rail of modular or standalone lounge units.*

*Tip: USB C delivers more power and capability to charge larger devices like laptops.*

	Standard Includes	Required to Specify
▶ Need help? Product details, page 62	<ul style="list-style-type: none"> <li>• Power module: black</li> <li>• Hardware to install and wire manager clips</li> <li>• Power cord: 72" L</li> <li>• Power configuration: Two power, one USB A + C port</li> </ul>	1 Style number 2 Options, if selected (see below)

	Options	U.S. Price	Required to Specify
<b>Power Configuration</b>	<ul style="list-style-type: none"> <li>• One power, one USB C</li> </ul>	+\$140	Select with one power, one USB C.
<b>Related Products</b>	<ul style="list-style-type: none"> <li>• Standalone lounge</li> <li>• Freestanding screens</li> </ul>		▶ Page 76 ▶ Page 90

Specification Information	
<b>Style Number</b>	U.S. Base Price

## Lounge Power Module

COENLPWR    \$631

 **For Canadian Pricing**  
 Multiply U.S. Price by the Canadian price factor.  
 ▶ See page 1 for details.

# Coalesse Ensemble Lounge System Modular In-line Tables

DESIGN COALESSE DESIGN STUDIO

*Tip: Square table can be used at end-of-run, in-between two lounge modules, or as a corner where change of direction is desired.*

Standard Includes	Required to Specify
<ul style="list-style-type: none"> <li>▶ Need help? Product details, page 62</li> <li>• Table top:                             <ul style="list-style-type: none"> <li>– Group 1 laminate with 0.6 mm flat plastic edge</li> </ul> </li> <li>• No power</li> <li>• Steel rail: group 1 paint</li> <li>• Ships ready to assemble</li> </ul>	<ol style="list-style-type: none"> <li>1 Style number</li> <li>2 Laminate color number for table top</li> <li>3 Plastic edge color number for laminate table top</li> <li>4 Paint color number for rail</li> <li>5 Options, if selected (see below)</li> </ol> <p>▶ See <i>Coalesse Surface Materials Reference Guide</i>.</p>

	Options	U.S. Price	Required to Specify
<b>Surface Materials</b>	<b>In-line table top</b>		
	• Group 2 laminate	Prices below	Specify with group 2 laminate and select color number.
	• Group 3 laminate	Prices below	Specify with group 3 laminate and select color number.
	• Group 1 wood veneer	Prices below	Specify with group 1 wood veneer and select color number.
	• Group 2 wood veneer	Prices below	Specify with group 2 wood veneer and select color number.
	• Group 3 wood veneer	Prices below	Specify with group 3 wood veneer and select color number.
	<b>Rail</b>		
	• Group 2 paint	+\$ 20	Select paint color number.
	• Group 3 paint	+\$ 42	Select paint color number.
<b>Power</b>	• No power	No cost	Specify with no power.
	• With power	+\$207	Specify with power.
<b>Power Configuration</b>	<b>Power module</b>		
	• One power	No cost	Specify with power module and one power and select finish.
	• One USB A/C	+\$435	Specify with power module and one USB and select finish.
<b>Related Products</b>	• Standalone lounge		▶ Page 76
	• Freestanding screens		▶ Page 90

*Tip: If power is selected, consider cable routing details to ensure cord length is adequate to reach building power.*

*Tip: Power and USB modules are available in 6000 Black, 6052 Milk, or 6D03 Graphite.*

## Specification Information

Style Number	Dimensions			U.S. Base Prices			Veneer:		
	D	W	H	Laminate: Group 1	Group 2	Group 3	Group 1	Group 2	Group 3

### In-Line Rectangular Table

COENLRT	16 <sup>3</sup> / <sub>10</sub> "	32"	3 <sup>1</sup> / <sub>10</sub> "	\$513	\$518	\$543	\$ 997	\$1063	\$1220
---------	-----------------------------------	-----	----------------------------------	-------	-------	-------	--------	--------	--------



*Tip: Rectangular table can be used as end-of-run or in-between two lounge units. Tables cannot be specified side by side.*

### In-Line Square Table

COENLST	32"	32"	3 <sup>1</sup> / <sub>10</sub> "	\$798	\$810	\$853	\$1633	\$1740	\$1989
---------	-----	-----	----------------------------------	-------	-------	-------	--------	--------	--------

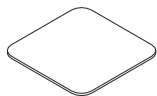

*Tip: Square table can be used at end-of-run, in-between two lounge modules, or as a corner where change of direction is desired.*

*Tip: In-line square table can become a freestanding table by adding two sets of end feet. In-line rectangular table cannot be freestanding.*

# Coalesse Ensemble Lounge System Modular Planter

DESIGN COALESSE DESIGN STUDIO

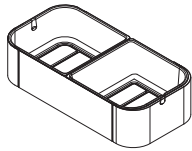

**Planter Liner (each):**  
15 1/2"D x 15 1/2"W x 7"H

*Tip: Planters are able to be specified side by side, but neither planter is able to have the optional cover.*

*Tip: The planter cannot be freestanding.*

*Tip: When planter is specified with no cover, you must specify with two liners. If a cover is desired, planter must be specified with one liner.*

*Tip: If power is selected, consider cable routing details to ensure cord length is adequate to reach building power.*

*Tip: Power and USB modules are available in 6000 Black, 6052 Milk, or 6D03 Graphite.*

Standard Includes	Required to Specify
<ul style="list-style-type: none"> <li>▶ Need help? Product details, page 62</li> <li>• No cover; must select one or two liners</li> <li>• Steel planter shell: group 1 paint</li> <li>• Ships ready to assemble</li> </ul>	<ul style="list-style-type: none"> <li>1 Style number</li> <li>2 Liner (see below under Required Selections)</li> <li>3 Paint color number for planter shell</li> <li>4 Options, if selected (see below)</li> <li>▶ See <i>Coalesse Surface Materials Reference Guide</i>.</li> </ul>

Required Options	U.S. Price	Required to Specify
<b>Liner</b>	<ul style="list-style-type: none"> <li>• With one liner +\$ 63</li> <li>• With two liners +\$127</li> </ul>	<ul style="list-style-type: none"> <li>Specify with <i>one liner</i>.</li> <li>Specify with <i>two liners</i>.</li> </ul>
<b>Surface Materials</b>	<ul style="list-style-type: none"> <li>• <b>Planter shell</b></li> <li>• Group 2 paint +\$ 78</li> <li>• Group 3 paint +\$154</li> </ul>	<ul style="list-style-type: none"> <li>Specify with <i>group 2 paint</i> and select color number.</li> <li>Specify with <i>group 3 paint</i> and select color number.</li> </ul>

Options	U.S. Price	Required to Specify
<b>Planter cover</b>		
• Group 1 laminate	Price below	Specify with <i>group 1 laminate</i> and select color number.
• Group 2 laminate	Price below	Specify with <i>group 2 laminate</i> and select color number.
• Group 3 laminate	Price below	Specify with <i>group 3 laminate</i> and select color number.
• Group 1 wood veneer	Price below	Specify with <i>group 1 wood veneer</i> and select color number.
• Group 2 wood veneer	Price below	Specify with <i>group 2 wood veneer</i> and select color number.
<b>Planter Cover Cutout</b>	<ul style="list-style-type: none"> <li>• With one cutout +\$474</li> <li>• With one cutout and power module +\$680</li> </ul>	<ul style="list-style-type: none"> <li>Specify with <i>one cutout</i> and select finish.</li> <li>Specify with <i>one cutout and power module</i> and select finish.</li> </ul>
<b>Power Configuration</b>	<ul style="list-style-type: none"> <li>• <b>Power module</b></li> <li>• One power No cost</li> <li>• One USB A/C +\$435</li> </ul>	<ul style="list-style-type: none"> <li>Specify cover with <i>1 cutout and power module</i> and <i>one power</i> and select finish.</li> <li>Specify cover with <i>1 cutout and power module</i> and <i>one USB</i> and select finish.</li> </ul>
<b>Related Products</b>	<ul style="list-style-type: none"> <li>• Standalone lounge</li> <li>• Freestanding screens</li> </ul>	<ul style="list-style-type: none"> <li>▶ Page 76</li> <li>▶ Page 90</li> </ul>

## Specification Information

Style Number	Dimension		H	U.S. Base Price	Options (Add \$to Base Price)				
	D	W			Planter Shell	Laminate Cover:			Veneer Cover:
					Group 1	Group 2	Group 3	Group 1	Group 2

Planter									
COENLCNTR	32"	16 3/16"	10 1/8"	\$1102	No cost	+\$5	+\$30	+\$484	+\$550

*Tip: If selecting a laminate or veneer cover, you will be asked to specify the bezel. The bezel is available in low gloss black, milk smooth, and graphite matte. The bezel selection will drive the power finish.*

*Tip: The planter shell is available in Group 1, 2, and 3 paints. The supporting rail is not specifiable and will match the planter shell.*

# Coalesse Ensemble Lounge System Freestanding Screens

DESIGN COALESSE DESIGN STUDIO

*Tip: When moving a screen, it is recommended that two people lift and carry it, one on either side to avoid dragging.*

*Tip: Zipper is not specifiable; it is available only in black.*

*Tip: The primary panel is identified as the larger panel; the secondary panel is identified as the smaller panel. On the J and corner screens, the primary panel will always be the straight section of the screen.*

*Tip: All screens are shown with standalone bases. Additional standalone or nested bases can be ordered separately.*

Standard Includes		Required to Specify
-------------------	--	---------------------

<ul style="list-style-type: none"> <li>▶ Need help? Product details, page 62</li> </ul>	<ul style="list-style-type: none"> <li>• Screen: steel frame with an upholstered cover</li> <li>• Metal base: group 1 paint</li> </ul>	<ol style="list-style-type: none"> <li>1 Style number</li> <li>2 Fabric color for primary screen panel</li> <li>3 Fabric color for secondary screen</li> <li>4 Paint color number for base</li> <li>5 Options, if selected (see below)</li> </ol> <ul style="list-style-type: none"> <li>▶ See <i>Coalesse Surface Materials Reference Guide</i>.</li> </ul>
---	--	--

Options	U.S. Price	Required to Specify
---------	------------	---------------------

<b>Surface Materials</b> <ul style="list-style-type: none"> <li>• <b>Screen</b></li> <li>• Fabric</li> </ul>	Prices below	Select fabric color number for primary and secondary panels.
<ul style="list-style-type: none"> <li>• <b>Base</b></li> <li>• Group 2 paint</li> <li>• Group 3 paint</li> </ul>	+\$22 +\$79	Select paint color number. Select paint color number.
<b>Base Type</b> <ul style="list-style-type: none"> <li>• Standalone base</li> <li>• Nesting base</li> </ul>	No cost No cost	Specify with <i>standalone base</i> . Specify with <i>nesting base</i> .
<b>Handedness</b> (J-Shape only) <ul style="list-style-type: none"> <li>• Right-handed</li> <li>• Left-handed</li> </ul>	No cost No cost	Specify with <i>right-handed</i> . Specify with <i>left-handed</i> .
<b>Related Products</b> <ul style="list-style-type: none"> <li>• Standalone lounge</li> <li>• Freestanding screens</li> </ul>		<ul style="list-style-type: none"> <li>▶ Page 76</li> <li>▶ Page 90</li> </ul>

### Specification Information

Style Number	U.S. Base Price
--------------	-----------------

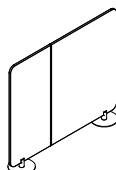

Overall: 60<sup>1</sup>/<sub>5</sub>"W x 51<sup>2</sup>/<sub>5</sub>"H

## Low Straight Screen

COENSLS \$1811

### Fabric Upcharges

	Fabric Groups:								
	2	3	4	5	6	7	8	9	10
Primary Panel	+\$132	+\$242	+\$371	+\$561	+\$812	+\$1089	+\$1382	+\$1645	+\$1924
Secondary Panel	+\$ 68	+\$123	+\$191	+\$288	+\$416	+\$ 557	+\$ 708	+\$ 842	+\$ 985

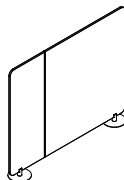

Overall: 75<sup>9</sup>/<sub>10</sub>"W x 62<sup>7</sup>/<sub>10</sub>"H

## Medium Straight Screen

COENSMS \$2374

### Fabric Upcharges

	Fabric Groups:								
	2	3	4	5	6	7	8	9	10
Primary Panel	+\$157	+\$288	+\$444	+\$671	+\$971	+\$1301	+\$1652	+\$1965	+\$2300
Secondary Panel	+\$ 80	+\$148	+\$227	+\$343	+\$495	+\$ 663	+\$ 842	+\$1002	+\$1172



**For Canadian Pricing**  
 Multiply U.S. Price by the Canadian price factor.

▶ See page 1 for details.

▶ Specification Information, continued on next page

# Coalesse Ensemble Lounge System Freestanding Screens

DESIGN COALESSE DESIGN STUDIO

► Specification Information, continued from previous page

## Specification Information

Style Number	U.S. Base Price
--------------	-----------------

*Tip: The primary panel is identified as the larger panel; the secondary panel is identified as the smaller panel. On the J and corner screens, the primary panel will always be the straight section of the screen.*

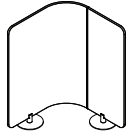

Overall: 33<sup>3</sup>/<sub>5</sub>"W x 33<sup>1</sup>/<sub>2</sub>"D x 51<sup>2</sup>/<sub>5</sub>"H

### Low Corner Screen

COENSLC \$2362

#### Fabric Upcharges

	Fabric Groups:									
	2	3	4	5	6	7	8	9	10	
Primary Panel	+\$132	+\$242	+\$371	+\$ 561	+\$ 812	+\$1089	+\$1382	+\$1645	+\$1924	
Secondary Panel	+\$ 68	+\$123	+\$191	+\$ 288	+\$ 416	+\$ 557	+\$ 708	+\$ 842	+\$ 985	

*Tip: All screens are shown with standalone base. Additional standalone or nested bases can be ordered separately.*

*Tip: Handedness is determined from the seated position, assuming the screen behind you.*

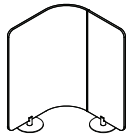

Overall: 33<sup>3</sup>/<sub>5</sub>"W x 33<sup>1</sup>/<sub>2</sub>"D x 62<sup>7</sup>/<sub>10</sub>"H

### Medium Corner Screen

COENSMC \$2799

#### Fabric Upcharges

	Fabric Groups:									
	2	3	4	5	6	7	8	9	10	
Primary Panel	+\$157	+\$288	+\$444	+\$ 671	+\$ 971	+\$1301	+\$1652	+\$1965	+\$2300	
Secondary Panel	+\$ 80	+\$148	+\$227	+\$ 343	+\$ 495	+\$ 663	+\$ 842	+\$1002	+\$1172	

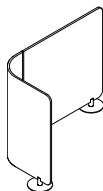

Low J Screen-Right  
Overall: 64<sup>9</sup>/<sub>10</sub>"W x 33<sup>1</sup>/<sub>2</sub>"D x 51<sup>4</sup>/<sub>5</sub>"H

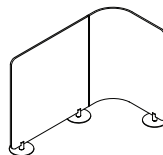

Low J Screen-Left

### Low J Screen

COENSLJ \$3421

#### Fabric Upcharges

	Fabric Groups:									
	2	3	4	5	6	7	8	9	10	
Primary Panel	+\$266	+\$487	+\$752	+\$1136	+\$1643	+\$2201	+\$2796	+\$3326	+\$3892	
Secondary Panel	+\$132	+\$242	+\$371	+\$ 561	+\$ 812	+\$1089	+\$1382	+\$1645	+\$1924	

► Specification Information, continued on next page



**For Canadian Pricing**  
Multiply U.S. Price by the Canadian price factor.  
► See page 1 for details.

# Coalesse Ensemble Lounge System Freestanding Screens *continued*

DESIGN COALESSE DESIGN STUDIO

► Specification Information, continued from previous page

*Tip: The primary panel is identified as the larger panel; the secondary panel is identified as the smaller panel. On the J and corner screens, the primary panel will always be the straight section of the screen.*

*Tip: All screens are shown with standalone base. Additional standalone or nested bases can be ordered separately.*

*Tip: Handedness is determined from the seated position, assuming the screen behind you.*

## Specification Information

**Style Number**      **U.S. Base Price**

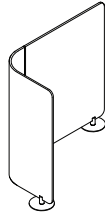

**Medium J Screen-Right**  
Overall: 64<sup>9</sup>/<sub>10</sub>"W x 33<sup>1</sup>/<sub>2</sub>"D x 62<sup>7</sup>/<sub>10</sub>"H

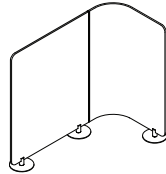

**Medium J Screen-Left**

### Medium J Screen

COENSMJ      \$4014

#### Fabric Upcharges

	Fabric Groups:								
	2	3	4	5	6	7	8	9	10
Primary Panel	+\$317	+\$581	+\$897	+\$1355	+\$1960	+\$2627	+\$3336	+\$3970	+\$4644
Secondary Panel	+\$157	+\$288	+\$444	+\$ 671	+\$ 971	+\$1301	+\$1652	+\$1965	+\$2300

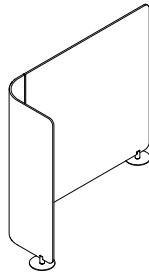

**High J Screen-Right**  
Overall: 64<sup>9</sup>/<sub>10</sub>"W x 33<sup>1</sup>/<sub>2</sub>"D x 78<sup>1</sup>/<sub>2</sub>"H

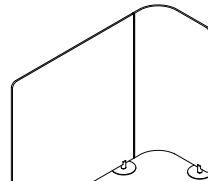

**High J Screen-Left**

### High J Screen

COENSHJ      \$4764

#### Fabric Upcharges

	Fabric Groups:								
	2	3	4	5	6	7	8	9	10
Primary Panel	+\$394	+\$723	+\$1114	+\$1683	+\$2435	+\$3263	+\$4144	+\$4931	+\$5570
Secondary Panel	+\$195	+\$359	+\$553	+\$ 835	+\$1208	+\$1618	+\$2056	+\$2447	+\$2862

► Specification Information, continued on next page



**For Canadian Pricing**  
Multiply U.S. Price by the Canadian price factor.  
► See page 1 for details.

# Coalesse Ensemble Lounge System Freestanding Screens

DESIGN COALESSE DESIGN STUDIO

*Tip: Nesting base is not handed.*

*Tip: The maximum number of screens that can nest together is two.*

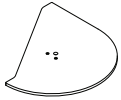

Overall: 11"W x 11"D



Overall: 11"W x 11"D

*Tip: Nesting base allows two screens to nest together. Note, the bases do not attach to one another, they simply nest together to create a more streamlined look.*

► Specification Information, continued from previous page

## Specification Information

Style Number	U.S. Base Price
--------------	-----------------

### Nesting Base

COENSDB	\$237
---------	-------

### Standalone Base

COENSSB	\$237
---------	-------



**For Canadian Pricing**  
 Multiply U.S. Price by the  
 Canadian price factor.  
 ► See page 1 for details.

# Coupe/Coupe Grande/Mobile Lounge Seating

DESIGN DENNIE PIMENTAL / JOHN DUFFY

Coupe offers versatile lounge seating that is adaptable to multiple environments and spatial needs.

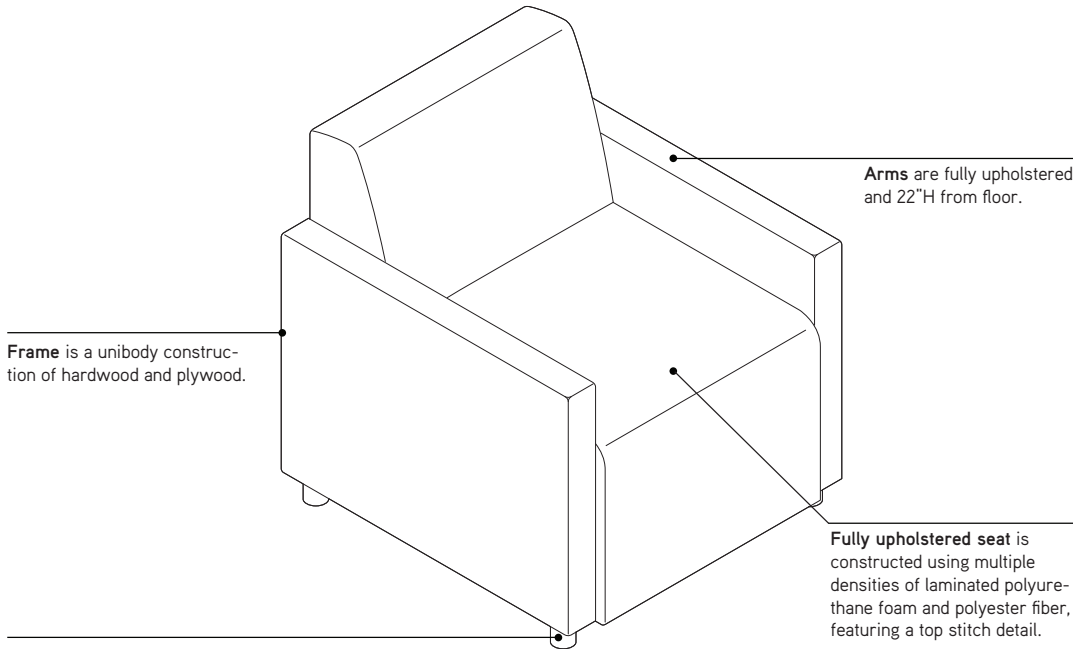

Frame is a unibody construction of hardwood and plywood.

Arms are fully upholstered and 22"H from floor.

Fully upholstered seat is constructed using multiple densities of laminated polyurethane foam and polyester fiber, featuring a top stitch detail.

4-leg base includes non-marring, non-adjustable glides. Standard solid beech wood legs, also available in brushed aluminum, powder coat, or clear acrylic as options.

## Product Details

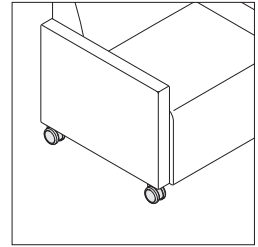
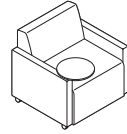

Coupe Grande's mobile chair is available with swivel hard casters with locking and non-locking wheels, or soft casters for use on hard floors. Optional tablet arm available in laminate 13<sup>1</sup>/<sub>2</sub>" diameter.

## Surface Materials

► See *Coalesse Surface Materials Reference Guide* for further information.

### Upholstery

- Fabric
- Leather

### Legs

- Solid wood
- Brushed aluminum
- Paint
- Clear acrylic

### Tablet on mobile chair

- Laminate

## Program and Services

Customer's Own Material/Leather (COM/COL) Program is available.

► See *Coalesse Surface Materials Reference Guide* for additional information.

# Coupe Lounge Seating

DESIGN DENNIE PIMENTAL / JOHN DUFFY

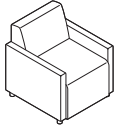

Overall: 28"D 26½"W 30"H  
 Inside: 20"D 22"W 13"H  
 Seat: 17"H  
 Arm: 22"H

*Tip: Fabrics and leathers will appear loose with comfort wrinkles when upholstered.*

*Tip: Recommended leathers are Elmosoft group 1 and Elmorustical group 2.*

*Tip: Special color match, consult Customer Service.*

*Tip: For Customer's Own Material or Leather, see necessary requirements, important processing instructions, and ordering information*  
 ▶ See *Coalesse Surface Materials Reference Guide*.

Standard Includes	Required to Specify
▶ Need help? Product details, page 94 • Frame: unibody construction of hardwood plywood utilizing box joinery • Legs: solid beech • Glides: non-adjustable • Upholstery: multiple densities of laminated polyurethane foam and polyester fiber on seat and back with top stitch sewing detail	1 Style number 2 Wood color number for legs 3 Fabric or leather color number for upholstery on seat and back 4 Options, if selected (see below) ▶ See <i>Coalesse Surface Materials Reference Guide</i> .

Options	U.S. Price	Required to Specify
<b>Surface Materials</b> • Acrylic backer • Lounge chair	+\$ 63	Specify with acrylic backer. ▶ See <i>Coalesse Surface Materials Reference Guide</i> .
<b>Legs</b> • Brushed aluminum • Powder coat	+\$267 +\$214	Specify with brushed aluminum legs. Specify with powder coat legs and select color: 4138 Graphite Gloss 4140 Arctic White Gloss 4142 Platinum Gloss 4144 Black Gloss 4148 Midnight Brown Gloss Specify with acrylic legs.
• Acrylic: clear	+\$376	

Lounge Seating

Specification Information														
Style Number	U.S. Base Prices											Leather Groups:		
	Fabric Groups:											COL	1	2
	COM	1	2	3	4	5	6	7	8	9	10			

Lounge Chair														
470	\$2554	\$2554	\$2665	\$2757	\$2867	\$3033	\$3238	\$3472	\$3721	\$3941	\$4176	\$3056	\$5854	\$6411
COM/yds = 4¼, COL/sq ft = 94														

 **For Canadian Pricing**  
 Multiply U.S. Price by the Canadian price factor.  
 ▶ See page 1 for details.

# Coupe Grande/Mobile Lounge Seating

DESIGN DENNIE PIMENTAL / JOHN DUFFY

*Tip: Fabrics and leathers will appear loose with comfort wrinkles when upholstered.*

*Tip: Recommended leathers are Elmosoft group 1 and Elmorustical group 2.*

*Tip: Special color match, consult Customer Service.*

*Tip: For Customer's Own Material or Leather, see necessary requirements, important processing instructions, and ordering information*

► See *Coalesse Surface Materials Reference Guide*.

Standard Includes	Required to Specify
<p>► Need help? Product details, page 94</p> <ul style="list-style-type: none"> <li>• Frame: unibody construction of hardwood plywood utilizing box joinery</li> <li>• Legs: solid beech</li> <li>• Glides: non-adjustable</li> <li>• Upholstery: multiple densities of laminated polyurethane foam and polyester fiber on seat and back with top stitch sewing detail</li> <li>• On 476M model:                             <ul style="list-style-type: none"> <li>– Casters: swivel hard</li> <li>– Locking and non-locking wheels</li> </ul> </li> <li>• Tablet:                             <ul style="list-style-type: none"> <li>– Laminate</li> <li>– 13½" diameter</li> </ul> </li> </ul>	<ol style="list-style-type: none"> <li>1 Style number</li> <li>2 Wood color number for legs</li> <li>3 Fabric or leather color number for seat and back</li> <li>4 Laminate color number for 476M tablet, if selected</li> <li>5 Options, if selected (see below)</li> </ol> <p>► See <i>Coalesse Surface Materials Reference Guide</i>.</p>

Options	U.S. Price	Required to Specify
<b>Surface Materials</b> <ul style="list-style-type: none"> <li>• Acrylic backer                             <ul style="list-style-type: none"> <li>• Lounge chair</li> </ul> </li> </ul>	+\$ 78	Specify with acrylic backer. ► See <i>Coalesse Surface Materials Reference Guide</i> .
<b>Casters on 476M only</b> <ul style="list-style-type: none"> <li>• Soft casters</li> </ul>	No cost	Specify with soft casters.
<b>Legs</b> <ul style="list-style-type: none"> <li>• Brushed aluminum</li> <li>• Powder coat</li> </ul>	+\$267 +\$214	Specify with brushed aluminum legs. Specify with powder coat legs and select color: 4138 Graphite Gloss 4140 Arctic White Gloss 4142 Platinum Gloss 4144 Black Gloss 4148 Midnight Brown Gloss Specify with acrylic legs.
<ul style="list-style-type: none"> <li>• Acrylic: clear</li> </ul>	+\$376	
<b>Tablet 476M only</b> <ul style="list-style-type: none"> <li>• Omit tablet</li> </ul>	-\$262	Specify with remove tablet.

## Specification Information

Style Number	U.S. Base Prices										Leather Groups:		
	Fabric Groups:										COL	1	2
COM	1	2	3	4	5	6	7	8	9	10			

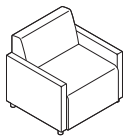

Overall: 28"D 31"W 30"H  
 Inside: 20"D 25"W 13"H  
 Seat: 17"H  
 Arm: 22"H

### Grande Lounge Chair

476	\$2988	\$2988	\$3119	\$3226	\$3357	\$3552	\$3793	\$4068	\$4362	\$4621	\$4896	\$3478	\$6808	\$7452
-----	--------	--------	--------	--------	--------	--------	--------	--------	--------	--------	--------	--------	--------	--------

COM/yds = 5, COL/sq ft = 110

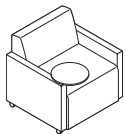

Overall: 28"D 31"W 30"H  
 Inside: 20"D 25"W 13"H  
 Seat: 17"H  
 Arm: 22"H

### Mobile Lounge Chair

476M	\$3828	\$3828	\$3959	\$4066	\$4197	\$4392	\$4633	\$4908	\$5202	\$5461	\$5736	\$4318	\$7632	\$8286
------	--------	--------	--------	--------	--------	--------	--------	--------	--------	--------	--------	--------	--------	--------

COM/yds = 5, COL/sq ft = 110

# Davos Lounge Seating by Viccarbe

DESIGN JEFFREY BERNETT

Elegantly contemporary, Davos is a natural for social spaces. Configure the lounge with benches in a lobby, lounge, or living room setting.

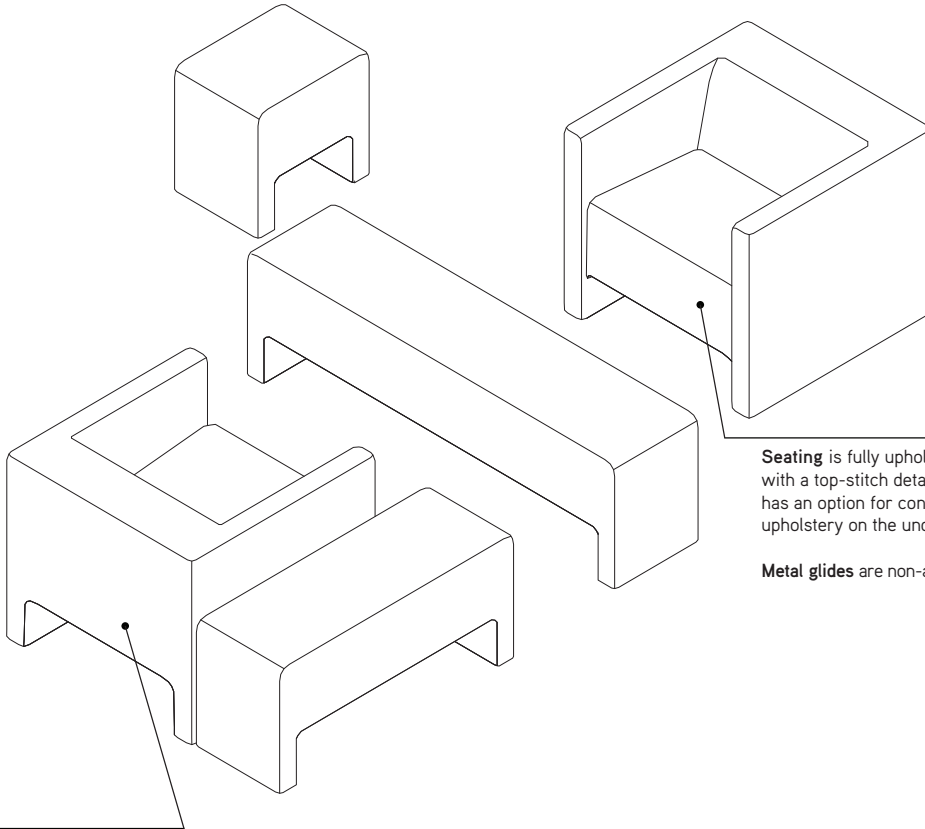

Frame is constructed of hardwood.

Seating is fully upholstered with a top-stitch detail and has an option for contrasting upholstery on the underside.

Metal glides are non-adjustable.

## Product Details

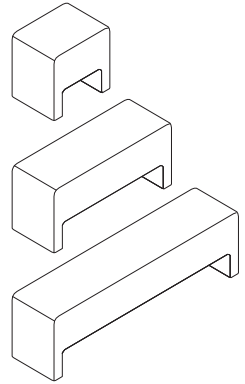

Benches are available in three sizes: the small bench measures 18"W, the medium bench measures 38"W, and the large bench measures 59½"W. All benches are fully upholstered with the option for contrasting upholstery on the underside.

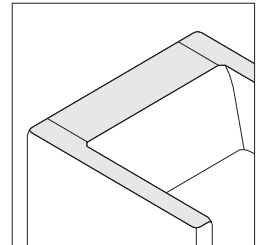

Top-stitch detail is featured on the back cushion and arm of chair.

## Surface Materials

► See *Coalesse Surface Materials Reference Guide* for further information.

Upholstery (contrasting fabric available)

- Fabric
- Leather

## Program and Services

Customer's Own Material/Leather (COM/COL) Program is available.

► See *Coalesse Surface Materials Reference Guide* for additional information.

# Davos Lounge Seating by Viccarbe

DESIGN JEFFREY BERNETT

*Tip: For Customer's Own Material or Leather, see necessary requirements, important processing instructions, and ordering information*  
 ▶ See *Coalesse Surface Materials Reference Guide*.

*Tip: Fabrics and leathers will appear loose with comfort wrinkles when upholstered.*  
 ▶ See page 100 for *Multi-Fabric Diagram*.

*Tip: K suffix must be specified for leather underside.*

*Tip: Models with fabric underside include black denim section to allow for proper air flow. If this aesthetic is not desired, select contrasting option with leather underside.*

Standard Includes	Required to Specify
-------------------	---------------------

▶ Need help? Product details, page 97 • Upholstery for chair or bench: fabric or leather • Glides: non-adjustable metal	1 Style number 2 Number of fabrics if contrasting fabric style number is selected 3 Fabric or leather color number for upholstery 4 Options, if selected (see below) ▶ See <i>Coalesse Surface Materials Reference Guide</i> .
---	--

Options	U.S. Price	Required to Specify
---------	------------	---------------------

<b>Surface Materials</b> • Contrasting fabric <hr/> <b>Acrylic backer</b> • Lounge chair • Large bench • Medium bench • Small bench	+\$192 per fabric <hr/> +\$ 89 +\$ 53 +\$ 41 +\$ 25	Add suffix K to the style number and select fabric color number. <hr/> Specify with <i>acrylic backer</i> . Specify with <i>acrylic backer</i> . Specify with <i>acrylic backer</i> . Specify with <i>acrylic backer</i> . ▶ See <i>Coalesse Surface Materials Reference Guide</i> .
---	---	---

## Specification Information

Style Number	U.S. Base Prices										Leather Groups:	
	Fabric Groups:										COL	
COM	1	2	3	4	5	6	7	8	9	10	1	2

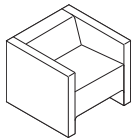

Overall: 30"D 30"W 25½"H  
 Seat: 19"D 24"W 16½"H

### Lounge Chair

CODAV	\$3467	\$3467	\$3626	\$3759	\$3916	\$4155	\$4449	\$4787	\$5144	\$5461	\$5799	\$3909	\$6345	\$6808
-------	--------	--------	--------	--------	--------	--------	--------	--------	--------	--------	--------	--------	--------	--------

COM/yds = 5, COL/sq ft = 110

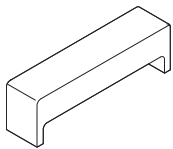

Overall: 13¼"D 59½"W 17½"H

### Large Bench

CODAV60	\$2822	\$2822	\$2928	\$3013	\$3116	\$3272	\$3462	\$3682	\$3915	\$4121	\$4340	\$3264	\$4651	\$4909
---------	--------	--------	--------	--------	--------	--------	--------	--------	--------	--------	--------	--------	--------	--------

COM/yds = 3¼, COL/sq ft = 71½

▶ Specification Information, continued on next page



**For Canadian Pricing**  
 Multiply U.S. Price by the Canadian price factor.  
 ▶ See page 1 for details.

# Davos Lounge Seating by Viccarbe

DESIGN JEFFREY BERNETT

► Specification Information, continued from previous page

## Specification Information

Style Number	U.S. Base Prices										Leather Groups:		
	Fabric Groups:										COL		
	COM	1	2	3	4	5	6	7	8	9	10	1	2

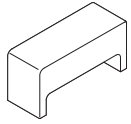

Overall: 13¼"D 38"W 17½"H

### Medium Bench

CODAV38	\$2029	\$2029	\$2102	\$2161	\$2233	\$2340	\$2472	\$2624	\$2785	\$2928	\$3080	\$2471	\$3730	\$3961
---------	--------	--------	--------	--------	--------	--------	--------	--------	--------	--------	--------	--------	--------	--------

COM/yds = 2½, COL/sq ft = 55



Overall: 13¼"D 18½"W 17½"H

### Small Bench

CODAV16	\$1302	\$1302	\$1358	\$1404	\$1460	\$1544	\$1646	\$1764	\$1890	\$2000	\$2119	\$1744	\$2717	\$2920
---------	--------	--------	--------	--------	--------	--------	--------	--------	--------	--------	--------	--------	--------	--------

COM/yds = 1¾, COL/sq ft = 39

Lounge Seating



**For Canadian Pricing**  
 Multiply U.S. Price by the  
 Canadian price factor.  
 ► See page 1 for details.

# Davos Lounge Seating Multi-Fabric Diagram

DESIGN JEFFREY BERNETT

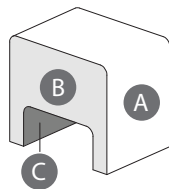
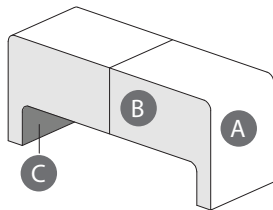
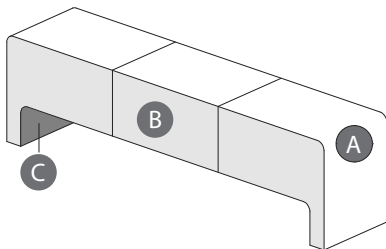
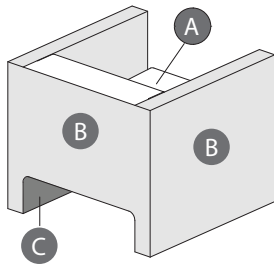
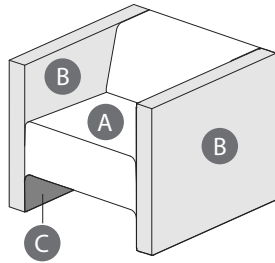

TO: \_\_\_\_\_

FROM: \_\_\_\_\_

DATE: \_\_\_\_\_

FAX...888.413.5161

## Davos Lounge Chair

- A** Seat (upholstery selections default for entire unit if B is not selected): \_\_\_\_\_
- B** Arms and Back: \_\_\_\_\_
- C** Underside: \_\_\_\_\_

## Davos Large Bench

- A** Seat (upholstery selections default for entire unit if B is not selected): \_\_\_\_\_
- B** Side: \_\_\_\_\_
- C** Underside: \_\_\_\_\_

## Davos Medium Bench

- A** Seat (upholstery selections default for entire unit if B is not selected): \_\_\_\_\_
- B** Side: \_\_\_\_\_
- C** Underside: \_\_\_\_\_

## Davos Small Bench

- A** Seat (upholstery selections default for entire unit if B is not selected): \_\_\_\_\_
- B** Side: \_\_\_\_\_
- C** Underside: \_\_\_\_\_

*See specifying for contrasting fabric upcharge. List price based on highest group textile specified.*

*\*\*Highest group pricing will not apply to 1 and 2 leathers when applied to the underside.*

# Hosu Lounge Seating

DESIGN PATRICIA URQUIOLA

Hosu lounge seating offers a comforting, personal space to relax and get things done.

Fully upholstered with contoured backrest cushion and frame which allows back to flex to support user's back shape.

Attached lumbar pillow is 3" thick in coordinating upholstery.

Pockets on side and rear for additional storage are standard.

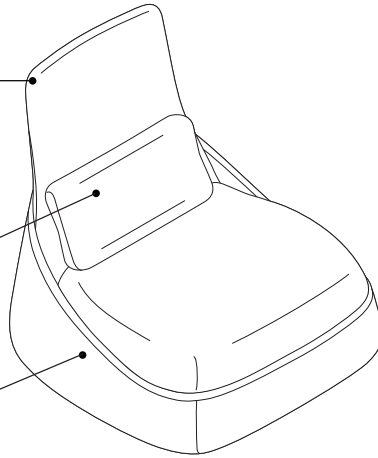

Glides are non-adjustable.

## Product Details

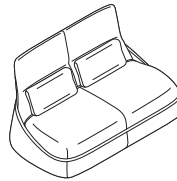
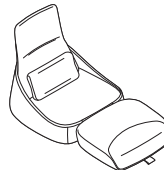
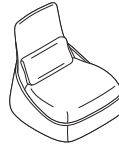

Lounge seating is available as a fixed single seat lounge or with a convertible chaise foldout. A fixed 2-seat lounge is also available.

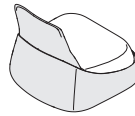

Storage pockets are located where the seat, backrest, and base wrap come together. Large pockets in the rear are ideal for holding magazines, and smaller pockets on the sides are sized appropriately for handheld devices. Cable pass-through holes are in the rear of the seat.

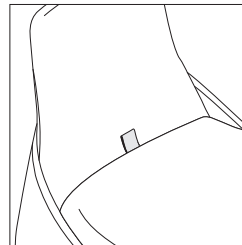

Convertible lounge converts to an extended low lounge with chaise ottoman using a webbed pull tab. The pull tab is available in red, blue, or black. The footbed surface is leather.

## Surface Materials

► See *Coalesse Surface Materials Reference Guide* for further information.

### Seat, back, footrest, and pillow

- Fabric
- Leather

### Wrap

- Plastic

### Pull tab

- Nylon

## Programs and Services

### Customer's Own Material/Leather (COM/COL) Program is available.

► See *Coalesse Surface Materials Reference Guide* for additional information.

# Hosu Lounge Seating

DESIGN PATRICIA URQUIOLA

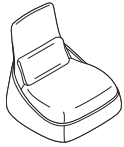

*Tip: Fabrics and leathers will appear loose with comfort wrinkles when upholstered.*

*Tip: Vinyls will produce more wrinkles than other textiles.*

*Tip: Recommended leathers are Elmosoft group 1 and Elmorustical group 2.*

*Tip: Frame design allows back to flex to support occupants back shape.*

*Tip: Due to the design and construction techniques of Hosu lounge seating only certain textiles can be successfully applied, therefore all COM fabrics must be submitted to Coalesse for approval prior to order acceptance.*

*Tip: Hexa fabrics (fabric group 10) were specifically designed by Patricia Urquiola for Hosu lounge seating.*

► See *Coalesse Surface Materials Reference Guide* for complete listing of Hexa fabrics.

Standard Includes	Required to Specify
<p>► Need help? Product details, page 101</p> <ul style="list-style-type: none"> <li>• Frame: plywood tab construction</li> <li>• Multiple densities of polyurethane foam and polyester fiber</li> <li>• Seat and back: fabric or leather</li> <li>• Wrap: made from ABS plastic</li> <li>• Footrest on fabric chair, if selected: leather</li> <li>• Footrest on leather chair, if selected: leather to match seat and back</li> <li>• Glides: non-adjustable</li> <li>• Pull tab on ottoman, if selected: Nylon strap</li> <li>• Grommet for wire pass-through on models COURQLO and COURQLOK, if selected</li> <li>• Pillow: fabric or leather</li> </ul>	<ol style="list-style-type: none"> <li>1 Style number</li> <li>2 Number of fabrics if contrasting fabric style number is selected</li> <li>3 Fabric or leather color number for upholstery on seat, back, and pillow</li> <li>4 Leather color number for footrest, if selected</li> <li>5 Color number for pull tab with ottoman, if selected: CL40 Red CL41 Blue CL42 Black</li> <li>6 Options, if selected (see below)</li> </ol> <p>► See <i>Coalesse Surface Materials Reference Guide</i>.</p>

Options	U.S. Price	Required to Specify
<p><b>Surface Materials</b></p> <p><b>Pillow for lounge chair and lounge chair with ottoman</b></p> <ul style="list-style-type: none"> <li>• Fabric groups 1-5 No cost</li> <li>• Fabric group 6 +\$ 171</li> <li>• Fabric group 7 +\$ 230</li> <li>• Fabric group 8 +\$ 292</li> <li>• Fabric group 9 +\$ 347</li> <li>• Fabric group 10 +\$ 405</li> <li>• Leather group 1 +\$ 546</li> <li>• Leather group 2 +\$ 657</li> <li>• Customer's Own Material (COM) No cost</li> <li>• Customer's Own Leather (COL) +\$ 442</li> </ul> <p><b>Pillows for 2-seat lounge</b></p> <ul style="list-style-type: none"> <li>• Fabric groups 1-5 No cost</li> <li>• Fabric group 6 +\$ 300</li> <li>• Fabric group 7 +\$ 402</li> <li>• Fabric group 8 +\$ 511</li> <li>• Fabric group 9 +\$ 607</li> <li>• Fabric group 10 +\$ 709</li> <li>• Leather group 1 +\$ 968</li> <li>• Leather group 2 +\$1170</li> <li>• Customer's Own Material (COM) No cost</li> <li>• Customer's Own Leather (COL) +\$ 442</li> </ul> <p>• Contrasting fabric +\$ 192 per fabric</p>		<p>Specify fabric color number. Specify fabric color number. Specify fabric color number. Specify fabric color number. Specify fabric color number. Specify fabric color number. Specify fabric color number. Specify fabric color number. Specify fabric color number. Specify fabric color number. Specify fabric color number. Specify fabric color number. Specify fabric color number. Specify fabric color number.</p> <p>► See <i>Coalesse Surface Materials Reference Guide</i>. ► See <i>Coalesse Surface Materials Reference Guide</i>.</p> <hr/> <p>Specify fabric color number. Specify fabric color number. Specify fabric color number. Specify fabric color number. Specify fabric color number. Specify fabric color number. Specify fabric color number. Specify fabric color number. Specify fabric color number.</p> <p>► See <i>Coalesse Surface Materials Reference Guide</i>. ► See <i>Coalesse Surface Materials Reference Guide</i>.</p> <hr/> <p>Add suffix <b>K</b> to the style number and select fabric color number.</p> <hr/> <p>Specify <i>with acrylic backer</i>. Specify <i>with acrylic backer</i>. Specify <i>with acrylic backer</i>.</p> <p>► See <i>Coalesse Surface Materials Reference Guide</i>.</p>
<p><b>Acrylic backer</b></p> <ul style="list-style-type: none"> <li>• Lounge chair +\$ 63</li> <li>• Lounge chair with ottoman +\$ 89</li> <li>• 2-seat lounge +\$ 118</li> </ul>		



**For Canadian Pricing**  
Multiply U.S. Price by the Canadian price factor.  
► See page 1 for details.

# Hosu Lounge Seating

DESIGN PATRICIA URQUIOLA

## Specification Information

Style Number	U.S. Base Prices										Leather Groups:		
	Fabric Groups:										COL		
	COM	1	2	3	4	5	6	7	8	9	10	1	2

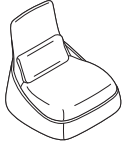

Overall: 35½"D 34½"W 35"H  
 Inside: 24"D 31"W 14"H  
 Pillow: 3"D 20½"W 10½"H  
 Seat height: 14"H

### Lounge Chair with Lumbar Pillow

COURQL	\$3492	\$3492	\$3609	\$3707	\$3824	\$4001	\$4218	\$4467	\$4731	\$4965	\$5214	\$3934	\$5718	\$5981
--------	--------	--------	--------	--------	--------	--------	--------	--------	--------	--------	--------	--------	--------	--------

Lounge chair: COM/yds = 4¼, COL/sq ft = 94  
 Pillow: COM/yds = 1, COL/sq ft = 22

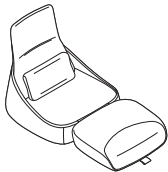

Overall: 35½"D 34½"W 35"H  
 Overall extended: 57"L  
 Inside: 24"D 31"W 14"H  
 Inside extended: 48"L  
 Pillow: 3"D 20½"W 10½"H  
 Footrest: 24"D 31"W 8½"H  
 Seat height: 14"H  
 Seat height extended: 9"H

### Lounge Chair With Footrest and Lumbar Pillow

COURQLO	\$4209	\$4209	\$4368	\$4500	\$4659	\$4898	\$5191	\$5529	\$5885	\$6202	\$6538	\$4651	\$7212	\$7565
---------	--------	--------	--------	--------	--------	--------	--------	--------	--------	--------	--------	--------	--------	--------

Lounge chair: COM/yds = 5¾, COL/sq ft = 126  
 Pillow: COM/yds = 1, COL/sq ft = 22

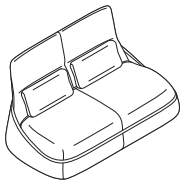

Overall: 35½"D 64½"W 35"H  
 Inside: 24"D 57½"W 14"H  
 Pillows: 3"D 24"W 10½"H  
 Seat height: 14"H

### 2-Seat Lounge with Two Lumbar Pillows

COURQS <b>X10/26</b>	\$5585	\$5585	\$5772	\$5927	\$6114	\$6393	\$6738	\$7134	\$7553	\$7925	\$8320	\$6027	\$8946	\$9349
----------------------	--------	--------	--------	--------	--------	--------	--------	--------	--------	--------	--------	--------	--------	--------

Lounge: COM/yds = 6¾, COL/sq ft = 143  
 Pillows: COM/yds = 1¾, COL/sq ft = 39



**For Canadian Pricing**  
 Multiply U.S. Price by the  
 Canadian price factor.  
 ▶ See page 1 for details.

**X10/26** = Last order entry  
 October 18, 2026

# Hosu Lounge Seating Multi-Fabric Diagram

DESIGN PATRICIA URQUIOLA

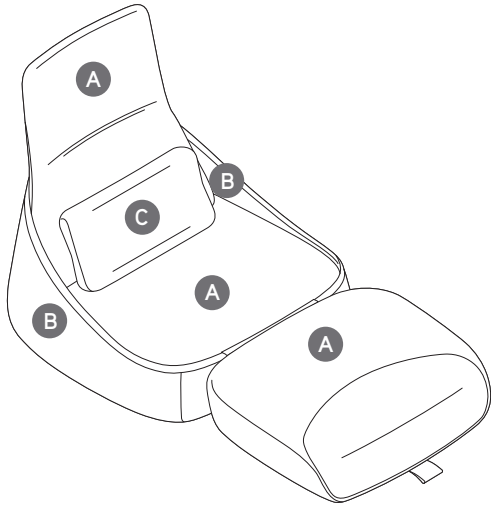

TO: \_\_\_\_\_

FROM: \_\_\_\_\_

DATE: \_\_\_\_\_

FAX....888.413.5161

**A** Seat & back: \_\_\_\_\_

\_\_\_\_\_

**B** Wrap: \_\_\_\_\_

\_\_\_\_\_

**C** Pillow: \_\_\_\_\_

\_\_\_\_\_

*Contrasting upcharge for each contrasting textile pricing based on highest group textile specified. See specifying for contrasting upcharge.*

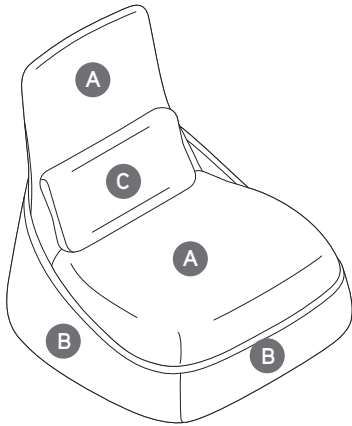

Specify Model below:

COURQLK Lounge Chair with Lumbar Pillow

COURQLOK Lounge Chair with Footrest and Lumbar Pillow

COURQSK 2-Seat Lounge with Two Lumbar Pillows

Coalesse

# Hosu Lounge Seating Multi-Fabric Diagram

DESIGN PATRICIA URQUIOLA

# Jean Nouvel Seating Collection

DESIGN JEAN NOUVEL

Elegantly proportioned and comfortable lounge seating by renowned architect Jean Nouvel for social and collaborative spaces. Three seating elements: a sofa, a lounge chair, and a tête-à-tête, plus an ottoman comprise the collection.

All Jean Nouvel seating collection components are upholstered.

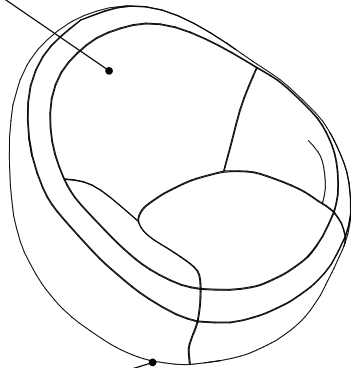

A swivel return option is available on the lounge chair. Glides are black plastic non-adjustable.

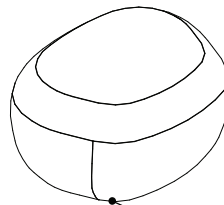

Glides are black plastic feet and non-adjustable.

Jean Nouvel tête-à-tête allows two users to collaborate or work individually.

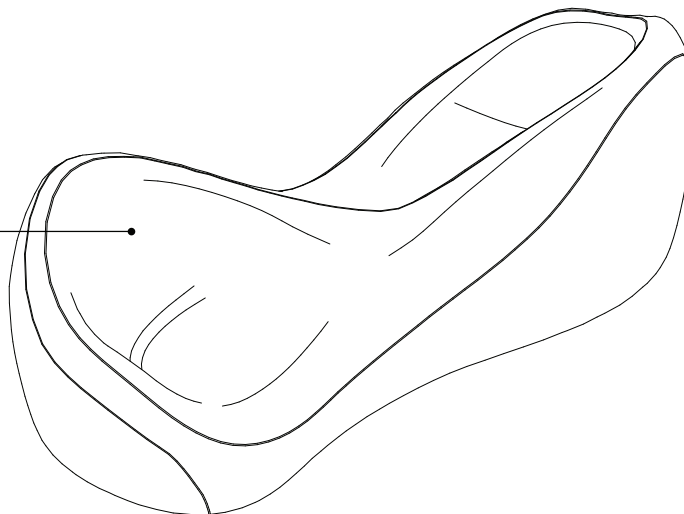

## Product Details



Designed to work well with all three Jean Nouvel seating products, the ottoman provides additional support in lounge posture.

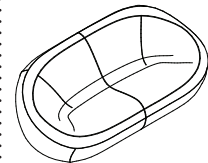

The sofa comfortably sits two people.

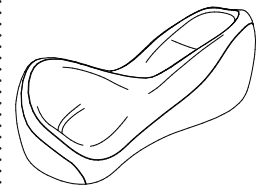

The tête-à-tête lounge sits two users in individual seats but within the same lounge piece.

The swivel-return cylinder option on the lounge has a built-in memory and will return to the fixed position when the user leaves the chair.

# Jean Nouvel Seating Collection

DESIGN JEAN NOUVEL

## Surface Materials

► See *Coalesse Surface Materials Reference Guide* for further information.

## Upholstery

- Fabric
- Leather

## Program and Services

Customer's Own Material/Leather (COM/COL) Program is available.

► See *Coalesse Surface Materials Reference Guide* for additional information.

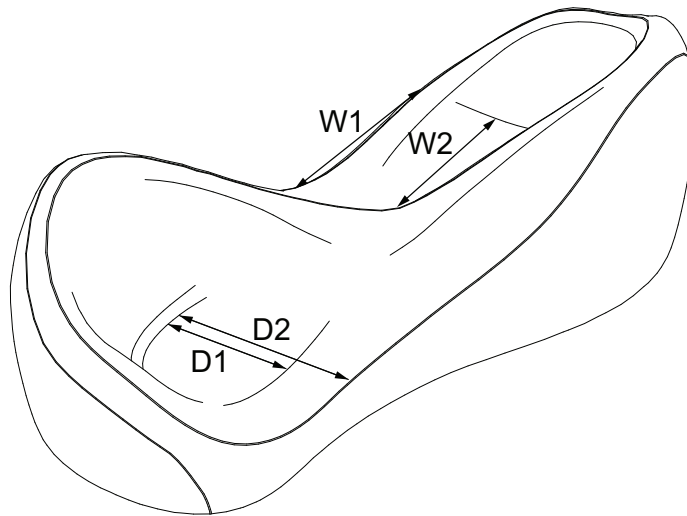
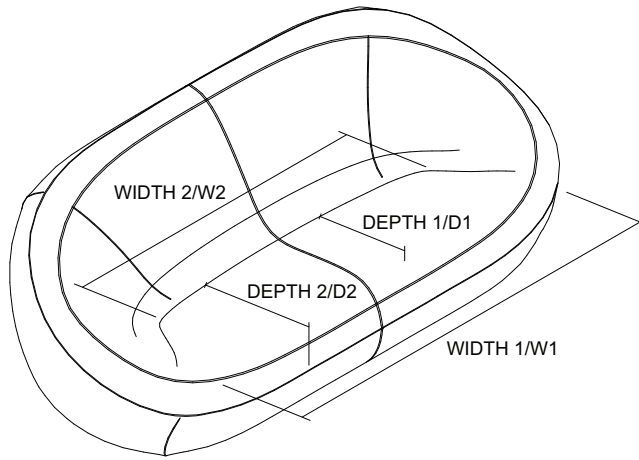

	Overall				Internal Dimensions			
	Depth	Width	Height	Seat Height	Seat Depth D1	Seat Depth D2	Seat Width W1	Seat Width W2
<b>Lounge</b>	36 <sup>5</sup> / <sub>8</sub> "	37 <sup>3</sup> / <sub>8</sub> "	32 <sup>5</sup> / <sub>8</sub> "	15 <sup>3</sup> / <sub>4</sub> "	18"	22"	24 <sup>2</sup> / <sub>5</sub> "	20"
<b>Sofa</b>	37 <sup>1</sup> / <sub>2</sub> "	73 <sup>5</sup> / <sub>8</sub> "	32 <sup>3</sup> / <sub>4</sub> "	15 <sup>3</sup> / <sub>4</sub> "	18 <sup>1</sup> / <sub>2</sub> "	22"	57"	50"
<b>Tête-à-Tête</b>	37 <sup>1</sup> / <sub>2</sub> "	88 <sup>5</sup> / <sub>8</sub> "	32 <sup>5</sup> / <sub>8</sub> "	15 <sup>3</sup> / <sub>4</sub> "	18"	20"	24 <sup>2</sup> / <sub>5</sub> "	20"
<b>Ottoman</b>	21"	25"	14 <sup>1</sup> / <sub>2</sub> "	N.A.	N.A.	N.A.	N.A.	N.A.

*Tip: Due to the organic, sculptural shape, dimensions vary. Please reference the above illustration for the location of D1, D2, W1, and W2 internal dimensions.*

# Jean Nouvel Seating Collection

DESIGN JEAN NOUVEL

	Standard Includes	Required to Specify
► Need help? Product details, page 106	<ul style="list-style-type: none"> <li>• Frame: rotomodeled shell with plywood supports overlaid with foam</li> <li>• Upholstery: multiple densities of polyetherane foam and polyester fiber</li> <li>• Seat and back: upholstery</li> <li>• Plastic glides: black</li> <li>• Ships fully assembled</li> </ul>	1 Style number 2 Fabric or leather color number for upholstery 3 Options, if selected (see below) ► See <i>Coalesse Surface Materials Reference Guide</i> .

	Options	U.S. Price	Required to Specify
<b>Surface Materials</b>	<b>Acrylic backer</b> <ul style="list-style-type: none"> <li>• Lounge</li> <li>• Ottoman</li> <li>• Sofa</li> <li>• Tête-à-tête</li> </ul>	+\$ 63 +\$ 26 +\$121 +\$137	Specify with acrylic backer. Specify with acrylic backer. Specify with acrylic backer. Specify with acrylic backer. ► See <i>Coalesse Surface Materials Reference Guide</i> .
<b>Base Type</b>	<b>Lounge base</b> <ul style="list-style-type: none"> <li>• Hard glide</li> <li>• Swivel return</li> </ul>	No cost +\$317	Specify with hard glides. Specify with swivel return.

Tip: Base type is only available for lounge.

## Specification Information

Style Number	U.S. Base Prices										Leather Groups:			
	Fabric Groups:										COL	1	2	
	COM	1	2	3	4	5	6	7	8	9	10			

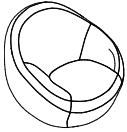

Overall: 36<sup>5</sup>/<sub>8</sub>"D x 37<sup>3</sup>/<sub>8</sub>"W x 32<sup>5</sup>/<sub>8</sub>"H  
Seat height: 15<sup>3</sup>/<sub>4</sub>"

### Jean Nouvel Lounge

CONCLC	\$3099	\$3099	\$3230	\$3338	\$3468	\$3663	\$3906	\$4182	\$4477	\$4736	\$5013	\$ 6419	\$4358	\$4740
--------	--------	--------	--------	--------	--------	--------	--------	--------	--------	--------	--------	---------	--------	--------



Overall: 21"D x 25"W x 14<sup>1</sup>/<sub>2</sub>"H

### Jean Nouvel Ottoman

CONLCOT	\$ 993	\$ 993	\$1043	\$1083	\$1132	\$1205	\$1296	\$1400	\$1510	\$1607	\$1711	\$ 2018	\$1378	\$1496
---------	--------	--------	--------	--------	--------	--------	--------	--------	--------	--------	--------	---------	--------	--------

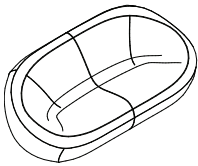

Overall: 37<sup>1</sup>/<sub>2</sub>"D x 73<sup>5</sup>/<sub>8</sub>"W x 32<sup>3</sup>/<sub>4</sub>"H  
Seat height: 15<sup>3</sup>/<sub>4</sub>"

### Jean Nouvel Sofa

CONLCSF	\$6276	\$6276	\$6488	\$6665	\$6876	\$7194	\$7587	\$8037	\$8515	\$8937	\$9386	\$12,242	\$8558	\$9232
---------	--------	--------	--------	--------	--------	--------	--------	--------	--------	--------	--------	----------	--------	--------

► Specification Information, continued on next page



**For Canadian Pricing**  
 Multiply U.S. Price by the Canadian price factor.  
 ► See page 1 for details.

# Jean Nouvel Seating Collection

DESIGN JEAN NOUVEL

► Specification Information, continued from previous page

## Specification Information

Style Number	U.S. Base Prices										Leather Groups:		
	Fabric Groups:										COL		
	COM	1	2	3	4	5	6	7	8	9	10	1	2

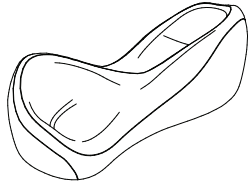

Overall: 37 1/2"D x 88 5/8"W x 32 5/8"H  
 Seat height: 15 3/4"

## Jean Nouvel Tête-à-Tête

CONLCTT	\$8335	\$8335	\$8612	\$8844	\$9119	\$9535	\$10,049	\$10,638	\$11,263	\$11,813	\$12,402	\$15,510	\$11,057	\$11,883
---------	--------	--------	--------	--------	--------	--------	----------	----------	----------	----------	----------	----------	----------	----------

Lounge Seating



**For Canadian Pricing**  
 Multiply U.S. Price by the  
 Canadian price factor.  
 ► See page 1 for details.

# Joel Lounge Chair by Walter Knoll

DESIGN EOOS

The Joel lounge chair is a new take on the classic club chair - refined, modern, and comfortable.

Arms are integral to backrest with no seams for added comfort.

Swivel-return base with auto-return mechanism returns chair to front-facing alignment.

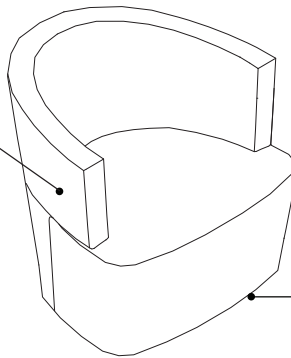

Frame is a two-piece construction. The seat is plywood and the back is steel for increased durability.

Disc base is  $\frac{5}{16}$ " thick, with a chrome plated steel cover with plastic glides.

## Product Details

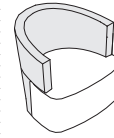

Integral arms provide added comfort for a range of postures.

## Surface Materials

► See *Coalesse Surface Materials Reference Guide* for further information.

**Upholstery** (contrasting fabric available)

- Fabric
- Leather

## Base

- Polished trivalent chrome

## Programs and Services

**Customer's Own Material/Leather (COM/COL) Program** is available.

► See *Coalesse Surface Materials Reference Guide* for additional information.

# Joel Lounge Chair by Walter Knoll

DESIGN EOOS



**Overall:** 29"D x 30 1/4"W x 27 1/2"H  
**Seat:** 16 1/4"H  
**Arm:** 26 1/4"H  
**Inside:** 21 1/2"D x 16 1/2"W x 11"H

*Tip: Fabrics and leathers will appear loose with comfort wrinkles when upholstered.*

*Tip: For Customer's Own Material or Leather, see necessary requirements, important processing instructions, and ordering information*  
 ▶ See *Coalesse Surface Materials Reference Guide*.

Standard Includes	Required to Specify
▶ Need help? Product details, page 110 • Base frame: steel with molded rigid foam • Seat frame: plywood with molded foam • Base: chrome plated steel • Auto swivel return mechanism	1 Style number 2 Number of fabrics if contrasting fabric style number is selected 3 Fabric or leather color number for upholstery 4 Options, if selected (see below) ▶ See <i>Coalesse Surface Materials Reference Guide</i> .

Options	U.S. Price	Required to Specify
<b>Surface Materials</b> • Contrasting fabric	+\$192 per fabric	Add suffix K to the style number and select fabric color number.
<b>Acrylic backer</b> • Backer	+\$ 53	Specify with <i>acrylic backer</i> . ▶ See <i>Coalesse Surface Materials Reference Guide</i> .

Lounge Seating

## Specification Information

Style Number	U.S. Base Prices												Leather Groups:	
	Fabric Groups:												COL	1
	COM	1	2	3	4	5	6	7	8	9	10			
COMK100	\$3045	\$3045	\$3159	\$3254	\$3367	\$3537	\$3748	\$3989	\$4246	\$4471	\$4713	\$3487	\$5630	\$5902

COM/yds = 3 1/2, COL/sq ft = 77

 **For Canadian Pricing**  
 Multiply U.S. Price by the Canadian price factor.  
 ▶ See page 1 for details.

# Joel Lounge Chair Multi-Fabric Diagram

DESIGN E00S

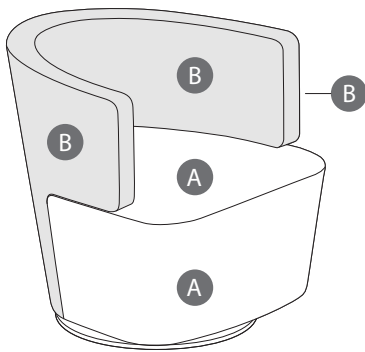

TO: \_\_\_\_\_

FROM: \_\_\_\_\_

DATE: \_\_\_\_\_

FAX...888.413.5161

**A** Seat (upholstery selections default for entire unit if B is not selected): \_\_\_\_\_

**B** Back: \_\_\_\_\_

*Contrasting upcharge for each contrasting textile pricing based on highest group textile specified. See specifying for contrasting upcharge.*

Coalesse

# Joel Lounge Chair Multi-Fabric Diagram

DESIGN E00S

# Lagunitas Lounge System

DESIGN TOAN NGUYEN

**The Lagunitas lounge system**

offers a wide range of highly customizable settings, bringing a new level of versatility to all the ways we work. Lagunitas adapts to changing work styles and shifting postures. Lagunitas utilizes a full range of design expressions with benches, lounge pieces, and tables. Fabric and knit, combined with high and low panels, allow for a full range of aesthetic and functional possibilities. Benches complement the range of lounge pieces. Work, occasional, and personal tables are curated to work specifically with Lagunitas lounges and benches. Integrated power options for the lounges, benches, and tables are available. Lagunitas supports existing and emerging work activities in an endless number of social, collaborative, and personal settings.

*Tip: This product line is part of a collection and will be found in multiple locations in this specification guide and/or Coalesse Tables, Storage, and Accessories Specification Guide.*

► See *Collections*, page 5.

**Lounges and benches** are offered in 1-, 2-, and 3-seat models. The chaise is offered in 2- and 3-seat models. The corresponding table offering works with the seating dimensions for complete systematic compatibility.

**Screens** are available in two heights for lounges and chaises. Low-back screens are 26<sup>3</sup>/<sub>4</sub>"H and high-back screens are 50"H. Overall height of low-back units is 32<sup>3</sup>/<sub>8</sub>".

**Screens** are available in knit or fabric.

**Articulating back** is standard on lounges and chaises which allow user to change from a lounge position to a task position within the same unit. An integrated pull at the top and bottom intuitively identifies the back and aids in the function of the back.

**Lounge units** can be connected together to create permanent connections for L- and U-configurations. The alignment connector bracket package includes two brackets to connect the seat decks and one screen alignment clip to keep the screens aligned.

**Tables** are offered in three types; work, occasional, and personal tables. 26"H table dimensions are curated to work with the lounge pieces for optimal compatibility. 28<sup>1</sup>/<sub>2</sub>"H work tables are compatible with standard height seating. ► See *Coalesse Tables, Storage, and Accessories Specification Guide*.

**Table bases and columns** are standard in powder coat paint.

**All corners** are standard with a stationary corner cushion for all 2- and 3-seat lounges and chaises. Arm cushions are optional on units with left- and right-hand screens to allow for articulating backs on all back cushions.

**Welt cord** is standard on fabric screens and will match the outside screen fabric selection if contrasting is selected.

**Seat deck** is available in knit or fabric and must be same material as the screen.

**Lounges and chaises** are standard with two glides per screen section or seat deck. Each glide can adjust 1/2" for uneven floors.

**Work and occasional table tops** are standard in High-Pressure Laminate with a 3 mm plastic edge or wood veneer with a 3 mm matching edge profile.

**Table glides** are non-adjustable and are clear plastic.

**Personal table tops** are standard in High-Pressure Laminate with 3 mm plastic edge.

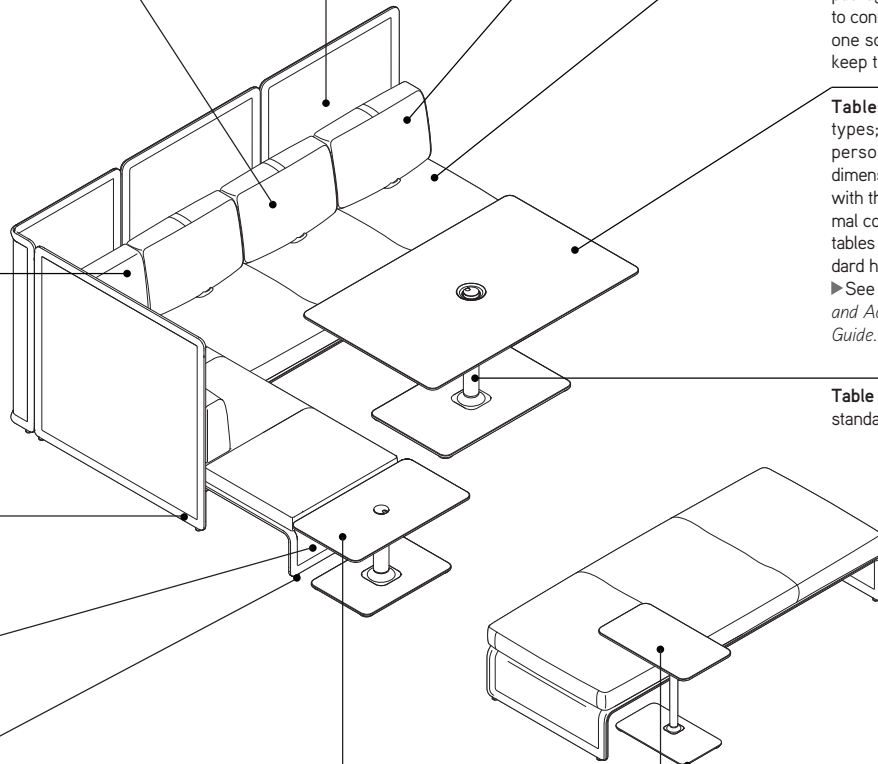

# Lagunitas Lounge System

DESIGN TOAN NGUYEN

## Product Details

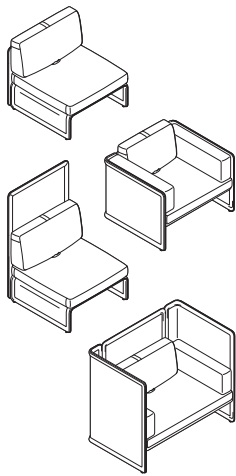

**1-seat lounges** are available in low- and high-back screens. Screens can be back only or back and left- and right-hand screens. 1-seat lounges are standard with upholstered fabric or knit screen(s), fabric or knit seat deck, fabric or leather seat cushion, and articulating back cushions. Fabric or leather end arm cushions are available.

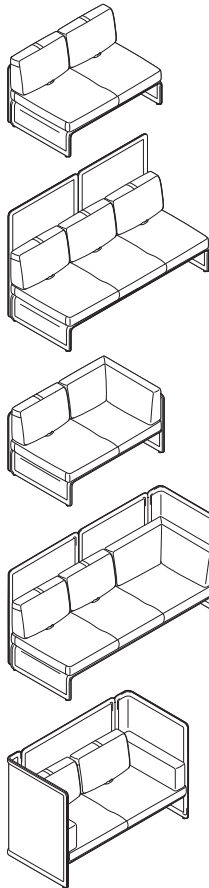

**2- and 3-seat lounges** are available in low- and high-back screens. Screens can be back only or back with left- or right-hand screens, or back and left- and right-hand screens. 2- and 3-seat lounges are standard with upholstered fabric or knit screen(s), fabric or knit seat deck, fabric or leather seat cushions, fabric or leather articulating back(s) and or corner cushion(s). Fabric or leather end arm cushions are available. *Tip: Handedness is noted by seated position.*

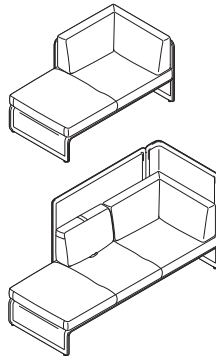

**2- and 3-seat chaises** are available in low- and high-back screens. Screens are back and left- or right-handed. 2- and 3-seat chaises are standard with upholstered fabric or knit screens, fabric or knit seat deck, fabric or leather seat and corner cushion. *Tip: Handedness is determined while in the seated position.*

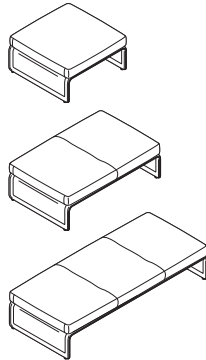

**Benches** are available in 1-, 2-, or 3-seat models. Benches are standard with an upholstered knit or fabric seat deck and a fabric or leather seat cushion.

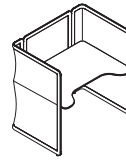

**Lagunitas focus nook** is available with 50"H high-back screens and is offered in two types of materials, knit and fabric. The worksurface is 28½"H and is compatible with standard height seating. Worksurface is available in laminate with matching or complementing 3 mm flat edge band profile; or wood veneer with matching 3 mm flat wood edge band. Optional lighting grommet and power are specifiable on the left or right side of the worksurface. ▶ See page 164.

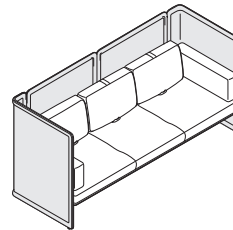

**Screens** are offered in two types of materials, knit and fabric. The knit panels allow for some transparency and light to pass through the panels. The fabric panels can be either monolithic (non-contrasting) or can be specified in differing finishes (contrasting) for the inside and outside of the screen. *Tip: If a contrasting screen is specified, the fabric must be chosen from the same fabric family.*

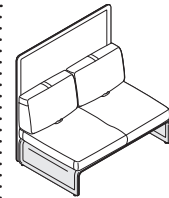

**Seat deck** is offered in two types of materials, knit and fabric. The seat deck material must match the screen material. If knit is specified on the screen, the seat deck will be applied automatically to the screen choice. If fabric is specified, seat deck must match either the inside or outside screen finish if contrasting is selected. When non-contrasting fabric screen is selected, seat deck will match screen fabric.

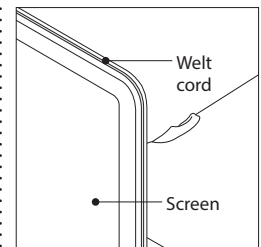

**A welt cord** is standard on all fabric specified screens and seat decks. The welt cord finish is non-specifiable and is the same fabric finish as the outside screen specification when contrasting screens are specified. For non-contrasting screens the welt cord matches the screen specification. The knit screen and seat deck does not require a welt cord.

# Lagunitas Lounge System *continued*

DESIGN TOAN NGUYEN

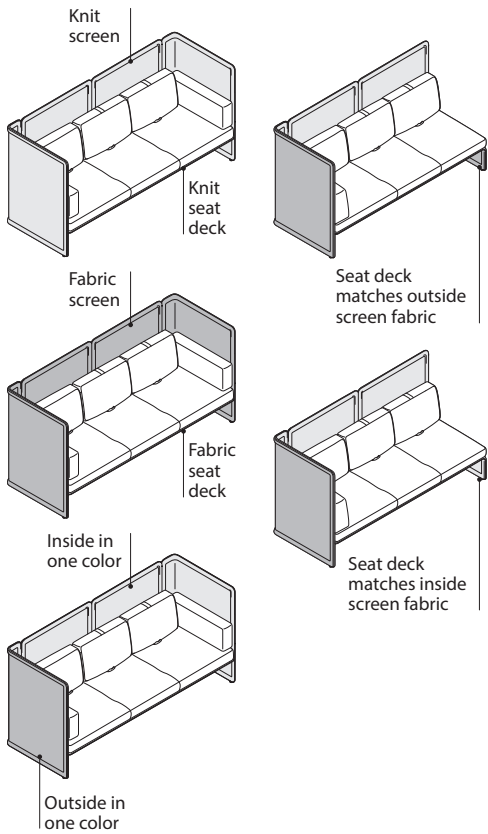

**Screens and seat deck can be specified in:**

- Knit
- Fabric (one fabric choice)
- Contrasting fabric (must be from fabric family)
  - Inside screen
  - Outside screen
  - Seat deck must match either the inside or outside fabric choice

*Tip: Leather and vinyl are not approved for the screen(s) and seat deck. Consult the fabric database for fabric approvals.*

*Tip: It is important to understand the seat deck implication for contrasting fabric selection when two or more pieces are attached or adjacent to each other. The seat deck for contrasting fabric specification is either the outside screen (top example) or inside screen (bottom example).*

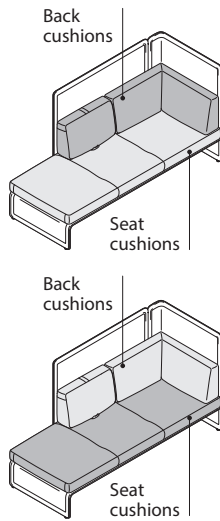

**Seat back and seat cushions can be specified in:**

- Fabric or leather (one fabric choice)
- Contrasting fabric or leather
  - Seat backs
  - Seat cushion
  - Top and bottom pulls on articulating back cushion(s)

The seat back, seat cushion, as well as, top and bottom pulls on the articulating back can be specified in fabric or leather. It can be specified as non-contrasting, one finish; or contrasting, finish for back cushions(s) and finish for seat cushion. Specification of back cushion is for all back cushions for that style number. Specification of seat cushion is for all seat cushions for the style number.

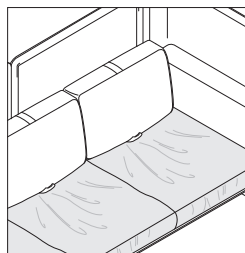

**Comfort wrinkles** are intended to occur over the time to increase the comfort of Lagunitas. Very little maintenance is required to reduce the definition: smooth the cushion fabric with a spreading/wiping motion.

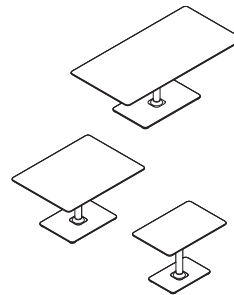

**Personal table** is available in one size. It can easily be moved to your desired location for short term laptop work or simply used to set your coffee. The personal table is comprised of a single column with rectangular base available in powder coat paint and a rectangular table top in laminate with matching or complementing 3 mm flat edge band profile.

**Work tables** are available in six differing sizes, ranging from 30"W to 72"W that coordinate with the lounge dimensions to create a variety of social, collaborative, and personal applications. The work tables are available in two heights: 26"H and 28½"H. The work tables are comprised of a single column rectangular base in powder coat paint and a rectangular table top in laminate with matching or complementing 3 mm flat edge band profile or wood veneer with matching 3 mm flat wood edge band.

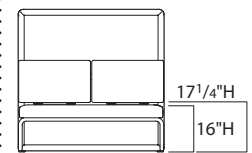

**16" seat height** is standard on all seating and benches. The 16"H seat height integrates specifically with the heights of all Lagunitas tables. There is an additional 1¼" crown of the seat cushion, which makes it 17¼" to work with the 26" work table height.

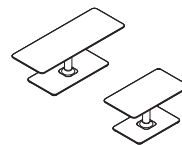

**Occasional tables** are available in two sizes, 32"W and 48"W, that coordinate with the lounge, chaise, and bench dimensions. The occasional tables are comprised of a single column with rectangular base available in powder coat paint and a rectangular table top in laminate with matching or complementing 3 mm flat edge band profile or wood veneer with matching 3 mm flat wood edge band.

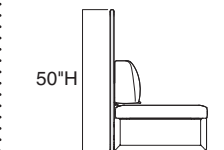
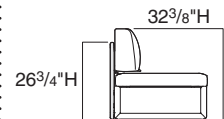

**Two screen heights** are available, 26¾"H for the low-back screen and 50"H for the high-back screen. Seat back cushions extend above the low-back screen, therefore, the overall height of low-back units is 32⅜"H. Low-back screens are designed to provide an open environment. High-back screens are designed to provide privacy.

# Lagunitas Lounge System

DESIGN TOAN NGUYEN

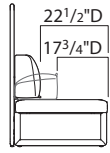

**Seat depth** accommodates two depths due to the articulated back design. In the lounge position, the seat depth is 22<sup>1</sup>/<sub>2</sub>"D and in the task position, the seat depth is 17<sup>3</sup>/<sub>4</sub>"D.

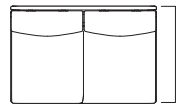

Lounge



Bench

**The overall seat depth on benches** is 32<sup>5</sup>/<sub>8</sub>"D. The overall depth for lounge seating is 34"D.

1-seat lounge, left- and right-hand screens

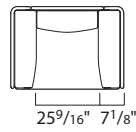

2-seat lounge, left-hand screen

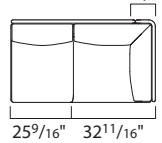

3-seat lounge

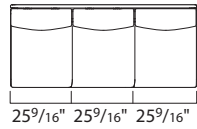

3-seat lounge, right-hand screen

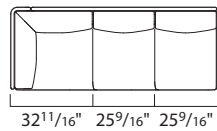

3-seat lounge, left- and right-hand screens

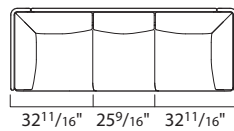

3-seat chaise, right-hand configuration

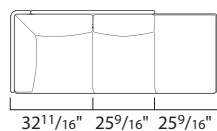

3-seat bench

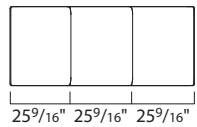

**Two seat widths** are available, 25<sup>9</sup>/<sub>16</sub>"W and 32<sup>11</sup>/<sub>16</sub>"W. When specifying corner or end cushions, the 32<sup>11</sup>/<sub>16</sub>"W module is used. The corner cushion and end cushion account for 7<sup>1</sup>/<sub>8</sub>" of the 32<sup>11</sup>/<sub>16</sub>" width, equating to the same seating space as the 25<sup>9</sup>/<sub>16</sub>"W module.

*Exception: 1-seat lounge with three screens has an overall width of 46<sup>7</sup>/<sub>8</sub>" allowing for a seating space of 32<sup>11</sup>/<sub>16</sub>"W.*

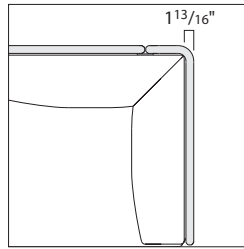

**An additional 1<sup>13</sup>/<sub>16</sub>" thickness** for each end screen or corner is added to the seating width to obtain the overall width of the product.

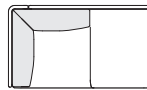

**Corner cushions** are standard when specifying two or three screens with closed end(s). Corner cushions are fixed and do not articulate.

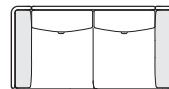

Two end cushions with two articulating backs

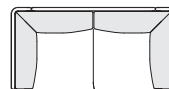

Two corner cushions

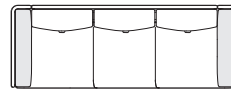

Two end cushions with three articulating backs

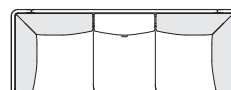

Two corner cushions with middle articulating back

**Two corner cushions or two end cushions** are available on all 2- and 3-seat lounges when back, left- and right-hand screens are specified. If articulating backs are specified, end cushions are required.



Lounge position



Task position

**The articulating back** is standard on all lounges and 3-seat chaises (2-seat chaises are only available with a corner cushion). The articulating back allows the user to easily change postures from a lounge position, when the back cushion is fully upright, to a task position, when the seat back is articulated down. Simply use the integrated pulls, one at the top and one at the bottom, to position the seat back to the desired position. The articulating mechanism is completely hidden behind the back cushion, and attaches the cushion to the seat frame.

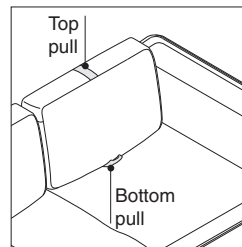

**Pulls at top and bottom of all articulating backs** aid the user to change from a lounge position to a task position and back to the lounge position.

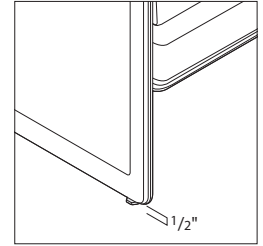

**Glides** adjust 1/2" for uneven floors. There are two glides per screen and/or seat deck. Glides have a metal rounded foot.

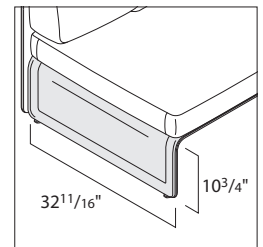

**Space** is available under the seat deck of all Lagunitas seating to provide a place to temporarily store personal items. The clearance height, without power module(s), is 10<sup>3</sup>/<sub>4</sub>" and the depth is 32<sup>11</sup>/<sub>16</sub>".

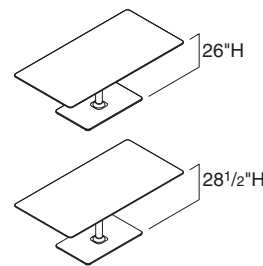

**Work tables** are available in two heights: 26"H tables are optimized to work with the lounge seat height, while 28<sup>1</sup>/<sub>2</sub>"H tables work with standard height seating.

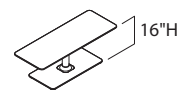

**Occasional tables** are available in one optimized height, 16"H, to work with the lounge seat height.

# Lagunitas Lounge System *continued*

DESIGN TOAN NGUYEN

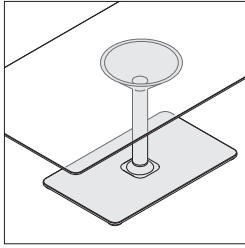

All work and occasional tables have a rectangular metal base with a centered column. The 3" column includes a cone at the top that attaches to the work surface. There are five rectangular base dimensions:

- 16"D x 23<sup>5</sup>/<sub>8</sub>"W x <sup>3</sup>/<sub>8</sub>"H for 18"D x 32"W, 24"D x 30"W, and 24"D x 36"W work tables;
- 16"D x 31<sup>5</sup>/<sub>8</sub>"W x <sup>3</sup>/<sub>8</sub>"H for 18"D x 48"W occasional table;
- 21"D x 28<sup>1</sup>/<sub>2</sub>"W x <sup>3</sup>/<sub>8</sub>"H for 36"D x 40"W and 36"D x 48"W work tables;
- 21"D x 35"W x <sup>3</sup>/<sub>8</sub>"H for 36"D x 57"W x work table; and
- 21"D x 35"W x <sup>1</sup>/<sub>2</sub>"H for 36"D x 72"W x work table

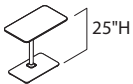

The personal table is available in one height, 25"H, to work with the lounge seat height.

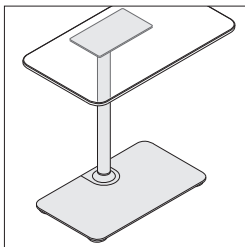

The personal table has a rectangular metal base with the column centered at the back of the base. The 1<sup>1</sup>/<sub>4</sub>" column includes a flat plate at the top that attaches to the underside of the top. The base plate dimension is 10<sup>3</sup>/<sub>4</sub>"D x 15<sup>3</sup>/<sub>4</sub>"W x <sup>3</sup>/<sub>8</sub>"H.

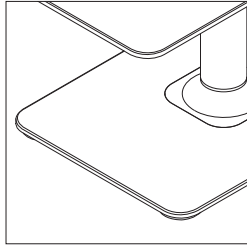

Non-adjustable 3" diameter plastic glides are standard on all tables. Glides are <sup>3</sup>/<sub>8</sub>" thick for the 36"D x 72"W table; <sup>1</sup>/<sub>2</sub>" thick for all other work and occasional tables; and <sup>1</sup>/<sub>4</sub>" thick for the personal table. For all work and occasional tables the glide height is needed to route cords.

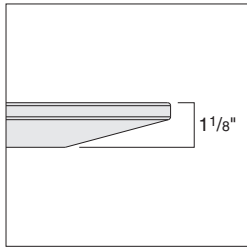

Tables are standard with a knife edge profile, that has the appearance of a <sup>1</sup>/<sub>2</sub>" thick top that tapers to an overall top thickness of 1<sup>1</sup>/<sub>8</sub>".

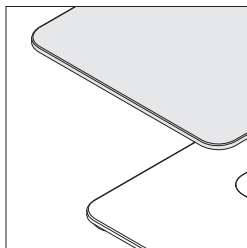

High-Pressure Laminate tables are standard with a matching or complementing 3 mm flat edge band. Wood veneer tables are standard with a matching wood 3 mm flat edge band. The underside of the table top is finished in black.

Specials are possible with Lagunitas. To confirm practicality and obtain a quotation, contact Customer Service at 1.800.627.6770.

## Connections

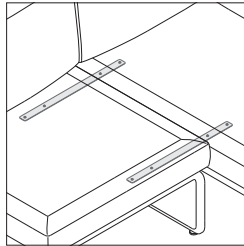

Alignment connector bracket package includes two seat attachment brackets and one screen alignment clip. The alignment connector bracket package is used when permanent connection is needed for L-, U-, and straight configurations of two or more pieces. The screen alignment clip is not needed for any bench connections, only the two seat attachment brackets would be utilized. The alignment connector bracket package should not be used if reconfigurations of the furniture pieces are required.

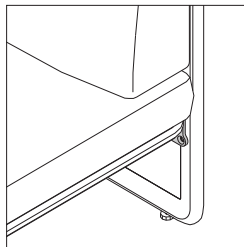

Attachment brackets for screen connection to seat deck must be specified in either platinum matte or low gloss black. Along with the brackets, the entire frame underneath will be painted to match the bracket finish specified.

Brackets can be specified in:

- 4710 Low Gloss Black paint (for dark color fabrics)
- 4141 Platinum Matte paint (for light color fabrics)

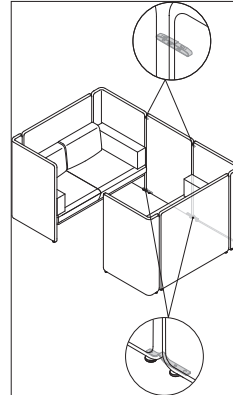

Lounge booth connector screen comes with two bottom brackets and two screen ganging alignment clips. The bottom brackets can be specified in either 4710 Low Gloss Black Paint or 4141 Platinum Matte Paint. The paint should match the bracket specification of the lounge.

## Power, Data, Wiring & Cabling

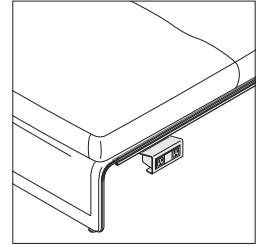

Optional power can be specified on all seating components (lounge, chaise, and bench):

- The power module consists of two power outlets.
- The USB power module consists of one USB A+C 20W port and one power outlet.

Power modules can be positioned anywhere along the attachment rail underneath the front lounge seat.

Power modules are available in black. One optional power module is available on 1-seat lounges. One or two optional power modules are available on 2- and 3-seat lounges.

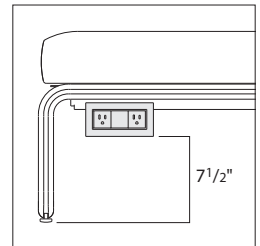

The power and USB power module options are located 7<sup>1</sup>/<sub>2</sub>" from the floor.

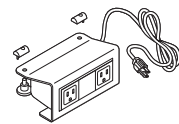

The power module has a 72"L cord and contains wire manager clips to route the cord underneath the seat deck when desired.

# Lagunitas Lounge System

DESIGN TOAN NGUYEN

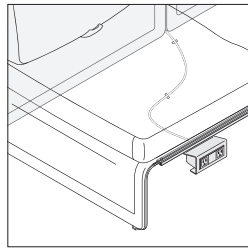

The power module cord is routed to the back utilizing clips attached to the underside of the lounge. The cord is then routed between the gap where the two screens meet when wall plug in access is needed.

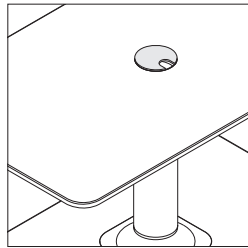

A metal grommet is an option on all work and occasional tables. The 3" grommet is flush-mounted and located in the center of the table top over the cone and column. The metal grommet is available in anodized silver only.

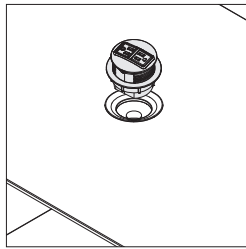

Round power modules are available on the focus nook, and all work and occasional tables. On the focus nook worksurface, the power module is specifiable on the back right or left side. On the tables, the power module is located in the center of the table top over the cone/column. The 3" power module features tamper resistant power simplexes, an 8'L power cord with 15-amp plug, and is available in four colors.

The round power modules are available in three configurations:

- Two TR simplex receptacles
- One TR simplex receptacle and two USB A charging ports
- One TR simplex receptacle, one USB A charging port, and one USB C charging port

*Tip: USB receptacles conveniently charge a range of electronic devices. Some devices may not be compatible.*

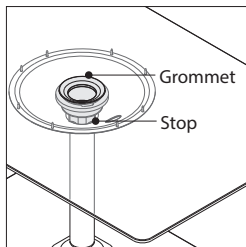

PowerPod grommet and stop is an option on all work and occasional tables. The grommet is located in the center of the table top over the cone/column. The stop attaches to the column to help hold and route cords and cables through the column. The grommet and stop cap are available in black or milk.

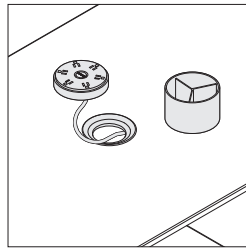

The grommet allows for pass through of cords and cables at the desktop. The grommet is open to allow for the PowerPod to be housed over or stored on the table. The grommet inside dimension is 3 1/2" and outside dimension is 5 1/16".

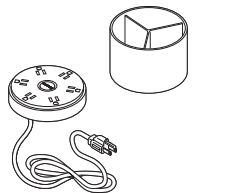

PowerPod includes six 15 amp outlets with an energy saving illuminated on/off switch. It comes with a 6' cord with three prong plug. The top tray is milk and the power source is silver with a milk face. It is UL and CSA listed.

*Tip: PowerPod is sold separately.*

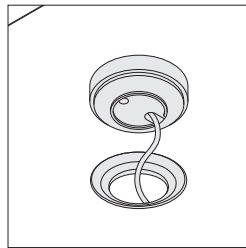

The contour of the PowerPod bottom cradle is designed to work in conjunction with the grommet for a snug fit or can be used independently without a grommet.

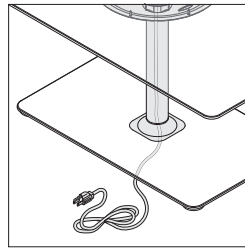

Work and occasional tables route cables and cords from the desktop through the column out through the base. Cords can be concealed in the cone.

*Tip: A powerstrip cannot fit inside the cone.*

*Tip: If a desktop device is desired, other than the standard PowerPod or power module, consult Specials engineering for capability.*

## Surface Materials

### Screen(s) and seat deck:

- Knit
- Fabric (contrasting and non-contrasting - contrasting must be same fabric family)

### Seat and back cushion(s), contrasting and non-contrasting:

- Fabric
- Leather

### Lounge attachment brackets and frame:

- Paint

### Lounge glides:

- Non-specifiable plated metal

### Lounge power and USB power modules (options):

- Black powder paint with black receptacles

### Work and occasional table top surface:

- Laminated with matching or complementing 3 mm plastic edge band
- Wood veneer with matching 3 mm wood edge
- Custom wood finish (option)

### Table base (cone or plate, column, and bottom plate):

- Paint

### Table glides:

- Non-specifiable clear plastic

### Metal grommet (option):

- Non-specifiable (anodized silver)

### PowerPod grommet and stop cover (option):

- 6000 Black plastic
- 6052 Milk plastic

### Table power modules:

- 4013 Silver/Black (silver powder paint with black receptacles)
- 4180 Graphite Matte
- 4242 Milk Matte
- 4710 Low Gloss Black

### Personal table top surface:

- Laminate with matching or complementing 3 mm plastic edge band

*Tip: Refer to the Coalesse Surface Materials Reference Guide for additional surface materials information.*

# Lagunitas Lounge System *continued*

DESIGN TOAN NGUYEN

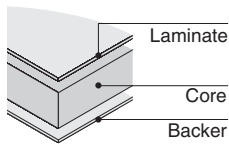

**Laminates** are available in two standard groups. Additional laminates from any manufacturer may also be practical—see *Other laminates* below.

**Group 1 laminates** include:

- Coalesse standard laminates  
▶ See *Coalesse Surface Materials Reference Guide*.
- Steelcase standard laminates (code 290A)  
▶ See *Steelcase Surface Materials Reference Manual*.
- Any standard-grade Wilsonart laminate in solid color, woodgrain, or pattern finish (code 290A)

**Group 2 laminates**

(code 290B) include any standard-grade, solid color, woodgrain, or patterned laminate from Nevamar (includes Matrix), Formica, or Pionite. Group 2 laminates may have extended lead times. For details, contact Customer Service at 1.800.627.6770.

**Other laminates** that are not included in the Group 1 or Group 2 offerings may also be available, such as Abet Laminati and Laminart. To determine availability and pricing, contact Customer Service at 1.800.627.6770, with the laminate manufacturer's name and the name and number of the laminate you want.

**Laminate swatches** are reproduced in the Surface Materials Color Palettes.

▶ See *Coalesse Surface Materials Reference Guide* for a list.

**Swatch cards and actual samples of Coalesse standard laminates** are available from your Coalesse Customer Service representative. For samples of laminates from other manufacturers, contact them directly:

- Wilsonart  
1.800.433.3222
- Nevamar  
1.800.638.4380
- Formica  
1.800.FORMICA
- Pionite  
1.800.285.5161

*Tip: Laminate manufacturers change their offerings frequently. Always check availability before ordering.*

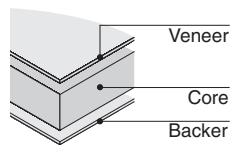

**Wood veneer table tops** are fabricated with Architectural Grade AA hand-selected hardwood veneer, plain sliced, book matched, and bonded to the core with a backing sheet for balance. Coalesse's primary wood finish, Clarity, is a water-borne UV topcoat, which protects the environment while providing exceptional durability and resistance to water and chemical stains. Due to natural variations in wood, finished products may vary from samples in color, texture, and grain.

**Wood** is a natural material; slight variations occur in veneer texture, color, grain configuration, and stain acceptance. Coalesse stains are all applied with an exacting regard for consistency and are well within traditional tolerances for wood products.

*Tip: You should know that finished tops may vary slightly in tone or character from each other or from the samples Coalesse produces. No guarantee can be made of an absolutely exact match.*

**Wood veneer swatches** are reproduced in the Surface Materials Color Palettes.

▶ See *Coalesse Surface Materials Reference Guide* for a list.

**Swatch cards and actual samples of Coalesse standard wood veneers** are available from your Coalesse Customer Service representative.

**Additional wood veneer species** are available. To confirm availability and to determine pricing, contact Customer Service at 1.800.627.6770.

**Stains** applied to Coalesse wood veneer table tops are standard with the same stain color applied to both the top and the solid hardwood edge profile. Coalesse strives to produce a consistently high quality product and some natural variation in color is to be expected. This is especially apparent on natural woods which have no stain applied, for example 3525 Natural Maple. This color variation is normal and reflects the unique and natural properties of wood. This should not be considered a defect.

**Stain swatches** are reproduced in the Surface Materials Color Palettes.

▶ See *Coalesse Surface Materials Reference Guide* for a list.

**Swatch cards and actual samples of standard wood veneers** are available from your Customer Service representative.

## Programs & Services

**Customer's Own Material/Leather (COM/COL) Program** is available.

▶ See *Coalesse Surface Materials Reference Guide* for additional information.

# Lagunitas Lounge System Thought Starters and Applications

DESIGN TOAN NGUYEN

Lagunitas offers a wide range of highly customizable settings with varying degrees of privacy and multimodal support that become a desired third place to collaborate, socialize, or focus on personal work as individuals spend less time at traditional workstations and require different postures for working.  
 Note: This product line is a collection and will be found in multiple locations in this specification guide and/or Coalesse Tables, Storage, and Accessories Specification Guide.  
 ▶ See page 5.

## Individual Carrels

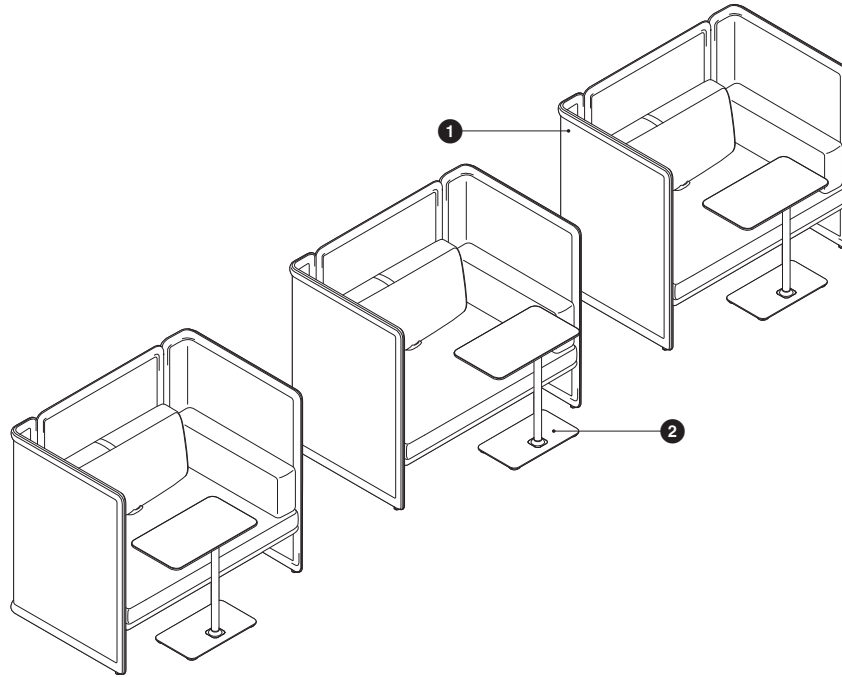

	Quantity	Style Number	Description	Components
1	3	COLAGLH13	1-Seat Lounge with High-Back Screen and Two Side Screens; One Articulating Back	Screen and Seat Deck Seat Back
2	3	COLAGTP	Personal Table	Table

# Lagunitas Lounge System Thought Starters and Applications *continued*

DESIGN TOAN NGUYEN

Note: This product line is a collection and will be found in multiple locations in this specification guide and/or Coalesse Tables, Storage, and Accessories Specification Guide.  
 ▶ See page 5.

## Private Meeting

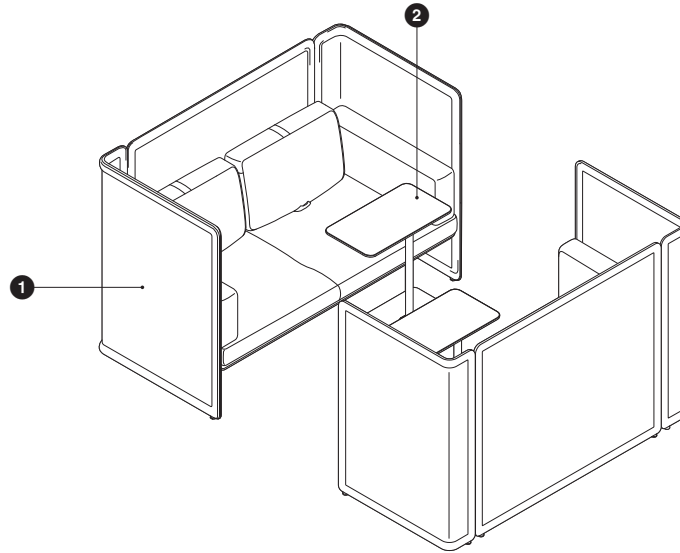

Quantity	Style Number	Description	Components
1	2	COLAGLH23	2-Seat Lounge with High-Back Screen and Two Side Screens; Two Articulating Backs
			Screen and Seat Deck
			Seat
			Back
2	2	COLAGTP	Personal Table
			Table

# Lagunitas Lounge System Thought Starters and Applications

DESIGN TOAN NGUYEN

Note: This product line is a collection and will be found in multiple locations in this specification guide and/or Coalesse Tables, Storage, and Accessories Specification Guide.  
 ▶ See page 5.

## Island

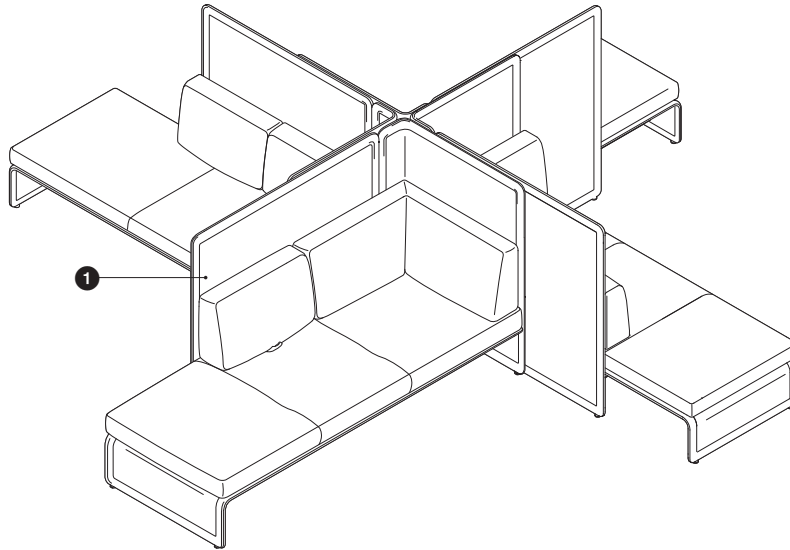

Lounge Seating

Quantity	Style Number	Description	Components
1	4	COLAGCH3 3-Seat Chaise with High-Back Screen and One Side Screen; One Articulating Back (Left-hand configuration)	Screen and Seat Deck  Seat Back

# Lagunitas Lounge System Thought Starters and Applications *continued*

DESIGN TOAN NGUYEN

Note: This product line is a collection and will be found in multiple locations in this specification guide and/or Coalesse Tables, Storage, and Accessories Specification Guide.  
 ▶ See page 5.

## Small Social

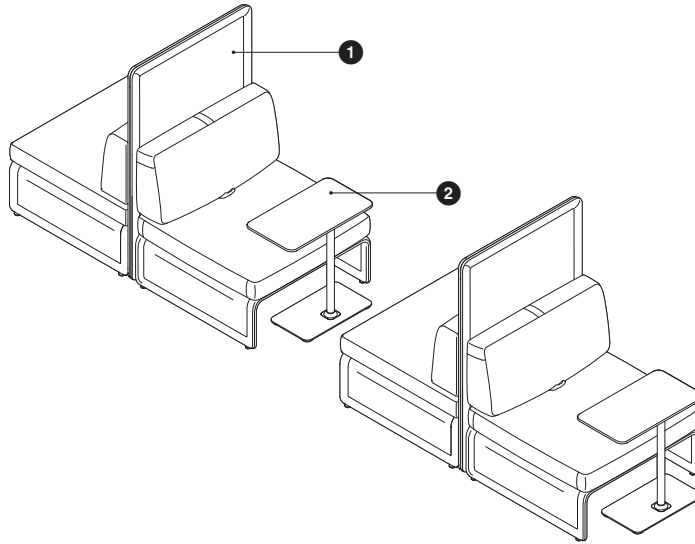

Quantity	Style Number	Description	Components
1	4	COLAGLH11 1-Seat Lounge with High-Back Screen; One Articulating Back	Screen and Seat Deck Seat Back
2	2	COLAGTP Personal Table	Table

# Lagunitas Lounge System Thought Starters and Applications

DESIGN TOAN NGUYEN

Note: This product line is a collection and will be found in multiple locations in this specification guide and/or Coalesse Tables, Storage, and Accessories Specification Guide.  
 ▶ See page 5.

## Booth Setting

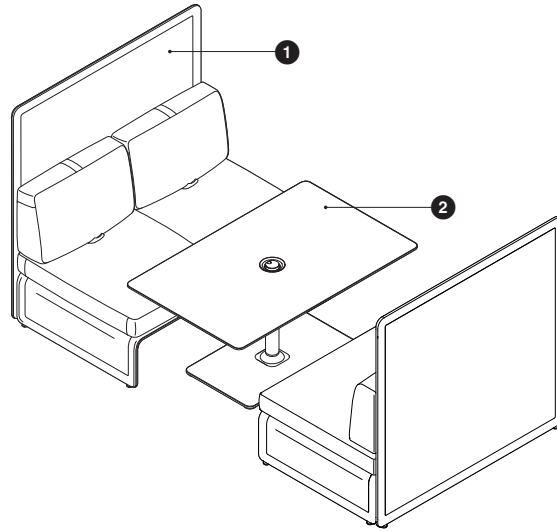

	Quantity	Style Number	Description	Components
1	2	COLAGLH21	2-Seat Lounge with High-Back Screen; Two Articulating Backs	Screen and Seat Deck Seat Back
2	1	COLAGTRECT	Work Table	Table

# Lagunitas Lounge System Thought Starters and Applications *continued*

DESIGN TOAN NGUYEN

Note: This product line is a collection and will be found in multiple locations in this specification guide and/or Coalesse Tables, Storage, and Accessories Specification Guide.  
 ▶ See page 5.

## Crossover

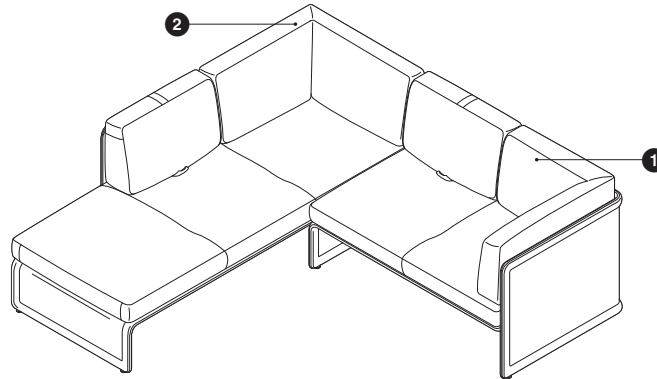

Quantity	Style Number	Description	Components
1	COLAGLL22	2-Seat Lounge with Low-Back Screen and One Side Screen; One Articulating Back and One Corner Cushion	Screen and Seat Deck <hr/> Seat <hr/> Back
2	COLAGCL3	3-Seat Chaise with Low-Back Screen and One Side Screen; One Articulating Back and One Corner Cushion (Left-hand configuration)	Screen and Seat Deck <hr/> Seat <hr/> Back

# Lagunitas Lounge System Thought Starters and Applications

DESIGN TOAN NGUYEN

Note: This product line is a collection and will be found in multiple locations in this specification guide and/or Coalesse Tables, Storage, and Accessories Specification Guide.  
 ▶ See page 5.

## L-Configuration

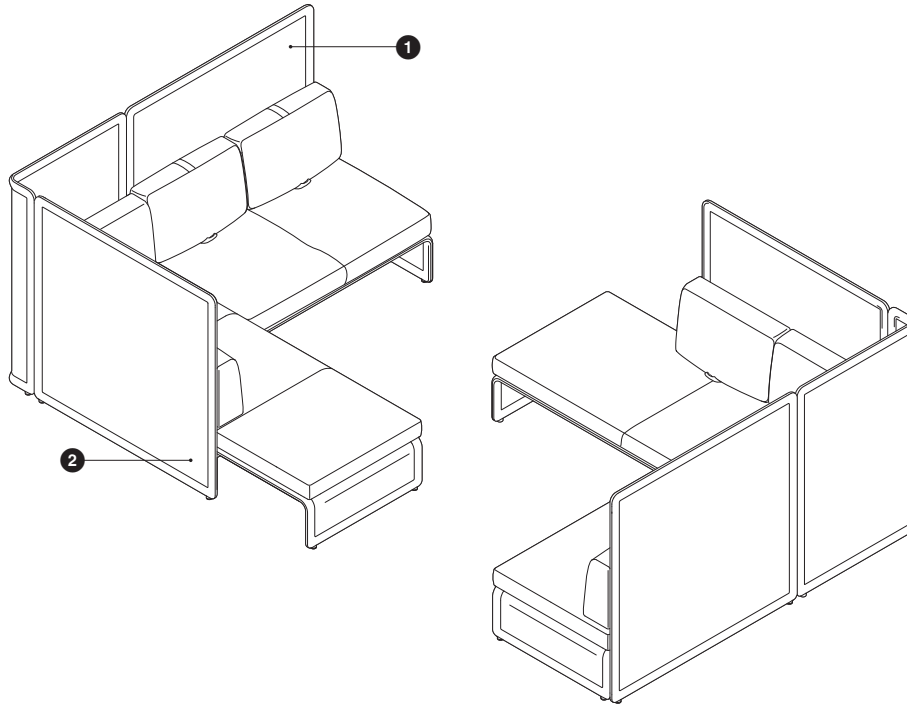

	Quantity	Style Number	Description	Components
1	2	COLAGLH22	2-Seat Lounge with High-Back Screen; Two Articulating Backs	Screen and Seat Deck <hr/> Seat <hr/> Back
2	2	COLAGCH3	3-Seat Chaise with High-Back Screen and One Side Screen; One Articulating Back and One Corner Cushion (Left-hand configuration)	Screen and Seat Deck <hr/> Seat <hr/> Back

Lounge Seating

# Lagunitas Lounge System Thought Starters and Applications *continued*

DESIGN TOAN NGUYEN

Note: This product line is a collection and will be found in multiple locations in this specification guide and/or Coalesse Tables, Storage, and Accessories Specification Guide.  
 ▶ See page 5.

## Benching

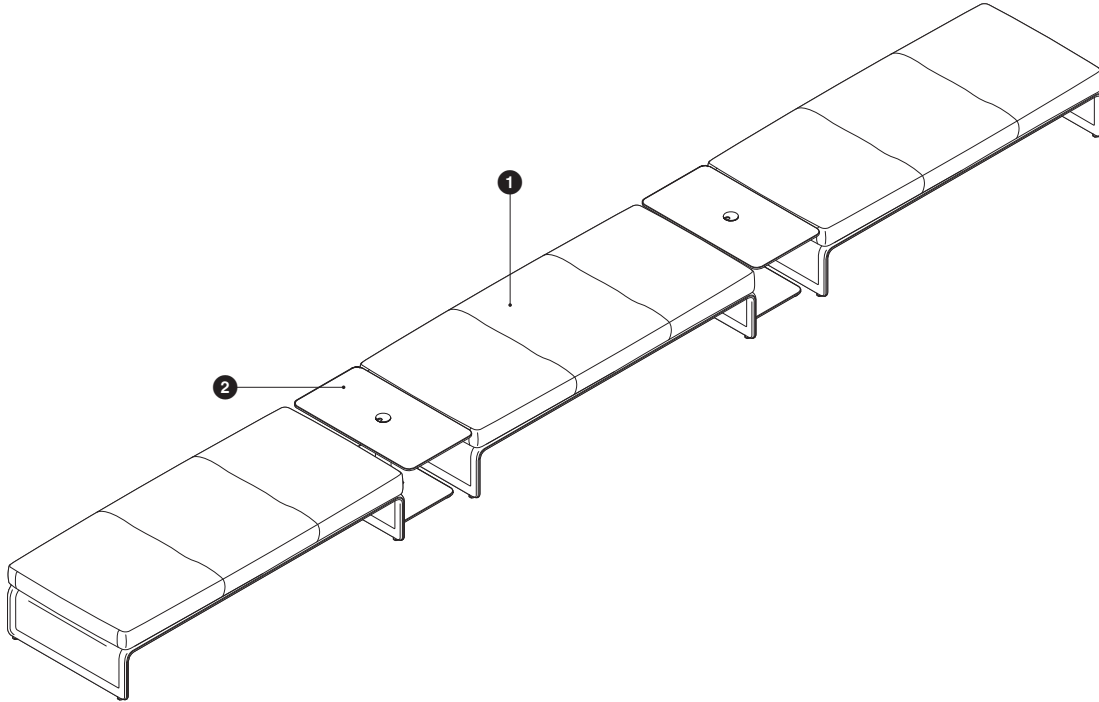

	Quantity	Style Number	Description	Components
1	3	COLAGB3	3-Seat Bench	Seat Deck Seat
2	2	COLAGTO	Occasional Table	Table

# Lagunitas Lounge System Thought Starters and Applications

DESIGN TOAN NGUYEN

Note: This product line is a collection and will be found in multiple locations in this specification guide and/or Coalesse Tables, Storage, and Accessories Specification Guide.  
 ▶ See page 5.

## Benching, continued

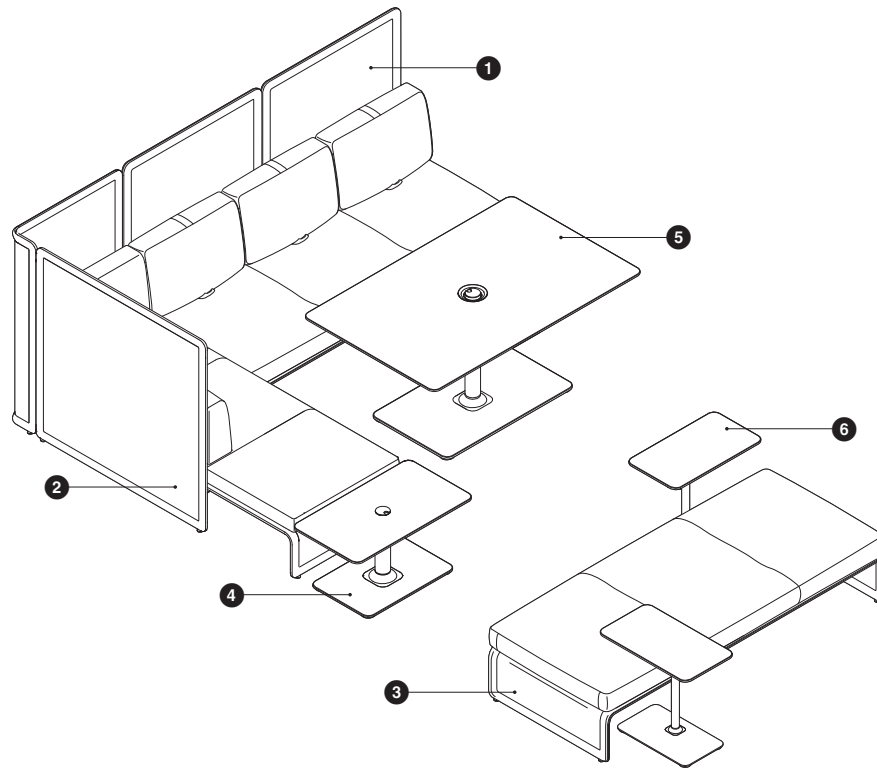

	Quantity	Style Number	Description	Components
1	1	COLAGLH31	3-Seat Lounge with High-Back Screen; Three Articulating Backs	Screen and Seat Deck Seat Back
2	1	COLAGCH3	3-Seat Chaise with High-Back Screen and One Side Screen; One Articulating Back and One Corner Cushion (Left-hand configuration)	Screen and Seat Deck Seat Back
3	1	COLAGB3	3-Seat Bench	Seat Deck Seat
4	1	COLAGTO	32"W Occasional Table	Occasional Table
5	1	COLAGTRECT	57"W Work Table	Work Table
6	2	COLAGTP	Personal Table	Personal Table

# Lagunitas Lounge System Thought Starters and Applications *continued*

DESIGN TOAN NGUYEN

Note: This product line is a collection and will be found in multiple locations in this specification guide and/or Coalesse Tables, Storage, and Accessories Specification Guide.  
 ▶ See page 5.

## Lagunitas Enclosed Booth Setting

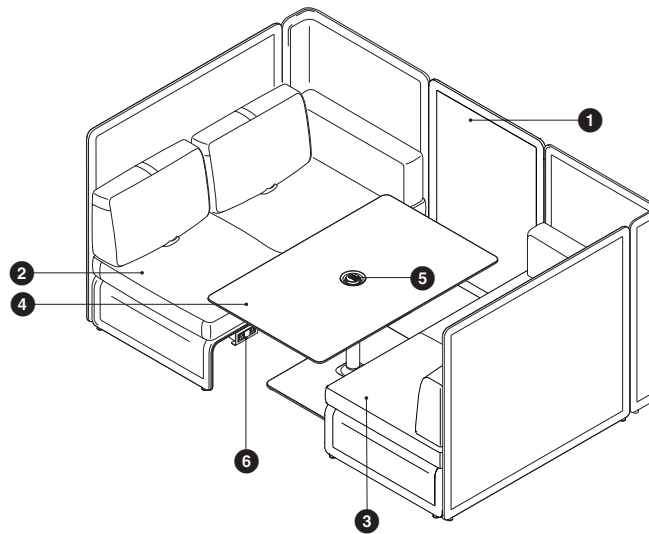

Quantity	Style Number	Description	Components
1	COLAGLBS	Lounge Booth Connector Screen	Screen
2	COLAGLH22	2-Seat Lounge with High-Back Screen and One Side Screen; Two Articulating Backs (Left Screen)	Seat and Seat Deck Seat Back
3	COLAGLH22	2-Seat Lounge with High-Back Screen and One Side Screen; Two Articulating Backs (Right Screen)	Seat and Seat Deck
4	COLAGTRECT	Work Table 57"W	Table
5	Option	USB Table Power Module	USB Power (option)
6	Option	USB Lounge Power Module	USB Power (option)

# Lagunitas Lounge System Thought Starters and Applications

DESIGN TOAN NGUYEN

Note: This product line is a collection and will be found in multiple locations in this specification guide and/or Coalesse Tables, Storage, and Accessories Specification Guide.  
 ▶ See page 5.

## Lagunitas Private Meeting Booth

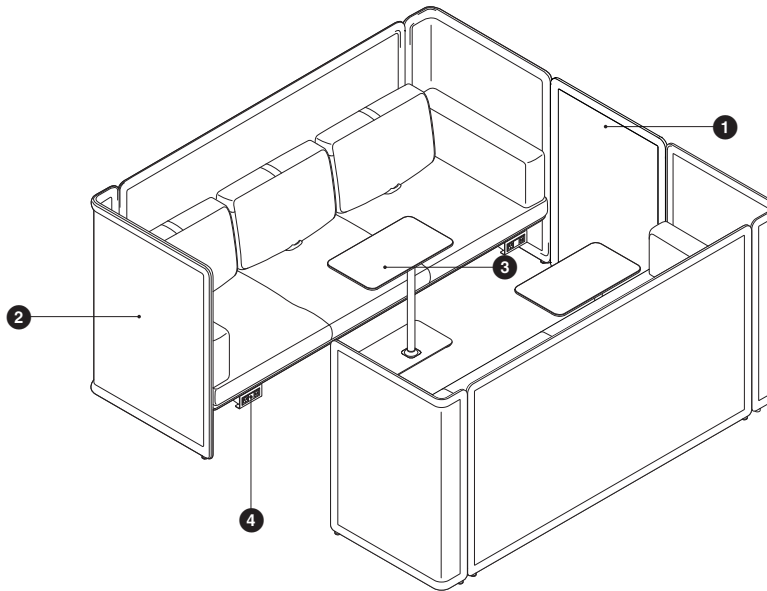

Lounge Seating

	Quantity	Style Number	Description	Components
1	1	COLAGLBS	Lounge Booth Connector Screen	Screen
2	2	COLAGLH33	3-Seat Lounge with High-Back Screen and Two Side Screens; Three Articulating Backs	Seat and Seat Deck Seat Back
3	2	COLAGTP	Personal Table	Table
4	4	Option	USB Lounge Power Module	USB Power (option)

# Lagunitas Lounge System Thought Starters and Applications *continued*

DESIGN TOAN NGUYEN

Note: This product line is a collection and will be found in multiple locations in this specification guide and/or Coalesse Tables, Storage, and Accessories Specification Guide.  
 ▶ See page 5.

## Lagunitas Enclosed Rejuvenation Booth Setting

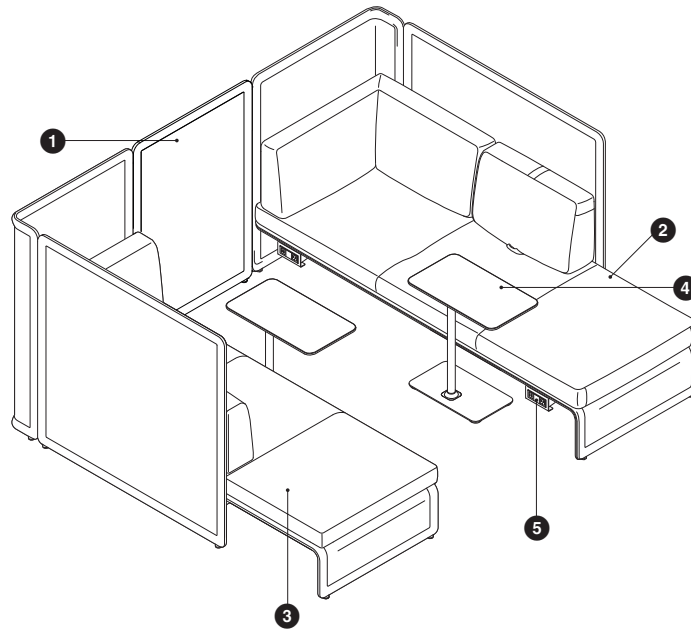

	Quantity	Style Number	Description	Components
1	1	COLAGLBS	Lounge Booth Connector Screen	Screen
2	1	COLAGCH3	3-Seat Chaise with High-Back Screen and One Side Screen; One Articulating Back and One Corner Cushion (Left Screen)	Seat and Seat Deck  Seat Back
3	1	COLAGCH3	3-Seat Chaise with High-Back Screen and One Side Screen; One Articulating Back and One Corner Cushion (Right Screen)	Seat and Seat Deck
4	2	COLAGTP	Personal Table	Table
5	4	Option	USB Lounge Power Module	USB Power (option)

# Lagunitas Lounge System Multi-Fabric Diagram

DESIGN TOAN NGUYEN

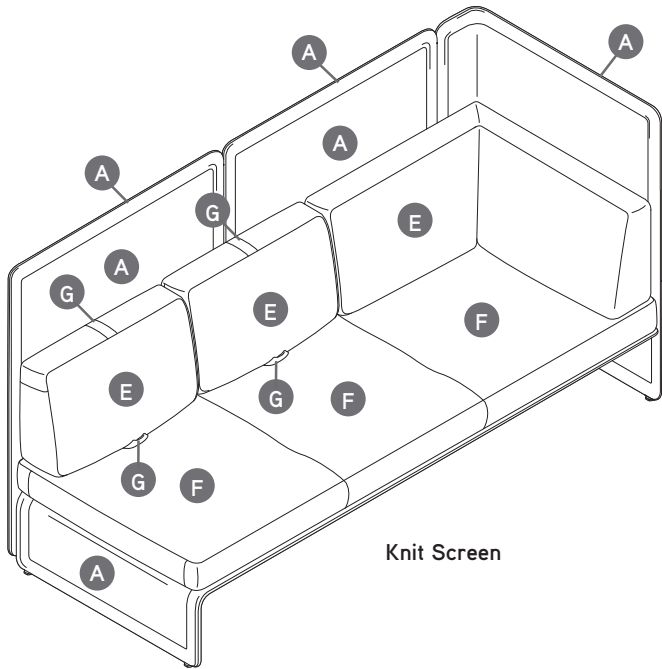

**Knit Screen**

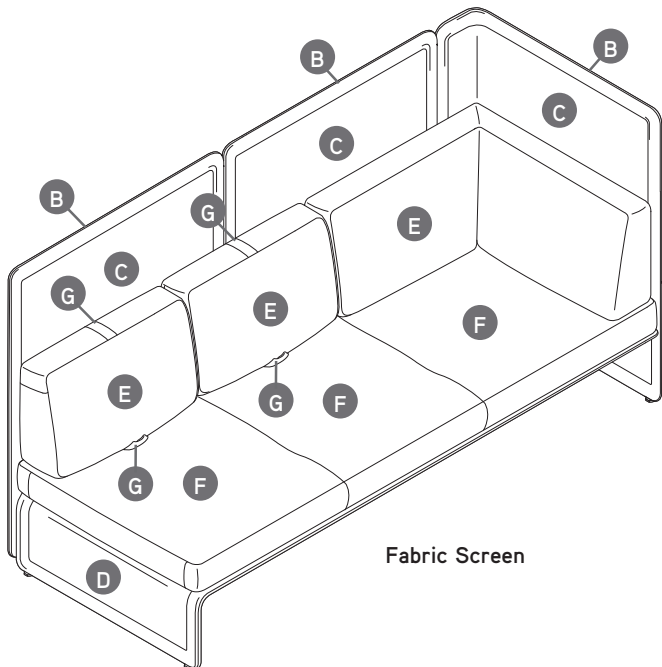

**Fabric Screen**

*Tip: When selecting contrasting fabric screens, fabrics must be from same fabric family.*

TO: \_\_\_\_\_

FROM: \_\_\_\_\_

DATE: \_\_\_\_\_

FAX...888.413.5161

**A** Knit screen, if selected (seat deck will match knit screen):  
\_\_\_\_\_

**B** Outside fabric screen, if contrasting fabric screen is selected:  
\_\_\_\_\_

**C** Inside fabric screen, if contrasting fabric screen is selected:  
\_\_\_\_\_

**D** Seat deck (must select to match outside or inside screen):  
\_\_\_\_\_

**E** Back/Corner cushion:  
\_\_\_\_\_

**F** Seat cushion:  
\_\_\_\_\_

**G** Top and bottom articulating back cushion pulls:  
\_\_\_\_\_

*See specifying for contrasting fabric upcharge specified on screen and cushion.*

*See specifying for contrasting fabric upcharge on articulating back cushions pulls.*

# Lagunitas Lounge System 1-Seat Lounges

DESIGN TOAN NGUYEN

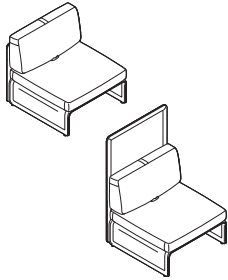

► Need help?  
Product details,  
page 114

### Standard Includes

- Screen: group 1 knit
- Seat deck: group 1 knit to match screen
- Non-contrasting seat cushion, articulating back cushion and pulls, back corner cushion, and end arm cushions: fabric or leather
- Bracket: paint
- Six adjustable glides
- Ships assembled

### Required to Specify

- 1 Style number
  - 2 Knit color number for screen
  - 3 Fabric or leather color number for non-contrasting seat cushion, articulating back cushion and pulls, and end arm cushions, if selected
  - 4 Paint color number for bracket:  
4141 Platinum Matte  
4710 Low Gloss Black
  - 5 Options, if selected (see below)
- See *Coalesse Surface Materials Reference Guide*.

*Tip: If contrasting screen is selected, it is required to specify whether seat deck finish will match inner screen or outer screen.*

*Tip: Contrasting fabric for articulating back pulls upcharge is applied one time per style number.*

*Tip: When contrasting fabric for articulating back pulls is selected, only one contrasting fabric can be specified and will apply to all pulls.*

*Tip: For Customer's Own Material or Leather, see necessary requirements, important processing instructions and ordering information.*

► See *Coalesse Surface Materials Reference Guide*.

*Tip: For any portion of the product that requires a COM, the additional upcharge is a one time charge per product.*

*Tip: For any portion of the product that requires a COL, the additional upcharge is a one time charge per product.*

	Options	U.S. Price	Required to Specify
<b>Surface Materials</b>	<b>Fabric screen</b>		
	• 1-seat lounge with low-back screen	+\$283	Specify with screen type fabric.
	• 1-seat lounge with low-back screen and two side screens	+\$524	Specify with screen type fabric.
	• 1-seat lounge with high-back screen	+\$324	Specify with screen type fabric.
	• 1-seat lounge with high-back screen and two side screens	+\$645	Specify with screen type fabric.
	• Contrasting fabric for screen	+\$192	Specify with contrasting fabric and select fabric or leather color number.
	• Contrasting fabric for cushion	+\$192	Specify with contrasting fabric and select fabric or leather color number.
	• Contrasting fabric for top and bottom articulating back pulls	+\$192	Specify with contrasting fabric and select fabric or leather color number.
	• Fabric upcharges	Prices at right	Specify fabric color number.
		<b>Knit screen</b>	
	• Group 1 knit screen	No cost	Specify with screen type knit and select knit color number.
	• Group 2 knit screen		
	– 1-seat lounge with low-back screen	+\$290	Specify with screen type knit and select knit color number.
	– 1-seat lounge with low-back screen and two side screens	+\$622	Specify with screen type knit and select knit color number.
	– 1-seat lounge with high-back screen	+\$331	Specify with screen type knit and select knit color number.
	– 1-seat lounge with high-back screen and two side screens	+\$748	Specify with screen type knit and select knit color number.
	<b>Acrylic backer</b>		
	• 1-seat lounge with low-back screen	+\$ 52	Specify with acrylic backer.
	• 1-seat lounge with low-back screen and two side screens	+\$108	Specify with acrylic backer.
	• 1-seat lounge with high-back screen	+\$ 85	Specify with acrylic backer.
	• 1-seat lounge with high-back screen and two side screens	+\$140	Specify with acrylic backer. ► See <i>Coalesse Surface Materials Reference Guide</i> .
	• COM	No cost	Specify with COM and select fabric color number. ► See <i>Coalesse Surface Materials Reference Guide</i> .
	• COL	+\$433	Specify with COL and select leather color number. ► See <i>Coalesse Surface Materials Reference Guide</i> .

► Options, continued on next page

# Lagunitas Lounge System 1-Seat Lounges

DESIGN TOAN NGUYEN

*Tip: For each USB port specified, there is one USB per port.*

► Options, continued from previous page

	Options	U.S. Price	Required to Specify
<b>Power/USB Configuration</b>	• One power module: two power in 4710 Low Gloss Black paint	+\$481	Specify with one power module, with two power.
	• One power module: one USB A+C 20W/ one power in 4710 Low Gloss Black paint	+\$638	Specify with one power module, with one power/one USB A+C 20W.
<b>Related Products</b>	<ul style="list-style-type: none"> <li>• Bench</li> <li>• Chaise</li> <li>• Collaborative and conference tables</li> <li>• Occasional tables</li> <li>• Personal table</li> <li>• Lounge booth connector screen and alignment connector</li> </ul>		<ul style="list-style-type: none"> <li>► Page 160</li> <li>► Pages 152-156</li> <li>► See <i>Coalesse Tables, Storage, and Accessories Specification Guide</i>.</li> <li>► See <i>Coalesse Tables, Storage, and Accessories Specification Guide</i>.</li> <li>► See <i>Coalesse Tables, Storage, and Accessories Specification Guide</i>.</li> <li>► Pages 162-163</li> </ul>

► Specification Information, on next page



**For Canadian Pricing**  
 Multiply U.S. Price by the Canadian price factor.  
 ► See page 1 for details.

# Lagunitas Lounge System 1-Seat Lounges *continued*

DESIGN TOAN NGUYEN

► Options, on previous page

## Specification Information

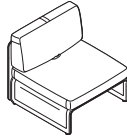

**One articulating back**  
**Overall:** 32¾"W x 34"D x 32¾"H  
**Inside (Lounge):** 32¾"W x 22½"D  
**Inside (Task):** 32¾"W x 17¾"D  
**Seat:** 16"H

Style Number U.S. Base Price

### 1-Seat Lounge with Low-Back Screen

COLAGLL1 \$4692

#### Fabric Upcharges

	Fabric Groups:										Leather Groups:	
	1	2	3	4	5	6	7	8	9	10	1	2
Articulating Back Pulls (if top and bottom contrasting pulls are selected)	No cost	+\$ 2	+\$ 15	+\$ 30	+\$ 51	+\$ 78	+\$109	+\$ 141	+\$ 171	+\$ 202	+\$ 264	+\$ 314
Seat Cushion	No cost	+\$11	+\$ 65	+\$131	+\$230	+\$352	+\$492	+\$ 640	+\$ 771	+\$ 912	+\$1133	+\$1355
Back Cushion	No cost	+\$14	+\$ 87	+\$173	+\$304	+\$465	+\$650	+\$ 846	+\$1019	+\$1204	+\$1133	+\$1355
Inside Screen	No cost	+\$23	+\$132	+\$262	+\$456	+\$701	+\$978	+\$1273	+\$1533	+\$1809	N.A.	N.A.
Outside Screen	No cost	+\$22	+\$131	+\$261	+\$457	+\$701	+\$978	+\$1272	+\$1532	+\$1809	N.A.	N.A.

*Tip: Articulating back pull fabric upcharges only apply when contrasting pulls are selected.*

**One Articulating Back:** Seat Deck: 2.6 yards, Inside Screen: 1.4 yards, Outside Screen: 1.6 yards, Seat Cushion: 1.94 yards, 48.4 sq ft, Back Cushion: 1.56 yards, 48.4 sq ft, Contrasting Pulls on Articulating Back Cushion: 0.44 yards, 1.1 sq ft

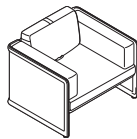

**One articulating back and end arm cushions**  
**Overall:** 49¼"W x 34"D x 32¾"H  
**Seat:** 16"H

Style Number U.S. Base Price

### 1-Seat Lounge with Low-Back Screen and Two Side Screens

COLAGLL13 \$7468

#### Fabric Upcharges

	Fabric Groups:										Leather Groups:	
	1	2	3	4	5	6	7	8	9	10	1	2
Articulating Back Pulls (if top and bottom contrasting pulls are selected)	No cost	+\$ 2	+\$ 15	+\$ 30	+\$ 51	+\$ 78	+\$ 109	+\$ 141	+\$ 171	+\$ 202	+\$ 264	+\$ 314
Seat Cushion	No cost	+\$11	+\$ 68	+\$135	+\$236	+\$363	+\$ 506	+\$ 659	+\$ 794	+\$ 938	+\$1342	+\$1604
Back Cushion	No cost	+\$25	+\$156	+\$312	+\$546	+\$839	+\$1172	+\$1526	+\$1837	+\$2170	+\$2833	+\$3387
Inside Screen	No cost	+\$28	+\$174	+\$347	+\$609	+\$934	+\$1304	+\$1697	+\$2045	+\$2415	N.A.	N.A.
Outside Screen	No cost	+\$31	+\$175	+\$348	+\$610	+\$936	+\$1306	+\$1701	+\$2047	+\$2417	N.A.	N.A.

*Tip: Articulating back pull fabric upcharges only apply when contrasting pulls are selected.*

**One Articulating Back and End Arm Cushions:** Arm: 0, Seat Deck: 1.8 yards, Inside Screen: 4.4 yards, Outside Screen: 5.1 yards, Seat Cushion: 1.58 yards, 57.2 sq ft, Back Cushion: 4.34 yards, 121 sq ft, Contrasting Pulls on Articulating Back Cushion: 0.44 yards, 1.1 sq ft

► Specification Information, continued on next page



**For Canadian Pricing**  
 Multiply U.S. Price by the Canadian price factor.  
 ► See page 1 for details.

# Lagunitas Lounge System 1-Seat Lounges

DESIGN TOAN NGUYEN

► Specification Information, continued from previous page

## Specification Information

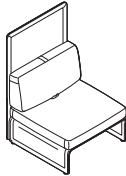

**One articulating back**  
**Overall:** 32¾"W x 34"D x 50"H  
**Inside (Lounge):** 32¾"W x 22½"D  
**Inside (Task):** 32¾"W x 17¾"D  
**Seat:** 16"H

Style Number U.S. Base Price

### 1-Seat Lounge with High-Back Screen

COLAGLH11 \$5075

#### Fabric Upcharges

	Fabric Groups:										Leather Groups:	
	1	2	3	4	5	6	7	8	9	10	1	2
Articulating Back Pulls (if top and bottom contrasting pulls are selected)	No cost	+\$ 2	+\$ 15	+\$ 30	+\$ 51	+\$ 78	+\$109	+\$ 141	+\$ 171	+\$ 202	+\$ 264	+\$ 314
Seat Cushion	No cost	+\$12	+\$ 66	+\$132	+\$230	+\$353	+\$493	+\$ 641	+\$ 772	+\$ 912	+\$1133	+\$1355
Back Cushion	No cost	+\$15	+\$ 88	+\$174	+\$304	+\$466	+\$651	+\$ 847	+\$1020	+\$1205	+\$1133	+\$1355
Inside Screen	No cost	+\$18	+\$110	+\$218	+\$383	+\$589	+\$822	+\$1071	+\$1288	+\$1522	N.A.	N.A.
Outside Screen	No cost	+\$18	+\$109	+\$218	+\$384	+\$588	+\$822	+\$1070	+\$1288	+\$1522	N.A.	N.A.

*Tip: Articulating back pulls fabric upcharges only apply when contrasting pulls are selected.*

**One Articulating Back:** Seat Deck: 2.6 yards, Inside Screen: 1.4 yards, Outside Screen: 1.6 yards, Seat Cushion: 1.94 yards, 48.4 sq ft, Back Cushion: 1.56 yards, 48.4 sq ft, Contrasting Pulls on Articulating Back Cushion: 0.44 yards, 1.1 sq ft

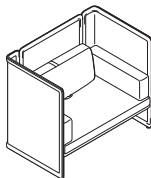

**One articulating back and end arm cushions**  
**Overall:** 49¼"W x 34"D x 50"H  
**Seat:** 16"H

Style Number U.S. Base Price

### 1-Seat Lounge with High-Back Screen and Two Side Screens

COLAGLH13 \$9228

#### Fabric Upcharges

	Fabric Groups:										Leather Groups:	
	1	2	3	4	5	6	7	8	9	10	1	2
Articulating Back Pulls (if top and bottom contrasting pulls are selected)	No cost	+\$ 2	+\$ 15	+\$ 30	+\$ 51	+\$ 78	+\$ 109	+\$ 141	+\$ 171	+\$ 202	+\$ 264	+\$ 314
Seat Cushion	No cost	+\$12	+\$ 68	+\$135	+\$236	+\$ 363	+\$ 507	+\$ 660	+\$ 794	+\$ 939	+\$1342	+\$1604
Back Cushion	No cost	+\$26	+\$156	+\$312	+\$546	+\$ 840	+\$1172	+\$1527	+\$1838	+\$2170	+\$2833	+\$3387
Inside Screen	No cost	+\$33	+\$193	+\$384	+\$672	+\$1032	+\$1440	+\$1875	+\$2257	+\$2665	N.A.	N.A.
Outside Screen	No cost	+\$31	+\$192	+\$383	+\$672	+\$1030	+\$1438	+\$1873	+\$2256	+\$2665	N.A.	N.A.

*Tip: Articulating back pulls fabric upcharges only apply when contrasting pulls are selected.*

**One Articulating Back and End Arm Cushions:** Arm: 0, Seat Deck: 1.8 yards, Inside Screen: 4.4 yards, Outside Screen: 5.1 yards, Seat Cushion: 1.58 yards, 57.2 sq ft, Back Cushion: 4.34 yards, 121 sq ft, Contrasting Pulls on Articulating Back Cushion: 0.44 yards, 1.1 sq ft

  
**For Canadian Pricing**  
 Multiply U.S. Price by the Canadian price factor.  
 ► See page 1 for details.

# Lagunitas Lounge System 2-Seat Lounges

DESIGN TOAN NGUYEN

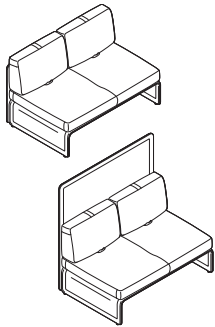

► Need help?  
Product details,  
page 114

### Standard Includes

- Screen: group 1 knit
- Seat deck: group 1 knit to match screen
- Non-contrasting seat cushion, articulating back cushion and pulls, back corner cushion, and end arm cushions: fabric or leather
- Bracket: paint
- Six adjustable glides
- Ships assembled

### Required to Specify

- 1 Style number
  - 2 Handedness (see below under Required Selections)
  - 3 Knit color number for screen
  - 4 Fabric or leather color number for non-contrasting seat cushion, articulating back cushion and pulls, back corner cushion, and end arm cushions, if selected
  - 5 Paint color number for bracket:  
4141 Platinum Matte  
4710 Low Gloss Black
  - 6 Options, if selected (see below)
- See *Coalesse Surface Materials Reference Guide*.

	Required Sections	U.S. Price	Required to Specify
--	-------------------	------------	---------------------

<b>Handedness</b>	• Left-hand, 2-seat lounges only (seated position)	No cost	Specify with <i>left-hand configuration</i> .
	• Right-hand, 2-seat lounges only (seated position)	No cost	Specify with <i>right-hand configuration</i> .

	Options	U.S. Price	Required to Specify
--	---------	------------	---------------------

<b>Surface Materials</b>	<b>Fabric screen</b>		
	• 2-seat lounge with low-back screen	+\$242	Specify with <i>screen type fabric</i> .
	• 2-seat lounge with low-back screen and one side screen	+\$363	Specify with <i>screen type fabric</i> .
	• 2-seat lounge with low-back screen and two side screens	+\$481	Specify with <i>screen type fabric</i> .
	• 2-seat lounge with high-back screen	+\$283	Specify with <i>screen type fabric</i> .
	• 2-seat lounge with high-back screen and one side screen	+\$444	Specify with <i>screen type fabric</i> .
	• 2-seat lounge with high-back screen and two side screens	+\$603	Specify with <i>screen type fabric</i> .
	• Contrasting fabric for screen	+\$192	Specify with <i>contrasting fabric</i> and select fabric or leather color number.
	• Contrasting fabric for cushion	+\$192	Specify with <i>contrasting fabric</i> and select fabric or leather color number.
	• Contrasting fabric for top and bottom articulating back pulls	+\$192	Specify with <i>contrasting fabric</i> and select fabric or leather color number.
	• Fabric upcharges	Prices at right	Specify fabric color number.
	<b>Knit screen</b>		
	• Group 1 knit screen	No cost	Specify with <i>screen type knit</i> and select knit color number.
• Group 2 knit screen			
– 2-seat lounge with low-back screen	+\$375	Specify with <i>screen type knit</i> and select knit color number.	
– 2-seat lounge with low-back screen and one side screen	+\$581	Specify with <i>screen type knit</i> and select knit color number.	
– 2-seat lounge with low-back screen and two side screens	+\$788	Specify with <i>screen type knit</i> and select knit color number.	
– 2-seat lounge with high-back screen	+\$417	Specify with <i>screen type knit</i> and select knit color number.	
– 2-seat lounge with high-back screen and one side screen	+\$667	Specify with <i>screen type knit</i> and select knit color number.	
– 2-seat lounge with high-back screen and two side screens	+\$914	Specify with <i>screen type knit</i> and select knit color number.	

► Options, continued on next page

*Tip: If contrasting screen is selected, it is required to specify whether seat deck finish will match inner screen or outer screen.*

*Tip: Contrasting fabric for articulating back pulls upcharge is applied one time per style number.*

*Tip: When contrasting fabric for articulating back pulls is selected, only one contrasting fabric can be specified and will apply to all pulls.*



**For Canadian Pricing**  
Multiply U.S. Price by the Canadian price factor.  
► See page 1 for details.

# Lagunitas Lounge System 2-Seat Lounges

DESIGN TOAN NGUYEN

► Options, continued from previous page

	Options	U.S. Price	Required to Specify
<b>Surface Materials, continued</b>	<b>Acrylic backer</b>		
	• 2-seat lounge with low-back screen	+\$ 82	Specify with acrylic backer.
	• 2-seat lounge with low-back screen and one side screen	+\$ 128	Specify with acrylic backer.
	• 2-seat lounge with low-back screen and two side screens	+\$ 173	Specify with acrylic backer.
	• 2-seat lounge with high-back screen	+\$ 128	Specify with acrylic backer.
	• 2-seat lounge with low-back screen and one side screen	+\$ 193	Specify with acrylic backer.
	• 2-seat lounge with high-back screen and two side screens	+\$ 257	Specify with acrylic backer. ► See Coalesse Surface Materials Reference Guide.
	• COM	No cost	Specify with COM and select fabric color number. ► See Coalesse Surface Materials Reference Guide.
	• COL	+\$ 433	Specify with COL and select leather color number. ► See Coalesse Surface Materials Reference Guide.
<b>Power/USB Configuration</b>	• One power module: two power in 4710 Low Gloss Black paint	+\$ 481	Specify with one power module, with two power.
	• One power module: one USB A+C 20W/ one power in 4710 Low Gloss Black paint	+\$ 638	Specify with one power module, with one power/one USB A+C 20W.
	• Two power modules: two power each in 4710 Low Gloss Black paint	+\$ 962	Specify with two power modules, with two power.
	• Two power modules: one USB A+C 20W/ one power each in 4710 Low Gloss Black paint	+\$1276	Specify with two power modules, with one power/one USB A+C 20W.
<b>Related Products</b>	• Bench		► Page 160
	• Chaise		► Pages 152–156
	• Collaborative and conference tables		► See Coalesse Tables, Storage, and Accessories Specification Guide.
	• Occasional tables		► See Coalesse Tables, Storage, and Accessories Specification Guide.
	• Personal table		► See Coalesse Tables, Storage, and Accessories Specification Guide.
	• Lounge booth connector screen and alignment connector		► Pages 162–163

► Specification Information, on next page

*Tip: For Customer's Own Material or Leather, see necessary requirements, important processing instructions and ordering information.*  
► See Coalesse Surface Materials Reference Guide.

*Tip: For any portion of the product that requires a COM, the additional upcharge is a one time charge per product.*

*Tip: For any portion of the product that requires a COL, the additional upcharge is a one time charge per product.*

*Tip: For each USB port specified, there is one USB per port.*

  
**For Canadian Pricing**  
Multiply U.S. Price by the Canadian price factor.  
► See page 1 for details.

# Lagunitas Lounge System 2-Seat Lounges *continued*

DESIGN TOAN NGUYEN

► Options, on previous page

## Specification Information

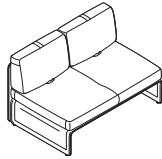

**Two articulating backs**  
**Overall:** 51¼"W x 34"D x 32¾"H  
**Inside (Lounge):** 51¼"W x 22½"D  
**Inside (Task):** 51¼"W x 17¾"D  
**Seat:** 16"H

Style Number U.S. Base Price

### 2-Seat Lounge with Low-Back Screen

COLAGLL21 \$6770

#### Fabric Upcharges

	Fabric Groups:										Leather Groups:	
	1	2	3	4	5	6	7	8	9	10	1	2
Articulating Back Pulls (if top and bottom contrasting pulls are selected)	No cost	+\$ 2	+\$ 15	+\$ 30	+\$ 51	+\$ 78	+\$109	+\$ 141	+\$ 171	+\$ 202	+\$ 264	+\$ 314
Seat Cushion	No cost	+\$14	+\$ 82	+\$162	+\$285	+\$438	+\$611	+\$ 795	+\$ 958	+\$1131	+\$1342	+\$1604
Back Cushion	No cost	+\$15	+\$ 85	+\$169	+\$296	+\$454	+\$634	+\$ 825	+\$ 993	+\$1173	+\$1905	+\$2279
Inside Screen	No cost	+\$22	+\$129	+\$256	+\$448	+\$688	+\$960	+\$1250	+\$1504	+\$1777	N.A.	N.A.
Outside Screen	No cost	+\$20	+\$127	+\$255	+\$447	+\$686	+\$958	+\$1248	+\$1503	+\$1776	N.A.	N.A.

*Tip: Articulating back pull fabric upcharges only apply when contrasting pulls are selected.*

**Two Articulating Backs:** Seat Deck: 3.4 yards, Inside Screen: 2 yards, Outside Screen: 2.2 yards, Seat Cushion: 2.36 yards, 57.2 sq ft, Back Cushion: 2.44 yards, 81.4 sq ft, Contrasting Pulls on Articulating Back Cushions: 0.44 yards, 2.2 sq ft

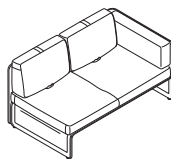

**Two articulating backs**  
**Overall:** 59¾"W x 34"D x 32¾"H  
**Seat:** 16"H

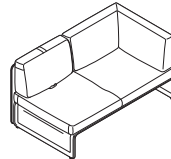

**One articulating back and one corner cushion**  
**Overall:** 59¾"W x 34"D x 32¾"H  
**Seat:** 16"H

Style Number U.S. Base Price

### 2-Seat Lounge with Low-Back Screen and One Side Screen

COLAGLL22 \$7877

#### Fabric Upcharges

	Fabric Groups:										Leather Groups:	
	1	2	3	4	5	6	7	8	9	10	1	2
Articulating Back Pulls (if top and bottom contrasting pulls are selected)	No cost	+\$ 2	+\$ 15	+\$ 30	+\$ 51	+\$ 78	+\$109	+\$ 141	+\$ 171	+\$ 202	+\$ 264	+\$ 314
Seat Cushion	No cost	+\$14	+\$ 80	+\$159	+\$279	+\$427	+\$ 596	+\$ 776	+\$ 935	+\$1105	+\$1342	+\$1604
Back Cushion	No cost	+\$22	+\$129	+\$256	+\$449	+\$690	+\$ 962	+\$1253	+\$1509	+\$1782	+\$2424	+\$2896
Inside Screen	No cost	+\$28	+\$170	+\$338	+\$591	+\$906	+\$1265	+\$1646	+\$1981	+\$2341	N.A.	N.A.
Outside Screen	No cost	+\$27	+\$169	+\$337	+\$590	+\$904	+\$1264	+\$1645	+\$1981	+\$2339	N.A.	N.A.

*Tip: Articulating back pull fabric upcharges only apply when contrasting pulls are selected.*

**Two Articulating Backs:** Arm: 0, Seat Deck: 2.7 yards, Inside Screen: 3.5 yards, Outside Screen: 3.9 yards, Seat Cushion: 2.31 yards, 57.2 sq ft, Back Cushion: 3.83 yards, 103.4 sq ft, Contrasting Pulls on Articulating Back Cushions: 0.44 yards, 2.2 sq ft

**One Articulating Back and One Corner Cushion:** Arm: 0, Seat Deck: 2.7 yards, Inside Screen: 3.5 yards, Outside Screen: 3.9 yards, Seat Cushion: 2.31 yards, 57.2 sq ft, Back Cushion: 3.83 yards, 103.4 sq ft, Contrasting Pulls on Articulating Back Cushion: 0.44 yards, 1.1 sq ft

► Specification Information, continued on next page



**For Canadian Pricing**  
 Multiply U.S. Price by the Canadian price factor.

► See page 1 for details.

# Lagunitas Lounge System 2-Seat Lounges

DESIGN TOAN NGUYEN

► Specification Information, continued from previous page

## Specification Information

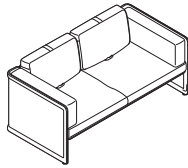

**Two articulating backs**  
**Overall:** 67¾"W x 34"D x 32¾"H  
**Seat:** 16"H

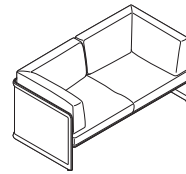

**Two corner cushions**  
**Overall:** 67¾"W x 34"D x 32¾"H  
**Seat:** 16"H

Style Number      U.S. Base Price

### 2-Seat Lounge with Low-Back Screen and Two Side Screens

COLAGLL23      \$9652

#### Fabric Upcharges

	Fabric Groups:										Leather Groups:	
	1	2	3	4	5	6	7	8	9	10	1	2
Articulating Back Pulls (if top and bottom contrasting pulls are selected)	No cost	+\$ 2	+\$ 15	+\$ 30	+\$ 51	+\$ 78	+\$ 109	+\$ 141	+\$ 171	+\$ 202	+\$ 264	+\$ 314
Seat Cushion	No cost	+\$13	+\$ 76	+\$151	+\$265	+\$ 407	+\$ 569	+\$ 741	+\$ 891	+\$1053	+\$1492	+\$1785
Back Cushion	No cost	+\$26	+\$166	+\$330	+\$579	+\$ 888	+\$1241	+\$1615	+\$1945	+\$2298	+\$3552	+\$4247
Inside Screen	No cost	+\$35	+\$210	+\$419	+\$733	+\$1126	+\$1571	+\$2046	+\$2463	+\$2910	N.A.	N.A.
Outside Screen	No cost	+\$34	+\$209	+\$419	+\$733	+\$1125	+\$1572	+\$2046	+\$2463	+\$2910	N.A.	N.A.

*Tip: Articulating back pull fabric upcharges only apply when contrasting pulls are selected.*

**Two Articulating Backs:** Arm: 0, Seat Deck: 1.6 yards, Inside Screen: 4.9 yards, Outside Screen: 5.6 yards, Seat Cushion: 2.22 yards, 63.8 sq ft, Back Cushion: 5.22 yards, 151.8 sq ft, Contrasting Pulls on Articulating Back Cushions: 0.44 yards, 2.2 sq ft

**Two Corner Cushions:** Arm: 0, Seat Deck: 1.6 yards, Inside Screen: 4.9 yards, Outside Screen: 5.6 yards, Seat Cushion: 2.22 yards, 63.8 sq ft, Back Cushion: 5.22 yards, 151.8 sq ft

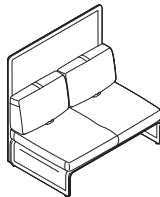

**Two articulating backs**  
**Overall:** 51¼"W x 34"D x 50"H  
**Inside (Lounge):** 51¼"W x 22½"D  
**Inside (Task):** 51¼"W x 17¾"D  
**Seat:** 16"H

Style Number      U.S. Base Price

### 2-Seat Lounge with High-Back Screen

COLAGLH21      \$7833

#### Fabric Upcharges

	Fabric Groups:										Leather Groups:	
	1	2	3	4	5	6	7	8	9	10	1	2
Articulating Back Pulls (if top and bottom contrasting pulls are selected)	No cost	+\$ 2	+\$ 15	+\$ 30	+\$ 51	+\$ 78	+\$109	+\$ 141	+\$ 171	+\$ 202	+\$ 264	+\$ 314
Seat Cushion	No cost	+\$14	+\$ 81	+\$162	+\$285	+\$438	+\$611	+\$ 795	+\$ 958	+\$1131	+\$1342	+\$1604
Back Cushion	No cost	+\$14	+\$ 84	+\$168	+\$295	+\$453	+\$633	+\$ 824	+\$ 992	+\$1172	+\$1905	+\$2279
Inside Screen	No cost	+\$22	+\$133	+\$265	+\$464	+\$712	+\$994	+\$1294	+\$1558	+\$1841	N.A.	N.A.
Outside Screen	No cost	+\$22	+\$133	+\$266	+\$464	+\$712	+\$994	+\$1294	+\$1558	+\$1840	N.A.	N.A.

*Tip: Articulating back pull fabric upcharges only apply when contrasting pulls are selected.*

**Two Articulating Backs:** Seat Deck: 3.4 yards, Inside Screen: 2 yards, Outside Screen: 2.2 yards, Seat Cushion: 2.36 yards, 57.2 sq ft, Back Cushion: 2.44 yards, 81.4 sq ft, Contrasting Pulls on Articulating Back Cushions: 0.44 yards, 2.2 sq ft

 **For Canadian Pricing**  
 Multiply U.S. Price by the Canadian price factor.  
 ► See page 1 for details.

► Specification Information, continued on next page

Lounge Seating

# Lagunitas Lounge System 2-Seat Lounges *continued*

DESIGN TOAN NGUYEN

► Specification Information, continued from previous page

## Specification Information

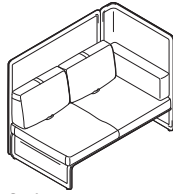

**Two articulating backs**  
**Overall:** 59<sup>3</sup>/<sub>8</sub>"W x 34"D x 50"H  
**Seat:** 16"H

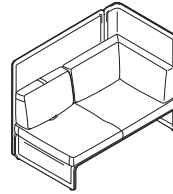

**One articulating back and one corner cushion**  
**Overall:** 59<sup>3</sup>/<sub>8</sub>"W x 34"D x 50"H  
**Seat:** 16"H

Style Number U.S. Base Price

### 2-Seat Lounge with High-Back Screen and One Side Screen

COLAGLH22 \$9584

#### Fabric Upcharges

	Fabric Groups:										Leather Groups:	
	1	2	3	4	5	6	7	8	9	10	1	2
Articulating Back Pulls (if top and bottom contrasting pulls are selected)	No cost	+\$ 2	+\$ 15	+\$ 30	+\$ 51	+\$ 78	+\$109	+\$ 141	+\$ 171	+\$ 202	+\$ 264	+\$ 314
Seat Cushion	No cost	+\$14	+\$ 83	+\$167	+\$292	+\$448	+\$ 627	+\$ 816	+\$ 982	+\$1161	+\$1342	+\$1604
Back Cushion	No cost	+\$24	+\$140	+\$280	+\$490	+\$751	+\$1049	+\$1365	+\$1644	+\$1941	+\$2424	+\$2896
Inside Screen	No cost	+\$30	+\$174	+\$347	+\$608	+\$932	+\$1301	+\$1693	+\$2038	+\$2408	N.A.	N.A.
Outside Screen	No cost	+\$30	+\$175	+\$347	+\$608	+\$932	+\$1301	+\$1693	+\$2038	+\$2408	N.A.	N.A.

*Tip: Articulating back pull fabric upcharges only apply when contrasting pulls are selected.*

**Two Articulating Backs:** Arm: 0, Seat Deck: 2.7 yards, Inside Screen: 3.5 yards, Outside Screen: 3.9 yards, Seat Cushion: 2.31 yards, 57.2 sq ft, Back Cushion: 3.83 yards, 103.4 sq ft, Contrasting Pulls on Articulating Back Cushions: 0.44 yards, 2.2 sq ft

**One Articulating Back and One Corner Cushion:** Arm: 0, Seat Deck: 2.7 yards, Inside Screen: 3.5 yards, Outside Screen: 3.9 yards, Seat Cushion: 2.31 yards, 57.2 sq ft, Back Cushion: 3.83 yards, 103.4 sq ft, Contrasting Pulls on Articulating Back Cushion: 0.44 yards, 1.1 sq ft

► Specification Information, continued on next page



**For Canadian Pricing**  
 Multiply U.S. Price by the Canadian price factor.  
 ► See page 1 for details.

# Lagunitas Lounge System 2-Seat Lounges

DESIGN TOAN NGUYEN

► Specification Information, continued from previous page

## Specification Information

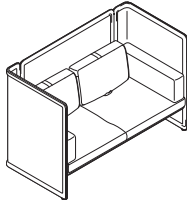

**Two articulating backs**  
Overall: 67¾"W x 34"D x 50"H  
Seat: 16"H

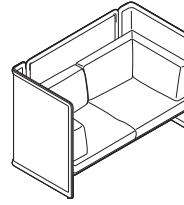

**Two corner cushions**  
Overall: 67¾"W x 34"D x 50"H  
Seat: 16"H

Style Number U.S. Base Price

### 2-Seat Lounge with High-Back Screen and Two Side Screens

COLAGLH23 \$11,669

#### Fabric Upcharges

	Fabric Groups:										Leather Groups:	
	1	2	3	4	5	6	7	8	9	10	1	2
Articulating Back Pulls (if top and bottom contrasting pulls are selected)	No cost	+\$ 2	+\$ 15	+\$ 30	+\$ 51	+\$ 78	+\$ 109	+\$ 141	+\$ 171	+\$ 202	+\$ 264	+\$ 314
Seat Cushion	No cost	+\$14	+\$ 78	+\$156	+\$273	+\$ 419	+\$ 584	+\$ 762	+\$ 917	+\$1082	+\$1492	+\$1785
Back Cushion	No cost	+\$28	+\$171	+\$340	+\$596	+\$ 914	+\$1275	+\$1662	+\$2000	+\$2363	+\$3552	+\$4247
Inside Screen	No cost	+\$35	+\$210	+\$419	+\$733	+\$1126	+\$1572	+\$2047	+\$2464	+\$2911	N.A.	N.A.
Outside Screen	No cost	+\$33	+\$208	+\$418	+\$732	+\$1125	+\$1571	+\$2045	+\$2462	+\$2909	N.A.	N.A.

**Two Articulating Backs:** Arm: 0, Seat Deck: 1.6 yards, Inside Screen: 4.9 yards, Outside Screen: 5.6 yards, Seat Cushion: 2.22 yards, 63.8 sq ft, Back Cushion: 5.22 yards, 151.8 sq ft, Contrasting Pulls on Articulating Back Cushions: 0.44 yards, 2.2 sq ft

**Two Corner Cushions:** Arm: 0, Seat Deck: 1.6 yards, Inside Screen: 4.9 yards, Outside Screen: 5.6 yards, Seat Cushion: 2.22 yards, 63.8 sq ft, Back Cushion: 5.22 yards, 151.8 sq ft

*Tip: Articulating back pull fabric upcharges only apply when contrasting pulls are selected.*

Lounge Seating

 **For Canadian Pricing**  
Multiply U.S. Price by the Canadian price factor.  
► See page 1 for details.

# Lagunitas Lounge System 3-Seat Lounges

DESIGN TOAN NGUYEN

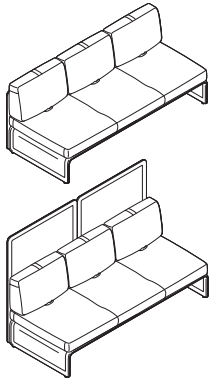

► Need help?  
Product details,  
page 114

### Standard Includes

- Screen: group 1 knit
- Seat deck: group 1 knit to match screen
- Non-contrasting seat cushion, articulating back cushion and pulls, back corner cushion, and end arm cushions: fabric or leather
- Bracket: paint
- Eight adjustable glides
- Ships assembled

### Required to Specify

- 1 Style number
  - 2 Handedness (see below under Required Selections)
  - 3 Knit color number for screen
  - 4 Fabric or leather color number for non-contrasting seat cushion, articulating back cushion and pulls, back corner cushion, and end arm cushions, if selected
  - 5 Paint color number for bracket:  
4141 Platinum Matte  
4710 Low Gloss Black
  - 6 Options, if selected (see below)
- See *Coalesse Surface Materials Reference Guide*.

	Required Sections	U.S. Price	Required to Specify
--	-------------------	------------	---------------------

<b>Handedness</b>	• Left-hand, 3-seat lounges only (seated position)	No cost	Specify <i>left-hand configuration</i> .
	• Right-hand, 3-seat lounges only (seated position)	No cost	Specify <i>right-hand configuration</i> .

	Options	U.S. Price	Required to Specify
--	---------	------------	---------------------

<b>Surface Materials</b>	<b>Fabric screen</b>		
	• 3-seat lounge with low-back screen	+\$ 363	Specify with screen type fabric.
	• 3-seat lounge with low-back screen and one side screen	+\$ 481	Specify with screen type fabric.
	• 3-seat lounge with low-back screen and two side screens	+\$ 603	Specify with screen type fabric.
	• 3-seat lounge with high-back screen	+\$ 405	Specify with screen type fabric.
	• 3-seat lounge with high-back screen and one side screen	+\$ 524	Specify with screen type fabric.
	• 3-seat lounge with high-back screen and two side screens	+\$ 687	Specify with screen type fabric.
	• Contrasting fabric for screen	+\$ 192	Specify <i>with contrasting fabric</i> and select fabric or leather color number.
	• Contrasting fabric for cushion	+\$ 192	Specify <i>with contrasting fabric</i> and select fabric or leather color number.
	• Contrasting fabric for top and bottom articulating back pulls	+\$ 192	Specify <i>with contrasting fabric</i> and select fabric or leather color number.
	• Fabric upcharges	Prices at right	Specify fabric color number.
	<b>Knit screen</b>		
	• Group 1 knit screen	No cost	Specify <i>with screen type knit</i> and select knit color number.
• Group 2 knit screen			
– 3-seat lounge with low-back screen	+\$ 458	Specify <i>with screen type knit</i> and select knit color number.	
– 3-seat lounge with low-back screen and one side screen	+\$ 706	Specify <i>with screen type knit</i> and select knit color number.	
– 3-seat lounge with low-back screen and two side screens	+\$ 953	Specify <i>with screen type knit</i> and select knit color number.	
– 3-seat lounge with high-back screen	+\$ 495	Specify <i>with screen type knit</i> and select knit color number.	
– 3-seat lounge with high-back screen and one side screen	+\$ 787	Specify <i>with screen type knit</i> and select knit color number.	
– 3-seat lounge with high-back screen and two side screens	+\$1078	Specify <i>with screen type knit</i> and select knit color number.	

*Tip: If contrasting screen is selected, it is required to specify whether seat deck finish will match inner screen or outer screen.*

*Tip: Contrasting fabric for articulating back pulls upcharge is applied one time per style number.*

*Tip: When contrasting fabric for articulating back pulls is selected, only one contrasting fabric can be specified and will apply to all pulls.*



**For Canadian Pricing**  
Multiply U.S. Price by the Canadian price factor.  
► See page 1 for details.

► Options, continued on next page

# Lagunitas Lounge System 3-Seat Lounges

DESIGN TOAN NGUYEN

► Options, continued from previous page

	Options	U.S. Price	Required to Specify
<b>Surface Materials, continued</b>	<b>Acrylic backer</b>		
	• 3-seat lounge with low-back screen	+\$ 113	Specify with acrylic backer.
	• 3-seat lounge with low-back screen and one side screen	+\$ 169	Specify with acrylic backer.
	• 3-seat lounge with low-back screen and two side screens	+\$ 229	Specify with acrylic backer.
	• 3-seat lounge with high-back screen	+\$ 193	Specify with acrylic backer.
	• 3-seat lounge with high-back screen and one side screen	+\$ 248	Specify with acrylic backer.
	• 3-seat lounge with high-back screen and two side screens	+\$ 309	Specify with acrylic backer.
			► See Coalesse Surface Materials Reference Guide.
	• COM	No cost	Specify with COM and select fabric color number. ► See Coalesse Surface Materials Reference Guide.
	• COL	+\$ 433	Specify with COL and select leather color number. ► See Coalesse Surface Materials Reference Guide
<b>Power/USB Configuration</b>	• One power module: two power in 4710 Low Gloss Black paint	+\$ 481	Specify with one power module, with two power.
	• One power module: one USB A+C 20W/one power in 4710 Low Gloss Black paint	+\$ 638	Specify with one power module, with one power/one USB A+C 20W.
	• Two power modules: two power each in 4710 Low Gloss Black paint	+\$ 962	Specify with two power modules, with two power.
	• Two power modules: one USB A+C 20W/one power each in 4710 Low Gloss Black paint	+\$1276	Specify with two power modules, with one power/one USB A+C 20W.
<b>Related Products</b>	• Bench		► Page 160
	• Chaise		► Pages 152–156
	• Collaborative and conference tables		► See Coalesse Tables, Storage, and Accessories Specification Guide.
	• Occasional tables		► See Coalesse Tables, Storage, and Accessories Specification Guide.
	• Personal table		► See Coalesse Tables, Storage, and Accessories Specification Guide.
	• Lounge booth connector screen and alignment connector		► Pages 162–163

► Specification Information, on next page

*Tip: For Customer's Own Material or Leather, see necessary requirements, important processing instructions and ordering information.*  
► See Coalesse Surface Materials Reference Guide.

*Tip: For any portion of the product that requires a COM, the additional upcharge is a one time charge per product.*

*Tip: For any portion of the product that requires a COL, the additional upcharge is a one time charge per product.*

*Tip: For each USB port specified, there is one USB per port.*

  
**For Canadian Pricing**  
Multiply U.S. Price by the Canadian price factor.  
► See page 1 for details.

# Lagunitas Lounge System 3-Seat Lounges *continued*

DESIGN TOAN NGUYEN

► Options, on previous page

## Specification Information

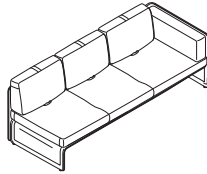

**Three articulating backs**  
**Overall:** 76¾"W x 34"D x 32¾"H  
**Inside (Lounge):** 76¾"W x 22½"D  
**Inside (Task):** 76¾"W x 17¾"D  
**Seat:** 16"H

Style Number	U.S. Base Price
--------------	-----------------

### 3-Seat Lounge with Low-Back Screen

COLAGLL31	\$8819
-----------	--------

#### Fabric Upcharges

	Fabric Groups:										Leather Groups:	
	1	2	3	4	5	6	7	8	9	10	1	2
Articulating Back Pulls (if top and bottom contrasting pulls are selected)	No cost	+\$ 2	+\$ 15	+\$ 30	+\$ 51	+\$ 78	+\$ 109	+\$ 141	+\$ 171	+\$ 202	+\$ 264	+\$ 314
Seat Cushion	No cost	+\$18	+\$114	+\$228	+\$400	+\$614	+\$ 858	+\$1116	+\$1344	+\$1588	+\$1855	+\$2220
Back Cushion	No cost	+\$21	+\$133	+\$266	+\$465	+\$714	+\$ 998	+\$1299	+\$1565	+\$1848	+\$2833	+\$3387
Inside Screen	No cost	+\$31	+\$183	+\$363	+\$636	+\$975	+\$1361	+\$1773	+\$2135	+\$2521	N.A.	N.A.
Outside Screen	No cost	+\$31	+\$181	+\$363	+\$636	+\$975	+\$1361	+\$1773	+\$2134	+\$2521	N.A.	N.A.

**Three Articulating Backs:** Seat Deck: 3.6 yards, Inside Screen: 3.2 yards, Outside Screen: 3.7 yards, Seat Cushion: 2.83 yards, 79.2 sq ft, Back Cushion: 3.66 yards, 121 sq ft, Contrasting Pulls on Articulating Back Cushions: 0.44 yards, 3.3 sq ft

► Specification Information, continued on next page

*Tip: Articulating back pull fabric upcharges only apply when contrasting pulls are selected.*



**For Canadian Pricing**  
 Multiply U.S. Price by the Canadian price factor.  
 ► See page 1 for details.

# Lagunitas Lounge System 3-Seat Lounges

DESIGN TOAN NGUYEN

► Specification Information, continued from previous page

## Specification Information

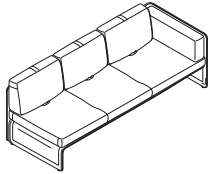

**Three articulating backs**  
**Overall:** 76¾"W x 34"D x 32¾"H  
**Seat:** 16"H

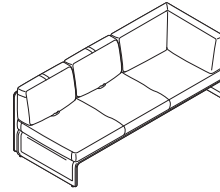

**Two articulating backs and one corner cushion**  
**Overall:** 85"W x 34"D x 32¾"H  
**Seat:** 16"H

**Style Number**                      **U.S. Base Price**

### 3-Seat Lounge with Low-Back Screen and One Side Screen

**COLAGLL32**                      \$10,415

#### Fabric Upcharges

	Fabric Groups:										Leather Groups:	
	1	2	3	4	5	6	7	8	9	10	1	2
Articulating Back Pulls (if top and bottom contrasting pulls are selected)	No cost	+\$ 2	+\$ 15	+\$ 30	+\$ 51	+\$ 78	+\$ 109	+\$ 141	+\$ 171	+\$ 202	+\$ 264	+\$ 314
Seat Cushion	No cost	+\$17	+\$101	+\$204	+\$357	+\$ 546	+\$ 764	+\$ 995	+\$1197	+\$1415	+\$1749	+\$2092
Back Cushion	No cost	+\$30	+\$183	+\$365	+\$640	+\$ 982	+\$1372	+\$1786	+\$2151	+\$2540	+\$3346	+\$4003
Inside Screen	No cost	+\$37	+\$220	+\$440	+\$770	+\$1182	+\$1650	+\$2148	+\$2587	+\$3055	N.A.	N.A.
Outside Screen	No cost	+\$36	+\$220	+\$439	+\$769	+\$1182	+\$1650	+\$2148	+\$2586	+\$3054	N.A.	N.A.

*Tip: Articulating back pull fabric upcharges only apply when contrasting pulls are selected.*

**Three Articulating Backs:** Arm: 0, Seat Deck: 2.3 yards, Inside Screen: 4.6 yards, Outside Screen: 5.4 yards, Seat Cushion: 2.9 yards, 74.8 sq ft, Back Cushion: 4.72 yards, 143 sq ft, Contrasting Pulls on Articulating Back Cushions: 0.44 yards, 3.3 sq ft

**Two Articulating Backs and One Corner Cushion:** Arm: 0, Seat Deck: 2.3 yards, Inside Screen: 4.6 yards, Outside Screen: 5.4 yards, Seat Cushion: 2.9 yards, 74.8 sq ft, Back Cushion: 4.72 yards, 143 sq ft, Contrasting Pulls on Articulating Back Cushions: 0.44 yards, 2.2 sq ft

► Specification Information, continued on next page

  
**For Canadian Pricing**  
 Multiply U.S. Price by the  
 Canadian price factor.  
 ► See page 1 for details.

# Lagunitas Lounge System 3-Seat Lounges *continued*

DESIGN TOAN NGUYEN

► Specification Information, continued from previous page

## Specification Information

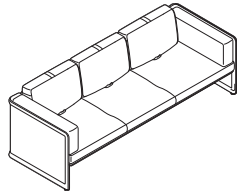

**Three articulating backs**  
**Overall:** 93¼"W x 34"D x 32¾"H  
**Seat:** 16"H

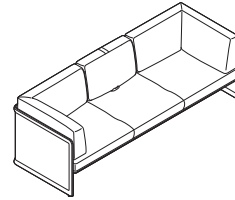

**One articulating back and two corner cushions**  
**Overall:** 93¼"W x 34"D x 32¾"H  
**Seat:** 16"H

Style Number                      U.S. Base Price

### 3-Seat Lounge with Low-Back Screen and Two Side Screens

COLAGLL33                      \$11,526

#### Fabric Upcharges

	Fabric Groups:										Leather Groups:	
	1	2	3	4	5	6	7	8	9	10	1	2
Articulating Back Pulls (if top and bottom contrasting pulls are selected)	No cost	+\$ 2	+\$ 15	+\$ 30	+\$ 51	+\$ 78	+\$ 109	+\$ 141	+\$ 171	+\$ 202	+\$ 264	+\$ 314
Seat Cushion	No cost	+\$16	+\$102	+\$205	+\$360	+\$ 552	+\$ 771	+\$1004	+\$1209	+\$1428	+\$1855	+\$2220
Back Cushion	No cost	+\$36	+\$218	+\$436	+\$764	+\$1172	+\$1637	+\$2131	+\$2567	+\$3032	+\$4481	+\$5358
Inside Screen	No cost	+\$42	+\$261	+\$520	+\$912	+\$1399	+\$1954	+\$2544	+\$3063	+\$3618	N.A.	N.A.
Outside Screen	No cost	+\$43	+\$261	+\$520	+\$912	+\$1399	+\$1953	+\$2544	+\$3063	+\$3618	N.A.	N.A.

*Tip: Articulating back pull fabric upcharges only apply when contrasting pulls are selected.*

**Three Articulating Backs:** Arm: 0, Seat Deck: 2 yards, Inside Screen: 6.1 yards, Outside Screen: 7.1 yards, Seat Cushion: 2.92 yards, 79.2 sq ft, Back Cushion: 6.44 yards, 191.4 sq ft, Contrasting Pulls on Articulating Back Cushions: 0.44 yards, 3.3 sq ft

**One Articulating Back and Two Corner Cushions:** Arm: 0, Seat Deck: 2 yards, Inside Screen: 6.1 yards, Outside Screen: 7.1 yards, Seat Cushion: 2.92 yards, 79.2 sq ft, Back Cushion: 6.44 yards, 191.4 sq ft, Contrasting Pulls on Articulating Back Cushion: 0.44 yards, 1.1 sq ft

► Specification Information, continued on next page



**For Canadian Pricing**  
 Multiply U.S. Price by the Canadian price factor.  
 ► See page 1 for details.

# Lagunitas Lounge System 3-Seat Lounges

DESIGN TOAN NGUYEN

► Specification Information, continued from previous page

## Specification Information

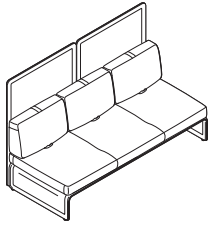

**Three articulating backs**  
**Overall:** 76<sup>7</sup>/<sub>8</sub>"W x 34"D x 50"H  
**Inside (Lounge):** 76<sup>7</sup>/<sub>8</sub>"W x 22<sup>1</sup>/<sub>2</sub>"D  
**Inside (Task):** 76<sup>7</sup>/<sub>8</sub>"W x 17<sup>3</sup>/<sub>4</sub>"D  
**Seat:** 16"H

**Style**                      **U.S. Base**  
**Number**                    **Price**

### 3-Seat Lounge with High-Back Screen

**COLAGLH31**                      \$10,226

#### Fabric Upcharges

	Fabric Groups:										Leather Groups:	
	1	2	3	4	5	6	7	8	9	10	1	2
Articulating Back Pulls (if top and bottom contrasting pulls are selected)	No cost	+\$ 2	+\$ 15	+\$ 30	+\$ 51	+\$ 78	+\$ 109	+\$ 141	+\$ 171	+\$ 202	+\$ 264	+\$ 314
Seat Cushion	No cost	+\$18	+\$114	+\$228	+\$400	+\$614	+\$ 858	+\$1116	+\$1344	+\$1588	+\$1855	+\$2220
Back Cushion	No cost	+\$21	+\$133	+\$266	+\$465	+\$714	+\$ 998	+\$1300	+\$1565	+\$1848	+\$2833	+\$3387
Inside Screen	No cost	+\$31	+\$184	+\$366	+\$640	+\$982	+\$1372	+\$1786	+\$2150	+\$2540	N.A.	N.A.
Outside Screen	No cost	+\$32	+\$184	+\$365	+\$640	+\$982	+\$1372	+\$1786	+\$2151	+\$2539	N.A.	N.A.

**Three Articulating Backs:** Seat Deck: 3.6 yards, Inside Screen: 3.2 yards, Outside Screen: 3.7 yards, Seat Cushion: 2.83 yards, 79.2 sq ft, Back Cushion: 3.66 yards, 121 sq ft, Contrasting Pulls on Articulating Back Cushions: 0.44 yards, 3.3 sq ft

► Specification Information, continued on next page

*Tip: Articulating back pull fabric upcharges only apply when contrasting pulls are selected.*

Lounge Seating



**For Canadian Pricing**  
 Multiply U.S. Price by the Canadian price factor.  
 ► See page 1 for details.

# Lagunitas Lounge System 3-Seat Lounges *continued*

DESIGN TOAN NGUYEN

► Specification Information, continued from previous page

## Specification Information

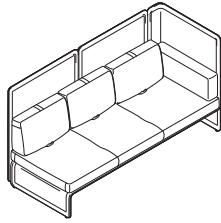

**Three articulating backs**  
Overall: 85"W x 34½"D x 50"H  
Seat: 16"H

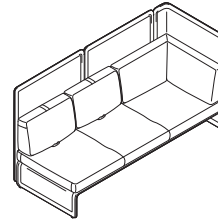

**Two articulating backs with one corner cushion**  
Overall: 85"W x 34½"D x 50"H  
Seat: 16"H

Style Number U.S. Base Price

### 3-Seat Lounge with High-Back Screen and One Side Screen

COLAGLH32 \$11,990

#### Fabric Upcharges

	Fabric Groups:										Leather Groups:	
	1	2	3	4	5	6	7	8	9	10	1	2
Articulating Back Pulls (if top and bottom contrasting pulls are selected)	No cost	+\$ 2	+\$ 15	+\$ 30	+\$ 51	+\$ 78	+\$ 109	+\$ 141	+\$ 171	+\$ 202	+\$ 264	+\$ 314
Seat Cushion	No cost	+\$16	+\$101	+\$204	+\$357	+\$ 546	+\$ 764	+\$ 995	+\$1197	+\$1415	+\$1749	+\$2092
Back Cushion	No cost	+\$31	+\$184	+\$366	+\$641	+\$ 983	+\$1373	+\$1787	+\$2152	+\$2541	+\$3346	+\$4003
Inside Screen	No cost	+\$37	+\$222	+\$442	+\$774	+\$1189	+\$1660	+\$2161	+\$2602	+\$3073	N.A.	N.A.
Outside Screen	No cost	+\$37	+\$223	+\$442	+\$774	+\$1188	+\$1661	+\$2161	+\$2602	+\$3073	N.A.	N.A.

*Tip: Articulating back pull fabric upcharges only apply when contrasting pulls are selected.*

**Three Articulating Backs:** Arm: 0, Seat Deck: 2.3 yards, Inside Screen: 4.6 yards, Outside Screen: 5.4 yards, Seat Cushion: 2.9 yards, 74.8 sq ft, Back Cushion: 4.72 yards, 143 sq ft, Contrasting Pulls on Articulating Back Cushions: 0.44 yards, 3.3 sq ft

**Two Articulating Backs with One Corner Cushion:** Arm: 0, Seat Deck: 2.3 yards, Inside Screen: 4.6 yards, Outside Screen: 5.4 yards, Seat Cushion: 2.9 yards, 74.8 sq ft, Back Cushion: 4.72 yards, 143 sq ft, Contrasting Pulls on Articulating Back Cushions: 0.44 yards, 2.2 sq ft

► Specification Information, continued on next page



**For Canadian Pricing**  
Multiply U.S. Price by the Canadian price factor.  
► See page 1 for details.

# Lagunitas Lounge System 3-Seat Lounges

DESIGN TOAN NGUYEN

► Specification Information, continued from previous page

## Specification Information

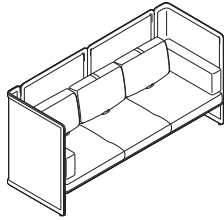

Three articulating backs  
Overall: 93<sup>3</sup>/<sub>8</sub>"W x 34"D x 50"H  
Seat: 16"H

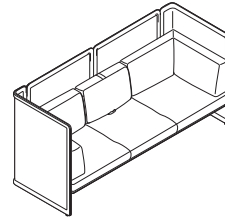

One articulating back and two corner cushions  
Overall: 93<sup>3</sup>/<sub>8</sub>"W x 34"D x 50"H  
Seat: 16"H

Style Number U.S. Base Price

### 3-Seat Lounge with High-Back Screen and Two Side Screens

COLAGLH33 \$14,085

#### Fabric Upcharges

	Fabric Groups:										Leather Groups:	
	1	2	3	4	5	6	7	8	9	10	1	2
Articulating Back Pulls (if top and bottom contrasting pulls are selected)	No cost	+\$ 2	+\$ 15	+\$ 30	+\$ 51	+\$ 78	+\$ 109	+\$ 141	+\$ 171	+\$ 202	+\$ 264	+\$ 314
Seat Cushion	No cost	+\$17	+\$102	+\$205	+\$360	+\$ 552	+\$ 771	+\$1004	+\$1209	+\$1428	+\$1855	+\$2220
Back Cushion	No cost	+\$36	+\$218	+\$436	+\$764	+\$1172	+\$1637	+\$2132	+\$2567	+\$3031	+\$4481	+\$5358
Inside Screen	No cost	+\$43	+\$262	+\$522	+\$916	+\$1406	+\$1963	+\$2556	+\$3078	+\$3636	N.A.	N.A.
Outside Screen	No cost	+\$41	+\$261	+\$522	+\$916	+\$1405	+\$1962	+\$2555	+\$3077	+\$3636	N.A.	N.A.

Tip: Articulating back pull fabric upcharges only apply when contrasting pulls are selected.

**Three Articulating Backs:** Arm: 0, Seat Deck: 2 yards, Inside Screen: 6.1 yards, Outside Screen: 7.1 yards, Seat Cushion: 2.92 yards, 79.2 sq ft, Back Cushion: 6.44 yards, 191.4 sq ft, Contrasting Pulls on Articulating Back Cushions: 0.44 yards, 3.3 sq ft

**One Articulating Back and Two Corner Cushions:** Arm: 0, Seat Deck: 2 yards, Inside Screen: 6.1 yards Outside Screen: 7.1 yards, Seat Cushion: 2.92 yards, 79.2 sq ft, Back Cushion: 6.44 yards, 191.4 sq ft, Contrasting Pulls on Articulating Back Cushion: 0.44 yards, 1.1 sq ft

Lounge Seating

 **For Canadian Pricing**  
Multiply U.S. Price by the Canadian price factor.  
► See page 1 for details.

# Lagunitas Lounge System 2-Seat Chaises

DESIGN TOAN NGUYEN

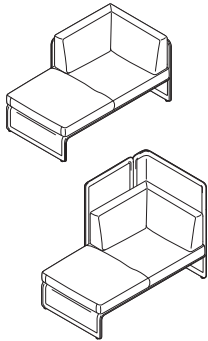

*Tip: Handedness is determined while in the seated position. Illustration above shows left-hand chaise.*

*Tip: If contrasting screen is selected, it is required to specify whether seat deck finish will match inner screen or outer screen.*

*Tip: Contrasting fabric for articulating back pulls upcharge is applied one time per style number.*

*Tip: When contrasting fabric for articulating back pulls is selected, only one contrasting fabric can be specified and will apply to all pulls.*

Standard Includes		Required to Specify
<ul style="list-style-type: none"> <li>▶ Need help? Product details, page 114</li> <li>• Screen: group 1 knit</li> <li>• Seat deck: group 1 knit to match screen</li> <li>• Non-contrasting seat cushion, articulating back cushion and pulls, back corner cushion, and end arm cushion, if selected: fabric or leather</li> <li>• Bracket: paint</li> <li>• Six adjustable glides</li> <li>• Ships assembled</li> </ul>		<ol style="list-style-type: none"> <li>1 Style number</li> <li>2 Handedness (see below under Required Selections)</li> <li>3 Knit color number for screen</li> <li>4 Fabric or leather color number for non-contrasting seat cushion, articulating back cushion and pulls, back corner cushion, and end arm cushion, if selected</li> <li>5 Paint color number for bracket: 4141 Platinum Matte 4710 Low Gloss Black</li> <li>6 Options, if selected (see below)</li> </ol> <p>▶ See <i>Coalesse Surface Materials Reference Guide</i>.</p>

	Required Sections	U.S. Price	Required to Specify
<b>Handedness</b>	<ul style="list-style-type: none"> <li>• Left-hand, 2-seat chaises only (seated position)</li> <li>• Right-hand, 2-seat chaises only (seated position)</li> </ul>	No cost	Specify with <i>left-hand configuration</i> .
		No cost	Specify with <i>right-hand configuration</i> .

	Options	U.S. Price	Required to Specify
<b>Surface Materials</b>	<b>Fabric screen</b>		
	• 2-seat chaise with one low-back screen and one right- or one left-hand screen	+\$363	Specify with <i>screen type fabric</i> .
	• 2-seat chaise with one high-back screen and one right- or one left-hand screen	+\$444	Specify with <i>screen type fabric</i> .
	• Contrasting fabric for screen	+\$192	Specify with <i>contrasting fabric</i> and select fabric or leather color number.
	• Contrasting fabric for cushion	+\$192	Specify with <i>contrasting fabric</i> and select fabric or leather color number.
	• Contrasting fabric for top and bottom articulating back pulls	+\$192	Specify with <i>contrasting fabric</i> and select fabric or leather color number.
	• Fabric upcharges	Prices at right	Specify fabric color number.
	<b>Knit screen</b>		
	• Group 1 knit screen	No cost	Specify with <i>screen type knit</i> and select knit color number.
	• Group 2 knit screen		
– 2-seat chaise with one low-back screen and one right- or one left-hand screen	+\$578	Specify with <i>screen type knit</i> and select knit color number.	
– 2-seat chaise with one high-back screen and one right- or one left-hand screen	+\$667	Specify with <i>screen type knit</i> and select knit color number.	
<b>Acrylic backer</b>			
• 2-seat chaise with one low-back screen and one right- or one left-hand screen	+\$108	Specify with <i>acrylic backer</i> .	
• 2-seat chaise with one high-back screen and one right- or one left-hand screen	+\$161	Specify with <i>acrylic backer</i> .	

▶ Options, continued on next page

▶ See *Coalesse Surface Materials Reference Guide*.



**For Canadian Pricing**  
Multiply U.S. Price by the Canadian price factor.  
▶ See page 1 for details.

# Lagunitas Lounge System 2-Seat Chaises

DESIGN TOAN NGUYEN

*Tip: For Customer's Own Material or Leather, see necessary requirements, important processing instructions and ordering information.*

► See Coalesse Surface Materials Reference Guide.

*Tip: For any portion of the product that requires a COM, the additional upcharge is a one time charge per product.*

*Tip: For any portion of the product that requires a COL, the additional upcharge is a one time charge per product.*

*Tip: For each USB port specified, there is one USB per port.*

► Options, continued from previous page

	Options	U.S. Price	Required to Specify
<b>Surface Materials, continued</b>	• COM	No cost	Specify with COM and select fabric color number
	• COL	+\$ 433	Specify with COL and select leather color number. ► See Coalesse Surface Materials Reference Guide
<b>Power/USB Configuration</b>	• One power module: two power in 4710 Low Gloss Black paint	+\$ 481	Specify with one power module, with two power.
	• One power module: one USB A+C 20W/one power in 4710 Low Gloss Black paint	+\$ 638	Specify with one power module, with one power/one USB A+C 20W.
	• Two power modules: two power each in 4710 Low Gloss Black paint	+\$ 962	Specify with two power modules, with two power.
	• Two power modules: one USB A+C 20W/one power each in 4710 Low Gloss Black paint	+\$1276	Specify with two power modules, with one power/one USB A+C 20W.
<b>Related Products</b>	<ul style="list-style-type: none"> <li>• Lounge</li> <li>• Bench</li> <li>• Collaborative and conference tables</li> <li>• Occasional tables</li> <li>• Personal table</li> <li>• Lounge booth connector screen and alignment connector</li> </ul>		<ul style="list-style-type: none"> <li>► Pages 134–144</li> <li>► Page 160</li> <li>► See Coalesse Tables, Storage, and Accessories Specification Guide.</li> <li>► See Coalesse Tables, Storage, and Accessories Specification Guide.</li> <li>► See Coalesse Tables, Storage, and Accessories Specification Guide.</li> <li>► Pages 162–163</li> </ul>

► Specification Information, on next page



**For Canadian Pricing**  
Multiply U.S. Price by the Canadian price factor.  
► See page 1 for details.

# Lagunitas Lounge System 2-Seat Chaises *continued*

DESIGN TOAN NGUYEN

► Options, on previous page

## Specification Information

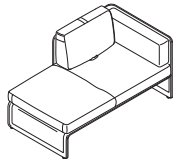

**One articulating back**  
**Overall:** 59<sup>3</sup>/<sub>8</sub>"W x 34"D x 32<sup>3</sup>/<sub>8</sub>"H  
**Seat:** 16"H

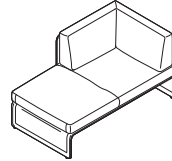

**One corner cushion**  
**Overall:** 59<sup>3</sup>/<sub>8</sub>"W x 34"D x 32<sup>3</sup>/<sub>8</sub>"H  
**Seat:** 16"H

**Style Number**                      **U.S. Base Price**

### 2-Seat Chaise with Low-Back Screen and One Side Screen

**COLAGCL2**                      \$6467

#### Fabric Upcharges

	Fabric Groups:										Leather Groups:	
	1	2	3	4	5	6	7	8	9	10	1	2
Articulating Back Pulls (if top and bottom contrasting pulls are selected)	No cost	+\$ 2	+\$ 15	+\$ 30	+\$ 51	+\$ 78	+\$ 109	+\$ 141	+\$ 171	+\$ 202	+\$ 264	+\$ 314
Seat Cushion	No cost	+\$14	+\$ 90	+\$180	+\$315	+\$485	+\$ 677	+\$ 882	+\$1062	+\$1254	+\$1534	+\$1836
Back Cushion	No cost	+\$15	+\$ 88	+\$175	+\$307	+\$472	+\$ 658	+\$ 857	+\$1032	+\$1219	+\$1492	+\$1785
Inside Screen	No cost	+\$24	+\$151	+\$302	+\$530	+\$812	+\$1134	+\$1477	+\$1779	+\$2102	N.A.	N.A.
Outside Screen	No cost	+\$25	+\$152	+\$303	+\$531	+\$812	+\$1136	+\$1479	+\$1780	+\$2103	N.A.	N.A.

**One Articulating Back:** Arm: 0, Seat Deck: 2.7 yards, Inside Screen: 2.7 yards, Outside Screen: 3.2 yards, Seat Cushion: 2.64 yards, 66 sq ft, Back Cushion: 2.61 yards, 63.8 sq ft, Contrasting Pulls on Articulating Back Cushion: 0.44 yards, 1.1 sq ft

**One Corner Cushion:** Arm: 0, Seat Deck: 2.7 yards, Inside Screen: 2.7 yards, Outside Screen: 3.2 yards, Seat Cushion: 2.64 yards, 66 sq ft, Back Cushion: 2.61 yards, 63.8 sq ft

► Specification Information, on next page

*Tip: Handedness is determined while in the seated position. Illustration above shows left-hand chaise.*

*Tip: Articulating back pull fabric upcharges only apply when contrasting pulls are selected.*



**For Canadian Pricing**  
 Multiply U.S. Price by the Canadian price factor.  
 ► See page 1 for details.

# Lagunitas Lounge System 2-Seat Chaises

DESIGN TOAN NGUYEN

► Specification Information, continued from previous page

## Specification Information

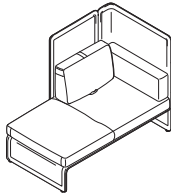

**One articulating back**  
Overall: 59<sup>3</sup>/<sub>8</sub>"W x 34"D x 50"H  
Seat: 16"H

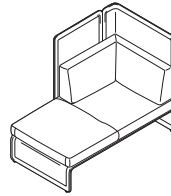

**One corner cushion**  
Overall: 59<sup>3</sup>/<sub>8</sub>"W x 34"D x 50"H  
Seat: 16"H

Style Number                      U.S. Base Price

### 2-Seat Chaise with High-Back Screen and One Side Screen

COLAGCH2                      \$7571

#### Fabric Upcharges

	Fabric Groups:										Leather Groups:	
	1	2	3	4	5	6	7	8	9	10	1	2
Articulating Back Pulls (if top and bottom contrasting pulls are selected)	No cost	+\$ 2	+\$ 15	+\$ 30	+\$ 51	+\$ 78	+\$ 109	+\$ 141	+\$ 171	+\$ 202	+\$ 264	+\$ 314
Seat Cushion	No cost	+\$15	+\$ 93	+\$186	+\$326	+\$500	+\$ 699	+\$ 910	+\$1096	+\$1296	+\$1534	+\$1836
Back Cushion	No cost	+\$15	+\$ 89	+\$177	+\$311	+\$477	+\$ 666	+\$ 867	+\$1043	+\$1232	+\$1492	+\$1785
Inside Screen	No cost	+\$24	+\$155	+\$311	+\$545	+\$838	+\$1170	+\$1524	+\$1836	+\$2168	N.A.	N.A.
Outside Screen	No cost	+\$25	+\$156	+\$311	+\$545	+\$838	+\$1170	+\$1523	+\$1836	+\$2168	N.A.	N.A.

**One Articulating Back:** Arm: 0, Seat Deck: 2.7 yards, Inside Screen: 2.7 yards, Outside Screen: 3.2 yards, Seat Cushion: 2.64 yards, 66 sq ft, Back Cushion: 2.61 yards, 63.8 sq ft, Contrasting Pulls on Articulating Back Cushion: 0.44 yards, 1.1 sq ft

**One Corner Cushion:** Arm: 0, Seat Deck: 2.7 yards, Inside Screen: 2.7 yards, Outside Screen: 3.2 yards, Seat Cushion: 2.64 yards, 66 sq ft, Back Cushion: 2.61 yards, 63.8 sq ft

*Tip: Handedness is determined while in the seated position. Illustration above shows left-hand chaise.*

*Tip: Articulating back pull fabric upcharges only apply when contrasting pulls are selected.*



**For Canadian Pricing**  
Multiply U.S. Price by the Canadian price factor.  
► See page 1 for details.

# Lagunitas Lounge System 3-Seat Chaises

DESIGN TOAN NGUYEN

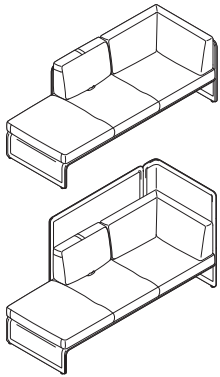

Tip: Handedness is determined while in the seated position. Illustration above shows left-hand chaise.

Tip: If contrasting screen is selected, it is required to specify whether seat deck finish will match inner screen or outer screen.

Tip: Contrasting fabric for articulating back pulls upcharge is applied one time per style number.

Tip: When contrasting fabric for articulating back pulls is selected, only one contrasting fabric can be specified and will apply to all pulls.

Standard Includes		Required to Specify
<p>► Need help? Product details, page 114</p> <ul style="list-style-type: none"> <li>• Screen: group 1 knit</li> <li>• Seat deck: group 1 knit to match screen</li> <li>• Non-contrasting seat cushion, articulating back cushion and pulls, back corner cushion, and end arm cushions, if selected: fabric or leather</li> <li>• Bracket: paint</li> <li>• Six adjustable glides</li> <li>• Ships assembled</li> </ul>		<ol style="list-style-type: none"> <li>1 Style number</li> <li>2 Handedness (see below under Required Selections)</li> <li>3 Knit color number for screen</li> <li>4 Fabric or leather color number for non-contrasting seat cushion, articulating back cushion and pulls, back corner cushion, and end arm cushion, if selected</li> <li>5 Paint color number for bracket: 4141 Platinum Matte 4710 Low Gloss Black</li> <li>6 Options, if selected (see below)</li> </ol> <p>► See <i>Coalesse Surface Materials Reference Guide</i>.</p>

Required Sections	U.S. Price	Required to Specify
<b>Handedness</b> <ul style="list-style-type: none"> <li>• Left-hand, 3-seat chaises only (seated position)</li> <li>• Right-hand, 3-seat chaises only (seated position)</li> </ul>	No cost	Specify with <i>left-hand configuration</i> .
	No cost	Specify with <i>right-hand configuration</i> .

Options	U.S. Price	Required to Specify
<b>Surface Materials</b> <ul style="list-style-type: none"> <li>• <b>Fabric screen</b></li> <li>• 3-seat chaise with one low-back screen and one right- or one left-hand screen</li> <li>• 3-seat chaise with one high-back screen and one right- or one left-hand screen</li> </ul>	+\$481 +\$524	Specify with <i>screen type fabric</i> .
<ul style="list-style-type: none"> <li>• Contrasting fabric for screen</li> <li>• Contrasting fabric for cushion</li> </ul>	+\$192 +\$192	Specify with <i>contrasting fabric</i> and select fabric or leather color number.
<ul style="list-style-type: none"> <li>• Contrasting fabric for top and bottom articulating back pulls</li> </ul>	+\$192	Specify with <i>contrasting fabric</i> and select fabric or leather color number.
<ul style="list-style-type: none"> <li>• Fabric upcharges</li> </ul>	Prices at right	Specify fabric color number.
<b>Knit screen</b> <ul style="list-style-type: none"> <li>• Group 1 knit screen</li> <li>• Group 2 knit screen               <ul style="list-style-type: none"> <li>– 3-seat chaise with one low-back screen and one right- or one left-hand screen</li> <li>– 3-seat chaise with one high-back screen and one right- or one left-hand screen</li> </ul> </li> </ul>	No cost +\$698 +\$783	Specify with <i>screen type knit</i> and select knit color number.
<b>Acrylic backer</b> <ul style="list-style-type: none"> <li>• 3-seat chaise with one low-back screen and one right- or one left-hand screen</li> <li>• 3-seat chaise with one high-back screen and one right- or one left-hand screen</li> </ul>	+\$140 +\$226	Specify with <i>acrylic backer</i> .

► See *Coalesse Surface Materials Reference Guide*.

► Options, continued on next page



**For Canadian Pricing**  
 Multiply U.S. Price by the Canadian price factor.  
 ► See page 1 for details.

# Lagunitas Lounge System 3-Seat Chaises

DESIGN TOAN NGUYEN

*Tip: For Customer's Own Material or Leather, see necessary requirements, important processing instructions and ordering information.*  
 ▶ See Coalesse Surface Materials Reference Guide.

*Tip: For any portion of the product that requires a COM, the additional upcharge is a one time charge per product.*

*Tip: For any portion of the product that requires a COL, the additional upcharge is a one time charge per product.*

*Tip: For each USB port specified, there is one USB per port.*

▶ Options, continued from previous page

	Options	U.S. Price	Required to Specify
<b>Surface Materials, continued</b>	• COM	No cost	Specify with COM and select fabric color number. ▶ See Coalesse Surface Materials Reference Guide.
	• COL	+\$ 433	Specify with COL and select leather color number. ▶ See Coalesse Surface Materials Reference Guide.
<b>Power/USB Configuration</b>	• One power module: two power in 4710 Low Gloss Black paint	+\$ 481	Specify with one power module, with two power.
	• One power module: one USB A+C 20W/one power in 4710 Low Gloss Black paint	+\$ 638	Specify with one power module, with one power/one USB A+C 20W.
	• Two power modules: two power each in 4710 Low Gloss Black paint	+\$ 962	Specify with two power modules, with two power.
	• Two power modules: one USB A+C 20W/one power each in 4710 Low Gloss Black paint	+\$1276	Specify with two power modules, with one power/one USB A+C 20W.
<b>Related Products</b>	<ul style="list-style-type: none"> <li>• Lounge</li> <li>• Bench</li> <li>• Collaborative and conference tables</li> </ul>		<ul style="list-style-type: none"> <li>▶ Pages 134–144</li> <li>▶ Page 160</li> <li>▶ See Coalesse Tables, Storage, and Accessories Specification Guide.</li> </ul>
	<ul style="list-style-type: none"> <li>• Occasional tables</li> <li>• Personal table</li> <li>• Lounge booth connector screen and alignment connector</li> </ul>		<ul style="list-style-type: none"> <li>▶ See Coalesse Tables, Storage, and Accessories Specification Guide.</li> <li>▶ See Coalesse Tables, Storage, and Accessories Specification Guide.</li> <li>▶ Page Pages 162–163</li> </ul>

▶ Specification Information, on next page

 **For Canadian Pricing**  
 Multiply U.S. Price by the Canadian price factor.  
 ▶ See page 1 for details.

# Lagunitas Lounge System 3-Seat Chaises *continued*

DESIGN TOAN NGUYEN

► Options, on previous page

## Specification Information

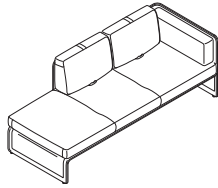

**Two articulating backs**  
**Overall:** 85"W x 34"D x 32<sup>3</sup>/<sub>8</sub>"H  
**Seat:** 16"H

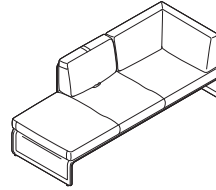

**One articulating back and one corner cushion**  
**Overall:** 85"W x 34"D x 32<sup>3</sup>/<sub>8</sub>"H  
**Seat:** 16"H

**Style Number**                      **U.S. Base Price**

### 3-Seat Chaise with Low-Back Screen and One Side Screen

**COLAGCL3**                      \$8640

#### Fabric Upcharges

	Fabric Groups:										Leather Groups:	
	1	2	3	4	5	6	7	8	9	10	1	2
Articulating Back Pulls (if top and bottom contrasting pulls are selected)	No cost	+\$ 2	+\$ 15	+\$ 30	+\$ 51	+\$ 78	+\$ 109	+\$ 141	+\$ 171	+\$ 202	+\$ 264	+\$ 314
Seat Cushion	No cost	+\$17	+\$118	+\$237	+\$418	+\$644	+\$ 899	+\$1172	+\$1412	+\$1668	+\$2098	+\$2512
Back Cushion	No cost	+\$19	+\$132	+\$266	+\$468	+\$721	+\$1009	+\$1313	+\$1583	+\$1869	+\$2424	+\$2896
Inside Screen	No cost	+\$25	+\$168	+\$339	+\$595	+\$915	+\$1279	+\$1667	+\$2008	+\$2372	N.A.	N.A.
Outside Screen	No cost	+\$25	+\$168	+\$339	+\$596	+\$916	+\$1280	+\$1666	+\$2007	+\$2371	N.A.	N.A.

**Two Articulating Backs:** Arm: 0, Seat Deck: 3.7 yards, Inside Screen: 3.5 yards, Outside Screen: 3.9 yards, Seat Cushion: 3.31 yards, 90.2 sq ft, Back Cushion: 3.83 yards, 103.4 sq ft, Contrasting Pulls on Articulating Back Cushions: 0.44 yards, 2.2 sq ft

**One Articulating Back and One Corner Cushion:** Arm: 0, Seat Deck: 3.7 yards, Inside Screen: 3.5 yards, Outside Screen: 3.9 yards, Seat Cushion: 3.31 yards, 90.2 sq ft, Back Cushion: 3.83 yards, 103.4 sq ft, Contrasting Pulls on Articulating Back Cushion: 0.44 yards, 1.1 sq ft

► Specification Information, on next page

*Tip: Handedness is determined while in the seated position. Illustration above shows left-hand chaise.*

*Tip: Articulating back pull fabric upcharges only apply when contrasting pulls are selected.*



**For Canadian Pricing**  
 Multiply U.S. Price by the Canadian price factor.  
 ► See page 1 for details.

# Lagunitas Lounge System 3-Seat Chaises

DESIGN TOAN NGUYEN

► Specification Information, continued from previous page

## Specification Information

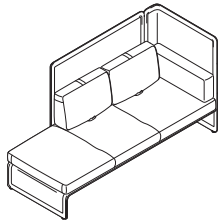

**Two articulating backs**  
Overall: 85"W x 34"D x 50"H  
Seat: 16"H

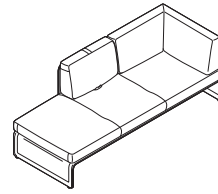

**One articulating back and one corner cushion**  
Overall: 85"W x 34"D x 50"H  
Seat: 16"H

**Style Number**                      **U.S. Base Price**

### 3-Seat Chaise with High-Back Screen and One Side Screen

**COLAGCH3**                      \$9680

#### Fabric Upcharges

	Fabric Groups:										Leather Groups:	
	1	2	3	4	5	6	7	8	9	10	1	2
Articulating Back Pulls (if top and bottom contrasting pulls are selected)	No cost	+\$ 2	+\$ 15	+\$ 30	+\$ 51	+\$ 78	+\$ 109	+\$ 141	+\$ 171	+\$ 202	+\$ 264	+\$ 314
Seat Cushion	No cost	+\$20	+\$120	+\$241	+\$421	+\$647	+\$ 902	+\$1175	+\$1415	+\$1671	+\$2098	+\$2512
Back Cushion	No cost	+\$22	+\$135	+\$269	+\$472	+\$724	+\$1012	+\$1317	+\$1586	+\$1873	+\$2424	+\$2896
Inside Screen	No cost	+\$30	+\$176	+\$351	+\$615	+\$944	+\$1318	+\$1715	+\$2066	+\$2439	N.A.	N.A.
Outside Screen	No cost	+\$28	+\$176	+\$351	+\$615	+\$942	+\$1317	+\$1714	+\$2064	+\$2438	N.A.	N.A.

**Two Articulating Backs:** Arm: 0, Seat Deck: 3.7 yards, Inside Screen: 3.5 yards, Outside Screen: 3.9 yards, Seat Cushion: 3.31 yards, 90.2 sq ft, Back Cushion: 3.83 yards, 103.4 sq ft, Contrasting Pulls on Articulating Back Cushions: 0.44 yards, 2.2 sq ft

**One Articulating Back and One Corner Cushion:** Arm: 0, Seat Deck: 3.7 yards, Inside Screen: 3.5 yards, Outside Screen: 3.9 yards, Seat Cushion: 3.31 yards, 90.2 sq ft, Back Cushion: 3.83 yards, 103.4 sq ft, Contrasting Pulls on Articulating Back Cushion: 0.44 yards, 1.1 sq ft

*Tip: Handedness is determined while in the seated position. Illustration above shows left-hand chaise.*

*Tip: Articulating back pull fabric upcharges only apply when contrasting pulls are selected.*

Lounge Seating



**For Canadian Pricing**  
Multiply U.S. Price by the Canadian price factor.  
► See page 1 for details.

# Lagunitas Lounge System Benches

DESIGN TOAN NGUYEN

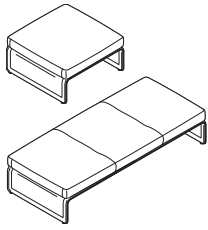

Standard Includes		Required to Specify
<ul style="list-style-type: none"> <li>▶ Need help? Product details, page 114</li> </ul>	<ul style="list-style-type: none"> <li>• Seat deck: group 1 knit</li> <li>• Seat cushion: fabric or leather</li> <li>• Four adjustable glides</li> <li>• Ships assembled</li> </ul>	<ol style="list-style-type: none"> <li>1 Style number</li> <li>2 Knit color number for seat deck</li> <li>3 Fabric or leather color number for seat cushion</li> <li>4 Options, if selected (see below)</li> </ol> <p>▶ See <i>Coalesse Surface Materials Reference Guide</i>.</p>

Options	U.S. Price	Required to Specify
<b>Surface Materials</b> <ul style="list-style-type: none"> <li>• Acrylic backer                             <ul style="list-style-type: none"> <li>• 1-seat bench cushion +\$ 25</li> <li>• 2-seat bench cushion +\$ 34</li> <li>• 3-seat bench cushion +\$ 46</li> </ul> </li> </ul>		Specify with acrylic backer. Specify with acrylic backer. Specify with acrylic backer. ▶ See <i>Coalesse Surface Materials Reference Guide</i> .
<ul style="list-style-type: none"> <li>• Fabric seat deck</li> </ul>	Prices at right	Specify with fabric seat deck and select fabric color number.
<b>Knit seat deck</b> <ul style="list-style-type: none"> <li>• Group 1 knit seat deck</li> </ul>	No cost	Specify with screen type knit and select fabric color number.
<ul style="list-style-type: none"> <li>• Group 2 knit seat deck                             <ul style="list-style-type: none"> <li>– 1-seat bench +\$ 123</li> <li>– 2-seat bench +\$ 167</li> <li>– 3-seat bench +\$ 209</li> </ul> </li> </ul>		Specify with screen type knit and select fabric color number. Specify with screen type knit and select fabric color number. Specify with screen type knit and select fabric color number.
<ul style="list-style-type: none"> <li>• COM</li> </ul>	No cost	Specify with COM and select fabric color number. ▶ See <i>Coalesse Surface Materials Reference Guide</i> .
<ul style="list-style-type: none"> <li>• COL</li> </ul>	+\$ 431	Specify with COL and select leather color number. ▶ See <i>Coalesse Surface Materials Reference Guide</i> .

*Tip: For Customer's Own Material or Leather, see necessary requirements, important processing instructions and ordering information.*  
▶ See *Coalesse Surface Materials Reference Guide*.

*Tip: For any portion of the product that requires a COM, the additional upcharge is a one time charge per product.*

*Tip: For any portion of the product that requires a COL, the additional upcharge is a one time charge per product.*

*Tip: For each USB port specified, there is one USB per port.*

<b>Power/USB Configuration</b> <ul style="list-style-type: none"> <li>• 1-seat benches                             <ul style="list-style-type: none"> <li>• One power module: two power in 4710 Low Gloss Black paint +\$ 481</li> <li>• One power module: one USB A+C 20W/one power in 4710 Low Gloss Black paint +\$ 638</li> </ul> </li> <li>• 2- and 3-seat benches                             <ul style="list-style-type: none"> <li>• Two power modules: two power each in 4710 Low Gloss Black paint +\$ 962</li> <li>• Two power modules: one USB A+C 20W/one power each in 4710 Low Gloss Black paint +\$1276</li> </ul> </li> </ul>		Specify with one power module, with two power. Specify with one power module, with one power/one USB A+C 20W.  Specify with two power modules, with two power.  Specify with two power modules, with one power/one USB A+C 20W.
--	--	--

<b>Related Products</b> <ul style="list-style-type: none"> <li>• Lounge</li> <li>• Chaise</li> <li>• Collaborative and conference tables</li> <li>• Occasional tables</li> <li>• Personal table</li> </ul>	<ul style="list-style-type: none"> <li>▶ Pages 134–144</li> <li>▶ Pages 152–156</li> <li>▶ See <i>Coalesse Tables, Storage, and Accessories Specification Guide</i>.</li> <li>▶ See <i>Coalesse Tables, Storage, and Accessories Specification Guide</i>.</li> <li>▶ See <i>Coalesse Tables, Storage, and Accessories Specification Guide</i>.</li> </ul>
--	---



**For Canadian Pricing**  
Multiply U.S. Price by the Canadian price factor.  
▶ See page 1 for details.

# Lagunitas Lounge System Benches

DESIGN TOAN NGUYEN

## Specification Information

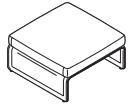

**Overall:** 32<sup>3</sup>/<sub>4</sub>"W x 32<sup>3</sup>/<sub>4</sub>"D x 16"H  
**Seat Deck:** 2.8 yards  
**Seat Cushion:** 2.6 yards, 57.2 sq ft

Style Number      U.S. Base Price

### 1-Seat Bench

COLAGB1      \$2965

#### Fabric Upcharges

	Fabric Groups:										Leather Groups:	
	1	2	3	4	5	6	7	8	9	10	1	2
Seat Deck	+\$164	+\$169	+\$197	+\$229	+\$279	+\$341	+\$411	+\$486	+\$ 551	+\$ 622	N.A.	N.A.
Seat Cushion	No cost	+\$ 5	+\$ 33	+\$ 65	+\$115	+\$177	+\$247	+\$322	+\$ 387	+\$ 458	+\$1342	+\$1604

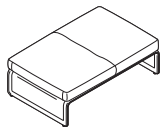

**Overall:** 51<sup>1</sup>/<sub>4</sub>"W x 32<sup>3</sup>/<sub>4</sub>"D x 16"H  
**Seat Deck:** 3.1 yards  
**Seat Cushion:** 3.2 yards, 70.4 sq ft

### 2-Seat Bench

COLAGB2      \$3543

#### Fabric Upcharges

	Fabric Groups:										Leather Groups:	
	1	2	3	4	5	6	7	8	9	10	1	2
Seat Deck	+\$164	+\$169	+\$197	+\$229	+\$279	+\$340	+\$411	+\$486	+\$ 551	+\$ 621	N.A.	N.A.
Seat Cushion	No cost	+\$ 15	+\$ 89	+\$177	+\$310	+\$477	+\$665	+\$865	+\$1042	+\$1231	+\$1648	+\$1969

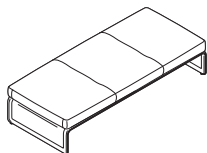

**Overall:** 76<sup>7</sup>/<sub>8</sub>"W x 32<sup>3</sup>/<sub>4</sub>"D x 16"H  
**Seat Deck:** 3.5 yards  
**Seat Cushion:** 4 yards, 88 sq ft

### 3-Seat Bench

COLAGB3      \$4348

#### Fabric Upcharges

	Fabric Groups:										Leather Groups:	
	1	2	3	4	5	6	7	8	9	10	1	2
Seat Deck	+\$164	+\$169	+\$197	+\$229	+\$279	+\$340	+\$411	+\$ 486	+\$ 551	+\$ 621	N.A.	N.A.
Seat Cushion	No cost	+\$ 18	+\$114	+\$228	+\$400	+\$615	+\$859	+\$1117	+\$1346	+\$1591	+\$2058	+\$2463

# Lagunitas Lounge System Accessories

DESIGN TOAN NGUYEN

## Lounge Booth Connector Screen



Screen: 38½"W x 50"H

*Tip: Lounge booth connector screen joins two high screen lounges, enclosing one side of booth.*

Standard Includes	Required to Specify
<ul style="list-style-type: none"> <li>▶ Need help? Product details, page 114</li> <li>• Screen: group 1 knit</li> <li>• Two bottom brackets: 4710 Low Gloss Black or 4141 Platinum Matte paint</li> <li>• Two screen ganging alignment clips</li> </ul>	<ul style="list-style-type: none"> <li>1 Style number</li> <li>2 Knit color number for screen</li> <li>3 Paint color number for bracket</li> <li>4 Options, if selected (see below)</li> <li>▶ See <i>Coalesse Surface Materials Reference Guide</i>.</li> </ul>

Surface Materials	Options	U.S. Price	Required to Specify
	<b>Knit screen</b>		
	• Group 1 knit	No cost	Specify with <i>screen type knit</i> and select knit color number.
	• Group 2 knit	+\$139	Specify with <i>screen type knit</i> and select knit color number.
	• Fabric screen	+\$324	Specify with <i>screen type fabric</i> .
	• Contrasting fabric	+\$192	Specify with <i>contrasting fabric</i> and select fabric color number.
	• Fabric upcharges	Prices below	Specify fabric color number.
	• COM	No cost	Specify with <i>COM</i> and select fabric color number. ▶ See <i>Coalesse Surface Materials Reference Guide</i> .

<b>Related Products</b>	<ul style="list-style-type: none"> <li>• Lounge</li> <li>• Chaise</li> </ul>	<ul style="list-style-type: none"> <li>▶ Pages 134–144</li> <li>▶ Pages 152–156</li> </ul>
-------------------------	--	--

### Specification Information

Style Number	U.S. Base Price
COLAGLBS	\$2176

	Fabric Upcharges									
	Fabric Groups:									
	1	2	3	4	5	6	7	8	9	10
Inside Screen	No cost	+\$ 8	+\$ 46	+\$ 92	+\$160	+\$245	+\$342	+\$445	+\$ 536	+\$ 632
Outside Screen	No cost	+\$16	+\$100	+\$200	+\$351	+\$540	+\$754	+\$981	+\$1182	+\$1397

**Booth Connector Screen:** Inside Screen: 1.4 yards, Outside Screen: 2.6 yards



**For Canadian Pricing**  
Multiply U.S. Price by the Canadian price factor.  
▶ See page 1 for details.

# Lagunitas Lounge System Accessories

DESIGN TOAN NGUYEN

## Alignment Connector

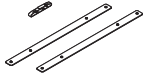

Standard Includes		Required to Specify
▶ Need help? Product details, page 114	<ul style="list-style-type: none"><li>• Screen and seat deck connector package: pin, bracket, and hardware</li><li>• Ships ready to assemble</li></ul>	Style number

Related Products	
<ul style="list-style-type: none"><li>• Lounge</li><li>• Chaise</li></ul>	<ul style="list-style-type: none"><li>▶ Pages 134-144</li><li>▶ Pages 152-156</li></ul>

Specification Information	
Style Number	U.S. Price
COLAGCI	\$64

Lounge Seating

  
**For Canadian Pricing**  
Multiply U.S. Price by the  
Canadian price factor.  
▶ See page 1 for details.

# Lagunitas Focus Nook

**Lagunitas focus nook** is a cozy, touch-down destination that offers users a traditional work posture and responds to the demand for privacy and focus throughout the open workspace. The Lagunitas focus nook is infused with the same Lagunitas design aesthetic and surface materials. It is available in a breadth of materials and finishes, inviting expression while optimizing space.

**50"H screens** are offered in two material types: knit and fabric.

**Knit screens** allow for some transparency and light to pass through the panels. Available in 17 colors.

**Adjustable leveling glides** have a range of 1/2" to accommodate uneven floors.

**Fabric screens** are available with non-contrasting or contrasting (inside and outside of the screen) fabric.

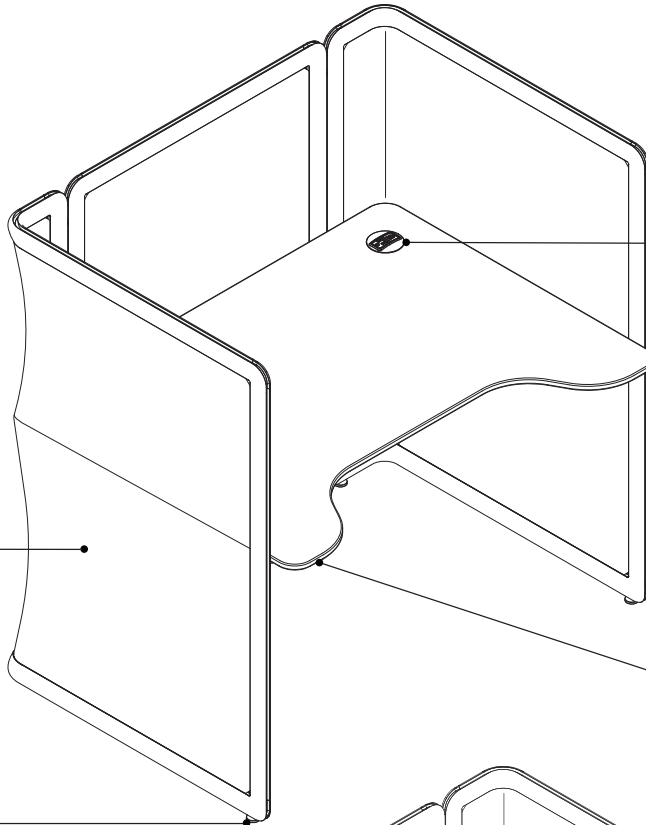

**Power modules** are available for easy access to power.

**Cable management tray** keeps below surface cords hidden.

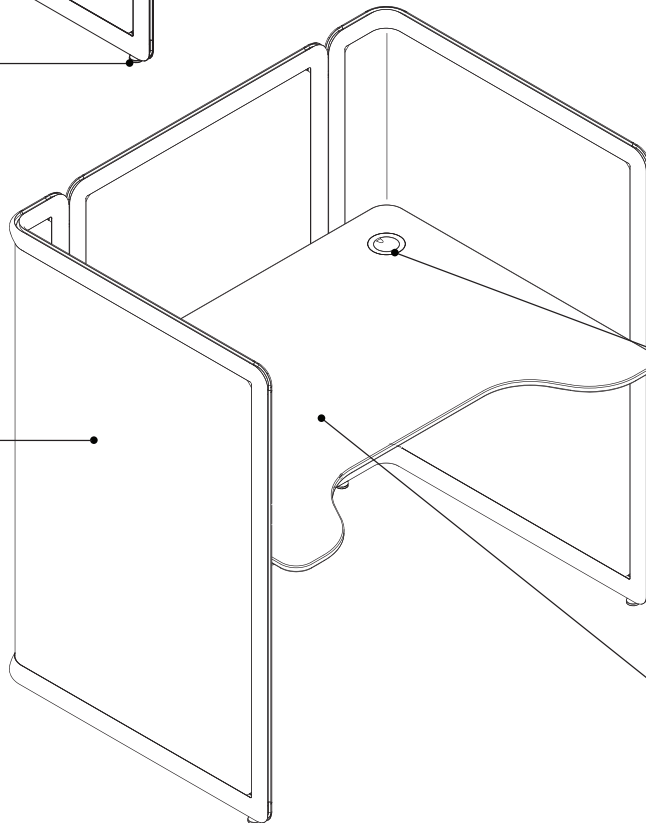

**Light grommet** is available to route on-surface light to the below-surface power source.

**Worksurface** is 28 1/2"H and is available in laminate and wood veneer in a wide variety of finishes.

# Lagunitas Focus Nook

**Product Details**

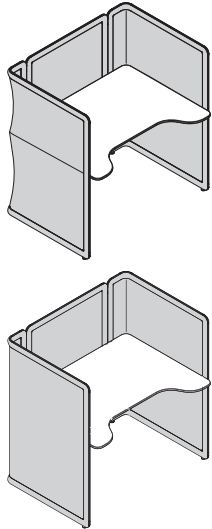

Screens are offered in two types of materials: knit and fabric. The knit panels allow for some transparency and light to pass through. The fabric panels can either be monolithic (non-contrasting) or specified in differing finishes (contrasting) for the inside and outside of the screen.

*Tip: If a contrasting screen is specified, the fabric must be chosen from the same fabric family.*

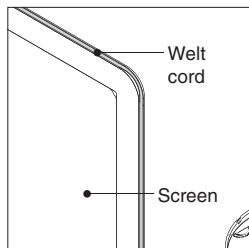

A welt cord is standard on all fabric specified screens. The welt cord finish is non-specifiable and is the same fabric finish as the outside screen when contrasting screens are specified. For non-contrasting screens, the welt cord matches the screen specification. The knit screen does not require a welt cord.

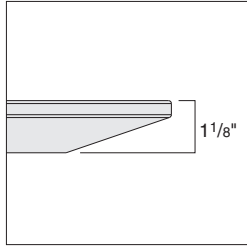

Laminate or wood veneer work surface is standard with a knife edge profile that has the appearance of a 5/8" thick top, which tapers to an overall top thickness of 1 1/8".

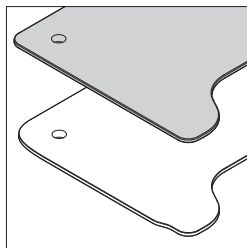

High-Pressure Laminate work surface is standard with a matching or complementing 3 mm flat edge band. Wood veneer tables are standard with a matching wood 3 mm flat edge band. The underside of the table top is finished in black.

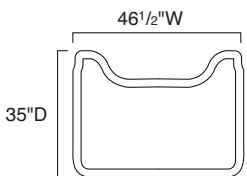

Knit Screen Surface

Knit screen work surface measures 35"D x 46 1/2"W.

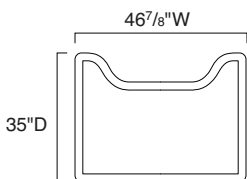

Fabric Screen Surface

Fabric screen work surface measures 35"D x 46 7/8"W.

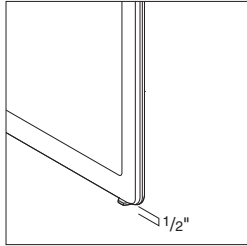

Glides adjust 1/2" for uneven floors. There are two glides per screen. Glides have a metal rounded foot.

**Power, Data, Wiring & Cabling**

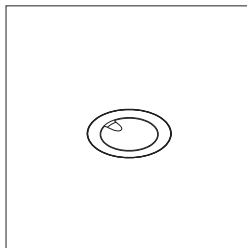

2" light grommet is available to accommodate an on-surface light by routing the on-surface light plug to the below-surface power source. Grommet is specifiable on the left or right side of work surface and is available in three color options.

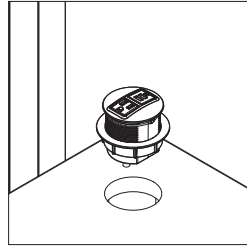

Round power modules are specifiable on the back right or back left side of the work surface. The 3" power module features tamper resistant power simplexes, an 8'L power cord with 15-amp plug. Plug includes a built-in circuit breaker measuring 2 1/4"D x 1 1/2"W x 1 1/2"H. Round power module is available in four color options, and three configurations:

- Two TR simplex receptacles
- One TR simplex receptacle and two USB A charging ports
- One TR simplex receptacle, one USB A charging port, and one USB C charging port

*Tip: USB receptacles conveniently charge a range of electronic devices. Some devices may not be compatible.*

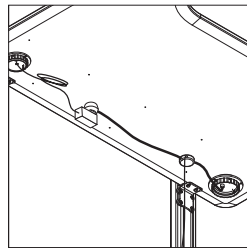

Power package is available when light grommet is specified. Power package includes power module with a below work surface convenience outlet to power the available on-surface light and retain a single power cord out. Specifiable on the back right or back left side of the work surface.

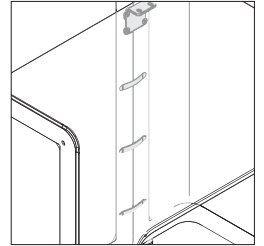

Magnetic wire management brackets are black and come standard with the power module and power package to neatly manage the cord to the floor.

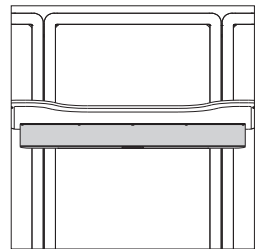

Cable management tray neatly conceals below surface cords to the underside of the work surface.

**Surface Materials**

**Screens:**

- Knit
- Fabric

**Screen attachment brackets:**

- 4710 Low Gloss Black

**Worksurface:**

- Laminate with matching or complementing 3 mm plastic edge band
- Wood veneer with matching 3 mm wood edge

**Glides:**

- Non-specifiable plated metal

**Power module and power package (options):**

- 4013 Silver/Black
- 4180 Graphite Matte
- 4242 Milk Matte
- 4710 Low Gloss Black

**Light grommet (option):**

- 6000 Black
- 6052 Milk
- 6D03 Graphite

**Cable management tray (option):**

- 4710 Low Gloss Black paint

► See *Coalesse Surface Materials Reference Guide* for more information.

# Lagunitas Focus Nook

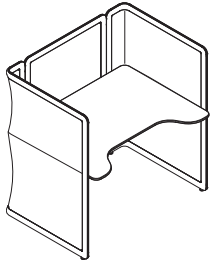

Tip: If a contrasting screen is specified, the fabric must be chosen from the same fabric family.

Tip: Grommets and power devices are specifiable on either the right or left side.

Tip: Power package must be specified when power and lighting grommet is specified.

Tip: Power simplex receptacles are tamper resistant.

Tip: When power module or power package in 4242 Milk Matte is specified, the 8' infeed cord will be white. When any other finish is specified, the infeed cord will be black.

Tip: Power/USB configuration upcharges are in addition to the power module or power package upcharge.



**For Canadian Pricing**  
Multiply U.S. Price by the Canadian price factor.  
▶ See page 1 for details.

Standard Includes		Required to Specify	
▶ Need help? Product details, page 164	<ul style="list-style-type: none"> <li>Screen: group 1 knit</li> <li>Worksurface:                             <ul style="list-style-type: none"> <li>– Group 1 laminate with 3 mm flat plastic edge</li> </ul> </li> <li>Brackets: 4710 Black Low Gloss Black paint</li> <li>Six adjustable glides</li> <li>Ships ready to assemble</li> </ul>	<ol style="list-style-type: none"> <li>Style number</li> <li>Knit color number for screen</li> <li>Laminate color number for table top</li> <li>Plastic edge color number for laminate top, if selected</li> <li>Options, if selected (see below)</li> </ol>	▶ See <i>Coalesse Surface Materials Reference Guide</i> .
Surface Materials	Options	U.S. Price	Required to Specify
	<b>Fabric screen</b> <ul style="list-style-type: none"> <li>Fabric screen</li> <li>Contrasting fabric for screen</li> </ul>	+\$645 +\$192	Specify with screen type fabric. Specify with contrasting fabric and select fabric color number. Specify fabric color number.
	<ul style="list-style-type: none"> <li>Fabric upcharges</li> </ul>	Prices at right	Specify fabric color number.
	<b>Knit screen</b> <ul style="list-style-type: none"> <li>Group 1 knit screen</li> <li>Group 2 knit screen</li> </ul>	No cost +\$748	Specify with screen type knit and select knit color number. Specify with screen type knit and select knit color number.
	<ul style="list-style-type: none"> <li>COM</li> </ul>	No cost	Specify with COM and select fabric color number. ▶ See <i>Coalesse Surface Materials Reference Guide</i> .
	<b>Worksurface</b> <ul style="list-style-type: none"> <li>Group 2 laminate</li> <li>Group 3 laminate</li> <li>Group 1 composite veneer</li> <li>Group 2 composite veneer</li> <li>Group 1 wood veneer</li> <li>Group 2 wood veneer</li> </ul>	Prices at right Prices at right Prices at right Prices at right Prices at right Prices at right	Specify with group 2 laminate and select laminate color number. Specify with group 3 laminate and select laminate color number. Specify with group 1 composite veneer and select composite veneer color number. Specify with group 2 composite veneer and select composite veneer color number. Specify with group 1 wood veneer and select wood color number. Specify with group 2 wood veneer and select wood color number.
	<b>2" Light Grommet</b> <ul style="list-style-type: none"> <li>2" light grommet</li> </ul>	+\$ 35	Specify with 2" grommet and select color number.
	<b>Power/USB Configuration</b> <ul style="list-style-type: none"> <li>Power options (with three magnetic wire management brackets)</li> <li>Power module</li> <li>Power package (contains power module and below surface convenience plug for on-surface light)</li> </ul>	+\$401 +\$626	Specify with power module and select color number. Specify with power package and select color number.
	<b>Power/USB configurations</b> <ul style="list-style-type: none"> <li>Two TR simplex receptacles</li> <li>One TR simplex receptacle and two USB A charging ports</li> <li>One TR simplex receptacle, one USB A charging port, and one USB C charging port</li> </ul>	No cost +\$157 +\$157	Specify with two power. Specify with one power, two USB A. Specify with one power, one USB A, one USB C.
	<b>Cable Management Tray</b> <ul style="list-style-type: none"> <li>Cable management tray</li> </ul>	+\$191	Specify with tray and select color number.
	<b>Related Products</b> <ul style="list-style-type: none"> <li>Lagunitas lounge seating</li> <li>Lagunitas work and occasional tables</li> </ul>		▶ Pages 134–144 ▶ See <i>Coalesse Tables, Storage and Accessories</i> .

# Lagunitas Focus Nook

## Specification Information

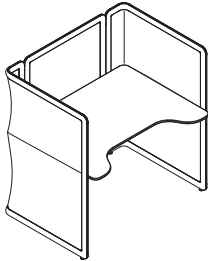

Knit Screen

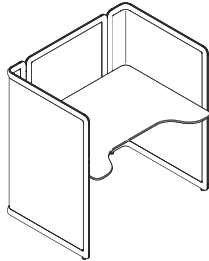

Fabric Screen

Style Number	Dimensions			U.S. Base Prices					
	W	D	H	Flat Vinyl Edge on Laminate Top		Flat Wood Edge on Composite Veneer Top		Flat Wood Edge on Wood Veneer Top	
				Group 1	Groups 2 and 3	Group 1	Group 2	Group 1	Group 2
COLAGFN	49 1/4"	37"	50"	\$6061	\$6267	\$7604	\$7954	\$7758	\$8143

### Fabric Upcharges

	Fabric Groups:									
	1	2	3	4	5	6	7	8	9	10
Inside Screen	No cost	+\$21	+\$129	+\$257	+\$450	+\$ 692	+\$ 966	+\$1259	+\$1515	+\$1789
Outside Screen	No cost	+\$31	+\$193	+\$387	+\$679	+\$1043	+\$1458	+\$1898	+\$2286	+\$2701

Inside screen: 4.4 yds, Outside screen: 5.1 yds

Lounge Seating

 **For Canadian Pricing**  
 Multiply U.S. Price by the Canadian price factor.  
 ▶ See page 1 for details.

# LessThanFive Lounge

DESIGN MICHAEL YOUNG

The **LessThanFive lounge** is handcrafted from carbon fiber, making it exceptionally light and strong.

**Lightweight**, weighing less than five pounds.

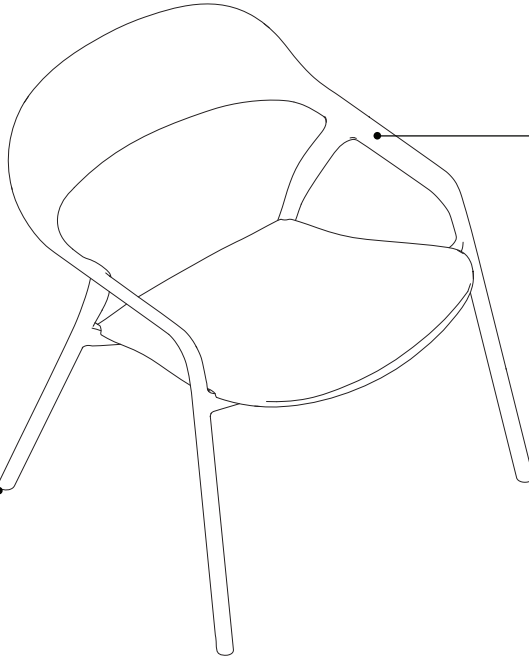

**Glides** are soft felt.

**Frame** is constructed entirely of carbon fiber, and comes in several standard finishes. Customization options are also available.

## Product Details

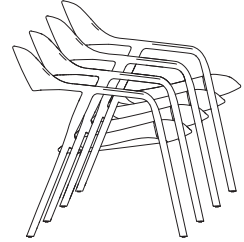

**Stackable** up to four high.

## Surface Materials

► See *Coalesse Surface Materials Reference Guide* for further information.

**Frame**  
• Paint

*Tip: Consult the Coalesse concierge team for customization options.*

# LessThanFive Lounge

DESIGN MICHAEL YOUNG

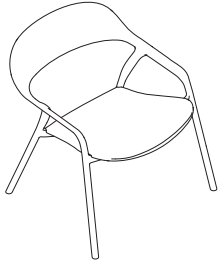

Overall: 26"D 27 1/2"W 27 1/2"H  
Seat Height: 15 3/4"H

Standard Includes		Required to Specify
<ul style="list-style-type: none"> <li>▶ Need help? Product details, page 168</li> </ul>	<ul style="list-style-type: none"> <li>• Frame: constructed of carbon fiber</li> <li>• Finish: smooth paint</li> <li>• Soft felt glides</li> </ul>	<ul style="list-style-type: none"> <li>1 Style number</li> <li>2 Paint color number for frame</li> <li>3 Options, if selected (see below)</li> <li>▶ See <i>Coalesse Surface Materials Reference Guide</i>.</li> </ul>

Options	U.S. Price	Required to Specify
<b>Surface Materials</b> <ul style="list-style-type: none"> <li>• 4233 Carbon Weave</li> </ul>	+\$289	Specify with 4233 Carbon Weave.

Specification Information		
Style Number	Quantity	U.S. Base Price

## LessThanFive Lounge

COLT5L	1	\$2295
--------	---	--------

Lounge Seating

 **For Canadian Pricing**  
Multiply U.S. Price by the Canadian price factor.  
▶ See page 1 for details.

# Marien152 Lounge Seating

DESIGN COALESSE DESIGN GROUP AND ARIK LEVY

Marien152 is a richly tailored seating experience that's inspired by the home and designed for the workday. Design personalization is built into the collection through a wide range of upholstery, color, base, and materiality choices. Thoughtful proportions and a signature cushioned back create a comfortable lounge chair that can support work. Available with a wood or metal base.

Leather may be specified with a contrasting back cushion only.

Black glides are available in hard and soft options.

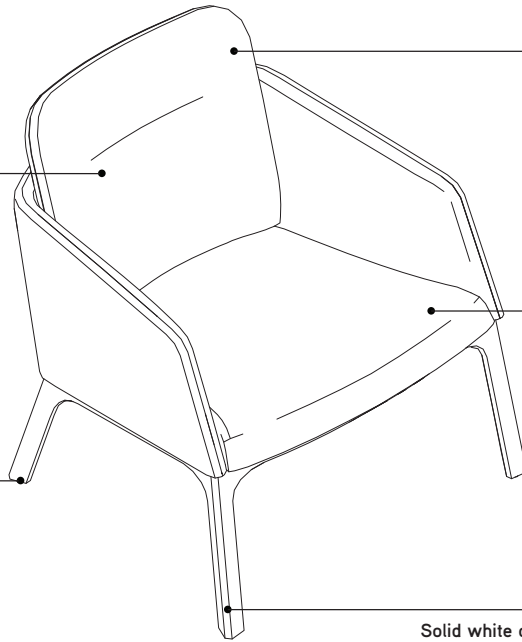

Back cushion gives the appearance of a soft, loose pillow. Intentionally relaxed upholstery on the back cushion adds to the welcoming appeal.

Contrasting fabric is available on seat, surround, and back cushion.

Solid white oak frame has a chamfered edge profile.

360° swivel base provides full range of motion.

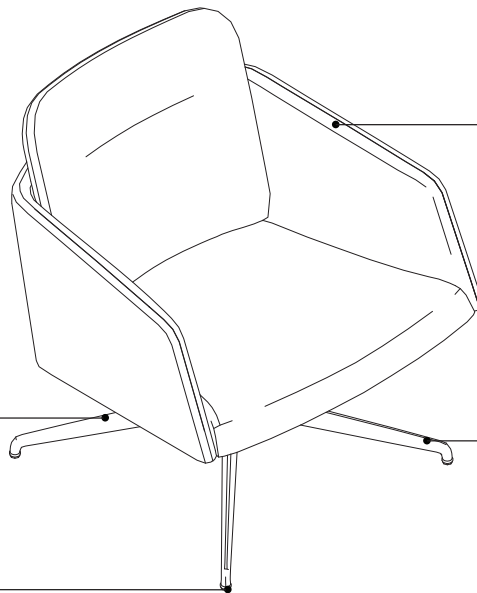

Gently sloping arms are subtle yet supportive.

Base is standard in powder coat paint and polished aluminum.

Black glides are available in hard and soft options.

# Marien152 Lounge Seating

DESIGN COALESSE DESIGN GROUP AND ARIK LEVY

## Product Details

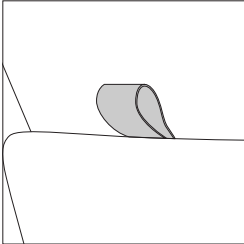

**Standard leather pull**, located behind the back cushion, allows users to easily move the chair. Leather in the color coal only. Option to specify without pull if desired.

## Surface Materials

### Upholstery

- Fabric
- Leather

### Metal base

- Paint
- Polished chrome

### Wood base

- Solid white oak wood frame

## Programs & Services

**Customer's Own Material/Leather (COM/COL) Program** is available.

► See *Coalesse Surface Materials Reference Guide* for additional information.

# Marien152 Seating Metal Base Lounge

DESIGN COALESSE DESIGN GROUP AND ARIK LEVY

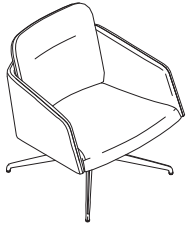

Overall: 28½"D x 29"W x 30½"H  
 Inside: 20½"D x 21"W  
 Seat: 16½"H  
 Arm: 23"H

Standard Includes		Required to Specify
<ul style="list-style-type: none"> <li>▶ Need help? Product details, page 170</li> </ul>	<ul style="list-style-type: none"> <li>• Seat, back cushion, and surround: upholstery</li> <li>• Leather strap: coal</li> <li>• Base: 8046 Polished Aluminum or group 1 paint</li> <li>• 360° swivel</li> <li>• Black hard glides</li> </ul>	<ol style="list-style-type: none"> <li>1 Style number</li> <li>2 Contrasting fabric (see below under Required Selections)</li> <li>3 Fabric or leather color number for upholstery on seat, surround, and back cushion</li> <li>4 Metal or paint color number for base</li> <li>5 Options, if selected (see below)</li> </ol> <p>▶ See <i>Coalesse Surface Materials Reference Guide</i>.</p>

Required Selections	U.S. Price	Required to Specify
<b>Contrasting Fabric</b>	<ul style="list-style-type: none"> <li>• Non contrasting fabric: No cost</li> <li>• Contrasting back cushion fabric: +\$192</li> <li>• Contrasting surround fabric: +\$192</li> <li>• Contrasting seat fabric: +\$192</li> <li>• Contrasting all fabrics: +\$192</li> </ul>	<ul style="list-style-type: none"> <li>Specify with <i>non contrasting</i>.</li> <li>Specify with <i>contrasting back cushion</i>.</li> <li>Specify with <i>contrasting surround</i>.</li> <li>Specify with <i>contrasting seat</i>.</li> <li>Specify with <i>contrasting all fabrics</i>.</li> </ul>

Options	U.S. Price	Required to Specify
<b>Surface Materials</b>	<p><b>Base</b></p> <ul style="list-style-type: none"> <li>• Polished aluminium: No cost</li> <li>• Group 1 paint: No cost</li> <li>• Group 3 paint: +\$111</li> </ul> <hr/> <p><b>Acrylic backer</b></p> <ul style="list-style-type: none"> <li>• Backer: +\$ 49</li> </ul>	<ul style="list-style-type: none"> <li>Specify with <i>aluminium matte polished</i>.</li> <li>Specify paint color number.</li> <li>Specify paint color number.</li> </ul> <hr/> <ul style="list-style-type: none"> <li>Specify with <i>acrylic backer</i>.</li> </ul>
<b>Glide Type</b>	<ul style="list-style-type: none"> <li>• Hard glides: No cost</li> <li>• Soft glides: No cost</li> </ul>	<ul style="list-style-type: none"> <li>Specify with <i>hard glides</i>.</li> <li>Specify with <i>soft glides</i>.</li> </ul>
<b>Pull</b>	<ul style="list-style-type: none"> <li>• With leather pull: No cost</li> <li>• Without leather pull: No cost</li> </ul>	<ul style="list-style-type: none"> <li>Specify with <i>pull</i>.</li> <li>Specify <i>without pull</i>.</li> </ul>
<b>Related Products</b>	<ul style="list-style-type: none"> <li>• Conference seating</li> <li>• Guest seating</li> <li>• Stools</li> </ul>	<ul style="list-style-type: none"> <li>▶ Page 300</li> <li>▶ Page 345</li> <li>▶ Pages 392-394</li> </ul>

## Specification Information

Style Number		U.S. Base Prices												Leather Groups:		
		Fabric Groups:											COL	1	2	
		COM	1	2	3	4	5	6	7	8	9	10				
COMARLCMB	Seat	\$1980	\$1980	\$2011	\$2036	\$2067	\$2112	\$2168	\$2232	\$2301	\$2361	\$2425	\$2094	\$2458	\$2558	
	Surround	No cost	No cost	+\$ 49	+\$ 89	+\$136	+\$208	+\$296	+\$398	+\$505	+\$601	+\$703	+\$114	+\$478	+\$578	
	Back cushion	No cost	No cost	+\$ 25	+\$ 45	+\$ 70	+\$107	+\$151	+\$203	+\$257	+\$307	+\$359	+\$114	+\$523	+\$642	

COM/yds: Seat = .97, Surround = 1.53, Cushion = .78, COL/sq ft: Seat = 15, Surround = 39, Cushion = 16



**For Canadian Pricing**  
 Multiply U.S. Price by the Canadian price factor.  
 ▶ See page 1 for details.

# Marien152 Seating Wood Base Lounge

DESIGN COALESSE DESIGN GROUP AND ARIK LEVY

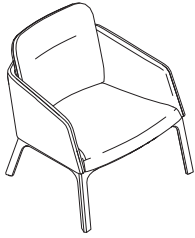

Overall: 28½"D x 29"W x 30½"H  
 Inside: 20½"D x 21"W  
 Seat: 16½"H  
 Arm: 23"H

Standard Includes		Required to Specify
<ul style="list-style-type: none"> <li>▶ Need help? Product details, page 170</li> </ul>	<ul style="list-style-type: none"> <li>• Seat, back cushion, and surround: upholstery</li> <li>• Leather strap: coal</li> <li>• Base: group 1 oak wood</li> <li>• Black hard glides</li> </ul>	<ol style="list-style-type: none"> <li>1 Style number</li> <li>2 Contrasting fabric (see below under Required Selections)</li> <li>3 Fabric or leather color number for upholstery on seat, surround, and back cushion</li> <li>4 Wood color number for base</li> <li>5 Options, if selected (see below)</li> </ol> <p>▶ See <i>Coalesse Surface Materials Reference Guide</i>.</p>

Required Selections	U.S. Price	Required to Specify
<b>Contrasting Fabric</b> <ul style="list-style-type: none"> <li>• Non contrasting fabric</li> <li>• Contrasting back cushion fabric</li> <li>• Contrasting surround fabric</li> <li>• Contrasting seat fabric</li> <li>• Contrasting all fabrics</li> </ul>	No cost +\$192 +\$192 +\$192 +\$192	Specify <i>with non contrasting</i> . Specify <i>with contrasting back cushion</i> . Specify <i>with contrasting surround</i> . Specify <i>with contrasting seat</i> . Specify <i>with contrasting all fabrics</i> .

Options	U.S. Price	Required to Specify
<b>Surface Materials</b> <ul style="list-style-type: none"> <li>• <b>Wood base</b></li> <li>• Group 1 wood</li> <li>• Group 2 wood</li> </ul>	No cost +\$ 90	Specify wood color number. Specify wood color number.
<ul style="list-style-type: none"> <li>• <b>Acrylic backer</b></li> <li>• Backer</li> </ul>	+\$ 49	Specify <i>with acrylic backer</i> .
<b>Glide Type</b> <ul style="list-style-type: none"> <li>• Hard glides</li> <li>• Soft glides</li> </ul>	No cost No cost	Specify <i>with hard glides</i> . Specify <i>with soft glides</i> .
<b>Pull</b> <ul style="list-style-type: none"> <li>• With leather pull</li> <li>• Without leather pull</li> </ul>	No cost No cost	Specify <i>with pull</i> . Specify <i>without pull</i> .
<b>Related Products</b> <ul style="list-style-type: none"> <li>• Conference seating</li> <li>• Guest seating</li> <li>• Stools</li> </ul>		▶ Page 300 ▶ Page 345 ▶ Pages 392–394

Lounge Seating

## Specification Information

Style Number		U.S. Base Prices										Leather Groups:			
		Fabric Groups:										COL			
		COM	1	2	3	4	5	6	7	8	9	10	1	2	
COMARLCWB	Seat	\$2537	\$2537	\$2568	\$2593	\$2624	\$2669	\$2725	\$2789	\$2858	\$2918	\$2982	\$2765	\$4305	\$4666
	Surround	No cost	No cost	+\$ 49	+\$ 89	+\$136	+\$208	+\$296	+\$398	+\$505	+\$601	+\$703	+\$114	+\$478	+\$578
	Back cushion	No cost	No cost	+\$ 25	+\$ 45	+\$ 70	+\$107	+\$151	+\$203	+\$257	+\$307	+\$359	+\$114	+\$523	+\$642

COM/yds: Seat = .97, Surround = 1.53, Cushion = .78, COL/sq ft: Seat = 15, Surround = 39, Cushion = 16

 **For Canadian Pricing**  
 Multiply U.S. Price by the Canadian price factor.  
 ▶ See page 1 for details.

# Marien152 Lounge Seating Multi-Fabric Diagram

DESIGN COALESSE DESIGN GROUP AND ARIK LEVY

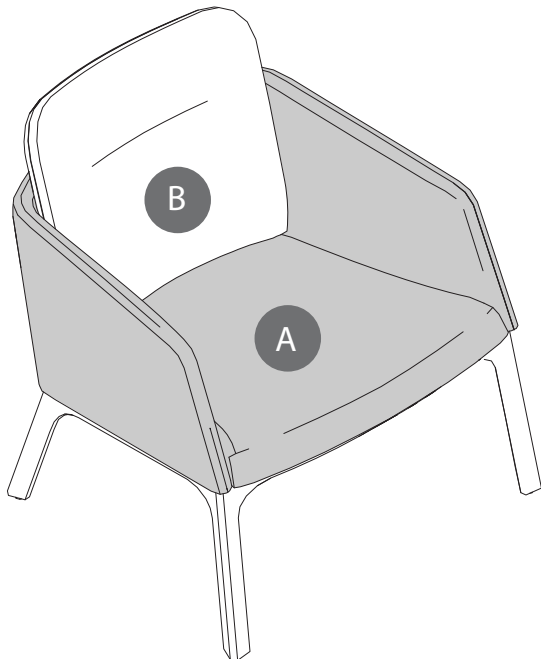
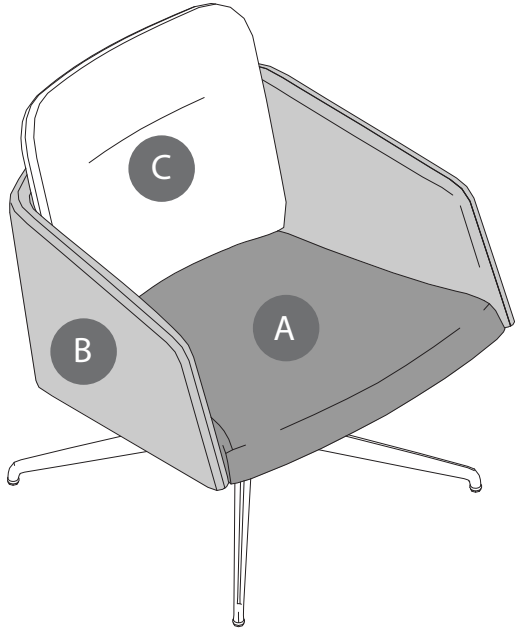

TO: \_\_\_\_\_

FROM: \_\_\_\_\_

DATE: \_\_\_\_\_

FAX...888.413.5161

## FABRIC

**A** Seat: \_\_\_\_\_

\_\_\_\_\_

**B** Surround: \_\_\_\_\_

\_\_\_\_\_

**C** Back: \_\_\_\_\_

\_\_\_\_\_

## LEATHER

**A** Seat + Surround: \_\_\_\_\_

\_\_\_\_\_

**B** Back Cushion: \_\_\_\_\_

\_\_\_\_\_

Specify Model below:

COMARLCMB Metal Base Chair

COMARLCWB Wood Base Chair

*See specifying for contrasting fabric upcharge.  
List price based on highest fabric group usage.*

Coalesse

# Marien152 Lounge Seating Multi-Fabric Diagram

DESIGN COALESSE DESIGN GROUP AND ARIK LEVY

# Massaud Lounge Seating

DESIGN JEAN-MARIE MASSAUD

Massaud lounge seating is designed for relaxed postures and connecting with technology at the office or at home. *Tip: This product line is a collection and will be found in multiple locations in this specification guide.*  
▶ See Collections, page 5.

**Inner seat back** features a duvet stitching technique accented with comfort wrinkles.

**Swivel-return base with auto-return mechanism** returns chair to front-facing alignment.

**Plastic glides** are  $\frac{11}{32}$ " thick to allow cords to pass safely underneath without causing damage to the floor.

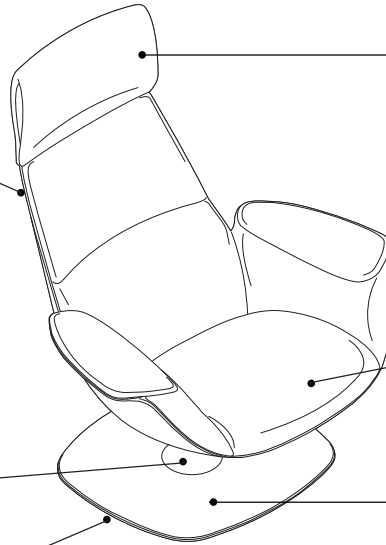

**Backrest** features an articulating headrest with removable pillow.

**Wire management** through seat cushion.

**Flat base** is  $\frac{3}{8}$ " thick and allows users to rotate 95° left or right to prevent cords from wrapping around base of a fully rotating seat.

# Massaud Lounge Seating

DESIGN JEAN-MARIE MASSAUD

## Product Details



**Lounge seating** includes the standard lounge chair and a work lounge chair with swiveling tablet.



**Tablet on work lounge** offers 180 square inches of surface area with a depth adjustment of 2<sup>3</sup>/<sub>4</sub>" to accommodate a wide range of users.

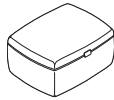

**Matching ottoman** is 20<sup>1</sup>/<sub>2</sub>"D x 26"W x 14"H, and features 10<sup>5</sup>/<sub>8</sub>" rectangular storage space. It is standard with one space divider and bottom insert in 3224 Charcoal. Lid features pull-tab opening with dampened, dual, four-bar hinge mechanism. Left and right storage pockets are standard with felt glides or integral molded feet.

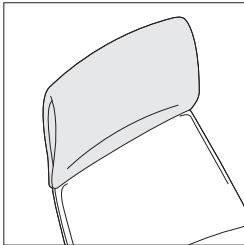

**Backrest** features an articulating headrest which contains a removable, teardrop-shaped pillow to allow for optimal user comfort. Headrest pillow resides inside an upholstered pocket, permanently attached to the backrest.

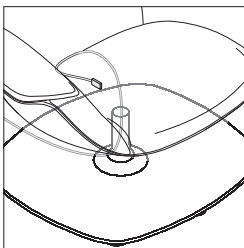

**Wire management** is concealed with seat hinges that open to reveal a passage to the floor. Base support features a hollow passageway of 3/4" diameter to allow clearance for cords.

## Surface Materials

► See *Coalesse Surface Materials Reference Guide* for further information.

**Upholstery** (contrasting fabric available)

- Fabric
- Leather

**Tablet**

- Brisa

**Base**

- Paint

## Programs and Services

**Customer's Own Material/Leather (COM/COL) Program** is available.

► See *Coalesse Surface Materials Reference Guide* for additional information.

# Massaud Lounge Seating

DESIGN JEAN-MARIE MASSAUD

*Tip: Upholstery intent is loose to provide visual and inviting comfort.*

*Tip: Headrest is articulated to adjust forward and back 2¾" to accommodate support needs. Headrest contains removeable pillow to allow reorientation and differing heights.*

*Tip: Base swivels with automatic return to center position.*

*Tip: group 3 paints are not available on Massaud ottoman pull tab.*

Standard Includes		Required to Specify
► Need help? Product details, page 176	<ul style="list-style-type: none"> <li>• Base: group 1 paint</li> <li>• Seat and inner back, and outer back: fabric or leather</li> <li>• Arm caps: fabric or leather</li> <li>• Work lounge tablet, if selected: Brisa only</li> <li>• Removable pillow: fabric or leather to match inner back</li> <li>• Ottoman, if selected: fabric or leather</li> <li>• Pull tab on ottoman, if selected: paint</li> </ul>	1 Style number 2 Paint color number for base 3 Fabric or leather color number for inner and outer back, and arm caps 4 Brisa color number for work lounge tablet 5 Fabric or leather color number for ottoman, if selected 6 Paint color number for pull tab on ottoman, if selected 7 Options, if selected (see below) ► See <i>Coalesse Surface Materials Reference Guide</i> .

Options	U.S. Price	Required to Specify
<b>Surface Materials</b>	<ul style="list-style-type: none"> <li>• Contrasting arm cap +\$192</li> <li>• Contrasting inner back +\$192</li> <li>• Contrasting outer back +\$192</li> <li>• Contrasting all target surfaces +\$384</li> </ul>	Specify with <i>contrasting arm cap</i> . Specify with <i>contrasting inner back</i> . Specify with <i>contrasting outer back</i> . Specify with <i>contrasting all</i> . ► See <i>Coalesse Surface Materials Reference Guide</i> .
<b>Base</b>	<ul style="list-style-type: none"> <li>• Group 3 paint +\$120</li> </ul>	Specify paint color number.
<b>Acrylic backer</b>	<ul style="list-style-type: none"> <li>• Lounge and work lounge +\$ 66</li> <li>• Ottoman +\$ 34</li> </ul>	Specify with <i>acrylic backer</i> . Specify with <i>acrylic backer</i> .
<b>Related Products</b>	<ul style="list-style-type: none"> <li>• Collaboration seating</li> </ul>	► Page 308

## Specification Information

Style Number	U.S. Base Prices										Leather Groups:			
	Fabric Groups:										COL	1	2	
	COM	1	2	3	4	5	6	7	8	9	10			



Overall: 33"D 36½"W 41½"H  
Seat Height: 15½"H

## Lounge Chair

COMCLG	Inner back and seat	\$5702	\$5702	\$5785	\$5854	\$5936	\$6061	\$6214	\$6389	\$6576	\$6739	\$ 6915	\$5924	\$ 6745	\$ 6948
	Outer back	No cost	No cost	+\$ 72	+\$132	+\$204	+\$310	+\$443	+\$596	+\$757	+\$899	+\$1051	+\$223	+\$1041	+\$1244

COM/yds: Inner back and seat = 2.5, Outer back = 2.6, Arm caps = .5  
COL/sq ft: Inner back and seat = 55, Outer back = 55, Arm caps = 20

► Specification Information, continued on next page



**For Canadian Pricing**  
Multiply U.S. Price by the Canadian price factor.  
► See page 1 for details.

# Massaud Lounge Seating

DESIGN JEAN-MARIE MASSAUD

► Specification Information, continued from previous page

## Specification Information

Style Number	U.S. Base Prices													Leather Groups:		
	Fabric Groups:													COL		
	COM	1	2	3	4	5	6	7	8	9	10	1	2			



Overall: 33"D 41½"W 41½"H  
 Seat Height: 15½"H  
 Top of Cushion to Bottom of Tablet: 6½"H

### Work Lounge Chair

COMCWL	Inner back and seat	\$6785	\$6785	\$6868	\$6937	\$7019	\$7143	\$7296	\$7472	\$7658	\$7822	\$ 7998	\$7006	\$ 7881	\$ 8097
	Outer back	No cost	No cost	+\$ 72	+\$132	+\$204	+\$310	+\$443	+\$596	+\$757	+\$899	+\$1051	+\$223	+\$1098	+\$1313

COM/yds: Inner back and seat = 2.5, Outer back = 2.6, Arm caps = .5  
 COL/sq ft: Inner back and seat = 55, Outer back = 55, Arm caps = 20

Tip: Pivoting tablet is fixed at a height of 17/8".



Overall: 20½"D 26"W 14"H

### Ottoman

COMCOT	\$2686	\$2686	\$2769	\$2838	\$2920	\$3045	\$3198	\$3373	\$3560	\$3723	\$ 3899	\$ 3128	\$ 3990	\$ 4244
--------	--------	--------	--------	--------	--------	--------	--------	--------	--------	--------	---------	---------	---------	---------

COM/yds = 3, COL/sq ft = 55

Tip: Ottoman is standard with one space divider and bottom insert. Divider and bottom insert are available in 3224 Charcoal only.

Tip: Ottoman is standard with Coalesse imprinted on pull and a left- and right-hand storage pocket.

Tip: Ottoman is not available in contrasting fabrics.



**For Canadian Pricing**  
 Multiply U.S. Price by the Canadian price factor.  
 ► See page 1 for details.

# Massaud Lounge Seating Multi-Fabric Diagram

DESIGN JEAN-MARIE MASSAUD

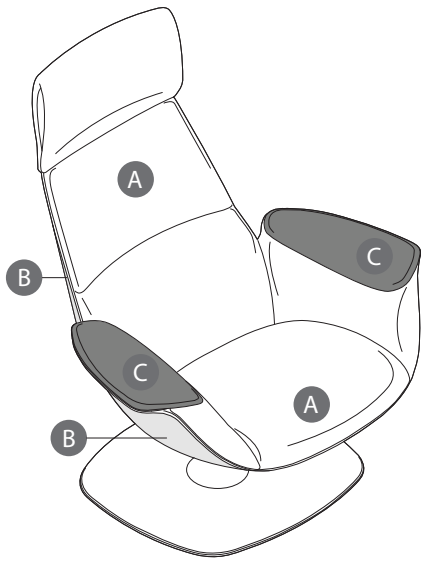

TO: \_\_\_\_\_

FROM: \_\_\_\_\_

DATE: \_\_\_\_\_

FAX...888.413.5161

**A** Inner Back and Seat: \_\_\_\_\_

\_\_\_\_\_

**B** Outer Back: \_\_\_\_\_

\_\_\_\_\_

**C** Arm Cap: \_\_\_\_\_

\_\_\_\_\_

Specify Model below:

COMCLG Lounge Chair

COMCWL Work Lounge Chair

*Tip: Ottoman is not available in contrasting fabrics.  
See specifying for contrasting fabric upcharge.  
List price based on highest fabric group usage.*

# Medici Lounge Chair

Medici lounge is a lounge chair made from solid ash wood, offered in multiple wood finish options.

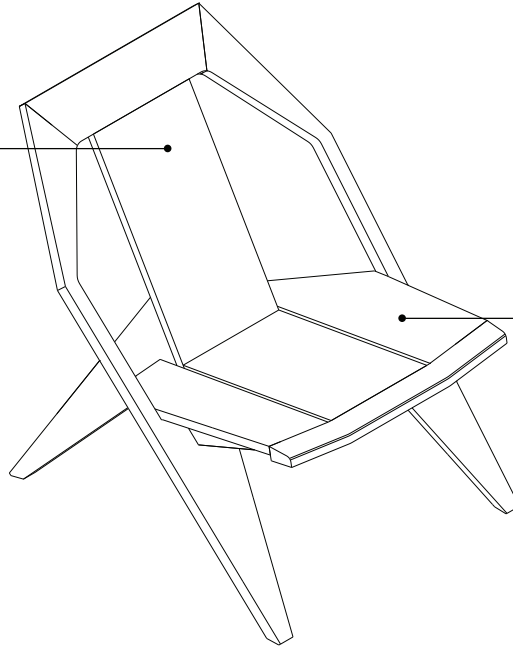

Reclined seat

Reclined seat

## Product Details

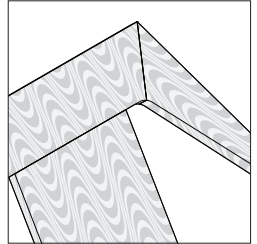

Oiled thermo-treated is available as wood option (for outdoor use).

## Surface Materials

► See *Coalesse Surface Materials Reference Guide* for further information.

- Frame**
- Wood

## Actual Dimensions

Depth	29.52"
Width	26.96"
Height	31.29"

# Medici Lounge Chair

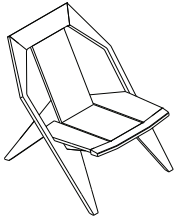

Standard Includes	Required to Specify
<ul style="list-style-type: none"> <li>▶ Need help? Product details, page 181</li> <li>• Frame: Solid ash</li> <li>• Legal wood cutting</li> </ul>	<ul style="list-style-type: none"> <li>Style number</li> <li>▶ See <i>Coalesse Surface Materials Reference Guide</i>.</li> </ul>

Specification Information						
Style Number	Dimensions			Weight	Finish	U.S. Price
	D	W	H			
IAM102	29.52"	26.96"	31.27"	35.27	Black Ash	\$2730
IAM103	29.52"	26.96"	31.27"	35.27	Grey Ash	\$2730
IAM104	29.52"	26.96"	31.27"	35.27	Natural Ash	\$2730
IAM105	29.52"	26.96"	31.27"	35.27	Red Ash	\$2730
IAM106	29.52"	26.96"	31.27"	35.27	Thermo Oiled Ash	\$3064
IAM107	29.52"	26.96"	31.27"	35.27	Yellow Ash	\$2730



**For Canadian Pricing**  
 Multiply U.S. Price by the Canadian price factor.  
 ▶ See page 1 for details.

Coalesse

# Medici Lounge Chair

# Millbrae Lifestyle Lounge Seating

DESIGN COALESSE DESIGN GROUP

**Millbrae Lifestyle lounge seating** is designed for relaxed postures in a social office setting, creating a social feel in the workplace.

*Tip: This product line is a collection and will be found in multiple locations in this specification guide and/or Coalesse Tables, Storage, and Accessories Specification Guide.*

► See *Collections*, page 5.

Lounge seating is available in 1-, 2-, or 3-seat lounge with two enclosed arms.

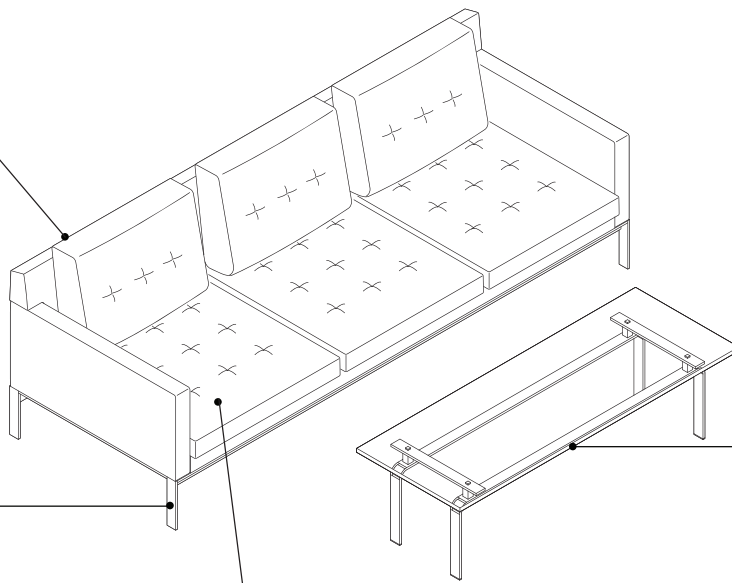

Four leg base is steel with durable plastic glides.

Seat cushions are attached. Back cushions are loose with attachment straps.

Occasional tables are available in three styles: square tables, rectangle tables, and side tables. All are standard with a 3/4" glass top and four-leg steel base.  
► See *Coalesse Tables, Storage, and Accessories Specification Guide*.

# Millbrae Lifestyle Lounge Seating

DESIGN COALESSE DESIGN GROUP

## Product Details

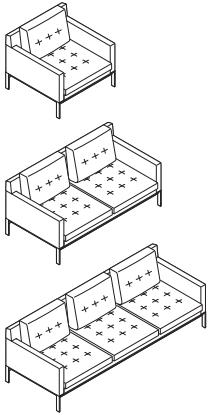

Lounge seating is available in 1-, 2-, and 3-seat lounge with tufted pattern accents and separate back pillows. Attachment straps are an available option. All styles have four steel legs, 1/2" x 1 3/4" with fixed plastic glides.

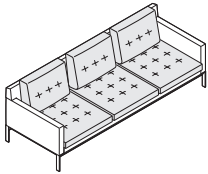

**Upholstery detail** features tufted pattern accents with double needle top stitch and is available in a wide range of fabrics and leathers.



**Arm bolsters** are available round or square in coordinating upholstery, and are 18 1/2"D x 7"W x 7"H.

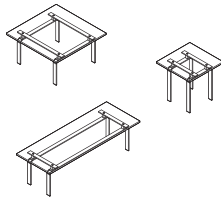

**Occasional tables** are available in three styles: square, rectangle, and side tables. Square tables are available in three sizes: 30"D x 30"W x 15"H, 36"D x 36"W x 15"H, or 48"D x 48"W x 15"H. Rectangle tables are available in two sizes: 20"D x 54"W x 15"H or 30"D x 60"W x 15"H. Side tables are 20"D x 20"W x 20"H. ▶ See *Coalesse Tables, Storage, and Accessories Specification Guide*.

## Surface Materials

▶ See *Coalesse Surface Materials Reference Guide* for further information.

### Upholstery

- Fabric
- Leather

### Base

- Paint
- 4862 Stainless Steel (option)

### Table tops

- Glass

## Programs & Services

**Customer's Own Material/Leather (COM/COL) Program** is available.

▶ See *Coalesse Surface Materials Reference Guide* for additional information.

# Millbrae Contract Lounge Seating

DESIGN COALESSE DESIGN GROUP

**Millbrae Contract lounge seating** enhances the social feel of today's progressive workplaces and is inspired by mid-century designs.

*Tip: This product line is a collection and will be found in multiple locations in this specification guide and/or Coalesse Tables, Storage, and Accessories Specification Guide.*

▶ See *Collections*, page 5.

**Lounge chairs** are available in arm, armless, or single-arm styles with fixed glides.

**Benches** are available in 1-, 2-, 3-, or 4-seat models with fixed glides.

**Ganging kit** is available for Contract lounges and benches to be ganged.

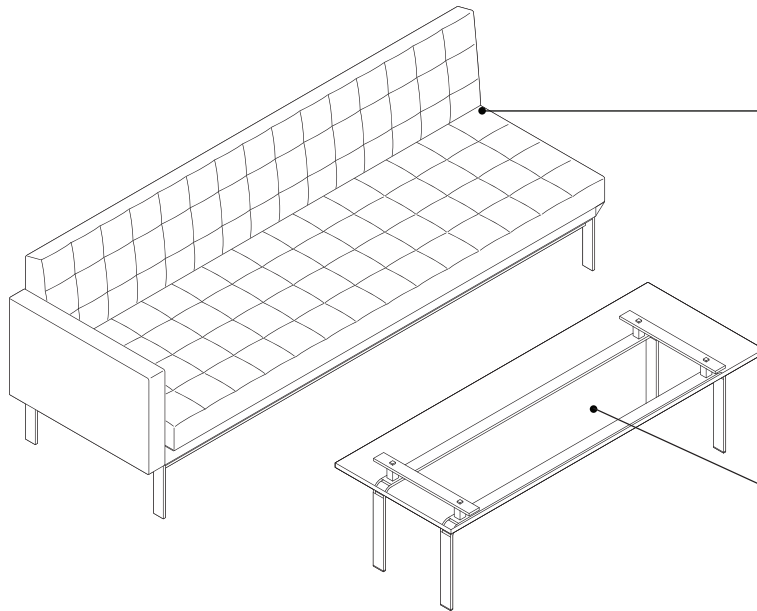

**Lounges** are available in 1-, 2-, 3-, or 4-seat options. All lounges offer arm, armless, and single-arm options with fixed glides.

**Occasional tables** are available in three styles: square tables, rectangle tables, and side tables. All are standard with  $\frac{3}{4}$ " glass top and four-leg steel base.

▶ See *Coalesse Tables, Storage, and Accessories Specification Guide*.

# Millbrae Contract Lounge Seating

DESIGN COALESSE DESIGN GROUP

## Product Details

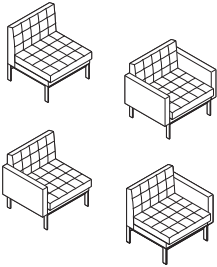

**Lounge chairs** are available with arms, armless, or a single-arm. Armless chairs are 30"D x 26"W x 31"H. Each arm adds 3" to the width. Steel legs are 1/2" x 1 3/4" with fixed glides.

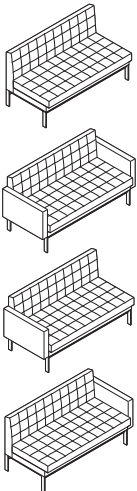

**2-seat lounges** are available with arms, armless, or a single-arm. Armless lounges are 30"D x 52"W x 31"H. Each arm adds 6" to the width. Steel legs are 1/2" x 1 3/4" with fixed glides.

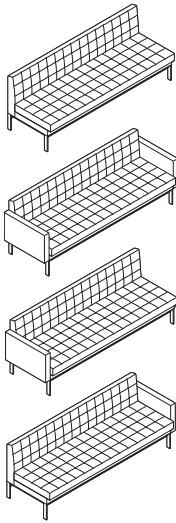

**3-seat lounges** are available with arms, armless, or a single-arm. Armless lounges are 30"D x 78"W x 31"H. Each arm adds 6" to the width. Steel legs are 1/2" x 1 3/4" with fixed glides.

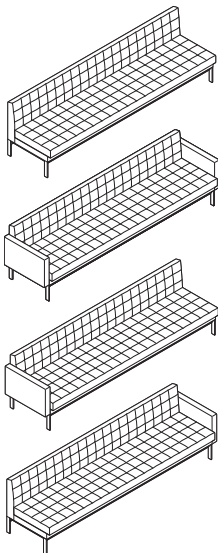

**4-seat lounges** are available with arms, armless, or a single-arm; armless lounges are 30"D x 104"W x 31"H, each arm adds 3" to the width. Steel legs are 1/2" x 1 3/4" with fixed glides.

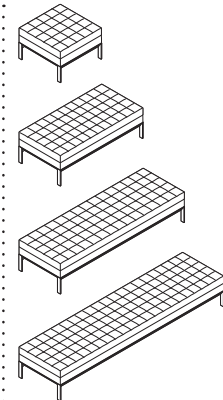

**Benches** are available in 1-, 2-, 3-, or 4-seat. All are 16 1/2"H with four steel legs (1/2" x 1 3/4") with fixed glides. Front and side ganging brackets available.

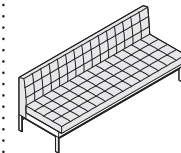

**Upholstery** features a quilted pattern accent with a double needle top-stitch and is available in a wide range of fabrics and leathers.



**Arm bolsters** are available round or square in coordinating upholstery, and are 18 1/2"D x 7"W x 7"H.



**Ganging kit for Contract lounges and benches** is available for front and side ganging using 3/16" thick steel plates.

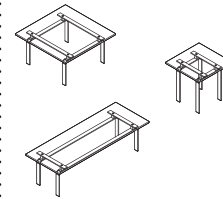

**Occasional tables** are available in three styles: square, rectangle, and side tables. Square tables are available in three sizes: 30"D x 30"W x 15"H, 36"D x 36"W x 15"H, or 48"D x 48"W x 15"H. Rectangle tables are available in two sizes: 20"D x 54"W x 15"H or 30"D x 60"W x 15"H. Side tables are 20"D x 20"W x 20"H. ▶ See *Coalesse Tables, Storage, and Accessories Specification Guide*.

## Surface Materials

▶ See *Coalesse Surface Materials Reference Guide* for further information.

## Upholstery

- Fabric
- Leather

## Base

- Paint
- 4862 Stainless Steel (option)

## Table tops

- Glass

## Programs and Services

### Customer's Own Material/Leather (COM/COL) Program is available.

▶ See *Coalesse Surface Materials Reference Guide* for additional information.



# Millbrae Lifestyle/Contract Lounge Seating

DESIGN COALESSE DESIGN GROUP

## Specification Information

Style Number	U.S. Base Prices										Leather Groups:		
	Fabric Groups:										COL		
	COM	1	2	3	4	5	6	7	8	9	10	1	2



Overall: 35"D 35"W 28¾"H  
 Overall inside: 29"D 29"W 17"H  
 Inside to pillow: 22"D 29"W 17"H

## Lifestyle Lounge Seating

### Lounge Chair

COMSL1	\$4102	\$4102	\$4268	\$4407	\$4569	\$4817	\$5123	\$ 5472	\$ 5845	\$ 6173	\$ 6521	\$4544	\$ 6941	\$ 7272
--------	--------	--------	--------	--------	--------	--------	--------	---------	---------	---------	---------	--------	---------	---------

COM/yds = 5¼, COL/sq ft = 115

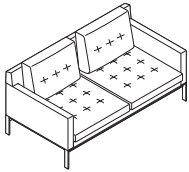

Overall: 35"D 64"W 28¾"H  
 Overall inside: 29"D 58"W 17"H  
 Inside to pillow: 22"D 58"W 17"H

### 2-Seat Lounge

COMSL2	\$6219	\$6219	\$6479	\$6697	\$6953	\$7343	\$7824	\$ 8371	\$ 8957	\$ 9473	\$10,020	\$6661	\$10,693	\$11,215
--------	--------	--------	--------	--------	--------	--------	--------	---------	---------	---------	----------	--------	----------	----------

COM/yds = 8¼, COL/sq ft = 181

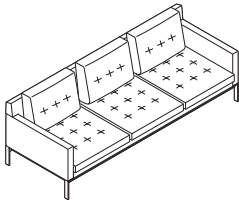

Overall: 35"D 92½"W 28¾"H  
 Overall inside: 29"D 87"W 17"H  
 Inside to pillow: 22"D 87"W 17"H

### 3-Seat Lounge

COMSL3	\$7784	\$7784	\$8115	\$8393	\$8719	\$9215	\$9826	\$10,524	\$11,269	\$11,926	\$12,622	\$8226	\$13,495	\$14,159
--------	--------	--------	--------	--------	--------	--------	--------	----------	----------	----------	----------	--------	----------	----------

COM/yds = 10½, COL/sq ft = 231

► Specification Information, continued on next page



**For Canadian Pricing**  
 Multiply U.S. Price by the  
 Canadian price factor.  
 ► See page 1 for details.

# Millbrae Lifestyle/Contract Lounge Seating *continued*

DESIGN COALESSE DESIGN GROUP

► Specification Information, continued from previous page

## Specification Information

Style Number	U.S. Base Prices										Leather Groups:		
	Fabric Groups:										COL		
	COM	1	2	3	4	5	6	7	8	9	10	1	2

### Contract Lounge Chairs

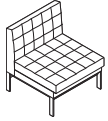

Overall: 30"D 26"W 31"H  
Inside seat height: 22"D 17"H

#### Without Arms

COMFL1	\$3412	\$3412	\$3499	\$3571	\$3657	\$3787	\$3947	\$4129	\$4325	\$4497	\$4679	\$3854	\$4761	\$4917
--------	--------	--------	--------	--------	--------	--------	--------	--------	--------	--------	--------	--------	--------	--------

COM/yds = 2¾, COL/sq ft = 60

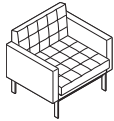

Overall: 30"D 32"W 31"H  
Inside: 22"D 26½"W 17"H

#### With Arms

COMFLA1	\$3889	\$3889	\$4016	\$4121	\$4246	\$4434	\$4668	\$4933	\$5217	\$5467	\$5732	\$4331	\$6065	\$6320
---------	--------	--------	--------	--------	--------	--------	--------	--------	--------	--------	--------	--------	--------	--------

COM/yds = 4, COL/sq ft = 88



Overall: 30"D 29"W 31"H  
Inside: 22"D 26½"W 17"H

#### With Left Arm Facing

COMFLLA1	\$3643	\$3643	\$3745	\$3832	\$3933	\$4086	\$4276	\$4491	\$4722	\$4925	\$5141	\$4085	\$5426	\$5632
----------	--------	--------	--------	--------	--------	--------	--------	--------	--------	--------	--------	--------	--------	--------

COM/yds = 3¼, COL/sq ft = 72

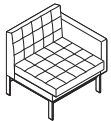

Overall: 30"D 29"W 31"H  
Inside: 22"D 26½"W 17"H

#### With Right Arm Facing

COMFLRA1	\$3643	\$3643	\$3745	\$3832	\$3933	\$4086	\$4276	\$4491	\$4722	\$4925	\$5141	\$4085	\$5426	\$5632
----------	--------	--------	--------	--------	--------	--------	--------	--------	--------	--------	--------	--------	--------	--------

COM/yds = 3¼, COL/sq ft = 72

► Specification Information, continued on next page



#### For Canadian Pricing

Multiply U.S. Price by the Canadian price factor.

► See page 1 for details.

# Millbrae Lifestyle/Contract Lounge Seating

DESIGN COALESSE DESIGN GROUP

► Specification Information, continued from previous page

## Specification Information

Style Number	U.S. Base Prices										Leather Groups:		
	Fabric Groups:										COL	1	2
	COM	1	2	3	4	5	6	7	8	9	10		

### Contract 2-Seat Lounges

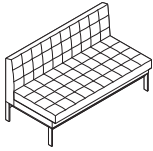

Overall: 30"D 52"W 31"H  
Inside seat height: 22"D 17"H

#### Without Arms

COMFL2	\$5449	\$5449	\$5592	\$5711	\$5850	\$6062	\$6325	\$6623	\$6943	\$7225	\$7523	\$5891	\$7597	\$7851
--------	--------	--------	--------	--------	--------	--------	--------	--------	--------	--------	--------	--------	--------	--------

COM/yds = 4½, COL/sq ft = 99

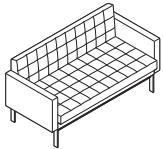

Overall: 30"D 58"W 31"H  
Inside: 22"D 52½"W 17"H

#### With Arms

COMFLA2	\$5920	\$5920	\$6101	\$6253	\$6433	\$6704	\$7039	\$7420	\$7828	\$8188	\$8570	\$6362	\$8902	\$9251
---------	--------	--------	--------	--------	--------	--------	--------	--------	--------	--------	--------	--------	--------	--------

COM/yds = 5¾, COL/sq ft = 126

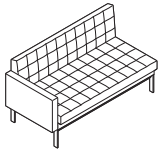

Overall: 30"D 55"W 31"H  
Inside: 22"D 52¾"W 17"H

#### With Left Arm Facing

COMFLLA2	\$5675	\$5675	\$5833	\$5965	\$6120	\$6357	\$6648	\$6980	\$7335	\$7648	\$7979	\$6117	\$8235	\$8533
----------	--------	--------	--------	--------	--------	--------	--------	--------	--------	--------	--------	--------	--------	--------

COM/yds = 5, COL/sq ft = 110

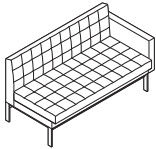

Overall: 30"D 55"W 31"H  
Inside: 22"D 52¾"W 17"H

#### With Right Arm Facing

COMFLRA2	\$5675	\$5675	\$5833	\$5965	\$6120	\$6357	\$6648	\$6980	\$7335	\$7648	\$7979	\$6117	\$8235	\$8533
----------	--------	--------	--------	--------	--------	--------	--------	--------	--------	--------	--------	--------	--------	--------

COM/yds = 5, COL/sq ft = 110

► Specification Information, continued on next page



**For Canadian Pricing**  
Multiply U.S. Price by the  
Canadian price factor.  
► See page 1 for details.

# Millbrae Lifestyle/Contract Lounge Seating *continued*

DESIGN COALESSE DESIGN GROUP

► Specification Information, continued from previous page

## Specification Information

Style Number	U.S. Base Prices										Leather Groups:		
	Fabric Groups:										COL		
	COM	1	2	3	4	5	6	7	8	9	10	1	2

### Contract 3-Seat Lounges

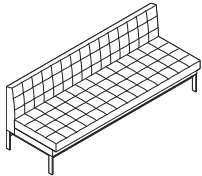

Overall: 30"D 78"W 31"H  
Inside seat height: 22"D 17"H

#### Without Arms

COMFL3	\$6848	\$6848	\$7037	\$7196	\$7383	\$7666	\$8016	\$8414	\$8840	\$ 9214	\$ 9613	\$7290	\$ 9816	\$10,164
--------	--------	--------	--------	--------	--------	--------	--------	--------	--------	---------	---------	--------	---------	----------

COM/yds = 6, COL/sq ft = 132

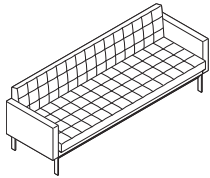

Overall: 30"D 84"W 31"H  
Inside: 22"D 78½"W 17"H

#### With Arms

COMFLA3	\$7342	\$7342	\$7578	\$7777	\$8010	\$8364	\$8801	\$9299	\$9832	\$10,300	\$10,798	\$7784	\$11,126	\$11,569
---------	--------	--------	--------	--------	--------	--------	--------	--------	--------	----------	----------	--------	----------	----------

COM/yds = 7½, COL/sq ft = 159

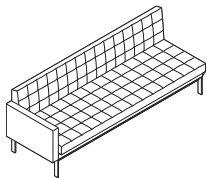

Overall: 30"D 81"W 31"H  
Inside: 22"D 78¾"W 17"H

#### With Left Arm Facing

COMFLLA3	\$7096	\$7096	\$7309	\$7487	\$7697	\$8016	\$8409	\$8858	\$9337	\$9759	\$10,206	\$7538	\$10,485	\$10,880
----------	--------	--------	--------	--------	--------	--------	--------	--------	--------	--------	----------	--------	----------	----------

COM/yds = 6¾, COL/sq ft = 148

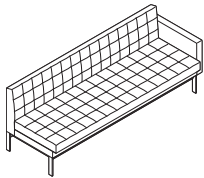

Overall: 30"D 81"W 31"H  
Inside: 22"D 78¾"W 17"H

#### With Right Arm Facing

COMFLRA3	\$7096	\$7096	\$7309	\$7487	\$7697	\$8016	\$8409	\$8858	\$9337	\$9759	\$10,206	\$7538	\$10,485	\$10,880
----------	--------	--------	--------	--------	--------	--------	--------	--------	--------	--------	----------	--------	----------	----------

COM/yds = 6¾, COL/sq ft = 148

► Specification Information, continued on next page

# Millbrae Lifestyle/Contract Lounge Seating

DESIGN COALESSE DESIGN GROUP

► Specification Information, continued from previous page

## Specification Information

Style Number	U.S. Base Prices										Leather Groups:	
	Fabric Groups:										COL	
COM	1	2	3	4	5	6	7	8	9	10	1	2

### Contract 4-Seat Lounges

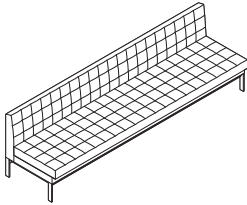

Overall: 30"D 104"W 31"H  
Inside seat height: 22"D 17"H

#### Without Arms

COMFL4	\$7357	\$7357	\$7602	\$7806	\$8047	\$8413	\$8865	\$ 9379	\$ 9929	\$10,414	\$10,928	\$7799	\$11,127	\$11,570
--------	--------	--------	--------	--------	--------	--------	--------	---------	---------	----------	----------	--------	----------	----------

COM/yds = 7¾, COL/sq ft = 170

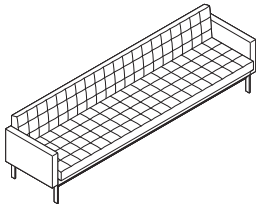

Overall: 30"D 110"W 31"H  
Inside: 22"D 104½"W 17"H

#### With Arms

COMFLA4	\$7819	\$7819	\$8094	\$8326	\$8599	\$9011	\$9522	\$10,102	\$10,723	\$11,270	\$11,851	\$8261	\$12,435	\$12,968
---------	--------	--------	--------	--------	--------	--------	--------	----------	----------	----------	----------	--------	----------	----------

COM/yds = 8¾, COL/sq ft = 192

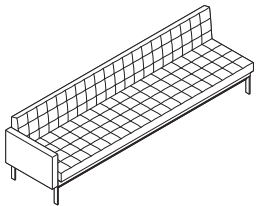

Overall: 30"D 107"W 31"H  
Inside: 22"D 104¾"W 17"H

#### With Left Arm Facing

COMFLLA4	\$7589	\$7589	\$7849	\$8067	\$8323	\$8713	\$9193	\$ 9741	\$10,327	\$10,843	\$11,390	\$8031	\$11,764	\$12,253
----------	--------	--------	--------	--------	--------	--------	--------	---------	----------	----------	----------	--------	----------	----------

COM/yds = 8¼, COL/sq ft = 181

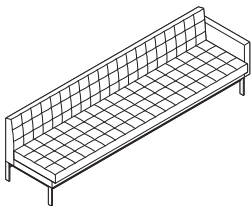

Overall: 30"D 107"W 31"H  
Inside: 22"D 104¾"W 17"H

#### With Right Arm Facing

COMFLRA4	\$7589	\$7589	\$7849	\$8067	\$8323	\$8713	\$9193	\$ 9741	\$10,327	\$10,843	\$11,390	\$8031	\$11,764	\$12,253
----------	--------	--------	--------	--------	--------	--------	--------	---------	----------	----------	----------	--------	----------	----------

COM/yds = 8¼, COL/sq ft = 181

► Specification Information, continued on next page

# Millbrae Lifestyle/Contract Lounge Seating *continued*

DESIGN COALESSE DESIGN GROUP

► Specification Information, continued from previous page

## Specification Information

Style Number	U.S. Base Prices										Leather Groups:		
	Fabric Groups:										COL		
	COM	1	2	3	4	5	6	7	8	9	10	1	2

## Contract Lounge Benches

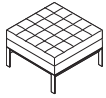

Overall: 26"D 26"W 16½"H

### 1-Seat Bench

COMFLB1	\$2747	\$2747	\$2803	\$2849	\$2903	\$2985	\$3088	\$3204	\$3328	\$3438	\$3554	\$3189	\$3712	\$3823
---------	--------	--------	--------	--------	--------	--------	--------	--------	--------	--------	--------	--------	--------	--------

COM/yds = 1¾, COL/sq ft = 39

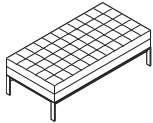

Overall: 26"D 52"W 16½"H

### 2-Seat Bench

COMFLB2	\$3818	\$3818	\$3905	\$3977	\$4063	\$4193	\$4353	\$4535	\$4731	\$4903	\$5073	\$4260	\$5167	\$5323
---------	--------	--------	--------	--------	--------	--------	--------	--------	--------	--------	--------	--------	--------	--------

COM/yds = 2¾, COL/sq ft = 60

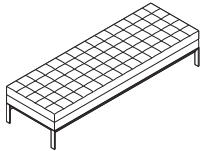

Overall: 26"D 78"W 16½"H

### 3-Seat Bench

COMFLB3	\$4457	\$4457	\$4559	\$4646	\$4747	\$4900	\$5090	\$5305	\$5536	\$5739	\$5955	\$4899	\$6240	\$6446
---------	--------	--------	--------	--------	--------	--------	--------	--------	--------	--------	--------	--------	--------	--------

COM/yds = 3¾, COL/sq ft = 72

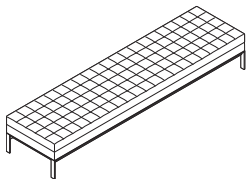

Overall: 26"D 104"W 16½"H

### 4-Seat Bench

COMFLB4	\$4935	\$4935	\$5077	\$5197	\$5336	\$5548	\$5811	\$6109	\$6429	\$6711	\$7009	\$5377	\$7083	\$7337
---------	--------	--------	--------	--------	--------	--------	--------	--------	--------	--------	--------	--------	--------	--------

COM/yds = 4½, COL/sq ft = 93

► Specification Information, continued on next page



### For Canadian Pricing

Multiply U.S. Price by the Canadian price factor.

► See page 1 for details.

# Millbrae Lifestyle/Contract Lounge Seating

DESIGN COALESSE DESIGN GROUP

► Specification Information, continued from previous page

## Specification Information

Style Number	U.S. Base Prices										Leather Groups:		
	Fabric Groups:										COL		
	COM	1	2	3	4	5	6	7	8	9	10	1	2

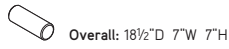

### Contract Lounge Round Arm Bolster

COMLPRND	\$473	\$473	\$497	\$517	\$541	\$575	\$620	\$669	\$722	\$769	\$819	\$915	\$ 893	\$ 942
----------	-------	-------	-------	-------	-------	-------	-------	-------	-------	-------	-------	-------	--------	--------

COM/yds = ¾, COL/sq ft = 17



### Contract Lounge Square Arm Bolster

COMLPSQR	\$473	\$473	\$505	\$531	\$563	\$610	\$668	\$735	\$805	\$868	\$934	\$915	\$1016	\$1080
----------	-------	-------	-------	-------	-------	-------	-------	-------	-------	-------	-------	-------	--------	--------

COM/yds = 1, COL/sq ft = 22

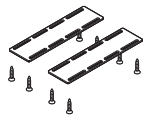

### Contract Lounge Ganging Kit

COMF1	\$111	N.A.	N.A.	N.A.	N.A.	N.A.	N.A.	N.A.	N.A.	N.A.	N.A.	N.A.	N.A.	N.A.
-------	-------	------	------	------	------	------	------	------	------	------	------	------	------	------

 **For Canadian Pricing**  
 Multiply U.S. Price by the  
 Canadian price factor.  
 ► See page 1 for details.

# Millbrae Lifestyle/Contract Lounge Seating

DESIGN COALESSE DESIGN

## Multi-Fabric Diagram

### Lifestyle

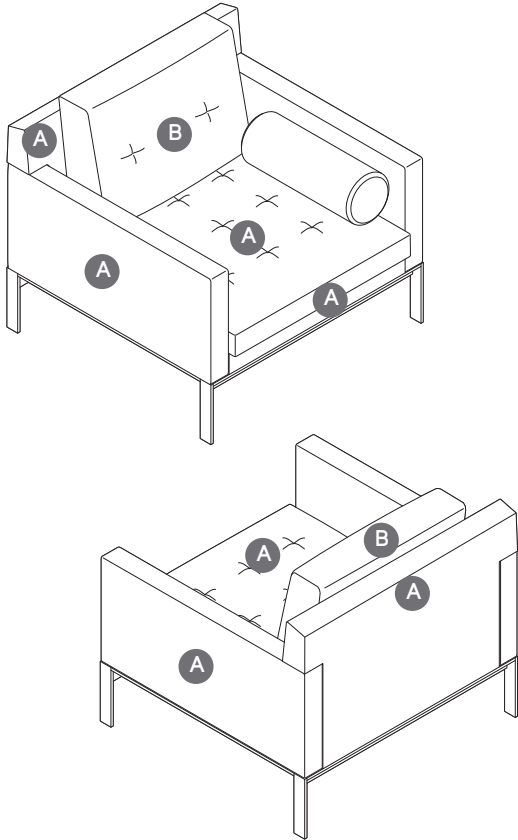

TO: \_\_\_\_\_

FROM: \_\_\_\_\_

DATE: \_\_\_\_\_

FAX....888.413.5161

**A** Seat, Back, and Arms: \_\_\_\_\_  
 \_\_\_\_\_  
 \_\_\_\_\_

**B** Back Cushion: \_\_\_\_\_  
 \_\_\_\_\_  
 \_\_\_\_\_

*Tip: Arm bolsters must be specified separately.*

*Tip: Attachment straps are standard on back pillow of lifestyle chairs.*

*Contrasting upcharge for each contrasting textile pricing based on highest group textile specified. See specifying for contrasting upcharge.*

# Millbrae Lifestyle/Contract Lounge Seating

DESIGN COALESSE DESIGN

## Multi-Fabric Diagram

### Contract

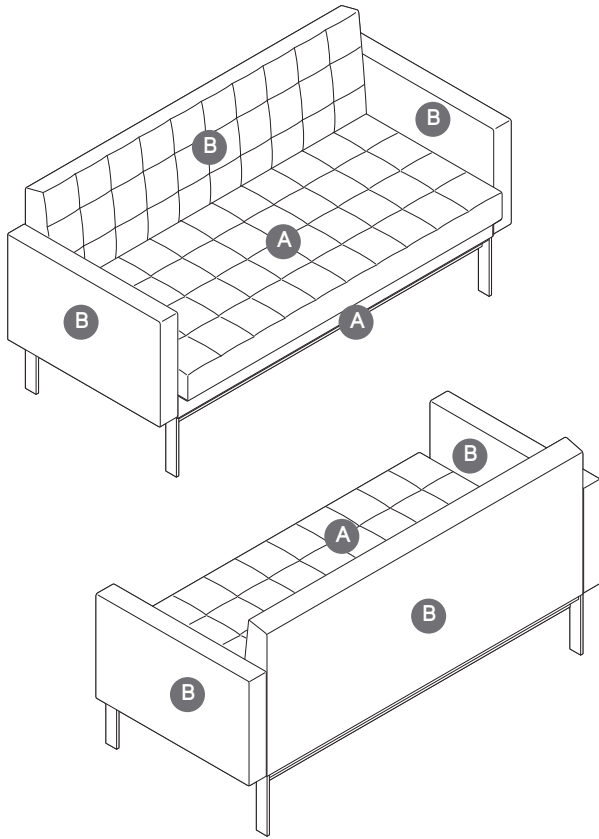

TO: \_\_\_\_\_

FROM: \_\_\_\_\_

DATE: \_\_\_\_\_

FAX...888.413.5161

**A** Seat: \_\_\_\_\_  
\_\_\_\_\_  
\_\_\_\_\_

**B** Back and Arms: \_\_\_\_\_  
\_\_\_\_\_  
\_\_\_\_\_

*Tip: Arm bolsters must be specified separately.*

*Contrasting upcharge for each contrasting textile pricing based on highest group textile specified. See specifying for contrasting upcharge.*

Lounge Seating

# Montara650 Lounge Chair

DESIGN LIEVORE ALTHERR MOLINA

Montara650 lounge chair is infused with comfort and craft, with its refined upholstery and customizable details. This simple lounge solution brings warmth, materiality, and posture to in-between spaces.

*Tip: This product line is a collection and will be found in multiple locations in this specification guide and/or Coalesse Tables, Storage, and Accessories Specification Guide.*

► See *Collections*, page 5.

**Shell** is a durable, one-piece plywood with oak veneer and is offered fully upholstered, <sup>3</sup>/<sub>4</sub> upholstered back, or upholstered seat.

**Frame** is standard in powder coat paint. Polished trivalent chrome is optional.

**Glides** are polyethylene for superior durability on carpeted and hard floors.

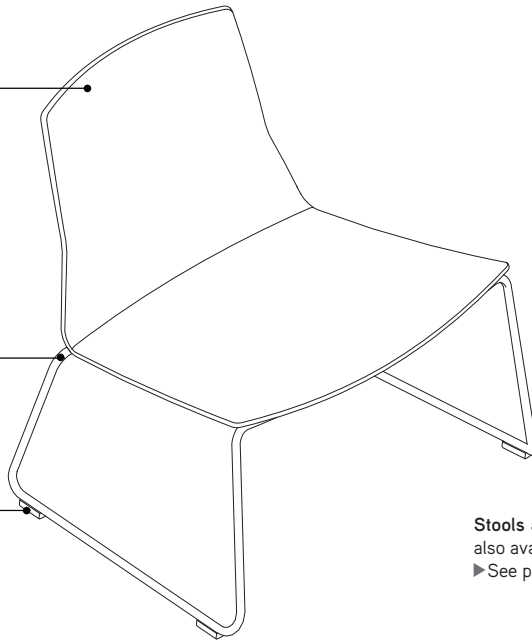

Stools and guest chairs are also available.  
► See page 350 and 402

## Product Details

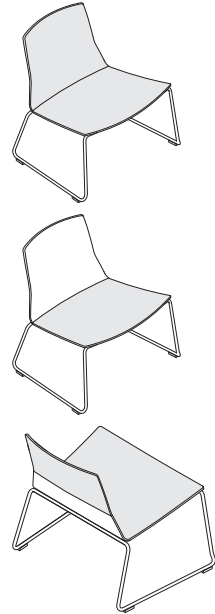

**Upholstery choices** include: fully upholstered, wood shell with upholstered seat, and wood shell with <sup>3</sup>/<sub>4</sub> upholstered back.

## Surface Materials

► See *Coalesse Surface Materials Reference Guide* for further information.

**Wood shell**

- Oak veneered plywood

**Frame**

- Paint
- Polished trivalent chrome

**Upholstery**

- Fabric
- Leather

## Program and Services

**Customer's Own Material/Leather (COM/COL) Program** is available.

► See *Coalesse Surface Materials Reference Guide* for additional information.

Coalesse

# Montara650 Lounge Chair

DESIGN LIEVORE ALTHERR MOLINA

# Montara650 Lounge Chair

DESIGN LIEVORE ALTHERR MOLINA



*Tip: Leathers will appear loose with comfort wrinkles when upholstered.*

*Tip: For Customer's Own Material or Leather, see necessary requirements, important processing instructions, and ordering information.*  
 ▶ See *Coalesse Surface Materials Reference Guide* and online fabric database at <http://fabric.coalesse.com>.

Standard Includes		Required to Specify
▶ Need help? Product details, page 198	<ul style="list-style-type: none"> <li>• Seat and back upholstery, if selected</li> <li>• Shell: wood shell with <sup>3</sup>/<sub>4</sub> upholstery or wood shell with upholstered seat, if selected: wood veneer group 1</li> <li>• Sled base: group 1 paint</li> <li>• Glides</li> </ul>	<ol style="list-style-type: none"> <li>1 Style number</li> <li>2 Upholstery version (see below under Required Selections)</li> <li>3 Contrasting fabric on <sup>3</sup>/<sub>4</sub> upholstered or fully upholstered, if selected (see below under Required Selections)</li> <li>4 Fabric and/or leather color number for seat and/or back, if selected</li> <li>5 Wood finish on shell, if selected</li> <li>6 Paint color number for base</li> <li>7 Options, if selected (see below)</li> </ol> ▶ See <i>Coalesse Surface Materials Reference Guide</i> .

Required Selections	U.S. Price	Required to Specify
<b>Upholstery Version</b> <ul style="list-style-type: none"> <li>• Wood shell with <sup>3</sup>/<sub>4</sub> upholstery</li> <li>• Wood shell with upholstered seat</li> <li>• Fully upholstered</li> </ul>	Prices at right Prices at right Prices at right	Specify with <sup>3</sup> / <sub>4</sub> upholstered. Specify with upholstered seat and wood back. Specify with upholstered seat and back.
<b>Contrasting Fabric on Fully Upholstered</b> <ul style="list-style-type: none"> <li>• Non contrasting fabric</li> <li>• Contrasting fabric</li> </ul>	No cost +\$192	Specify with non contrasting fabric. Specify with contrasting fabric. ▶ See <i>Multi Fabric Diagram</i> , page 206

Options	U.S. Price	Required to Specify
<b>Surface Materials</b> <p><b>Base</b></p> <ul style="list-style-type: none"> <li>• Group 3 paint</li> <li>• Polished trivalent chrome</li> </ul> <p><b>Shell</b></p> <ul style="list-style-type: none"> <li>• Group 1 wood veneer</li> <li>• Group 2 wood veneer</li> </ul> <p><b>Acrylic backer</b></p> <ul style="list-style-type: none"> <li>• Seat</li> <li>• Seat and back</li> </ul>	+\$114 +\$118 No cost +\$102 +\$ 9 +\$ 25	Specify paint color number. Specify with polished trivalent chrome. Specify with VP01 Oak Light, VP03 Black Oak, or VP05 White Oak. Specify with VP02 Smoked Oak or VP04 Grey Oak. Specify with acrylic backer. Specify with acrylic backer.
<b>Related Products</b> <ul style="list-style-type: none"> <li>• Guest seating</li> <li>• Stools</li> <li>• Café tables</li> <li>• Occasional tables</li> </ul>		▶ Page 350 ▶ Page 402 ▶ See <i>Coalesse Tables, Storage, and Accessories Specification Guide</i> . ▶ See <i>Coalesse Tables, Storage, and Accessories Specification Guide</i> .

Specification Information													
Style Number	U.S. Base Prices										Leather Groups:		
	COM	1	2	3	4	5	6	7	8	9	10	COL	1

Overall: 25½"D x 29"W x 21¼"H  
 Seat: 16"

## Wood Shell Lounge Chair with Upholstered Seat

COSFZLC	Seat	\$1447	\$1447	\$1451	\$1478	\$1511	\$1560	\$1622	\$1691	\$1765	\$1832	\$1901	\$1804	\$1649	\$1709
COM/yds = 1, COL/sq ft = 9															

▶ Specification Information, continued on next page

 **For Canadian Pricing**  
 Multiply U.S. Price by the Canadian price factor.  
 ▶ See page 1 for details.

# Montara650 Lounge Chair

DESIGN LIEVORE ALTHERR MOLINA

► Specification Information, continued from previous page

## Specification Information

Style Number	U.S. Base Prices													
	Fabric Groups:										Leather Groups:			
	COM	1	2	3	4	5	6	7	8	9	10	COL	1	2



Overall: 25½"D x 29"W x 21¼"H  
Seat: 16"

### Wood Shell Lounge Chair with ¾ Upholstered Back

COSFZLC	Seat	\$1600	\$1600	\$1604	\$1631	\$1664	\$1713	\$1775	\$1844	\$1918	\$1985	\$2054	\$1957	\$1802	\$1862
	Back	+\$ 17	+\$ 17	+\$ 30	+\$ 54	+\$ 82	+\$126	+\$179	+\$241	+\$306	+\$363	+\$424	+\$123	+\$534	+\$652

COM/yds = 1, COL/sq ft = 17

Overall: 25½"D x 29"W x 21¼"H  
Seat: 16"

### Fully Upholstered Lounge Chair

COSFZLC	Seat	\$1486	\$1486	\$1490	\$1517	\$1550	\$1599	\$1661	\$1730	\$1804	\$1871	\$1940	\$1843	\$1688	\$1748
	Back	+\$ 32	+\$ 32	+\$ 60	+\$110	+\$169	+\$258	+\$369	+\$496	+\$630	+\$749	+\$876	+\$123	+\$637	+\$786

COM/yds = 2½, COL/sq ft = 32

Lounge Seating



**For Canadian Pricing**  
Multiply U.S. Price by the  
Canadian price factor.  
► See page 1 for details.

# Montara650 Rocker

DESIGN LIEVORE ALTHERR MOLINA

**Montara650 rocker** is classically casual and is infused with comfort and craft. The rhythmic motion invites movement, supporting physical and emotion wellbeing at work.

*Tip: This product line is a collection and will be found in multiple locations in this specification guide and/or Coalesse Tables, Storage, and Accessories Specification Guide.*

► See Collections, page 5.

**Shell** is a durable, one-piece plywood with oak-veneer and is offered fully upholstered, <sup>3</sup>/<sub>4</sub> upholstered back, or upholstered seat.

**Frame** is standard in powder coat paint. Polished trivalent chrome is optional.

**Runners** are solid oak with clear finish.

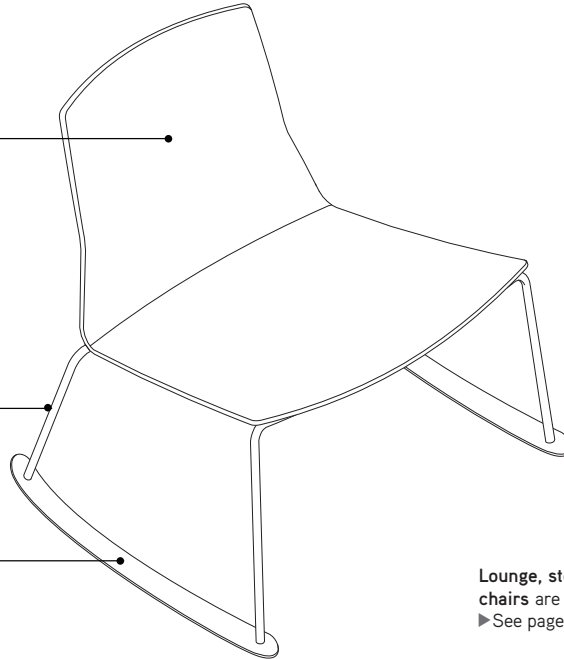

Lounge, stools, and guest chairs are also available.  
► See pages 184, 350, and 402

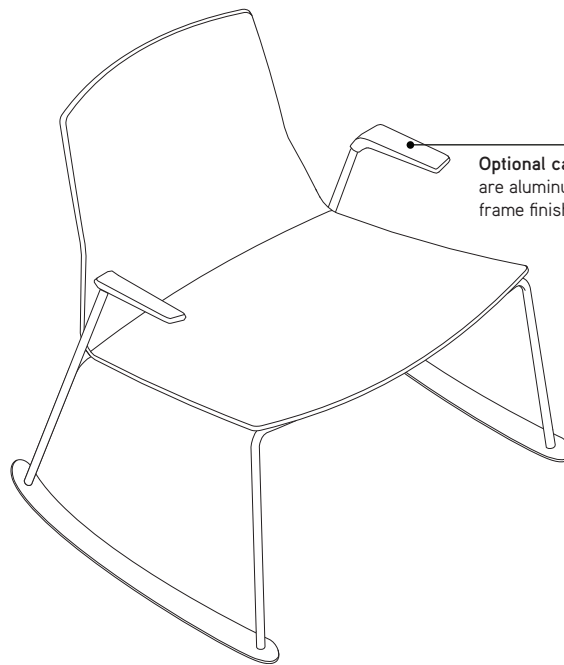

**Optional cantilever arms** are aluminum and will match frame finish.

## Product Details

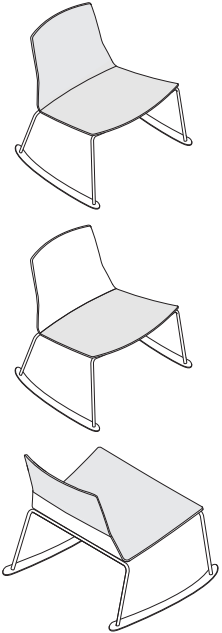

**Upholstery choices** include: fully upholstered, wood shell with upholstered seat, and wood shell with <sup>3</sup>/<sub>4</sub> upholstered back.

## Surface Materials

► See *Coalesse Surface Materials Reference Guide* for further information.

### Wood shell

- Oak veneered plywood

### Frame

- Paint
- Polished trivalent chrome

### Upholstery

- Fabric
- Leather

## Program and Services

**Customer's Own Material/Leather (COM/COL) Program** is available.

► See *Coalesse Surface Materials Reference Guide* for additional information.

Coalesse

# Montara650 Rocker

DESIGN LIEVORE ALTHERR MOLINA

# Montara650 Rocker

DESIGN LIEVORE ALTHERR MOLINA



*Tip: Leathers will appear loose with comfort wrinkles when upholstered.*

*Tip: For Customer's Own Material or Leather, see necessary requirements, important processing instructions, and ordering information.*

► See *Coalesse Surface Materials Reference Guide* and online fabric database at <http://fabric.coalesse.com>.



**With arms**

Overall: 29"D x 28½"W x 30"H  
 Seat: 16"  
 Arm: 23½"

Standard Includes	Required to Specify
-------------------	---------------------

- |  |   |   |
|--|---|---|
| <ul style="list-style-type: none"> <li>► Need help? Product details, page 202</li> </ul> | <ul style="list-style-type: none"> <li>• Seat and back upholstery, if selected</li> <li>• Shell: wood shell with ¾ upholstery or wood shell with upholstered seat, if selected: wood veneer group 1</li> <li>• Base: group 1 paint</li> <li>• Runners: solid oak in clear finish</li> </ul> | <ol style="list-style-type: none"> <li>1 Style number</li> <li>2 Upholstery version (see below under Required Selections)</li> <li>3 Contrasting fabric on ¾ upholstered or fully upholstered, if selected (see below under Required Selections)</li> <li>4 Fabric and/or leather color number for seat and/or back, if selected</li> <li>5 Wood finish on shell, if selected</li> <li>6 Paint color number for base</li> <li>7 Options, if selected (see below)</li> </ol> <p>► See <i>Coalesse Surface Materials Reference Guide</i>.</p> |
|--|---|---|

Required Selections	U.S. Price	Required to Specify
---------------------	------------	---------------------

- |  |  |  |
|--|--|--|
| <p><b>Upholstery Version</b></p> <ul style="list-style-type: none"> <li>• Wood shell with ¾ upholstery</li> <li>• Wood shell with upholstered seat</li> <li>• Fully upholstered</li> </ul> | <p>Prices at right<br/>                 Prices at right<br/>                 Prices at right</p> | <p>Specify with ¾ upholstered.<br/>                 Specify with upholstered seat and wood back.<br/>                 Specify with upholstered seat and back.</p>  |
| <p><b>Contrasting Fabric on ¾ and Fully Upholstered</b></p> <ul style="list-style-type: none"> <li>• Non contrasting fabric</li> <li>• Contrasting fabric</li> </ul>                       | <p>No cost<br/>                 +\$192</p>   | <p>Specify with non contrasting fabric.<br/>                 Specify with contrasting fabric.<br/>                 ► See <i>Multi-Fabric Diagram</i>, page 206</p> |
| <p><b>Arm Type</b></p> <ul style="list-style-type: none"> <li>• Armless</li> <li>• With arms</li> </ul>  | <p>No cost<br/>                 +\$153</p>   | <p>Specify with no arms.<br/>                 Specify with arms.</p>   |

Options	U.S. Price	Required to Specify
---------	------------	---------------------

- |  |  |  |
|--|--|--|
| <p><b>Surface Materials</b></p> <p><b>Base, armless</b></p> <ul style="list-style-type: none"> <li>• Group 3 paint</li> <li>• Polished trivalent chrome</li> </ul> <p><b>Base, with arms</b></p> <ul style="list-style-type: none"> <li>• Group 3 paint</li> <li>• Polished trivalent chrome</li> </ul> <p><b>Wood shell</b></p> <ul style="list-style-type: none"> <li>• Group 1 wood veneer</li> <li>• Group 2 wood veneer</li> </ul> <p><b>Acrylic backer</b></p> <ul style="list-style-type: none"> <li>• Seat</li> <li>• Seat and back</li> </ul> | <p>+ \$114<br/>                 + \$118<br/> <br/>                 + \$114<br/>                 + \$261<br/> <br/>                 No cost<br/>                 + \$102<br/> <br/>                 + \$ 9<br/>                 + \$ 25</p> | <p>Specify paint color number.<br/>                 Specify with polished trivalent chrome.<br/> <br/>                 Specify paint color number.<br/>                 Specify with polished trivalent chrome.<br/> <br/>                 Specify with VP01 Oak Light, VP03 Black Oak, or VP05 White Oak.<br/>                 Specify with VP02 Smoked Oak or VP04 Grey Oak.<br/> <br/>                 Specify with acrylic backer.<br/>                 Specify with acrylic backer.</p> |
|--|--|--|

- |  |   |
|--|---|
| <p><b>Related Products</b></p> <ul style="list-style-type: none"> <li>• Guest seating</li> <li>• Stools</li> <li>• Café tables</li> <li>• Occasional tables</li> </ul> | <p>► Page 350<br/>                 ► Page 402<br/>                 ► See <i>Coalesse Tables, Storage, and Accessories Specification Guide</i>.<br/>                 ► See <i>Coalesse Tables, Storage, and Accessories Specification Guide</i>.</p> |
|--|---|



**For Canadian Pricing**  
 Multiply U.S. Price by the Canadian price factor.  
 ► See page 1 for details.

# Montara650 Rocker

DESIGN LIEVORE ALTHERR MOLINA

## Specification Information

Style Number	U.S. Base Prices														Leather Groups:		
	Fabric Groups:														COL		
	COM	1	2	3	4	5	6	7	8	9	10	1	2				



Overall: 29"D x 28½"W x 30"H  
Seat: 16"

### Wood Shell Rocker with Upholstered Seat

COSFZRC	Seat	\$2194	\$2194	\$2198	\$2225	\$2258	\$2307	\$2369	\$2438	\$2512	\$2579	\$2648	\$2551	\$2396	\$2456
COM/yds = 1, COL/sq ft = 9															

Overall: 29"D x 28½"W x 30"H  
Seat: 16"

### Wood Shell Rocker with ¾ Upholstered Back

COSFZRC	Seat	\$2347	\$2347	\$2351	\$2378	\$2411	\$2460	\$2522	\$2591	\$2665	\$2732	\$2801	\$2704	\$2549	\$2609
	Back	+\$ 17	+\$ 17	+\$ 30	+\$ 54	+\$ 82	+\$126	+\$179	+\$241	+\$306	+\$363	+\$424	+\$123	+\$534	+\$652

COM/yds = 1, COL/sq ft = 17

Overall: 29"D x 28½"W x 30"H  
Seat: 16"

### Fully Upholstered Rocker

COSFZRC	Seat	\$2233	\$2233	\$2237	\$2264	\$2297	\$2346	\$2408	\$2477	\$2551	\$2618	\$2687	\$2590	\$2435	\$2495
	Back	+\$ 32	+\$ 32	+\$ 60	+\$110	+\$169	+\$258	+\$369	+\$496	+\$630	+\$749	+\$876	+\$123	+\$637	+\$786

COM/yds = 2½, COL/sq ft = 32

 **For Canadian Pricing**  
Multiply U.S. Price by the  
Canadian price factor.  
▶ See page 1 for details.

# Montara650 Lounge Chair and Rocker Multi-Fabric Diagram

DESIGN LIEVORE ALTHERR MOLINA

TO: \_\_\_\_\_

FROM: \_\_\_\_\_

DATE: \_\_\_\_\_

FAX...888.413.5161

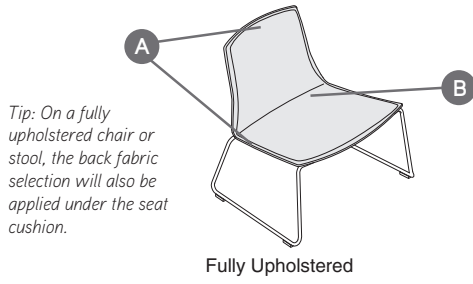

**A** Back: \_\_\_\_\_

\_\_\_\_\_

**B** Seat: \_\_\_\_\_

\_\_\_\_\_

*Contrasting upcharge for each contrasting textile pricing based on highest group textile specified. See specifying for contrasting upcharge.*

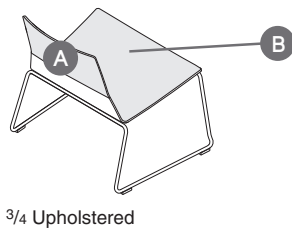

Specify Model below:

COSFZLC Montara650 Lounge Chair

COSFZRC Montara650 Rocker

Coalesse

# Montara650 Lounge Chair and Rocker Multi-Fabric Diagram

DESIGN LIEVORE ALTHERR MOLINA

# Passerelle Lounge Seating

DESIGN STUDIO B

Passerelle lounge seating is a rich tradition of fine craftsmanship. It is exemplified in a button-tufted, double needle stitch detail, while the defined edges of the internal frame allow for a tightly upholstered appearance.

*Tip: This product line is a collection and will be found in multiple locations in this specification guide and/or Coalesse Tables, Storage, and Accessories Specification Guide.*

► See *Collections*, page 5.

Benches with tufted button detail are available in three sizes.

Lounge seating is available in 1-, 2-, or 3-seat lounge. Arm bolsters are available with optional attachment straps.

4-leg base is standard in solid maple with non-adjustable glides.

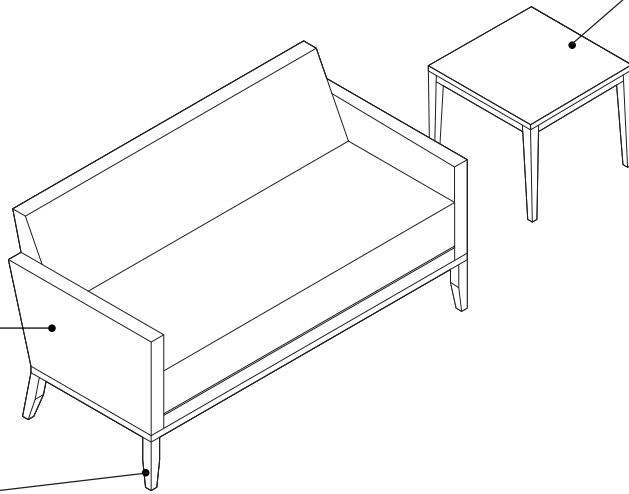

Occasional tables are available in three sizes. All have a veneer top and a solid maple frame. An optional interport power module is available.

► See *Coalesse Tables, Storage, and Accessories Specification Guide*.

# Passerelle Lounge Seating

DESIGN STUDIO B

## Product Details

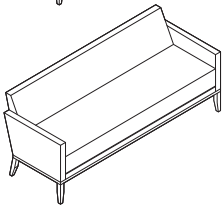
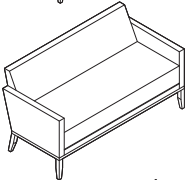
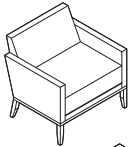

**Lounge seating** is available in 1-, 2-, and 3-seat with crisply tucked upholstery. 4-leg base is standard in solid maple, with 27 finishes available. Custom match wood finish option is also available on base.

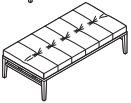
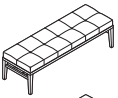

**Benches** are available in two sizes. The frame is constructed of solid maple. The upholstery is hand-tailored with a button-tufted, double needle stitched detail.



**Arm bolster pillows** are available with optional attachment rings.

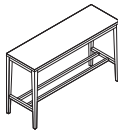
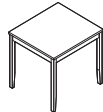
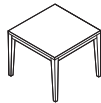

**Occasional tables with solid hardwood frame** are available with any Coalesse standard finish. Custom match wood finishes are also available. Veneer top is 1" thick with optional contrasting finish. ▶ See *Coalesse Tables, Storage, and Accessories Specification Guide*

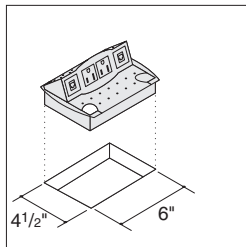

**Interport power/data module** is an available option for the 17"H table and the 21"H table, and is available for center location only.

## Surface Materials

▶ See *Coalesse Surface Materials Reference Guide* for further information.

### Upholstery

- Fabric
- Leather

### Legs

- Maple solid wood

## Programs and Services

**Customer's Own Material/Leather (COM/COL) Program** is available.

▶ See *Coalesse Surface Materials Reference Guide* for additional information.

# Passerelle Lounge Seating

DESIGN STUDIO B

*Tip: Fabrics and leathers will appear loose with comfort wrinkles when upholstered.*

*Tip: Recommended leathers are Elmosoft group 1 and Elmorustical group 2.*

*Tip: Special color match, consult Customer Service.*

*Tip: For Customer's Own Material or Leather, see necessary requirements, important processing instructions, and ordering information*  
 ▶ See *Coalesse Surface Materials Reference Guide*.

Standard Includes	Required to Specify
▶ Need help? Product details, page 208 • Frame: unibody construction with finger jointed plywood • Upholstery: multiple densities of polyurethane foam and polyester fiber on seat, back, and arms • Legs: solid maple with non-adjustable glides	1 Style number 2 Number of fabrics if contrasting fabric style number is selected 3 Fabric or leather color number for upholstery on seat, back, and arms 4 Wood color number for legs 5 Options, if selected (see below) ▶ See <i>Coalesse Surface Materials Reference Guide</i> .

Options	U.S. Price	Required to Specify
<b>Surface Materials</b> • Contrasting fabric <hr/> <b>Acrylic backer</b> • Lounge chair • 2-seat lounge • 3-seat lounge • Arm bolster	+\$192 per fabric <hr/> +\$ 53 +\$ 74 +\$ 89 +\$ 11	Add suffix K to the style number and select fabric color number. <hr/> Specify with acrylic backer. Specify with acrylic backer. Specify with acrylic backer. Specify with acrylic backer. ▶ See <i>Coalesse Surface Materials Reference Guide</i> .
<b>Bolster/Pillow Attachment Rings</b> • Attachment rings on bolster pillow attach to lounge chair/lounge attachment straps	+\$103	Specify with attachment rings.
<b>Lounge Chair/Lounge Attachment Straps</b> • Attachment straps on lounge chair/lounge attach to bolster pillow attachment rings	No cost	Specify with attachment straps for left and right sides.
<b>Related Products</b> • Occasional tables		▶ See <i>Coalesse Tables, Storage, and Accessories Specification Guide</i> .

## Specification Information

Style Number	U.S. Base Prices										Leather Groups:		
	Fabric Groups:										COL		
	COM	1	2	3	4	5	6	7	8	9	10	1	2

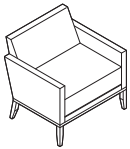

Overall: 27"D 30½"W 29"H  
 Inside: 19"D 26"W 17"H  
 Seat: 17½"H  
 Arm: 23"H

### Lounge Chair

440-WB	\$2705	\$2705	\$2838	\$2948	\$3080	\$3277	\$3523	\$3802	\$4101	\$4363	\$4644	\$3256	\$6281	\$ 6846
--------	--------	--------	--------	--------	--------	--------	--------	--------	--------	--------	--------	--------	--------	---------

COM/yds = 4, COL/sq ft = 88

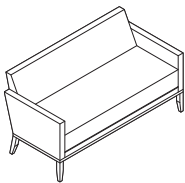

Overall: 27"D 56½"W 29"H  
 Inside: 19"D 52"W 17"H  
 Seat: 17½"H  
 Arm: 23"H

### 2-Seat Lounge

440-2WB	\$4919	\$4919	\$5100	\$5252	\$5433	\$5705	\$6043	\$6428	\$6837	\$7199	\$7584	\$5478	\$9703	\$10,327
---------	--------	--------	--------	--------	--------	--------	--------	--------	--------	--------	--------	--------	--------	----------

COM/yds = 5½, COL/sq ft = 121

▶ Specification Information, continued from previous page

# Passerelle Lounge Seating

DESIGN STUDIO B

► Specification Information, continued from previous page

## Specification Information

Style Number	U.S. Base Prices										Leather Groups:			
	Fabric Groups:										COL	1	2	
	COM	1	2	3	4	5	6	7	8	9	10			

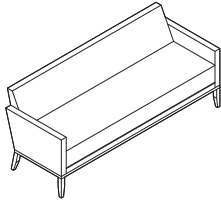

Overall: 27"D 72¾"W 29"H  
 Inside: 19"D 68"W 17"H  
 Seat: 17½"H  
 Arm: 23"H

### 3-Seat Lounge

440-3WB	\$5560	\$5560	\$5784	\$5969	\$6191	\$6525	\$6940	\$7412	\$7915	\$8359	\$8832	\$6111	\$11,364	\$12,043
---------	--------	--------	--------	--------	--------	--------	--------	--------	--------	--------	--------	--------	----------	----------

COM/yds = 6¾, COL/sq ft = 149



Overall: 17½"W 5¾"Dia

### Arm Bolster

440-B	\$ 462	\$ 462	\$ 496	\$ 523	\$ 556	\$ 605	\$ 667	\$ 736	\$ 811	\$ 877	\$ 947	\$1027	\$ 1367	\$ 1827
-------	--------	--------	--------	--------	--------	--------	--------	--------	--------	--------	--------	--------	---------	---------

COM/yds = 1, COL/sq ft = 18

Lounge Seating

 **For Canadian Pricing**  
 Multiply U.S. Price by the  
 Canadian price factor.  
 ► See page 1 for details.

# Passerelle Lounge Seating Benches

DESIGN STUDIO B

*Tip: Fabrics and leathers will appear loose with comfort wrinkles when upholstered.*

*Tip: For plain upholstery option or contrasting textiles, contact Customer Service.*

*Tip: Recommended leathers are Elmosoft group 1 and Elmorustical group 2.*

*Tip: Special color match, consult Customer Service.*

*Tip: For Customer's Own Material or Leather, see necessary requirements, important processing instructions, and ordering information*  
 ▶ See *Coalesse Surface Materials Reference Guide*.

Standard Includes		Required to Specify
▶ Need help? Product details, page 209	<ul style="list-style-type: none"> <li>• Frame: solid maple</li> <li>• Upholstery: multiple densities of polyurethane foam</li> <li>• Legs: solid maple with non-adjustable glides</li> <li>• Button detail: tufted and double needed</li> </ul>	1 Style number 2 Fabric or leather color number for upholstery on bench 3 Wood color number for legs 4 Options, if selected (see below) ▶ See <i>Coalesse Surface Materials Reference Guide</i> .

Options	U.S. Price	Required to Specify
<b>Surface Materials</b> Acrylic backer • 20"D x 60"W bench • 30"D x 60"W bench	+\$41 +\$58	Specify with acrylic backer. Specify with acrylic backer. ▶ See <i>Coalesse Surface Materials Reference Guide</i> .
<b>Related Products</b> • Occasional tables		▶ See <i>Coalesse Tables, Storage, and Accessories Specification Guide</i> .

## Specification Information

Style Number	U.S. Base Prices										Leather Groups:		
	Fabric Groups:										COL	1	2
COM	1	2	3	4	5	6	7	8	9	10			

## Bench

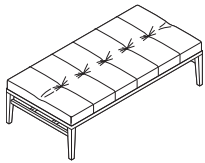

Overall: 30"D 60"W 17"H

440-B3060WB	\$3281	\$3281	\$3414	\$3524	\$3656	\$3853	\$4099	\$4378	\$4677	\$4939	\$5220	\$3846	\$6921	\$7520
-------------	--------	--------	--------	--------	--------	--------	--------	--------	--------	--------	--------	--------	--------	--------

COM/yds = 4, COL/sq ft = 88

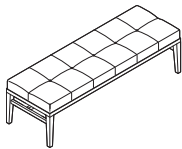

Overall: 20"D 60"W 17"H

440-B2060WB	\$2856	\$2856	\$2947	\$3023	\$3113	\$3250	\$3418	\$3610	\$3815	\$3996	\$4188	\$3415	\$5520	\$5937
-------------	--------	--------	--------	--------	--------	--------	--------	--------	--------	--------	--------	--------	--------	--------

COM/yds = 2¾, COL/sq ft = 61

▶ Specification Information, continued on next page



**For Canadian Pricing**  
 Multiply U.S. Price by the Canadian price factor.  
 ▶ See page 1 for details.

# Passerelle Lounge Seating Multi-Fabric Diagram

DESIGN STUDIO B

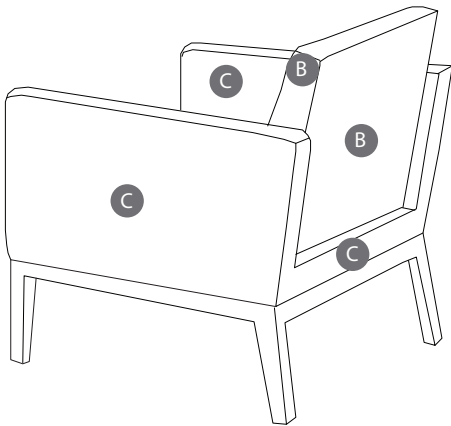
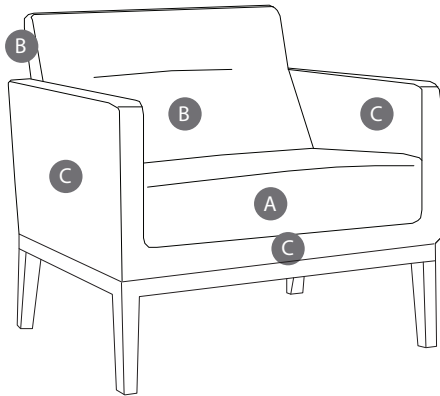

Model 440-WBK Shown Above

TO: \_\_\_\_\_

FROM: \_\_\_\_\_

DATE: \_\_\_\_\_

FAX...888.413.5161

**A** Upholstery Selection (default for entire unit if B is not selected):  
 \_\_\_\_\_  
 \_\_\_\_\_

**B** Back: \_\_\_\_\_  
 \_\_\_\_\_

**C** Arms: \_\_\_\_\_  
 \_\_\_\_\_

Total list price upcharge for contrasting fabrics: \$ \_\_\_\_\_

*See specifying for contrasting fabric upcharge.  
List price based on highest fabric group usage.*

Specify Model below:

440-WBK Passerelle Lounge Chair

440-2WBK Passerelle 2-Seat Lounge

440-3WBK Passerelle 3-Seat Lounge

# Ripple Benches

DESIGN LAURINDA SPEAR, FAIA

Ripple benches are sculptured and fully upholstered in two orientations for flat or wave seating.

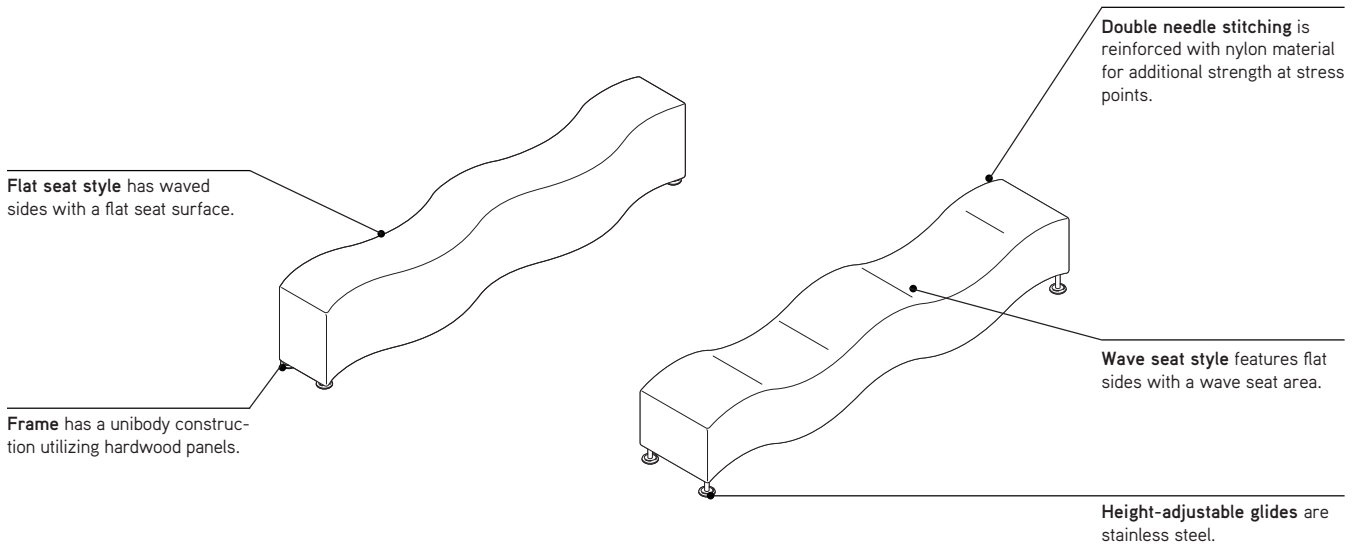

# Ripple Benches

DESIGN LAURINDA SPEAR, FAIA

## Product Details

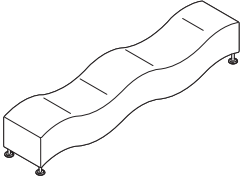
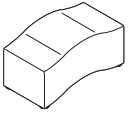

**Wave seat** is available in two sizes. The 1-seat is 35¾"W and the 3-seat is 96"W. Both are fully upholstered with a top stitch detail. The bottom of the seats are covered with fabric.

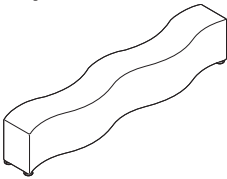
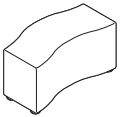

**Flat seat** is available in two sizes. The 1-seat is 35½"W and the 3-seat is 96"W. Both are fully upholstered with a top stitch detail. The bottom of the seats are covered with fabric.

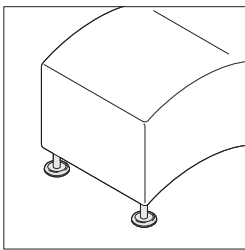

**Height-adjustable glides** are stainless steel.

## Surface Materials

► See *Coalesse Surface Materials Reference Guide* for further information.

**Upholstery** (contrasting fabric available)

- Fabric
- Leather

## Programs and Services

**Customer's Own Material/Leather (COM/COL) Program** is available.

► See *Coalesse Surface Materials Reference Guide* for additional information.

# Ripple Benches

DESIGN LAURINDA SPEAR, FAIA

*Tip: Fabrics and leathers will appear loose with comfort wrinkles when upholstered.*

*Tip: Pricing based on highest group textile specified.*

*Tip: Due to the design and construction techniques of Ripple lounge, only certain textiles can be successfully applied, therefore COM fabrics must be submitted to Coalesse for approval prior to order acceptance. Solid patterns with no repeat are recommended.*

*Tip: Recommended leathers are Elmosoft group 1 and Elmorustical group 2.*

*Tip: Special color match, consult Customer Service.*

*Tip: For Customer's Own Material or Leather, see necessary requirements, important processing instructions, and ordering information*  
 ▶ See *Coalesse Surface Materials Reference Guide*.

*Tip: 35" is a single seat and 96" is a 3-seat lounge.*

Standard Includes		Required to Specify
▶ Need help? Product details, page 214	<ul style="list-style-type: none"> <li>• Frame: unibody construction with finger jointed plywood</li> <li>• Upholstery: multiple densities of laminated polyurethane foam</li> <li>• Glides: height adjustable with stainless steel finish leveling polyurethane glides</li> <li>• Double needle stitch seams</li> </ul>	1 Style number 2 Number of fabrics if contrasting fabric style number is selected 3 Fabric or leather color number for upholstery on bench 4 Options, if selected (see below) ▶ See <i>Coalesse Surface Materials Reference Guide</i> .

Options	U.S. Price	Required to Specify
<b>Surface Materials</b> <ul style="list-style-type: none"> <li>• Contrasting fabric</li> </ul>	+\$192 per fabric	Add suffix K to the style number and select fabric color number.
<b>Acrylic backer</b> <ul style="list-style-type: none"> <li>• Wave and flat seats</li> <li>• Little Ripple wave and flat seats</li> </ul>	+\$111 +\$ 50	Specify with <i>acrylic backer</i> . Specify with <i>acrylic backer</i> . ▶ See <i>Coalesse Surface Materials Reference Guide</i> .

## Specification Information

Style Number	U.S. Base Prices										Leather Groups:		
	Fabric Groups:										COL	1	2
	COM	1	2	3	4	5	6	7	8	9	10		

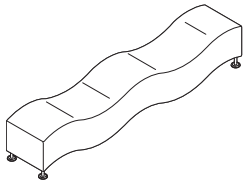

Overall: 19¼"D 97"W 19¼"H  
Dip: 14"H

## Upholstered Wave Seat

490-B96VRT	\$3583	\$3583	\$3819	\$4016	\$4248	\$4600	\$5033	\$5532	\$6059	\$6523	\$7019	\$4109	\$8680	\$9578
------------	--------	--------	--------	--------	--------	--------	--------	--------	--------	--------	--------	--------	--------	--------

COM/yds = 7½, COL/sq ft = 143

▶ Specification Information, continued on next page



**For Canadian Pricing**  
 Multiply U.S. Price by the Canadian price factor.  
 ▶ See page 1 for details.

# Ripple Benches

DESIGN LAURINDA SPEAR, FAIA

► Specification Information, continued from previous page

## Specification Information

Style Number	U.S. Base Prices										Leather Groups:		
	Fabric Groups:										COL		
	COM	1	2	3	4	5	6	7	8	9	10	1	2

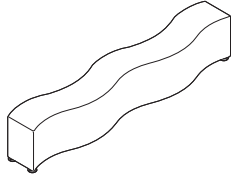

Overall: 19¼"D 97"W 19¼"H  
Seat Surface: 19"H

### Upholstered Flat Seat

490-B96HRZ	\$3583	\$3583	\$3819	\$4016	\$4248	\$4600	\$5033	\$5532	\$6059	\$6523	\$7019	\$4109	\$8680	\$9578
------------	--------	--------	--------	--------	--------	--------	--------	--------	--------	--------	--------	--------	--------	--------

COM/yds = 7½, COL/sq ft = 143

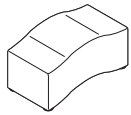

Overall: 19"D 35¾"W 19¼"H

### Little Ripple Wave Seat

490-B35VRT	\$1436	\$1436	\$1507	\$1566	\$1635	\$1741	\$1871	\$2020	\$2179	\$2318	\$2467	\$1950	\$3488	\$3793
------------	--------	--------	--------	--------	--------	--------	--------	--------	--------	--------	--------	--------	--------	--------

COM/yds = 2¼, COL/sq ft = 50

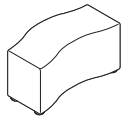

Overall: 19"D 35½"W 19"H

### Little Ripple Flat Seat

490-B35HRZ	\$1436	\$1436	\$1507	\$1566	\$1635	\$1741	\$1871	\$2020	\$2179	\$2318	\$2467	\$1950	\$3488	\$3793
------------	--------	--------	--------	--------	--------	--------	--------	--------	--------	--------	--------	--------	--------	--------

COM/yds = 2¼, COL/sq ft = 50



**For Canadian Pricing**  
Multiply U.S. Price by the  
Canadian price factor.  
► See page 1 for details.

# Ripple Benches Multi-Fabric Diagram

DESIGN LAURINDA SPEAR, FAIA

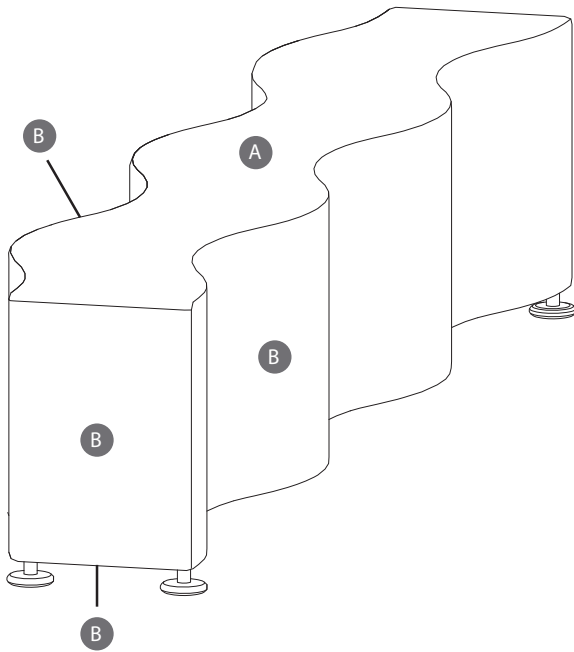

Model 490-B96HRZK Shown Above

TO: \_\_\_\_\_

FROM: \_\_\_\_\_

DATE: \_\_\_\_\_

FAX....888.413.5161

**A** Upholstery Selection (default for entire unit if B is not selected):

\_\_\_\_\_  
\_\_\_\_\_

**B** Side, Bottom, and End: \_\_\_\_\_

\_\_\_\_\_

Total list price upcharge for contrasting fabrics: \$ \_\_\_\_\_

*See specifying for contrasting fabric upcharge.  
List price based on highest fabric group usage.*

Specify Model below:

- 490-B96VRTK Ripple Upholstered Wave Seat
- 490-B96HRZK Ripple Upholstered Flat Seat
- 490-B35VRTK Ripple Little Ripple Wave Seat
- 490-B35HRZK Ripple Little Ripple Flat Seat

Coalesse

# Ripple Benches Multi-Fabric Diagram

DESIGN LAURINDA SPEAR, FAIA

# Sidewalk Lounge Seating

DESIGN STUDIO B

Sidewalk lounge seating is a crisp, lightly scaled, and portable collection for comfort and mobility, allowing a workspace to become a social space.

Upholstery is hand-tailored, featuring a horizontally tucked upholstery detail and double needle topstitched seams.

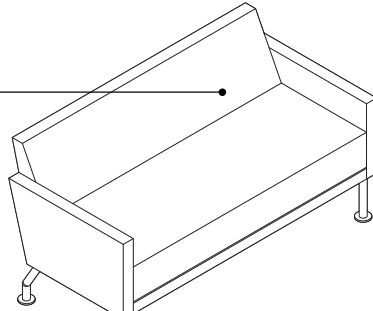

Frame is a unibody construction with finger jointed plywood.

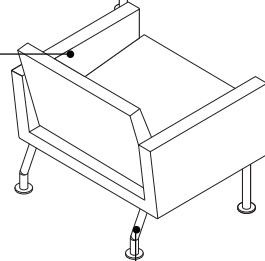

4-leg steel base is standard in powder coat paint with easy gliding "go" glides.

Lounge chairs are available in a low back (shown here), or a high back.

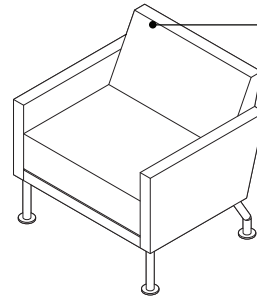

# Sidewalk Lounge Seating

DESIGN STUDIO B

## Product Details

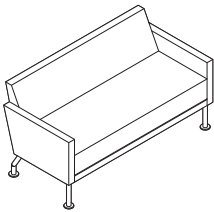
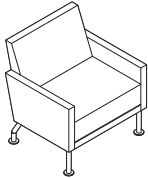
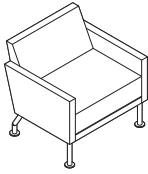

Lounge seating is available in three styles: low-back chair, high-back chair, and a 2-seat lounge. Seat height from floor is 17½"H.

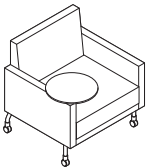
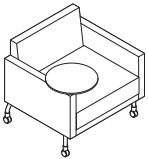

Mobile lounge seating is available in a low back or high back with casters and a pivoting table arm. Extra tablet pivoter and cupholder available.

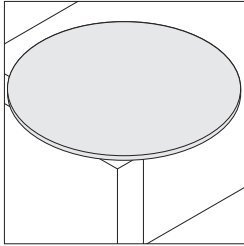

Tablet is 13½" and is standard in laminate. Extra tablet pivoter is available, allowing tablet to be moved side to side.

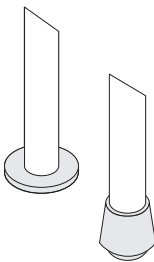

"Go" glides are standard. "No go" glides are optional.

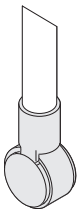

Casters on mobile model are dual-wheel, swivel, and non-locking. Locking casters are optional.



Arm bolster in coordinating fabric is available (5½"D x 17½"H).

## Surface Materials

► See *Coalesse Surface Materials Reference Guide* for further information.

### Upholstery

- Fabric
- Leather

### Base

- Paint

### Tablet

- Laminate

## Programs and Services

Customer's Own Material/Leather (COM/COL) Program is available.

► See *Coalesse Surface Materials Reference Guide* for additional information.

# Sidewalk Lounge Seating

DESIGN STUDIO B

*Tip: Fabrics and leathers will appear loose with comfort wrinkles when upholstered.*

*Tip: Recommended leathers are Elmosoft group 1 and Elmorustical group 2.*

*Tip: Special color match, consult Customer Service.*

*Tip: For multi-fabric diagram, refer to page 225.*

*Tip: Specify tablet from facing position.*

*Tip: Cup holder must be specified with tablet.*

*Tip: For Customer's Own Material or Leather, see necessary requirements, important processing instructions, and ordering information*  
 ▶ See *Coalesse Surface Materials Reference Guide*.

*Tip: Extra pivoter allows tablet to be moved side to side.*

*Tip: Tablet can be installed on mobile models only.*

Standard Includes	Required to Specify
▶ Need help? Product details, page 220 • Frame: unibody construction with finger jointed plywood • Upholstery: multiple densities of polyurethane foam and polyester fiber on seat, back, and arms. • Lounge: - Legs: 4799 Platinum Metallic powder coat steel legs with "go" glides • Mobile: - 13½" diameter tablet: laminate - Legs: 4799 Platinum Metallic powder coat steel legs with casters - Casters: four non-locking	1 Style number 2 Number of fabrics if contrasting fabric style number is selected 3 Fabric or leather color number for upholstery on seat, back, and arms 4 Options, if selected (see below) ▶ See <i>Coalesse Surface Materials Reference Guide</i> .

Options	U.S. Price	Required to Specify
<b>Surface Materials</b> • Contrasting fabric <hr/> <b>Acrylic backer</b> • Lounge chair • Lounge 2-seat chair • Arm bolster	+\$192 per fabric   +\$ 58 +\$ 81 +\$ 11	Add suffix K to the style number and select fabric color number.   Specify with acrylic backer. Specify with acrylic backer. Specify with acrylic backer. ▶ See <i>Coalesse Surface Materials Reference Guide</i> .
<b>Cup Holder</b> • Cup holder	+\$ 81	Specify with cup holder.
<b>Tablet Side Storage</b> • Tablet side storage	+\$120	Specify with tablet side storage and select left- or right-facing.
<b>Extra Pivoter</b> • Extra pivoter	+\$289	Specify with extra pivoter.
<b>Omit Tablet</b> • Omit tablet	-\$252	Specify with omit tablet.
<b>Glides</b> <b>Lounge</b> • "No go" ½" polyethylene glide  <b>Mobile</b> • Go glides	No cost   No cost	Specify with "no go" glides.   Specify with "go" glides.
<b>Casters</b> • Locking casters	No cost	Specify with locking casters.
<b>Related Products</b> • Ottoman/benches • Occasional tables		▶ See page 228 ▶ See <i>Coalesse Tables, Storage, and Accessories Specification Guide</i> .

## Specification Information

Style Number	U.S. Base Prices										Leather Groups:		
	Fabric Groups:										COL	1	2
	COM	1	2	3	4	5	6	7	8	9	10		

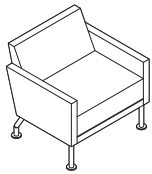

Overall: 27"D 30½"W 29"H  
 Inside: 19"D 26"W 17"H  
 Seat: 17½"H  
 Arm: 23"H

## Low-Back Lounge Chair

444	\$2548	\$2548	\$2671	\$2774	\$2897	\$3081	\$3308	\$3569	\$3846	\$4090	\$4350	\$3083	\$6052	\$6579
-----	--------	--------	--------	--------	--------	--------	--------	--------	--------	--------	--------	--------	--------	--------

COM/yds = 4, COL/sq ft = 88

▶ Specification Information, continued on next page



### For Canadian Pricing

Multiply U.S. Price by the Canadian price factor.

▶ See page 1 for details.

# Sidewalk Lounge Seating

DESIGN STUDIO B

► Specification Information, continued from previous page

## Specification Information

Style Number	U.S. Base Prices										Leather Groups:			
	Fabric Groups:										COL	1	2	
	COM	1	2	3	4	5	6	7	8	9	10			

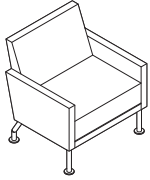

Overall: 27"D 30½"W 32"H  
 Inside: 19"D 26"W 20"H  
 Seat: 17½"H  
 Arm: 23"H

### High-Back Lounge Chair

446	\$2817	\$2817	\$2955	\$3071	\$3209	\$3416	\$3672	\$3966	\$4276	\$4552	\$4845	\$3368	\$6527	\$7058
-----	--------	--------	--------	--------	--------	--------	--------	--------	--------	--------	--------	--------	--------	--------

COM/yds = 4½, COL/sq ft = 99

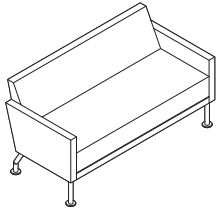

Overall: 27"D 56½"W 29"H  
 Inside: 19"D 52"W 17"H  
 Seat: 17½"H  
 Arm: 23"H

### 2-Seat Lounge

444-2	\$4030	\$4030	\$4199	\$4340	\$4509	\$4762	\$5074	\$5433	\$5813	\$6151	\$6507	\$4581	\$8698	\$9291
-------	--------	--------	--------	--------	--------	--------	--------	--------	--------	--------	--------	--------	--------	--------

COM/yds = 5½, COL/sq ft = 121

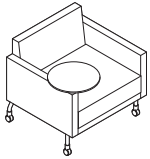

Overall: 27"D 30½"W 29"H  
 Inside: 19"D 26"W 17"H  
 Seat: 17½"H  
 Arm: 22½"H

### Low-Back, Mobile Lounge Chair with Tablet

444M	\$3461	\$3461	\$3584	\$3687	\$3810	\$3994	\$4221	\$4482	\$4759	\$5003	\$5263	\$3987	\$6957	\$7548
------	--------	--------	--------	--------	--------	--------	--------	--------	--------	--------	--------	--------	--------	--------

COM/yds = 4, COL/sq ft = 88

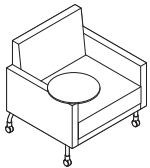

Overall: 27"D 30½"W 32"H  
 Inside: 19"D 26"W 20"H  
 Seat: 17½"H  
 Arm: 22½"H

### High-Back, Mobile Lounge Chair with Tablet

446M	\$3737	\$3737	\$3875	\$3991	\$4129	\$4336	\$4592	\$4886	\$5196	\$5472	\$5765	\$4272	\$7624	\$8275
------	--------	--------	--------	--------	--------	--------	--------	--------	--------	--------	--------	--------	--------	--------

COM/yds = 4½, COL/sq ft = 99

► Specification Information, continued on next page

# Sidewalk Lounge Seating *continued*

DESIGN STUDIO B

► Specification Information, continued from previous page

## Specification Information

Style Number	U.S. Base Prices										Leather Groups:		
	Fabric Groups:										COL		
	COM	1	2	3	4	5	6	7	8	9	10	1	2



Overall: 17½"H 5¾" Dia

## Arm Bolster

440-B	\$462	\$462	\$496	\$523	\$556	\$605	\$667	\$736	\$811	\$877	\$947	\$1027	\$1367	\$1827
-------	-------	-------	-------	-------	-------	-------	-------	-------	-------	-------	-------	--------	--------	--------

COM/yds = 1, COL/sq ft = 18



**For Canadian Pricing**  
 Multiply U.S. Price by the  
 Canadian price factor.  
 ► See page 1 for details.

# Sidewalk Lounge Seating Multi-Fabric Diagram

DESIGN STUDIO B

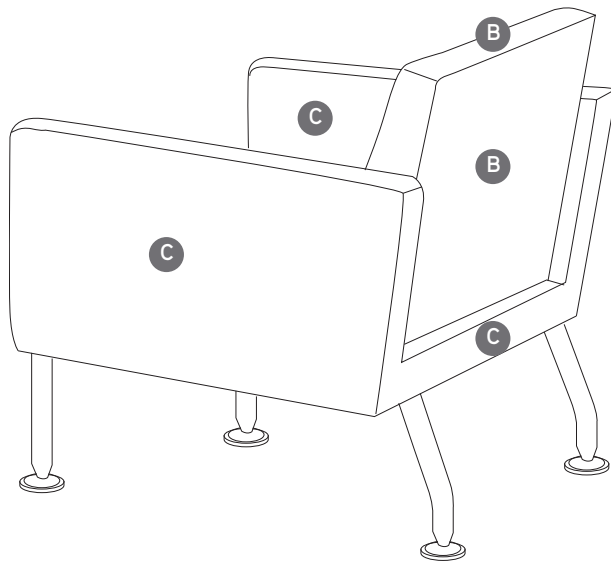
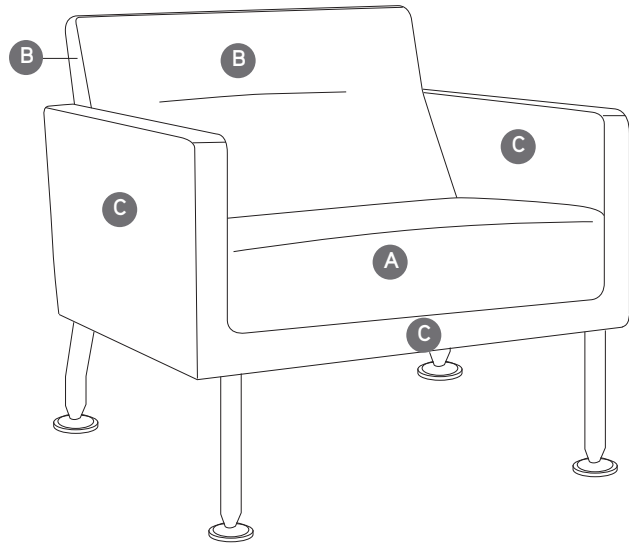

TO: \_\_\_\_\_

FROM: \_\_\_\_\_

DATE: \_\_\_\_\_

FAX...888.413.5161

**A** Upholstery Selection (default for entire unit if B is not selected):  
 \_\_\_\_\_  
 \_\_\_\_\_

**B** Back: \_\_\_\_\_  
 \_\_\_\_\_

**C** Arms: \_\_\_\_\_  
 \_\_\_\_\_

Total list price upcharge for contrasting fabrics: \$ \_\_\_\_\_

*See specifying for contrasting fabric upcharge.  
 List price based on highest fabric group usage.*

Specify Model below:

- 444K Sidewalk Low-Back Lounge Chair or Mobile Lounge Chair
- 446K Sidewalk High-Back Lounge Chair or Mobile Lounge Chair
- 444-2K Sidewalk 2-Seat Lounge

# Sidewalk Lounge Seating Collaborative

DESIGN STUDIO B

Sidewalk collaborative lounge was designed with engagement, comfort, and mobility in mind.

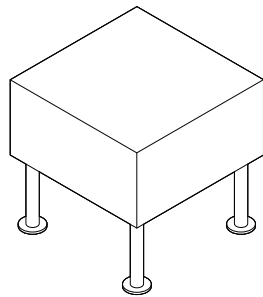

## Product Details

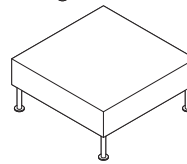
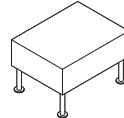
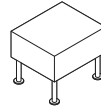
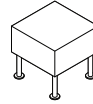

Ottomans are available in four sizes: 17"D x 17"W x 17"H, 17"D x 20"W x 17"H, 20"D x 26"W x 17"H, and 36"D x 36"W x 17"H. All ottomans are visually compatible with all other pieces in the Sidewalk collection.

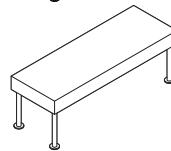
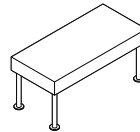
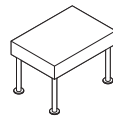

Benches are available in three sizes: 17"D x 24"W x 17"H, 17"D x 36"W x 17"H, and 17"D x 48"W x 17"H. All benches are visually compatible with all other pieces in the Sidewalk collection.

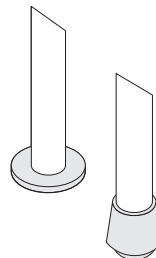

"Go" glides are standard.  
"No go" glides are optional.

## Surface Materials

► See *Coalesse Surface Materials Reference Guide* for further information.

### Upholstery

- Fabric
- Leather

### Base

- Paint

## Programs and Services

Customer's Own Material/Leather (COM/COL) Program is available.

► See *Coalesse Surface Materials Reference Guide* for additional information.

# Sidewalk Lounge Seating Collaborative

DESIGN STUDIO B

*Tip: Fabrics and leathers will appear loose with comfort wrinkles when upholstered.*

*Tip: Recommended leathers are Elmosoft group 1 and Elmorustical group 2.*

*Tip: Special color match, consult Customer Service.*

*Tip: For Customer's Own Material or Leather, see necessary requirements, important processing instructions, and ordering information*  
 ▶ See *Coalesse Surface Materials Reference Guide*.

Standard Includes		Required to Specify	
▶ Need help? Product details, page 226	<ul style="list-style-type: none"> <li>• Frame: unibody construction with finger jointed plywood</li> <li>• Upholstery: multiple densities of polyurethane foam and polyester fiber on seat and back</li> <li>• Legs: 4799 Platinum Metallic powder coat steel with "go" glides</li> </ul>	1 Style number 2 Fabric or leather color number for upholstery 3 Options, if selected (see below) ▶ See <i>Coalesse Surface Materials Reference Guide</i> .	
Options		U.S. Price	Required to Specify
<b>Surface Materials</b>	<b>Acrylic backer</b> <ul style="list-style-type: none"> <li>• 17"D x 17"W and 17"D x 20"W ottomans</li> <li>• 20"D x 26"W ottoman</li> </ul>	+\$21  +\$28	Specify with acrylic backer.  Specify with acrylic backer. ▶ See <i>Coalesse Surface Materials Reference Guide</i> .
<b>Glides</b>	<ul style="list-style-type: none"> <li>• "No go" 1/2" polyethylene glides</li> </ul>	No cost	Specify with "no go" glides.
<b>Related Products</b>	<ul style="list-style-type: none"> <li>• Occasional tables</li> </ul>		▶ See <i>Coalesse Tables, Storage, and Accessories Specification Guide</i> .

## Specification Information

Style Number	U.S. Base Prices										Leather Groups:			
	Fabric Groups:										COL	1	2	
	COM	1	2	3	4	5	6	7	8	9	10			

### Ottoman

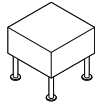

Overall: 17"D 17"W 17"H

<b>430-H1717</b>	\$1455	\$1455	\$1501	\$1540	\$1586	\$1655	\$1740	\$1838	\$1941	\$2034	\$2131	\$2006	\$2455	\$2849
------------------	--------	--------	--------	--------	--------	--------	--------	--------	--------	--------	--------	--------	--------	--------

COM/yds = 1½, COL/sq ft = 22½

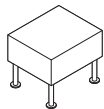

Overall: 17"D 20"W 17"H

<b>430-H1720</b>	\$1455	\$1455	\$1501	\$1540	\$1586	\$1655	\$1740	\$1838	\$1941	\$2034	\$2131	\$2006	\$2455	\$2849
------------------	--------	--------	--------	--------	--------	--------	--------	--------	--------	--------	--------	--------	--------	--------

COM/yds = 1½, COL/sq ft = 24

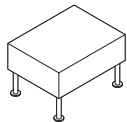

Overall: 20"D 26"W 17"H

<b>430-H2026</b>	\$1740	\$1740	\$1802	\$1853	\$1915	\$2007	\$2120	\$2251	\$2389	\$2511	\$2641	\$2266	\$3018	\$3421
------------------	--------	--------	--------	--------	--------	--------	--------	--------	--------	--------	--------	--------	--------	--------

COM/yds = 2, COL/sq ft = 36

 **For Canadian Pricing**  
 Multiply U.S. Price by the Canadian price factor.  
 ▶ See page 1 for details.

# Sidewalk Lounge Seating Ottoman/Benches

DESIGN STUDIO B

*Tip: Fabrics and leathers will appear loose with comfort wrinkles when upholstered.*

*Tip: Recommended leathers are Elmosoft group 1 and Elmorustical group 2.*

*Tip: Special color match, consult Customer Service.*

*Tip: For Customer's Own Material or Leather, see necessary requirements, important processing instructions, and ordering information*  
 ▶ See *Coalesse Surface Materials Reference Guide*.

Standard Includes		Required to Specify	
▶ Need help? Product details, page 226	<ul style="list-style-type: none"> <li>• Frame: unibody construction with finger jointed plywood.</li> <li>• Upholstery: multiple densities of polyurethane foam and polyester fiber on ottoman/benches</li> <li>• Legs: 4799 Platinum Metallic powder coat steel with "go" glides</li> </ul>	1 Style number 2 Fabric or leather color number for upholstery on ottoman/benches 3 Options, if selected (see below) ▶ See <i>Coalesse Surface Materials Reference Guide</i> .	
Options		U.S. Price	Required to Specify
<b>Surface Material</b>	<b>Acrylic backer</b> <ul style="list-style-type: none"> <li>• 17"D x 24"W bench</li> <li>• 17"D x 36"W bench</li> <li>• 17"D x 48"W bench</li> <li>• Ottoman</li> </ul>	+\$21 +\$28 +\$36 +\$50	Specify with acrylic backer. Specify with acrylic backer. Specify with acrylic backer. ▶ See <i>Coalesse Surface Materials Reference Guide</i> .
<b>Glides</b>	<ul style="list-style-type: none"> <li>• "No go" 1/2" polyethylene glides</li> </ul>	No cost	Specify with "no go" glides.
<b>Related Products</b>	<ul style="list-style-type: none"> <li>• Occasional tables</li> </ul>		▶ See <i>Coalesse Tables, Storage, and Accessories Specification Guide</i> .

## Specification Information

Style Number	U.S. Base Prices										Leather Groups:			
	Fabric Groups:										COL	1	2	
	COM	1	2	3	4	5	6	7	8	9	10			

## Benches

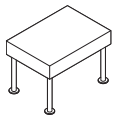

Overall: 17"D 24"W 17"H

430-B1724	\$1576	\$1576	\$1613	\$1645	\$1682	\$1736	\$1804	\$1883	\$1965	\$2039	\$2117	\$2125	\$2662	\$3036
-----------	--------	--------	--------	--------	--------	--------	--------	--------	--------	--------	--------	--------	--------	--------

COM/yds = 1 1/2, COL/sq ft = 27

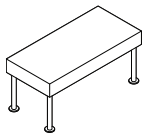

Overall: 17"D 36"W 17"H

430-B1736	\$1854	\$1854	\$1916	\$1967	\$2029	\$2121	\$2234	\$2365	\$2503	\$2625	\$2755	\$2392	\$3144	\$3564
-----------	--------	--------	--------	--------	--------	--------	--------	--------	--------	--------	--------	--------	--------	--------

COM/yds = 2, COL/sq ft = 36

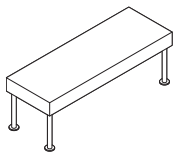

Overall: 17"D 48"W 17"H

430-B1748	\$2136	\$2136	\$2213	\$2277	\$2354	\$2469	\$2611	\$2774	\$2947	\$3100	\$3263	\$2662	\$3626	\$4046
-----------	--------	--------	--------	--------	--------	--------	--------	--------	--------	--------	--------	--------	--------	--------

COM/yds = 2 1/2, COL/sq ft = 45

▶ Specification Information, continued on next page



### For Canadian Pricing

Multiply U.S. Price by the Canadian price factor.

▶ See page 1 for details.

# Sidewalk Lounge Seating Ottoman/Benches

DESIGN STUDIO B

► Specification Information, continued from previous page

**Specification Information**

Style Number	U.S. Base Prices										Leather Groups:		
	Fabric Groups:										COL		
	COM	1	2	3	4	5	6	7	8	9	10	1	2

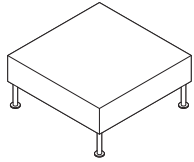

Overall: 36"D 36"W 17"H

## Ottoman

430-H3636	\$2161	\$2161	\$2245	\$2316	\$2400	\$2527	\$2683	\$2863	\$3052	\$3221	\$3400	\$2687	\$4731	\$5200
-----------	--------	--------	--------	--------	--------	--------	--------	--------	--------	--------	--------	--------	--------	--------

COM/yds = 2¾, COL/sq ft = 61

Lounge Seating

**For Canadian Pricing**  
 Multiply U.S. Price by the  
 Canadian price factor.  
 ► See page 1 for details.

# Sistema Lounge System General Overview

DESIGN LIEVORE ALTHERR MOLINA FOR VICCARBE

**Sistema lounge system** is an innovative modular system of fully customizable arms, backrest heights, base options, and accessories in the spirit of the modern sofa. With Sistema, build anything from a classic, high-back sofa to a sleek bench, a social sectional in any length, to a quiet niche for one or two.

**Lounges with leg bases** are available as 2- and 3-seat units that can be used on their own or together, for endless straight-run configurations. There is an ability to personalize with varying lounge, table, and leg choices.

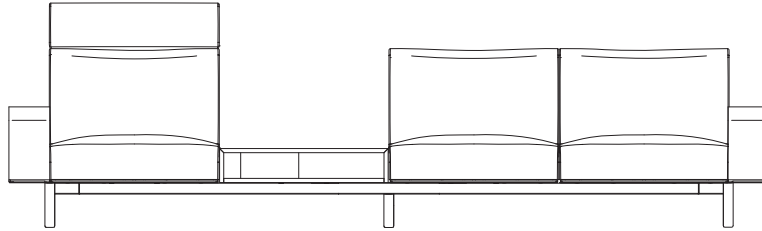

**Individual modular lounge components with fully-upholstered base** are available in a range of back height and arm choices. Integrated ganging device keeps units aligned.

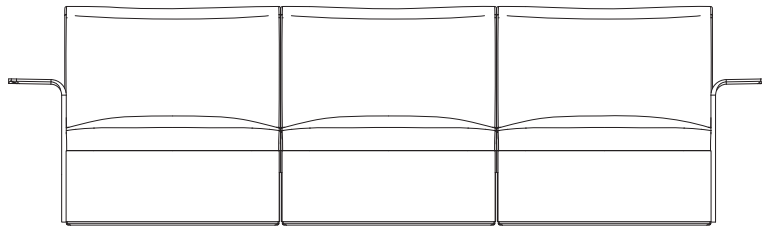

Coalesse

# Sistema Lounge System General Overview

DESIGN LIEVORE ALTHERR MOLINA FOR VICCARBE

# Sistema Lounge System Leg Base

DESIGN LIEVORE ALTHERR MOLINA FOR VICCARBE

**Lounge choices** include backless bench, low-, mid-, or high-back lounge components.

**Arm bolster** is user movable and can be positioned anywhere between lounge units. It provides arm support, boundary, or a landing place for mobile technology. Arm bolster is specified separately.

**End legs** are available in metal or wood choices. One set per each end is required. Legs are not included and must be ordered separately.

**Modular design** allows individual components to be easily repositioned or reconfigured on the frame by an installer.

**Backless bench**

**Upholstered and plywood arm options** are available. Arms can be specified at end locations only.

**In-line box table** includes cylinder cutout for storage. Cylinder can be specified in black or milk finishes. Slim table option is also available.

**Connector legs** gang 2- and 3-seat frames together. They are available in metal or wood options. Legs are not included and must be ordered separately.

Each position can be specified with varying lounge or table choices. Configuration shown: (2) 3-seat lounge frames with (1) connector leg and (2) end legs.

**Power module** is ordered separately and can be installed in the end positions on individual lounge units or centered between two units (as shown).

**1-seat connector lounge, leg base** is specified with a 5-seat configuration only. This unit connects (2) 2-seat frames together and positions the leg in a centered location. It can be specified with table or lounge and includes a connector frame and legs.

Each position can be specified with varying lounge or table choices. Configuration shown: (2) 2-seat lounge frames with 1-seat unit with legs and (2) end legs.

**In-line slim table**

Each position can be specified with varying lounge or table choices. Configuration shown: (2) 2-seat lounge frames with 1-seat unit with legs and (2) end legs.

# Sistema Lounge System Leg Base

DESIGN LIEVORE ALTHERR MOLINA FOR VICCARBE

## Product Details

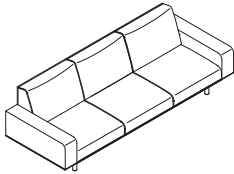
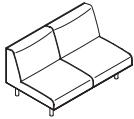

**Modular design** allows each component to be personalized with varying lounge and table choices. Create 2- and 3- seat lounges, or gang together to create endless straight configurations. Individual components are assembled to a welded steel frame. Lounge units ship installed to frame. Tables ship separately and are assembled in the field with four bolts. Lounge units ship facing same direction and can be easily flipped in the field to support yin-yang applications. Legs are ordered and shipped separately.

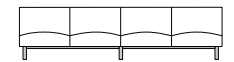

End Legs    Connector Legs    End Legs

**Connector legs** gang 2- and 3- seat frames together.

**End legs** are specified at the end positions of each configuration.

**Legs** are available in wood or metal finishes and are specified separately based on desired configuration.

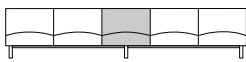

**1-seat connector lounge, leg base** is specified with a 5-seat configuration only. This unit connects two 2-seat lounge frames together and positions the leg in a centered location. It can be specified with table or lounge and includes a connector frame and legs.

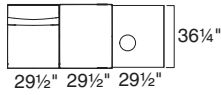

**Overall depth and width of each lounge and in-line table component** is the same due to its modular design, allowing units to be reconfigured. Overall depth is 36 1/4". Overall width of each unit is 29 1/2".

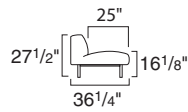

Low-back lounge

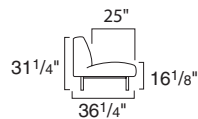

Mid-back lounge

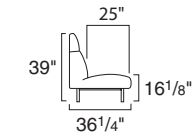

High-back lounge

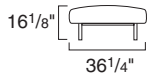

Backless bench

**Three backrest height options** unit are available (low, mid, or high back). A backless bench is also available. Seat depth on lounge chairs measures 25". Bench units have an overall depth of 36 1/4". Seat height is 16 1/8".

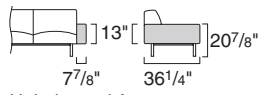

Upholstered Arm

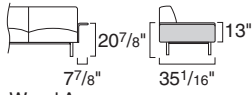

Wood Arm

**Upholstered and wood arms** are available. Arms can be specified in end positions only. Arms extend the overall width of the lounge unit by 7 7/8". Wood arms are one piece plywood with oak veneer.

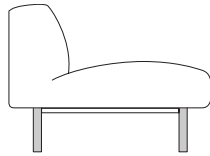

Cylinder legs, metal

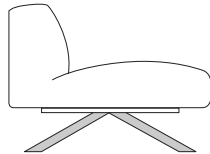

Scissor legs

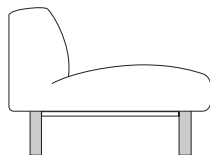

Cylinder legs, wood

**End and connector legs** are available in metal and wood choices; metal cylinder and scissor legs are available in painted finishes, and wood cylinder legs are solid oak. Cylinder legs offer 1/2" of adjustment. Legs are specified separately.

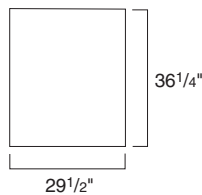

Slim table

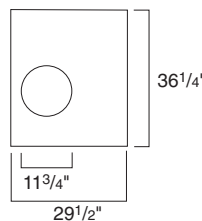

Box table

**In-line slim and box tables** are available. Tables are oak veneer with plywood core and exposed, stained edges. Box table has an 11 3/4" diameter cylinder cutout for storage. Cylinder is available in 6000 Black and 6052 Milk.

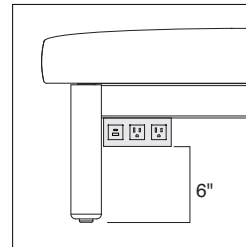

**Power modules** are ordered separately and installed in set positions under upholstered units only. USB C single 60W can charge tablets and laptops. Configurations available:

- (2) power, (1) USB A+C 20W port
- (1) power, (1) USB C single 60W

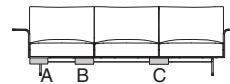

**Power modules** can be installed in set positions under upholstered units only.

- (A) Right position on individual lounge units.
- (B) Left position on individual lounge units.
- (C) Shared position between two lounge units facing the same direction.

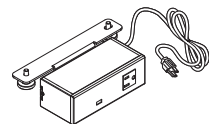
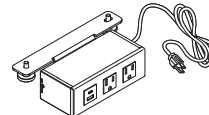

**Power modules** have a 72" L cord and contain wire manager clips to route cord under seat when desired.

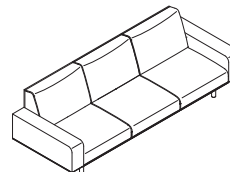

**Each component** is specified and can be ordered in contrasting fabrics, if desired.

## Surface Materials

### Seat and back on lounge

- Fabric
- Leather

### Arms on lounge

- Upholstered in fabric or leather
- Oak veneered plywood

### Legs

- Metal cylinder and painted steel legs
- Wood cylinder leg - solid oak
- Steel frame - painted in black

### Slim and box tables

- Oak veneered plywood
- Box table cylinder cutout - 6000 Black - 6052 Milk

### Arm bolster

- Upholstered in fabric or leather
- Metal fin is painted black

# Sistema Lounge System Fully-Upholstered Base

DESIGN LIEVORE ALTHERR MOLINA FOR VICCARBE

Individual modular lounge components with fully upholstered base are specified separately and include integrated ganging device to keep units aligned.

Lounges are available with three backrest height options: low, mid, or high back. Backless bench lounge is also available.

Lounges can be specified armless (bench), right or left arm, or with arms. Narrow and wide upholstered arm or wood arm is available.

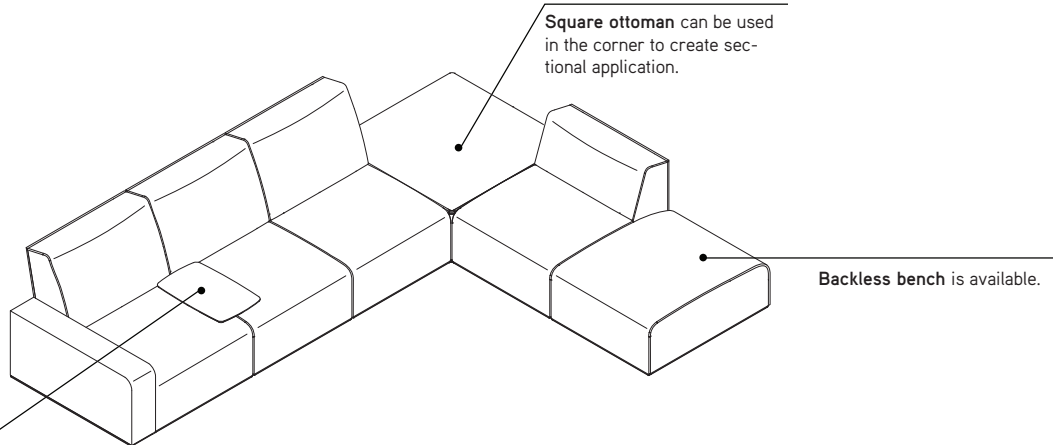

Moveable table is user movable and can be positioned anywhere between lounge components. Moveable table is ordered separately.

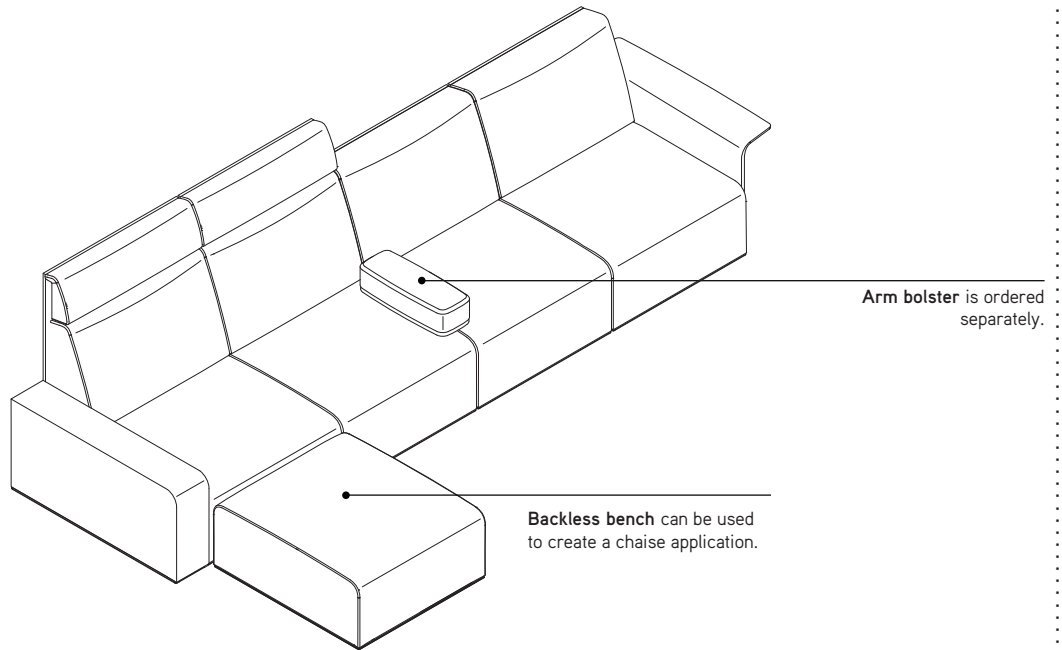

# Sistema Lounge System Fully-Upholstered Base

DESIGN LIEVORE ALTHERR MOLINA FOR VICCARBE

## Product Details

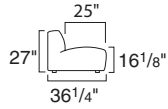
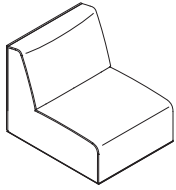

Low-back lounge

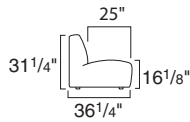
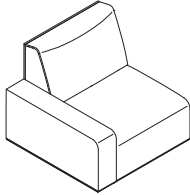

Mid-back lounge

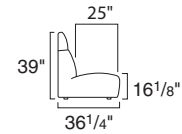
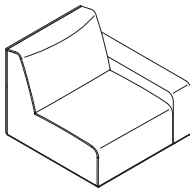

High-back lounge

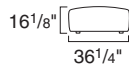
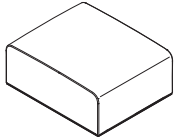

Backless bench

Three backrest height options are available: low, mid, or high back. A backless bench is also available. Seat depth on lounge chairs measures 25". Bench units have an overall depth of 36 1/4". Seat height is 16 1/8".

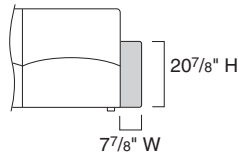
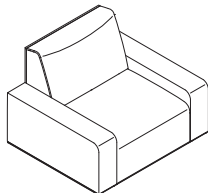

Upholstered narrow arm

Individual modular lounge components with fully upholstered base are specified separately and include integrated ganging device to keep units aligned. Three backrest height and three arm options are available. A backless bench is also available.

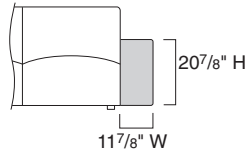

Upholstered wide arm

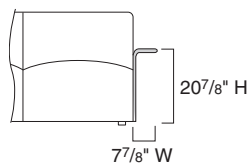

Wood Arm

Upholstered and wood arms are available. Arms can be specified on individual arm units on left or right side, or with two arms. Upholstered arms are available in narrow or wide options. Wood arms are one piece of plywood with oak veneer.

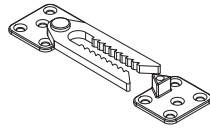

**Integrated ganging device** is included and keeps units aligned.

**Lounges** can be specified in contrasting upholstery, if desired.

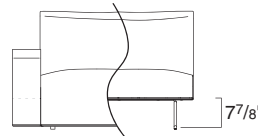

**Additional seam** will be included on arms when fabric is in horizontal/cross direction. The seam location aligns with the height of Sistema lounge with legs for visual connection.

## Ottomans and Accessories

**Accessories and ottomans** can be used across the entire Sistema product line to add a decorative touch and function.

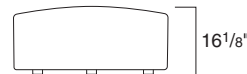

**Round and square ottomans** are available. Round ottoman is 36 1/4" in diameter. Square ottoman measures 36 1/4" x 36 1/4".



**Moveable table** is user movable and can be positioned anywhere between lounge units. Table measures 13"D x 20 1/2"L.

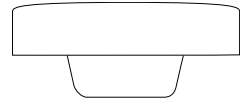

**Arm bolster** is user movable and can be positioned anywhere between lounge units. The upholstered unit provides arm support, boundary, or a landing place for mobile technology. Arm bolster measures 8 2/3"D x 20 1/2"L.



**Pillows** are a great way to elevate the design and comfort of any lounge setting. Square pillow measures 17 3/4"L x 17 3/4"H. The lumbar pillow is more firm to provide support and measures 20 2/3"L x 9 5/8"H.

## Surface Materials

### Seat and back on lounge

- Fabric
- Leather

### Arms on lounge

- Upholstered in fabric or leather
- Oak veneered plywood

### Moveable table

- Oak veneered plywood
- Wood fin matches table finish

### Arm bolster

- Upholstered in fabric or leather
- Metal fin is painted black

### Ottomans

- Upholstered in fabric or leather

### Pillows

- Upholstered in fabric or leather

# Sistema Lounge System 2- and 3-Seat Lounges, Leg Base

DESIGN LIEVORE ALTHERR MOLINA FOR VICCARBE

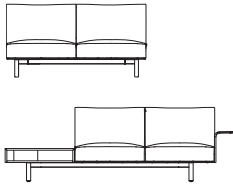

Tip: End legs are used with 2- and 3- seat lounge frames and are in the end location. One set per each end is required. Legs are not included and must be ordered separately.  
 ▶Page 239.

Tip: Lounge units ship installed to frame. Tables require field installation with four bolts.

Tip: Each position can be personalized with modular lounge or table component and is required to be specified. Specification starts with the right position, which is from the user seated position.

Standard Includes	Required to Specify
<ul style="list-style-type: none"> <li>• Lounge: constructed with finger-jointed plywood</li> <li>• Seat and back:                             <ul style="list-style-type: none"> <li>- Fabric or leather</li> <li>- Multiple densities of polyurethane foam and polyester fiber, web seat suspension</li> </ul> </li> <li>• Table, if selected: plywood core with oak wood veneer</li> <li>• Arms, if selected: upholstered or wood</li> <li>• Welded steel frame: black</li> </ul>	<ol style="list-style-type: none"> <li>1 Style number</li> <li>2 Position (see below under Required Selections)</li> <li>3 Fabric or leather color number for seat and back, if selected</li> <li>4 Wood color number for table, if selected</li> <li>5 Finish color number for arms, if selected</li> <li>6 Options, if selected (see below)</li> </ol> <p>▶See <i>Coalesse Surface Materials Reference Guide</i>.</p>

Position	Required Selections	U.S. Price	Required to Specify
2-seat lounge	• Bench		
	- Right position	Prices at right	Specify with <i>bench right position</i> and select fabric color number.
	- Left position	Prices at right	Specify with <i>bench left position</i> and select fabric color number.
	• Low-back lounge		
	- Right position	Prices at right	Specify with <i>low-back right position</i> and select fabric color number.
	- Left position	Prices at right	Specify with <i>low-back left position</i> and select fabric color number.
	• Mid-back lounge		
	- Right position	Prices at right	Specify with <i>mid-back right position</i> and select fabric color number.
	- Left position	Prices at right	Specify with <i>mid-back left position</i> and select fabric color number.
	• High-back lounge		
	- Right position	Prices at right	Specify with <i>high-back right position</i> and select fabric color number.
	- Left position	Prices at right	Specify with <i>high-back left position</i> and select fabric color number.
	• Table		
	- Right position	Prices at right	Specify with <i>table right position</i> and select wood color number.
- Left position	Prices at right	Specify with <i>table left position</i> and select wood color number.	
3-seat lounge	• Bench		
	- Right position	Prices at right	Specify with <i>bench right position</i> and select fabric color number.
	- Center position	Prices at right	Specify with <i>bench center position</i> and select fabric color number.
	- Left position	Prices at right	Specify with <i>bench left position</i> and select fabric color number.
	• Low-back lounge		
	- Right position	Prices at right	Specify with <i>low-back right position</i> and select fabric color number.
	- Center position	Prices at right	Specify with <i>low-back center position</i> and select fabric color number.
	- Left position	Prices at right	Specify with <i>low-back left position</i> and select fabric color number.
	• Mid-back lounge		
	- Right position	Prices at right	Specify with <i>mid-back right position</i> and select fabric color number.
	- Center position	Prices at right	Specify with <i>mid-back center position</i> and select fabric color number.
	- Left position	Prices at right	Specify with <i>mid-back left position</i> and select fabric color number.
	• High-back lounge		
	- Right position	Prices at right	Specify with <i>high-back right position</i> and select fabric color number.
- Center position	Prices at right	Specify with <i>high-back center position</i> and select fabric color number.	
- Left position	Prices at right	Specify with <i>high-back left position</i> and select fabric color number.	

▶Required Selections , continued on next page

 **For Canadian Pricing**  
 Multiply U.S. Price by the Canadian price factor.  
 ▶ See page 1 for details.

# Sistema Lounge System 2- and 3-Seat Lounges, Leg Base

DESIGN LIEVORE ALTHERR MOLINA FOR VICCARBE

*Tip: When selecting COM or COL, pricing is per each position.*

► Required Selections, continued from previous page

	Required Selections	U.S. Price	Required to Specify
<b>Position, continued</b>	• Table		
	– Right position	Prices at right	Specify with <i>table right position</i> and select wood color number.
	– Center position	Prices at right	Specify with <i>table center position</i> and select wood color number.
	– Left position	Prices at right	Specify with <i>table left position</i> and select wood color number.

	Options	U.S. Price	Required to Specify
<b>Surface Materials</b>	• Customer’s Own Material (COM)—per position	No cost	Specify with <i>COM</i> and select fabric color number.
	• Customer’s Own Leather (COL)—per position	+\$ 197	Specify with <i>COL</i> and select fabric color number.
	<b>Acrylic backer—entire product</b>		
	• 2-seat lounge	+\$ 88	Specify with <i>acrylic backer</i> .
	• 3-seat lounge	+\$ 136	Specify with <i>acrylic backer</i> .
	• Fabric upcharges	Prices at right	Specify fabric color number.

<b>Arm Type</b>	<b>Arm—if selected, per arm</b>		
	• Upholstery	+\$ 647	Specify with <i>upholstered arm</i> and select fabric color number.
	• Wood veneer group 1	+\$1357	Specify with <i>wood arm</i> and select wood veneer group 1 color number.
	• Wood veneer group 2	+\$1490	Specify with <i>wood arm</i> and select wood veneer group 2 color number.

<b>Related Products</b>	• End and connector legs		► Page 239
	• 1-seat connector lounge		► Page 240
	• Arm bolster		► Page 249
	• Moveable table		► Page 250
	• Ottomans		► Page 248
	• Pillows		► Page 251
	• Power module		► Page 242

► Specification Information on next page

 **For Canadian Pricing**  
Multiply U.S. Price by the Canadian price factor.  
► See page 1 for details.

# Sistema Lounge System 2- and 3-Seat Lounges, Leg Base *continued*

DESIGN LIEVORE ALTHERR MOLINA FOR VICCARBE

► Options on previous page

## Specification Information

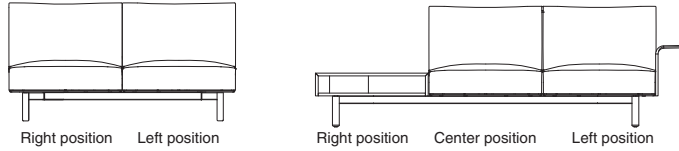

\*Legs are not included and must be ordered separately.

Tip: Each position can be personalized with modular lounge or table component.

Tip: Start with 2- or 3-seat lounge frame and then specify each position.

Tip: For upholstered components with COM, use the base price and add COM upcharge for each position it applies.

Tip: Cylinder cutout on box table can be specified in 6000 Black or 6052 Milk.

Tip: End and connector legs must be specified separately.

Tip: Comfort wrinkles are intended to occur over time with upholstered fabrics and leathers.

Style Number	U.S. Base Price (Frame)	Options (Add \$ to Base Price)							
		Per position upcharges:							
		Bench	Low-Back Lounge	Mid-Back Lounge	High-Back Lounge	Slim Table Wood Veneer Group 1	Slim Table Wood Veneer Group 2	Box Table Wood Veneer Group 1	Box Table Wood Veneer Group 2

### 2-Seat Lounge Frame, Leg Base

COSISL2	\$447	+\$1241	+\$1697	+\$1773	+\$1962	+\$2277	+\$2454	+\$3794	+\$4092
---------	-------	---------	---------	---------	---------	---------	---------	---------	---------

### 3-Seat Lounge Frame, Leg Base

COSISL3	\$600	+\$1241	+\$1697	+\$1773	+\$1962	+\$2277	+\$2454	+\$3794	+\$4092
---------	-------	---------	---------	---------	---------	---------	---------	---------	---------

### Fabric Upcharges

	Fabric Groups:										Leather Groups:	
	1	2	3	4	5	6	7	8	9	10	1	2
<b>Bench</b>	+\$35	+\$64	+\$119	+\$183	+\$280	+\$399	+\$536	+\$682	+\$ 809	+\$ 946	+\$736	+\$1543
<b>Low-Back Lounge</b>												
Seat	+\$35	+\$64	+\$119	+\$183	+\$280	+\$399	+\$536	+\$682	+\$ 809	+\$ 946	+\$680	+\$1451
Back	+\$44	+\$81	+\$149	+\$228	+\$349	+\$499	+\$670	+\$851	+\$1012	+\$1183	+\$625	+\$1338
<b>Mid-Back Lounge</b>												
Seat	+\$35	+\$64	+\$119	+\$183	+\$280	+\$399	+\$536	+\$682	+\$ 809	+\$ 946	+\$680	+\$1451
Back	+\$44	+\$81	+\$149	+\$228	+\$349	+\$499	+\$670	+\$851	+\$1012	+\$1183	+\$699	+\$1489
<b>High-Back Lounge</b>												
Seat	+\$35	+\$64	+\$119	+\$183	+\$280	+\$399	+\$536	+\$682	+\$ 809	+\$ 946	+\$680	+\$1451
Back	+\$44	+\$81	+\$149	+\$228	+\$349	+\$499	+\$670	+\$851	+\$1012	+\$1183	+\$925	+\$1939

<b>Upholstered Arm</b>	+\$31	+\$57	+\$104	+\$160	+\$245	+\$349	+\$469	+\$596	+\$ 708	+\$ 828	+\$415	+\$ 501
------------------------	-------	-------	--------	--------	--------	--------	--------	--------	---------	---------	--------	---------

COM: Seat: 2 yards/ 41 sq ft, Low back: 2½ yards/ 38 sq ft, Mid back: 2½ yards/ 42 sq ft, High back: 2½ yards/ 54 sq ft, Bench: 2 yards/ 43 sq ft, Upholstered arm: 1¾ yards/ 39 sq ft

Tip: For upholstered arm fabric group pricing, add upcharge to arm option.



**For Canadian Pricing**  
Multiply U.S. Price by the Canadian price factor.

► See page 1 for details.

# Sistema Lounge System End Legs and Connector Frame

DESIGN LIEVORE ALTHERR MOLINA FOR VICCARBE

*Tip: End legs and connector frame are used with 2- and 3-seat lounge frames.*

Standard Includes	Required to Specify
<ul style="list-style-type: none"> <li>▶ Need help? Product details, page 230</li> <li>• Frame: black steel</li> <li>• Cylinder metal legs: group 1 paint</li> <li>• Ship ready-to-assemble and connect to 2- and 3-seat lounge frames</li> </ul>	<ul style="list-style-type: none"> <li>1 Style number</li> <li>2 Paint color number for legs</li> <li>3 Options, if selected (see below)</li> <li>▶ See <i>Coalesse Surface Materials Reference Guide</i>.</li> </ul>

Leg Type	Options	U.S. Price	Required to Specify
	<b>Cylinder metal legs</b>		
	• Group 1 paint	No cost	Specify <i>with cylinder metal legs</i> and select paint color number.
	• Group 3 paint	+\$ 59	Specify <i>with cylinder metal legs</i> and select paint color number.
	<b>Scissor metal legs</b>		
	• Group 1 paint	+\$ 23	Specify <i>with scissor metal legs</i> and select paint color number.
	• Group 3 paint	+\$ 82	Specify <i>with scissor metal legs</i> and select paint color number.
	<b>Cylinder wood legs</b>		
	• Wood veneer group 1	+\$152	Specify <i>with cylinder wood</i> and select wood veneer group 1 color number.
	• Wood veneer group 2	+\$189	Specify <i>with cylinder wood</i> and select wood veneer group 2 color number.
<b>Related Products</b>	• 2- and 3-seat lounge frames		▶ Page 236

### Specification Information

Style Number	U.S. Base Price
--------------	-----------------

### End Legs

COSISEL	\$303
---------	-------

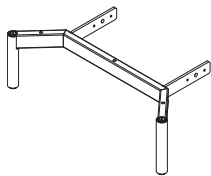

*Tip: End legs are used with 2- and 3- seat lounge frames and are in the end location. One per each end is required.*

### Connector Frame with Legs

COSISGL	\$418
---------	-------

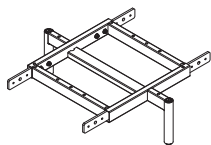

*Tip: Connector frame is used to gang 2- and 3- seat lounge frames together. Legs are included.*

**For Canadian Pricing**  
 Multiply U.S. Price by the Canadian price factor.  
 ▶ See page 1 for details.

# Sistema Lounge System 1-Seat Connector Lounge, Leg Base

DESIGN LIEVORE ALTHERR MOLINA FOR VICCARBE

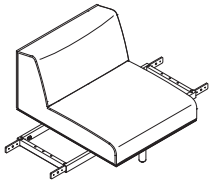

Tip: 1-seat connector lounge is used for a 5-seat lounge configuration only. It is the center unit and gangs two 2-seat frames together.

	Standard Includes	Required to Specify
► Need help? Product details, page 232	<ul style="list-style-type: none"> <li>Lounge, center position: constructed with finger-jointed plywood</li> <li>Seat and back, if selected:                             <ul style="list-style-type: none"> <li>Fabric or leather</li> <li>Multiple densities of polyurethane foam and polyester fiber, web seat suspension</li> </ul> </li> <li>Table, if selected: plywood core with oak wood veneer</li> <li>Steel connector frame: black</li> <li>Cylinder metal legs: group 1 paint</li> <li>Ships ready-to-assemble</li> </ul>	<ol style="list-style-type: none"> <li>Style number</li> <li>Position (see below under Required Selections)</li> <li>Fabric or leather color number for seat and back, if selected</li> <li>Wood color number for table, if selected</li> <li>Paint number for legs</li> <li>Options, if selected (see below)</li> </ol> <p>► See <i>Coalesse Surface Materials Reference Guide</i>.</p>

	Required Selections	U.S. Price	Required to Specify
<b>Position</b>	<b>1-seat lounge</b> <ul style="list-style-type: none"> <li>Bench                             <ul style="list-style-type: none"> <li>Center position</li> </ul> </li> <li>Low-back lounge                             <ul style="list-style-type: none"> <li>Center position</li> </ul> </li> <li>Mid-back lounge                             <ul style="list-style-type: none"> <li>Center position</li> </ul> </li> <li>High-back lounge                             <ul style="list-style-type: none"> <li>Center position</li> </ul> </li> <li>Table                             <ul style="list-style-type: none"> <li>Center position</li> </ul> </li> </ul>	<ul style="list-style-type: none"> <li>Prices at right</li> <li>Prices at right</li> <li>Prices at right</li> <li>Prices at right</li> <li>Prices at right</li> </ul>	<ul style="list-style-type: none"> <li>Specify with <i>bench center position</i> and select fabric color number.</li> <li>Specify with <i>low-back center position</i> and select fabric color number.</li> <li>Specify with <i>mid-back center position</i> and select fabric color number.</li> <li>Specify with <i>high-back center position</i> and select fabric color number.</li> <li>Specify with <i>table center position</i> and select fabric color number.</li> </ul>

	Options	U.S. Price	Required to Specify
<b>Surface Materials</b>	<ul style="list-style-type: none"> <li>Customer's Own Material (COM)</li> <li>Customer's Own Leather (COL)</li> </ul>	<ul style="list-style-type: none"> <li>No cost</li> <li>+\$197</li> </ul>	<ul style="list-style-type: none"> <li>Specify with <i>COM</i> and select fabric color number.</li> <li>Specify with <i>COL</i> and select fabric color number.</li> </ul>
	<ul style="list-style-type: none"> <li>Acrylic backer—entire product</li> <li>Fabric upcharges</li> </ul>	<ul style="list-style-type: none"> <li>+\$ 47</li> <li>Prices at right</li> </ul>	<ul style="list-style-type: none"> <li>Specify with <i>acrylic backer</i>.</li> <li>Specify fabric color number.</li> </ul>
<b>Leg Type</b>	<b>Cylinder metal legs</b> <ul style="list-style-type: none"> <li>Group 1 paint</li> <li>Group 3 paint</li> </ul> <b>Scissor metal legs</b> <ul style="list-style-type: none"> <li>Group 1 paint</li> <li>Group 3 paint</li> </ul> <b>Cylinder wood legs</b> <ul style="list-style-type: none"> <li>Wood veneer group 1</li> <li>Wood veneer group 2</li> </ul>	<ul style="list-style-type: none"> <li>No cost</li> <li>+\$ 59</li> <li>+\$ 23</li> <li>+\$ 82</li> <li>+\$152</li> <li>+\$189</li> </ul>	<ul style="list-style-type: none"> <li>Specify with <i>cylinder metal legs</i> and select paint color number.</li> <li>Specify with <i>cylinder metal legs</i> and select paint color number.</li> <li>Specify with <i>scissor metal legs</i> and select paint color number.</li> <li>Specify with <i>scissor metal legs</i> and select paint color number.</li> <li>Specify with <i>cylinder wood</i> and select wood veneer group 1 color number.</li> <li>Specify with <i>cylinder wood</i> and select wood veneer group 2 color number.</li> </ul>
<b>Related Products</b>	<ul style="list-style-type: none"> <li>2- and 3-seat lounge frames</li> <li>Power module</li> </ul>		<ul style="list-style-type: none"> <li>► Page 236</li> <li>► Page 242</li> </ul>



**For Canadian Pricing**  
Multiply U.S. Price by the Canadian price factor.  
► See page 1 for details.

# Sistema Lounge System 1-Seat Connector Lounge, Leg Base

DESIGN LIEVORE ALTHERR MOLINA FOR VICCARBE

Tip: Start with connector frame base price and then specify lounge or table and any options.

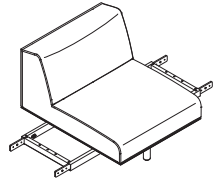

Tip: Cylinder cutout box table can be specified in 6052 Milk or 6000 Black.

Tip: For upholstered connectors with COM, use the base price and add COM upcharge.

Tip: Comfort wrinkles are intended to occur over time with upholstered fabrics and leathers.

## Specification Information

Style Number	U.S. Base Price (Frame)	Options (Add \$ to Base Price)							
		Per position upcharges:							
		Bench	Low-Back Lounge	Mid-Back Lounge	High-Back Lounge	Slim Table Wood Veneer Group 1	Slim Table Wood Veneer Group 2	Box Table Wood Veneer Group 1	Box Table Wood Veneer Group 2

## 1-Seat Connector Lounge Frame, Leg Base

COSISL1	\$379	+\$1241	+\$1697	+\$1773	+\$1962	+\$2277	+\$2454	+\$3794	+\$4092
---------	-------	---------	---------	---------	---------	---------	---------	---------	---------

## Fabric Upcharges

Style	Fabric Groups:										Leather Groups:	
	1	2	3	4	5	6	7	8	9	10	1	2
<b>Bench</b>	+\$35	+\$64	+\$119	+\$183	+\$280	+\$399	+\$536	+\$682	+\$ 809	+\$ 946	+\$736	+\$1543
<b>Low-Back Lounge</b>												
Seat	+\$35	+\$64	+\$119	+\$183	+\$280	+\$399	+\$536	+\$682	+\$ 809	+\$ 946	+\$680	+\$1451
Back	+\$44	+\$81	+\$149	+\$228	+\$349	+\$499	+\$670	+\$851	+\$1012	+\$1183	+\$625	+\$1338
<b>Mid-Back Lounge</b>												
Seat	+\$35	+\$64	+\$119	+\$183	+\$280	+\$399	+\$536	+\$682	+\$ 809	+\$ 946	+\$680	+\$1451
Back	+\$44	+\$81	+\$149	+\$228	+\$349	+\$499	+\$670	+\$851	+\$1012	+\$1183	+\$699	+\$1489
<b>High-Back Lounge</b>												
Seat	+\$35	+\$64	+\$119	+\$183	+\$280	+\$399	+\$536	+\$682	+\$ 809	+\$ 946	+\$680	+\$1451
Back	+\$44	+\$81	+\$149	+\$228	+\$349	+\$499	+\$670	+\$851	+\$1012	+\$1183	+\$925	+\$1939

COM: Seat: 2 yards/ 41 sq ft, Low back: 2½ yards/ 38 sq ft, Mid back: 2½ yards/ 42 sq ft, High back: 2½ yards/ 54 sq. ft, Bench: 2 yards/ 43 sq ft.

 **For Canadian Pricing**  
 Multiply U.S. Price by the Canadian price factor.  
 ▶ See page 1 for details.

# Sistema Lounge System Power Module for Lounge, Leg Base

DESIGN LIEVORE ALTHERR MOLINA FOR VICCARBE

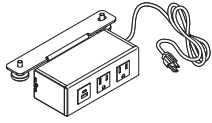

*Tip: Cannot be installed under tables.*

*Tip: Can be installed in pre-defined locations on leg base lounges.*

*Tip: USB C single 60W delivers more power and capability to charge larger devices like laptops.*

Standard Includes	Required to Specify
<ul style="list-style-type: none"> <li>▶ Need help? Product details, page 233</li> <li>• Installation hardware and wire manager clips</li> <li>• Power cord: 72" L</li> <li>• Power configuration: two power, one USB A dual port</li> </ul>	<ul style="list-style-type: none"> <li>1 Style number</li> <li>2 Options, if selected (see below)</li> <li>▶ See <i>Coalesse Surface Materials Reference Guide</i>.</li> </ul>

Options	U.S. Price	Required to Specify
<b>Power Configuration</b> <ul style="list-style-type: none"> <li>• One power, one USB C single 60W</li> </ul>	+\$140	Specify with one power, one USB C.
<b>Related Products</b> <ul style="list-style-type: none"> <li>• 2- and 3-seat lounge frames</li> <li>• 1-seat connector lounge</li> </ul>		<ul style="list-style-type: none"> <li>▶ Page 236</li> <li>▶ Page 240</li> </ul>

Specification Information	
Style Number	U.S. Base Price
COSISPWR	\$631



**For Canadian Pricing**  
 Multiply U.S. Price by the Canadian price factor.  
 ▶ See page 1 for details.

Coalesse

# Sistema Lounge System

Power Module for Lounge, Leg Base

DESIGN LIEVORE ALTHERR MOLINA FOR VICCARBE

# Sistema Lounge System Fully-Upholstered Base

DESIGN LIEVORE ALTHERR MOLINA FOR VICCARBE

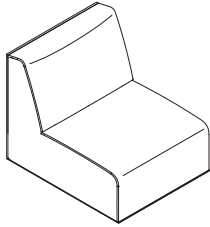

	Standard Includes	Required to Specify
<p>► Need help? Product details, page 234</p>	<ul style="list-style-type: none"> <li>Lounge: constructed with finger-jointed plywood</li> <li>Seat and back:                             <ul style="list-style-type: none"> <li>- Fabric or leather</li> <li>- Multiple densities of polyurethane foam and polyester fiber, web seat suspension</li> </ul> </li> <li>Upholstered arm, if selected: fabric</li> <li>Glides: 1/2" of adjustment</li> <li>Integrated ganging device</li> <li>Ships assembled</li> </ul>	<ol style="list-style-type: none"> <li>Style number</li> <li>Fabric or leather color number for seat and back</li> <li>Fabric or leather color number for arm, if selected</li> <li>Options, if selected (see below)</li> </ol> <p>► See <i>Coalesse Surface Materials Reference Guide</i>.</p>

	Options	U.S. Price	Required to Specify
<b>Surface Materials</b>	• Customer's Own Material (COM)	No cost	Specify with <i>COM</i> and select fabric color number.
	• Customer's Own Leather (COL)	+\$197	Specify with <i>COL</i> and select fabric color number.
	• Acrylic backer	+\$ 47	Specify with <i>acrylic backer</i> .
	• Fabric upcharges • Fabric upcharges	Prices at right Prices at right	Specify fabric color number. Specify fabric color number.
<b>Lounge Back Height</b>	• Low-back lounge height	No cost	Specify with <i>low-back lounge height</i> .
	• Mid-back lounge height	+\$ 78	Specify with <i>mid-back lounge height</i> .
	• High-back lounge height	+\$265	Specify with <i>high-back lounge height</i> .
<b>Arm Type</b>	<b>Arm—if lounge chair with arm(s) selected, per arm</b>		
	• Upholstered arm	No cost	Specify with <i>upholstered arm</i> and select fabric color number.
	• Wide, upholstered arm	+\$ 37	Specify with <i>wide upholstered arm</i> and select fabric color number.
	• Wood veneer group 1	+\$865	Specify with <i>wood arm</i> and select wood veneer group 1 color number.
	• Wood veneer group 2	+\$998	Specify with <i>wood arm</i> and select wood veneer group 2 color number.
<b>Related Products</b>	<ul style="list-style-type: none"> <li>Arm bolster</li> <li>Moveable table</li> <li>Ottomans</li> <li>Pillows</li> </ul>	<ul style="list-style-type: none"> <li>► Page 249</li> <li>► Page 250</li> <li>► Page 248</li> <li>► Page 251</li> </ul>	



**For Canadian Pricing**  
 Multiply U.S. Price by the Canadian price factor.  
 ► See page 1 for details.

# Sistema Lounge System Fully-Upholstered Base

DESIGN LIEVORE ALTHERR MOLINA FOR VICCARBE

## Specification Information

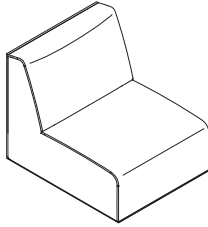

**Overall:** 29<sup>1</sup>/<sub>2</sub>"W x 36<sup>1</sup>/<sub>4</sub>"D  
**Low back:** 27<sup>1</sup>/<sub>2</sub>"H  
**Mid back:** 31<sup>1</sup>/<sub>4</sub>"H  
**High back:** 39"H  
**Seat height:** 16<sup>1</sup>/<sub>8</sub>"  
**Seat depth:** 25"

**Style Number**                      **U.S. Base Price**

### Lounge Chair, Armless

**COSISLC**                      \$1697

#### Fabric Upcharges

	Fabric Groups:										Leather Groups:	
	1	2	3	4	5	6	7	8	9	10	1	2
Seat	+\$35	+\$64	+\$119	+\$183	+\$280	+\$399	+\$536	+\$682	+\$ 809	+\$ 946	+\$680	+\$1451
Low Back	+\$44	+\$81	+\$149	+\$228	+\$349	+\$499	+\$670	+\$851	+\$1012	+\$1183	+\$625	+\$1338
Mid Back	+\$44	+\$81	+\$149	+\$228	+\$349	+\$499	+\$670	+\$851	+\$1012	+\$1183	+\$699	+\$1489
High Back	+\$44	+\$81	+\$149	+\$228	+\$349	+\$499	+\$670	+\$851	+\$1012	+\$1183	+\$925	+\$1939

*Tip: Comfort wrinkles are intended to occur over time with upholstered fabrics and leathers.*

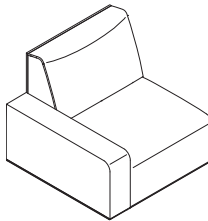

**Overall:** 37<sup>1</sup>/<sub>3</sub>"W x 36<sup>1</sup>/<sub>4</sub>"D  
**Low back:** 27<sup>1</sup>/<sub>2</sub>"H  
**Mid back:** 31<sup>1</sup>/<sub>4</sub>"H  
**High back:** 39"H  
**Seat height:** 16<sup>1</sup>/<sub>8</sub>"  
**Seat depth:** 25"

### Lounge Chair, Right Arm

**COSIS1R**                      \$2991

#### Fabric Upcharges

	Fabric Groups:										Leather Groups:	
	1	2	3	4	5	6	7	8	9	10	1	2
Seat	+\$35	+\$64	+\$119	+\$183	+\$280	+\$399	+\$536	+\$682	+\$ 809	+\$ 946	+\$680	+\$1451
Low Back	+\$44	+\$81	+\$149	+\$228	+\$349	+\$499	+\$670	+\$851	+\$1012	+\$1183	+\$625	+\$1338
Mid Back	+\$44	+\$81	+\$149	+\$228	+\$349	+\$499	+\$670	+\$851	+\$1012	+\$1183	+\$699	+\$1489
High Back	+\$44	+\$81	+\$149	+\$228	+\$349	+\$499	+\$670	+\$851	+\$1012	+\$1183	+\$925	+\$1939
Upholstered Arm	+\$31	+\$57	+\$104	+\$160	+\$245	+\$349	+\$469	+\$596	+\$ 708	+\$ 828	+\$670	+\$1402
Wide, Upholstered Arm	+\$35	+\$64	+\$119	+\$183	+\$280	+\$399	+\$536	+\$682	+\$ 809	+\$ 946	+\$708	+\$1478

*Tip: Overall width on lounge chair with wide upholstered arm is 41<sup>1</sup>/<sub>3</sub>".*

*Tip: For upholstered or fabric grade pricing, add upcharge to arm option.*

 **For Canadian Pricing**  
 Multiply U.S. Price by the Canadian price factor.  
 ▶ See page 1 for details.

▶ Specification Information, continued on next page

# Sistema Lounge System Fully-Upholstered Base *continued*

DESIGN LIEVORE ALTHERR MOLINA FOR VICCARBE

► Specification Information, continued from previous page

## Specification Information

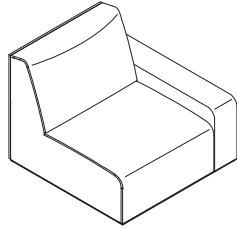

**Overall:** 37<sup>1</sup>/<sub>3</sub>"W x 36<sup>1</sup>/<sub>4</sub>"D  
**Low back:** 27<sup>1</sup>/<sub>2</sub>"H  
**Mid back:** 31<sup>1</sup>/<sub>4</sub>"H  
**High back:** 39"H  
**Seat height:** 16<sup>1</sup>/<sub>8</sub>"  
**Seat depth:** 25"

**Style Number**                      **U.S. Base Price**

### Lounge Chair, Left Arm

**COSIS1L**                      \$2991

#### Fabric Upcharges

	Fabric Groups:										Leather Groups:	
	1	2	3	4	5	6	7	8	9	10	1	2
Seat	+\$35	+\$64	+\$119	+\$183	+\$280	+\$399	+\$536	+\$682	+\$ 809	+\$ 946	+\$680	+\$1451
Low Back	+\$44	+\$81	+\$149	+\$228	+\$349	+\$499	+\$670	+\$851	+\$1012	+\$1183	+\$625	+\$1338
Mid Back	+\$44	+\$81	+\$149	+\$228	+\$349	+\$499	+\$670	+\$851	+\$1012	+\$1183	+\$699	+\$1489
High Back	+\$44	+\$81	+\$149	+\$228	+\$349	+\$499	+\$670	+\$851	+\$1012	+\$1183	+\$925	+\$1939
Upholstered Arm	+\$31	+\$57	+\$104	+\$160	+\$245	+\$349	+\$469	+\$596	+\$ 708	+\$ 828	+\$670	+\$1402
Wide, Upholstered Arm	+\$35	+\$64	+\$119	+\$183	+\$280	+\$399	+\$536	+\$682	+\$ 809	+\$ 946	+\$708	+\$1478

*Tip: Comfort wrinkles are intended to occur over time with upholstered fabrics and leathers.*

*Tip: Overall width on lounge chair with wide upholstered arm is 41<sup>1</sup>/<sub>8</sub>".*

*Tip: For upholstered or fabric grade pricing, add upcharge to arm option.*

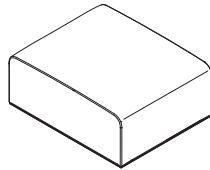

**Overall:** 29<sup>1</sup>/<sub>2</sub>"W x 36<sup>1</sup>/<sub>4</sub>"D x 16<sup>1</sup>/<sub>8</sub>"H

### Backless Bench Lounge

**COSISBN**                      \$1379

#### Fabric Upcharges

	Fabric Groups:										Leather Groups:	
	1	2	3	4	5	6	7	8	9	10	1	2
Bench	No cost	+\$64	+\$119	+\$183	+\$280	+\$399	+\$536	+\$682	+\$ 809	+\$ 946	+\$783	+\$1628

► Specification Information, continued on next page



**For Canadian Pricing**  
 Multiply U.S. Price by the  
 Canadian price factor.  
 ► See page 1 for details.

# Sistema Lounge System Fully-Upholstered Base

DESIGN LIEVORE ALTHERR MOLINA FOR VICCARBE

► Specification Information, continued from previous page

## Specification Information

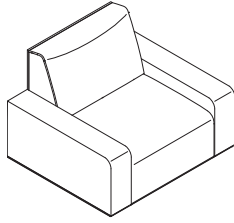

**Overall:** 45<sup>1</sup>/<sub>4</sub>"W x 36<sup>1</sup>/<sub>4</sub>"D  
**Low back:** 27<sup>1</sup>/<sub>2</sub>"H  
**Mid back:** 31<sup>1</sup>/<sub>4</sub>"H  
**High back:** 39"H  
**Seat height:** 16<sup>1</sup>/<sub>8</sub>"  
**Seat depth:** 25"

**Style**                      **U.S. Base**  
**Number**                    **Price**

### Lounge Chair, with Arms

**COSIS2A**                      \$2991

*Tip: Comfort wrinkles are intended to occur over time with upholstered fabrics and leathers.*

*Tip: Overall width on lounge chair with wide upholstered arm is 41<sup>1</sup>/<sub>3</sub>".*

### Fabric Upcharges

	Fabric Groups:										Leather Groups:	
	1	2	3	4	5	6	7	8	9	10	1	2
Seat	+\$35	+\$ 64	+\$119	+\$183	+\$280	+\$399	+\$ 536	+\$ 682	+\$ 809	+\$ 946	+\$ 680	+\$1451
Low Back	+\$44	+\$ 81	+\$149	+\$228	+\$349	+\$499	+\$ 670	+\$ 851	+\$1012	+\$1183	+\$ 625	+\$1338
Mid Back	+\$44	+\$ 81	+\$149	+\$228	+\$349	+\$499	+\$ 670	+\$ 851	+\$1012	+\$1183	+\$ 699	+\$1489
High Back	+\$44	+\$ 81	+\$149	+\$228	+\$349	+\$499	+\$ 670	+\$ 851	+\$1012	+\$1183	+\$ 925	+\$1939
Upholstered Arm	+\$61	+\$114	+\$209	+\$321	+\$490	+\$698	+\$ 939	+\$1192	+\$1416	+\$1656	+\$1340	+\$2804
Wide, Upholstered Arm	+\$70	+\$129	+\$238	+\$365	+\$559	+\$798	+\$1072	+\$1363	+\$1618	+\$1893	+\$1416	+\$2956

**COM:** Seat: 2 yards/ 44 sq ft, Low back: 2<sup>1</sup>/<sub>2</sub> yards/ 45 sq ft, Mid back: 2<sup>1</sup>/<sub>2</sub> yards/ 49 sq ft, High back: 2<sup>1</sup>/<sub>2</sub> yards/ 54 sq ft, Bench: 2 yards/ 45 sq ft, Upholstered arm: 1<sup>3</sup>/<sub>4</sub> yards/ 39 sq ft, Wide upholstered arm: 2 yards/ 41 sq ft

*Tip: For upholstered or fabric grade pricing, add upcharge to arm option.*



**For Canadian Pricing**  
 Multiply U.S. Price by the Canadian price factor.  
 ► See page 1 for details.

# Sistema Lounge System Ottomans and Accessories

DESIGN LIEVORE ALTHERR MOLINA FOR VICCARBE

## Ottomans

*Tip: Ottomans and accessories complement the entire Sistema lounge system.*

Standard Includes	Required to Specify
<p>► Need help? Product details, page 234</p> <ul style="list-style-type: none"> <li>Ottoman frame: constructed with finger jointed plywood</li> <li>Ottoman upholstery: multiple densities of polyurethane foam and polyester fiber with web seat suspension</li> <li>Ottoman glide: 1/2" of adjustment</li> <li>Integrated ganging device, if square ottoman selected</li> <li>Ships assembled</li> </ul>	<ul style="list-style-type: none"> <li>1 Style number</li> <li>2 Fabric or leather color number</li> <li>3 Options, if selected (see below)</li> </ul> <p>► See <i>Coalesse Surface Materials Reference Guide</i>.</p>

Options	U.S. Price	Required to Specify
<p><b>Surface Materials</b></p> <ul style="list-style-type: none"> <li>Customer's Own Leather (COL)</li> </ul>	+\$196	Specify with COL and select fabric color number.
<p><b>Acrylic backer</b></p> <ul style="list-style-type: none"> <li>Round or square ottoman</li> </ul>	+\$ 47	Specify with acrylic backer.
<p><b>Related Products</b></p> <ul style="list-style-type: none"> <li>2- and 3-seat lounge</li> <li>1-seat connector lounge</li> <li>Lounge chairs</li> </ul>		<ul style="list-style-type: none"> <li>► Page 236</li> <li>► Page 240</li> <li>► Page 244</li> </ul>

### Specification Information

Style Number	U.S. Base Prices										Leather Groups:	
	Fabric Groups:										1	2
COM	1	2	3	4	5	6	7	8	9	10	1	2

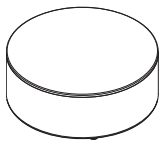

Overall: 36 1/4" Dia x 16 1/8" H

### Round Ottoman

COSISOR	\$1650	\$1650	\$1731	\$1799	\$1878	\$1999	\$2149	\$2320	\$2501	\$2662	\$2833	\$2527	\$3466
---------	--------	--------	--------	--------	--------	--------	--------	--------	--------	--------	--------	--------	--------

COM: 2 1/4 yards/ 50 sq ft.

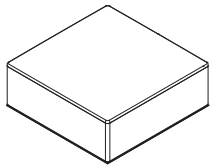

Overall: 36 1/4" W x 36 1/4" D x 16 1/8" H

### Square Ottoman

COSISOS	\$1672	\$1672	\$1778	\$1865	\$1968	\$2126	\$2320	\$2542	\$2779	\$2987	\$3209	\$2721	\$3884
---------	--------	--------	--------	--------	--------	--------	--------	--------	--------	--------	--------	--------	--------

COM: 3 1/4 yards/ 62 sq ft.

*Tip: Integrated ganging device included on square ottoman to gang to lounge chair in corner application.*



**For Canadian Pricing**  
 Multiply U.S. Price by the Canadian price factor.  
 ► See page 1 for details.

# Sistema Lounge System Ottomans and Accessories

DESIGN LIEVORE ALTHERR MOLINA FOR VICCARBE

## Arm Bolster, Moveable



Standard Includes		Required to Specify
<ul style="list-style-type: none"> <li>▶ Need help? Product details, page 234</li> </ul>	<ul style="list-style-type: none"> <li>• Arm bolster: upholstered with painted black metal fin</li> </ul>	<ul style="list-style-type: none"> <li>1 Style number</li> <li>2 Fabric or leather color number</li> <li>3 Options, if selected (see below)</li> <li>▶ See <i>Coalesse Surface Materials Reference Guide</i>.</li> </ul>

Options	U.S. Price	Required to Specify
<b>Surface Materials</b> <ul style="list-style-type: none"> <li>• Customer's Own Leather (COL)</li> </ul>	+\$196	Specify with COL and select fabric color number.
<ul style="list-style-type: none"> <li>• Acrylic backer</li> </ul>	+\$ 11	Specify with acrylic backer.
<b>Related Products</b> <ul style="list-style-type: none"> <li>• 2- and 3-seat lounge</li> <li>• 1-seat connector lounge</li> <li>• Lounge chairs</li> </ul>		<ul style="list-style-type: none"> <li>▶ Page 236</li> <li>▶ Page 240</li> <li>▶ Page 244</li> </ul>

Specification Information														
Style Number	U.S. Base Prices												Leather Groups:	
	Fabric Groups:												1	2
	COM	1	2	3	4	5	6	7	8	9	10			
COSISAB	\$713	\$713	\$762	\$803	\$850	\$923	\$1013	\$1115	\$1224	\$1321	\$1423	\$998	\$1335	

COM: 1½ yards/ 18 sq ft.

Lounge Seating

 **For Canadian Pricing**  
 Multiply U.S. Price by the Canadian price factor.  
 ▶ See page 1 for details.

# Sistema Lounge System Ottomans and Accessories *continued*

DESIGN LIEVORE ALTHERR MOLINA FOR VICCARBE

## Moveable Table



Standard Includes	Required to Specify
-------------------	---------------------

<ul style="list-style-type: none"> <li>▶ Need help? Product details, page 234</li> </ul>	<ul style="list-style-type: none"> <li>• Moveable table: plywood core with oak wood veneer</li> </ul>	<ul style="list-style-type: none"> <li>1 Style number</li> <li>2 Wood color number for table</li> <li>3 Options, if selected (see below)</li> <li>▶ See <i>Coalesse Surface Materials Reference Guide</i>.</li> </ul>
--	---	---

Options	U.S. Price	Required to Specify
---------	------------	---------------------

<b>Surface Materials</b>	<ul style="list-style-type: none"> <li>• Wood veneer group 1</li> <li>• Wood veneer group 2</li> </ul>	<ul style="list-style-type: none"> <li>Prices below</li> <li>Prices below</li> </ul>	<ul style="list-style-type: none"> <li>Specify with group 1 wood veneer and select color number.</li> <li>Specify with group 2 wood veneer and select color number.</li> </ul>
--------------------------	--	--	--

<b>Related Products</b>	<ul style="list-style-type: none"> <li>• 2- and 3-seat lounge</li> <li>• 1-seat connector lounge</li> <li>• Lounge chairs</li> </ul>	<ul style="list-style-type: none"> <li>▶ Page 236</li> <li>▶ Page 240</li> <li>▶ Page 244</li> </ul>
-------------------------	--	--

Specification Information		
Style Number	U.S. Base Prices	
	Veneer Groups:	
	1	2

COSISTBL	\$877	\$964
----------	-------	-------



**For Canadian Pricing**  
 Multiply U.S. Price by the Canadian price factor.  
 ▶ See page 1 for details.

# Sistema Lounge System Ottomans and Accessories

DESIGN LIEVORE ALTHERR MOLINA FOR VICCARBE

## Pillows

Standard Includes		Required to Specify
<ul style="list-style-type: none"> <li>▶ Need help? Product details, page 235</li> </ul>	<ul style="list-style-type: none"> <li>• Pillow: upholstery</li> </ul>	<ul style="list-style-type: none"> <li>1 Style number</li> <li>2 Fabric or leather color number</li> <li>3 Options, if selected (see below)</li> <li>▶ See <i>Coalesse Surface Materials Reference Guide</i>.</li> </ul>

	Options	U.S. Price	Required to Specify
<b>Surface Materials</b>	<ul style="list-style-type: none"> <li>• Customer's Own Leather (COL)</li> <li>• Acrylic backer</li> </ul>	<ul style="list-style-type: none"> <li>+\$196</li> <li>+\$ 11</li> </ul>	<ul style="list-style-type: none"> <li>Specify with COL and select fabric color number.</li> <li>Specify with acrylic backer.</li> </ul>
<b>Related Products</b>	<ul style="list-style-type: none"> <li>• 2- and 3-seat lounge</li> <li>• 1-seat connector lounge</li> <li>• Lounge chairs</li> </ul>		<ul style="list-style-type: none"> <li>▶ Page 236</li> <li>▶ Page 240</li> <li>▶ Page 244</li> </ul>

Specification Information													
Style Number	U.S. Base Prices										Leather Groups:		
	Fabric Groups:										1	2	
	COM	1	2	3	4	5	6	7	8	9	10		

### Square Pillow

COPILSQ	\$455	\$455	\$488	\$515	\$547	\$595	\$654	\$723	\$796	\$860	\$929	\$758	\$1095
---------	-------	-------	-------	-------	-------	-------	-------	-------	-------	-------	-------	-------	--------

COM: 1 yard/ 18 sq ft.



Overall: 17<sup>3</sup>/<sub>4</sub>"L x 17<sup>3</sup>/<sub>4</sub>"H

### Lumbar Pillow

COPILLM	\$416	\$416	\$449	\$476	\$508	\$556	\$615	\$684	\$757	\$821	\$890	\$719	\$1056
---------	-------	-------	-------	-------	-------	-------	-------	-------	-------	-------	-------	-------	--------

COM: 1 yard/ 18 sq ft.

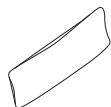

Overall: 20<sup>2</sup>/<sub>3</sub>"L x 9<sup>5</sup>/<sub>6</sub>"H



**For Canadian Pricing**  
 Multiply U.S. Price by the Canadian price factor.  
 ▶ See page 1 for details.

# Sistema Lounge System Multi-Fabric Diagram

DESIGN LIEVORE ALTHERR MOLINA FOR VICCARBE

TO: \_\_\_\_\_

FROM: \_\_\_\_\_

DATE: \_\_\_\_\_

FAX....888.413.5161

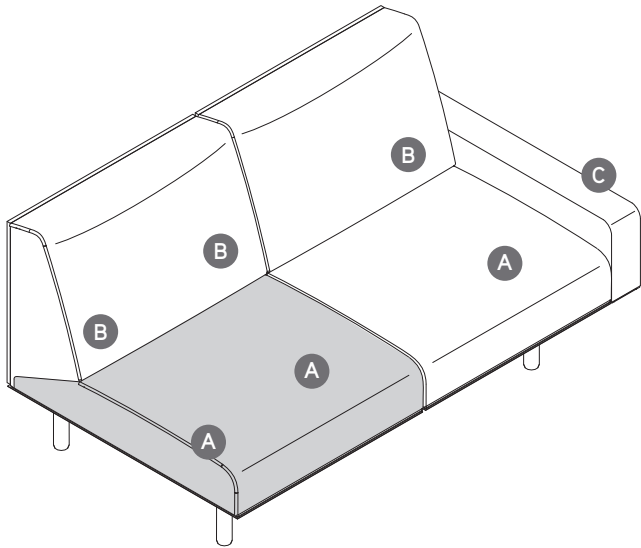

**A** Seat: \_\_\_\_\_

\_\_\_\_\_

**B** Back: \_\_\_\_\_

\_\_\_\_\_

**C** Arm: \_\_\_\_\_

\_\_\_\_\_

*Tip: Each individual component is specified and can be ordered in contrasting fabrics.*

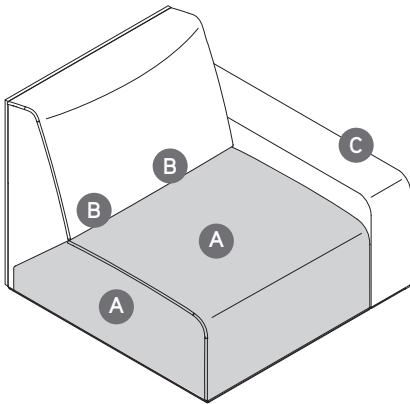

Coalesse

# Sistema Lounge System Multi-Fabric Diagram

DESIGN LIEVORE ALTHERR MOLINA FOR VICCARBE

# SW\_1 Lounge Seating

DESIGN SCOTT WILSON & MINIMAL

Three inches lower than conventional seating and with a more relaxed posture, the SW\_1 lounge chair is a conference/lounge hybrid that creates a more intimate and comfortable environment for collaboration.

*Tip: This product line is part of a collection and will be found in multiple locations in this specification guide and/or Coalesse Tables, Storage, and Accessories Specification Guide.*

► See *Collections*, page 5.

Seat back is available in two heights: a low back 36<sup>3</sup>/<sub>4</sub>"H or a high back 41<sup>3</sup>/<sub>4</sub>"H.

Swivel base has an automatic, return-to-center mechanism.

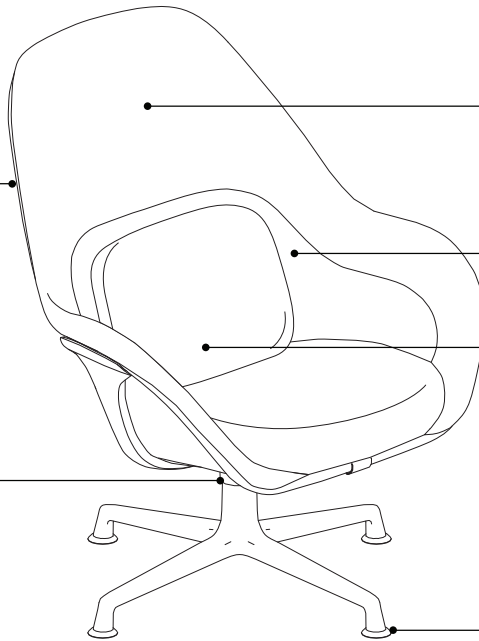

Backrest reclines at an angle of approximately 102° to the seat.

Knit back provides back support and breathability.

Lumbar pillow enhances comfort. It is available in coordinating or contrasting upholstery.

Glides are aluminum with a non-marring, plastic insert.

SW\_1 collection features collaboration seating, collaborative and conference tables, and occasional tables.

► For collaboration seating, see page 314.

► For tables, see *Coalesse Tables, Storage, and Accessories Specification Guide*.

# SW\_1 Lounge Seating

DESIGN SCOTT WILSON & MINIMAL

## Product Details



SW\_1 lounge seating is available in a low back or high back; the low back overall height is 36<sup>3</sup>/<sub>4</sub>"H, the high back overall height is 41<sup>3</sup>/<sub>4</sub>"H.



Swiveling tablet arm option is available in left- and right-hand models. Tubular steel support arm allows tablet to freely swivel 110° for easy user ingress and egress.

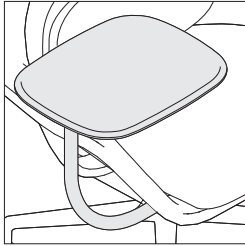

Tablet arm is 12<sup>5</sup>/<sub>32</sub>" x 15" x 5/8" thick. Tablet surface is available in black or milk.



Lumbar pillow in coordinating or contrasting upholstery is available, 4<sup>1</sup>/<sub>4</sub>"D x 16<sup>1</sup>/<sub>2</sub>"W x 10<sup>1</sup>/<sub>2</sub>"H. Lumbar pillow is relocatable for optimal comfort.

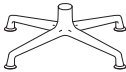

4-star base is aluminum matte polished with non-marring, easy gliding nylon feet.

Swivel return mechanism is standard. It has built in memory and will return to the fixed position when the user leaves the chair.

## Surface Materials

► See *Coalesse Surface Materials Reference Guide* for further information.

**Upholstery** (contrasting fabric available)

- Knit
- Fabric
- Leather

**Base**

- Aluminum matte polished

## Programs and Services

**Customer's Own Material/Leather (COM/COL) Program** is available.

► See *Coalesse Surface Materials Reference Guide* for further information.

# SW\_1 Lounge Seating

DESIGN SCOTT WILSON & MINIMAL



*Tip: For Customer's Own Material or Leather, see necessary requirements, important processing instructions, and ordering information*  
 ▶ See *Coalesse Surface Materials Reference Guide*.

	Standard Includes	Required to Specify
▶ Need help? Product details, page 254	<ul style="list-style-type: none"> <li>• Seat and upper back: fabric or leather</li> <li>• Lower back: knit</li> <li>• Base: 8040 Aluminum Matte Polished</li> <li>• Frame: steel tube</li> <li>• Glides: aluminum with non marring plastic insert</li> <li>• Swivel return mechanism</li> <li>• Ottoman, if selected: fabric or leather</li> </ul>	<ol style="list-style-type: none"> <li>1 Style number</li> <li>2 Fabric or leather color number for seat, upper back, or ottoman, if selected</li> <li>3 Knit color number for lower back</li> <li>4 Options, if selected (see below)</li> </ol> ▶ See <i>Coalesse Surface Materials Reference Guide</i> .

	Options	U.S. Price	Required to Specify
<b>Surface Materials</b>	<ul style="list-style-type: none"> <li>• Contrasting fabric</li> </ul>	+\$ 192	Specify with <i>contrasting fabric</i> and select fabric color number.
	<b>Acrylic backer</b>		
	<ul style="list-style-type: none"> <li>• Chairs</li> <li>• Ottoman</li> </ul>	+\$ 51 +\$ 19	Specify with <i>acrylic backer</i> . Specify with <i>acrylic backer</i> . ▶ See <i>Coalesse Surface Materials Reference Guide</i> .
	<b>Lumbar pillow for lounge chairs</b>		
	<ul style="list-style-type: none"> <li>• Fabric group 1</li> <li>• Fabric group 2</li> <li>• Fabric group 3</li> <li>• Fabric group 4</li> <li>• Fabric group 5</li> <li>• Fabric group 6</li> <li>• Fabric group 7</li> <li>• Fabric group 8</li> <li>• Fabric group 9</li> <li>• Fabric group 10</li> <li>• Leather group 1</li> <li>• Leather group 2</li> <li>• Customer's Own Material (COM)</li> <li>• Customer's Own Leather (COL)</li> </ul>	No cost +\$ 41 +\$ 76 +\$ 116 +\$ 177 +\$ 252 +\$ 340 +\$ 430 +\$ 512 +\$ 598 +\$ 356 +\$ 365 No cost +\$ 442	Specify fabric color number. Specify fabric color number. Specify fabric color number. Specify fabric color number. Specify fabric color number. Specify fabric color number. Specify fabric color number. Specify fabric color number. Specify fabric color number. Specify fabric color number. Specify leather color number. Specify leather color number. Specify fabric color number. ▶ See <i>Coalesse Surface Materials Reference Guide</i> . Specify leather color number. ▶ See <i>Coalesse Surface Materials Reference Guide</i> .
<b>Lumbar Pillow</b>	<ul style="list-style-type: none"> <li>• No pillow</li> <li>• Pillow</li> </ul>	No cost +\$ 378	Specify with <i>no pillow</i> . Specify with <i>pillow</i> .
<b>Swivel Mechanism</b>	<ul style="list-style-type: none"> <li>• Swivel-only mechanism (omit return feature)</li> </ul>	No cost	Specify with <i>swivel-only mechanism</i> .
<b>Tablet</b>	<ul style="list-style-type: none"> <li>• No tablet</li> <li>• Right tablet (seated position)</li> <li>• Left tablet (seated position)</li> </ul>	No cost +\$1130 +\$1130	Specify with <i>no tablet</i> . Specify with <i>right tablet</i> and select 6000 Black or 6052 Milk finish. Specify with <i>left tablet</i> and select 6000 Black or 6052 Milk finish.
<b>Related Products</b>	<ul style="list-style-type: none"> <li>• Collaborative and conference tables</li> <li>• Occasional tables</li> <li>• Collaboration seating</li> </ul>		▶ See <i>Coalesse Tables, Storage, and Accessories Specification Guide</i> . ▶ See <i>Coalesse Tables, Storage, and Accessories Specification Guide</i> . ▶ Page 314



Top of Cushion to Bottom of Tablet: 8 1/2"H

*Tip: Paint on lounge tablet arm support will complement 8040 Aluminum Matte polished base.*

*Tip: Handedness is determined while in the seated position.*



**For Canadian Pricing**  
 Multiply U.S. Price by the Canadian price factor.  
 ▶ See page 1 for details.

# SW\_1 Lounge Seating

DESIGN SCOTT WILSON & MINIMAL

## Specification Information

Style Number	U.S. Base Prices										Leather Groups:			
	Fabric Groups:										COL	1	2	
	COM	1	2	3	4	5	6	7	8	9	10			



Overall: 28 1/4"D 32 1/4"W 36 3/4"H  
 Seat: 16"H  
 Arm: 23"H

### Low-Back Collaborative Lounge Chair

COW613	Seat	\$3644	\$3644	\$3677	\$3704	\$3737	\$3785	\$3846	\$3915	\$3988	\$4053	\$4122	\$3778	\$ 4090	\$ 4141
	Upper back	No cost	No cost	+\$ 58	+\$106	+\$162	+\$248	+\$353	+\$475	+\$602	+\$716	+\$837	+\$310	+\$1036	+\$1164

COM/yds = 3, COL/sq ft = 60  
 Pillow COM/yds = 1 1/4, COL/sq ft = 27 1/2



Overall: 30"D 32 1/4"W 41 3/4"H  
 Seat: 16"H  
 Arm: 23"H

### High-Back Collaborative Lounge Chair

COW713	Seat	\$4220	\$4220	\$4253	\$4280	\$4313	\$4361	\$4422	\$4491	\$4564	\$4629	\$4698	\$4354	\$ 4666	\$ 4717
	Upper back	No cost	No cost	+\$ 65	+\$120	+\$186	+\$283	+\$403	+\$542	+\$688	+\$819	+\$956	+\$310	+\$1036	+\$1164

COM/yds = 3, COL/sq ft = 60  
 Pillow COM/yds = 1 1/4, COL/sq ft = 27 1/2



Overall: 20"D 23"W 14"H

### Ottoman

COW210	\$1820	\$1820	\$1853	\$1880	\$1913	\$1961	\$2022	\$2091	\$2164	\$2229	\$2298	\$2262	\$ 2363	\$ 2427
--------	--------	--------	--------	--------	--------	--------	--------	--------	--------	--------	--------	--------	---------	---------

COM/yds = 1, COL/sq ft = 22

 **For Canadian Pricing**  
 Multiply U.S. Price by the Canadian price factor.  
 ▶ See page 1 for details.

# SW\_1 Lounge Seating Multi-Fabric Diagram

DESIGN STUDIO B

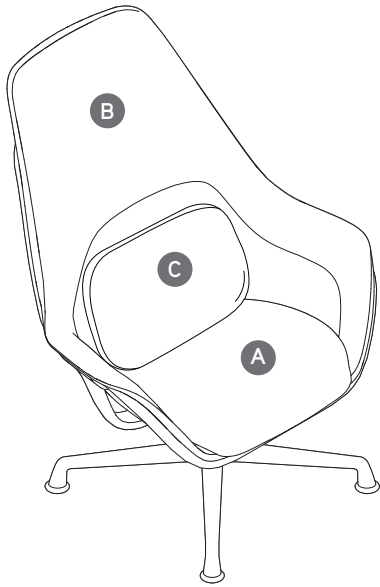

TO: \_\_\_\_\_

FROM: \_\_\_\_\_

DATE: \_\_\_\_\_

FAX....888.413.5161

**A** Seat: \_\_\_\_\_

\_\_\_\_\_

**B** Upper Back: \_\_\_\_\_

\_\_\_\_\_

**C** Lumbar Pillow: \_\_\_\_\_

\_\_\_\_\_

Contrasting fabric charges will apply. List price based on highest group textile specified.

*See specifying for contrasting textile upcharge based on highest group textile specified. Lumbar pillow, specified separately as an option, is not included in upcharge for contrasting.*

Specify Model below:

COW613 Low-Back Collaborative Lounge Chair

COW713 High-Back Collaborative Lounge Chair

Coalesse

# SW\_1 Lounge Seating Multi-Fabric Diagram

DESIGN STUDIO B

# Switch Lounge Seating

DESIGN E00S

Switch lounge seating combines comfort and elegant design, featuring double needle stitch detail and satin finish steel legs.

*Tip: This product line is part of a collection and will be found in multiple locations in this specification guide and/or Coalesse Tables, Storage, and Accessories Specification Guide.*

► See *Collections*, page 5.

**Upholstery** features multiple densities of polyurethane foam and polyester fiber on seat back and arms.

**Base** features four tubular steel legs with adjustable glides.

**Loose back and seat cushions** are standard. Attachment straps are available.

**Arm bolster pillows** are available with optional attachment straps.

**Frame** is solid hardwood and wood veneer.

**Occasional tables** are available in three sizes, with a  $\frac{5}{8}$ " thick, green tinted, tempered glass top. Legs are visually compatible with seating with adjustable glides.

► See *Coalesse Tables, Storage, and Accessories Specification Guide*

**Switch collection** features guest seating and stools.

► Pages 360 and 407

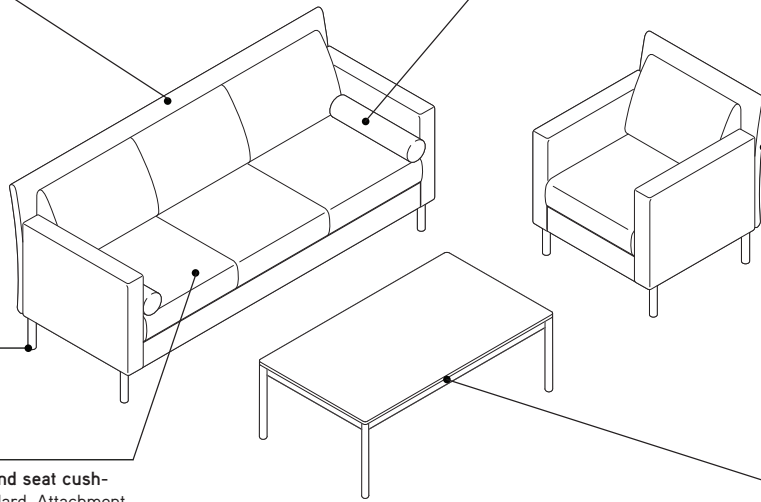

# Switch Lounge Seating

DESIGN E00S

## Product Details

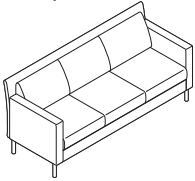
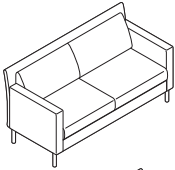
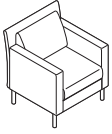

Standard lounge seating is available as a 1-, 2-, or 3-seat model.

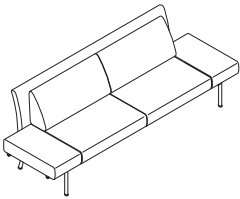

2-seat lounge with extensions allows users to fold the arms up and down, independent of each other, extending the overall width to 96"W.

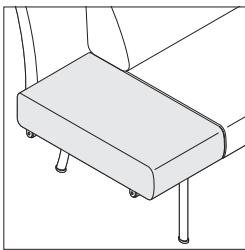

Extensions in the down position offer additional surface area for belongings.

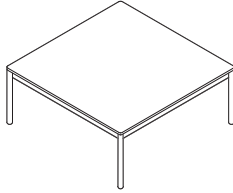
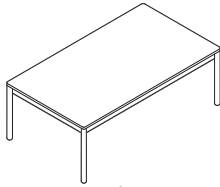
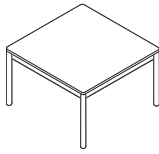

Occasional tables are available in three sizes: square 24<sup>3</sup>/<sub>8</sub>"D x 24<sup>3</sup>/<sub>8</sub>"W x 15"H, rectangle 24<sup>3</sup>/<sub>8</sub>"D x 43<sup>1</sup>/<sub>4</sub>"W x 15"H, and square 36"D x 36"W x 15"H.



Arm bolster in coordinating fabric is available (17<sup>1</sup>/<sub>2</sub>"D x 5<sup>3</sup>/<sub>4</sub>" diameter).

## Surface Materials

► See *Coalesse Surface Materials Reference Guide* for further information.

### Upholstery

- Fabric
- Leather

### Base

- Matte chrome finish

## Programs and Services

Customer's Own Material/Leather (COM/COL) Program is available.

► See *Coalesse Surface Materials Reference Guide* for further information.

# Switch Lounge Seating

DESIGN E00S

*Tip: Fabrics and leathers will appear loose with comfort wrinkles when upholstered.*

*Tip: Due to seat conversion arms are 4 1/2"W. Lowered arm has weight limit of 100 lb.*

*Tip: Recommended leathers are Elmosoft group 1 and Elmorustical group 2.*

► For multi-fabric diagram, see page 264.

*Tip: Loose cushions standard.*

*Tip: Arm bolsters must be specified separately.*

*Tip: Special color match, consult Customer Service.*

*Tip: For Customer's Own Material or Leather, see necessary requirements, important processing instructions, and ordering information*

► See Coalesse Surface Materials Reference Guide.

*Tip: 391-4 2-seat with extensions, when extended: Both arms = 96"W overall One arm = 84"W overall Arms not extended = 71"W overall (closed).*

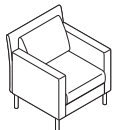

**Overall:** 29 1/2"D 28"W 32 1/2"H  
**Inside:** 19"D 20"W 17"H  
**Seat:** 18 1/2"H  
**Arm:** 26"H

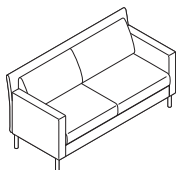

**Overall:** 24 1/2"D 62"W 33"H  
**Inside:** 19"D 54 1/2"W 33"H  
**Seat:** 18 1/2"H  
**Arm:** 26 1/4"H



**For Canadian Pricing**  
 Multiply U.S. Price by the Canadian price factor.  
 ► See page 1 for details.

## Standard Includes

- Need help? Product details, page 260
- Selected solid hardwood and wood veneer frame
- 2-seat lounge with extension: tubular steel frame with solid hardwood arms
  - Arms are 4 1/2" wide
- Upholstery: multiple densities of polyurethane foam and polyester fiber on seat back and arms
- Legs: matte chrome finish on steel
- Arm bolster, if selected: fabric or leather

## Required to Specify

- 1 Style number
  - 2 Number of fabrics if contrasting fabric style number is selected
  - 3 Fabric or leather color number for upholstery on seat, back, and arms, or arm bolsters, if selected
  - 4 Options, if selected (see below)
- See Coalesse Surface Materials Reference Guide.

## Options

Options	U.S. Price	Required to Specify
<b>Surface Materials</b>	• Contrasting fabric +\$192 per fabric	Add suffix K to the style number and select fabric color number.
	<b>Acrylic backer</b>	
	• Lounge chair +\$ 63	Specify with acrylic backer.
	• 2-seat lounge +\$118	Specify with acrylic backer.
	• 3-seat lounge +\$126	Specify with acrylic backer.
	• 2-seat lounge with extensions +\$141	Specify with acrylic backer.
	• Arm bolster +\$ 11	Specify with acrylic backer.
		► See Coalesse Surface Materials Reference Guide.
<b>Attachment Straps</b>	• 391 +\$206	Specify with attachment straps.
	• 391-2 +\$412	Specify with attachment straps.
	• 391-3 +\$618	Specify with attachment straps.
	• 391-4 +\$412	Specify with attachment straps.
	• Bolster +\$107	Specify with attachment straps.
<b>Related Products</b>	• Guest seating	► Page 360
	• Stools	► Page 407
	• Occasional tables	► See Coalesse Tables, Storage, and Accessories Specification Guide.

## Specification Information

Style Number	U.S. Base Prices										Leather Groups:			
	Fabric Groups:										COL	1	2	
	COM	1	2	3	4	5	6	7	8	9	10			

### Lounge Chair

391	\$3814	\$3814	\$3984	\$4126	\$4295	\$4550	\$4866	\$5227	\$5610	\$5948	\$ 6309	\$4336	\$ 8067	\$ 9132
-----	--------	--------	--------	--------	--------	--------	--------	--------	--------	--------	---------	--------	---------	---------

COM/yds = 4 1/2, COL/sq ft = 99

### 2-Seat Lounge

391-2	\$5993	\$5993	\$6277	\$6514	\$6795	\$7221	\$7746	\$8348	\$8986	\$9550	\$10,152	\$6516	\$12,589	\$14,131
-------	--------	--------	--------	--------	--------	--------	--------	--------	--------	--------	----------	--------	----------	----------

COM/yds = 7 1/2, COL/sq ft = 165

► Specification Information, continued on next page

# Switch Lounge Seating

DESIGN E00S

► Specification Information, continued from previous page

## Specification Information

Style Number	U.S. Base Prices										Leather Groups:			
	Fabric Groups:										COL	1	2	
	COM	1	2	3	4	5	6	7	8	9	10			

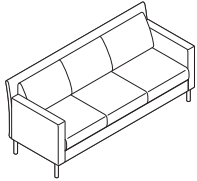

Overall: 30½"D 73"W 33"H  
 Inside: 20"D 66"W 33"H  
 Seat: 20"D 18¾"H  
 Arm: 26¼"H

### 3-Seat Lounge

391-3	\$7844	\$7844	\$8147	\$8400	\$8700	\$9154	\$ 9715	\$10,356	\$11,037	\$11,639	\$12,280	\$8367	\$16,612	\$18,552
-------	--------	--------	--------	--------	--------	--------	---------	----------	----------	----------	----------	--------	----------	----------

COM/yds = 8, COL/sq ft = 176

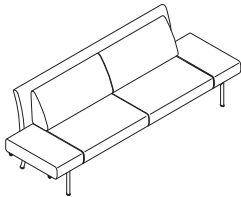

Lounge overall: 35"D 70½"W 33"H  
 Overall extended: 35"D 95½"W 33"H  
 Seat: 23"D 16¼"H  
 Arm: 29"D 26½"W  
 One arm up: 77"W

### 2-Seat Lounge with Extensions

391-4	\$8355	\$8355	\$8696	\$8981	\$9318	\$9830	\$10,460	\$11,181	\$11,948	\$12,625	\$13,346	\$8878	\$18,331	\$20,498
-------	--------	--------	--------	--------	--------	--------	----------	----------	----------	----------	----------	--------	----------	----------

COM/yds = 9, COL/sq ft = 198



Overall: 17½"D 5¾"Dia

### Arm Bolster

391-B	\$ 371	\$ 371	\$ 409	\$ 441	\$ 479	\$ 536	\$ 605	\$ 685	\$ 771	\$ 846	\$ 926	\$ 900	\$ 1254	\$ 1669
-------	--------	--------	--------	--------	--------	--------	--------	--------	--------	--------	--------	--------	---------	---------

COM/yds = 1, COL/sq ft = 18

Lounge Seating

 **For Canadian Pricing**  
 Multiply U.S. Price by the  
 Canadian price factor.  
 ► See page 1 for details.

# Switch Lounge Seating Multi-Fabric Diagram

DESIGN E00S

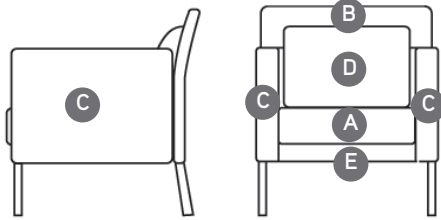

**Model 391 Shown Above**

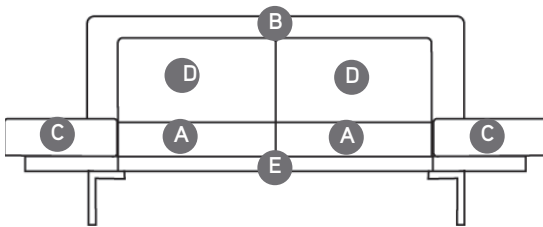

**Model 391-4 Shown Above**

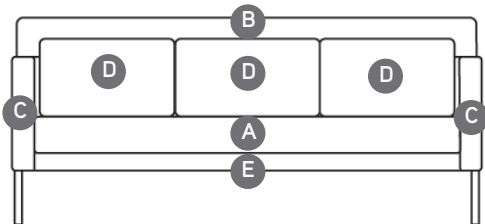

**391-3 Shown Above**

TO: \_\_\_\_\_

FROM: \_\_\_\_\_

DATE: \_\_\_\_\_

FAX....888.413.5161

**A** Seat (upholstery selections default for entire unit if B is not selected): \_\_\_\_\_

\_\_\_\_\_

**B** Back: \_\_\_\_\_

\_\_\_\_\_

**C** Arm: \_\_\_\_\_

\_\_\_\_\_

**D** Back Cushion: \_\_\_\_\_

\_\_\_\_\_

**E** Base Frame: \_\_\_\_\_

\_\_\_\_\_

**Due to soft nature of loose cushions, genuine leathers are recommended. All other textiles must be submitted for pre-approval.**

*Tip: Arm bolsters must be specified separately.*

*See specifying for contrasting fabric upcharge. List price based on highest fabric group usage.*

Specify Model below:

391K Switch Lounge Chair

391-2K Switch 2-Seat Lounge (not shown)

391-3K Switch 3-Seat Lounge

391-4K Switch 2-Seat Lounge with Extension

Coalesse

# Switch Lounge Seating

Multi-Fabric Diagram

DESIGN E00S

# Thoughtful Lounge Seating

DESIGN PAMELA LIGHT, FIIDA SHIELDS

**Thoughtful lounge seating** features a slightly winged back for comfort, while double needle stitching and upholstery detail provides effortless style.

**Frame** is a unibody construction with finger jointed plywood.

**Backrest** embraces the user with a sweeping, concave design and side wings.

**Base** features four solid hardwood legs with subtle curve design; non-adjustable glides standard.

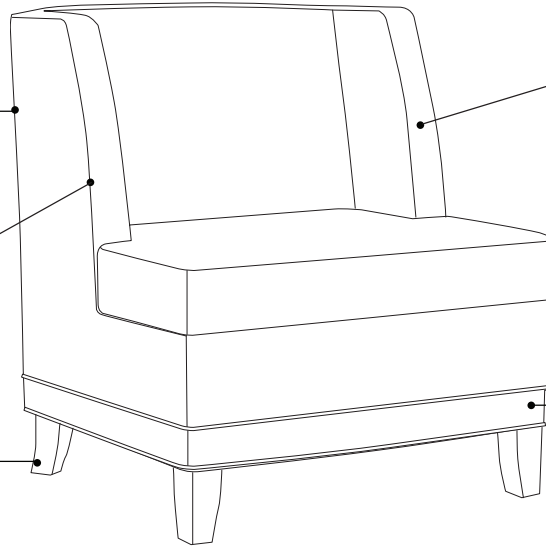

**Upholstery** features double needle stitching detail on the seams.

**Contrast welting around base** is available.

**Matching ottoman** is also available.

# Thoughtful Lounge Seating

DESIGN PAMELA LIGHT, FIIDA SHIELDS

## Product Details

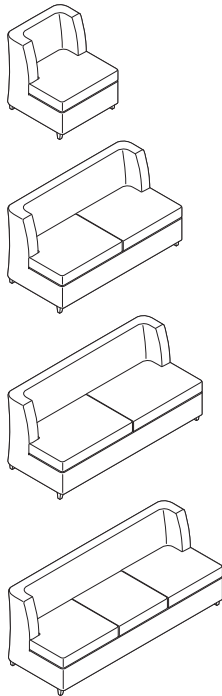

**Lounge seating** is available in four styles: lounge chair, small lounge, medium lounge, and long lounge; ranging in widths from 28<sup>3</sup>/<sub>4</sub>"W to 80<sup>3</sup>/<sub>4</sub>"W. All styles are fully upholstered with four solid hardwood maple or walnut legs. The base features a two-tiered welt design which wraps around the entire lounge chair/lounge.

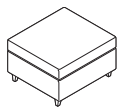

**Matching ottoman** carries the design signature of the lounge seating and features the same four legs and two-tiered base welting; 26<sup>1</sup>/<sub>4</sub>"D x 28<sup>1</sup>/<sub>2</sub>"W x 17<sup>3</sup>/<sub>4</sub>"H.

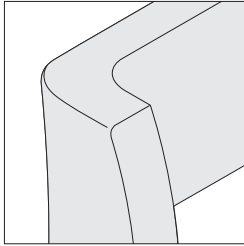

**Side wings and sweeping concave design of the backrest** provide the user with the feeling of being embraced.

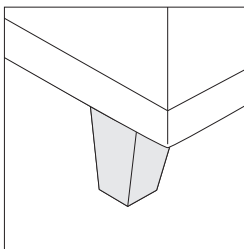

**Base** features four solid hardwood legs; non-adjustable glides are standard. Two-tiered welt design on base is available in contrasting welting to create a unique aesthetic.

## Surface Materials

► See *Coalesse Surface Materials Reference Guide* for further information.

### Upholstery

- Fabric
- Leather

### Legs

- Solid maple wood
- Solid walnut wood

## Programs and Services

**Customer's Own Material/Leather (COM/COL) Program** is available.

► See *Coalesse Surface Materials Reference Guide* for further information.

# Thoughtful Lounge Seating

DESIGN PAMELA LIGHT, FIIDA SHIELDS

*Tip: Fabrics and leathers will appear loose with comfort wrinkles when upholstered.*

*Tip: All polyurethane foam meets CAL-117 specifications.*

*Tip: Pricing based on highest group textile specified.*

*Tip: Seats will always have some comfort wrinkles. The amount of wrinkles will vary depending on the fabric.*

*Tip: When contrasting fabric and non-contrasting welt are selected, the welt will match the base frame.*

*Tip: Welting COM yardage required = 1/2 yards or 22 square feet.*

*Tip: Recommended leathers are Elmosoft group 1 and Elmorustical group 2.*

*Tip: Special color match, consult Customer Service.*

*Tip: For Customer's Own Material or Leather, see necessary requirements, important processing instructions, and ordering information*  
 ▶ See *Coalesse Surface Materials Reference Guide*.

Standard Includes	Required to Specify
▶ Need help? Product details, page 266 • Frame: unibody construction with finger jointed plywood • Legs: solid maple or walnut wood • Upholstery: multiple densities of polyurethane foam • Double needle stitch on seams	1 Style number 2 Number of fabrics if contrasting fabric style number is selected 3 Fabric or leather color number for upholstery on seat and back 4 Wood species 5 Wood color number for legs 6 Options, if selected (see below) ▶ See <i>Coalesse Surface Materials Reference Guide</i> .

Options	U.S. Price	Required to Specify
<b>Surface Materials</b> • Contrasting fabric • Contrasting welt for welting around base of chair	+\$192 per fabric +\$300	Add suffix K to the style number and select fabric color number. Specify with <i>contrasting welt</i> and select fabric color number.
<b>Acrylic backer</b> • Lounge chair • Small lounge • Medium lounge • Long lounge • Ottoman	+\$ 88 +\$156 +\$174 +\$192 +\$ 41	Specify with <i>acrylic backer</i> . Specify with <i>acrylic backer</i> . Specify with <i>acrylic backer</i> . Specify with <i>acrylic backer</i> . Specify with <i>acrylic backer</i> . ▶ See <i>Coalesse Surface Materials Reference Guide</i> .

## Specification Information

Style Number	U.S. Base Prices										Leather Groups:		
	Fabric Groups:										COL	1	2
COM	1	2	3	4	5	6	7	8	9	10			

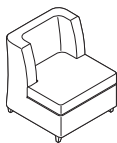

Overall: 29¾"D 28¾"W 32"H  
 Inside: 20"D 21½"W 14½"H  
 Seat: 17½"H

## Lounge Chair

385	\$3551	\$3551	\$3711	\$3846	\$4006	\$4247	\$4545	\$4887	\$5248	\$5568	\$5909	\$4077	\$8192	\$8984
-----	--------	--------	--------	--------	--------	--------	--------	--------	--------	--------	--------	--------	--------	--------

COM/yds = 5½, COL/sq ft = 121

▶ Specification Information, continued on next page



**For Canadian Pricing**  
 Multiply U.S. Price by the Canadian price factor.  
 ▶ See page 1 for details.

# Thoughtful Lounge Seating

DESIGN PAMELA LIGHT, FIIDA SHIELDS

► Specification Information, continued from previous page

## Specification Information

Style Number	U.S. Base Prices										Leather Groups:		
	Fabric Groups:										COL		
	COM	1	2	3	4	5	6	7	8	9	10	1	2

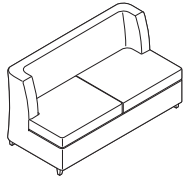

Overall: 30¼"D 60¾"W 32"H  
 Inside: 20¼"D 53½"W 14½"H  
 Seat: 17½"H

### Small Lounge

385-60	\$6672	\$6672	\$6979	\$7236	\$ 7540	\$ 8001	\$ 8570	\$ 9222	\$ 9913	\$10,524	\$11,174	\$7200	\$15,153	\$16,670
--------	--------	--------	--------	--------	---------	---------	---------	---------	---------	----------	----------	--------	----------	----------

COM/yds = 10½, COL/sq ft = 231

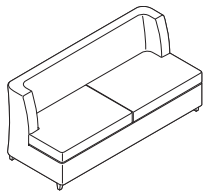

Overall: 30¾"D 70¾"W 32"H  
 Inside: 20½"D 63½"W 14½"H  
 Seat: 17½"H

### Medium Lounge

385-70	\$8834	\$8834	\$9169	\$9452	\$ 9786	\$10,290	\$10,912	\$11,628	\$12,384	\$13,052	\$13,765	\$9385	\$18,054	\$19,731
--------	--------	--------	--------	--------	---------	----------	----------	----------	----------	----------	----------	--------	----------	----------

COM/yds = 11½, COL/sq ft = 253

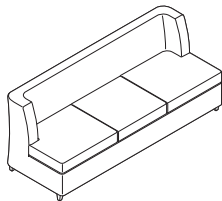

Overall: 31¼"D 80¾"W 32"H  
 Inside: 20¾"D 73½"W 14½"H  
 Seat: 17½"H

### Long Lounge

385-80	\$9302	\$9302	\$9674	\$9988	\$10,357	\$10,916	\$11,606	\$12,398	\$13,237	\$13,979	\$14,769	\$9837	\$19,527	\$21,372
--------	--------	--------	--------	--------	----------	----------	----------	----------	----------	----------	----------	--------	----------	----------

COM/yds = 12¾, COL/sq ft = 281

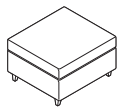

Overall: 26¼"D 28½"W 17¾"H

### Ottoman

385-H	\$2562	\$2562	\$2642	\$2709	\$ 2790	\$ 2910	\$ 3059	\$ 3230	\$ 3411	\$ 3571	\$ 3741	\$3100	\$ 5119	\$ 5512
-------	--------	--------	--------	--------	---------	---------	---------	---------	---------	---------	---------	--------	---------	---------

COM/yds = 2¾, COL/sq ft = 61



**For Canadian Pricing**  
 Multiply U.S. Price by the  
 Canadian price factor.  
 ► See page 1 for details.

# Thoughtful Lounge Seating Multi-Fabric Diagram

DESIGN PAMELA LIGHT, FIIDA SHIELDS

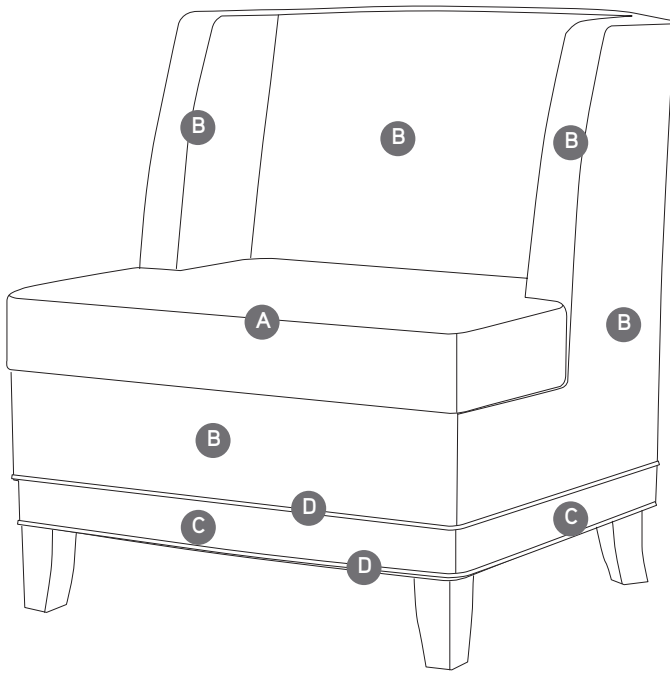

TO: \_\_\_\_\_

FROM: \_\_\_\_\_

DATE: \_\_\_\_\_

FAX....888.413.5161

**A** Seat (default for entire unit if B is not selected):  
 \_\_\_\_\_

**B** Arms and Back: \_\_\_\_\_  
 \_\_\_\_\_

**C** Base Frame: \_\_\_\_\_  
 \_\_\_\_\_

**D** Welt: \_\_\_\_\_  
 \_\_\_\_\_

Please indicate which model:

- 385K
- 385-60K
- 385-70K
- 385-80K

Total list price upcharge for contrasting fabrics: \$ \_\_\_\_\_

*See specifying for contrasting fabric upcharge. List price based on highest fabric group usage.*

**\*Contrasting welt offered as a separate option.**

*Tip: When contrasting fabric and non-contrasting welt are selected, the welt will match base frame.*

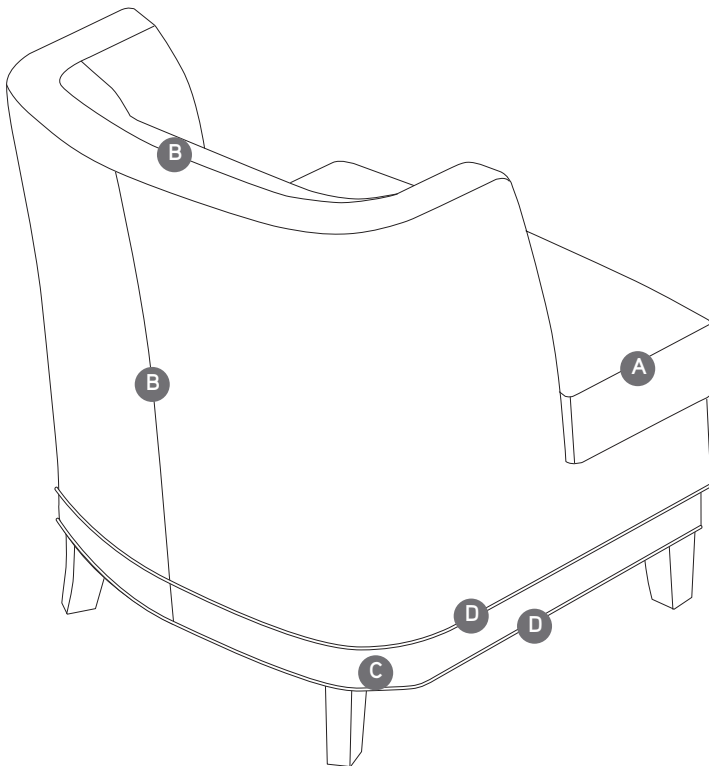

Coalesse

# Thoughtful Lounge Seating Multi-Fabric Diagram

DESIGN PAMELA LIGHT, FIIDA SHIELDS

# Together Benches by Walter Knoll

DESIGN E00S

**Together** elevates the upholstered bench to an impressive new height while reinventing the corner seat. Corner shapes define space and create rooms within rooms; straight benches offer open seating.

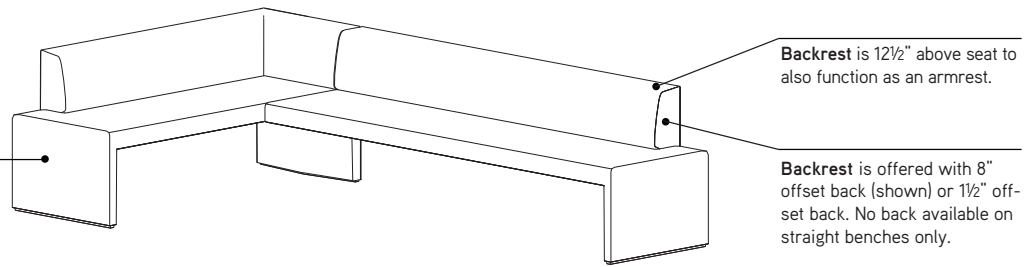

**End and corner legs** are fully upholstered panels featuring fixed glides.

**Together** features straight benches and corner benches, available in varying dimensions.

**Backrest** is 12½" above seat to also function as an armrest.

**Backrest** is offered with 8" offset back (shown) or 1½" offset back. No back available on straight benches only.

# Together Benches by Walter Knoll

DESIGN EOOS

## Product Details

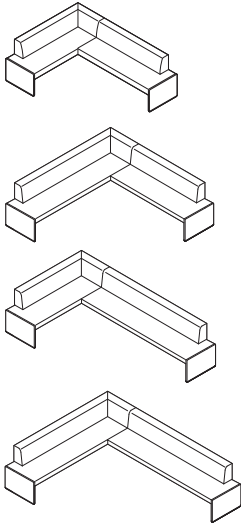

**Left corner with back, 8" offset styles** are 31"H and are available in four overall sizes: 70½"D x 96¼"W, 97¼"D x 96¼"W, 70½"D x 123"W, and 97¼"D x 123"W.

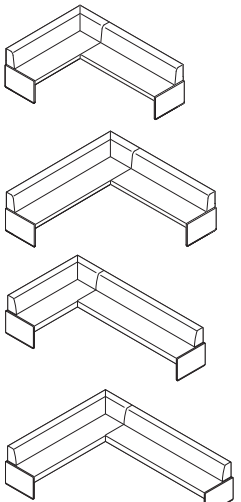

**Left corner with back, 1½" offset styles** are 31"H and are available in four overall sizes: 70½"D x 96¼"W, 97¼"D x 96¼"W, 70½"D x 123"W, and 97¼"D x 123"W.

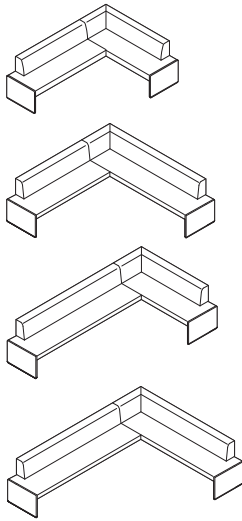

**Right corner with back, 8" offset styles** are 31"H and are available in four overall sizes: 70½"D x 96¼"W, 97¼"D x 96¼"W, 70½"D x 123"W, and 97¼"D x 123"W.

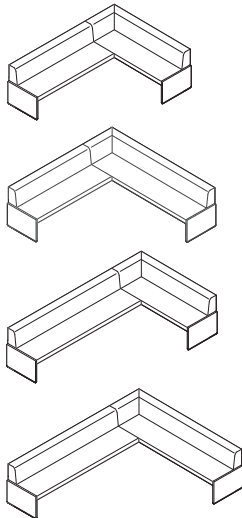

**Right corner with back, 1½" offset styles** are 31"H and are available in four overall sizes: 70½"D x 96¼"W, 97¼"D x 96¼"W, 70½"D x 123"W, and 97¼"D x 123"W.

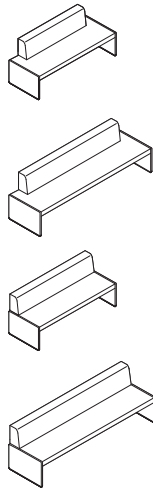

**Straight with back styles** are available with 8" offset or 1½" offset; all with 26¾"D and 31"H.

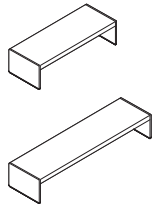

**Straight without back styles** are available with 26¾"D and 18½"H. Available in two sizes: 71"W and 97¾"W.

## Surface Materials

► See *Coalesse Surface Materials Reference Guide* for further information.

### Upholstery

- Fabric
- Leather

## Programs and Services

**Customer's Own Material/Leather (COM/COL) Program** is available.  
 ► See *Coalesse Surface Materials Reference Guide* for additional information.

# Together Benches by Walter Knoll

DESIGN E00S

*Tip: Fabrics and leathers will appear loose with comfort wrinkles when upholstered.*

▶ See page 280 for multi-fabric diagram.

▶ See page 281 for offset diagram.

*Tip: For Customer's Own Material or Leather, see necessary requirements, important processing instructions, and ordering information*  
▶ See *Coalesse Surface Materials Reference Guide*.

Standard Includes		Required to Specify	
▶ Need help? Product details, page 272	<ul style="list-style-type: none"> <li>Upholstery for chair: fabric or leather</li> <li>Glides</li> </ul>	1 Style number	2 Number of fabrics if contrasting fabric style number is selected
		3 Fabric or leather color number for upholstery	4 Options, if selected (see below)
		▶ See <i>Coalesse Surface Materials Reference Guide</i> .	
Options		Required to Specify	
Surface Materials	U.S. Price	Add suffix K to the style number and select fabric color number.	
<ul style="list-style-type: none"> <li>Contrasting fabric</li> </ul>	+\$192 per fabric		
<b>Acrylic backer</b>			
<ul style="list-style-type: none"> <li>71"W straight bench without back</li> </ul>	+\$ 56	Specify with acrylic backer.	
<ul style="list-style-type: none"> <li>97¾"W straight bench without back</li> </ul>	+\$ 63	Specify with acrylic backer.	
<ul style="list-style-type: none"> <li>26¾"D x 71"W benches</li> </ul>	+\$ 80	Specify with acrylic backer.	
<ul style="list-style-type: none"> <li>26¾"D x 97¾"W and 97/10"W benches</li> </ul>	+\$ 93	Specify with acrylic backer.	
<ul style="list-style-type: none"> <li>69¾"D x 96¼"W benches</li> </ul>	+\$152	Specify with acrylic backer.	
<ul style="list-style-type: none"> <li>96½"D x 96¼"W and 69¾"D x 123"W benches</li> </ul>	+\$174	Specify with acrylic backer.	
<ul style="list-style-type: none"> <li>96½"D x 123"W bench</li> </ul>	+\$192	Specify with acrylic backer.	
		▶ See <i>Coalesse Surface Materials Reference Guide</i> .	
Back Offset	U.S. Price	Required to Specify	
<ul style="list-style-type: none"> <li>Back offset</li> </ul>	No cost	Specify with back offset.	

## Specification Information

Style Number	U.S. Base Prices										Leather Groups:		
	Fabric Groups:										COL	1	2
COM	1	2	3	4	5	6	7	8	9	10			

### Left Corner with Back, 8" Offset

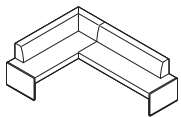

Overall: 70½"D 96¼"W 31"H  
Seat: 19"D 18½"H

COT09669L8	\$12,953	\$12,953	\$13,252	\$13,499	\$13,796	\$14,242	\$14,795	\$15,427	\$16,099	\$16,691	\$17,324	\$13,395	\$19,167	\$20,293
COM/yds = 9¾, COL/sq ft = 215														

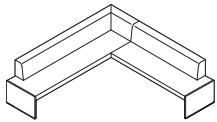

Overall: 97¼"D 96¼"W 31"H  
Seat: 19"D 18½"H

COT09696L8	\$13,989	\$13,989	\$14,318	\$14,591	\$14,918	\$15,410	\$16,020	\$16,717	\$17,458	\$18,110	\$18,808	\$14,431	\$20,804	\$22,045
COM/yds = 10¾, COL/sq ft = 237														

▶ Specification Information, continued on next page



**For Canadian Pricing**  
Multiply U.S. Price by the Canadian price factor.  
▶ See page 1 for details.

# Together Benches by Walter Knoll

DESIGN EOOS

► Specification Information, continued from previous page

## Specification Information

Style Number	U.S. Base Prices										Leather Groups:		
	Fabric Groups:										COL		
	COM	1	2	3	4	5	6	7	8	9	10	1	2

### Left Corner with Back, 8" Offset, continued

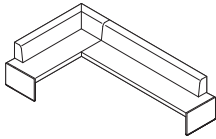

Overall: 70½"D 123"W 31"H  
Seat: 19"D 18½"H

COTO12369L8	\$14,405	\$14,405	\$14,749	\$15,036	\$15,378	\$15,893	\$16,531	\$17,260	\$18,035	\$18,718	\$19,448	\$14,847	\$21,520	\$22,820
-------------	----------	----------	----------	----------	----------	----------	----------	----------	----------	----------	----------	----------	----------	----------

COM/yds = 11¼, COL/sq ft = 248

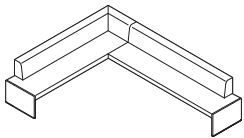

Overall: 97¼"D 123"W 31"H  
Seat: 19"D 18½"H

COTO12396L8	\$15,177	\$15,177	\$15,559	\$15,878	\$16,257	\$16,829	\$17,539	\$18,349	\$19,210	\$19,969	\$20,780	\$15,619	\$22,876	\$24,296
-------------	----------	----------	----------	----------	----------	----------	----------	----------	----------	----------	----------	----------	----------	----------

COM/yds = 12½, COL/sq ft = 270

### Left Corner with Back, 1½" Offset

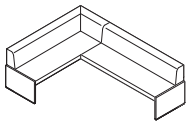

Overall: 70½"D 96¼"W 31"H  
Seat: 19"D 18½"H

COTO9669L15	\$13,247	\$13,247	\$13,560	\$13,822	\$14,133	\$14,603	\$15,184	\$15,849	\$16,554	\$17,177	\$17,842	\$13,689	\$19,764	\$20,949
-------------	----------	----------	----------	----------	----------	----------	----------	----------	----------	----------	----------	----------	----------	----------

COM/yds = 10¼, COL/sq ft = 226

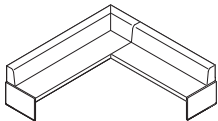

Overall: 97¼"D 96¼"W 31"H  
Seat: 19"D 18½"H

COTO9696L15	\$14,286	\$14,286	\$14,630	\$14,917	\$15,259	\$15,774	\$16,412	\$17,141	\$17,916	\$18,599	\$19,329	\$14,728	\$21,401	\$22,701
-------------	----------	----------	----------	----------	----------	----------	----------	----------	----------	----------	----------	----------	----------	----------

COM/yds = 11¼, COL/sq ft = 248

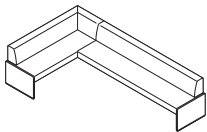

Overall: 70½"D 123"W 31"H  
Seat: 19"D 18½"H

COTO12369L15	\$14,694	\$14,694	\$15,053	\$15,352	\$15,709	\$16,247	\$16,914	\$17,675	\$18,485	\$19,198	\$19,961	\$15,136	\$22,113	\$23,471
--------------	----------	----------	----------	----------	----------	----------	----------	----------	----------	----------	----------	----------	----------	----------

COM/yds = 11¾, COL/sq ft = 259

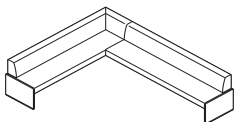

Overall: 97¼"D 123"W 31"H  
Seat: 19"D 18½"H

COTO12396L15	\$15,457	\$15,457	\$15,846	\$16,172	\$16,558	\$17,143	\$17,867	\$18,693	\$19,570	\$20,345	\$21,172	\$15,899	\$23,472	\$24,949
--------------	----------	----------	----------	----------	----------	----------	----------	----------	----------	----------	----------	----------	----------	----------

COM/yds = 12¾, COL/sq ft = 281

► Specification Information, continued on next page

# Together Benches by Walter Knoll *continued*

DESIGN E00S

► Specification Information, continued from previous page

## Specification Information

Style Number	U.S. Base Prices										Leather Groups:			
	Fabric Groups:										COL	1	2	
	COM	1	2	3	4	5	6	7	8	9	10			

### Right Corner with Back, 8" Offset

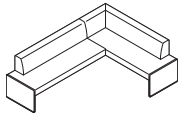

Overall: 70½"D 96¼"W 31"H  
Seat: 19"D 18½"H

<b>COT09669R8</b>	\$12,953	\$12,953	\$13,252	\$13,499	\$13,796	\$14,242	\$14,795	\$15,427	\$16,099	\$16,691	\$17,324	\$13,395	\$19,167	\$20,293
-------------------	----------	----------	----------	----------	----------	----------	----------	----------	----------	----------	----------	----------	----------	----------

COM/yds = 9¾, COL/sq ft = 215

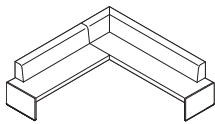

Overall: 97¼"D 96¼"W 31"H  
Seat: 19"D 18½"H

<b>COT09696R8</b>	\$13,989	\$13,989	\$14,318	\$14,591	\$14,918	\$15,410	\$16,020	\$16,717	\$17,458	\$18,110	\$18,808	\$14,431	\$20,804	\$22,045
-------------------	----------	----------	----------	----------	----------	----------	----------	----------	----------	----------	----------	----------	----------	----------

COM/yds = 10¾, COL/sq ft = 237

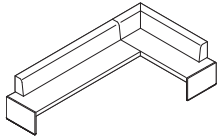

Overall: 70½"D 123"W 31"H  
Seat: 19"D 18½"H

<b>COT12369R8</b>	\$14,405	\$14,405	\$14,749	\$15,036	\$15,378	\$15,893	\$16,531	\$17,260	\$18,035	\$18,718	\$19,448	\$14,847	\$21,520	\$22,820
-------------------	----------	----------	----------	----------	----------	----------	----------	----------	----------	----------	----------	----------	----------	----------

COM/yds = 11¼, COL/sq ft = 248

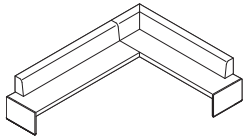

Overall: 97¼"D 123"W 31"H  
Seat: 19"D 18½"H

<b>COT12396R8</b>	\$15,177	\$15,177	\$15,559	\$15,878	\$16,257	\$16,829	\$17,539	\$18,349	\$19,210	\$19,969	\$20,780	\$15,619	\$22,876	\$24,296
-------------------	----------	----------	----------	----------	----------	----------	----------	----------	----------	----------	----------	----------	----------	----------

COM/yds = 12½, COL/sq ft = 270

► Specification Information, continued on next page

*Tip: For Customer's Own Material or Leather, see necessary requirements, important processing instructions, and ordering information*

► See Coalesse Surface Materials Reference Guide.

*Tip: Fabrics and leathers will appear loose with comfort wrinkles when upholstered.*

► See page 281 for offset diagram.



#### For Canadian Pricing

Multiply U.S. Price by the Canadian price factor.

► See page 1 for details.

# Together Benches by Walter Knoll

DESIGN EOOS

► Specification Information, continued from previous page

## Specification Information

Style Number	U.S. Base Prices										Leather Groups:		
	Fabric Groups:										COL		
	COM	1	2	3	4	5	6	7	8	9	10	1	2

### Right Corner with Back, 1 1/2" Offset

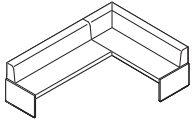

Overall: 70 1/2"D 96 1/4"W 31"H  
Seat: 19"D 18 1/2"H

<b>COTO9669R15</b>	\$13,247	\$13,247	\$13,560	\$13,822	\$14,133	\$14,603	\$15,184	\$15,849	\$16,554	\$17,177	\$17,842	\$13,689	\$19,764	\$20,949
--------------------	----------	----------	----------	----------	----------	----------	----------	----------	----------	----------	----------	----------	----------	----------

COM/yds = 10 1/4, COL/sq ft = 226

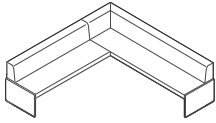

Overall: 97 1/4"D 96 1/4"W 31"H  
Seat: 19"D 18 1/2"H

<b>COTO9696R15</b>	\$14,286	\$14,286	\$14,630	\$14,917	\$15,259	\$15,774	\$16,412	\$17,141	\$17,916	\$18,599	\$19,329	\$14,728	\$21,401	\$22,701
--------------------	----------	----------	----------	----------	----------	----------	----------	----------	----------	----------	----------	----------	----------	----------

COM/yds = 11 1/4, COL/sq ft = 248

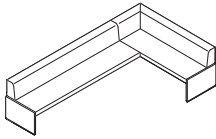

Overall: 70 1/2"D 123"W 31"H  
Seat: 19"D 18 1/2"H

<b>COTO12369R15</b>	\$14,694	\$14,694	\$15,053	\$15,352	\$15,709	\$16,247	\$16,914	\$17,675	\$18,485	\$19,198	\$19,961	\$15,136	\$22,113	\$23,471
---------------------	----------	----------	----------	----------	----------	----------	----------	----------	----------	----------	----------	----------	----------	----------

COM/yds = 11 3/4, COL/sq ft = 259

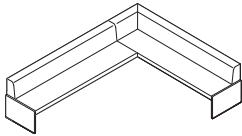

Overall: 97 1/4"D 123"W 31"H  
Seat: 19"D 18 1/2"H

<b>COTO12396R15</b>	\$15,457	\$15,457	\$15,846	\$16,172	\$16,558	\$17,143	\$17,867	\$18,693	\$19,570	\$20,345	\$21,172	\$15,899	\$23,472	\$24,949
---------------------	----------	----------	----------	----------	----------	----------	----------	----------	----------	----------	----------	----------	----------	----------

COM/yds = 12 3/4, COL/sq ft = 281

► Specification Information, continued on next page

► See page 281 for offset diagram.



**For Canadian Pricing**  
Multiply U.S. Price by the Canadian price factor.  
► See page 1 for details.

# Together Benches by Walter Knoll *continued*

DESIGN E00S

► Specification Information, continued from previous page

## Specification Information

Style Number	U.S. Base Prices										Leather Groups:			
	Fabric Groups:										COL	1	2	
	COM	1	2	3	4	5	6	7	8	9	10			

### Straight with Back, 8" Offset

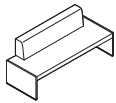

Overall: 26¾"D 71"W 31"H  
Seat: 19"D 18½"H

COTO69WB8	\$6286	\$6286	\$6432	\$6553	\$6696	\$6915	\$7184	\$7492	\$7819	\$ 8107	\$ 8416	\$6728	\$ 9493	\$10,044
-----------	--------	--------	--------	--------	--------	--------	--------	--------	--------	---------	---------	--------	---------	----------

COM/yds = 4¾, COL/sq ft = 105

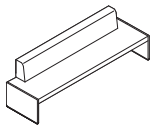

Overall: 26¾"D 97¾"W 31"H  
Seat: 19"D 18½"H

COTO96WB8	\$7268	\$7268	\$7459	\$7618	\$7808	\$8094	\$8450	\$8855	\$9285	\$ 9664	\$10,070	\$7710	\$11,379	\$12,102
-----------	--------	--------	--------	--------	--------	--------	--------	--------	--------	---------	----------	--------	----------	----------

COM/yds = 6¼, COL/sq ft = 138

### Straight with Back, 1½" Offset

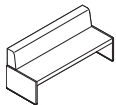

Overall: 26¾"D 71"W 31"H  
Seat: 19"D 18½"H

COTO69WB15	\$6561	\$6561	\$6714	\$6842	\$6994	\$7222	\$7506	\$7830	\$8174	\$ 8478	\$ 8803	\$7003	\$ 9919	\$10,499
------------	--------	--------	--------	--------	--------	--------	--------	--------	--------	---------	---------	--------	---------	----------

COM/yds = 5, COL/sq ft = 110

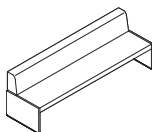

Overall: 26¾"D 97¾"W 31"H  
Seat: 19"D 18½"H

COTO96WB15	\$7551	\$7551	\$7750	\$7916	\$8113	\$8411	\$8779	\$9201	\$9648	\$10,043	\$10,465	\$7993	\$11,808	\$12,559
------------	--------	--------	--------	--------	--------	--------	--------	--------	--------	----------	----------	--------	----------	----------

COM/yds = 6½, COL/sq ft = 143

► Specification Information, continued on next page

*Tip: For Customer's Own Material or Leather, see necessary requirements, important processing instructions, and ordering information*

► See *Coalesse Surface Materials Reference Guide*.

*Tip: Fabrics and leathers will appear loose with comfort wrinkles when upholstered.*

► See page 281 for offset diagram.



#### For Canadian Pricing

Multiply U.S. Price by the Canadian price factor.

► See page 1 for details.

# Together Benches by Walter Knoll

DESIGN EOOS

► Specification Information, continued from previous page

## Specification Information

Style Number	U.S. Base Prices										Leather Groups:		
	Fabric Groups:										COL		
	COM	1	2	3	4	5	6	7	8	9	10	1	2

### Straight without Back

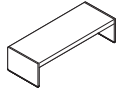

Overall: 26¾"D 71"W 18½"H  
Seat: 18½"H

<b>COTO69</b>	\$4510	\$4510	\$4632	\$4735	\$4856	\$5040	\$5266	\$5526	\$5801	\$6044	\$6304	\$4952	\$7267	\$7731
---------------	--------	--------	--------	--------	--------	--------	--------	--------	--------	--------	--------	--------	--------	--------

COM/yds = 4, COL/sq ft = 88

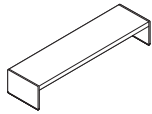

Overall: 26¾"D 97¾"W 18½"H  
Seat: 18½"H

<b>COTO96</b>	\$5163	\$5163	\$5354	\$5513	\$5703	\$5989	\$6345	\$6750	\$7180	\$7559	\$7965	\$5605	\$8370	\$8921
---------------	--------	--------	--------	--------	--------	--------	--------	--------	--------	--------	--------	--------	--------	--------

COM/yds = 4¾, COL/sq ft = 105

Lounge Seating

 **For Canadian Pricing**  
Multiply U.S. Price by the Canadian price factor.  
► See page 1 for details.

# Together Benches Multi-Fabric Diagram

DESIGN E00S

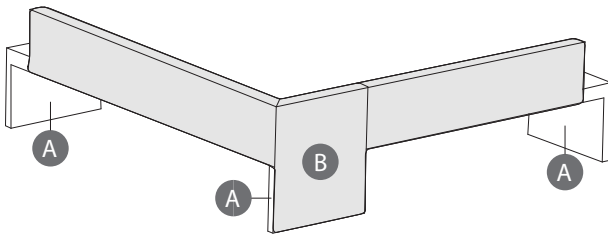
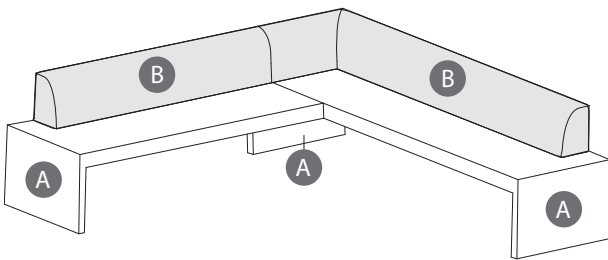
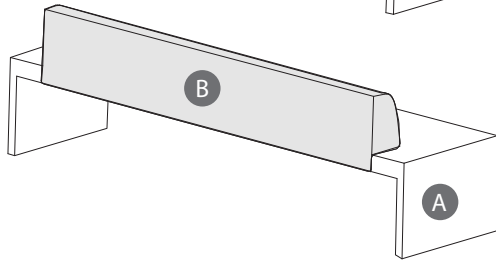
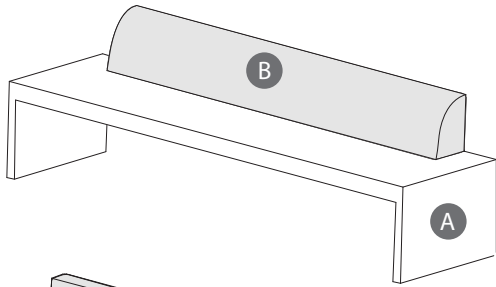

TO: \_\_\_\_\_

FROM: \_\_\_\_\_

DATE: \_\_\_\_\_

FAX...888.413.5161

## Together Bench/Straight with Back

**A** Upholstery selections (default for entire unit if B is not selected): \_\_\_\_\_

**B** Back: \_\_\_\_\_

## Together Bench/Corner with Back

**A** Upholstery selections (default for entire unit if B is not selected): \_\_\_\_\_

**B** Back: \_\_\_\_\_

*See specifying for contrasting fabric upcharge. List price based on highest fabric group usage.*

# Together Benches Offset Diagram

DESIGN E00S

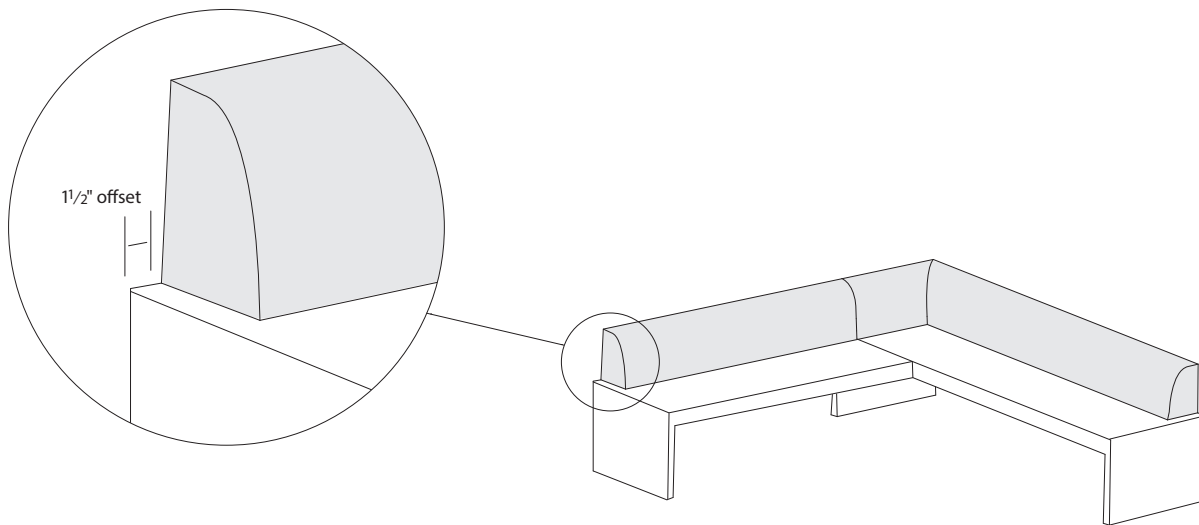
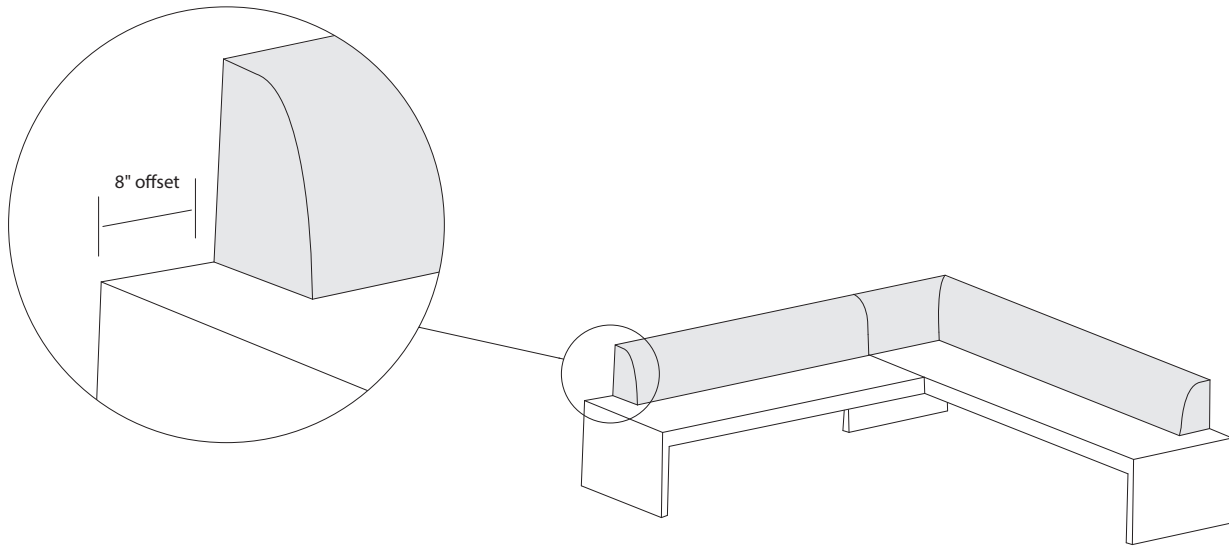

# Visalia Lounge Seating

DESIGN COALESSE DESIGN GROUP

Visalia lounge seating is a range of soft seating efficiently scaled and designed to be grouped to promote collaboration. It can also be arranged for relaxed reflection in offices, lobbies, or hospitality environments.

**Upholstery** features top-stitched upper and lower facets that can be upholstered in one material or two, for an attractive contrasting effect.

**Seat and back cushions** are attached.

**Frame** is a unibody construction with finger jointed plywood.

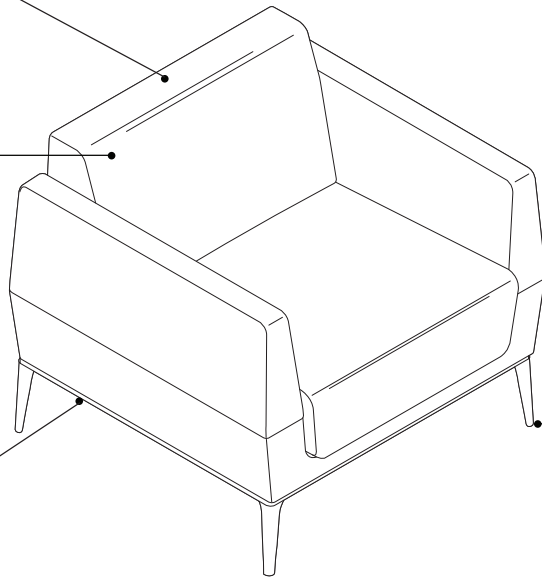

**4-leg base in cast aluminum** is standard in powder coat paint.

Visalia lounge seating features a lounge chair, 2-seat lounge, 3-seat lounge, ottoman, and bench.

# Visalia Lounge Seating

DESIGN COALESSE DESIGN GROUP

## Product Details

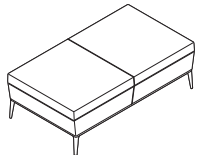
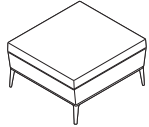
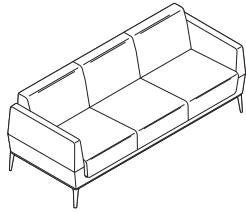
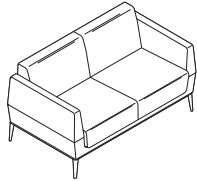
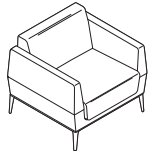

**Lounge seating** features five fully upholstered, complementary models: lounge chair, 2-seat lounge, 3-seat lounge, ottoman, and bench. All models feature a 4-leg, cast aluminum base with a powder coat painted finish. Upholstery is hand tailored. Double needle top stitching detail on upper and lower upholstery seams is available.

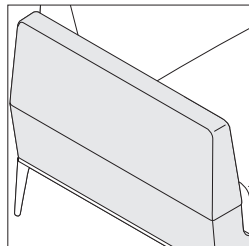

**Faceted arm** features a top-stitched detail on its upper and lower facets.

## Surface Materials

► See *Coalesse Surface Materials Reference Guide* for further information.

### Upholstery\*

- Fabric
- Leather

\*Available in one tone or two tone

### Base

- Paint

## Programs & Services

**Customer's Own Material/Leather (COM/COL) Program** is available.

► See *Coalesse Surface Materials Reference Guide* for further information.

# Visalia Lounge Seating

DESIGN COALESSE DESIGN GROUP

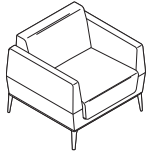

*Tip: Fabrics and leathers will appear loose with comfort wrinkles when upholstered.*

*Tip: All cushions are attached.*

*Tip: Recommended leathers are Elmosoft group 1 and Elmorustical group 2.*

*Tip: Special color match, consult Customer Service.*

*Tip: For Customer's Own Material or Leather, see necessary requirements, important processing instructions, and ordering information*  
 ► See *Coalesse Surface Materials Reference Guide*.

Standard Includes	Required to Specify
<ul style="list-style-type: none"> <li>► Need help? Product details, page 282</li> <li>• Frame: unibody construction with finger jointed plywood</li> <li>• Cast aluminum base: group 1 paint</li> <li>• Upholstery: multiple densities of polyurethane foams and polyester fiber on seat and back</li> <li>• Upper and lower upholstery accents with double needle top stitch, if selected</li> </ul>	<ol style="list-style-type: none"> <li>1 Style number</li> <li>2 Fabric or leather color number for seat, back, and arms</li> <li>3 Upholstery accent color number, if selected</li> <li>4 Paint color number for base:                         <ul style="list-style-type: none"> <li>4138 Graphite Gloss Black Matte</li> <li>4141 Platinum Matte</li> <li>4144 Black Gloss</li> <li>4145 Milk Gloss</li> <li>4148 Midnight Brown Gloss</li> <li>4180 Graphite Matte</li> <li>4193 Midnight Brown Matte</li> <li>4238 Mocha Smooth</li> <li>4239 Clay Smooth</li> <li>4240 Chalk Smooth</li> <li>4242 Milk Smooth</li> <li>4710 Low Gloss Black</li> </ul> </li> <li>5 Options, if selected (see below)</li> </ol> <p>► See <i>Coalesse Surface Materials Reference Guide</i>.</p>

Required Selections	U.S. Price	Required to Specify
Upholstery accent	Prices to right	Select accent upholstery.

Options	U.S. Price	Required to Specify
<b>Surface Materials</b> <ul style="list-style-type: none"> <li>• <b>Base</b></li> <li>• Group 3 paint</li> </ul>	+\$157	Specify paint color number.
<b>Acrylic backer</b>		
• Lounge chair with single fabric	+\$ 56	Specify with acrylic backer.
• Lounge chair with two fabrics	+\$ 63	Specify with acrylic backer.
• 2-seat lounge with single fabric	+\$ 78	Specify with acrylic backer.
• 2-seat lounge with two fabrics	+\$ 85	Specify with acrylic backer.
• 3-seat lounge with single fabric	+\$ 89	Specify with acrylic backer.
• 3-seat lounge with two fabrics	+\$100	Specify with acrylic backer.
• Ottomans with single fabric	+\$ 28	Specify with acrylic backer.
• Ottomans with two fabrics	+\$ 28	Specify with acrylic backer.
• 2-seat benches with single fabric	+\$ 36	Specify with acrylic backer.
• 2-seat benches with two fabrics	+\$ 36	Specify with acrylic backer.

► See *Coalesse Surface Materials Reference Guide*.



**For Canadian Pricing**  
 Multiply U.S. Price by the Canadian price factor.  
 ► See page 1 for details.

# Visalia Lounge Seating

DESIGN COALESSE DESIGN GROUP

## Specification Information

### Lounge Chair

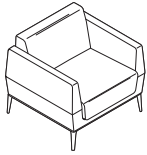

Overall: 29"D 31¾"W 28"H  
 Seat height: 16¼"H  
 Arm height to the floor: 23"H  
 Inside: 19"D 23"W 16¼"H

### 2-Seat Lounge

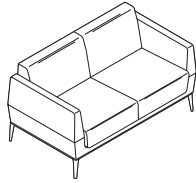

Overall: 29"D 53¾"W 28"H  
 Seat height: 16¼"H  
 Arm height to the floor: 23"H  
 Inside: 19"D 45"W 16¼"H

### 3-Seat Lounge

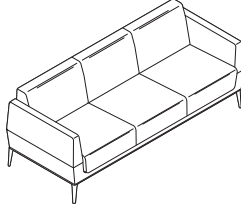

Overall: 29"D 73¾"W 28"H  
 Seat height: 16¼"H  
 Arm height to the floor: 23"H  
 Inside: 19"D 65"W 16¼"H

### Ottoman

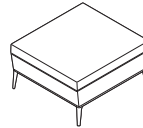

Overall: 29"D 30"W 16¼"H

### Bench

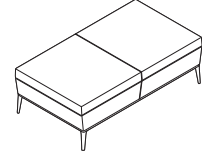

Overall: 29"D 52"W 16¼"H

Lounge Seating

Style Number	Upholstery	U.S. Base Prices										Leather Groups:			
		Fabric Groups:										COL	1	2	
		COM	1	2	3	4	5	6	7	8	9	10			

### Lounge Chair with Single Fabric

COJHL100		\$3486	\$3486	\$3606	\$3708	\$3824	\$4006	\$4223	\$4477	\$4746	\$4983	\$5232	\$3928	\$5237	\$5443
	COM/yds = 3¾, COL/sq ft = 83														

### Lounge Chair with Accent Upholstery

COJHLC100	Standard Upholstery	\$3571	\$3571	\$3666	\$3748	\$3840	\$3986	\$4160	\$4362	\$4578	\$4767	\$4967	\$3909	\$5203	\$5394
	COM/yds = 3, COL/sq ft = 66														
	Accent Upholstery	No cost	No cost	+\$ 32	+\$ 59	+\$ 90	+\$138	+\$196	+\$264	+\$335	+\$399	+\$465	+\$442	+\$543	+\$ 607
	COM/yds = 1, COL/sq ft = 22														

### 2-Seat Lounge with Single Fabric

COJHL200		\$5381	\$5381	\$5541	\$5676	\$5831	\$6075	\$6364	\$6702	\$7061	\$7377	\$7709	\$5823	\$7806	\$8090
	COM/yds = 5, COL/sq ft = 110														

### 2-Seat Lounge with Accent Upholstery

COJHLC200	Standard Upholstery	\$5466	\$5466	\$5608	\$5732	\$5870	\$6088	\$6349	\$6653	\$6976	\$7261	\$7560	\$5908	\$7893	\$8181
	COM/yds = 4½, COL/sq ft = 99														
	Accent Upholstery	No cost	No cost	+\$ 32	+\$ 59	+\$ 90	+\$138	+\$196	+\$264	+\$335	+\$399	+\$465	+\$442	+\$689	+\$ 767
	COM/yds = 1¼, COL/sq ft = 27														

### 3-Seat Lounge with Single Fabric

COJHL300		\$6203	\$6203	\$6396	\$6557	\$6744	\$7036	\$7384	\$7789	\$8219	\$8599	\$8998	\$6645	\$9331	\$9698
	COM/yds = 6, COL/sq ft = 132														

### 3-Seat Lounge with Accent Upholstery

COJHLC300	Standard Upholstery	\$6288	\$6288	\$6464	\$6613	\$6783	\$7051	\$7369	\$7741	\$8135	\$8483	\$8848	\$6730	\$9296	\$9646
	COM/yds = 5½, COL/sq ft = 121														
	Accent Upholstery	No cost	No cost	+\$ 56	+\$103	+\$ 157	+\$243	+\$344	+\$462	+\$588	+\$698	+\$814	+\$442	+\$946	+\$1053
	COM/yds = 1¾, COL/sq ft = 39														

► Specification Information, continued on next page



**For Canadian Pricing**  
 Multiply U.S. Price by the  
 Canadian price factor.  
 ► See page 1 for details.

# Visalia Lounge Seating *continued*

DESIGN COALESSE DESIGN GROUP

► Specification Information, continued from previous page

## Specification Information

### Lounge Chair

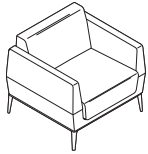

Overall: 29"D 31¾"W 28"H  
 Seat height: 16¼"H  
 Arm height to the floor: 23"H  
 Inside: 19"D 23"W 16¼"H

### 2-Seat Lounge

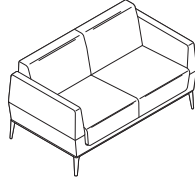

Overall: 29"D 53¾"W 28"H  
 Seat height: 16¼"H  
 Arm height to the floor: 23"H  
 Inside: 19"D 45"W 16¼"H

### 3-Seat Lounge

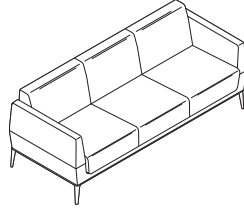

Overall: 29"D 73¾"W 28"H  
 Seat height: 16¼"H  
 Arm height to the floor: 23"H  
 Inside: 19"D 65"W 16¼"H

### Ottoman

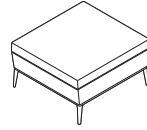

Overall: 29"D 30"W 16¼"H

### Bench

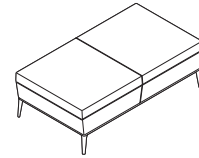

Overall: 29"D 52"W 16¼"H

Style  
Number

Upholstery

U.S. Base Prices

Fabric Groups:  
COM 1 2 3 4 5 6 7 8 9 10

Leather Groups:  
COL 1 2

## Ottoman with Single Fabric

COJHB100		\$1927	\$1927	\$1990	\$2044	\$2106	\$2202	\$2319	\$2455	\$2597	\$2724	\$2858	\$3003	\$3132
	COM/yds = 2, COL/sq ft = 44													

## Ottoman with Accent Upholstery

COJHBC100	Standard Upholstery	\$2012	\$2012	\$2044	\$2071	\$2102	\$2150	\$2208	\$2276	\$2347	\$2411	\$2477	\$2454	\$2555	\$2619
	COM/yds = 1, COL/sq ft = 22														
	Accent Upholstery	No cost	No cost	+\$ 32	+\$ 59	+\$ 90	+\$138	+\$196	+\$264	+\$335	+\$399	+\$465	+\$442	+\$543	+\$607
	COM/yds = 1, COL/sq ft = 22														

## 2-Seat Bench with Single Fabric

COJHB200		\$2819	\$2819	\$2914	\$2995	\$3088	\$3233	\$3408	\$3610	\$3824	\$4014	\$4215	\$3261	\$4271	\$4449
	COM/yds = 3, COL/sq ft = 50														

## 2-Seat Bench with Accent Upholstery

COJHBC200	Standard Upholstery	\$2904	\$2904	\$2960	\$3007	\$3061	\$3147	\$3248	\$3366	\$3492	\$3602	\$3718	\$3346	\$3855	\$3965
	COM/yds = 1¾, COL/sq ft = 39														
	Accent Upholstery	No cost	No cost	+\$ 32	+\$ 59	+\$ 90	+\$138	+\$196	+\$264	+\$335	+\$399	+\$465	+\$442	+\$689	+\$767
	COM/yds = 1, COL/sq ft = 22														



**For Canadian Pricing**  
 Multiply U.S. Price by the  
 Canadian price factor.  
 ► See page 1 for details.

# Visalia Lounge Seating Multi-Fabric Diagram

DESIGN COALESSE DESIGN GROUP

Applies to Visalia models including: lounge chair, 2-seat lounge, 3-seat lounge, ottoman, and 2-seat bench.

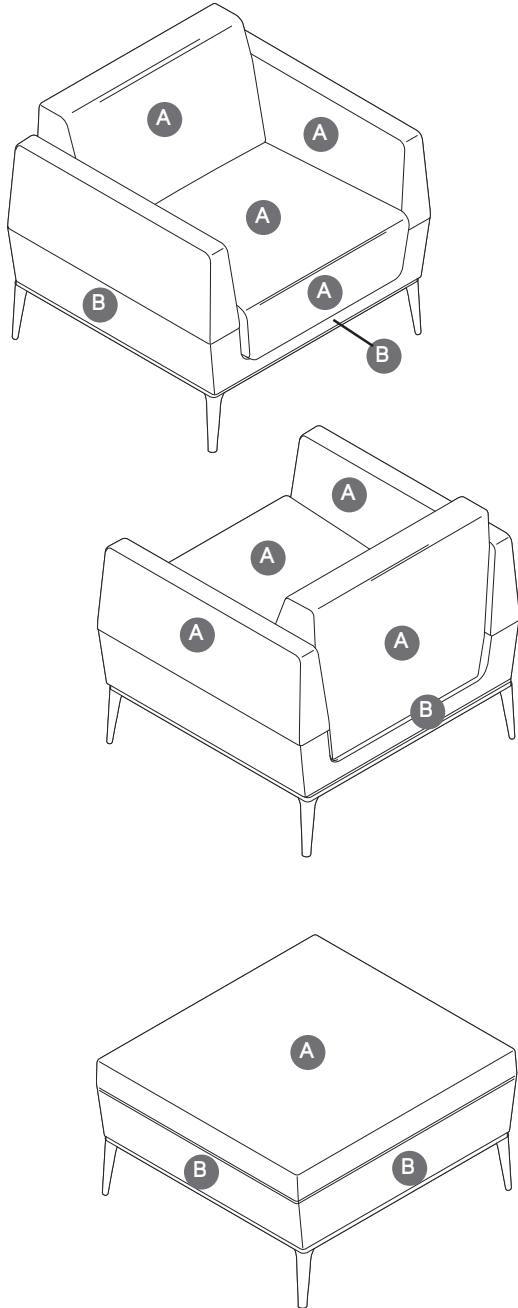

TO: \_\_\_\_\_

FROM: \_\_\_\_\_

DATE: \_\_\_\_\_

FAX....888.413.5161

**A** Upholstery Selection (default for entire unit if B is not selected): \_\_\_\_\_

**B** Accent: \_\_\_\_\_

Specify model below:

- COJHLC100 Lounge Chair
- COJHLC200 2-Seat Lounge
- COJHLC300 3-Seat Lounge
- COJHBC100 Ottoman
- COJHBC200 2-Seat Bench



---

# Collaboration Seating

\*These product lines are collections and will be found in multiple locations in this specification guide and/or *Coalesse Tables, Storage, and Accessories Specification Guide*.

▶ See *Collections*, page 5

<b>Bindu Conference Seating</b>	<b>290</b>
<b>Chord Conference Seating</b>	<b>294</b>
<b>Marien152 Conference Seating</b>	<b>298</b>
<b>Lox Seating*</b>	<b>303</b>
<b>Massaud Conference Seating*</b>	<b>306</b>
<b>SW_1 Conference Seating*</b>	<b>313</b>
<b>Adjustment Feature Definitions</b>	<b>316</b>

# Bindu Conference Seating

DESIGN BRIAN KANE

**Bindu conference seating** combines the comfort and craft of an upholstered lounge with the performance needs of a work task chair.

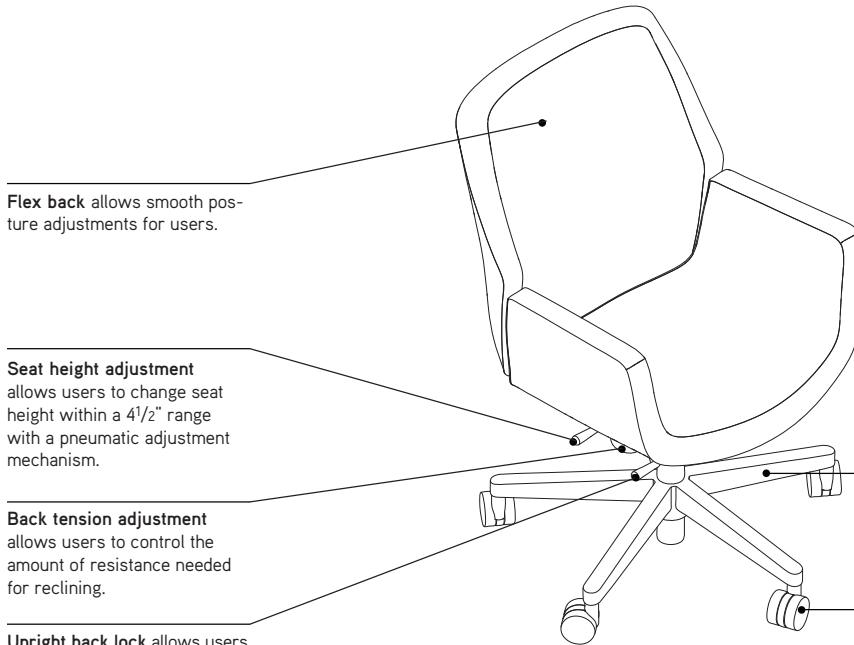

**Flex back** allows smooth posture adjustments for users.

**Seat height adjustment** allows users to change seat height within a 4 1/2" range with a pneumatic adjustment mechanism.

**Back tension adjustment** allows users to control the amount of resistance needed for reclining.

**Upright back lock** allows users to lock the backrest in a full, upright position. To unlock for free tilting, push handle back towards seat.

**5-star base** is black resin. A polished aluminum base is available as an option.

**Casters** are standard with hard, dual-wheels that roll smoothly on carpets. Optional soft casters are available for use on hard floors and chair mats.

# Bindu Conference Seating

DESIGN BRIAN KANE

## Product Details



**Bindu conference seating** is offered in mid back and high back.

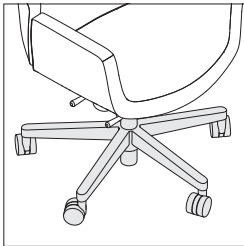

**5-star base** is available in black or optional polished aluminum.

**Casters** are standard with hard, dual-wheels that roll smoothly on carpets. Soft casters for use on hard floors are an available option.

## Adjustment Features

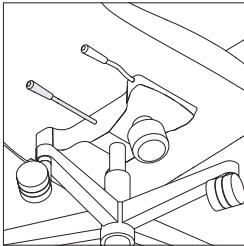

**Seat height** adjusts pneumatically. Lift lever to activate cylinder for desired height. To raise height, stand slightly while lifting lever; to lower, sit while lifting lever and weight pressure will lower seat height. Range of adjustability is 4<sup>1</sup>/<sub>2</sub>" with a maximum seat height of 20<sup>1</sup>/<sub>2</sub>".

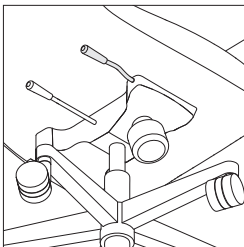

**Upright back lock** allows users to lock the backrest in a full, upright position. To unlock for free tilting, push handle back towards seat.

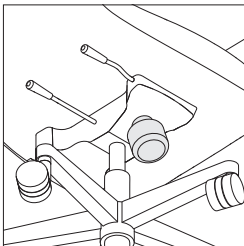

**Back tension control knob** turns clockwise to increase tension and counter-clockwise to decrease tension, allowing free tilt.

## Surface Materials

► See *Coalesse Surface Materials Reference Guide* for further information.

### Upholstery

- Fabric
- Leather

### Base

- Black resin
- Polished aluminum

## Programs & Services

**Customer's Own Material/Leather (COM/COL) Program** is available.

► See *Coalesse Surface Materials Reference Guide* for additional information.

# Bindu Conference Seating

DESIGN BRIAN KANE

*Tip: Fabrics and leathers will appear loose with comfort wrinkles when upholstered.*

*Tip: For Customer's Own Material or Leather, see necessary requirements, important processing instructions, and ordering information*  
 ▶ See *Coalesse Surface Materials Reference Guide*.

*Tip: Craft in upholstery cautions the use of stripes and patterns on Bindu. Please use fabric database when specifying.*

*Tip: For fabric with a large pattern and a specific pattern location is desired, contact Customer Service.*

Standard Includes		Required to Specify
▶ Need help? Product details, page 290	<ul style="list-style-type: none"> <li>Bent plywood frame</li> <li>Chair: fabric</li> <li>Molded polypropylene foam</li> <li>Base (Desk and Conference): 6205 Black resin</li> <li>Dual wheel hard casters, desk and conference</li> <li>Back tilt lock</li> </ul>	1 Style number 2 Fabric or leather color number for upholstery 3 Options, if selected (see below) ▶ See <i>Coalesse Surface Materials Reference Guide</i> .

	Options	U.S. Price	Required to Specify
<b>Surface Materials</b>	<b>Acrylic backer</b> <ul style="list-style-type: none"> <li>Mid-back chair</li> <li>High-back chair</li> </ul>	+\$ 50 +\$ 52	Specify with acrylic backer. Specify with acrylic backer. ▶ See <i>Coalesse Surface Materials Reference Guide</i> .
<b>Base</b>	<ul style="list-style-type: none"> <li>8046 Polished Aluminum</li> </ul>	+\$242	Specify with 8046 Polished Aluminum.
<b>Casters</b>	<ul style="list-style-type: none"> <li>Soft casters</li> </ul>	+\$ 38	Specify with soft casters.

Specification Information														
Style Number	U.S. Base Prices										Leather Groups:			
	Fabric Groups:										COL	1	2	
	COM	1	2	3	4	5	6	7	8	9	10			

## Mid-Back Conference Chair

CO300	\$2309	\$2309	\$2419	\$2509	\$2618	\$2782	\$2985	\$3216	\$3463	\$3681	\$3912	\$2751	\$4464	\$4811
-------	--------	--------	--------	--------	--------	--------	--------	--------	--------	--------	--------	--------	--------	--------

COM/yds = 3, COL/sq ft = 66



Overall: 25"D 25"W 35½"-40¼"H  
 Inside: 18¾"D 18½"-19½"W 21"H  
 Seat: 16"-20½"H  
 Arm: 24¼"-29"H

## High-Back Conference Chair

CO400	\$2696	\$2696	\$2815	\$2913	\$3031	\$3209	\$3429	\$3679	\$3947	\$4182	\$4433	\$3138	\$5001	\$5379
-------	--------	--------	--------	--------	--------	--------	--------	--------	--------	--------	--------	--------	--------	--------

COM/yds = 3.25, COL/sq ft = 72



Overall: 25"D 25"W 45½"-50¼"H  
 Inside: 18¾"D 18½"-19½"W 31"H  
 Seat: 16"-20½"H  
 Arm: 24¼"-29"H



**For Canadian Pricing**  
 Multiply U.S. Price by the Canadian price factor.  
 ▶ See page 1 for details.

Coalesse

# Bindu Conference Seating

DESIGN BRIAN KANE

# Chord Conference Seating

DESIGN MICHAEL SHIELDS

**Chord conference seating** offers built-in, passive ergonomic curvature of the back, making this design well-suited for long-term conferencing.

**Back and pillow top option** wraps over the seat edge.

**Conference chair upholstery** features a double-needle stitching technique and an accent welt that flows across the back and down the arms.

**Seat height adjustment** allows users to change seat height within a 3" range with a pneumatic adjustment mechanism.

**Casters** are standard with black-hooded, hard, dual wheels that roll smoothly on carpets. Optional soft casters are available for use on hard floors and chair mats.

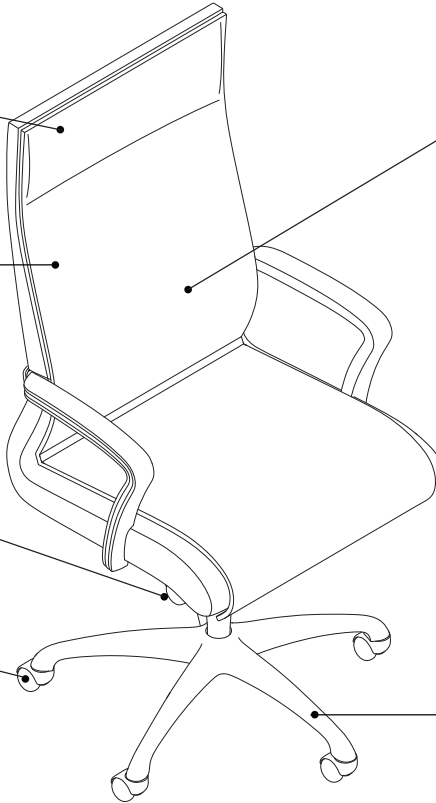

**Fixed lumbar support.**

**Tilt tension adjustment** allows users to control the amount of resistance needed for reclining.

**Swivel-tilt mechanism** swivels 360°. Seat and back stay in a fixed position (no recline).

**5-star base** is black resin. A polished aluminum base is available as an option.

# Chord Conference Seating

DESIGN MICHAEL SHIELDS

## Product Details



**Chord conference seating** is offered in mid back or high back.

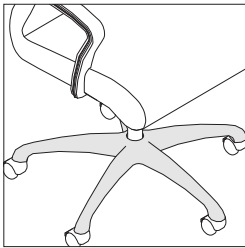

**5-star base** is standard in black resin or optional polished aluminum.

**Casters** are standard with hard, dual-wheels that roll smoothly on carpets. Soft casters for use on hard floors are an available option.

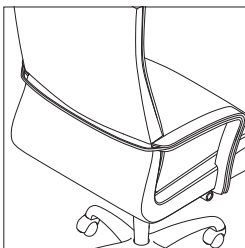

**Accent welt** flows across the back and down the arms (contrasting fabric option).

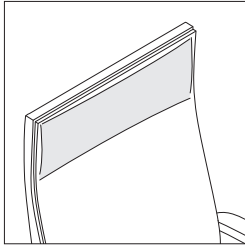

**Pillowback versions** are available on mid-back and high-back chairs for added comfort.

## Adjustment Features

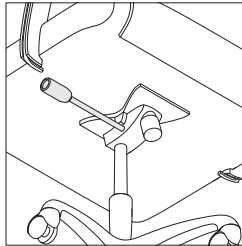

**Seat height** adjusts pneumatically. Lift lever to activate cylinder for desired height. To raise height, slightly stand while lifting lever; to lower, sit while lifting and weight pressure will lower seat height. Range of adjustability is 3" with a maximum seat height of 22".

**Upright back lock** allows users to lock the backrest in a full, upright position. To unlock for free tilting, push handle back towards seat.

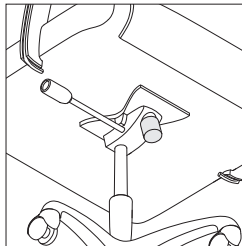

**Tension control knob** allows the user to increase tension (will require more force to tilt chair back), by turning the knob clockwise. For reduced tension and more responsive tilt adjustment, turn knob counter-clockwise.

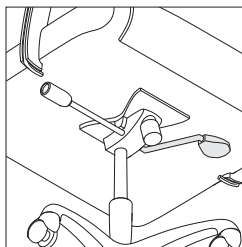

**Knee tilt control (optional)** minimizes the rise of the front of the chair when the chair is in a reclined position, allowing the user's feet to remain on the floor. Push handle up to lock and down to free tilting.

## Surface Materials

► See *Coalesse Surface Materials Reference Guide* for further information.

**Upholstery** (contrasting fabric available)

- Fabric
- Leather

**Arms**

- Black
- Aluminum

**Base**

- Black resin
- Polished aluminum

## Programs & Services

**Customer's Own Material/Leather (COM/COL) Program** is available.

► See *Coalesse Surface Materials Reference Guide* for additional information.

# Chord Conference Seating

DESIGN MICHAEL SHIELDS

*Tip: Fabrics and leathers will appear loose with comfort wrinkles when upholstered.*

*Tip: For Customer's Own Material or Leather, see necessary requirements, important processing instructions, and ordering information*  
 ▶ See *Coalesse Surface Materials Reference Guide*.

*Tip: Arm is cast from 100% recycled material then hand buffed to a mirror finish. Arm caps are molded in black.*

*Tip: List price based on highest fabric group usage.*

*Tip: Contrasting option available only on 798-P and 796-P.*

*Tip: Chord does not pass CAL 133 with urethane arms. To choose the CAL 133 option polished aluminum arms must be selected.*



Overall: 23"D 24½"W 36"-39"H  
 Inside: 18"D 20½"W 18½"H  
 Seat: 18½"-21½"H  
 Arm: 25¾"-28¾"H



**For Canadian Pricing**  
 Multiply U.S. Price by the Canadian price factor.  
 ▶ See page 1 for details.

Standard Includes		Required to Specify
▶ Need help? Product details, page 294	<ul style="list-style-type: none"> <li>• Frame: hardwood plywood assembled into unibody structures utilizing interlocking finger joinery</li> <li>• Cushioning:                             <ul style="list-style-type: none"> <li>- back: multiple laminations of high-density polyurethane foam over an elastic sheet suspension system for lumbar support</li> <li>- seat: closed cell, contour molded urethane foam</li> </ul> </li> <li>• Upholstery:                             <ul style="list-style-type: none"> <li>- seams are double needle stitched with seam binding for extended durability</li> <li>- unique wrap around welt detail and is cut from the same fabric as specified on chair</li> </ul> </li> <li>• Arms: resilient self-skinned urethane molded around carbon steel armature, black or aluminum arm with urethane cap, if selected</li> <li>• Chair controls: tilt-swivel with tilt tension, pneumatic height adjustment, and tilt lockout</li> <li>• Bases: five star black resin</li> <li>• Casters: black hooded dual wheel</li> </ul>	1 Style number 2 Number of fabrics if contrasting fabric style number is selected 3 Fabric or leather color number for upholstery on seat and back 4 Options, if selected (see below) ▶ See <i>Coalesse Surface Materials Reference Guide</i> .

Options	U.S. Price	Required to Specify
<b>Surface Materials</b>		
• <b>Welt detail</b>		
• Contrasting fabric welt	+\$101	Specify with <i>contrasting fabric welt</i> and select fabric color number.
• Contrasting leather welt	+\$147	Specify with <i>contrasting leather welt</i> and select fabric color number.
• Contrasting fabric	+\$192 per fabric	Add suffix <b>K</b> to the style number and select fabric color number.
• <b>Acrylic backer</b>		
• Conference, mid-back, and high-back large chairs	+\$ 30	Specify with <i>acrylic backer</i> .
• High-back large chair	+\$ 36	Specify with <i>acrylic backer</i> .
• Mid-back with pillow chairs	+\$ 50	Specify with <i>acrylic backer</i> .
• High-back with pillow chairs	+\$ 52	Specify with <i>acrylic backer</i> . ▶ See <i>Coalesse Surface Materials Reference Guide</i> .
<b>Base</b>		
• Polished aluminum with black, hooded dual wheel casters	+\$103	Specify with <i>polished aluminum base</i> .
<b>Casters</b>		
• Soft wheel casters	+\$ 75	Specify with <i>soft casters</i> .
<b>Control</b>		
• Knee-tilt with pneumatic height adjustment and tilt lockout	+\$256	Specify with <i>knee-tilt</i> .

Specification Information														
Style Number	U.S. Base Prices										Leather Groups:			
	Fabric Groups:										COL	1	2	
	COM	1	2	3	4	5	6	7	8	9	10			

## Conference Narrow/Narrow with Urethane Arms

795	\$1806	\$1806	\$1876	\$1934	\$2003	\$2107	\$2236	\$2383	\$2540	\$2678	\$2825	\$2296	\$3302	\$3516
-----	--------	--------	--------	--------	--------	--------	--------	--------	--------	--------	--------	--------	--------	--------

COM/yds = 2, COL/sq ft = 40

## Conference Narrow/Narrow with Aluminum Arms

795AU	\$2417	\$2417	\$2487	\$2545	\$2614	\$2718	\$2847	\$2994	\$3151	\$3289	\$3436	\$2907	\$3913	\$4127
-------	--------	--------	--------	--------	--------	--------	--------	--------	--------	--------	--------	--------	--------	--------

▶ Specification Information, continued on next page

# Chord Conference Seating

DESIGN MICHAEL SHIELDS

► Specification Information, continued from previous page

## Specification Information

Style Number	U.S. Base Prices										Leather Groups:			
	Fabric Groups:										COL	1	2	
	COM	1	2	3	4	5	6	7	8	9	10			



Overall: 23¾"D 26"W 37½"-40½"H  
 Inside: 19"D 22"W 21½"H  
 Seat: 19"-22"H  
 Arm: 25¾"-28¾"H

### Mid-Back with Urethane Arms

796	\$2015	\$2015	\$2085	\$2143	\$2212	\$2316	\$2445	\$2592	\$2749	\$2887	\$3034	\$2505	\$3518	\$3723
-----	--------	--------	--------	--------	--------	--------	--------	--------	--------	--------	--------	--------	--------	--------

COM/yds = 2, COL/sq ft = 40

### Mid-Back with Aluminum Arms

796AU	\$2626	\$2626	\$2696	\$2754	\$2823	\$2927	\$3056	\$3203	\$3360	\$3498	\$3645	\$3115	\$4129	\$4334
-------	--------	--------	--------	--------	--------	--------	--------	--------	--------	--------	--------	--------	--------	--------



Overall: 23¾"D 26"W 37½"-40½"H  
 Inside: 18½"D 22"W 19"H  
 Seat: 19"-22"H  
 Arm: 25¾"-28¾"H

### Mid-Back/Pillow Upholstery with Urethane Arms

796-P	\$2494	\$2494	\$2598	\$2686	\$2790	\$2946	\$3140	\$3360	\$3595	\$3803	\$4023	\$2984	\$4545	\$4861
-------	--------	--------	--------	--------	--------	--------	--------	--------	--------	--------	--------	--------	--------	--------

COM/yds = 3, COL/sq ft = 60

### Mid-Back/Pillow Upholstery with Aluminum Arms

796-PAU	\$3105	\$3105	\$3265	\$3304	\$3339	\$3421	\$3477	\$3669	\$3787	\$3950	\$4225	\$3595	\$5156	\$5472
---------	--------	--------	--------	--------	--------	--------	--------	--------	--------	--------	--------	--------	--------	--------

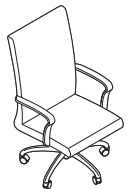

Overall: 23"D 24½"W 44½"-47½"H  
 Inside: 18"D 20½"W 18½"H  
 Seat: 18½"-21½"H  
 Arm: 25¾"-28¾"H

### High-Back Narrow/Narrow with Urethane Arms

797	\$2508	\$2508	\$2578	\$2636	\$2705	\$2809	\$2938	\$3085	\$3242	\$3380	\$3527	\$2998	\$3756	\$3969
-----	--------	--------	--------	--------	--------	--------	--------	--------	--------	--------	--------	--------	--------	--------

COM/yds = 2, COL/sq ft = 44

### High-Back Narrow/Narrow with Aluminum Arms

797AU	\$3119	\$3119	\$3420	\$3189	\$3247	\$3316	\$3549	\$3696	\$3853	\$3991	\$4138	\$3609	\$4367	\$4580
-------	--------	--------	--------	--------	--------	--------	--------	--------	--------	--------	--------	--------	--------	--------

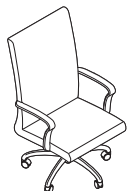

Overall: 23¾"D 26"W 46"-49"H  
 Inside: 19"D 22"W 18½"H  
 Seat: 18½"-21½"H  
 Arm: 25¾"-28¾"H

### High-Back/Large Scale with Urethane Arms

798	\$2528	\$2528	\$2607	\$2673	\$2751	\$2867	\$3012	\$3178	\$3354	\$3510	\$3675	\$3029	\$3769	\$3981
-----	--------	--------	--------	--------	--------	--------	--------	--------	--------	--------	--------	--------	--------	--------

COM/yds = 2¼, COL/sq ft = 44

### High-Back/Large Scale with Aluminum Arms

798AU	\$3139	\$3139	\$3218	\$3284	\$3362	\$3478	\$3623	\$3789	\$3965	\$4121	\$4286	\$3640	\$4380	\$4592
-------	--------	--------	--------	--------	--------	--------	--------	--------	--------	--------	--------	--------	--------	--------



Overall: 23¾"D 26"W 46"-49"H  
 Inside: 19"D 22"W 19"H  
 Seat: 19"-22"H  
 Arm: 26¾"H-28¾"H

### High-Back/Large Scale with Pillow Upholstery with Urethane Arms

798-P	\$2702	\$2702	\$2806	\$2894	\$2998	\$3154	\$3348	\$3568	\$3803	\$4011	\$4231	\$3192	\$4754	\$5069
-------	--------	--------	--------	--------	--------	--------	--------	--------	--------	--------	--------	--------	--------	--------

COM/yds = 3, COL/sq ft = 66

### High-Back/Large Scale with Pillow Upholstery with Aluminum Arms

798-PAU	\$3313	\$3313	\$3417	\$3505	\$3609	\$3765	\$3959	\$4179	\$4414	\$4622	\$4842	\$3803	\$5365	\$5680
---------	--------	--------	--------	--------	--------	--------	--------	--------	--------	--------	--------	--------	--------	--------

# Marien152 Conference Seating

DESIGN COALESSE DESIGN GROUP AND ARIK LEVY

Marien152 is a richly tailored seating experience that's inspired by the home and designed for the workday. An innovative back cushion provides support with soft, residential style. Easy personalization is built into the collection through a wide range of color, form, and materiality choices.

Back cushion gives the appearance of a soft, loose pillow while built-in flex allows the cushion to move with the user. Intentionally relaxed upholstery on the back cushion adds to the welcoming appeal.

Contrasting fabric is available on seat, surround, and back cushion.

360° swivel base provides full range of motion.

Seat height adjustment allows users to change seat height within a 5" range with the assistance of a pneumatic gas cylinder.

Gently sloping arms are subtle yet supportive.

Black casters have hard, dual wheels that roll smoothly on carpet. Soft casters are designed to roll quietly and are available for use on hard floors and chair mats.

Base is standard in powder coat paint and polished aluminum.

Base is standard in powder coat paint and polished aluminum. It is a fixed height with 360° swivel only.

Black glides are available in hard and soft options.

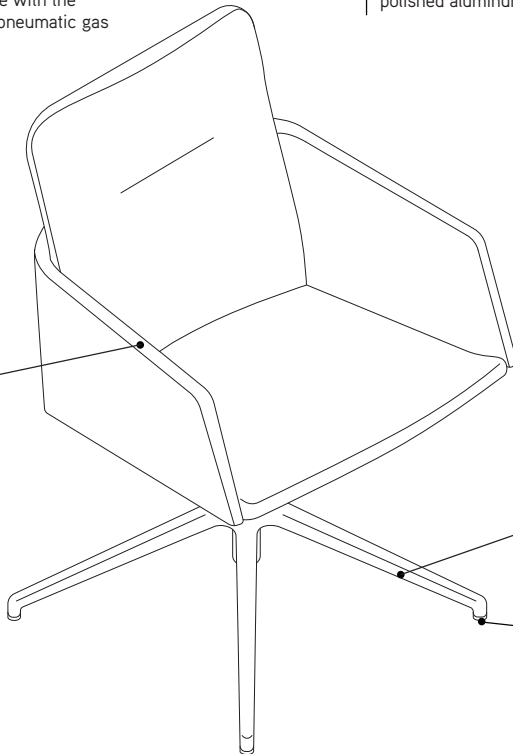
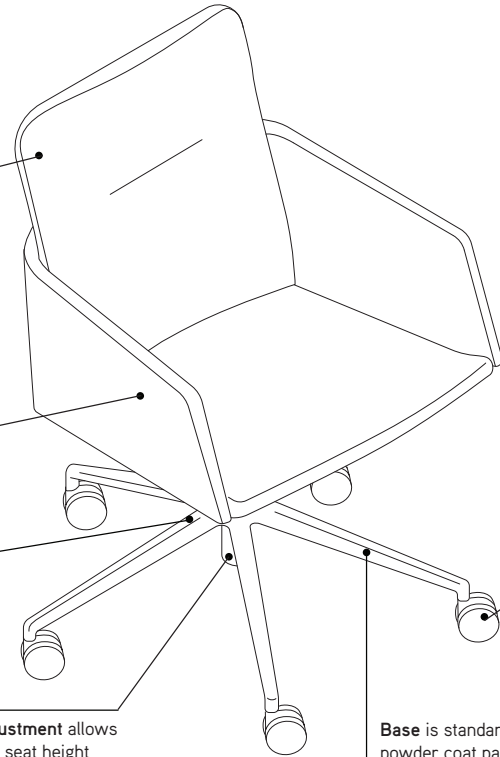

# Marien152 Conference Seating

DESIGN COALESSE DESIGN GROUP AND ARIK LEVY

## Product Details

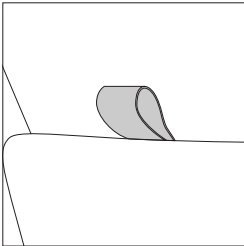

**Standard leather pull**, located behind the back cushion, allows users to easily move the chair. Leather in the color coal only. Option to specify without pull if desired.

## Surface Materials

### 4-star and 5-star metal bases

- Painted
- Polished aluminum

## Programs & Services

**Customer's Own Material/Leather (COM/COL) Program** is available.  
▶ See *Coalesse Surface Materials Reference Guide* for additional information.

# Marien152 Conference Seating

DESIGN COALESSE DESIGN GROUP AND ARIK LEVY

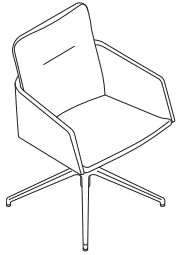

	Standard Includes	Required to Specify
<p>► Need help? Product details, page 298</p>	<ul style="list-style-type: none"> <li>• Seat, back, and surround: upholstery</li> <li>• Leather strap: coal</li> <li>• Base: 8046 Polished Aluminum or group 1 paint</li> <li>• 4-star base:                             <ul style="list-style-type: none"> <li>– Fixed height</li> <li>– 360° swivel</li> <li>– Black hard glides</li> </ul> </li> <li>• 5-star base:                             <ul style="list-style-type: none"> <li>– 5" pneumatic height adjustment, 360° swivel</li> <li>– Black dual wheel casters</li> </ul> </li> </ul>	<ol style="list-style-type: none"> <li>1 Style number</li> <li>2 Contrasting fabric (see below under Required Selections)</li> <li>3 Fabric or leather color number for upholstery on seat, surround, and back</li> <li>4 Metal or paint color number for base</li> <li>5 Options, if selected (see below)</li> </ol> <p>► See <i>Coalesse Surface Materials Reference Guide</i>.</p>

	Required Selections	U.S. Price	Required to Specify
<b>Contrasting Fabric</b>	<ul style="list-style-type: none"> <li>• Non contrasting fabric</li> <li>• Contrasting back fabric</li> <li>• Contrasting surround fabric</li> <li>• Contrasting seat fabric</li> <li>• Contrasting all fabrics</li> </ul>	<p>No cost</p> <p>+\$192</p> <p>+\$192</p> <p>+\$192</p> <p>+\$192</p>	<p>Specify with <i>non contrasting</i>.</p> <p>Specify with <i>contrasting back</i>.</p> <p>Specify with <i>contrasting surround</i>.</p> <p>Specify with <i>contrasting seat</i>.</p> <p>Specify with <i>contrasting all fabrics</i>.</p>

	Options	U.S. Price	Required to Specify
<b>Surface Materials</b>	<p><b>Base</b></p> <ul style="list-style-type: none"> <li>• Polished aluminium</li> <li>• Group 1 paint</li> <li>• Group 3 paint</li> </ul> <hr/> <ul style="list-style-type: none"> <li>• Backer</li> </ul>	<p>No cost</p> <p>No cost</p> <p>+\$111</p> <hr/> <p>+\$ 49</p>	<p>Specify with <i>aluminium matte polished</i>.</p> <p>Specify paint color number.</p> <p>Specify paint color number.</p> <hr/> <p>Specify with <i>acrylic backer</i>.</p>
<b>Caster or Glide Type</b>	<p><b>Chairs with 4-star base</b></p> <ul style="list-style-type: none"> <li>• Hard glides</li> <li>• Soft glides</li> </ul> <hr/> <p><b>Chairs with 5-star base</b></p> <ul style="list-style-type: none"> <li>• Hard casters</li> <li>• Soft casters</li> </ul>	<p>No cost</p> <p>No cost</p> <hr/> <p>No cost</p> <p>+\$ 31</p>	<p>Specify with <i>hard glides</i>.</p> <p>Specify with <i>soft glides</i>.</p> <hr/> <p>Specify with <i>hard casters</i>.</p> <p>Specify with <i>soft casters</i>.</p>
<b>Pull</b>	<ul style="list-style-type: none"> <li>• With leather pull</li> <li>• Without leather pull</li> </ul>	<p>No cost</p> <p>No cost</p>	<p>Specify with <i>pull</i>.</p> <p>Specify <i>without pull</i>.</p>
<b>Related Products</b>	<ul style="list-style-type: none"> <li>• Guest seating</li> </ul>		<p>► Page 345</p>



**For Canadian Pricing**  
 Multiply U.S. Price by the  
 Canadian price factor.  
 ► See page 1 for details.

# Marien152 Conference Seating

DESIGN COALESSE DESIGN GROUP AND ARIK LEVY

## Specification Information

Style Number	U.S. Base Prices													
	Fabric Groups:										Leather Groups:			
	COM	1	2	3	4	5	6	7	8	9	10	COL	1	2



Overall: 24"D x 26"W x 31"H  
 Inside: 16 1/2"D x 18"W  
 Seat: 18"H

### 4-Star Conference Chair

COMARCCH4	Seat	\$1954	\$1954	\$1979	\$1999	\$2024	\$2061	\$2105	\$2157	\$2211	\$2261	\$2313	\$2072	\$ 2393	\$ 2496
	Surround	No cost	No cost	+\$ 40	+\$ 72	+\$ 111	+\$170	+\$243	+\$325	+\$413	+\$491	+\$574	+\$ 118	+\$1012	+\$1245
	Back	No cost	No cost	+\$ 21	+\$ 39	+\$ 60	+\$ 92	+\$130	+\$174	+\$222	+\$264	+\$308	+\$ 118	+\$ 331	+\$ 407

COM/yds: Seat = .78, Surround = 1.25, Cushion = .67, COL/sq ft: Seat = 9, Surround = 30, Cushion = 11

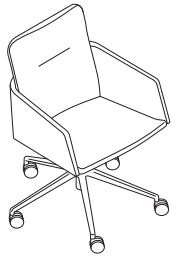

Overall: 24"D x 26"W x 31-36"H  
 Inside: 16 1/2"D x 18"W  
 Seat: 17"-22"H

### 5-Star Conference Chair

COMARCCH5	Seat	\$1954	\$1954	\$1979	\$1999	\$2024	\$2061	\$1995	\$2157	\$2211	\$2261	\$2313	\$2072	\$ 2393	\$ 2496
	Surround	No cost	No cost	+\$ 40	+\$ 72	+\$ 111	+\$170	+\$243	+\$325	+\$413	+\$491	+\$574	+\$ 118	+\$1012	+\$1245
	Back	No cost	No cost	+\$ 21	+\$ 39	+\$ 60	+\$ 92	+\$130	+\$174	+\$222	+\$264	+\$308	+\$ 118	+\$ 331	+\$ 407

COM/yds: Seat = .78, Surround = 1.25, Cushion = .67, COL/sq ft: Seat = 9, Surround = 30, Cushion = 11

Collaboration Seating

 **For Canadian Pricing**  
 Multiply U.S. Price by the  
 Canadian price factor.  
 ▶ See page 1 for details.

# Marien152 Conference Seating Multi-Fabric Diagram

DESIGN COALESSE DESIGN GROUP AND ARIK LEVY

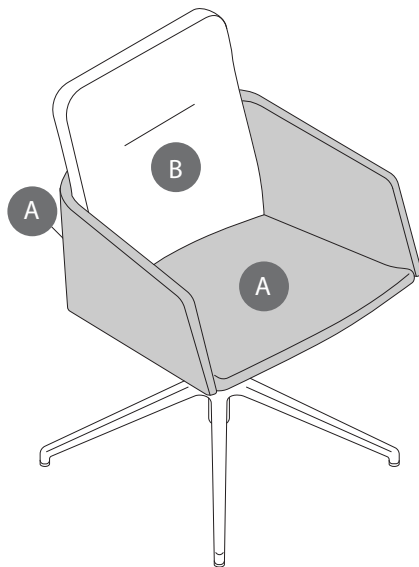
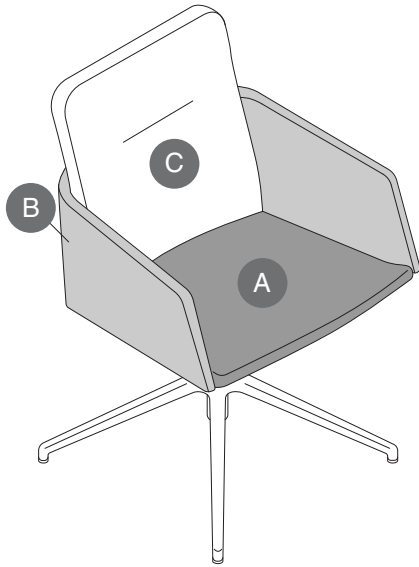

TO: \_\_\_\_\_

FROM: \_\_\_\_\_

DATE: \_\_\_\_\_

FAX...888.413.5161

### FABRIC

**A** Seat: \_\_\_\_\_

\_\_\_\_\_

**B** Surround: \_\_\_\_\_

\_\_\_\_\_

**C** Back: \_\_\_\_\_

\_\_\_\_\_

### LEATHER

**A** Seat + Surround: \_\_\_\_\_

\_\_\_\_\_

**B** Back: \_\_\_\_\_

\_\_\_\_\_

Specify Model below:

COMARCCH4 4-Star Base Chair

COMARCCH5 5-Star Base Chair

*See specifying for contrasting fabric upcharge.  
List price based on highest fabric group usage.*

# Lox Seating

DESIGN PEARSON LLOYD

Lox provides comfortable and sleek seating in social spaces for informal gatherings in cafés and lobbies, meeting rooms, and dining rooms as well as in dynamic, collaborative meeting spaces.

Seat back can be upholstered.

Swivel mechanism is standard.

Glides are black plastic; felt glides are available for use on non-carpeted surfaces.

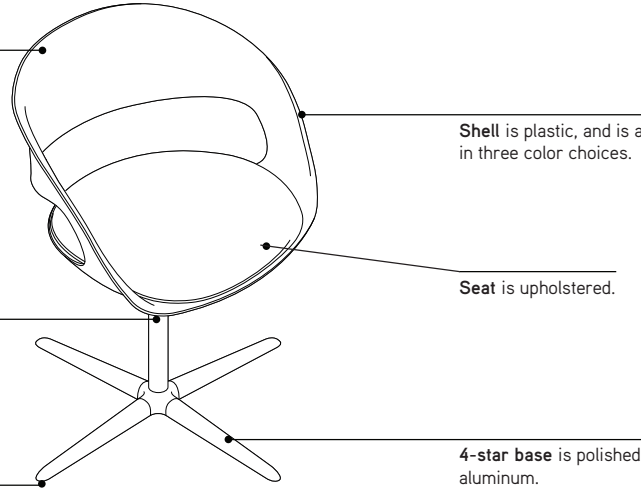

Shell is plastic, and is available in three color choices.

Seat is upholstered.

4-star base is polished aluminum.

Seat back can be upholstered.

Swivel mechanism with spring is standard.

Casters have hard, dual wheels that roll smoothly on carpets. Soft casters with roll control have been designed to roll quietly and are available for use on hard floors and chair mats.

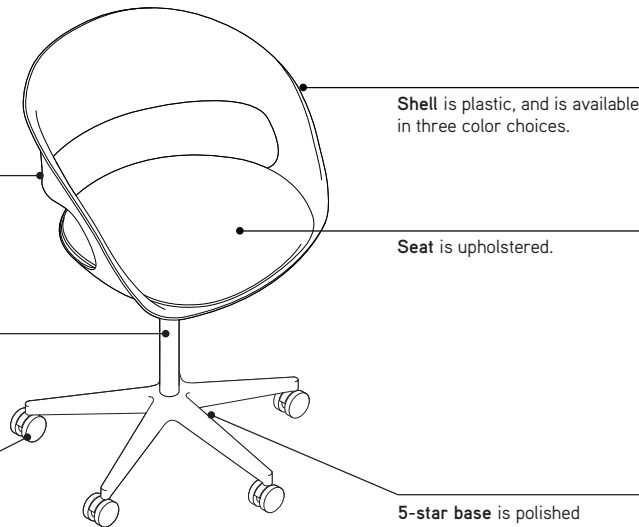

Shell is plastic, and is available in three color choices.

Seat is upholstered.

5-star base is polished aluminum.

## Product Details

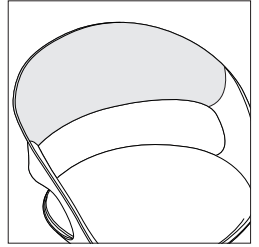

Textile patterns require seams on the inside back of chair. Limited solid textiles and leathers also require seams.

## Surface Materials

► See *Coalesse Surface Materials Reference Guide* for further information.

### Upholstery

- Fabric
- Leather

### Shell

- Plastic

### 4- or 5-star base

- Polished aluminum

## Program & Services

Customer's Own Material/Leather (COM/COL) Program is available.

► See *Coalesse Surface Materials Reference Guide* for additional information.

# Lox Seating

DESIGN PEARSON LLOYD

*Tip: For Customer's Own Material or Leather, see necessary requirements, important processing instructions, and ordering information*  
 ▶ See *Coalesse Surface Materials Reference Guide*.

*Tip: Due to the design and construction techniques of the Lox chairs only certain textiles can be successfully applied, therefore all COM fabrics must be submitted to Coalesse for approval prior to order acceptance.*

*Tip: Textile patterns for chair with upholstered back will require seams on the inside back of the chair. Limited solid textiles or leathers may also require seams. For specific textile information, visit the fabric database at [www.coalesse.com](http://www.coalesse.com).*

Standard Includes		Required to Specify
▶ Need help? Product details, page 303	<ul style="list-style-type: none"> <li>• Shell: plastic</li> <li>• Base: 8046 Polished Aluminum</li> <li>• Seat: fixed upholstery with polyurethane foam base</li> <li>• Back: fixed upholstery with polyurethane foam base, if selected</li> <li>• 4-star base:                             <ul style="list-style-type: none"> <li>– Swivel mechanism</li> <li>– Glides: plastic</li> </ul> </li> <li>• 5-star base:                             <ul style="list-style-type: none"> <li>– Swivel mechanism with spring</li> <li>– Dual-wheel, hard casters: black</li> </ul> </li> </ul>	1 Style number 2 Plastic color number for shell: 6345 Black 6346 White 6349 Greige 3 Fabric or leather color number for upholstery 4 Options, if selected (see below) ▶ See <i>Coalesse Surface Materials Reference Guide</i> .

Options	U.S. Price	Required to Specify
<b>Surface Materials</b> <ul style="list-style-type: none"> <li>• Acrylic backer</li> <li>• Chair with upholstered seat</li> <li>• Chair with upholstered seat and back</li> </ul>	+\$ 7 +\$13	Specify with acrylic backer. Specify with acrylic backer. ▶ See <i>Coalesse Surface Materials Reference Guide</i> .
<b>Felt Glides</b> <ul style="list-style-type: none"> <li>• Glides (available on COLX400 and COLX410)</li> </ul>	No cost	Specify with felt glides.
<b>Casters</b> <ul style="list-style-type: none"> <li>• Soft wheel casters with roll control (available on COLX500 and COLX510)</li> </ul>	+\$34	Specify with soft casters.
<b>Related Products</b> <ul style="list-style-type: none"> <li>• Stools</li> </ul>		▶ Page 363

Specification Information													
Style Number	U.S. Base Prices										Leather Groups:		
	COM	1	2	3	4	5	6	7	8	9	10	COL	1

## 4-Star Base Chair with Upholstered Seat

COLX400	\$1850	\$1850	\$1875	\$1895	\$1920	\$1957	\$2002	\$2054	\$2108	\$2158	\$2210	\$2305	\$2006	\$2209
---------	--------	--------	--------	--------	--------	--------	--------	--------	--------	--------	--------	--------	--------	--------

COM/yds = 3/4, COL/sq ft = 13

## 4-Star Base Chair with Upholstered Seat and Back

COLX410	\$2184	\$2184	\$2226	\$2260	\$2300	\$2363	\$2437	\$2524	\$2615	\$2698	\$2785	\$2639	\$2728	\$2793
---------	--------	--------	--------	--------	--------	--------	--------	--------	--------	--------	--------	--------	--------	--------

COM/yds = 1/4, COL/sq ft = 22

▶ Specification Information, continued on next page



Overall: 27"D 27"W 31"H  
 Seat: 18"D 18"W 19"H



Overall: 27"D 27"W 31"H  
 Seat: 18"D 18"W 19"H



**For Canadian Pricing**  
 Multiply U.S. Price by the Canadian price factor.  
 ▶ See page 1 for details.

# Lox Seating

DESIGN PEARSON LLOYD

► Specification Information, continued from previous page

## Specification Information

Style Number	U.S. Base Prices										Leather Groups:		
	Fabric Groups:										COL	1	2
	COM	1	2	3	4	5	6	7	8	9	10		

### 5-Star Base Chair with Upholstered Seat

COLX500	\$2058	\$2058	\$2083	\$2103	\$2128	\$2165	\$2210	\$2262	\$2316	\$2366	\$2418	\$2513	\$2214	\$2417
---------	--------	--------	--------	--------	--------	--------	--------	--------	--------	--------	--------	--------	--------	--------

COM/yds = 3/4, COL/sq ft = 13



Overall: 27"D 27"W 31"H  
Seat: 18"D 18"W 19"H

### 5-Star Base Chair with Upholstered Seat and Back

COLX510	\$2437	\$2437	\$2479	\$2513	\$2553	\$2616	\$2690	\$2777	\$2868	\$2951	\$3038	\$2892	\$2981	\$3046
---------	--------	--------	--------	--------	--------	--------	--------	--------	--------	--------	--------	--------	--------	--------

COM/yds = 1/4, COL/sq ft = 22



Overall: 27"D 27"W 31"H  
Seat: 18"D 18"W 19"H



**For Canadian Pricing**  
Multiply U.S. Price by the  
Canadian price factor.  
► See page 1 for details.

# Massaud Conference Seating

DESIGN COALESSE DESIGN GROUP AND JEAN-MARIE MASSAUD

**Conference and duvet conference chairs** feature different upholstery techniques expressed through the unique geometry on each chair's inner back.

*Tip: These techniques apply to mid- and low-back chairs with both loop and integrated arms.*

*Tip: This product line is part of a collection and will be found in multiple locations in this specification guide.*

**Aluminum loop arm**, available in painted or polished finishes, is contoured for comfort and is available on mid-back chairs only. Optional upholstered arm caps are available.

**Casters** have hard, dual-wheels that roll smoothly on carpets. Soft casters with roll control have been designed to roll quietly and are available for use on hard floors and chair mats.

**Back tension adjustment** offers two settings to allow the user to adjust the rate of increase or decrease in force as the user reclines. Turn lever forward to increase tension. Turn lever back to decrease.

**Seat height adjustment** allows users to change seat height within a 5" range with the assistance of a pneumatic gas cylinder.

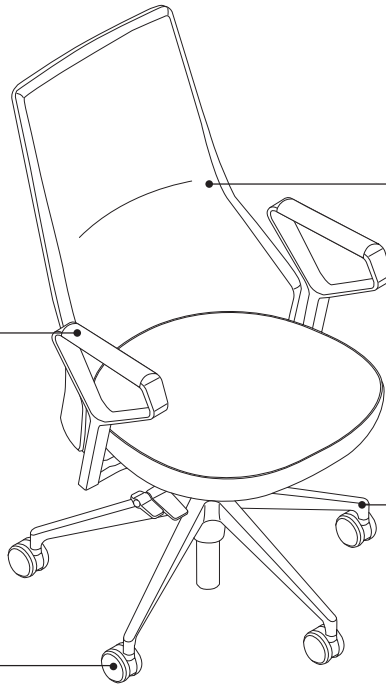

**Conference chair upholstery** features a horizontal, single needle stitching technique on the chair's inner back.

**5-star base** is standard on mid-back chair with loop arm.

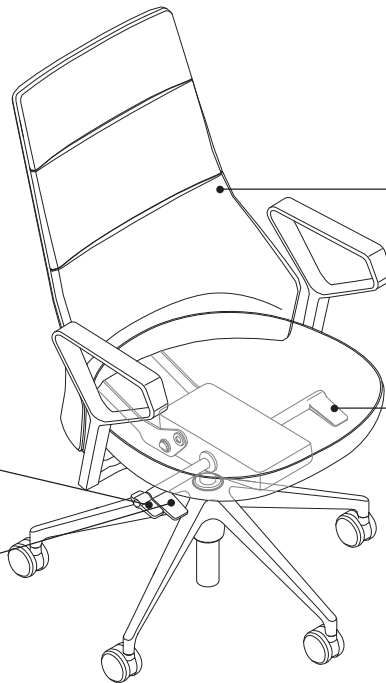

**Duvet conference chair upholstery** features a duvet stitching technique accented with comfort wrinkles on the chair's inner back.

**Recline adjustment** allows user to choose from three recline positions: full-tilt, mid-stop, and full upright positions.

**Synchro-tilt mechanism** is weight activated and automatically responds to recline resistance proportionate to the user's weight. The chair and back move in a 3:1 ratio.

# Massaud Conference Seating

DESIGN COALESSE DESIGN GROUP AND JEAN-MARIE MASSAUD

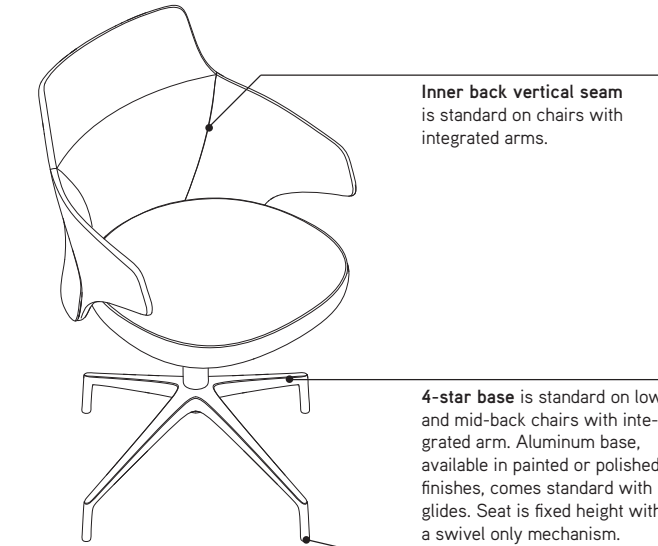

**Inner back vertical seam** is standard on chairs with integrated arms.

**4-star base** is standard on low and mid-back chairs with integrated arm. Aluminum base, available in painted or polished finishes, comes standard with glides. Seat is fixed height with a swivel only mechanism.

**Non-adjustable glide** is standard on low- and mid-back chairs. Easy slide glide is optional and features a wide surface, allowing a smooth slide on carpet and soft flooring.

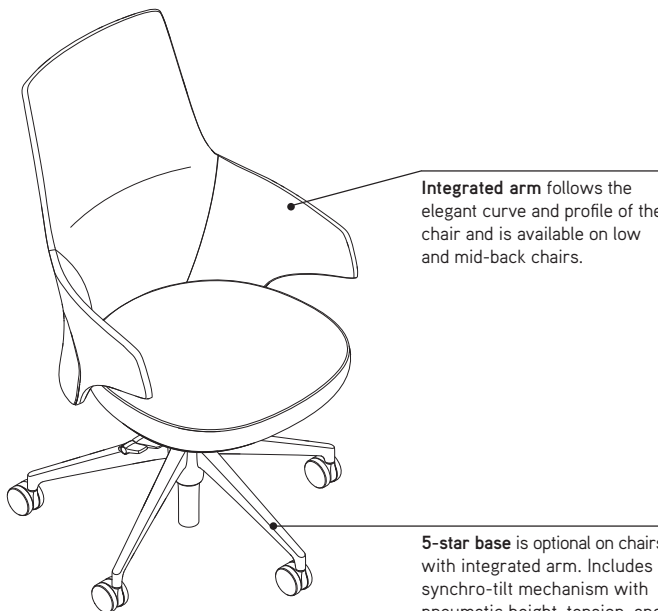

**Integrated arm** follows the elegant curve and profile of the chair and is available on low and mid-back chairs.

**5-star base** is optional on chairs with integrated arm. Includes synchro-tilt mechanism with pneumatic height, tension, and recline adjustments.

## Product Details

*Tip: Upholstery details apply to mid- and low-back chairs with both loop and integrated arms.*

### Seamless Upholstery

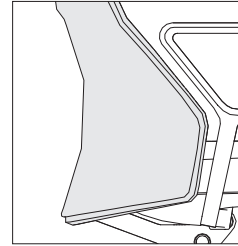

**Outer back seams** are not required on conference and duvet conference chairs with seamless upholstery selection.

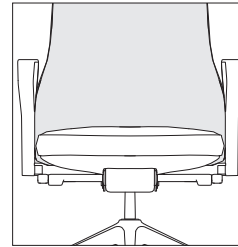

**Inner back vertical seams** are not required on conference chairs with seamless upholstery selection.

### Seamed Upholstery

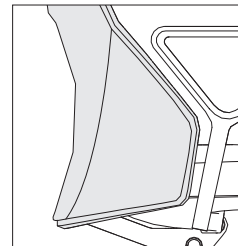

**Outer back seams** are required on conference and duvet conference chairs with seamed upholstery selection.

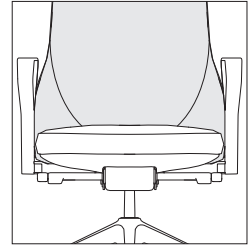

**Inner back vertical seams** are required on conference chairs with seamed upholstery selection.

*Tip: Duvet conference chairs with loop arms always have horizontal inner back seams, but vertical seams are not required. Conference and duvet conference chairs with integrated arms always have vertical inner back seams.*

## Surface Materials

### Seamless Upholstery:

- Designtex Chromatic
- Designtex Heather
- Designtex Billiard Cloth
- Designtex Pigment
- Designtex Melrose
- Maharam Hallingdal
- Maharam Messenger
- Steelcase Cogent: Connect
- Steelcase Billiard Multi-Use by Designtex

### Seamed Upholstery:

- Any upholstery not listed above will require seams.

### Base and arms

- Aluminum matte polished
- Paint

### Easy slide glides (option):

- Paint

## Programs & Services

**Customer's Own Material/Leather (COM/COL) Program** is available.

► See *Coalesse Surface Materials Reference Guide* for additional information.

# Massaud Conference Seating

DESIGN COALESSE DESIGN GROUP AND JEAN-MARIE MASSAUD



*Tip: For duvet conference chairs, fabrics and leathers will appear loose with comfort wrinkles when upholstered.*

*Tip: For Customer's Own Material or Leather, see necessary requirements, important processing instructions, and ordering information.*

► See *Coalesse Surface Materials Reference Guide* and online fabric database at <http://fabric.coalesse.com>

*Tip: Pneumatic height adjustment allows user to change seat height, with the assistance of a pneumatic gas cylinder. Synchro-tilt mechanism has three recline positions and two tension positions.*

*Tip: Faux leathers and vinyls are not recommended on arm cap upholstery.*

*Tip: Loop arms can be adjusted out 1" on either side. Requires tools and must be done by a facility manager.*

*Tip: Easy slide glides are to be used on carpet and soft flooring.*

	Standard Includes	Required to Specify
► Need help? Product details, page 306	<ul style="list-style-type: none"> <li>• Base: 8040 Aluminum Matte Polished or group 1 paint</li> <li>• Inner back and seat:                             <ul style="list-style-type: none"> <li>- Conference chair, if selected: horizontal single needle stitching detail on inner back</li> <li>- Duvet conference chair, if selected: comfort wrinkles on inner back</li> </ul> </li> <li>• Outer back and inner back: see upholstery understanding                             <ul style="list-style-type: none"> <li>► See page 307 for seaming placement based on upholstery selection</li> </ul> </li> <li>• Pneumatic height adjustment and synchro-tilt mechanism</li> <li>• Arms:                             <ul style="list-style-type: none"> <li>- Mid-back chair, if selected: 8040 Aluminum Matte or group 1 paint</li> </ul> </li> <li>• Polished loop arms (without arm caps):                             <ul style="list-style-type: none"> <li>- Low-back chair, if selected: fully upholstered integrated arms</li> </ul> </li> <li>• Base:                             <ul style="list-style-type: none"> <li>- Chairs with loop arms, if selected: 5-star base with black, dual wheel hard casters</li> <li>- Chairs with integrated arms, if selected: 4-star base with non-adjustable glides</li> </ul> </li> </ul>	<ol style="list-style-type: none"> <li>1 Style number</li> <li>2 Metal of paint color number for base and arms</li> <li>3 Fabric or leather color number for upholstery on seat, inner, and outer back</li> <li>4 Options, if selected (see below)</li> </ol> <p>► See <i>Coalesse Surface Materials Reference Guide</i>.</p>

	Options	U.S. Price	Required to Specify
<b>Surface Materials</b>	<ul style="list-style-type: none"> <li>• Contrasting inner back</li> <li>• Contrasting outer back</li> <li>• Contrasting seat</li> <li>• Contrasting all target surfaces</li> </ul>	<p>+\$192</p> <p>+\$192</p> <p>+\$192</p> <p>+\$384</p>	<p>Specify with <i>contrasting inner back</i>.</p> <p>Specify with <i>contrasting outer back</i>.</p> <p>Specify with <i>contrasting seat</i>.</p> <p>Specify with <i>contrasting all</i>.</p> <p>► See <i>Coalesse Surface Materials Reference Guide</i>.</p>
	<b>Base and arms</b>		
	<ul style="list-style-type: none"> <li>• Aluminum matte polished</li> <li>• Group 1 paint</li> <li>• Group 3 paint</li> </ul>	<p>No cost</p> <p>No cost</p> <p>+\$114</p>	<p>Specify with <i>aluminum matte polished</i>.</p> <p>Specify paint color number.</p> <p>Specify paint color number.</p>
<b>Acrylic backer</b>	<ul style="list-style-type: none"> <li>• Conference chair</li> <li>• Duvet conference chair</li> </ul>	<p>+\$ 49</p> <p>+\$ 79</p>	<p>Specify with <i>acrylic backer</i>.</p> <p>Specify with <i>acrylic backer</i>.</p>
<b>Base</b>	<b>Chairs with integrated arms</b>		
	<ul style="list-style-type: none"> <li>• 4-star base</li> <li>• 5-star base</li> </ul>	<p>No cost</p> <p>+\$ 79</p>	<p>Specify with <i>4-star base</i>.</p> <p>Specify with <i>5-star base</i>.</p>
<b>Arm Caps</b>	<b>Chairs with loop arms</b>		
	<ul style="list-style-type: none"> <li>• Faux leather and vinyl are excluded</li> </ul>	<p>+\$315</p>	<p>Specify with <i>arm caps</i> and select finish.</p>
<b>Caster or Glide Type</b>	<b>Chairs with 5-star base</b>		
	<ul style="list-style-type: none"> <li>• Hard casters</li> <li>• Soft casters</li> </ul>	<p>No cost</p> <p>+\$ 31</p>	<p>Specify with <i>hard casters</i>.</p> <p>Specify with <i>soft casters</i>.</p>
	<b>Chairs with 4-star base</b>		
	<ul style="list-style-type: none"> <li>• Easy slide glides</li> </ul>	<p>No cost</p>	<p>Specify with <i>easy slide glides</i> and select 6167 Black or 6168 Natural finish.</p>
<b>Related Products</b>	<ul style="list-style-type: none"> <li>• Lounge seating</li> </ul>		► Page 178



**For Canadian Pricing**  
 Multiply U.S. Price by the Canadian price factor.  
 ► See page 1 for details.

# Massaud Conference Seating

DESIGN COALESSE DESIGN GROUP AND JEAN-MARIE MASSAUD

## Specification Information

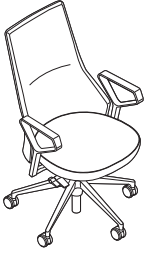

**With 5-star base**

**Overall:** 23¾"W x 25"D x 38¼"-43½"H

**Inside:** 19¼"W x 18"D

**Seat:** 16¾"-21¾" H

**Arm:** 24½"-29¾"H

Style Number	U.S. Base Prices										Leather Groups:		
	Fabric Groups:										COL		
	COM	1	2	3	4	5	6	7	8	9	10	1	2

### Mid-Back Conference Chair with Loop Arm

COMCCHMBST	Seat	\$2651	\$2651	\$2714	\$2766	\$2828	\$2922	\$3038	\$3170	\$3311	\$3435	\$3568	\$2832	\$3143	\$3264
	Inner back	No cost	No cost	+\$ 30	+\$ 54	+\$ 83	+\$128	+\$181	+\$244	+\$310	+\$368	+\$430	+\$123	+\$396	+\$486
	Outer back	No cost	No cost	+\$ 30	+\$ 54	+\$ 83	+\$128	+\$181	+\$244	+\$310	+\$368	+\$430	+\$123	+\$345	+\$428

COM/yds: Seat = 1.6, Inner Back = .75, Outer Back = .75, Optional Arm Caps = .25 COL/sq ft: Seat = 21, Inner Back = 15, Outer Back = 16, Optional Arm Caps = 2

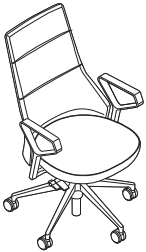

**With 5-star base**

**Overall:** 23¾"W x 25"D x 38¼"-43½"H

**Inside:** 19¼"W x 18"D

**Seat:** 16¾"-21¾" H

**Arm:** 24½"-29¾"H

### Mid-Back Duvet Conference Chair with Loop Arm

COMCCHMBDV	Seat	\$2651	\$2651	\$2710	\$2759	\$2817	\$2905	\$3014	\$3137	\$3270	\$3386	\$3511	\$2832	\$3143	\$3264
	Inner back	No cost	No cost	+\$ 55	+\$100	+\$155	+\$237	+\$339	+\$455	+\$578	+\$687	+\$802	+\$123	+\$396	+\$486
	Outer back	No cost	No cost	+\$ 32	+\$ 58	+\$ 89	+\$136	+\$194	+\$260	+\$330	+\$392	+\$459	+\$123	+\$345	+\$428

COM/yds: Seat = 1.6, Inner Back = .90, Outer Back = .75, Optional Arm Caps = .90 COL/sq ft: Seat = 21, Inner Back = 15, Outer Back = 16, Optional Arm Caps = 2

► Specification Information, continued on next page



**For Canadian Pricing**

Multiply U.S. Price by the Canadian price factor.

► See page 1 for details.

# Massaud Conference Seating continued

DESIGN COALESSE DESIGN GROUP AND JEAN-MARIE MASSAUD

► Specification Information, continued from previous page

## Specification Information



**With 4-star base**  
**Overall:** 24¾"W x 22½"D x 34"H  
**Inside:** 23¾"W x 18"D  
**Seat:** 18"H  
**Arm:** 26½"H



**With 5-star base**  
**Overall:** 24¾"W x 23"D x 31½"-36¾"H  
**Inside:** 23¾"W x 18"D  
**Seat:** 16¾"-21¾"H  
**Arm:** 24½"-29¾"H

Style Number	U.S. Base Prices										Leather Groups:			
	Fabric Groups:										COL	1	2	
	COM	1	2	3	4	5	6	7	8	9	10			

### Low-Back Conference Chair with Integrated Arm

COMCCHLBSTNT	Seat	\$2263	\$2263	\$2322	\$2371	\$2429	\$2517	\$2626	\$2749	\$2882	\$2998	\$3123	\$2444	\$2755	\$2876
	Inner back	No cost	No cost	+\$ 55	+\$100	+\$155	+\$237	+\$339	+\$455	+\$578	+\$687	+\$802	+\$123	+\$501	+\$622
	Outer back	No cost	No cost	+\$ 32	+\$ 58	+\$ 89	+\$136	+\$194	+\$260	+\$330	+\$392	+\$459	+\$123	+\$345	+\$428

COM/yds: Seat = 1.5, Inner Back = 1.4, Outer back = .8 COL/sq ft: Seat = 23.75, Inner Back = 15, Outer Back = 16



**With 4-star base**  
**Overall:** 24¾"W x 22½"D x 34"H  
**Inside:** 23¾"W x 18"D  
**Seat:** 18"H  
**Arm:** 26½"H



**With 5-star base**  
**Overall:** 24¾"W x 23"D x 31½"-36¾"H  
**Inside:** 23¾"W x 18"D  
**Seat:** 16¾"-21¾"H  
**Arm:** 24½"-29¾"H

### Low-Back Duvet Conference Chair with Integrated Arm

COMCCHLBDVNT	Seat	\$2263	\$2263	\$2322	\$2371	\$2429	\$2517	\$2626	\$2749	\$2882	\$2998	\$3123	\$2444	\$2755	\$2876
	Inner back	No cost	No cost	+\$ 55	+\$100	+\$155	+\$237	+\$339	+\$455	+\$578	+\$687	+\$802	+\$123	+\$501	+\$622
	Outer back	No cost	No cost	+\$ 32	+\$ 58	+\$ 89	+\$136	+\$194	+\$260	+\$330	+\$392	+\$459	+\$123	+\$345	+\$428

COM/yds: Seat = 1.5, Inner Back = 1.4, Outer back = .8 COL/sq ft: Seat = 23.75, Inner Back = 15, Outer Back = 16

► Specification Information, continued on next page



**For Canadian Pricing**  
 Multiply U.S. Price by the Canadian price factor.  
 ► See page 1 for details.

# Massaud Conference Seating

DESIGN COALESSE DESIGN GROUP AND JEAN-MARIE MASSAUD

► Specification Information, continued from previous page

## Specification Information

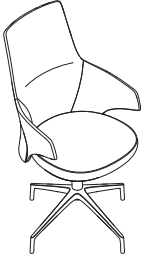

**With 4-star base**  
**Overall:** 24¾"W x 24½"D x 40¼"H  
**Inside:** 19¼"W x 18"D  
**Seat:** 18"H  
**Arm:** 26½"H



**With 5-star base**  
**Overall:** 24¾"W x 25"D x 38¼"-43½"H  
**Inside:** 19¼"W x 18"D  
**Seat:** 16¾"-21¾"H  
**Arm:** 24½"-29¾"H

Style Number	U.S. Base Prices										Leather Groups:			
	Fabric Groups:										COL	1	2	
	COM	1	2	3	4	5	6	7	8	9	10			

### Mid-Back Conference Chair with Integrated Arm

COMCCHMBSTNT	Seat	\$2743	\$2743	\$2802	\$2851	\$2909	\$2997	\$3106	\$3229	\$3362	\$3478	\$3603	\$2924	\$3235	\$3356
	Inner back	No cost	No cost	+\$ 55	+\$100	+\$155	+\$237	+\$339	+\$455	+\$578	+\$687	+\$802	+\$123	+\$497	+\$618
	Outer back	No cost	No cost	+\$ 32	+\$ 58	+\$ 89	+\$136	+\$194	+\$260	+\$330	+\$392	+\$459	+\$123	+\$345	+\$428

COM/yds: Seat = 1.5, Inner Back = 1.4, Outer back = .8 COL/sq ft: Seat = 23.75, Inner Back = 15, Outer Back = 16

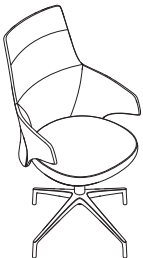

**With 4-star base**  
**Overall:** 24¾"W x 24½"D x 40¼"H  
**Inside:** 19¼"W x 18"D  
**Seat:** 18"H  
**Arm:** 26½"H



**With 5-star base**  
**Overall:** 24¾"W x 25"D x 38¼"-43½"H  
**Inside:** 19¼"W x 18"D  
**Seat:** 16¾"-21¾"H  
**Arm:** 24½"-29¾"H

### Mid-Back Duvet Conference Chair with Integrated Arm

COMCCHMBDVNT	Seat	\$2743	\$2743	\$2775	\$2801	\$2832	\$2879	\$2937	\$3003	\$3073	\$3135	\$3202	\$2924	\$3235	\$3356
	Inner back	No cost	No cost	+\$ 55	+\$100	+\$155	+\$237	+\$339	+\$455	+\$578	+\$687	+\$802	+\$123	+\$497	+\$618
	Outer back	No cost	No cost	+\$ 32	+\$ 58	+\$ 89	+\$136	+\$194	+\$260	+\$330	+\$392	+\$459	+\$123	+\$345	+\$428

COM/yds: Seat = 1.5, Inner Back = 1.4, Outer back = .8 COL/sq ft: Seat = 23.75, Inner Back = 15, Outer Back = 16

 **For Canadian Pricing**  
 Multiply U.S. Price by the Canadian price factor.  
 ► See page 1 for details.

# Massaud Conference Seating Multi-Fabric Diagram

DESIGN COALESSE DESIGN GROUP AND JEAN-MARIE MASSAUD

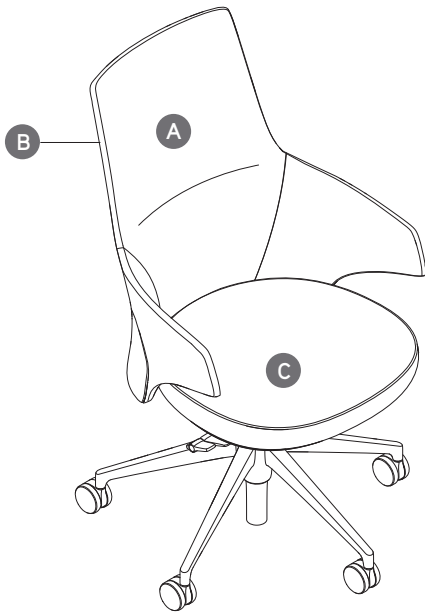
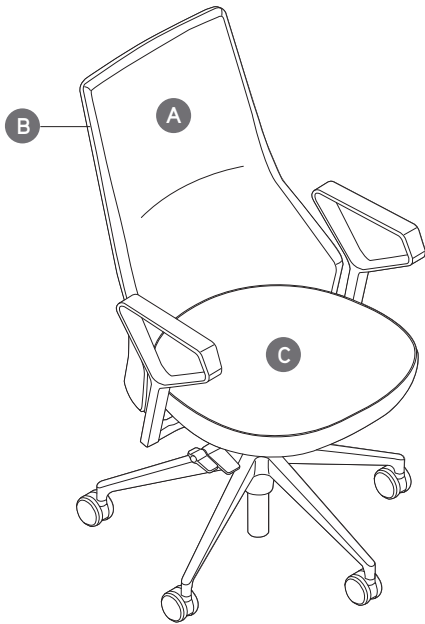

TO: \_\_\_\_\_

FROM: \_\_\_\_\_

DATE: \_\_\_\_\_

FAX...888.413.5161

**A** Inner Back: \_\_\_\_\_

\_\_\_\_\_

**B** Outer Back: \_\_\_\_\_

\_\_\_\_\_

**C** Seat: \_\_\_\_\_

\_\_\_\_\_

*Contrasting upcharge for each contrasting textile pricing based on highest group textile specified. See specifying for contrasting upcharge.*

Specify Model below:

COMCCHMBST Massaud Mid-Back Conference Chair with Loop Arm

COMCCHMBDV Massaud Mid-Back Duvet Conference Chair with Loop Arm

COMCCHLBTNT Massaud Low-Back Conference Chair with Integrated Arm

COMCCHLBDVNT Massaud Low-Back Duvet Conference Chair with Integrated Arm

COMCCHMBSTNT Massaud Mid-Back Conference Chair with Integrated Arm

COMCCHMBDVNT Massaud Mid-Back Duvet Conference Chair with Integrated Arm

*Tip: On chairs with integrated arm, the inner back selection [A] also applies to the entire integrated arm (both front and back).*

# SW\_1 Conference Seating

DESIGN SCOTT WILSON & MINIMAL

**SW\_1 conference seating** offers a wide range of expressive possibilities with the use of knit mixed with fabric or leather upholstery. *Tip: This product line is part of a collection and will be found in multiple locations in this specification guide and/or Coalesse Tables, Storage, and Accessories Specification Guide.*

► See Collections, page 5.

**Knit back** provides back support and breathability.

**5-star base** is standard in aluminum matte polished.

**Casters** are standard with hard, dual-wheels in black that roll smoothly on carpets. Soft casters are available in black for use on hard floors and chair mats.

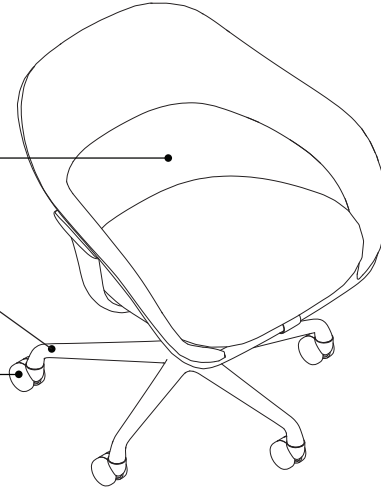

**360° swivel base mechanism** provides full range of motion.

**Knit back** provides back support and breathability.

**Glides** are standard in aluminum with non-marring plastic insert.

**Swivel return mechanism** has a built in memory and will return to the fixed position when the user leaves the chair.

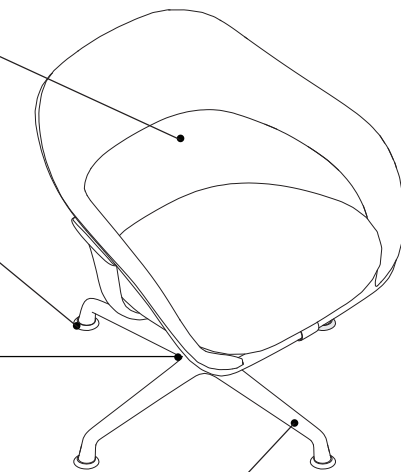

**4-star base** is standard in aluminum matte polished.

## Product Details

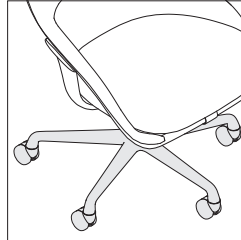

**Conference chair with 5-star base** is standard with black, dual-wheel casters. Aluminum matte polished casters are available as an option.

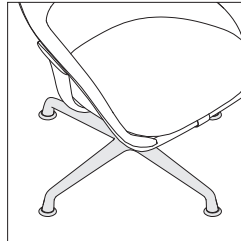

**Conference chair with 4-star base** is available for guest seating. Seat height is 18".

## Adjustment Features

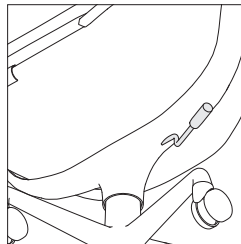

**Seat height** adjusts pneumatically. Lift lever to activate cylinder for desired height. To raise height, slightly stand while lifting lever; to lower, sit while lifting lever and weight pressure will adjust seat height. Range of adjustability is 3 1/2" with a maximum height of 19 3/4".

**360° swivel mechanism** is standard on 5-star base and provides user with a full range of motion.

**Swivel return mechanism** is standard on 4-star base. It has a built in memory and will return to the fixed position when the user leaves the chair.

## Surface Materials

► See *Coalesse Surface Materials Reference Guide* for further information.

**Upholstery** (contrasting fabric available)

- Knit
- Fabric
- Leather

**Base**

- Aluminum matte polished

**Casters on 5-star base**

- Black plastic
- Aluminum matte polished

**Glides on 4-star base**

- Aluminum with non-marring plastic insert

## Programs & Services

**Customer's Own Material/Leather (COM/COL) Program** is available.

► See *Coalesse Surface Materials Reference Guide* for additional information.

# SW\_1 Conference Seating

DESIGN SCOTT WILSON & MINIMAL

*Tip: For Customer's Own Material or Leather, see necessary requirements, important processing instructions, and ordering information*  
 ▶ See *Coalesse Surface Materials Reference Guide*.

	Standard Includes	Required to Specify
▶ Neep help? Product details. Page 313	<ul style="list-style-type: none"> <li>• Seat and upper back: fabric or leather</li> <li>• Lower back: knit</li> <li>• Base: 8040 Aluminum Matte Polished</li> <li>• Frame: steel tube</li> <li>• Glides on conference chair with 4-star base, if selected: aluminum with non marring plastic insert</li> <li>• Casters on conference chair with 5-star base, if selected: dual wheel hard casters, black only</li> <li>• Swivel return mechanism on conference chair with 4-star base, if selected</li> <li>• Swivel mechanism on conference chair with 5-star base, if selected</li> </ul>	1 Style number 2 Upholstery color number for seat or upper back 3 Knit color number for lower back 4 Options, if selected (see below) ▶ See <i>Coalesse Surface Materials Reference Guide</i> .

	Options	U.S. Price	Required to Specify
<b>Surface Materials</b>	<ul style="list-style-type: none"> <li>• Contrasting fabric</li> </ul>	+\$192	Specify with <i>contrasting fabric</i> and select fabric color number.
	<b>Acrylic backer</b> <ul style="list-style-type: none"> <li>• Backer</li> </ul>	+\$ 51	Specify with <i>acrylic backer</i> . ▶ See <i>Coalesse Surface Materials Reference Guide</i> .
<b>Mechanism</b>	<ul style="list-style-type: none"> <li>• Full swivel (omit swivel-return feature)</li> </ul>	No cost	Specify with <i>swivel-only mechanism</i> .
<b>Casters</b>	<ul style="list-style-type: none"> <li>• Black soft casters</li> <li>• Hard black casters with polished aluminum body</li> <li>• Soft black casters with polished aluminum body</li> </ul>	+\$ 41 +\$111 +\$152	Specify with <i>soft casters</i> . Specify with <i>hard polished aluminum casters</i> . Specify with <i>soft polished aluminum casters</i> .
<b>Related Products</b>	<ul style="list-style-type: none"> <li>• Collaborative and conference tables</li> <li>• Occasional tables</li> <li>• Lounge seating</li> </ul>		▶ See <i>Coalesse Tables, Storage, and Accessories Specification Guide</i> . ▶ See <i>Coalesse Tables, Storage, and Accessories Specification Guide</i> . ▶ Page 256

## Specification Information

Style Number	U.S. Base Prices										Leather Groups:			
	Fabric Groups:										COL	1	2	
	COM	1	2	3	4	5	6	7	8	9	10			



Overall: 25¼"D 28"W 31½"H  
 Seat: 18"H  
 Arm: 25¼"H

### Conference Chair with 4-Star Base

<b>COW413</b>	Seat	\$3255	\$3255	\$3288	\$3315	\$3348	\$3396	\$3457	\$3526	\$3599	\$3664	\$3733	\$3389	\$ 3701	\$ 3752
	Upper back	No cost	No cost	+\$ 50	+\$ 91	+\$ 93	+\$141	+\$202	+\$271	+\$344	+\$409	+\$478	+\$310	+\$1036	+\$1164

COM/yds = 3, COL/sq ft = 60



Overall: 25¼"D 28"W  
 29½"H-33"H  
 Seat: 16¼"H-19¾"H  
 Arm: 23½"H-27"H

### Conference Chair with 5-Star Base

<b>COW415</b>	Seat	\$3255	\$3255	\$3288	\$3315	\$3348	\$3396	\$3457	\$3526	\$3599	\$3664	\$3733	\$3389	\$ 3701	\$ 3752
	Upper back	No cost	No cost	+\$ 50	+\$ 91	+\$ 93	+\$141	+\$202	+\$271	+\$344	+\$409	+\$478	+\$310	+\$1036	+\$1164

COM/yds = 3, COL/sq ft = 60

# SW\_1 Conference Seating Multi-Fabric Diagram

DESIGN SCOTT WILSON & MINIMAL

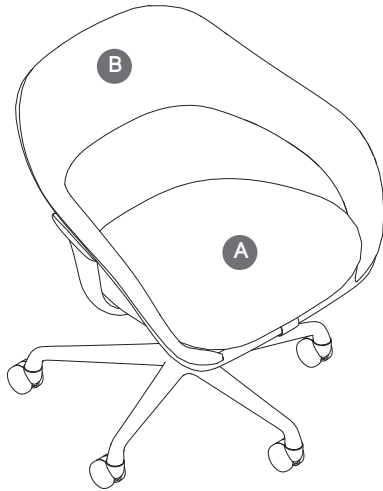

TO: \_\_\_\_\_

FROM: \_\_\_\_\_

DATE: \_\_\_\_\_

FAX...888.413.5161

**A** Seat: \_\_\_\_\_  
\_\_\_\_\_

**B** Upper Back: \_\_\_\_\_  
\_\_\_\_\_

Contrasting fabric charges will apply. List price based on highest group textile specified.

*Contrasting upcharge for each contrasting textile pricing based on highest group textile specified. See specifying for contrasting upcharge.*

Specify Model below:

COW413 Conference Chair with 4-Star Base

COW415 Conference Chair with 5-Star Base

# Adjustment Feature Definitions

**Active mechanism (AM+)** allows the seat and back angle to be adjusted independently of each other. The seat can be locked at various angles, and the back can free tilt with adjustable tension or lock in four positions.

**Arms**, height adjustable allow the user to independently move each arm up and down.

**Arms**, width-adjustable allows the arm rests to be adjusted in and out.

**Arms**, folding allows the user to independently fold each arm up or down for total freedom of leg movement and posture accommodation.

**Back**, height adjustable allows the user to raise or lower the chair back within a given range.

**Back lock**, forward allows the user to lock the backrest in a full upright position or release it to recline.

**Back stop**, selective allows the user to lock and unlock the backrest in any position within the tilt range.

**Back tilt tension adjustment** regulates the ease of tilt movement of the back only.

**Back and seat tilt** (Your Power mechanism) automatically responds to the weight and seating position of the user with an individual back resistance.

**Base**, free swivel allows chair to swivel 360°.

**Base**, memory-return swivel allows a chair to swivel 360°, but return to the forward-facing position when released.

**Base**, nesting four-prong has two front legs that are lower than the two rear legs, allowing chairs to nest for storage. A nylon tooth on the base engages a notch in the seat when folded. This engagement properly aligns the seat and base for nesting.

**Folding seat** allows the seat to flip up, while the chair automatically rises for nesting and storage.

**Knee tilt control** (low front rise) minimizes the rise of the front of the seat when the chair is in a reclined position, allowing the users' feet to remain on the floor. This feature reduces pressure under the thighs, allowing for continuous blood circulation.

**Lumbar support**, adjustable provides additional lower back comfort by allowing the user to move the lumbar support up or down, as well as increase or decrease the amount of support.

**Passive mechanism (PM)** allows the seat and back to move in synchronization without manual adjustment.

**Pneumatic height** allows the user to change the seat height assisted by a pneumatic gas cylinder.

**Seat angle adjustment** allows the user to change and lock the seat angle in various positions.

**Seat depth**, adjustable allows the user to slide the seat forward or back within a set range.

**Seat tilt control** allows the seat and back to rotate as a unit backward one position and forward two positions.

**Seat**, zero front rise allows the user to tilt back in the chair while feet remain on the floor because the seat front remains level.

**Swivel-tilt mechanism control** allows the chair to swivel 360° and the fixed seat and back to tilt in unison when the user leans back.

**Synchro-tilt mechanism** synchronizes the tilting movement of the seat and back in a set ratio.

**Tilt tension** adjustment allows the user to vary the amount of recline resistance. Your Power mechanism allows the back and seat tilt to adjust automatically to the weight and seating position of the user.

**Your Preference control** allows the user to adjust the back tilt by selecting one of four settings: weight activated, weight activated with 20% resistance boost, mid-stop recline, and upright back lock.

---

# Guest Seating

\*These product lines are collections and will be found in multiple locations in this specification guide and/or *Coalesse Tables, Storage, and Accessories Specification Guide*.

▶ See *Collections*, page 5

<b>Bindu Chairs</b>	<b>318</b>
<b>Bob Chair*</b>	<b>320</b>
<b>Branca Chair</b>	<b>323</b>
<b>Capa Chairs</b>	<b>325</b>
<b>Enea Lottus Chairs*</b>	<b>328</b>
<b>Enea Altzo943 Chairs*</b>	<b>334</b>
<b>Kathryn Chairs</b>	<b>336</b>
<b>LessThanFive Chairs</b>	<b>340</b>
<b>Leva Chair</b>	<b>342</b>
<b>Marien152 Guest Seating</b>	<b>344</b>
<b>Montara650 Chairs*</b>	<b>348</b>
<b>Round Outdoor Chairs</b>	<b>353</b>
<b>Seta Chair</b>	<b>355</b>
<b>She Said Chair</b>	<b>357</b>
<b>Switch Chairs*</b>	<b>359</b>
<b>Wrapp Chairs</b>	<b>361</b>

# Bindu Chairs

DESIGN BRIAN KANE

**Bindu chair** combines the comfort of an upholstered lounge with the performance needs of a work task chair.

**Bindu chair** offered in mid back and low back. Low-back chair is shown.

**Flex back** allows smooth posture adjustments for users.

**Glides** are black and non-marring.

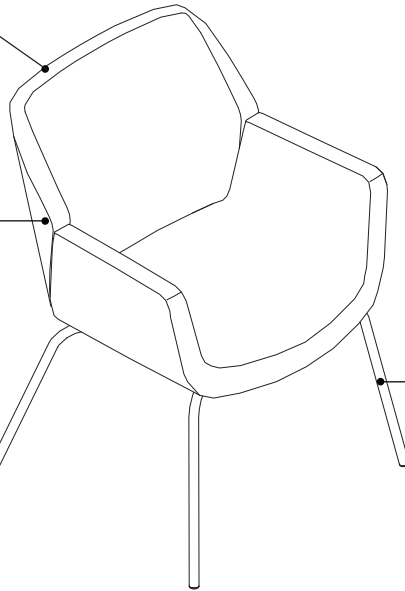

**4-leg base** is standard on guest chair.

## Product Details

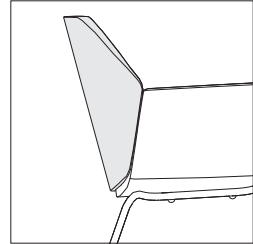

**Flex back and unique arm detail** allow for fluid posture adjustments.

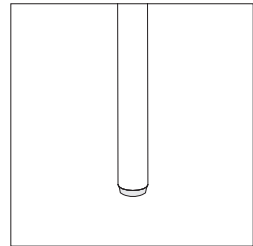

**Glides** are black and non-marring.

## Surface Materials

► See *Coalesse Surface Materials Reference Guide* for further information.

### Upholstery

- Fabric
- Leather

### Base

- Black gloss
- Polished trivalent chrome

## Program & Services

**Customer's Own Material/Leather (COM/COL) Program** is available.

► See *Coalesse Surface Materials Reference Guide* for additional information.

# Bindu Chairs

DESIGN BRIAN KANE

*Tip: Fabrics and leathers will appear loose with comfort wrinkles when upholstered.*

*Tip: Craft in upholstery cautions the use of stripes and patterns on Bindu. Please use fabric database when specifying.*

*Tip: For Customer's Own Material or Leather, see necessary requirements, important processing instructions, and ordering information*  
 ▶ See Coalesse Surface Materials Reference Guide.

*Tip: For fabric with large pattern and specific pattern location is desired, contact Customer Service.*



**Overall:** 25"D 24½"W 33¾"H  
**Inside:** 18¾"D 18½"-19½"W 15"H  
**Seat:** 17¾"H  
**Arm:** 26¼"H



**Overall:** 25"D 24½"W 37¾"H  
**Inside:** 18¾"D 18½"-19½"W 21"H  
**Seat:** 17¾"H  
**Arm:** 26¼"H

Standard Includes	Required to Specify
-------------------	---------------------

▶ Need help? Product details, page 318	<ul style="list-style-type: none"> <li>Bent plywood frame</li> <li>Chair: fabric</li> <li>Molded polypropylene foam</li> <li>Frame: 4144 Black Gloss</li> <li>Glides: black, non-marring</li> </ul>	1 Style number 2 Fabric or leather color number for upholstery 3 Options, if selected (see below) ▶ See Coalesse Surface Materials Reference Guide.
--	---	--

Options	U.S. Price	Required to Specify
---------	------------	---------------------

<b>Surface Materials</b>	<b>Acrylic backer</b> <ul style="list-style-type: none"> <li>Backer</li> </ul>	+\$ 50	Specify with acrylic backer. ▶ See Coalesse Surface Materials Reference Guide.
<b>Base</b>	<ul style="list-style-type: none"> <li>9207 Polished Trivalent Chrome (available on CO200G &amp; CO300G)</li> </ul>	+\$242	Specify with 9207 Polished Trivalent Chrome.

### Specification Information

Style Number	U.S. Base Prices										Leather Groups:			
	Fabric Groups:										COL	1	2	
	COM	1	2	3	4	5	6	7	8	9	10			

### Low-Back Chair

CO200G	\$1934	\$1934	\$2044	\$2134	\$2243	\$2407	\$2610	\$2841	\$3088	\$3306	\$3537	\$2376	\$4089	\$4436
--------	--------	--------	--------	--------	--------	--------	--------	--------	--------	--------	--------	--------	--------	--------

COM/yds = 3, COL/sq ft = 66

### Mid-Back Chair

CO300G	\$2218	\$2218	\$2328	\$2418	\$2527	\$2691	\$2894	\$3125	\$3372	\$3590	\$3821	\$2660	\$4373	\$4720
--------	--------	--------	--------	--------	--------	--------	--------	--------	--------	--------	--------	--------	--------	--------

COM/yds = 3, COL/sq ft = 66



**For Canadian Pricing**  
 Multiply U.S. Price by the Canadian price factor.  
 ▶ See page 1 for details.

# Bob Chair by Walter Knoll

DESIGN PEARSON LLOYD

**Bob chair** is well-crafted with careful detailing. It is equally suited to the office or boardroom.

*Tip: This product line is a collection and will be found in multiple locations in this specification guide and/or Coalesse Tables, Storage, and Accessories Specification Guide.*

► See *Collections*, page 5.

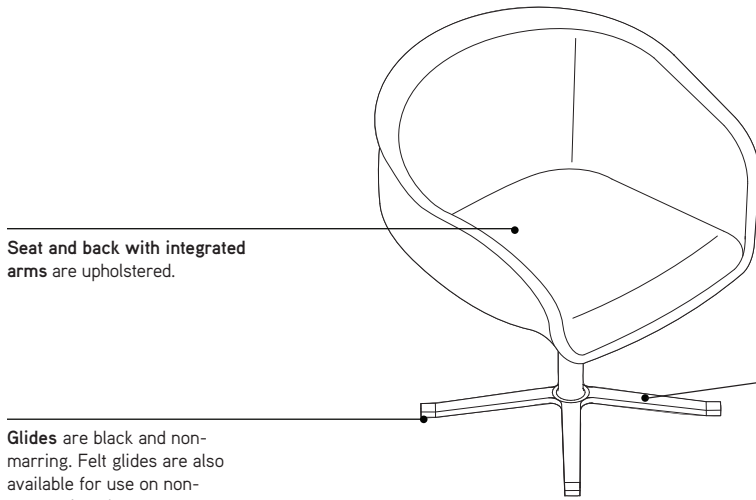

Seat and back with integrated arms are upholstered.

Glides are black and non-marring. Felt glides are also available for use on non-carpeted surfaces.

4-leg base has a swivel-only mechanism.

## Product Details

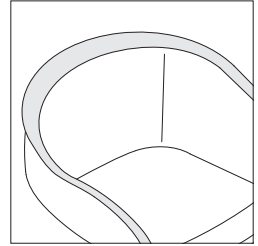

Fluted arm detail creates a pocket seat.

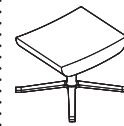

Ottoman in matching upholstery is available.

## Surface Materials

► See *Coalesse Surface Materials Reference Guide* for further information.

**Upholstery** (contrasting fabric available)

- Fabric
- Leather

**Base**

- Aluminum matte polished
- Painted aluminum

## Program & Services

**Customer's Own Material/Leather (COM/COL) Program** is available.

► See *Coalesse Surface Materials Reference Guide* for additional information.

# Bob Chair by Walter Knoll

DESIGN PEARSON LLOYD

*Tip: For Customer's Own Material or Leather, see necessary requirements, important processing instructions, and ordering information*  
 ▶ See *Coalesse Surface Materials Reference Guide*.

*Tip: Fabrics and leathers will appear loose with comfort wrinkles when upholstered.*

### Standard Includes

- ▶ Need help? Product details, page 320
- Swivel base: 8040 Aluminum Matte Polished or group 1 paint
- Upholstery for chair: fabric or leather
- Glides

### Required to Specify

- 1 Style number
  - 2 Metal of paint color number for base and arms
  - 3 Fabric or leather color number for upholstery on seat, inner, and outer back
  - 4 Options, if selected (see below)
- ▶ See *Coalesse Surface Materials Reference Guide*.

### Options

Options	U.S. Price	Required to Specify
<b>Surface Materials</b>		
• Contrasting fabric	+\$192 per fabric	Add suffix K to the style number and select fabric color number.
<b>Base</b>		
• Aluminum matte polished	No cost	Specify with <i>aluminum matte polished</i> .
• Group 1 paint	No cost	Specify paint color number.
• Group 3 paint	+\$114	Specify paint color number.
<b>Acrylic backer</b>		
• Backer for guest chair	+\$ 36	Specify with <i>acrylic backer</i> .
• Backer for ottoman	+\$ 13	Specify with <i>acrylic backer</i> . ▶ See <i>Coalesse Surface Materials Reference Guide</i> .
<b>Glides</b>		
• Felted glides	+\$ 23	Specify with <i>felted glides</i> .
<b>Related Products</b>		
• Collaborative and conference tables		▶ See <i>Coalesse Tables, Storage, and Accessories Specification Guide</i> .
• Occasional tables		▶ See <i>Coalesse Tables, Storage, and Accessories Specification Guide</i> .
• Lounge seating		▶ Page 38

### Specification Information

Style Number	U.S. Base Prices										Leather Groups:			
	Fabric Groups:										COL	1	2	
	COM	1	2	3	4	5	6	7	8	9	10			

### Guest Chair

231	\$2960	\$2960	\$3030	\$3087	\$3154	\$3255	\$3380	\$3523	\$3677	\$3812	\$3956	\$3420	\$4584	\$4819
-----	--------	--------	--------	--------	--------	--------	--------	--------	--------	--------	--------	--------	--------	--------

COM/yds = 2, COL/sq ft = 44

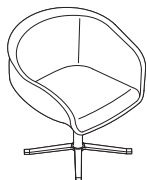

Overall: 25¼"D 27¼"W 29¾"H  
 Inside: 18"D 18"W 12½"H  
 Seat: 18½"H  
 Arm: 26½"H

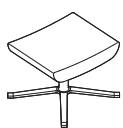

Overall: 18½"D 19¾"W 15¼"H

### Ottoman

221-H	\$1321	\$1321	\$1356	\$1384	\$1418	\$1469	\$1531	\$1603	\$1680	\$1747	\$1819	\$1781	\$2316	\$2433
-------	--------	--------	--------	--------	--------	--------	--------	--------	--------	--------	--------	--------	--------	--------

COM/yds = 1, COL/sq ft = 22

 **For Canadian Pricing**  
 Multiply U.S. Price by the Canadian price factor.  
 ▶ See page 1 for details.

# Bob Guest Seating Multi-Fabric Diagram

DESIGN PEARSON LLOYD

TO: \_\_\_\_\_

FROM: \_\_\_\_\_

DATE: \_\_\_\_\_

FAX...888.413.5161

**A** Seat (upholstery selections default for entire unit if B is not selected): \_\_\_\_\_

**B** Back and Arms: \_\_\_\_\_

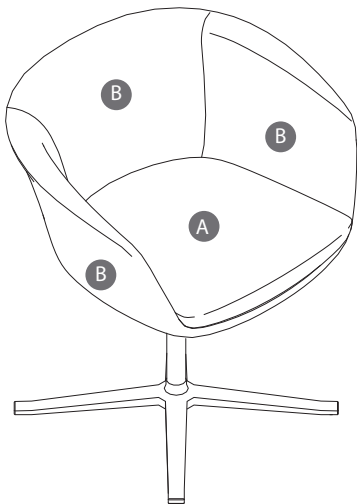

Specify Model below:

231K

221-HK

*See specifying for contrasting fabric upcharge. List price based on highest fabric group usage.*

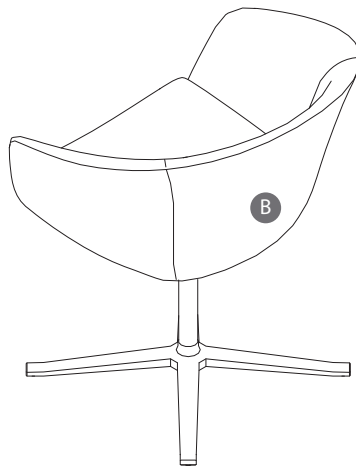

# Branca Chair

**Branca chair** is a guest chair made from a single piece of wood, offered in multiple different wood finish options.

**Ash wood frame**

**Back leg** supports the critical joints of the armrest, the seat, and the back.

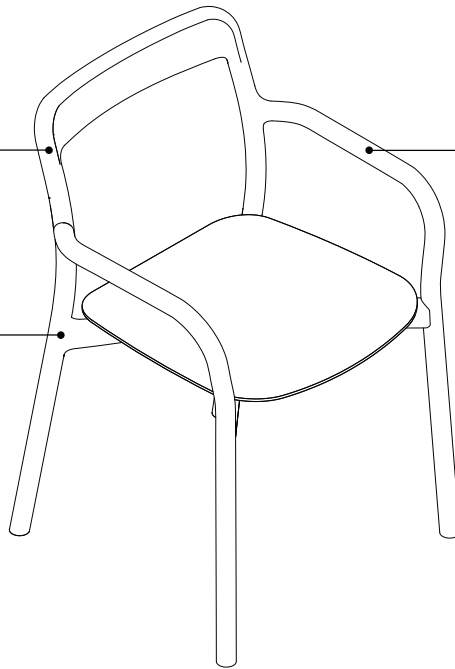

**Stackable up to three units high.**

## Product Details

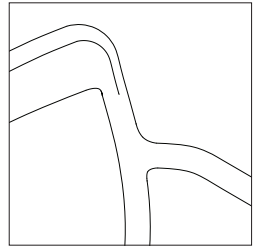

**Seamless joinery**

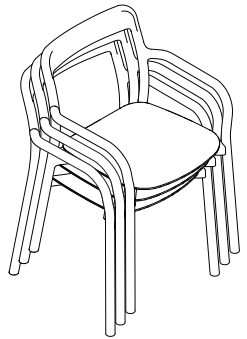

**The chair can be stacked up to three units high.**

## Surface Materials

► See *Coalesse Surface Materials Reference Guide* for further information.

- Frame**
- Wood

## Actual Dimensions

<b>Depth</b>	21.06"
<b>Width</b>	22.04"
<b>Height</b>	32.67"

# Branca Chair

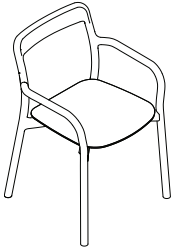

Standard Includes	Required to Specify
-------------------	---------------------

- |  |  |
|--|--|
| <ul style="list-style-type: none"> <li>▶ Need help? Product details, page 323</li> </ul> | <ul style="list-style-type: none"> <li>• Frame: Solid ash</li> <li>• Legal wood cutting</li> </ul>                                 |
|  | <ul style="list-style-type: none"> <li>▶ Style number</li> <li>▶ See <i>Coalesse Surface Materials Reference Guide</i>.</li> </ul> |

Specification Information						
Style Number	Dimensions			Weight	Finish	U.S. Price
	D	W	H			
IAM13	21.06"	22.04"	32.67"	34.17	Black Ash	\$2411
IAM14	21.06"	22.04"	32.67"	34.17	Brown Ash	\$2411
IAM15	21.06"	22.04"	32.67"	34.17	Green Ash	\$2411
IAM16	21.06"	22.04"	32.67"	34.17	Natural Ash	\$2411
IAM17	21.06"	22.04"	32.67"	34.17	White Ash	\$2411



**For Canadian Pricing**  
 Multiply U.S. Price by the  
 Canadian price factor.  
 ▶ See page 1 for details.

# Capa Chairs

DESIGN E00S

Capa adds contemporary style with practical comfort. Capa has a unique shape, fully upholstered body, and double-needle topstitching.

**Upholstery** is molded around frame components.

**Flex back design** forms to match user's back shape.

**Glides** are black and non-marring.

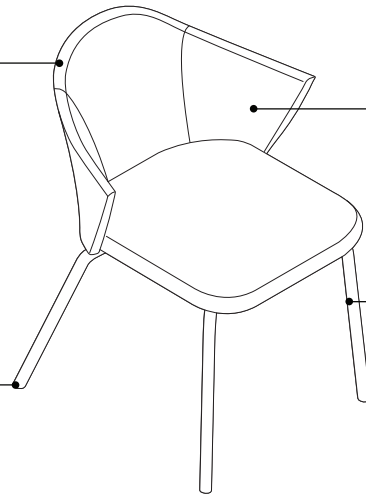

**Side panels** are recessed.

**4-leg base** allows for stacking up to five high with stacking dolly and three high on floor.

## Product Details

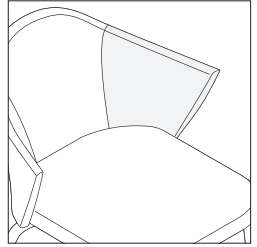

**Recessed side panel** creates arm rest without restricting user postures.

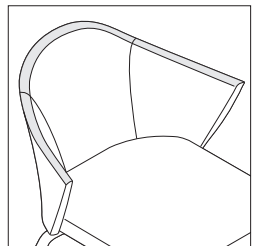

**Topstitching design** features a double-needle technique.

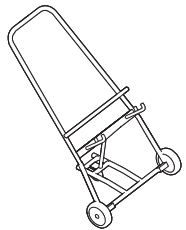

**Stacking dolly** is available to stack, move, and store up to five chairs. Dolly measures 34"D x 26"W x 34"H.

## Surface Materials

► See *Coalesse Surface Materials Reference Guide* for further information.

**Upholstery** (contrasting fabric available)

- Fabric
- Leather

### Legs

- Matte chrome
- Polished chrome

## Program & Services

**Customer's Own Material/Leather (COM/COL) Program** is available.

► See *Coalesse Surface Materials Reference Guide* for additional information.

# Capa Chairs

DESIGN EOOS



**Overall:** 24<sup>3</sup>/<sub>4</sub>"D 23<sup>3</sup>/<sub>4</sub>"W 31<sup>1</sup>/<sub>2</sub>"H  
**Inside:** 18"D 16<sup>1</sup>/<sub>2</sub>"W 15"H  
**Seat:** 18"H  
**Arm:** 28"H

*Tip: Fabrics and leathers will appear loose with comfort wrinkles when upholstered.*

*Tip: Frame design allows back to flex to match occupant's back shape.*

*Tip: Due to the design and construction techniques of the Capa Chair only certain textiles can be successfully applied, therefore all COM fabrics must be submitted to Coalesse for approval prior to order acceptance.*

*Tip: Recommended leathers are Elmosoft group 1 and Elmorustical group 2.*

*Tip: Special color match, consult Customer Service.*

*Tip: For Customer's Own Material or Leather, see necessary requirements, important processing instructions, and ordering information*  
 ▶ See Coalesse Surface Materials Reference Guide.

*Tip: Chair stacks five high with stacking dolly and three high on floor.*

Standard Includes		Required to Specify
▶ Need help? Product details, page 325	<ul style="list-style-type: none"> <li>• Frame: hardwood plywood, steel tubing and bar stock</li> <li>• Arms: solid steel rod and bar stock</li> <li>• Upholstery: arms, back, and seat foam are molded around the frame components</li> <li>• Legs: matte chrome (M) or polished chrome (PC) leg finish</li> </ul>	1 Style number 2 Number of fabrics if contrasting fabric style number is selected 3 Fabric or leather color number for upholstery 4 Options, if selected (see below) ▶ See Coalesse Surface Materials Reference Guide.

Options	U.S. Price	Required to Specify
<b>Surface Materials</b>		
• Contrasting fabric	+\$192 per fabric	Add suffix K to the style number and select fabric color number.
<b>Acrylic backer</b>		
• Backer	+\$ 28	Specify with acrylic backer. ▶ See Coalesse Surface Materials Reference Guide.

Specification Information													
Style Number	U.S. Base Prices										Leather Groups:		
	Fabric Groups:										COL		
	COM	1	2	3	4	5	6	7	8	9	10	1	2

Chairs														
<b>1810M</b>	\$1794	\$1794	\$1866	\$1925	\$1996	\$2102	\$2234	\$2385	\$2545	\$2687	\$2837	\$2332	\$3772	\$4057
<b>1810PC</b>	\$1838	\$1838	\$1910	\$1969	\$2040	\$2146	\$2278	\$2429	\$2589	\$2731	\$2881	\$2376	\$3824	\$4101

COM/yds = 2, COL/sq ft = 44

 **For Canadian Pricing**  
 Multiply U.S. Price by the Canadian price factor.  
 ▶ See page 1 for details.

Coalesse

# Capa Chairs

DESIGN E00S

# Enea Lottus Chairs

DESIGN LIEVORE ALTHERR MOLINA

Enea Lottus is sculpted for comfort with just the right amount of flex. Chairs are available in armless, loop arm, and cantilevered arm versions.

*Tip: This product line is a collection and will be found in multiple locations in this specification guide and/or Coalesse Tables, Storage, and Accessories Specification Guide.*

► See *Collections*, page 5.

Shell is polypropylene with a flex back.

4-leg base allows for stacking (stacking dolly available).

Glides are black polypropylene. Felt glides are optional, for use on non-carpeted surfaces.

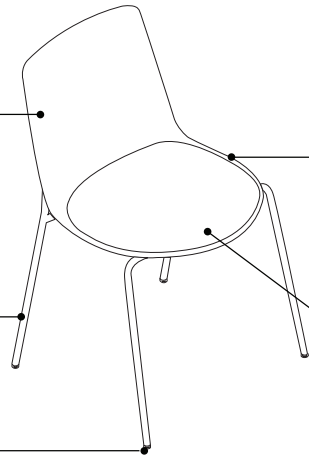

Frame is constructed of steel tubing for added stability.

Seat is available with no insert, upholstered insert, or polypropylene insert.

## Product Details



Chairs are available in armless, cantilever arm, or loop arm versions.

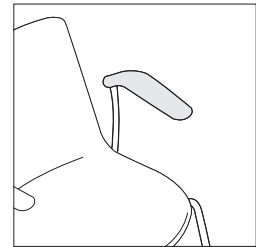

Cantilever arm comes standard with polypropylene arm cap.

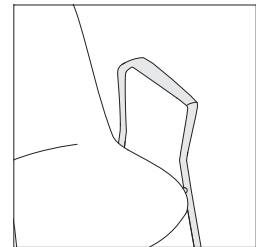

Aluminum loop arm chairs are available.

# Enea Lottus Chairs

DESIGN LIEVORE ALTHERR MOLINA

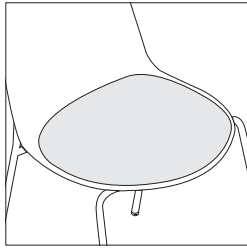

**Upholstered and polypropylene insert seat detail** is available.

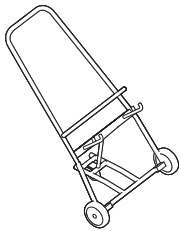

**Stacking dolly** is available to stack, move, and store chairs. Armless chairs are able to stack 10 high on dolly. Cantilever and loop arm chairs stack six high on dolly.

## Surface Materials

► See *Coalesse Surface Materials Reference Guide* for further information.

**Seat, back, and arm cap**

- Polypropylene

**Base and frame**

- Paint

**Upholstery (seat)**

- Fabric
- Leather

## Program & Services

**Customer's Own Material/Leather (COM/COL) Program** is available.

► See *Coalesse Surface Materials Reference Guide* for additional information.

# Enea Lottus Chairs Armless

DESIGN LIEVORE ALTHERR MOLINA

*Tip: For Customer's Own Material or Leather, see necessary requirements, important processing instructions, and ordering information*  
 ▶ See *Coalesse Surface Materials Reference Guide*.

*Tip: CAL133 for polypropylene and fire code seating are available as a special quote. Polypropylene color will change slightly when FR treatment is applied. Contact Customer Service for availability and pricing. Minimum quantity will apply.*

*Tip: Lottus chair with no insert stacks 10 high on floor. Lottus chair with polypropylene or upholstered insert stacks four high on floor. Lottus chair stacks six high with dolly.*

Standard Includes	Required to Specify
-------------------	---------------------

- |  |  |   |
|--|--|---|
| ▶ Need help? Product details, page 328 | <ul style="list-style-type: none"> <li>Base and frame constructed of painted steel tubing</li> <li>Seat and back: polypropylene</li> <li>Insert, if selected: polypropylene or upholstery</li> </ul> | 1 Style number<br>2 Plastic color number for seat and back<br>3 Fabric or leather color number for upholstery insert, if selected<br>4 Paint color number for base and frame<br>5 Options, if selected (see below)<br>▶ See <i>Coalesse Surface Materials Reference Guide</i> . |
|--|--|---|

Options	U.S. Price	Required to Specify
---------	------------	---------------------

<b>Surface Materials</b>	<b>Base</b> <ul style="list-style-type: none"> <li>Group 1 paint</li> <li>Group 3 paint</li> </ul> <b>Acrylic backer</b> <ul style="list-style-type: none"> <li>Backer for chair with upholstered insert</li> </ul>	No cost +\$114  +\$ 7	Specify paint color number. Specify paint color number.  Specify with acrylic backer. ▶ See <i>Coalesse Surface Materials Reference Guide</i> .
<b>Felt Glides</b>	<ul style="list-style-type: none"> <li>Glides</li> </ul>	No cost	Specify with felt glides.
<b>Related Products</b>	<ul style="list-style-type: none"> <li>Café tables</li> <li>Occasional tables</li> <li>Stools</li> </ul>		▶ See <i>Coalesse Tables, Storage, and Accessories Specification Guide</i> . ▶ See <i>Coalesse Tables, Storage, and Accessories Specification Guide</i> . ▶ Pages 378-382

## Specification Information

Style Number	U.S. Base Prices										Leather Groups:		Polypropylene	
	Fabric Groups:													
	COM	1	2	3	4	5	6	7	8	9	10	COL	1	2



Overall: 20¾"D 20¾"W 30½"H  
 Seat: 18"H  
 Seat Depth: 16½"D  
 Stacked 10 high: 24½"D x 19½"W x 44"H  
 Dolly in up-right position: 40"D x 26"W x 46"H  
 Doll in reclined position: 47"D x 26"W x 44"H

### Armless Chair with No Insert

COEL100	\$563	N.A.	N.A.	N.A.	N.A.	N.A.	N.A.	N.A.	N.A.	N.A.	N.A.	N.A.	N.A.	N.A.	N.A.
---------	-------	------	------	------	------	------	------	------	------	------	------	------	------	------	------



Overall: 20¾"D 20¾"W 30½"H  
 Seat: 18"H  
 Seat Depth: 16½"D

### Armless Chair with Polypropylene Insert

COEL100INSERT	N.A.	N.A.	N.A.	N.A.	N.A.	N.A.	N.A.	N.A.	N.A.	N.A.	N.A.	N.A.	N.A.	N.A.	N.A.	\$629
---------------	------	------	------	------	------	------	------	------	------	------	------	------	------	------	------	-------

▶ Specification Information, continued on next page

**For Canadian Pricing**  
 Multiply U.S. Price by the Canadian price factor.  
 ▶ See page 1 for details.

# Enea Lottus Chairs Armless

DESIGN LIEVORE ALTHERR MOLINA

► Specification Information, continued from previous page

**Specification Information**

Style Number	U.S. Base Prices										Leather Groups:		Poly-propylene	
	Fabric Groups:										COL	1		2
	COM	1	2	3	4	5	6	7	8	9	10			



Overall: 20¾"D 20¾"W 30½"H  
 Seat: 18"H  
 Seat Depth: 16½"D

## Armless Chair with Upholstered Insert

COEL100UPH	\$817	\$817	\$842	\$862	\$888	\$925	\$970	\$1023	\$1079	\$1127	\$1180	\$1238	\$1205	\$1253	N.A.
------------	-------	-------	-------	-------	-------	-------	-------	--------	--------	--------	--------	--------	--------	--------	------

COM/yds = ¾, COL/sq ft = 15

**Specification Information**

Style Number	U.S. Price

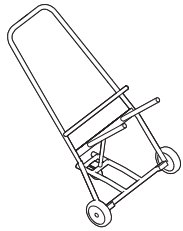

Overall: 27"D 25"W 46"H

## Stacking Dolly

COELDOLLY	\$1183
-----------	--------

*Tip: Dolly can be used with any Enea Lottus chair.*

*Tip: Armless chairs, cantilever arm chairs, and loop arm chairs stack six high on dolly.*

Guest Seating

**For Canadian Pricing**  
 Multiply U.S. Price by the Canadian price factor.  
 ► See page 1 for details.

# Enea Lottus Chairs Cantilever Arm

DESIGN LIEVORE ALTHERR MOLINA

Tip: Cantilever arm can hook on table to provide storing option.

Tip: Cantilever arm stacks six high.

Tip: Can specify arm cap in any plastic color for Lottus.

Tip: For Customer's Own Material or Leather, see necessary requirements, important processing instructions, and ordering information  
 ▶ See Coalesse Surface Materials Reference Guide.

Tip: CAL133 for polypropylene and fire code seating are available as a special quote. Polypropylene color will change slightly when FR treatment is applied. Contact Customer Service for availability and pricing. Minimum quantity will apply.

Standard Includes	Required to Specify
▶ Need help? Product details, page 328 • Base and frame constructed of painted steel tubing • Seat and back: polypropylene • Arm cap: polypropylene • Insert, if selected: polypropylene or upholstery	1 Style number 2 Plastic color number for seat, back, and arm cap 3 Fabric or leather color number for upholstery insert, if selected 4 Paint color number for base and frame 5 Options, if selected (see below) ▶ See Coalesse Surface Materials Reference Guide.

Options	U.S. Price	Required to Specify
<b>Surface Materials</b> • <b>Base</b> • Group 1 paint • Group 3 paint • <b>Acrylic backer</b> • Backer for chair with upholstered insert	No cost +\$114 +\$ 7	Specify paint color number. Specify paint color number. Specify with acrylic backer. ▶ See Coalesse Surface Materials Reference Guide.
<b>Felt Glides</b> • Glides	No cost	Specify with felt glides.
<b>Related Products</b> • Café tables • Occasional tables • Stools		▶ See Coalesse Tables, Storage, and Accessories Specification Guide. ▶ See Coalesse Tables, Storage, and Accessories Specification Guide. ▶ Pages 378-382

## Specification Information

Style Number	U.S. Base Prices										Leather Groups:		Polypropylene	
	Fabric Groups:										COL	1		2
COM	1	2	3	4	5	6	7	8	9	10	COL	1	2	



Overall: 20¾"D 23¾"W 30½"H  
 Seat: 18"H  
 Seat Depth: 16½"D  
 Arm: 26"H  
 Stacked 6 high: 24½"D x 24½"W x 44"H  
 Dolly in up-right position: 40"D x 26"W x 46"H  
 Doll in reclined position: 47"D x 26"W x 38"H

### Cantilever Arm Chair with No Insert

COEL200	\$693	N.A.	N.A.	N.A.	N.A.	N.A.	N.A.	N.A.	N.A.	N.A.	N.A.	N.A.	N.A.	N.A.	N.A.
---------	-------	------	------	------	------	------	------	------	------	------	------	------	------	------	------



Overall: 20¾"D 23¾"W 30½"H  
 Seat: 18"H  
 Seat Depth: 16½"D  
 Arm: 26"H

### Cantilever Arm Chair with Polypropylene Insert

COEL200INSERT	N.A.	N.A.	N.A.	N.A.	N.A.	N.A.	N.A.	N.A.	N.A.	N.A.	N.A.	N.A.	N.A.	N.A.	\$761
---------------	------	------	------	------	------	------	------	------	------	------	------	------	------	------	-------



Overall: 20¾"D 23¾"W 30½"H  
 Seat: 18"H  
 Seat Depth: 16½"D  
 Arm: 26"H

### Cantilever Arm Chair with Upholstered Insert

COEL200UPH	\$946	\$946	\$971	\$991	\$1017	\$1054	\$1099	\$1152	\$1208	\$1256	\$1309	\$1367	\$1334	\$1382	N.A.
------------	-------	-------	-------	-------	--------	--------	--------	--------	--------	--------	--------	--------	--------	--------	------

COM/yds = ¾, COL/sq ft = 15

# Enea Lottus Chairs Aluminum Loop Arm

DESIGN LIEVORE ALTHERR MOLINA

*Tip: For Customer's Own Material or Leather, see necessary requirements, important processing instructions, and ordering information*  
 ▶ See Coalesse Surface Materials Reference Guide.

*Tip: CAL133 for polypropylene and fire code seating are available as a special quote. Polypropylene color will change slightly when FR treatment is applied. Contact Customer Service for availability and pricing. Minimum quantity will apply.*

*Tip: Arm chair stacks six high.*

Standard Includes		Required to Specify	
▶ Need help? Product details, page 328	<ul style="list-style-type: none"> <li>Base and frame constructed of painted steel tubing</li> <li>Seat and back: polypropylene</li> <li>Arm: aluminum</li> <li>Insert, if selected: polypropylene or upholstery</li> </ul>	<ol style="list-style-type: none"> <li>Style number</li> <li>Plastic color number for seat, back, and arm cap</li> <li>Fabric or leather color number for upholstery insert, if selected</li> <li>Paint color number for base and frame</li> <li>Options, if selected (see below)</li> </ol>	▶ See Coalesse Surface Materials Reference Guide.

Options	U.S. Price	Required to Specify
<b>Surface Materials</b> <b>Base</b> <ul style="list-style-type: none"> <li>Group 1 paint</li> <li>Group 3 paint</li> </ul> <b>Acrylic backer</b> <ul style="list-style-type: none"> <li>Backer for chair with upholstered insert</li> </ul>	No cost +\$114  +\$ 7	Specify paint color number. Specify paint color number.  Specify with acrylic backer. ▶ See Coalesse Surface Materials Reference Guide.
<b>Felt Glides</b>	<ul style="list-style-type: none"> <li>Glides</li> </ul>	No cost Specify with felt glides.
<b>Related Products</b>	<ul style="list-style-type: none"> <li>Café tables</li> <li>Occasional tables</li> <li>Stools</li> </ul>	▶ See Coalesse Tables, Storage, and Accessories Specification Guide. ▶ See Coalesse Tables, Storage, and Accessories Specification Guide. ▶ Pages 378–382

Specification Information															
Style Number	U.S. Base Prices										Leather Groups:		Polypropylene		
	Fabric Groups:										COL	1		2	
	COM	1	2	3	4	5	6	7	8	9	10		1	2	



Overall: 20¾"D x 22"W x 30½"H  
 Seat: 18"H  
 Seat Depth: 16½"D  
 Arm: 26"H

## Aluminum Loop Arm Chair with No Insert

COEL300	\$ 751	N.A.	N.A.	N.A.	N.A.	N.A.	N.A.	N.A.	N.A.	N.A.	N.A.	N.A.	N.A.	N.A.	N.A.
---------	--------	------	------	------	------	------	------	------	------	------	------	------	------	------	------



Overall: 20¾"D x 22"W x 30½"H  
 Seat: 18"H  
 Seat Depth: 16½"D  
 Arm: 26"H

## Aluminum Loop Arm Chair with Polypropylene Insert

COEL300INSERT	N.A.	N.A.	N.A.	N.A.	N.A.	N.A.	N.A.	N.A.	N.A.	N.A.	N.A.	N.A.	N.A.	N.A.	\$812
---------------	------	------	------	------	------	------	------	------	------	------	------	------	------	------	-------



Overall: 20¾"D x 22"W x 30½"H  
 Seat: 18"H  
 Seat Depth: 16½"D  
 Arm: 26"H

## Aluminum Loop Arm Chair with Upholstered Insert

COEL300UPH	\$1000	\$1000	\$1025	\$1045	\$1071	\$1108	\$1153	\$1206	\$1262	\$1310	\$1363	\$1442	\$1388	\$1436	N.A.
------------	--------	--------	--------	--------	--------	--------	--------	--------	--------	--------	--------	--------	--------	--------	------

COM/yds = ¾, COL/sq ft = 15

# Enea Altzo943 Chairs

DESIGN: ESTUDI MANEL MOLINA DESIGN ORIGIN: SPAIN

**Enea Altzo943 seating collection** brings residential warmth and soul to the workplace. Answering the demand for mixed materials, Altzo943 combines a precision-molded seat shell with solid oak legs. The special oval profile of the legs follows the pure curvature of the shell for a complete, harmonious design statement.  
*Tip: This product line is part of a collection and will be found in multiple locations in this specification guide.*  
▶ See *Collections*, page 5.

**Seat and back** are polypropylene with a slight flex and rounded edges for optimal comfort; available in 12 colors.

**Wood legs** are solid wood oak; available in six finishes.

**Glides** are polyethylene for superior durability on carpeted and hard floors.

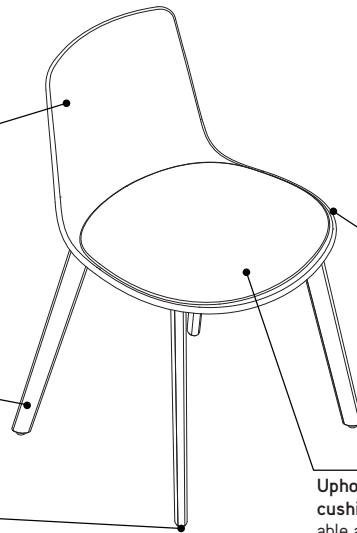

**Casting under the seat** is painted in textured finishes to match polypropylene seat shell.

**Upholstered seat cushion insert** is available and is 1/2" thick.

## Product Details

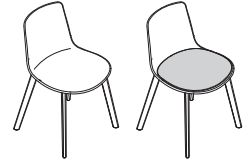

**Upholstered seat cushion insert** is available.

## Surface Materials

▶ See *Coalesse Surface Materials Reference Guide* for further information.

**Seat and back**

- Polypropylene

**Seat casting**

- Paint

**Legs**

- Solid oak

**Upholstery (seat)**

- Fabric
- Leather

## Program and Services

**Customer's Own Material/Leather (COM/COL) Program** is available.

▶ See *Coalesse Surface Materials Reference Guide* for additional information.

# Enea Altzo943 Chairs

DESIGN: ESTUDI MANEL MOLINA DESIGN ORIGIN: SPAIN

Standard Includes		Required to Specify
<ul style="list-style-type: none"> <li>▶ Need help? Product details, page 334</li> </ul>	<ul style="list-style-type: none"> <li>• Legs: solid oak</li> <li>• Seat and seat casting:                             <ul style="list-style-type: none"> <li>– Polypropylene seat with matching textured paint on seat casting</li> </ul> </li> <li>• Seat cushion insert, if selected: upholstery</li> <li>• Glides, non-adjustable</li> </ul>	<ol style="list-style-type: none"> <li>1 Style number</li> <li>2 Plastic color number for polypropylene seat</li> <li>3 Fabric or leather color number for upholstered seat cushion insert, if selected</li> <li>4 Wood finish for legs:                             <ul style="list-style-type: none"> <li>– V3AK Natural Oak</li> <li>– VP01 Light Oak</li> <li>– VP02 Smoke Oak</li> <li>– VP03 Black Oak</li> <li>– VP04 Grey Oak</li> <li>– VP05 White Oak</li> </ul> </li> <li>6 Options, if selected (see below)</li> </ol> <p>▶ See <i>Coalesse Surface Materials Reference Guide</i>.</p>

*Tip: For Customer's Own Material or Leather, see necessary requirements, important processing instructions, and ordering information.*  
▶ See *Coalesse Surface Materials Reference Guide*.

Options	U.S. Price	Required to Specify
<b>Surface Materials</b> <ul style="list-style-type: none"> <li>• <b>Legs</b></li> <li>• Group 1 wood veneer</li> <li>• Group 2 wood veneer</li> </ul>	<p>No cost</p> <p>+\$89</p>	<p>Specify with V3AK Natural Oak, VP01 Oak Light, VP03 Black Oak, or VP05 White Oak. Specify with VP02 Smoked Oak or VP04 Grey Oak.</p>
<ul style="list-style-type: none"> <li>• <b>Acrylic backer</b></li> <li>• Chair with upholstered seat cushion insert</li> </ul>	<p>+\$ 7</p>	<p>Specify with acrylic backer. ▶ See <i>Coalesse Surface Materials Reference Guide</i>.</p>
<b>Related Products</b> <ul style="list-style-type: none"> <li>• Altzo943 stools</li> <li>• Lottus café tables</li> <li>• Lottus occasional tables</li> </ul>		<p>▶ Page 386</p> <p>▶ See <i>Coalesse Tables, Storage, and Accessories Specification Guide</i>.</p> <p>▶ See <i>Coalesse Tables, Storage, and Accessories Specification Guide</i>.</p>

## Specification Information

Style Number	U.S. Base Prices										Leather Groups:		Polypropylene	
	Fabric Groups:										COL	1		2
	COM	1	2	3	4	5	6	7	8	9	10			



Overall: 20<sup>3</sup>/<sub>4</sub>"D 22"W 30<sup>1</sup>/<sub>2</sub>"H  
Seat: 18"H  
Seat Depth: 16<sup>1</sup>/<sub>2</sub>"D

### Armless Chair without Seat Cushion

COALT100	N.A.	N.A.	N.A.	N.A.	N.A.	N.A.	N.A.	N.A.	N.A.	N.A.	N.A.	N.A.	N.A.	N.A.	\$907
----------	------	------	------	------	------	------	------	------	------	------	------	------	------	------	-------



Overall: 20<sup>3</sup>/<sub>4</sub>"D 22"W 30<sup>1</sup>/<sub>2</sub>"H  
Seat: 18"H  
Seat Depth: 16<sup>1</sup>/<sub>2</sub>"D

### Armless Chair with Upholstered Seat Cushion Insert

COALT100UPH	\$1085	\$1085	\$1117	\$1142	\$1173	\$1219	\$1276	\$1341	\$1411	\$1472	\$1538	\$1487	\$1454	\$1498	N.A.
-------------	--------	--------	--------	--------	--------	--------	--------	--------	--------	--------	--------	--------	--------	--------	------

# Kathryn Chairs

DESIGN STUDIO B

The Kathryn chair is a classically constructed guest chair offered with an open wood back, an upholstered wood back panel, or a fully upholstered back.

Back contains passive ergonomic support and is steam bent. Available in open, panel, or fully upholstered.

Glides are non-adjustable.

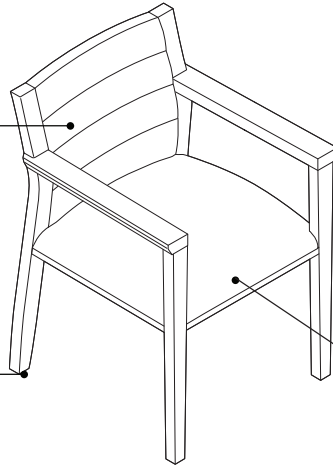

Frame is solid European beech hardwood.

Seat is upholstered and incorporates a welt detail.

## Product Details

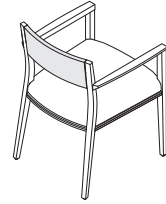

Open-back detail is available in all standard wood finishes with optional upholstered panel back.

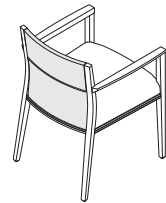

Back with fully upholstered detail is available.

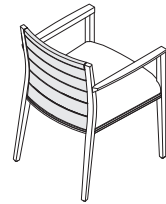

Ribbed detail on fully upholstered back is available.

## Surface Materials

► See *Coalesse Surface Materials Reference Guide* for further information.

### Upholstery

- Fabric
- Leather

### Frame (and open back)

- Wood

## Program & Services

Customer's Own Material/Leather (COM/COL) Program is available.

► See *Coalesse Surface Materials Reference Guide* for additional information.

Coalesse

# Kathryn Chairs

DESIGN STUDIO B

# Kathryn Chairs

DESIGN STUDIO B

*Tip: Fabrics and leathers will appear loose with comfort wrinkles when upholstered.*

*Tip: Recommended leathers are Elmosoft group 1 and Elmorustical group 2.*

*Tip: Special color match, consult Customer Service.*

*Tip: For Customer's Own Material or Leather, see necessary requirements, important processing instructions, and ordering information*  
 ▶ See *Coalesse Surface Materials Reference Guide*.

Standard Includes		Required to Specify
▶ Need help? Product details, page 336	<ul style="list-style-type: none"> <li>• Frame: solid European beech hardwood</li> <li>• Mortise and tenon joinery</li> <li>• Upholstery: multiple densities of laminated polyurethane foam and polyester fiber</li> <li>• Glides: non-adjustable</li> </ul>	1 Style number 2 Number of fabrics if contrasting fabric style number is selected 3 Fabric or leather color number for upholstery 4 Wood color number for frame 5 Options, if selected (see below) ▶ See <i>Coalesse Surface Materials Reference Guide</i> .

Options	U.S. Price	Required to Specify
<b>Surface Materials</b>		
• Contrasting fabric	+\$192 per fabric	Add suffix K to the style number and select fabric color number.
• Contrasting welt	+\$219	Specify with <i>contrasting welt</i> and select fabric color number.
<b>Acrylic backer</b>		
• Chair with open back	+\$ 11	Specify with <i>acrylic backer</i> .
• Chair with upholstery	+\$ 21	Specify with <i>acrylic backer</i> .
		▶ See <i>Coalesse Surface Materials Reference Guide</i> .

## Specification Information

Style Number	U.S. Base Prices										Leather Groups:		
	Fabric Groups:										COL	1	2
COM	1	2	3	4	5	6	7	8	9	10			

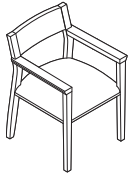

Overall: 22<sup>3</sup>/<sub>4</sub>"D 22<sup>3</sup>/<sub>20</sub>"W 32"H  
 Inside: 19"D 18<sup>1</sup>/<sub>2</sub>"W 14"H

## Wood with Open Back

2540-1	\$1536	\$1536	\$1571	\$1598	\$1632	\$1684	\$1746	\$1819	\$1895	\$1962	\$2034	\$2012	\$2385	\$2489
--------	--------	--------	--------	--------	--------	--------	--------	--------	--------	--------	--------	--------	--------	--------

COM/yds = 1, COL/sq ft = 18

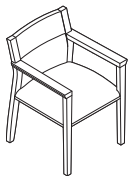

Overall: 22<sup>3</sup>/<sub>4</sub>"D 22<sup>3</sup>/<sub>20</sub>"W 32"H  
 Inside: 19"D 18<sup>1</sup>/<sub>2</sub>"W 14"H  
 Seat: 18"H  
 Arm: 26"H

## Wood/Upholstered with Panel Back

2542-1	\$1615	\$1615	\$1668	\$1709	\$1760	\$1837	\$1930	\$2039	\$2153	\$2254	\$2363	\$2091	\$2693	\$2857
--------	--------	--------	--------	--------	--------	--------	--------	--------	--------	--------	--------	--------	--------	--------

COM/yds = 1<sup>1</sup>/<sub>2</sub>, COL/sq ft = 27

▶ Specification Information, continued on next page



**For Canadian Pricing**  
 Multiply U.S. Price by the Canadian price factor.  
 ▶ See page 1 for details.

# Kathryn Chairs

DESIGN STUDIO B

► Specification Information, continued from previous page

## Specification Information

Style Number	U.S. Base Prices										Leather Groups:		
	Fabric Groups:										COL		
	COM	1	2	3	4	5	6	7	8	9	10	1	2

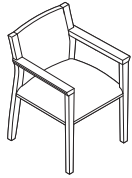

Overall: 22¾"D 22¾"W 32"H  
 Inside: 19"D 18½"W 14"H  
 Seat: 18"H  
 Arm: 26"H

### Fully Upholstered Back

2547-1	\$1820	\$1820	\$1873	\$1914	\$1965	\$2042	\$2135	\$2244	\$2358	\$2459	\$2567	\$2296	\$2898	\$3062
--------	--------	--------	--------	--------	--------	--------	--------	--------	--------	--------	--------	--------	--------	--------

COM/yds = 1½, COL/sq ft = 27

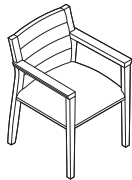

Overall: 22¾"D 22¾"W 32"H  
 Inside: 19"D 18½"W 14"H  
 Seat: 18"H  
 Arm: 26"H

### Fully Upholstered Back with Ribbed Upholstery

2547-1RIBD	\$1876	\$1876	\$1929	\$1970	\$2021	\$2098	\$2191	\$2300	\$2414	\$2515	\$2623	\$2352	\$2954	\$3118
------------	--------	--------	--------	--------	--------	--------	--------	--------	--------	--------	--------	--------	--------	--------

 **For Canadian Pricing**  
 Multiply U.S. Price by the  
 Canadian price factor.  
 ► See page 1 for details.

# LessThanFive Chairs

DESIGN MICHAEL YOUNG

The **LessThanFive** chair is handcrafted from carbon fiber, making it exceptionally light and strong.

**Lightweight**, weighing less than five pounds.

**Glides** are soft felt.

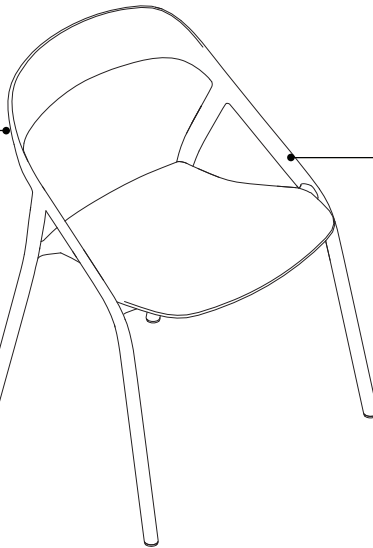

**Frame** is constructed entirely of carbon fiber, and comes in several standard finishes. Customization options are also available.

## Product Details

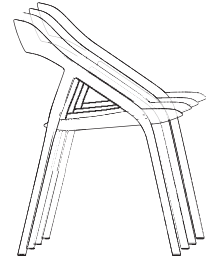

**Stackable** up to four high.

**LessThanFive Essential Series** is available in four neutral finishes, purchased in packs of two or four at a reduced price point. No customization is available for Essential styles.

## Surface Materials

► See *Coalesse Surface Materials Reference Guide* for further information.

**Frame**  
• Paint

*Tip: Consult the Coalesse concierge team for customization options.*

# LessThanFive Chairs

DESIGN MICHAEL YOUNG



Overall: 20½"D 23½"W 30"H  
 Inside Seat: 17½"D 19"W 18"H

Tip: Chair stacks four high.

Tip: LessThanFive essential styles have a defined finish palette. Please see Coalesse Surface Materials Reference Guide for available finishes.

Tip: LessThanFive essential series can only contain one color per pack.

Standard Includes		Required to Specify
<ul style="list-style-type: none"> <li>▶ Need help? Product details, page 340</li> </ul>	<ul style="list-style-type: none"> <li>• Frame: constructed of carbon fiber</li> <li>• Finish: smooth paint</li> <li>• Soft felt glides</li> </ul>	<ul style="list-style-type: none"> <li>1 Style number</li> <li>2 Paint color number for frame</li> <li>3 Options, if selected (see below)</li> <li>▶ See <i>Coalesse Surface Materials Reference Guide</i>.</li> </ul>

Options	U.S. Price	Required to Specify
<b>Surface Materials</b> <ul style="list-style-type: none"> <li>• 4233 Carbon Weave</li> </ul>	+\$320	Specify with 4233 Carbon Weave.

Specification Information		
Style Number	Quantity	U.S. Base Price
<b>LessThanFive</b>		
COLT5	1	\$2295

LessThanFive Essential Series		
Style Number	Quantity	U.S. Base Price
COLT5E	2	\$3670
COLT5EP	4	\$6882

 **For Canadian Pricing**  
 Multiply U.S. Price by the Canadian price factor.  
 ▶ See page 1 for details.

# Leva Chair

Leva is a guest chair made from ash wood, offered in multiple different wood finish options.

Ash wood frame

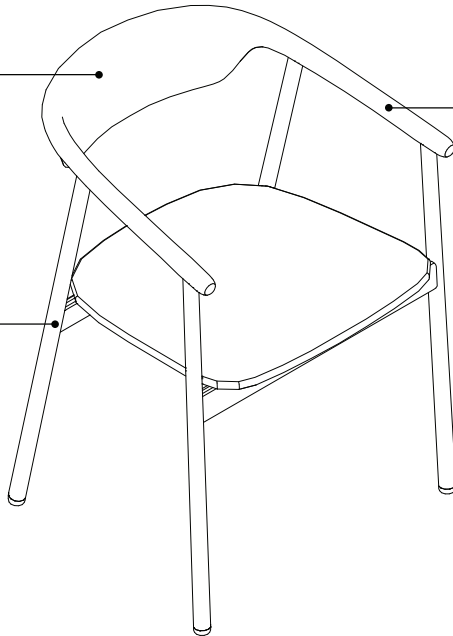

Steam bent arms

Back leg supports the critical joints of the armrest, the seat, and the back.

## Product Details



Leva is offered in multiple different wood finishes.

## Surface Materials

► See *Coalesse Surface Materials Reference Guide* for further information.

- Frame**
- Wood

## Actual Dimensions

Depth	20.07"
Width	22.04"
Height	29.92"

# Leva Chair

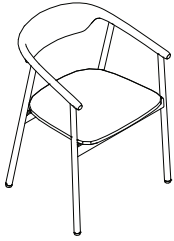

Standard Includes	Required to Specify
-------------------	---------------------

- |  |  |
|--|--|
| <ul style="list-style-type: none"> <li>▶ Need help? Product details, page 342</li> </ul> | <ul style="list-style-type: none"> <li>• Frame: Solid Ash</li> <li>• Legal wood cutting</li> </ul>                               |
|  | <ul style="list-style-type: none"> <li>Style number</li> <li>▶ See <i>Coalesse Surface Materials Reference Guide</i>.</li> </ul> |

Specification Information						
Style Number	Dimensions			Weight	Finish	U.S. Price
	D	W	H			
IAM98	20.07"	22.04"	29.92"	18.73	Black Ash	\$1795
IAM99	20.07"	22.04"	29.92"	18.73	Grey Ash	\$1795
IAM100	20.07"	22.04"	29.92"	18.73	Natural Ash	\$1795
IAM101	20.07"	22.04"	29.92"	18.73	Red Ash	\$1795

 **For Canadian Pricing**  
 Multiply U.S. Price by the Canadian price factor.  
 ▶ See page 1 for details.

# Marien152 Guest Seating

DESIGN COALESSE DESIGN GROUP AND ARIK LEVY

Marien152 is a richly tailored seating experience that's inspired by the home and designed for the workday. An innovative back cushion provides support with soft, residential style. Easy personalization is built into the collection through a wide range of color, form, and materiality choices.

Contrasting fabric is available on seat, surround, and back cushion.

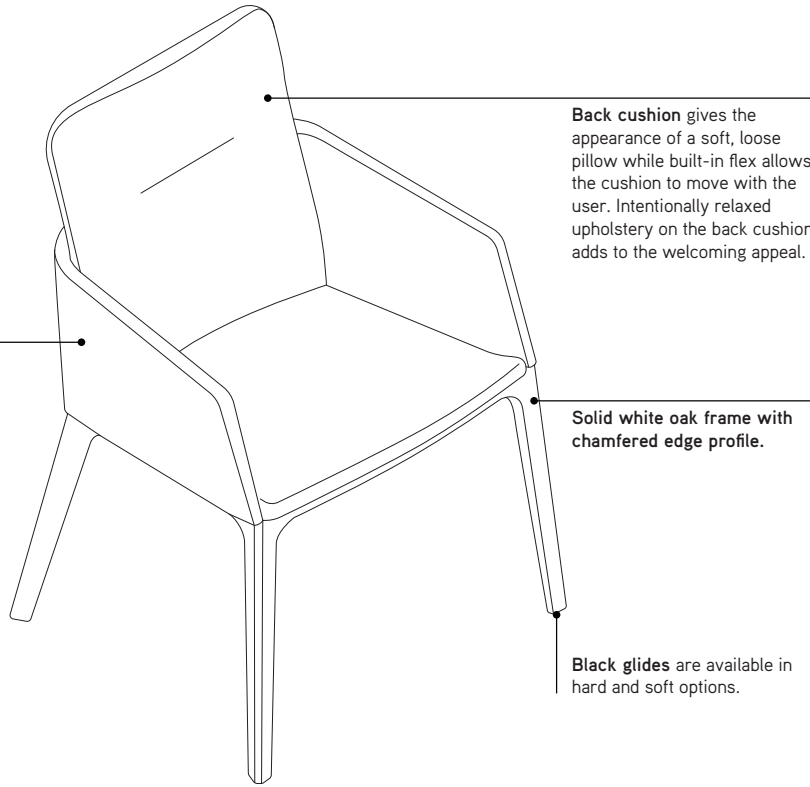

Gently sloping arms are subtle yet supportive.

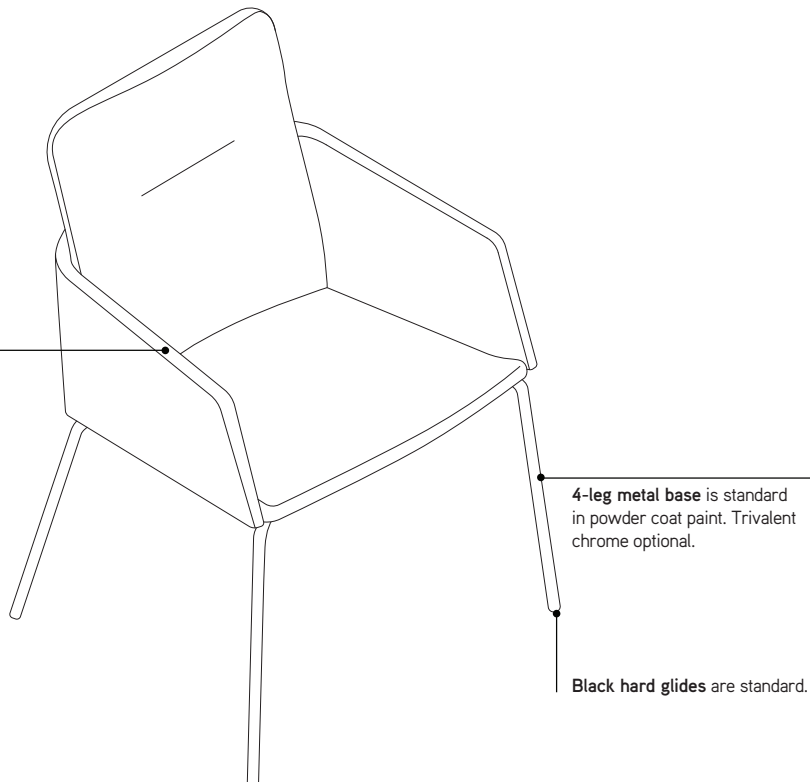

## Product Details

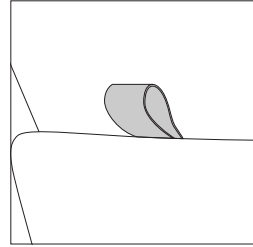

Standard leather pull, located behind the back cushion, allows users to easily move the chair. Leather in the color coal only. Option to specify without pull if desired.

## Surface Materials

### Upholstery

- Fabric
- Leather

### 4-leg metal base

- Painted
- Trivalent chrome

### 4-leg wood base

- Solid white oak wood frame

## Programs & Services

Customer's Own Material/Leather (COM/COL) Program is available. ▶ See *Coalesse Surface Materials Reference Guide* for additional information.

# Marien152 Guest Seating Wood Base

DESIGN COALESSE DESIGN GROUP AND ARIK LEVY

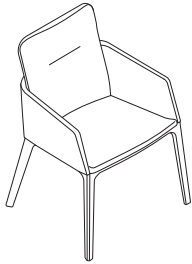

Overall: 23 1/2" D x 25" W x 31 1/2" H  
 Inside: 16 1/2" D x 18" W  
 Seat: 18 1/2" H

Standard Includes		Required to Specify
<ul style="list-style-type: none"> <li>▶ Need help? Product details, page 344</li> </ul>	<ul style="list-style-type: none"> <li>• Seat, back, and surround: upholstery</li> <li>• Leather strap: coal</li> <li>• Base: group 1 oak stain</li> <li>• Black hard glides</li> </ul>	<ol style="list-style-type: none"> <li>1 Style number</li> <li>2 Contrasting fabric (see below under Required Selections)</li> <li>3 Fabric or leather color number for upholstery on seat, surround, and back</li> <li>4 Stain color number for base</li> <li>5 Options, if selected (see below)</li> </ol> ▶ See <i>Coalesse Surface Materials Reference Guide</i> .

Required Selections	U.S. Price	Required to Specify
<b>Contrasting Fabric</b>	<ul style="list-style-type: none"> <li>• Non contrasting fabric: No cost</li> <li>• Contrasting back fabric: +\$192</li> <li>• Contrasting surround fabric: +\$192</li> <li>• Contrasting seat fabric: +\$192</li> <li>• Contrasting all fabrics: +\$192</li> </ul>	Specify <i>with non contrasting</i> . Specify <i>with contrasting back</i> . Specify <i>with contrasting surround</i> . Specify <i>with contrasting seat</i> . Specify <i>with contrasting all fabrics</i> .

Options	U.S. Price	Required to Specify
<b>Surface Materials</b>	<ul style="list-style-type: none"> <li>• <b>Wood Base</b></li> <li>• Group 1 stain: No cost</li> <li>• Group 2 stain: +\$ 90</li> </ul>	Specify wood stain number. Specify wood stain number.
	<ul style="list-style-type: none"> <li>• Backer: +\$ 49</li> </ul>	Specify <i>with acrylic backer</i> .
<b>Caster or Glide Type</b>	<ul style="list-style-type: none"> <li>• Hard glides: No cost</li> <li>• Soft glides: No cost</li> </ul>	Specify <i>with hard glides</i> . Specify <i>with soft glides</i> .
<b>Pull</b>	<ul style="list-style-type: none"> <li>• With leather pull: No cost</li> <li>• Without leather pull: No cost</li> </ul>	Specify <i>with pull</i> . Specify <i>without pull</i> .
<b>Related Products</b>	<ul style="list-style-type: none"> <li>• Conference seating</li> </ul>	▶ Page 300

## Specification Information

Style Number		U.S. Base Prices										Leather Groups:			
		Fabric Groups:										COL			
		COM	1	2	3	4	5	6	7	8	9	10	1	2	
COMARCHWB	Seat	\$2464	\$2464	\$2489	\$2509	\$2534	\$2571	\$2615	\$2667	\$2721	\$2771	\$2823	\$2582	\$ 2903	\$ 3006
	Surround	No cost	No cost	+\$ 40	+\$ 72	+\$111	+\$170	+\$243	+\$325	+\$413	+\$491	+\$574	+\$ 118	+\$1012	+\$1245
	Back	No cost	No cost	+\$ 21	+\$ 39	+\$ 60	+\$ 92	+\$130	+\$174	+\$222	+\$264	+\$308	+\$ 118	+\$ 331	+\$ 407

COM/yds: Seat = .78, Surround = 1.25, Cushion = .67, COL/sq ft: Seat = 9, Surround = 30, Cushion = 11

 **For Canadian Pricing**  
 Multiply U.S. Price by the Canadian price factor.  
 ▶ See page 1 for details.

# Marien152 Guest Seating Metal Base

DESIGN COALESSE DESIGN GROUP AND ARIK LEVY

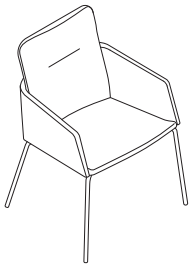

Overall: 24"D x 26"W x 31½"H  
 Inside: 16½"D x 18"W  
 Seat: 18"H

Standard Includes		Required to Specify
<ul style="list-style-type: none"> <li>▶ Need help? Product details, page 344</li> </ul>	<ul style="list-style-type: none"> <li>• Seat, back, and surround: upholstery</li> <li>• Leather strap: coal</li> <li>• Base: group 1 paint</li> <li>• Black hard glides</li> </ul>	<ol style="list-style-type: none"> <li>1 Style number</li> <li>2 Contrasting fabric (see below under Required Selections)</li> <li>3 Fabric or leather color number for upholstery on seat, surround, and back</li> <li>4 Paint color number for base</li> <li>5 Options, if selected (see below)</li> </ol> <p>▶ See <i>Coalesse Surface Materials Reference Guide</i>.</p>

Required Selections	U.S. Price	Required to Specify
<b>Contrasting Fabric</b>	<ul style="list-style-type: none"> <li>• Non contrasting fabric: No cost</li> <li>• Contrasting back fabric: +\$192</li> <li>• Contrasting surround fabric: +\$192</li> <li>• Contrasting seat fabric: +\$192</li> <li>• Contrasting all fabrics: +\$192</li> </ul>	<ul style="list-style-type: none"> <li>Specify with <i>non contrasting</i>.</li> <li>Specify with <i>contrasting back</i>.</li> <li>Specify with <i>contrasting surround</i>.</li> <li>Specify with <i>contrasting seat</i>.</li> <li>Specify with <i>contrasting all fabrics</i>.</li> </ul>

Options	U.S. Price	Required to Specify
<b>Surface Materials</b>	<ul style="list-style-type: none"> <li><b>Base</b></li> <li>• Group 1 paint: No cost</li> <li>• Group 3 paint: +\$111</li> <li>• Trivalent chrome: +\$114</li> </ul>	<ul style="list-style-type: none"> <li>Specify paint color number.</li> <li>Specify paint color number.</li> <li>Specify with <i>trivalent chrome</i>.</li> </ul>
	<ul style="list-style-type: none"> <li>• Backer: +\$ 49</li> </ul>	<ul style="list-style-type: none"> <li>Specify with <i>acrylic backer</i>.</li> </ul>
<b>Pull</b>	<ul style="list-style-type: none"> <li>• With leather pull: No cost</li> <li>• Without leather pull: No cost</li> </ul>	<ul style="list-style-type: none"> <li>Specify with <i>pull</i>.</li> <li>Specify <i>without pull</i>.</li> </ul>

**Related Products** • Conference seating ▶ Page 300

## Specification Information

Style Number		U.S. Base Prices													
		Fabric Groups:										Leather Groups:			
		COM	1	2	3	4	5	6	7	8	9	10	COL	1	2
COMARCHMB	Seat	\$1671	\$1671	\$1696	\$1716	\$1741	\$1778	\$1822	\$1874	\$1928	\$1978	\$2030	\$1789	\$ 2110	\$ 2213
	Surround	No cost	No cost	+\$ 40	+\$ 72	+\$111	+\$170	+\$243	+\$325	+\$413	+\$491	+\$574	+\$118	+\$1012	+\$1245
	Back	No cost	No cost	+\$ 21	+\$ 39	+\$ 60	+\$ 92	+\$130	+\$174	+\$222	+\$264	+\$308	+\$118	+\$ 331	+\$ 407

COM/yds: Seat = .78, Surround = 1.25, Cushion = .67, COL/sq ft: Seat = 9, Surround = 30, Cushion = 11



**For Canadian Pricing**  
 Multiply U.S. Price by the Canadian price factor.  
 ▶ See page 1 for details.

# Marien152 Guest Seating Multi-Fabric Diagram

DESIGN COALESSE DESIGN GROUP AND ARIK LEVY

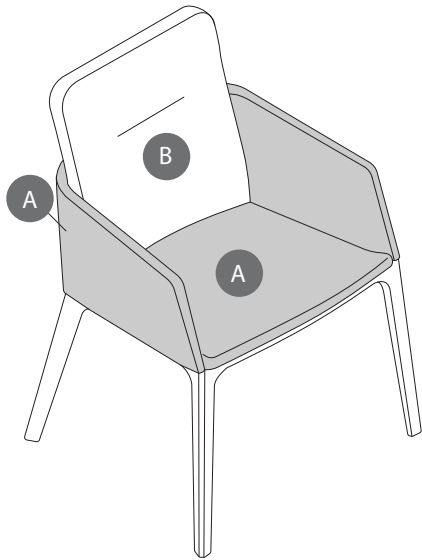
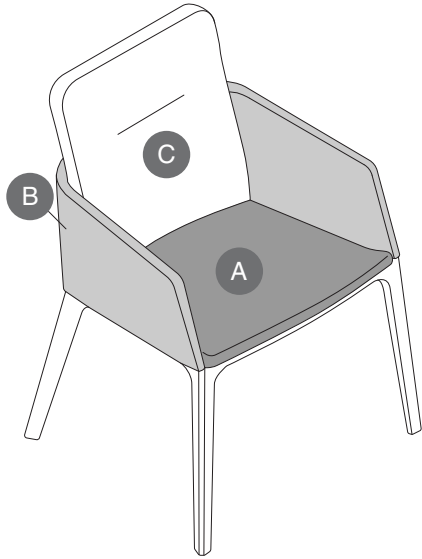

TO: \_\_\_\_\_

FROM: \_\_\_\_\_

DATE: \_\_\_\_\_

FAX....888.413.5161

### FABRIC

**A** Seat: \_\_\_\_\_

**B** Surround: \_\_\_\_\_

**C** Back: \_\_\_\_\_

### LEATHER

**A** Seat + Surround: \_\_\_\_\_

**B** Back: \_\_\_\_\_

Specify Model below:

COMARCHWB Wood Base Chair

COMARCHMB Metal Base Chair

*See specifying for contrasting fabric upcharge.  
List price based on highest fabric group usage.*

# Montara650 Chairs

DESIGN LIEVORE ALTHERR MOLINA

Montara650 seating is infused with comfort and craft, with its refined upholstery and customizable details. The sculpted seating pairs with simple pedestal tables to provide an inspired social solution for today's mobile workforce.

*Tip: This product line is a collection and will be found in multiple locations in this specification guide and/or Coalesse Tables, Storage, and Accessories Specification Guide.*

► See Collections, page 5.

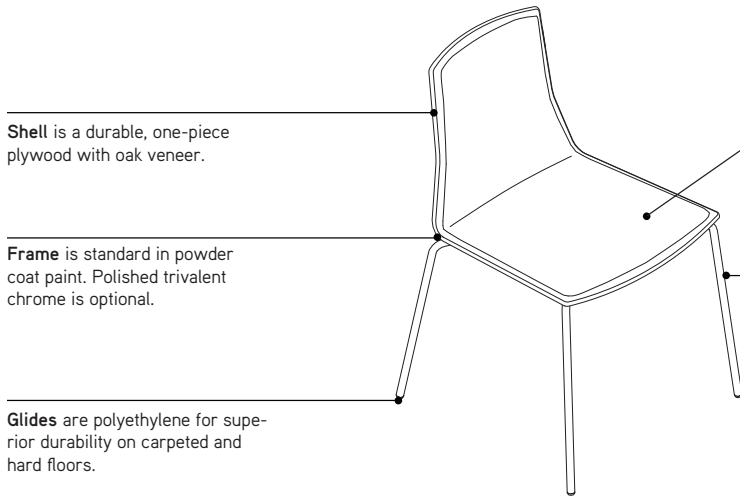

**Shell** is a durable, one-piece plywood with oak veneer.

**Frame** is standard in powder coat paint. Polished trivalent chrome is optional.

**Glides** are polyethylene for superior durability on carpeted and hard floors.

**Upholstery choices** include: wood shell, wood shell with upholstered seat, wood shell with  $\frac{3}{4}$  upholstery, or fully upholstered.

**4-leg base** is standard. Available with loop arms or armless. Arms are aluminum and match the frame finish.

**Stools** are also available. ► See page 402

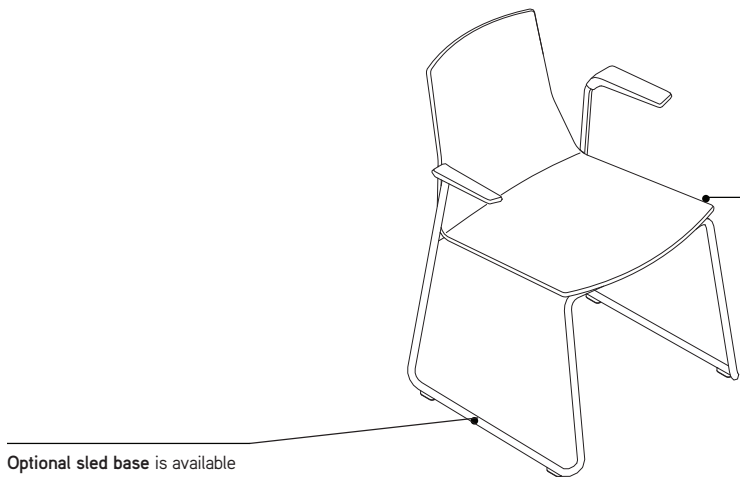

**Optional sled base** is available with cantilever arms or armless. Arms are aluminum and match the frame finish.

**Chairs** are stackable. The stack pad is standard and protects upholstery from damage. Chairs stack to six high.

## Product Details

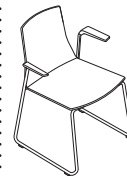
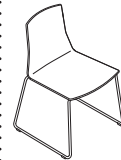
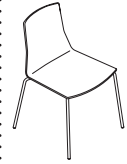

**Chairs** are available with a 4-leg base (armless or with loop arms) and with a sled base (armless or with cantilever arms).

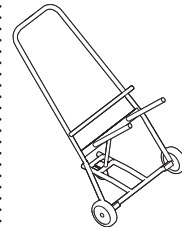

**The Enea Iottus dolly** can be used for storage or easy transport. Chairs stack to six high on the dolly.

# Montara650 Chairs

DESIGN LIEVORE ALTHERR MOLINA

## Surface Materials

► See *Coalesse Surface Materials Reference Guide* for further information.

### Wood shell

- Oak veneered plywood

### Frame

- Paint
- Polished trivalent chrome (optional)

### Upholstery

- Fabric
- Leather

## Program & Services

**Customer's Own Material/Leather (COM/COL) Program** is available.

► See *Coalesse Surface Materials Reference Guide* for additional information.

# Montara650 Chairs

DESIGN LIEVORE ALTHERR MOLINA



*Tip: Leathers will appear loose with comfort wrinkles when upholstered.*

*Tip: For Customer's Own Material or Leather, see necessary requirements, important processing instructions, and ordering information.*  
 ▶ See *Coalesse Surface Materials Reference Guide* and online fabric database at <http://fabric.coalesse.com>.

Standard Includes	Required to Specify
-------------------	---------------------

- |   |  |
|---|--|
| <ul style="list-style-type: none"> <li>▶ Need help? Product details, page 348</li> <li>• Seat and back: upholstery, if selected</li> <li>• Shell: wood shell, wood shell with upholstered seat, or ¾ upholstery with wood shell, if selected: group 1 wood veneer</li> <li>• Base: group 1 paint</li> <li>• Glides</li> </ul> | <ol style="list-style-type: none"> <li>1 Style number</li> <li>2 Upholstery version (see below under Required Selections)</li> <li>3 Contrasting fabric on ¾ or fully upholstered, if selected (see below under Required Selections)</li> <li>4 Fabric and/or leather color number for seat and/or back, if selected</li> <li>5 Wood finish on shell, if selected</li> <li>6 Base type (see below under Required Selections)</li> <li>7 Paint color number for base</li> <li>8 Options, if selected (see below)</li> </ol> <p>▶ See <i>Coalesse Surface Materials Reference Guide</i>.</p> |
|---|--|

Required Selections	U.S. Price	Required to Specify
---------------------	------------	---------------------

<b>Upholstery Version</b>	<ul style="list-style-type: none"> <li>• Wood shell</li> <li>• Wood shell with upholstered seat</li> <li>• Wood shell with ¾ upholstery</li> <li>• Fully upholstered</li> </ul>	Prices at right Prices at right Prices at right Prices at right	Specify with wood seat and back. Specify with upholstered seat, wood back. Specify with ¾ upholstered. Specify with upholstered seat and back.
<b>Contrasting Fabric on ¾ and Fully Upholstered</b>	<ul style="list-style-type: none"> <li>• Non contrasting fabric</li> <li>• Contrasting fabric</li> </ul>	No cost +\$192	Specify with non contrasting fabric. Specify with contrasting fabric.
<b>Base Type</b>	<ul style="list-style-type: none"> <li>• 4-leg</li> <li>• Sled base</li> <li>• Sled base with cantilever arms</li> <li>• 4-leg base with loop arms</li> </ul>	No cost +\$ 79 +\$232 +\$185	Specify with 4-leg. Specify with sled base. Specify with sled cantilever arm. Specify with 4-leg loop arm.

Options	U.S. Price	Required to Specify
---------	------------	---------------------

<b>Surface Materials</b>	<b>Base, armless</b> <ul style="list-style-type: none"> <li>• Group 1 paint</li> <li>• Polished trivalent chrome</li> <li>• Group 3 paint</li> </ul>	No cost +\$ 80 +\$114	Specify paint color number. Specify with polished trivalent chrome. Specify paint color number.
	<b>Base, with arms</b> <ul style="list-style-type: none"> <li>• Group 1 paint</li> <li>• Group 3 paint</li> <li>• Polished trivalent chrome</li> </ul>	No cost +\$114 +\$263	Specify paint color number. Specify paint color number. Specify with polished trivalent chrome.
	<b>Wood shell</b> <ul style="list-style-type: none"> <li>• Group 1 wood veneer</li> <li>• Group 2 wood veneer</li> </ul>	No cost +\$102	Specify with VP01 Oak Light, VP03 Black Oak, or VP05 White Oak. Specify with VP02 Smoked Oak or VP04 Grey Oak.
	<b>Acrylic backer</b> <ul style="list-style-type: none"> <li>• Seat</li> <li>• Seat and back</li> </ul>	+\$ 9 +\$ 25	Specify with acrylic backer. Specify with acrylic backer.

<b>Related Products</b>	<ul style="list-style-type: none"> <li>• Café tables</li> <li>• Lounge seating</li> <li>• Stools</li> </ul>	▶ See <i>Coalesse Tables, Storage, and Accessories Specification Guide</i> . ▶ Page 200 ▶ Page 402
-------------------------	---	--



**For Canadian Pricing**  
 Multiply U.S. Price by the Canadian price factor.  
 ▶ See page 1 for details.

# Montara650 Chairs

DESIGN LIEVORE ALTHERR MOLINA

## Specification Information



**4-leg, armless**  
Overall: 20½"W x 20½"D x 31"H  
Seat: 17½"H



**4-leg with loop arms**  
Overall: 24"W x 20½"D x 31"H  
Seat: 17½"H  
Arms: 25¼"H



**Sled base, armless**  
Overall: 20½"W x 20½"D x 31"H  
Seat: 17½"H



**Sled base with cantilever arms**  
Overall: 22"W x 20½"D x 31"H  
Seat: 17½"H  
Arms: 25"H

Style Number U.S. Base Price

### Wood Shell Chair

COSFZCH	Seat	\$828
---------	------	-------

Style Number U.S. Base Prices

Fabric Groups:  
COM 1 2 3 4 5 6 7 8 9 10

Leather Groups:  
COL 1 2

### Wood Shell Chair with Upholstered Seat

COSFZCH	Seat	\$1006	\$1006	\$1013	\$1066	\$1113	\$1181	\$1267	\$1365	\$1469	\$1561	\$1631	\$1381	\$1198	\$1250
---------	------	--------	--------	--------	--------	--------	--------	--------	--------	--------	--------	--------	--------	--------	--------

COM/yds = ¾, COL/sq ft: 8

### Wood Shell Chair with ¾ Upholstery

COSFZCH	Seat	\$1166	\$1166	\$1173	\$1226	\$1273	\$1341	\$1427	\$1525	\$1629	\$1721	\$1791	\$1541	\$1358	\$1410
	Back	+\$ 17	+\$ 17	+\$ 28	+\$ 52	+\$ 79	+\$120	+\$172	+\$231	+\$293	+\$349	+\$408	+\$128	+\$213	+\$265

COM/yds = ¾, COL/sq ft: 16

### Fully Upholstered Chair

COSFZCH	Seat	\$1047	\$1047	\$1054	\$1107	\$1154	\$1222	\$1308	\$1406	\$1510	\$1602	\$1672	\$1422	\$1239	\$1291
	Back	+\$ 25	+\$ 25	+\$ 44	+\$ 80	+\$121	+\$185	+\$264	+\$354	+\$450	+\$536	+\$627	+\$128	+\$474	+\$580

COM/yds = 1¼, COL/sq ft: 19

Guest Seating



**For Canadian Pricing**  
Multiply U.S. Price by the  
Canadian price factor.  
▶ See page 1 for details.

# Montara650 Chair and Stool Multi-Fabric Diagram

DESIGN LIEVORE ALTHERR MOLINA

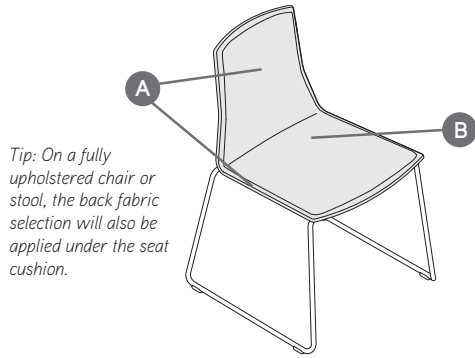

*Tip: On a fully upholstered chair or stool, the back fabric selection will also be applied under the seat cushion.*

Fully Upholstered

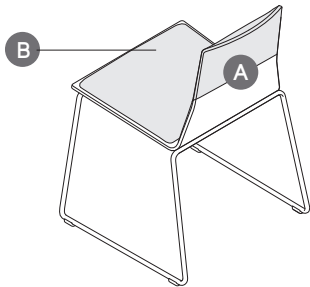

3/4 Upholstered

TO: \_\_\_\_\_

FROM: \_\_\_\_\_

DATE: \_\_\_\_\_

FAX...888.413.5161

**A** Back: \_\_\_\_\_

\_\_\_\_\_

**B** Seat: \_\_\_\_\_

\_\_\_\_\_

*Contrasting upcharge for each contrasting textile pricing based on highest group textile specified. See specifying for contrasting upcharge.*

Specify Model below:

COSFZCH Montara650 Chair

COSFZST Montara650 Stool

# Round Outdoor Chairs

The Round outdoor chair is characterized by an elemental design of snug and comfortable shapes, representing a simple, contemporary design.

Metal mesh seat, welded to a tubular steel frame.

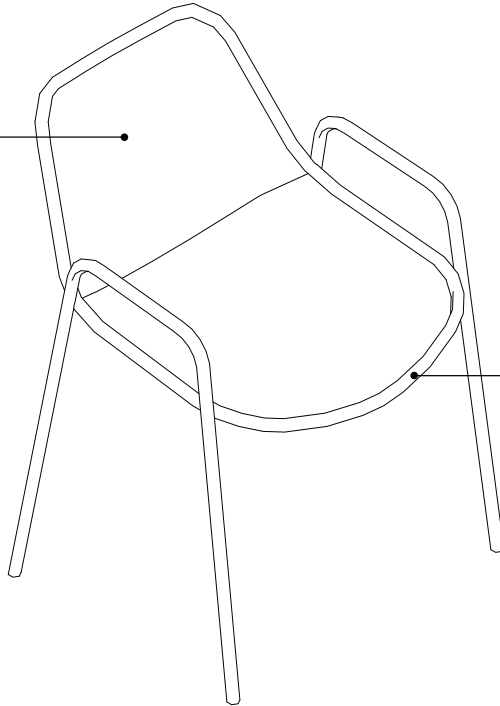

Outdoor grade powder coat paint.

## Product Details

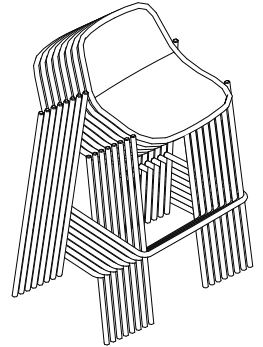

The chair can be stacked up to eight units high.

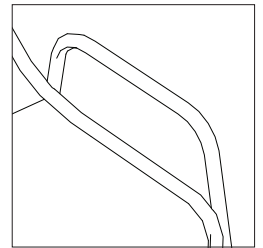

Arm and armless options are available.

## Surface Materials

► See *Coalesse Surface Materials Reference Guide* for further information.

**Frame**  
• Steel

## Actual Dimensions

Depth	23.25"
Width	24.75"
Height	32"

# Round Outdoor Chairs

Standard Includes	Required to Specify
-------------------	---------------------

► Need help? Product details, page 353

- Frame: metal mesh seat, crafted using a deep drawing technique, welded to a tubular steel frame:
  - 4251 EMU Brown
  - 4257 Antique Iron
  - 7234 EMU Black
  - 7271 EMU White
- Finish: outdoor grade powder coat paint
- Glides: nylon
- Design: Christophe Pillet

1 Style number  
 2 Options, if selected (see below)  
 ► See *Coalesse Surface Materials Reference Guide*.

*Tip: Additional powder coat paint finishes are available with an upcharge (Other Emu paint finishes).*

*Tip: Chair stacks eight high.*

Options	U.S. Price	Required to Specify
---------	------------	---------------------

**Surface Materials**

- Standard Emu palette color: No cost
- Other Emu palette color: +\$263

Specify with *standard Emu palette color* and select color number.  
 Specify with *other Emu palette color* and select color number.

**Related Products**

- Round outdoor stools

► Page 404

Specification Information					
Style Number	Dimensions			Quantity	U.S. Base Price
	D	W	H		

**Armless Chair**

CO2465	23.25"	24.75"	32"	4	\$1771
--------	--------	--------	-----	---	--------

**Arm Chair**

CO2466	23.25"	24.75"	32"	4	\$1920
--------	--------	--------	-----	---	--------

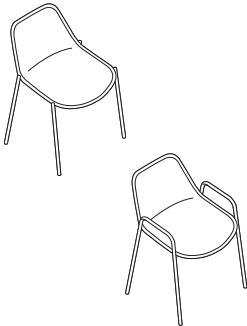

**For Canadian Pricing**  
 Multiply U.S. Price by the Canadian price factor.  
 ► See page 1 for details.

# Seta Chair

Seta chair is a guest chair made from ash wood, offered in multiple wood finish options.

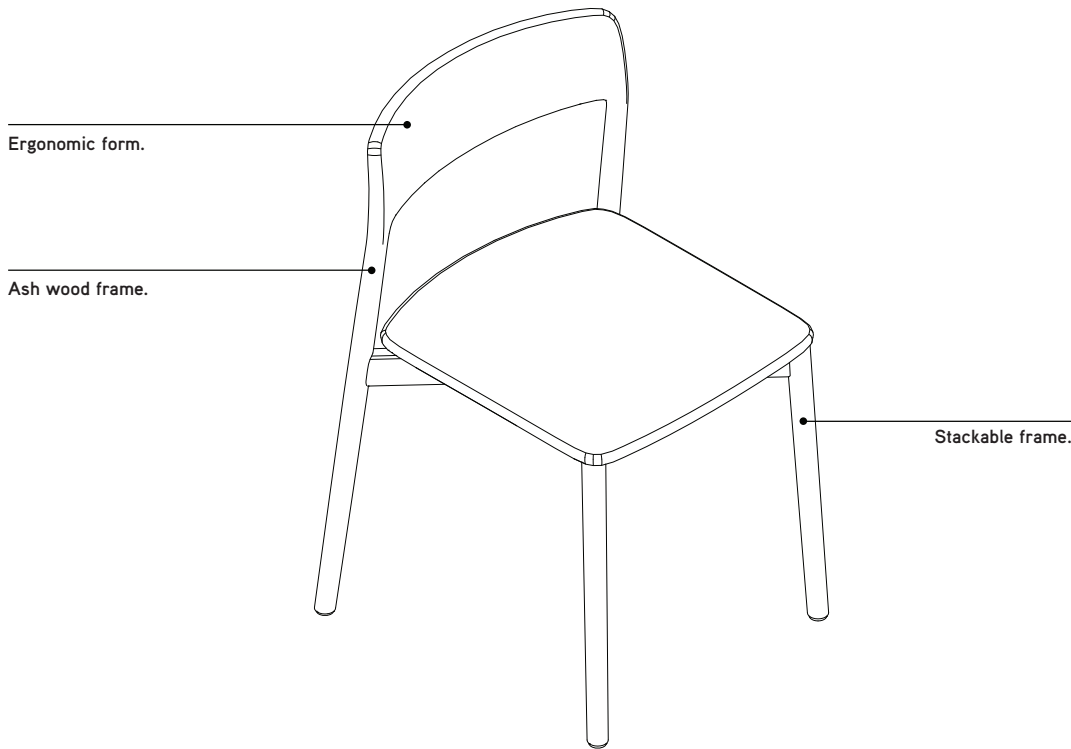

## Product Details

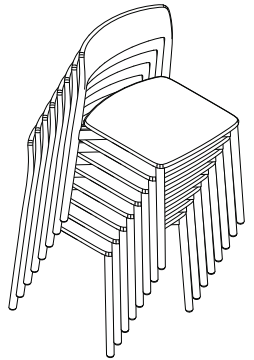

The chair can be stacked up to eight units high.

## Surface Materials

See *Coalesse Surface Materials Reference Guide* for further information.

- Frame
- Wood

## Actual Dimensions

Depth	19.3"
Width	20.1"
Height	29.9"

# Seta Chair



Standard Includes		Required to Specify
<ul style="list-style-type: none"> <li>▶ Need help? Product details, page 355</li> </ul>	<ul style="list-style-type: none"> <li>• Frame: Ash</li> <li>• Legal wood cutting</li> </ul>	<ol style="list-style-type: none"> <li>1 Style number</li> <li>2 Wood color number for frame</li> <li>3 Options, if selected (see below)</li> </ol> <ul style="list-style-type: none"> <li>▶ See <i>Coalesse Surface Materials Reference Guide</i>.</li> </ul>

	Options	U.S. Price	Required to Specify
<b>Surface Materials</b>	<ul style="list-style-type: none"> <li>• Black ash</li> <li>• Grey ash</li> <li>• Natural ash</li> <li>• Red ash</li> <li>• Neon blue ash</li> </ul>	<p>No cost No cost No cost No cost No cost</p>	<p>Specify with <i>black ash</i>. Specify with <i>grey ash</i>. Specify with <i>natural ash</i>. Specify with <i>red ash</i>. Specify with <i>neon blue ash</i>.</p>

Specification Information					
Style Number	Dimensions			Weight	U.S. Price
	D	W	H		
IAM262	19.3"	20.1"	29.9"	16.5	\$1430

 **For Canadian Pricing**  
 Multiply U.S. Price by the Canadian price factor.  
 ▶ See page 1 for details.

# She Said Chair

The **She Said chair** is a guest chair made from ash wood, offered in multiple wood finish options.

Ash wood frame

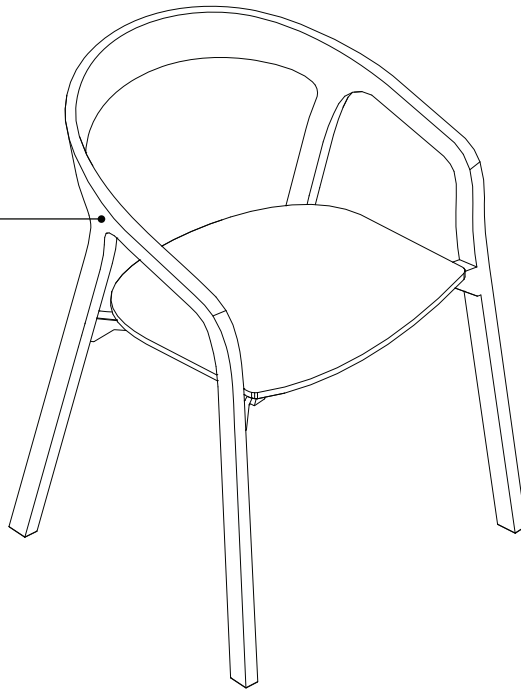

## Product Details

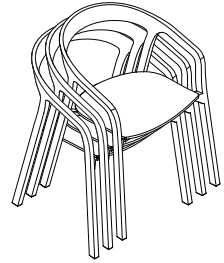

The chair can be stacked up to three units high.

## Surface Materials

► See *Coalesse Surface Materials Reference Guide* for further information.

### Frame

- Steel

## Actual Dimensions

Depth	22.24"
Width	23.62"
Height	30.31"

# She Said Chair

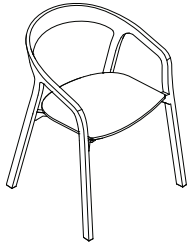

Standard Includes	Required to Specify
<ul style="list-style-type: none"> <li>▶ Need help? Product details, page 357</li> <li>• Frame: Ash</li> <li>• Legal wood cutting</li> </ul>	<ul style="list-style-type: none"> <li>1 Style number</li> <li>2 Wood color number for frame</li> <li>▶ See <i>Coalesse Surface Materials Reference Guide</i>.</li> </ul>

### Specification Information

Style Number	Dimensions			Weight	Finish	U.S. Price
	D	W	H			
IAM156	22.24"	23.62"	30.31"	33.06	Black Ash	\$2131
IAM157	22.24"	23.62"	30.31"	33.06	Natural Ash	\$2131
IAM158	22.24"	23.62"	30.31"	33.06	Neon Blue Ash	\$2131
IAM159	22.24"	23.62"	30.31"	33.06	White Ash	\$2131



**For Canadian Pricing**  
 Multiply U.S. Price by the Canadian price factor.  
 ▶ See page 1 for details.

# Switch Chairs

DESIGN E00S

- **Switch chairs** bring modern and comfortable seating to the workplace.
- *Tip: This product line is a collection and will be found in multiple locations in this specification guide and/or Coalesse Tables, Storage, and Accessories Specification Guide.*
- ▶ See *Collections*, page 5.

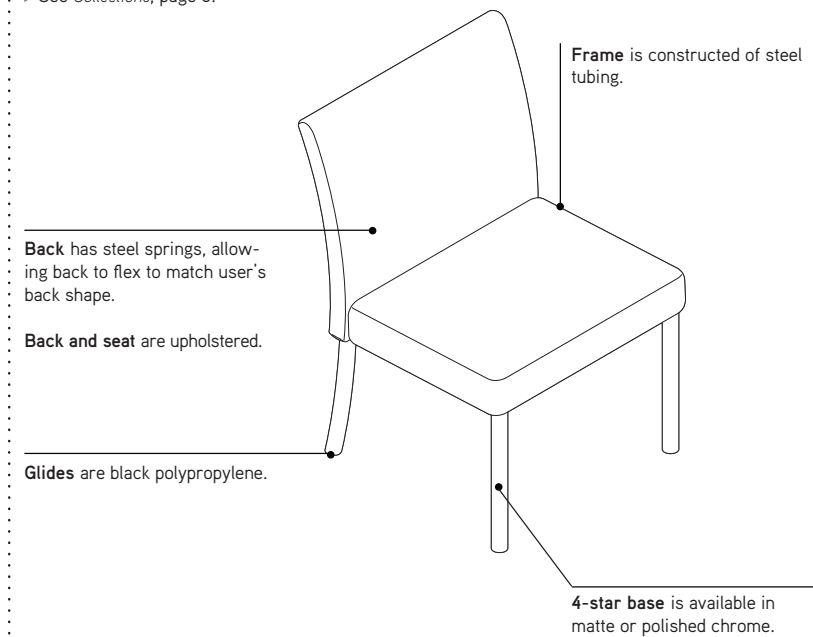

## Product Details

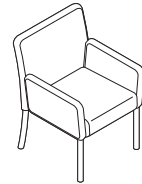
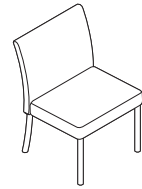

**Switch** is available with or without arms in a leg base.

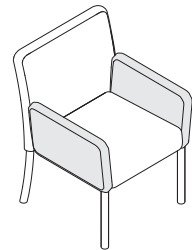

**Upholstered arm detail** is available on 4-leg base only.

## Surface Materials

▶ See *Coalesse Surface Materials Reference Guide* for further information.

**Upholstery** (contrasting fabric available)

- Fabric
- Leather

**Frame**

- Matte chrome
- Polished chrome

## Program & Services

**Customer's Own Material/Leather (COM/COL) Program** is available.

▶ See *Coalesse Surface Materials Reference Guide* for additional information.

# Switch Chairs

DESIGN E00S

*Tip: Fabrics and leathers will appear loose with comfort wrinkles when upholstered.*

*Tip: Recommended leathers are Elmosoft group 1 and Elmorustical group 2.*

*Tip: Special color match, consult Customer Service.*

*Tip: For Customer's Own Material or Leather, see necessary requirements, important processing instructions, and ordering information*

▶ See *Coalesse Surface Materials Reference Guide*.

*Tip: Pricing based on highest group textile specified.*

*Tip: Steel springs allow back to flex to match occupant's back shape.*

Standard Includes		Required to Specify	
▶ Need help? Product details, page 359	<ul style="list-style-type: none"> <li>Frame: Constructed of steel tubing and bar stock</li> <li>Arms: solid steel rod and bar stock</li> <li>Upholstery: Back and seat are molded foam and fiber</li> <li>Legs: matte chrome (M) or polished chrome (PC) leg finish</li> </ul>	<ol style="list-style-type: none"> <li>Style number</li> <li>Number of fabrics if contrasting fabric style number is selected</li> <li>Fabric or leather color number for upholstery on seat</li> <li>Options, if selected (see below)</li> </ol>	▶ See <i>Coalesse Surface Materials Reference Guide</i> .
Options		U.S. Price	Required to Specify
<b>Surface Materials</b>	• Contrasting fabric	+\$192 per fabric	Add suffix K to the style number and select fabric color number.
	<b>Acrylic backer</b>		
	• Armless chair	+\$ 28	Specify with acrylic backer.
	• Arm chair	+\$ 41	Specify with acrylic backer.
			▶ See <i>Coalesse Surface Materials Reference Guide</i> .
<b>Related Products</b>	• Lounge seating		▶ Page 262
	• Stools		▶ Page 407
	• Occasional tables		▶ See <i>Coalesse Tables, Storage, and Accessories Specification Guide</i> .

## Specification Information

Style Number	U.S. Base Prices										Leather Groups:		
	Fabric Groups:										COL	1	2
COM	1	2	3	4	5	6	7	8	9	10			

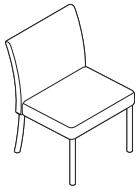

Overall: 22½"D 21½"W 33½"H  
 Inside: 18½"D 19¼"W 15½"H  
 Seat: 18½"H

## Armless Chairs

1500M	\$1905	\$1905	\$1951	\$1989	\$2037	\$2105	\$2191	\$2289	\$2392	\$2485	\$2582	\$2423	\$3436	\$3637
1500PC	\$1973	\$1973	\$2019	\$2057	\$2105	\$2173	\$2259	\$2357	\$2460	\$2553	\$2650	\$2491	\$3504	\$3706

COM/yds = 1½, COL/sq ft = 27

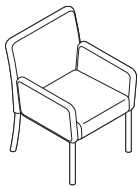

Overall: 22½"D 25¾"W 33½"H  
 Inside: 18½"D 19"W 15½"H  
 Seat: 18½"H  
 Arm: 26½"H

## Arm Chairs

1510M	\$2178	\$2178	\$2256	\$2319	\$2397	\$2511	\$2655	\$2817	\$2990	\$3144	\$3307	\$2701	\$4444	\$4784
1510PC	\$2257	\$2257	\$2335	\$2398	\$2476	\$2590	\$2734	\$2896	\$3069	\$3223	\$3386	\$2780	\$4504	\$4863

COM/yds = 2½, COL/sq ft = 45



### For Canadian Pricing

Multiply U.S. Price by the Canadian price factor.

▶ See page 1 for details.

# Wrapp Chairs by Viccarbe

DESIGN MARK KRUSIN

Wrapp chair combines a snug, winged back with a generous contoured seat, inclined slightly for comfort and support.

Back is fully upholstered with back stitch detail.

Seat is upholstered foam with slight incline for added comfort and support.

Glides are black polypropylene.

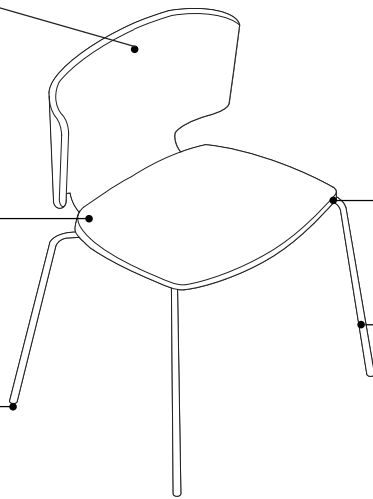

Frame is standard polished trivalent chrome.

4-leg base or sled base are available.

## Product Details

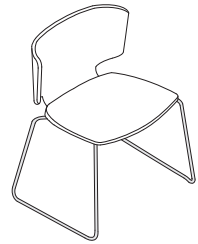

Sled base is available.

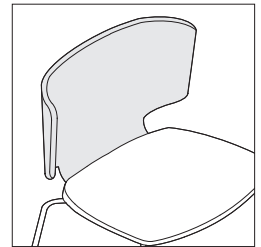

Back stitch detail is standard on all upholstery.

## Surface Materials

► See *Coalesse Surface Materials Reference Guide* for further information.

**Upholstery** (contrasting fabric available)

- Fabric
- Leather

**Frame**

- Polished trivalent chrome

## Program & Services

**Customer's Own Material/Leather (COM/COL) Program** is available.

► See *Coalesse Surface Materials Reference Guide* for additional information.

# Wrapp Chairs by Viccarbe

DESIGN MARK KRUSIN

*Tip: Fabrics and leathers will appear loose with comfort wrinkles when upholstered.*

*Tip: Stacking is not recommended as the frame will dent the foam on the seat on which it is being stacked.*

*Tip: For Customer's Own Material or Leather, see necessary requirements, important processing instructions, and ordering information*  
 ▶ See *Coalesse Surface Materials Reference Guide*.

Standard Includes		Required to Specify	
▶ Need help? Product details, page 361	<ul style="list-style-type: none"> <li>Upholstery for chair: fabric or leather</li> <li>Frame: polished trivalent chrome</li> </ul>	1 Style number 2 Number of fabrics if contrasting fabric style number is selected 3 Fabric or leather color number for upholstery 4 Options, if selected (see below) ▶ See <i>Coalesse Surface Materials Reference Guide</i> .	
Options		Required to Specify	
<b>Surface Materials</b>	<ul style="list-style-type: none"> <li>Contrasting fabric</li> </ul>	+\$192 per fabric	Add suffix K to the style number and select fabric color number.
	<ul style="list-style-type: none"> <li><b>Acrylic backer</b></li> <li>Backer</li> </ul>	+\$ 21	Specify with acrylic backer. ▶ See <i>Coalesse Surface Materials Reference Guide</i> .

Specification Information													
Style Number	U.S. Base Prices												Leather Groups:
	Fabric Groups:												COL
COM	1	2	3	4	5	6	7	8	9	10	1	2	



Overall: 21"D 25¼"W 29½"H  
 Inside: 16"D 19½"W 17½"H  
 Seat: 17½"H

## 4-Leg Chair

COWRP4LEG	\$1959	\$1959	\$2012	\$2055	\$2107	\$2185	\$2282	\$2393	\$2510	\$2613	\$2724	\$2401	\$3211	\$3382
-----------	--------	--------	--------	--------	--------	--------	--------	--------	--------	--------	--------	--------	--------	--------

COM/yds = 1½, COL/sq ft = 33

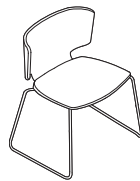

Overall: 20¼"D 24½"W 28¾"H  
 Inside: 16"D 19½"W 17½"H  
 Seat: 17½"H

## Sled-Base Chair

COWRPSLD	\$2028	\$2028	\$2081	\$2124	\$2176	\$2252	\$2351	\$2462	\$2579	\$2682	\$2793	\$2470	\$3280	\$3451
----------	--------	--------	--------	--------	--------	--------	--------	--------	--------	--------	--------	--------	--------	--------

COM/yds = 1½, COL/sq ft = 33

 **For Canadian Pricing**  
 Multiply U.S. Price by the Canadian price factor.  
 ▶ See page 1 for details.

---

# Stools

\*These product lines are collections and will be found in multiple locations in this specification guide and/or *Coalesce Tables, Storage, and Accessories Specification Guide*.

▶ See *Collections*, page 5

<b>Branca Stools</b>	<b>364</b>
<b>Cugino Stool</b>	<b>368</b>
<b>Cugino Soft Stool</b>	<b>370</b>
<b>Enea Café Wood Stools*</b>	<b>372</b>
<b>Enea Lottus Post Stools*</b>	<b>376</b>
<b>Enea Lottus Sled Stools*</b>	<b>380</b>
<b>Enea Altzo943 Stools*</b>	<b>384</b>
<b>LessThanFive Stool</b>	<b>388</b>
<b>Marien152 Stools*</b>	<b>390</b>
<b>Medici Stool</b>	<b>397</b>
<b>Montara650 Stools*</b>	<b>400</b>
<b>Round Outdoor Stool</b>	<b>404</b>
<b>Switch Stools*</b>	<b>406</b>

# Branca Barstool

**Branca barstool** is a stool made from a single piece of wood, offered in multiple different wood finish options.

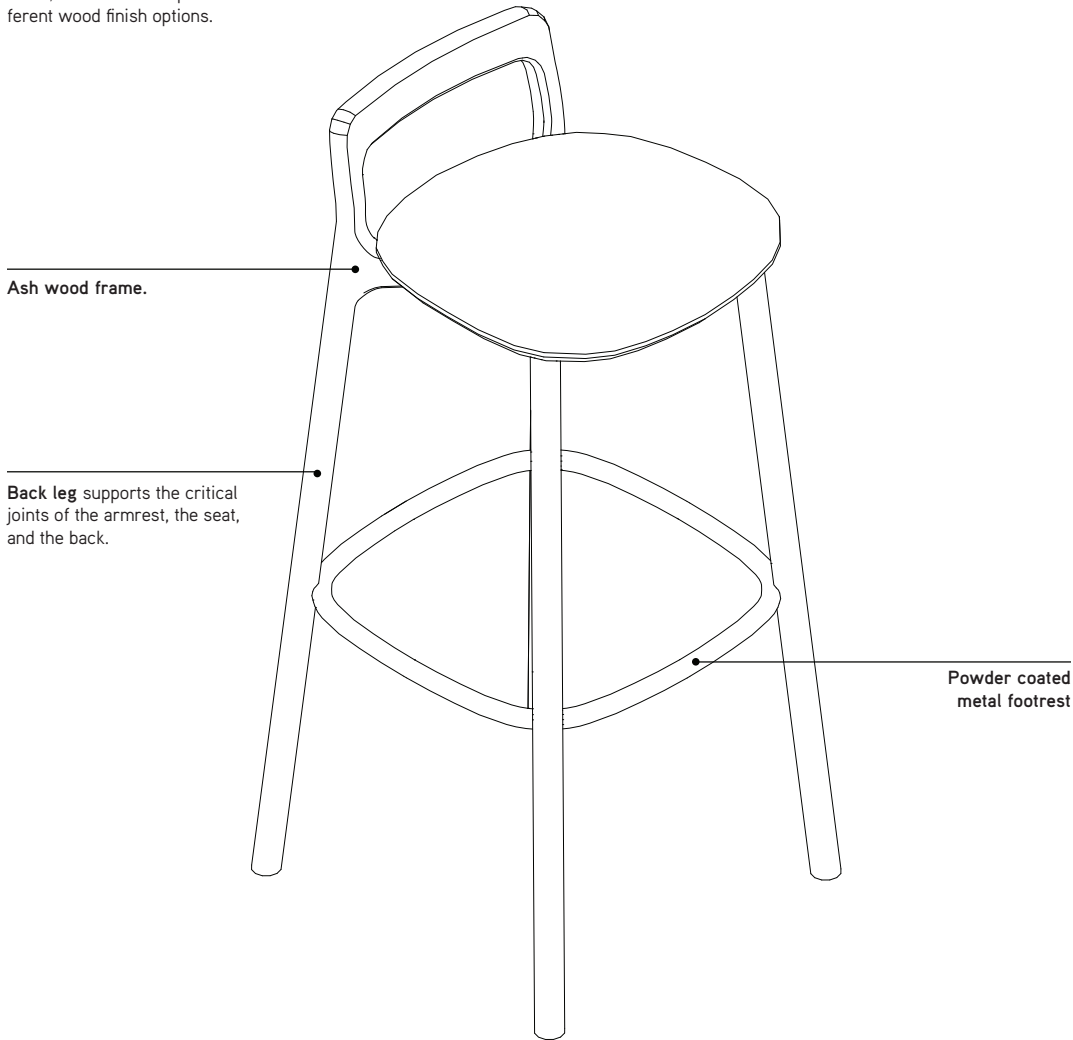

## Product Details

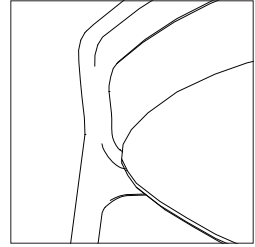

Seamless joinery.

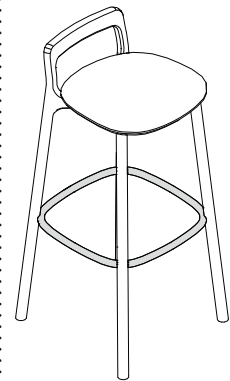

Powder coated metal footrest.

## Surface Materials

► See *Coalesse Surface Materials Reference Guide* for further information.

- Frame**
- Wood

## Actual Dimensions

Depth	16.33"
Width	15.74"
Height	34.25"

# Branca Barstool

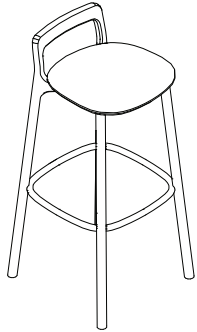

Standard Includes		Required to Specify
<ul style="list-style-type: none"> <li>▶ Need help? Product details, page 364</li> </ul>	<ul style="list-style-type: none"> <li>• Frame: Solid ash</li> <li>• Legal wood cutting</li> </ul>	<ul style="list-style-type: none"> <li>Style number</li> <li>▶ See <i>Coalesse Surface Materials Reference Guide</i>.</li> </ul>

Specification Information						
Style Number	Dimensions			Weight	Finish	U.S. Price
	D	W	H			
IAM1	16.33"	15.74"	34.25"	16.31	Black Ash	\$1465
IAM2	16.33"	15.74"	34.25"	16.31	Brown Ash	\$1465
IAM3	16.33"	15.74"	34.25"	16.31	Natural Ash	\$1465
IAM4	16.33"	15.74"	34.25"	16.31	White Ash	\$1465
IAM5	16.33"	15.74"	34.25"	16.31	Green Ash	\$1465



**For Canadian Pricing**  
 Multiply U.S. Price by the Canadian price factor.  
 ▶ See page 1 for details.

# Branca Counter Stool

Branca counter stool is a stool made from a single piece of wood, offered in multiple different wood finish options.

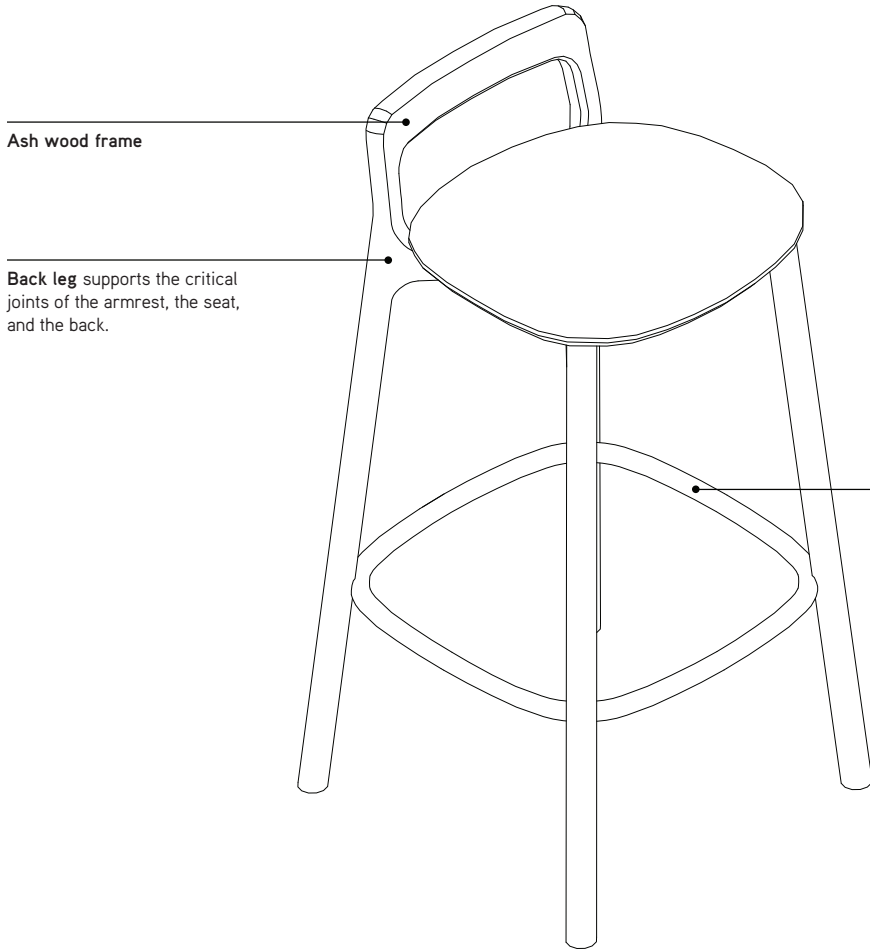

Ash wood frame

Back leg supports the critical joints of the armrest, the seat, and the back.

Powder coated metal footrest

## Product Details

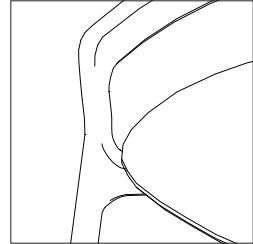

Seamless joinery.

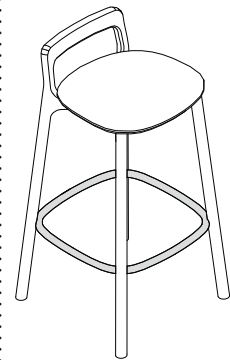

Powder coated metal footrest.

## Surface Materials

► See *Coalesse Surface Materials Reference Guide* for further information.

Frame  
• Wood

## Actual Dimensions

Depth	15.74"
Width	15.35"
Height	30.31"

# Branca Counter Stool

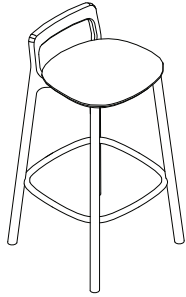

Standard Includes	Required to Specify
<ul style="list-style-type: none"> <li>Need help? Product details, page 366</li> <li>Frame: Solid ash</li> <li>Legal wood cutting</li> </ul>	<ul style="list-style-type: none"> <li>Style number</li> <li>See <i>Coalesse Surface Materials Reference Guide</i>.</li> </ul>

Specification Information						
Style Number	Dimensions			Weight	Finish	U.S. Price
	D	W	H			
IAM6	15.74"	15.35"	30.31"	14.99	Black Ash	\$1465
IAM7	15.74"	15.35"	30.31"	14.99	Brown Ash	\$1465
IAM8	15.74"	15.35"	30.31"	14.99	Green Ash	\$1465
IAM9	15.74"	15.35"	30.31"	14.99	Natural Ash	\$1465
IAM10	15.74"	15.35"	30.31"	14.99	White Ash	\$1465

Stools

 **For Canadian Pricing**  
 Multiply U.S. Price by the Canadian price factor.  
 ▶ See page 1 for details.

# Cugino Stool

**Cugino** is a stool made from solid oak with multiple wood finish options.

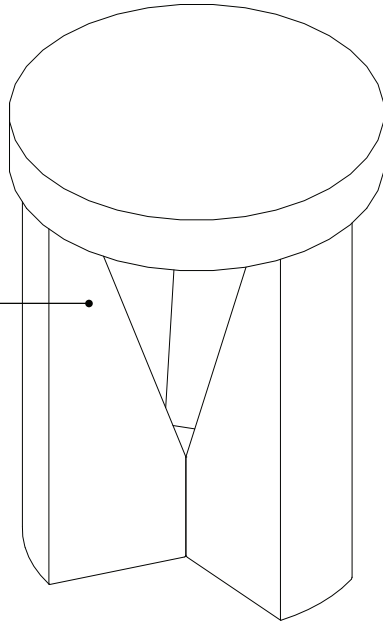

Solid oak frame

## Product Details

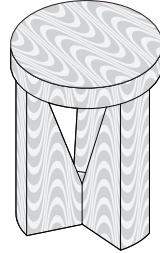

Two wood frame finish options are available.

## Surface Materials

► See *Coalesse Surface Materials Reference Guide* for further information.

**Frame**  
• Wood

## Actual Dimensions

Depth	12.99"
Width	12.99"
Height	17.71"

# Cugino Stool

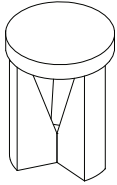

Standard Includes		Required to Specify
<ul style="list-style-type: none"> <li>▶ Need help? Product details, page 368</li> </ul>	<ul style="list-style-type: none"> <li>• Frame: Oak</li> <li>• Legal wood cutting</li> </ul>	<ul style="list-style-type: none"> <li>Style number</li> <li>▶ See <i>Coalesse Surface Materials Reference Guide</i>.</li> </ul>

Options	U.S. Price	Required to Specify
<b>Surface Materials</b> <ul style="list-style-type: none"> <li>• Black oak</li> <li>• Natural oak</li> </ul>	<ul style="list-style-type: none"> <li>No cost</li> <li>No cost</li> </ul>	<ul style="list-style-type: none"> <li>Specify with <i>black oak</i>.</li> <li>Specify with <i>natural oak</i>.</li> </ul>

Specification Information					
Style Number	Dimensions			Weight	U.S. Price
	D	W	H		
IAM61	12.99"	12.99"	17.71"	24.25	\$1801

 **For Canadian Pricing**  
 Multiply U.S. Price by the Canadian price factor.  
 ▶ See page 1 for details.

# Cugino Soft Stool

Cugino soft is a stool/table made from pine wood with a FORBO Desktop® Linoleum.

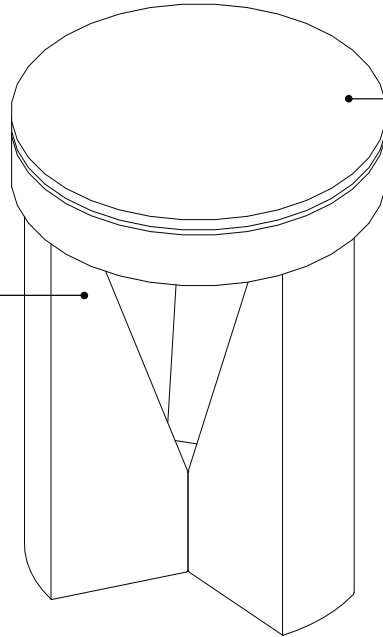

FORBO Desktop® Linoleum offered in multiple finish options.

Pine wood frame

## Product Details

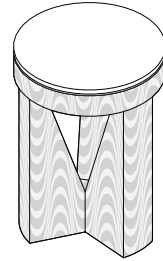

Light weight spruce wood.

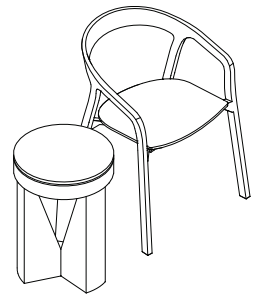

Can be used as a stool or a side table.

## Surface Materials

► See *Coalesse Surface Materials Reference Guide* for further information.

**Frame**  
• Wood

## Actual Dimensions

Depth	12.99"
Width	12.99"
Height	17.71"

# Cugino Soft Stool

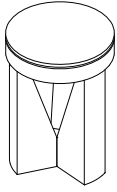

Standard Includes		Required to Specify
<ul style="list-style-type: none"> <li>▶ Need help? Product details, page 368</li> </ul>	<ul style="list-style-type: none"> <li>• Frame: Pine</li> <li>• Legal wood cutting</li> </ul>	Style number ▶ See <i>Coalesse Surface Materials Reference Guide</i> .

	Options	U.S. Price	Required to Specify
<b>Surface Materials</b>	<ul style="list-style-type: none"> <li>• Natural pine</li> <li>• Burgundy laminate</li> <li>• Pistachio laminate</li> <li>• Powder laminate</li> <li>• Orange blast laminate</li> </ul>	No cost No cost No cost No cost No cost	Select <i>natural pine</i> color number. Select <i>burgundy laminate</i> color number. Select <i>pistachio laminate</i> color number. Select <i>powder laminate</i> color number. Select <i>orange blast laminate</i> color number.

Specification Information					
Style Number	Dimensions			Weight	U.S. Price
	D	W	H		
IAM61SOFT	12.99"	12.99"	17.71"	24.25	\$970

**For Canadian Pricing**  
 Multiply U.S. Price by the Canadian price factor.  
 ▶ See page 1 for details.

# Enea Café Wood Stools

DESIGN JOSEP LLUSCA

The warm, modern design of the Enea café wood stool makes a statement with a residential design character. The Enea café wood stool is available in two heights (counter or bar) and has solid wood oak legs.

*Tip: This product line is a collection and will be found in multiple locations in this specification guide and/or Coalesse Tables, Storage, and Accessories Specification Guide.*

► See Collections, page 5.

Seat is available in molded polypropylene, wood, or upholstery.

Casting under the seat is offered in textured paints.

Wood legs are solid wood oak, with a natural finish.

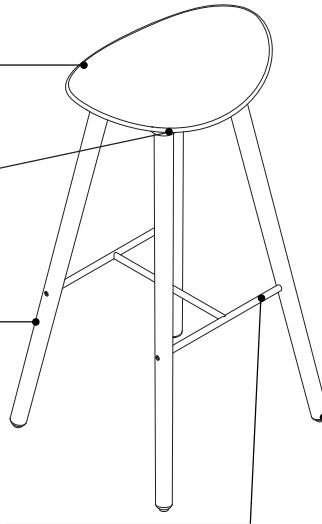

Footring in trivalent chrome is standard on all wood leg stools.

Glides are non-adjustable and available in black polyethylene, for superior durability on carpeted and hard floors.

Enea collection features bar and café stools, guest seating, café tables, and occasional tables.

► For guest seating, see page 328.

► For tables, see *Coalesse Tables, Storage, and Accessories Specification Guide*.

## Surface Materials

► See *Coalesse Surface Materials Reference Guide* for further information.

### Seat

- Polypropylene
- Rift-cut oak plywood
- Fabric or leather upholstery

### Frame/legs

- Solid oak

## Programs & Services

Customer's Own Material/Leather (COM/COL) Program is available.

► See *Coalesse Surface Materials Reference Guide* for additional information.

Coalesse

# Enea Café Wood Stools

DESIGN JOSEP LLUSCA

# Enea Café Wood Stools

DESIGN JOSEP LLUSCA

*Tip: Recommended leathers are Elmosoft group 1 and Elmorustical group 2.*

*Tip: Special color match, consult Customer Service.*

*Tip: For Customer's Own Material or Leather, see necessary requirements, important processing instructions, and ordering information*  
 ▶ See Coalesse Surface Materials Reference Guide.

Standard Includes	Required to Specify
▶ Need help? Product details, page 372 • Legs: solid oak with natural finish • Footring: 9201 Polished Trivalent Chrome • Seat and seat casting: – Polypropylene seat with matching textured paint on seat casting, if selected – V3AK Rift-Cut Oak veneer plywood seat with 4062 Anthracite Grey textured paint on seat casting, if selected – Upholstered seat with textured paint on seat casting, if selected • Glides, non-adjustable: black plastic	1 Style number 2 Plastic color number for polypropylene seat, if selected 3 Fabric or leather color number for upholstered seat, if selected 4 Paint color number for seat casting, if upholstered seat selected: 4062 Anthracite Grey 7207 Black 7241 Arctic White 5 Options, if selected (see below) ▶ See Coalesse Surface Materials Reference Guide.

Options	U.S. Price	Required to Specify
<b>Surface Materials</b> • Acrylic backer • Backer	+\$4	Specify with acrylic backer. ▶ See Coalesse Surface Materials Reference Guide.
<b>Related Products</b> • Café tables • Occasional tables • Guest seating		▶ See Coalesse Tables, Storage, and Accessories Specification Guide. ▶ See Coalesse Tables, Storage, and Accessories Specification Guide. ▶ Pages 328–334

## Specification Information

Style Number	U.S. Base Prices										Leather Groups:		Wood	Polypropylene	
	Fabric Groups:										COL				
	COM	1	2	3	4	5	6	7	8	9	10	1	2		



Overall: 14½"D 16½"W 27½"H  
 Seat: 25¾"H

## Café Wood Counter-Height Stool with Upholstered Seat

COH352W27	\$1266	\$1266	\$1299	\$1325	\$1358	\$1405	\$1465	\$1534	\$1606	\$1670	\$1739	\$1562	\$1803	\$1856	N.A.	N.A.
-----------	--------	--------	--------	--------	--------	--------	--------	--------	--------	--------	--------	--------	--------	--------	------	------



Overall: 15¾"D 16½"W 31⅓"H  
 Seat: 29¾"H

## Café Wood Bar-Height Stool with Upholstered Seat

COH352W31	\$1344	\$1344	\$1377	\$1403	\$1436	\$1483	\$1543	\$1612	\$1684	\$1748	\$1817	\$1640	\$1881	\$1934	N.A.	N.A.
-----------	--------	--------	--------	--------	--------	--------	--------	--------	--------	--------	--------	--------	--------	--------	------	------

▶ Specification Information, continued on next page



**For Canadian Pricing**  
 Multiply U.S. Price by the Canadian price factor.  
 ▶ See page 1 for details.

# Enea Café Wood Stools

DESIGN JOSEP LLUSCA

► Specification Information, continued from previous page

Specification Information																
Style Number	U.S. Base Prices										Leather Groups:		Wood	Polypropylene		
	Fabric Groups:										COL	1			2	
	COM	1	2	3	4	5	6	7	8	9	10					



Overall: 14½"D 16½"W 27½"H  
Seat: 25¾"H

## Café Wood Counter-Height Stools

Wood Seat																
COH350W27	\$1205	N.A.	N.A.	N.A.	N.A.	N.A.	N.A.	N.A.	N.A.	N.A.	N.A.	N.A.	N.A.	N.A.	N.A.	N.A.
Polypropylene Seat																
COH353W27	N.A.	N.A.	N.A.	N.A.	N.A.	N.A.	N.A.	N.A.	N.A.	N.A.	N.A.	N.A.	N.A.	N.A.	N.A.	\$1000



Overall: 15¾"D 16½"W 31½"H  
Seat: 29¾"H

## Café Wood Bar-Height Stools

Wood Seat																
COH350W31	\$1284	N.A.	N.A.	N.A.	N.A.	N.A.	N.A.	N.A.	N.A.	N.A.	N.A.	N.A.	N.A.	N.A.	N.A.	N.A.
Polypropylene Seat																
COH353W31	N.A.	N.A.	N.A.	N.A.	N.A.	N.A.	N.A.	N.A.	N.A.	N.A.	N.A.	N.A.	N.A.	N.A.	N.A.	\$1077

 **For Canadian Pricing**  
Multiply U.S. Price by the  
Canadian price factor.  
► See page 1 for details.

# Enea Lottus Post Stools Post Base

DESIGN LIEVORE ALTHERR MOLINA

Enea Lottus is a flexible, multi-height collection of seating and tables that integrates simply and cleanly with any space. Sculpted for comfort with just the right flex, the elegant shell of the Lottus stool can be used alone or customized with a colored insert or upholstered cushion.

*Tip: This product line is a collection and will be found in multiple locations in this specification guide and/or Coalesse Tables, Storage, and Accessories Specification Guide.*

► See Collections, page 5.

Post stool is available in counter height or bar height.

Seat and backrest is one-piece, injection-molded polypropylene construction with rounded edges for comfort.

Base and frame are constructed of steel. Standard in powder coat paint.

Post base allows seat to freely swivel 360°. Base is a steel plate with four plastic glides.

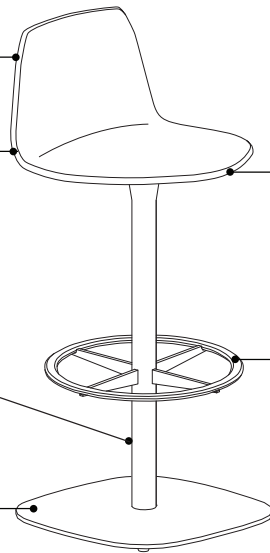

Seat insert is available in polypropylene or upholstered insert. Polypropylene insert is flush with seat and attached. Upholstered insert is 1/2" thick foam pad and attached.

Tubular steel foot ring is fixed at 9" from the floor.

**Enea Lottus collection** features post and sled base stools, guest seating, café tables, and occasional tables.  
 ► For guest seating, see page 328.  
 ► For tables, see *Coalesse Tables, Storage, and Accessories Specification Guide*.

## Surface Materials

► See *Coalesse Surface Materials Reference Guide* for further information.

### Shell

- Polypropylene

### Shell insert (optional)

- Polypropylene
- Upholstery

### Base and frame

- Paint

### Footring

- Paint to match the base and frame
- Polished trivalent chrome (optional)

## Programs & Services

**Customer's Own Material/Leather (COM/COL) Program** is available.

► See *Coalesse Surface Materials Reference Guide* for additional information.

Coalesse

# Enea Lottus Post Stools

Post Base

DESIGN LIEVORE ALTHERR MOLINA

# Enea Lottus Post Stools Post Base

DESIGN LIEVORE ALTHERR MOLINA

*Tip: Post stool seat swivels.*

*Tip: For Customer's Own Material or Leather, see necessary requirements, important processing instructions, and ordering information*

▶ See *Coalesse Surface Materials Reference Guide*.

*Tip: CAL133 for polypropylene and fire code seating are available as a special quote. Polypropylene color will change slightly when FR treatment is applied. Contact Customer Service for availability and pricing. Minimum quantity will apply.*

	Standard Includes	Required to Specify
--	-------------------	---------------------

▶ Need help? Product details, page 376	<ul style="list-style-type: none"> <li>Base and frame constructed of painted steel tubing</li> <li>Seat and back: polypropylene</li> <li>Insert, if selected: polypropylene or upholstery</li> <li>Foot ring: paint to match the base and frame</li> </ul>	1 Style number 2 Plastic color number for seat and back 3 Fabric or leather color number for upholstery insert, if selected 4 Paint color number for base and frame 5 Options, if selected (see below) ▶ See <i>Coalesse Surface Materials Reference Guide</i> .
--	--	---

	Options	U.S. Price	Required to Specify
--	---------	------------	---------------------

<b>Surface Materials</b>	<b>Base</b> <ul style="list-style-type: none"> <li>Group 1 paint</li> <li>Group 3 paint</li> </ul>	No cost +\$157	Specify paint color number. Specify paint color number.
	<b>Acrylic backer</b> <ul style="list-style-type: none"> <li>Chair with upholstered insert</li> </ul>	+\$ 7	Specify with acrylic backer. ▶ See <i>Coalesse Surface Materials Reference Guide</i> .
	<ul style="list-style-type: none"> <li>Polished trivalent chrome ring</li> </ul>	+\$100	Specify with trivalent chrome ring.
<b>Related Products</b>	<ul style="list-style-type: none"> <li>Café tables</li> <li>Occasional tables</li> <li>Guest seating</li> </ul>		▶ See <i>Coalesse Tables, Storage, and Accessories Specification Guide</i> . ▶ See <i>Coalesse Tables, Storage, and Accessories Specification Guide</i> . ▶ Pages 330-333

### Specification Information

Style Number	U.S. Base Prices										Leather Groups:		Poly-propylene	
	Fabric Groups:													
	COM	1	2	3	4	5	6	7	8	9	10	COL	1	2

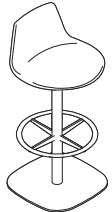

Overall: 19¾"D 19¾"W 34½"H  
 Seat: 26¼"H  
 Seat Depth: 13⅞"D

### Post Base Counter-Height Stool with No Insert

COEL700	\$1591	N.A.	N.A.	N.A.	N.A.	N.A.	N.A.	N.A.	N.A.	N.A.	N.A.	N.A.	N.A.	N.A.	N.A.
---------	--------	------	------	------	------	------	------	------	------	------	------	------	------	------	------

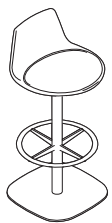

Overall: 19¾"D 19¾"W 34½"H  
 Seat: 26¼"H  
 Seat Depth: 13⅞"D

### Post Base Counter-Height Stool with Polypropylene Insert

COEL700INSERT	N.A.	N.A.	N.A.	N.A.	N.A.	N.A.	N.A.	N.A.	N.A.	N.A.	N.A.	N.A.	N.A.	N.A.	N.A.	\$1635
---------------	------	------	------	------	------	------	------	------	------	------	------	------	------	------	------	--------

▶ Specification Information, continued on next page

# Enea Lottus Post Stools Post Base

DESIGN LIEVORE ALTHERR MOLINA

► Specification Information, continued from previous page

**Specification Information**

Style Number	U.S. Base Prices										Leather Groups:		Polypropylene	
	Fabric Groups:										COL	1		2
	COM	1	2	3	4	5	6	7	8	9	10			

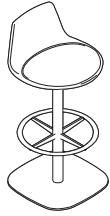

Overall: 19¾"D 19¾"W 34½"H  
 Seat: 26¼"H  
 Seat Depth: 13⅞"D

## Post Base Counter-Height Stool with Upholstered Insert

COEL700UPH	\$1824	\$1824	\$1849	\$1869	\$1895	\$1932	\$1977	\$2030	\$2086	\$2134	\$2187	\$2266	\$2212	\$2260	N.A.
------------	--------	--------	--------	--------	--------	--------	--------	--------	--------	--------	--------	--------	--------	--------	------

COM/yds = ¾, COL/sq ft = 15

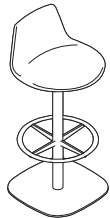

Overall: 19¾"D 19¾"W 38½"H  
 Seat: 30"H  
 Seat Depth: 13⅞"D

## Post Base Bar-Height Stool with No Insert

COEL600	\$1609	N.A.	N.A.	N.A.	N.A.	N.A.	N.A.	N.A.	N.A.	N.A.	N.A.	N.A.	N.A.	N.A.	N.A.
---------	--------	------	------	------	------	------	------	------	------	------	------	------	------	------	------

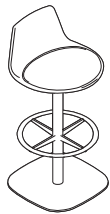

Overall: 19¾"D 19¾"W 38½"H  
 Seat: 30"H  
 Seat Depth: 13⅞"D

## Post Base Bar-Height Stool with Polypropylene Insert

COEL600INSERT	N.A.	N.A.	N.A.	N.A.	N.A.	N.A.	N.A.	N.A.	N.A.	N.A.	N.A.	N.A.	N.A.	N.A.	\$1654
---------------	------	------	------	------	------	------	------	------	------	------	------	------	------	------	--------

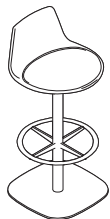

Overall: 19¾"D 19¾"W 38½"H  
 Seat: 30"H  
 Seat Depth: 13⅞"D

## Post Base Bar-Height Stool with Upholstered Insert

COEL600UPH	\$1843	\$1843	\$1868	\$1888	\$1914	\$1951	\$1996	\$2049	\$2105	\$2153	\$2206	\$2285	\$2231	\$2279	N.A.
------------	--------	--------	--------	--------	--------	--------	--------	--------	--------	--------	--------	--------	--------	--------	------

COM/yds = ¾, COL/sq ft = 15

# Enea Lottus Sled Stools Sled Base

DESIGN LIEVORE ALTHERR MOLINA

Enea Lottus is a flexible, multi-height collection of seating and tables that integrates simply and cleanly with any space. Sculpted for comfort with just the right flex, the elegant shell of the Lottus stool can be used alone or customized with a colored insert or upholstered cushion.

*Tip: This product line is a collection and will be found in multiple locations in this specification guide and/or Coalesse Tables, Storage, and Accessories Specification Guide.*

▶ See Collections, page 5.

Sled stool is available in counter height or bar height.

Seat and backrest is one-piece, injection-molded polypropylene construction with rounded edges for optimal comfort.

Frame is constructed of steel tubing. Standard in powder coat paint.



Seat insert is available in polypropylene or upholstered insert. Polypropylene insert is flush with seat and attached. Upholstered insert is 1/2" thick foam pad and attached.

Sled base features a steel, tubular, integrated footrest, located 13" from the floor.

**Enea Lottus collection** features post and sled base stools, guest seating, café tables, and occasional tables.  
▶ For guest seating, see page 328.  
▶ For tables, see *Coalesse Tables, Storage, and Accessories Specification Guide*.

## Surface Materials

▶ See *Coalesse Surface Materials Reference Guide* for further information.

### Shell

- Polypropylene

### Shell insert (optional)

- Polypropylene
- Upholstery

### Base and frame

- Paint

## Programs & Services

**Customer's Own Material/Leather (COM/COL) Program** is available.

▶ See *Coalesse Surface Materials Reference Guide* for additional information.

Coalesse

# Enea Lottus Sled Stools Sled Base

DESIGN LIEVORE ALTHERR MOLINA

# Enea Lottus Sled Stools Sled Base

DESIGN LIEVORE ALTHERR MOLINA

*Tip: For Customer's Own Material or Leather, see necessary requirements, important processing instructions, and ordering information*  
 ▶ See *Coalesse Surface Materials Reference Guide*.

*Tip: CAL133 for polypropylene and fire code seating are available as a special quote. Polypropylene color will change slightly when FR treatment is applied. Contact Customer Service for availability and pricing. Minimum quantity will apply.*

*Tip: If base and frame are specified in a white, platinum, or champagne finish, glides will be white. For all other base and frame colors, glides will be black.*

## Standard Includes Required to Specify

- |  |  |   |
|--|--|---|
| ▶ Need help? Product details, page 380 | <ul style="list-style-type: none"> <li>• Base and frame constructed of painted steel tubing</li> <li>• Seat and back: polypropylene</li> <li>• Insert, if selected: polypropylene or upholstery</li> </ul> | 1 Style number<br>2 Plastic color number for seat and back<br>3 Fabric or leather color number for upholstery insert, if selected<br>4 Paint color number for base and frame<br>5 Options, if selected (see below)<br>▶ See <i>Coalesse Surface Materials Reference Guide</i> . |
|--|--|---|

## Options U.S. Price Required to Specify

Options	U.S. Price	Required to Specify
<b>Surface Materials</b> <b>Base</b> <ul style="list-style-type: none"> <li>• Group 1 paint</li> <li>• Group 3 paint</li> </ul>	No cost +\$114	Specify paint color number. Specify paint color number.
<b>Acrylic backer</b> <ul style="list-style-type: none"> <li>• Backer for chair with upholstered insert</li> </ul>	+\$ 7	Specify with acrylic backer. ▶ See <i>Coalesse Surface Materials Reference Guide</i> .
<b>Related Products</b> <ul style="list-style-type: none"> <li>• Café tables</li> <li>• Occasional tables</li> <li>• Guest seating</li> </ul>		▶ See <i>Coalesse Tables, Storage, and Accessories Specification Guide</i> . ▶ See <i>Coalesse Tables, Storage, and Accessories Specification Guide</i> . ▶ Pages 330–333

## Specification Information

Style Number	U.S. Base Prices										Leather Groups:		Polypropylene	
	Fabric Groups:										COL	1		2
	COM	1	2	3	4	5	6	7	8	9	10			



Overall: 18"D 18¼"W 34½"H  
 Seat: 26¼"H  
 Seat Depth: 137⁄9"D

## Sled Base Counter-Height Stool with No Insert

COEL500	\$824	N.A.	N.A.	N.A.	N.A.	N.A.	N.A.	N.A.	N.A.	N.A.	N.A.	N.A.	N.A.	N.A.	N.A.
---------	-------	------	------	------	------	------	------	------	------	------	------	------	------	------	------



Overall: 18"D 18¼"W 34½"H  
 Seat: 26¼"H  
 Seat Depth: 137⁄9"D

## Sled Base Counter-Height Stool with Polypropylene Insert

COEL500INSERT	N.A.	N.A.	N.A.	N.A.	N.A.	N.A.	N.A.	N.A.	N.A.	N.A.	N.A.	N.A.	N.A.	N.A.	\$871
---------------	------	------	------	------	------	------	------	------	------	------	------	------	------	------	-------

▶ Specification Information, continued on next page



**For Canadian Pricing**  
 Multiply U.S. Price by the Canadian price factor.  
 ▶ See page 1 for details.

# Enea Lottus Sled Stools Sled Base

DESIGN LIEVORE ALTHERR MOLINA

► Specification Information, continued from previous page

## Specification Information

Style Number	U.S. Base Prices										Leather Groups:		Polypropylene	
	Fabric Groups:										COL	1		2
	COM	1	2	3	4	5	6	7	8	9	10			



Overall: 18"D 18 1/4"W 34 1/2"H  
 Seat: 26 1/4"H  
 Seat Depth: 13 7/8"D

### Sled Base Counter-Height Stool with Upholstered Insert

COEL500UPH	\$1058	\$1058	\$1083	\$1103	\$1129	\$1166	\$1211	\$1264	\$1320	\$1368	\$1421	\$1500	\$1446	\$1494	N.A.
------------	--------	--------	--------	--------	--------	--------	--------	--------	--------	--------	--------	--------	--------	--------	------

COM/yds = 3/4, COL/sq ft = 15



Overall: 18"D 18 1/4"W 38 1/2"H  
 Seat: 30"H  
 Seat Depth: 13 7/8"D

### Sled Base Bar-Height Stool with No Insert

COEL400	\$ 905	N.A.	N.A.	N.A.	N.A.	N.A.	N.A.	N.A.	N.A.	N.A.	N.A.	N.A.	N.A.	N.A.	N.A.
---------	--------	------	------	------	------	------	------	------	------	------	------	------	------	------	------



Overall: 18"D 18 1/4"W 38 1/2"H  
 Seat: 30"H  
 Seat Depth: 13 7/8"D

### Sled Base Bar-Height Stool with Polypropylene Insert

COEL400INSERT	N.A.	N.A.	N.A.	N.A.	N.A.	N.A.	N.A.	N.A.	N.A.	N.A.	N.A.	N.A.	N.A.	N.A.	\$954
---------------	------	------	------	------	------	------	------	------	------	------	------	------	------	------	-------



Overall: 18"D 18 1/4"W 38 1/2"H  
 Seat: 30"H  
 Seat Depth: 13 7/8"D

### Sled Base Bar-Height Stool with Upholstered Insert

COEL400UPH	\$1142	\$1142	\$1167	\$1187	\$1213	\$1250	\$1295	\$1348	\$1404	\$1452	\$1505	\$1584	\$1530	\$1578	N.A.
------------	--------	--------	--------	--------	--------	--------	--------	--------	--------	--------	--------	--------	--------	--------	------

COM/yds = 3/4, COL/sq ft = 15

# Enea Altzo943 Stools

DESIGN: ESTUDI MANEL MOLINA DESIGN ORIGIN: SPAIN

**Enea Altzo943 seating collection** brings residential warmth and soul to the workplace. Answering the demand for mixed materials, Altzo943 combines a precision-molded seat shell with solid oak legs. The special oval profile of the legs follows the pure curvature of the shell for a complete, harmonious design statement.  
*Tip: This product line is part of a collection and will be found in multiple locations in this specification guide.*  
 ▶ See Collections, page 5.

**Seat and back** is polypropylene with a slight flex and rounded edges for optimal comfort; available in 12 colors.

**Wood legs** are solid wood oak; available in six finishes.

**Glides** are polyethylene for superior durability on carpeted and hard floors.

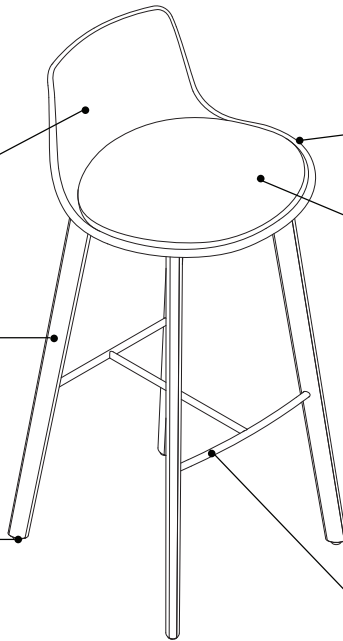

**Casting under the seat** is painted in textured finishes to match polypropylene seat shell.

**Upholstered seat cushion insert** is available and is 1/2" thick.

**Footring in trivalent chrome** comes standard.

## Product Details



Altzo943 stools are available in two heights (to the seat): counter height (26"H) and bar height (30"H).

**Upholstered seat cushion insert** is available.

## Surface Materials

▶ See *Coalesse Surface Materials Reference Guide* for further information.

**Seat and back**

- Polypropylene

**Seat casting**

- Paint

**Legs**

- Solid oak

**Upholstery (seat)**

- Fabric
- Leather

## Program and Services

**Customer's Own Material/Leather (COM/COL) Program** is available.

▶ See *Coalesse Surface Materials Reference Guide* for additional information.

Coalesse

# Enea Altzo943 Stools

DESIGN: ESTUDI MANEL MOLINA DESIGN ORIGIN: SPAIN

# Enea Altzo943 Stools

DESIGN: ESTUDI MANEL MOLINA DESIGN ORIGIN: SPAIN

Standard Includes		Required to Specify
<ul style="list-style-type: none"> <li>▶ Need help? Product details, page 384</li> </ul>	<ul style="list-style-type: none"> <li>• Legs: solid oak</li> <li>• Footring: 9201 Polished Trivalent Chrome</li> <li>• Seat and seat casting:                             <ul style="list-style-type: none"> <li>- Polypropylene seat with matching textured paint on seat casting</li> </ul> </li> <li>• Seat cushion insert, if selected: upholstery</li> <li>• Glides, non-adjustable</li> </ul>	<ol style="list-style-type: none"> <li>1 Style number</li> <li>2 Plastic color number for polypropylene seat</li> <li>3 Fabric or leather color number for upholstered seat cushion insert, if selected</li> <li>4 Wood finish for legs:                             <ul style="list-style-type: none"> <li>- V3AK Natural Oak</li> <li>- VP01 Light Oak</li> <li>- VP02 Smoke Oak</li> <li>- VP03 Black Oak</li> <li>- VP04 Grey Oak</li> <li>- VP05 White Oak</li> </ul> </li> <li>5 Options, if selected (see below)</li> </ol> <p>▶ See <i>Coalesse Surface Materials Reference Guide</i>.</p>

*Tip: For Customer's Own Material or Leather, see necessary requirements, important processing instructions, and ordering information.*  
▶ See *Coalesse Surface Materials Reference Guide*.

Options	U.S. Price	Required to Specify
<b>Surface Materials</b> <ul style="list-style-type: none"> <li>• <b>Legs</b> <ul style="list-style-type: none"> <li>• Group 1 wood veneer</li> <li>• Group 2 wood veneer</li> </ul> </li> </ul>	<p>No cost</p> <p>+\$89</p>	<p>Specify with V3AK Natural Oak, VP01 Oak Light, VP03 Black Oak, or VP05 White Oak. Specify with VP02 Smoked Oak or VP04 Grey Oak.</p>
<ul style="list-style-type: none"> <li>• <b>Acrylic backer</b> <ul style="list-style-type: none"> <li>• Stool with upholstered seat cushion insert</li> </ul> </li> </ul>	<p>+\$ 7</p>	<p>Specify with acrylic backer. ▶ See <i>Coalesse Surface Materials Reference Guide</i>.</p>
<b>Related Products</b> <ul style="list-style-type: none"> <li>• Altzo943 chairs</li> <li>• Lottus café tables</li> <li>• Lottus occasional tables</li> </ul>		<p>▶ Page 335 ▶ See <i>Coalesse Tables, Storage, and Accessories Specification Guide</i>. ▶ See <i>Coalesse Tables, Storage, and Accessories Specification Guide</i>.</p>

## Specification Information

Style Number	U.S. Base Prices										Leather Groups:		Polypropylene	
	Fabric Groups:										COL	1		2
	COM	1	2	3	4	5	6	7	8	9	10			

## Counter-Height Stool



Overall: 18"D 18¼"W 34½"H  
Seat: 26¼"H  
Seat Depth: 13⅞"D

### Polypropylene Seat and Back

COALT400	N.A.	N.A.	N.A.	N.A.	N.A.	N.A.	N.A.	N.A.	N.A.	N.A.	N.A.	N.A.	N.A.	N.A.	N.A.	\$1183
----------	------	------	------	------	------	------	------	------	------	------	------	------	------	------	------	--------



Overall: 18"D 18¼"W 34½"H  
Seat: 26¼"H  
Seat Depth: 13⅞"D

### Polypropylene Seat and Upholstered Seat Cushion Insert

COALT400UPH	\$1361	\$1361	\$1393	\$1418	\$1449	\$1495	\$1552	\$1617	\$1687	\$1748	\$1814	\$1763	\$1730	\$1773	N.A.
-------------	--------	--------	--------	--------	--------	--------	--------	--------	--------	--------	--------	--------	--------	--------	------

▶ Specification Information, continued on next page

# Enea Altzo943 Stools

DESIGN: ESTUDI MANEL MOLINA DESIGN ORIGIN: SPAIN

► Specification Information, continued from previous page

## Specification Information

Style Number	U.S. Base Prices										Leather Groups:		Polypropylene	
	Fabric Groups:										COL	1		2
	COM	1	2	3	4	5	6	7	8	9	10			

### Bar-Height Stool



Overall: 18"D 18¼"W 38½"H  
 Seat: 30"H  
 Seat Depth: 13⅞"D

#### Polypropylene Seat and Back

COALT500	N.A.	N.A.	N.A.	N.A.	N.A.	N.A.	N.A.	N.A.	N.A.	N.A.	N.A.	N.A.	N.A.	N.A.	\$1253
----------	------	------	------	------	------	------	------	------	------	------	------	------	------	------	--------



Overall: 18"D 18¼"W 38½"H  
 Seat: 30"H  
 Seat Depth: 13⅞"D

#### Polypropylene Seat and Upholstered Seat Cushion Insert

COALT500UPH	\$1431	\$1431	\$1463	\$1488	\$1519	\$1565	\$1622	\$1687	\$1757	\$1818	\$1884	\$1833	\$1800	\$1844	N.A.
-------------	--------	--------	--------	--------	--------	--------	--------	--------	--------	--------	--------	--------	--------	--------	------

 **For Canadian Pricing**  
 Multiply U.S. Price by the Canadian price factor.  
 ► See page 1 for details.

# LessThanFive Stool

DESIGN MICHAEL YOUNG

The **LessThanFive** stool is handcrafted from carbon fiber, making it exceptionally light and strong.

**Lightweight**, weighing less than five pounds.

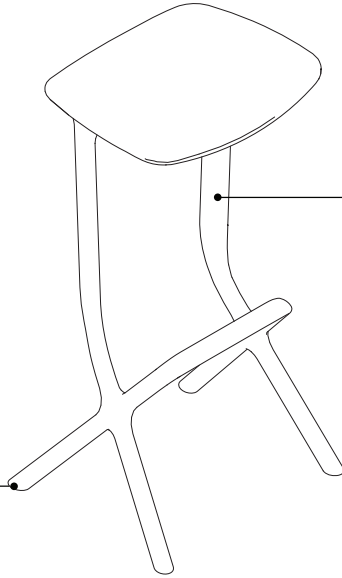

**Glides** are soft felt.

**Frame** is constructed entirely of carbon fiber, and comes in several standard finishes. Customization options are also available.

## Surface Materials

► See *Coalesse Surface Materials Reference Guide* for further information.

**Frame**  
• Paint

*Tip: Consult the Coalesse concierge team for customization options.*

# LessThanFive Stool

DESIGN MICHAEL YOUNG



Overall: 13½"D 16"W 31"H

Standard Includes		Required to Specify
<ul style="list-style-type: none"> <li>▶ Need help? Product details, page 388</li> </ul>	<ul style="list-style-type: none"> <li>• Frame: constructed of carbon fiber</li> <li>• Finish: smooth paint</li> <li>• Soft felt glides</li> </ul>	<ul style="list-style-type: none"> <li>1 Style number</li> <li>2 Paint color number for frame</li> <li>3 Options, if selected (see below)</li> <li>▶ See <i>Coalesse Surface Materials Reference Guide</i>.</li> </ul>

Options	U.S. Price	Required to Specify
<b>Surface Materials</b> <ul style="list-style-type: none"> <li>• 4233 Carbon Weave</li> </ul>	+\$261	Specify with 4233 Carbon Weave.

### Specification Information

Style Number	Quantity	U.S. Base Price
--------------	----------	-----------------

### LessThanFive Stool

COLT5S	1	\$2075
--------	---	--------

 **For Canadian Pricing**  
 Multiply U.S. Price by the Canadian price factor.  
 ▶ See page 1 for details.

# Marien152 Stools Seating

DESIGN COALESSE DESIGN GROUP AND ARIK LEVY

Marien152 is a richly tailored seating experience that's inspired by the home and designed for the workday. Design personalization is built into the collection through a wide range of upholstery, color, base, and materiality choices. Thoughtful proportions and a signature cushioned back create a comfortable stool that can support work. Available in bar- or counter-height, and with a wood or metal base.

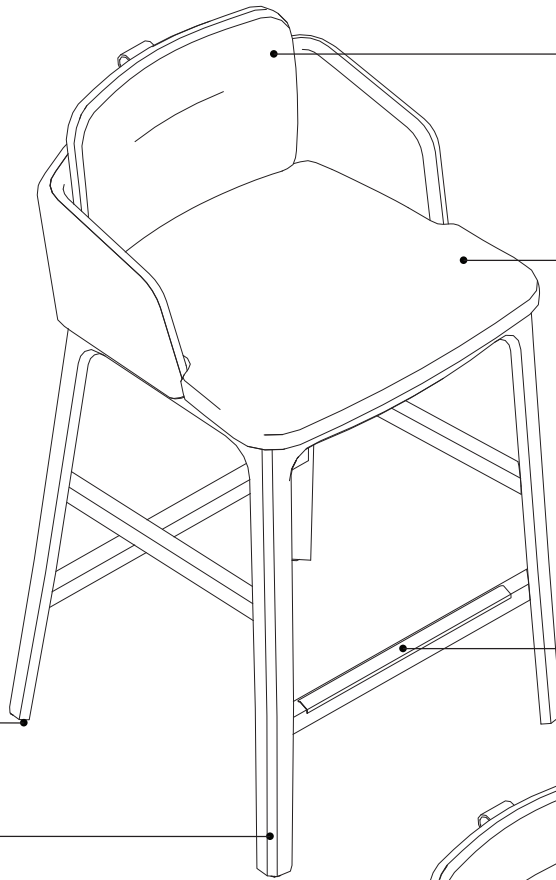

Back cushion gives the appearance of a soft, loose pillow. Intentionally relaxed upholstery on the back cushion adds to the welcoming appeal.

Contrasting fabric is available on seat, surround, and back cushion.

Footrest has protective metal top.

Black glides are available in hard and soft options.

Solid white oak frame has a chamfered edge profile.

Back cushion gives the appearance of a soft, loose pillow. Intentionally relaxed upholstery on the back cushion adds to the welcoming appeal.

Leather may be specified with a contrasting back cushion only.

Contrasting fabric is available on seat, surround, and back cushion.

Base is standard in powder coat paint and polished aluminum.

Black hard glides are standard.

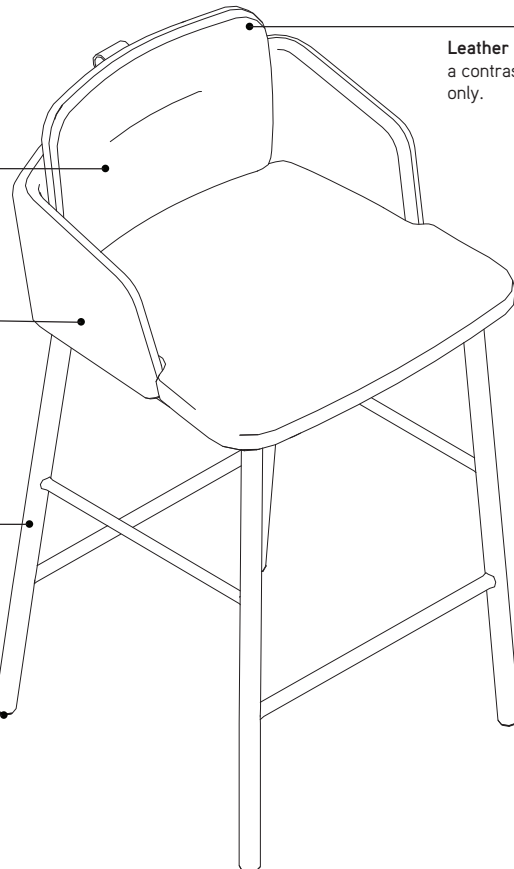

# Marien152 Stools Seating

DESIGN COALESSE DESIGN GROUP AND ARIK LEVY

## Product Details

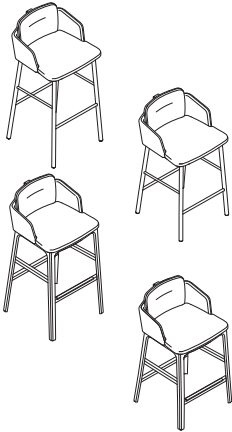

**Marien152 stools** are available in bar and counter heights.

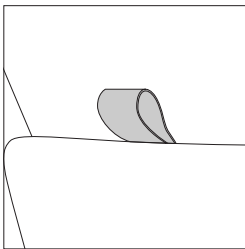

**Standard leather pull**, located behind the back cushion, allows users to easily move the chair. Leather in the color coal only. Option to specify without pull if desired.

## Surface Materials

### Upholstery

- Fabric
- Leather

### Metal base

- Paint
- Polished chrome

### Wood base

- Solid white oak wood frame

## Programs & Services

**Customer's Own Material/Leather (COM/COL) Program** is available.

► See *Coalesse Surface Materials Reference Guide* for additional information.

# Marien152 Seating Bar-Height Stool

DESIGN COALESSE DESIGN GROUP AND ARIK LEVY



Standard Includes		Required to Specify
<ul style="list-style-type: none"> <li>▶ Need help? Product details, page 390</li> </ul>	<ul style="list-style-type: none"> <li>• Seat, back cushion, and surround: upholstery</li> <li>• Leather strap: coal</li> <li>• Base: group 1 paint</li> <li>• Black hard glides</li> </ul>	<ol style="list-style-type: none"> <li>1 Style number</li> <li>2 Contrasting fabric (see below under Required Selections)</li> <li>3 Fabric or leather color number for upholstery on seat, surround, and back cushion</li> <li>4 Paint color number for base</li> <li>5 Options, if selected (see below)</li> </ol> <p>▶ See <i>Coalesse Surface Materials Reference Guide</i>.</p>

Required Selections	U.S. Price	Required to Specify
<b>Contrasting Fabric</b> <ul style="list-style-type: none"> <li>• Non contrasting fabric</li> <li>• Contrasting back cushion fabric</li> <li>• Contrasting surround fabric</li> <li>• Contrasting seat fabric</li> <li>• Contrasting all fabrics</li> </ul>	<ul style="list-style-type: none"> <li>No cost</li> <li>+\$192</li> <li>+\$192</li> <li>+\$192</li> <li>+\$192</li> </ul>	<ul style="list-style-type: none"> <li>Specify with <i>non contrasting</i>.</li> <li>Specify with <i>contrasting back cushion</i>.</li> <li>Specify with <i>contrasting surround</i>.</li> <li>Specify with <i>contrasting seat</i>.</li> <li>Specify with <i>contrasting all fabrics</i>.</li> </ul>

Options	U.S. Price	Required to Specify
<b>Surface Materials</b> <ul style="list-style-type: none"> <li>• <b>Metal base</b> <ul style="list-style-type: none"> <li>• Group 1 paint</li> <li>• Group 3 paint</li> <li>• Polished chrome</li> </ul> </li> <li>• <b>Wood base</b> <ul style="list-style-type: none"> <li>• Group 1 wood</li> <li>• Group 2 wood</li> </ul> </li> <li>• <b>Acrylic backer</b> <ul style="list-style-type: none"> <li>• Backer</li> </ul> </li> </ul>	<ul style="list-style-type: none"> <li>No cost</li> <li>+\$111</li> <li>+\$114</li> <li>No cost</li> <li>+\$ 90</li> <li>+\$ 31</li> </ul>	<ul style="list-style-type: none"> <li>Specify paint color number.</li> <li>Specify paint color number.</li> <li>Specify with <i>polished chrome</i>.</li> <li>Specify wood color number.</li> <li>Specify wood color number.</li> <li>Specify with <i>acrylic backer</i>.</li> </ul>
<b>Glide Type</b> <ul style="list-style-type: none"> <li>• <b>Bar stool wood base</b> <ul style="list-style-type: none"> <li>• Hard glides</li> <li>• Soft glides</li> </ul> </li> </ul>	<ul style="list-style-type: none"> <li>No cost</li> <li>No cost</li> </ul>	<ul style="list-style-type: none"> <li>Specify with <i>hard glides</i>.</li> <li>Specify with <i>soft glides</i>.</li> </ul>
<b>Pull</b> <ul style="list-style-type: none"> <li>• With leather pull</li> <li>• Without leather pull</li> </ul>	<ul style="list-style-type: none"> <li>No cost</li> <li>No cost</li> </ul>	<ul style="list-style-type: none"> <li>Specify with <i>pull</i>.</li> <li>Specify without <i>pull</i>.</li> </ul>
<b>Related Products</b> <ul style="list-style-type: none"> <li>• Conference seating</li> <li>• Guest seating</li> <li>• Lounge seating</li> </ul>		<ul style="list-style-type: none"> <li>▶ Page 300</li> <li>▶ Page 345</li> <li>▶ Pages 172-173</li> </ul>



**For Canadian Pricing**  
 Multiply U.S. Price by the  
 Canadian price factor.  
 ▶ See page 1 for details.

# Marien152 Seating Bar-Height Stool

DESIGN COALESSE DESIGN GROUP AND ARIK LEVY

## Specification Information

Style Number	U.S. Base Prices										Leather Groups:			
	Fabric Groups:										COL	1	2	
	COM	1	2	3	4	5	6	7	8	9	10			

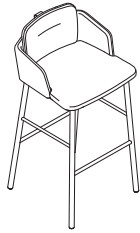

Overall: 19½"D x 19"W x 39"H  
 Inside: 16"D x 15¾"W  
 Seat: 30½"H  
 Surround: 23"H

### Bar-Height Stool Metal Base

COMARBSMB	Seat	\$1594	\$1594	\$1619	\$1639	\$1664	\$1701	\$1745	\$1797	\$1851	\$1901	\$1953	\$1708	\$1927	\$2002
	Surround	No cost	No cost	+\$ 40	+\$ 72	+\$ 111	+\$170	+\$243	+\$325	+\$413	+\$491	+\$574	+\$114	+\$376	+\$469
	Back cushion	No cost	No cost	+\$ 21	+\$ 39	+\$ 60	+\$ 92	+\$130	+\$174	+\$222	+\$264	+\$308	+\$114	+\$181	+\$223

COM/yds: Seat = 1.06, Surround = .64, Cushion = .58, COL/sq ft: Seat = 11, Surround = 12, Cushion = 6

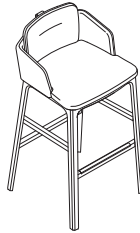

Overall: 19½"D x 19"W x 39"H  
 Inside: 16"D x 15¾"W  
 Seat: 30½"H  
 Surround: 23"H

### Bar-Height Stool Wood Base

COMARBSWB	Seat	\$2309	\$2309	\$2334	\$2354	\$2379	\$2416	\$2460	\$2512	\$2566	\$2616	\$2668	\$2423	\$2642	\$2717
	Surround	No cost	No cost	+\$ 40	+\$ 72	+\$ 111	+\$170	+\$243	+\$325	+\$413	+\$491	+\$574	+\$114	+\$376	+\$469
	Back cushion	No cost	No cost	+\$ 21	+\$ 39	+\$ 60	+\$ 92	+\$130	+\$174	+\$222	+\$264	+\$308	+\$114	+\$181	+\$223

COM/yds: Seat = 1.06, Surround = .64, Cushion = .58, COL/sq ft: Seat = 11, Surround = 12, Cushion = 6

Stools

 **For Canadian Pricing**  
 Multiply U.S. Price by the  
 Canadian price factor.  
 ▶ See page 1 for details.

# Marien152 Seating Counter-Height Stool

DESIGN COALESSE DESIGN GROUP AND ARIK LEVY



Standard Includes		Required to Specify
<ul style="list-style-type: none"> <li>▶ Need help? Product details, page 390</li> </ul>	<ul style="list-style-type: none"> <li>• Seat, back cushion, and surround: upholstery</li> <li>• Leather strap: coal</li> <li>• Base: group 1 paint</li> <li>• Black hard glides</li> </ul>	<ol style="list-style-type: none"> <li>1 Style number</li> <li>2 Contrasting fabric (see below under Required Selections)</li> <li>3 Fabric or leather color number for upholstery on seat, surround, and back cushion</li> <li>4 Paint color number for base</li> <li>5 Options, if selected (see below)</li> </ol> <ul style="list-style-type: none"> <li>▶ See <i>Coalesse Surface Materials Reference Guide</i>.</li> </ul>

Required Selections	U.S. Price	Required to Specify
<b>Contrasting Fabric</b> <ul style="list-style-type: none"> <li>• Non contrasting fabric</li> <li>• Contrasting back cushion fabric</li> <li>• Contrasting surround fabric</li> <li>• Contrasting seat fabric</li> <li>• Contrasting all fabrics</li> </ul>	<ul style="list-style-type: none"> <li>No cost</li> <li>+\$192</li> <li>+\$192</li> <li>+\$192</li> <li>+\$192</li> </ul>	<ul style="list-style-type: none"> <li>Specify with <i>non contrasting</i>.</li> <li>Specify with <i>contrasting back cushion</i>.</li> <li>Specify with <i>contrasting surround</i>.</li> <li>Specify with <i>contrasting seat</i>.</li> <li>Specify with <i>contrasting all fabrics</i>.</li> </ul>

Options	U.S. Price	Required to Specify
<b>Surface Materials</b> <ul style="list-style-type: none"> <li>• <b>Metal base</b> <ul style="list-style-type: none"> <li>• Group 1 paint</li> <li>• Group 3 paint</li> <li>• Polished chrome</li> </ul> </li> <li>• <b>Wood base</b> <ul style="list-style-type: none"> <li>• Group 1 wood</li> <li>• Group 2 wood</li> </ul> </li> <li>• <b>Acrylic backer</b> <ul style="list-style-type: none"> <li>• Backer</li> </ul> </li> </ul>	<ul style="list-style-type: none"> <li>No cost</li> <li>+\$111</li> <li>+\$114</li> <li>No cost</li> <li>+\$ 90</li> <li>+\$ 31</li> </ul>	<ul style="list-style-type: none"> <li>Specify paint color number.</li> <li>Specify paint color number.</li> <li>Specify with <i>polished chrome</i>.</li> <li>Specify wood color number.</li> <li>Specify wood color number.</li> <li>Specify with <i>acrylic backer</i>.</li> </ul>
<b>Glide Type</b> <ul style="list-style-type: none"> <li>• <b>Counter-height stool wood base</b> <ul style="list-style-type: none"> <li>• Hard glides</li> <li>• Soft glides</li> </ul> </li> </ul>	<ul style="list-style-type: none"> <li>No cost</li> <li>No cost</li> </ul>	<ul style="list-style-type: none"> <li>Specify with <i>hard glides</i>.</li> <li>Specify with <i>soft glides</i>.</li> </ul>
<b>Pull</b> <ul style="list-style-type: none"> <li>• With leather pull</li> <li>• Without leather pull</li> </ul>	<ul style="list-style-type: none"> <li>No cost</li> <li>No cost</li> </ul>	<ul style="list-style-type: none"> <li>Specify with <i>pull</i>.</li> <li>Specify <i>without pull</i>.</li> </ul>
<b>Related Products</b> <ul style="list-style-type: none"> <li>• Conference seating</li> <li>• Guest seating</li> <li>• Lounge seating</li> </ul>		<ul style="list-style-type: none"> <li>▶ Page 300</li> <li>▶ Page 345</li> <li>▶ Pages 172-173</li> </ul>



**For Canadian Pricing**  
 Multiply U.S. Price by the  
 Canadian price factor.  
 ▶ See page 1 for details.

# Marien152 Seating Counter-Height Stool

DESIGN COALESSE DESIGN GROUP AND ARIK LEVY

## Specification Information

Style Number	U.S. Base Prices														
	Fabric Groups:													Leather Groups:	
	COM	1	2	3	4	5	6	7	8	9	10	COL	1	2	



Overall: 19½"D x 19"W x 34½"H  
 Inside: 16"D x 15¾"W  
 Seat: 26½"H  
 Surround: 30½"H

### Counter-Height Stool Metal Base

COMARCSMB	Seat	\$1594	\$1594	\$1628	\$1655	\$1688	\$1739	\$1800	\$1869	\$1944	\$2011	\$2080	\$1708	\$1927	\$2002
	Surround	No cost	No cost	+\$ 21	+\$ 37	+\$ 57	+\$ 88	+\$124	+\$167	+\$212	+\$252	+\$294	+\$114	+\$376	+\$469
	Back cushion	No cost	No cost	+\$ 19	+\$ 34	+\$ 52	+\$ 79	+\$113	+\$151	+\$192	+\$228	+\$267	+\$114	+\$181	+\$223

COM/yds: Seat = 1.06, Surround = .64, Cushion = .58, COL/sq ft: Seat = 11, Surround = 12, Cushion = 6



Overall: 19½"D x 19"W x 34½"H  
 Inside: 16"D x 15¾"W  
 Seat: 26½"H  
 Surround: 30½"H

### Counter-Height Stool Wood Base

COMARCSWB	Seat	\$2309	\$2309	\$2343	\$2370	\$2403	\$2454	\$2515	\$2584	\$2659	\$2726	\$2795	\$2423	\$2642	\$2717
	Surround	No cost	No cost	+\$ 21	+\$ 37	+\$ 57	+\$ 88	+\$124	+\$167	+\$212	+\$252	+\$294	+\$114	+\$376	+\$469
	Back cushion	No cost	No cost	+\$ 19	+\$ 34	+\$ 52	+\$ 79	+\$113	+\$151	+\$192	+\$228	+\$267	+\$114	+\$181	+\$223

COM/yds: Seat = 1.06, Surround = .64, Cushion = .58, COL/sq ft: Seat = 11, Surround = 12, Cushion = 6

Stools

 **For Canadian Pricing**  
 Multiply U.S. Price by the  
 Canadian price factor.  
 ▶ See page 1 for details.

# Marien152 Stools Seating Multi-Fabric Diagram

DESIGN COALESSE DESIGN GROUP AND ARIK LEVY

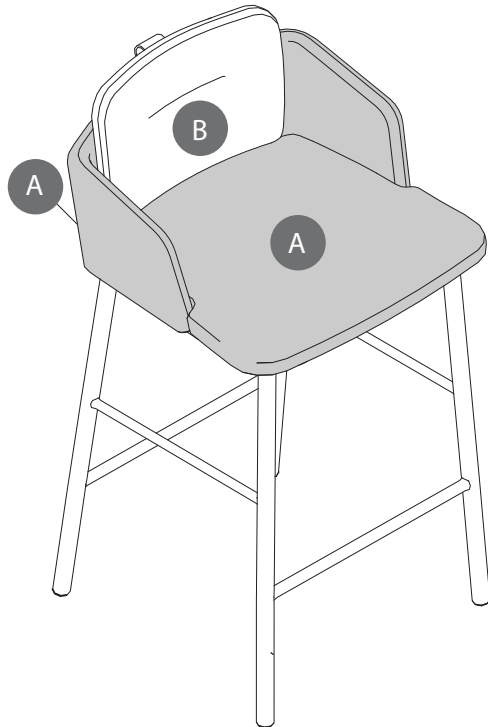
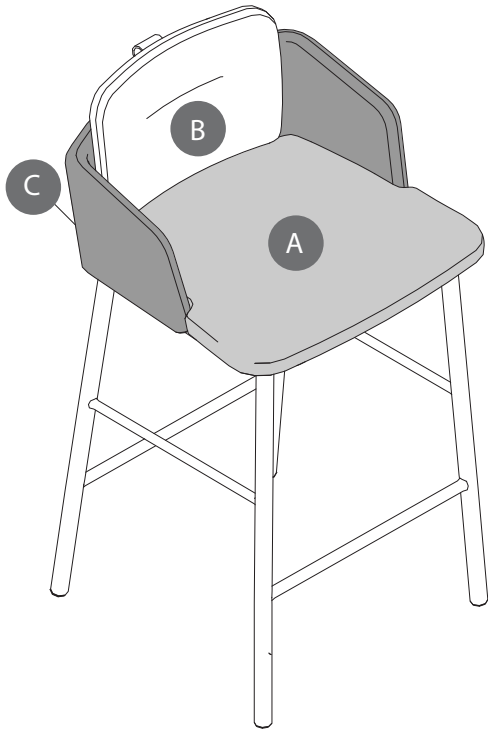

TO: \_\_\_\_\_

FROM: \_\_\_\_\_

DATE: \_\_\_\_\_

FAX...888.413.5161

### FABRIC

**A** Seat: \_\_\_\_\_

\_\_\_\_\_

**B** Back: \_\_\_\_\_

\_\_\_\_\_

**C** Surround: \_\_\_\_\_

\_\_\_\_\_

### LEATHER

**A** Seat + Surround: \_\_\_\_\_

\_\_\_\_\_

**B** Back: \_\_\_\_\_

\_\_\_\_\_

Specify Model below:

COMARBSMB Bar-Stool Metal Base

COMARBSWB Bar-Stool Wood Base

COMARCSMB Counter-Height Stool Metal Base

COMARCSWB Counter-Height Stool Wood Base

*See specifying for contrasting fabric upcharge.  
List price based on highest fabric group usage.*

# Medici Stool

Medici stool is a stool made from solid ash wood, offered in different wood finish options.

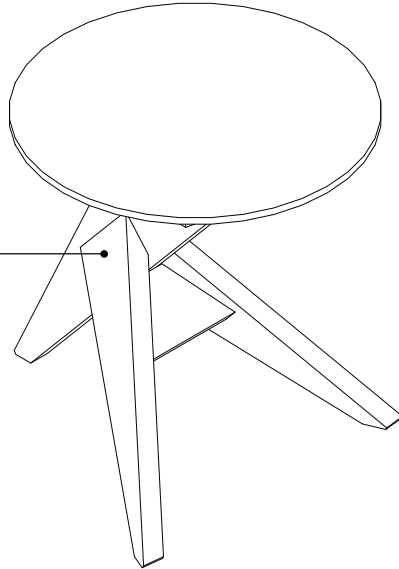

Ash wood frame

## Product Details

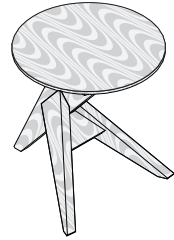

Oiled thermo-treated is available as wood option (for outdoor use).

## Surface Materials

► See *Coalesse Surface Materials Reference Guide* for further information.

### Frame

- Wood

## Actual Dimensions

Depth	29.52"
Width	26.96"
Height	31.29"

# Medici Stool

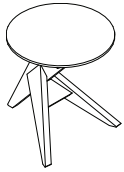

Standard Includes	Required to Specify
<ul style="list-style-type: none"> <li>▶ Need help? Product details, page 397</li> <li>• Frame: Ash</li> <li>• Legal wood cutting</li> </ul>	<ul style="list-style-type: none"> <li>Style number</li> <li>▶ See <i>Coalesse Surface Materials Reference Guide</i>.</li> </ul>

### Specification Information

Style Number	Dimensions			Weight	Finish	U.S. Price
	D	W	H			
IAM108	19.48"	23.42"	15.74"	13.22	Black ash	\$1040
IAM109	19.48"	23.42"	15.74"	13.22	Grey ash	\$1040
IAM110	19.48"	23.42"	15.74"	13.22	Natural ash	\$1040
IAM111	19.48"	23.42"	15.74"	13.22	Red ash	\$1040
IAM112	19.48"	23.42"	15.74"	13.22	Thermo oiled ash	\$1188
IAM113	19.48"	23.42"	15.74"	13.22	Yellow ash	\$1040



**For Canadian Pricing**  
 Multiply U.S. Price by the Canadian price factor.  
 ▶ See page 1 for details.

Coalesse

# Medici Stool

# Montara650 Stools

DESIGN LIEVORE ALTHERR MOLINA

Montara650 is a comprehensive collection that offers a simple, refined design that can be customized to support a range of applications, postures, and aesthetics.

*Tip: This product line is a collection and will be found in multiple locations in this specification guide and/or Coalesse Tables, Storage, and Accessories Specification Guide.*

► See Collections, page 5.

**Shell** is a durable, one-piece plywood construction with oak veneer.

**Upholstery choices** include: wood shell, wood shell with upholstered seat, or fully upholstered.

**Frame** is standard in powder coat paint. Polished trivalent chrome is also available.

**Montara650 collection** features guest seating and pedestal tables.

► For guest seating, see page 348

► For tables, see *Coalesse Tables, Storage, and Accessories Specification Guide*.

**Sled base** features an integral footrest and polyethylene glides.

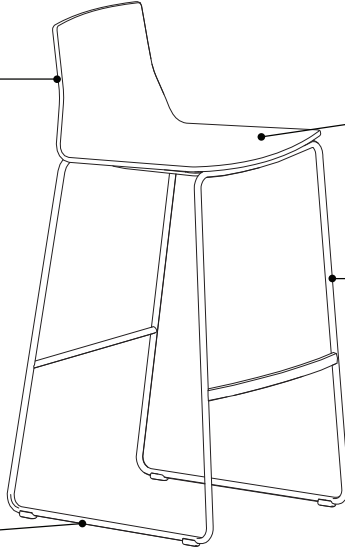

# Montara650 Stools

DESIGN LIEVORE ALTHERR MOLINA

## Product Details

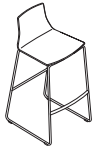

**Montara650 stools** are available in two heights (to the seat): counter height (26"H) and bar height (30"H).

## Surface Materials

► See *Coalesse Surface Materials Reference Guide* for further information.

### Upholstery

- Fabric
- Leather

### Wood shell

- Oak veneered plywood

### Frame

- Paint
- Trivalent chrome

## Programs & Services

**Customer's Own Material/Leather (COM/COL) Program** is available.

► See *Coalesse Surface Materials Reference Guide* for additional information.

# Montara650 Stools

DESIGN LIEVORE ALTHERR MOLINA

*Tip: Leathers will appear loose with comfort wrinkles when upholstered.*

*Tip: For Customer's Own Material or Leather, see necessary requirements, important processing instructions, and ordering information.*

► See *Coalesse Surface Materials Reference Guide* and online fabric database at <http://fabric.coalesse.com>.

Standard Includes	Required to Specify
<ul style="list-style-type: none"> <li>► Need help? Product details, page 400</li> <li>• Seat and back upholstery, if selected</li> <li>• Shell: wood shell or wood shell with upholstered seat, if selected: wood veneer group 1</li> <li>• Sled base: group 1 paint</li> <li>• Glides</li> </ul>	<ol style="list-style-type: none"> <li>1 Style number</li> <li>2 Application (see below under Required Selections)</li> <li>3 Upholstery version (see below under Required Selections)</li> <li>4 Contrasting fabric on fully upholstered, if selected (see below under Required Selections)</li> <li>5 Fabric and/or leather color number for seat and/or back, if selected</li> <li>6 Wood finish on shell, if selected</li> <li>7 Paint color number for base</li> <li>8 Options, if selected (see below)</li> </ol> <p>► See <i>Coalesse Surface Materials Reference Guide</i>.</p>



Stool at counter height  
Overall: 18½"W 19½"D 35½"H  
Seat: 26"H



Stool at bar height  
Overall: 18½"W 19½"D 39½"H  
Seat: 30"H

Required Selections	U.S. Price	Required to Specify
<b>Application</b> <ul style="list-style-type: none"> <li>• Counter height</li> <li>• Bar height</li> </ul>	No cost +\$ 79	Specify with counter height. Specify with bar height.
<b>Upholstery Version</b> <ul style="list-style-type: none"> <li>• Wood shell</li> <li>• Wood shell with upholstered seat</li> <li>• Fully upholstered</li> </ul>	Price at right Price at right Price at right	Specify with wood seat and back. Specify with upholstered seat and wood back. Specify with upholstered seat and back.
<b>Contrasting Fabric on Fully Upholstered</b> <ul style="list-style-type: none"> <li>• Non contrasting fabric</li> <li>• Contrasting fabric</li> </ul>	No cost +\$192	Specify with non contrasting fabric. Specify with contrasting fabric. ► See <i>Multi Fabric Diagram</i> , page 206

Options	U.S. Price	Required to Specify
<b>Surface Materials</b> <ul style="list-style-type: none"> <li><b>Base</b> <ul style="list-style-type: none"> <li>• Group 3 paint</li> <li>• Polished trivalent chrome base</li> </ul> </li> </ul>	+\$114 +\$118	Specify paint color number. Specify with polished trivalent chrome.
<ul style="list-style-type: none"> <li><b>Shell</b> <ul style="list-style-type: none"> <li>• Group 1 wood veneer</li> <li>• Group 2 wood veneer</li> </ul> </li> </ul>	No cost +\$102	Specify with VP01 Oak Light, VP03 Black Oak, or VP05 White Oak. Specify with VP02 Smoked Oak or VP04 Grey Oak.
<ul style="list-style-type: none"> <li><b>Acrylic backer</b> <ul style="list-style-type: none"> <li>• Seat</li> <li>• Seat and back</li> </ul> </li> </ul>	+\$ 9 +\$ 25	Specify with acrylic backer. Specify with acrylic backer.
<b>Related Products</b> <ul style="list-style-type: none"> <li>• Guest seating</li> <li>• Lounge seating</li> <li>• Café tables</li> <li>• Occasional tables</li> </ul>		► Page 350 ► Page 200 ► See <i>Coalesse Tables, Storage, and Accessories Specification Guide</i> . ► See <i>Coalesse Tables, Storage, and Accessories Specification Guide</i> .

 **For Canadian Pricing**  
Multiply U.S. Price by the Canadian price factor.  
► See page 1 for details.

# Montara650 Stools

DESIGN LIEVORE ALTHERR MOLINA



Stool at counter height  
 Overall: 18½"W x 19½"D x 35½"H  
 Seat: 26"H

## Specification Information

Style Number	U.S. Base Price
--------------	-----------------

### Wood Shell Stool

COSFZST	\$1186
---------	--------

## Specification Information

Style Number	U.S. Base Prices										Leather Groups:		
	Fabric Groups:										COL		
	COM	1	2	3	4	5	6	7	8	9	10	1	2

### Wood Shell Stool with Upholstered Seat

COSFZST	Seat	\$1364	\$1364	\$1369	\$1392	\$1417	\$1456	\$1503	\$1559	\$1617	\$1669	\$1724	\$1739	\$1611	\$1674
---------	------	--------	--------	--------	--------	--------	--------	--------	--------	--------	--------	--------	--------	--------	--------

COM/yds = ¾, COL/sq ft = 7

### Fully Upholstered Stool

COSFZST	Seat	\$1405	\$1405	\$1410	\$1433	\$1458	\$1497	\$1544	\$1600	\$1658	\$1710	\$1765	\$1780	\$1652	\$1715
	Back	+\$ 21	+\$ 21	+\$ 31	+\$ 55	+\$ 84	+\$129	+\$184	+\$247	+\$313	+\$372	+\$435	+\$460	+\$474	+\$580

COM/yds = 1¼, COL/sq ft = 18



**For Canadian Pricing**  
 Multiply U.S. Price by the  
 Canadian price factor.  
 ▶ See page 1 for details.

# Round Outdoor Stool

The **Round stool** is characterized by an elemental design of snug and comfortable shapes; representing a simple, contemporary design.

Metal mesh seat welded to a tubular steel frame.

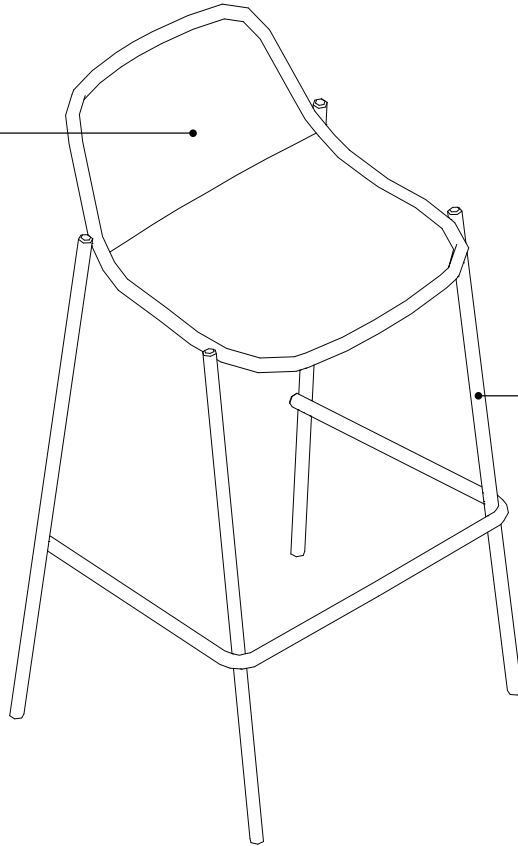

Outdoor grade powder coat paint.

## Product Details

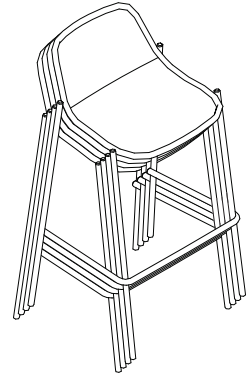

The stool can be stacked up to four units high.

## Surface Materials

► See *Coalesse Surface Materials Reference Guide* for further information.

- Frame**
- Steel

## Actual Dimensions

Depth	20.5"
Width	22.75"
Height	39.25"

# Round Outdoor Stool



*Tip: Additional powder coat paint finishes are available with an upcharge (other Emu paint finishes).*

*Tip: Stool stacks four high.*

Standard Includes	Required to Specify
-------------------	---------------------

- |  |  |  |
|--|--|--|
| <ul style="list-style-type: none"> <li>▶ Need help? Product details, page 404</li> </ul> | <ul style="list-style-type: none"> <li>• Frame: metal mesh seat, crafted using a deep drawing technique, welded to a tubular steel frame:                             <ul style="list-style-type: none"> <li>- 4251 EMU Brown</li> <li>- 4257 Antique Iron</li> <li>- 7234 EMU Black</li> <li>- 7271 EMU White</li> </ul> </li> <li>• Finish: outdoor grade powder coat paint</li> <li>• Glides: nylon</li> <li>• Design: Christophe Pillet</li> </ul> | <ul style="list-style-type: none"> <li>1 Style number</li> <li>2 Options, if selected (see below)</li> <li>▶ See <i>Coalesse Surface Materials Reference Guide</i>.</li> </ul> |
|--|--|--|

Options	U.S. Price	Required to Specify
---------	------------	---------------------

<b>Surface Materials</b>	<ul style="list-style-type: none"> <li>• Standard Emu palette color</li> <li>• Other Emu palette color</li> </ul>	<ul style="list-style-type: none"> <li>No cost</li> <li>+\$263</li> </ul>	<ul style="list-style-type: none"> <li>Specify <i>with standard Emu palette color</i> and select color number.</li> <li>Specify <i>with other Emu palette color</i> and select color number.</li> </ul>
--------------------------	---	---	---

Specification Information					
Style Number	Dimensions			Quantity	U.S. Base Price
	D	W	H		

CO2467	20.5"	22.75"	39.25"	2	\$1420
--------	-------	--------	--------	---	--------



**For Canadian Pricing**  
 Multiply U.S. Price by the Canadian price factor.  
 ▶ See page 1 for details.

# Switch Stools

DESIGN E00S

Switch stool is upholstered and offered in two heights: counter and bar. Switch stool shares the clean lines and flared back of the Switch lounge and chair.

*Tip: This product line is a collection and will be found in multiple locations in this specification guide and/or Coalesse Tables, Storage, and Accessories Specification Guide.*

► See Collections, page 5.

Switch stool is available in counter height or bar height.

**Seat and back cushions** are constructed of molded foam with comfort pockets for optimal comfort.

**Adjustable glides** are standard to accommodate uneven floors.

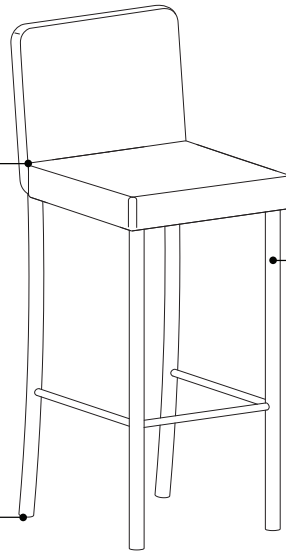

**Legs** feature four tubular steel legs with integrated steel footrests at the front and sides.

**The Switch collection** features chairs, stools, lounge seating, and occasional tables.  
► For chairs, see page 359  
► For lounge seating, see page 260  
► For tables, see *Coalesse Tables, Storage, and Accessories Specification Guide*.

## Surface Materials

► See *Coalesse Surface Materials Reference Guide* for further information.

## Upholstery

- Fabric
- Leather

## Legs

- Matte chrome
- Polished chrome

## Programs & Services

**Customer's Own Material/Leather (COM/COL) Program** is available.

► See *Coalesse Surface Materials Reference Guide* for additional information.

# Switch Stools

DESIGN E00S

*Tip: Fabrics and leathers will appear loose with comfort wrinkles when upholstered.*

*Tip: Recommended leathers are Elmosoft group 1 and Elmorustical group 2.*

*Tip: Special color match, consult Customer Service.*

*Tip: Pricing based on highest group textile specified.*

*Tip: For Customer's Own Material or Leather, see necessary requirements, important processing instructions, and ordering information*  
 ▶ See *Coalesse Surface Materials Reference Guide*.

Standard Includes		Required to Specify	
▶ Need help? Product details, page 406	<ul style="list-style-type: none"> <li>Frame: Constructed of steel tubing and bar stock</li> <li>Upholstery: back foam are molded around the frame components.</li> <li>Seat foam is molded with "comfort pockets"</li> <li>Legs: matte chrome (M) or polished chrome (PC) leg finish</li> </ul>	<ol style="list-style-type: none"> <li>Style number</li> <li>Number of fabrics if contrasting fabric style number is selected</li> <li>Fabric or leather color number for upholstery</li> <li>Options, if selected (see below)</li> </ol> ▶ See <i>Coalesse Surface Materials Reference Guide</i> .	
Options		Required to Specify	
<b>Surface Materials</b>	<ul style="list-style-type: none"> <li>Contrasting fabric</li> </ul>	+\$192 per fabric	Add suffix K to the style number and select fabric color number.
	<ul style="list-style-type: none"> <li><b>Acrylic backer</b></li> <li>Backer</li> </ul>	+\$ 13	Specify with acrylic backer. ▶ See <i>Coalesse Surface Materials Reference Guide</i> .
<b>Related Products</b>	<ul style="list-style-type: none"> <li>Lounge seating</li> <li>Guest seating</li> <li>Occasional tables</li> </ul>		▶ Page 262 ▶ Page 360 ▶ See <i>Coalesse Tables, Storage, and Accessories Specification Guide</i> .

Specification Information													
Style Number	U.S. Base Prices										Leather Groups:		
	Fabric Groups:										COL		
	COM	1	2	3	4	5	6	7	8	9	10	1	2

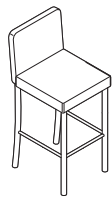

Overall: 19"D 16"W 38"H  
 Inside: 15"D 15"W 11¾"H  
 Seat: 27¾"H

## Counter-Height Stools

1404M	\$1949	\$1949	\$1988	\$2020	\$2059	\$2116	\$2187	\$2269	\$2355	\$2432	\$2513	\$2472	\$3290	\$3465
1404PC	\$1986	\$1986	\$2025	\$2057	\$2096	\$2153	\$2224	\$2306	\$2392	\$2469	\$2550	\$2509	\$3327	\$3512

COM/yds = 1¼, COL/sq ft = 23

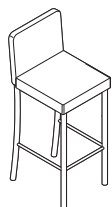

Overall: 19¾"D 16"W 41½"H  
 Inside: 15"D 15"W 11¾"H  
 Seat: 31¼"H

## Bar-Height Stools

1405M	\$2007	\$2007	\$2046	\$2078	\$2117	\$2174	\$2245	\$2327	\$2413	\$2490	\$2571	\$2525	\$3348	\$3523
1405PC	\$2064	\$2064	\$2103	\$2135	\$2174	\$2231	\$2302	\$2384	\$2470	\$2547	\$2628	\$2587	\$3405	\$3580

COM/yds = 1¼, COL/sq ft = 23



**For Canadian Pricing**  
 Multiply U.S. Price by the Canadian price factor.  
 ▶ See page 1 for details.



---

# Resources

Style Number Index

410

# Style Number Index

Style Number	Page	Description	Style Number	Page	Description
1404M	407	Switch Counter-Height Stool	45-T3730LER	57	Circa Ganging Table
1404PC	407	Switch Counter-Height Stool	45-T3730LG	57	Circa Ganging Table
1405M	407	Switch Bar-Height Stool	45-T42RD	59	Circa Freestanding Table
1405PC	407	Switch Bar-Height Stool	451-2500	50	Circa Straight Seat Chair
1810M	326	Capa Chair	451-3730FI	49	Circa 30° Inside Wedge Armless Seat
1810PC	326	Capa Chair	451-3730FO	49	Circa 30° Outside Wedge Seat
216	38	Bob Lounge Swivel Chair	451-5000	50	Circa Straight Loveseat
221	39	Bob Lounge Chair w/Headrest	451-7460FI	49	Circa 60° Inside Wedge Loveseat
221-H	39, 321	Bob Ottoman	451-7460FO	49	Circa 60° Outside Wedge Loveseat
231	321	Bob Guest Chair	451-A1800ER	52	Circa Straight Armrest
2540-1	338	Kathryn Wood with Open Back	451-A1800G	52	Circa Straight Armrest
2542-1	338	Kathryn Wood/Uph with Panel Back	451-A1815FIER	53	Circa 15° Inside Armrest
2547-1	339	Kathryn Fully Uphol Back	451-A1815FIG	53	Circa 15° Inside Armrest
2547-1RIBD	339	Kathryn Fully Uphol Back w/Ribbed uph	451-A1815FOER	54	Circa 15° Outside Armrest
385	268	Thoughtful Lounge Chair	451-A1815FOG	53	Circa 15° Outside Armrest
385-60	269	Thoughtful Small Lounge	451-A3730FIER	53	Circa 30° Inside Armrest
385-70	269	Thoughtful Medium Lounge	451-A3730FIG	53	Circa 30° Inside Armrest
385-80	269	Thoughtful Long Lounge	451-A3730FOER	54	Circa 30° Outside Armrest
385-H	269	Thoughtful Ottoman	451-A3730FOG	54	Circa 30° Outside Armrest
391	262	Switch Chair	451-B42RD	54	Circa Round Ottoman
391-2	262	Switch Two-Seat	451-B5000	51	Circa Straight Bench
391-3	263	Switch Three-Seat	451-B7460FI	50	Circa 60° Inside Wedge Bench
391-4	263	Switch Two-Seat w/Extensions	451-B7460FO	50	Circa 60° Outside Wedge Bench
391-B	263	Switch Arm Bolster	451-GANGPKG	51, 54	Circa Ganging Kit
430-B1724	228	Sidewalk Bench	460-3	30	Await Modular Three-Seat Lounge
430-B1736	228	Sidewalk Bench	460-4	30	Await Modular Four-Seat Lounge
430-B1748	228	Sidewalk Bench	460-4B	31	Await Modular Four-Seat Bench
430-H1717	227	Sidewalk Collaborative Ottoman	460-GANGPKG	32	Ganging Kit
430-H1720	227	Sidewalk Collaborative Ottoman	460-H	31	Await Modular Ottoman
430-H2026	227	Sidewalk Collaborative Ottoman	460-SE22	33	Await Lounge Table
430-H3636	229	Sidewalk Ottoman	460-SE22PD	33	Await Lounge Table
440-2WB	210	Passerelle Two-Seat Lounge	460-SE30	33	Await Lounge Table
440-3WB	211	Passerelle Three-Seat Lounge	460-SE30PD	33	Await Lounge Table
440-B	211	Passerelle Arm Bolster	460-SE44	33	Await Lounge Table
440-B2060WB	212	Passerelle Bench	460-SE44PD	33	Await Lounge Table
440-B3060WB	212	Passerelle Bench	461-1B	32	Await Connector Bench
440-WB	210	Passerelle Chair	461-2B	32	Await Connector Bench
444	222	Sidewalk Lowback Chair	461-3B	32	Await Connector Bench
444-2	223	Sidewalk Two-Seat	470	95	Coupe Lounge Chair
444M	223	Sidewalk Lowback Chair w/Tablet	476	96	Coupe Grande Chair
446	223	Sidewalk Highback Chair	476M	96	Coupe Grande Chair
446M	223	Sidewalk Mobile Highback Chair w/Tablet	490-B35HRZ	217	Ripple Bench
45-T1300H	58	Circa Freestanding Table	490-B35VRT	217	Little Ripple Wave Bench
45-T1300HER	58	Circa Ganging Table	490-B96HRZ	217	Ripple Flat Seat Bench
45-T1300HG	57	Circa Ganging Table	490-B96VRT	216	Ripple Wave Bench
45-T1300LER	57	Circa Ganging Table	795	296	Chord Conference Chair
45-T1300LG	57	Circa Ganging Table	795AU	296	Chord Conference Chair
45-T1815H	57	Circa Freestanding Table	796	297	Chord Midback Chair
45-T1815HER	56	Circa Ganging Table	796-P	297	Chord Midback Chair
45-T1815HG	56	Circa Ganging Table	796-PAU	297	Chord Midback Chair
45-T1815LER	56	Circa Ganging Table	796AU	297	Chord Midback Chair
45-T1815LG	56	Circa Ganging Table	797	297	Chord High Back Chair
45-T28HER	58	Circa Ganging Table	797AU	297	Chord Midback Chair
45-T3730HER	57	Circa Ganging Table	798	297	Chord High-Back Chair
45-T3730HG	57	Circa Ganging Table	798-P	297	Chord High-Back Chair

## Style Number Index

Style Number	Page	Description	Style Number	Page	Description
798-PAU	297	Chord Midback Chair	COENLLM	86	Coalesse Ensemble Middle Feet
798AU	297	Chord Midback Chair	COENLPL1	81	Coalesse Ensemble Modular 1-seat Perf Lge
CO200G	319	Bindu-Low Back Guest/Side Chair	COENLPLC	77	Coalesse Ensemble Standalone 1-seat Perf Lge
CO2465	354	Round Outdoor Armless Chair	COENLPWR	87	Coalesse Ensemble Lounge Power Module
CO2466	354	Round Outdoor Arm Chair	COENLRT	88	Coalesse Ensemble In-Line Rectangular Table
CO2467	405	Stool-Round Outdoor	COENLST	88	Coalesse Ensemble In-Line Square Table
CO300	292	Bindu-Mid Back Executive Chair	COENSDB	93	Coalesse Ensemble Nesting Base
CO300G	319	Bindu-Mid Back Guest/Side Chair	COENSHJ	92	Coalesse Ensemble High J Screen
CO400	292	Bindu Mid-Back High Back Executive Chair	COENSLC	91	Coalesse Ensemble Low Corner Screen
COALT100	335	Enea Altzo943 Chair, Armless	COENSLJ	91	Coalesse Ensemble Low J Screen
COALT100UPH	335	Enea Altzo943 Chair, Armless, Upholstered	COENSLS	90	Coalesse Ensemble Low Straight Screen
COALT400	386	Enea Altzo943 Stool, Counter Height	COENSMC	91	Coalesse Ensemble Medium Corner Screen
COALT400UPH	386	Enea Altzo943 Stool, Counter Height, Upholstered	COENSMJ	92	Coalesse Ensemble Medium J Screen
COALT500	387	Enea Altzo943 Stool, Bar Height	COENSMS	90	Coalesse Ensemble Medium Straight Screen
COALT500UPH	387	Enea Altzo943 Stool, Bar Height, Upholstered	COENS SB	93	Coalesse Ensemble Standalone Base
CODAV	98	Davos Chair	COH350W27	375	Enea Wood Café Stool, Counter-Height
CODAV16	99	Davos Small Bench	COH350W31	375	Enea Wood Café Stool, Bar-Height
CODAV38	99	Davos Medium Bench	COH352W27	374	Enea Wood Café Stool, Counter-Height Upholstered
CODAV60	98	Davos Large Bench	COH352W31	374	Enea Wood Café Stool, Bar-Height Upholstered
COEL100	330	Enea Lottus Armless Chair	COH353W27	375	Enea Wood Café Stool, Counter-Height
COEL100INSERT	330	Enea Lottus Armless Chair	COH353W31	375	Enea Wood Café Stool, Bar-Height
COEL100UPH	331	Enea Lottus Armless Chair	COJHB100	286	Visalia Lounge
COEL200	332	Enea Lottus Cantilever Arm Chair	COJHB200	286	Visalia Lounge
COEL200INSERT	332	Enea Lottus Cantilever Arm Chair	COJHBC100	286	Visalia Lounge
COEL200UPH	332	Enea Lottus Cantilever Arm Chair	COJHBC200	286	Visalia Lounge
COEL300	333	Enea Lottus Aluminum Loop Arm Chair	COJHL100	285	Visalia Lounge
COEL300INSERT	333	Enea Lottus Aluminum Loop Arm Chair	COJHL200	285	Visalia Lounge
COEL300UPH	333	Enea Lottus Aluminum Loop Arm Chair	COJHL300	285	Visalia Lounge
COEL400	383	Enea Lottus Sled-Base Stool	COJHLC100	285	Visalia Lounge
COEL400INSERT	383	Enea Lottus Sled-Base Stool	COJHLC200	285	Visalia Lounge
COEL400UPH	383	Enea Lottus Sled-Base Stool	COJHLC300	285	Visalia Lounge
COEL500	382	Enea Lottus Sled-Base Stool	COLAGB1	161	Lagunitas 1-Seat Bench
COEL500INSERT	382	Enea Lottus Sled-Base Stool	COLAGB2	161	Lagunitas 2-Seat Bench
COEL500UPH	383	Enea Lottus Sled-Base Stool	COLAGB3	161	Lagunitas 3-Seat Bench
COEL600	379	Enea Lottus Post-Base Stool	COLAGCH2	155	Lagunitas 2-Seat Chaise
COEL600INSERT	379	Enea Lottus Post-Base Stool	COLAGCH3	159	Lagunitas 3-Seat Chaise
COEL600UPH	379	Enea Lottus Post-Base Stool	COLAGCI	163	Alignment Connector
COEL700	378	Enea Lottus Post-Base Stool	COLAGCL2	154	Lagunitas 2-Seat Chaise
COEL700INSERT	378	Enea Lottus Post-Base Stool	COLAGCL3	158	Lagunitas 3-Seat Chaise
COEL700UPH	379	Enea Lottus Post-Base Stool	COLAGFN	167	Lagunitas Focus Nook
COELDOLLY	331	Enea Lottus Stacking Dolly	COLAGLBS	162	Lounge Booth Screen
COENLBB	83	Coalesse Ensemble Backless Bench	COLAGLH11	137	Lagunitas 1-Seat Lnge w/ High-Bk Scrn
COENLCF	85	Coalesse Ensemble Armrest End Connector	COLAGLH13	137	Lagunitas 1-Seat Lnge w/ HB Scrn, 2 Side Scrns
COENLCFE	85	Coalesse Ensemble Armrest End Connector	COLAGLH21	141	Lagunitas 2-Seat Lnge w/ High-Bk Scrn
COENLCG	85	Coalesse Ensemble Corner Ganging Kit	COLAGLH22	142	Lagunitas 2-Seat Lnge w/ HB Scrn, 1 Side Scrn
COENLCH2	83	Coalesse Ensemble Modular 2-seat Chaise	COLAGLH23	143	Lagunitas 2-Seat Lnge w/ HB Scrn, 2 Side Scrns
COENLCHC2	79	Coalesse Ensemble Standalone 2-seat Chaise	COLAGLH31	149	Lagunitas 3-Seat Lnge w/ High-Bk Scrn
COENLCL1	82	Coalesse Ensemble Modular 1-seat Corner Lounge	COLAGLH32	150	Lagunitas 3-Seat Lnge w/ HB Scrn, 1 Side Scrn
COENLCNTNR	89	Coalesse Ensemble Planter	COLAGLH33	151	Lagunitas 3-Seat Lnge w/ HB Scrn, 2 Side Scrns
COENLEA	84	Coalesse Ensemble End Armrest	COLAGLL11	136	Lagunitas 1-Seat Lnge w/ Low-Bk Scrn
COENLFL1	81	Coalesse Ensemble Modular 1-seat Fixed Lounge	COLAGLL13	136	Lagunitas 1-Seat Lnge w/ LB Scrn, 2 Side Scrns
COENLFL2	72	Coalesse Ensemble Modular 2-seat Lounge	COLAGLL21	140	Lagunitas 2-Seat Lnge w/ Low-Bk Scrn
COENLFLC	77	Coalesse Ensemble Standalone 1-seat Fixed Louge	COLAGLL22	140	Lagunitas 2-Seat Lnge w/ LB Scrn, 1 Side Scrn
COENLFLC2	78	Coalesse Ensemble Standalone 2-seat Lounge	COLAGLL23	141	Lagunitas 2-Seat Lnge w/ LB Scrn, 2 Side Scrns
COENLLE	86	Coalesse Ensemble End Feet	COLAGLL31	146	Lagunitas 3-Seat Lnge w/ Low-Bk Scrn

# Style Number Index *continued*

Style Number	Page	Description	Style Number	Page	Description
COLAGLL32	147	Lagunitas 3-Seat Lnge w/ LB Scrn, 1 Side Scrn	COMSL3	189	Millbrae 3-Seat
COLAGLL33	148	Lagunitas 3-Seat Lnge w/ LB Scrn, 2 Side Scrns	CONLCLC	108	Jean Nouvel Lounge
COLT5	341	LessThanFive Chair	CONLCOT	108	Jean Nouvel Ottoman
COLT5E	341	LessThanFive Essential Chairs	CONLCSF	108	Jean Nouvel Sofa
COLT5EP	341	LessThanFive Essential Chairs	CONLCTT	109	Jean Nouvel Tête-à-Tête
COLT5L	169	LessThanFive Lounge	COPILLM	251	Sistema Lumbar Pillow
COLT5S	389	LessThanFive Stool	COPILSQ	251	Sistema Square Pillow
COLX400	304	Lox Chair, Upholstered Seat	COSFZCH	351	Montara650 Chair
COLX410	304	Lox Chair, Upholstered Seat and Back	COSFZLC	200-201	Montara650 Lounge
COLX500	305	Lox Chair, Upholstered Seat	COSFZRC	205	Montara650 Rocker
COLX510	305	Lox Chair, Upholstered Seat and Back	COSFZST	403	Montara650 Stools
COMARBSMB	393	Marien152 Stool, Bar-Height	COSIS1L	246	Sistema Lounge Chair, Left Arm
COMARBSWB	393	Marien152 Stool, Bar-Height	COSIS1R	245	Sistema Lounge Chair, Right Arm
COMARCCH4	301	Marien152 Conference Seating	COSIS2A	247	Sistema Lounge Chair with Arms
COMARCCH5	301	Marien152 Conference Seating	COSISAB	249	Sistema Arm Bolster
COMARCHMB	346	Marien152 Guest Seating, Metal Base	COSISBN	246	Sistema Backless Bench Lounge
COMARCHWB	345	Marien152 Guest Seating, Wood Base	COSISEL	239	Sistema End Legs
COMARCSMB	395	Marien152 Stool, Counter-Height	COSISGL	239	Sistema Connector Frame with Legs
COMARCSWB	395	Marien152 Stool, Counter-Height	COSISL1	241	Sistema 1-St Cnctr Frame, Leg Base
COMARLCMB	172	Marien152 Lounge, Metal Base	COSISL2	238, 241, 246-247	Sistema 2-St Lounge Frame, Leg Base
COMARLCWB	173	Marien152 Lounge, Wood Base	COSISL3	238	Sistema 3-St Lounge Frame, Leg Base
COMCCHLBDVNT	310	Massaud Low-Back Duvet Conference Chair	COSISLC	245	Sistema Lounge Chair, Armless
COMCCHLBSTNT	310	Massaud Low-Back Duvet Conference Chair	COSISOR	248	Sistema Round Ottoman
COMCCHMBDV	309	Massaud Mid-Back Duvet Conference Chair	COSISOS	248	Sistema Square Ottoman
COMCCHMBDVNT	311	Massaud Mid-Back Duvet Conference Chair	COSISPWR	242	Sistema Power Module
COMCCHMBST	309	Massaud Mid-Back Duvet Conference Chair	COSISTBL	250	Sistema Moveable Table
COMCCHMBSTNT	311	Massaud Mid-Back Duvet Conference Chair	COTO12369L15	275	Together Bench
COMCLG	178	Massaud Lounge Chair	COTO12369L8	275	Together Bench
COMCOT	179	Massaud Ottoman	COTO12369R15	277	Together Bench
COMCWL	179	Massaud Work Lounge Chair	COTO12369R8	276	Together Bench
COMF1	195	Millbrae Ganging Kit	COTO12396L15	275	Together Bench
COMFL1	190	Millbrae Lounge	COTO12396L8	275	Together Bench
COMFL2	191	Millbrae Lounge	COTO12396R15	277	Together Bench
COMFL3	192	Millbrae 3-Seat Lounge	COTO12396R8	276	Together Bench
COMFL4	193	Millbrae 4-Seat Lounge	COTO69	279	Together Bench
COMFLA1	190	Millbrae Lounge	COTO69WB15	278	Together Bench
COMFLA2	191	Millbrae 2-Seat Lounge	COTO69WB8	278	Together Bench
COMFLA3	192	Millbrae 3-Seat Lounge	COTO96	279	Together Bench
COMFLA4	193	Millbrae 4-Seat Lounge	COTO9669L15	275	Together Bench
COMFLB1	194	Millbrae 1-Seat Bench	COTO9669L8	274	Together Bench
COMFLB2	194	Millbrae 2-Seat Bench	COTO9669R15	277	Together Bench
COMFLB3	194	Millbrae 3-Seat Bench	COTO9669R8	276	Together Bench
COMFLB4	194	Millbrae 4-Seat Bench	COTO9696L15	275	Together Bench
COMFLLA1	190	Millbrae Lounge	COTO9696L8	274	Together Bench
COMFLLA2	191	Millbrae 2-Seat Lounge	COTO9696R15	277	Together Bench
COMFLLA3	192	Millbrae 3-Seat Lounge	COTO9696R8	276	Together Bench
COMFLLA4	193	Millbrae 4-Seat Lounge	COTO96WB15	278	Together Bench
COMFLRA1	190	Millbrae Lounge	COTO96WB8	278	Together Bench
COMFLRA2	191	Millbrae 2-Seat Lounge	COURQL	103	Hosu Lounge w/Attached Lumbar
COMFLRA3	192	Millbrae 3-Seat Lounge	COURQLQ	103	Hosu Lounge w/Otto and Attached Lumbar
COMFLRA4	193	Millbrae 4-Seat Lounge	COURQS	103	Hosu 2-Seat Lounge
COMLPRND	195	Millbrae Round Arm Bolster	COW210	257	SW_1 Ottoman
COMLPSQR	195	Millbrae Square Arm Bolster	COW413	314	SW_1 Conference Chair
COMSL1	189	Millbrae Lounge	COW415	314	SW_1 Conference Chair
COMSL2	189	Millbrae 2-Seat	COW613	257	SW_1 Low-Back Collaborative Lounge Chair

# Style Number Index

Style Number	Page	Description
COW713	257	SW_1 High-Back Collaborative Lounge Chair
COWK100	111	Joel Lounge
COWRP4LEG	362	Wrapp Chair, 4 Leg
COWRPSLD	362	Wrapp Chair, Sled-Base
IAM1	365	Branca Bar Stool, Black Ash
IAM10	367	Branca Counter Stool, White Ash
IAM100	343	Leva Armchair, Natural Ash
IAM101	343	Leva Armchair, Red Ash
IAM102	182	Medici Lounge, Black Ash
IAM103	182	Medici Lounge, Grey Ash
IAM104	182	Medici Lounge, Natural Ash
IAM105	182	Medici Lounge, Red Ash
IAM106	182	Medici Lounge, Thermo Oiled Ash
IAM107	182	Medici Lounge, Yellow Ash
IAM108	398	Medici Stool, Black Ash
IAM109	398	Medici Stool, Grey Ash
IAM110	398	Medici Stool, Natural Ash
IAM111	398	Medici Stool, Red Ash
IAM112	398	Medici Stool, Thermo Oiled Ash
IAM113	398	Medici Stool, Yellow Ash
IAM13	324	Branca Chair, Black Ash
IAM14	324	Branca Chair, Brown Ash, Nat Ash Seat
IAM15	324	Branca Chair, Green Ash
IAM156	358	She Said Chair, Black Ash
IAM157	358	She Said Chair, Natural Ash
IAM158	358	She Said Chair, Neon Blue Ash
IAM159	358	She Said Chair, White Ash
IAM16	324	Branca Chair, Natural Ash
IAM17	324	Branca Chair, White Ash
IAM2	365	Branca Bar Stool, Brown Ash, Nat Ash Seat
IAM262	356	Seta Chair
IAM3	365	Branca Bar Stool, Natural Ash
IAM4	365	Branca Bar Stool, White Ash
IAM5	365	Branca Bar Stool, Green Ash
IAM6	367	Branca Counter Stool, Black Ash
IAM61	369	Cugino
IAM61SOFT	371	Cugino Soft, Natural Pine
IAM7	367	Branca Cnter Stl, Brown Ash, Nat Ash Seat
IAM8	367	Branca Counter Stool, Green Ash
IAM9	367	Branca Counter Stool, Natural Ash
IAM98	343	Leva Armchair, Black Ash
IAM99	343	Leva Armchair, Grey Ash

# Trademark List

™/® The following is a non-exhaustive list of trademarks and registered trademarks for products of Steelcase Inc. or one of its related corporate entities: Agree, Airtouch, Aisla, Alight, Amia, Answer, Apprise, Aspekt, Avenir, Await, B-Free, Ballet, Bassline, Bindu, Bivi, Bix, Bottomline, Brody, Buoy, Cachet, Campfire, Capa, CF Series, CG\_1, Chord, Circa, Clipper, Cobi, Collaboration, Convene, Coupe, Cura, Currency, dash, Divisio, Duo, E-Table 2, Edge Series, Elbrook, Elective Elements, Embold, Empath, Everwall, Exponents, Folio, FrameOne, Gesture, Groupwork, Host, Hosu, i2i, Jenny, Kart, Kathryn, Kick, Lagunitas, Leap, Leela, LessThanFive, LiveBack, LiveSeat, Mackinac, Marien152, Max-Stacker, media:scape, Migration, Millbrae, Mineral, Mitra, Montage, Montara650, MoreThanFive, Move, Node, Ocular, Ology, Opus, Paperflo, Passerelle, Player, Pocket, Potrero415, QiVi, Radia, Regard, Relay, Reply, Ripple, Roam, Sarto, Scoop, Sebastopol, Senti Series, Senza, Shortcut, Sidewalk, Siento, Sieste, SILQ, Soffio, Sorrel, SOTO, Steelcase Eclipse, Steelcase Flex, Steelcase Karman, Steelcase Relay, Steelcase Rise, Steelcase Series, Surround, SW\_1, Switch, Sync, Tava, Tenor, Think, Thoughtful, Thread, Together, Train, Trees, Turnstone, Umami, Underscore, V.I.A., Verb, Verge, Verlay, Victor2, Visalia, WorkValet, and X-tenz.

™/® The following are trademarks or registered trademarks of AMQ Solutions, LLC: 3F, Activ, Amobi, Bixby, Bodi, Cluvo, Concur, Embank, FL-X, Iline, Jaku, Kinex, Personality Plus, Revi, S-Series, Siya, Tektis, Tizu, Uptake, and Zilo.

™/® The following are trademarks or registered trademarks of Orangebox Ltd., Cardiff, UK: Air3, Aspect, Avi, Away from the Desk, Border, Campers & Dens, Coppice, Cubb, Kirm, On the QT, Ramsey, Skomer, Sully, Track-B, and Vale.

™/® The following are trademarks or registered trademarks of Viccarbe Habitat, S.L.: Aleta, Cambio, Designed in The Sun, Foro, Funda, Holy Day, Kelly, Last Minute, Noha, Savina, Sistema, Sistema, Viable, and Wrapp.

® The following are registered brands of Steelcase Inc. and its family of companies: Steelcase, AMQ, Coalesse, Designtex, Halcon, Orangebox, Smith System, and Viccarbe.

® The following registered trademarks are under license from AWI Licensing Company, Dover, DE: SoundScapes, DuraBrite, BioBlock, and Armstrong.

® The following registered trademarks are under license from Byrne Electrical, Rockford, MI: Interport, Mini-Port, Axil Z, and Ellora.

® The following is a registered trademark of DuPont, Wilmington, DE: Corian.

® The following is a registered trademark of Genlyte Thomas Company, Louisville, KY: Lightolier.

® The following is a registered trademark of Hilti Corporation, FL-9494 Schaan, Principality of Liechtenstein: Hilti.

® The following is a registered trademark of Leviton Manufacturing Company, Little Neck, NY: Decora.

® The following is a registered trademark of Mechanical Plastics Corp, Elmsford, NY: Toggler.

® The following is a registered trademark of Microsoft Corporation, Redmond, WA: Microsoft.

® The following are registered trademarks of Orangebox Ltd., Cardiff, UK: Orangebox.

® The following is a registered trademark of Panduit Corporation, Lockport, IL: Panduit.

® The following is a registered trademark of Trav (Press), Cuneo, Italy: Assisa.

® The following is a registered trademark of Virtual Ink, Boston, MA: mimioActive.

® The following registered trademarks are under license from Wilkhahn Furniture Products: Avera, Senzo, Versal, and Wilkhahn FS.

® The following are registered trademarks of Polyvision Corp: Flow, Motif, Polyvision, Sans, and Serif.

® The following is a registered trademark of Wilsonart International, Temple, TX: Chemsurf.

® The following is a registered trademark of Wiremold, West Hartford, CT: Wiremold.

® The following is a registered trademark of EMU Group S.P.A., Perugia, Italy: EMU.

® The following is a registered trademark of Security People, Inc.: Digilock.

® The following are registered trademarks of Natural Capital Partners Europe Limited: CarbonNeutral and the CarbonNeutral Certified logo.

™ The following is a trademark of Microsoft Corporation, Redmond, WA: Windows.

™ The following is a trademark of Rodman Industries, Inc., Oconomowoc, WI: ResinCore1.

™ The following is a trademark of Ultrafabrics, LLC, Elmsford, NY: Ultraleather.

™ The following trademarks are under license from Wilkhahn Furniture products: Cana, Linus, Logon, Picto, Range, Stitz, Thema, Timetable, and Tubis.

™ The following trademarks are under license from Walter Knoll: Andoo, Bob, Lazlo, Lox, Ribbon, and Together.

™ The following trademarks are under license from PP Möbler: Bar and Flag Halyard.

™ The following trademarks are under license from Carl Hansen: Elbow, Paddle, Shell, Wing, and Wishbone.

™ The following trademarks are under license from Cambridge Sound Management, LLC Cambridge, MA: QtPro Soundmasking, Qt Quiet Technology, and Sonet Qt.

™ The following is a trademark of Electri-Cable Assemblies, Shelton, CT: Interact.

™ The following is a trademark of Clestra Hauserman: IRYS.

™ The following is a trademark of Wiesner-Hager Möbel GmbH: Nooi.

™ The following are trademarks of Polyvision: Accord, a3, e3, Boundri, and Nota.

™ The following is a trademark of Bostock Company, Inc: SnapCab.

™ The following is a trademark of Williams-Sonoma, Inc: West Elm.

™ The following is a trademark of Elena Marquina Testor: nanimarquina.

™ The following is a trademark of Forbo International SA: Forbo.

Trademarks used herein are the property of Steelcase Inc. or their respective owners.