



Answer Beam and Answer Fence Specification Guide

Availability

Electronic price list updated with release 204.C (U.S.) and 158.C (Canada), dated June 15, 2026.

All specifications subject to change without notice. Reference the electronic catalog/Hedberg for current pricing.

Transitional products in this specification guide are **maintained for existing customers only** and are likely to be phased out over time. These products are indicated with a . Products that are scheduled to be culled are indicated with an , followed by the last order entry date.

Surface Materials

The surface materials team has announced the launch of the Finish Library, found at www.steelcase.com/finishlibrary/.

► For a list of all trademarks, refer to the last page of this specification guide. © 2026 Steelcase Inc.

Working With This Specification Guide

Ten Tips: How to Get the Most Out of This Book	2
Additional Resources	4

Answer Beam

Understanding	5
Specifying	163

Answer Fence

Understanding	299
Specifying	331

Surface Materials

Resources



For Canadian Pricing

Canadian factor can be found at www.steelcase.com/CADpricing. Calculate in the following order to avoid rounding errors:

- Multiply the base price and each option by the Canadian factor.
- Round each to the nearest dollar.
- Add base and options for total list price.

Ten Tips: How to Get the Most Out of This Book

Tip 1

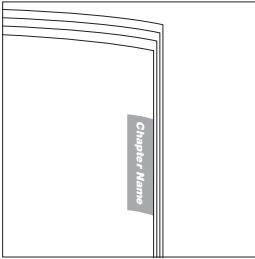

Watch the tabs on the right-hand edges of the pages. They'll always indicate which chapter you are in.

Tip 2

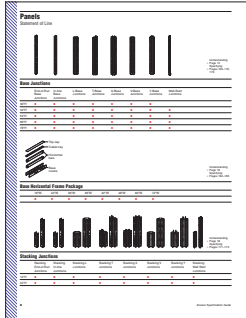

Use the Statement of Line pages for an overview of the available components, their sizes, and page references for additional information. Each *Understanding* chapter includes a statement of line after the table of contents.

Tip 3



Find cross references by looking for page numbers flagged with an arrow.

Tip 4

Study the product detail pages in the *Understanding* section to learn everything an expert knows about specific products. Each product detail page in this section contains the following features, where applicable:

- Product Drawing
- Actual Dimensions
- Product Details
- Connections
- Wiring and Cabling
- Surface Materials
- Application Topics

Product Drawing

shows you what the product looks like and points out important features.

Product Details

gives specific information on the product and how it is used.

Connections

describes how the product is assembled or how it attaches to another product.

Actual Dimensions table lists the dimensions of the product.

Wiring and Cabling details the power and cable-management and cable routing capabilities of the product.

Surface Materials lists what material is used for each part of the product.

Additional Resources

Answer beam and

Answer fence are supported with an array of informational materials, tools, and software to help you plan an installation efficiently.

Product brochures and planning tools

can be ordered through your Steelcase area office by calling 1.800.784.0358 or through the Marketing Resources web site at village.steelcase.com.

Printed Materials

Surface Materials Reference Manual

This publication provides:

- An explanation of the surface materials
- "Available on" matrices
- Vertical surface fabric and seating upholstery selection listing
- Technical data for surface materials
- Surface material care and cleaning instructions

Computer Tools

Electronic Catalog

Accurate sales quotations and purchase orders for Steelcase products are created with specification software that uses Steelcase Electronic Catalog data. Use the data to specify and price style numbers and options for every Steelcase product. The data is updated bimonthly by Steelcase and provided to software programs including: the Hedberg Business System, SmartTools – Steelcase's design and specification software (for more information on SmartTools, please email SmartTools@steelcase.com), the ProjectMatrix Project-Symbols libraries, as well as 20-20 CAP Studio.

Furniture Symbol Graphic Data

Steelcase creates 2D and 3D furniture symbols (with attributes) for planning and initially specifying Steelcase products. This data is incorporated into several add-on software packages that work in either a Microstation or an AutoCAD drafting environment.

Digital Publications

You can access these digital publications at www.steelcase.com or village.steelcase.com.

Planning Ideas

Planning ideas are available to help inspire, envision, and plan great solutions. 2D and 3D AutoCAD drawings, Sketch-Up files, and SmartTools drawings are available on the Planning Ideas site: www.steelcase.com/planningideas.

Support

Steelcase Capabilities

Steelcase products are distributed, installed, and serviced through a network of more than 600 dealers worldwide. Steelcase is also represented with offices and corporate showrooms in 26 U.S. cities, 4 Canadian cities, and in France, Germany, Great Britain, and Japan. Every Steelcase product meets our exceptionally high standards of quality and durability and comes with the Steelcase assurance of excellence in service.

For ordering or product assistance,

call your local dealer, the Steelcase Solutions Resource Team, or the Steelcase Solutions Fulfillment Team at 1.888.STEELCASE (1.888.783.3522) or send an e-mail to lineone@steelcase.com.

Call the Steelcase Solutions Resource Team prior to placing an order, when working on a bid, or when you need information about product applications and specifications.

Call the Steelcase Solutions Fulfillment Team if you have submitted an order to Steelcase and you need to speak to your Solutions Fulfillment Team Representative about the order. Also call if you have any post-shipment quality concerns or service parts questions.

For warranty information, please go to <http://www.steelcase.com/warranty/>.

Outside the U.S.A., Canada, Mexico, Puerto Rico, and the U.S. Virgin Islands, call 1.616.247.2500.

Related Products

Worktools include a full line of ergonomically designed products that enhances and improves the work setting. Product platforms include computer support tools, organizational worktools, and personal lighting.

► For additional information, refer to *Steelcase Worktools Specification Guide* or contact Steelcase at 1.888.STEELCASE (1.888.783.3522) or send an email to lineone@steelcase.com.

Answer Assembly Tool

As an alternative to using a rubber mallet, frames can be assembled using the Answer Assembly Tool.

Call Steelcase for pricing and order information.

1.888.STEELCASE (1.888.783.3522) or send an email to lineone@steelcase.com.

Sustainability

At Steelcase, we believe business can be a force for good. We create long-lasting products that are better for people and better for the planet. Our products and operations use life cycle thinking to meet our commitment to reducing climate change. This commitment is reinforced by practices such as designing to minimize global warming and other life cycle impacts, ensuring material health, and enabling end-of-use strategies.

To learn more at a corporate level, visit: <https://www.steelcase.com/discover/steelcase/esg-overview/environmental/>

Product Environmental Profiles, which provide key environmental attributes such as recycled content, embodied carbon and recyclability, as well as product certifications can be found by searching for Steelcase at Origin.build.

Understanding Answer Beam

Product Details

Answer Beam Structure	7
Answer Beam Skins	33
Answer Beam Power	43
Boundary, Worksurface, and Beam Screens	67
Answer Beam Stability Guidelines	101
Universal Systems Worksurfaces and Supports	111
Currency Storage	135
Storage Tops, Stanchions, and Connectors	143
High-Density Storage Products	149
Verb Accessories	157

Understanding Answer Beam Structure



Statement of Line	8
--------------------------	----------

Product Details

Answer Beam Overview	11
Answer Beam Buildups	12
Answer Beam Junctions	14
Answer Beam Junction Elements	16
Answer Beam-to-Panel Change-of-Height Junctions	20
Answer Beam-to-Panel Change-of-Height Visual Overview	24
Answer Beam Horizontal Frame Packages	26
Answer Beam Top Cap Rail	28
Answer Panel and Beam Foot	30

Statement of Line

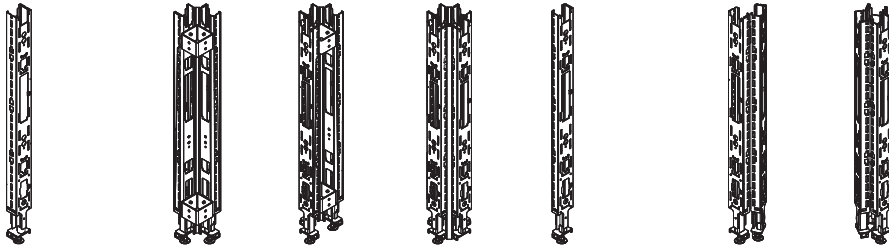

Understanding
 ▶ Page 14
 Specifying
 ▶ Pages 166–170

Beam Junctions

In-Line Beam Junction	L Beam Junction	T Beam Junction	X Beam Junction	End-of-Run Beam Junction	V Beam Junction	Y Beam Junction
●	●	●	●	●	●	●

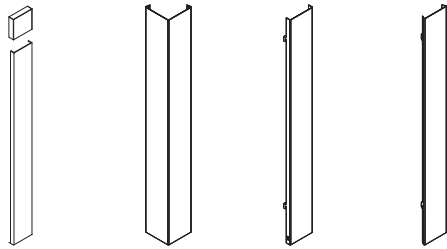

Understanding
 ▶ Pages 17–18
 Specifying
 ▶ Pages 175–177



Understanding
 ▶ Page 20
 Specifying
 ▶ Pages 171–173

Vertical Beam Trims

End-of-Run Vertical Beam Trim	L Vertical Beam Trim	T Vertical Beam Trim	V Vertical Beam Trim
●	●	●	●

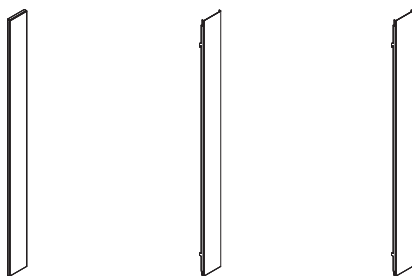

Understanding
 ▶ Page 20
 Specifying
 ▶ Page 178

Change-of-Height Junctions

L Beam-to-Panel Change-of-Height Junction	T Beam-to-Panel Change-of-Height Junction	X Beam-to-Panel Change-of-Height Junction
●	●	●

▶ See Answer Beam-to-Panel Change-of-Height Visual Overview, page 24.



Understanding
 ▶ Page 16
 Specifying
 ▶ Page 180

Change-of-Height Trims

L Beam Corner Change-of-Height Trim	T Beam Corner Change-of-Height Trim	X Beam Corner Change-of-Height Trim
●	●	●

▶ See Answer Beam-to-Panel Change-of-Height Visual Overview, page 24.

Beam Junction Post

●



Understanding
 ▶ Page 16
 Specifying
 ▶ Page 180



Understanding
 ▶ Page 18
 Specifying
 ▶ Page 181

Junction Blocks

90° Corner 120° Corner

● ●

Inside Corner Light Seals

54" 66" 78"

● ● ●

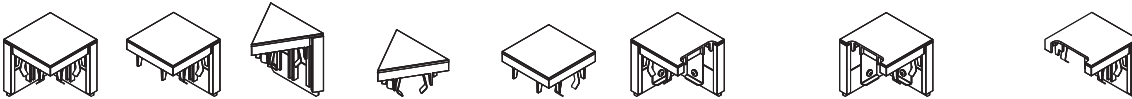

Understanding
 ▶ Page 16
 Specifying
 ▶ Page 181

Beam Junctions Caps

L Beam Junction Cap T Beam Junction Cap V Beam Junction Cap Y Beam Junction Cap X Beam Junction Cap L Beam Change-of-Height Junction Cap Right Handed L Beam Change-of-Height Junction Cap Left Handed T Beam Change-of-Height Junction Cap

● ● ● ● ● ● ● ●

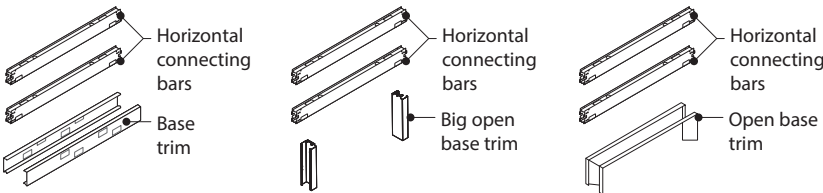

Understanding
 ▶ Page 26
 Specifying
 ▶ Pages 182–184

Beam Horizontal Frame Packages

	Standard Base	Big Open Base	Open Base
24"W	●	●	●
30"W	●	●	●
36"W	●	●	●
42"W	●	●	●
48"W	●	●	●
60"W	●	●	●
72"W	●	●	●

Statement of Line, continued

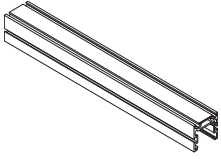

Understanding
▶ Page 28
Specifying
▶ Page 185

Beam Top Cap Rails

24"W	30"W	36"W	42"W	48"W	54"W	60"W	66"W	72"W	78"W	84"W	90"W	96"W
●	●	●	●	●	●	●	●	●	●	●	●	●

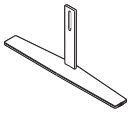

Understanding
▶ Page 30
Specifying
▶ Page 186

Panel and Beam Foot

21"L

Answer Beam Overview

The Answer beam supports privacy screens, worksurfaces, and personal storage on a light-scale spine that delivers power and data at multiple elevations.

Beam frame is made up of three major elements—vertical junctions, horizontal connecting bars, and a top cap rail.

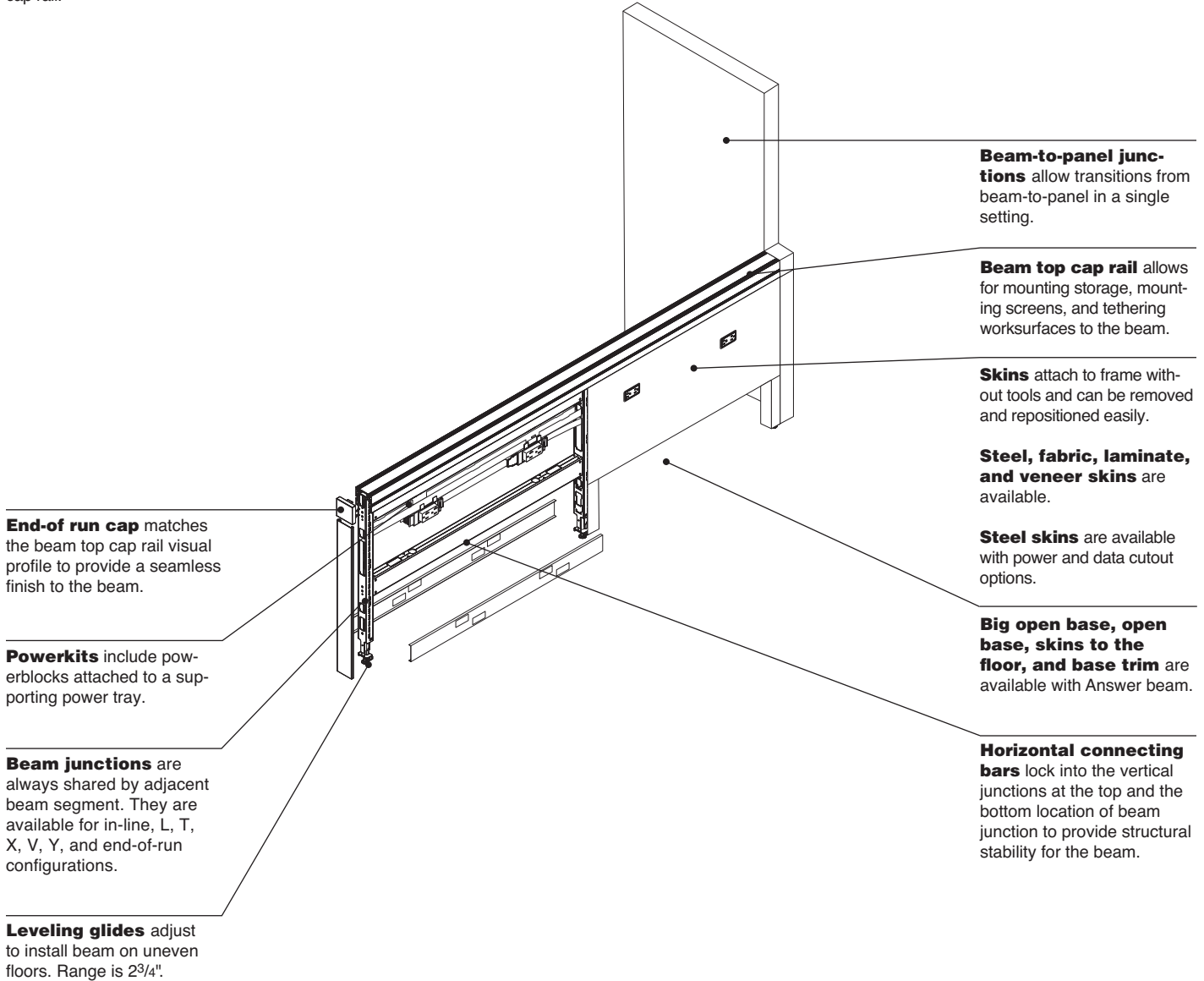

Beam-to-panel junctions allow transitions from beam-to-panel in a single setting.

Beam top cap rail allows for mounting storage, mounting screens, and tethering worksurfaces to the beam.

Skins attach to frame without tools and can be removed and repositioned easily.

Steel, fabric, laminate, and veneer skins are available.

Steel skins are available with power and data cutout options.

Big open base, open base, skins to the floor, and base trim are available with Answer beam.

Horizontal connecting bars lock into the vertical junctions at the top and the bottom location of beam junction to provide structural stability for the beam.

End-of run cap matches the beam top cap rail visual profile to provide a seamless finish to the beam.

Powerkits include powerblocks attached to a supporting power tray.

Beam junctions are always shared by adjacent beam segment. They are available for in-line, L, T, X, V, Y, and end-of-run configurations.

Leveling glides adjust to install beam on uneven floors. Range is 2³/₄".

Actual Dimensions

Height 28¹/₂"

Tip: Height is minimum from floor to beam top cap rail. Leveling glides can extend 2³/₄".

Answer Beam Buildups

Frames

Begin by planning your frames. Junction height is 28½" and the horizontal connecting bars determine width.

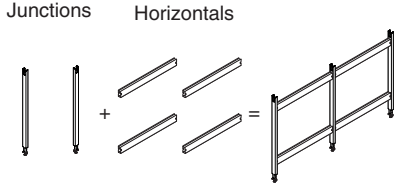

Beam Top Cap Rail

Select beam top cap. Beam top caps are available in the following widths: 24", 30", 36", 42", 48", 54", 60", 66", 72", 78", 84", 90", and 96". The beam top cap rail can span in-line junctions.



Skins

Order skins for both sides of beam. Skins are available in standard base, to-the-floor, and big open base configurations.

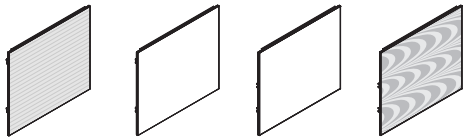

Tackable acoustical fabric covered skins

Steel skins

Laminate skins

Wood skins

Power

Specify powerkits where power is needed. Power can be expressed in the base, just above the base, or at 20"H. Steel skins are available with cutouts for power and data access at 20"H. Fabric skins can support power and data by field-cutting openings.

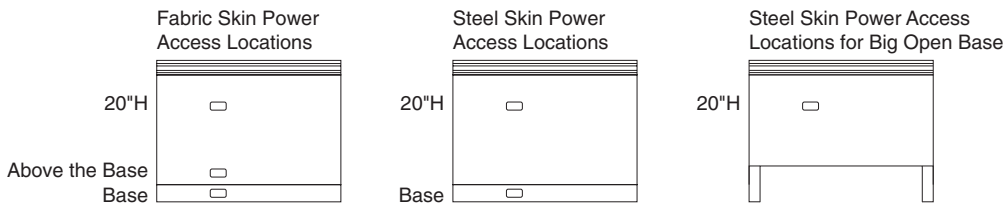

Answer Beam Junctions

Answer beam junctions give the beam a height of 28¹/₂".

Beam junctions complete the structure of beam buildups and are available for in-line, L, T, X, V, Y, and end-of-run configurations. Answer beam segments always share a junction with adjacent beam segments. You order the style of junction you need separately.

► Specifying, pages 166–170

Slots in junction accept the beam's horizontal connecting bars, cable trays every 6", and powerkits every 12" vertically.

Slotted channels in junction accommodate worksurface supports and storage-to-beam brackets.

Trim is included with L, T, V, and end-of-run beam junctions to finish exposed surfaces.

Large openings are used to route power or cables through an L, T, X, V, Y, and in-line beam junction.

Lay-in cable routing is accommodated in base area.

Leveling glides adjust the beam segment to install beam on uneven floors. Range is 2³/₄".

Inside corner light seals are only needed in 90° applications and are included in the style number when ordering.

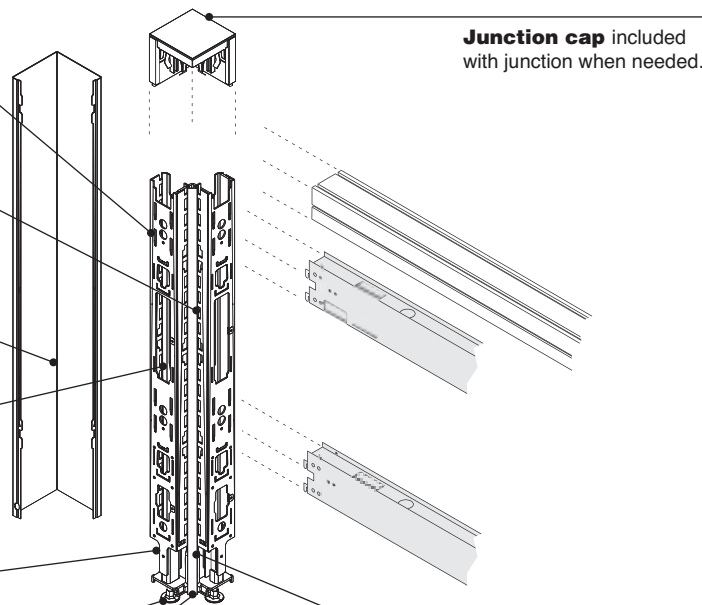

Junction cap included with junction when needed.

Block and post construction allows the ability to add or remove posts on corner junction for easy reconfiguration.

Product Details

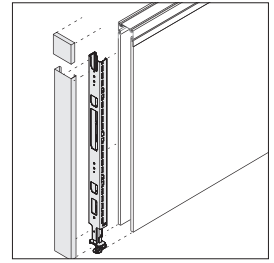

End-of-run beam junction includes beam end-of-run junction, beam end-of-run vertical trim, and beam end cap.

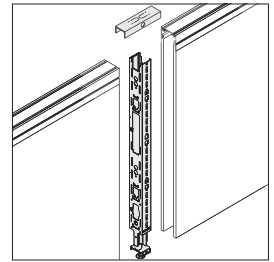

In-line beam junction includes beam in-line junction and beam top cap rail aligner.

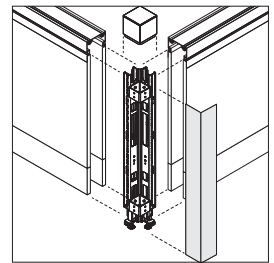

L beam junction includes junction, inside corner light seal(s), vertical trim, and L beam junction cap.

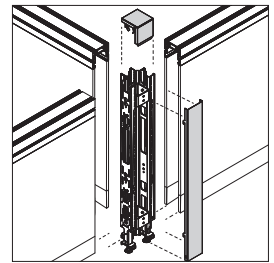

T beam junction includes junction, inside corner light seal(s), vertical trim, and T beam junction cap.

Actual Dimensions

Depth 3"

Height 27¹¹/₁₆"

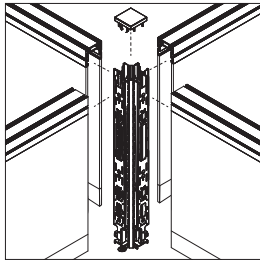

X beam junction includes junction, inside corner light seal(s), and X beam junction cap.

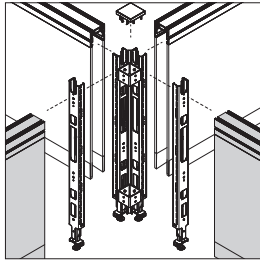

Posts can be added or removed from corner junctions to change from one corner configuration to another.

Connections

Answer beam junctions are unique to the Answer beam and are not compatible with Answer panel buildups.

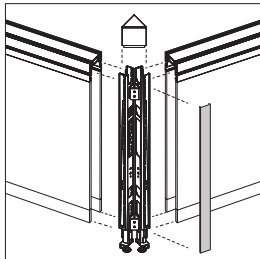

V beam junction includes junction, vertical trim, and V beam junction cap.

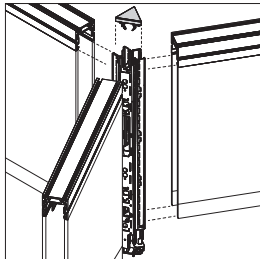

Y beam junction includes junction, and Y beam junction cap.

Omit trim on end-of-run beam junction when connecting a beam end-of-run boundary screen.

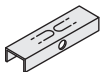

A beam top cap rail aligner is included with in-line junctions.

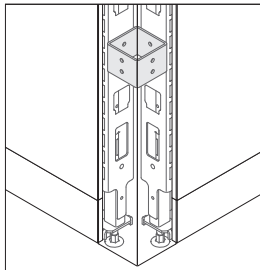

Block and post construction of corner junctions allow junctions to be easily added or removed to configure between L,T, X, V, or Y in an application

Junction caps are junction type specific. When reconfiguring corner junctions, the appropriate junction cap will need to be specified.

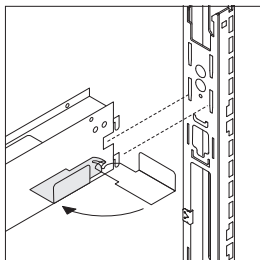

Quick lock on both ends of the beam's horizontal connecting bars engage the junction in a tight structural connection.

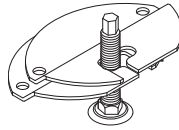

Floor anchor brackets are available to secure junctions to the floor to prevent beam movement. Brackets are intended for use in seismic zones and may require additional code approvals.

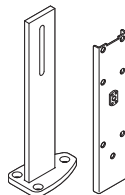

Junction stabilizer bracket can be used to add rigidity to a beam segment. Bracket must be bolted to a concrete floor.

Bracket foot is visible on one side of beam when installed.

Junction stabilizer bracket blocks power routing in the beam base and just above the base areas. The bracket covers the slots on the junction where the powerkit connects in these two zones. It also blocks the ability for a powerkit harness, pass-through powerkit, or modular harness to route in the base area from an adjacent beam segment.

Junction stabilizer bracket also blocks lay in of cables in base area of beam segment.

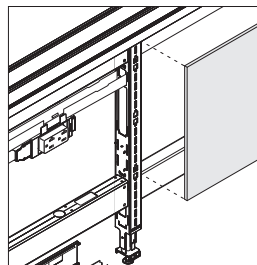

Skins extend onto junction and meet skin of adjacent beam segment. The slotted channel of the junction is accessible between these two skins.

Wiring and Cabling

Lay-in cable and power routing is accommodated in base area.

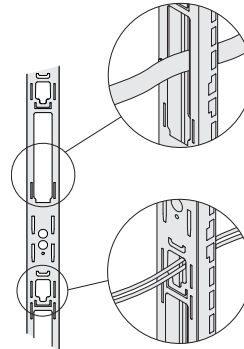

Horizontal routing of power and cables can be accommodated through openings in junctions.

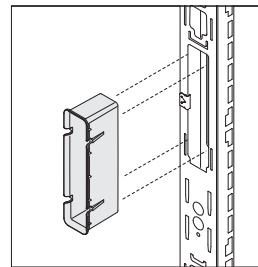

Junction tall sleeves can be ordered to cover the exposed metal edges in the large cable routing opening of junctions.

43" or 80" modular harnesses available to change the height at which you are routing power kits or to route power from the beam base to different heights.



Carpet gripper glide caps may be added to junction glides to help hold beam in place.

Surface Materials

Beam junction

- Black paint
- Tip: Junction is hidden when properly installed.*

Beam junction cap

- Paint

Beam vertical trim

- Paint

Answer Beam Junction Elements

Beam Junction Post



► Specifying, page 180

Product Details

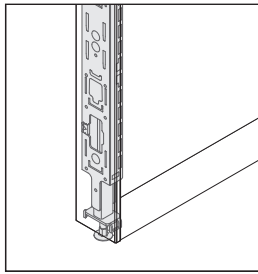

Beam junction post is available in 28¹/₂"H and can be ordered separately for use in building beam junctions.

Beam junction posts

do not come with trim. All trim must be specified separately.

Beam junction posts can be fastened to 90° corner or 120° corner junction blocks. Posts can be easily added or removed from the junction blocks to reconfigure the application.

Fasteners are included with the beam junction blocks. For additional fasteners order part number T521882MP (quantity 50).

Surface Materials

- Black paint only

Junction Blocks



► Specifying, page 180

Product Details

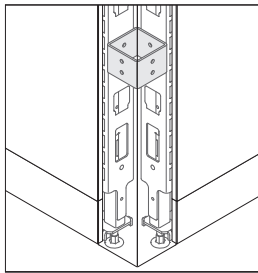

90° corner and 120° corner junction blocks can be ordered separately for use in building beam junctions that are not supported by style numbers.

90° corner and 120° corner junction blocks

are available in packages of three, four, or five. Two junction boxes are needed for each beam junction.

Four fasteners are included with each junction block.

Beam junction post can be easily added or removed from junction blocks to reconfigure the application.

When using 120° corner junction blocks with Answer Beam junctions, washers must be added between the block and the junction. Washer available through service parts.

Surface Materials

- Black paint only

Beam Junction Caps



► Specifying, page 181

Product Details

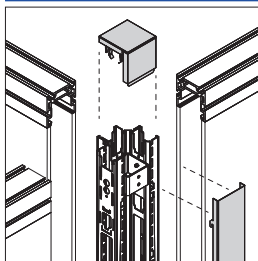

L, T, X, V, and Y beam-to-beam junction caps can be ordered separately for use in building and reconfiguring beam junctions.

Beam junction caps are junction type specific. When reconfiguring corner junctions, the appropriate junction cap will need to be specified.

Surface Materials

- Paint

**End-of-Run Vertical
Beam Trim and End
Cap Package**



► Specifying, page 175

Product Details

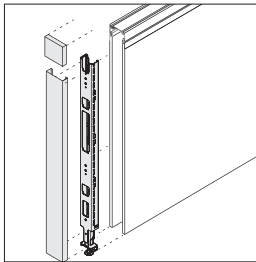

Answer beam end-of-run package consists of a vertical end-of-run trim and end-of-run junction cap.

Surface Materials

Vertical trim
• Paint

End-of-run junction cap
• Paint

Actual Dimensions

Height 28½"

L Vertical Beam Trim



► Specifying, page 176

Product Details

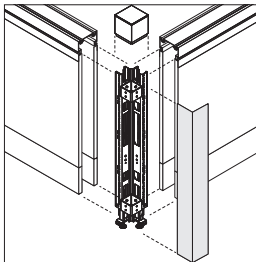

L junction caps are not included with L vertical beam trim and must be ordered separately.

Surface Materials

• Paint

Actual Dimensions

Height 28½"

T Vertical Beam Trim



► Specifying, page 176

Product Details

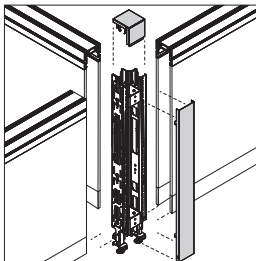

T junction caps are not included with T vertical beam trim and must be ordered separately.

Surface Materials

• Paint

Actual Dimensions

Height 28½"

Answer Beam Junction Elements, continued

V Vertical Beam Trim



► Specifying, page 177

Product Details

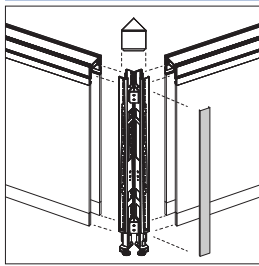

V junction caps are not included with V vertical beam trim and must be ordered separately.

Surface Materials

- Paint

Actual Dimensions

Height 28¹/₂"

Inside Corner Light Seal



► Specifying, page 181

Product Details

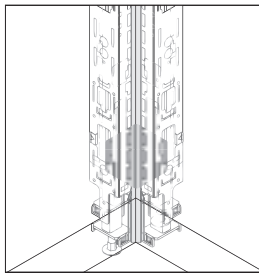

Inside corner light seals are available in 54"H, 66"H, and 78"H and need to be specified in 90° corner junction applications (they are not required in 120° corner applications).

Inside corner light seals are available in packages of four.

Inside corner light seals can be field cut to accommodate shorter post heights.

Surface Materials

- Black paint only

Answer Beam-to-Panel Change-of-Height Junctions

Answer beam and Answer panel systems can connect to seamlessly blend the two planning solutions.

Beam-to-panel change-of-height junctions include the necessary change-of-height trim (including junction cap and aligners) for the change-of-height portion.

Beam-to-panel change-of height junctions are available in L, T, and X configurations.

Beam-to-panel change-of-height junctions support L, T, and X connections for up to two different heights.

Change-of-height trim is available for beam-to-panel connections for L, T, and X configurations.

Beam-to-panel change-of-height junctions are shipped assembled.

L Beam-to-Panel Change-of-Height Junction

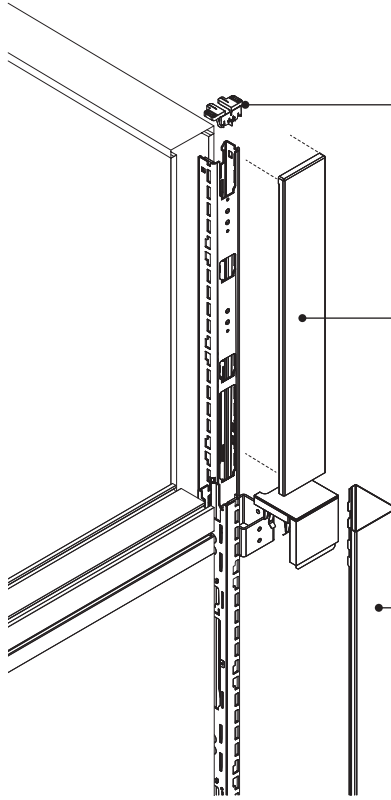

An end-of-run aligner is included with the end-of-run change-of-height trim to provide tight alignment between the panel top cap and the change-of-height trim. No junction cap is required.

End-of-run change-of-height trim is used at end-of-run or in-line change-of-height. The top of the trim aligns with the top cap on the panel.

L vertical trim is used to finish trimming out the base of the beam-to-panel connection. Vertical trim is included when specifying the change-of-height junction.

T vertical trim is used to finish trimming out the base of the beam or panel. Vertical trim is included when specifying the change-of-height junction.

T Beam-to-Panel Change-of-Height Junction

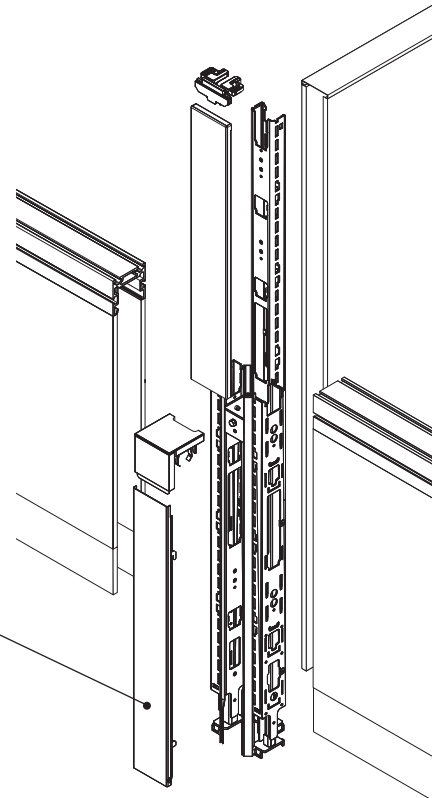

Actual Dimensions

Depth	3"
Change-of-Height Trim Height	7 ¹ / ₈ ", 13 ³ / ₈ ", 15 ⁹ / ₁₆ ", 25 ³ / ₄ ", 31 ¹⁵ / ₁₆ ", and 38 ¹ / ₈ "

X Beam-to-Panel Change-of-Height Junction

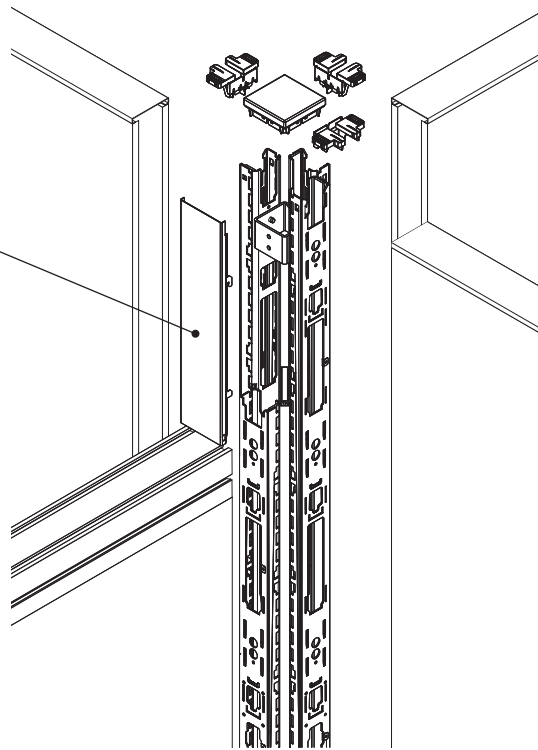

T corner change-of-height trim is used in T or X change-of-height applications where there are two panels at the same height located in-line with each other.

Product Details

Beam-to-panel change-of-height junctions connect beam junctions to 36"H, 48"H, 54"H, and 66"H panel junctions.

L beam-to-panel change-of-height connections are handed due to the handedness of the junction cap. The correct handed L beam-to-panel change-of-height junction style number should be specified.

Handedness of L beam-to-panel change-of-height junctions is determined by which side of the beam the panel is on when looking down the beam.

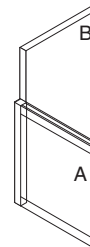

For right hand L beam-to-panel change-of-height junction, the panel is on the right side of the beam.

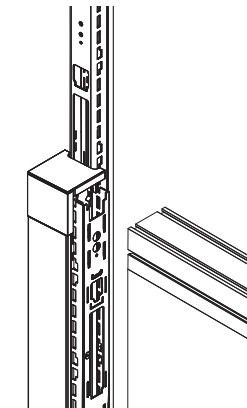

Right-handed L beam-to-panel change-of-height junctions include the following style numbers:

- TSB2QCLJ
- TSB24CLJ
- TSB28CLJ
- TSB25CLJ
- TSB26CLJ

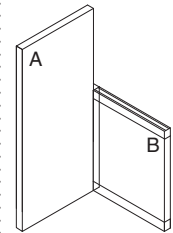

For left hand L beam-to-panel change-of-height junction, the panel is on the left side of the beam.

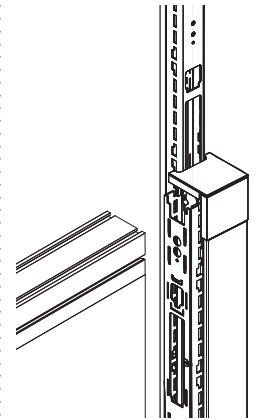

Left-hand L beam-to-panel change-of-height junctions include the following style numbers:

- TSBQ2CLJ
- TSB42CLJ
- TSB82CLJ
- TSB52CLJ
- TSB62CLJ

L beam-to-panel change-of-height junctions include a handed beam junction cap.

T beam-to-panel change-of-height junctions connecting two beam segments and one panel segment include a T beam junction cap.

T beam-to-panel change-of-height junctions connecting one beam segment and two panel segments include a 90° panel junction cap.

X beam-to-panel change-of-height junctions include a 90° panel junction cap.

Answer Beam-to-Panel Change-of-Height Junctions, continued

The beam-to-panel change-of-height junctions include the necessary change-of-height panel trim to finish the junction.

Change-of-height trim for the beam-to-panel configurations supported by style numbers are available to order separately from the junction and support reconfiguration.

Left-handed L, right-handed L, T, and X change-of-height junction caps for beam-to-panel configurations are available to order separately from the junction and support reconfiguration.

Surface Materials

Change-of-height trim

- Paint

Junction cap

- Paint

Aligner

- Black plastic only

Answer Beam-to-Panel Change-of-Height Visual Overview

Selecting a Junction

To determine the application you need, follow these steps:

1. Find the type of beam-to-panel change-of-height junction required – L, T, or X. All the applications that are supported by style numbers are shown on the following pages.

2. It may help if you make a sketch of the junction you are trying to build and then match it with the junction shown on the following pages.

3. Find the type of junction you are looking for in the following pages and see the corresponding specifying page.

Style numbers for junctions are based on the heights of the frames.

Digit in Style Number	Corresponding Frame Height
-----------------------	----------------------------

2	28 1/2"
Q	36"
4	42"
5	54"
6	66"
8	48"

Right-Handed L Configuration

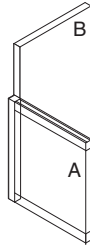

A	B	Style Number
28 1/2"	36"	TSB2QCLJ
28 1/2"	42"	TSB24CLJ
28 1/2"	48"	TSB28CLJ
28 1/2"	54"	TSB25CLJ
28 1/2"	66"	TSB26CLJ

▶ Page 171 to specify

Junction includes

- Right-handed L beam-to-panel change-of-height junction
- Inside corner light seal
- L vertical beam trim
- End-of-run change-of-height panel trim
- Right-handed L beam-to-panel change-of-height junction cap
- Aligners

Tip: When specifying, remember this junction is handed. Specify the correct L beam-to-panel change-of-height junction.

Left-Handed L Configuration

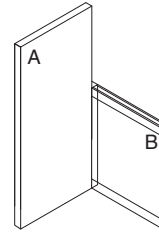

A	B	Style Number
36"	28 1/2"	TSBQ2CLJ
42"	28 1/2"	TSB42CLJ
48"	28 1/2"	TSB82CLJ
54"	28 1/2"	TSB52CLJ
66"	28 1/2"	TSB62CLJ

▶ Page 171 to specify

Junction includes

- Left-handed L beam-to-panel change-of-height junction
- Inside corner light seal
- L vertical beam trim
- End-of-run change-of-height panel trim
- Left-handed L beam-to-panel change-of-height junction cap
- Aligners

Tip: When specifying, remember this junction is handed. Specify the correct L beam-to-panel change-of-height junction.

T Junctions

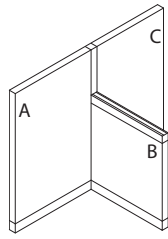
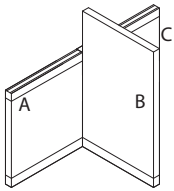

A	B	C	Style Number
28 1/2"	36"	28 1/2"	TSB2Q2CTJ
28 1/2"	42"	28 1/2"	TSB242CTJ
28 1/2"	48"	28 1/2"	TSB282CTJ
28 1/2"	54"	28 1/2"	TSB252CTJ
28 1/2"	66"	28 1/2"	TSB262CTJ

▶ Page 172 to specify

Junction includes

- T beam-to-panel change-of-height junction
- Inside corner light seals
- T vertical beam trim
- End-of-run change-of-height panel trim
- T beam-to-panel change-of-height junction cap
- Aligners

A	B	C	Style Number
36"	28 1/2"	36"	TSBQ2QCTJ
42"	28 1/2"	42"	TSB424CTJ
48"	28 1/2"	48"	TSB828CTJ
54"	28 1/2"	54"	TSB525CTJ
66"	28 1/2"	66"	TSB626CTJ

▶ Page 172 to specify

Junction includes

- T beam-to-panel change-of-height junction
- Inside corner light seals
- T vertical beam trim
- T change-of-height panel trim
- 90° junction cap
- Aligner

X Junctions

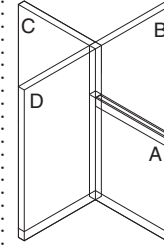
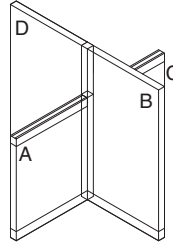

A	B	C	D	Style Number
28 1/2"	36"	28 1/2"	36"	TSB2Q2QCXJ
28 1/2"	42"	28 1/2"	42"	TSB2424CXJ
28 1/2"	48"	28 1/2"	48"	TSB2828CXJ
28 1/2"	54"	28 1/2"	54"	TSB2525CXJ
28 1/2"	66"	28 1/2"	66"	TSB2626CXJ

▶ Page 173 to specify

Junction includes

- X beam-to-panel change-of-height junction
- Inside corner light seals
- Two T change-of-height panel trims
- 90° junction cap
- Aligner

A	B	C	D	Style Number
28 1/2"	36"	36"	36"	TSB2QQQCXJ
28 1/2"	42"	42"	42"	TSB2444CXJ
28 1/2"	48"	48"	42"	TSB2888CXJ
28 1/2"	54"	54"	54"	TSB2555CXJ
28 1/2"	66"	66"	66"	TSB2666CXJ

▶ Page 173 to specify

Junction includes

- X beam-to-panel change-of-height junction
- Inside corner light seals
- T change-of-height panel trim
- 90° junction cap
- Aligners

Answer Beam Horizontal Frame Packages

Beam horizontal frame packages include horizontal connecting bars that lock into vertical junctions and complete the structure of beam. A pair of base trims are also included. Cable tray and base cable tray are available as options.
 ▶ Specifying, page 182

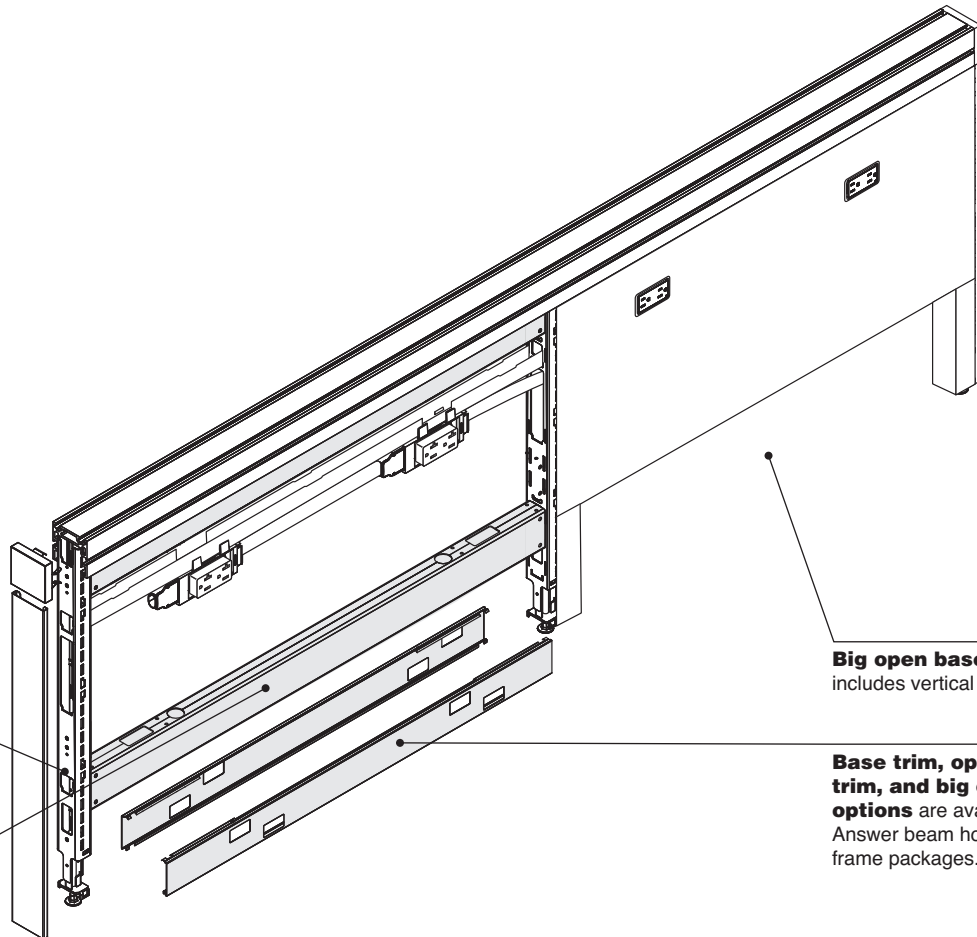

Quick lock connects horizontal connecting bars to vertical junctions for quick assembly.

Horizontal connecting bars lock into vertical junctions. The bottom bar must always be positioned in the lowest slot in a junction.

Big open base option includes vertical trim.

Base trim, open base trim, and big open base options are available on Answer beam horizontal frame packages.

Actual Dimensions

Width 23¹³/₁₆" , 29¹³/₁₆" , 35¹³/₁₆" , 41¹³/₁₆" , 47¹³/₁₆" , 59¹³/₁₆" , and 71¹³/₁₆"

Base trim height 3³/₄"

Big open base height 9¹¹/₁₆"

Receptacle Knockout

Width of opening 2⁵/₈"

Height of opening 1³/₈"

Product Details

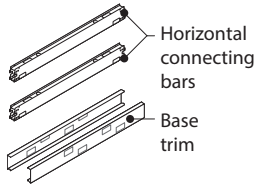

Beam horizontal frame packages include horizontal connecting bars and base trims. Options for big open base and open base are available. Cable trays and base cable trays are optional. Skins, top cap rail, and beam vertical junctions are specified separately.

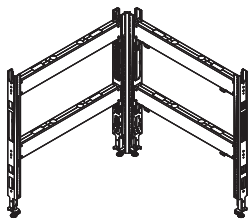

Two horizontal connecting bars must be used in each beam segment.

Horizontal connecting bars determine beam segment width.

Horizontal connecting bars can be used and reused across Answer panel, Answer beam, and Answer fence applications.

The beam top cap rail is specified separately and is not included in the beam horizontal frame package.

Omit base trim option should be selected when using skins to the floor.

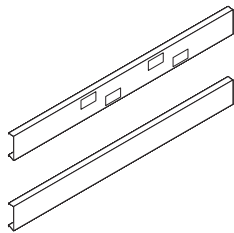

Base trims are available with or without knockouts. Base trims with knockouts accommodate power and communication terminations.

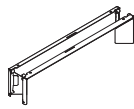

Open base trims are available. They do not accommodate power and data routing or entry in the base.

Open base trims occupy the same space as the standard base trims. Open base trims occupy the bottom 3¾" of the beam segment; the height of the opening is 2½".

Standard base trims and open base trims can be used and reused on Answer panel applications.

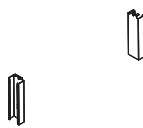

Big open base option is available on beam. The beam horizontal frame package includes two inside vertical trims in addition to two horizontal connecting bars.

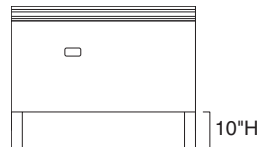

Big open base option provides a larger open base aesthetic for the beam. The opening is 10"H.

When the big open base option is specified, big open base skins must be used.

Big open base trim package is available for reconfiguring a beam segment from standard base trim to the big open base. The big open base trim package includes two inside vertical trims.

When beam big open base is used, power is available only at 20"H.

For a power and data infeed cover for use with Answer panel or Answer Beam big open base trim, contact Specials.

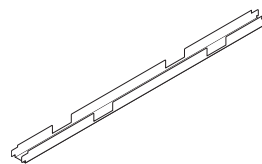

Cable tray can be positioned every 6" vertically above the base to support cable routing.

Cable tray can accept added cable carriers attached below tray to expand horizontal cable management options. ▶ See *Montage Specification Guide* for cable carrier (ZCC).

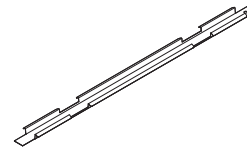

Base cable tray is used only in the base to support lay-in cable routing in the base. Base cable tray cannot be used if omit base trim option is selected for one or both sides of the beam segment, or if open base trim or big open base trim is used.

Connections

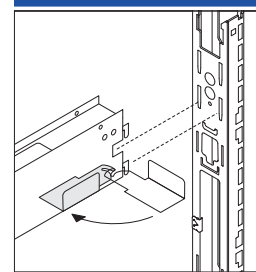

Quick lock on both ends of beam's horizontal connecting bars engage the junction in a tight structural connection.

Wiring & Cabling

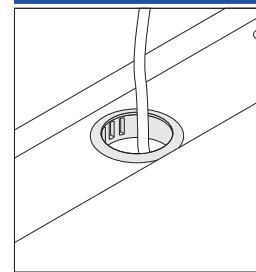

Feed-through horizontal connecting bar cable sleeves can be added in the field to finish the exposed metal edges of vertical cable pass-through openings.

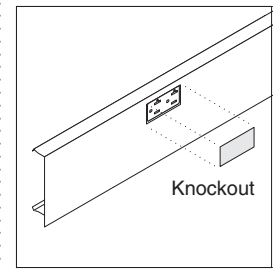

Knockouts in base trim can be removed in the field where needed. Knockout dimensions are 1⅜"H by 2⅝"W.

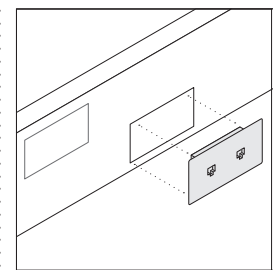

Communication outlets attach to openings in beam base trim. Order communication outlets from an outside vendor. Knockouts for communication in base accommodate modular furniture size only.

Surface Materials

Horizontal connecting bars
• Black paint
Tip: Components are hidden when properly installed.

Base trim, open base trim, and big open base inside vertical trim
• Paint

Application Topics

A cable tray can be used to provide extra support for 60"W and 72"W full skins where people may lean against the beam.

Answer Beam Top Cap Rail

Answer beam top cap rail can support stanchion mounted storage, connect screens, and tether worksurfaces to create a lighter-scale, efficient workstation.
 ▶ Specifying, page 185

Top cap rail

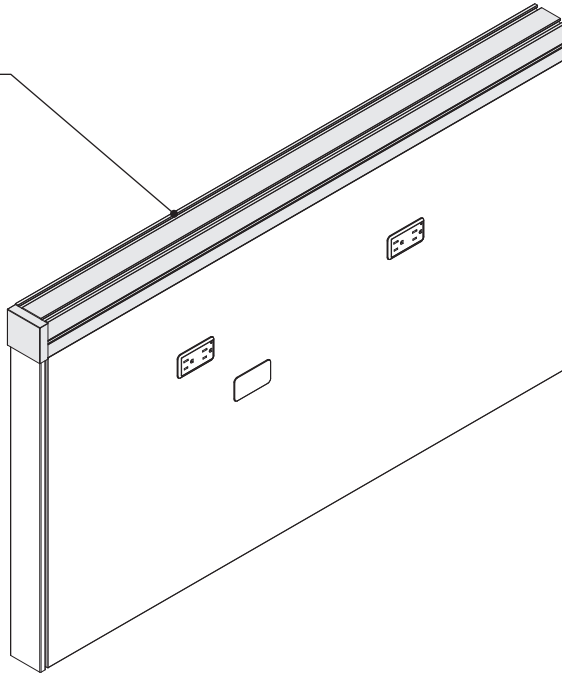

Product Details

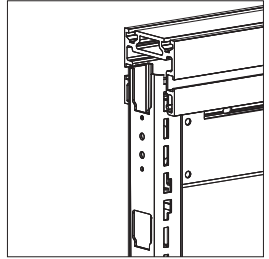

Beam top cap rail connects to the horizontal connecting bar in the top position.

Beam top cap rail can span in-line beam junctions.

Spanning top cap rails can only be used in an in-line condition. They cannot span over a corner junction.

Beam top cap rail can span the following Answer beam in-line junction combinations.

Beam Top Cap Rail Width	Combination of Junction Widths
48"W	24"W + 24"W
54"W	30"W + 24"W
60"W	30"W + 30"W
66"W	36"W + 30"W
72"W	36"W + 36"W
78"W	42"W + 36"W
84"W	42"W + 42"W
90"W	42"W + 48"W
96"W	48"W + 48"W

Actual Dimensions

Width 24", 30", 36", 42", 48", 54", 60", 66", 72", 78", 84", 90", and 96"

Connections

Currency storage can be stanchion-mounted off the top cap rail.

▶ See *Currency Specification Guide*.

The Universal screen for Answer beam can be connected to the beam top cap rail.

Universal worksurfaces can be tethered to Answer beam top cap rail in both parallel and perpendicular applications.

Dash LED lights, dash mini LED lights, LED radial or linear desktop lights, and SOTO LED lights are compatible and connect to the Answer beam top cap rail.

▶ See *Worktools Specification Guide*.

Surface Materials

Top cap

- Clear anodized aluminum only

Answer Panel and Beam Foot

The Answer panel and beam foot

supports a freestanding beam run without additional support from corner beam-to-beam junctions, beam-to-panel connections, tethered low storage or, tethered worksurfaces.

► Specifying, page 186



Panel and beam foot

Product Details

Panel and beam foot attaches to end-of-run and in-line junctions to support a freestanding beam run.

Answer panel and beam foot is compatible with Answer panel and Answer beam.

Vertical attachment post is offset on the panel and beam foot and allows for a choice of proud or inset installation at the end-of-run by rotating the panel and beam foot.

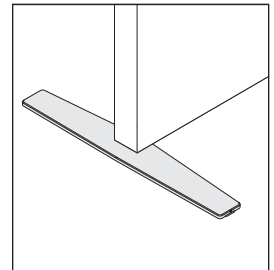

Panel and beam foot positioned proud of the end of run accommodates Ology, Migration, and Airtouch height-adjustable desks. It is used parallel to the panel without overlapping desk supports and panel feet.

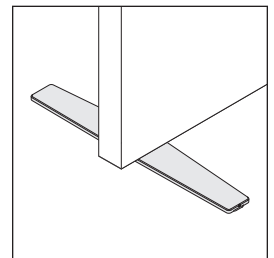

Panel and beam foot positioned inset from the end-of-run provides a cleaner visual and accommodates Ology, Migration, and Airtouch height-adjustable desks.

Actual Dimensions

Width	3¼"
Length	21"
Height	5/8"

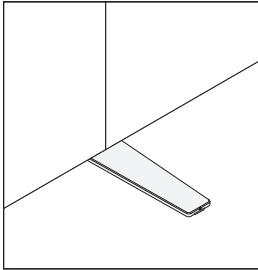

Panel and beam foot will be centered on beam in-line junctions.

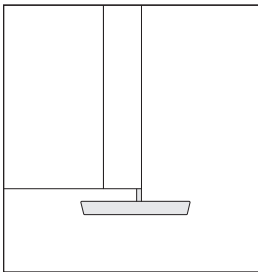

Glide for use with panel and beam foot is included in the beam junction. This glide is designed to maintain standard beam height and minimize the gap between the beam and floor.

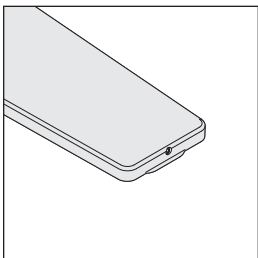

Set screws in the end of the foot provide 1/4" of micro adjustment.

Surface Materials

- Foot**
 - Paint

Application Topics

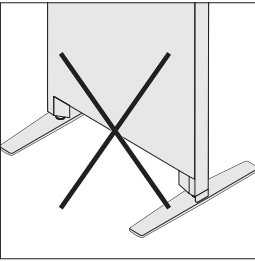

Open base trim cannot be used in conjunction with a panel and beam foot.

Big open base trim can be used in conjunction with a panel and beam foot.

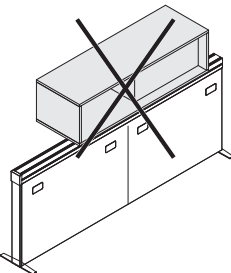

Stanchion mounted storage is not permitted on freestanding beam runs supported only by panel and beam feet.

The Answer fence foot cannot be used on the Answer beam.

Wiring & Cabling

Panel and beam foot blocks power routing in the beam base and just above the base areas. The vertical attachment post covers the slots on the junction where the powerkit connects in these two zones. It also blocks the ability for a powerkit harness, pass-through powerkit, or modular harness to route in the base area from an adjacent beam segment.

Base power infeed cannot be located in beam section where a panel and beam foot is located. Place infeed in adjacent section.

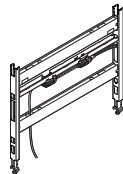

Multipurpose infeed connects power from the building floor into a panel run supported by panel feet. Conduit can be run under the beam or through a knockout in the basetrim.

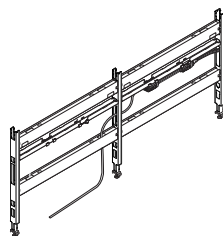

San Francisco power infeed can be used if liquid tight conduit is required. Plan to have a long enough infeed to attach to a modular power kit in the beam segment adjacent to the entry panel.

Power can be accessed in the third position up from the base through field cut fabric skins or receptacle cutouts in steel skins.

Understanding Answer Beam Skins



Statement of Line **34**



Fabric-Covered Beam Skins **36**

Steel Beam Skins **38**

Laminate Beam Skins **41**

Wood Beam Skins **42**

Statement of Line

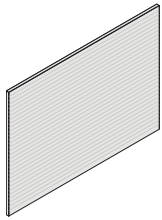

Understanding
 ▶ Page 36
 Specifying
 ▶ Pages 188–190

Fabric-Covered Beam Skins

	24"W	30"W	36"W	42"W	48"W	60"W	72"W
15 ⁵ / ₈ "H	●B	●B	●B	●B	●B	●B	●B
21 ¹ / ₆ "H	●	●	●	●	●	●	●
24 ⁷ / ₈ "H	●F	●F	●F	●F	●F	●F	●F

B = Big open base sizes

F = To the floor sizes

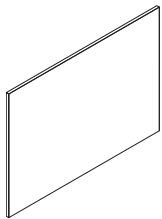

Understanding
 ▶ Page 38
 Specifying
 ▶ Pages 191–193

Steel Beam Skins

	24"W	30"W	36"W	42"W	48"W	60"W	72"W
15 ⁵ / ₈ "H	●B	●B	●B	●B	●B	●B	●B
21 ¹ / ₆ "H	●	●	●	●	●	●	●
24 ⁷ / ₈ "H	●F	●F	●F	●F	●F	●F	●F

B = Big open base sizes

F = To the floor sizes

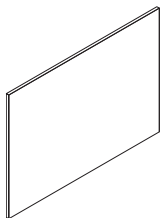

Understanding
 ▶ Page 41
 Specifying
 ▶ Pages 194–195

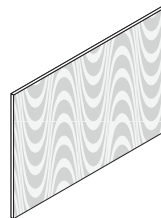

Understanding
 ▶ Page 42
 Specifying
 ▶ Pages 196–197

Laminate Beam Skins

	24"W	30"W	36"W	42"W	48"W
21 ¹ / ₆ "H	●	●	●	●	●
24 ⁷ / ₈ "H	●F	●F	●F	●F	●F

F = To the floor sizes

Tip: Laminate beam skins are not available with the big open base.

Wood Beam Skins

	24"W	30"W	36"W	42"W	48"W
21 ¹ / ₆ "H	●	●	●	●	●
24 ⁷ / ₈ "H	●F	●F	●F	●F	●F

F = To the floor sizes

Tip: Wood beam skins are not available with the big open base.



Answer Beam
Skins

Fabric-Covered Beam Skins

Fabric-covered beam skins are tackable acoustical and available in multiple configurations to finish the appearance of a beam.
 ▶ Specifying, pages 188–190

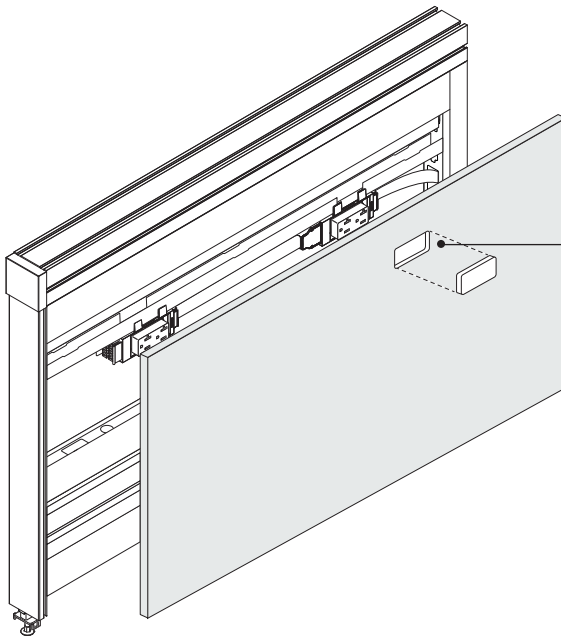

Power and communication can be accessed at 20" and just above the base by cutting skin in the field. Templates for cutting both receptacle and communication cutouts are available from Service Parts (T500940SR). Filler to close unwanted cutout in a skin is available from Service Parts (TS7STFSR).

Product Details

Fabric-covered beam skins are available in standard height, to-the-floor height, and big open base height.

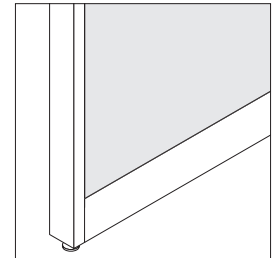

Standard height beam skins are sized to work in conjunction with base trims to finish the beam.

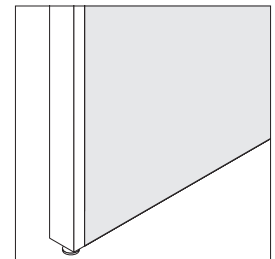

To-the-floor skins are sized to extend to the bottom of the beam. They can be used on one or both sides of the beam.
Tip: Omit base trim option should be selected on the horizontal frame when using beam skins to the floor.

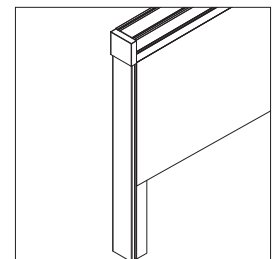

Big open base skins are sized to work in conjunction with big open base trims, leaving the bottom of the beam open. They must be used on both sides of a beam.
Tip: Select the big open base option on horizontal frames that are receiving big open base height skins.

Actual Dimensions

Width	23 ¹³ / ₁₆ " , 29 ¹³ / ₁₆ " , 35 ¹³ / ₁₆ " , 41 ¹³ / ₁₆ " , 47 ¹³ / ₁₆ " , 59 ¹³ / ₁₆ " , and 71 ¹³ / ₁₆ "
Height Standard Size	21 ¹ / ₁₆ "
Height To the Floor Size	24 ⁷ / ₈ "
Height Big Open Base Size	15 ⁵ / ₈ "

Connections

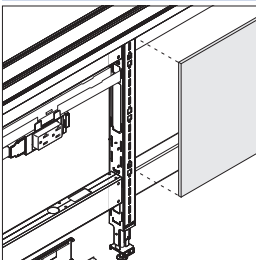

Skins extend onto junction and meet skin of adjacent beam segment.

Skins for Answer beam are unique to the Answer beam and are not compatible with Answer panel buildups.

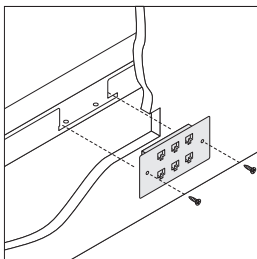

NEMA-size communication outlets can be installed on the face of a beam skin without using a faceplate, but just the screws. Order communication outlets from an outside vendor. NEMA-size communication outlets cannot be used in the base.

Wiring & Cabling

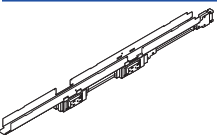

Powerkits are available in widths that correspond to beam widths.

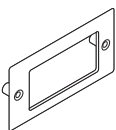

Faceplate is used to surround receptacle when field-cutting fabric skins. Specify receptacle (TS7RC) and faceplate (TS7UFPLATE) for each cutout.

Surface Materials

Skins
• Fabric

Fabric application is standard in the warp horizontal direction. Warp vertical direction is available as an option. Exceptions to this are all 72"W skins, which can only accommodate fabric in the horizontal direction. ▶ See *Specification Guidelines for Directional Fabrics*, page 364, for more information.

Application Topics

Answer Beam buildups
▶ Page 12

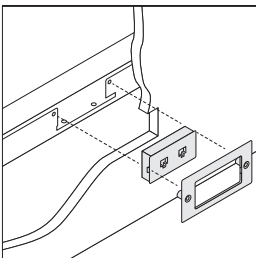

Faceplate, ordered separately, is used to surround modular furniture size communication outlet when field-cutting fabric skins.

Steel Beam Skins

Steel beam skins provide a clean, finished look to a beam and offer multiple options for access to power and data.

► Specifying, pages 191–193

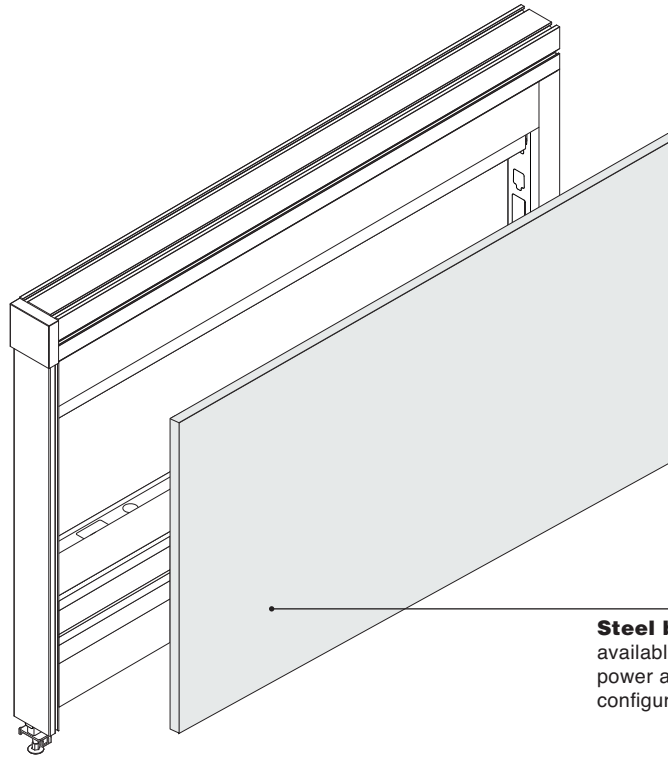

Steel beam skins are available in a number of power and data cutout configurations.

Product Details

Steel beam skins are available in standard height, to-the-floor height, and big open base height.

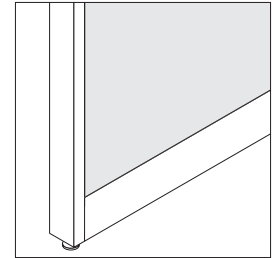

Standard height beam skins are sized to work in conjunction with base trims to finish the beam.

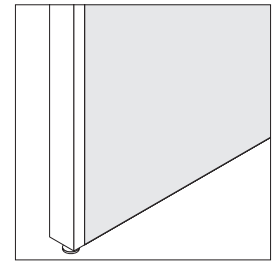

To-the-floor skins are sized to extend to the bottom of the beam. They can be used on one or both sides of the beam.

Tip: Omit base trim option should be selected on the horizontal frame when using beam skins to the floor.

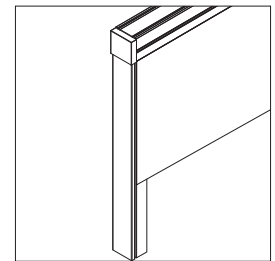

Big open base skins are sized to work in conjunction with big open base trims, leaving the bottom of the beam open. They must be used on both sides of a beam.

Tip: Select the big open base option on horizontal frames that are receiving big open base height skins.

Steel beam skins are only available in painted steel.

Actual Dimensions	
Width	23 ¹³ / ₁₆ ", 29 ¹³ / ₁₆ ", 35 ¹³ / ₁₆ ", 41 ¹³ / ₁₆ ", 47 ¹³ / ₁₆ ", 59 ¹³ / ₁₆ ", and 71 ¹³ / ₁₆ "
Height Standard Size	21 ¹ / ₁₆ "
Height To the Floor Size	24 ⁷ / ₈ "
Height Big Open Base	15 ⁵ / ₈ "

Connections

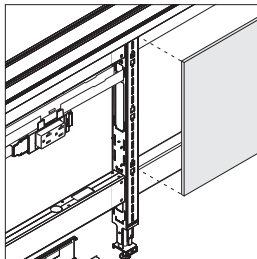

Skins extend onto junction and meet skin of adjacent beam segment.

Skins for Answer beam are unique to the Answer beam and are not compatible with Answer panel buildups.

Wiring & Cabling

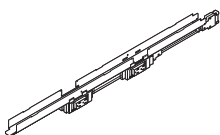

Powerkits are available in widths that correspond to beam widths.

Power and data can be accessed at 20"H in steel skins by specifying power and data cutouts.

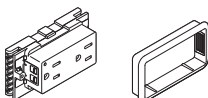

For 20"H power access in steel skins, specify TS7RC receptacles and TS7RCT trim rings for each cutout.

For 24"W and 30"W steel skins, hardwire receptacle cutout option will always have a single centered hardwire cutout.

For 36"W and wider steel skins, hardwire receptacle cutout option will always come with a left and right hardwire cutout.

Data cutouts are available in furniture style data cutouts and NEMA data cutouts.

Surface Materials

Skins

- Painted steel

Application Topics

Answer beam buildups

▶ Page 12

Steel skins with modular power cutouts are available in the following cutout configurations.

24"W steel skins are available in the following modular power and data cutout configurations:



30"W steel skins are available in the following modular power and data cutout configurations:

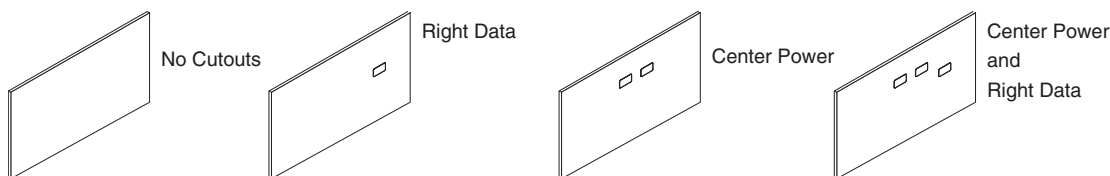

36"W steel skins are available in the following modular power and data cutout configurations:

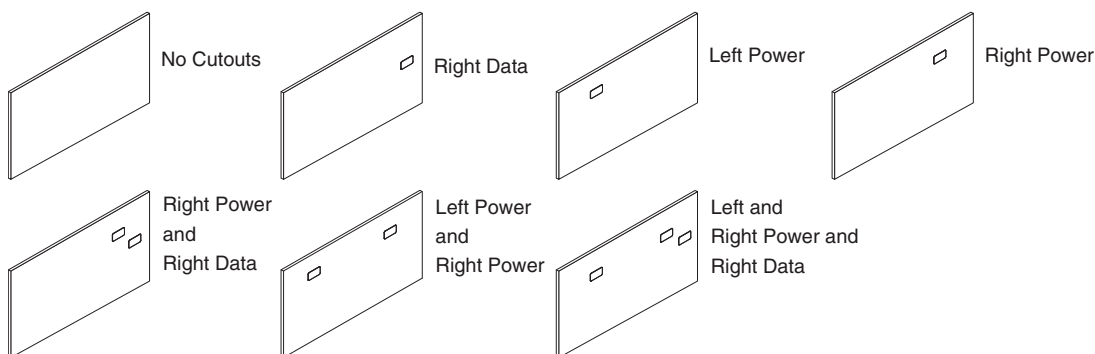

42"W and 48"W steel skins are available in the following modular power and data cutout configurations:

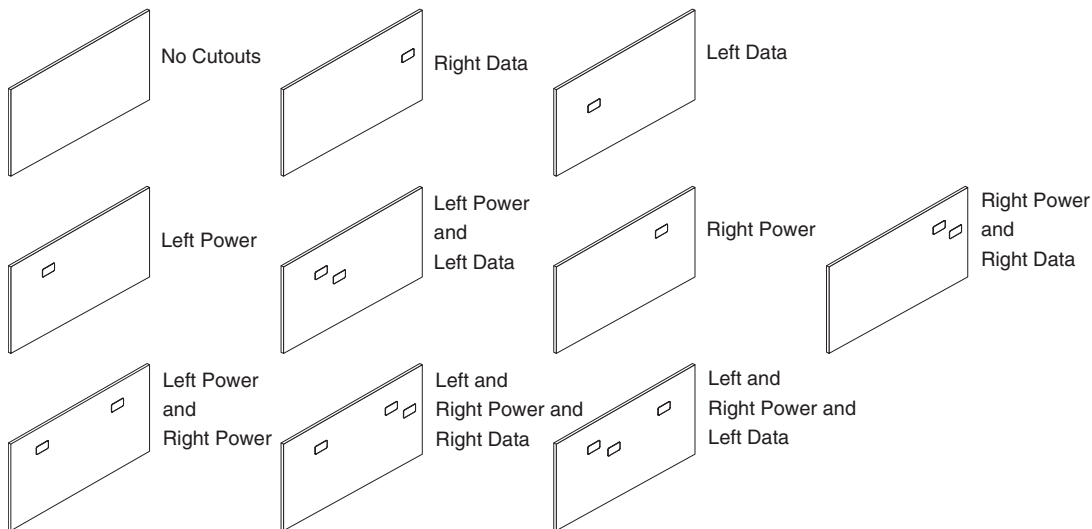

Steel Beam Skins, continued

Application Topics, continued

60"W and 72"W steel skins are available in the following modular power and data cutout configurations:

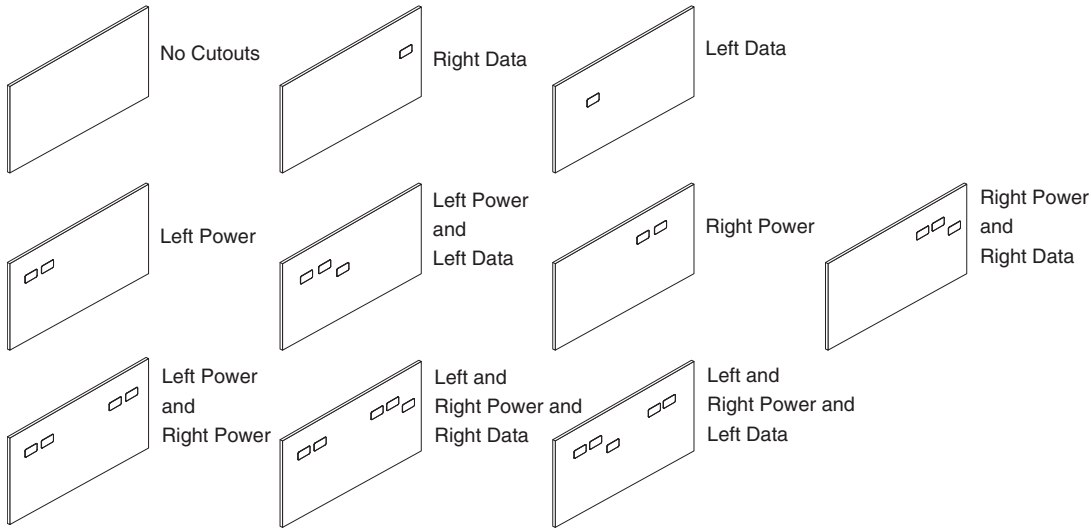

Steel skins with hardwire power cutouts are available in the following cutout configurations.

24"W and 30"W steel skins are available in the following hardwire power and data cutout configurations:

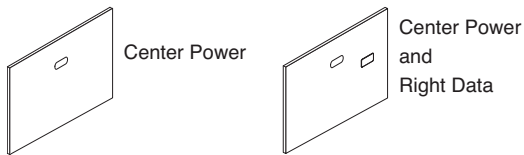

36"W steel skins are available in the following power and data cutout configurations:

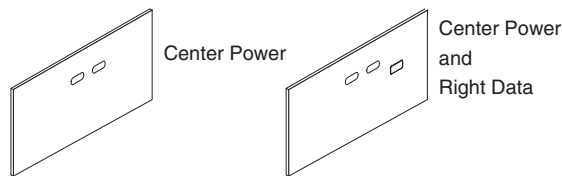

42", 48", 60", 72"W steel skins are available in the following power and data cutout configurations:

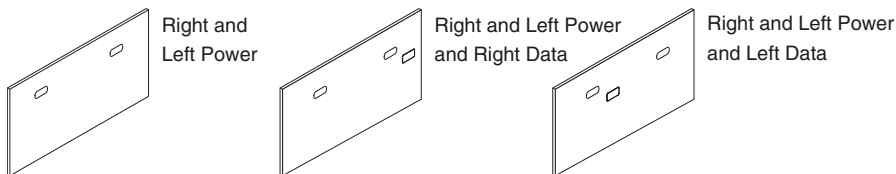

Laminate Beam Skins

Laminate skins attach to frames to finish the appearance of a beam.

► Specifying, pages 194–195

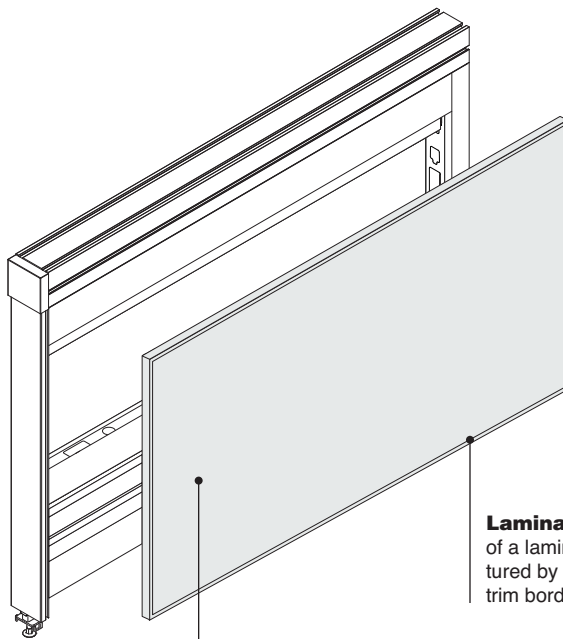

Laminate skins consist of a laminate surface captured by a painted metal trim border on all sides.

Laminate skins are non-tackable.

Skins can be removed and repositioned.

Actual Dimensions

Width 25⁵³/₆₄" , 29⁵³/₆₄" , 35⁵³/₆₄" , 41⁵³/₆₄" , and 47⁵³/₆₄"

Height Standard Size 21¹/₁₆"

Height To the Floor Size 24⁷/₈"

Product Details

Laminate beam skins are available in standard height and to-the-floor height.

Laminate beam skins are not available on the big open base.

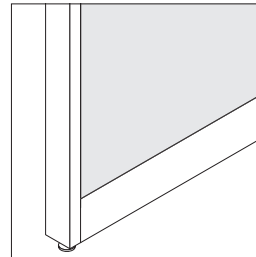

Standard height beam skins are sized to work in conjunction with base trims to finish the beam.

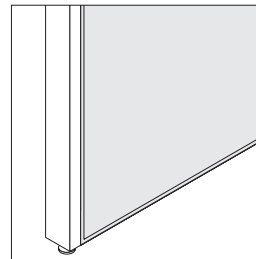

To-the-floor skins are sized to extend to the bottom of the beam. They can be used on one or both sides of the beam.

Tip: Omit base trim option should be selected on the horizontal frame when using beam skins to the floor.

Connections

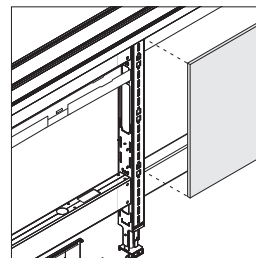

Skins extend onto junction and meet skin of adjacent beam segment.

Skins for Answer beam are unique to the Answer beam and are not compatible with Answer panel buildups.

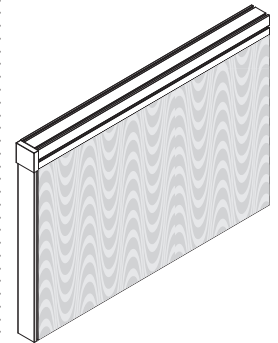

Woodgrain and directional laminate patterns run vertically as standard with an option of running horizontally.

Wiring & Cabling

Power and communication cannot be accessed in laminate skins.

Surface Materials

Laminate skins

- Laminate (standard)
- Open Line laminate (option)

Trim

- Paint

Price Group 1 (Smooth)

- 4238 Mocha
- 4239 Clay
- 4240 Chalk
- 4242 Milk

Price Group 2 (Textured)

- 7207 Black
- 7225 Sand
- 7237 Slate
- 7241 Arctic White
- 7243 Seagull
- 7250 Sterling Dark Solid
- 7360 Merle

Price Group 2 (Metallic)

- 4799 Platinum Metallic

Tip: Consider adjacent panel trim paint color.

Wood Beam Skins

Wood skins attach to frames to finish the appearance of a beam.

► Specifying, pages 196–197

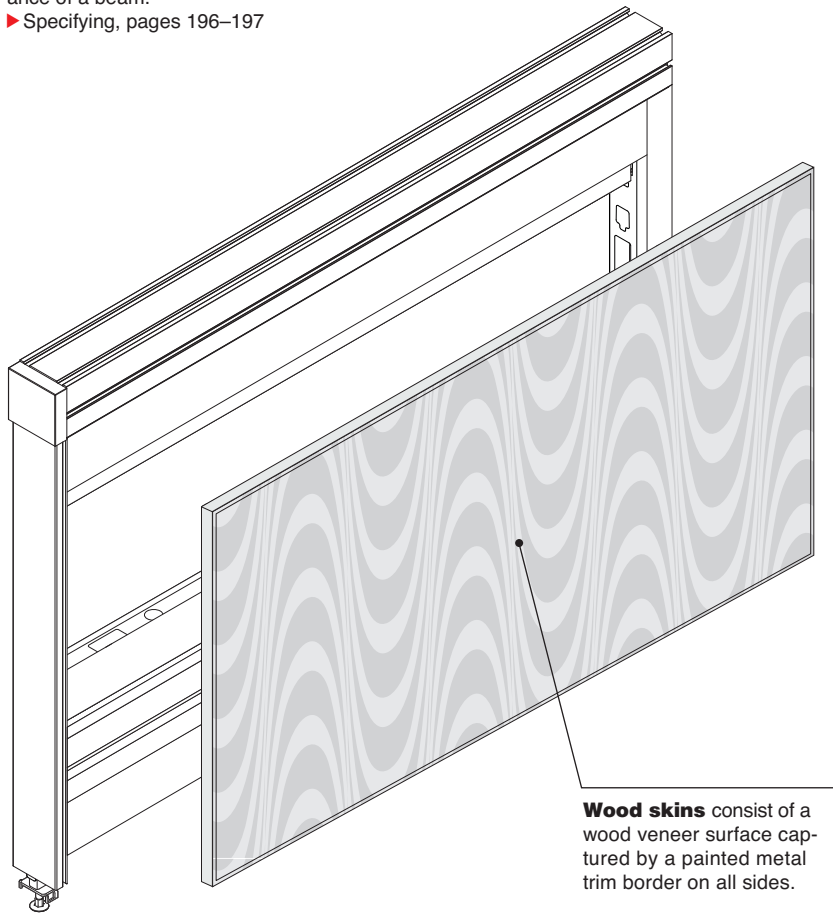

Wood skins consist of a wood veneer surface captured by a painted metal trim border on all sides.

Wood skins are non-tackable.

Wood skins can be removed and repositioned on another frame.

Vertical grain direction is standard on wood skins. Horizontal grain direction is available as an option.

Product Details

Wood beam skins are available in standard height and to-the-floor height.

Wood beam skins are not available on the big open base.

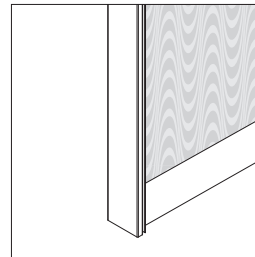

Standard height beam skins are sized to work in conjunction with base trims to finish the beam.

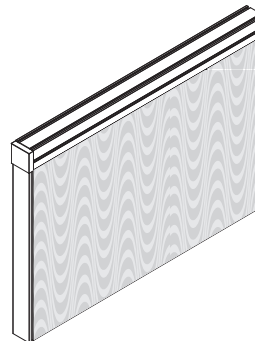

To-the-floor skins are sized to extend to the bottom of the beam. They can be used on one or both sides of the beam.

Tip: Omit base trim option should be selected on the horizontal frame when using beam skins to the floor.

Connections

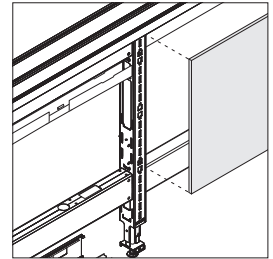

Skins extend onto junction and meet skin of adjacent beam segment.

Skins for Answer beam are unique to the Answer beam and are not compatible with Answer panel buildups.

Wiring & Cabling

Power and communication cannot be accessed in wood skins.

Surface Materials

Wood skins

- Natural wood veneer (standard)
- Customiz stain (option)

Trim

- Paint

Price Group 1 (Smooth)

- 4238 Mocha
- 4239 Clay
- 4240 Chalk
- 4242 Milk

Price Group 2 (Textured)

- 7207 Black
- 7225 Sand
- 7237 Slate
- 7241 Arctic White
- 7243 Seagull
- 7250 Sterling Dark Solid
- 7360 Merle

Price Group 2 (Metallic)

- 4799 Platinum Metallic

Tip: Consider adjacent panel trim paint color.

Actual Dimensions

Width 23⁵³/₆₄", 29⁵³/₆₄", 35⁵³/₆₄", 41⁵³/₆₄", and 47⁵³/₆₄"

Height Standard Size 21¹/₁₆"

Height To the Floor 24⁷/₈"

Understanding Answer Beam Power

All Answer electrical components are listed by Underwriters Laboratory (UL) and certified by the Canadian Standards Association (CSA).



Statement of Line	44
Wiring Schematics	47
How to Calculate Power Needs	48
Cable Capacities	50
Interface Products	
Beam Utility Pole - L, T, and X Junctions	52
Beam End-of-Run Junction with Utility Pole	54
Base Power Infeed	56
Special Requirements for New York City	57
Distribution Products	
Powerkits	58
Pass-Through Powerkits	58
Cable Trays	58
Modular Harness	60
Multipurpose Power Infeed	60
Special Requirements for Hardwired Solution	61
Access Products	
Receptacle	62
USB Receptacle	62
Blank Receptacle	62
Receptacle Trim Ring	63
Faceplate	63
Beam Receptacle Filler	63
Data Filler	63
Accessories	
Junction Tall Sleeve	64
Feed-Through Horizontal Cable Sleeve	64
Grommet for Vertical Junction and Horizontal Connecting Bars	64
Grommet for Junction	65
Duplex Cable Grommet	65
Under Worksurface Cable Manager	65

Statement of Line

Interface Products

The **interface** is the point at which the utilities within a beam connect to a building's power and communication network. All power components are field installed.

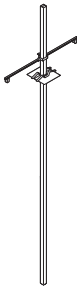

Beam Utility Pole-L, T, and X Junctions

Understanding
 ▶ Page 52
 Specifying
 ▶ Page 200

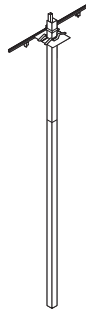

Beam End-of-Run Junction with Utility Pole

Understanding
 ▶ Page 54
 Specifying
 ▶ Page 201

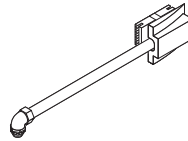

Base Power Infeeds

Understanding
 ▶ Page 56
 Specifying
 ▶ Page 202

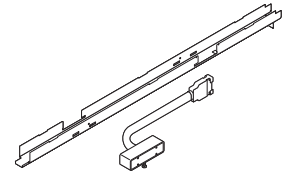

Base Power Infeed for Use in New York City

Understanding
 ▶ Page 57
 Specifying
 ▶ Page 203

Distribution Products

Distribution refers to the way that power and communication networks are routed through a beam.

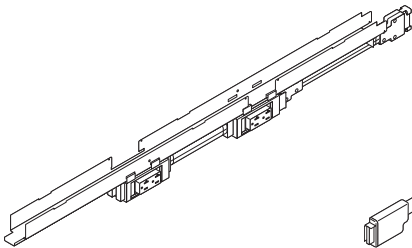

Powerkits

Understanding
 ▶ Page 58
 Specifying
 ▶ Page 204

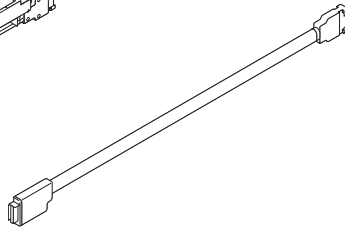

Pass-Through Powerkits

Understanding
 ▶ Page 58
 Specifying
 ▶ Page 205

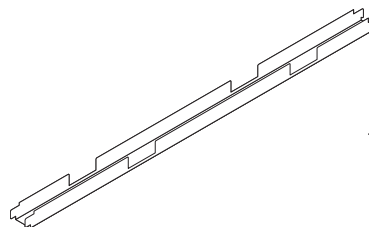

Cable Trays

Understanding
 ▶ Page 58
 Specifying
 ▶ Page 206

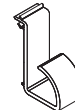

Under Worksurface Cable Manager

Understanding
 ▶ Page 65
 Specifying
 ▶ Page 207

Distribution Products, continued

Distribution refers to the way that power and communication networks are routed through a beam.

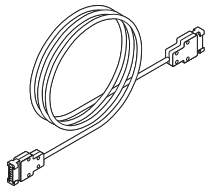

Modular Harness
 Understanding
 ▶ Page 60
 Specifying
 ▶ Page 208

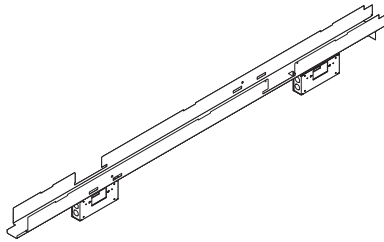

Hardwired Powerkits
 Understanding
 ▶ Page 61
 Specifying
 ▶ Page 209

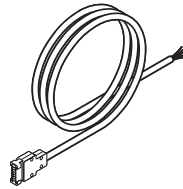

Multipurpose Power Infeed
 Understanding
 ▶ Page 60
 Specifying
 ▶ Page 210



Multipurpose Infeed Conduit Covers
 Understanding
 ▶ Page 60
 Specifying
 ▶ Page 210

Access Products

Access to power and communication networks is accommodated by power receptacles and communication outlets installed in a beam.

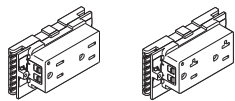

Receptacles
 Understanding
 ▶ Page 62
 Specifying
 ▶ Page 211



USB Receptacles
 Understanding
 ▶ Page 62
 Specifying
 ▶ Page 212

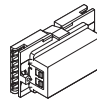

Blank Receptacle Cut-Out Cover
 Understanding
 ▶ Page 62
 Specifying
 ▶ Page 213



Receptacle Trim Ring
 Understanding
 ▶ Page 63
 Specifying
 ▶ Page 214

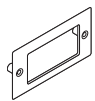

Faceplate
 Understanding
 ▶ Page 63
 Specifying
 ▶ Page 215



Beam Receptacle Filler
 Understanding
 ▶ Page 63
 Specifying
 ▶ Page 216



Data Filler
 Understanding
 ▶ Page 63
 Specifying
 ▶ Page 216

Accessories

Accessories are used to help customize your wiring and cabling needs.

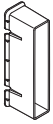

Junction Tall Sleeve

Understanding

- ▶ Page 64
- ▶ Page 217



Feed-Through Horizontal Cable Sleeve

Understanding

- ▶ Page 64
- ▶ Page 217

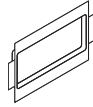

Grommet for Vertical Junctions and Horizontal Connecting Bars

Understanding

- ▶ Page 64
- ▶ Page 217



Grommet for Junction

Understanding

- ▶ Page 65
- ▶ Page 218

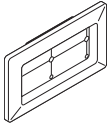

Duplex Cable Grommet

Understanding

- ▶ Page 65
- ▶ Page 218

Wiring Schematics

Details for the Electrician

Answer offers three different wiring schematics to allow you to match your specific wiring strategy to any typical building wiring plan.

Tip: All the components in an electrical system must use the same wiring schematic. The components are keyed and color coded to make it impossible to connect mismatched parts.

Black = Four-circuit, 3+1

Brown = Four-circuit, 2+2

Rust = Three-circuit, separate neutrals (3SN)

Shared neutrals = 10 gauge

Non-shared neutrals = 12 gauge

Hot wires = 12 gauge

Four-Circuit, 3+1

Circuit Panel 1

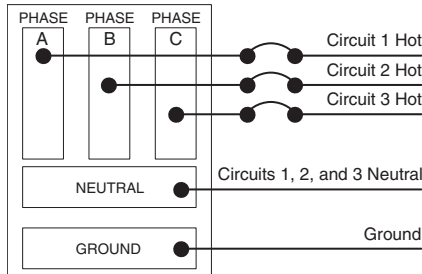

Circuit Panel 2

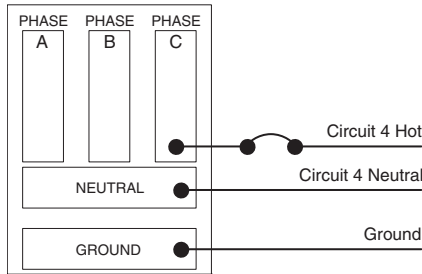

In the four-circuit 3+1 schematic, circuits 1, 2, and 3 are distributed from the first circuit panel and are supported with one shared neutral and one shared ground. Circuit 4 is distributed from a second circuit panel and is supported with a separate neutral and ground.

Single 3-Phase Circuit Panel

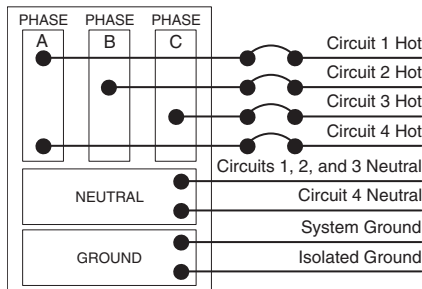

On a single 3-phase circuit panel, all four circuits are distributed as shown.

Four-Circuit, 2+2

Circuit Panel 1

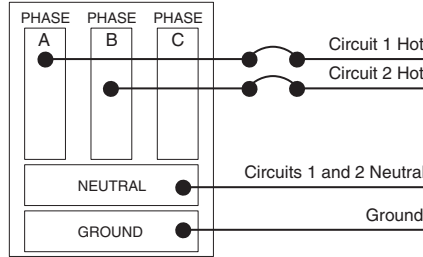

Circuit Panel 2

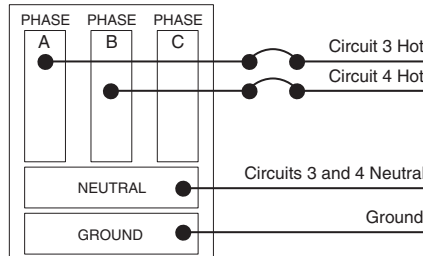

In the four-circuit 2+2 schematic, circuits 1 and 2 are distributed from two different phases from the first circuit panel and are supported with one shared neutral and one shared ground. Circuits 3 and 4 are distributed from a second circuit panel and supported by their own shared neutral and ground.

Single 3-Phase Circuit Panel

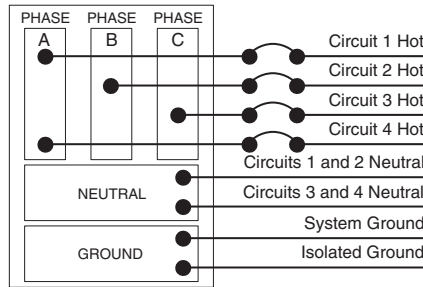

On a single 3-phase circuit panel, all four circuits are distributed as shown.

Split-Phase Circuit Panel

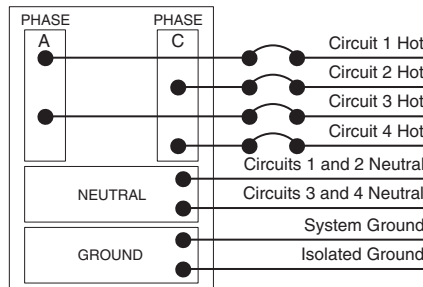

On a split-phase circuit panel, all four circuits are distributed as shown.

Three-Circuit, Separate Neutrals

Circuit Panel 1

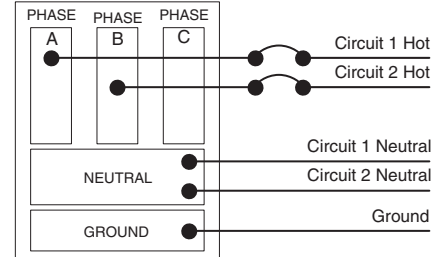

Circuit Panel 2

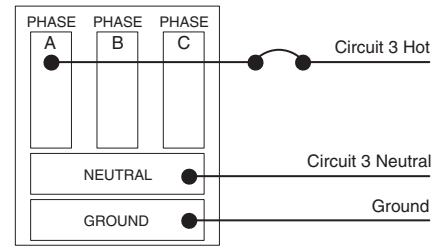

In the three-circuit, separate neutral schematic, circuits 1 and 2 are distributed from two different phases from the first circuit panel. Each circuit is supported with its own neutral and a common ground. Circuit 3 is distributed from the second circuit panel and is supported by its own neutral and ground.

Single 3-Phase Circuit Panel

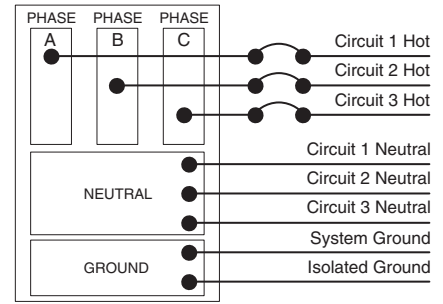

On a single 3-phase circuit panel, three circuits are distributed as shown.

Split-Phase Circuit Panel

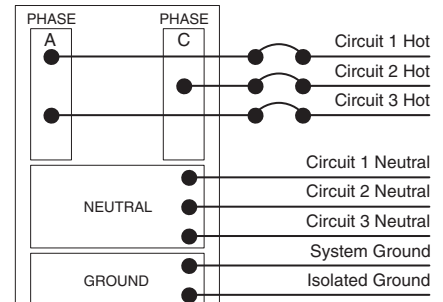

On a split-phase circuit panel, three circuits are distributed as shown.

How to Calculate Power Needs

Answer Beam Power
Use This to Determine How Many Power-Ins You'll Need

When planning a power network, you must calculate the amperage requirements of all your electrical components so you can provide sufficient electricity to power them.

If your usage is not known in advance: The National Electrical Code (NEC) allows a maximum of 13 receptacles on each 20-amp circuit. This provides up to 30 receptacles for each 3-circuit power-in.

If your usage is known in advance:

Add up the amperage used by each piece of equipment in the workstation. Whenever you reach 60 amps (20 amps times 3 circuits) from items that are likely to be used at the same time, you have reached the limit for a single power-in. Specify another power-in and continue until all equipment is powered.

If the circuits will normally be subject to a continuous load (three or more hours of continuous use, such as lights or computers), the NEC requires that circuit capacity be "de-rated" by 20 percent. Therefore, treat circuits used for continuous loads as if they were rated at 16 amps instead of the regular 20 amps.

Try to anticipate future increases in power requirements and build some excess capacity into your plan.

▶ See table at right for typical and actual amperage usages for components.

To calculate amperage when the wattage of a device is known, divide watts by 120.

Some appliances, such as large copiers, coffee makers, or space heaters require most of the current available on a 20-amp circuit. It is recommended that such devices be supplied with their own receptacle/circuit, directly from the building. This leaves the capacity of the furniture circuits available for the more dynamic requirements of the office equipment.

Local electrical codes vary. Consult a qualified electrical contractor or engineer for the proper planning of electrical circuits in your locale.

Approximate power consumption for common devices

• Device	• Wattage	• Amperage	• Voltage	• Number of Devices Supported on Single 20 Amp Circuit
Laptop (Low)	30	0.25	120	64
Laptop (High)	100	0.83	120	19
CPU/Desktop Computer (Low)	65	0.54	120	30
CPU/Desktop Computer (High)	150	1.25	120	13
Monitor (Low)	15	0.13	120	128
Monitor (High)	80	0.67	120	24
Phone	5	0.04	120	384
High Power Tablet	10	0.08	120	192
Lower Power Tablet	45	0.38	120	43
Desktop Printer	40	0.33	120	48
42" LCD Screen	120	1.00	120	16
Projector (Small)	50	0.42	120	38
Projector (Medium)	250	2.08	120	8
Projector (Large)	800	6.67	120	2
Desktop Lamp	20	0.17	120	96
Large Printer/Copier	1600	13.33	120	1
Small Printer/Copier	800	6.67	120	2
Paper Shredder (Small)	250	2.08	120	8
Paper Shredder (Large)	800	6.67	120	2
Desktop Fan	25	0.21	120	77
Standing Fan	125	1.04	120	15
Coffee Maker (Low)	500	4.17	120	4
Coffee Maker (High)	1500	12.50	120	1
Microwave (Low)	600	5.00	120	3
Microwave (High)	1000	8.33	120	2
Refrigerator (Low)	200	1.67	120	10
Refrigerator (High)	1500	12.50	120	1
Vacuum (Low)	200	1.67	120	10
Vacuum (High)	1500	12.50	120	1
Space Heater (Low)	400	3.33	120	5
Space Heater (High)	1500	12.50	120	1
Height-Adjustable Desk (Low Power Consumption)*	200	1.67	120	10
Height-Adjustable Desk (High Power Consumption)*	550	4.58	120	3

Tip: These calculations are estimations and are meant solely for informational purposes. It is important to conduct proper power planning for each installation to prevent overloading a circuit.

** Refer to the Height-Adjustable Desks Specification Guide for specific product information.*

Cable Capacities

Test and verify capacities for your individual situation.

We recommend that testing be conducted using your specific cable, as well as the furniture configuration you are considering. Cable capacities in this table are based on actual cable studies performed by an independent contractor following EIA/TIA codes and practices and can be taken as an accurate assessment of maximum practical capacity. Actual cable capacities may vary slightly depending on which manufacturer produced the cable and the specific field conditions.

Cable capacities are based on Category 6 and Category 6a cables at 55% fill capacity.

Tip: Tests were performed on junctions with tall sleeves installed.

Cables Tested

A CommScope Systimax Gigaspeed 1071E Series Category 6 Cable
OD=0.23"

B CommScope Systimax X10D 1091B Series Category 6A Cable
OD=0.285"

Power harnesses reduce cable capacity.

An average of 10-15 cables will be reduced per harness used. However, this number varies according to installation practices and the type of cables used.

When laying cables vertically behind skins, capacity is dependent on skin width.

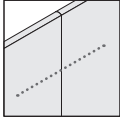
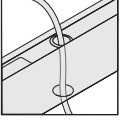
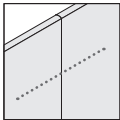
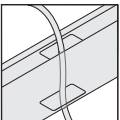
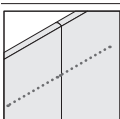
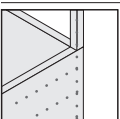
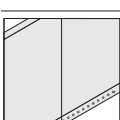
		A	B			A	B
Straight Horizontal Routing				Straight Vertical Routing			
	Horizontal pass-through (straight) at cable routing opening	12	7		Vertical cable routing through round openings of horizontal connecting bar; two locations per bar	11	7
	Horizontal pass-through (straight) at rectangular opening for modular power harness (available every 12" inside frame)	72	47		Vertical cable routing through rectangular openings of horizontal connecting bars; two locations per bar	24	16
	Lay-in cable routing at base of beam with power	36	22		Vertical cable routing inside utility pole and exiting into the beam	50	40
	Lay-in cable routing at base of beam without power or with power harness routed above	48	30				

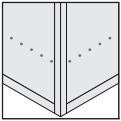
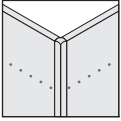
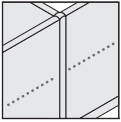
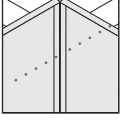
	A	B
L, T, X, V, and Y Horizontal Routing		
	Horizontal pass-through at cable routing opening	8 5
	Horizontal pass-through (corner) at rectangular opening for modular power harness	48 26
	Horizontal pass-through (straight) at cable routing opening (T configuration)	12 7
	Horizontal pass-through (straight) at cable routing opening (X configuration)	12 7

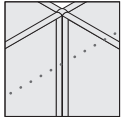
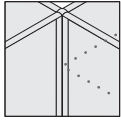
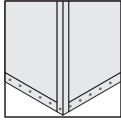
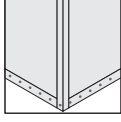
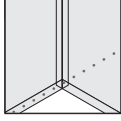
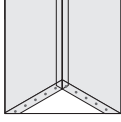
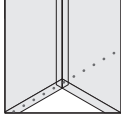
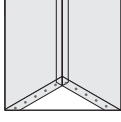
	A	B
L, T, X, V, and Y Horizontal Routing		
	Horizontal pass-through (straight) at rectangular opening for modular power harness	72 47
	Horizontal pass-through (corner) at cable routing opening	8 5
	Lay-in cable routing (corner) at base of beam with power in L, T, or V configuration	14 9
	Lay-in cable routing (corner) at base of beam without power in L, T, or V configuration	14 9
	Lay-in cable routing (straight) at base of beam with power in X or Y configuration	36 22
	Lay-in cable routing (corner) at base of beam with power in X or Y configuration	11 6
	Lay-in cable routing (straight) at base of beam without power, or with power harness routed above in X or Y configuration	48 30
	Lay-in cable routing (corner) at base of beam without power, or with power harness routed above in X or Y configuration	14 9

Beam Utility Pole-L, T, and X Junctions

Utility pole-L, T, or X brings power and cabling from the ceiling and introduces it into the beam. Junction is not included as utility pole connects into the existing beam junction.
▶ Specifying, page 200

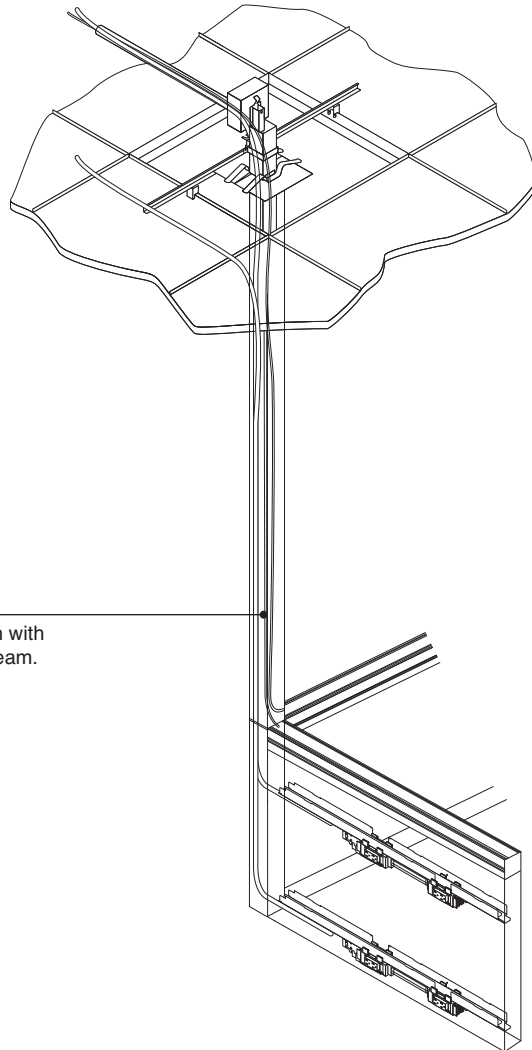

Utility pole is flush with the footprint of the beam.

Product Details

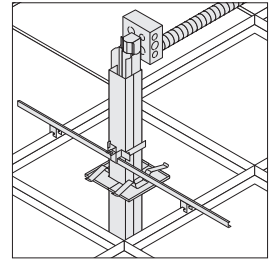

Ceiling attachment kit secures the top of the utility pole to the suspended ceiling grid. Hardwired connection to the building's power can be made in the junction box.

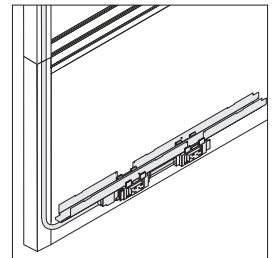

Power harness for use with utility pole is available to bring power down from the ceiling and into the beam to make a modular connection to a powerkit.
Tip: Power harnesses are ordered separately from the utility pole.

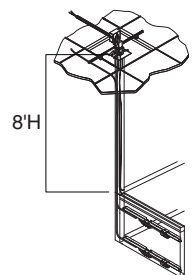

Utility pole can extend up to 8' above the beam.

Shield on power harness permits a utility pole to accommodate power and communication cable routing at the same time. For applications where more cable routing is needed, you can use the utility pole without a power harness.

Connections

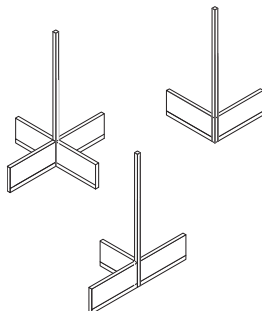

Utility pole can be used at an L, T, or X junction configuration. It cannot be used in an V or Y configuration. Utility pole is not shipped with a junction.

Ceiling trim plate measures 7" x 7" when installed.

Wiring & Cabling

Three wiring schematics are available—3+1, 2+2, and three circuits with separate neutrals (3SN). All the components in an electrical distribution system must use the same wiring schematic. For safety, the components are keyed, labeled, and color-coded to make it impossible to connect mismatched parts.
▶ Page 47

All Answer electrical components are listed by Underwriters Laboratory (UL) and certified by the Canadian Standards Association (CSA).

Local electrical codes vary. Consult a qualified electrical contractor or engineer for the proper installation of all electrical components.

Chicago and New York have special requirements.
▶ Pages 57 and 61

Surface Materials

Utility pole
• Paint

Ceiling trim plate
• White paint

Beam End-of-Run Junction with Utility Pole

End-of-run junction with utility pole brings power and cabling from the ceiling and introduces it into the beam through openings in the base, above the base, and at 20"H. Includes a junction and replaces the need to order one separately.
► Specifying, page 200

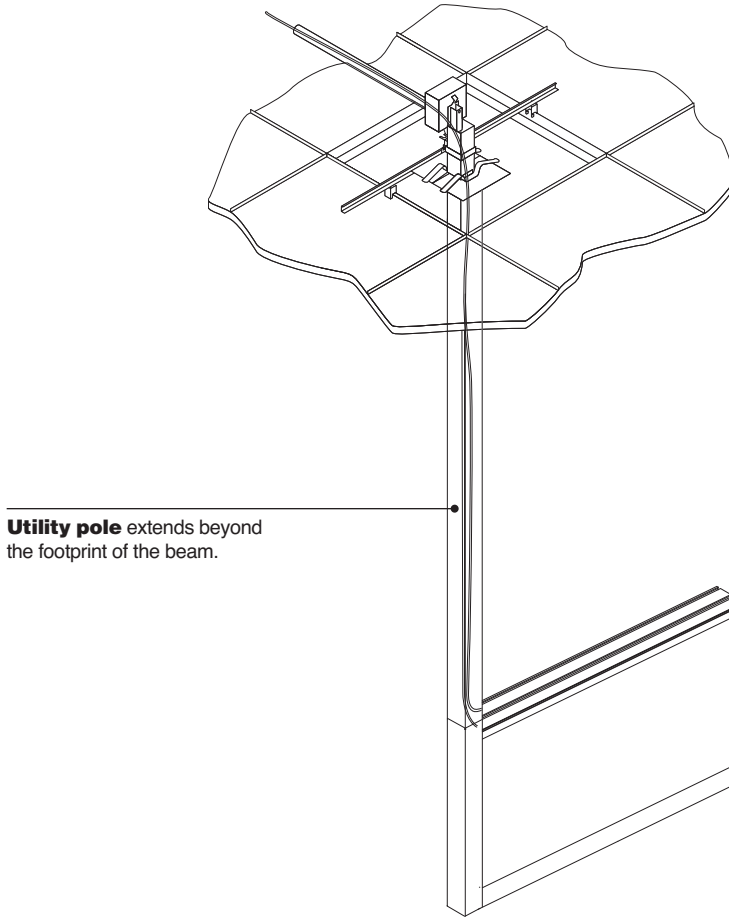

Utility pole extends beyond the footprint of the beam.

Product Details

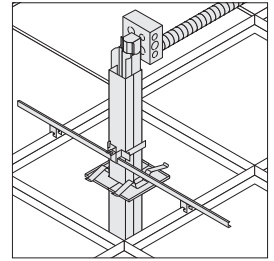

Ceiling attachment kit secures the top of the utility pole to the suspended ceiling grid. Hardwired connection to the building's power can be made in the junction box.

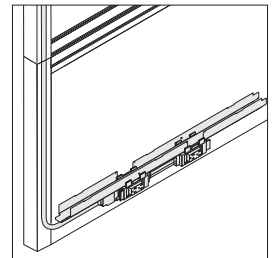

Power harness for use with utility pole is available to bring power down from the ceiling and into the beam to make a modular connection to a powerkit.
Tip: Power harnesses are ordered separately from the utility pole.

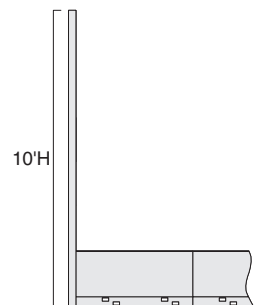

Ceiling heights up to 10' can be accommodated.

Shield on power harness permits a utility pole to accommodate power and communication cable routing at the same time. For applications where more cable routing is needed, you can use the utility pole without a power harness.

Connections

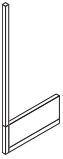

Utility pole works with beam junctions. It can only be used at an end-of-run, and is always shipped with a junction, so don't double order.

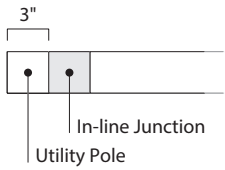

End-of-run application uses an in-line junction. Utility pole extends 3" beyond the footprint of the beam.

Ceiling trim plate measures 7" x 7" when installed.

Wiring & Cabling

Three wiring schematics are available—3+1, 2+2, and three circuits with separate neutrals (3SN). All the components in an electrical distribution system must use the same wiring schematic. For safety, the components are keyed, labeled, and color-coded to make it impossible to connect mismatched parts.
▶ Page 47

All Answer electrical components are listed by Underwriters Laboratory (UL) and certified by the Canadian Standards Association (CSA).

Local electrical codes vary. Consult a qualified electrical contractor or engineer for the proper installation of all electrical components.

Chicago and New York have special requirements.
▶ Pages 57 and 61

Surface Materials

Beam junction
• Black paint

Utility pole
• Paint

Vertical and upright trim
• Paint

Ceiling trim plate
• White paint

Base Power Infeed

Base power infeed connects power in the building floor to a powerkit in the base of a beam. Infeed occupies one receptacle opening.

► Specifying, page 202

Connector on end of base power infeed harness occupies one receptacle location in power block.

Flexible harness makes hardwired connection to building monument. The harness must be backfed through the base trim prior to connection into the building monument.

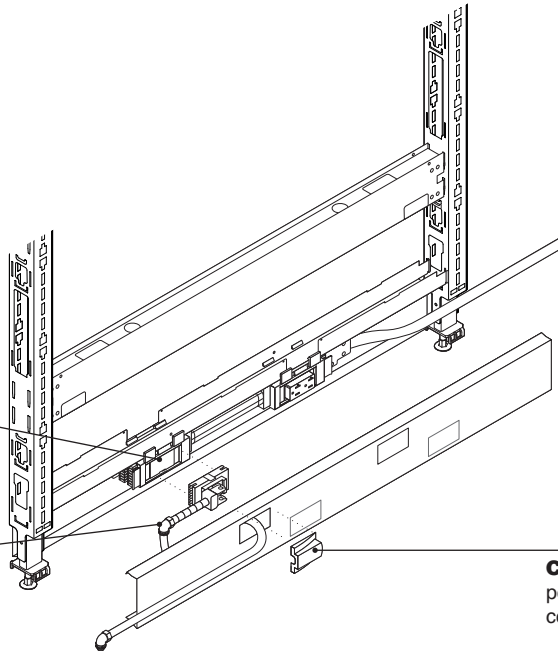

Cover is included with base power infeed to conceal the connection.

Wiring & Cabling

Connector on base power infeed must be placed behind base trim and harness must be backfed through base trim opening prior to an electrician making the connection to power in the building floor.

Three wiring schematics are available—3+1, 2+2, and three circuits with separate neutrals (3SN). All the components in an electrical distribution system must use the same wiring schematic. For safety the components are keyed, labeled, and color-coded to make it impossible to connect mismatched parts.

► Page 47

All Answer electrical components are listed by Underwriters Laboratory (UL) and certified by the Canadian Standards Association (CSA).

Local electrical codes vary. Consult a qualified electrical contractor or engineer for the proper installation of all electrical components.

Special requirements are needed for San Francisco.
► See page 202 for specification.

Base power infeed cannot be used on beam junctions supported by panel feet. Use a multipurpose infeed instead.

Big open base beam segments cannot use base power infeed. Bring power in using a multipurpose infeed.

Surface Materials

Power infeed cover

- Plastic

Conduit

- Black plastic

Special Requirements for New York City

New York City electrical code requires modular power components to be field installed by the electrician. Because Answer power components are always field installed, they are okay for use in New York. ▶ Specifying, page 203

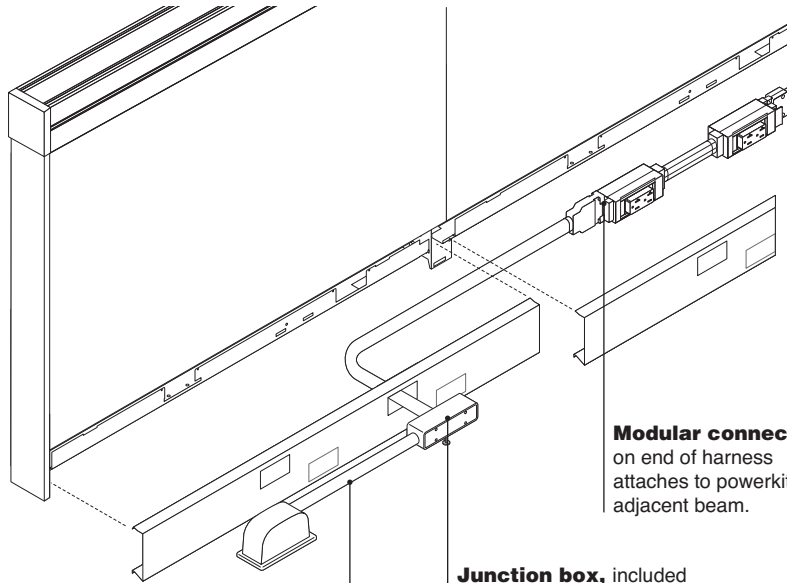

Modular connector on end of harness attaches to powerkit in adjacent beam.

Junction box, included with infeed, allows electrician to make a hardwire connection to the building power supply. Box covers opening in base trim.

Conduits supplied by electrician.

Order New York City power infeed of the width that corresponds to the width of the beam it will be installed in. *Tip: Remember that the beam with the New York City power infeed installed cannot accommodate any receptacles in the base because a powerkit cannot be installed. Install a powerkit higher in the beam to accommodate receptacles or use adjacent beam segments to install receptacles.*

Distribution Products

Powerkits are a combination of modular power blocks, harnesses, and connectors that attach to a power tray for installation inside an Answer beam. Powerkits are available in widths that correspond to beam widths.

► Specifying, page 204

Powerkits may be specified in a non-PVC version. For those trying to gain the LEED Innovation in Design credit, non-PVC should be selected.

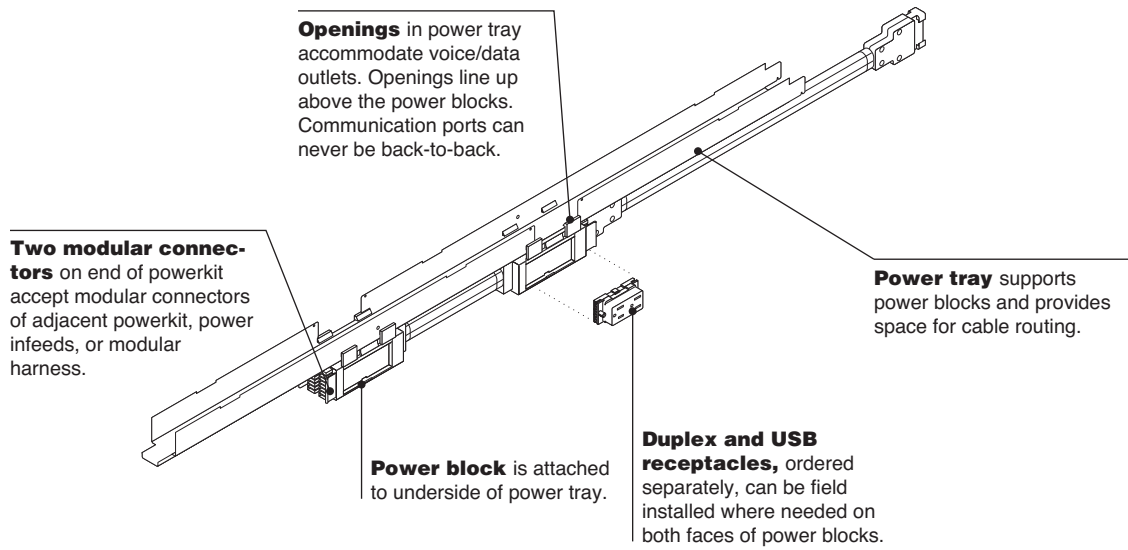

Pass-through powerkits are available for applications where you want to extend the power between beam segments but have no need for access in a specific beam.

► Specifying, page 205

Pass-through powerkits may be specified in a non-PVC version. For those trying to gain the LEED Innovation in Design credit, non-PVC should be selected.

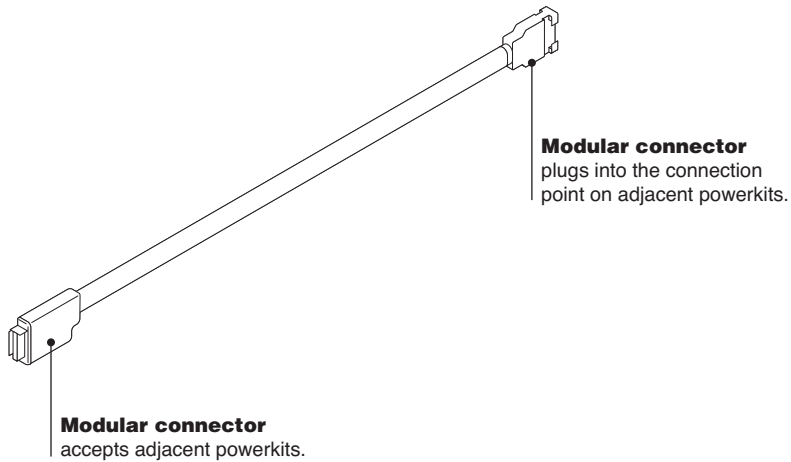

Cable trays can be installed every 6" vertically and rear-ranged at various heights within a beam for communications access and cable routing.

► Specifying, page 206

Exception: Cable tray cannot be used in the base of the beam.

Cable tray can accept added cable carriers attached below tray to expand horizontal cable management options.

► See *Montage Specification Guide* for cable carrier (ZCC).

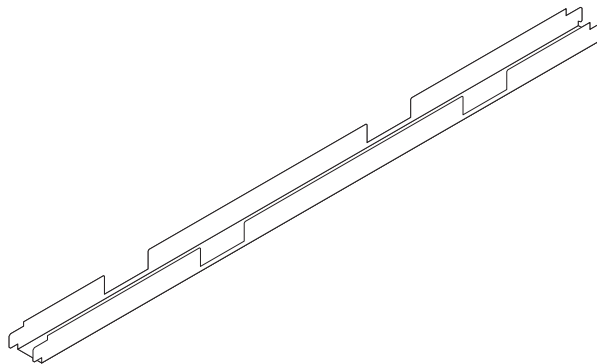

Product Details

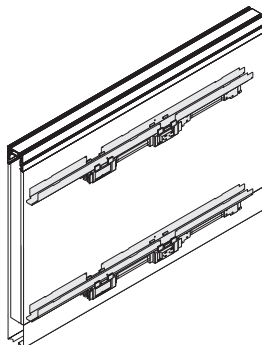

Powerkits can be installed in the base, just above the base or 20"H from the floor.

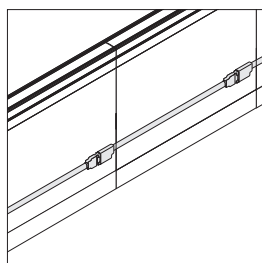

Pass-through powerkits extend power between beam segments.

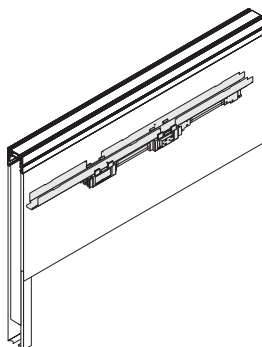

Big open base beam segments only support power and data access at 20"H.

Standard Base Trim Width of beam segment determines how many receptacle and communication locations are available.

12"

 24"W with one power block. Communication opening is located below and to the right of the power block.

12"

 30"W with two power blocks. Communication opening is located below and to the right of the right-hand power block.

12"

 36"W to 48"W with two power blocks. Communication openings are located below and to the right of each of the power blocks.

12"

 60"W to 72"W with four power blocks. Communication openings are located below and to the right of each right-hand power block of each power block pair.

Hardwired Base Trim Width of beam segment determines how many receptacle and communication locations are available.

12"

 24"W with one power block. Communication opening is located below and to the right of the power block.

10.3"

 30"W with two power blocks. Communication opening is located below and to the right of the right-hand power block.

12"

 36"W with two power blocks. Communication opening is located below and to the right of the right-hand power block.

12"

 42"W to 48"W with two power blocks. Communication openings are located below and to the right of each of the power blocks.

12"

 60"W to 72"W hardwire powerkit comes with two power blocks. The hardware base trim has two power knockout options on each end of the base trim. The power block can be installed at either knockout location. Communication openings are located below and to the right of each right-hand power block of each power block pair.

Tip: Communication openings are located 2 1/2" further right than standard base trims to accommodate wider hardwired junction boxes.



15-amp or 20-amp duplex receptacles snap into powerkits on one side or both sides of the beam.

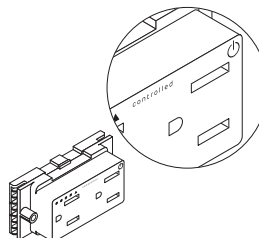

Controlled receptacle must be indicated when tying into the building management system. Duplex receptacles have an option for a factory permanent, pad stamp power icon symbol with the word controlled per compliance with the Energy Code.



USB receptacles available in three wiring schematics with multiple line options, snap into powerkits on one side or both sides of the beam. USB receptacles offer easy access to two charging ports. Each port provides 1 ampere of output. USB receptacles conveniently charge a wide range of electronic devices. Some devices may not be compatible.

Install duplex or USB receptacles only where you want them. Add more receptacles in the future.

Three wiring schematics are available—3+1, 2+2, and three circuits with separate neutrals (3SN). All the components in an electrical distribution system must use the same wiring schematic. For safety the components are keyed, labeled, and color-coded to make it impossible to connect mismatched parts.

▶ Page 47

Fabric skins allow access to power and data just above the base and at 20"H in the field. Specify TS7UFPLATE faceplates for use with field cut fabric skins. Cutting templates are available through Service Parts (T500940SR).

Steel skins can be specified with cutouts to access power and communication at 20"H. Specify TS7RC power receptacles, TS7USB USB receptacles, and TS7RCT trim rings when accessing power through steel skins.

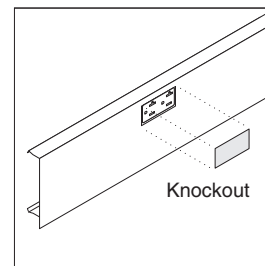

Knockouts and cutouts for receptacles in the beam base trim and skins are always 10 5/8" from the outside edges of the beam. Knockouts for communication in base accommodate modular furniture size only.

Filler to close unwanted openings in base trim is available from Service Parts.

Wire separators are not required. All electrical harnesses are shielded.

Local electrical codes vary. Consult a qualified electrical contractor or engineer for the proper installation of all electrical components.

Chicago and New York have special requirements. ▶ Pages 57 and 61

Modular Harness

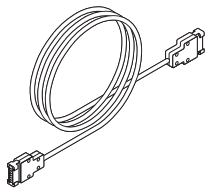

► Specifying, page 208

Product Details

Modular harnesses are available to connect powerkits at different heights. Available in 43" and 80" lengths.

Extra length modular harness is required when connecting two power kits located at different heights inside the beam in a corner or in-line application.

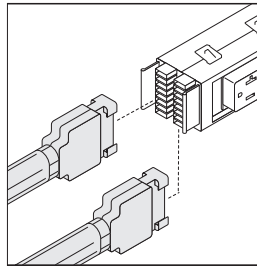

Harnesses plug into connection points on the powerkit. Every powerkit has multiple connection points to allow branching of power.

Modular harness may be specified in a non-PVC version.

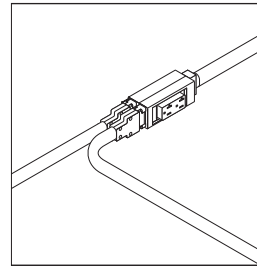

T-connection is formed by connecting two harnesses to a power block.

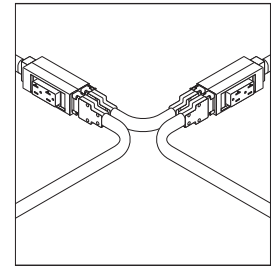

X-connection is formed by connecting two harnesses to two successive power blocks.

Modular harness may be specified in a non-PVC version. For those trying to gain the LEED Innovation in Design credit, non-PVC should be selected.

Multipurpose Power Infeed

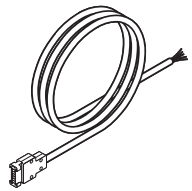

► Specifying, page 210

Product Details

Multipurpose power infeed is shielded to allow power and communication routing side by side. Available in 6', 12', and 24' lengths.

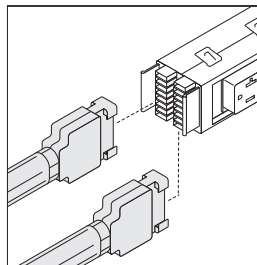

Multipurpose power infeeds bring power into the beam and make a modular connection to a powerkit.

Multipurpose power infeeds can be used with utility poles. Specify power harness separately.

Multipurpose power infeeds may be specified in a non-PVC version. For those trying to gain the LEED Innovation in Design credit, non-PVC should be selected.

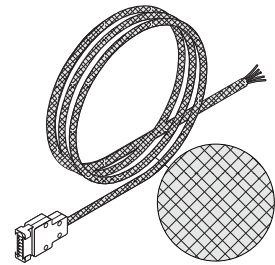

Multipurpose infeed conduit cover is aesthetic only and conceals the metallic portion of the multipurpose infeed.

Special Requirements for Hardwired Solution

Chicago electrical code requires the power distribution network to be hardwired on site. These installations require hardwired powerkits.
 ▶ Specifying, page 209
Tip: Any hardwired installation can use the components of the hardwired powerkit.

Order beam without power and order a hardwired powerkit of the corresponding width.
 ▶ Page 209

Power tray is included in hardwired powerkit to secure junction boxes and to attach to beam frame.

When hardwire power is placed in a non-based application, fabric skins must be fieldcut and steel skins must specify hardwire power cutouts.
Tip: Hardwire powerkit applications in the base location require a hardwire base trim for correct alignment of power and data receptacles.

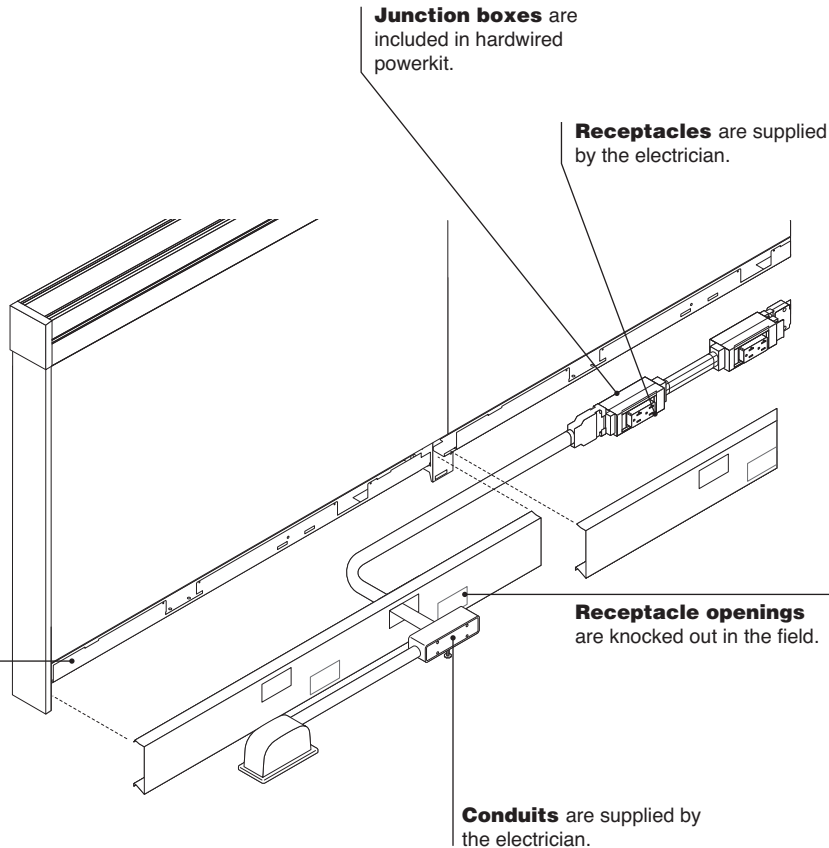

Wiring & Cabling

Junction box can accommodate two receptacles back to back. Electrician can use Leviton 5325 or equivalent receptacles.

When hardwire kit is installed in 30"W beam base, only one junction box can be used (installer to decide which position to utilize). Two junction boxes can be used in all other beam locations.

When installing a hardwire kit above the base in a 30"W beam, there is an additional set of holes on the tray that will need to be utilized to allow two hardwired boxes to be accommodated.

Electrician must make all hardwire connections in the field. Electrician must supply all conduits, wires, nuts, and connection to building power supply.

Order Chicago-version of shelf lights. These lights have a built-in circuit breaker.

Connections

Powerkit can be installed in beam base, just above the base, or at 20"H.

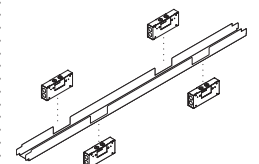

Junction boxes are typically mounted below the power tray; however, they can be mounted above when power is routed in a location other than the panel base. A bracket is included for mounting junction boxes above the power tray.

Number of Junction Boxes is Determined by Beam Width

Beam width	Junction boxes
24"	1
30"	2
36"	2
42"	2
48"	2
60"	2
72"	2

Access Products

Receptacles

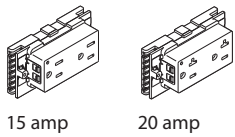

15 amp 20 amp
▶ Specifying, page 211

Product Details

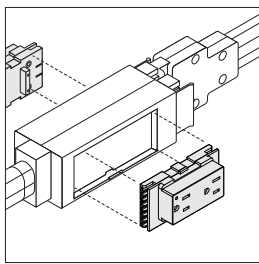

15-amp or 20-amp receptacles, ordered separately, snap into both faces of power block in the field.

Tip: Use TS7RCT trim covers with steel skins.

Tip: Use TS7UFPLATE face-plates with fabric skins.

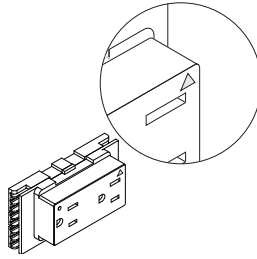

Orange triangle indicates to users the receptacles that are connected to isolated grounds.

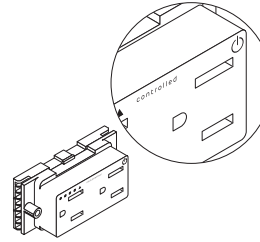

Controlled receptacle must be indicated when tying into the building management system. Duplex receptacles have an option for a factory permanent, pad stamp power icon symbol with the word controlled per compliance with the Energy Code.

Surface Materials

- Receptacle**
- 6000 Black
 - 6009 Arctic White
 - 6249 Platinum Solid
 - 6527 Merle
 - 6654 Sand
 - 6697 Fog
 - 6B03 Red

USB Receptacle



▶ Specifying, page 212

Product Details

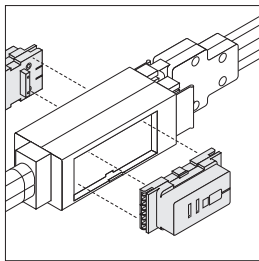

USB receptacles, ordered separately, snap into both faces of power block in the field.

Tip: Use TS7RCT trim covers with steel skins.

Tip: Use TS7UFPLATE face-plates with fabric skins.

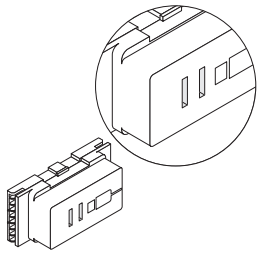

USB receptacles, are available in three wiring schematics with multiple line options. USB receptacles offer easy access to two charging ports. Each port provides one ampere of output. USB receptacles conveniently charge a wide range of electronic devices. Some devices may not be compatible.

Surface Materials

- USB Receptacle**
- 6000 Black
 - 6009 Arctic White
 - 6249 Platinum Solid
 - 6527 Merle
 - 6654 Sand
 - 6697 Fog
 - 6B03 Red

Blank Receptacle Cut-Out Cover



▶ Specifying, page 213

Product Details

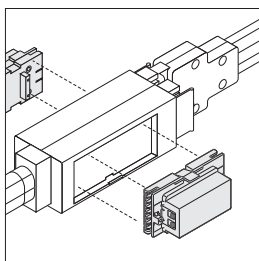

Blank cut-out covers are available for receptacle cutouts in steel skins where power is not expressed.

Tip: Use TS7UFPLATE face-plates with fabric skins.

Surface Materials

- Blank Cut-Out Cover**
- 6000 Black
 - 6009 Arctic White
 - 6249 Platinum Solid
 - 6527 Merle
 - 6654 Sand
 - 6697 Fog

Receptacle Trim Ring



► Specifying, page 214

Product Details

Receptacle trim ring is used with each receptacle, receptacle cut-out cover, or USB on a steel skin to cover the edge of the cut-out and create a precise transition between the cut-out and the receptacle.

Trim ring will only work on receptacle TS7RC, TS7USB, and TS7BCC.

Only specify when using steel skins.

Surface Materials

Receptacle Trim Ring

- 6000 Black
- 6009 Arctic White
- 6249 Platinum Solid
- 6527 Merle
- 6654 Sand
- 6697 Fog

Faceplate

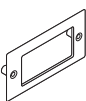

► Specifying, page 215

Product Details

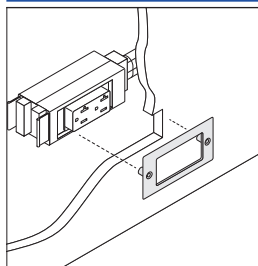

Faceplate, ordered separately, is used to surround receptacle when a fabric skin is field-cut. Templates for field cutting are available through Service Parts (T500940SR).

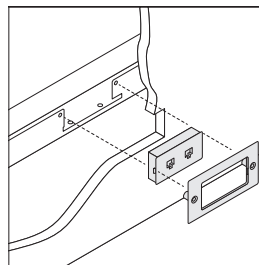

Faceplate is used to surround modular furniture size communication or DECORA outlets when installed in the face of a tackable acoustical beam skin. Templates for field cutting are available through Service Parts (T500940SR).

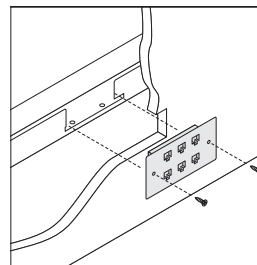

NEMA-size communication outlets (single gang) do not require a Steelcase faceplate. Cannot be used in base.

Surface Materials

Faceplate

- 6000 Black
- 6009 Arctic White
- 6249 Platinum Solid
- 6651 Tungsten
- 6652 Titanium
- 6654 Sand
- 6697 Fog

Beam Receptacle Filler



► Specifying, page 216

Product Details

Beam receptacle fillers are available to fill unused receptacle openings in steel skins. They are offered in packages of 20.

Surface Materials

Beam Receptacle Filler

- 6000 Black
- 6009 Arctic White
- 6249 Platinum Solid
- 6527 Merle
- 6654 Sand
- 6697 Fog

Data Filler



► Specifying, page 216

Product Details

Data fillers are available to fill unused furniture style data openings. They are offered in packages of 20.

Surface Materials

Data Filler

- 6000 Black
- 6009 Arctic White
- 6249 Platinum Solid
- 6527 Merle
- 6654 Sand
- 6697 Fog

Accessories

Junction Tall Sleeve

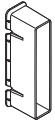

► Specifying, page 217

Product Details

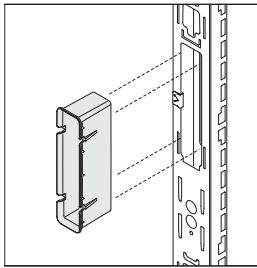

Junction tall sleeve can be added to vertical junctions to cover the exposed metal edges in the large cable routing openings of junctions.

Junction tall sleeves are ordered separate from vertical junctions and are available in packages of 10.

Surface Materials

- Red plastic only

Feed-Through Horizontal Cable Sleeve



► Specifying, page 217

Product Details

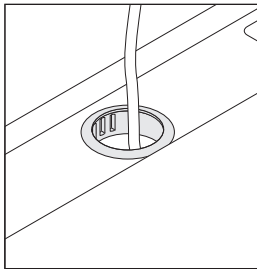

Feed-through horizontal connecting bar cable sleeves can be added in the field to finish the exposed metal edges of vertical cable pass-through openings.

Surface Materials

Feed-through horizontal cable sleeve

- Black plastic only

Grommet for Vertical Junctions and Horizontal Connecting Bars

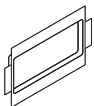

► Specifying, page 218

Product Details

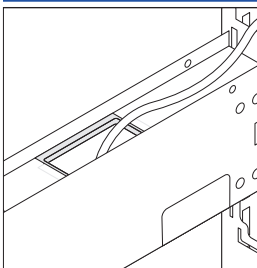

Grommet for horizontal connecting bar and junctions can be added in the field to finish the exposed metal edges of cable pass-through openings. For cable sleeves used with junctions.

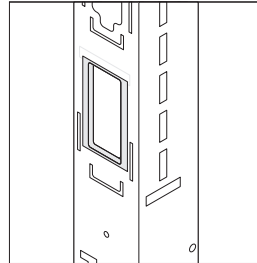

Grommets can also be used with power trays or cable trays.

Surface Materials

- Black plastic only

Grommet for Junction

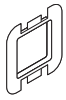

► Specifying, page 218

Product Details

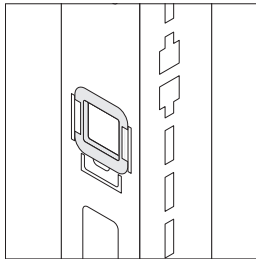

Grommet for junction can be added in the field to finish the exposed metal edges of horizontal cable pass-through openings.

Surface Materials

- Black plastic only

Duplex Cable Grommet

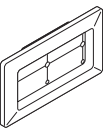

► Specifying, page 218

Product Details

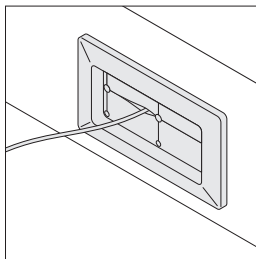

Cable grommet can be inserted in receptacle openings to route cables from the panel base into the panel.

Surface Materials

Duplex cable grommet

- 6000 Black
- 6009 Arctic White
- 6249 Platinum Solid
- 6607 Woodrose
- 6608 Driftwood
- 6609 Smoke
- 6612 Grey V2
- 6655 Warm White
- 6697 Fog

Under Worksurface Cable Manager

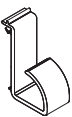

► Specifying, page 207

Product Details

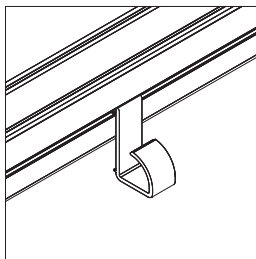

Under worksurface cable manager clips into the side of the top cap rail and manages cables along the beam.

Surface Materials

- 6249 Platinum Solid

Understanding Boundary, Worksurface, and Beam Screens



Statement of Line **68**

Answer Beam End-of-Run Straight Boundary Screens **76**

Answer Beam On-Module In-Line Boundary Screens **80**

Answer Beam Centered In-Line Boundary Screens **82**

Worksurface and Beam Screens

Universal Beam Screen **84**

Universal Privacy/Modesty Screens **86**

Universal Privacy Screens **90**

Sarto Beam Screens **93**

Sarto Privacy/Modesty Screens **95**

Sarto Privacy Screens **98**

Divisio Side Screen **100**

Statement of Line

Answer Beam End-of-Run Straight Boundary Screens

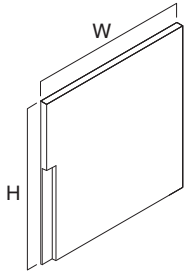

Understanding
 ▶ Page 76
 Specifying
 ▶ Page 220

End-of-Run Straight Boundary Screens—Single Sided

	27"W	33"W	39"W	45"W	51"W	57"W	63"W	69"W	75"W
28 ¹ / ₂ "H	●	●	●	●	●	●	●	●	●
42"H	●	●	●	●	●	●	●	●	●
48"H	●	●	●	●	●	●	●	●	●

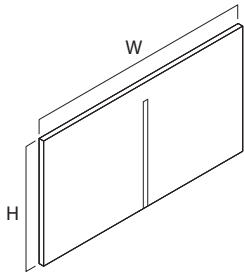

Understanding
 ▶ Page 76
 Specifying
 ▶ Page 220

End-of-Run Straight Boundary Screens—Spanning

	51"W	57"W	63"W	69"W	75"W
28 ¹ / ₂ "H	●	●	●	●	●
42"H	●	●	●	●	●
48"H	●	●	●	●	●

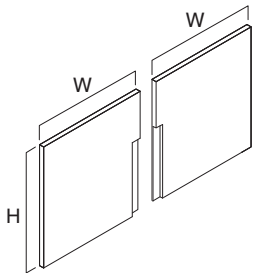

Understanding
 ▶ Page 76
 Specifying
 ▶ Page 220

End-of-Run Straight Boundary Screens—Split

	25 ¹ / ₂ "W	31 ¹ / ₂ "W	37 ¹ / ₂ "W	43 ¹ / ₂ "W	49 ¹ / ₂ "W	55 ¹ / ₂ "W	61 ¹ / ₂ "W	67 ¹ / ₂ "W	73 ¹ / ₂ "W
28 ¹ / ₂ "H	●	●	●	●	●	●	●	●	●
42"H	●	●	●	●	●	●	●	●	●
48"H	●	●	●	●	●	●	●	●	●

Tip: Width must be specified for each split segment.

Answer Beam End-of-Run L Return Single-Sided Screens

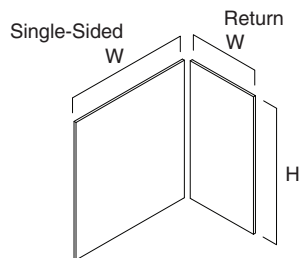

Understanding
 ▶ Page 76
 Specifying
 ▶ Page 224

End-of-Run L Return Boundary Screen—Single Sided (Primary Screens)

	27"W	33"W	39"W	45"W	51"W	57"W	63"W	69"W	75"W
28 1/2"H	●	●	●	●	●	●	●	●	●
42"H	●	●	●	●	●	●	●	●	●
48"H	●	●	●	●	●	●	●	●	●

Return Screens

	18"W	24"W	30"W
28 1/2"H	●	●	●
42"H	●	●	●
48"H	●	●	●

Tip: Primary and return screens may be specified with equal or unequal widths.

Answer Beam End-of-Run L Return Split Boundary Screens

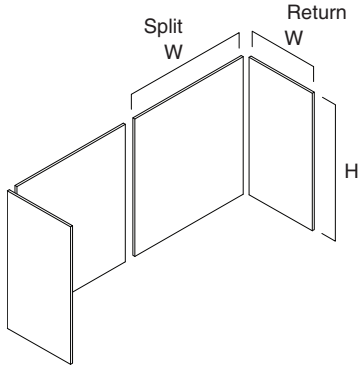

Understanding
 ▶ Page 76
 Specifying
 ▶ Page 224

End-of-Run L Return Boundary Screens—Split (Primary Screens)

	25 ¹ / ₂ "W	31 ¹ / ₂ "W	37 ¹ / ₂ "W	43 ¹ / ₂ "W	49 ¹ / ₂ "W	55 ¹ / ₂ "W	61 ¹ / ₂ "W	67 ¹ / ₂ "W	73 ¹ / ₂ "W
28 ¹ / ₂ "H	●	●	●	●	●	●	●	●	●
42"H	●	●	●	●	●	●	●	●	●
48"H	●	●	●	●	●	●	●	●	●

Return Screens

	18"W	24"W	30"W
28 ¹ / ₂ "H	●	●	●
42"H	●	●	●
48"H	●	●	●

Tip: Width must be specified for each split segment.

Answer Beam On-Module In-Line Boundary Screens

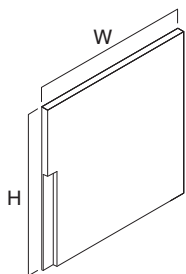

Understanding
 ▶ Page 80
 Specifying
 ▶ Page 232

On-Module T Boundary Screens

	27"W	33"W	39"W	45"W	51"W	57"W	63"W	69"W	75"W
42"H	●	●	●	●	●	●	●	●	●
48"H	●	●	●	●	●	●	●	●	●

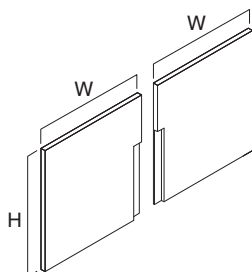

Understanding
 ▶ Page 80
 Specifying
 ▶ Page 232

On-Module X Boundary Screens

	25 1/2"W	31 1/2"W	37 1/2"W	43 1/2"W	49 1/2"W	55 1/2"W	61 1/2"W	67 1/2"W	73 1/2"W
42"H	●	●	●	●	●	●	●	●	●
48"H	●	●	●	●	●	●	●	●	●

Tip: Width must be specified for each split segment.

Statement of Line, continued

Answer Beam Centered In-Line Boundary Screens

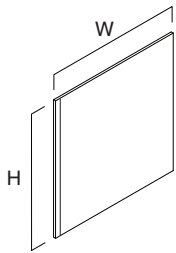

Understanding
 ▶ Page 82
 Specifying
 ▶ Page 236

Answer Beam Centered In-Line Boundary Screens

	24"W	30"W	36"W	42"W	48"W	54"W	60"W	66"W	72"W
28½"H	●	●	●	●	●	●	●	●	●
42"H	●	●	●	●	●	●	●	●	●
48"H	●	●	●	●	●	●	●	●	●

Tip: Spanning boundary screens are available in both single-connect and dual-connect.

Answer Beam Screens

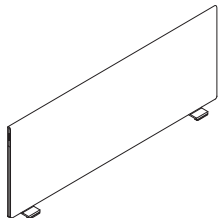

Understanding
 ▶ Page 84
 Specifying
 ▶ Page 238

Universal Screens

	24"W	30"W	36"W	42"W	48"W	54"W	60"W	66"W	72"W	78"W	84"W	90"W	96"W
13½"H	●	●	●	●	●	●	●	●	●	●	●	●	●
19½"H	●	●	●	●	●	●	●	●	●	●	●	●	●

Answer Beam Worksurface and Beam Screens

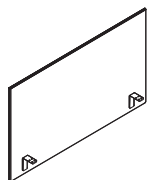

Understanding
 ▶ Page 86
 Specifying
 ▶ Page 240

Universal Privacy/Modesty Screens

	Height Above Worksurface	42"W	48"W	54"W	60"W	66"W
Privacy Mount Height*	19 ¹ / ₅ "H	●	●	●	●	●
Privacy/Modesty Mount Height*	13"H	●	●	●	●	●

Tip: Overall screen height is 25⁷/₁₀"H.

**Privacy mount height measures 48" from the floor to the top of the screen and privacy/modesty mount height measures 42" from the floor to the top of the screen. Privacy mount shown.*

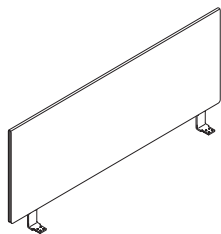

Understanding
 ▶ Page 90
 Specifying
 ▶ Page 242

Universal Privacy Screens

	24"W	30"W	36"W	42"W	48"W	54"W	60"W	66"W	72"W	78"W	84"W	90"W	96"W
13 ¹ / ₂ "H	●	●	●	●	●	●	●	●	●	●	●	●	●
19 ¹ / ₂ "H	●	●	●	●	●	●	●	●	●	●	●	●	●

Statement of Line, continued

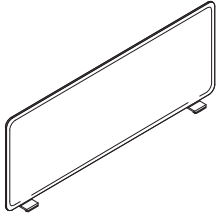

Understanding
 ▶ Page 93
 Specifying
 ▶ Page 244

Sarto Beam Screens

	24"W	30"W	36"W	42"W	48"W	54"W	60"W	66"W	72"W	78"W	84"W	90"W	96"W
13½"H	●	●	●	●	●	●	●	●	●	●	●	●	●
19½"H	●	●	●	●	●	●	●	●	●	●	●	●	●

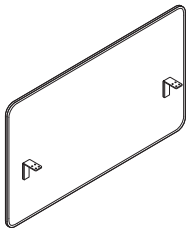

Understanding
 ▶ Page 94
 Specifying
 ▶ Page 246

Sarto Privacy/Modesty Screens

	24"W	29"W	42"W	46"W	48"W	54"W	58"W	60"W	66"W	70"W
24"H	●	●	●	●	●	●	●	●	●	●
30"H	●	●	●	●	●	●	●	●	●	●

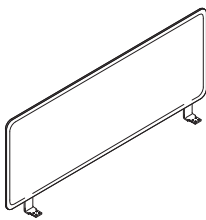

Understanding
 ▶ Page 98
 Specifying
 ▶ Page 248

Sarto Privacy Screens

	24"W	29"W	30"W	36"W	42"W	46"W	48"W	54"W	58"W	60"W	66"W	70"W	72"W	78"W	84"W	90"W	96"W
13½"H	●	●	●	●	●	●	●	●	●	●	●	●	●	●	●	●	●
19½"H	●	●	●	●	●	●	●	●	●	●	●	●	●	●	●	●	●
24"H	●	●	●	●	●	●	●	●	●	●	●	●	●	●	●	●	●
36"H	●	●	●	●	●	●	●	●	●	●	●	●	●	●	●	●	●

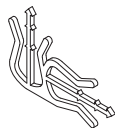

Understanding
▶ Page 98
Specifying
▶ Page 250

Sarto Alignment Bracket



Understanding
▶ Page 100
Specifying
▶ Page 251

Divisio Side Screen

29¹/₂"D

11⁵/₈"H ●

Answer Beam End-of-Run Straight Boundary Screens

Answer beam end-of-run boundary screens provide light scale space division and privacy for a variety of worksettings.

Answer beam end-of-run boundary screens attach to the Answer beam at the end-of-run as an alternative to a return panel or beam segment, when power and storage components are not required.

► Specifying, pages 220–224

Answer beam end-of-run boundary screens have a thickness of 1³/₁₆".

Screens are available in laminate or wood veneer.

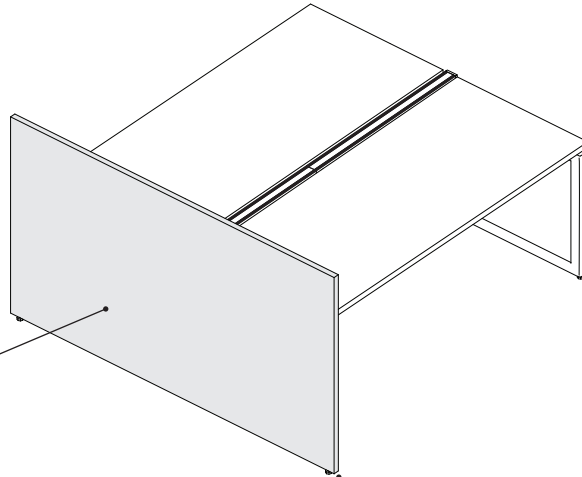

Boundary screens come standard with adjustable glides, with a range of 1¹/₂". The glides are located 1¹/₂" from the outside of each edge.

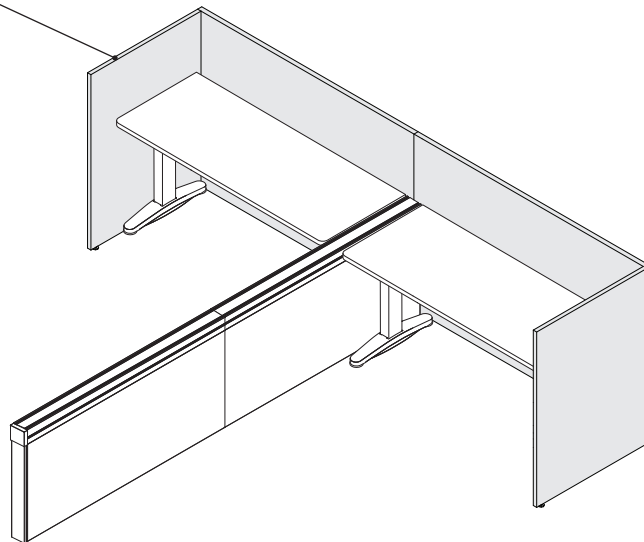

Product Details

Answer beam boundary screens are available in three configurations: end-of-run, on-module in-line, and centered in-line.

For more information on Answer beam on-module in-line boundary screens, ► Page 80

For more information on centered in-line Answer beam boundary screens, ► Page 82

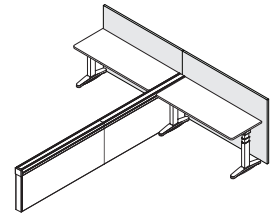

Answer beam end-of-run boundary screens attach to the Answer beam using an end-of-run junction.

Actual Dimensions

Height	28 ¹ / ₂ ", 42", and 48"
Single-Sided Width	27", 33", 39", 45", 51", 57", 63", 69", and 75"
Spanning Width	51", 57", 63", 69", and 75"
Split Width	25 ¹ / ₂ ", 31 ¹ / ₂ ", 37 ¹ / ₂ ", 43 ¹ / ₂ ", 49 ¹ / ₂ ", 55 ¹ / ₂ ", 61 ¹ / ₂ ", 67 ¹ / ₂ ", and 73 ¹ / ₂ "
Return Width	18", 24", and 30"
Thickness	1 ³ / ₁₆ "

Tip: Answer beam boundary screen widths can also be specified parametrically.

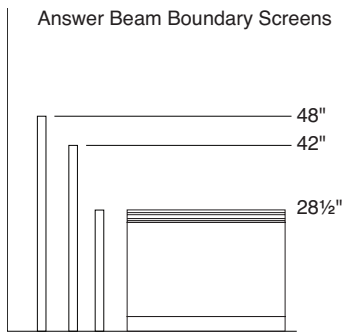

Answer beam boundary screens have modular heights and widths. Parametric widths are allowed from 27"W to 75"W increasing in 1/16" increments. Boundary screen return widths are available at 18", 24", and 30", and are also available parametrically from 18"W to 30"W increasing in 1/16" increments.

Answer beam end-of-run boundary screens are available in five different configurations.

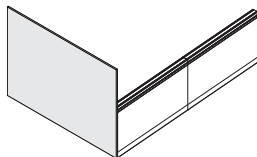

1. Single-sided boundary screens provide boundary to one side of an Answer beam and are specified as either left or right. Right handed application is shown above.

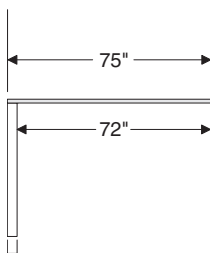

3" Answer beam thickness

Straight single-sided beam end-of-run boundary screens will always include the 3" thickness of the Answer beam to which they attach. Minimum width for a single-sided boundary screen is 27" (24" inside, and 3" for the Answer beam thickness). The maximum width is 75" (72" inside, and 3" for Answer beam thickness). The above image is shown with a right handed application.

Tip: The above image shows a 75" specified width. The planning width is 72".

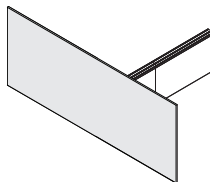

2. Spanning beam end-of-run boundary screens use one screen segment to provide boundary of equal widths to both sides of an Answer beam.

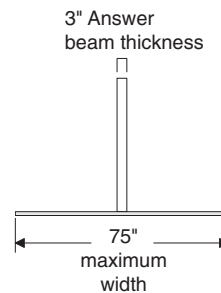

Spanning beam end-of-run boundary screens always extend in equal dimension from the beam to which they attach and include the 3" thickness on the Answer beam. Minimum width for a spanning boundary screen is 51" (48" inside, and 3" for the Answer beam thickness). The maximum width is 75" (72" inside and 3" for Answer beam thickness).

Tip: The above image shows a 75" specified width. The planning width is 36" on each side of the beam.

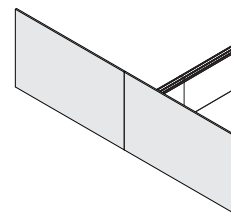

3. Split beam end-of-run boundary screens use two screen segments to provide boundary to both sides of an Answer beam. Both sides of a split boundary screen are the same height.

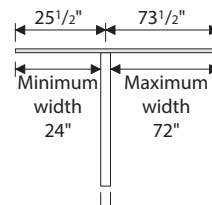

3" Answer beam thickness

Split boundary screens can either be equal or asymmetrical in dimension from the beam to which they attach and include the 3" thickness of the Answer beam. Minimum width for a split boundary screen is 25 1/2" (24" inside, and 1 1/2" for half of the Answer beam thickness) for each side of the beam. The maximum width is 73 1/2" (72" inside, and 1 1/2" for half of the Answer beam thickness) for each side of the beam.

Tip: The above image shows a 25 1/2" specified left width and a 73 1/2" specified right width. The planning left width is 24" and the planning right width is 72".

Answer Beam End-of-Run Straight Boundary Screens, continued

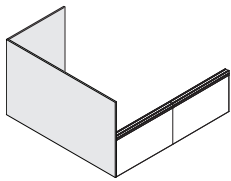

4. Single-sided L return beam end-of-run boundary screens provide boundary and additional privacy to one side of an Answer beam. Both screen segments (primary and return screen) are the same height and are specified as either left or right handed. Right handed application is shown above.

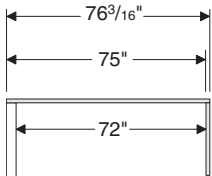

3" Answer beam thickness

Single-sided L return beam end-of-run boundary screens in modular widths have inside clearance in 6" increments to wrap standard width worksurfaces in 6" increments. Beam connected segments (the primary screens) are available in widths of 27" (24" inside, and 3" for Answer beam thickness) to 75" (72" inside, and 3" for Answer beam thickness). The inside width of modular returns are 18", 24", or 30". There is an additional 1 3/16" that will be added to the return width for the primary screen thickness. Both boundary screens have equal heights and are specified as either left or right handed. Right handed application is shown above.

Tip: The above image shows a 75" specified width. The planning width is 72".

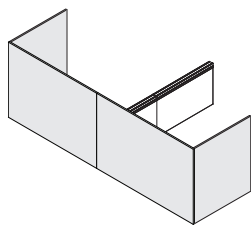

5. Split L return beam end-of-run boundary screens consist of four segments to provide boundary and additional side privacy to both sides of an Answer beam. Split L configuration screens do not have to have symmetrical widths, but must have the same height.

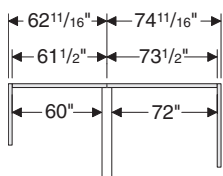

3" Answer beam thickness

Split L return beam end-of-run boundary screens in modular widths have inside clearance in 6" increments to wrap standard width worksurfaces from 24" to 72" in 6" increments for each side of the split. The inside width of modular returns will be 18", 24", or 30". There is an additional 1 3/16" that will be added to the return width for the primary boundary screen thickness. Each beam connected segment is available in widths from 25 1/2" (24" inside, and 1 1/2" for half of the Answer beam thickness) to 73 1/2" (72" inside, and 1 1/2" for half of the Answer beam thickness).

Tip: The above image shows a 61 1/2" specified left width and a 73 1/2" specified right width. The planning left width is 60" and the planning right width is 72".

Connections

The 28 1/2"H boundary screen aligns with top of the beam top cap rail.

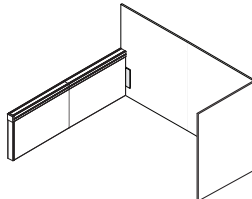

Answer beam end-of-run boundary screens have a metal cover plate that covers the bracket that connects the boundary screen to the end-of-run junction. The cover is located 22" from the bottom of the screen and is 3"W and 14"H.

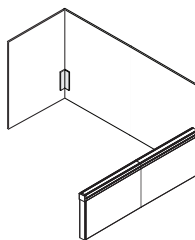

Return segments also have a second metal cover plate that covers the connection bracket that connects the return to the primary screen segment.

Surface Materials

Boundary screens

- Laminate
- Wood veneer

Edge on laminate screen

- Plastic

Bracket cover

- Paint

Tip: When specifying the paint finish for the bracket cover, select a finish that compliments the selected laminate or veneer finish.

Open Line laminates with grain direction can only be applied vertically. Open Line laminates are not allowed on boundary screens that are greater than 59"W or have segments that are greater than 59"W.

On single-sided boundary screens, horizontal wood grain laminates and veneers can be applied up to 75"W. Vertical wood grain laminates can be applied up to 59"W. Vertical wood grain veneers can be applied up to 75"W.

On spanning boundary screens, wood grain laminates and veneers can be horizontal grain direction up to 75"W. Vertical wood grain laminates can be applied up to 59"W. Vertical wood grain veneers can be applied up to 75"W.

On split boundary screens, horizontal wood grain laminates and veneers can be applied up to 73 1/2"W. Vertical wood grain laminates can be applied up to 59"W. Vertical wood grain veneers can be applied up to 73 1/2"W.

On split boundary screens with horizontal grain direction, the grain pattern of two screen segments may not align.

All boundary screen sides will have the same finish applied.

Application Topics

Answer beam end-of-run boundary screens do not support hang-on components.

Answer beam end-of-run boundary screens attach at the end-of-run location of an Answer beam segment.
Tip: Select "omit trim" option for beam end-of-run junctions that attach to beam end-of-run boundary screens.

Answer beam end-of-run boundary screens cannot attach to an Answer beam end-of-run junction where an Answer foot is utilized.

One single-sided boundary screen may be attached at the end of the Answer beam. If the intent is to have a boundary screen in both directions of the beam, use either spanning or split Answer beam end-of-run boundary screens.

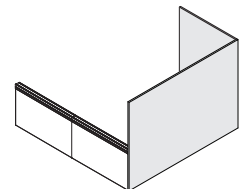

Single-sided and split boundary screens are available left and right handed. This is determined by the user facing the attaching Answer beam. Left sided application is shown above.

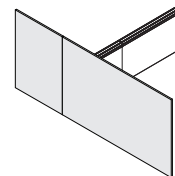

Split boundary widths do not have to be symmetrical.

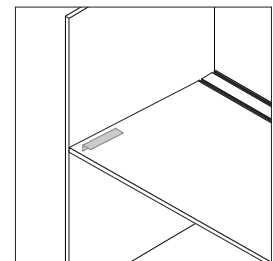

A front edge of a worksurface can be supported off of an Answer beam boundary screen with the boundary screen worksurface support bracket (Service part 1148776001SR). Order separately.

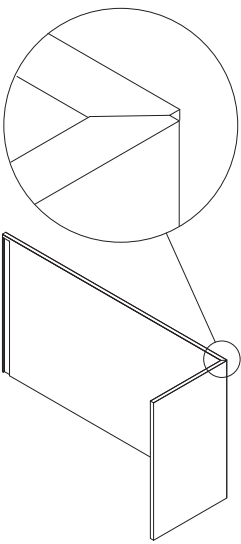

All L return boundary screens have a step miter detail at the adjoining edge.

Answer Beam On-Module In-Line Boundary Screens

Answer beam boundary screens provide light scale space division and privacy for a variety of worksettings.

Answer beam on-module in-line boundary screens attach to the Answer beam mid-run as an alternative to a return beam segment, when power and storage components are not required.

► Specifying, pages 232–235

Answer beam on-module boundary screens have a thickness of $1\frac{3}{16}$ ".

Screens are available in laminate or wood veneer.

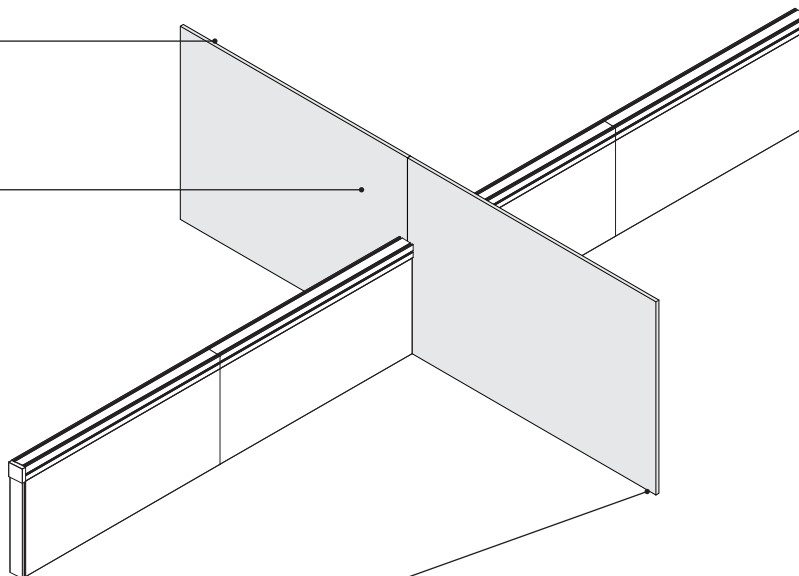

Boundary screens come standard with adjustable glides, with a range of $1\frac{1}{2}$ ". The glides are located $1\frac{1}{2}$ " from the outside of each edge.

Actual Dimensions

Height	42" and 48"
On-Module T Width	27", 33", 39", 45", 51", 57", 63", 69", and 75"
On-Module X Width	25½", 31½", 37½", 43½", 49½", 55½", 61½", 67½", and 73½"
Thickness	1⅜"

Tip: Answer beam boundary screen widths can also be specified parametrically.

Product Details

Answer beam boundary screens are available in three configurations: end-of-run, on-module in-line, and centered in-line. For more information on end-of-run boundary screens, ► Page 76

For more information on centered in-line boundary screens. ► Page 82

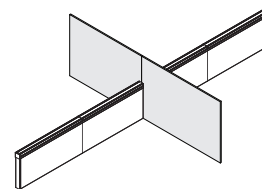

Answer beam on-module boundary screens attach to the Answer beam using a boundary screen on-module junction.



When specifying Answer beam on-module in-line boundary screens, specify an on-module in-line boundary screen junction separately. ► Page 235

An on-module in-line boundary screen junction takes the place of an in-line junction.

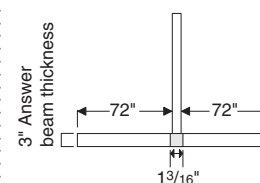

Answer beam on-module in-line boundary screens maintain planning dimension of the beam.

On-module in-line beam boundary screens add $1\frac{3}{16}$ " to the overall dimension of a beam run.

Answer beam boundary screens have modular heights and widths. Parametric widths are allowed from 27"W to 75"W increasing in $\frac{1}{16}$ " increments.

Answer beam on-module in-line boundary screens are available in two different configurations.

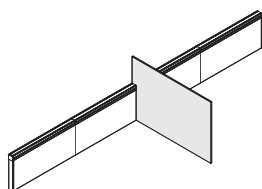

1. Answer beam on-module T boundary screens provide boundary to one side of an Answer beam.

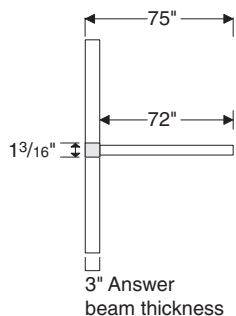

Answer beam on-module T boundary screens will always include the 3" thickness of the Answer beam to which they attach. Minimum width for a single-sided boundary screen is 27" (24" inside, and 3" for the Answer beam thickness). The maximum width is 75" (72" inside, and 3" for Answer beam thickness).

Tip: The above image shows a 75" specified width. The planning width is 72".

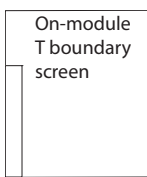

Answer beam

Answer beam on-module T boundary screens extend over the top of the beam and are flush with the back edge of the beam.

Answer beam on-module T boundary screens include a $1\frac{3}{16}$ "W painted junction trim to finish the side of the beam that is opposite the T boundary screen.

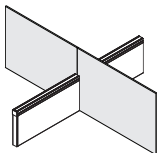

Answer beam on-module X boundary screens use two screen segments to provide boundary to both sides of an Answer beam. Both sides of a split boundary screen are the same height.

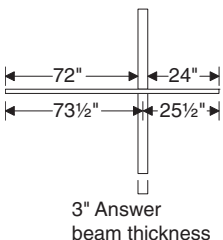

Answer beam on-module X boundary screen can either be equal or asymmetrical in dimension from the beam to which they attach and include the 3" thickness of the Answer beam. Minimum width for a split boundary screen is $25\frac{1}{2}$ " (24" inside, and $1\frac{1}{2}$ " for half of the Answer beam thickness) for each side of the beam. The maximum width is $73\frac{1}{2}$ " (72" inside, and $1\frac{1}{2}$ " for half of the Answer beam thickness) for each side of the beam.

Tip: The above image shows a $25\frac{1}{2}$ " specified right width and a $73\frac{1}{2}$ " specified left width. The planning right width is 24" and the planning left width is 72".

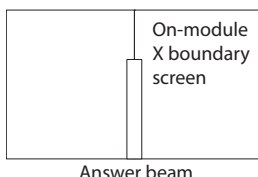

Answer beam

Answer beam on-module X boundary screens extend over the top of the beam. The two segments of the beam where the on-module X boundary screen meets at is the center point above the beam.

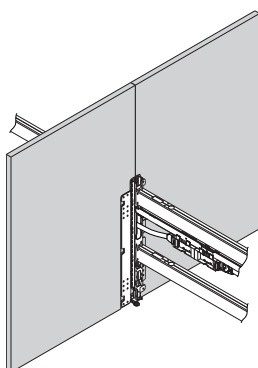

On-module in-line boundary screens do not limit power and data routing in the beam. The on-module in-line boundary screens are notched around the beam.

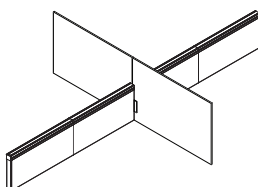

Answer beam on-module in-line boundary screens have a metal cover plate that covers the bracket that connects the boundary screen to the on-module boundary screen junction. The cover is located 22" from the bottom of the screen and is 3"W and 14"H.

Surface Materials

Boundary screens

- Laminate
- Wood veneer

Edge on laminate

- Plastic

Bracket cover

- Paint

Junction trim (on-module T only)

- Paint

Tip: When specifying the paint finish for the bracket cover, select a finish that compliments the selected laminate or veneer finish.

Open Line laminates with grain direction

can only be applied vertically. Open Line laminates are not allowed on boundary screens that are greater than 59"W or have segments that are greater than 59"W. Vertical wood grain veneers can be applied up to 75"W.

On on-module X beam boundary screens, horizontal wood grain laminates and veneers can be applied up to $73\frac{1}{2}$ "W. Vertical wood grain laminates can be applied up to 59"W. Vertical wood grain veneers can be applied up to $73\frac{1}{2}$ "W.

On on-module X beam boundary screens with horizontal grain direction, the grain pattern of two screen segments may not align.

All boundary screen sides will have the same finish applied.

Application Topics

Answer beam on-module boundary screens do not support hang-on components.

Answer beam on-module boundary screens cannot attach to an Answer beam junction where an Answer foot is utilized.

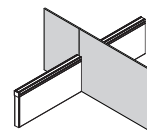

On-module X boundary screen widths do not have to be symmetrical.

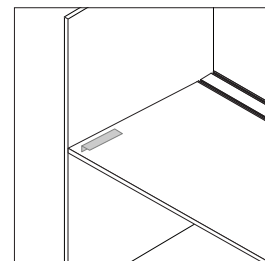

A front edge of a worksurface can be supported off of an Answer beam boundary screen with the boundary screen worksurface support bracket (Service part 1148776001SR). Order separately.

On-module beam boundary screens do not prevent power and data from routing through the beam junction. Screens are notched to wrap around beam.

Boundary, Worksurface, and Beam Screens

Answer Beam Centered In-Line Boundary Screens

Answer beam

Boundary screens

provide light scale space division and privacy for a variety of worksettings.

► Specifying, pages 236

Answer beam centered in-line boundary screens have a thickness of $1\frac{3}{16}$ ".

Screens are available in laminate or wood veneer.

Boundary screens

come standard with adjustable glides, with a range of $1\frac{1}{2}$ ". The glides are located $1\frac{1}{2}$ " from the outside of each edge.

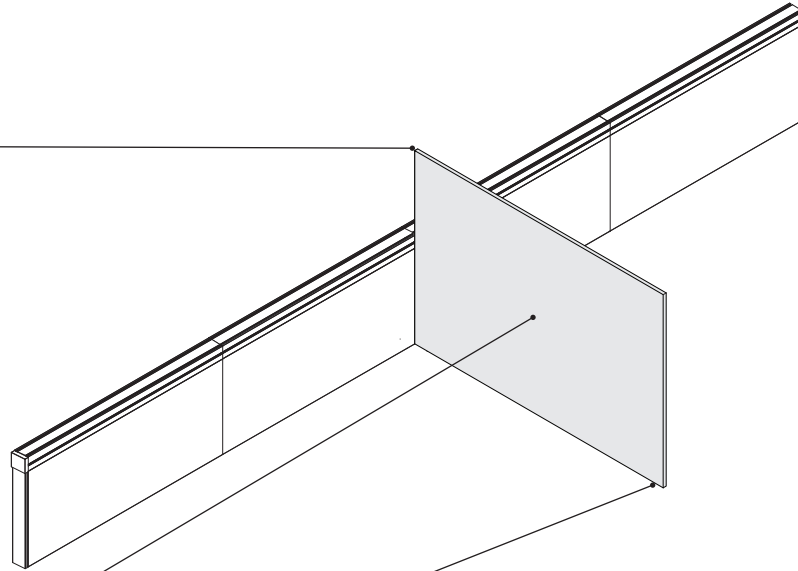

Product Details

Answer beam boundary screens are available in three configurations: end-of-run, on-module in-line, and centered in-line. For more information on Answer beam end-of-run boundary screens, ► Page 76

For more information on Answer beam on-module in-line boundary screens, ► Page 80

Answer beam centered in-line boundary screens attach into standard in-line beam junctions.

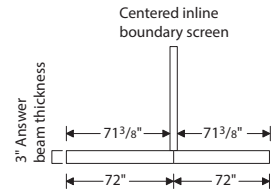

Answer beam centered in-line boundary screens decrease the planning dimension of the beam by $\frac{5}{8}$ " on either side of the centered in-line boundary screen.

Beam centered in-line boundary screens have modular heights and widths. Parametric widths are allowed from 24"W to 72"W increasing in $\frac{1}{16}$ " increments.

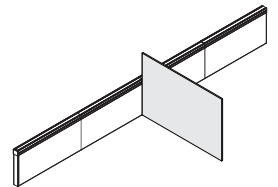

Answer beam centered in-line boundary screens end at the Answer beam in-line junction.

Actual Dimensions

Height	28 $\frac{1}{2}$ ", 42", and 48"
Centered In-line Width	24", 30", 36", 42", 48", 54", 60", 66", and 72"
Thickness	$1\frac{3}{16}$ "

Tip: Answer beam boundary screen widths can also be specified parametrically.

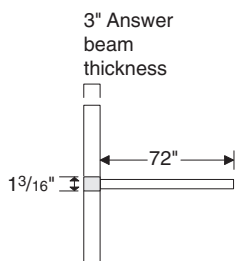

Answer beam centered in-line boundary screen width

is the same as its inside planning dimension. Tip: The above image shows a 72" specified width. The planning width is 72".

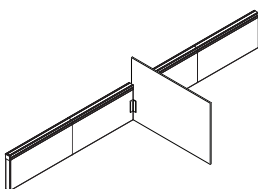

On Answer beam centered in-line boundary screens, there is a metal cover plate that covers the connection bracket that connects the boundary screen to the in-line junction. The cover is located 22" from the bottom of the screen and is 3"W and 14"H.

Application Topics

Answer beam centered in-line boundary screens do not support hang-on components.

Centered in-line boundary screens attach at the in-line junction of an Answer beam.

Answer beam centered in-line boundary screens cannot attach to an Answer beam where an Answer foot is utilized.

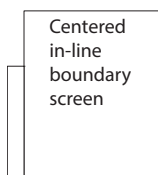

Answer beam

Centered in-line boundary screens do not wrap around the Answer beam.

Surface Materials

Boundary screens

- Laminate
- Wood veneer

Edge on laminate screen

- Plastic

Bracket cover

- Paint

Tip: When specifying the paint finish for the bracket cover, select a finish that compliments the selected laminate or veneer finish.

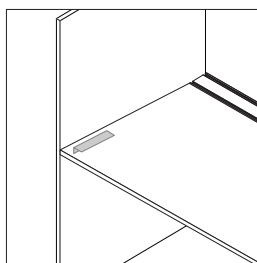

A front edge of a worksurface can be supported off of an Answer beam boundary screen with the boundary screen worksurface support bracket (Service part 1148776001SR). Order separately.

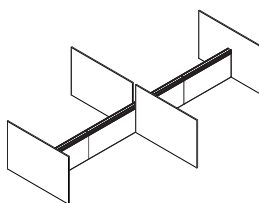

Centered in-line boundary screens can create a double sided boundary screen application by specifying two centered in-line boundary screens separately.

Open Line laminates with grain direction

can only be applied vertically. Open Line laminates are not allowed on boundary screens that are greater than 59"W or have segments that are greater than 59"W.

For Answer beam centered in-line boundary screens

horizontal wood grain laminates and veneers can be applied up to 75"W. Vertical wood grain laminates can be applied up to 59"W. Vertical wood grain veneers can be applied up to 75"W.

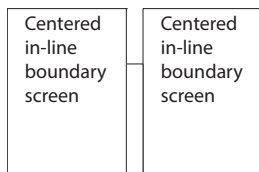

When two centered in-line boundary screens

are applied to the same in-line junction in a double sided application, there will be a 3"W gap between the two boundary screens.

All boundary screen

sides will have the same finish applied.

Universal Beam Screen

Universal beam screens

provide a tackable boundary element along the Answer beam. They are available in two heights to accommodate varying levels of privacy.

► Specifying, page 238

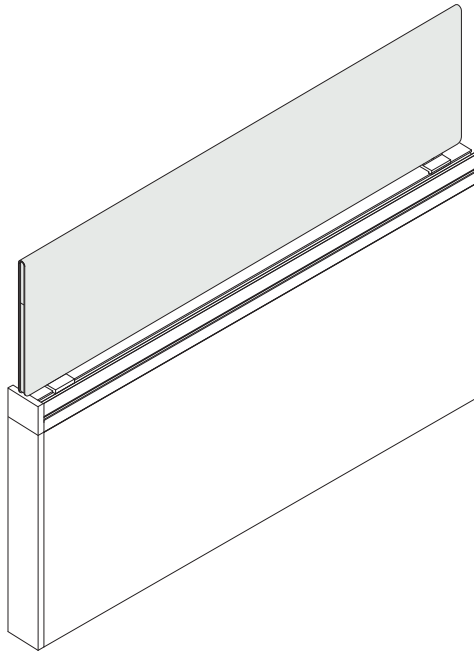

Product Details

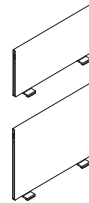

Universal beam screens are tackable and available in 13½"H and 19½"H, and have widths from 24"W to 96"W.

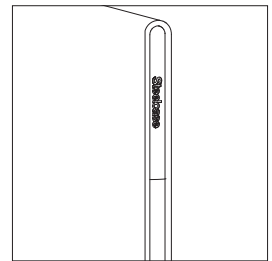

The edge of the screen is comprised of two different materials. The upper segment is merle plastic. The lower portion is PET which can be specified in medium heather grey to provide contrast or dark heather grey for a uniform visual.

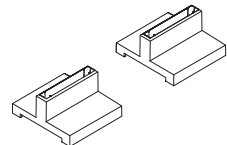

Brackets are included with screens. Two brackets are used on all screens.

Screen brackets are each two pieces which slide into the channels on the top of the beam. A plastic cap slides over the two pieces to hold the bracket together prior to sliding the screen onto the brackets.

Actual Dimensions

Overall Height 13½" or 19½"

Width 24", 30", 36", 42", 48", 54", 60", 66", 72", 78", 84", 90", or 96"

Tip: 13½"H screen aligns with a 42" datum from the floor. 19½" screen aligns with a 48" datum from the floor.

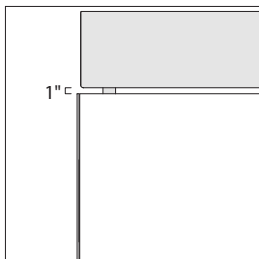

Gap is 1" between universal screen and mounting surface.

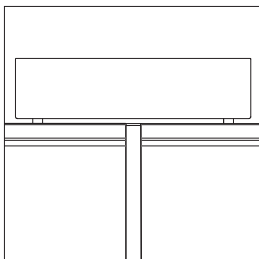

Universal beam screen can span over a junction.

Surface Materials

Screen

- Fabric
- ▶ See *Surface Materials*, page 357.

Edge (upper segment)

- 7360 Merle

Edge (lower segment)

- P630 Medium Heather Grey PET
- P631 Dark Heather Grey PET

Bracket cover

- 4799 Platinum Metallic

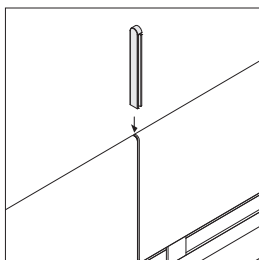

When fabric screens are placed directly adjacent to each other, a small aligner can be placed in between the screens at the top to connect them for planar alignment. Aligners are ordered separately in packages of 10.

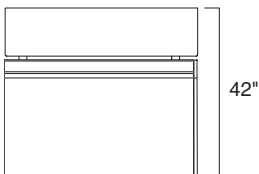

The 13¹/₂"H universal beam screen will reach a 42" height on the beam.

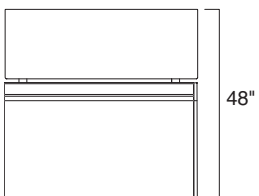

The 19¹/₂"H universal beam screen will reach a 48" height on the beam.

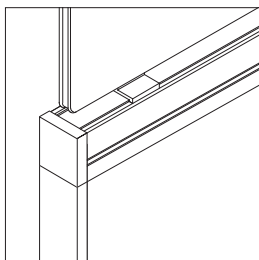

Universal beam screen can install anywhere along the beam top cap rail.

Universal Privacy/Modesty Screens

Universal privacy/modesty screen provides a boundary element for height adjustable desks and fixed worksurfaces. It can be used with Ology, Migration, Series 5 worksurfaces, Elective Elements, Universal tables, and Universal panel-mount worksurfaces.
 ▶ Specifying, page 240

Universal privacy/modesty screens are available in one height, 25⁷/₁₀" , with two mount location options to provide either privacy or privacy/modesty.

Universal privacy/modesty screen is pin tackable.

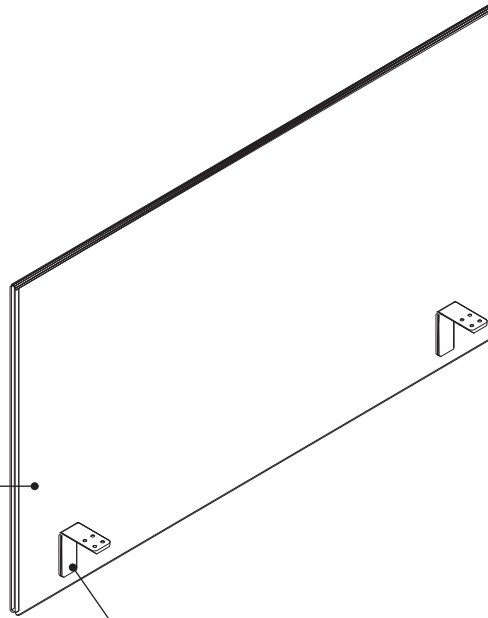

The screen is attached to the worksurface using simple L-brackets and 1" screws.

Product Details

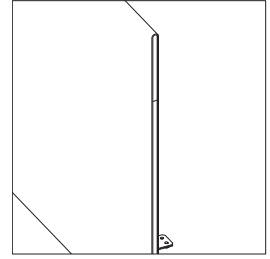

The edge of the screen is comprised of two different materials. The upper segment is merle plastic. The lower portion is PET which can be specified in medium heather grey to provide contrast or dark heather grey for a uniform visual.

The screen may be used on 3/4"-1 1/2" thick worksurfaces.

The width of the screen can be equal to or less than the width of the worksurface to which it will attach. Some restrictions apply due to location of worksurface legs and supports.

Surface Materials

Screen

- Fabric
- ▶ See *Surface Materials*, page 357.

Edge (upper segment)

- 7360 Merle

Edge (lower segment)

- P630 Medium Heather Grey PET
- P631 Dark Heather Grey PET

Brackets

- 7360 Merle

Actual Dimensions

Width	42", 48", 54", 60", or 66"
Height	25 ⁷ / ₁₀ "
Weight	9.79 lb, 10.315 lb, 10.84 lb, 11.365 lb, 11.89 lb
Thickness	3/4"

Application Topics

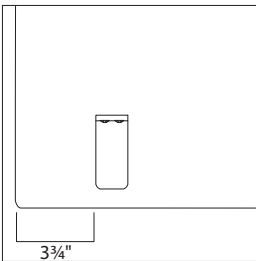

Universal privacy/modesty screen mounts to worksurfaces using simple L-brackets and screws. The brackets are positioned 3 3/4" in from each side of the screen.

Screen height attachment locations are determined when specifying privacy (top of screen will be at 48") or privacy/modesty (top of screen will be at 42"). The location cannot be changed in the field.

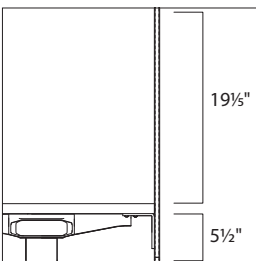

Privacy configuration provides 19 1/8" of screen above the work surface and 5 1/2" of screen below the work surface. The height is measured from the top of the mounting surface to the top of the screen, and from the bottom of the mounting surface to the bottom of the screen. The top of the screen will align with the bottom of the top trim on a 48"H Answer panel.

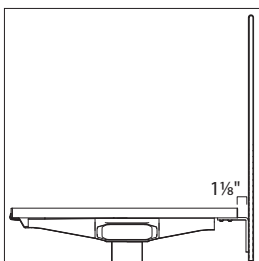

Screen can be mounted with a 1 1/8" cord drop or flush with no cord drop.

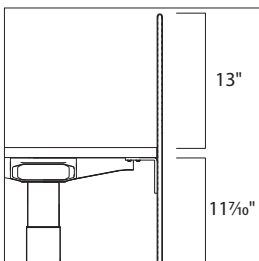

Privacy/modesty configuration provides 13" of screen above the work surface and 11 7/10" of screen below the work surface. The height is measured from the top of the mounting surface to the top of the screen, and from the bottom of the mounting surface to the bottom of the screen. The top of the screen will align with the bottom of the top trim on a 42"H Answer panel.

Both the privacy and privacy/modesty configurations allow the height-adjustable desks to be lowered to the lowest position (22") while preserving pinch point gap. Privacy version will not interfere with integrated storage.

Universal privacy/modesty screens can be used with universal worksurfaces and tables where surface supports and leg brackets are not in same location of the screen L-bracket attachment points.

- Example 1—Worksurfaces supported by a panel side bracket or cantilever can accept privacy/modesty screen placed 6" in from end with these brackets.
- Example 2—Tables with double elliptical post C-legs can accept screens 6" shorter than total table width but not same width.

Privacy/modesty screens can also be used with Elective Elements surfaces with some restrictions when combined with gate leg or the Elective Elements adjustable-height leg.

Privacy modesty screens must never be wider than the surface to which they are attached.
Tip: It is recommended that CET SmartTools Planning aid be used to ensure proper application of screen to work surface or tables.

Universal Privacy/Modesty Screens, continued

Maximum Rear Screen Sizes Based on Worksurface Edge Types on Migration Intro, Migration Pro, and Pro with Boost High-Speed

Screen Type	Square or Square with Knife Edge or 2" Radius	5" Radius	2" Radius with Knife Edge or 5" Radius with Knife Edge
Universal Privacy Screen (UFPS)	Max Screen Width = Width of Desk	Max Screen Width = Width of Desk Minus 3"	Max Screen Width = Width of Desk Minus 5"
Universal Privacy/Modesty Screen (UFPM)	Max Screen Width = Width of Desk	Max Screen Width = Width of Desk Minus 3"	Max Screen Width = Width of Desk Minus 5"
Sarto Privacy Screen (PSPS)	Max Screen Width = Width of Desk	Max Screen Width = Width of Desk Minus 3"	Max Screen Width = Width of Desk Minus 5"
Sarto Privacy/Modesty Screen (PSPM)	Max Screen Width = Width of Desk	Max Screen Width = Width of Desk Minus 2 1/2"	Max Screen Width = Width of Desk Minus 5"

Tip: Measurements provided do not include cutouts and overhang rules.

Tip: Rear screens are not compatible with Migration Pro and Intro organic bow front and back shape.

Maximum Side Screen Sizes Based on Worksurface Edge Types on Migration Intro, Migration Pro, and Pro with Boost High-Speed

Screen Type	Square or 2" Radius without Knife Edge	Square or 2" Radius with Knife Edge	5" Radius without Knife Edge	5" Radius with Knife Edge
Universal Privacy Screen (UFPS)	Max Screen Width = Depth of Desk	N/A	Max Screen Width = Depth of Desk Minus 3"	N/A
Sarto Privacy Screen (PSPS) with Option SIDESCN Selected	Max Screen Width = Depth of Desk	Max Screen Width = Depth of Desk	Max Screen Width = Depth of Desk Minus 4"	Max Screen Width = Depth of Desk Minus 4"
Sarto Privacy/Modesty Screen (PSPM) with Option SIDESCN Selected	Max Screen Width = Depth of Desk	Max Screen Width = Depth of Desk	N/A	N/A

Tip: Measurements provided do not include cutouts and overhang rules.

Tip: Side screens are not compatible with Migration Pro and Intro organic bow front and back shape.

Universal Privacy Screens

Universal privacy screens

provide a boundary and privacy element for height adjustable desks and fixed worksurfaces. It can be used with Ology, Migration, Series 5, Elective Elements, Universal worksurfaces, and TS Series worksurfaces.

► Specifying, page 242

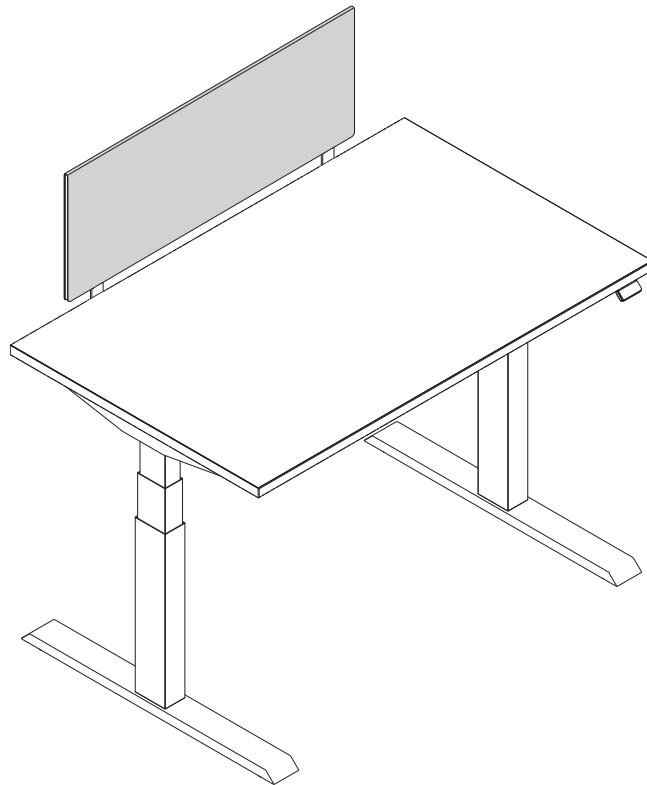

Product Details

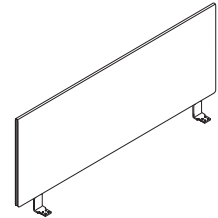

Universal privacy screens are tackable and available in 13½"H and 19½"H, and have widths from 24"W to 96"W.

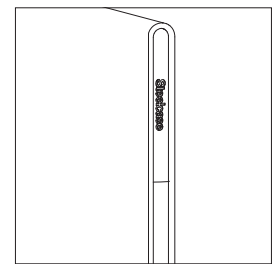

The edge of the screen is comprised of two different materials. The upper segment is merle plastic. The lower portion is PET which can be specified in medium heather grey to provide contrast or dark heather grey for a uniform visual.

The screen may be used on ¾"-1½" thick worksurfaces.

The width of the screen can be equal to or less than the width of the worksurface to which it will attach. Some restrictions apply due to location of worksurface legs and supports.

Actual Dimensions

Height	12½" or 18½"
Overall Height	13½" or 19½"
Width	24", 30", 36", 42", 48", 54", 60", 66", 72", 78", 84", 90", or 96"

Tip: Overall height is measured from top of mounting surface to the top of the screen.

Tip: 13½"H screen aligns with a 42" datum from the floor. 19½" screen aligns with a 48" datum from the floor.

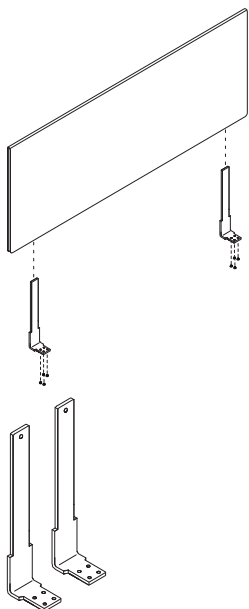

Brackets are included with screens. Two brackets are used on all screens.

Universal privacy screen slides onto brackets.

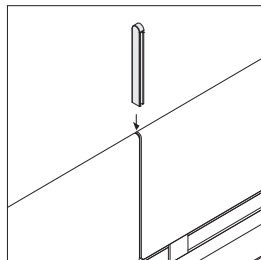

When fabric screens are placed directly adjacent to each other, a small aligner can be placed in between the screens at the top to connect them for planar alignment. Aligners are ordered separately in packages of 10.

Surface Materials

Screen

- Fabric
- ▶ See *Surface Materials*, page 357.

Edge (upper segment)

- 7360 Merle

Edge (lower segment)

- P630 Medium Heather Grey PET
- P631 Dark Heather Grey PET

Brackets

- 4799 Platinum
- 7241 Textured Arctic White
- 7360 Textured Merle

Universal Privacy Screens, continued

Maximum Rear Screen Sizes Based on Worksurface Edge Types on Migration Intro, Migration Pro, and Pro with Boost High-Speed

Screen Type	Square or Square with Knife Edge or 2" Radius	5" Radius	2" Radius with Knife Edge or 5" Radius with Knife Edge
Universal Privacy Screen (UFPS)	Max Screen Width = Width of Desk	Max Screen Width = Width of Desk Minus 3"	Max Screen Width = Width of Desk Minus 5"
Universal Privacy/Modesty Screen (UFPM)	Max Screen Width = Width of Desk	Max Screen Width = Width of Desk Minus 3"	Max Screen Width = Width of Desk Minus 5"
Sarto Privacy Screen (PSPS)	Max Screen Width = Width of Desk	Max Screen Width = Width of Desk Minus 3"	Max Screen Width = Width of Desk Minus 5"
Sarto Privacy/Modesty Screen (PSPM)	Max Screen Width = Width of Desk	Max Screen Width = Width of Desk Minus 2 1/2"	Max Screen Width = Width of Desk Minus 5"

*Tip: Measurements provided do not include cutouts and overhang rules.
 Tip: Rear screens are not compatible with Migration Pro and Intro organic bow front and back shape.*

Maximum Side Screen Sizes Based on Worksurface Edge Types on Migration Intro, Migration Pro, and Pro with Boost High-Speed

Screen Type	Square or 2" Radius without Knife Edge	Square or 2" Radius with Knife Edge	5" Radius without Knife Edge	5" Radius with Knife Edge
Universal Privacy Screen (UFPS)	Max Screen Width = Depth of Desk	N/A	Max Screen Width = Depth of Desk Minus 3"	N/A
Sarto Privacy Screen (PSPS) with Option SIDESCN Selected	Max Screen Width = Depth of Desk	Max Screen Width = Depth of Desk	Max Screen Width = Depth of Desk Minus 4"	Max Screen Width = Depth of Desk Minus 4"
Sarto Privacy/Modesty Screen (PSPM) with Option SIDESCN Selected	Max Screen Width = Depth of Desk	Max Screen Width = Depth of Desk	N/A	N/A

*Tip: Measurements provided do not include cutouts and overhang rules.
 Tip: Side screens are not compatible with Migration Pro and Intro organic bow front and back shape.*

Sarto Beam Screens

Sarto beam screens provide a light scale tackable boundary element along the Answer beam. They are available in two modular heights to accommodate varying levels of privacy.
 ▶ Specifying, page 244

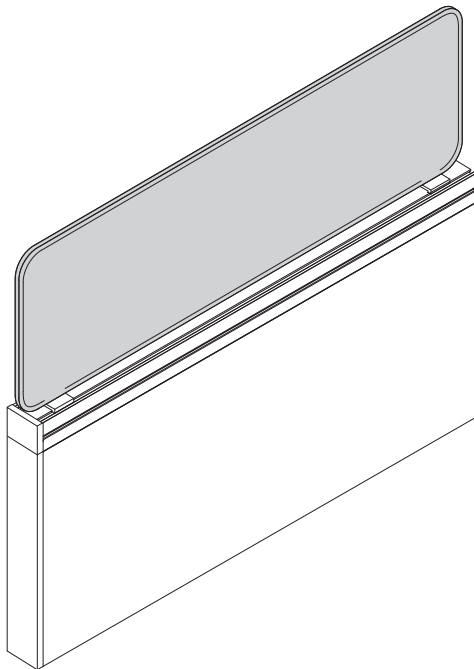

Actual Dimensions

Screen Height	12½" or 18½"
Overall Height	13½" or 19½"
Width	24", 30", 36", 42", 48", 54", 60", 66", 72", 78", 84", 90", or 96"

Tip: Modular 13½"H screen aligns with a 42" datum from the floor. Modular 19½"H screen aligns with a 48" datum from the floor.

Tip: Parametric specifications are available for Sarto beam screens.

Tip: Parametric specifications define actual screen height and width. Overall height will be about inch larger than specified height due to gap between screen and mounting surface. Newly ordered parametric screens may not align exactly with previously specified modular sizes, even if the same dimension is specified. It is highly recommended to use CET SmartTools to verify all dimensions.

Product Details

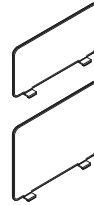

Sarto beam screens are tackable. They are available in modular heights, 13½"H and 19½"H, and have modular widths ranging from 24"W to 96"W. Screens are also available to specify parametrically.

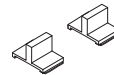

Brackets and hard stops are included with screens. Two brackets are used on screens 54"W and smaller. Three brackets are used on screens 60"W and larger.

Screen brackets each contain two pieces that slide into the channels on the top of the beam. A plastic cap slides over the two pieces to hold the bracket together. The hard stops are then added before sliding the screen onto the brackets.

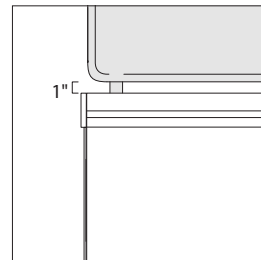

Gap is 1" between sarto screen and mounting surface.

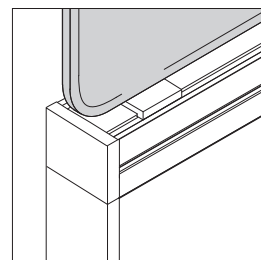

Sarto beam screen can install anywhere along the beam top cap rail.

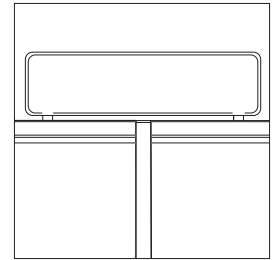

Sarto beam screen can span over a junction, provided there is no conflict between the brackets and the junction. The third bracket on longer screens may conflict with the junction. Please consult CET SmartTools for confirmation before finalizing specification.

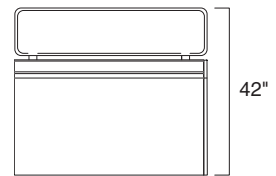

The modular 13½"H sarto beam screen will reach a 42" height off the floor.

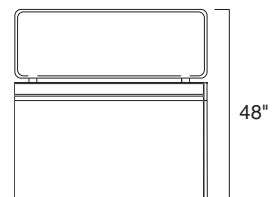

The modular 19½"H sarto beam screen will reach a 48" height off the floor.

Surface Materials

Screen

- Fabric
- ▶ See *Surface Materials*, page 357.

Brackets and hard stops

- 7360 Merle

Bracket cover

- 4799 Platinum Metallic

Sarto Privacy/Modesty Screens

Sarto privacy/modesty screen provides a light scale boundary element for height adjustable desks and fixed worksurfaces. It can be used with Ology, Migration Desking Collection, Elective Elements, universal tables, and universal panel-mount worksurfaces.

► Specifying, page 246

Sarto privacy/modesty screens are available in overall heights from 24" to 30", with a privacy height option to provide varying levels of privacy and modesty.

Sarto privacy/modesty screen is pin tackable.

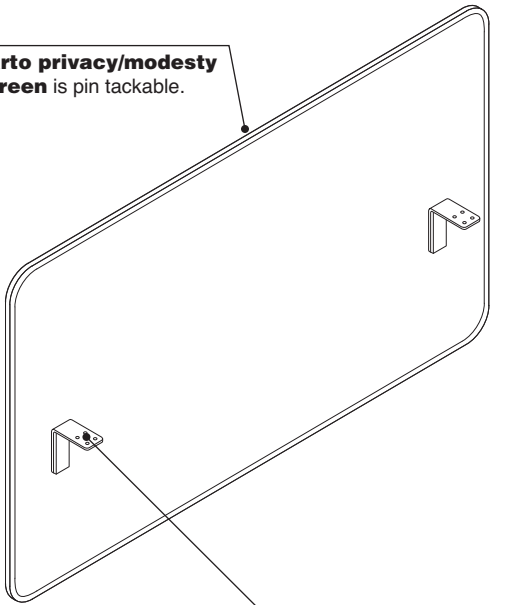

The screen is attached to the worksurface using simple L-brackets and 1" screws.

Product Details

The screen may be used on 3/4"–1 1/2" thick worksurfaces.

Screens are available in modular or parametric sizes.

The width of the screen can be equal to or less than the width of the worksurface to which it will attach. Some restrictions apply due to location of worksurface legs and supports.

Weight of screens are calculated as follows:
Screen: 0.0044 lb per inch²
Bracket: 0.2 lb per bracket.

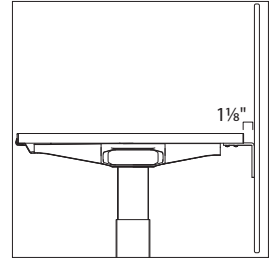

Screen can be mounted to the back edge of the worksurface with a 1/8" cord drop or flush with no cord drop.

Screens 36"W and narrower can be mounted as side screens, and are always mounted flush to the edge of the worksurface. This application grows the footprint of the workstation by 9/16" per screen.

Application Topics

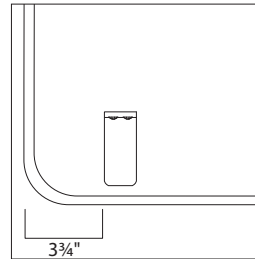

Sarto privacy/modesty screen mounts to worksurfaces using simple L-brackets and screws. The brackets are positioned 3 3/4" in from each side of the screen. Two L-brackets are included with screens narrower than 60"W. Three or four L-brackets are included on screens 60"W and wider.

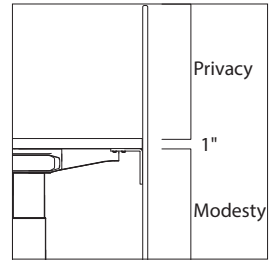

Screens are specified by first selecting an overall screen height (24"–30"), then specifying a privacy height. Privacy height is measured from the top of the screen to the top of the worksurface. Allowable privacy height selection changes based on the specified overall height.

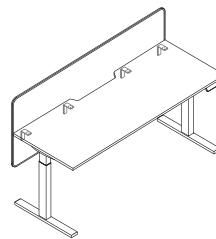

Worksurface type is available for screens 60" wide or wider, and allows the Sarto privacy/modesty screen to mount to a scalloped worksurface (for example Bivi Height-Adjustable Desk).

All privacy heights allow a height adjustable desk to be lowered to the lowest position (22") while preserving pinch point gap.

Actual Dimensions

Width	23"–70"
Height	24"–30"
Thickness	9/16"

To match screens

ordered on or before June 20, 2021, please consult the following information to determine proper privacy height.

- 24"H Screen, Privacy/Modesty Configuration – Privacy Height = 13½"
- 24"H Screen, Privacy Configuration – Privacy Height = 16½"
- 30"H Screen, Privacy Configuration – Privacy Height = 22½"

Sarto privacy/modesty screens

can be used with universal worksurfaces and tables where surface supports and leg brackets are not in same location of the screen L-bracket attachment points.

- Example 1—Worksurfaces supported by a panel side bracket or cantilever can accept privacy/modesty screen placed 6" in from end with these brackets.
- Example 2—Tables with double elliptical post C-legs can accept screens 6" shorter than total table width but not same width.

Sarto privacy/modesty screens

cannot be used with Ology or Migration Pro and Intro modesty panels.

Privacy/modesty screens

can also be used with Elective Elements surfaces with some restrictions when combined with gate leg or the Elective Elements adjustable-height leg.

Privacy/modesty screens

must never be wider than the surface to which they are attached.

Tip: It is recommended that CET SmartTools planning aid be used to ensure proper application of screen to worksurface or tables.

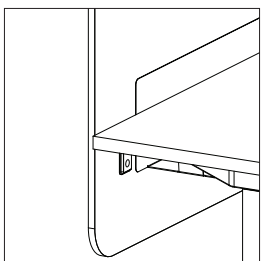

Sarto privacy/modesty screens

can be installed with the Migration metal cable tray. When specifying a Sarto screen equal to or greater than 60"W to use with the cable tray, select the "with tray application" option. The metal tray is an option with the desk or can be ordered separately.

Tip: Screen width must be 10½" wider than the metal cable tray.

Surface Materials

Screen

- Fabric
- ▶ See *Surface Materials*, page 357.

Brackets

- 7360 Merle

Sarto Privacy/Modesty Screens, continued

Maximum Rear Screen Sizes Based on Worksurface Edge Types on Migration Intro, Migration Pro, and Pro with Boost High-Speed

Screen Type	Square or Square with Knife Edge or 2" Radius	5" Radius	2" Radius with Knife Edge or 5" Radius with Knife Edge
Universal Privacy Screen (UFPS)	Max Screen Width = Width of Desk	Max Screen Width = Width of Desk Minus 3"	Max Screen Width = Width of Desk Minus 5"
Universal Privacy/Modesty Screen (UFPM)	Max Screen Width = Width of Desk	Max Screen Width = Width of Desk Minus 3"	Max Screen Width = Width of Desk Minus 5"
Sarto Privacy Screen (PSPS)	Max Screen Width = Width of Desk	Max Screen Width = Width of Desk Minus 3"	Max Screen Width = Width of Desk Minus 5"
Sarto Privacy/Modesty Screen (PSPM)	Max Screen Width = Width of Desk	Max Screen Width = Width of Desk Minus 2 1/2"	Max Screen Width = Width of Desk Minus 5"

Tip: Measurements provided do not include cutouts and overhang rules.

Tip: Rear screens are not compatible with Migration Pro and Intro organic bow front and back shape.

Maximum Side Screen Sizes Based on Worksurface Edge Types on Migration Intro, Migration Pro, and Pro with Boost High-Speed

Screen Type	Square or 2" Radius without Knife Edge	Square or 2" Radius with Knife Edge	5" Radius without Knife Edge	5" Radius with Knife Edge
Universal Privacy Screen (UFPS)	Max Screen Width = Depth of Desk	N/A	Max Screen Width = Depth of Desk Minus 3"	N/A
Sarto Privacy Screen (PSPS) with Option SIDESCN Selected	Max Screen Width = Depth of Desk	Max Screen Width = Depth of Desk	Max Screen Width = Depth of Desk Minus 4"	Max Screen Width = Depth of Desk Minus 4"
Sarto Privacy/Modesty Screen (PSPM) with Option SIDESCN Selected	Max Screen Width = Depth of Desk	Max Screen Width = Depth of Desk	N/A	N/A

Tip: Measurements provided do not include cutouts and overhang rules.

Tip: Side screens are not compatible with Migration Pro and Intro organic bow front and back shape.

Sarto Privacy Screens

Sarto privacy screens provide a light scale boundary and privacy element for height-adjustable desks and fixed worksurfaces. It can be used with Ology, Migration Desking Collection, Elective Elements, universal worksurfaces, and TS Series worksurfaces.

► Specifying, page 248

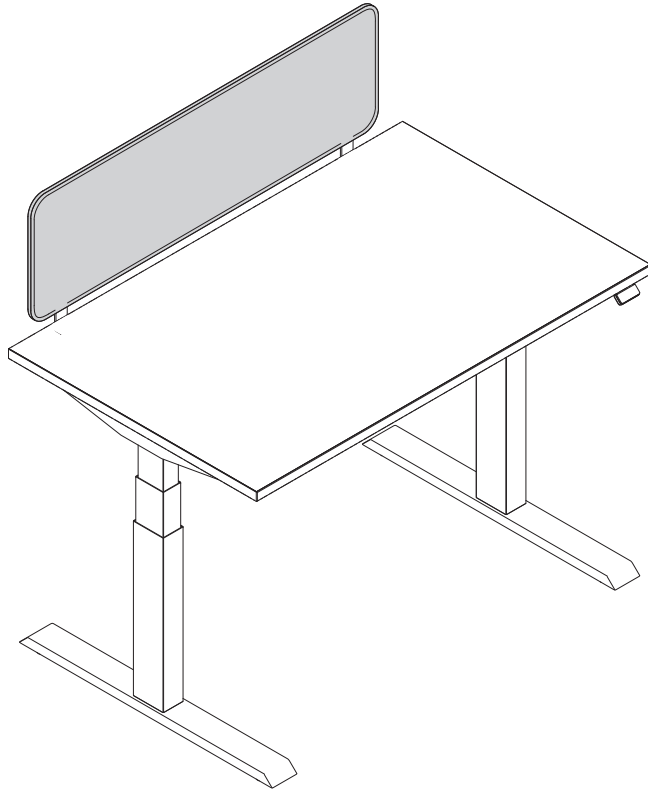

Product Details

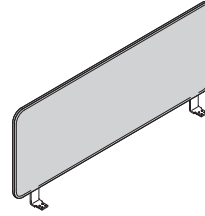

Sarto privacy screens are tackable. They are available in four modular heights, 13½"H, 19½"H, 23½"H, and 35½"H, and have widths ranging from 24"W to 96"W. Screens can also be specified parametrically.

The screen may be used on ¾"–1½" thick worksurfaces.

The width of the screen can be equal to or less than the width of the worksurface to which it will attach. Some restrictions apply due to location of worksurface legs and supports.

Tip: It is recommended that CET SmartTools planning aid be used to ensure proper application of screen to worksurface or tables.

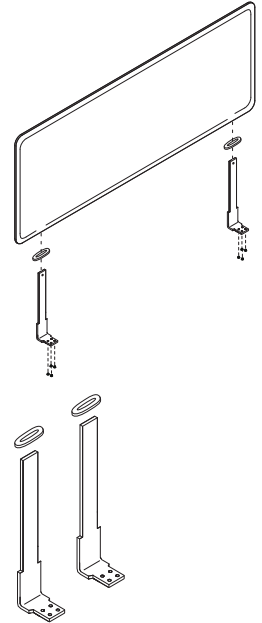

Brackets and hard stops are included with screens. Screens narrower than 60"W use two brackets, while screens 60"W and larger utilize three brackets. The third bracket is centered on the width of the screen.

Offset brackets are included with 29"W screens, to help maintain appropriate pinch points between the screen and adjacent objects. Side screen option is available for screens 36"W and narrower.

Sarto privacy screen slides onto brackets.

Alignment brackets are available to help eliminate gapping and misalignment between back and side screens. Alignment brackets are available as their own style (**PSCB**).

Weight of screens are calculated as follows:
Screen: 0.0044 lb per inch²
Bracket: 1.2 lb per bracket.

Surface Materials

Screen

- Fabric
- See *Surface Materials*, page 357.

Brackets and hard stops

- 7360 Merle

Actual Dimensions

Screen Height	12½"–34½"
Overall Height	13½"–35½"
Width	24"–96"

Tip: Overall height is measured from top of mounting surface to the top of the screen.

Maximum Rear Screen Sizes Based on Worksurface Edge Types on Migration Intro, Migration Pro, and Pro with Boost High-Speed

Screen Type	Square or Square with Knife Edge or 2" Radius	5" Radius	2" Radius with Knife Edge or 5" Radius with Knife Edge
Universal Privacy Screen (UFPS)	Max Screen Width = Width of Desk	Max Screen Width = Width of Desk Minus 3"	Max Screen Width = Width of Desk Minus 5"
Universal Privacy/Modesty Screen (UFPM)	Max Screen Width = Width of Desk	Max Screen Width = Width of Desk Minus 3"	Max Screen Width = Width of Desk Minus 5"
Sarto Privacy Screen (PSPS)	Max Screen Width = Width of Desk	Max Screen Width = Width of Desk Minus 3"	Max Screen Width = Width of Desk Minus 5"
Sarto Privacy/Modesty Screen (PSPM)	Max Screen Width = Width of Desk	Max Screen Width = Width of Desk Minus 2 1/2"	Max Screen Width = Width of Desk Minus 5"

Tip: Measurements provided do not include cutouts and overhang rules.

Tip: Rear screens are not compatible with Migration Pro and Intro organic bow front and back shape.

Maximum Side Screen Sizes Based on Worksurface Edge Types on Migration Intro, Migration Pro, and Pro with Boost High-Speed

Screen Type	Square or 2" Radius without Knife Edge	Square or 2" Radius with Knife Edge	5" Radius without Knife Edge	5" Radius with Knife Edge
Universal Privacy Screen (UFPS)	Max Screen Width = Depth of Desk	N/A	Max Screen Width = Depth of Desk Minus 3"	N/A
Sarto Privacy Screen (PSPS) with Option SIDESCN Selected	Max Screen Width = Depth of Desk	Max Screen Width = Depth of Desk	Max Screen Width = Depth of Desk Minus 4"	Max Screen Width = Depth of Desk Minus 4"
Sarto Privacy/Modesty Screen (PSPM) with Option SIDESCN Selected	Max Screen Width = Depth of Desk	Max Screen Width = Depth of Desk	N/A	N/A

Tip: Measurements provided do not include cutouts and overhang rules.

Tip: Side screens are not compatible with Migration Pro and Intro organic bow front and back shape.

Divisio Side Screen

Divisio side screen is magnetic and provides a territorial boundary between users. The user-movable functionality allows users to decide when and where they need additional privacy. The screens may be used on any 3/4"- to 1 1/2"-thick worksurface.

► Specifying, page 251

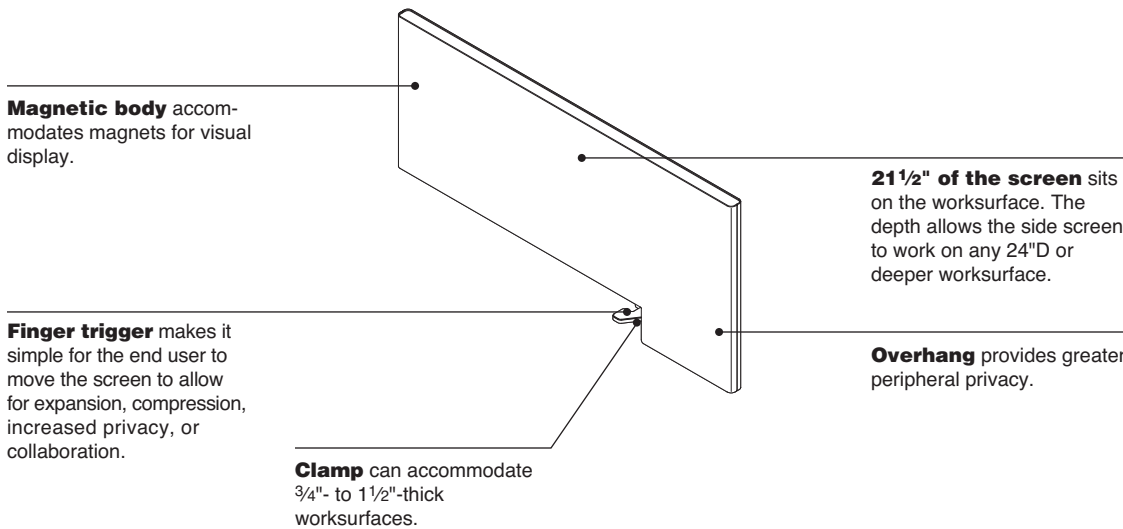

Product Details

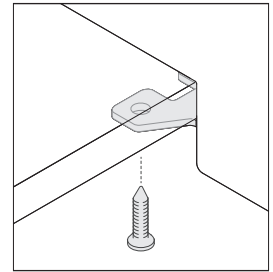

Divisio side screen can be made more permanent by adding two screws through the clamp. For 3/4" thick worksurfaces, FrameOne, a #10 x 3/4" countersunk screw is recommended. For worksurfaces over 3/4" thick, a #10 x 7/8" countersunk wood screw is recommended.

Actual Dimensions

Depth	29 1/2" (total), 21 1/2" (sits on worksurface)
Width	1 1/4"
Height	14 1/4" (total), 11 5/8" (above worksurface)

Understanding Answer Beam Stability Guidelines

Stability Guidelines

102

Stability Guidelines

Answer beam, when installed properly, is an exceptionally stable furniture system. That applies to workstations using beam alone, beam-supported components, or freestanding furniture.

Counterweight packages for storage products are required to ensure product stability.
▶ See *Storage Specification Guide*.

The following section on beam stability gives some guidelines to be used with common system furniture configurations. Guidelines are given to beam with and without components. Consult your local dealer or Steelcase representative prior to deviating from these guidelines.

Guidelines for Freestanding Beam
▶ Page 103

Guidelines for Single-Sided Planning with Stanchion Mounted Centered Storage
▶ Page 105

Guidelines for Double-Sided Planning with Stanchion Mounted Centered Storage
▶ Page 106

Guidelines for Single-Sided Parallel Stanchion Mounted Storage with Mid-Storage Support
▶ Page 107

Guidelines for Double-Sided Parallel Stanchion Mounted Storage with Mid-Storage Support
▶ Page 108

Guidelines for Single-Sided Perpendicular Stanchion Mounted Storage with Mid-Storage Support
▶ Page 109

Guidelines for Double-Sided Perpendicular Stanchion Mounted Storage with Mid-Storage Support
▶ Page 110

Guidelines for Freestanding Application

Beam-mounted storage is not allowed in freestanding beam configurations. Worksurfaces supported only by beam cantilevers cannot be added to an Answer beam application supported only by feet.

Tip: The maximum beam with screen height is 48"H.

Tip: Single Answer beam segments supported by panel feet must be at least six feet wide.

Tip: Freestanding Answer beam runs with multiple beam segments must have a panel and beam foot every 10 feet.

Tip: A panel and beam foot is required within three feet of the end-of-run.

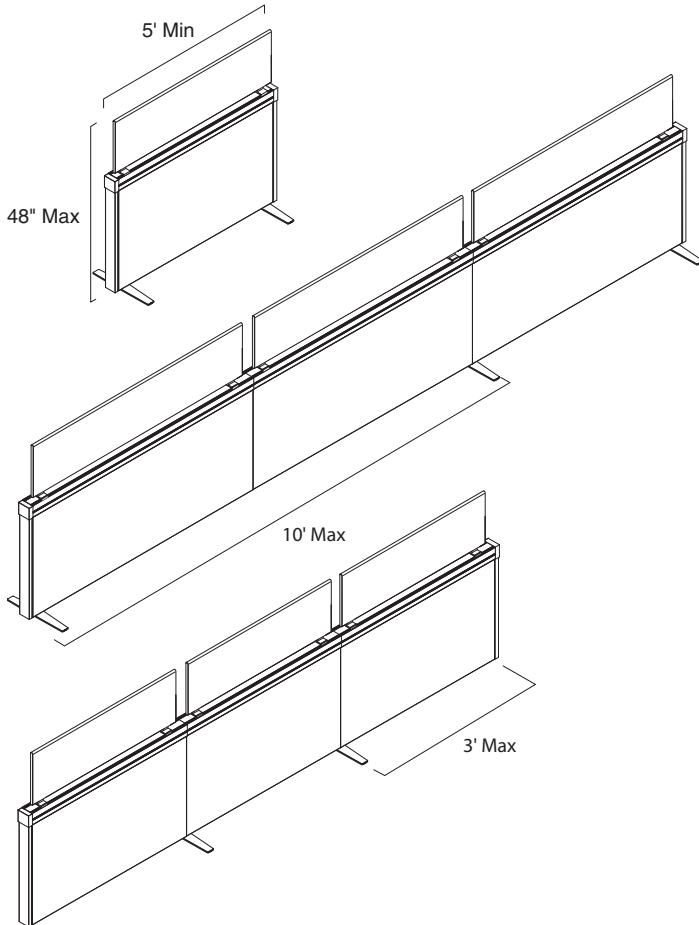

Stability Guidelines, continued

Guidelines for Answer Beam Applications without Stanchion Mounted Storage

- Answer Beam must be supported every 10'.

Answer Beam supports that can take the place of a panel and beam foot

- Answer beam spanning or split end-of-run boundary screen
- Answer beam T or X junction
- Answer panel T or X junction
- On-module X in-line boundary screens
- Centered in-line boundary screens (double sided)
- Double-sided mid-storage support application
- Worksurface supported as indicated below

Acceptable worksurface applications as primary supports

- Post leg with cantilever
- Universal FrameOne legs (half loop, open loop, and closed loop)
- Tether brackets with Answer panel and beam foot
- Tether brackets with Two High low storage supporting worksurface
- Tether brackets with One-High or 1.5-High storage (attached to beam storage-to-beam connector and beam intermediate worksurface support)

Allowable mid-run supports (applied to one or both sides)

- One-High, 1.5-High, Two High (18"D or 24"D) Currency cabinet or credenza, attached to beam with storage-to-beam connector (parallel or perpendicular application)
- ▶ See *Currency Specification Guide*.

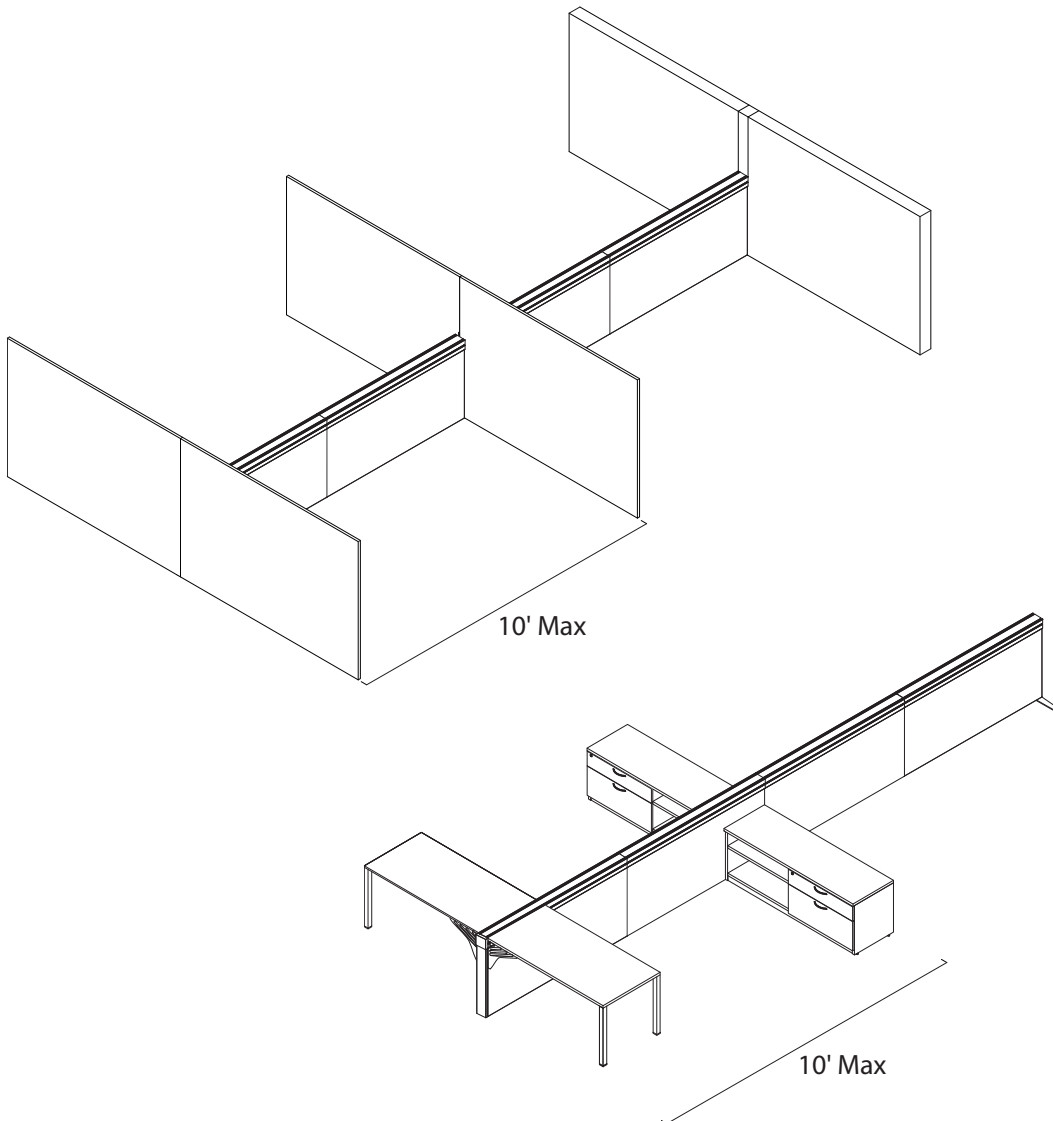

Guidelines for Single-Sided Planning with Stanchion Mounted Centered Storage

- End-of-run support must be applied at each end of beam run. End-of-run support can be Answer beam end-of-run boundary screen, Answer beam, or Answer panel.
- Answer panel or beam foot must be applied on beam runs longer than 6'. Maximum spacing from foot to end-of-run and foot-to-foot is 6'.
- Low storage and tethered worksurfaces can be applied, but do not count as support elements in single-sided planning with stanchion mounted centered storage.

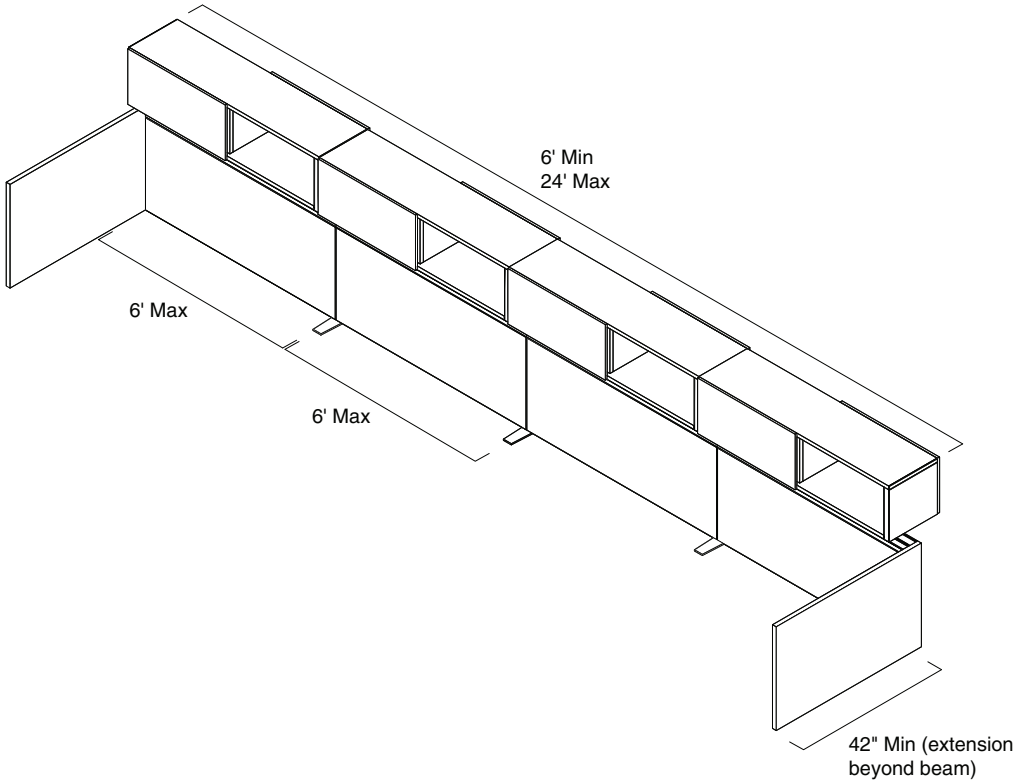

Stability Guidelines, continued

Guidelines for Double-Sided Planning with Stanchion Mounted Centered Storage

- Double-sided primary supports must be applied at each end-of-beam run. Primary supports can be Answer beam end-of-run spanning or split boundary screen, Answer beam T junction, Answer panel T junction, double-sided mid-storage support applications, or worksurfaces (see details below for worksurface supports).
- Beam runs can be longer than 24' if double-sided primary supports are applied at least every 24' feet.
- Double-sided primary supports can be on-module in-line boundary screen, centered in-line boundary screen, Answer beam X junction, Answer panel X junction, double-sided mid-storage support applications, or tethered worksurfaces (see details below for worksurface supports).
- On beam runs longer than 10', the maximum spacing from primary support to mid-run support is 10' (see details below for allowable mid-run support). The maximum spacing from mid-run support to mid-run support is also 10'.

A single worksurface connected to the beam using only worksurface tethers is not allowed at the beam end-of-run unless one of the following guidelines are met:

- Single worksurface needs to have a boundary screen at the end-of-run on the side of the beam the worksurface is located.
- Single worksurface needs to be supported by beam junction or Answer panel connection.
- Single worksurface needs to be supported with a junction attached support (beam cantilever or Universal FrameOne leg for Answer Beam).

Acceptable worksurface applications as primary supports (parallel or perpendicular)

- Post leg with cantilever
- Universal FrameOne legs (half loop, open loop, and closed loop) support Answer beam
- Tether brackets with Answer panel and beam foot
- Tether brackets with Two High low storage supporting worksurface
- Tether brackets with One-High or 1.5-High storage (attached to beam storage-to-beam connector and beam intermediate worksurface support)

Allowable mid-run supports (applied to one or both sides)

- Answer panel or beam foot
- One-High, 1.5-High, Two High (18"D or 24"D) Currency cabinet or credenza, attached to beam with storage-to-beam connector (parallel or perpendicular application)
- ▶ See *Currency Specification Guide*.
- On-module in-line boundary screens
- Centered in-line boundary screens
- Answer beam junction
- Answer panel junction

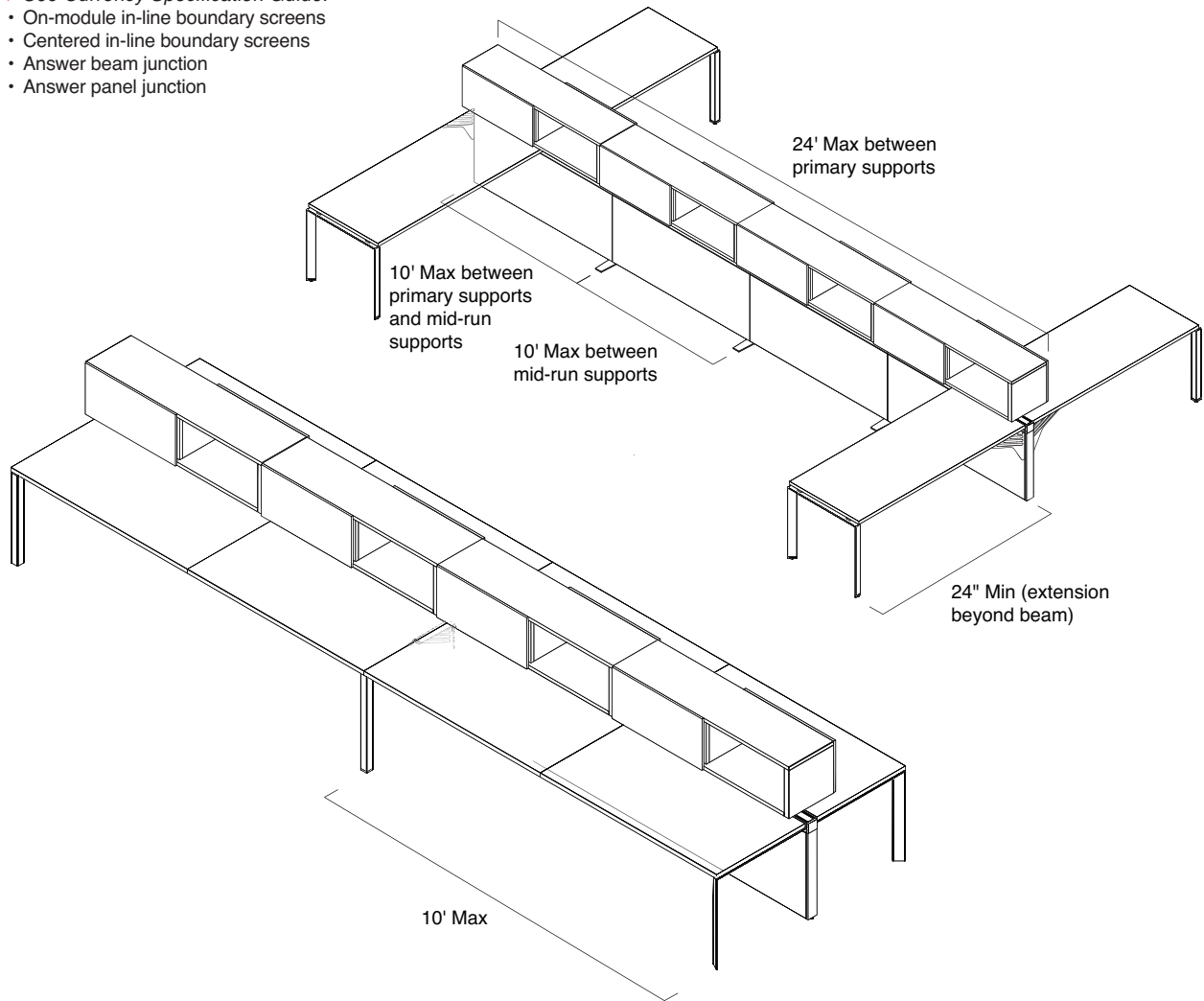

Guidelines for Single-Sided Parallel Stanchion Mounted Storage with Mid-Storage Support

- Supporting low storage must be connected to a beam with a storage-to-beam connector bracket. When low storage is at the end-of-run position, the storage-to-beam connector bracket should be placed at the end-of-run position.
- For single-sided applications, the supporting low storage requires counterweights.
- Worksurfaces supporting parallel stanchion mounted storage with mid-storage support must be tethered to the beam. Worksurface support can include:
 - Cantilever and front edge support
 - Universal FrameOne legs (half loop, open loop, and closed loop) for Answer beam
 - Tether brackets with Answer panel and beam foot
- For single-sided applications, when only worksurfaces are supporting stanchion mounted storage and the beam, the worksurfaces must utilize a front edge worksurface support every 6'.
- For single-sided applications, when only worksurfaces are supporting stanchion mounted storage and the beam, worksurface depth in benching application must be 30"D.

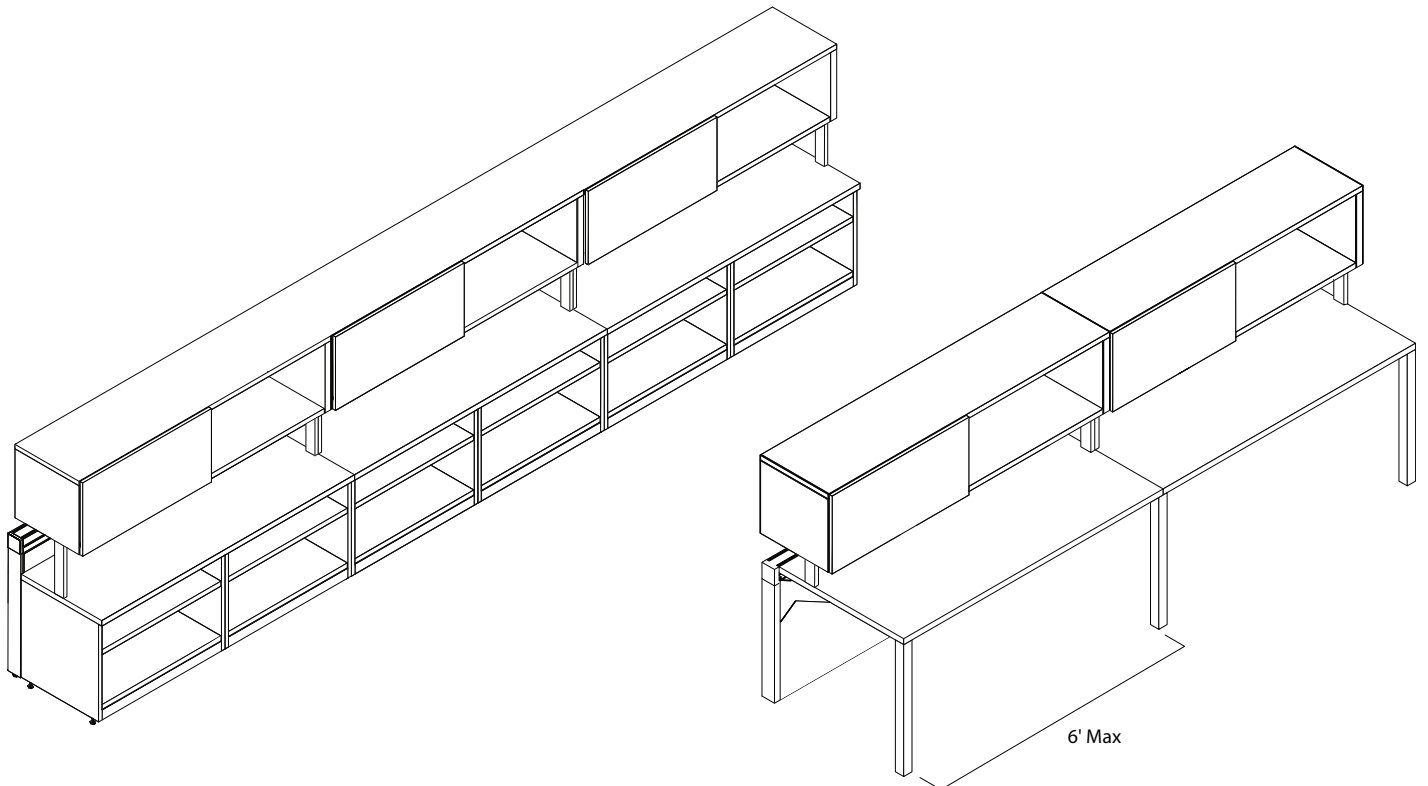

Guidelines for Double-Sided Parallel Stanchion Mounted Storage with Mid-Storage Support

- Supporting low-storage must be connected to a beam with a storage-to-beam connector bracket. When low storage is at the end-of-run position, the storage-to-beam connector bracket should be placed at the end-of-run position.
- Worksurfaces supporting parallel stanchion mounted storage with mid-storage support must be attached to the beam. Worksurface support can include:
 - Cantilever and front edge support
 - Universal FrameOne legs (half loop, open loop, and closed loop) for Answer beam
 - Tether brackets with Answer panel and beam foot and front edge support
- Double-sided parallel stanchion mounted storage with mid-storage supports counts as a beam support.
- The beam must meet the application guidelines for freestanding beam application if the application has no stanchion mounted centered storage.
- The beam must meet the application guidelines for stanchion mounted centered storage if the beam application also contains stanchion mounted centered storage.

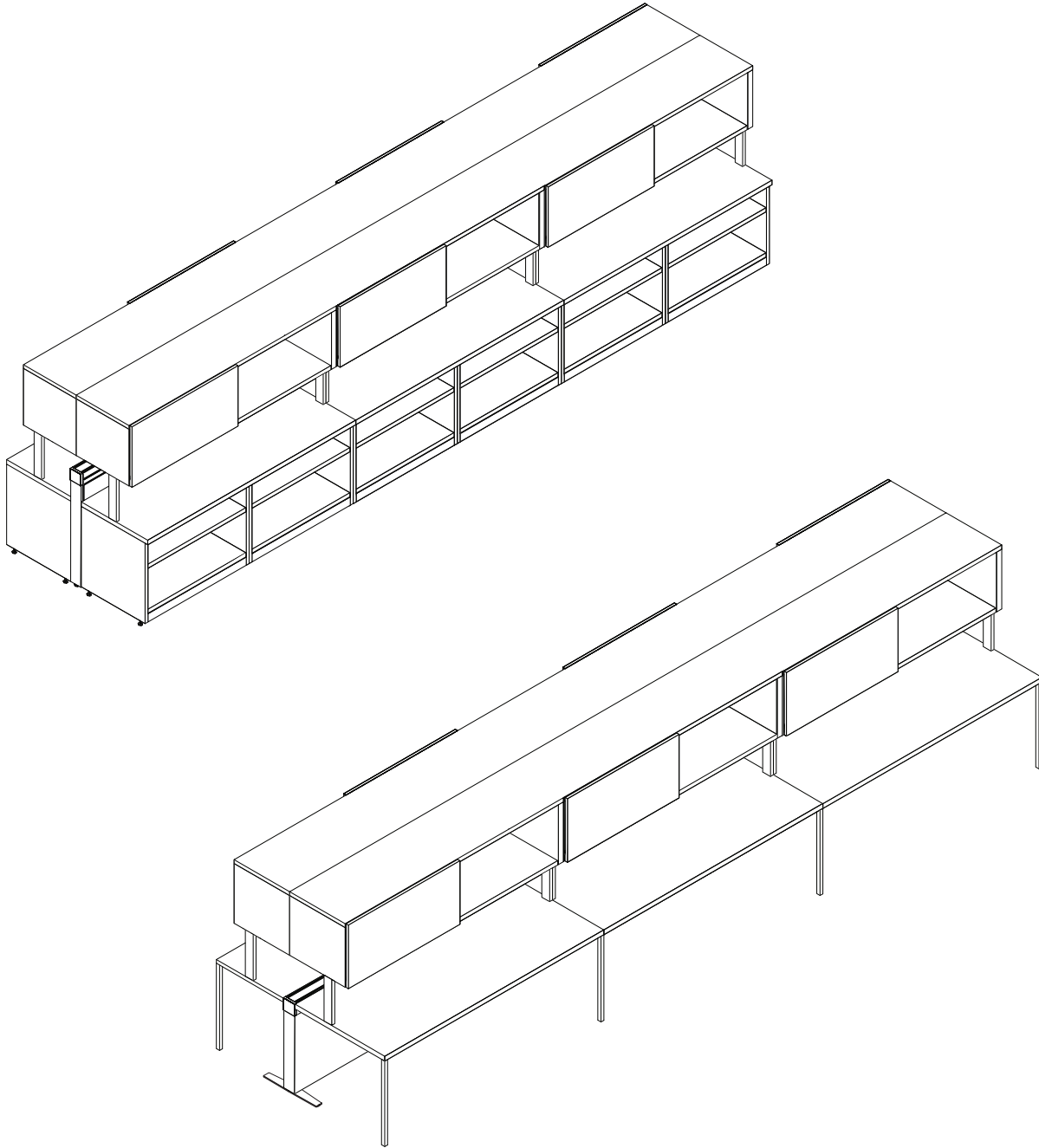

Guidelines for Single-Sided Perpendicular Stanchion Mounted Storage with Mid-Storage Support

- Supporting low-storage must be connected to a beam with a storage-to-beam connector bracket.
- Single-sided perpendicular stanchion mounted storage with mid-storage supports count as a beam support.
- When there is low storage back-to-back supporting perpendicular stanchion mounted storage, the low storage should be ganged together to ensure consistent alignment.
- The beam must meet the application guidelines for freestanding beam application if the application has no stanchion mounted centered storage.
- The beam must meet the application guidelines for stanchion mounted centered storage if the beam application also contains stanchion mounted centered storage.

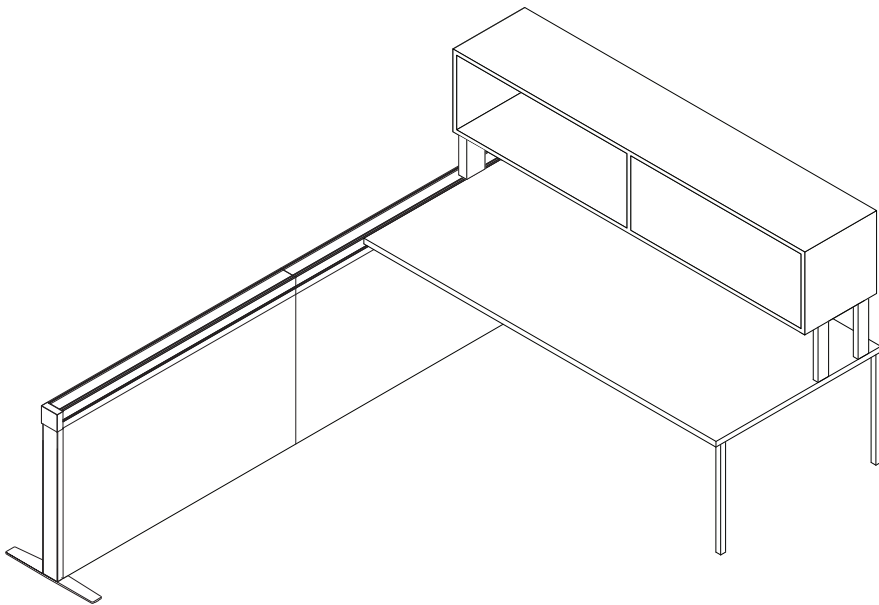
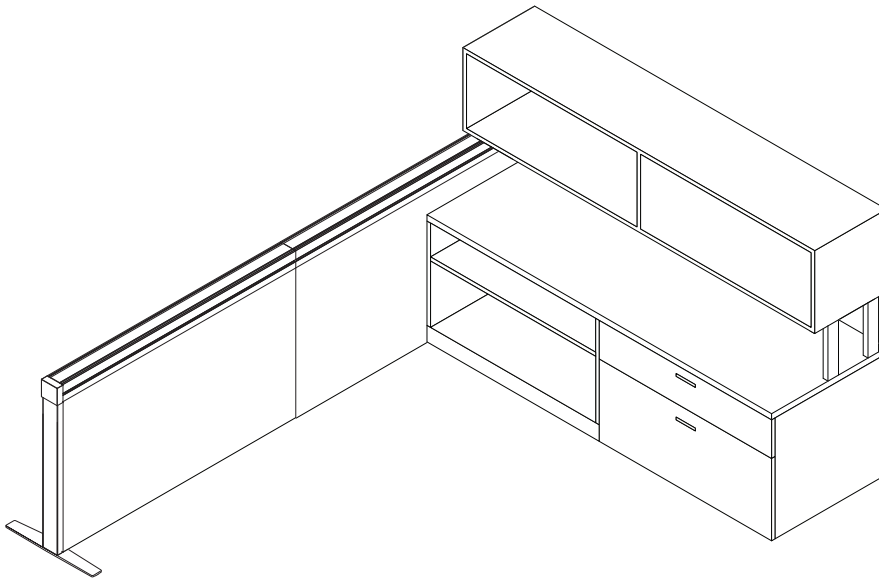

Guidelines for Double-Sided Perpendicular Stanchion Mounted Storage with Mid-Storage Support

- Supporting low-storage must be connected to a beam with a storage-to-beam connector bracket.
- Double-sided perpendicular stanchion mounted storage with mid-storage supports count as a beam support.
- When there is low storage back-to-back supporting perpendicular stanchion mounted storage, the low storage should be ganged together to ensure consistent alignment.
- The beam must meet the application guidelines for freestanding beam application if the application has no stanchion mounted centered storage.
- The beam must meet the application guidelines for stanchion mounted centered storage if the beam application also contains stanchion mounted centered storage.

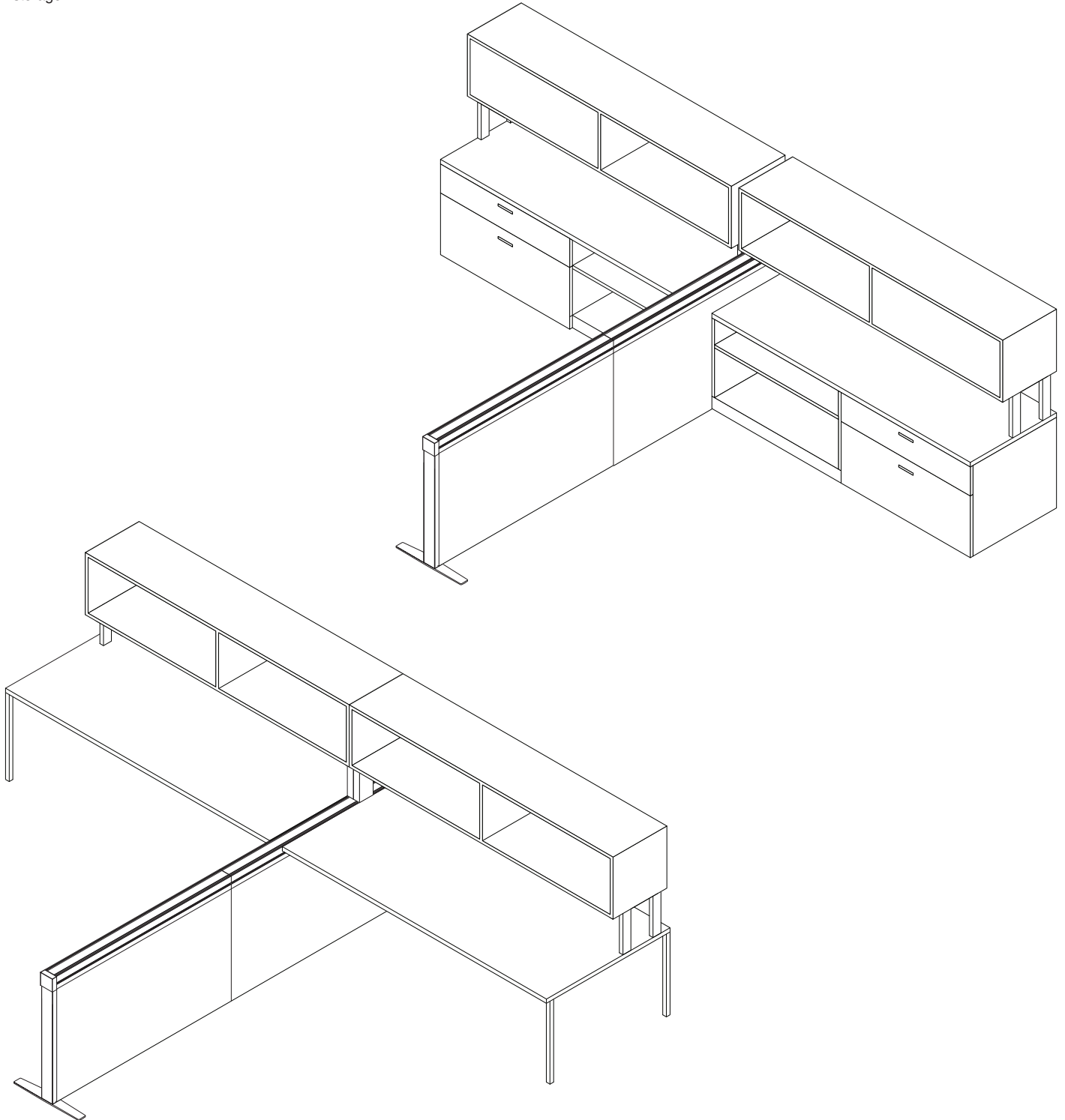

Understanding Universal Systems Worksurfaces and Supports



Statement of Line 112

Worksurface Support Guidelines	116
Universal Systems Worksurfaces	118
Universal Systems Worksurfaces with Soft Edge, Power and Data Access Door and Tray	122
Universal Systems Worksurfaces with Power Access Door	126
Universal Beam-Mounted Worksurface Supports	128
Beam FrameOne Legs and Supports for Universal Worksurfaces	130
Infills for FrameOne Legs for Universal Worksurfaces	132
Knife Edge Worksurface Application Guidelines	133

Statement of Line

All worksurface sizes and shapes are available in High-Pressure Laminate with 3 mm edge. Most sizes and shapes are also available in High-Pressure Laminate with knife edge or in wood veneer with square edge. See Specifying pages for details.

Worksurface dimensions shown apply to both wood veneer and High-Pressure Laminate versions of each worksurface.

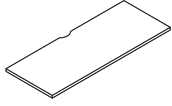

Understanding
 ▶ Page 118
 Specifying
 ▶ Pages 254–258

Straight Worksurfaces

With 1/2" Cord Drop

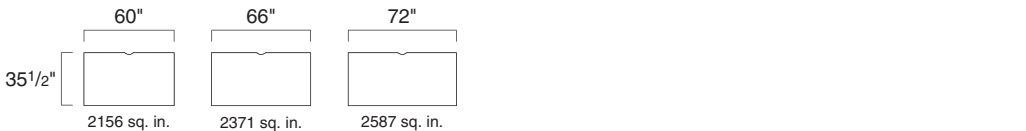
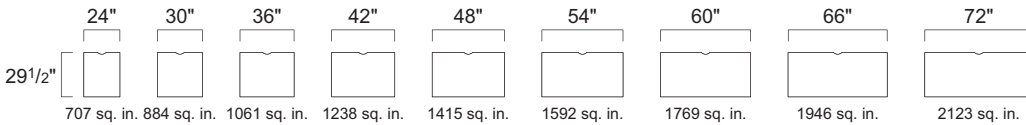
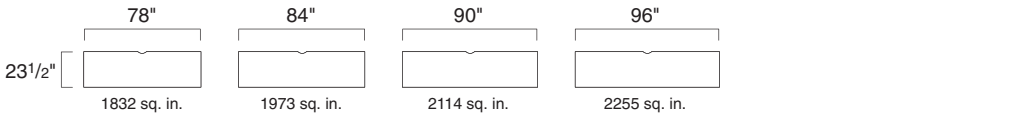
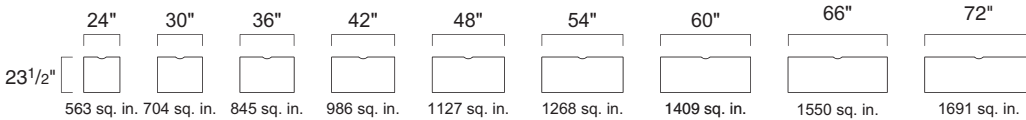
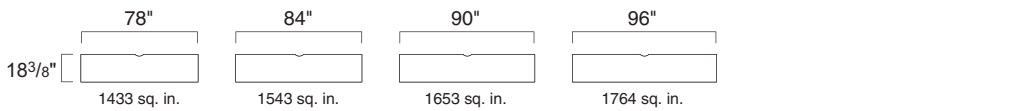
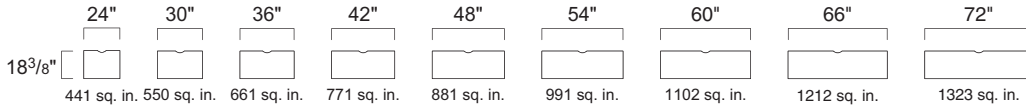

Tip: Worksurfaces greater than 30"D can only be used in free-standing applications.

Tip: Common dimensions displayed, parametric dimensions available in depths from 18" to 36" and widths from 18" to 120" in 1/16" increments both depth and width.

All worksurface sizes and shapes are available in High-Pressure Laminate with 3 mm edge. Most sizes and shapes are also available in High-Pressure Laminate with knife edge or in wood veneer with square edge. See Specifying pages for details.

Worksurface dimensions shown apply to both wood veneer and High-Pressure Laminate versions of each worksurface.

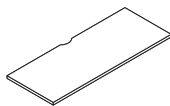

Understanding
 ▶ Page 118
 Specifying
 ▶ Pages 254–258

Straight Worksurfaces, continued

With Full Depth

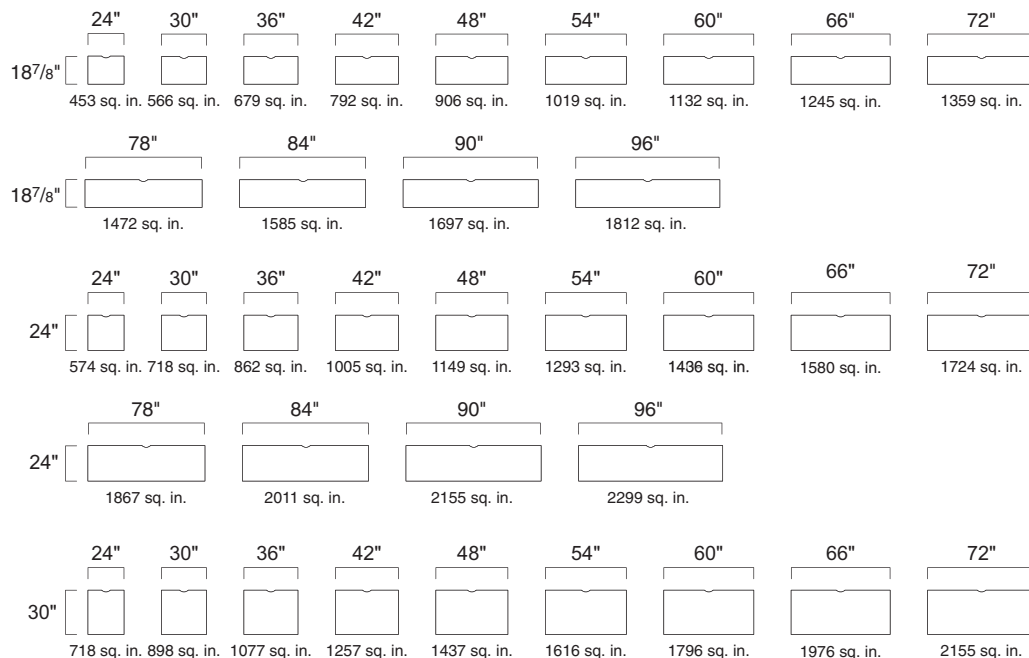

Tip: Common dimensions displayed, parametric dimensions available in depths from 18" to 36" and widths from 18" to 120" in 1/16" increments both depth and width.

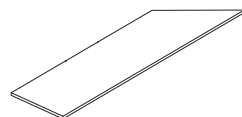

Understanding
 ▶ Page 118
 Specifying
 ▶ Page 262

Straight 120° Worksurfaces

With 1/2" Cord Drop

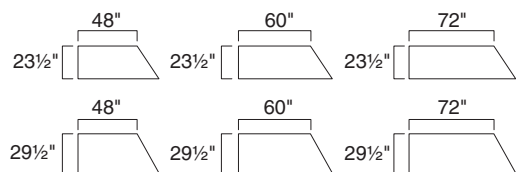

*Right-hand units shown.
 Left-hand units available.

Statement of Line, continued

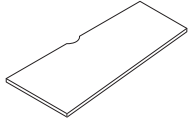

Understanding
 ▶ Page 118
 Specifying
 ▶ Page 264

Tapered Worksurfaces*

With 1/2" Cord Drop

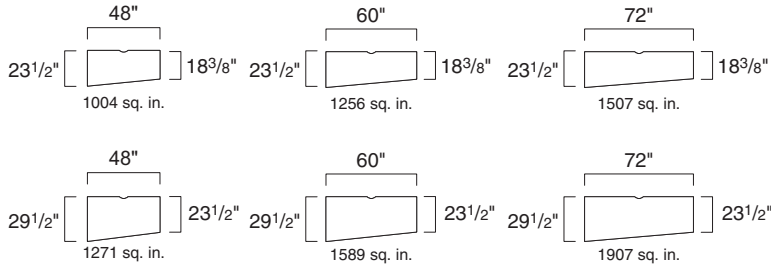

With Full Depth

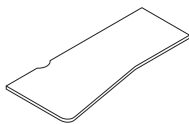
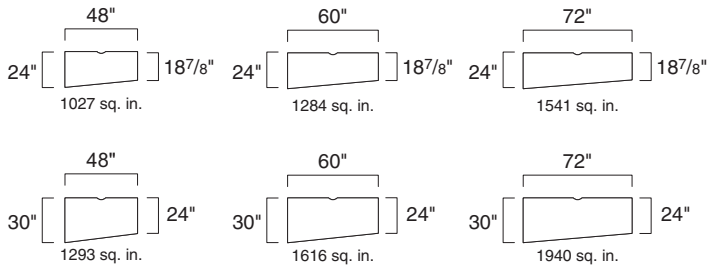

Understanding
 ▶ Page 118
 Specifying
 ▶ Page 265

Taper-Flat Worksurfaces*

With 1/2" Cord Drop

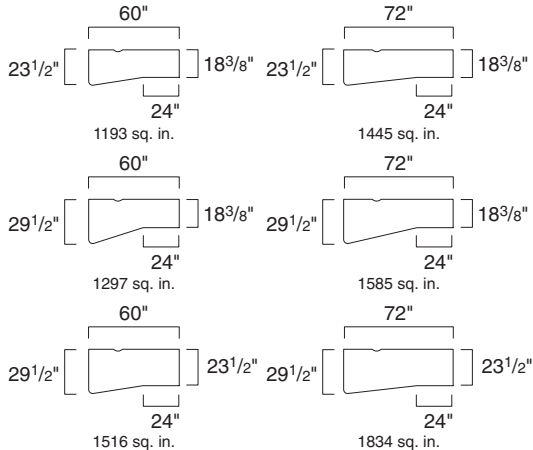

With Full Depth

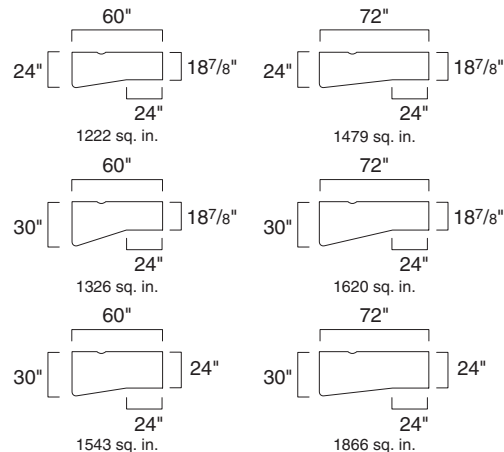

*Left-hand units shown.
 Right-hand units available.

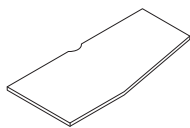

Understanding
 ▶ Page 118
 Specifying
 ▶ Page 266

Single-Tapered Worksurfaces*

With 1/2" Cord Drop

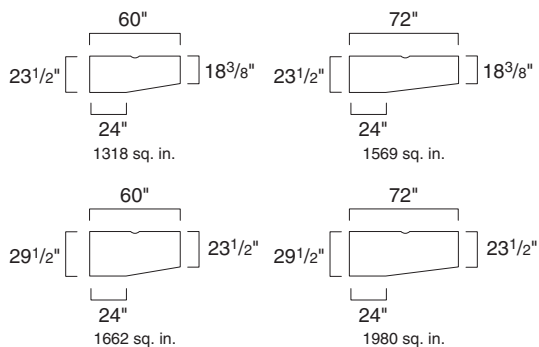

With Full Depth

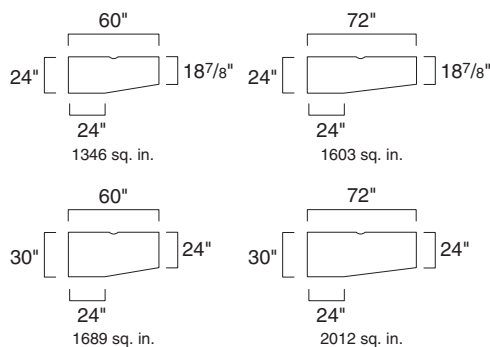

*Left-hand units shown.
 Right-hand units available.



Understanding
 ▶ Page 118
 Specifying
 ▶ Page 267

Corner, 120° Worksurfaces

Corner, 120° Worksurfaces With 1/2" Cord Drop

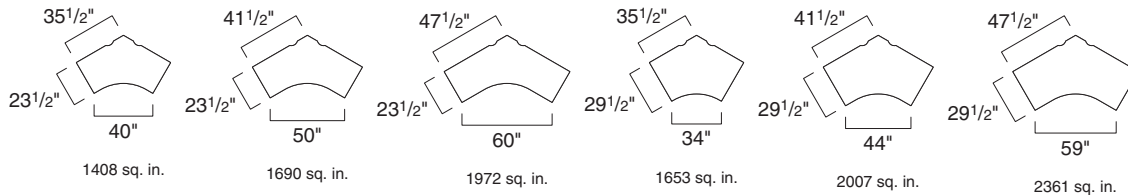

Worksurface Support Guidelines

Worksurface spans greater than 54" require a brace or additional support to the floor. Spans greater than 72" wide cannot be supported only by a reinforcing channel, and require additional supports to the floor. Calculate span distance by measuring from edge of one end of worksurface to edge of other end of worksurface.

Exception: When using pedestals or lateral files to support a worksurface, measure from the inside edge of the storage unit.

Worksurfaces can span up to 60" in heavy load applications and up to 72" in light load applications if a reinforcing channel is used. A light load application is less than 40 pounds placed on a worksurface. Reinforcing channel must be specified separately.

▶ See *Storage Specification Guide*.

Exception: Knife edge worksurfaces require support on spans greater than 48"W.

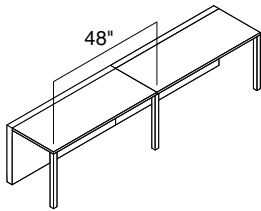

Reinforcing channel is not required on worksurfaces with spans less than 54"W.

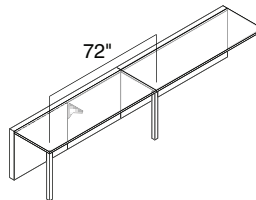

Lightly loaded applications typically include a workstation with monitors, lighting, limited organizational tools, and personal items.

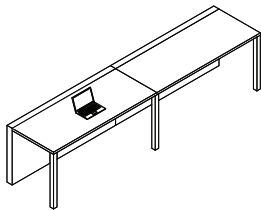

Reinforcing channel or additional support is required for worksurfaces with spans greater than 54"W and less than 72"W in light use applications and on worksurfaces with spans greater than 54"W and less than 60"W in heavy load applications.

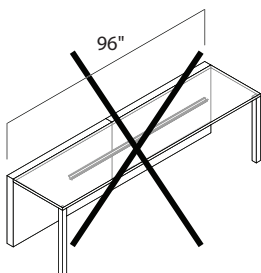

Worksurface span cannot be supported solely by a reinforcing channel. Additional to the floor supports are required.

Tip: Reinforcing channels add 1"D below the worksurface.

Tip: For maximum effectiveness, place the reinforcing channel in the middle of the worksurface span.

Calculate span distance by measuring from edge of one end of worksurface to edge of other end of worksurface. To determine size of reinforcing channel needed, deduct the amount listed in the matrix below from the measured span. Deduction in inches is based on combination of the left-hand and right-hand supports.

Example: 72"W measured span, with application of cantilever for left-hand support and end panel for right-hand support, has a span deduction of 6" for a reinforcing channel size of 66" (72"-6" = 66"). For this application, use reinforcing channel TS7WKSPT66.

Worksurface Span Deductions for Determining Reinforcing Channel Size		Right-Hand Support						
		End Panel	FrameOne Leg	FrameOne Leg-Table Application	Intermediate Support	DBL Post Leg	Cantilever	All other Legs/Supports
Left-Hand Support	FrameOne Leg	-6"	-6"	-9"	-9"	-6"	-6"	-6"
	FrameOne Leg-Table Application	-9"	-9"	-12"	-12"	-9"	-9"	-9"
	Intermediate Support	-9"	-9"	-12"	-12"	-9"	-9"	-9"
	DBL Post Leg	-6"	-6"	-9"	-9"	-6"	-6"	-6"
	Cantilever	-6"	-6"	-9"	-9"	-6"	-6"	-6"
	All other Legs/Supports	-6"	-6"	-9"	-9"	-6"	-6"	-6"

Reinforcing Channel Sizes		
Style Number	Nominal	Actual
TS7WKSPT39	39"W	39.231"W
TS7WKSPT48	48"W	47.547"W
TS7WKSPT51	51"W	50.547"W
TS7WKSPT54	54"W	53.547"W
TS7WKSPT	57"W	56.547"W
TS7WKSPT60	60"W	59.547"W
TS7WKSPT63	63"W	62.547"W
TS7WKSPT66	66"W	65.547"W
TS7WKSPT72	72"W	71.547"W

Tip: If the deducted span distance falls between two reinforcing channel sizes, select the smaller of the two sizes.

Reinforcing Channel Size for Straight 120° Worksurfaces

To calculate the reinforcing channel size for a straight 120° worksurface, use the user edge length, subtract 6" and order the next shortest channel. Also, reference the chart below.

Back Edge Width	Worksurface Depth	User Edge Depth	Reinforcing Channel Size
48"	23½"	61⅛"	54"
48"	29½"	65⅛"	57"
60"	23½"	73⅞"	66"
60"	29½"	77⅛"	66"
72"	23½"	85⅞"	72"
72"	29½"	89⅛"	72"

Universal Systems Worksurfaces

Systems worksurfaces— with 1/2" cord drop feature built-in cable management flexibility, allowing cords to drop below the worksurface at any point along the back edge. ▶ Specifying page 254

Systems worksurfaces— full depth feature a tighter fit to beams for a cleaner aesthetic or to stay on module when using perpendicular to beams.

Systems straight worksurfaces with 1/2" cord drop and full depth are available in a variety of widths and depths in parametric dimensions.

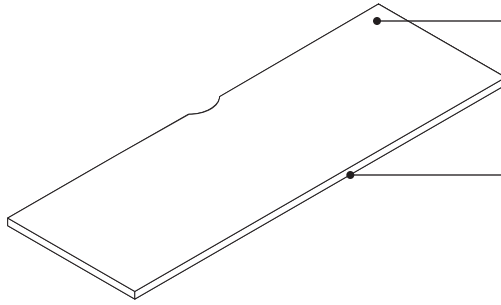

Full-depth worksurfaces fit flush against beams. Cords and cables are routed through cable scallops.

Front (user's) edge is available in two edge profiles on laminate worksurfaces. Wood veneer worksurfaces have a square (3 mm) edge profile only. Back and side edges are flat.

Cable scallops allow cords and plugs to pass behind the worksurface. Cable scallops can be omitted as an option.

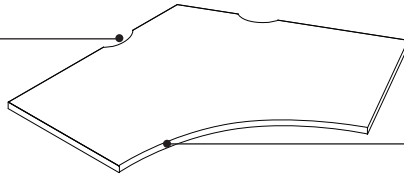

Worksurface has a wood core with a High-Pressure Laminate or wood veneer surface and is 13/16" thick.

Product Details

High-Pressure Laminate Worksurfaces

Front (user's) edge profile is available in two shapes.

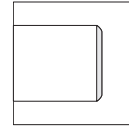

3 mm edge profile

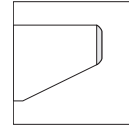

Knife edge profile

PVC-free, 3 mm edge profiles are proprietary polyolefin blend for all solid colors and seven woodgrain finishes. Matching 1 mm side and back edges are also PVC-free.

▶ See surface material listing in this book for specific PVC-free availability.

Knife edge with 3 mm user edge is available on straight and straight 120° systems worksurfaces.

Edge profile finishes are specified separately from laminate color.

Wood Veneer Worksurfaces

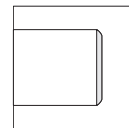

Front (user's) edge profile is wood veneer with a square (3 mm) radius. Back edge and edge that joins to adjacent worksurfaces are flat. Wood edge color matches finish specified for worksurface.

Universal worksurfaces are undersized about 0.05 inches from ordered dimension to ensure fit in panel wrapped applications.

Edge Profiles

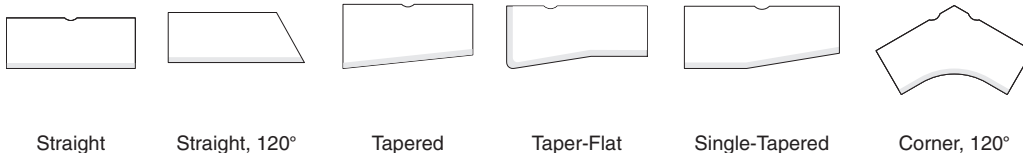

Straight

Straight, 120°

Tapered

Taper-Flat

Single-Tapered

Corner, 120°

Edge profile is applied to front (user's) edge only.

*Tip: Straight worksurface width is available parametric from 18"W–120"W in 1/16" increments. Straight worksurface depth can be specified parametric from 18"D–36"D in 1/16" increments.

Straight worksurfaces are available to specify parametrically. The parametric dimensions available are from 18" to 36" deep and from 18" to 120" wide in 1/16" increments both depth and width.

Parametric straight worksurfaces are available in laminate with a 3 mm plastic edge, knife edge, or soft edge options and wood veneer with square edge or soft edge options.

Parametric straight worksurfaces have the option to specify a scallop, grommet cutouts, power and data access door and tray cutout, or power access door.

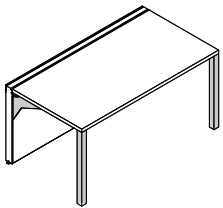

30"D straight, tapered, taper-flat and single-tapered cantilevered worksurfaces require additional floor support along the front edge, such as post leg.

Legs with casters cannot support freestanding worksurfaces that are less than 24" deep.

Connections

Worksurfaces can be used freestanding or in beam-supported installations.

Supports are ordered separately and installed in the field.

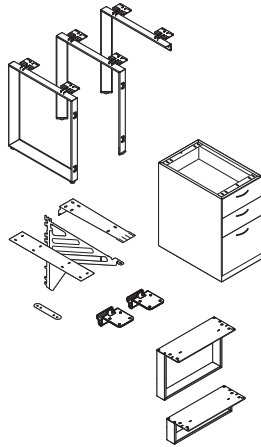

For beam-supported applications you can use:

- Closed loop beam support
 - Open loop beam support
 - Half loop beam support
 - Intermediate beam support
 - Tether bracket
 - Beam cantilever with tie plate
 - Support plate
 - Columns or legs
- Pages 272–278

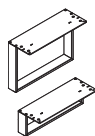

Intermediate beam supports replace the need for other types of worksurface support when used with One-High or 1.5-High Currency storage.

Tip: Intermediate beam supports are optimized to ensure alignment with Answer beam when supporting worksurfaces with Currency storage.

► See *Currency Specification Guide*.

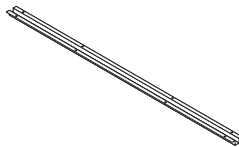

Worksurface spans greater than 54" require additional support of a cantilever, pedestal, intermediate support, or leg. Exception: Worksurfaces can span up to 60" in heavy load applications and up to 72" in light load applications if a TS7WKSPT reinforcing channel is used. Reinforcing channel must be specified separately.
► Page 273

Knife edge worksurfaces require reinforcement channels for spans greater than 48". Use TS7WKSPT39 for 54"W worksurfaces, TS7WKSPT for 60"W and 66"W worksurfaces, and TS7WKSPT72 for 72" worksurfaces.

Heavy load worksurfaces spanning greater than 60", or all worksurface spans wider than 72" require additional support of a cantilever, pedestal, intermediate support, or leg.

Wiring & Cabling

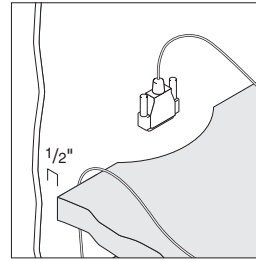

Worksurface depth is 1/2" less than nominal and allows cords and cables to pass over at any point. Cable scallops provide space for plugs to pass over the back edge of the worksurface.

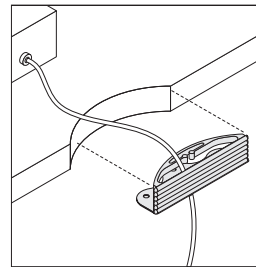

Cable scallop allows cord plugs to easily pass below the worksurface. Worksurface wire managers are available to convert cable scallops into grommets in freestanding applications. Wire managers are included with wood veneer worksurfaces. Wire managers for use with laminate worksurface must be ordered separately.

Cable scallop can be omitted for freestanding applications or beam-supported applications where plugs do not need to pass over the back edge of the worksurface.

Cable management devices are available to help manage conventional and fiber-optic cables beneath the worksurface.
► Page 207

Parametric straight worksurfaces have two grommet cutout options. The 2" round grommet cutout option fits the **AWAG2** grommet which is specified separately.
► See page 270

The 3" round grommet cutout option fits the **TSAEGROM** grommet which is specified separately.
► See page 270

The grommet cutout option is not available on a worksurface when the power access door option is selected.

Grommet cutouts in parametric straight worksurfaces can be specified in the center, the left, or the right sides of the worksurface. Grommet cutouts are available in the below configurations.

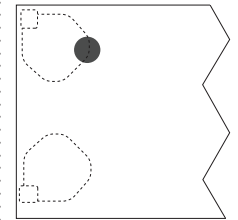

FrameOne post legs will interfere with the left or right grommet cutouts on parametric Universal straight worksurfaces.

Universal Systems Worksurfaces, continued

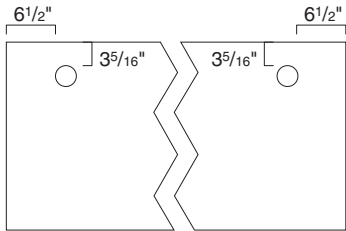

Grommet cutouts in parametric straight worksurfaces are located $3\frac{5}{16}$ " from the back edge of the worksurface to the back edge of the grommet cutout. Left and right grommet cutouts are located $6\frac{1}{2}$ " from the edge of the worksurface to the outside edge of the grommet cutout.

Grommet Location on Worksurface	Minimum Worksurface Widths
Center, Right, or Left	All widths
Right and Left	At least 25"W
Right and Center	At least 34"W
Left and Center	At least 34"W
Center, Right, and Left	At least 34"W

Surface Materials

High-Pressure Laminate Worksurfaces

- Laminate
- ▶ See *Surface Materials Reference Manual*.
- Open Line laminate (option) A program including non-Steelcase laminates which are suitable for use on Steelcase products.
- ▶ See *Surface Materials Reference Manual*.

Front (user's) edge(s)

- Plastic

Back and side edges

- Plastic color default to match user's edge

Wood Veneer Worksurfaces

- Wood veneer (standard)
- Customiz stain (option)

Square (3 mm) edge profile

- Wood veneer to match worksurface

Front (user's) edge(s)

- Wood edge band

Application Topics

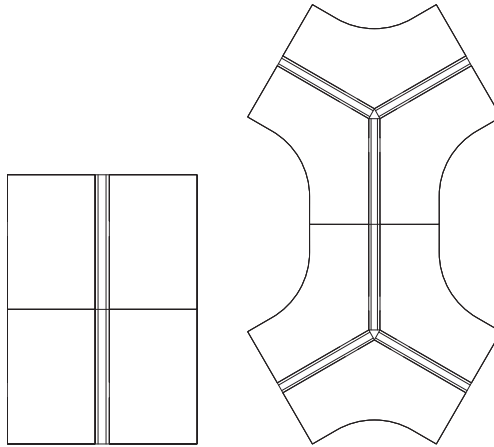

Full-depth worksurfaces provide an uninterrupted working surface and are designed to allow traditional corner or L-configuration planning without creating uneven gaps.

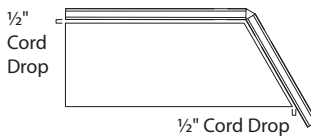

Straight 120° worksurfaces with 1/2" cord drop maintain the 1/2" cord drop on the diagonal edge and the back edge.

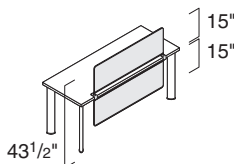

Screens mount to worksurfaces in privacy position or below the worksurface for modesty.

▶ Page 240

Worksurfaces used in beam-supported installations must follow applicable beam stability guidelines.

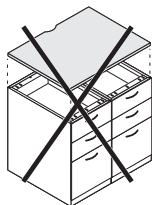

Do not use a Universal Systems Worksurface as a top for storage that matches the worksurface width. Universal Systems Worksurfaces are slightly undersized for beam-wrapped applications and will not fit over full-width storage. Use field-installed storage tops for this type of application.

▶ See *Storage Specification Guide*.

Knife edge worksurfaces have limitations for support options and application restrictions.

▶ See *Answer Specification Guide*.

Shipping

Palletizing streamlines unloading and staging of worksurfaces. Identical worksurfaces ordered on the same line item are packed on pallets containing 5–50 worksurfaces depending on worksurface size. Remaining worksurfaces are packed individually in cartons. If palletizing is not desired, order in quantities of four or less per line item. For maximum unload efficiency, utilize pallet handling equipment at job site whenever possible. Wood veneer worksurfaces cannot be palletized.

Universal Systems Worksurfaces with Soft Edge, Power and Data Access Door and Tray

Soft edge provides a comfortable user experience reducing strain on wrists and forearms.

► Specifying page 258

Power and data access door and tray provides desk top access and management of cords.

► Specifying page 268

Soft edge and power and data access door and tray cutout are available in modular and parametric straight worksurfaces, both 1/2" cord drop and full depth.

Cutout is optional; power and data access door and tray is ordered separately. 24"W cutout is centered near the back of the worksurface.

Edge is soft to the touch and flexes to conform to the arm.

Power and data access door and tray is available with cord or with modular or hardwire connection.

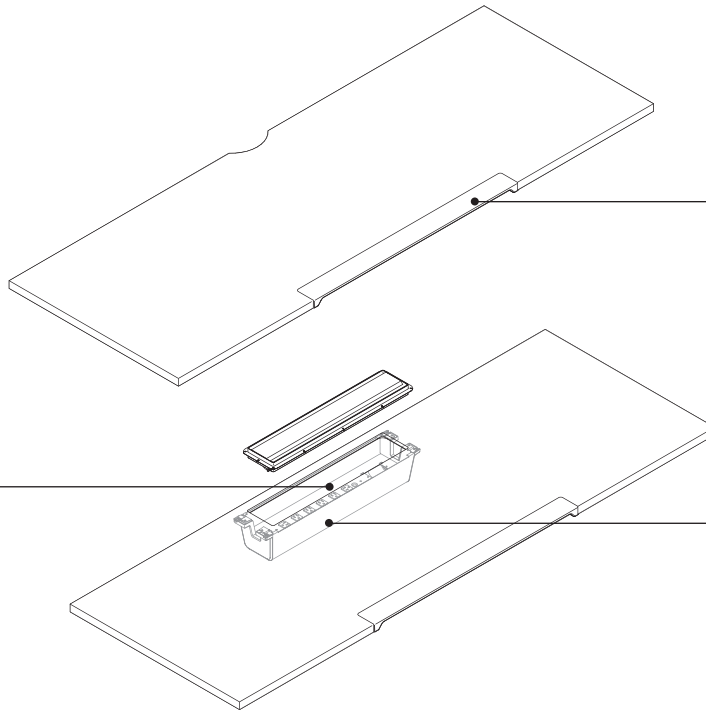

Soft edge is 36" wide centered on the worksurface; balance of front edge is 3 mm radius. Back and side edges are flat.

Soft edge and power and data access door and tray are available on straight and taper Universal Systems Worksurfaces with 1/2" cord drop and full depth.

Tray includes six simplex receptacles and cutout for data access.

Soft Edge, Power and Data Access Door and Tray Worksurface Availability

	48"W	54"W	60"W	65"W	72"W	78"W	84"W	90"W	96"W	102"W	108"W	114"W	120"W
Modular	48"W	54"W	60"W	65"W	72"W	78"W	84"W	90"W	96"W	102"W	108"W	114"W	120"W
Parametric	48"W-	54"W-	60"W-	65"W-	72"W-	78"W-	84"W-	90"W-	96"W-	102"W-	108"W-	114"W-	120"W
	53 ¹⁵ / ₁₆ "W	59 ¹⁵ / ₁₆ "W	64 ¹⁵ / ₁₆ "W	71 ¹⁵ / ₁₆ "W	77 ¹⁵ / ₁₆ "W	83 ¹⁵ / ₁₆ "W	89 ¹⁵ / ₁₆ "W	95 ¹⁵ / ₁₆ "W	101 ¹⁵ / ₁₆ "W	107 ¹⁵ / ₁₆ "W	113 ¹⁵ / ₁₆ "W	119 ¹⁵ / ₁₆ "W	

	Modular Straights	Parametric Straights	48"W	54"W	60"W	65"W	72"W	78"W	84"W	90"W	96"W	102"W	108"W	114"W	120"W
24", 30", and 36"D*	24"-36"D*	●	●	●	●	●	●	●	●	●	●	●	●	●	●
Modular Tapered			48"W	60"W	72"W										
29 ¹ / ₂ "D or 30"D to 23 ¹ / ₂ "D or 24"D			●	●	●										

● Only soft edge, only power & data access door & tray, or both
 *Tip: Subtract 1/2" for worksurfaces with cord drop.

Dimensions

	Soft edge	Cutout for Door	Tray (below worksurface)
Width	36"	24"	27 ¹ / ₈ "
Depth	3"	4 ⁵ / ₈ "	6"
Thickness	1/2" at front	N.A.	N.A.
Height	N.A.	N.A.	4 ³ / ₄ "

Universal Systems Worksurfaces with Soft Edge, Power and Data Access Door and Tray

Product Details

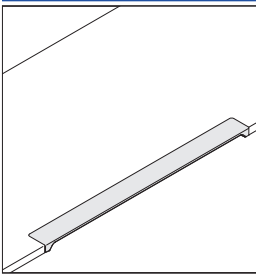

Soft edge profile is polyurethane.

High-Pressure Laminate Worksurfaces

PVC-free, 3 mm edge profiles are proprietary polyolefin blend for all solid colors and seven woodgrain finishes. Matching 1 mm side and back edges are also PVC-free. See surface material listing in this book for specific PVC-free availability.

3 mm front edge is specifiable. Back and side edges match 3 mm front edge.

Edge profile finish for 3 mm front edge is specified separately from laminate color.

Wood Veneer Worksurfaces

Front (user's) edge profile is wood veneer with a square (3 mm) radius. Back edge and edge that joins to adjacent worksurfaces are flat. Wood edge color matches finish specified for work surface.

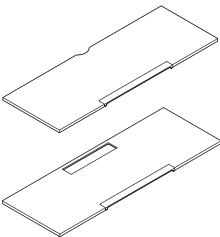

Scallops are omitted on work surface when cutout for power and data access door and tray option is selected.

Power and data access door and tray cutouts are 3⁹/₁₆" from the back edge of the work surface and always centered on the width of the work surface.

Power and data access door and tray cutouts are available on worksurfaces 24"D through 36"D.

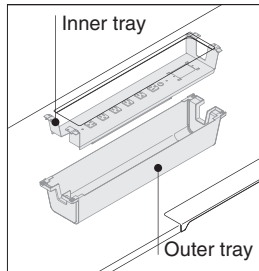

Inner tray provides under the surface power and data connections and access and cord management.

Outer tray provides cover and management for harness, cord, and/or data cables to and from the beam.

Power and data access door and tray flips toward the user.

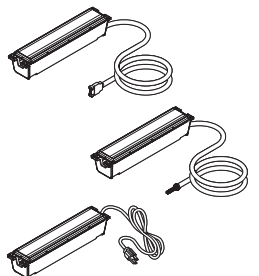

Modular, cord and plug, or hardwire options are available.

Corded version includes 10' cord with plug. Modular and hardwire versions each include 8' of harness.

Three wiring schematics are available in the modular version – 3+1, 2+2, and 3 separate neutrals (3SN). Each has a single circuit. 3+1 and 2+2 have the option for line 1, 2, 3, or 4 with either a system or isolated ground. 3SN has the option for line 1, 2, or 3 with either a system or isolated ground.

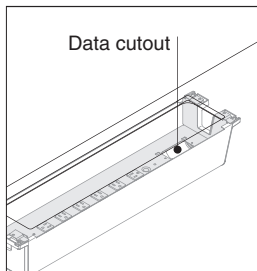

Data cutout in tray can accommodate either a single gang or a modular furniture communication faceplate. Tray includes adapter to accommodate modular faceplate.

Beam receptacle fillers and data fillers are available to fill unused data cutouts. Order separately in packages of 20.

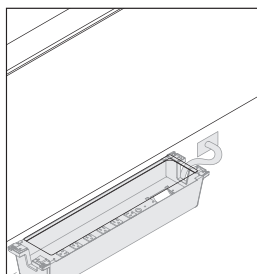

With the modular and hardwire version, the harness enters the beam through a field cut opening in a fabric skin. A grommet is included to provide a finished edge to the field cut opening in the skin where the harness enters the beam. Inside the beam the harness can connect to a powerkit or it can use either a harness to harness connector or a branching harness to connect to other modular harness trays or modular harnesses.

Cord and plug version has an integrated overload circuit breaker.

Non-PVC versions are available for each power solution.

Connections

Fixed storage can be used with worksurfaces with soft edge but must not encroach the 36" width of the edge.

Worksurfaces connected perpendicular should not encroach the 36" width of the soft edge.

Soft edge worksurfaces are available with the same support options and follow the same application rules as other Universal Systems worksurfaces.

▶ See page 118 for *Universal Systems Worksurfaces* understanding. *Exception: 48"W work surface with soft edge used with the FrameOne post leg has some limitations.*

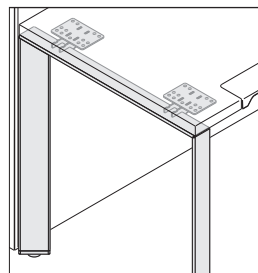

In an end-of-run condition, the FrameOne post leg will not fit when used with 48"W soft edge worksurfaces, use half, open, or closed loop legs.

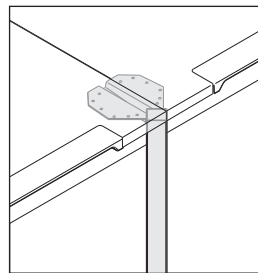

In shared applications, the FrameOne post leg can be angled and positioned at the front edge or for a square orientation it must be inset 1" from the front edge when used with 48"W soft edge worksurfaces.

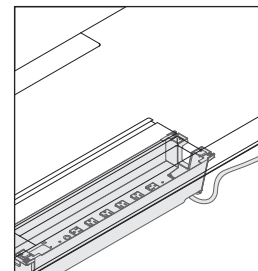

Access holes in tray allow power and data to be routed straight back when work surface is against the beam or routed to the sides when the work surface is perpendicular to the beam.

Worksurfaces with power and data access door and tray are available with the same support options and follow the same application rules as other Universal Systems worksurfaces.

▶ See page 118 for *Universal Systems Worksurfaces* understanding.

Tray with cord and plug can be used in a free-standing table application.

Worksurfaces with power and data access door and tray with modular or hardwire power cannot be used in a freestanding application. The work surface must either be attached to a panel or beam on one end or if the work surface is attached to low storage with an intermediate support on one end, the cabinet must be attached to the beam or ganged to another storage cabinet. This applies to both parallel or perpendicular to the panel or beam applications.

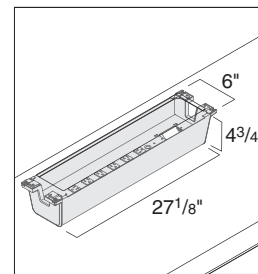

Height of tray is 43/4" so lower storage height must be accounted for when used adjacent to tray.

Width of outer tray below the worksurface is 27¹/₈" so adjacent lower storage dimensions must be accounted for on each worksurface width.

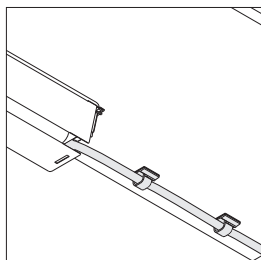

Tray with cord and plug includes two cord clips to help manage the cord below the worksurface.



Tray with modular harness or hardware harness includes two harness clips to help manage the harness below the worksurface.

Soft edge worksurfaces and power and data access door and tray worksurfaces require reinforcement channel or other support on worksurfaces 60"W or beam.

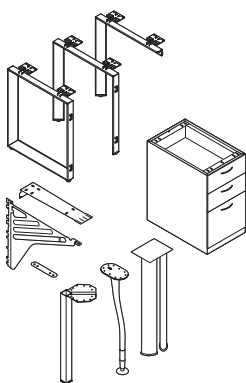

Worksurfaces greater than 72"W require additional support such as cantilevers, pedestals, or legs beyond the brace.

Wiring & Cabling

Chicago, New York, and Los Angeles have special requirements.

Underwriter Laboratory (UL) listed. The power and data tray has been designed to meet U.S. and Canadian national electrical and energy codes and most local building codes. Local electrical codes vary, so consult with your local authority having jurisdiction as they have final say if the products as installed are compliant with local code. Consult a qualified electrician or electrical engineer for proper installation of all electrical equipment.

Surface Materials

High-Pressure Laminate Worksurfaces

- Laminate
- ▶ See *Surface Materials Reference Manual*.
- Open Line laminate (option)
- A program including non-Steelcase laminates which are suitable for use on Steelcase products.
- ▶ See *Surface Materials Reference Manual*.

Soft edge

- 6615 Grey V5 Plastic

3 mm front edge

- Plastic

Back and side edges

- Plastic color default to match 3 mm front edge

Wood Veneer Worksurfaces

- Wood veneer (standard)
- Customiz stain (option)

Soft edge

- 6615 Grey V5 Plastic

Square (3 mm) edge profile

- Wood veneer to match worksurface

Front (user's) edge(s)

- Wood edge band

Power and Data Access Door and Tray

Door

- Paint
- Anodized aluminum

Door bezel

- 6694 Slate Plastic

Inner and outer tray

- 7237 Slate Paint

End caps for outer tray

- 6694 Slate Plastic

Beam grommet

- Plastic:
 - 6000 Black
 - 6009 Arctic White
 - 6249 Platinum Solid
 - 6654 Sand
 - 6697 Fog

Pad

- 6615 Grey V5 Plastic

Universal Systems
Worksurfaces with Soft
Edge, Power and Data
Access Door and Tray

Universal Systems Worksurfaces with Power Access Door

Power access door option on worksurfaces allows for convenient pass through access to beam outlets.
 ▶ Specifying page 268

Systems straight worksurfaces with power access door are available in a variety of widths and depths in modular and parametric dimensions.

Power access door provides desk top access and management of cords.

Power access door is only available on worksurfaces with a 1/2" cord drop.

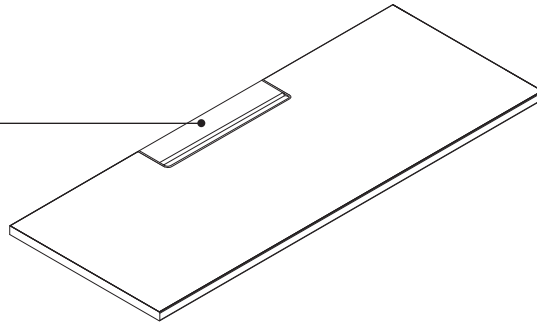

Actual Dimensions

Modular*	Parametric**	Centered	Left	Right	Left and Right	Left and Center	Right and Center	Left, Right, and Center
Straights—18³/₈", 23¹/₂", and 29¹/₂"D*								
30"W	30"W–35 ¹⁵ / ₁₆ "W	●						
36", 42", and 48"W	36"W–53 ¹⁵ / ₁₆ "W	●	●	●				
54", 60", and 66"W	54"W–71 ¹⁵ / ₁₆ "W	●	●	●	●			
72", 78", 84", 90", and 96"W	72"W–120"W	●	●	●	●	●	●	●
Straight 120° Worksurfaces—23¹/₂" and 29¹/₂"D								
48" and 60"W	N.A.	●	●	●				
72"W	N.A.	●	●	●	●	●	●	●
Square Edge Tops—18³/₈" and 23¹/₂"D								
30", 36", and 42"W	N.A.	●						
48", 54", 60", and 66"W	N.A.	●	●	●				
72", 78", 84", 90", and 96"W	N.A.	●	●	●	●	●	●	●

Dimensions

Cutout for Door	
Width	16 ¹ / ₈ "
Depth	4 ¹ / ₄ "

*Tip: Modular 29¹/₂"D worksurface is only available up to 72"W.

**Tip: Worksurface width is available parametric from 18"W–120"W in 1/16" increments. Worksurface depth can be specified parametric from 18³/₈"D–36"D in 1/16" increments.

Product Details

High-Pressure Laminate Worksurfaces

PVC-free, 3 mm edge profiles are proprietary polyolefin blend for all solid colors and seven woodgrain finishes. Matching 1 mm side and back edges are also PVC-free.

▶ See *Surface Materials Reference Manual* for specific PVC-free availability.

3 mm front edge is specifiable. Back and side-edges match 3 mm front edge.

Edge profile finish for 3 mm front edge is specified separately from laminate color.

Wood Veneer Worksurfaces

Front (user's) edge profile is wood veneer with a square (3 mm) radius. Back edge and edge that joins to adjacent worksurfaces are flat. Wood edge color matches finish specified for worksurface.

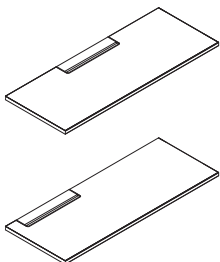

Scallops are omitted on all worksurfaces with a power access door.

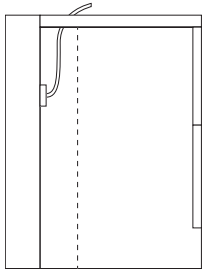

Power access door provides access to power outlets in the beam.

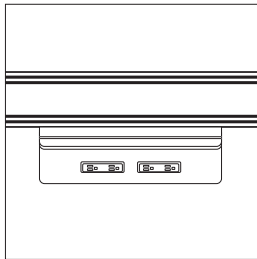

Currency storage with recessed back should be used when storage will be placed in front of a power outlet.

▶ See *Currency Specification Guide*.

Recessed back storage features a 3¾" cavity to allow access to outlets below the worksurface.

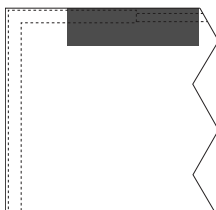
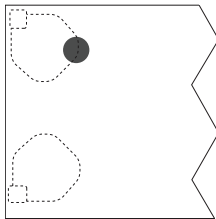

Left and right configured power access doors will interfere with FrameOne post leg support and freestanding end panels (UE18, UE24, and UE30).

Surface Materials

High-Pressure Laminate Worksurfaces

- Laminate
 - ▶ See *Surface Materials Reference Manual*.
 - Open Line laminate (option)
- A program including non-Steelcase laminates which are suitable for use on Steelcase products.
- ▶ See *Surface Materials Reference Manual*.

- 3 mm front edge**
- Plastic

- Back and side edges**
- Plastic color default to match 3 mm front edge

- Wood Veneer Worksurfaces**
- Wood veneer (standard)
 - Customiz stain (option)

- Square (3 mm) edge profile**
- Wood veneer to match worksurface

- Front (user's) edge(s)**
- Wood edge band

Power Access Door

- Door**
- 4799 Platinum Metallic
 - 7207 Black
 - 7241 Arctic White
 - 7360 Merle
 - 8043 Clear Anodized Aluminum

- Door bezel**
- 6527 Merle

Universal Beam-Mounted Worksurface Supports

For Answer Beam Applications

Worksurface supports

can be used to beam-support worksurfaces in various configurations.

► Specifying, page 272

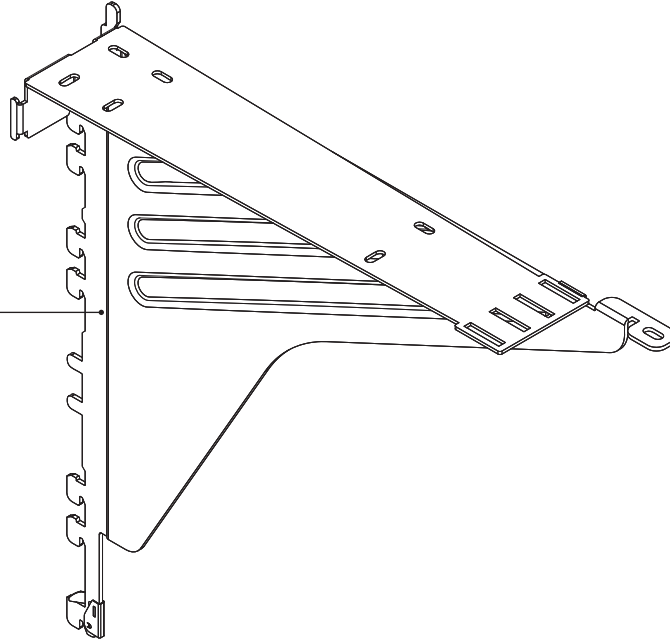

Beam cantilever can be used to beam-support a worksurface at 28½"H.

Worksurface-to-beam tether brackets feature alignment tab used to set a depth for Universal Systems Worksurfaces—with ½" cord drop. This tab is bent down or broken off when installing full-depth worksurfaces.

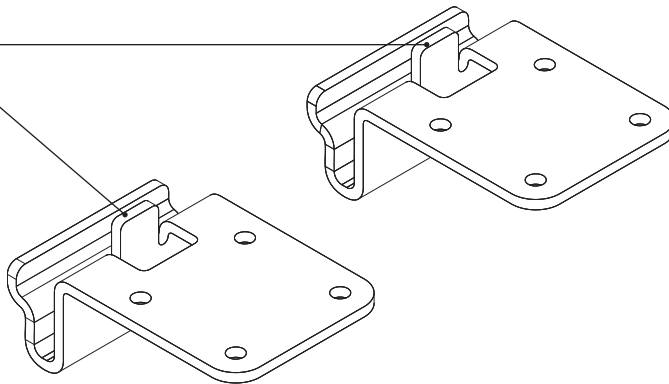

Actual Dimensions

	Cantilever	Tether Brackets
Height	16"	1"
Depth	17¾"	3"

Product Details

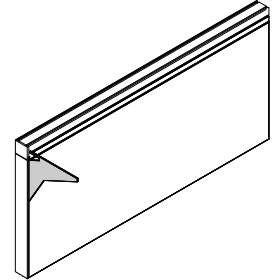

Cantilevers engage in vertical slots on vertical junctions of Answer beam.
Tip: Cantilevers for use with beam have a unique attachment to accommodate the aluminum rail and should only be used with Answer beam.

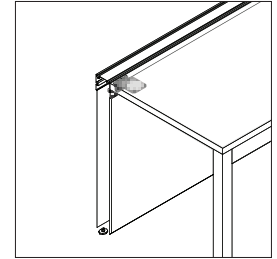

Tether brackets attach into the beam rail and can support the back edge of a worksurface.
Tip: Tether brackets do not provide adequate structural support to stabilize the beam.
 ► See Application Guidelines for beam support requirements when using tether brackets.

Tether brackets are available individually or in pairs.

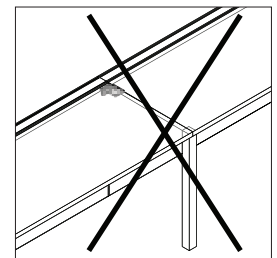

Tether bracket cannot be shared to support two worksurfaces.

For all perpendicular worksurfaces and parallel worksurfaces 72" or less, two worksurface-to-beam brackets are required.

For parallel worksurfaces greater than 72", three worksurface-to-beam brackets are required.

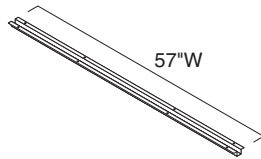
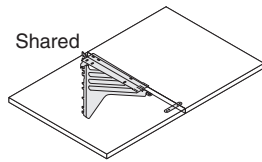
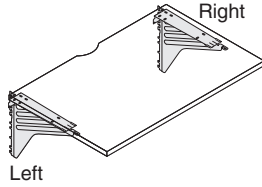

Worksurface spans greater than 54" require additional support of a cantilever, pedestal, intermediate support, or leg. Exception: Worksurfaces can span up to 60" in heavy load applications and up to 72" in light load applications if a TS7WKSPT reinforcing channel is used. Reinforcing channel must be specified separately.
▶ Specifying, page 273

Cantilevers support worksurfaces at 28½". Cantilever is non-handed and can be used to support either end of a worksurface, or shared to support two worksurfaces at the same height simultaneously. One tie plate ships with each cantilever.

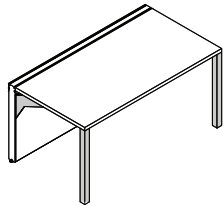

30"D cantilevered worksurfaces require additional floor support along the front edge.

26⅙"D-36"D parametric straight cantilevered worksurfaces require additional floor support along the front edge, such as a pedestal, end panel, post leg, side support bracket, or an adjacent return worksurface.

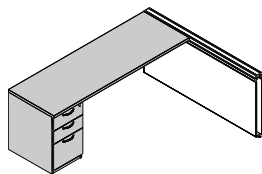

Pedestals and lateral files can be used to support the end of a worksurface.
▶ See *Storage Specification Guide*.

Surface Materials

Reinforcing channel
• Black paint only

Cantilever
• Paint

Tether bracket
• 4799 Platinum Metallic paint only

Application Topics

Universal beam-mounted worksurface supports are designed so the worksurface is even with the top of the Answer beam top cap rail.

Universal beam-mounted worksurface supports support the worksurface at slightly lower height than the Universal panel-mounted worksurface supports or is supported by both beam and panel.

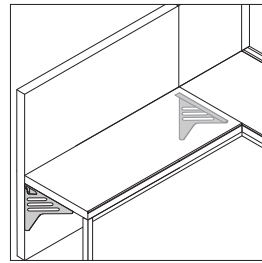

Universal beam-mounted worksurface supports should be used on Answer panels when a worksurface tethered to the Answer beam is adjacent.

Worksurfaces greater than 30"D can only be used in freestanding applications and cannot be beam mounted.

Worksurfaces used in beam-supported installations must follow applicable beam stability guidelines.

Beam FrameOne Legs and Supports for Universal Worksurfaces

Legs and supports

share a common visual with FrameOne bench and support Universal worksurfaces in freestanding, storage-supported, or beam-supported applications.

► Specifying pages 274–278

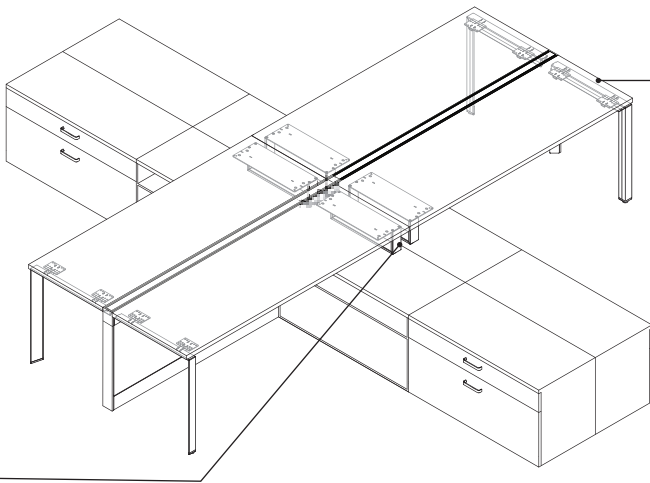
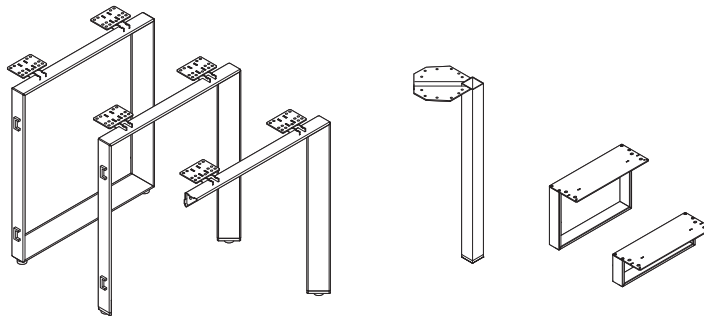

Beam intermediate support

is used with Currency One-High or 1.5-High storage as a work-surface support allowing for nesting of low storage.

► See *Currency Specification Guide*.

Post leg is square to provide a complementary visual to FrameOne legs. Post leg can be used as a column support.

Leveling glide allows worksurface height to be adjusted on uneven floors.

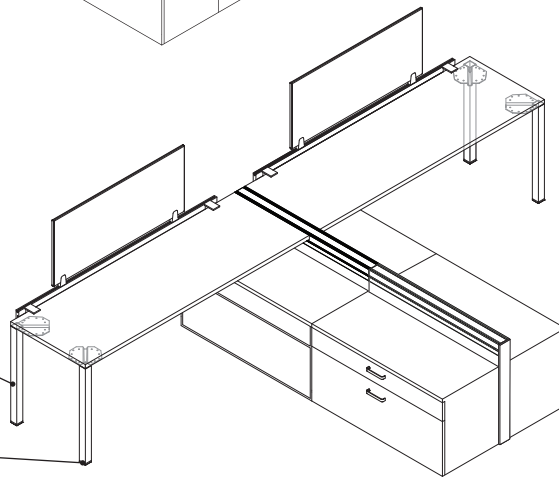

Spacers between top of legs and worksurface provide a floating look to the worksurface and match visual of FrameOne bench.

Product Details

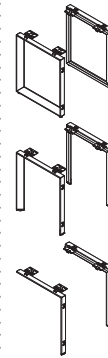

Closed, open, and half-loop legs are handed when beam supporting and must be specified left or right when facing the front of the worksurface. Freestanding tethered and table versions are non-handed.

Beam FrameOne legs can be used with Answer beam. FrameOne legs for Answer panel cannot be used with Answer Beam.

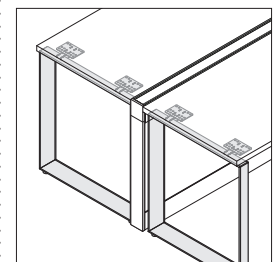

Closed, open, and half-loop legs are available in beam supporting versions. They support the ends of worksurface; they are not shared supports between two worksurfaces.

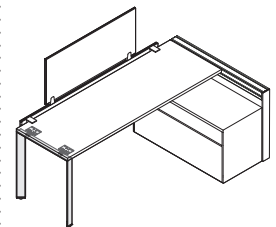

Closed and open-loop legs are available in tethered versions in which one side of the worksurface is attached to a beam, or storage.

Dimensions

	Beam closed, Open, and Half-Loop Legs	Post Leg	Beam Intermediate Supports	
			For One-High storage	For 1.5-High storage
Height*	28 1/2"	28 1/2"	28 1/2"	28 1/2"
Height	N.A.	N.A.	11 1/4"	5 1/4"
Depth	24" or 30"	N.A.	16"	16"
Width	N.A.	N.A.	23 1/16"	23 1/16"
Glide range	2 1/4"	1"	N.A.	N.A.

*Height dimensions include the thickness of the worksurface.

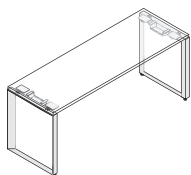

Closed and open-loop legs are available in table versions in which both sides of the work surface are supported by the legs. Post legs can also be used to create freestanding tables.

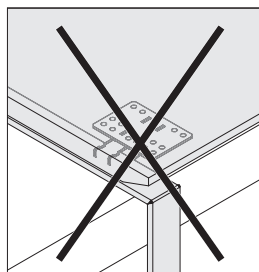

Closed, open, and half-loop legs do not align properly with knife-edge worksurfaces. Instead use cantilevers.
▶ See page 118 for knife-edge work surface application guidelines.

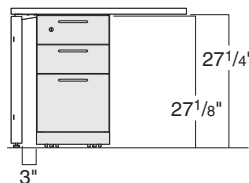

27"H mobile, freestanding, or fixed pedestals do not fit flush to the inside of the closed, open, or half-loop leg, there is a 3" gap due to the work surface support plate. 25 1/2"H freestanding pedestals or 21"H mobile pedestals will fit flush.

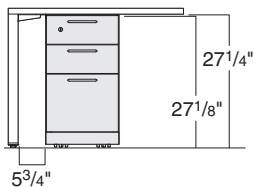

27"H mobile, freestanding, or fixed pedestals do not fit flush to the inside of the post leg, there is a 5 3/4" gap due to the work surface support plate. 25 1/2"H freestanding pedestals or 21"H mobile pedestals will fit flush.

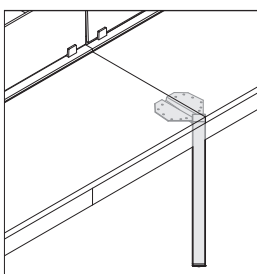

Post leg can be shared between two work surfaces.

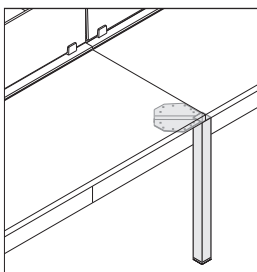

Post leg in shared applications can be square or oriented angled to the front edge of the work surface.

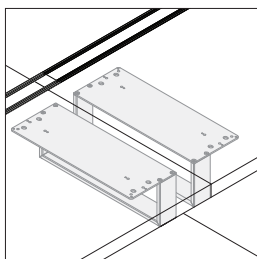

Beam Intermediate supports replace the need for other types of work surface support when used with One-High or 1.5-High Currency storage.
▶ See *Currency Specification Guide*.

Storage used with beam intermediate supports need to use laminate or wood square edge top.

Intermediate supports for use with Answer panel should not be used with Answer beam because the work surface will not align to the top of the beam rail.

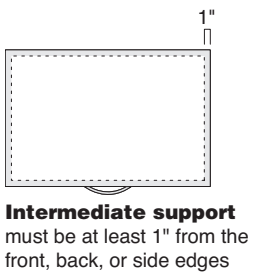

Intermediate support must be at least 1" from the front, back, or side edges of the storage unit to allow clearance for installation.

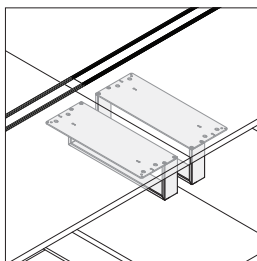

Worksurfaces 18"D to 24"D allow intermediate support to be positioned below the work surface 1" from the front or back.

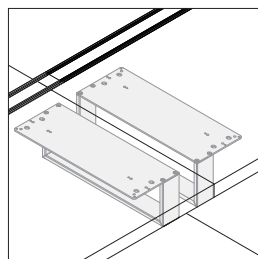

For worksurfaces 24 1/16"D to 30"D, intermediate supports must be placed a minimum of 1" from the front or back edge, and a maximum of 7" from the front or back edge.

Worksurface may extend up to 10" maximum overhang of intermediate support as long as the other end of the work surface is anchored to the beam.

Intermediate support cannot support worksurfaces larger than 30"D.

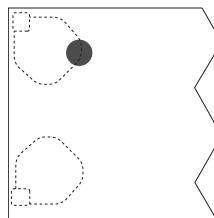

FrameOne post legs will interfere with left and right oriented grommet cutouts in parametric straight Universal worksurfaces.

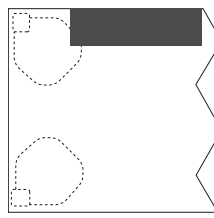

FrameOne post legs will interfere with left and right oriented power access doors on Universal worksurfaces.

Connections

Answer beam requires unique FrameOne legs when attaching to the beam.
Tip: FrameOne legs for beam support can only be used with Answer beam.

For One-High and 1.5-High Currency storage applications used with worksurfaces perpendicular to Answer beam, intermediate support is needed.
▶ Page 274

Surface Materials

Legs and intermediate support

- Paint

Spacer caps for beam attached legs

- Black plastic only

Glide cap for legs

- 6694 Slate only

Shipping

Closed, open, and half-loop legs are packed in boxes of six when ordered on the same line item.

Bracing for intermediate supports ship separately from intermediate supports and are field installed into storage cases.

Infills for FrameOne Legs for Universal Worksurfaces

Infills are available in laminate and veneer and are used with open and closed loop FrameOne legs.
▶ Specifying page 275

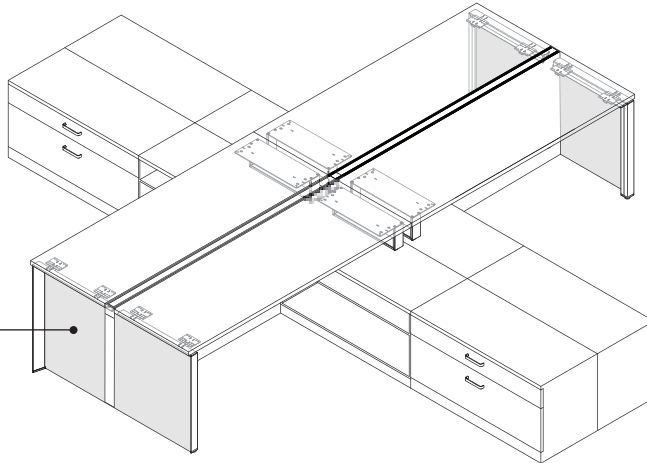

Infills provide added privacy.

Product Details

Infills can be used with both beam connected or freestanding versions of open and closed loop FrameOne legs for universal worksurfaces.

Connectors attach to the back side of the legs.

Surface Materials

Surfaces

- Laminate
- Veneer

Planning Dimension

Infills are available 24"W and 30"W.

Knife Edge Worksurface Application Guidelines

When planning an L-configuration, two UFB flat brackets should be used to support the worksurfaces. A cantilever is not wide enough to support the gap where the knife edge worksurface comes together.

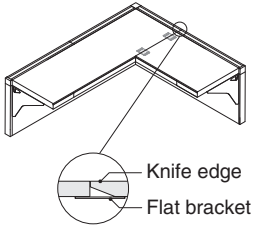

Freestanding L-configuration should be avoided due to profile on the backside of the worksurface.

Compatible storage includes box/file mobile pedestals and One-High storage.

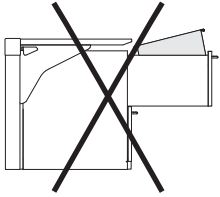

Knife edge with 27"H lateral and 27"H pedestal

Knife edge worksurface over 27"H storage can make files difficult to access.

Knife edge worksurfaces require reinforcement channels for unsupported spans greater than 48". Use TS7WKSP39 for 54"W worksurfaces, TS7WKSP7 for 60"W and 66"W worksurfaces, and TS7WKSP72 for 72" worksurfaces.

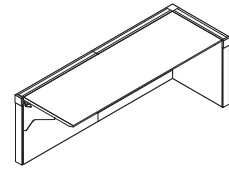
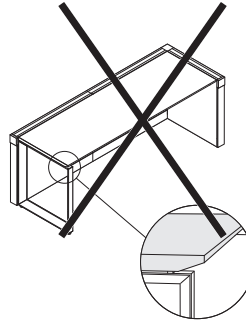
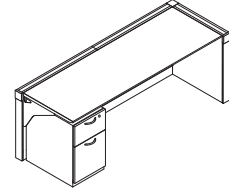
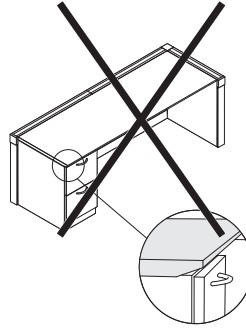

Currency 27"H standard pedestals, brackets, and FrameOne legs for Universal do not align properly with knife edge worksurfaces. Instead, use cantilevers as shown.

► See *Currency Specification Guide*.

Currency Storage

Product Details

Overheads and Organizers	136
One-High, 1.5-High, and Two-High Lower Storage and Lateral Files	140

▶ See *Currency Specification Guide* for more information on Currency products.

Currency Overheads and Organizers

Currency overheads and organizers

provide storage above a work surface and can be used in a variety of applications. See matrix for options.

▶ Page 139

Tip: Using Currency storage with Universal Steel storage is not recommended.

▶ See *Currency Specification Guide*.

Sliding door overheads

have a non-locking sliding door. Door is available in Low-Pressure Laminate, High-Pressure Laminate, and optional markerboard surface.

Tip: Markerboard is slightly thicker than the standard laminate.

Hinged door overheads

have two, three, or four locking doors depending on width. Doors are available in Low-Pressure Laminate and High-Pressure Laminate.

Tip: Markerboard is slightly thicker than the standard laminate.

Open overheads

have two equal-spaced openings.

Finished top, back, and sides

are standard on overheads and organizers.

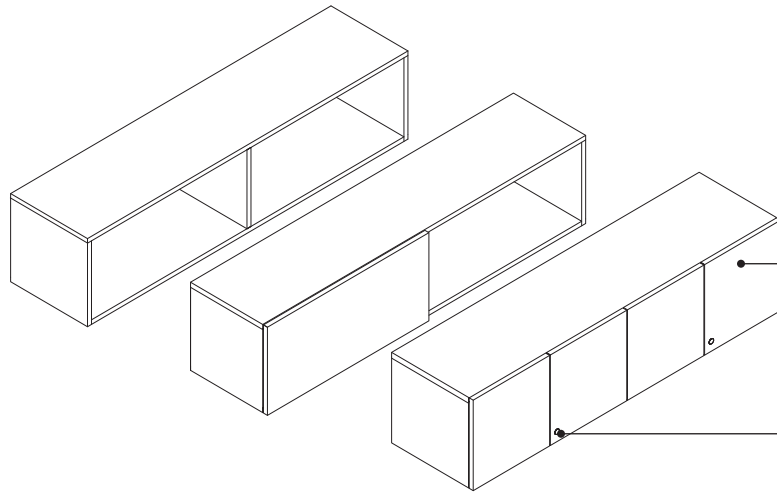

Personal overhead and organizer configurations provide access on one side of a unit. Cases have a fixed divider in the middle.

Lock is standard on overheads with hinged doors. Locks are specified with storage, but shipped separately. Locks are field installed.

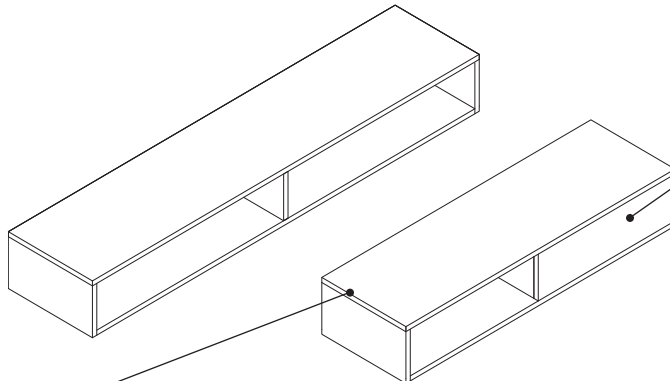

Shared overheads and organizer configurations provide dual sided access.

Currency overheads and organizers provide support and storage for users in beam-based settings. A number of configurations are available to support storage in parallel and perpendicular orientation to the beam, in both shared and personal storage configurations.

Overheads mounted perpendicular to the beam and low storage provide personal storage and privacy between users.

Overheads mounted parallel to the beam provide shared storage and privacy along the beam.

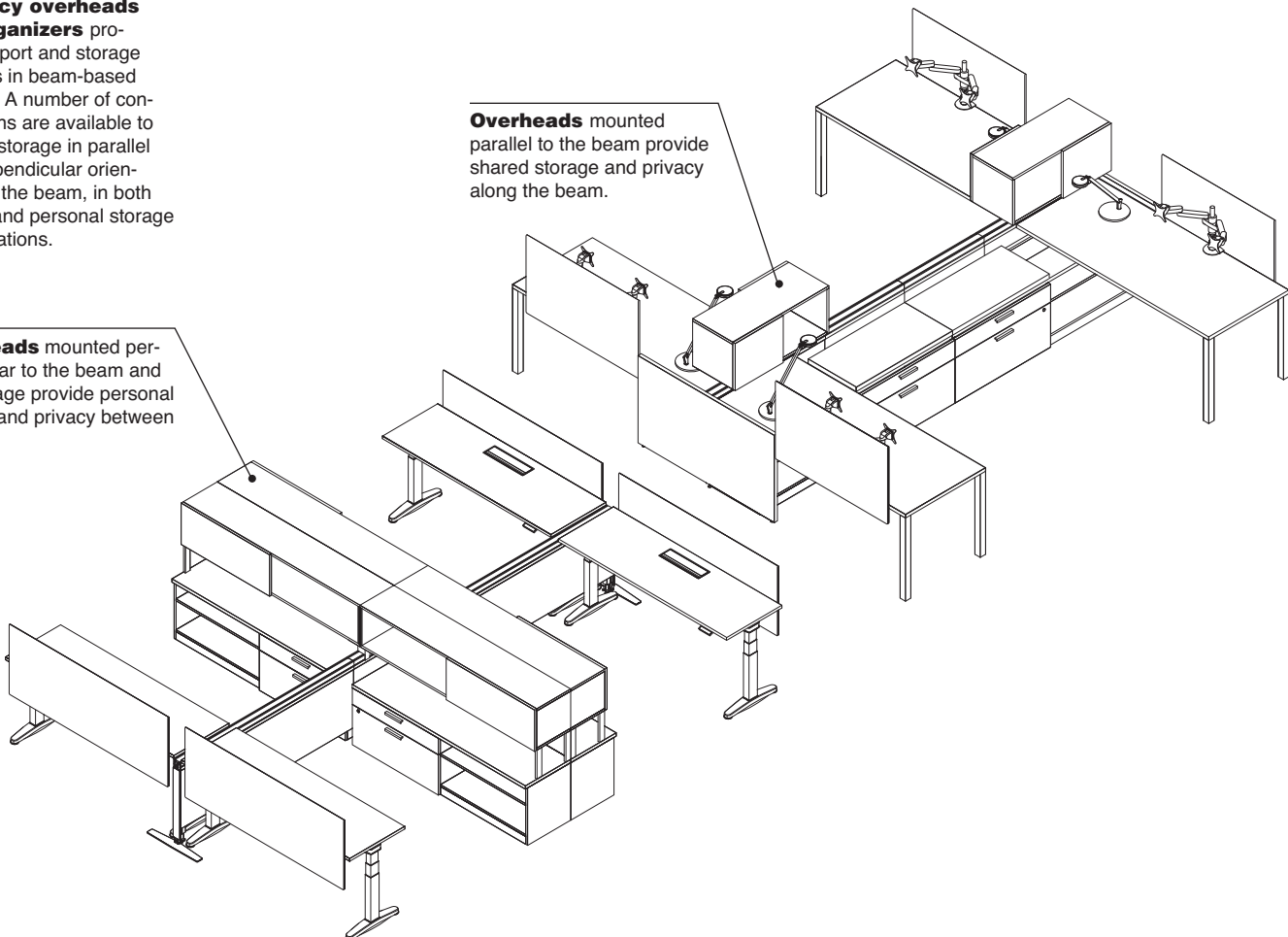

Actual Dimensions

Standard Widths*

	Overheads with Sliding or Hinged Doors	Overheads with Open Fronts	Organizer
Depth	16"	15"	15"
Width	36", 42", 48", 54", 60", 66", and 72"	36", 42", 48", 54", 60", 66", and 72"	36", 42", 48", 54", 60", 66", and 72"
Height	15"	15"	8 ²⁷ / ₃₂ "

Single-Sided Perpendicular, Answer Beam Application**

	Overheads with Sliding or Hinged Doors	Overheads with Open Fronts	Organizer
Depth	16"	15"	15"
Width	63", 69", and 75"	63", 69", and 75"	63", 69", and 75"
Height	15"	15"	8 ²⁷ / ₃₂ "

Dual-Sided Perpendicular, Answer Beam Application***

	Overheads with Sliding or Hinged Doors	Overheads with Open Fronts	Organizer
Depth	16"	15"	15"
Width	61 ¹ / ₂ ", 67 ¹ / ₂ ", and 73 ¹ / ₂ "	61 ¹ / ₂ ", 67 ¹ / ₂ ", and 73 ¹ / ₂ "	61 ¹ / ₂ ", 67 ¹ / ₂ ", and 73 ¹ / ₂ "
Height	15"	15"	8 ²⁷ / ₃₂ "

*Units are on module to match width of panel, Answer beam, or other 6" module product dimensions.

** Units are 3" wider than module to accommodate width of Answer beam.

*** Units are 1¹/₂" wider than module to partially overlap the Answer beam.

Currency Overheads and Organizers, continued

Product Details

Organizers are available personal or shared. Personal provides storage on one side only. Shared storage is divided down the center, with half storage on one side and half storage on the opposite side. Personal storage has a center divider.

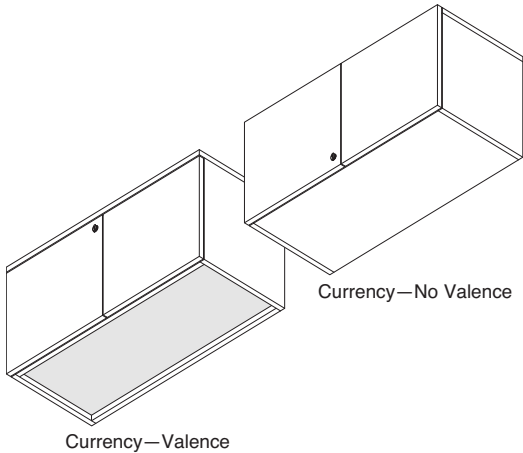

Currency overheads are designed differently than Currency overheads. Please note Currency overheads do not have a light-concealing valence. If light is still to be added to underside of overhead, refer to "actual dimension" tables of lighting options to confirm light width doesn't exceed case width.

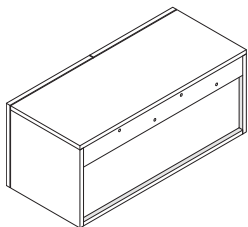

Wall mount overheads have a 1" gap between the back panel and end panel.

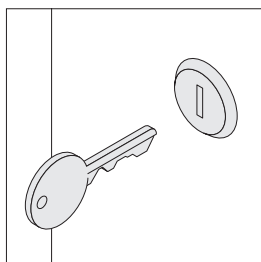

Locks are standard on overheads with hinged doors. Lock cylinders must be specified separately, and are field installed.

Field installed locks are available with consecutive, specific, and random keying options. Field installed lock cylinders, **LOCK9201FR** or **LOCK9250FR** must be specified separately.

Application Topics

Bracket options

▶ Page 139

Stability Guidelines

▶ Page 101

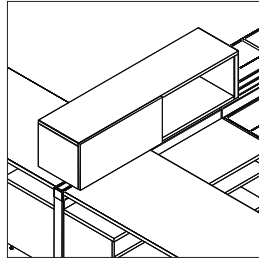

Standard width overheads and organizers are on-module to align with Answer beam widths and should be used in parallel application with the beam.

Overheads and organizers for perpendicular application are intended for use only with Answer Beam. They are wider than module width to accommodate the width of the beam and remain on-module with storage below.

In all Answer Beam applications where overhead or organizer are being mounted on Answer Beam, select the appropriate bracket option. Mid-storage support and stanchion kits for mounting with Answer Beam must be ordered separately. ▶ Pages 283–284



Units for single-sided perpendicular application are dimensioned 3" wider than module width to fully overlap the beam and align with on-module storage on the other end.

Tip: Units for single-sided perpendicular application should only be used with Answer Beam.



Units for dual-sided perpendicular application are dimensioned 1 1/2" wider than module width to partially overlap the beam.

Tip: Units for dual-sided perpendicular application should only be used with Answer Beam.

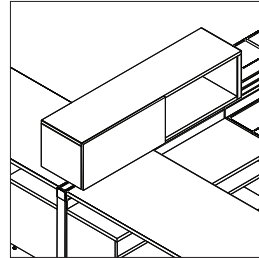

Units for parallel application are on-module width and can be used anywhere along a beam.

Low storage or credenzas used to support one end of overheads or organizers must be connected to Answer Beam using storage-to-beam connector.

Storage-to-beam connector can not be used with Answer panels.

When overheads are placed side-by-side in parallel application to Answer beam, it is recommended that the units be ganged. **TSBAWAK** is the style number for the ganging bracket to use for low and mid-storage in beam applications.

▶ Page 285

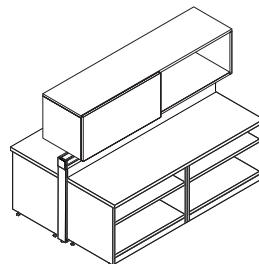

Shared storage in parallel application should always be centered over the beam.

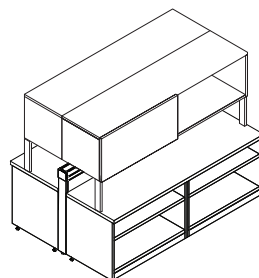

Personal storage in parallel application can be used back-to-back.

Tip: Use centered stanchions and mid-storage supports to support the front edge of the overhead unit.

Overheads and organizers in parallel applications must not extend past end of beam.

Tip: Beam-mounted storage is not allowed in freestanding beam configurations.

Connections

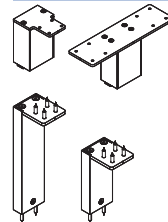

When ganging storage units together for Answer Beam application, use ganging bracket **AWAK**. When ganging overheads and organizers for Answer Beam applications, use ganging bracket **TSBAWAK**. Use mid-storage supports or stanchion supports when mounting overheads and organizers for Answer Beam applications. ▶ Pages 283–284

Surface Materials

Case

- Low-Pressure Laminate
- High-Pressure Laminate

Headsets

- Low-Pressure Laminate
- High-Pressure Laminate
- White Markerboard (2977)—sliding door only

Locks

- 9201 Polished Chrome
- 9250 Ember chrome

On-module attachment brackets

- Black paint only

Bracket Options		
	Personal Overhead/Organizer	Shared Overhead/Organizer
Answer Beam	Select Answer Beam option. Order Answer Beam mount bracket separately. Order brackets separately.	Select Answer Beam option. Order Answer Beam mount bracket separately.
Wall Mount	Select wall mount option. Brackets included.	N.A.
Suspended between Currency Towers	Select suspended between towers option. Order cabinet-to-cabinet attachment kit (AWAK) separately.	Select suspended between towers option. Order cabinet-to-cabinet attachment kit (AWAK) separately.
Answer Panel Mount	Select Answer panel bracket option for use with overheads and organizers up to 48"W only. Sizes larger than 48"W cannot be panel mounted. Must comply with Answer Stability Guidelines, see the <i>Answer Solutions Specification Guide</i> . Brackets included.	N.A.
Answer Duo Support Column (Perpendicular)	Select Answer Duo support column option for use with 54"W to 66"W overheads or organizers only. Must comply with Answer Stability Guidelines, see the <i>Answer Solutions Specification Guide</i> . Brackets and column included.	Select Answer Duo support column option for use with 54"W to 66"W overheads or organizers only. Must comply with Answer Stability Guidelines, see the <i>Answer Solutions Specification Guide</i> .
Top Cap Mount on Answer	Select top cap mount on Answer option. Order Answer top cap mount brackets separately, for use with overheads or organizers up to 72"W only. Sizes larger than 72"W cannot be panel mounted. Must comply with Answer Stability Guidelines, see the <i>Answer Solutions Specification Guide</i> . Order brackets separately.	Select top cap mount on Answer option. Order Answer top cap mount brackets separately, for use with overheads or organizers up to 72"W only. Sizes larger than 72"W cannot be panel mounted. Must comply with Answer Stability Guidelines, see the <i>Answer Solutions Specification Guide</i> .

Weight Capacity							
Overhead	Weight Capacity	Wall Mount Brackets		W/Answer Beam Dual-Sided Application		W/Answer Beam Single-Sided Application	
		Organizer	Shared	Organizer	Shared	Organizer	Shared
Width	lbs						
36"	157 ² / ₅	•	•				
42"	184 ¹ / ₂	•	•				
48"	211 ¹ / ₂	•	•				
54"	238 ³ / ₅	•	•				
60"	265 ³ / ₅	•	•				
61 ¹ / ₂ "	272 ² / ₅			•	•		
63"	279 ¹ / ₅					•	•
66"	292 ⁷ / ₁₀	•	•				
67 ¹ / ₂ "	299 ¹ / ₂			•	•		
69"	306 ¹ / ₅					•	•
72"	316 ⁷ / ₁₀	•	•				
73 ¹ / ₂ "	323 ¹ / ₂			•	•		
75"	330 ¹ / ₅					•	•

Currency One-High, 1.5-High, and Two-High Lower Storage and Lateral Files

One-High, 1.5-High, and Two-High Currency low storage and lateral files are floor standing and can support worksurfaces at 15³/₈"H, 21³/₈"H, or 27⁵/₁₆"H.

Tip: Using Currency storage with Universal Steel storage is not recommended.

▶ See *Currency Specification Guide*.

Tops can be optioned on to low storage and laterals, and are either 1¹/₈" or 1³/₈" thick. If no top is selected, low storage and laterals accommodate attachment to a worksurface or common top. Attachment hardware is included.

Drawer and door fronts are available in Low-Pressure Laminate and High-Pressure Laminate, and are full to the bottom of the case (no toe kick).

Finished back and sides are standard on low storage and lateral files. Recessed back option on 18⁷/₈" depth units have an unfinished back.

File drawers open their full depth for total access to the contents and have an integrated U-channel on the drawer bodies for hanging file folder frames.

Adjustable shelf thickness is ³/₄".

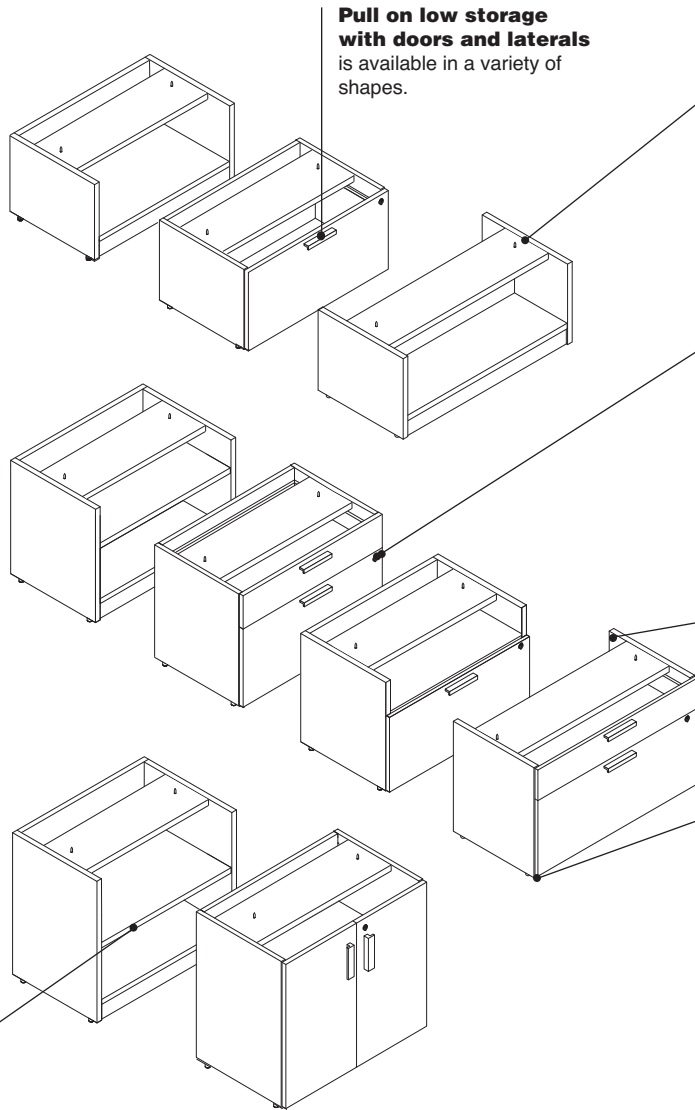

Pull on low storage with doors and laterals is available in a variety of shapes.

One-High, 1.5-High, and Two-High Currency storage provides support to Answer beam settings. A variety of configurations are available to support application needs. Units with recessed backs, to allow access to beam power outlets, come without top.

Lock is standard on low storage with doors and lateral files. Lock is located in the top left corner of the right handed door of low storage with doors. Lock is located in the bottom drawer of lateral files, and locks the drawer it is located in and the one above. Locks are specified with storage, but shipped separately. Locks are field installed.

Recessed back option on 18⁷/₈" depth units provides access to power and data outlets in panel, beam, or wall.

Leveling glides adjust to install low storage and laterals on uneven floors and have a 1¹/₄" adjustable glide range.

Actual Dimensions

	One-High File	1.5-High Box/File and Open/File	Two-High File/File
Depth	18 ⁷ / ₈ " and 24"	18 ⁷ / ₈ " and 24"	18 ⁷ / ₈ ", 22 ³ / ₄ ", and 24"
Width	30" and 36"	30" and 36"	30" and 36"
Height	15 ³ / ₈ "	21 ³ / ₈ "	27 ⁵ / ₁₆ "
	One-High Open Low Storage	1.5-High Open Low Storage	Two-High Open Low Storage
Depth	18 ⁷ / ₈ " and 24"	18 ⁷ / ₈ " and 24"	18 ⁷ / ₈ ", 22 ³ / ₄ ", and 24"
Width	30", 36", and 42"	30", 36", and 42"	30", 36", and 42"
Height	15 ³ / ₈ "	21 ³ / ₈ "	27 ⁵ / ₁₆ "

*The top (if specified) matches the depth of units with drawers and doors.

Tip: All heights are without top. Add either 1¹/₈" or 1³/₈" (depending on selection) to achieve overall height with top.

Product Details

Drawers are a black, bore and dowel construction.

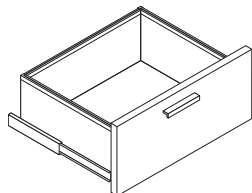

File drawer body is standard with integrated U-channel to accommodate hanging folder files.

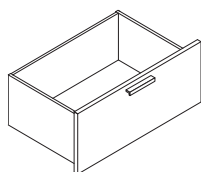

36"W file drawers accommodate front-to-back and side-to-side letter filing, as well as front-to-back legal filing. 24"D file drawers also accommodate side-to-side legal filing.

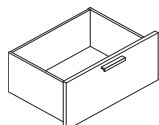

30"W file drawers accommodate front-to-back and side-to-side letter filing, as well as front-to-back legal filing. 24"D file drawers also accommodate side-to-side legal filing.

Safety interlock system allows only one drawer to be rolled-out at a time.

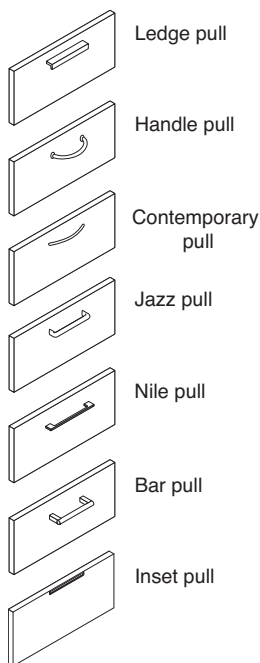

Pulls on low storage with doors and lateral files are available in the following styles: ledge, handle, contemporary, jazz, transitional, Nile, bar, and inset.

Pilot-hole to pilot-hole dimensions are as follows:

- Ledge: 96 mm
- Handle: 96 mm
- Contemporary: 128 mm
- Jazz: 128 mm
- Transitional: 160 mm
- Nile: 160 mm or 320 mm (pending storage type)
- Bar: 128 mm
- Inset: N.A.

Lateral files receive the 320 mm Nile pull. All other storage units receive the 160 mm Nile pull.

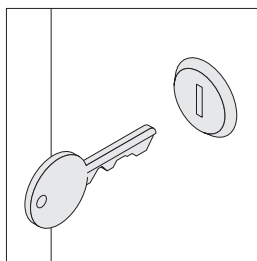

Locks are available field-installed. Low storage with doors and lateral files are shipped installed with plugs, with the locks separate.

Optional field installed locks are available with consecutive, specific, and random keying options. Field installed lock cylinders, **LOCK9201FR** or **LOCK9250FR** must be specified separately. When cylinders are ordered, the factory will omit lock cylinders from all Currency storage products.

Counterweight packages are required to ensure product stability and are ordered as an option, or separately through service parts.

Counterweights are available as a service part package for use when furniture is reconfigured into application which require the use of counterweights.

Counterweight type and quantity varies depending on size and storage configuration. Units with counterweights will ship with either standard or steel counterweights. Steel counterweight pricing will equal the price of two standard counterweights.

One adjustable shelf is included in 1.5-High and Two-High open and hinged door configurations.

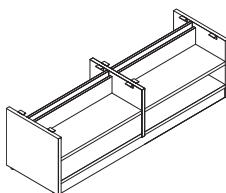

42"W open configurations have a center support.

Recessed back storage includes laminate front and sides. The back of the storage is inset 3³/₄" to allow access to Answer beam power receptacles. Recessed back storage does not include a top.

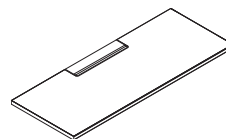

Square edge tops with 1/2" cord drop are ordered separately through Universal Systems Worksurfaces. Specify option hinged door for power and data outlet access. ▶ See Answer Freestanding Specification Guide.

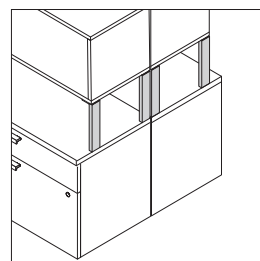

When One-High or 1.5-High storage is used in conjunction with intermediate supports or stanchions, specify no top open and order square edge tops with 1/2" cord drop or common top separately.

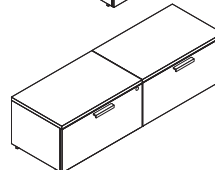
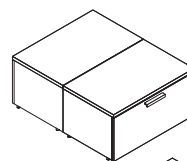

Ganging hardware is available to provide alignment by joining adjacent components side-by-side, back-to-back, or both.

Side-by-side units with individual tops will result in a nominal 3³/₃₂" gap.

Wiring and Cabling

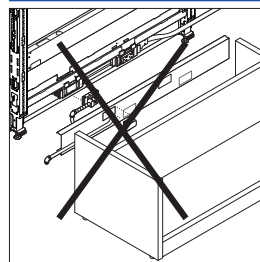

Recessed back units cannot be used to conceal base power infeed. ▶ Page 202

Application Topics

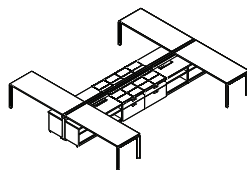

One-High, 1.5 High, and Two-High laminate lateral files provide storage and support to beam-based settings. A variety of configurations are available to support application needs.

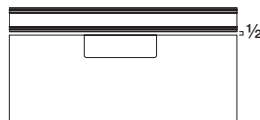

Square edge tops with 1/2" cord drop features an optional power access door and 1/2" cord drop for access to power in Answer beam.

Square edge tops with 1/2" cord drop should be used with storage with recessed back. ▶ Page 280

Whenever a low storage unit is to be used to support overheads or organizers that are supported at one end with Answer beam, tops must be removed and square edge tops must be specified separately. Note that the power access door tops always have a 1/2" cord drop at back.

Low storage that is used to support one end of overheads or organizers must be connected to Answer beam using a storage-to-beam connector.

Currency One-High, 1.5-High, and Two-High Lower Storage and Lateral Files, continued

For single-sided applications that have stanchion mounted storage running parallel to beam, the supporting low storage connected to beam must be specified with counterweights. For double-sided application that have stanchion mounted storage the supporting low storage must be connected to a beam with a storage-to-beam connector bracket.

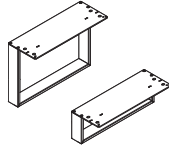

Intermediate supports are used with Currency One-High or 1.5-High storage as a worksurface support, allowing for nesting of low storage. Use square edge tops with 1/2" cord drop when used in beam applications.

Answer storage-to-beam connector cannot be used with Answer panels.

Recessed-back storage features a 3/4"D cavity to allow access to outlets below the storage top.

Currency low storage cannot be placed over Answer beam support foot.

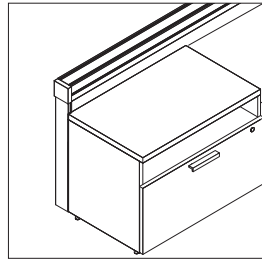

Storage to beam connector attaches to One-High, 1.5-High, and Two-High storage to Answer beam to support a beam segment. Connector must attach to a finished back. One-High, 1.5-High, and Two-High storage can not be placed over Answer beam foot.

Storage-to-beam connector can not be used with Answer panels.

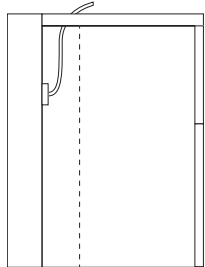

Currency storage with recessed back should be used when storage will be placed in front of a power outlet.

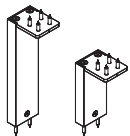

Use mid storage supports attached to 1.5-High and Two-High laminate storage to support the opposite end of stanchion mounted storage on an Answer beam.

▶ Page 284

Surface Materials

Currency storage can be specified with different case, headset, and top laminate finishes.

Tip: Low-Pressure Laminate headsets cannot be specified with High-Pressure Laminate cases.

Low storage or lateral file case

- Low-Pressure Laminate
- High-Pressure Laminate

Headsets

- Low-Pressure Laminate
- High-Pressure Laminate

Top

- Low-Pressure Laminate
- High-Pressure Laminate

Ledge pull

- 4799 Platinum Metallic
- 7207 Black

Handle pull

- 0835 Black
- 9211 Nickel

Contemporary pull

- 0835 Black
- 9201 Polished Chrome
- 9211 Nickel
- 9212 Silver

Jazz pull

- 0835 Black
- 4799 Platinum Metallic
- 9201 Polished Chrome
- 9211 Nickel
- 9212 Silver

Transitional pull

- 0835 Black
- 4799 Platinum Metallic
- 7280 Smooth Bronze
- 9211 Nickel

Nile pull

- 0835 Black
- 4799 Platinum Metallic
- 7280 Smooth Bronze
- 9201 Polished Chrome
- 9211 Nickel

Bar pull

- 0835 Black
- 9201 Polished Chrome
- 9211 Nickel
- 9212 Silver

Inset pull

- 4799 Platinum Metallic
- 4803 Near Black Metallic
- 7241 Arctic White

Lock

- 9201 Polished Chrome
- 9250 Ember Chrome

Drawer bodies, drawer suspensions, and glides

- Black

Understanding Storage Tops, Stanchions, and Connectors

Square Edge Tops	144
Answer Beam Stanchion Supports	146
Mid-Storage Supports	147
Storage-to-Beam Connector	148

Square Edge Tops

Square edge tops with 1/2" cord drop for use with Answer beam

allow multiple low storage units to be combined under one surface, while allowing access to power and room for cables along a beam.

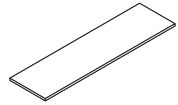

► Specifying, page 280

Product Details

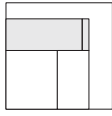

Proud front

Square edge tops for use with beam align with proud front Currency storage units.

Edge profile is plastic on laminate top and is specified separately from laminate color.

Square edge tops with 1/2" cord drop can be used on the following:

- One-High Lateral Files
- 1.5-High Lateral Files
- Two-High Lateral Files
- Credenzas

Attachment hardware ships with the top.

Wiring and Cabling

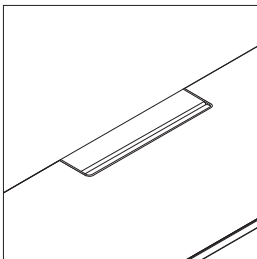

Power access door is optional on square edge top for beam and allows access to power receptacles in the beam.

Tip: Specify Currency storage with recessed backs for use in conjunction with power access door on square edge top.

► See *Currency Specification Guide*.

Square edge top with 1/2" cord drop power access door is available in the following configurations.

Width of Square Edge Top	Power Access Door Location				
	Center	Left	Right	Left and Right	Left, Right, and Center
30"W	●				
36"W to 48"W	●	●	●		
54"W to 66"W	●	●	●	●	
72"W to 96"W	●	●	●	●	●

Application Topics

Square edge tops with 1/2" cord drop should be used to access power in applications where laminate storage is parallel to Answer beam.

Specify recessed back option on low storage when using square edge tops with 1/2" cord drop and optional power access door to access power in Answer beam.

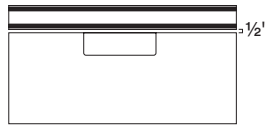

Square edge top feature 1/2" cord drop along the back edge to allow cords to drop below the worksurface anywhere along the back edge.

Square edge top with 1/2" cord drop should be used with 1.5-High and Two-High Currency laterals with recessed back option to provide access to the power at the 20"H location on the beam.

► See *Currency Specification Guide*.

Square edge top with 1/2" cord drop are not needed with One-High Currency laterals because the power access on the beam at 20"H is not blocked by the storage.

Surface Materials

Laminate

- Open Line laminate (option)

Edge

- Plastic

Power access door

- 4799 Platinum Metallic
- 7207 Black
- 7241 Arctic White
- 7360 Merle
- 8043 Clear Anodized Aluminum

Door bezel

- 6527 Merle

Actual Dimensions

Square edge tops

Depth	18 3/8" or 23 1/2"
Width	30", 36", 42", 48", 54", 60", 66", 72", 78", 84", 90", or 96"
Height	13 1/16"

Square Edge Tops

For use with Proud Front Products

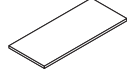

► Specifying, page 282

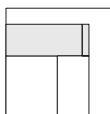
Product Details

Proud front

Square edge tops can be specified.

Edge profile is plastic on laminate top and is specified separately from laminate color.

Connections

Not all top sizes are intended for use on all furniture. See *Specifying* pages to determine the appropriate sized top for your furniture.

Square edge tops with proud fronts can be used on the following:

- Lateral files
- Combination cabinets
- Storage cabinets
- Wardrobe cabinets

Attachment hardware ships with the top.

Contact Specials for common tops placed over group storage and placed back-to-back to ensure correct sizing for the application.

Surface Materials**Top**

- Laminate
- Open Line laminate (option)
- Plastic side-edge

Actual Dimensions**Proud-front tops**

Depth	18 ⁷ / ₈ ", 24", 37 ¹³ / ₁₆ ", or 48 ¹ / ₁₆ "
Width	24", 30", 36", 42", 48 ¹ / ₁₆ ", 60 ¹ / ₁₆ ", 66 ¹ / ₁₆ ", 72 ¹ / ₁₆ ", 78 ¹ / ₁₆ ", 84 ¹ / ₁₆ ", 90 ¹ / ₈ ", 96 ¹ / ₈ ", or 108 ¹ / ₈ "
Height	1 ³ / ₁₆ "

Application Topics

Field-installed tops can also be used with pedestals to create credenzas, but the tops will overhang the pedestals by 1/2" at the back.

Square edge tops should be used in beam applications where storage is perpendicular to the spine or when a full depth top is desired.

Answer Beam Stanchion Supports

Stanchion supports

allow parallel and perpendicular attachment of laminate overhead storage or organizer to a beam.

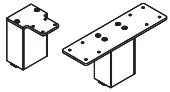

► Specifying, page 283

Product Details

Answer beam stanchions come in a pair. Both stanchions are used in both parallel and perpendicular storage applications.

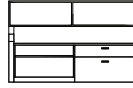

Single-sided stanchion supports allow attachment of overhead storage biased to one side of a beam.

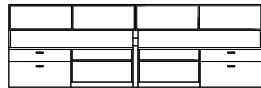

Shared stanchion supports allow for attachment of a single overhead centered over a beam, or for two perpendicular overhead storage units.

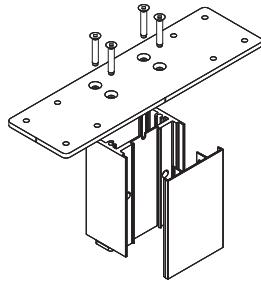

Stanchion support cover conceals attachment hardware.

Application Topics

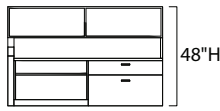

Currency overheads supported by beam stanchions align with fabric screens and boundary screens at 48"H.

► See *Currency Specification Guide*.



Currency organizers supported by beam stanchions align with fabric screens and boundary screens at 42"H.

► See *Currency Specification Guide*.

Connections

Attachment hardware is standard with stanchion supports to secure the support to the overhead storage unit and the beam.

Stanchion supports attach directly into beam rail and can be positioned anywhere along the beam.

Stanchion supports screw into underside of overhead storage.

Surface Materials

Paint

- 4799 Platinum Metallic

Actual Dimensions

Single Sided

Support Height	4 1/2"
----------------	--------

Width	4"
-------	----

Depth	3"
-------	----

Height with Overhead	48"H
----------------------	------

Height with Organizer	42"H
-----------------------	------

Double Sided/Shared

Support Height	4 1/2"
----------------	--------

Width	10"
-------	-----

Depth	3"
-------	----

Height with Overhead	48"H
----------------------	------

Height with Organizer	42"H
-----------------------	------

Mid-Storage Supports

Mid-storage supports allow overheads and organizers to be mounted perpendicular to a beam segment.

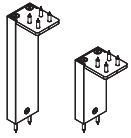

► Specifying, page 284

Product Details

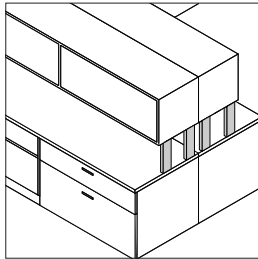

Mid-storage supports attach to 1.5-High and Two-High laminate storage or beam-tethered worksurfaces to support the opposite end of stanchion-mounted storage on an Answer beam.

Connections

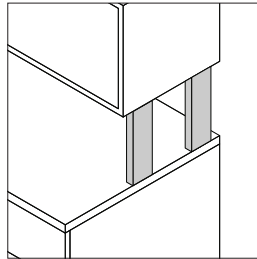

Single overhead configuration require two mid-storage supports per end.

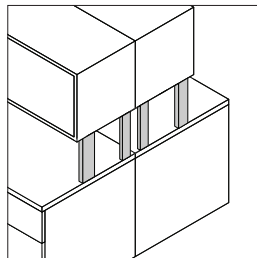

Overheads in back-to-back configuration cannot share a center mid-storage support. Two mid-storage supports must be used side by side.

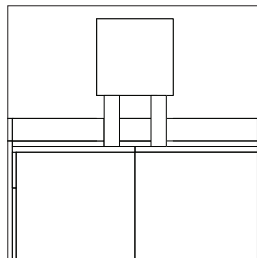

Overhead storage supported by mid-storage supports can span two lower storage units.

Mid-storage support defaces the top of the lower laminate storage or worksurface it attaches to.

Attachment hardware is standard with mid-storage supports to secure the support to an overhead storage unit and a worksurface in the field.

Application Topics



Currency overheads supported by mid-storage supports align with fabric screens and boundary screens at 48"H.
► See *Currency Specification Guide*.



Currency organizers supported by mid-storage supports are 42"H above finished floor.
► See *Currency Specification Guide*.

When using mid-storage supports on low storage, omit the storage top and specify squared edge to achieve the correct alignment.

Surface Materials

Paint
• 4799 Platinum Metallic

Actual Dimensions

1.5-High Support	
Support Height	10½"
Aligned Height with Organizer	42"
Aligned Height with Overhead	48"
Two-High Support	
Support Height	4½"
Aligned Height with Organizer	42"
Aligned Height with Overhead	48"

Storage-to-Beam Connector

Storage-to-beam connector engages beam junctions to storage to provide stability and support to a beam segment.

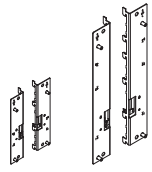

► Specifying, page 286

Product Details

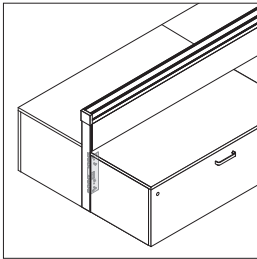

Low storage-to-beam connector attaches One-High Currency storage to beams.

► See *Currency Specification Guide*.

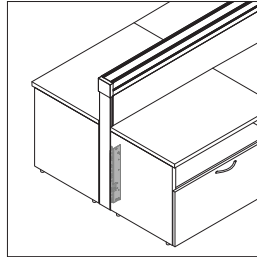

Medium storage-to-beam connectors attach 1.5-High and Two-High Currency storage to a beam segment.

► See *Currency Specification Guide*.

Storage-to-beam connector is available in versions for use with fabric and steel skins or with laminate and wood skins.

Tip: Specify appropriate bracket for beam skin to ensure optimal stability.

Connections

Storage-to-beam connector engages into slots in beam junction.

Storage-to-beam connector attaches to laminate storage back with screws and defaces the back side of the storage unit.

Recessed back laminate storage requires unique storage-to-beam connector bracket.

Surface Materials

Connector
• Black paint only

Actual Dimensions

Height 10³/₁₆" or 16³/₈"

Understanding High-Density Storage Products



Statement of Line **150**



High-Density Storage **152**

High-Density Storage Value Package **154**

Statement of Line

24" or 30"D

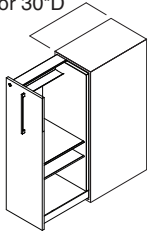

Understanding
 ▶ Page 152
 Specifying
 ▶ Page 288

High-Density Storage

	12"W	15"W
42"H	●	●
48"H	●	●

24" or 30"D

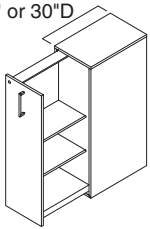

Understanding
 ▶ Page 154
 Specifying
 ▶ Page 292

High-Density Storage Value Package

	12"W	15"W
42"H	●	●
48"H	●	●

High-Density Storage

High-density storage is a personal storage product that provides ample organizational space with the added benefit of extendable privacy. Two configurations are available, shelf and bag drop. Resident workers are supported with room for their piles, files, and supplies to support their work flow in the high-density storage with shelf versions. Mobile workers have temporary storage and ease of access for all their belongings in the high-density storage with bag drop versions.

► Specifying, page 288

Front is available in laminate or veneer.

Contrasting front is available as an option.

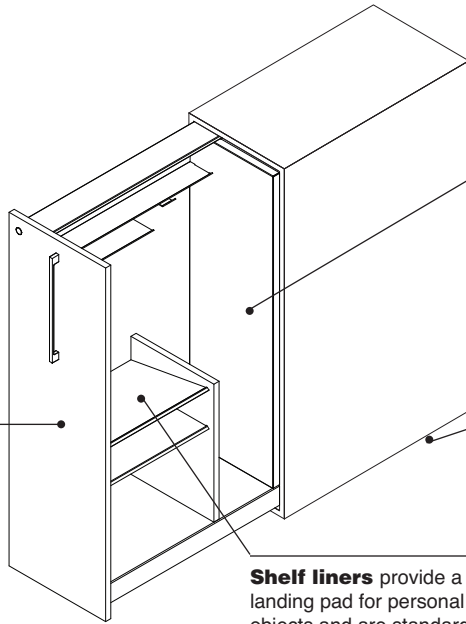

Coat closet, available as an option, is 7"W on 24"D units and 8"W on 30"D units and standard with two coat hooks.

Leveling glides adjust to install case on uneven floors and have a 1/2" adjustable range.

Shelf liners provide a soft landing pad for personal objects and are standard in the bag drop configuration.

Locks are standard on door. Locks are standard factory-installed, keyed random. ► *Lock and Keying*, page 375

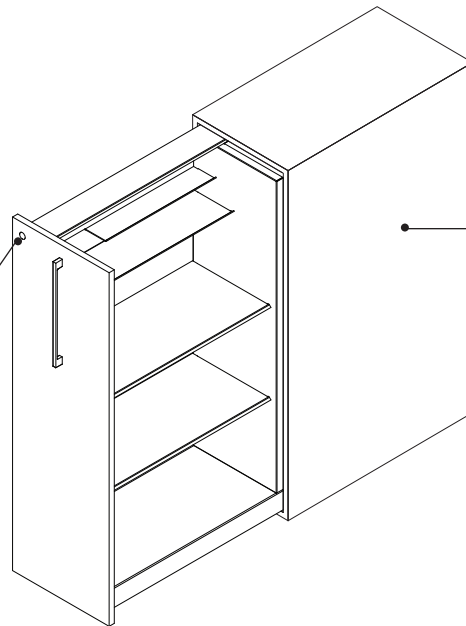

Case is available in laminate or veneer.

Product Details

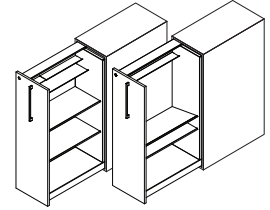

Two configurations are available on the 15"W version, the shelf configuration or the bag drop configuration. Only the shelf configuration is available on the 12"W version.

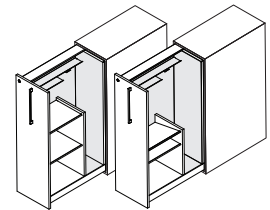

Coat closet is available as an option.

Left-hand configuration

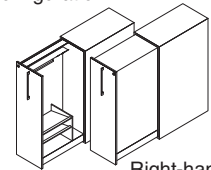

Right-hand configuration

Left-hand and right-hand configurations are available.

Mirrors are standard in all cases.

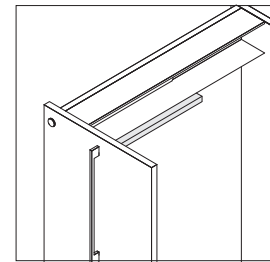

Light is available as an option on the bag drop configuration only.

Actual Dimensions

Depth 24" and 30"

Width 12" and 15"

Height 42" and 48"

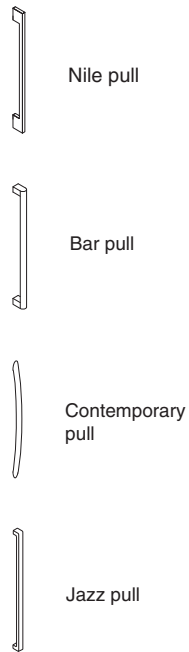

Nile pull

Bar pull

Contemporary pull

Jazz pull

Pull on high-density storage defaults with a Nile pull. Bar, contemporary, and jazz pull are available as an option.

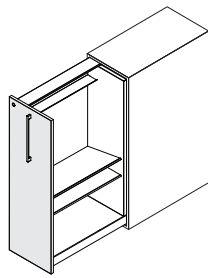

Contrasting fronts and horizontal grain direction are available options for laminate front/laminate case, veneer front/laminate case, or laminate front/veneer case.

Application Topics

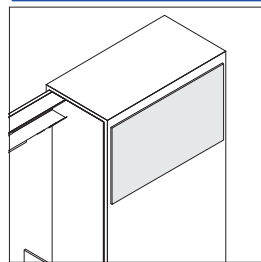

Magnetic boards, available as an option, are fabric-wrapped steel providing a place for visual display. The size of the magnetic board is determined by high-density case height and depth. Magnetic boards are field installed.

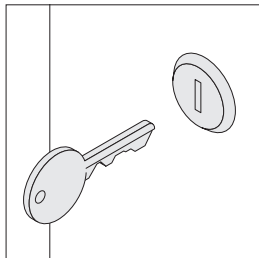

Locks are available factory- or field-installed. Factory-installed locks are standard and available keyed random only. Optional field-installed locks are available with consecutive, specific, and random keying options. Master-keyed locks are also available. Field-installed lock cylinders must be specified separately.

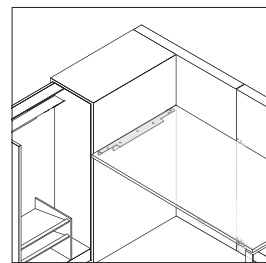

Worksurface support bracket can be used to mount a worksurface off one side of the high-density storage eliminating the need for other worksurface supports such as legs or end supports next to the case.

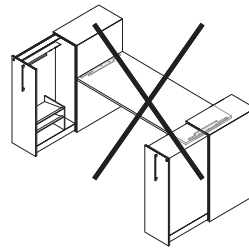

Worksurface support bracket can be used to support one side of a worksurface only.

Surface Materials

Case, including front

- Laminate
- Veneer

Case interior and worksurface support bracket

- Paint

Shelf

- 7360 Merle

Contemporary, jazz, and bar pulls

- 0835 Black
- 9201 Polished Chrome
- 9211 Nickel
- 9212 Silver

Nile pulls

- 0835 Black
- 4799 Platinum Metallic
- 7280 Smooth Bronze
- 9201 Polished Chrome
- 9211 Nickel

Magnetic board

- Cogent: Connect
- Billiard Multi-Use by Designtex

Panel connector bracket

- 0835 Black

Lock

- 9201 Polished Chrome
- 9250 Ember Chrome (option)

Application Topics

Storage Capacities and Dimensions

▶ See *Storage Specification Guide*

Counterweight Requirements for Storage Products

▶ See *Storage Specification Guide*

Shipping

High-density storage is normally shipped in heavy-duty, recyclable stretch wrap to reduce the amount of corrugated board needed.

High-Density Storage—Value Package

The high-density storage value package is a simplified configuration of high-density storage that solves organizational needs at a lower pricepoint. It is available with a laminate case with steel interior and limited specification options.
 ▶ Specifying, page 292

Locks are standard on door. Locks are standard factory-installed, keyed random.
 ▶ *Lock and Keying*, page 375

Front is laminate.

Contrasting front is available as an option.

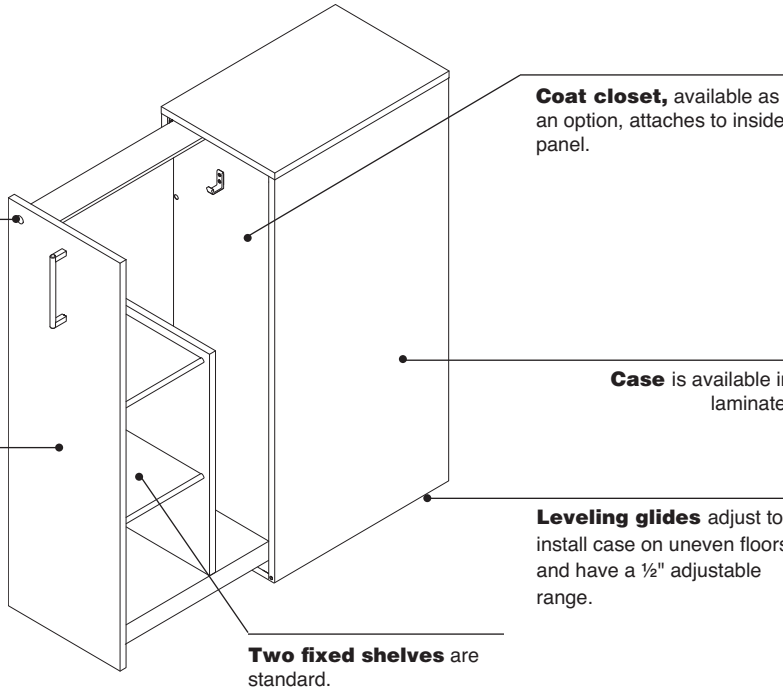

Product Details

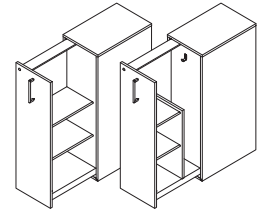

Coat closet is available as an option.
Tip: Coat hook is unique to the value package and will be visually different than in high-density storage.

Left-hand and right-hand configurations are available.

Value package does not include mirror, lock cover, or upper shelves found in high-density storage units.



Nile pull



Bar pull



Contemporary pull



Jazz pull

Pull on high-density storage defaults with a Nile pull. Bar, contemporary, and jazz pull are available as an option.

Actual Dimensions

Depth 24" and 30"

Width 12" and 15"

Height 42" and 48"

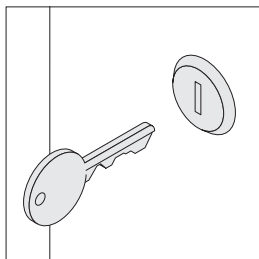

Locks are available factory- or field-installed. Factory-installed locks are standard and available keyed random only. Optional field-installed locks are available with consecutive, specific, and random keying options. Master-keyed locks are also available. Field-installed lock cylinders must be specified separately.

▶ *Lock and Keying*, page 375

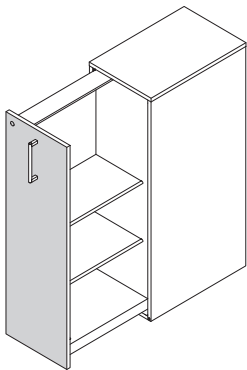

Contrasting fronts and horizontal grain direction are available options.

Application Topics

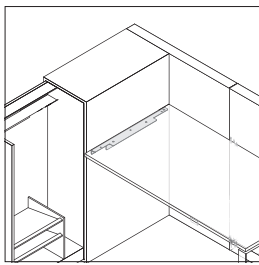

Worksurface support bracket can be used to mount a worksurface off one side of the high-density storage eliminating the need for other worksurface supports such as legs or end supports next to the case.

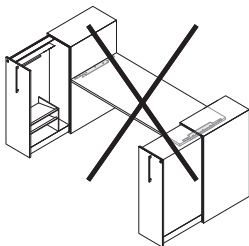

Worksurface support bracket can be used to support one side of a worksurface only.

Surface Materials

Case, including front

- Laminate

Case interior and worksurface support bracket

- Paint

Shelf

- 7360 Merle

Contemporary, jazz, and bar pulls

- 0835 Black
- 9201 Polished Chrome
- 9211 Nickel
- 9212 Silver

Nile pulls

- 0835 Black
- 4799 Platinum Metallic
- 7280 Smooth Bronze
- 9201 Polished Chrome
- 9211 Nickel

Panel connector bracket

- 0835 Black

Lock

- 9201 Polished Chrome
- 9250 Ember Chrome (option)

Application Topics

Storage Capacities and Dimensions

▶ See *Storage Specification Guide*

Counterweight Requirements for Storage Products

▶ See *Storage Specification Guide*

Shipping

High-density storage is normally shipped in heavy-duty, recyclable stretch wrap to reduce the amount of corrugated board needed.

Understanding Verb Accessories



Statement of Line

158



Verb Personal Whiteboard and Brackets

160

Statement of Line

Verb Personal Whiteboard and Brackets



Personal Whiteboard

- Understanding
- ▶ Page 160
- Specifying
- ▶ Page 296



Marker Clip

- Understanding
- ▶ Page 160
- Specifying
- ▶ Page 296

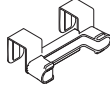

**Verb Bracket
Single-Sided**

- Understanding
- ▶ Page 160
- Specifying
- ▶ Page 297

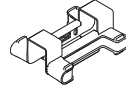

**Verb Bracket
Double-Sided**

- Understanding
- ▶ Page 160
- Specifying
- ▶ Page 297

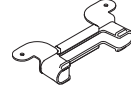

**Verb Bracket for
Worksurfaces**

- Understanding
- ▶ Page 160
- Specifying
- ▶ Page 297

Verb Whiteboard and Brackets

For Answer Beam Applications

Verb brackets allow a Verb personal whiteboard to be displayed and stored off of a boundary screen or worksurface.

► Specifying, page 297

Verb brackets for boundary screens clip to the top edge of a boundary screen.

Verb personal whiteboards are a two-sided whiteboard that easily remove from the brackets for use at personal workstations.

► Specifying, page 296

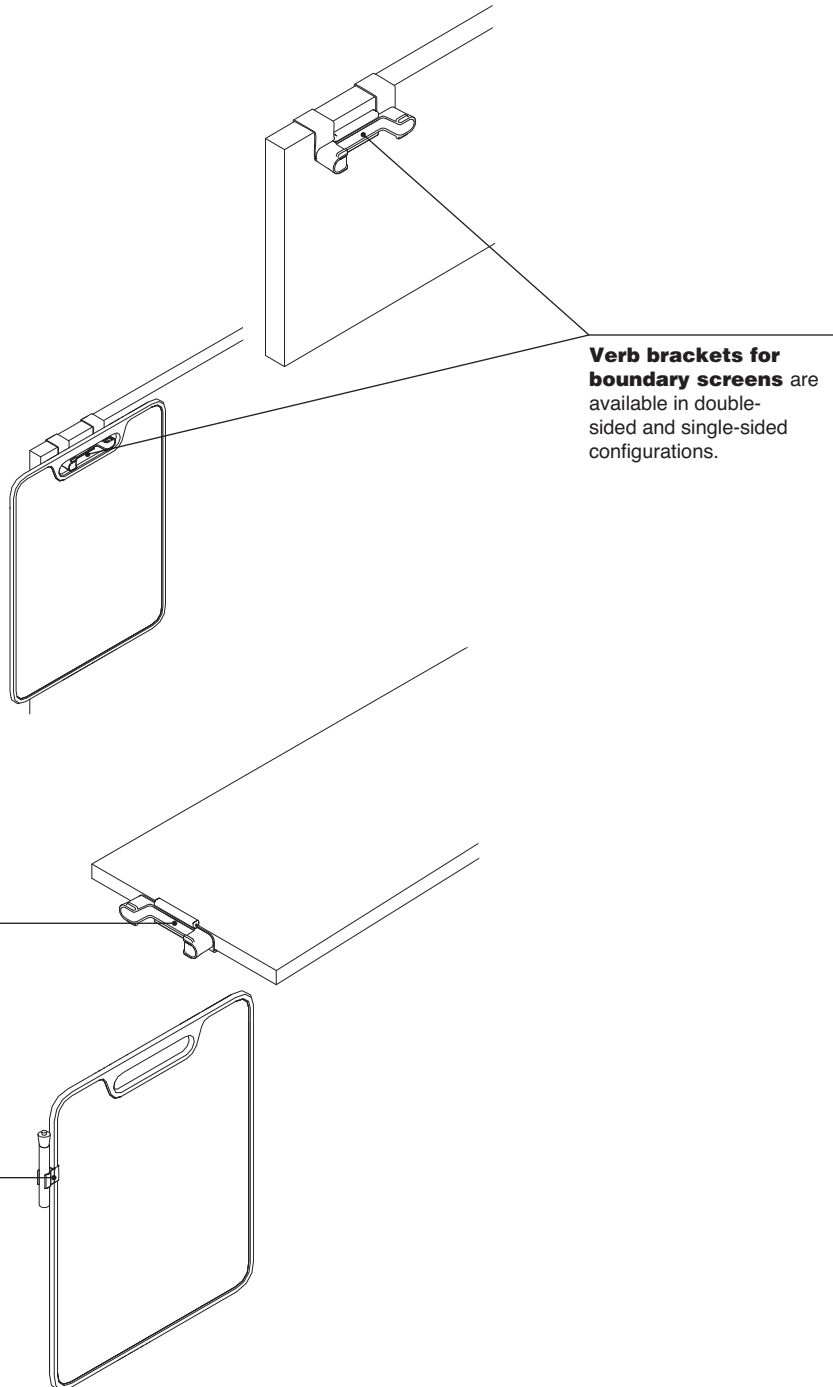

Verb brackets for boundary screens are available in double-sided and single-sided configurations.

Verb brackets for Universal worksurfaces stores the Verb personal whiteboard at the edge of a Universal worksurface.

Verb marker clip attaches to the Verb personal whiteboard and holds dry erase markers to the edge of the personal whiteboard.

Product Details

For more information on the Verb personal whiteboard, see *Steelcase Learning Specification Guide*.

Verb brackets for boundary screens can clip to the top edge of Answer beam end-of-run boundary screens, Answer beam on-module in-line screens, Answer beam centered in-line boundary screens and Answer panel boundary screens.

Verb brackets for Universal worksurfaces attach to Universal worksurfaces.

Application Topics

Verb brackets for boundary screens are not permanently attached to the boundary screen and can be repositioned along the boundary screen.

Verb brackets for Universal worksurfaces are screwed into the undersurface of the worksurface.

Maintenance

- Wipe board with a clean cloth moistened by a liquid markerboard cleaner or a solution of 50% water and 50% isopropyl alcohol. Rinse with clear water.
- Wipe dry with a clean cloth. If your board is used daily, the cleaning should be performed at least 2-3 times a week.

More thorough cleaning may be required if writing is left on the board for more than two days.

Markers

Use any high-quality dry erase marker.

CAUTION! The use of Low Odor markers may cause ghosting to occur. If Low Odor markers have been used, the surface can be completely cleaned by following the cleaning instructions above. Remember to discard eraser if used with Low Odor markers.

Removing Permanent Marker

Option 1:

- Write over the top of the permanent marker ink with a dry-erase marker
- Simply erase

Option 2:

- Moisten a clean, dry cloth with isopropyl alcohol
- Wipe the board in a circular motion to loosen marker residue
- Rinse with clear water
- Dry the board with a clean cloth
- Repeat these steps as necessary

Installer's Instructions for Initial Cleaning at Time of Installation

Tip: These initial cleaning instructions are shipped with every board.

- For initial cleaning, wipe your board with a clean cloth moistened by a mild, alcohol-based cleaner.
- Rinse with clear water. This step is simple, but very important.
- Wipe dry with a clean cloth.

Surface Materials

Verb brackets for boundary screens

- 6249 Platinum Solid

Verb brackets for Universal worksurfaces

- 6249 Platinum Solid

Verb marker clip

- 6249 Platinum Solid

Verb personal whiteboard

- e³ CeramicSteel

Specifying Answer Beam

Answer Beam Structure	165
Answer Beam Skins	187
Answer Beam Power	199
Boundary, Worksurface, and Beam Screens	219
Universal System Worksurfaces and Supports	253
Storage Tops, Stanchions, and Accessories	279
High-Density Storage Products	287
Verb Accessories	295

Specifying Answer Beam Structure

Junctions

In-Line Beam Junction	166
L and T Beam Junctions	167
X Beam Junction	168
End-of-Run Beam Junction	169
V and Y Beam Junctions	170
L Beam-to-Panel Change-of-Height Junctions	171
T Beam-to-Panel Change-of-Height Junctions	172
X Beam-to-Panel Change-of-Height Junctions	173
Brackets	174

Trim

End-of-Run Vertical Beam Trim and Cap Package	175
L and T Vertical Beam Trims	176
V Vertical Beam Trim	177
L and T Beam-to-Panel Change-of-Height Trims	178
X Beam-to-Panel Change-of-Height Trims	179

Beam Junction Elements

Beam Junction Post	180
Junction Blocks	180
Gripper Glide Caps	180
Inside Corner Light Seals	181
Beam Junction Caps	181

Beam Horizontal Frame Packages

Base Trims and Open Base Conversion Kits

Beam Top Cap Rails

Panel and Beam Foot

In-Line Beam Junction



Tip: In-line beam junctions do not require junction cap or vertical trim.

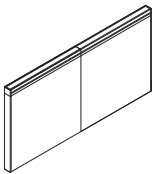

Standard Includes	Required to Specify
-------------------	---------------------

- | | | |
|---|---|--------------|
| ▶ Need help?
Product details,
page 14 | <ul style="list-style-type: none"> • Junction • Aligner | Style number |
|---|---|--------------|

Specification Information		
Height	Style Number	U.S. Price

28½"	TSB28IJ	\$119
:	:	:
:	:	:



For Canadian Pricing
 Multiply U.S. Price by the
 Canadian price factor.
 ▶ See page 1 for details.

L and T Beam Junctions

Standard Includes		Required to Specify
<ul style="list-style-type: none"> ▶ Need help? Product details, page 14 	<ul style="list-style-type: none"> • Junction • Inside corner light seal(s) • Vertical trim: paint price group 1 • Junction cap: paint 	<ul style="list-style-type: none"> 1 Style number 2 Paint color number for trim 3 Paint color number for junction cap 4 Options, if selected (see below) ▶ See <i>Surface Materials</i>, page 358.

Tip: Paint finish selection for vertical trim and junction cap can be different.

Options	U.S. Price	Required to Specify
Surface Materials	Trim <ul style="list-style-type: none"> • Paint price group 1 • Paint price group 2 • Paint price group 3 	<ul style="list-style-type: none"> Specify paint color number. Specify paint color number. Specify paint color number.
	<ul style="list-style-type: none"> No cost +\$17 +\$37 	

Specification Information		
Height	Style Number	U.S. Base Price

L Beam Junction

28½"	TSB28LJ	\$263
:	:	:

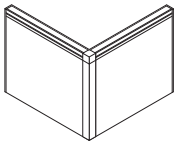

T Beam Junction

28½"	TSB28TJ	\$263
:	:	:

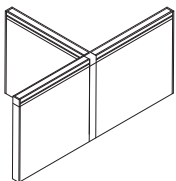

For Canadian Pricing
 Multiply U.S. Price by the Canadian price factor.
 ▶ See page 1 for details.

X Beam Junction

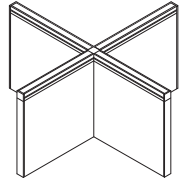

Standard Includes		Required to Specify
▶ Need help? Product details, page 14	<ul style="list-style-type: none"> • Junction • Inside corner light seals • Junction cap: paint 	1 Style number 2 Paint color number for junction cap ▶ See <i>Surface Materials</i> , page 358.

Specification Information		
Height	Style Number	U.S. Price
28½"	TSB28XJ	\$263
.	.	.

 **For Canadian Pricing**
 Multiply U.S. Price by the
 Canadian price factor.
 ▶ See page 1 for details.

End-of-Run Beam Junction



Tip: Omit trim on end-of-run beam junction when connecting a beam end-of-run boundary screen.

Tip: Paint finish selection for vertical trim and end cap can be different.

Standard Includes		Required to Specify
<ul style="list-style-type: none"> ▶ Need help? Product details, page 14 	<ul style="list-style-type: none"> • Junction • Vertical trim: paint price group 1 • Beam end cap: paint 	<ol style="list-style-type: none"> 1 Style number 2 Paint color number for trim 3 Paint color number for junction cap 4 Options, if selected (see below) <ul style="list-style-type: none"> ▶ See <i>Surface Materials</i>, page 358.

Options	U.S. Price	Required to Specify
Surface Materials <ul style="list-style-type: none"> • Trim • Paint price group 1 • Paint price group 2 • Paint price group 3 	No cost +\$17 +\$37	Specify paint color number. Specify paint color number. Specify paint color number.
Trim <ul style="list-style-type: none"> • Omit trim 	-\$89	Specify <i>with omit trim</i> .

Specification Information		
Height	Style Number	U.S. Base Price
28½"	TSB28EJ	\$168
:	:	:

 **For Canadian Pricing**
 Multiply U.S. Price by the Canadian price factor.
 ▶ See page 1 for details.

V and Y Beam Junctions

Standard Includes		Required to Specify
-------------------	--	---------------------

▶ Need help? Product details, page 14	<ul style="list-style-type: none"> • Junction • Vertical trim on V junction: paint price group 1 • Junction cap: paint 	1 Style number 2 Paint color number for trim on V junction 3 Paint color number for junction cap on V and Y junction 4 Options, if selected (see below) ▶ See <i>Surface Materials</i> , page 358.
---	---	--

Options	U.S. Price	Required to Specify
---------	------------	---------------------

Surface Materials <ul style="list-style-type: none"> • Paint price group 1 • Paint price group 2 • Paint price group 3 	Trim on V junction No cost +\$17 +\$37	Specify paint color number. Specify paint color number. Specify paint color number.
---	--	---

Tip: Paint finish selection for vertical trim and junction cap on V junction can be different.

Specification Information		
---------------------------	--	--

Height	Style Number	U.S. Base Price
--------	--------------	-----------------

V Junction

28½"	TSB28VJ	\$398
------	----------------	-------

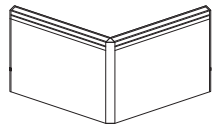

Y Junction

28½"	TSB28YJ	\$398
------	----------------	-------

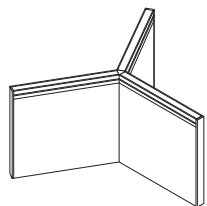

For Canadian Pricing

Multiply U.S. Price by the Canadian price factor.

▶ See page 1 for details.

L Beam-to-Panel Change-of-Height Junctions

Tip: Remember to specify necessary junction cap and aligners if the omit trim option is selected.

Tip: L beam-to-panel change-of-height connections are handed due to the handedness of the junction cap. The correct handed L beam-to-panel change-of-height junction style number should be specified.

Tip: Omit trim option omits all vertical and change-of-height trim.

Tip: Paint finish selection for vertical trim and junction cap can be different.

Standard Includes		Required to Specify
-------------------	--	---------------------

<ul style="list-style-type: none"> ▶ Need help? Product details, page 20 	<ul style="list-style-type: none"> • Junction • Inside corner light seal • Vertical trim: paint price group 1 • Junction cap: paint • Beam L vertical trim • Aligner 	<ul style="list-style-type: none"> 1 Style number 2 Paint color number for trim 3 Paint color number for junction cap 4 Options, if selected (see below) ▶ See <i>Surface Materials</i>, page 358.
---	--	---

Options	U.S. Price	Required to Specify
---------	------------	---------------------

Surface Materials <ul style="list-style-type: none"> • Trim • Paint price group 1 • Paint price group 2 • Paint price group 3 	No cost +\$17 +\$37	Specify paint color number. Specify paint color number. Specify paint color number.
Trim <ul style="list-style-type: none"> • Omit trim 	Prices below	Specify <i>with omit trim</i> .

Specification Information

Corresponding Panel Height	Style Number	U.S. Base Price	Option (Add \$ to Base Price)
A	B		Omit Trim

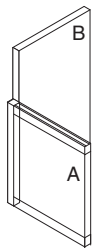

- Tip: Junction includes:
- Right hand L beam-to-panel change-of-height junction
 - Inside corner light seal
 - L vertical beam trim
 - End-of-run change-of-height trim
 - Right hand L beam-to-panel change-of-height junction cap
 - Aligners

Right-Handed L Beam-to-Panel Change-of-Height Junctions

28½"	36"	TSB2QCLJ	\$663	-\$192
28½"	42"	TSB24CLJ	\$663	-\$192
28½"	48"	TSB28CLJ	\$663	-\$192
28½"	54"	TSB25CLJ	\$678	-\$195
28½"	66"	TSB26CLJ	\$678	-\$195

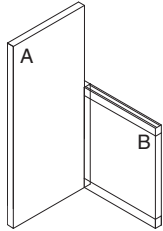

- Tip: Junction includes:
- Left hand L beam-to-panel change-of-height junction
 - Inside corner light seal
 - L vertical beam trim
 - End-of-run change-of-height trim
 - Left hand L beam-to-panel change-of-height junction cap
 - Aligners

Left-Handed L Beam-to-Panel Change-of-Height Junctions

36"	28½"	TSBQ2CLJ	\$663	-\$192
42"	28½"	TSB42CLJ	\$663	-\$192
48"	28½"	TSB82CLJ	\$663	-\$192
54"	28½"	TSB52CLJ	\$678	-\$195
66"	28½"	TSB62CLJ	\$678	-\$195

T Beam-to-Panel Change-of-Height Junctions

Standard Includes	Required to Specify
-------------------	---------------------

<ul style="list-style-type: none"> ▶ Need help? Product details, page 20 	<ul style="list-style-type: none"> • Junction • Inside corner light seals • Vertical trim: paint price group 1 • Junction cap: paint • T vertical beam trim • Aligners 	<ul style="list-style-type: none"> 1 Style number 2 Paint color number for trim 3 Paint color number for junction cap 4 Options, if selected (see below) ▶ See <i>Surface Materials</i>, page 358.
---	--	---

Options	U.S. Price	Required to Specify
---------	------------	---------------------

Surface Materials <ul style="list-style-type: none"> • Paint price group 1 • Paint price group 2 • Paint price group 3 	Trim <ul style="list-style-type: none"> • Paint price group 1 • Paint price group 2 • Paint price group 3 	<ul style="list-style-type: none"> No cost +\$17 +\$37 	<ul style="list-style-type: none"> Specify paint color number. Specify paint color number. Specify paint color number.
Trim	• Omit trim	Prices below	Specify <i>with omit trim</i> .

Tip: Omit trim option omits all vertical and change-of-height trim.

Tip: Remember to specify necessary junction cap and aligners if the omit trim option is selected.

Tip: Paint finish selection for vertical trim and junction cap can be different.

Specification Information					
Corresponding Panel Height	Style Number	U.S. Base Price	Option		

Corresponding Panel Height	Style Number	U.S. Base Price	Option		
A B C			(Add \$ to Base Price)		
			Omit Trim		

28½"	36"	28½"	TSB2Q2CTJ	\$776	-\$192
28½"	42"	28½"	TSB242CTJ	\$776	-\$192
28½"	48"	28½"	TSB282CTJ	\$776	-\$192
28½"	54"	28½"	TSB252CTJ	\$793	-\$195
28½"	66"	28½"	TSB262CTJ	\$793	-\$195

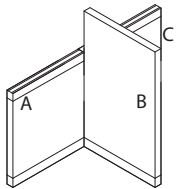

Tip: Junction includes:

- T beam-to-panel change-of-height junction
- Inside corner light seal(s)
- T vertical trim
- End-of-run change-of-height trim
- Aligners

36"	28½"	36"	TSBQ2QCTJ	\$776	-\$192
42"	28½"	42"	TSB424CTJ	\$776	-\$192
48"	28½"	48"	TSB828CTJ	\$776	-\$192
54"	28½"	54"	TSB525CTJ	\$793	-\$195
66"	28½"	66"	TSB626CTJ	\$793	-\$195

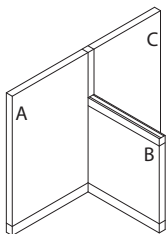

Tip: Junction includes:

- T beam-to-panel change-of-height junction
- Inside corner light seal(s)
- T beam vertical trim
- T change-of-height trim
- Aligners

For Canadian Pricing
 Multiply U.S. Price by the Canadian price factor.
 ▶ See page 1 for details.

X Beam-to-Panel Change-of-Height Junctions

Standard Includes		Required to Specify
<ul style="list-style-type: none"> ▶ Need help? Product details, page 20 	<ul style="list-style-type: none"> • Junction • Inside corner light seals • Vertical trim: paint price group 1 • Junction cap: paint • Aligners 	<ol style="list-style-type: none"> 1 Style number 2 Paint color number for trim 3 Paint color number for junction cap 4 Options, if selected (see below) <ul style="list-style-type: none"> ▶ See <i>Surface Materials</i>, page 358.

Options	U.S. Price	Required to Specify
Surface Materials <ul style="list-style-type: none"> • Trim • Paint price group 1 • Paint price group 2 • Paint price group 3 	No cost +\$17 +\$37	Specify paint color number. Specify paint color number. Specify paint color number.
Trim <ul style="list-style-type: none"> • Omit trim 	Prices below	Specify <i>with omit trim</i> .

Tip: Omit trim option omits all change-of-height trim.

Tip: Remember to specify necessary junction cap and aligners if the omit trim option is selected.

Specification Information

Corresponding Panel Height				Style Number	U.S. Base Price	Option (Add \$ to Base Price)
A	B	C	D			Omit Trim
28½"	36"	28½"	36"	TSB2Q2QCXJ	\$776	-\$187
28½"	42"	28½"	42"	TSB2424CXJ	\$776	-\$187
28½"	48"	28½"	48"	TSB2828CXJ	\$776	-\$187
28½"	54"	28½"	54"	TSB2525CXJ	\$793	-\$192
28½"	66"	28½"	66"	TSB2626CXJ	\$793	-\$192

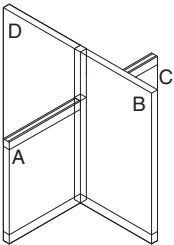

Tip: Junction includes:

- X beam-to-panel change-of-height junction
- Two T beam-to-panel change-of-height trims
- 90° junction cap
- Aligners

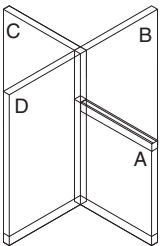

Tip: Junction includes:

- X beam-to-panel change-of-height junction
- Inside corner light seals
- T change-of-height trim
- 90° junction cap
- Aligners

28½"	36"	36"	36"	TSB2QQQCXJ	\$776	-\$187
28½"	42"	42"	42"	TSB2444CXJ	\$776	-\$187
28½"	48"	48"	48"	TSB2888CXJ	\$776	-\$187
28½"	54"	54"	54"	TSB2555CXJ	\$793	-\$192
28½"	66"	66"	66"	TSB2666CXJ	\$793	-\$192

 **For Canadian Pricing**
 Multiply U.S. Price by the Canadian price factor.
 ▶ See page 1 for details.

Brackets

Floor Anchor Bracket



Tip: Floor anchor bolts are not included.

Standard Includes	Required to Specify
-------------------	---------------------

- | | | |
|---|--|--|
| <ul style="list-style-type: none"> ▶ Need help? Product details, page 15 | <ul style="list-style-type: none"> • Two-piece floor anchor bracket: black paint only | <ul style="list-style-type: none"> Style number |
|---|--|--|

Specification Information		
Style Number	U.S. Price	

• Style Number	• U.S. Price	
• CBRKTS	• \$70	

Junction Stabilizer Brackets

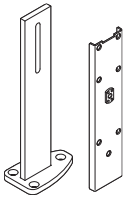

Tip: Junction stabilizer bracket blocks power routing in the base and just above the base areas. Lay-in cable routing in the base is also blocked by the bracket.

Standard Includes	Required to Specify
-------------------	---------------------

- | | | |
|---|---|--|
| <ul style="list-style-type: none"> ▶ Need help? Product details, page 15 | <ul style="list-style-type: none"> • Bracket: black paint only | <ul style="list-style-type: none"> Style number |
|---|---|--|

Specification Information		
Height	Style Number	U.S. Price

• Height	• Style Number	• U.S. Price
• 10½"	• TS7SBNJ	• \$122



For Canadian Pricing

Multiply U.S. Price by the Canadian price factor.

▶ See page 1 for details.

End-of-Run Vertical Beam Trim and Cap Package



Tip: Paint finish selection for vertical trim and junction cap can be different.

Standard Includes		Required to Specify
-------------------	--	---------------------

<ul style="list-style-type: none"> ▶ Need help? Product details, page 17 	<ul style="list-style-type: none"> • Vertical trim: paint price group 1 • Junction cap: paint 	<ol style="list-style-type: none"> 1 Style number 2 Paint color number for trim 3 Paint color number for junction cap 4 Options, if selected (see below) <ul style="list-style-type: none"> ▶ See <i>Surface Materials</i>, page 358.
---	---	--

Options	U.S. Price	Required to Specify
---------	------------	---------------------

Surface Materials	Trim	U.S. Price	Required to Specify
	<ul style="list-style-type: none"> • Paint price group 1 • Paint price group 2 • Paint price group 3 	No cost +\$17 +\$37	Specify paint color number. Specify paint color number. Specify paint color number.

Specification Information		
---------------------------	--	--

Height	Style Number	U.S. Base Price
28½"	TSB28EVTP	\$122



For Canadian Pricing
 Multiply U.S. Price by the Canadian price factor.
 ▶ See page 1 for details.

L and T Vertical Beam Trims

Standard Includes		Required to Specify
▶ Need help? Product details, page 17	• Trim: paint price group 1	1 Style number 2 Paint color number for trim 3 Options, if selected (see below) ▶ See <i>Surface Materials</i> , page 358.

Options	U.S. Price	Required to Specify
Surface Materials		
• Paint price group 1	No cost	Specify paint color number.
• Paint price group 2	+\$17	Specify paint color number.
• Paint price group 3	+\$37	Specify paint color number.

Specification Information		
Height	Style Number	U.S. Base Price
.....

L Vertical Trim		
28½"	TSB28LVT	\$106
.....



T Vertical Trim		
28½"	TSB28TVT	\$106
.....



For Canadian Pricing
 Multiply U.S. Price by the
 Canadian price factor.
 ▶ See page 1 for details.

V Vertical Beam Trim



Standard Includes		Required to Specify
▶ Need help? Product details, page 18	• Trim: paint price group 1	1 Style number 2 Paint color number for trim 3 Options, if selected (see below) ▶ See <i>Surface Materials</i> , page 358.

Options	U.S. Price	Required to Specify
Surface Materials	• Paint price group 1 • Paint price group 2 • Paint price group 3	No cost +\$17 +\$37 Specify paint color number. Specify paint color number. Specify paint color number.

Specification Information		
Height	Style Number	U.S. Base Price
28½"	TSB28VVT	\$130



For Canadian Pricing
Multiply U.S. Price by the Canadian price factor.
▶ See page 1 for details.

Change-of-Height Trims

Standard Includes		Required to Specify
▶ Need help? Product details, page 20	• Trim: paint price group 1	1 Style number 2 Paint color number for trim 3 Options, if selected (see below) ▶ See <i>Surface Materials</i> , page 358.

Options	U.S. Price	Required to Specify
Surface Materials • Paint price group 1 • Paint price group 2 • Paint price group 3	No cost +\$17 +\$37	Specify paint color number. Specify paint color number. Specify paint color number.

Specification Information		
Corresponding Panel Height	Style Number	U.S. Base Price

Change-of-Height Trim for L Beam-to-Panel Change-of-Height Junctions

28"	36"	TSB2QCLCHT	\$ 97
28"	42"	TSB24CLCHT	\$ 97
28"	48"	TSB28CLCHT	\$ 97
28"	54"	TSB25CLCHT	\$106
28"	60"	TSB20CLCHT	\$106
28"	66"	TSB26CLCHT	\$106

Change-of-Height Trim for T Beam-to-Panel Change-of-Height Junctions

28"	36"	28"	TSB2Q2CTCHT	\$ 97
28"	42"	28"	TSB242CTCHT	\$ 97
28"	48"	28"	TSB282CTCHT	\$106
28"	54"	28"	TSB252CTCHT	\$ 97
28"	60"	28"	TSB202CTCHT	\$106
28"	66"	28"	TSB262CTCHT	\$106
36"	28"	36"	TSBQ2QCTCHT	\$ 97
42"	28"	42"	TSB424CTCHT	\$ 97
48"	28"	48"	TSB828CTCHT	\$106
54"	28"	54"	TSB525CTCHT	\$106
60"	28"	60"	TSB020CTCHT	\$ 97
66"	28"	66"	TSB626CTCHT	\$106

▶ **Specification Information, continued on next page**



 **For Canadian Pricing**
Multiply U.S. Price by the Canadian price factor.
▶ See page 1 for details.

► Specification Information, continued from previous page

Specification Information

Corresponding Panel Height	Style Number	U.S. Base Price
-------------------------------	-----------------	-----------------------

Change-of-Height Trim for X Beam-to-Panel Change-of-Height Junctions

28"	36"	TSB2QCXCHT	\$ 97
28"	42"	TSB24CXCHT	\$ 97
28"	48"	TSB28CXCHT	\$ 97
28"	54"	TSB25CXCHT	\$106
28"	60"	TSB20CXCHT	\$106
28"	66"	TSB26CXCHT	\$106



For Canadian Pricing
Multiply U.S. Price by the
Canadian price factor.
► See page 1 for details.

Beam Junction Elements

Beam Junction Post



Tip: Junction post can be used at an end-of-run configuration or to change a junction application between an L, T, X, V, or Y.

Standard Includes		Required to Specify
▶ Need help? Product details, page 16	• Junction post	Style number

Specification Information		
Height	Style Number	U.S. Price
28½"	TSB28JP	\$79

Junction Blocks

Tip: When using 120° corner junction blocks with Answer beam junctions, washers must be added between the block and the junction. Washer available through Service Parts.



Standard Includes		Required to Specify
▶ Need help? Product details, page 16	• Junction blocks • Fasteners	Style number

Specification Information			
Application	Package Quantity	Style Number	U.S. Price
90°	3	TS790JB3	\$ 52
90°	4	TS790JB4	\$ 69
90°	5	TS790JB5	\$ 88
120°	3	TS7120JB3	\$ 79
120°	4	TS7120JB4	\$106
120°	5	TS7120JB5	\$130

Gripper Glide Caps



Standard Includes		Required to Specify
▶ Need help? Product details, page 15	• Package of 10 gripper glide caps: soft black plastic only	Style number

Specification Information	
Style Number	U.S. Price
TS7GGC10	\$70

 **For Canadian Pricing**
Multiply U.S. Price by the Canadian price factor.
▶ See page 1 for details.

Inside Corner Light Seals



Tip: Inside corner light seals can be field cut for use on beam junctions.

Standard Includes		Required to Specify
▶ Need help? Product details, page 18	• Inside corner light seal, package of four: black plastic	Style number
Specification Information		
• Height	• Style Number	• U.S. Price
54"	TS754ICLS	\$34
66"	TS766ICLS	\$34
78"	TS778ICLS	\$34
:	:	:

Beam Junction Caps

Tip: Change-of-height junction caps are used with beam-to-panel connections.

Standard Includes		Required to Specify
▶ Need help? Product details, page 16	• Junction cap: paint	1 Style number 2 Paint color number for junction cap ▶ See <i>Surface Materials</i> , page 358.

Specification Information		
• Corresponding Panel Application	• Style Number	• U.S. Price
:	:	:

Junction Caps		
L	TSBLJC	\$18
T	TSBTJC	\$18
V	TSBVJC	\$18
Y	TSBYJC	\$18
X	TSBXJC	\$18
:	:	:

Change-of-Height Junction Caps		
L right hand	TSBLJCCHR	\$18
L left hand	TSBLJCCHL	\$18
T	TSBTJCCH	\$18
:	:	:



Beam Horizontal Frame Packages

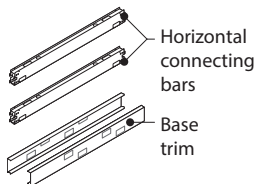

Tip: You must order vertical junctions separately to complete your frame.

► Pages 166–170

Tip: Remember to omit base trim(s) when using skins to the floor.

Tip: Omit base trim and separately specify hardwire base trims when accessing hardwire power in the base.

Tip: Beam top cap rail is ordered separately.

Tip: When open base trim or big open base option is selected, both base trims are omitted.

Tip: Base cable tray cannot be used if open base or big open base is selected, or if omit base trim is selected for one or both sides of beam.

Tip: Remember to order skins to complete the beam.

► Page 187

Standard Includes	Required to Specify
-------------------	---------------------

- Need help? Product details, page 26
- Base trim with knockouts: paint price group 1
 - Two horizontal connecting bars: black paint only

- 1 Style number
 - 2 Paint color number for trim
 - 3 Options, if selected (see below)
- See *Surface Materials*, page 358.

Options	U.S. Price	Required to Specify
---------	------------	---------------------

Surface Materials	<ul style="list-style-type: none"> • Paint price group 1 • Paint price group 2 • Paint price group 3 	No cost +\$ 17 +\$ 37	Specify paint color number. Specify paint color number. Specify paint color number.
Base Trim	<ul style="list-style-type: none"> • Knockouts one side, plain one side (24"W to 72"W) • Plain both sides (24"W to 72"W) • Omit one side, knockouts one side, 24"W to 36"W • Omit one side, knockouts one side, 42"W to 48"W • Omit one side, knockouts one side, 60"W to 72"W • Omit one side, plain one side, 24"W to 36"W • Omit one side, plain one side, 42"W to 48"W • Omit one side, plain one side, 60"W to 72"W • Omit both sides, 24"W to 36"W • Omit both sides, 42"W to 48"W • Omit both sides, 60"W to 72"W 	No cost No cost –\$ 3 –\$ 4 –\$ 5 –\$ 3 –\$ 4 –\$ 5 –\$ 6 –\$ 8 –\$ 10	Specify with knockouts one side, plain one side. Specify with plain both sides. Specify with omit one side, knockouts one side. Specify with omit one side, knockouts one side. Specify with omit one side, knockouts one side. Specify with omit one side, plain one side. Specify with omit one side, plain one side. Specify with omit one side, plain one side. Specify with omit both sides. Specify with omit both sides. Specify with omit both sides.
Open Base Trim	<ul style="list-style-type: none"> • Open base 	No cost	Specify with open base.
Big Open Base	<ul style="list-style-type: none"> • Big open base 	+\$107	Specify with big open base.
Cable Tray	<ul style="list-style-type: none"> • Cable tray 	No cost	Specify with cable tray.
Base Cable Tray	<ul style="list-style-type: none"> • Base cable tray 	+\$ 5	Specify with base cable tray.

Specification Information		
Width	Style Number	U.S. Base Price

24"	TSB24HF	\$130
30"	TSB30HF	\$140
36"	TSB36HF	\$148
42"	TSB42HF	\$170
48"	TSB48HF	\$179
60"	TSB60HF	\$227
72"	TSB72HF	\$312
:	:	:

For Canadian Pricing
 Multiply U.S. Price by the Canadian price factor.
 ► See page 1 for details.

Base Trims and Open Base Conversion Kits

Base Trims

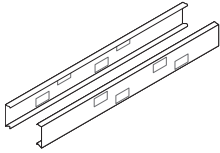

Standard Includes		Required to Specify
<ul style="list-style-type: none"> ▶ Need help? Product details, page 26 	<ul style="list-style-type: none"> • Base trim with knockouts: paint 	<ul style="list-style-type: none"> 1 Style number 2 Paint color number for trim 3 Options, if selected (see below) ▶ See <i>Surface Materials</i>, page 358.

Options	U.S. Price	Required to Specify
Base Trim <ul style="list-style-type: none"> • Plain 	No cost	Specify <i>with no knockouts</i> .

Specification Information		
Width	Style Number	U.S. Price
24"	TS724BT	\$32
30"	TS730BT	\$35
36"	TS736BT	\$37
42"	TS742BT	\$38
48"	TS748BT	\$39
60"	TS760BT	\$47
72"	TS772BT	\$51
:	:	:

Open Base Conversion Kits

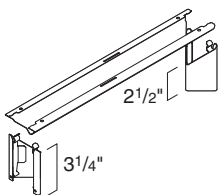

Standard Includes		Required to Specify
<ul style="list-style-type: none"> ▶ Need help? Product details, page 26 	<ul style="list-style-type: none"> • Trim: paint 	<ul style="list-style-type: none"> 1 Style number 2 Paint color number for trim ▶ See <i>Surface Materials</i>, page 358.

Specification Information		
Width	Style Number	U.S. Price
24"	TS724OBK	\$62
30"	TS730OBK	\$65
36"	TS736OBK	\$69
42"	TS742OBK	\$72
48"	TS748OBK	\$78
60"	TS760OBK	\$82
72"	TS772OBK	\$90
:	:	:



For Canadian Pricing
 Multiply U.S. Price by the Canadian price factor.
 ▶ See page 1 for details.

Base Trims and Open Base Conversion Kits, continued

Big Open Base Trim Package

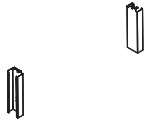

Standard Includes		Required to Specify
<ul style="list-style-type: none"> ▶ Need help? Product details, page 26 	<ul style="list-style-type: none"> • Two inside vertical trim: paint price group 1 	<ul style="list-style-type: none"> 1 Style number 2 Paint color number for trim 3 Options, if selected (see below) ▶ See <i>Surface Materials</i>, page 358.

Options	U.S. Price	Required to Specify
Surface Materials <ul style="list-style-type: none"> • Paint price group 1 • Paint price group 2 • Paint price group 3 	<ul style="list-style-type: none"> No cost +\$17 +\$37 	<ul style="list-style-type: none"> Specify paint color number. Specify paint color number. Specify paint color number.

Specification Information	
Style Number	U.S. Base Price
TSBBOBTRM	\$115

Hardwire Base Trim

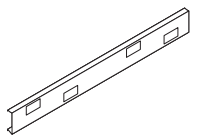

Standard Includes	Required to Specify
<ul style="list-style-type: none"> • Base trim with knockouts for hardwired power kit: paint 	<ul style="list-style-type: none"> 1 Style number 2 Paint color number from trim ▶ See <i>Surface Materials</i>, page 358.

Specification Information		
Width	Style Number	U.S. Price
24"	TS724BTH	\$32
30"	TS730BTH	\$35
36"	TS736BTH	\$37
42"	TS742BTH	\$38
48"	TS748BTH	\$39
60"	TS760BTH	\$47
72"	TS772BTH	\$51

 **For Canadian Pricing**
 Multiply U.S. Price by the Canadian price factor.
 ▶ See page 1 for details.

Beam Top Cap Rails

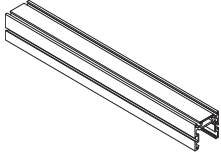

Tip: Beam top cap rails 48" to 96" width span Answer beam in-line junctions.
▶ See page 28 for configurations.

Standard Includes	Required to Specify
-------------------	---------------------

- | | | |
|---|---|--------------|
| ▶ Need help?
Product details,
page 28 | • Top cap rail: clear anodized aluminum | Style number |
|---|---|--------------|

Specification Information		
Width	Style Number	U.S. Price

24"	TSB24TC	\$418
30"	TSB30TC	\$424
36"	TSB36TC	\$434
42"	TSB42TC	\$443
48"	TSB48TC	\$480
54"	TSB54TC	\$512
60"	TSB60TC	\$535
66"	TSB66TC	\$560
72"	TSB72TC	\$595
78"	TSB78TC	\$635
84"	TSB84TC	\$657
90"	TSB90TC	\$710
96"	TSB96TC	\$714
:	:	:

Answer Beam Structure

For Canadian Pricing
Multiply U.S. Price by the Canadian price factor.
▶ See page 1 for details.

Panel and Beam Foot

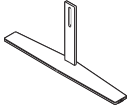

Standard Includes		Required to Specify
-------------------	--	---------------------

▶ Need help? Product details, page 30	<ul style="list-style-type: none"> Panel and beam foot: paint price group 1 Attachment hardware 	1 Style number 2 Paint color number for panel and beam foot 3 Options, if selected (see below) ▶ See <i>Surface Materials</i> , page 358.
---------------------------------------	---	--

Options	U.S. Price	Required to Specify
---------	------------	---------------------

Surface Materials <ul style="list-style-type: none"> Paint price group 1 Paint price group 2 Paint price group 3 	No cost +\$17 +\$37	Specify paint color number. Specify paint color number. Specify paint color number.
--	---------------------------	---

Specification Information	
---------------------------	--

• Style Number	• U.S. Base Price
•	•
•	•
•	•
•	•
TS7PF	\$411
•	•



For Canadian Pricing
 Multiply U.S. Price by the Canadian price factor.
 ▶ See page 1 for details.

Specifying Answer Beam Skins

Fabric-Covered Beam Skins	188
Fabric-Covered Beam Skins To The Floor	189
Fabric-Covered Beam Skins Big Open Base	190
Steel Beam Skins	191
Steel Beam Skins To The Floor	192
Steel Beam Skins Big Open Base	193
Laminate Beam Skins	194
Laminate Beam Skins To The Floor	195
Wood Beam Skins	196
Wood Beam Skins To The Floor	197

Fabric-Covered Beam Skins

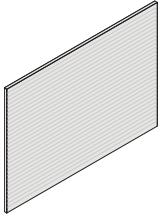

Tip: 72"W fabric-covered beam skins accommodate fabric in the horizontal direction only.

Tip: For further information about fabric direction, see page 364.

Standard Includes	Required to Specify
-------------------	---------------------

- | | | |
|---|---|---|
| <ul style="list-style-type: none"> ▶ Need help? Product details, page 36 | <ul style="list-style-type: none"> • 21¹/₁₆"H tackable acoustical beam skin, fabric direction with horizontal application, if selected: fabric price group 1 | <ul style="list-style-type: none"> 1 Style number 2 Fabric color number for skin surface 3 Options, if selected (see below) ▶ See <i>Surface Materials</i>, page 358. |
|---|---|---|

Surface Materials	Options	U.S. Price	Required to Specify
-------------------	---------	------------	---------------------

Surface Materials	• Fabric price group A	-\$ 4	Specify fabric color number.
	• Fabric price group 1	No cost	Specify fabric color number.
	• Fabric price group 2	+\$ 34	Specify fabric color number.
	• Fabric price group 3	+\$ 57	Specify fabric color number.
	• Fabric price group 4	+\$ 84	Specify fabric color number.
	• Fabric price group 5	+\$134	Specify fabric color number.
	• Fabric price group 6	+\$179	Specify fabric color number.
	• Fabric price group 7	+\$232	Specify fabric color number.
	• Fabric price group 8	+\$313	Specify fabric color number.
	• Fabric price group 9	+\$376	Specify fabric color number.
	• Fabric price group 10	+\$431	Specify fabric color number.
• Fabric price group COM	+\$ 25	Specify fabric color number.	

Fabric direction on 24"W-60"W panels

- | | | |
|------------------------|---------|------------------------------------|
| • Vertical application | No cost | Specify with vertical application. |
|------------------------|---------|------------------------------------|

Specification Information

Width	Style Number	U.S. Base Price
24"	TSB24TK	\$174
30"	TSB30TK	\$188
36"	TSB36TK	\$198
42"	TSB42TK	\$210
48"	TSB48TK	\$227
60"	TSB60TK	\$260
72"	TSB72TK	\$288
:	:	:



For Canadian Pricing

Multiply U.S. Price by the Canadian price factor.

▶ See page 1 for details.

Fabric-Covered Beam Skins To The Floor

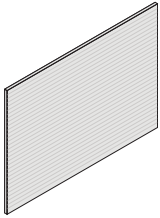

Tip: Remember to omit base trim(s) on a horizontal frame package when using a beam skin to the floor.

Tip: 72"W fabric-covered beam skins accommodate fabric in the horizontal direction only.

Tip: For further information about fabric direction, see page 364.

Standard Includes	Required to Specify
-------------------	---------------------

- | | | |
|---|---|--|
| <ul style="list-style-type: none"> ▶ Need help? Product details, page 36 | <ul style="list-style-type: none"> • 24⁷/₈"H beam skins, fabric direction with horizontal application, if selected: fabric price group 1 | <ol style="list-style-type: none"> 1 Style number 2 Fabric color number for skin surface 3 Options, if selected (see below) <ul style="list-style-type: none"> ▶ See <i>Surface Materials</i>, page 358. |
|---|---|--|

Options	U.S. Price	Required to Specify
---------	------------	---------------------

Surface Materials	<ul style="list-style-type: none"> • Fabric price group A • Fabric price group 1 • Fabric price group 2 • Fabric price group 3 • Fabric price group 4 • Fabric price group 5 • Fabric price group 6 • Fabric price group 7 • Fabric price group 8 • Fabric price group 9 • Fabric price group 10 • Fabric price group COM 	<ul style="list-style-type: none"> –\$ 4 No cost +\$ 34 +\$ 57 +\$ 84 +\$134 +\$179 +\$232 +\$313 +\$376 +\$431 +\$ 25 	<ul style="list-style-type: none"> Specify fabric color number. Specify fabric color number. Specify fabric color number. Specify fabric color number. Specify fabric color number. Specify fabric color number. Specify fabric color number. Specify fabric color number. Specify fabric color number. Specify fabric color number. Specify fabric color number. Specify fabric color number.
--------------------------	---	--	--

Fabric direction on 24"W–60"W skins

- | | | |
|--|---|---|
| <ul style="list-style-type: none"> • Vertical application | <ul style="list-style-type: none"> No cost | <ul style="list-style-type: none"> Specify <i>with vertical application</i>. |
|--|---|---|

Specification Information

Width	Style Number	U.S. Base Price
24"	TSB24TKF	\$198
30"	TSB30TKF	\$208
36"	TSB36TKF	\$216
42"	TSB42TKF	\$230
48"	TSB48TKF	\$245
60"	TSB60TKF	\$277
72"	TSB72TKF	\$309
:	:	:



For Canadian Pricing

Multiply U.S. Price by the Canadian price factor.

▶ See page 1 for details.

Fabric-Covered Beam Skins Big Open Base

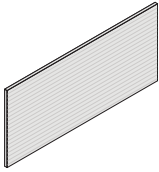

Tip: Remember to omit base trim(s) on a horizontal frame package when using a beam skin for big open base.

Tip: 72"W fabric-covered beam skins accommodate fabric in the horizontal direction only.

Tip: For further information about fabric direction, see page 364.

Standard Includes	Required to Specify
-------------------	---------------------

- | | | |
|---|---|--|
| <ul style="list-style-type: none"> ▶ Need help? Product details, page 36 | <ul style="list-style-type: none"> • 15⁵/₈"H beam skins, fabric direction with horizontal application, if selected: fabric price group 1 | <ol style="list-style-type: none"> 1 Style number 2 Fabric color number for skin surface 3 Options, if selected (see below) <ul style="list-style-type: none"> ▶ See <i>Surface Materials</i>, page 358. |
|---|---|--|

Options	U.S. Price	Required to Specify
---------	------------	---------------------

Surface Materials	• Fabric price group A	–\$ 4	Specify fabric color number.
	• Fabric price group 1	No cost	Specify fabric color number.
	• Fabric price group 2	+\$ 34	Specify fabric color number.
	• Fabric price group 3	+\$ 57	Specify fabric color number.
	• Fabric price group 4	+\$ 84	Specify fabric color number.
	• Fabric price group 5	+\$134	Specify fabric color number.
	• Fabric price group 6	+\$179	Specify fabric color number.
	• Fabric price group 7	+\$232	Specify fabric color number.
	• Fabric price group 8	+\$313	Specify fabric color number.
	• Fabric price group 9	+\$376	Specify fabric color number.
	• Fabric price group 10	+\$431	Specify fabric color number.
• Fabric price group COM	+\$ 25	Specify fabric color number.	

Fabric direction on 24"W–60"W skins

- | | | |
|------------------------|---------|--|
| • Vertical application | No cost | Specify <i>with vertical application</i> . |
|------------------------|---------|--|

Specification Information

Width	Style Number	U.S. Base Price
24"	TSB24TKBOB	\$154
30"	TSB30TKBOB	\$161
36"	TSB36TKBOB	\$169
42"	TSB42TKBOB	\$179
48"	TSB48TKBOB	\$193
60"	TSB60TKBOB	\$220
72"	TSB72TKBOB	\$241
:	:	:



For Canadian Pricing

Multiply U.S. Price by the Canadian price factor.

▶ See page 1 for details.

Steel Beam Skins

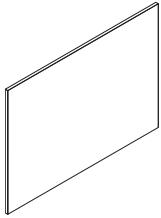

Tip: Data cutouts can be placed on the left or the right side of a steel beam skin. Data cutouts cannot be placed on both left and right side of steel beam skins.

Tip: Data cutouts is an option under receptacle location. Specify data cutout location under the appropriate receptacle selection. Data cutout price is additive to the receptacle cutout price.

Tip: On 24"W and 30"W steel skins, hardwire receptacle cutout option will always be with a centered hardwire cutout.

Tip: On 36"W and wider steel skins, hardwire receptacle cutout option will always come with a left and a right hardwire cutout.

Standard Includes	Required to Specify
-------------------	---------------------

- | | | |
|---------------------------------------|---|--|
| ▶ Need help? Product details, page 38 | <ul style="list-style-type: none"> • 21¹/₁₆"H steel beam skin: paint price group 1 | <ol style="list-style-type: none"> 1 Style number 2 Paint color number for skin surface 3 Options, if selected (see below) <p>▶ See <i>Surface Materials</i>, page 358.</p> |
|---------------------------------------|---|--|

Options	U.S. Price	Required to Specify
---------	------------	---------------------

Surface Materials	<ul style="list-style-type: none"> • Paint price group 1 • Paint price group 2 • Paint price group 3 	No cost +\$37 +\$61	Specify paint color number. Specify paint color number. Specify paint color number.
--------------------------	---	---------------------------	---

Data Cutout Only	24"W-30"W	36"W	42"W-72"W	Required to Specify
------------------	-----------	------	-----------	---------------------

<ul style="list-style-type: none"> • Left modular furniture data cutout or left NEMA data cutout 	N.A.	N.A.	+\$13	Specify with left modular furniture data cutout or left NEMA data cutout.
<ul style="list-style-type: none"> • Right modular furniture data cutout or right NEMA data cutout 	+\$13	+\$13	+\$13	Specify with right modular furniture data cutout or right NEMA data cutout.

Modular Receptacle Cutout	U.S. Price	36"W	42"W-72"W	Required to Specify
---------------------------	------------	------	-----------	---------------------

<ul style="list-style-type: none"> • Center receptacle cutout 	+\$13	N.A.	N.A.	Specify with center receptacle cutout.
<ul style="list-style-type: none"> • Center receptacle cutout with right modular furniture data cutout or right NEMA data cutout 	+\$13	N.A.	N.A.	Specify with center receptacle cutout and right modular furniture data cutout or right NEMA data cutout.

<ul style="list-style-type: none"> • Left receptacle cutout 	N.A.	+\$13	+\$13	Specify with left receptacle cutout.
<ul style="list-style-type: none"> • Left receptacle cutout with left modular furniture data cutout or left NEMA data cutout 	N.A.	N.A.	+\$26	Specify with left receptacle cutout and left modular furniture data cutout or left NEMA data cutout.

<ul style="list-style-type: none"> • Right receptacle cutout 	N.A.	+\$13	+\$13	Specify with right receptacle cutout.
<ul style="list-style-type: none"> • Right receptacle cutout with right modular furniture data cutout or right NEMA data cutout 	N.A.	+\$26	+\$26	Specify with right receptacle cutout and right modular furniture data cutout or right NEMA data cutout.

<ul style="list-style-type: none"> • Left and right receptacle cutout 	N.A.	+\$26	+\$26	Specify with left and right receptacle cutout.
<ul style="list-style-type: none"> • Left and right receptacle cutout with left modular furniture data cutout or left NEMA data cutout 	N.A.	N.A.	+\$39	Specify with left and right receptacle cutout and left modular furniture data cutout or left NEMA data cutout.

<ul style="list-style-type: none"> • Left and right receptacle cutout with right modular furniture data cutout or right NEMA data cutout 	N.A.	+\$39	+\$39	Specify with left and right receptacle cutout and right modular furniture data cutout or right NEMA data cutout.
---	------	-------	-------	--

Hardwire Power/Data Cutouts	U.S. Price	36"W	42"W-72"W	Required to Specify
-----------------------------	------------	------	-----------	---------------------

<ul style="list-style-type: none"> • Hardwired with left modular furniture data cutout or left NEMA data cutout 	N.A.	N.A.	+\$13	Specify with left modular furniture data cutout or left NEMA data cutout.
<ul style="list-style-type: none"> • Hardwired with right modular furniture data cutout or right NEMA data cutout 	+\$13	+\$13	+\$13	Specify with right modular furniture data cutout or right NEMA data cutout.

Specification Information		
Width	Style Number	U.S. Base Price

24"	TSB24HS	\$154
30"	TSB30HS	\$169
36"	TSB36HS	\$179
42"	TSB42HS	\$188
48"	TSB48HS	\$204
60"	TSB60HS	\$233
72"	TSB72HS	\$262

For Canadian Pricing
 Multiply U.S. Price by the Canadian price factor.
 ▶ See page 1 for details.

Steel Beam Skins To The Floor

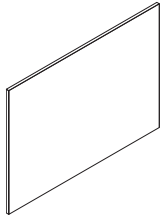

Tip: Remember to omit base trim(s) on horizontal frame package when using a beam skin to the floor.

Tip: Data cutouts can be placed on the left or the right side of a steel beam skin. Data cutouts cannot be placed on both left and right side of steel beam skins.

Tip: Data cutouts is an option under receptacle location. Specify data cutout location under the appropriate receptacle selection. Data cutout price is additive to the receptacle cutout price.

Tip: On 24"W and 30"W steel skins, hardwire receptacle cutout option will always be with a centered hardwire cutout.

Tip: On 36"W and wider steel skins, hardwire receptacle cutout option will always come with a left and a right hardwire cutout.

Standard Includes	Required to Specify
-------------------	---------------------

- | | | |
|---------------------------------------|--|--|
| ▶ Need help? Product details, page 38 | <ul style="list-style-type: none"> • 24⁷/₈"H steel beam skin: paint price group 1 | <ol style="list-style-type: none"> 1 Style number 2 Paint color number for skin surface 3 Options, if selected (see below) <p>▶ See <i>Surface Materials</i>, page 358.</p> |
|---------------------------------------|--|--|

Options	U.S. Price	Required to Specify
---------	------------	---------------------

Surface Materials	<ul style="list-style-type: none"> • Paint price group 1 • Paint price group 2 • Paint price group 3 	No cost +\$37 +\$61	Specify paint color number. Specify paint color number. Specify paint color number.
--------------------------	---	---------------------------	---

Data Cutout Only	24"W-30"W	36"W	42"W-72"W	Required to Specify
------------------	-----------	------	-----------	---------------------

• Left modular furniture data cutout or left NEMA data cutout	N.A.	N.A.	+\$13	Specify with left modular furniture data cutout or left NEMA data cutout.
	+\$13	+\$13	+\$13	Specify with right modular furniture data cutout or right NEMA data cutout.

Modular Receptacle Cutout	• Center receptacle cutout	+\$13	N.A.	N.A.	Specify with center receptacle cutout.
	• Center receptacle cutout with right modular furniture data cutout or right NEMA data cutout	+\$13	N.A.	N.A.	Specify with center receptacle cutout and right modular furniture data cutout or right NEMA data cutout.

• Left receptacle cutout	N.A.	+\$13	+\$13	Specify with left receptacle cutout.
	N.A.	N.A.	+\$26	Specify with left receptacle cutout and left modular furniture data cutout or left NEMA data cutout.

• Right receptacle cutout	N.A.	+\$13	+\$13	Specify with right receptacle cutout.
	N.A.	+\$26	+\$26	Specify with right receptacle cutout and right modular furniture data cutout or right NEMA data cutout.

• Left and right receptacle cutout	N.A.	+\$26	+\$26	Specify with left and right receptacle cutout.
	N.A.	N.A.	+\$39	Specify with left and right receptacle cutout and left modular furniture data cutout or left NEMA data cutout.
	N.A.	+\$39	+\$39	Specify with left and right receptacle cutout and right modular furniture data cutout or right NEMA data cutout.

Hardwire Power/Data Cutouts	• Hardwired with left modular furniture data cutout or left NEMA data cutout	N.A.	N.A.	+\$13	Specify with left modular furniture data cutout or left NEMA data cutout.
	• Hardwired with right modular furniture data cutout or right NEMA data cutout	+\$13	+\$13	+\$13	Specify with right modular furniture data cutout or right NEMA data cutout.

• Hardwired with receptacle cutout	+\$13	+\$13	+\$13	Specify with receptacle cutout.
	N.A.	N.A.	+\$26	Specify with left receptacle cutout and left modular furniture data cutout or left NEMA data cutout.

• Hardwired with right receptacle cutout and right modular furniture data cutout or right NEMA data cutout	+\$26	+\$26	+\$26	Specify with right receptacle cutout and right modular furniture data cutout or right NEMA data cutout.
--	-------	-------	-------	---

Specification Information

Width	Style Number	U.S. Base Price
24"	TSB24HSF	\$172
30"	TSB30HSF	\$189
36"	TSB36HSF	\$202
42"	TSB42HSF	\$208
48"	TSB48HSF	\$223
60"	TSB60HSF	\$252
72"	TSB72HSF	\$280

For Canadian Pricing
 Multiply U.S. Price by the Canadian price factor.
 ▶ See page 1 for details.

Steel Beam Skins Big Open Base

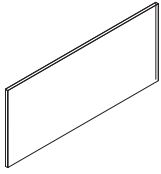

Tip: Data cutouts can be placed on the left or the right side of a steel beam skin. Data cutouts cannot be placed on both left and right side of steel beam skins.

Tip: Data cutouts is an option under receptacle location. Specify data cutout location under the appropriate receptacle selection. Data cutout price is additive to the receptacle cutout price.

Tip: On 24"W and 30"W steel skins, hardwire receptacle cutout option will always be with a centered hardwire cutout.

Tip: On 36"W and wider steel skins, hardwire receptacle cutout option will always come with a left and a right hardwire cutout.

Standard Includes	Required to Specify
-------------------	---------------------

- | | | |
|---------------------------------------|--|--|
| ▶ Need help? Product details, page 38 | <ul style="list-style-type: none"> 15⁵/₈"H steel beam skin: paint price group 1 | <ol style="list-style-type: none"> 1 Style number 2 Paint color number for skin surface 3 Options, if selected (see below) <p>▶ See <i>Surface Materials</i>, page 358.</p> |
|---------------------------------------|--|--|

Options	U.S. Price	Required to Specify
---------	------------	---------------------

Surface Materials	<ul style="list-style-type: none"> Paint price group 1 Paint price group 2 Paint price group 3 	No cost +\$ 37 +\$ 61	Specify paint color number. Specify paint color number. Specify paint color number.
--------------------------	---	-----------------------------	---

Data Cutout Only	24"W-30"W	36"W	42"W-72"W	Required to Specify
------------------	-----------	------	-----------	---------------------

Data Cutout Only	• Left modular furniture data cutout or left NEMA data cutout	N.A.	N.A.	+\$13	Specify with left modular furniture data cutout or left NEMA data cutout.
	• Right modular furniture data cutout or right NEMA data cutout	+\$13	+\$13	+\$13	Specify with right modular furniture data cutout or right NEMA data cutout.

Modular Receptacle Cutout	• Center receptacle cutout	+\$13	N.A.	N.A.	Specify with center receptacle cutout.
	• Center receptacle cutout with right modular furniture data cutout or right NEMA data cutout	+\$13	N.A.	N.A.	Specify with center receptacle cutout and right modular furniture data cutout or right NEMA data cutout.

Modular Receptacle Cutout	• Left receptacle cutout	N.A.	+\$13	+\$13	Specify with left receptacle cutout.
	• Left receptacle cutout with left modular furniture data cutout or left NEMA data cutout	N.A.	N.A.	+\$26	Specify with left receptacle cutout and left modular furniture data cutout or left NEMA data cutout.

Modular Receptacle Cutout	• Right receptacle cutout	N.A.	+\$13	+\$13	Specify with right receptacle cutout.
	• Right receptacle cutout with right modular furniture data cutout or right NEMA data cutout	N.A.	+\$26	+\$26	Specify with right receptacle cutout and right modular furniture data cutout or right NEMA data cutout.

Modular Receptacle Cutout	• Left and right receptacle cutout	N.A.	+\$26	+\$26	Specify with left and right receptacle cutout.
	• Left and right receptacle cutout with left modular furniture data cutout or left NEMA data cutout	N.A.	N.A.	+\$39	Specify with left and right receptacle cutout and left modular furniture data cutout or left NEMA data cutout.
	• Left and right receptacle cutout with right modular furniture data cutout or right NEMA data cutout	N.A.	+\$39	+\$39	Specify with left and right receptacle cutout and right modular furniture data cutout or right NEMA data cutout.

Hardwire Power/Data Cutouts	• Hardwired with left modular furniture data cutout or left NEMA data cutout	N.A.	N.A.	+\$13	Specify with left modular furniture data cutout or left NEMA data cutout.
	• Hardwired with right modular furniture data cutout or right NEMA data cutout	+\$13	+\$13	+\$13	Specify with right modular furniture data cutout or right NEMA data cutout.

Hardwire Power/Data Cutouts	• Hardwired with receptacle cutout	+\$13	+\$13	+\$13	Specify with receptacle cutout.
	• Hardwired with left receptacle cutout and left modular furniture data cutout or left NEMA data cutout	N.A.	N.A.	+\$26	Specify with left receptacle cutout and left modular furniture data cutout or left NEMA data cutout.

Hardwire Power/Data Cutouts	• Hardwired with right receptacle cutout and right modular furniture data cutout or right NEMA data cutout	+\$26	+\$26	+\$26	Specify with right receptacle cutout and right modular furniture data cutout or right NEMA data cutout.
-----------------------------	--	-------	-------	-------	---

Specification Information

Width	Style Number	U.S. Base Price
24"	TSB24HSBOB	\$120
30"	TSB30HSBOB	\$133
36"	TSB36HSBOB	\$146
42"	TSB42HSBOB	\$153
48"	TSB48HSBOB	\$164
60"	TSB60HSBOB	\$181
72"	TSB72HSBOB	\$207



For Canadian Pricing
Multiply U.S. Price by the Canadian price factor.

▶ See page 1 for details.

Laminate Beam Skins

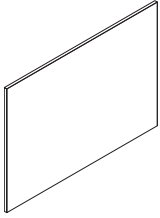

For laminate price group 2 and group 3 pricing, please refer to the electronic catalog or SmartTools.

Standard Includes		Required to Specify	
<ul style="list-style-type: none"> ▶ Need help? Product details, page 41 	<ul style="list-style-type: none"> • 21¹/₁₆"H skin: laminate price group 1 • Vertical grain direction for woodgrain and directional laminates • Trim: paint • Attachment hardware 	<ul style="list-style-type: none"> 1 Style number 2 Laminate color for skin surface 3 Paint color number for trim 4 Options, if selected (see below) ▶ See <i>Surface Materials</i>, page 358. 	
Options		U.S. Price	Required to Specify
Surface Materials <ul style="list-style-type: none"> • Laminate price group 2 • Laminate price group 3 • Open Line laminate 	<ul style="list-style-type: none"> • Laminate price group 2 • Laminate price group 3 • Open Line laminate 	See information at left See information at left +\$111 plus cost of laminate	<ul style="list-style-type: none"> Specify laminate color number. Specify laminate color number. ▶ See <i>Surface Materials Reference Manual</i>.
Grain direction <ul style="list-style-type: none"> • Horizontal 		No cost	Specify with horizontal grain direction.

Specification Information		
Width	Style Number	U.S. Base Price
24"	TSB24LS	\$549
30"	TSB30LS	\$575
36"	TSB36LS	\$601
42"	TSB42LS	\$640
48"	TSB48LS	\$660
:	:	:



For Canadian Pricing
 Multiply U.S. Price by the Canadian price factor.
 ▶ See page 1 for details.

Laminate Beam Skins To The Floor

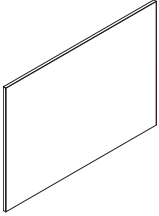

For laminate price group 2 and group 3 pricing, please refer to the electronic catalog or SmartTools.

Tip: Remember to omit base trim(s) on horizontal frame package when using a beam skin to the floor.

Standard Includes		Required to Specify
<ul style="list-style-type: none"> ▶ Need help? Product details, page 41 	<ul style="list-style-type: none"> • 24⁷/₈"H skin: laminate price group 1 • Vertical grain direction for woodgrain and directional laminates • Trim: paint • Attachment hardware 	<ol style="list-style-type: none"> 1 Style number 2 Laminate color for skin surface 3 Paint color number for trim 4 Options, if selected (see below) <ul style="list-style-type: none"> ▶ See <i>Surface Materials</i>, page 358.

Options	U.S. Price	Required to Specify
Surface Materials <ul style="list-style-type: none"> • Laminate price group 2 • Laminate price group 3 • Open Line laminate 	See information at left See information at left +\$111 plus cost of laminate	Specify laminate color number. Specify laminate color number. ▶ See <i>Surface Materials Reference Manual</i> .
Grain direction <ul style="list-style-type: none"> • Horizontal 	No cost	Specify with horizontal grain direction.

Specification Information		
Width	Style Number	U.S. Base Price
24"	TSB24LSF	\$579
30"	TSB30LSF	\$607
36"	TSB36LSF	\$630
42"	TSB42LSF	\$672
48"	TSB48LSF	\$689
.	.	.

 **For Canadian Pricing**
 Multiply U.S. Price by the Canadian price factor.
 ▶ See page 1 for details.

Wood Beam Skins

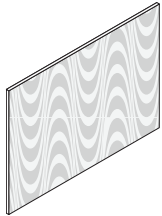

Tip: Vertical grain cathedral direction will point up. The cathedral direction for horizontal grain is random.

Standard Includes		Required to Specify
<ul style="list-style-type: none"> ▶ Need help? Product details, page 42 	<ul style="list-style-type: none"> • 21¼"H skin: composite veneer group 1 • Vertical grain direction • Trim: paint • Attachment hardware 	<ol style="list-style-type: none"> 1 Style number 2 Composite veneer color for skin surface 3 Paint color number for trim 4 Options, if selected (see below) <p>▶ See <i>Surface Materials</i>, page 358.</p>

Options	U.S. Price	Required to Specify
Surface Materials <ul style="list-style-type: none"> • Composite veneer group 1 • Composite veneer group 2 • Wood group 1 • Wood group 2 • Wood group 3 • Customiz stain 	No cost Prices below Prices below Prices below No cost	Specify composite veneer color number. Specify composite veneer color number. Specify wood color number. Specify wood color number. Specify wood color number. Specify with <i>Customiz stain</i> . ▶ See <i>Surface Materials Reference Manual</i> .
Grain direction <ul style="list-style-type: none"> • Horizontal 	No cost	Specify with <i>horizontal grain direction</i> .

Specification Information						
Width	Style Number	U.S. Base Price	Options (Add \$ to Base Price)			
:	:	:	Comp	Wood 1	Wood 2	Wood 3
:	:	:	Ven 2	:	:	:
24"	TSB24WS	\$735	+\$ 82	+\$19	+\$ 84	+\$301
30"	TSB30WS	\$779	+\$ 82	+\$19	+\$ 84	+\$301
36"	TSB36WS	\$824	+\$140	+\$24	+\$143	+\$502
42"	TSB42WS	\$876	+\$140	+\$24	+\$143	+\$502
48"	TSB48WS	\$926	+\$140	+\$24	+\$143	+\$502
:	:	:	:	:	:	:



For Canadian Pricing
 Multiply U.S. Price by the Canadian price factor.
 ▶ See page 1 for details.

Wood Beam Skins To The Floor

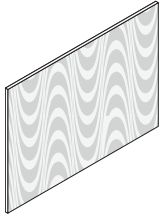

Tip: Remember to omit base trim(s) on horizontal frame package when using a beam skin to the floor.

Tip: Vertical grain cathedral direction will point up. The cathedral direction for horizontal grain is random.

Standard Includes	Required to Specify
-------------------	---------------------

<ul style="list-style-type: none"> ▶ Need help? Product details, page 42 	<ul style="list-style-type: none"> • 24⁷/₈"H skin: composite veneer group 1 • Vertical grain direction • Trim: paint • Attachment hardware 	<ol style="list-style-type: none"> 1 Style number 2 Composite veneer color for skin surface 3 Paint color number for trim 4 Options, if selected (see below) <p>▶ See <i>Surface Materials</i>, page 358.</p>
---	--	---

Options	U.S. Price	Required to Specify
---------	------------	---------------------

<p>Surface Materials</p> <ul style="list-style-type: none"> • Composite veneer group 1 • Composite veneer group 2 • Wood group 1 • Wood group 2 • Wood group 3 • Customiz stain 	<p>No cost</p> <p>Prices below</p> <p>Prices below</p> <p>Prices below</p> <p>No cost</p>	<p>Specify composite veneer color number.</p> <p>Specify composite veneer color number.</p> <p>Specify wood color number.</p> <p>Specify wood color number.</p> <p>Specify wood color number.</p> <p>Specify with <i>Customiz stain</i>.</p> <p>▶ See <i>Surface Materials Reference Manual</i>.</p>
<p>Grain direction</p> <ul style="list-style-type: none"> • Horizontal 		<p>No cost</p> <p>Specify with horizontal grain direction.</p>

Specification Information						
Width	Style Number	U.S. Base Price	Options (Add \$ to Base Price)			
:	:	:	Comp Ven 2	Wood 1	Wood 2	Wood 3

24"	TSB24WSF	\$768	+\$ 82	+\$19	+\$ 84	+\$301
30"	TSB30WSF	\$808	+\$ 82	+\$19	+\$ 84	+\$301
36"	TSB36WSF	\$862	+\$140	+\$24	+\$143	+\$502
42"	TSB42WSF	\$914	+\$140	+\$24	+\$143	+\$502
48"	TSB48WSF	\$963	+\$140	+\$24	+\$143	+\$502
:	:	:	:	:	:	:

For Canadian Pricing
Multiply U.S. Price by the Canadian price factor.
▶ See page 1 for details.

Specifying Answer Beam Power

Power

Beam Utility Pole—L, T, and X Junctions	200
Beam End-of-Run Junction with Utility Pole	201
Base Power Infeeds	202
Base Power Infeeds for Use in New York City	203
Powerkits	204
Pass-Through Powerkits	205
Cable Trays	206
Under Worksurface Cable Manager	207
Modular Harnesses	208
Hardwire Powerkits	209
Multipurpose Power Infeeds and Multipurpose Infeed Conduit Covers	210
Receptacle	211
USB Receptacle	212
Blank Cut-Out Cover	213
Receptacle Trim Ring	214
Faceplate	215
Fillers	216
Sleeves	217
Grommets	218

Beam Utility Pole–L, T, and X Junctions

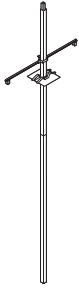

Tip: Order multipurpose power infeed separately. Page 210

Tip: Does not include junction. Junction is ordered separately.

Standard Includes		Required to Specify
-------------------	--	---------------------

- | | | |
|---|---|--|
| <ul style="list-style-type: none"> ▶ Need help? Product details, page 52 | <ul style="list-style-type: none"> • Utility pole and upright trim: paint price group 1 • Ceiling trim plate: white paint only • Mounting brackets | <ol style="list-style-type: none"> 1 Style number 2 Paint color number for utility pole and upright trim 3 Options, if selected (see below) <ul style="list-style-type: none"> ▶ See <i>Surface Materials</i>, page 358. |
|---|---|--|

Options	U.S. Price	Required to Specify
---------	------------	---------------------

Surface Materials <ul style="list-style-type: none"> • Paint price group 1 • Paint price group 2 • Paint price group 3 	No cost +\$17 +\$37	Specify paint color number. Specify paint color number. Specify paint color number.
--	---------------------------	---

Specification Information		
---------------------------	--	--

• Corresponding Beam Height	• Style Number	• U.S. Base Price
:	:	:
:	:	:

L Beam Utility Pole

28½"	TSB28LUP	\$292
:	:	:

T Beam Utility Pole

28½"	TSB28TUP	\$292
:	:	:

X Beam Utility Pole

28½"	TSB28XUP	\$292
:	:	:



For Canadian Pricing
 Multiply U.S. Price by the Canadian price factor.
 ▶ See page 1 for details.

Beam End-of-Run Junction with Utility Pole

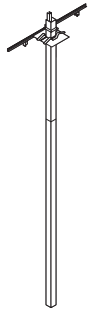

Tip: Order multipurpose power infeed separately.
▶ Page 210

Standard Includes		Required to Specify
▶ Need help? Product details, page 54	<ul style="list-style-type: none"> • Beam junction: black paint • Utility pole and upright trim: paint price group 1 • Ceiling trim plate: white paint only • Mounting brackets 	1 Style number 2 Paint color number for utility pole and upright trim 3 Options, if selected (see below) ▶ See <i>Surface Materials</i> , page 358.

Options	U.S. Price	Required to Specify
Surface Materials	<ul style="list-style-type: none"> • Paint price group 1 • Paint price group 2 • Paint price group 3 	No cost +\$17 +\$37
		Specify paint color number. Specify paint color number. Specify paint color number.

Specification Information		
Corresponding Beam Height	Style Number	U.S. Base Price
28½"	TSBERUP	\$644

Answer Beam Power

 **For Canadian Pricing**
 Multiply U.S. Price by the Canadian price factor.
 ▶ See page 1 for details.

Base Power Infeeds

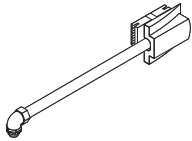

Tip: Power infeed occupies one receptacle location on powerkit.

Tip: Power infeed sits proud of the beam approximately 3" and will interfere with Universal storage with the Universal 3" base, FrameOne foot base, or c:scape glide.

Tip: Big open base beam segments cannot use base power infeed. Bring power in using a multipurpose infeed.

Standard Includes	Required to Specify
-------------------	---------------------

<ul style="list-style-type: none"> ▶ Need help? Product details, page 56 • Power infeed cover: plastic • 7/8"-diameter conduit: black plastic only 	<ol style="list-style-type: none"> 1 Style number 2 Plastic color number for power infeed cover: <ul style="list-style-type: none"> 6000 Black 6009 Arctic White 6249 Platinum Solid 6651 Tungsten 6652 Titanium 6654 Sand 6697 Fog 6B03 Red
---	---

Specification Information		
Length	Style Number	U.S. Price

:	:	:
:	:	:

4-Circuit, 3+1 Wiring Schematic

6'	TS76BPX	\$421
12'	TS712BPX	\$449

For Use in San Francisco

6'	TS76BPSFX	\$421
12'	TS712BPSFX	\$449
:	:	:

4-Circuit, 2+2 Wiring Schematic

6'	TS76BPY	\$421
12'	TS712BPY	\$449

For Use in San Francisco

6'	TS76BPSFY	\$421
12'	TS712BPSFY	\$449
:	:	:

3-Circuit, Separate Neutrals (3SN) Wiring Schematic

6'	TS76BPZ	\$421
12'	TS712BPZ	\$449

For Use in San Francisco

6'	TS76BPSFZ	\$421
12'	TS712BPSFZ	\$449
:	:	:



For Canadian Pricing
 Multiply U.S. Price by the Canadian price factor.
 ▶ See page 1 for details.

Base Power Infeeds for Use in New York City

Base Power Infeeds
for Use in New York City

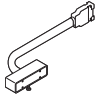

Tip: Power infeed sits proud of the beam approximately 3" and will interfere with Universal storage with the Universal 3" base, FrameOne foot base, or c:scape glide.

Standard Includes		Required to Specify
<ul style="list-style-type: none"> Need help? Product details, page 57 	<ul style="list-style-type: none"> Power infeed assembly 1/2"-diameter conduit Power infeed tray: black paint only Power infeed cover: black paint only 	Style number

Specification Information

			Non-PVC		
Corresponding Panel Width	Style Number	U.S. Price	Corresponding Panel Width	Style Number	U.S. Price
4-Circuit, 3+1 Wiring Schematic			4-Circuit, 3+1 Wiring Schematic		
24"	TS7BPNY24X	\$421	24"	TS7BPNY24XN	\$438
30"	TS7BPNY30X	\$421	30"	TS7BPNY30XN	\$438
36"	TS7BPNY36X	\$421	36"	TS7BPNY36XN	\$438
42"	TS7BPNY42X	\$421	42"	TS7BPNY42XN	\$438
48"	TS7BPNY48X	\$421	48"	TS7BPNY48XN	\$438
60"	TS7BPNY60X	\$421	60"	TS7BPNY60XN	\$438
72"	TS7BPNY72X	\$421	72"	TS7BPNY72XN	\$438
4-Circuit, 2+2 Wiring Schematic			4-Circuit, 2+2 Wiring Schematic		
24"	TS7BPNY24Y	\$421	24"	TS7BPNY24YN	\$438
30"	TS7BPNY30Y	\$421	30"	TS7BPNY30YN	\$438
36"	TS7BPNY36Y	\$421	36"	TS7BPNY36YN	\$438
42"	TS7BPNY42Y	\$421	42"	TS7BPNY42YN	\$438
48"	TS7BPNY48Y	\$421	48"	TS7BPNY48YN	\$438
60"	TS7BPNY60Y	\$421	60"	TS7BPNY60YN	\$438
72"	TS7BPNY72Y	\$421	72"	TS7BPNY72YN	\$438
3-Circuit, Separate Neutrals (3SN) Wiring Schematic			3-Circuit, Separate Neutrals (3SN) Wiring Schematic		
24"	TS7BPNY24Z	\$421	24"	TS7BPNY24ZN	\$438
30"	TS7BPNY30Z	\$421	30"	TS7BPNY30ZN	\$438
36"	TS7BPNY36Z	\$421	36"	TS7BPNY36ZN	\$438
42"	TS7BPNY42Z	\$421	42"	TS7BPNY42ZN	\$438
48"	TS7BPNY48Z	\$421	48"	TS7BPNY48ZN	\$438
60"	TS7BPNY60Z	\$421	60"	TS7BPNY60ZN	\$438
72"	TS7BPNY72Z	\$421	72"	TS7BPNY72ZN	\$438

 **For Canadian Pricing**
Multiply U.S. Price by the Canadian price factor.
▶ See page 1 for details.

Answer Beam Power

Powerkits

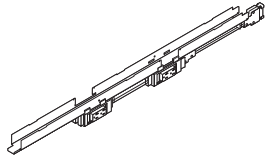

Tip: Remember to order receptacles and faceplates.
▶ Page 211

Standard Includes	Required to Specify
<ul style="list-style-type: none"> ▶ Need help? Product details, page 58 • Powerkit to accommodate modular duplex and USB receptacles on both sides: black plastic • Supporting power tray: black paint • Harness with modular connectors 	<ul style="list-style-type: none"> • Style number

Specification Information					
Powerkits				Non-PVC Powerkits	
Width	Number of Duplex Receptacles Per Side	Style Number	U.S. Price	Style Number	U.S. Price

4-Circuit, 3+1 Wiring Schematic

24"	1	TS7PK24X	\$338	TS7PK24XN	\$354
30"	2	TS7PK30X	\$338	TS7PK30XN	\$354
36"	2	TS7PK36X	\$338	TS7PK36XN	\$354
42"	2	TS7PK42X	\$338	TS7PK42XN	\$354
48"	2	TS7PK48X	\$338	TS7PK48XN	\$354
60"	4	TS7PK60X	\$510	TS7PK60XN	\$526
72"	4	TS7PK72X	\$510	TS7PK72XN	\$526

4-Circuit, 2+2 Wiring Schematic

24"	1	TS7PK24Y	\$338	TS7PK24YN	\$354
30"	2	TS7PK30Y	\$338	TS7PK30YN	\$354
36"	2	TS7PK36Y	\$338	TS7PK36YN	\$354
42"	2	TS7PK42Y	\$338	TS7PK42YN	\$354
48"	2	TS7PK48Y	\$338	TS7PK48YN	\$354
60"	4	TS7PK60Y	\$510	TS7PK60YN	\$526
72"	4	TS7PK72Y	\$510	TS7PK72YN	\$526

3-Circuit, Separate Neutrals (3SN) Wiring Schematic

24"	1	TS7PK24Z	\$338	TS7PK24ZN	\$354
30"	2	TS7PK30Z	\$338	TS7PK30ZN	\$354
36"	2	TS7PK36Z	\$338	TS7PK36ZN	\$354
42"	2	TS7PK42Z	\$338	TS7PK42ZN	\$354
48"	2	TS7PK48Z	\$338	TS7PK48ZN	\$354
60"	4	TS7PK60Z	\$510	TS7PK60ZN	\$526
72"	4	TS7PK72Z	\$510	TS7PK72ZN	\$526



For Canadian Pricing
Multiply U.S. Price by the Canadian price factor.
▶ See page 1 for details.

Pass-Through Powerkits

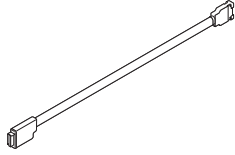

Standard Includes	Required to Specify
<ul style="list-style-type: none"> Need help? Product details, page 58 Powerkit to accommodate modular receptacles on both sides: black plastic Supporting power tray: black paint Harness with modular connectors 	Style number

Specification Information					
Pass-Through Powerkits				Non-PVC Pass-Through Powerkits	
Width	Number of Duplex Receptacles Per Side	Style Number	U.S. Price	Style Number	U.S. Price

4-Circuit, 3+1 Wiring Schematic

24"	0	TS7PT24X	\$271	TS7PT24XN	\$286
30"	0	TS7PT30X	\$271	TS7PT30XN	\$286
36"	0	TS7PT36X	\$271	TS7PT36XN	\$286
42"	0	TS7PT42X	\$271	TS7PT42XN	\$286
48"	0	TS7PT48X	\$271	TS7PT48XN	\$286
60"	0	TS7PT60X	\$303	TS7PT60XN	\$320
72"	0	TS7PT72X	\$303	TS7PT72XN	\$320
:	:	:	:	:	:

4-Circuit, 2+2 Wiring Schematic

24"	0	TS7PT24Y	\$271	TS7PT24YN	\$286
30"	0	TS7PT30Y	\$271	TS7PT30YN	\$286
36"	0	TS7PT36Y	\$271	TS7PT36YN	\$286
42"	0	TS7PT42Y	\$271	TS7PT42YN	\$286
48"	0	TS7PT48Y	\$271	TS7PT48YN	\$286
60"	0	TS7PT60Y	\$303	TS7PT60YN	\$320
72"	0	TS7PT72Y	\$303	TS7PT72YN	\$320
:	:	:	:	:	:

3-Circuit, Separate Neutrals (3SN) Wiring Schematic

24"	0	TS7PT24Z	\$271	TS7PT24ZN	\$286
30"	0	TS7PT30Z	\$271	TS7PT30ZN	\$286
36"	0	TS7PT36Z	\$271	TS7PT36ZN	\$286
42"	0	TS7PT42Z	\$271	TS7PT42ZN	\$286
48"	0	TS7PT48Z	\$271	TS7PT48ZN	\$286
60"	0	TS7PT60Z	\$303	TS7PT60ZN	\$320
72"	0	TS7PT72Z	\$303	TS7PT72ZN	\$320
:	:	:	:	:	:

For Canadian Pricing
 Multiply U.S. Price by the Canadian price factor.
 ▶ See page 1 for details.

Answer Beam Power

Cable Trays

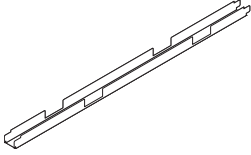

Tip: Cables may also be routed in top of powerkit.

Tip: One cable tray can be optioned at no cost when ordering base horizontal frame or panel packages.

Tip: Cable carriers can be added to 24"–72" wide trays.
 ▶ See *Montage Specification Guide* for style number **ZCC**.

Standard Includes	Required to Specify
-------------------	---------------------

- | | | |
|---------------------------------------|--------------------------------|--------------|
| ▶ Need help? Product details, page 58 | • Cable tray: black paint only | Style number |
|---------------------------------------|--------------------------------|--------------|

Specification Information			
• Dimensions	• Style	• U.S.	• Price
W	H	Number	Price

24"	2"	TS724CT	\$ 50
30"	2"	TS730CT	\$ 52
36"	2"	TS736CT	\$ 65
42"	2"	TS742CT	\$ 70
48"	2"	TS748CT	\$ 82
60"	2"	TS760CT	\$ 92
72"	2"	TS772CT	\$113



For Canadian Pricing
 Multiply U.S. Price by the Canadian price factor.
 ▶ See page 1 for details.

Under Worksurface Cable Manager

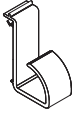

Standard Includes	Required to Specify
-------------------	---------------------

- | | |
|---|--------------------------------------|
| ▶ Need help?
Product details,
page 65 | • Cable manager: 6249 Platinum Solid |
|---|--------------------------------------|

Style number

Specification Information	
• Style • Number	• U.S. • Price

• Style • Number	• U.S. • Price
TSBUWCM	\$5

Answer Beam
Power



For Canadian Pricing

Multiply U.S. Price by the Canadian price factor.

▶ See page 1 for details.

Modular Harnesses

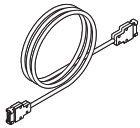

Standard Includes		Required to Specify
▶ Need help? Product details, page 60	• Conduit with two modular connectors: black	Style number

Specification Information

			Non-PVC		
• Length	• Style • Number	• U.S. • Price	• Length	• Style • Number	• U.S. • Price
4-Circuit, 3+1 Wiring Schematic			4-Circuit, 3+1 Wiring Schematic		
43"	TS743MHX	\$245	43"	TS743MHXN	\$263
80"	TS780MHX	\$325	80"	TS780MHXN	\$377
:	:	:	:	:	:
4-Circuit, 2+2 Wiring Schematic			4-Circuit, 2+2 Wiring Schematic		
43"	TS743MHY	\$245	43"	TS743MHYN	\$263
80"	TS780MHY	\$325	80"	TS780MHYN	\$377
:	:	:	:	:	:
3-Circuit, Separate Neutrals (3SN) Wiring Schematic			3-Circuit, Separate Neutrals (3SN) Wiring Schematic		
43"	TS743MHZ	\$245	43"	TS743MHZN	\$263
80"	TS780MHZ	\$325	80"	TS780MHZN	\$377
:	:	:	:	:	:

 **For Canadian Pricing**
 Multiply U.S. Price by the
 Canadian price factor.
 ▶ See page 1 for details.

Hardwire Powerkits

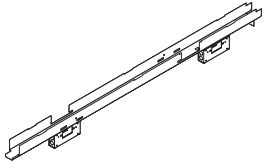

Tip: Specify hardwire base trims when accessing a hardwire powerkit in the base.

Standard Includes	Required to Specify
<ul style="list-style-type: none"> ▶ Need help? Product details, page 61 • Power tray • Junction box(es) • Cover plate(s) 	Style number

Specification Information			
Corresponding Panel Width	Number of Junction Boxes	Style Number	U.S. Price
24"	1	TS7CPK24	\$162
30"	2	TS7CPK30	\$162
36"	2	TS7CPK36	\$162
42"	2	TS7CPK42	\$162
48"	2	TS7CPK48	\$162
60"	2	TS7CPK60	\$205
72"	2	TS7CPK72	\$205
.	.	.	.



For Canadian Pricing
 Multiply U.S. Price by the Canadian price factor.
 ▶ See page 1 for details.

Multipurpose Power Infeeds and Multipurpose Infeed Conduit Covers

Multipurpose Power Infeed

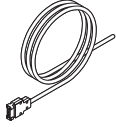

Tip: Utility poles must be specified separately.
 ▶ Page 200

Standard Includes		Required to Specify
▶ Need help? Product details, page 60	<ul style="list-style-type: none"> Multipurpose power infeed with modular connector Insulated color-coded wires for hardwired connection to building power source 	Style number

Specification Information

Length	Style Number	U.S. Price
--------	--------------	------------

4-Circuit, 3+1 Wiring Schematic

6'	TS76UPHX	\$426
12'	TS712UPHX	\$549
24'	TS724UPHX	\$797

4-Circuit, 2+2 Wiring Schematic

6'	TS76UPHY	\$426
12'	TS712UPHY	\$549
24'	TS724UPHY	\$797

3-Circuit, Separate Neutrals (3SN) Wiring Schematic

6'	TS76UPHZ	\$426
12'	TS712UPHZ	\$549
24'	TS724UPHZ	\$797

Non-PVC

Length	Style Number	U.S. Price
--------	--------------	------------

4-Circuit, 3+1 Wiring Schematic

6'	TS76UPHXN	\$426
12'	TS712UPHXN	\$565
24'	TS724UPHXN	\$819

4-Circuit, 2+2 Wiring Schematic

6'	TS76UPHYN	\$426
12'	TS712UPHYN	\$565
24'	TS724UPHYN	\$819

3-Circuit, Separate Neutrals (3SN) Wiring Schematic

6'	TS76UPHZN	\$426
12'	TS712UPHZN	\$565
24'	TS724UPHZN	\$819

Multipurpose Infeed Conduit Covers

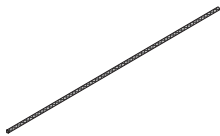

Standard Includes		Required to Specify
▶ Need help? Product details, page 60	<ul style="list-style-type: none"> Power infeed cover: black fabric Cover for 1/2" conduit: black fabric 	Style number

Specification Information

Length	Style Number	U.S. Price
--------	--------------	------------

6'	TS7BFCC6	\$ 96
12'	TS7BFCC12	\$197
24'	TS7BFCC24	\$395



For Canadian Pricing
 Multiply U.S. Price by the Canadian price factor.
 ▶ See page 1 for details.

Receptacle

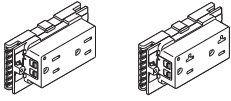

15 amp

20 amp

Tip: For steel beam skins, receptacle trim ring required for each power cutout location specified (ordered separately).

Tip: For field cut fabric skins, a faceplate is required (ordered separately).

Standard Includes	Required to Specify
-------------------	---------------------

<ul style="list-style-type: none"> ▶ Need help? Product details, page 62 • Receptacle: plastic 	<ol style="list-style-type: none"> 1 Style number 2 Plastic color number for receptacle 3 Wiring schematic (see below under Required Selections) 4 Line (see below under Required Selections) 5 Ground type (see below under Required Selections) 6 Amp type (see below under Required Selections) 7 Options, if selected (see below) <p>▶ See <i>Surface Materials</i>, page 358.</p>
--	---

Required Selections	U.S. Price	Required to Specify
---------------------	------------	---------------------

Wiring Schematic <ul style="list-style-type: none"> • 3+1 • 2+2 • 3SN 	<ul style="list-style-type: none"> No cost No cost No cost 	<ul style="list-style-type: none"> Specify <i>with 3+1.</i> Specify <i>with 2+2.</i> Specify <i>with 3SN.</i>
Line <ul style="list-style-type: none"> • Line 1 • Line 2 • Line 3 • Line 4 	<ul style="list-style-type: none"> No cost No cost No cost No cost 	<ul style="list-style-type: none"> Specify <i>with line 1.</i> Specify <i>with line 2.</i> Specify <i>with line 3.</i> Specify <i>with line 4.</i>
Ground Type <ul style="list-style-type: none"> • System • Isolated 	<ul style="list-style-type: none"> No cost No cost 	<ul style="list-style-type: none"> Specify <i>with system ground.</i> Specify <i>with isolated ground.</i>
Amp Type <ul style="list-style-type: none"> • 15 amp • 20 amp 	<ul style="list-style-type: none"> No cost +\$38 	<ul style="list-style-type: none"> Specify <i>with 15 amp.</i> Specify <i>with 20 amp.</i>

Options	U.S. Price	Required to Specify
---------	------------	---------------------

Controlled Stamp <ul style="list-style-type: none"> • No stamp • Controlled stamp 	<ul style="list-style-type: none"> No cost +\$ 5 	<ul style="list-style-type: none"> Specify <i>with no stamp.</i> Specify <i>with controlled stamp.</i>
--	--	--

Specification Information	
Style Number	U.S. Base Price

TS7RC	\$69
--------------	------



For Canadian Pricing

Multiply U.S. Price by the Canadian price factor.

▶ See page 1 for details.

USB Receptacle



Tip: For steel beam skins, receptacle trim ring required for each power cutout location specified. (ordered separately).

Tip: For field cut fabric skins, a faceplate is required (ordered separately).

Standard Includes	Required to Specify
-------------------	---------------------

<ul style="list-style-type: none"> ▶ Need help? Product details, page 62 • USB receptacle: plastic 	<ol style="list-style-type: none"> 1 Style number 2 Plastic color number for receptacle 3 Wiring schematic (see below under Required Selections) 4 Line (see below under Required Selections) <ul style="list-style-type: none"> ▶ See <i>Surface Materials</i>, page 358.
--	---

Required Selections	U.S. Price	Required to Specify
---------------------	------------	---------------------

Wiring Schematic <ul style="list-style-type: none"> • 3+1 • 2+2 • 3SN 	No cost No cost No cost	Specify <i>with 3+1</i> . Specify <i>with 2+2</i> . Specify <i>with 3SN</i> .
Line <ul style="list-style-type: none"> • Line 1 • Line 2 • Line 3 • Line 4 (Available in 3+1 and 2+2 only) 	No cost No cost No cost No cost	Specify <i>with line 1</i> . Specify <i>with line 2</i> . Specify <i>with line 3</i> . Specify <i>with line 4</i> .

Specification Information	
Style Number	U.S. Price

Style Number	U.S. Price
TS7USB	\$162



For Canadian Pricing

Multiply U.S. Price by the Canadian price factor.

▶ See page 1 for details.

Blank Cut-Out Cover

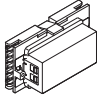

Tip: For steel beam skins, receptacle trim ring required for each power cutout location specified (ordered separately).

Standard Includes		Required to Specify
<ul style="list-style-type: none"> ▶ Need help? Product details, page 62 	<ul style="list-style-type: none"> • Cut-out cover: plastic 	<ol style="list-style-type: none"> 1 Style number 2 Plastic color number for cut-out cover 3 Wiring schematic, if selected (see below under Required Selections) <ul style="list-style-type: none"> ▶ See <i>Surface Materials</i>, page 358.

	Required Selections	U.S. Price	Required to Specify
Wiring Schematic	<ul style="list-style-type: none"> • 3+1 • 2+2 • 3SN 	<p>No cost</p> <p>No cost</p> <p>No cost</p>	<p>Specify <i>with 3+1.</i></p> <p>Specify <i>with 2+2.</i></p> <p>Specify <i>with 3SN.</i></p>

Specification Information	
Style Number	U.S. Price
TSFBCC	\$13

Answer Beam Power

 **For Canadian Pricing**
 Multiply U.S. Price by the Canadian price factor.
 ▶ See page 1 for details.

Receptacle Trim Ring



Tip: Receptacle trim ring required for each power cut-out location on steel beam skins.

Standard Includes		Required to Specify
▶ Need help? Product details, page 63	• Receptacle trim ring: plastic	1 Style number 2 Plastic color number for receptacle trim ring ▶ See <i>Surface Materials</i> , page 358.

Specification Information	
• Style Number	• U.S. Price
TS7RCT	\$17
:	:



For Canadian Pricing
 Multiply U.S. Price by the Canadian price factor.
 ▶ See page 1 for details.

Faceplate

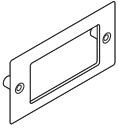

Tip: Specify faceplate when accessing power by field cutting fabric beam skins.

Standard Includes		Required to Specify
<ul style="list-style-type: none"> ▶ Need help? Product details, page 63 	<ul style="list-style-type: none"> • One faceplate: plastic • Ordered individually 	<ul style="list-style-type: none"> 1 Style number 2 Plastic color number for faceplate: <ul style="list-style-type: none"> 6000 Black 6009 Arctic White 6249 Platinum Solid 6651 Tungsten 6652 Titanium 6654 Sand 6697 Fog 6B03 Red

Specification Information

• Style Number	• U.S. Price

Faceplate for Duplex Receptacle and Communications

TS7UFPLATE	\$5



For Canadian Pricing

Multiply U.S. Price by the Canadian price factor.

▶ See page 1 for details.

Fillers

Beam Receptacle Filler



Tip: Beam receptacle filler package fills unused receptacle openings.

Standard Includes	Required to Specify
-------------------	---------------------

- | | | |
|---|---|--|
| <ul style="list-style-type: none"> ▶ Need help? Product details, page 63 | <ul style="list-style-type: none"> • Package of 20 receptacle fillers: plastic | <ul style="list-style-type: none"> 1 Style number 2 Plastic color number for receptacle fillers ▶ See <i>Surface Materials</i>, page 358. |
|---|---|--|

Specification Information	
---------------------------	--

Style Number	U.S. Price
TSBRF	\$148

Data Filler



Tip: Data filler package fills unused data openings.

Standard Includes	Required to Specify
-------------------	---------------------

- | | | |
|---|---|--|
| <ul style="list-style-type: none"> ▶ Need help? Product details, page 63 | <ul style="list-style-type: none"> • Package of 20 data fillers: plastic | <ul style="list-style-type: none"> 1 Style number 2 Plastic color number for data fillers ▶ See <i>Surface Materials</i>, page 358. |
|---|---|--|

Specification Information	
---------------------------	--

Style Number	U.S. Price
TS7DF	\$121



For Canadian Pricing

Multiply U.S. Price by the Canadian price factor.

▶ See page 1 for details.

Junction Tall Sleeves

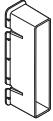

Standard Includes	Required to Specify
-------------------	---------------------

- | | | |
|---|--|--|
| <ul style="list-style-type: none"> ▶ Need help? Product details, page 64 | <ul style="list-style-type: none"> • Package of ten sleeves: red only | <ul style="list-style-type: none"> Style number |
|---|--|--|

Specification Information	
Style Number	U.S. Price

TS7JTSLVE	\$116
-----------	-------

Feed-Through Horizontal Cable Sleeves



Standard Includes	Required to Specify
-------------------	---------------------

- | | | |
|---|--|--|
| <ul style="list-style-type: none"> ▶ Need help? Product details, page 64 | <ul style="list-style-type: none"> • Package of 25 sleeves: black plastic | <ul style="list-style-type: none"> Style number |
|---|--|--|

Specification Information	
Style Number	U.S. Price

TS7FSLVE	\$162
----------	-------



For Canadian Pricing
 Multiply U.S. Price by the Canadian price factor.
 ▶ See page 1 for details.

Grommets

Grommets for Vertical Junctions (manufactured prior to October 2011) and Horizontal Connecting Bars

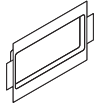

Tip: Grommets can be used on power trays and cable trays.

Standard Includes	Required to Specify
-------------------	---------------------

- | | | |
|---|---|--|
| <ul style="list-style-type: none"> ▶ Need help? Product details, page 64 | <ul style="list-style-type: none"> • Package of 25 grommets: black plastic | <ul style="list-style-type: none"> Style number |
|---|---|--|

Specification Information	
---------------------------	--

• Style Number	• U.S. Price
TS7HSLVE	\$166
·	·

Grommets for Junction



Standard Includes	Required to Specify
-------------------	---------------------

- | | | |
|---|--|--|
| <ul style="list-style-type: none"> ▶ Need help? Product details, page 65 | <ul style="list-style-type: none"> • Package of 25 grommets: black plastic only | <ul style="list-style-type: none"> Style number |
|---|--|--|

Specification Information	
---------------------------	--

• Style Number	• U.S. Price
TS7JSLVE	\$166
·	·

Duplex Cable Grommet

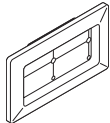

Standard Includes	Required to Specify
-------------------	---------------------

- | | | |
|---|--|--|
| <ul style="list-style-type: none"> ▶ Need help? Product details, page 65 | <ul style="list-style-type: none"> • Carton of five cable grommets: plastic | <ul style="list-style-type: none"> 1 Style number 2 Plastic color number for grommets ▶ See <i>Surface Materials</i>, page 358. |
|---|--|--|

Specification Information	
---------------------------	--

• Style Number	• U.S. Price
98863	\$52
·	·



For Canadian Pricing
 Multiply U.S. Price by the Canadian price factor.
 ▶ See page 1 for details.

Specifying Boundary, Worksurface, and Beam Screens

End-of-Run Straight Boundary Screens	
Single-Sided Boundary Screens	220
Spanning Boundary Screens	220
Split Boundary Screens	220
End-of-Run L Return Boundary Screens	
L Return Single-Sided Boundary Screens	224
L Return Split Boundary Screens	224
On-Module In-Line Boundary Screens	
On-Module T Boundary Screens	232
On-Module X Boundary Screens	232
On-Module In-Line Boundary Screen Junction	235
Centered In-Line Boundary Screens	236
Worksurface and Beam Screens	
Universal Beam Screens and Aligners	238
Universal Privacy/Modesty Screens	240
Universal Privacy Screens	242
Sarto Beam Screens	244
Sarto Privacy/Modesty Screens	246
Sarto Privacy Screens	248
Sarto Alignment Bracket	250
Divisio Side Screen	251

Answer Beam End-of-Run Boundary Screens

Straight

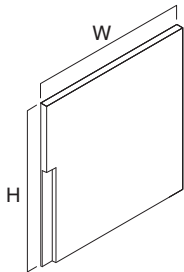

Standard Includes		Required to Specify
<ul style="list-style-type: none"> ▶ Need help? Product details, page 76 	<ul style="list-style-type: none"> Screen: High-Pressure Laminate price group 1 or composite veneer price group 1 Edge on laminate screen, if selected: plastic Height: 28½"H, 42"H, or 48"H Width: <ul style="list-style-type: none"> – Single-sided: 27"W–75"W – Spanning: 51"W–75"W – Split left and right: 25½"W–73½"W Connecting panel cover: paint price group 1 1½" adjustable glides Attachment hardware 	<ol style="list-style-type: none"> Style number Screen size type (see below under Required Selections) Screen height(s) Screen width(s) Handedness: on single-sided screens, if selected (see below under Required Selections) High-Pressure Laminate or composite veneer color for screen Plastic color number for edge on laminate screen, if selected Grain direction Paint color number for connecting panel cover Options, if selected (see below) <p>▶ See <i>Surface Materials</i>, page 358.</p>

Tip: Additional hardware upcharge is applied only when split style number is specified.

Tip: When specifying a beam end-of-run boundary screen, order an end-of-run junction with the omit trim option.

Tip: When specifying a split boundary screen, two screen widths will need to be specified.

Tip: When specifying the paint finish for the bracket cover, select a finish that compliments the selected laminate or veneer finish.

For laminate price group 2 and group 3 pricing, please refer to the electronic catalog or SmartTools.

Required Component		U.S. Price	
Additional Hardware	<ul style="list-style-type: none"> Split left and right 	+\$ 31	

	Required Selections	U.S. Price	Required to Specify
Screen Size Type	<ul style="list-style-type: none"> Modular Parametric 	No cost No cost	Specify <i>with modular</i> . Specify <i>with parametric</i> .
Handedness (Single-Sided Screens Only)	<ul style="list-style-type: none"> Right handed Left handed 	No cost No cost	Specify <i>with single-sided right</i> . Specify <i>with single-sided left</i> .

	Options	U.S. Price	Required to Specify
Surface Materials	Screen		
	<ul style="list-style-type: none"> Laminate price group 2 Laminate price group 3 Open Line laminate 	See information at left See information at left +\$220 plus cost of laminate	Specify laminate color number. Specify laminate color number. ▶ See <i>Surface Materials Reference Manual</i> .
	<ul style="list-style-type: none"> Composite veneer group 1 Composite veneer group 2 Wood group 1 Wood group 2 Wood group 3 Customiz stain 	Prices at right +\$215 Prices at right +\$236 +\$827 No cost	Specify composite veneer color number. Specify composite veneer color number. Specify wood color number. Specify wood color number. Specify wood color number. Specify <i>with Customiz stain</i> .
	Connecting panel cover		
	<ul style="list-style-type: none"> Paint price group 2 Paint price group 3 	+\$ 17 +\$ 37	Specify paint color number. Specify paint color number.
	Laminate wood grain direction		
	<ul style="list-style-type: none"> No direction Horizontal Vertical 	No cost No cost No cost	Specify <i>with no direction</i> . Specify <i>with horizontal grain direction</i> . Specify <i>with vertical grain direction</i> .
	Wood veneer grain direction		
	<ul style="list-style-type: none"> No direction Horizontal Vertical 	No cost No cost No cost	Specify <i>with no direction</i> . Specify <i>with horizontal grain direction</i> . Specify <i>with vertical grain direction</i> .



For Canadian Pricing

Multiply U.S. Price by the Canadian price factor.

▶ See page 1 for details.

Specification Information

• Style Number	• Dimensions H	• Screen Type • Modular Width	• U.S. Base Prices								
			• 27"W	• 33"W	• 39"W	• 45"W	• 51"W	• 57"W	• 63"W	• 69"W	• 75"W
		• Parametric Width	• 27"W – 32 ¹⁵ / ₁₆ "W	• 33"W – 38 ¹⁵ / ₁₆ "W	• 39"W – 44 ¹⁵ / ₁₆ "W	• 45"W – 50 ¹⁵ / ₁₆ "W	• 51"W – 56 ¹⁵ / ₁₆ "W	• 57"W – 62 ¹⁵ / ₁₆ "W	• 63"W – 68 ¹⁵ / ₁₆ "W	• 69"W – 74 ¹⁵ / ₁₆ "W	• 75"W

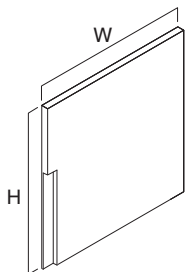

Boundary, Worksurface, and Beam Screens

Beam End-of-Run Straight Boundary Screens—Single Sided

High-Pressure Laminate

TSBSCSSD	28 ¹ / ₂ "H	\$ 774	\$ 923	\$ 1076	\$ 1226	\$ 1379	\$ 1530	\$ 1683	\$ 1833	\$ 1984
	42"H	\$ 804	\$ 985	\$ 1166	\$ 1346	\$ 1530	\$ 1711	\$ 1892	\$ 2075	\$ 2259
	48"H	\$ 819	\$ 1015	\$ 1213	\$ 1408	\$ 1606	\$ 1803	\$ 2000	\$ 2195	\$ 2395

Composite Veneer

TSBSCSSD	28 ¹ / ₂ "H	\$ 1046	\$ 1318	\$ 1592	\$ 1862	\$ 2136	\$ 2409	\$ 2683	\$ 2957	\$ 3228
	42"H	\$ 1227	\$ 1545	\$ 1863	\$ 2181	\$ 2498	\$ 2816	\$ 3136	\$ 3454	\$ 3775
	48"H	\$ 1319	\$ 1659	\$ 2000	\$ 2340	\$ 2682	\$ 3023	\$ 3364	\$ 3703	\$ 4046

Wood Veneer

TSBSCSSD	28 ¹ / ₂ "H	\$ 1074	\$ 1357	\$ 1644	\$ 1925	\$ 2212	\$ 2496	\$ 2783	\$ 3069	\$ 3352
	42"H	\$ 1269	\$ 1601	\$ 1933	\$ 2264	\$ 2596	\$ 2926	\$ 3260	\$ 3592	\$ 3927
	48"H	\$ 1369	\$ 1723	\$ 2079	\$ 2432	\$ 2790	\$ 3145	\$ 3500	\$ 3853	\$ 4212

► Specification Information, continued on next page



For Canadian Pricing

Multiply U.S. Price by the Canadian price factor.

► See page 1 for details.

Answer Beam End-of-Run Boundary Screens, Straight, continued

► Specification Information, continued from previous page

Specification Information											
Style Number	Dimensions H	Screen Type	U.S. Base Prices								
			Modular Width	27"W	33"W	39"W	45"W	51"W	57"W	63"W	69"W
		Parametric Width	27"W-	33"W-	39"W-	45"W-	51"W-	57"W-	63"W-	69"W-	75"W
		Width	32 ¹⁵ / ₁₆ "W	38 ¹⁵ / ₁₆ "W	44 ¹⁵ / ₁₆ "W	50 ¹⁵ / ₁₆ "W	56 ¹⁵ / ₁₆ "W	62 ¹⁵ / ₁₆ "W	68 ¹⁵ / ₁₆ "W	74 ¹⁵ / ₁₆ "W	

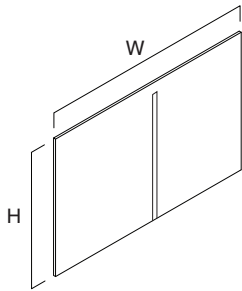

Beam End-of-Run Straight Boundary Screens—Spanning

High-Pressure Laminate

TSBSCSPN	Dimensions H	27"W	33"W	39"W	45"W	51"W	57"W	63"W	69"W	75"W
	28 ¹ / ₂ "H	N.A.	N.A.	N.A.	N.A.	\$1379	\$1530	\$1683	\$1833	\$1984
	42"H	N.A.	N.A.	N.A.	N.A.	\$1530	\$1711	\$1892	\$2075	\$2259
	48"H	N.A.	N.A.	N.A.	N.A.	\$1606	\$1803	\$2000	\$2195	\$2395

Composite Veneer

TSBSCSPN	Dimensions H	27"W	33"W	39"W	45"W	51"W	57"W	63"W	69"W	75"W
	28 ¹ / ₂ "H	N.A.	N.A.	N.A.	N.A.	\$2136	\$2409	\$2683	\$2957	\$3228
	42"H	N.A.	N.A.	N.A.	N.A.	\$2498	\$2816	\$3136	\$3454	\$3775
	48"H	N.A.	N.A.	N.A.	N.A.	\$2682	\$3023	\$3364	\$3703	\$4046

Wood Veneer

TSBSCSPN	Dimensions H	27"W	33"W	39"W	45"W	51"W	57"W	63"W	69"W	75"W
	28 ¹ / ₂ "H	N.A.	N.A.	N.A.	N.A.	\$2212	\$2496	\$2783	\$3069	\$3352
	42"H	N.A.	N.A.	N.A.	N.A.	\$2596	\$2926	\$3260	\$3592	\$3927
	48"H	N.A.	N.A.	N.A.	N.A.	\$2790	\$3145	\$3500	\$3853	\$4212

► Specification Information, continued on next page

 **For Canadian Pricing**
 Multiply U.S. Price by the Canadian price factor.
 ► See page 1 for details.

► Specification Information, continued from previous page

Specification Information											
Style Number	Dimensions H	Screen Type	U.S. Base Prices								
			Modular Width	25½"W	31½"W	37½"W	43½"W	49½"W	55½"W	61½"W	67½"W
		Parametric Width	25½"W-317/16"W	31½"W-377/16"W	37½"W-437/16"W	43½"W-497/16"W	49½"W-557/16"W	55½"W-617/16"W	61½"W-677/16"W	67½"W-737/16"W	73½"W

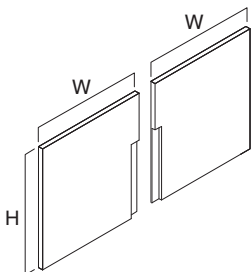

Beam End-of-Run Straight Boundary Screens—Split

High-Pressure Laminate

TSBSCSPT	28½"H	\$ 774	\$ 923	\$ 1076	\$ 1226	\$ 1379	\$ 1530	\$ 1683	\$ 1833	\$ 1984
	42"H	\$ 804	\$ 985	\$ 1166	\$ 1346	\$ 1530	\$ 1711	\$ 1892	\$ 2075	\$ 2259
	48"H	\$ 819	\$ 1015	\$ 1213	\$ 1408	\$ 1606	\$ 1803	\$ 2000	\$ 2195	\$ 2395

Composite Veneer

TSBSCSPT	28½"H	\$ 1046	\$ 1318	\$ 1592	\$ 1862	\$ 2136	\$ 2409	\$ 2683	\$ 2957	\$ 3228
	42"H	\$ 1227	\$ 1545	\$ 1863	\$ 2181	\$ 2498	\$ 2816	\$ 3136	\$ 3454	\$ 3775
	48"H	\$ 1319	\$ 1659	\$ 2000	\$ 2340	\$ 2682	\$ 3023	\$ 3364	\$ 3703	\$ 4046

Wood Veneer

TSBSCSPT	28½"H	\$ 1074	\$ 1357	\$ 1644	\$ 1925	\$ 2212	\$ 2496	\$ 2783	\$ 3069	\$ 3352
	42"H	\$ 1269	\$ 1601	\$ 1933	\$ 2264	\$ 2596	\$ 2926	\$ 3260	\$ 3592	\$ 3927
	48"H	\$ 1369	\$ 1723	\$ 2079	\$ 2432	\$ 2790	\$ 3145	\$ 3500	\$ 3853	\$ 4212

Tip: When specifying a split boundary screen, two screen widths need to be specified. The final price will include the price of both individual screen segments.



For Canadian Pricing

Multiply U.S. Price by the Canadian price factor.

► See page 1 for details.

Answer Beam End-of-Run Boundary Screens

L Return

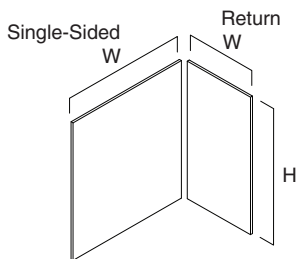

Standard Includes		Required to Specify
<ul style="list-style-type: none"> ▶ Need help? Product details, page 76 Primary and return screen: High-Pressure Laminate price group 1 or composite veneer price group 1 Edge on laminate screen: plastic, if selected Height: 28½"H, 42"H, or 48"H Width: <ul style="list-style-type: none"> – Single-sided: 27"W–75"W – Split left and right: 25½"W–73½"W Connecting panel cover: paint price group 1 1½" adjustable glides Attachment hardware 	<ol style="list-style-type: none"> Style number Screen size type (see below under Required Selections) Screen height(s) Screen width(s) Handedness: on single-sided screens, if selected (see below under Required Selections) High-Pressure Laminate or composite veneer color for screen Plastic color number for edge on laminate screen, if selected Grain direction Paint color number for connecting panel cover Options, if selected (see below) 	
		▶ See <i>Surface Materials</i> , page 358.

Required Component	U.S. Price
Additional Hardware	
• Single-connect single-sided L return	+\$ 61
• Single-connect split L return	+\$ 91

Tip: When specifying a beam end-of-run boundary screen, order an end-of-run junction with the omit trim option.

Tip: When specifying the paint finish for the bracket cover, select a finish that compliments the selected laminate or veneer finish.

For laminate price group 2 and group 3 pricing, please refer to the electronic catalog or SmartTools.

Tip: When specifying a split L return boundary screen, four screen widths will need to be specified.

Required Selections	U.S. Price	Required to Specify
Screen Size Type		
• Modular	No cost	Specify <i>with modular</i> .
• Parametric	No cost	Specify <i>with parametric</i> .
Handedness (Single-Sided Screens Only)		
• Right handed	No cost	Specify <i>with single-sided right</i> .
• Left handed	No cost	Specify <i>with single-sided left</i> .

Options	U.S. Price	Required to Specify
Surface Materials		
Screen		
• Laminate price group 2	See information at left	Specify laminate color number.
• Laminate price group 3	See information at left	Specify laminate color number.
• Open Line laminate	+\$220 plus cost of laminate	▶ See <i>Surface Materials Reference Manual</i> .
• Composite veneer group 1	Prices at right	Specify composite veneer color number.
• Composite veneer group 2	+\$215	Specify composite veneer color number.
• Wood group 1	Prices at right	Specify wood color number.
• Wood group 2	+\$236	Specify wood color number.
• Wood group 3	+\$827	Specify wood color number.
• Customiz stain	No cost	Specify <i>with Customiz stain</i> .
Connecting panel cover		
• Paint price group 2	+\$ 17	Specify paint color number.
• Paint price group 3	+\$ 37	Specify paint color number.
Laminate wood grain direction		
• No direction	No cost	Specify <i>with no direction</i> .
• Horizontal	No cost	Specify <i>with horizontal grain direction</i> .
• Vertical	No cost	Specify <i>with vertical grain direction</i> .
Wood veneer grain direction		
• No direction	No cost	Specify <i>with no direction</i> .
• Horizontal	No cost	Specify <i>with horizontal grain direction</i> .
• Vertical	No cost	Specify <i>with vertical grain direction</i> .



For Canadian Pricing

Multiply U.S. Price by the Canadian price factor.

▶ See page 1 for details.

Specification Information

• Style Number	• Dimensions H	• Screen Type	• U.S. Base Prices								
			• Modular Width	• Parametric Width	27"W	33"W	39"W	45"W	51"W	57"W	63"W
		• Parametric Width	27"W – 32 ¹ / ₁₆ "W	33"W – 38 ¹ / ₁₆ "W	39"W – 44 ¹ / ₁₆ "W	45"W – 50 ¹ / ₁₆ "W	51"W – 56 ¹ / ₁₆ "W	57"W – 62 ¹ / ₁₆ "W	63"W – 68 ¹ / ₁₆ "W	69"W – 74 ¹ / ₁₆ "W	75"W

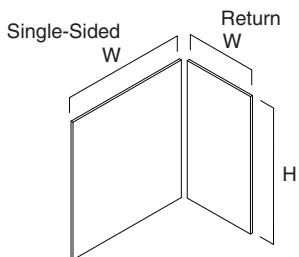

Beam End-of-Run L Return Boundary Screens—Single Sided

High-Pressure Laminate — Primary Screen

TSBSCLSSD	Dimensions H	18"W	24"W	30"W	36"W	42"W	48"W	54"W	60"W	66"W	72"W
	28 ¹ / ₂ "H	\$774	\$ 923	\$1076	\$1226	\$1379	\$1530	\$1683	\$1833	\$1984	
	42"H	\$804	\$ 985	\$1166	\$1346	\$1530	\$1711	\$1892	\$2075	\$2259	
	48"H	\$819	\$1015	\$1213	\$1408	\$1606	\$1803	\$2000	\$2195	\$2395	

• Style Number	• Dimensions H	• Screen Type	• U.S. Base Prices		
			• Modular Width	• Parametric Width	• U.S. Base Prices
		• Parametric Width	18"W – 23 ¹ / ₁₆ "W	24"W – 29 ¹ / ₁₆ "W	30"W

High-Pressure Laminate — Return Screen

TSBSCLSSD	Dimensions H	18"W	24"W	30"W
	28 ¹ / ₂ "H	+\$697	+\$774	+\$ 923
	42"H	+\$713	+\$804	+\$ 985
	48"H	+\$720	+\$819	+\$1015

Tip: When specifying an L return boundary screen, primary and return screen widths need to be specified. The final price will include the price of both individual screen segments.

► **Specification Information, continued on next page**



For Canadian Pricing

Multiply U.S. Price by the Canadian price factor.

► See page 1 for details.

Answer Beam End-of-Run Boundary Screens, L Return, continued

► Specification Information, continued from previous page

Specification Information											
• Style Number	• Dimensions H	• Screen Type	• U.S. Base Prices								
			• Modular Width	27"W	33"W	39"W	45"W	51"W	57"W	63"W	69"W
		• Parametric Width	27"W – 32 ¹⁵ / ₁₆ "W	33"W – 38 ¹⁵ / ₁₆ "W	39"W – 44 ¹⁵ / ₁₆ "W	45"W – 50 ¹⁵ / ₁₆ "W	51"W – 56 ¹⁵ / ₁₆ "W	57"W – 62 ¹⁵ / ₁₆ "W	63"W – 68 ¹⁵ / ₁₆ "W	69"W – 74 ¹⁵ / ₁₆ "W	75"W

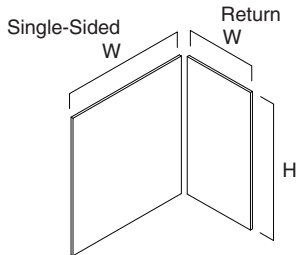

Beam End-of-Run L Return Boundary Screens—Single Sided

Composite Veneer — Primary Screen

TSBSCLSSD	Dimensions H	18"W	24"W	30"W	36"W	42"W	48"W	54"W	60"W	66"W
	28 ¹ / ₂ "H	\$1046	\$1318	\$1592	\$1862	\$2136	\$2409	\$2683	\$2957	\$3228
	42"H	\$1227	\$1545	\$1863	\$2181	\$2498	\$2816	\$3136	\$3454	\$3775
	48"H	\$1319	\$1659	\$2000	\$2340	\$2682	\$3023	\$3364	\$3703	\$4046

• Style Number	• Dimensions H	• Screen Type	• U.S. Base Prices		
			• Modular Width	18"W	24"W
		• Parametric Width	18"W – 23 ¹⁵ / ₁₆ "W	24"W – 29 ¹⁵ / ₁₆ "W	30"W

Composite Veneer — Return Screen

TSBSCLSSD	Dimensions H	18"W	24"W	30"W
	28 ¹ / ₂ "H	+\$ 931	+\$1074	+\$1357
	42"H	+\$1105	+\$1269	+\$1601
	48"H	+\$1194	+\$1369	+\$1723

Tip: When specifying an L return boundary screen, primary and return screen widths need to be specified. The final price will include the price of both individual screen segments.

► Specification Information, continued on next page

 **For Canadian Pricing**
 Multiply U.S. Price by the Canadian price factor.
 ► See page 1 for details.

► Specification Information, continued from previous page

Specification Information											
• Style Number	• Dimensions H	• Screen Type	• U.S. Base Prices								
			• Modular Width	27"W	33"W	39"W	45"W	51"W	57"W	63"W	69"W
		• Parametric Width	27"W – 32 ¹⁵ / ₁₆ "W	33"W – 38 ¹⁵ / ₁₆ "W	39"W – 44 ¹⁵ / ₁₆ "W	45"W – 50 ¹⁵ / ₁₆ "W	51"W – 56 ¹⁵ / ₁₆ "W	57"W – 62 ¹⁵ / ₁₆ "W	63"W – 68 ¹⁵ / ₁₆ "W	69"W – 74 ¹⁵ / ₁₆ "W	75"W

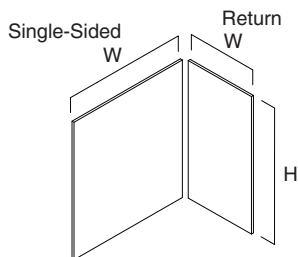

Beam End-of-Run L Return Boundary Screens—Single Sided

Wood Veneer — Primary Screen

TSBSCLSSD	Dimensions H	18"W	24"W	30"W	36"W	42"W	48"W	54"W	60"W	66"W
	28 ¹ / ₂ "H	\$1074	\$1357	\$1644	\$1925	\$2212	\$2496	\$2783	\$3069	\$3352
	42"H	\$1269	\$1601	\$1933	\$2264	\$2596	\$2926	\$3260	\$3592	\$3927
	48"H	\$1369	\$1723	\$2079	\$2432	\$2790	\$3145	\$3500	\$3853	\$4212

• Style Number	• Dimensions H	• Screen Type	• U.S. Base Prices		
			• Modular Width	18"W	24"W
		• Parametric Width	18"W – 23 ¹⁵ / ₁₆ "W	24"W – 29 ¹⁵ / ₁₆ "W	30"W

Wood Veneer — Return Screen

TSBSCLSSD	Dimensions H	18"W	24"W	30"W
	28 ¹ / ₂ "H	+\$ 931	+\$1074	+\$1357
	42"H	+\$1105	+\$1269	+\$1601
	48"H	+\$1194	+\$1369	+\$1723

Tip: When specifying an L return boundary screen, primary and return screen widths need to be specified. The final price will include the price of both individual screen segments.

► Specification Information, continued on next page



For Canadian Pricing

Multiply U.S. Price by the Canadian price factor.

► See page 1 for details.

Answer Beam End-of-Run Boundary Screens, L Return, continued

► Specification Information, continued from previous page

Specification Information											
Style Number	Dimensions H	Screen Type	U.S. Base Prices								
			Modular Width	25½"W	31½"W	37½"W	43½"W	49½"W	55½"W	61½"W	67½"W
		Parametric Width	25½"W-	31½"W-	37½"W-	43½"W-	49½"W-	55½"W-	61½"W-	67½"W-	73½"W-
			317/16"W	377/16"W	437/16"W	497/16"W	557/16"W	617/16"W	677/16"W	737/16"W	

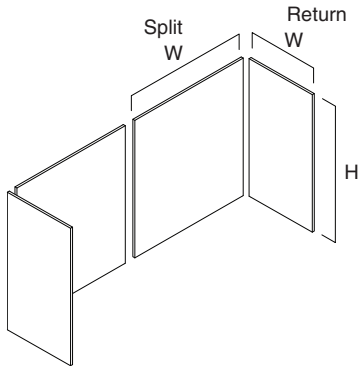

Beam End-of-Run L Return Boundary Screens—Split

High-Pressure Laminate — Primary Screen

TSBSCLSPT	28½"H	\$774	\$ 923	\$1076	\$1226	\$1379	\$1530	\$1683	\$1833	\$1984
	42"H	\$804	\$ 985	\$1166	\$1346	\$1530	\$1711	\$1892	\$2075	\$2259
	48"H	\$819	\$1015	\$1213	\$1408	\$1606	\$1803	\$2000	\$2195	\$2395

Style Number	Dimensions H	Screen Type	U.S. Base Prices		
			Modular Width	18"W	24"W
		Parametric Width	18"W-	24"W-	30"W
			23½/16"W	29½/16"W	

High-Pressure Laminate — Return Screen

TSBSCLSPT	28½"H	+\$697	+\$774	+\$ 923
	42"H	+\$713	+\$804	+\$ 985
	48"H	+\$720	+\$819	+\$1015

When specifying a split L return boundary screen, primary and return screen widths (four total) need to be specified. The final price will include the price of all four individual screen segments.

► Specification Information, continued on next page

 **For Canadian Pricing**
 Multiply U.S. Price by the Canadian price factor.
 ► See page 1 for details.

► Specification Information, continued from previous page

Specification Information											
Style Number	Dimensions H	Screen Type	U.S. Base Prices								
			Modular Width	25½"W	31½"W	37½"W	43½"W	49½"W	55½"W	61½"W	67½"W
		Parametric Width	25½"W-	31½"W-	37½"W-	43½"W-	49½"W-	55½"W-	61½"W-	67½"W-	73½"W
			317/16"W	377/16"W	437/16"W	497/16"W	557/16"W	617/16"W	677/16"W	737/16"W	

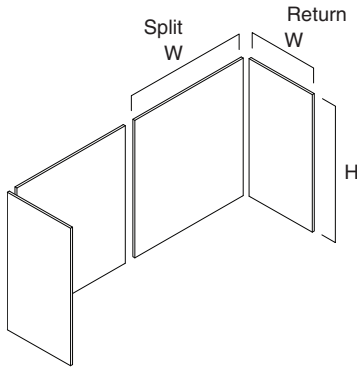

Boundary, Worksurface, and Beam Screens

Beam End-of-Run L Return Boundary Screens—Split

Composite Veneer — Primary Screen

TSBSCLSPT	28½"H	\$1046	\$1318	\$1592	\$1862	\$2136	\$2409	\$2683	\$2957	\$3228
	42"H	\$1227	\$1545	\$1863	\$2181	\$2498	\$2816	\$3136	\$3454	\$3775
	48"H	\$1319	\$1659	\$2000	\$2340	\$2682	\$3023	\$3364	\$3703	\$4046

Style Number	Dimensions H	Screen Type	U.S. Base Prices		
			Modular Width	18"W	24"W
		Parametric Width	18"W-	24"W-	30"W
			23½/16"W	29½/16"W	

Composite Veneer — Return Screen

TSBSCLSPT	28½"H	+\$ 931	+\$1074	+\$1357
	42"H	+\$1105	+\$1269	+\$1601
	48"H	+\$1194	+\$1369	+\$1723

When specifying a split L return boundary screen, primary and return screen widths (four total) need to be specified. The final price will include the price of all four individual screen segments.



For Canadian Pricing
Multiply U.S. Price by the Canadian price factor.
► See page 1 for details.

Answer Beam End-of-Run Boundary Screens, L Return, continued

► Specification Information, continued from previous page

Specification Information											
Style Number	Dimensions H	Screen Type	U.S. Base Prices								
			Modular Width	25½"W	31½"W	37½"W	43½"W	49½"W	55½"W	61½"W	67½"W
		Parametric Width	25½"W-	31½"W-	37½"W-	43½"W-	49½"W-	55½"W-	61½"W-	67½"W-	73½"W
			317/16"W	377/16"W	437/16"W	497/16"W	557/16"W	617/16"W	677/16"W	737/16"W	

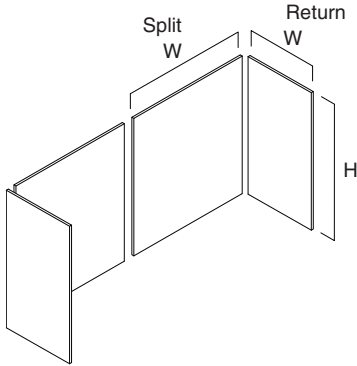

Beam End-of-Run L Return Boundary Screens—Split

Wood Veneer — Primary Screen

TSBSCLSPT	28½"H	\$1074	\$1357	\$1644	\$1925	\$2212	\$2496	\$2783	\$3069	\$3352
	42"H	\$1269	\$1601	\$1933	\$2264	\$2596	\$2926	\$3260	\$3592	\$3927
	48"H	\$1369	\$1723	\$2079	\$2432	\$2790	\$3145	\$3500	\$3853	\$4212

Style Number	Dimensions H	Screen Type	U.S. Base Prices		
			Modular Width	18"W	24"W
		Parametric Width	18"W-	24"W-	30"W
			23½/16"W	29½/16"W	

Wood Veneer — Return Screen

TSBSCLSPT	28½"H	+\$ 931	+\$1074	+\$1357
	42"H	+\$1105	+\$1269	+\$1601
	48"H	+\$1194	+\$1369	+\$1723

When specifying a split L return boundary screen, primary and return screen widths (four total) need to be specified. The final price will include the price of all four individual screen segments.



For Canadian Pricing

Multiply U.S. Price by the Canadian price factor.

► See page 1 for details.

Answer Beam On-Module In-Line Boundary Screens

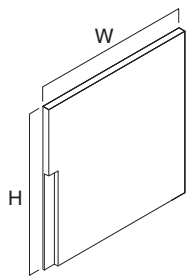

Standard Includes		Required to Specify
▶ Need help? Product details, page 80	• Screen: High-Pressure Laminate price group 1 or composite veneer price group 1	1 Style number
	• Edge on laminate screen, if selected: plastic	2 Screen size type (see below under Required Selections)
	• Height: 42"H or 48"H	3 Screen height(s)
	• Width:	4 Screen width(s)
	– On-module T: 27"W–75"W	5 High-Pressure Laminate or composite veneer color for screen
	– On-module X: 25½"W–73½"W	6 Plastic color number for edge on laminate screen, if selected
	• Bracket cover and bracket trim: paint price group 1	7 Grain direction
	• Junction trim: paint price group 1 (On-module T only)	8 Paint color number for connecting panel cover and bracket trim
	• 1½" adjustable glides	9 Paint color number for junction trim, if selected
	• Attachment hardware	10 Options, if selected (see below)
		▶ See <i>Surface Materials</i> , page 358.

Tip: Additional hardware upcharge is applied only when on-module X style number is specified.

Tip: Remember to specify Answer beam on-module in-line boundary screen junction when ordering an Answer beam on-module in-line boundary screen.

Tip: When specifying the paint finish for the bracket cover, select a finish that compliments the selected laminate or veneer finish.

For laminate price group 2 and group 3 pricing, please refer to the electronic catalog or SmartTools.

Required Component		U.S. Price	
Additional Hardware	• On-module X	+\$ 31	

Required Selections		U.S. Price	Required to Specify
Screen Size Type	• Modular	No cost	Specify <i>with modular</i> .
	• Parametric	No cost	Specify <i>with parametric</i> .

Options		U.S. Price	Required to Specify	
Surface Materials	Screen			
	• Laminate price group 2	See information at left	Specify laminate color number.	
	• Laminate price group 3	See information at left	Specify laminate color number.	
	• Open Line laminate	+\$220 plus cost of laminate	▶ See <i>Surface Materials Reference Manual</i> .	
	• Composite veneer group 1	Prices at right	Specify composite veneer color number.	
	• Composite veneer group 2	+\$215	Specify composite veneer color number.	
	• Wood group 1	Prices at right	Specify wood color number.	
	• Wood group 2	+\$236	Specify wood color number.	
	• Wood group 3	+\$827	Specify wood color number.	
	• Customiz stain	No cost	Specify <i>with Customiz stain</i> .	
	Connecting panel cover and bracket trim			
	• Paint price group 2	+\$ 17	Specify paint color number.	
• Paint price group 3	+\$ 37	Specify paint color number.		
Junction trim (on-module T only)				
• Paint price group 2	+\$ 17	Specify paint color number.		
• Paint price group 3	+\$ 37	Specify paint color number.		
Laminate wood grain direction				
• No direction	No cost	Specify <i>with no direction</i> .		
• Horizontal	No cost	Specify <i>with horizontal grain direction</i> .		
• Vertical	No cost	Specify <i>with vertical grain direction</i> .		
Wood veneer grain direction				
• No direction	No cost	Specify <i>with no direction</i> .		
• Horizontal	No cost	Specify <i>with horizontal grain direction</i> .		
• Vertical	No cost	Specify <i>with vertical grain direction</i> .		



For Canadian Pricing

Multiply U.S. Price by the Canadian price factor.

▶ See page 1 for details.

Specification Information

• Style Number	• Dimensions H	• Screen Type	• U.S. Base Prices								
			• Modular Width	27"W	33"W	39"W	45"W	51"W	57"W	63"W	69"W
• Parametric Width			27"W-32 ¹ / ₁₆ "W	33"W-38 ¹ / ₁₆ "W	39"W-44 ¹ / ₁₆ "W	45"W-50 ¹ / ₁₆ "W	51"W-56 ¹ / ₁₆ "W	57"W-62 ¹ / ₁₆ "W	63"W-68 ¹ / ₁₆ "W	69"W-74 ¹ / ₁₆ "W	75"W

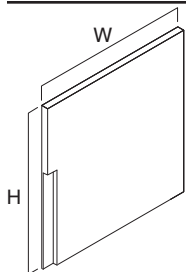

Boundary, Worksurface, and Beam Screens

Beam On-Module T Boundary Screen

High-Pressure Laminate

TSBBST	42"H	\$ 804	\$ 985	\$1166	\$1346	\$1530	\$1711	\$1892	\$2075	\$2259
	48"H	\$ 819	\$1015	\$1213	\$1408	\$1606	\$1803	\$2000	\$2195	\$2395

Composite Veneer

TSBBST	42"H	\$1227	\$1545	\$1863	\$2181	\$2498	\$2816	\$3136	\$3454	\$3775
	48"H	\$1319	\$1659	\$2000	\$2340	\$2682	\$3023	\$3364	\$3703	\$4046

Wood Veneer

TSBBST	42"H	\$1269	\$1601	\$1933	\$2264	\$2596	\$2926	\$3260	\$3592	\$3927
	48"H	\$1369	\$1723	\$2079	\$2432	\$2790	\$3145	\$3500	\$3853	\$4212

► Specification Information, continued on next page



For Canadian Pricing

Multiply U.S. Price by the Canadian price factor.

► See page 1 for details.

Answer Beam On-Module In-Line Boundary Screens, continued

► Specification Information, continued from previous page

Specification Information											
Style Number	Dimensions H	Screen Type	U.S. Base Prices								
			Modular Width	25½"W	31½"W	37½"W	43½"W	49½"W	55½"W	61½"W	67½"W
Parametric Width			25½"W-	31½"W-	37½"W-	43½"W-	49½"W-	55½"W-	61½"W-	67½"W-	73½"W
			317/16"W	377/16"W	437/16"W	497/16"W	557/16"W	617/16"W	677/16"W	737/16"W	

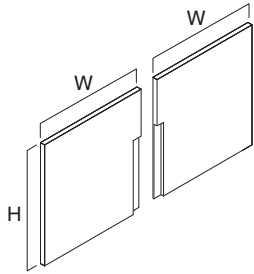

Beam On-Module X Boundary Screen

High-Pressure Laminate

TSBBSX	42"H	\$ 804	\$ 985	\$1166	\$1346	\$1530	\$1711	\$1892	\$2075	\$2259
	48"H	\$ 819	\$1015	\$1213	\$1408	\$1606	\$1803	\$2000	\$2195	\$2395

Composite Veneer

TSBBSX	42"H	\$1227	\$1545	\$1863	\$2181	\$2498	\$2816	\$3136	\$3454	\$3775
	48"H	\$1319	\$1659	\$2000	\$2340	\$2682	\$3023	\$3364	\$3703	\$4046

Wood Veneer

TSBBSX	42"H	\$1269	\$1601	\$1933	\$2264	\$2596	\$2926	\$3260	\$3592	\$3927
	48"H	\$1369	\$1723	\$2079	\$2432	\$2790	\$3145	\$3500	\$3853	\$4212

Tip: When specifying a beam on-module X boundary screen, two screen widths need to be specified. The final price will include the price of both individual screen segments.

 **For Canadian Pricing**
 Multiply U.S. Price by the Canadian price factor.
 ► See page 1 for details.

Answer Beam On-Module In-Line Boundary Screen Junction



Tip: When specifying a beam on-module in-line boundary screen, a beam on-module in-line boundary screen junction takes the place of a beam in-line junction.

Standard Includes	Required to Specify
-------------------	---------------------

- | | | |
|---|-------------------------|--------------|
| ▶ Need help?
Product details,
page 80 | • Junction: black paint | Style number |
|---|-------------------------|--------------|

Specification Information	
• Style • Number	• U.S. • Price

• Style • Number	• U.S. • Price
• TSBJIBS	• \$239

Boundary,
Worksurface, and
Beam Screens



For Canadian Pricing

Multiply U.S. Price by the Canadian price factor.

▶ See page 1 for details.

Centered In-Line Boundary Screens

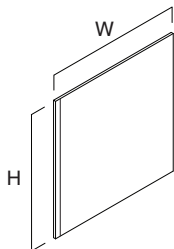

	Standard Includes	Required to Specify
<p>▶ Need help? Product details, page 82</p>	<ul style="list-style-type: none"> Screen: High-Pressure Laminate price group 1 or composite veneer price group 1 Edge on laminate screen, if selected: plastic Height: 28½"H, 42"H, or 48"H Width: <ul style="list-style-type: none"> – Single-sided: 24"W–72"W Connecting panel cover and bracket trim: paint price group 1 ½" adjustable glides Attachment hardware 	<ol style="list-style-type: none"> Style number Screen size type (see below under Required Selections) Screen height(s) Screen width(s) High-Pressure Laminate or composite veneer color for screen Plastic color number for edge on laminate screen, if selected Grain direction Paint color number for connecting panel cover and bracket trim Options, if selected (see below) <p>▶ See <i>Surface Materials</i>, page 358.</p>

	Required Selections	U.S. Price	Required to Specify
Screen Size Type	<ul style="list-style-type: none"> Modular Parametric 	No cost No cost	Specify <i>with modular</i> . Specify <i>with parametric</i> .

	Options	U.S. Price	Required to Specify
Surface Materials	<p>Screen</p> <ul style="list-style-type: none"> Laminate price group 2 Laminate price group 3 Open Line laminate Composite veneer group 1 Composite veneer group 2 Wood group 1 Wood group 2 Wood group 3 Customiz stain 	See information at left See information at left +\$220 plus cost of laminate Prices at right +\$215 Prices at right +\$236 +\$827 No cost	Specify laminate color number. Specify laminate color number. ▶ See <i>Surface Materials Reference Manual</i> . Specify composite veneer color number. Specify composite veneer color number. Specify wood color number. Specify wood color number. Specify wood color number. Specify <i>with Customiz stain</i> .
	Connecting panel cover and bracket trim		
	<ul style="list-style-type: none"> Paint price group 2 Paint price group 3 	+\$ 17 +\$ 37	Specify paint color number. Specify paint color number.
	Laminate wood grain direction		
	<ul style="list-style-type: none"> No direction Horizontal Vertical 	No cost No cost No cost	Specify <i>with no direction</i> . Specify <i>with horizontal grain direction</i> . Specify <i>with vertical grain direction</i> .
	Wood veneer grain direction		
	<ul style="list-style-type: none"> No direction Horizontal Vertical 	No cost No cost No cost	Specify <i>with no direction</i> . Specify <i>with horizontal grain direction</i> . Specify <i>with vertical grain direction</i> .

Tip: When specifying the paint finish for the bracket cover, select a finish that complements the selected laminate or veneer finish.

For laminate price group 2 and group 3 pricing, please refer to the electronic catalog or SmartTools.



For Canadian Pricing

Multiply U.S. Price by the Canadian price factor.

▶ See page 1 for details.

Specification Information

Style Number	Dimensions H	Screen Type	U.S. Base Prices								
			Modular Width	24"W	30"W	36"W	42"W	48"W	54"W	60"W	66" W
		Parametric Width	24"W-29 ¹⁵ / ₁₆ "W	30"W-35 ¹⁵ / ₁₆ "W	36"W-41 ¹⁵ / ₁₆ "W	42"W-47 ¹⁵ / ₁₆ "W	48"W-54 ¹⁵ / ₁₆ "W	54"W-59 ¹⁵ / ₁₆ "W	60"W-65 ¹⁵ / ₁₆ "W	66"W-71 ¹⁵ / ₁₆ "W	72"W

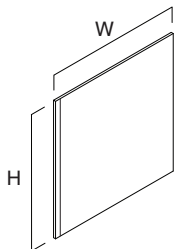

Boundary, Worksurface, and Beam Screens

High-Pressure Laminate

TSBBSCI	Dimensions H	24"W	30"W	36"W	42"W	48"W	54"W	60"W	66" W	72"W
	28 ¹ / ₂ "H	\$ 774	\$ 923	\$1076	\$1226	\$1379	\$1530	\$1683	\$1833	\$1984
	42"H	\$ 804	\$ 985	\$1166	\$1346	\$1530	\$1711	\$1892	\$2075	\$2259
	48"H	\$ 819	\$1015	\$1213	\$1408	\$1606	\$1803	\$2000	\$2195	\$2395

Composite Veneer

TSBBSCI	Dimensions H	24"W	30"W	36"W	42"W	48"W	54"W	60"W	66" W	72"W
	28 ¹ / ₂ "H	\$1046	\$1318	\$1592	\$1862	\$2136	\$2409	\$2683	\$2956	\$3228
	42"H	\$1227	\$1545	\$1863	\$2181	\$2498	\$2816	\$3136	\$3454	\$3775
	48"H	\$1319	\$1659	\$2000	\$2340	\$2682	\$3023	\$3364	\$3703	\$4046

Wood Veneer

TSBBSCI	Dimensions H	24"W	30"W	36"W	42"W	48"W	54"W	60"W	66" W	72"W
	28 ¹ / ₂ "H	\$1074	\$1357	\$1644	\$1925	\$2212	\$2496	\$2783	\$3069	\$3352
	42"H	\$1269	\$1601	\$1933	\$2264	\$2596	\$2926	\$3260	\$3592	\$3927
	48"H	\$1369	\$1723	\$2079	\$2432	\$2790	\$3145	\$3500	\$3853	\$4212



For Canadian Pricing

Multiply U.S. Price by the Canadian price factor.

▶ See page 1 for details.

Universal Beam Screens and Aligners

Universal Beam Screens

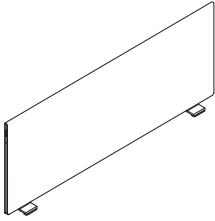

Tip: 13½"H screen will align at a 42" datum. 19½"H screen will align at a 48" datum.

Standard Includes	Required to Specify
-------------------	---------------------

- | | | |
|---|--|---|
| <ul style="list-style-type: none"> ▶ Need help? Product details, page 84 | <ul style="list-style-type: none"> • Screen: fabric price group 1 • Brackets and plastic cap: 7360 Merle • Bracket cover: 4799 Platinum Metallic • Edge: PET | <ol style="list-style-type: none"> 1 Style number 2 Width (see below under Required Selections) 3 Height (see below under Required Selections) 4 Fabric color number for screen 5 Edge color: <ul style="list-style-type: none"> P630 Medium Heather Grey PET P631 Dark Heather Grey PET 6 Options, if selected (see below) <p>▶ See <i>Surface Materials</i>, page 358.</p> |
|---|--|---|

Width	Required Selections	U.S. Price	Required to Specify
-------	---------------------	------------	---------------------

Width	<ul style="list-style-type: none"> • 24"W • 30"W • 36"W • 42"W • 48"W • 54"W • 60"W • 66"W • 72"W • 78"W • 84"W • 90"W • 96"W 	<ul style="list-style-type: none"> Prices at right Prices at right Prices at right Prices at right Prices at right Prices at right Prices at right Prices at right Prices at right Prices at right Prices at right Prices at right Prices at right 	<ul style="list-style-type: none"> Specify width. Specify width. Specify width. Specify width. Specify width. Specify width. Specify width. Specify width. Specify width. Specify width. Specify width. Specify width. Specify width.
--------------	--	---	--

Height	<ul style="list-style-type: none"> • 13½"H • 19½"H 	<ul style="list-style-type: none"> Prices at right Prices at right 	<ul style="list-style-type: none"> Specify height. Specify height.
---------------	--	--	--

Surface Materials	Options	U.S. Price	Required to Specify
-------------------	---------	------------	---------------------

Surface Materials	<ul style="list-style-type: none"> • Fabric price group 1 • Fabric price group 2 • Fabric price group 3 • Fabric price group 4 • Fabric price group 5 • Fabric price group 6 • Fabric price group 7 • Fabric price group 8 • Fabric price group 9 • Fabric price group 10 • Customer's Own Material (COM) 	<ul style="list-style-type: none"> No cost +\$ 53 +\$142 +\$178 +\$219 +\$256 +\$296 +\$332 +\$371 +\$408 +\$ 25 	<ul style="list-style-type: none"> Specify fabric color number. Specify fabric color number. Specify fabric color number. Specify fabric color number. Specify fabric color number. Specify fabric color number. Specify fabric color number. Specify fabric color number. Specify fabric color number. Specify fabric color number. Specify fabric color number. <p>▶ See <i>Surface Materials Reference Manual</i>.</p>
--------------------------	--	---	--

Related Products	<ul style="list-style-type: none"> • Aligners 	<p>▶ Page 239</p>
-------------------------	--	-------------------

 **For Canadian Pricing**
 Multiply U.S. Price by the Canadian price factor.
 ▶ See page 1 for details.

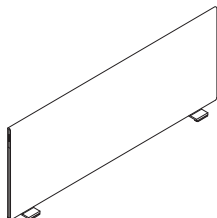

Specification Information									
Style Number	Height	U.S. Base Prices							
		24"W	30"W	36"W	42"W	48"W	54"W	60"W	66"W
TSBSC	13½"	\$661	\$710	\$762	\$809	\$ 858	\$ 905	\$ 955	\$1008
	19½"	\$762	\$835	\$912	\$989	\$1067	\$1143	\$1221	\$1296
▶ Specification Information, continued from above									
Style Number	Height	U.S. Base Prices							
		72"W	78"W	84"W	90"W	96"W			
TSBSC	13½"	\$1052	\$1099	\$1145	\$1193	\$1244			
	19½"	\$1375	\$1447	\$1523	\$1595	\$1669			

Boundary, Worksurface, and Beam Screens

Aligners



Tip: Aligners are for use with Universal screens only.

Standard Includes		Required to Specify
▶ Need help? Product details, page 85	• Aligners, package of 10: 6527 Merle	Style number
Specification Information		
Style Number	U.S. Price	
UFAL	\$39	



For Canadian Pricing

Multiply U.S. Price by the Canadian price factor.

▶ See page 1 for details.

Universal Privacy/Modesty Screens

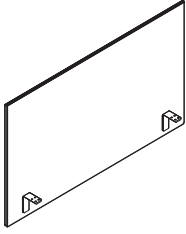

Tip: Universal privacy/modesty screens can be attached to 3/4"-1 1/2" thick worksurface, including height adjustable work-surfaces, universal work-surfaces, and Elective Elements work-surfaces.

Tip: The screens weigh between 9.79 lb and 11.89 lb. Take this into consideration when planning for use on height-adjustable work-surfaces.

Tip: The universal privacy/modesty screen is intended for use on the back of a worksurface.

Tip: Fabric is applied horizontally on the screen.

Tip: Screen allows for 1 1/8" cord drop or no cord drop. See understanding pages for product specific application guidelines.

Standard Includes	Required to Specify
-------------------	---------------------

- | | | |
|---|---|---|
| <ul style="list-style-type: none"> ▶ Need help? Product details, page 86 | <ul style="list-style-type: none"> • Screen: fabric price group 1 • Brackets: 7360 Merle • Edge: PET | <ol style="list-style-type: none"> 1 Style number 2 Width (see below under Required Selections) 3 Mount location (see below under Required Selections) 4 Fabric color number for screen 5 Edge color: <ul style="list-style-type: none"> P630 Medium Heather Grey PET P631 Dark Heather Grey PET 6 Options, if selected (see below) <p>▶ See <i>Surface Materials</i>, page 358.</p> |
|---|---|---|

Width	Required Selections	U.S. Price	Required to Specify
-------	---------------------	------------	---------------------

Width	<ul style="list-style-type: none"> • 42"W • 48"W • 54"W • 60"W • 66"W 	<p>Prices below</p> <p>Prices below</p> <p>Prices below</p> <p>Prices below</p> <p>Prices below</p>	<p>Specify width.</p> <p>Specify width.</p> <p>Specify width.</p> <p>Specify width.</p> <p>Specify width.</p>
--------------	--	---	---

Mount Location	Required Selections	U.S. Price	Required to Specify
----------------	---------------------	------------	---------------------

Mount Location	<ul style="list-style-type: none"> • Privacy (19 1/8" above the worksurface, 5 1/2" below the worksurface) • Privacy/modesty (13" above the worksurface, 11 7/10" below the worksurface) 	<p>No cost</p> <p>No cost</p>	<p>Specify with privacy application.</p> <p>Specify with privacy/modesty application.</p>
-----------------------	--	-------------------------------	---

Surface Materials	Options	U.S. Price	Required to Specify
-------------------	---------	------------	---------------------

Surface Materials	<ul style="list-style-type: none"> • Fabric price group 1 • Fabric price group 2 • Fabric price group 3 • Fabric price group 4 • Fabric price group 5 • Fabric price group 6 • Fabric price group 7 • Fabric price group 8 • Fabric price group 9 • Fabric price group 10 • Customer's Own Material (COM) 	<p>No cost</p> <p>+\$ 61</p> <p>+\$174</p> <p>+\$222</p> <p>+\$266</p> <p>+\$311</p> <p>+\$361</p> <p>+\$405</p> <p>+\$450</p> <p>+\$496</p> <p>+\$ 25</p>	<p>Specify fabric color number.</p> <p>Specify fabric color number.</p> <p>Specify fabric color number.</p> <p>Specify fabric color number.</p> <p>Specify fabric color number.</p> <p>Specify fabric color number.</p> <p>Specify fabric color number.</p> <p>Specify fabric color number.</p> <p>Specify fabric color number.</p> <p>Specify fabric color number.</p> <p>▶ See <i>Surface Materials Reference Manual</i>.</p>
--------------------------	--	--	---

Specification Information

Style Number	U.S. Base Prices				
	42"W	48"W	54"W	60"W	66"W
UFPM	\$734	\$780	\$829	\$880	\$929

For Canadian Pricing
 Multiply U.S. Price by the Canadian price factor.
 ▶ See page 1 for details.

Universal Privacy Screens

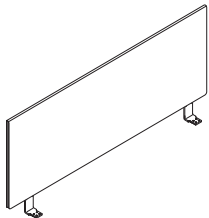

Tip: 13½"H screen will align at a 42" datum. 19½"H screen will align at a 48" datum.

Standard Includes	Required to Specify
<ul style="list-style-type: none"> ▶ Need help? Product details, page 90 • Screen: fabric price group 1 • Brackets: paint price group 1 • Edge: PET 	<ol style="list-style-type: none"> 1 Style number 2 Width (see below under Required Selections) 3 Height (see below under Required Selections) 4 Fabric color number for screen 5 Bracket finish color number 6 Edge color: <ul style="list-style-type: none"> P630 Medium Heather Grey PET P631 Dark Heather Grey PET 7 Options, if selected (see below) <p>▶ See <i>Surface Materials</i>, page 358.</p>

	Required Selections	U.S. Price	Required to Specify
Width	<ul style="list-style-type: none"> • 24"W • 30"W • 36"W • 42"W • 48"W • 54"W • 60"W • 66"W • 72"W • 78"W • 84"W • 90"W • 96"W 	<ul style="list-style-type: none"> Prices at right Prices at right Prices at right Prices at right Prices at right Prices at right Prices at right Prices at right Prices at right Prices at right Prices at right Prices at right Prices at right 	<ul style="list-style-type: none"> Specify width. Specify width. Specify width. Specify width. Specify width. Specify width. Specify width. Specify width. Specify width. Specify width. Specify width. Specify width. Specify width.
Height	<ul style="list-style-type: none"> • 13½"H • 19½"H 	<ul style="list-style-type: none"> Prices at right Prices at right 	<ul style="list-style-type: none"> Specify height. Specify height.

	Options	U.S. Price	Required to Specify
Surface Materials	<ul style="list-style-type: none"> • Fabric price group 1 • Fabric price group 2 • Fabric price group 3 • Fabric price group 4 • Fabric price group 5 • Fabric price group 6 • Fabric price group 7 • Fabric price group 8 • Fabric price group 9 • Fabric price group 10 • Customer's Own Material (COM) 	<ul style="list-style-type: none"> No cost +\$ 53 +\$142 +\$178 +\$219 +\$256 +\$296 +\$332 +\$371 +\$408 +\$ 25 	<ul style="list-style-type: none"> Specify fabric color number. Specify fabric color number. Specify fabric color number. Specify fabric color number. Specify fabric color number. Specify fabric color number. Specify fabric color number. Specify fabric color number. Specify fabric color number. Specify fabric color number. Specify fabric color number. <p>▶ See <i>Surface Materials Reference Manual</i>.</p>
	Bracket		
	<ul style="list-style-type: none"> • Paint price group 1 • Paint price group 2 	<ul style="list-style-type: none"> No cost +\$ 17 	<ul style="list-style-type: none"> Specify paint color number. Specify paint color number.
Related Products	<ul style="list-style-type: none"> • Aligner 		▶ Page 239



For Canadian Pricing

Multiply U.S. Price by the Canadian price factor.

▶ See page 1 for details.

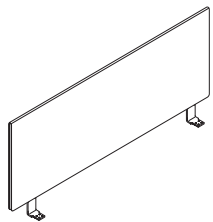

Specification Information

Style Number	Height	U.S. Base Prices							
		24"W	30"W	36"W	42"W	48"W	54"W	60"W	66"W
UFPS	13½"	\$480	\$515	\$548	\$586	\$619	\$656	\$691	\$726
	19½"	\$548	\$603	\$659	\$713	\$773	\$827	\$882	\$935

► **Specification Information, continued from above**

Style Number	Height	U.S. Base Prices				
		72"W	78"W	84"W	90"W	96"W
UFPS	13½"	\$763	\$ 797	\$ 830	\$ 865	\$ 901
	19½"	\$992	\$1047	\$1099	\$1154	\$1206

Boundary, Worksurface, and Beam Screens

 **For Canadian Pricing**
 Multiply U.S. Price by the Canadian price factor.
 ► See page 1 for details.

Sarto Beam Screens

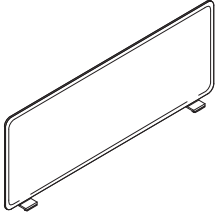

Standard Includes	Required to Specify
-------------------	---------------------

<ul style="list-style-type: none"> ▶ Need help? Product details, page 93 	<ul style="list-style-type: none"> • Screen: fabric price group 1 • Brackets and hard stops: 7360 Merle • Bracket cover: 4799 Platinum Metallic 	<ol style="list-style-type: none"> 1 Style number 2 Size option (see below under Required Selections) 3 Width (see below under Required Selections) 4 Height (see below under Required Selections) 5 Fabric color number for screen 6 Options, if selected (see below) <p>▶ See <i>Surface Materials</i>, page 358.</p>
---	--	---

Required Selections	U.S. Price	Required to Specify
---------------------	------------	---------------------

Size Option	<ul style="list-style-type: none"> • Modular • Parametric 	<p>No cost</p> <p>No cost</p>	<p>Specify <i>with modular</i>.</p> <p>Specify <i>with parametric</i>.</p>																												
Width	<table border="1"> <thead> <tr> <th style="background-color: #212121; color: white;">Modular</th> <th style="background-color: #212121; color: white;">Parametric</th> </tr> </thead> <tbody> <tr><td>• 24"W</td><td>24"W</td></tr> <tr><td>• 30"W</td><td>24¹/₁₆"W–30"W</td></tr> <tr><td>• 36"W</td><td>30¹/₁₆"W–36"W</td></tr> <tr><td>• 42"W</td><td>36¹/₁₆"W–42"W</td></tr> <tr><td>• 48"W</td><td>42¹/₁₆"W–48"W</td></tr> <tr><td>• 54"W</td><td>48¹/₁₆"W–54"W</td></tr> <tr><td>• 60"W</td><td>54¹/₁₆"W–60"W</td></tr> <tr><td>• 66"W</td><td>60¹/₁₆"W–66"W</td></tr> <tr><td>• 72"W</td><td>66¹/₁₆"W–72"W</td></tr> <tr><td>• 78"W</td><td>72¹/₁₆"W–78"W</td></tr> <tr><td>• 84"W</td><td>78¹/₁₆"W–84"W</td></tr> <tr><td>• 90"W</td><td>84¹/₁₆"W–90"W</td></tr> <tr><td>• 96"W</td><td>90¹/₁₆"W–96"W</td></tr> </tbody> </table>	Modular	Parametric	• 24"W	24"W	• 30"W	24 ¹ / ₁₆ "W–30"W	• 36"W	30 ¹ / ₁₆ "W–36"W	• 42"W	36 ¹ / ₁₆ "W–42"W	• 48"W	42 ¹ / ₁₆ "W–48"W	• 54"W	48 ¹ / ₁₆ "W–54"W	• 60"W	54 ¹ / ₁₆ "W–60"W	• 66"W	60 ¹ / ₁₆ "W–66"W	• 72"W	66 ¹ / ₁₆ "W–72"W	• 78"W	72 ¹ / ₁₆ "W–78"W	• 84"W	78 ¹ / ₁₆ "W–84"W	• 90"W	84 ¹ / ₁₆ "W–90"W	• 96"W	90 ¹ / ₁₆ "W–96"W	<p>Prices at right</p> <p>Prices at right</p> <p>Prices at right</p> <p>Prices at right</p> <p>Prices at right</p> <p>Prices at right</p> <p>Prices at right</p> <p>Prices at right</p> <p>Prices at right</p> <p>Prices at right</p> <p>Prices at right</p> <p>Prices at right</p> <p>Prices at right</p> <p>Prices at right</p> <p>Prices at right</p> <p>Prices at right</p>	<p>Specify width.</p> <p>Specify width.</p> <p>Specify width.</p> <p>Specify width.</p> <p>Specify width.</p> <p>Specify width.</p> <p>Specify width.</p> <p>Specify width.</p> <p>Specify width.</p> <p>Specify width.</p> <p>Specify width.</p> <p>Specify width.</p> <p>Specify width.</p> <p>Specify width.</p>
Modular	Parametric																														
• 24"W	24"W																														
• 30"W	24 ¹ / ₁₆ "W–30"W																														
• 36"W	30 ¹ / ₁₆ "W–36"W																														
• 42"W	36 ¹ / ₁₆ "W–42"W																														
• 48"W	42 ¹ / ₁₆ "W–48"W																														
• 54"W	48 ¹ / ₁₆ "W–54"W																														
• 60"W	54 ¹ / ₁₆ "W–60"W																														
• 66"W	60 ¹ / ₁₆ "W–66"W																														
• 72"W	66 ¹ / ₁₆ "W–72"W																														
• 78"W	72 ¹ / ₁₆ "W–78"W																														
• 84"W	78 ¹ / ₁₆ "W–84"W																														
• 90"W	84 ¹ / ₁₆ "W–90"W																														
• 96"W	90 ¹ / ₁₆ "W–96"W																														
Height	<table border="1"> <thead> <tr> <th style="background-color: #212121; color: white;">Modular</th> <th style="background-color: #212121; color: white;">Parametric</th> </tr> </thead> <tbody> <tr><td>• 13¹/₂"H</td><td>13¹/₂"H</td></tr> <tr><td>• 19¹/₂"H</td><td>13⁹/₁₆"H–19¹/₂"H</td></tr> </tbody> </table>	Modular	Parametric	• 13 ¹ / ₂ "H	13 ¹ / ₂ "H	• 19 ¹ / ₂ "H	13 ⁹ / ₁₆ "H–19 ¹ / ₂ "H	<p>Prices at right</p> <p>Prices at right</p>	<p>Specify height.</p> <p>Specify height.</p>																						
Modular	Parametric																														
• 13 ¹ / ₂ "H	13 ¹ / ₂ "H																														
• 19 ¹ / ₂ "H	13 ⁹ / ₁₆ "H–19 ¹ / ₂ "H																														

Tip: Modular 13¹/₂"H screen will align at a 42" datum. Modular 19¹/₂"H screen will align at a 48" datum.

Tip: It is highly recommended to use *CET SmartTools* to verify all dimensions, as there are minor differences between modular and parametric specifications.

Options	U.S. Price	Required to Specify
---------	------------	---------------------

Surface Materials	<ul style="list-style-type: none"> • Fabric price group 2 • Fabric price group 3 • Fabric price group 4 • Fabric price group 5 • Fabric price group 6 • Fabric price group 7 • Fabric price group 8 • Fabric price group 9 • Fabric price group 10 • Customer's Own Material (COM) 	<p>+\$ 53</p> <p>+\$142</p> <p>+\$178</p> <p>+\$219</p> <p>+\$256</p> <p>+\$296</p> <p>+\$332</p> <p>+\$371</p> <p>+\$408</p> <p>+\$ 25</p>	<p>Specify fabric color number.</p> <p>Specify fabric color number.</p> <p>Specify fabric color number.</p> <p>Specify fabric color number.</p> <p>Specify fabric color number.</p> <p>Specify fabric color number.</p> <p>Specify fabric color number.</p> <p>Specify fabric color number.</p> <p>Specify fabric color number.</p> <p>Specify fabric color number.</p> <p>▶ See <i>Surface Materials Reference Manual</i>.</p>
--------------------------	--	---	---



For Canadian Pricing

Multiply U.S. Price by the Canadian price factor.

▶ See page 1 for details.

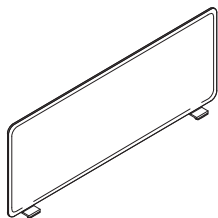

Specification Information										
Style Number	Height	Screen Type	U.S. Base Prices							
			Modular Width	24"W	30"W	36"W	42"W	48"W	54"W	60"W
		Parametric Width	24"W	24 ¹ / ₁₆ "W–30"W	30 ¹ / ₁₆ "W–36"W	36 ¹ / ₁₆ "W–42"W	42 ¹ / ₁₆ "W–48"W	48 ¹ / ₁₆ "W–54"W	54 ¹ / ₁₆ "W–60"W	
TSBPSC	13 ¹ / ₂ "		\$484	\$519	\$557	\$593	\$627	\$663	\$698	
	14"–19 ¹ / ₂ "		\$557	\$615	\$669	\$724	\$780	\$835	\$894	

► Specification Information, continued from above

Style Number	Height	Screen Type	U.S. Base Prices						
			Modular Width	66"W	72"W	78"W	84"W	90"W	96"W
		Parametric Width	60 ¹ / ₁₆ "W–66"W	66 ¹ / ₁₆ "W–72"W	72 ¹ / ₁₆ "W–78"W	78 ¹ / ₁₆ "W–84"W	84 ¹ / ₁₆ "W–90"W	90 ¹ / ₁₆ "W–96"W	
TSBPSC	13 ¹ / ₂ "		\$735	\$ 771	\$ 805	\$ 841	\$ 912	\$ 915	
	14"–19 ¹ / ₂ "		\$948	\$1006	\$1062	\$1117	\$1219	\$1229	

Boundary, Worksurface, and Beam Screens

 **For Canadian Pricing**
 Multiply U.S. Price by the Canadian price factor.
 ► See page 1 for details.

Sarto Privacy/Modesty Screens

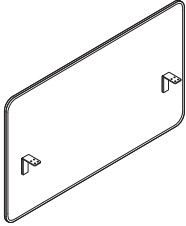

Tip: Sarto privacy/modesty screens can be attached to 3/4"-1 1/2" thick worksurface, including Ology, Migration, Elective Elements, universal tables, and universal panel-mount worksurfaces.

Tip: The screens weigh between 3.51 and 11.64 lb. Take this into consideration when planning for use on height-adjustable worksurfaces. See understanding pages to calculate screen weight.

Tip: Worksurface type option adds a fourth worksurface bracket and repositions brackets to avoid worksurface scallops.

Tip: Side screen option changes brackets to smaller L-brackets, mounting the screen mount flush to the side of the worksurface. Side screen option is only available on screens 36"W and narrower.

Standard Includes		Required to Specify
<ul style="list-style-type: none"> ▶ Need help? Product details, page 94 	<ul style="list-style-type: none"> • Screen: fabric price group 1 • Brackets: 7360 Merle 	<ol style="list-style-type: none"> 1 Style number 2 Size option (see below under Required Selections) 3 Width (see below under Required Selections) 4 Height (see below under Required Selections) 5 Privacy height (see below under Required Selections) 6 Worksurface type (see below under Required Selections) 7 Screen type (see below under Required Selections) 8 Fabric color number for screen 9 Options, if selected (see below) <ul style="list-style-type: none"> ▶ See <i>Surface Materials</i>, page 358.

	Required Selections	U.S. Price	Required to Specify																																																								
Size Option	<ul style="list-style-type: none"> • Modular • Parametric 	No cost No cost	Specify <i>with modular</i> . Specify <i>with parametric</i> .																																																								
Width	<table border="1"> <thead> <tr> <th colspan="2">Modular</th> <th colspan="2">Parametric</th> </tr> </thead> <tbody> <tr> <td>• N.A.</td> <td>23"W</td> <td>28 1/16"W</td> <td></td> </tr> <tr> <td>• 24"W</td> <td>N.A.</td> <td></td> <td></td> </tr> <tr> <td>• 29"W</td> <td>29"W</td> <td></td> <td></td> </tr> <tr> <td>• N.A.</td> <td>29 1/16"W</td> <td>36"W</td> <td></td> </tr> <tr> <td>• 42"W</td> <td>36 1/16"W</td> <td>42"W</td> <td></td> </tr> <tr> <td>• 46"W</td> <td>N.A.</td> <td></td> <td></td> </tr> <tr> <td>• 48"W</td> <td>42 1/16"W</td> <td>48"W</td> <td></td> </tr> <tr> <td>• 54"W</td> <td>48 1/16"W</td> <td>54"W</td> <td></td> </tr> <tr> <td>• 58"W</td> <td>N.A.</td> <td></td> <td></td> </tr> <tr> <td>• 60"W</td> <td>54 1/16"W</td> <td>60"W</td> <td></td> </tr> <tr> <td>• 66"W</td> <td>60 1/16"W</td> <td>66"W</td> <td></td> </tr> <tr> <td>• 70"W</td> <td>66 1/16"W</td> <td>70"W</td> <td></td> </tr> </tbody> </table>	Modular		Parametric		• N.A.	23"W	28 1/16"W		• 24"W	N.A.			• 29"W	29"W			• N.A.	29 1/16"W	36"W		• 42"W	36 1/16"W	42"W		• 46"W	N.A.			• 48"W	42 1/16"W	48"W		• 54"W	48 1/16"W	54"W		• 58"W	N.A.			• 60"W	54 1/16"W	60"W		• 66"W	60 1/16"W	66"W		• 70"W	66 1/16"W	70"W		Prices at right Prices at right Prices at right Prices at right Prices at right Prices at right Prices at right Prices at right Prices at right Prices at right Prices at right Prices at right	Specify width. Specify width. Specify width. Specify width. Specify width. Specify width. Specify width. Specify width. Specify width. Specify width. Specify width. Specify width.				
Modular		Parametric																																																									
• N.A.	23"W	28 1/16"W																																																									
• 24"W	N.A.																																																										
• 29"W	29"W																																																										
• N.A.	29 1/16"W	36"W																																																									
• 42"W	36 1/16"W	42"W																																																									
• 46"W	N.A.																																																										
• 48"W	42 1/16"W	48"W																																																									
• 54"W	48 1/16"W	54"W																																																									
• 58"W	N.A.																																																										
• 60"W	54 1/16"W	60"W																																																									
• 66"W	60 1/16"W	66"W																																																									
• 70"W	66 1/16"W	70"W																																																									
Height	<table border="1"> <thead> <tr> <th colspan="2">Modular</th> <th colspan="2">Parametric</th> </tr> </thead> <tbody> <tr> <td>• 24"H</td> <td>24"H</td> <td></td> <td></td> </tr> <tr> <td>• 30"H</td> <td>24 1/2"H</td> <td>30"H</td> <td></td> </tr> </tbody> </table>	Modular		Parametric		• 24"H	24"H			• 30"H	24 1/2"H	30"H		Prices at right Prices at right	Specify height. Specify height.																																												
Modular		Parametric																																																									
• 24"H	24"H																																																										
• 30"H	24 1/2"H	30"H																																																									
Privacy Height	<table border="1"> <thead> <tr> <th>Screen Height</th> <th>Minimum Privacy Height</th> <th>Maximum Privacy Height</th> <th></th> </tr> </thead> <tbody> <tr><td>• 24"H</td><td>9"H</td><td>16 1/2"H</td><td>No cost</td></tr> <tr><td>• 24 1/2"H</td><td>9 1/2"H</td><td>17"H</td><td>No cost</td></tr> <tr><td>• 25"H</td><td>10"H</td><td>17 1/2"H</td><td>No cost</td></tr> <tr><td>• 25 1/2"H</td><td>10 1/2"H</td><td>18"H</td><td>No cost</td></tr> <tr><td>• 26"H</td><td>11"H</td><td>18 1/2"H</td><td>No cost</td></tr> <tr><td>• 26 1/2"H</td><td>11 1/2"H</td><td>19"H</td><td>No cost</td></tr> <tr><td>• 27"H</td><td>12"H</td><td>19 1/2"H</td><td>No cost</td></tr> <tr><td>• 27 1/2"H</td><td>12 1/2"H</td><td>20"H</td><td>No cost</td></tr> <tr><td>• 28"H</td><td>13"H</td><td>20 1/2"H</td><td>No cost</td></tr> <tr><td>• 28 1/2"H</td><td>13 1/2"H</td><td>21"H</td><td>No cost</td></tr> <tr><td>• 29"H</td><td>14"H</td><td>21 1/2"H</td><td>No cost</td></tr> <tr><td>• 29 1/2"H</td><td>14 1/2"H</td><td>22"H</td><td>No cost</td></tr> <tr><td>• 30"H</td><td>15"H</td><td>22 1/2"H</td><td>No cost</td></tr> </tbody> </table>	Screen Height	Minimum Privacy Height	Maximum Privacy Height		• 24"H	9"H	16 1/2"H	No cost	• 24 1/2"H	9 1/2"H	17"H	No cost	• 25"H	10"H	17 1/2"H	No cost	• 25 1/2"H	10 1/2"H	18"H	No cost	• 26"H	11"H	18 1/2"H	No cost	• 26 1/2"H	11 1/2"H	19"H	No cost	• 27"H	12"H	19 1/2"H	No cost	• 27 1/2"H	12 1/2"H	20"H	No cost	• 28"H	13"H	20 1/2"H	No cost	• 28 1/2"H	13 1/2"H	21"H	No cost	• 29"H	14"H	21 1/2"H	No cost	• 29 1/2"H	14 1/2"H	22"H	No cost	• 30"H	15"H	22 1/2"H	No cost	No cost No cost No cost No cost No cost No cost No cost No cost No cost No cost No cost No cost	Specify privacy height. Specify privacy height. Specify privacy height. Specify privacy height. Specify privacy height. Specify privacy height. Specify privacy height. Specify privacy height. Specify privacy height. Specify privacy height. Specify privacy height. Specify privacy height.
Screen Height	Minimum Privacy Height	Maximum Privacy Height																																																									
• 24"H	9"H	16 1/2"H	No cost																																																								
• 24 1/2"H	9 1/2"H	17"H	No cost																																																								
• 25"H	10"H	17 1/2"H	No cost																																																								
• 25 1/2"H	10 1/2"H	18"H	No cost																																																								
• 26"H	11"H	18 1/2"H	No cost																																																								
• 26 1/2"H	11 1/2"H	19"H	No cost																																																								
• 27"H	12"H	19 1/2"H	No cost																																																								
• 27 1/2"H	12 1/2"H	20"H	No cost																																																								
• 28"H	13"H	20 1/2"H	No cost																																																								
• 28 1/2"H	13 1/2"H	21"H	No cost																																																								
• 29"H	14"H	21 1/2"H	No cost																																																								
• 29 1/2"H	14 1/2"H	22"H	No cost																																																								
• 30"H	15"H	22 1/2"H	No cost																																																								
Worksurface Type	For screens 60"W or greater <ul style="list-style-type: none"> • Without scallop • With scallop 	No cost +\$59	Specify <i>without scallop</i> . Specify <i>with scallop</i> .																																																								
Screen Type	<ul style="list-style-type: none"> • Rear screen • Side screen 	No cost No cost	Specify <i>with rear screen</i> . Specify <i>with side screen</i> .																																																								

Sarto Privacy Screens

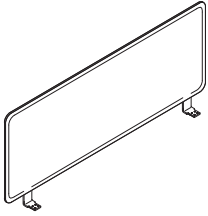

Standard Includes	Required to Specify
-------------------	---------------------

<ul style="list-style-type: none"> ▶ Need help? Product details, page 98 	<ul style="list-style-type: none"> • Screen: fabric price group 1 • Brackets and hard stops: 7360 Merle 	<ol style="list-style-type: none"> 1 Style number 2 Size option (see below under Required Selections) 3 Width (see below under Required Selections) 4 Height (see below under Required Selections) 5 Screen type (see below under Required Selections) 6 Fabric color number for screen 7 Options, if selected (see below) <ul style="list-style-type: none"> ▶ See <i>Surface Materials</i>, page 358.
---	---	---

Size Option	Required Selections	U.S. Price	Required to Specify
-------------	---------------------	------------	---------------------

Size Option	<ul style="list-style-type: none"> • Modular • Parametric 	<p>No cost</p> <p>No cost</p>	<p>Specify <i>with modular</i>.</p> <p>Specify <i>with parametric</i>.</p>
--------------------	---	-------------------------------	--

Width	Modular	Parametric	U.S. Price	Required to Specify
-------	---------	------------	------------	---------------------

Width	<ul style="list-style-type: none"> • 24"W • 29"W • 30"W • 36"W • 42"W • 46"W • 48"W • 54"W • 58"W • 60"W • 66"W • 70"W • 72"W • 78"W • 84"W • 90"W • 96"W 	<ul style="list-style-type: none"> • 24"W • N.A. • 24¹/₁₆"W–30"W • 30¹/₁₆"W–36"W • 36¹/₁₆"W–42"W • N.A. • 42¹/₁₆"W–48"W • 48¹/₁₆"W–54"W • N.A. • 54¹/₁₆"W–60"W • 60¹/₁₆"W–66"W • N.A. • 66¹/₁₆"W–72"W • 72¹/₁₆"W–78"W • 78¹/₁₆"W–84"W • 84¹/₁₆"W–90"W • 90¹/₁₆"W–96"W 	<p>Prices at right</p> <p>Prices at right</p> <p>Prices at right</p> <p>Prices at right</p> <p>Prices at right</p> <p>Prices at right</p> <p>Prices at right</p> <p>Prices at right</p> <p>Prices at right</p> <p>Prices at right</p> <p>Prices at right</p> <p>Prices at right</p> <p>Prices at right</p> <p>Prices at right</p> <p>Prices at right</p> <p>Prices at right</p>	<p>Specify width.</p> <p>Specify width.</p> <p>Specify width.</p> <p>Specify width.</p> <p>Specify width.</p> <p>Specify width.</p> <p>Specify width.</p> <p>Specify width.</p> <p>Specify width.</p> <p>Specify width.</p> <p>Specify width.</p> <p>Specify width.</p> <p>Specify width.</p> <p>Specify width.</p> <p>Specify width.</p>
--------------	--	--	---	---

Height	Modular	Parametric	U.S. Price	Required to Specify
--------	---------	------------	------------	---------------------

Height	<ul style="list-style-type: none"> • 13¹/₂"H • 19¹/₂"H • 23¹/₂"H • N.A. • 35¹/₂"H 	<ul style="list-style-type: none"> • 13¹/₂"H • 14"H–19¹/₂"H • 20"H–24"H • 24¹/₂"H–30"H • 30¹/₂"H–35¹/₂"H 	<p>Prices at right</p> <p>Prices at right</p> <p>Prices at right</p> <p>Prices at right</p> <p>Prices at right</p>	<p>Specify height.</p> <p>Specify height.</p> <p>Specify height.</p> <p>Specify height.</p> <p>Specify height.</p>
---------------	--	---	--	--

Screen Type	Required Selections	U.S. Price	Required to Specify
-------------	---------------------	------------	---------------------

Screen Type	<ul style="list-style-type: none"> • Rear screen • Side screen 	<p>No cost</p> <p>No cost</p>	<p>Specify <i>with rear screen</i>.</p> <p>Specify <i>with side screen</i>.</p>
--------------------	--	-------------------------------	---

Surface Materials	Options	U.S. Price	Required to Specify
-------------------	---------	------------	---------------------

Surface Materials	<ul style="list-style-type: none"> • Fabric price group 2 • Fabric price group 3 • Fabric price group 4 • Fabric price group 5 • Fabric price group 6 • Fabric price group 7 • Fabric price group 8 • Fabric price group 9 • Fabric price group 10 • Customer's Own Material (COM) 	<p>+\$ 53</p> <p>+\$142</p> <p>+\$178</p> <p>+\$219</p> <p>+\$256</p> <p>+\$296</p> <p>+\$332</p> <p>+\$371</p> <p>+\$408</p> <p>+\$ 25</p>	<p>Specify fabric color number.</p> <p>Specify fabric color number.</p> <p>Specify fabric color number.</p> <p>Specify fabric color number.</p> <p>Specify fabric color number.</p> <p>Specify fabric color number.</p> <p>Specify fabric color number.</p> <p>Specify fabric color number.</p> <p>Specify fabric color number.</p> <p>Specify fabric color number.</p> <p>▶ See <i>Surface Materials Reference Manual</i>.</p>
--------------------------	--	---	---

Attachment Brackets	Required Selections	U.S. Price	Required to Specify
---------------------	---------------------	------------	---------------------

Attachment Brackets	<ul style="list-style-type: none"> • No brackets • Migration side knife attachment bracket 	<p>No cost</p> <p>+\$ 16</p>	<p>Specify <i>with no brackets</i>.</p> <p>Specify <i>with Migration side knife attachment bracket</i>.</p>
----------------------------	--	------------------------------	---

Tip: Side screen option changes brackets to offset bayonet brackets maintaining adequate side to side pinch points. Side screen option is only available on screens 36"W and narrower.

Tip: To install 24"-30"W side screens on the Migration Pro desks (**HA2** or **HA3**) with knife edge, the Migration side knife attachment bracket option must be specified.

For Canadian Pricing
 Multiply U.S. Price by the Canadian price factor.
 ▶ See page 1 for details.

Specification Information

Style Number	Parametric Height	Modular Width	U.S. Base Prices													
			24"W	29"W or 30"W	36"W	42"W	46"W or 48"W	54"W	58"W or 60"W	66"W	70"W or 72"W	78"W	84"W	90"W	96"W	
		Parametric Width	24"W	24½"W	30½"W	36½"W	42½"W	48½"W	54½"W	60½"W	66½"W	72½"W	78½"W	84½"W	90½"W	96"W

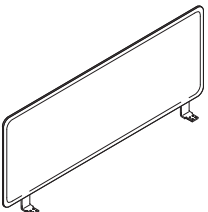

PSPS	Height	24"W	29"W or 30"W	36"W	42"W	46"W or 48"W	54"W	58"W or 60"W	66"W	70"W or 72"W	78"W	84"W	90"W	96"W
	13½"	\$348	\$373	\$400	\$424	\$450	\$479	\$504	\$530	\$ 556	\$ 601	\$ 626	\$ 653	\$ 678
	14"–19½"	\$397	\$438	\$479	\$519	\$559	\$599	\$639	\$678	\$ 723	\$ 789	\$ 826	\$ 871	\$ 909
	20"–24"	\$485	\$519	\$554	\$587	\$620	\$656	\$691	\$728	\$ 763	\$ 807	\$ 850	\$ 894	\$ 937
	24½"–30"	\$663	\$697	\$730	\$763	\$798	\$835	\$871	\$907	\$ 940	\$ 987	\$1041	\$1095	\$1159
	30½"–35½"	\$752	\$788	\$820	\$853	\$887	\$922	\$958	\$993	\$1031	\$1074	\$1121	\$1170	\$1219

Boundary, Worksurface, and Beam Screens

 **For Canadian Pricing**
 Multiply U.S. Price by the Canadian price factor.
 ▶ See page 1 for details.

Sarto Alignment Bracket

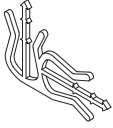

Tip: Alignment bracket is for use with Sarto privacy or Sarto privacy/modesty screens.

Tip: Alignment bracket is for Sarto screens in perpendicular applications.

Standard Includes	Required to Specify
-------------------	---------------------

- | | | |
|---|--|---------------------|
| <ul style="list-style-type: none"> ▶ Need help? Product details, page 98 | <ul style="list-style-type: none"> • Alignment bracket: translucent plastic | <p>Style number</p> |
|---|--|---------------------|

Specification Information	
---------------------------	--

Style Number	U.S. Price
PSCB	\$7
:	:



For Canadian Pricing

Multiply U.S. Price by the Canadian price factor.

▶ See page 1 for details.

Divisio Side Screen



Tip: The Divisio side screen can be used on any 3/4"- to 1 1/2"-thick worksurface.

Tip: The Divisio side screen has an overhang of 8". This is important when planning for returns or storage.

Tip: The Divisio side screen weighs approximately 14 1/2 pounds. Take this into consideration when planning for use on height-adjustable worksurfaces.

Tip: The Divisio side screen is intended for use on the front of a worksurface.

Tip: The Divisio side screen does not work on knife edge profiles.

Standard Includes		Required to Specify
▶ Need help? Product details, page 100	<ul style="list-style-type: none"> Screen: fabric price group A Top cap and clamp: 4799 Platinum paint 	1 Style number 2 Fabric color number ▶ See <i>Surface Materials Reference Manual</i> .

Options	U.S. Price	Required to Specify
Surface Materials		
Fabric		
• Fabric price group A	No cost	Specify fabric color number.
• Fabric price group 1	No cost	Specify fabric color number.
• Fabric price group 2	+\$ 23	Specify fabric color number.
• Fabric price group 3	+\$ 42	Specify fabric color number.
• Fabric price group 4	+\$ 61	Specify fabric color number.
• Fabric price group 5	+\$ 94	Specify fabric color number.
• Fabric price group 6	+\$ 425	Specify fabric color number.
• Fabric price group 7	+\$ 573	Specify fabric color number.
• Fabric price group 8	+\$ 730	Specify fabric color number.
• Fabric price group 9	+\$ 868	Specify fabric color number.
• Fabric price group 10	+\$1015	Specify fabric color number.
• Customer's Own Material (COM)	+\$ 25	▶ See <i>Surface Materials Reference Manual</i> .

Specification Information			
Dimensions		Style	U.S.
D	H	Number	Base Price
29 1/2"	11 5/8"	DVSS2912	\$552

Boundary, Worksurface, and Beam Screens

 **For Canadian Pricing**
 Multiply U.S. Price by the Canadian price factor.
 ▶ See page 1 for details.

Specifying Universal Systems Worksurfaces and Supports

Worksurfaces

Parametric Straight Worksurfaces	254
Parametric Straight Worksurfaces with Soft Edge Profile	258
120° Straight Worksurface	262
Tapered Worksurfaces	264
Taper-Flat Worksurfaces	265
Single-Tapered Worksurfaces	266
Corner, 120° Worksurfaces	267

Power and Data Access Door and Tray	268
--	------------

Grommets	270
-----------------	------------

Beam-Mounted Universal Systems Worksurface Supports	272
--	------------

FrameOne Legs and Supports for Universal Worksurfaces	274
--	------------

Infills for FrameOne Legs for Universal Worksurfaces	275
---	------------

Post Legs and Double Post Leg	276
--------------------------------------	------------

► Options, continued from previous page

	Options	U.S. Price	Required to Specify	
Surface Materials, continued	Door			
	• Paint • Anodized aluminum	No cost +\$ 14	Specify paint color number. Specify with 8043 Clear Anodized Aluminum.	
Cord Drop	• No cord drop • 1/2" cord drop	No cost No cost	Specify without cord drop. Specify with 1/2" cord drop.	
	Scallop	• Scallop • Omit scallop	No cost No cost	Specify with scallop. Specify with no scallop.
Cutout for Power and Data Access Door and Tray	Applies to 48"W to 120"W • Cutout	No cost	Specify with cutout for power and data access door.	
Power Access Door	Applies to 30"W to 35¹⁵/₁₆"W			
	• No power access • Power access door center	No cost +\$148	Specify with no power access. Specify with power access door center.	
	Applies to 36"W to 51¹⁵/₁₆"W			
	• No power access • Power access door center • Power access door left • Power access door right	No cost +\$148 +\$148 +\$148	Specify with no power access. Specify with power access door center. Specify with power access door left. Specify with power access door right.	
Power Access Door	Applies to 52"W to 71¹⁵/₁₆"W			
	• No power access • Power access door center • Power access door left • Power access door right • Power access door left and right	No cost +\$148 +\$148 +\$148 +\$296	Specify with no power access. Specify with power access door center. Specify with power access door left. Specify with power access door right. Specify with power access door left and right.	
	Applies to 72"W to 120"W			
	• No power access • Power access door center • Power access door left • Power access door right • Power access door left and right • Power access door left and center • Power access door right and center • Power access door left, right, and center	No cost +\$148 +\$148 +\$148 +\$296 +\$296 +\$296 +\$444	Specify with no power access. Specify with power access door center. Specify with power access door left. Specify with power access door right. Specify with power access door left. Specify with power access door left and center. Specify with power access door right and center. Specify with power access door left, right, and center.	
Grommet Cutout	• No grommet cutout • 2 inch grommet cutout • 3 inch grommet cutout	No cost No cost No cost	Specify with no grommet cutout. Specify with 2 inch grommet cutout. Specify with 3 inch grommet cutout.	
	Grommet Location	Applies to 18"W to 24¹⁵/₁₆"W • Center	No cost No cost	Specify with center grommet.
	Applies to 25"W to 33¹⁵/₁₆"W			
Grommet Location	• Center • Left • Right • Right and left	No cost No cost No cost No cost	Specify with center grommet. Specify with left grommet. Specify with right grommet. Specify with right and left grommet.	
	Applies to 34"W to 120"W			
	• Center • Left • Right • Right and left • Left and center • Right and center • Right, left, and center	No cost No cost No cost No cost No cost No cost No cost	Specify with center grommet. Specify with left grommet. Specify with right grommet. Specify with right and left grommet. Specify with left and center grommet. Specify with right and center grommet. Specify with right, left, and center grommet.	

Tip: When selecting with cord drop, subtract 1/2" from depth.

Tip: Scallop is available in the center location only. If cutout for power and data access door and tray or power access door is selected, scallop will default to omit scallop.

Tip: Power and data access door and tray is ordered separately to be used with cutout.

► Page 268

► See page 126 for worksurface size availability matrix.

Tip: Cutout for power and data access door and tray is available in the center location only. Worksurface depth must be greater than 24".

Tip: Power access door option is only available on straight worksurfaces with 1/2" cord drop.

Tip: Power access door option includes the power access door and a cutout for the door in the worksurface.

Tip: If cutout for power and data access door and tray or power access door is selected, grommet will default to no grommet.



For Canadian Pricing
Multiply U.S. Price by the Canadian price factor.

► See page 1 for details.

► Options, continued on next page

► Options, continued from previous page

Related Products

- Beam-mounted Universal Systems worksurface supports ► Page 272
- Reinforcing channel ► Page 273
- Legs and supports for Universal Systems Worksurfaces ► Pages 274–278
- Worksurface screens ► Pages 238–251
- Worksurface power and communication components ► Page 199
- 2½" round grommet ► Page 270
- 3" grommet package ► Page 270

Specification Information

Style Number	Dimensions		U.S. Base Prices						
	Modular Depth	Parametric Depth	Modular Width	18"W	24"W	30"W	36"W	42"W	48"W
					Parametric Width	18"W–23½" W	24"W–29½" W	30"W–35½" W	36"W–41½" W

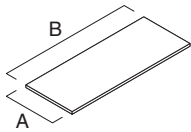

Tip: Dimension A = depth and dimension B = width.

Tip: Side and back edges of worksurface default to a flat profile.

Tip: Worksurfaces greater than 30"D can only be used in freestanding applications.

3 mm Edge Profile—Laminate

USWS	18 7/8"D	18"D–23 7/16"D	\$ 253	\$ 275	\$ 299	\$ 320	\$ 346	\$ 418
	24"D	23 1/2"D–29 7/16"D	\$ 287	\$ 306	\$ 330	\$ 346	\$ 376	\$ 444
	30"D	29 1/2"D–35 7/16"D	\$ 411	\$ 433	\$ 448	\$ 481	\$ 503	\$ 573
	36"D	35 1/2"D–36"D	\$ 494	\$ 513	\$ 536	\$ 557	\$ 583	\$ 654

Knife Edge Profile—Laminate

USWSK	18 7/8"D	18"D–23 7/16"D	\$ 385	\$ 405	\$ 428	\$ 450	\$ 509	\$ 578
	24"D	23 1/2"D–29 7/16"D	\$ 418	\$ 436	\$ 463	\$ 478	\$ 536	\$ 607
	30"D	29 1/2"D–35 7/16"D	\$ 543	\$ 562	\$ 579	\$ 614	\$ 665	\$ 735
	36"D	35 1/2"D–36"D	\$ 625	\$ 646	\$ 665	\$ 686	\$ 744	\$ 813

Square Edge Profile—Composite Veneer

USWSSW	18 7/8"D	18"D–23 7/16"D	\$1016	\$1070	\$1090	\$1115	\$1271	\$1343
	24"D	23 1/2"D–29 7/16"D	\$1048	\$1102	\$1123	\$1142	\$1299	\$1370
	30"D	29 1/2"D–35 7/16"D	\$1172	\$1227	\$1242	\$1274	\$1432	\$1502
	36"D	35 1/2"D–36"D	\$1416	\$1472	\$1491	\$1530	\$1715	\$1802

Square Edge Profile—Wood

USWSSW	18 7/8"D	18"D–23 7/16"D	\$1096	\$1150	\$1170	\$1195	\$1364	\$1436
	24"D	23 1/2"D–29 7/16"D	\$1128	\$1182	\$1203	\$1222	\$1392	\$1463
	30"D	29 1/2"D–35 7/16"D	\$1252	\$1307	\$1322	\$1354	\$1525	\$1595
	36"D	35 1/2"D–36"D	\$1512	\$1568	\$1587	\$1626	\$1830	\$1917

► Specifying, continued on next page

For Canadian Pricing
 Multiply U.S. Price by the Canadian price factor.
 ► See page 1 for details.

► Specifying, continued from previous page

54"W	60"W	66"W	72"W	78"W	84"W	90"W	96"W	102"W	108"W	114"W	120"W
54"W-	60"W-	66"W-	72"W-	78"W-	84"W-	90"W-	96"W-	102"W-	108"W-	114"W-	120"W
59 ¹⁵ / ₁₆ "W	65 ¹⁵ / ₁₆ "W	71 ¹⁵ / ₁₆ "W	77 ¹⁵ / ₁₆ "W	83 ¹⁵ / ₁₆ "W	89 ¹⁵ / ₁₆ "W	95 ¹⁵ / ₁₆ "W	101 ¹⁵ / ₁₆ "W	107 ¹⁵ / ₁₆ "W	113 ¹⁵ / ₁₆ "W	119 ¹⁵ / ₁₆ "W	
\$ 446	\$ 481	\$ 559	\$ 625	\$ 798	\$ 841	\$ 891	\$ 933	\$ 977	\$1022	\$1064	\$1107
\$ 477	\$ 503	\$ 564	\$ 631	\$ 845	\$ 941	\$ 971	\$1039	\$1085	\$1133	\$1179	\$1224
\$ 616	\$ 654	\$ 710	\$ 778	\$1002	\$1048	\$1092	\$1134	\$1176	\$1221	\$1263	\$1309
\$ 685	\$ 710	\$ 770	\$ 835	\$1048	\$1258	\$1309	\$1361	\$1413	\$1465	\$1515	\$1570
\$ 608	\$ 675	\$ 756	\$ 819	\$1011	\$1052	\$1101	\$1144	\$1202	\$1248	\$1289	\$1334
\$ 635	\$ 702	\$ 764	\$ 828	\$1055	\$1147	\$1184	\$1251	\$1311	\$1357	\$1404	\$1453
\$ 775	\$ 852	\$ 907	\$ 975	\$1215	\$1259	\$1300	\$1344	\$1402	\$1446	\$1492	\$1533
\$ 848	\$ 907	\$ 962	\$1033	\$1259	\$1466	\$1519	\$1573	\$1639	\$1692	\$1742	\$1795
\$1373	\$1571	\$1652	\$1715	\$1850	\$2084	\$2128	\$2179	\$2256	\$2299	\$2342	\$2421
\$1402	\$1597	\$1658	\$1723	\$1868	\$2118	\$2210	\$2246	\$2345	\$2395	\$2441	\$2521
\$1541	\$1747	\$1804	\$1871	\$2028	\$2288	\$2334	\$2376	\$2455	\$2499	\$2541	\$2621
\$1850	\$2095	\$2166	\$2249	\$2434	\$2746	\$2802	\$2853	\$2945	\$2998	\$3054	\$3146
\$1466	\$1681	\$1762	\$1825	\$1960	\$2208	\$2252	\$2303	\$2384	\$2427	\$2470	\$2549
\$1495	\$1707	\$1768	\$1833	\$1978	\$2242	\$2334	\$2370	\$2473	\$2523	\$2569	\$2649
\$1634	\$1857	\$1914	\$1981	\$2138	\$2412	\$2458	\$2500	\$2583	\$2627	\$2669	\$2749
\$1965	\$2236	\$2307	\$2390	\$2575	\$2895	\$2951	\$3002	\$3098	\$3151	\$3207	\$3299

Universal Systems Worksurfaces



For Canadian Pricing

Multiply U.S. Price by the Canadian price factor.

► See page 1 for details.

Parametric Straight Worksurfaces with Soft Edge Profile

High-Pressure Laminate, Composite Veneer, or Wood Veneer

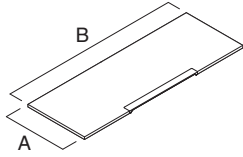

▶ Need help?
Product details,
page 122

Standard Includes

- Worksurface: High-Pressure Laminate price group 1 or composite veneer price group 1
- Laminate worksurface:
 - Plastic soft edge profile centered on worksurface
 - Plastic 3 mm edge profile on front edge
 - Plastic default flat profile on side and back edges
- Composite worksurface:
 - Plastic soft edge centered on worksurface
 - Composite square edge profile on front edge
 - Matching composite veneer flat profile on side and back edges
- Depth: 18"D–36"D
- Width: 18"W–120"W

Required to Specify

- 1 Style number
 - 2 Worksurface size type (see below under Required Selections)
 - 3 Depth (see below under Required Selections)
 - 4 Width (see below under Required Sections)
 - 5 User edge profile (see below)
 - 6 High-Pressure Laminate or composite veneer color number for worksurface
 - 7 Plastic color number for front edge on laminate worksurface, if selected
 - 8 Options, if selected (see below)
- ▶ See *Surface Materials*, page 358.

Tip: Long worksurface spans require additional support.
▶ See understanding section for details, page 117

	Required Selections	U.S. Price	Required to Specify
Worksurface Size Type	<ul style="list-style-type: none"> • Modular • Parametric 	No cost No cost	Specify with modular. Specify with parametric.

Depth	Modular	Parametric	U.S. Price	Required to Specify
	<ul style="list-style-type: none"> • 18⁷/₈"D • 24"D • 30"D • 36"D 	<ul style="list-style-type: none"> 18"D–23⁷/₁₆"D 23¹/₂"D–29⁷/₁₆"D 29¹/₂"D–35⁷/₁₆"D 35¹/₂"D–36"D 		

Width	Modular	Parametric	U.S. Price	Required to Specify
	<ul style="list-style-type: none"> • 48"W • 54"W • 60"W • 66"W • 72"W • 78"W • 84"W • 90"W • 96"W • 102"W • 108"W • 114"W • 120"W 	<ul style="list-style-type: none"> 48"W–53¹⁵/₁₆"W 54"W–59¹⁵/₁₆"W 60"W–65¹⁵/₁₆"W 66"W–71¹⁵/₁₆"W 72"W–77¹⁵/₁₆"W 78"W–83¹⁵/₁₆"W 84"W–89¹⁵/₁₆"W 90"W–95¹⁵/₁₆"W 96"W–101¹⁵/₁₆"W 102"W–107¹⁵/₁₆"W 108"W–113¹⁵/₁₆"W 114"W–119¹⁵/₁₆"W 120"W 		

For composite veneer price group 2, wood and laminate group 2 and 3 pricing, please refer to the electronic catalog or SmartTools.

	Options	U.S. Price	Required to Specify
--	---------	------------	---------------------

Surface Materials	High-Pressure Laminate worksurfaces		
	<ul style="list-style-type: none"> • Laminate price group 2 • Laminate price group 3 • Open Line laminate 	See information at left See information at left +\$111 plus cost of laminate	Specify laminate color number. Specify laminate color number. ▶ See <i>Surface Materials Reference Manual</i> .

	Composite veneer worksurfaces		
	<ul style="list-style-type: none"> • Composite veneer group 1 • Composite veneer group 2 	Prices at right See information at left	Specify composite veneer color number. Specify composite veneer color number.

	Wood veneer worksurfaces		
	<ul style="list-style-type: none"> • Wood group 1 • Wood group 2 • Wood group 3 • Customiz stain 	See information at left See information at left See information at left No cost	Specify wood color number. Specify wood color number. Specify wood color number. Specify with Customiz stain. ▶ See <i>Surface Materials Reference Manual</i> .

	Wood grain direction		
	<ul style="list-style-type: none"> • No direction • Long grain • Short grain 	No cost No cost No cost	Specify with no direction. Specify with long grain direction. Specify with short grain direction.

▶ Options, continued on next page

Tip: Short grain laminate is only available on surfaces 60"W or less.

► Options, continued from previous page

	Options	U.S. Price	Required to Specify
Surface Materials, continued	Door		
	• Paint • Anodized aluminum	No cost +\$ 14	Specify paint color number. Specify with 8043 Clear Anodized Aluminum.
Cord Drop	• No cord drop • 1/2" cord drop	No cost No cost	Specify without cord drop. Specify with 1/2" cord drop.
Scallop	• Scallop • Omit scallop	No cost No cost	Specify with scallop. Specify with no scallop.
Cutout for Power and Data Access Door and Tray	Applies to 48"W to 120"W • Cutout	No cost	Specify with cutout for power and data access door.
Power Access Door	Applies to 48"W to 51¹⁵/₁₆"W		
	• No power access • Power access door center • Power access door left • Power access door right	No cost +\$148 +\$148 +\$148	Specify with no power access. Specify with power access door center. Specify with power access door left. Specify with power access door right.
	Applies to 52"W to 71¹⁵/₁₆"W		
	• No power access • Power access door center • Power access door left • Power access door right • Power access door left and right	No cost +\$148 +\$148 +\$148 +\$296	Specify with no power access. Specify with power access door center. Specify with power access door left. Specify with power access door right. Specify with power access door left and right.
	Applies to 72"W to 120"W		
	• No power access • Power access door center • Power access door left • Power access door right • Power access door left and right • Power access door left and center • Power access door right and center • Power access door left, right, and center	No cost +\$148 +\$148 +\$148 +\$296 +\$296 +\$296 +\$444	Specify with no power access. Specify with power access door center. Specify with power access door left. Specify with power access door right. Specify with power access door left and right. Specify with power access door left and center. Specify with power access door right and center. Specify with power access door left, right, and center.
Grommet Cutout	• No grommet cutout • 2 inch grommet cutout • 3 inch grommet cutout	No cost No cost No cost	Specify with no grommet cutout. Specify with 2 inch grommet cutout. Specify with 3 inch grommet cutout.
Grommet Location	Applies to 48"W to 120"W • Center • Left • Right • Right and left • Left and center • Right and center • Right, left, and center	No cost No cost No cost No cost No cost No cost No cost	Specify with center grommet. Specify with left grommet. Specify with right grommet. Specify with right and left grommet. Specify with left and center grommet. Specify with right and center grommet. Specify with right, left, and center grommet.
Related Products	• Beam-mounted Universal Systems worksurface supports • Reinforcing channel • Legs and supports for Universal Systems Worksurfaces • Worksurface screens • Worksurface power and communication components • 2 1/2" round grommet • 3" grommet package		► Page 272 ► Page 273 ► Pages 274–278 ► Pages 238–251 ► Page 199 ► Page 270 ► Page 270

Tip: When selecting with cord drop, subtract 1/2" from depth.

Tip: Scallop is available in the center location only. If cutout for power and data access door and tray or power access door is selected, scallop will default to omit scallop.

Tip: Power and data access door and tray is ordered separately to be used with cutout.

► Page 268

► See page 126 for worksurface size availability matrix.

Tip: Cutout for power and data access door and tray is available in the center location only. Worksurface depth must be greater than 24".

Tip: Power access door option is only available on straight worksurfaces with 1/2" cord drop.

Tip: Power access door option includes the power access door and a cutout for the door in the worksurface.

Tip: If cutout for power and data access door and tray or power access door is selected, grommet will default to no grommet.

► Specification Information, on next page



For Canadian Pricing

Multiply U.S. Price by the Canadian price factor.

► See page 1 for details.

Parametric Straight Worksurfaces with Soft Edge Profile, High-Pressure Laminate, Composite Veneer, or Wood Veneer, continued

► Options, on previous page

Specification Information

• Style Number	• Dimensions		• U.S. Base Prices					
	Modular Depth	Parametric Depth		Modular Width	48"W	54"W	60"W	66"W
			Parametric Width	48"W–53 ¹⁵ / ₁₆ "W	54"W–59 ¹⁵ / ₁₆ "W	60"W–65 ¹⁵ / ₁₆ "W	66"W–71 ¹⁵ / ₁₆ "W	72"W–77 ¹⁵ / ₁₆ "W

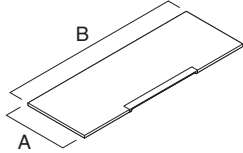

Tip: Dimension A = depth and dimension B = width.

Tip: Side and back edges of worksurface default to a flat profile.

Tip: Worksurfaces greater than 30"D can only be used in freestanding applications.

3 mm Edge Profile—Laminate

uswss	18 ⁷ / ₈ "D	18"D–23 ⁷ / ₁₆ "D	\$ 944	\$ 971	\$1006	\$1081	\$1147
	24"D	23 ¹ / ₂ "D – 29 ⁷ / ₁₆ "D	\$ 967	\$1000	\$1030	\$1093	\$1156
	30"D	29 ¹ / ₂ "D – 35 ⁷ / ₁₆ "D	\$1099	\$1139	\$1179	\$1232	\$1303
	36"D	35 ¹ / ₂ "D – 36"D	\$1257	\$1287	\$1320	\$1380	\$1446

Square Edge Profile—Composite Veneer

uswssws	18 ⁷ / ₈ "D	18"D–23 ⁷ / ₁₆ "D	\$1871	\$1899	\$2101	\$2183	\$2246
	24"D	23 ¹ / ₂ "D – 29 ⁷ / ₁₆ "D	\$1897	\$1931	\$2125	\$2189	\$2253
	30"D	29 ¹ / ₂ "D – 35 ⁷ / ₁₆ "D	\$2029	\$2071	\$2277	\$2334	\$2402
	36"D	35 ¹ / ₂ "D – 36"D	\$2329	\$2377	\$2624	\$2692	\$2776

Square Edge Profile—Wood

uswssws	18 ⁷ / ₈ "D	18"D–23 ⁷ / ₁₆ "D	\$1964	\$1992	\$2210	\$2293	\$2356
	24"D	23 ¹ / ₂ "D – 29 ⁷ / ₁₆ "D	\$1990	\$2024	\$2235	\$2299	\$2363
	30"D	29 ¹ / ₂ "D – 35 ⁷ / ₁₆ "D	\$2122	\$2164	\$2387	\$2444	\$2512
	36"D	35 ¹ / ₂ "D – 36"D	\$2437	\$2485	\$2755	\$2823	\$2907

► Specifying, continued on next page

 **For Canadian Pricing**
 Multiply U.S. Price by the Canadian price factor.
 ► See page 1 for details.

► Specifying, continued from previous page

78"W	84"W	90"W	96"W	102"W	108"W	114"W	120"W
78"W-	84"W-	90"W-	96"W-	102"W-	108"W-	114"W-	120"W
83 ¹⁵ / ₁₆ "W	89 ¹⁵ / ₁₆ "W	95 ¹⁵ / ₁₆ "W	101 ¹⁵ / ₁₆ "W	107 ¹⁵ / ₁₆ "W	113 ¹⁵ / ₁₆ "W	119 ¹⁵ / ₁₆ "W	
\$1323	\$1366	\$1417	\$1458	\$1504	\$1546	\$1589	\$1630
\$1370	\$1461	\$1497	\$1564	\$1611	\$1657	\$1703	\$1751
\$1529	\$1573	\$1615	\$1658	\$1702	\$1746	\$1789	\$1836
\$1573	\$1782	\$1836	\$1883	\$1938	\$1992	\$2045	\$2093
\$2377	\$2611	\$2659	\$2706	\$2784	\$2826	\$2872	\$2947
\$2399	\$2648	\$2741	\$2774	\$2875	\$2922	\$2972	\$3054
\$2556	\$2817	\$2860	\$2908	\$2985	\$3028	\$3069	\$3149
\$2965	\$3276	\$3330	\$3380	\$3474	\$3526	\$3581	\$3672
\$2487	\$2735	\$2783	\$2830	\$2913	\$2955	\$3001	\$3076
\$2509	\$2772	\$2865	\$2898	\$3004	\$3051	\$3101	\$3183
\$2666	\$2941	\$2984	\$3032	\$3114	\$3157	\$3198	\$3278
\$3096	\$3426	\$3480	\$3530	\$3628	\$3680	\$3735	\$3826

Universal Systems
Worksurfaces



For Canadian Pricing

Multiply U.S. Price by the Canadian price factor.

► See page 1 for details.

120° Straight Worksurfaces

High-Pressure Laminate

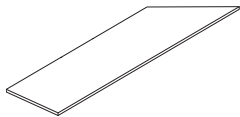

Tip: Supports for freestanding and beam-mounted applications must be specified separately.

For laminate group 2 and 3 pricing, please refer to the electronic catalog or SmartTools.

Tip: Long worksurface spans require additional support. ▶ See understanding section for details, page 117.

Tip: Power and data access door and tray is ordered separately to be used with cutout.

▶ Page 268
▶ See page 126 for worksurface size availability matrix.

Tip: When facing the user edge, the side the diagonal is on is the handed side.

Tip: Power access door option includes the power access door and a cutout for the door in the worksurface.

Standard Includes		Required to Specify	
▶ Need help? Product details, page 118	<ul style="list-style-type: none"> • Worksurface: High-Pressure Laminate price group 1 • Laminate worksurface: <ul style="list-style-type: none"> –Plastic 3 mm edge profile on front edge –Plastic default flat profile on side and back edges • Cable scallop on back edge 	<ol style="list-style-type: none"> 1 Style number 2 High-Pressure Laminate color number for worksurface 3 Plastic color number for front edge on laminate worksurface 4 Options, if selected (see below) 	▶ See <i>Surface Materials</i> , page 358.
Options	U.S. Price	Required to Specify	
Surface Materials	High-Pressure Laminate worksurfaces	Specify laminate color number. Specify laminate color number. ▶ See <i>Surface Materials Reference Manual</i> .	
	<ul style="list-style-type: none"> • Laminate price group 2 See information at left • Laminate price group 3 See information at left • Open Line laminate +\$111 plus cost of laminate 		
	Door		Specify paint color number. Specify with 8043 Clear Anodized Aluminum.
	<ul style="list-style-type: none"> • Paint price group 1 No cost • Anodized aluminum +\$ 14 per door 		
Scallop	<ul style="list-style-type: none"> • Omit scallop No cost 		Specify omit scallop.
Power Access Door	Applies to 48"W		Specify with no power access. Specify with power access door center. Specify with power access door left. Specify with power access door right.
	<ul style="list-style-type: none"> • No power access No cost • Power access door center +\$148 • Power access door left +\$148 • Power access door right +\$148 		
	Applies to 60"W		Specify with no power access. Specify with power access door center. Specify with power access door left. Specify with power access door right. Specify with power access door left and right.
	<ul style="list-style-type: none"> • No power access No cost • Power access door center +\$148 • Power access door left +\$148 • Power access door right +\$148 • Power access door left and right +\$296 		
	Applies to 72"W		Specify with no power access. Specify with power access door center. Specify with power door left. Specify with power door right. Specify with power access door left and right. Specify with power access door left and center. Specify with power access door right and center. Specify with power access door left, right, and center.
	<ul style="list-style-type: none"> • No power access No cost • Power access door center +\$148 • Power access door left +\$148 • Power access door right +\$148 • Power access door left right +\$296 • Power access door left and center +\$296 • Power access door right and center +\$295 • Power access door left, right, and center +\$444 		
Related Products	<ul style="list-style-type: none"> • Reinforcing channel • Legs and supports for Universal Systems Worksurfaces • Worksurface screens • Worksurface power and communication components 	▶ Page 273 ▶ Pages 274–278 ▶ Pages 238–251 ▶ Page 199	



For Canadian Pricing

Multiply U.S. Price by the Canadian price factor.

▶ See page 1 for details.

Specification Information

**U.S. Base Price
High-Pressure
Laminate**



• Dimensions				• Style Number	• Plastic 3 mm Edge
A	B	C	D		

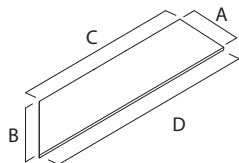

Left-Hand With 1/2" Cord Drop

23 1/2"	27 1/8"	48"	61 1/16"	USE2448LH	\$437
23 1/2"	27 1/8"	60"	73 9/16"	USE2460LH	\$497
23 1/2"	27 1/8"	72"	85 9/16"	USE2472LH	\$622
29 1/2"	34 1/16"	48"	65 1/16"	USE3048LH	\$563
29 1/2"	34 1/16"	60"	77 1/16"	USE3060LH	\$646
29 1/2"	34 1/16"	72"	89 1/16"	USE3072LH	\$768

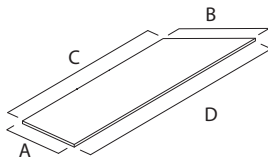

Right-Hand With 1/2" Cord Drop

23 1/2"	27 1/8"	48"	61 1/16"	USE2448RH	\$437
23 1/2"	27 1/8"	60"	73 9/16"	USE2460RH	\$497
23 1/2"	27 1/8"	72"	85 9/16"	USE2472RH	\$622
29 1/2"	34 1/16"	48"	65 1/16"	USE3048RH	\$563
29 1/2"	34 1/16"	60"	77 1/16"	USE3060RH	\$646
29 1/2"	34 1/16"	72"	89 1/16"	USE3072RH	\$768

Universal Systems
Worksurfaces



For Canadian Pricing

Multiply U.S. Price by the Canadian price factor.

▶ See page 1 for details.

Tapered Worksurfaces

High-Pressure Laminate

Tip: Supports for freestanding and beam-mounted applications must be specified separately.

Tip: Long worksurface spans require additional support.
▶ See understanding section for details, page 117.

Tip: Power and data access door and tray is ordered separately to be used with cutout.
▶ Page 268

For laminate price group 2 and 3 pricing, please refer to the electronic catalog or SmartTools.

Exception: Power and data access door and tray only fits on tapered worksurfaces that are 24" to 30" and 30" to 24" deep.



Standard Includes	Required to Specify
-------------------	---------------------

<ul style="list-style-type: none"> ▶ Need help? Product details, page 118 • Worksurface: High-Pressure Laminate price group 1 • Laminate worksurface: <ul style="list-style-type: none"> – Plastic 3 mm edge profile on front edge – Plastic default flat profile on side and back edges • Cable scallop on back edge 	<ol style="list-style-type: none"> 1 Style number 2 High-Pressure Laminate color number for worksurface 3 Plastic color number for front edge on laminate worksurface 4 Options, if selected (see below) <p>▶ See <i>Surface Materials</i>, page 358.</p>
--	---

Options	U.S. Price	Required to Specify
---------	------------	---------------------

Surface Materials High-Pressure Laminate worksurfaces <ul style="list-style-type: none"> • Laminate price group 2 • Laminate price group 3 • Open Line laminate 	See information at left See information at left +\$111 plus cost of laminate	Specify laminate color number. Specify laminate color number. ▶ See <i>Surface Materials Reference Manual</i> .
Scallop <ul style="list-style-type: none"> • Omit scallop 	No cost	Specify <i>omit scallop</i> .
Cutout for Power and Data Access Door and Tray <ul style="list-style-type: none"> • Cutout 	No cost	Specify <i>with cutout for power and data access door</i> .
Related Products <ul style="list-style-type: none"> • Legs and supports for Universal Systems Worksurfaces • Worksurface screens • Worksurface power and communication components 		▶ Pages 274–278 ▶ Pages 238–251 ▶ Page 199

Specification Information

			U.S. Base Price High-Pressure Laminate				U.S. Base Price High-Pressure Laminate
							
• Dimensions	• Style	• Plastic		• Dimensions	• Style	• Plastic	
A B C	Number	3 mm Edge		A B C	Number	3 mm Edge	

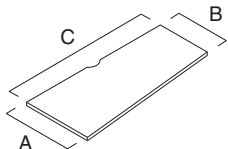

Left-Hand With 1/2" Cord Drop

23 1/2"	18 3/8"	48"	UTT2148	\$ 708
23 1/2"	18 3/8"	60"	UTT2160	\$ 805
23 1/2"	18 3/8"	72"	UTT2172	\$ 902
29 1/2"	23 1/2"	48"	UTT3248	\$ 830
29 1/2"	23 1/2"	60"	UTT3260	\$ 947
29 1/2"	23 1/2"	72"	UTT3272	\$1061

Left-Hand With Full Depth

24"	18 7/8"	48"	WTT2148	\$ 708
24"	18 7/8"	60"	WTT2160	\$ 805
24"	18 7/8"	72"	WTT2172	\$ 902
30"	24"	48"	WTT3248	\$ 830
30"	24"	60"	WTT3260	\$ 947
30"	24"	72"	WTT3272	\$1061

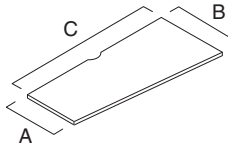

Right-Hand With 1/2" Cord Drop

18 3/8"	23 1/2"	48"	UTT1248	\$ 708
18 3/8"	23 1/2"	60"	UTT1260	\$ 805
18 3/8"	23 1/2"	72"	UTT1272	\$ 902
23 1/2"	29 1/2"	48"	UTT2348	\$ 830
23 1/2"	29 1/2"	60"	UTT2360	\$ 947
23 1/2"	29 1/2"	72"	UTT2372	\$1061

Right-Hand With Full Depth

18 7/8"	24"	48"	WTT1248	\$ 708
18 7/8"	24"	60"	WTT1260	\$ 805
18 7/8"	24"	72"	WTT1272	\$ 902
24"	30"	48"	WTT2348	\$ 830
24"	30"	60"	WTT2360	\$ 947
24"	30"	72"	WTT2372	\$1061

 **For Canadian Pricing**
Multiply U.S. Price by the Canadian price factor.
▶ See page 1 for details.

Taper-Flat Worksurfaces

High-Pressure Laminate

Tip: Supports for freestanding and beam-mounted applications must be specified separately.

Tip: Long worksurface spans require additional support.
 ▶ See understanding section for details, page 117.

For laminate price group 2 and 3 pricing, please refer to the electronic catalog or SmartTools.



Standard Includes	Required to Specify
-------------------	---------------------

<ul style="list-style-type: none"> ▶ Need help? Product details, page 118 • Worksurface: High-Pressure Laminate price group 1 • Laminate worksurface: <ul style="list-style-type: none"> –Plastic 3 mm edge profile on front edge –Plastic default flat profile on side and back edges • Cable scallop on back edge 	<ol style="list-style-type: none"> 1 Style number 2 High-Pressure Laminate color number for worksurface 3 Plastic color number for front edge on laminate worksurface 4 Options, if selected (see below) <p>▶ See <i>Surface Materials</i>, page 358.</p>
--	---

Options	U.S. Price	Required to Specify
---------	------------	---------------------

Surface Materials <ul style="list-style-type: none"> • High-Pressure Laminate worksurfaces • Laminate price group 2 • Laminate price group 3 • Open Line laminate 	See information at left See information at left +\$111 plus cost of laminate	Specify laminate color number. Specify laminate color number. ▶ See <i>Surface Materials Reference Manual</i> .
Scallop <ul style="list-style-type: none"> • Omit scallop 	No cost	Specify <i>omit scallop</i> .
Related Products <ul style="list-style-type: none"> • Legs and supports for Universal Systems Worksurfaces • Worksurface screens • Worksurface power and communication components 		▶ Pages 274–278 ▶ Pages 238–251 ▶ Page 199

Specification Information					
---------------------------	--	--	--	--	--

			U.S. Base Price High-Pressure Laminate				U.S. Base Price High-Pressure Laminate
• Dimensions A B C	• Style Number	• Plastic 3 mm Edge		• Dimensions A B C	• Style Number	• Plastic 3 mm Edge	

Left-Hand With 1/2" Cord Drop							
23 1/2"	18 3/8"	60"	UTTF2160	\$ 805			
23 1/2"	18 3/8"	72"	UTTF2172	\$ 902			
29 1/2"	18 3/8"	60"	UTTF3160	\$ 947			
29 1/2"	18 3/8"	72"	UTTF3172	\$1061			
29 1/2"	23 1/2"	60"	UTTF3260	\$ 947			
29 1/2"	23 1/2"	72"	UTTF3272	\$1061			

Left-Hand With Full Depth							
24"	18 7/8"	60"	WTTF2160	\$ 805			
24"	18 7/8"	72"	WTTF2172	\$ 902			
30"	18 7/8"	60"	WTTF3160	\$ 947			
30"	18 7/8"	72"	WTTF3172	\$1061			
30"	24"	60"	WTTF3260	\$ 947			
30"	24"	72"	WTTF3272	\$1061			

Right-Hand With 1/2" Cord Drop							
18 3/8"	23 1/2"	60"	UTTF1260	\$ 805			
18 3/8"	23 1/2"	72"	UTTF1272	\$ 902			
18 3/8"	29 1/2"	60"	UTTF1360	\$ 947			
18 3/8"	29 1/2"	72"	UTTF1372	\$1061			
23 1/2"	29 1/2"	60"	UTTF2360	\$ 947			
23 1/2"	29 1/2"	72"	UTTF2372	\$1061			

Right-Hand With Full Depth							
18 7/8"	24"	60"	WTTF1260	\$ 805			
18 7/8"	24"	72"	WTTF1272	\$ 902			
18 7/8"	30"	60"	WTTF1360	\$ 947			
18 7/8"	30"	72"	WTTF1372	\$1061			
24"	30"	60"	WTTF2360	\$ 947			
24"	30"	72"	WTTF2372	\$1061			

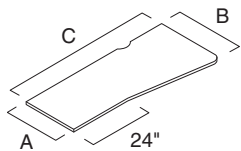
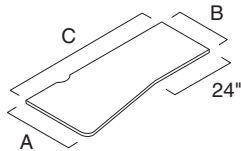

 **For Canadian Pricing**
 Multiply U.S. Price by the Canadian price factor.
 ▶ See page 1 for details.

Single-Tapered Worksurfaces

High-Pressure Laminate

Tip: Supports for freestanding and panel-mounted applications must be specified separately.

Tip: Long worksurface spans require additional support.
 ▶ See understanding section for details, page 117.

For laminate price group 2 and 3 pricing, please refer to the electronic catalog or SmartTools.



Standard Includes	Required to Specify
-------------------	---------------------

<ul style="list-style-type: none"> ▶ Need help? Product details, page 118 • Worksurface: High-Pressure Laminate price group 1 • Laminate worksurface: <ul style="list-style-type: none"> –Plastic 3 mm edge profile on front edge –Plastic default flat profile on side and back edges • Cable scallop on back edge 	<ol style="list-style-type: none"> 1 Style number 2 High-Pressure Laminate color number for worksurface 3 Plastic color number for front edge on laminate worksurface 4 Options, if selected (see below) ▶ See <i>Surface Materials</i> , page 358.
--	---

Options	U.S. Price	Required to Specify
---------	------------	---------------------

Surface Materials <ul style="list-style-type: none"> • High-Pressure Laminate worksurfaces • Laminate price group 2 • Laminate price group 3 • Open Line laminate 	See information at left See information at left +\$111 plus cost of laminate	Specify laminate color number. Specify laminate color number. ▶ See <i>Surface Materials Reference Manual</i> .
Scallop <ul style="list-style-type: none"> • Omit scallop 	No cost	Specify <i>omit scallop</i> .
Related Products <ul style="list-style-type: none"> • Legs and supports for Universal Systems Worksurfaces • Worksurface screens • Worksurface power and communication components 		▶ Pages 274–278 ▶ Pages 238–251 ▶ Page 199

Specification Information

			U.S. Base Price High-Pressure Laminate						U.S. Base Price High-Pressure Laminate		
											
• Dimensions	• Style		• Plastic			• Dimensions	• Style		• Plastic		
A B C	Number		3 mm	Edge		A B C	Number		3 mm	Edge	

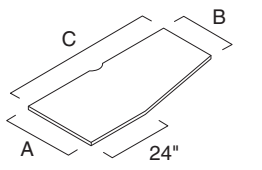

Left-Hand With 1/2" Cord Drop											
23 1/2"	18 3/8"	60"	UST2160	\$ 805							
23 1/2"	18 3/8"	72"	UST2172	\$ 902							
29 1/2"	23 1/2"	60"	UST3260	\$ 947							
29 1/2"	23 1/2"	72"	UST3272	\$1061							
⋮	⋮	⋮	⋮	⋮							

Left-Hand With Full Depth											
24"	18 7/8"	60"	WST2160	\$ 805							
24"	18 7/8"	72"	WST2172	\$ 902							
30"	24"	60"	WST3260	\$ 947							
30"	24"	72"	WST3272	\$1061							
⋮	⋮	⋮	⋮	⋮							

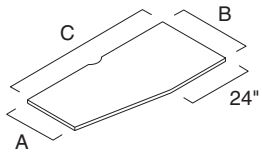

Right-Hand With 1/2" Cord Drop											
18 3/8"	23 1/2"	60"	UST1260	\$ 805							
18 3/8"	23 1/2"	72"	UST1272	\$ 902							
23 1/2"	29 1/2"	60"	UST2360	\$ 947							
23 1/2"	29 1/2"	72"	UST2372	\$1061							
⋮	⋮	⋮	⋮	⋮							

Right-Hand With Full Depth											
18 7/8"	24"	60"	WST1260	\$ 805							
18 7/8"	24"	72"	WST1272	\$ 902							
24"	30"	60"	WST2360	\$ 947							
24"	30"	72"	WST2372	\$1061							
⋮	⋮	⋮	⋮	⋮							

 **For Canadian Pricing**
 Multiply U.S. Price by the Canadian price factor.
 ▶ See page 1 for details.

Corner, 120° Worksurfaces

High-Pressure Laminate, Composite Veneer, or Wood Veneer

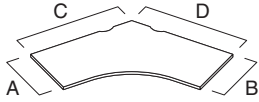

Tip: Supports must be specified separately, including side support brackets for rear corner support in panel-mounted applications.

Standard Includes	Required to Specify
<ul style="list-style-type: none"> Need help? Product details, page 118 Worksurface: High-Pressure Laminate price group 1 or composite veneer group 1 Laminate worksurface: <ul style="list-style-type: none"> Plastic 3 mm edge profile on front edge Plastic default flat profile on side and back edges Composite veneer worksurface: <ul style="list-style-type: none"> Composite veneer 3 mm edge profile on front edge Matching composite veneer flat profile on side and back edges Cable scallops on back edges 	<ol style="list-style-type: none"> Style number with appropriate edge profile suffix SW Composite veneer or wood with square edge ▶ See edge profiles below. High-Pressure Laminate or composite veneer color number for worksurface Plastic color number for front edge on laminate worksurface, if selected Options, if selected (see below) ▶ See <i>Surface Materials</i>, page 358.

For wood and laminate group 2 and 3 pricing, please refer to the electronic catalog or SmartTools.

Options	U.S. Price	Required to Specify
Surface Materials <ul style="list-style-type: none"> High-Pressure Laminate worksurfaces <ul style="list-style-type: none"> Laminate price group 2 Laminate price group 3 Open Line laminate Composite veneer worksurfaces <ul style="list-style-type: none"> Composite veneer group 1 Composite veneer group 2 Wood veneer worksurfaces <ul style="list-style-type: none"> Wood group 1 Wood group 2 Wood group 3 Customiz stain 	<ul style="list-style-type: none"> See information at left See information at left +\$111 plus cost of laminate Prices below +\$ 73 Prices below See information at left See information at left No cost 	<ul style="list-style-type: none"> Specify laminate color number. Specify laminate color number. ▶ See <i>Surface Materials Reference Manual</i>. Specify composite veneer color number. Specify composite veneer color number. Specify wood color number. Specify wood color number. Specify wood color number. Specify with <i>Customiz stain</i>. ▶ See <i>Surface Materials Reference Manual</i>.
Scallops <ul style="list-style-type: none"> Omit scallops 	No cost	Specify <i>omit scallops</i> .
Related Products <ul style="list-style-type: none"> Legs and supports for Universal Systems Worksurfaces Worksurface screens Worksurface power and communication components 		<ul style="list-style-type: none"> ▶ Pages 274–278 ▶ Pages 238–251 ▶ Page 199

Specification Information				U.S. Base Prices		
				High-Pressure Laminate	Composite Veneer	Wood
• Dimensions	• Style Number	• Plastic 3 mm Edge	• Composite Veneer Square Edge	• Wood Square Edge		
A B C D		No Suffix	Suffix SW	Suffix SW		

Freestanding or Panel-Mounted With 1/2" Cord Drop						
23 1/2"	23 1/2"	35 1/2"	35 1/2"	UB223636	\$1224	\$2403
23 1/2"	23 1/2"	41 1/2"	41 1/2"	UB224242	\$1273	\$2452
23 1/2"	23 1/2"	47 1/2"	47 1/2"	UB224848	\$1320	\$2499
29 1/2"	29 1/2"	35 1/2"	35 1/2"	UB333636	\$1273	\$2452
29 1/2"	29 1/2"	41 1/2"	41 1/2"	UB334242	\$1320	\$2499
29 1/2"	29 1/2"	47 1/2"	47 1/2"	UB334848	\$1366	\$2545

For Canadian Pricing
 Multiply U.S. Price by the Canadian price factor.
 ▶ See page 1 for details.

Universal Systems Worksurfaces

Power and Data Access Door & Tray

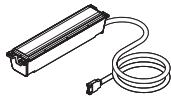

Tip: Remember to specify cutout for power and data tray on the worksurface style number.

Standard Includes	Required to Specify
-------------------	---------------------

- | | | |
|--|--|--|
| <ul style="list-style-type: none"> ▶ Need help? Product details, page 126 | <ul style="list-style-type: none"> • Door: paint • Door bezel: 6694 Slate • Inner tray with six simplex receptacles: 7237 Slate • Outer tray with end caps: 7237 Slate and 6694 Slate • Grommet (modular and hardwire only): plastic • Two cord clips or harness clips | <ul style="list-style-type: none"> 1 Style number 2 Paint color for door 3 Plastic color for grommet 4 Options, if selected (see below) ▶ See <i>Surface Materials</i>, page 358. |
|--|--|--|

Surface Materials	Door	U.S. Price	Required to Specify
-------------------	------	------------	---------------------

Surface Materials	Door <ul style="list-style-type: none"> • Paint • Anodized aluminum 	No cost +\$37	Specify paint color. Specify with 8043 clear anodized aluminum.
Power Schematics, Line Options, and Ground Options	3+1 <ul style="list-style-type: none"> • Line 1 <ul style="list-style-type: none"> – System ground – Isolated ground • Line 2 <ul style="list-style-type: none"> – System ground – Isolated ground • Line 3 <ul style="list-style-type: none"> – System ground – Isolated ground • Line 4 <ul style="list-style-type: none"> – System ground – Isolated ground 	No cost No cost No cost No cost No cost No cost	Specify with 3+1, line 1, system ground. Specify with 3+1, line 1, isolated ground. Specify with 3+1, line 2, system ground. Specify with 3+1, line 2, isolated ground. Specify with 3+1, line 3, system ground. Specify with 3+1, line 3, isolated ground. Specify with 3+1, line 4, system ground. Specify with 3+1, line 4, isolated ground.
	2+2 <ul style="list-style-type: none"> • Line 1 <ul style="list-style-type: none"> – System ground – Isolated ground • Line 2 <ul style="list-style-type: none"> – System ground – Isolated ground • Line 3 <ul style="list-style-type: none"> – System ground – Isolated ground • Line 4 <ul style="list-style-type: none"> – System ground – Isolated ground 	No cost No cost No cost No cost No cost No cost	Specify with 2+2, line 1, system ground. Specify with 2+2, line 1, isolated ground. Specify with 2+2, line 2, system ground. Specify with 2+2, line 2, isolated ground. Specify with 2+2, line 3, system ground. Specify with 2+2, line 3, isolated ground. Specify with 2+2, line 4, system ground. Specify with 2+2, line 4, isolated ground.
	3SN <ul style="list-style-type: none"> • Line 1 <ul style="list-style-type: none"> – System ground – Isolated ground • Line 2 <ul style="list-style-type: none"> – System ground – Isolated ground • Line 3 <ul style="list-style-type: none"> – System ground – Isolated ground 	No cost No cost No cost No cost	Specify with 3SN, line 1, system ground. Specify with 3SN, line 1, isolated ground. Specify with 3SN, line 2, system ground. Specify with 3SN, line 2, isolated ground. Specify with 3SN, line 3, system ground. Specify with 3SN, line 3, isolated ground.



For Canadian Pricing

Multiply U.S. Price by the Canadian price factor.

▶ See page 1 for details.

Specification Information

• Style	• U.S.
• Number	• Base
•	• Price
•	•

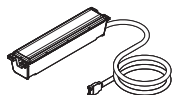

Modular Power

UTTRM	\$1706
•	•

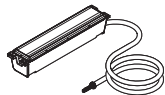

Hardwire Power

UTTRHW	\$1706
•	•

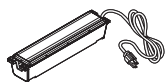

Cord and Plug

UTTRC	\$1706
•	•

 **For Canadian Pricing**
Multiply U.S. Price by the
Canadian price factor.
▶ See page 1 for details.

Grommets

2 1/2" Round Grommet



Tip: Grommet AWAG2 is for use on worksurfaces only.

Tip: When using AWAG2 in the Universal parametric straight worksurface, specify the 2" grommet cutout option. Actual diameter of cutout is 2 1/4".

Standard Includes		Required to Specify	
<ul style="list-style-type: none"> Grommet: paint or metal Installation instructions 		<ul style="list-style-type: none"> 1 Style number 2 Paint or metal color number ▶ See <i>Surface Materials</i>, page 358. 	

Specification Information			
Dimensions		Style	U.S.
D	W	Number	Price
2 1/2"	2 1/2"	AWAG2	\$110

3" Grommet Package



Tip: When using TSAEGROM in the Universal parametric straight worksurface, specify the 3" grommet cutout.

Standard Includes		Required to Specify	
<ul style="list-style-type: none"> ▶ Need help? Product details, page 119 	<ul style="list-style-type: none"> Package of 10 grommets: black plastic 	<ul style="list-style-type: none"> Style number 	

Specification Information	
Style	U.S.
Number	Price
TSAEGROM	\$91



For Canadian Pricing
 Multiply U.S. Price by the Canadian price factor.
 ▶ See page 1 for details.

Beam-Mounted Universal Systems Worksurface Supports

For Use with Answer Beam

Cantilevers

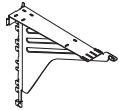

Tip: Answer beam junctions can accommodate only one cantilever at a seam.

Tip: 30"D straight cantilevered worksurfaces require additional floor support along the front edge, such as a pedestal or post leg.

Standard Includes	Required to Specify
-------------------	---------------------

- | | | |
|--|---|--|
| <ul style="list-style-type: none"> ▶ Need help? Product details, page 128 | <ul style="list-style-type: none"> • Cantilever: paint • Tie plate • Attachment hardware | <ul style="list-style-type: none"> 1 Style number 2 Paint color number for cantilever ▶ See <i>Surface Materials</i>, page 358. |
|--|---|--|

Specification Information		
---------------------------	--	--

Style Number	U.S. Price

Beam On-Module Cantilever

TSBUCANT	\$179
----------	-------

Support Plate

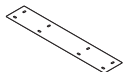

Tip: Support plate can also be used in freestanding applications.

Standard Includes	Required to Specify
-------------------	---------------------

- | | | |
|--|--|--|
| <ul style="list-style-type: none"> ▶ Need help? Product details, page 131 | <ul style="list-style-type: none"> • Support plate: black paint only • Attachment hardware | <ul style="list-style-type: none"> Style number |
|--|--|--|

Specification Information		
---------------------------	--	--

Dimensions	Style Number	U.S. Price
14"D	TS714WSP	\$122
20"D	TS720WSP	\$122

Worksurface-to-Beam Tether Brackets

Standard Includes	Required to Specify
-------------------	---------------------

- | | | |
|--|---|--|
| <ul style="list-style-type: none"> ▶ Need help? Product details, page 128 | <ul style="list-style-type: none"> • Tether brackets: 4799 Platinum • Attachment hardware | <ul style="list-style-type: none"> Style number |
|--|---|--|

Specification Information	
---------------------------	--

Style Number	U.S. Price



Single

TSBTB1	\$34
--------	------



Pair

TSBTB2	\$66
--------	------

Tie Plates



Standard Includes		Required to Specify
<ul style="list-style-type: none"> • Package of six tie plates: black paint only • Attachment hardware 		Style number

Specification Information		
Dimensions	Style Number	U.S. Price
3¾"L	TS7TIEPLATE	\$176

Reinforcing Channels

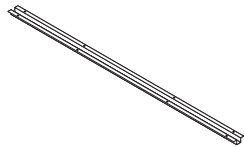

Tip: Reinforcing channel can also be used in free-standing applications.

Standard Includes		Required to Specify
<ul style="list-style-type: none"> ▶ Need help? Product details, page 119 	<ul style="list-style-type: none"> • Reinforcing channel: black paint only • Attachment hardware 	Style number

Specification Information		
Dimensions	Style Number	U.S. Price
39"W	TS7WKSPT39	\$82
48"W	TS7WKSPT48	\$82
51"W	TS7WKSPT51	\$82
54"W	TS7WKSPT54	\$82
57"W	TS7WKSPT	\$82
60"W	TS7WKSPT60	\$82
63"W	TS7WKSPT63	\$82
66"W	TS7WKSPT66	\$82
72"W	TS7WKSPT72	\$82

 **For Canadian Pricing**
Multiply U.S. Price by the Canadian price factor.
▶ See page 1 for details.

FrameOne Legs and Supports for Universal Worksurfaces

for Use with Answer Beam

Standard Includes		Required to Specify
<ul style="list-style-type: none"> ▶ Need help? Product details, page 130 	<ul style="list-style-type: none"> • Legs: paint • Intermediate support: 4799 Platinum • Attachment hardware 	<ul style="list-style-type: none"> 1 Style number 2 Paint color number for legs 3 Options, if selected (see below) ▶ See <i>Surface Materials</i>, page 358.

Options	U.S. Price	Required to Specify
Surface Materials For legs <ul style="list-style-type: none"> • Paint price group 1 • Paint price group 2 • Paint price group 3 	No cost +\$31 per leg +\$55 per leg	Specify paint color number. Specify paint color number. Specify paint color number.

Specification Information									
Plan Height	Depth	Style Number	U.S. Base Price	Style Number	U.S. Base Price	Style Number	U.S. Base Price	Style Number	U.S. Base Price
		Beam Supporting Left-Hand		Beam Supporting Right-Hand		Tethered Application		Table Application	

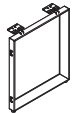

Closed Loop for Answer Beam

28½"	24"	TSBFC24LH	\$992	TSBFC24RH	\$992	UFC24	\$973	UFC24T	\$1057
28½"	30"	TSBFC30LH	\$992	TSBFC30RH	\$992	UFC30	\$973	UFC30T	\$1057



Open Loop for Answer Beam

28½"	24"	TSBFQ24LH	\$724	TSBFQ24RH	\$724	UFQ24	\$709	UFQ24T	\$ 793
28½"	30"	TSBFQ30LH	\$724	TSBFQ30RH	\$724	UFQ30	\$709	UFQ30T	\$ 793



Half Loop for Answer Beam

28½"	24"	TSBFH24LHB	\$627	TSBFH24RHB	\$627				
28½"	30"	TSBFH30LHB	\$627	TSBFH30RHB	\$627				



Post Leg

28½"		UFP	\$279						
------	--	------------	-------	--	--	--	--	--	--

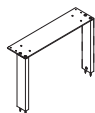

Intermediate Support for Answer Beam

For Use with One-High Universal Storage

28½"	16"	TSB1610H	\$438						
------	-----	-----------------	-------	--	--	--	--	--	--



For Use with 1.5-High Universal Storage

28½"	16"	TSB1615H	\$401						
------	-----	-----------------	-------	--	--	--	--	--	--



For Canadian Pricing

Multiply U.S. Price by the Canadian price factor.

▶ See page 1 for details.

Infills for FrameOne Legs for Universal Worksurfaces



Standard Includes	Required to Specify
<ul style="list-style-type: none"> ▶ Need help? Product details, page 132 • High-Pressure Laminate price group 1 infills • Edge on laminate infill, if selected: plastic • Brackets and caps 	<ol style="list-style-type: none"> 1 Style number 2 Laminate color number for infill 3 Plastic color number for edge on laminate infill, if selected 4 Options, if selected (see below) <ul style="list-style-type: none"> ▶ See <i>Surface Materials</i>, page 358.

For laminate price group 2 and 3 pricing, please refer to the electronic catalog or SmartTools.

Surface Materials	Options	U.S. Price	Required to Specify
	High-Pressure Laminate <ul style="list-style-type: none"> • Laminate price group 2 • Laminate price group 3 • Open Line laminate 	See information at left See information at left +\$111 plus cost of laminate	Specify laminate color number. Specify laminate color number. ▶ See <i>Surface Materials Reference Manual</i> .
	Composite veneer <ul style="list-style-type: none"> • Composite group 1 veneer surface with composite veneer edges • Composite group 2 veneer surface with composite veneer edges 	Prices below +\$161	Specify <i>with composite veneer</i> and indicate composite color number. Specify <i>with composite veneer</i> and indicate composite color number.
	Wood veneer <ul style="list-style-type: none"> • Wood group 1 veneer surface with wood veneer edges • Wood group 2 veneer surface with wood veneer edges • Wood group 3 veneer surface with wood veneer edges • Customiz stain 	Prices below +\$177 +\$619 No cost	Specify <i>with wood veneer</i> and indicate wood color number. Specify <i>with wood veneer</i> and indicate wood color number Specify <i>with wood veneer</i> and indicate wood color number. Specify <i>with Customiz stain</i> . ▶ See <i>Surface Materials Reference Manual</i> .

Tip: Wood group 2 and wood group 3 upcharges are in addition to wood group 1 upcharge.

Tip: Composite veneer group 2 upcharge is in addition to composite veneer group 1 upcharge.

Specification Information			
Planning Width	Style Number	U.S. Base Price	Option (Add \$ to Base Price)
·	·	· High-Pressure Laminate	· Composite Veneer
·	·	·	· Wood Veneer
·	·	·	·
·	·	·	·
·	·	·	·

For Closed Loop Legs

24"W	UFC24NF	\$ 953	+ \$306	+ \$337
30"W	UFC30NF	\$1061	+ \$334	+ \$368
·	·	·	·	·

For Open Loop Legs

24"W	UFQ24NF	\$ 953	+ \$306	+ \$337
30"W	UFQ30NF	\$1061	+ \$334	+ \$368
·	·	·	·	·



For Canadian Pricing
 Multiply U.S. Price by the Canadian price factor.
 ▶ See page 1 for details.

Post Legs and Double Post Legs

Tip: Height dimensions listed are nominal and include the thickness of a worksurface.

Tip: Standing height legs can be used as column support in panel-mounted applications only.

Tip: Corner worksurfaces require a leg in the back corner. Be sure to order fifth leg if specifying a package of four.

Tip: Legs with casters cannot support freestanding worksurfaces that are less than 24" deep.

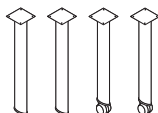

Standard Includes	Required to Specify
-------------------	---------------------

<ul style="list-style-type: none"> ▶ Need help? Product details, page 130 • Legs: paint • Attachment hardware • Non-locking caster, if selected: black plastic only 	<ul style="list-style-type: none"> 1 Style number 2 Paint color number for leg 3 Options, if selected (see below) ▶ See <i>Surface Materials</i>, page 358.
---	---

Options	U.S. Price	Required to Specify
---------	------------	---------------------

Surface Materials <ul style="list-style-type: none"> • Paint price group 1 • Paint price group 2 • Paint price group 3 	No cost +\$32 per leg +\$55 per leg	Specify paint color number. Specify paint color number. Specify paint color number.
--	---	---

Specification Information					
• Planning Height	• Style Number	• U.S. Base Price	• Planning Height	• Style Number	• U.S. Base Price

--	--	--	--	--	--

Post Leg with Glide

26"	UNPL	\$206
28½"	UPL	\$206
40⅞"	UHPL	\$260
⋮	⋮	⋮

Package of Four Post Legs with Glides

26"	UNPL4	\$824
28½"	UPL4	\$824
⋮	⋮	⋮

Post Leg with Caster

26"	UNPLC	\$234
28½"	UPLC	\$234
⋮	⋮	⋮

Package of Four Post Legs with Casters

26"	UNPL4C	\$936
28½"	UPL4C	\$936
⋮	⋮	⋮

Package of Four Post Legs with Two Glides and Two Casters

26"	UNPL4M	\$880
28½"	UPL4M	\$880
⋮	⋮	⋮

▶ Specification Information, continued on next page

 **For Canadian Pricing**
 Multiply U.S. Price by the Canadian price factor.
 ▶ See page 1 for details.

► Specification Information, continued from previous page

Specification Information

• Planning • Height	• Style • Number	• U.S. • Base • Price
•	•	•
•	•	•

Double Post Leg with Glides

28½"	UDPL	\$578
•	•	•



Tip: Double post legs can be used as a shared or column support in applications with other post legs.

Double Post C-Leg with Glides

28½"	UCL	\$657
•	•	•

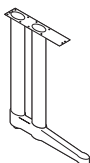

For Canadian Pricing

Multiply U.S. Price by the Canadian price factor.

► See page 1 for details.

Specifying Storage Tops, Stanchions, and Accessories

Square Edge Tops	280
Answer Beam Stanchion Supports	283
Mid-Storage Supports	284
Ganging Hardware for Currency	285
Storage to Beam Connector	286

Square Edge Tops

With 1/2" Cord Drop

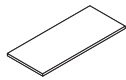

Tip: Square edge tops with 1/2" cord drop should be used with storage with recessed back.

Tip: Contact Specials for square edge tops placed over group storage and placed back-to-back to ensure correct sizing for the application.

Tip: Attachment hardware ships with the file cabinet. Additional screws can be ordered from Service Parts: 855010126MP (quantity of 100).

For laminate group 2 and 3 pricing, please refer to the electronic catalog or SmartTools.

Standard Includes	Required to Specify
<ul style="list-style-type: none"> ▶ Need help? Product details, page 144 • 1 3/16"H top with square edge profile on all sides: laminate price group 1 	<ol style="list-style-type: none"> 1 Style number 2 Laminate color number for top 3 Plastic color number for 1 mm edges of laminate top 4 Options, if selected (see below) <ul style="list-style-type: none"> ▶ See <i>Surface Materials</i>, page 358.

Surface Materials	Options	U.S. Price	Required to Specify
	Laminate top <ul style="list-style-type: none"> • Laminate price group 2 • Laminate price group 3 • Open Line laminate 	See information at left See information at left +\$111 plus cost of laminate	Specify laminate color number. Specify laminate color number. ▶ See <i>Surface Materials Reference Manual</i> .

	Door <ul style="list-style-type: none"> • Paint • Anodized aluminum 	No cost +\$ 14 per door	Specify paint color. Specify with 8043 Clear Anodized Aluminum.
--	--	----------------------------	--

Power Access Door	Applies to 30"W <ul style="list-style-type: none"> • No power access • Power access door center 	No cost +\$148	Specify with no power access. Specify with power access door center.
	Applies to 36"W to 48"W <ul style="list-style-type: none"> • No power access • Power access door center • Power access door left • Power access door right 	No cost +\$148 +\$148 +\$148	Specify with no power access. Specify with power access door center. Specify with power access door left. Specify with power access door right.
	Applies to 54"W to 66"W <ul style="list-style-type: none"> • No power access • Power access door center • Power access door left • Power access door right • Power access door left and right 	No cost +\$148 +\$148 +\$148 +\$296	Specify with no power access. Specify with power access door center. Specify with power access door left. Specify with power access door right. Specify with power access door left and right.
	Applies to 72"W to 96"W <ul style="list-style-type: none"> • No power access • Power access door center • Power access door left • Power access door right • Power access door left and right • Power access door left and center • Power access door right and center • Power access door left, right, and center 	No cost +\$148 +\$148 +\$148 +\$296 +\$296 +\$296 +\$444	Specify with no power access. Specify with power access door center. Specify with power access door left. Specify with power access door right. Specify with power access door left and right. Specify with power access door left and center. Specify with power access door right and center. Specify with power access door left, right, and center.



For Canadian Pricing

Multiply U.S. Price by the Canadian price factor.

▶ See page 1 for details.

Specification Information

Dimensions			Style	U.S.
D	W	H	Number	Base Price

Individual File Laminate Tops

18 ³ / ₈ "	30"	1 ³ / ₁₆ "	TSBST1830	\$ 292
18 ³ / ₈ "	36"	1 ³ / ₁₆ "	TSBST1836	\$ 315
18 ³ / ₈ "	42"	1 ³ / ₁₆ "	TSBST1842	\$ 342
23 ¹ / ₂ "	30"	1 ³ / ₁₆ "	TSBST2430	\$ 321
23 ¹ / ₂ "	36"	1 ³ / ₁₆ "	TSBST2436	\$ 342
23 ¹ / ₂ "	42"	1 ³ / ₁₆ "	TSBST2442	\$ 366

Laminate Common Tops

18 ³ / ₈ "	48"	1 ³ / ₁₆ "	TSBST1848	\$ 408
18 ³ / ₈ "	54"	1 ³ / ₁₆ "	TSBST1854	\$ 437
18 ³ / ₈ "	60"	1 ³ / ₁₆ "	TSBST1860	\$ 474
18 ³ / ₈ "	66"	1 ³ / ₁₆ "	TSBST1866	\$ 548
18 ³ / ₈ "	72"	1 ³ / ₁₆ "	TSBST1872	\$ 615
18 ³ / ₈ "	78"	1 ³ / ₁₆ "	TSBST1878	\$ 783
18 ³ / ₈ "	84"	1 ³ / ₁₆ "	TSBST1884	\$ 827
18 ³ / ₈ "	90"	1 ³ / ₁₆ "	TSBST1890	\$ 874
18 ³ / ₈ "	96"	1 ³ / ₁₆ "	TSBST1896	\$ 916
23 ¹ / ₂ "	48"	1 ³ / ₁₆ "	TSBST2448	\$ 436
23 ¹ / ₂ "	54"	1 ³ / ₁₆ "	TSBST2454	\$ 467
23 ¹ / ₂ "	60"	1 ³ / ₁₆ "	TSBST2460	\$ 496
23 ¹ / ₂ "	66"	1 ³ / ₁₆ "	TSBST2466	\$ 557
23 ¹ / ₂ "	72"	1 ³ / ₁₆ "	TSBST2472	\$ 620
23 ¹ / ₂ "	78"	1 ³ / ₁₆ "	TSBST2478	\$ 829
23 ¹ / ₂ "	84"	1 ³ / ₁₆ "	TSBST2484	\$ 918
23 ¹ / ₂ "	90"	1 ³ / ₁₆ "	TSBST2490	\$ 955
23 ¹ / ₂ "	96"	1 ³ / ₁₆ "	TSBST2496	\$1021

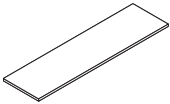
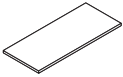
**For Canadian Pricing**

Multiply U.S. Price by the Canadian price factor.

► See page 1 for details.

Square Edge Tops

For Use with Proud Front Products

Tip: Attachment hardware ships with the file cabinet. Additional screws can be ordered from Service Parts: 855010126MP (quantity of 100).

Standard Includes		Required to Specify
<ul style="list-style-type: none"> ▶ Need help? Product details, page 145 	<ul style="list-style-type: none"> • 1 3/16"H top with square edge profile on all sides: laminate price group 1 • 1 mm edge: plastic 	<ol style="list-style-type: none"> 1 Style number 2 Laminate color number for top 3 Plastic color number for 1 mm edges of laminate top 4 Options, if selected (see below) <p>▶ See <i>Surface Materials</i>, page 358.</p>

For laminate group 2 and group 3 pricing, please refer to the electronic catalog or SmartTools.

Options	U.S. Price	Required to Specify
Surface Materials Laminate top <ul style="list-style-type: none"> • Laminate price group 2 • Laminate price group 3 • Open Line laminate 	See information at left See information at left +\$111 plus cost of laminate	Specify laminate color number. Specify laminate color number. ▶ See <i>Surface Materials Reference Manual</i> .

Specification Information				
Dimensions			Style	U.S.
D	W	H	Number	Base Price

Individual File Laminate Tops

18 7/8"	30"	1 3/16"	RATL1830P	\$ 319
18 7/8"	36"	1 3/16"	RATL1836P	\$ 345
18 7/8"	42"	1 3/16"	RATL1842P	\$ 372
24"	30"	1 3/16"	RATL2430P	\$ 352
24"	36"	1 3/16"	RATL2436P	\$ 372

Laminate Common Tops

18 7/8"	60 1/16"	1 3/16"	RATCL1860P	\$ 516
18 7/8"	66 1/16"	1 3/16"	RATCL1866P	\$ 598
18 7/8"	72 1/16"	1 3/16"	RATCL1872P	\$ 671
18 7/8"	78 1/16"	1 3/16"	RATCL1878P	\$ 853
18 7/8"	84 1/16"	1 3/16"	RATCL1884P	\$ 962
18 7/8"	90 1/8"	1 3/16"	RATCL1890P	\$1072
18 7/8"	96 1/8"	1 3/16"	RATCL1896P	\$1181
18 7/8"	108 1/8"	1 3/16"	RATCL18108P	\$1420
24"	60 1/16"	1 3/16"	RATCL2460P	\$ 544
24"	66 1/16"	1 3/16"	RATCL2466P	\$ 608
24"	72 1/16"	1 3/16"	RATCL2472P	\$ 686
24"	90 1/8"	1 3/16"	RATCL2490P	\$1150
24"	96 1/8"	1 3/16"	RATCL2496P	\$1263
24"	108 1/8"	1 3/16"	RATCL24108P	\$1524
37 13/16"	36"	1 3/16"	RATCL3636P	\$ 655
37 13/16"	72 1/16"	1 3/16"	RATCL3672P	\$ 902
48 1/16"	36"	1 3/16"	RATCL4836P	\$ 739
48 1/16"	72 1/16"	1 3/16"	RATCL4872P	\$1012

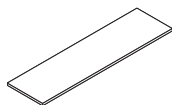
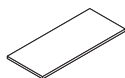

For Canadian Pricing
 Multiply U.S. Price by the Canadian price factor.

▶ See page 1 for details.

Answer Beam Stanchion Supports

Standard Includes	Required to Specify
<ul style="list-style-type: none"> ▶ Need help? Product details, page 146 • Stanchions, quantity of two: 4799 Platinum Metallic • Hardware kit 	Style number

Specification Information

Style Number	U.S. Price
--------------	------------

Single Sided

TSBSTS	\$290
---------------	-------

Double Sided/Centered

TSBSTC	\$290
---------------	-------

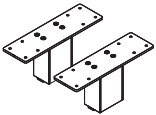

 **For Canadian Pricing**
 Multiply U.S. Price by the Canadian price factor.
 ▶ See page 1 for details.

Mid-Storage Supports

Standard Includes		Required to Specify
<ul style="list-style-type: none"> Need help? Product details, page 147 	<ul style="list-style-type: none"> Mid-storage support: 4799 Platinum Metallic Attachment hardware 	Style number

Specification Information				
Aligned Height with Organizer	Aligned Height with Overhead	Support Height	Style Number	U.S. Price

For Use with 1.5-High Currency

42"	48"	10½"	TSB15H	\$469
:	:	:	:	:

For Use with Two-High Currency or Worksurface

42"	48"	4½"	TSB2H	\$469
:	:	:	:	:



 **For Canadian Pricing**
 Multiply U.S. Price by the Canadian price factor.
 ▶ See page 1 for details.

Ganging Hardware for Currency Storage

Tip: Ganging hardware for Currency storage is used to provide rigidity between cabinets mounted side by side in a panel- or wall-mounted application.
▶ See Currency Specification Guide.

Standard Includes	Required to Specify
<ul style="list-style-type: none"> • Attachment kit: zinc • Four bolts and nuts per kit 	Style number

Specification Information	
Style Number	U.S. Price
TSBAWAK	\$68



For Canadian Pricing
Multiply U.S. Price by the Canadian price factor.
▶ See page 1 for details.

Storage to Beam Connector

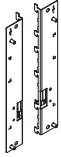

Tip: Storage-to-beam connector can not be used with Answer panels.

Standard Includes		Required to Specify
▶ Need help? Product details, page 148	<ul style="list-style-type: none"> • Skin material: fabric, steel, laminate, or veneer • Connector: black paint • Attachment hardware 	1 Style number 2 Fabric, steel, laminate, or veneer color number for connector 3 Options, if selected (see below) ▶ See <i>Surface Materials</i> , page 358.

Options	U.S. Price	Required to Specify
Skin Application <ul style="list-style-type: none"> • Fabric or steel • Laminate or veneer 	No cost No cost	Specify with fabric or steel skin material. Specify with laminate or veneer skin material.
Storage Height <ul style="list-style-type: none"> • 1.5-High or Two-High • One-High 	No cost No cost	Specify with 1.5-High or Two-High storage height. Specify with One-High storage height.
Application <ul style="list-style-type: none"> • Full • Recessed 	No cost No cost	Specify with full application. Specify with recessed applicaiton.
Handedness <ul style="list-style-type: none"> • Left-hand • Right-hand 	No cost No cost	Specify with left-hand. Specify with right-hand.

Specification Information	
Style Number	U.S. Price
CRSTBC	\$132
:	:



For Canadian Pricing
 Multiply U.S. Price by the Canadian price factor.
 ▶ See page 1 for details.

Specifying High-Density Storage Products

High-Density Storage	288
High-Density Storage Value Package	292
High-Density Worksurface Support Bracket	294

High-Density Storage

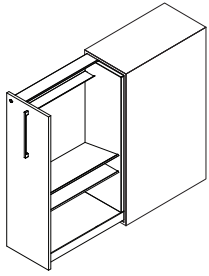

Drawing shows left-hand application, right-hand application is also available.

Standard Includes	Required to Specify
<ul style="list-style-type: none"> ▶ Need help? Product details, page 152 • Case: laminate price group 1 • Drawer front: laminate to match case • Case interior: paint • Mirror • Nile pull: metal • Lock, keyed random: 9201 Polished Chrome • Four adjustable leveling glides • Vertical grain direction 	<ol style="list-style-type: none"> 1 Style number 2 Case width (see below under Required Selections) 3 Case depth (see below under Required Selections) 4 Case height (see below under Required Selections) 5 Handedness (see below under Required Selections) 6 Interior configuration (see below under Required Selections) 7 Laminate color number for case and drawer front 8 Paint color number for case interior 9 Pull (see below under Required Selections) 10 Metal color number for pulls 11 Options, if selected (see below) <ul style="list-style-type: none"> ▶ See <i>Surface Materials</i>, page 358.

Tip: Shelf comes standard with 12"W storage.

Tip: Nile pull will default as the standard pull, you must confirm this selection or specify an optional pull.

Required Selections	U.S. Price	Required to Specify
Case Width <ul style="list-style-type: none"> • 12"W • 15"W 	Prices at right Prices at right	Specify with 12" width. Specify with 15" width.
Case Depth <ul style="list-style-type: none"> • 24"D • 30"D 	Prices at right Prices at right	Specify with 24" depth. Specify with 30" depth.
Case Height <ul style="list-style-type: none"> • 42"H • 48"H 	No cost +\$275	Specify with 42" height. Specify with 48" height.
Handedness <ul style="list-style-type: none"> • Left hand • Right hand 	No cost No cost	Specify left-hand. Specify right-hand.
Interior Configuration <ul style="list-style-type: none"> • 12"W storage • Shelf 	\$ 157 Included in in U.S. Base Price	Specify with shelf.
<ul style="list-style-type: none"> • 15"W storage • Bag drop • Shelf 	No cost +\$157	Specify with bag drop. Specify with shelf.

Pull

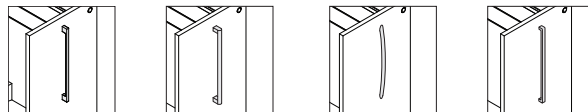

Nile pull Bar pull Contemporary pull Jazz pull

Options	U.S. Price	Required to Specify
Front Color Scheme <ul style="list-style-type: none"> • Non contrasting • Contrasting 	No cost +\$ 69	Specify with non contrasting. Specify with contrasting.
Surface Materials <ul style="list-style-type: none"> • Laminate on case • Laminate price group 2 • Laminate price group 3 • Open Line laminate 	See information at left See information at left +\$111 plus cost of laminate	Specify laminate color number. Specify laminate color number. ▶ See <i>Surface Material Reference Manual</i> .
<ul style="list-style-type: none"> • Laminate on contrasting case front • Laminate price group 2 • Laminate price group 3 • Open Line laminate on case front 	See information at left See information at left +\$111 plus cost of laminate	Specify laminate color number. Specify laminate color number. ▶ See <i>Surface Material Reference Manual</i> .

▶ Options, continued on next page

For laminate price group 2 and group 3 pricing, please refer to the electronic catalog or SmartTools.



For Canadian Pricing
Multiply U.S. Price by the Canadian price factor.
▶ See page 1 for details.

► Options, continued from previous page

	Options	U.S. Price	Required to Specify
Surface Materials, continued	Composite veneer for non-contrasting color scheme		
	• Composite group 1 veneer	+\$1838	Specify <i>with composite veneer</i> and indicate composite color number.
	• Composite group 2 veneer	+\$2291	Specify <i>with composite veneer</i> and indicate composite color number.
	Composite veneer for contrasting color scheme		
	• For case front		
	– Composite group 1 veneer	+\$ 368	Specify <i>with composite veneer</i> and indicate composite color number.
	– Composite group 2 veneer	+\$ 458	Specify <i>with composite veneer</i> and indicate composite color number.
	• For case		
	– Composite group 1 veneer	+\$1472	Specify <i>with composite veneer</i> and indicate composite color number.
	– Composite group 2 veneer	+\$1834	Specify <i>with composite veneer</i> and indicate composite color number.
	Wood veneer for non-contrasting color scheme		
	• Wood group 1 veneer	+\$2021	Specify <i>with wood veneer</i> and indicate wood color number.
	• Wood group 2 veneer	+\$2519	Specify <i>with wood veneer</i> and indicate wood color number.
	• Wood group 3 veneer	+\$3754	Specify <i>with wood veneer</i> and indicate wood color number.
	• Customiz stain	No cost	Specify <i>with Customiz stain</i> .
	Wood veneer for contrasting color scheme		
	• For case front		
	–Wood group 1 veneer	+\$ 405	Specify <i>with wood veneer</i> and indicate wood color number.
	–Wood group 2 veneer	+\$ 504	Specify <i>with wood veneer</i> and indicate wood color number.
–Wood group 3 veneer	+\$ 757	Specify <i>with wood veneer</i> and indicate wood color number.	
–Customiz stain	No cost	Specify <i>with Customiz stain</i> .	
• For case			
–Wood group 1 veneer	+\$1619	Specify <i>with wood veneer</i> and indicate wood color number.	
–Wood group 2 veneer	+\$2017	Specify <i>with wood veneer</i> and indicate wood color number.	
–Wood group 3 veneer	+\$3000	Specify <i>with wood veneer</i> and indicate wood color number.	
–Customiz stain	No cost	Specify <i>with Customiz stain</i> .	
Paint for case interior			
• Paint price group 1	No cost	Specify paint color number.	
• Paint price group 2	+\$ 94	Specify paint color number.	
• Paint price group 3	+\$ 246	Specify paint color number.	
Pull	Laminate or wood fronts		
	• Nile	No cost	Specify <i>with nile pull</i> .
	• Bar	+\$ 2	Specify <i>with bar pull</i> .
	• Contemporary	–\$ 39	Specify <i>with contemporary pull</i> .
	• Jazz	–\$ 11	Specify <i>with jazz pull</i> .
Light	• Light	+\$ 329	Specify <i>with light</i> .
Coat Closet	• Coat closet	+\$ 80	Specify <i>with coat closet</i> .
Grain Direction	• Horizontal	No cost	Specify <i>with horizontal grain direction</i> .

Tip: Contrasting fronts and horizontal grain direction are available options for laminate front/laminate case, veneer front/laminate case, or laminate front/veneer case.

Tip: Light is available with bag drop configuration only.

► Options, continued on next page



For Canadian Pricing

Multiply U.S. Price by the Canadian price factor.

► See page 1 for details.

► Options, continued from previous page

Options		U.S. Price		Required to Specify
Magnetic Board	One magnetic board	42"H	48"H	Specify Cogent: Connect fabric number. Specify Billiard Multi-Use by Designtex fabric number.
	• Fabric price group 2	+\$187	+\$235	
	• Fabric price group 3	+\$236	+\$284	
	Two magnetic boards	42"H	48"H	Specify Cogent: Connect fabric number. Specify Billiard Multi-Use by Designtex fabric number.
	• Fabric price group 2	+\$374	+\$470	
	• Fabric price group 3	+\$472	+\$568	
Lock and Keying	Lock			Specify with 9250 Ember Chrome lock.
	• Ember Chrome	No cost		
	Keying			► Page 375
	• Factory and field-installed keying			
Related Products	• Worksurface support bracket			► Page 294
	• Panel connector bracket			► See Answer Specification Guide

Specification Information

• Style Number	• Width	U.S. Base Prices	
		• 24"D	• 30"D
HDSTG	12"	\$4128	\$4511
	15"	\$4399	\$4782

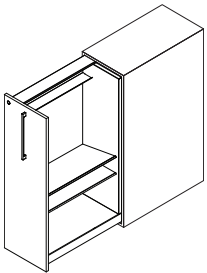

 **For Canadian Pricing**
 Multiply U.S. Price by the Canadian price factor.
 ► See page 1 for details.

High-Density Storage Value Package

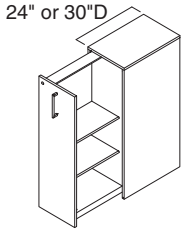

Drawing shows left-hand application, right-hand application is also available.

Tip: The high-density value package is a simplified version of high-density storage that includes two fixed shelves to solve organizational needs at a lower price point.

Tip: Nile pull will default as the standard pull, you must confirm this selection or specify an optional pull.

Standard Includes	Required to Specify
-------------------	---------------------

- | | |
|--|---|
| <ul style="list-style-type: none"> ▶ Need help? Product details, page 154 • Case: laminate price group 1 • Drawer front: laminate to match case • Case interior: paint • Two fixed shelves: 7360 Merle • Nile pull: metal • Lock, keyed random: 9201 Polished Chrome • Four adjustable leveling glides • Vertical grain direction | <ol style="list-style-type: none"> Style number Case width (see below under Required Selections) Case depth (see below under Required Selections) Case height (see below under Required Selections) Handedness (see below under Required Selections) Laminate color number for case and drawer front Paint color number for case interior Pull (see below under Required Selections) Metal color number for pulls Options, if selected (see below) <p>▶ See <i>Surface Materials</i>, page 358.</p> |
|--|---|

Required Selections	U.S. Price	Required to Specify
---------------------	------------	---------------------

Case Width	<ul style="list-style-type: none"> • 12"W • 15"W 	Prices at right Prices at right	Specify with 12" width. Specify with 15" width.
Case Depth	<ul style="list-style-type: none"> • 24"D • 30"D 	Prices at right Prices at right	Specify with 24" depth. Specify with 30" depth.
Case Height	<ul style="list-style-type: none"> • 42"H • 48"H 	No cost +\$275	Specify with 42" height. Specify with 48" height.
Handedness	<ul style="list-style-type: none"> • Left hand • Right hand 	No cost No cost	Specify left-hand. Specify right-hand.

Pull

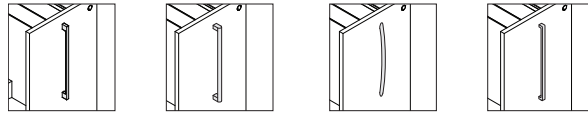

Nile pull Bar pull Contemporary pull Jazz pull

Options	U.S. Price	Required to Specify
---------	------------	---------------------

Front Color Scheme	<ul style="list-style-type: none"> • Non contrasting • Contrasting 	No cost +\$ 69	Specify with non contrasting. Specify with contrasting.
Surface Materials	<p>Laminate on case</p> <ul style="list-style-type: none"> • Laminate price group 2 • Laminate price group 3 • Open Line laminate 	See information at left See information at left +\$111 plus cost of laminate	Specify laminate color number. Specify laminate color number. ▶ See <i>Surface Material Reference Manual</i> .
	<p>Laminate on contrasting case front</p> <ul style="list-style-type: none"> • Laminate price group 2 on case front • Laminate price group 3 on case front • Open Line laminate on case front 	See information at left See information at left +\$111 plus cost of laminate	Specify laminate color number. Specify laminate color number. ▶ See <i>Surface Material Reference Manual</i> .
	<p>Paint for case interior</p> <ul style="list-style-type: none"> • Paint price group 1 • Paint price group 2 • Paint price group 3 	No cost +\$ 94 +\$246	Specify paint color number. Specify paint color number. Specify paint color number.

For laminate price group 2 and price group 3 pricing, please refer to the electronic catalog or SmartTools.



For Canadian Pricing
Multiply U.S. Price by the Canadian price factor.
▶ See page 1 for details.

▶ **Options, continued on next page**

► Options, continued from previous page

Options	U.S. Price	Required to Specify
Pull Laminate fronts <ul style="list-style-type: none"> • Nile • Bar • Contemporary • Jazz 	No cost +\$ 2 -\$39 -\$11	Specify <i>with nile pull</i> . Specify <i>with bar pull</i> . Specify <i>with contemporary pull</i> . Specify <i>with jazz pull</i> .
Coat Closet <ul style="list-style-type: none"> • Coat closet 	+\$80	Specify <i>with coat closet</i> .
Grain Direction <ul style="list-style-type: none"> • Horizontal 	No cost	Specify <i>with horizontal grain direction</i> .
Lock and Keying Lock <ul style="list-style-type: none"> • Ember Chrome 	No cost	Specify <i>with 9250 Ember Chrome lock</i> .
	Keying <ul style="list-style-type: none"> • Factory and field-installed keying 	► Page 375
Related Products <ul style="list-style-type: none"> • Worksurface support bracket 		► Page 294

Specification Information

Style Number	Width	U.S. Base Prices	
		24"D	30"D
HDSTGV	12"	\$3056	\$3439
	15"	\$3327	\$3710

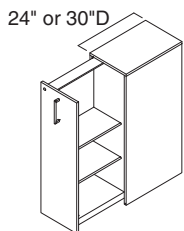

For Canadian Pricing

Multiply U.S. Price by the Canadian price factor.

► See page 1 for details.

High-Density Worksurface Support Bracket

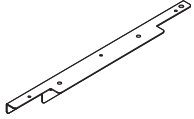

Standard Includes		Required to Specify
-------------------	--	---------------------

▶ Need help? Product details, page 153	<ul style="list-style-type: none"> Bracket: paint Attachment hardware 	1 Style number 2 Depth (see below under Required Selections) 3 Paint color number for bracket ▶ See <i>Surface Materials</i> , page 358.
--	---	---

Required Selections	U.S. Price	Required to Specify
---------------------	------------	---------------------

Depth	<ul style="list-style-type: none"> 24"D 30"D 	No cost No cost Specify with 24"D bracket. Specify with 30"D bracket.
--------------	--	--

Related Products	<ul style="list-style-type: none"> High-density storage 	▶ Pages 288 and 292
-------------------------	--	---------------------

Specification Information

Style Number	U.S. Price
HDWS	\$180



For Canadian Pricing

Multiply U.S. Price by the Canadian price factor.

▶ See page 1 for details.

Specifying Verb Accessories

Personal Whiteboard and Marker Clips	296
Verb Brackets	297

Personal Whiteboard and Marker Clips

Personal Whiteboard



Standard Includes		Required to Specify
▶ Need help? Product details, page 160	• Two-sided e ³ CeramicSteel with urethane edge molding	Style number

Specification Information			
• Dimensions		• Style	• U.S.
H	W	Number	Price
23"	18"	VWB2	\$303

Marker Clips



Standard Includes		Required to Specify
▶ Need help? Product details, page 160	• Package of 20 plastic marker clips: 6249 Platinum Solid	Style number

Specification Information	
• Style	• U.S.
Number	Price
BSMC	\$54



For Canadian Pricing
Multiply U.S. Price by the Canadian price factor.
▶ See page 1 for details.

Verb Brackets

For Use with Answer Boundary Screens and Universal Worksurfaces

Standard Includes	Required to Specify
<ul style="list-style-type: none"> ▶ Need help? Product details, page 160 • Plastic bracket: 6249 Platinum Solid 	Style number

Related Products
<ul style="list-style-type: none"> • Personal whiteboard ▶ Page 296

Specification Information	
• Style Number	• U.S. Price

Verb Bracket for Boundary Screen-Single Sided

BSVB1	\$59
•	•

Verb Bracket for Boundary Screen-Double Sided

BSVB2	\$98
•	•

For Universal Worksurfaces

USWSVB	\$59
•	•

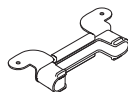
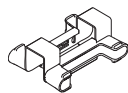
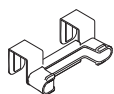

Tip: Attachment hardware included.

For Canadian Pricing
 Multiply U.S. Price by the Canadian price factor.
 ▶ See page 1 for details.

Understanding Answer Fence



Statement of Line 300

Answer Fence Overview	304
Answer Fence Buildups	305
Answer Fence Junctions	306
Answer Fence Foot	308
Answer Fence Horizontal Packages	310
Answer Fence Infeed Covers	313
Answer Fence Power Distribution and Access	314
Answer Fence End-of-Run Junction with Utility Pole	317
Answer Fence Utility Pole — L, T, or X Junctions	318
Universal Screens and Aligners	319
Sarto Fence Screens	320
Answer Fence Frameless Glass Screens with Recessed Attachment	321
Answer Fence Boundary Screens	322
Wiring Schematics	324
How to Calculate Power Needs	325
Cable Capacities	326
Answer Fence Stability Guidelines	327

Statement of Line

Answer Fence

Answer Fence Junctions



In-Line Fence Junction

Understanding
▶ Page 306
Specifying
▶ Page 332



End-of-Run Fence Junction

Understanding
▶ Page 306
Specifying
▶ Page 332

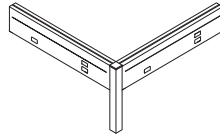

L Fence Junction

Understanding
▶ Page 306
Specifying
▶ Page 333

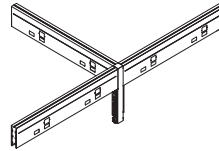

T Fence Junction

Understanding
▶ Page 306
Specifying
▶ Page 333

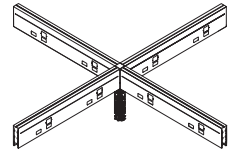

X Fence Junction

Understanding
▶ Page 306
Specifying
▶ Page 333

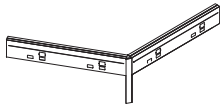

V Fence Junction

Understanding
▶ Page 306
Specifying
▶ Page 334

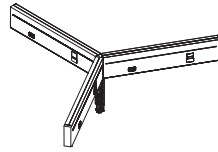

Y Fence Junction

Understanding
▶ Page 306
Specifying
▶ Page 334

Answer Fence Foot

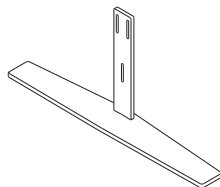

Fence Foot

Understanding
▶ Page 308
Specifying
▶ Page 336

Answer Fence Horizontal Packages

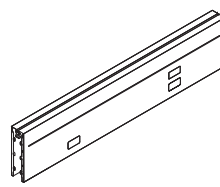

Horizontal Packages

Understanding
▶ Page 310
Specifying
▶ Page 337

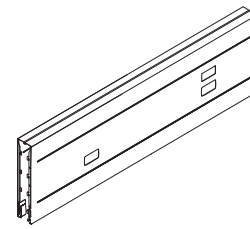

High-Capacity Horizontal Packages

Understanding
▶ Page 310
Specifying
▶ Page 338

Answer Fence Infeed Covers



Standard Infeed Cover
Understanding
▶ Page 313
Specifying
▶ Page 339

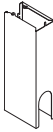

High-Capacity Infeed Cover
Understanding
▶ Page 313
Specifying
▶ Page 339

Answer Fence Utility Poles

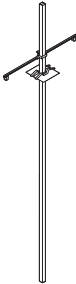

End-of-Run Junction with Utility Pole
Understanding
▶ Page 317
Specifying
▶ Page 340

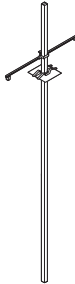

Utility Pole—L, T, or X Junctions
Understanding
▶ Page 318
Specifying
▶ Page 341

Answer Fence Power Distribution and Access

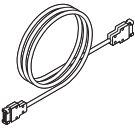

Power Harnesses
Understanding
▶ Page 314
Specifying
▶ Page 342

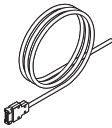

Multipurpose Power Infeeds
Understanding
▶ Page 314
Specifying
▶ Page 343



Multipurpose Infeed Conduit Covers
Understanding
▶ Page 314
Specifying
▶ Page 343



15 amp
Duplex Receptacle
Understanding
▶ Page 315
Specifying
▶ Page 344



USB Receptacle
Understanding
▶ Page 315
Specifying
▶ Page 345



Blank Cut-Out Cover
Understanding
▶ Page 315
Specifying
▶ Page 345



Receptacle Trim Ring
Understanding
▶ Page 316
Specifying
▶ Page 346



Data Filler
Understanding
▶ Page 316
Specifying
▶ Page 346



Grommet for Junction
Understanding
▶ Page 316
Specifying
▶ Page 347



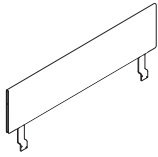

Understanding
 ▶ Page 319
 Specifying
 ▶ Page 348

Universal Screens

	24"W	30"W	36"W	42"W	48"W	54"W	60"W	66"W	72"W	78"W	84"W	90"W	96"W
13½"H	●	●	●	●	●	●	●	●	●	●	●	●	●
19½"H	●	●	●	●	●	●	●	●	●	●	●	●	●

Tip: Available in parametric sizes ranging from 24"W to 96"W and 13½"H to 19½"H in ½" increments.

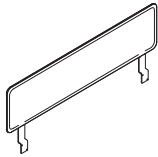

Understanding
 ▶ Page 320
 Specifying
 ▶ Page 350

Sarto Fence Screens

	24"W	30"W	36"W	42"W	48"W	54"W	60"W	66"W	72"W	78"W	84"W	90"W	96"W
13½"H	●	●	●	●	●	●	●	●	●	●	●	●	●
19½"H	●	●	●	●	●	●	●	●	●	●	●	●	●

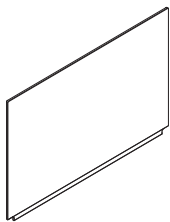

Understanding
 ▶ Page 321
 Specifying
 ▶ Page 352

Frameless Glass Screens with Recessed Attachment

	24"W	30"W	36"W	42"W	48"W	60"W	72"W
13½"H	●	●	●	●	●	●	●
19½"H	●	●	●	●	●	●	●

Straight Boundary Screens

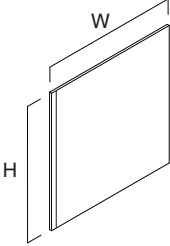

Understanding
 ▶ Page 322
 Specifying
 ▶ Page 354

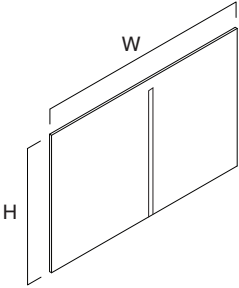

Understanding
 ▶ Page 322
 Specifying
 ▶ Page 354

Single-Sided Boundary Screens

	27"W	33"W	39"W
42"H	●	●	●
48"H	●	●	●

Spanning Boundary Screens

	51"W	57"W	63"W	69"W	75"W
42"H	●	●	●	●	●
48"H	●	●	●	●	●



Answer Fence Overview

Answer fence is a free-standing spine that allows for flexible power routing, data distribution, and light scale space division.

Answer fence features a light scale design with an open base.

The horizontal package determines the width of the fence segment; and includes horizontal connecting bar, steel covers, powerkit, and inside vertical trim.

Power harness, specified separately, allows power to move from one horizontal frame to the next.

Fence feet provide stability to the fence in in-line applications.

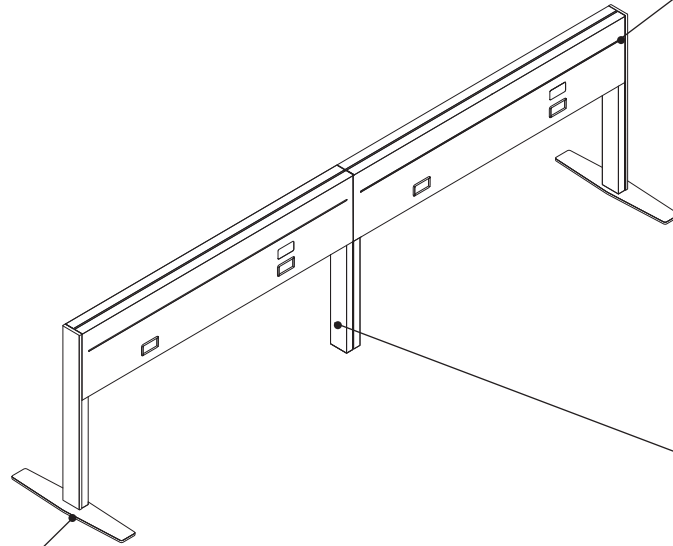

Answer fence features a horizontal design detail for distinguished aesthetic.

Junctions are specific to fence 27½"H, and are available in in-line, end-of-run, L, T, X, V, and Y configurations.

Frames

Begin by planning your horizontal frames. Junction height is 27½" and the horizontal package determines width.

Junctions + Horizontal Package = Frame

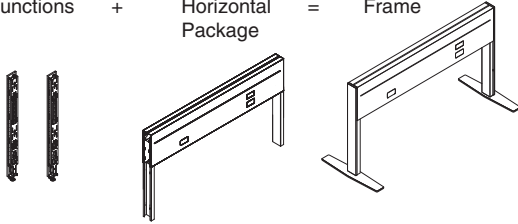

Power and Data

When selected, power is always 20"H, measured from the floor to the center line of the receptacle. Receptacle cutouts are determined by fence width and locations are not specifiable. Data cutouts are available for modular furniture style and single-gang (NEMA) faceplates and are always positioned above the receptacle (shown below). Power and data cutouts can be omitted for aisle-way applications or where power is not required.

24"W - Standard Cover

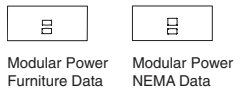

24"W - High-capacity Cover

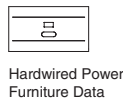
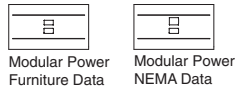

30"W - Standard Cover

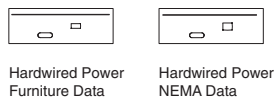
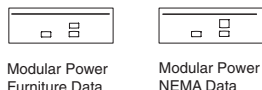

30"W - High-capacity Cover

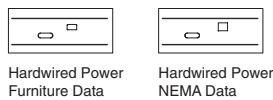
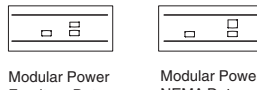

36"W - Standard Cover

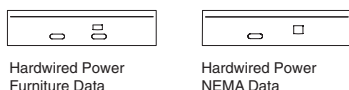
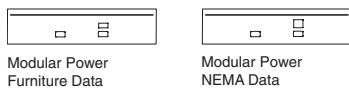

36"W - High-capacity Cover

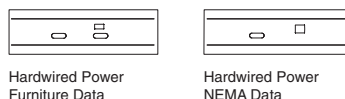

42"W and 48"W - Standard Cover

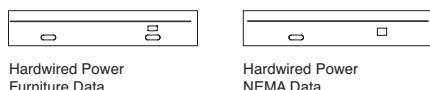
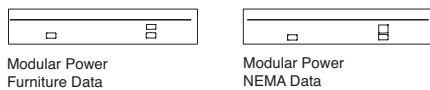

42"W and 48"W - High-capacity Cover

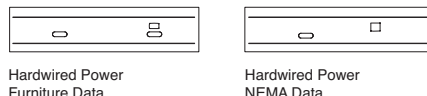
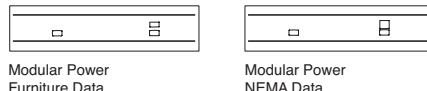

60"W and 72"W - Standard Cover

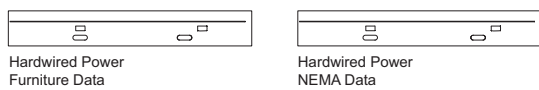
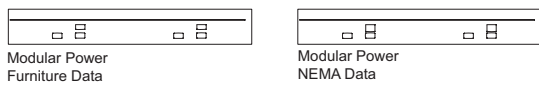

60"W and 72"W - High-capacity Cover

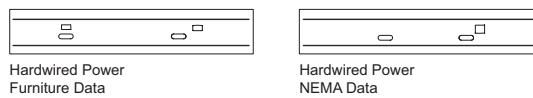
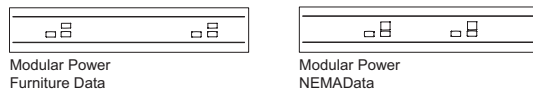

Answer Fence Junctions

Answer fence leverages the construction of the Answer panels. Answer fence junctions give the fence a height of 27½".

Answer fence junctions must be specified as in-line, end-of-run, L, T, X, V, or Y junctions.
 ▶ Specifying, page 332

Slots in junction accept the horizontal bar which is part of the horizontal package.

Large openings are used to route power and cables through an L, T, X, V, Y, and in-line junctions.

Outside vertical trim is included with L, T, V, and end-of-run junctions to finish exposed surfaces. Trim is available in paint.

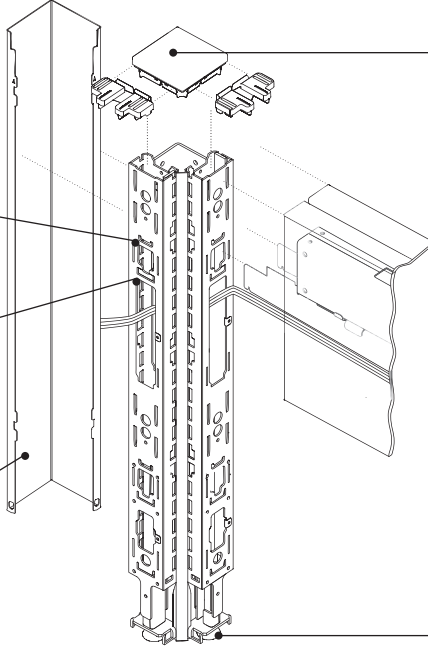

Junction cap and aligner are included with junction.

Leveling glides adjust to install fence on uneven floors. Range is 2¾".

Product Details

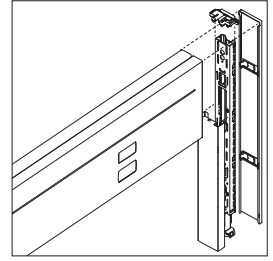

End-of-run fence junction includes junction, outside vertical trim, trim aligner, and junction cap. End-of-run trim adds ½" to footprint.
Tip: Inside vertical trim is included with horizontal package.

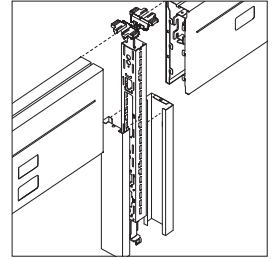

In-line fence junction includes junction and in-line fence cover aligner.
Tip: Inside vertical trim is included with horizontal package.

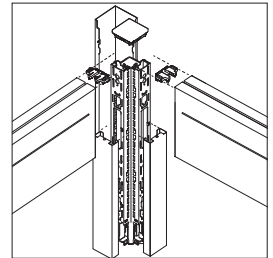

L fence junction includes junction, outside vertical trim, inside corner light seal(s), junction cap, and two plastic corner aligners.
Tip: Inside vertical trim is included with horizontal package.

Actual Dimensions

Depth	3"
Height	27½"

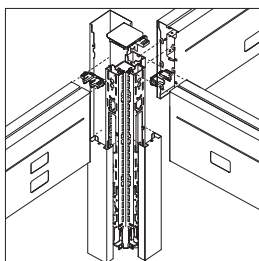

T fence junction includes junction, inside corner light seal(s), outside vertical trim, junction cap, and three plastic corner aligners.
Tip: Inside vertical trim is included with horizontal package.

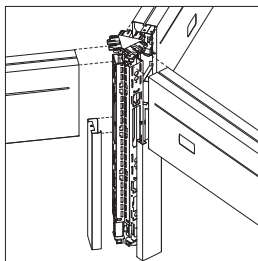

Y fence junction includes junction, junction cap, and two plastic top cap aligners.
Tip: Inside vertical trim is included with horizontal package.

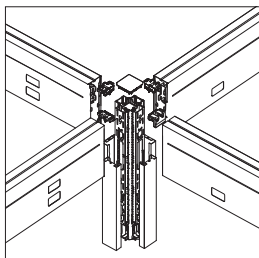

X fence junction includes junction, inside corner light seal(s), junction cap, and four plastic corner aligners.
Tip: Inside vertical trim is included with horizontal package.

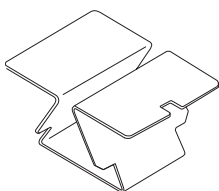

An in-line fence cover aligner is included with in-line junctions.



Fence aligners are included with end-of-run, L, T, X, V, and Y junctions.

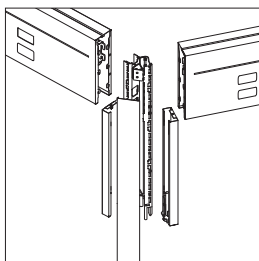

V fence junction includes junction, outside vertical trim, junction cap, and plastic aligner.
Tip: Inside vertical trim is included with horizontal package.

Connections

Junctions for Answer fence are unique to the Answer fence and are not compatible with Answer panel buildups.

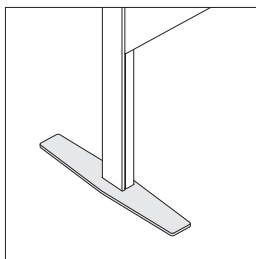

Answer fence foot can be used with fence junctions to provide support and stability.

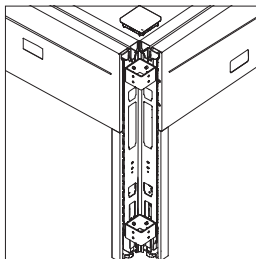

Block and post construction of corner junctions allow junction posts to be easily added or removed to configure between L, T, X, V, or Y in an application.
Tip: Junction and post trim can be ordered through Service Parts.

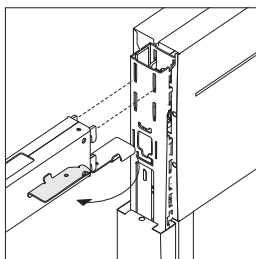

Quick lock on both ends of the fence horizontal connecting bars engage the junction in a tight structural connection.

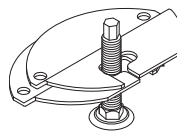

Floor anchor brackets are available to secure junctions to the floor to prevent fence movement. Brackets are intended for use in seismic zones and may require additional code approvals.



Carpet gripper glide caps may be added to fence junction glides to help hold fence in place.

Wiring & Cabling

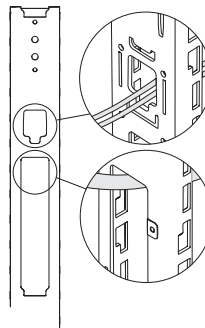

Answer fence junctions have the ability to support cabling by routing cable through openings in the junction.

Surface Materials

Junction

- Black paint
- Tip: Junction is hidden when properly installed.*

Fence vertical trim and junction cap

- Paint
- Tip: Junction cap matches outside vertical trim color on end-of-run, T, V, and L junctions.*

Application Topics

Stability Guidelines for application rules.
 ▶ Page 327

Answer Fence Foot

The fence foot attaches to the fence junction to provide stability to the end-of-run and in-line fence run.

► Specifying, page 336

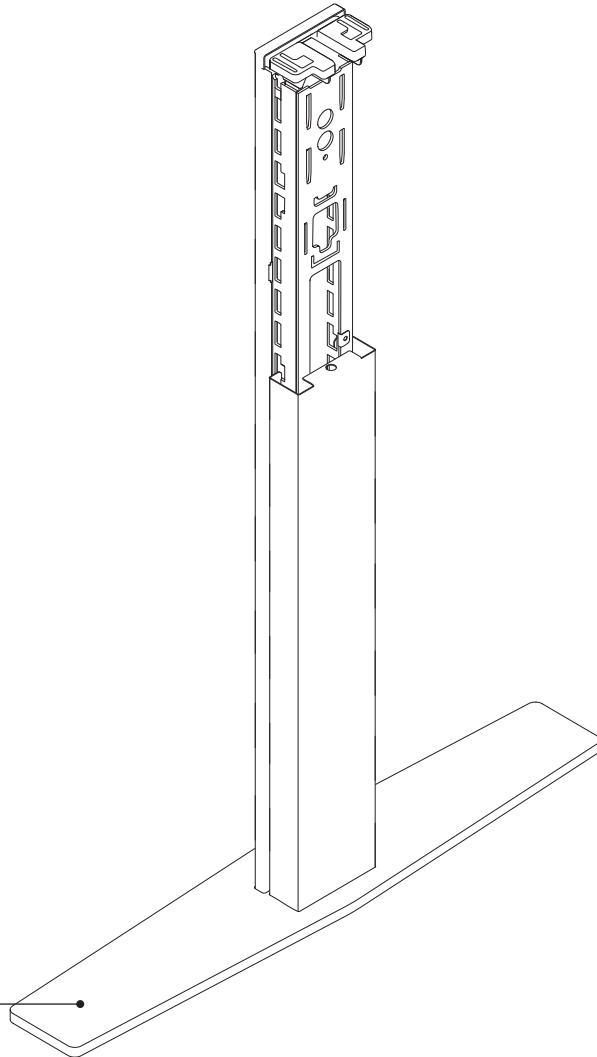

Fence foot

Actual Dimensions	
Width	3½"
Length	19½"
Height	⅝"

Product Details

Answer fence foot can be used with fence junctions to provide support and stability.

► See Stability Guidelines page 327, for more information.

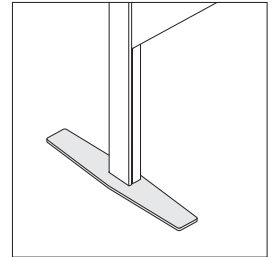

Fence foot will be offset on end-of-run junction.

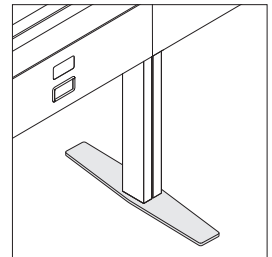

Fence foot will be centered on in-line junctions.

Fence foot accommodates Ology, Migration, Airtouch, and height adjustable desks.

Surface Materials

Foot
• Paint

Answer Fence Horizontal Packages

Answer fence horizontal packages include horizontal connecting bar, a pair of steel covers with power and data cutouts, a powerkit, and inside vertical trim.

► Specifying, page 337

Fence covers wrap to create top and bottom of the fence, providing a ¼" gap for use with Universal screens for fence.

Power and data cutouts are always included in predefined locations.

Horizontal connecting bar locks into vertical junctions.

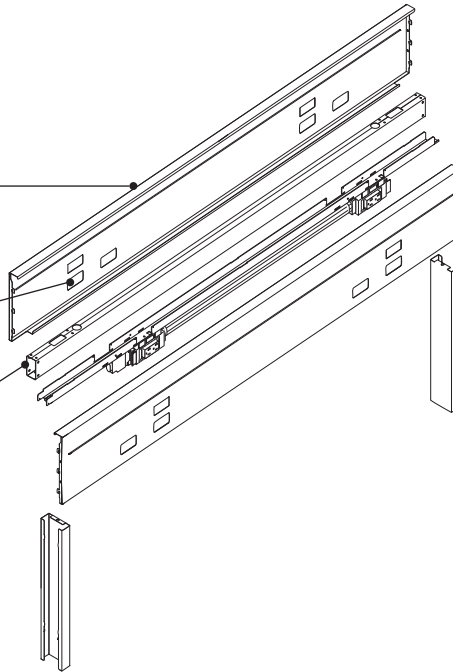

High-capacity horizontal packages include taller covers to accommodate additional data cables.

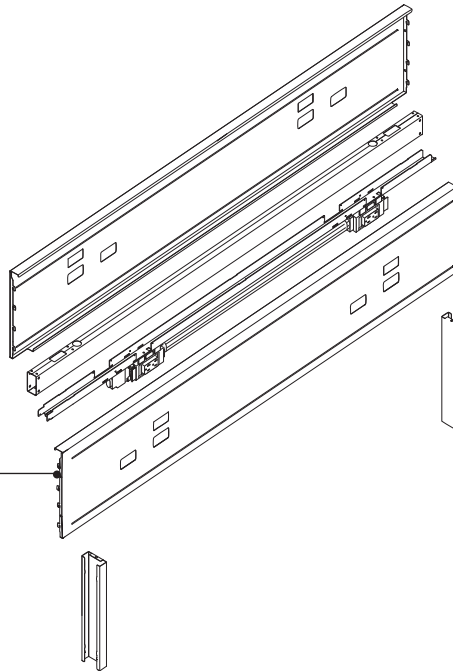

Actual Dimensions

Width 24", 30", 36", 42", 48", 60", and 72"

Height 10" and 13¼"

Product Details

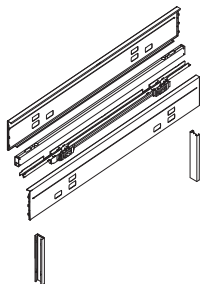

Answer fence horizontal package includes a horizontal connecting bar, a pair of steel covers with power and data cutouts, a powerkit, and inside vertical trim.

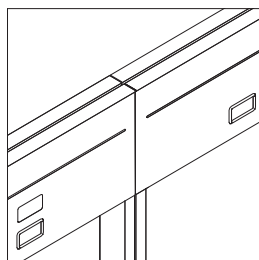

Answer fence cover features a bead design detail sized relative to the width of the cover.

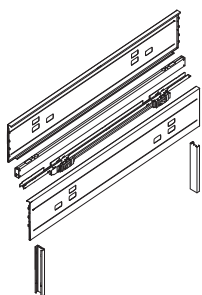

Answer fence high-capacity horizontal package includes a horizontal connecting bar, a pair of high-capacity steel covers, a powerkit, and inside vertical trim.

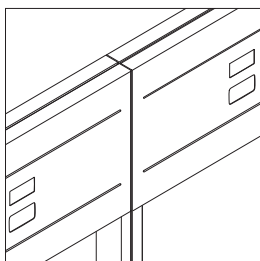

High-capacity fence cover features a second bead design detail.

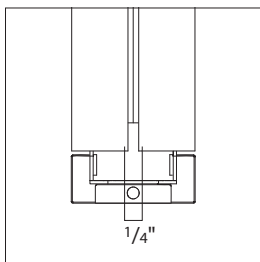

Steel covers come together at the top of the fence with a 1/4" gap allowing for use of screens on fence.

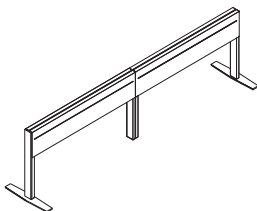

Covers can be specified with or without cutouts (Fence segments shown without cutouts). When specified with cutouts, covers always have both power and data cutouts.

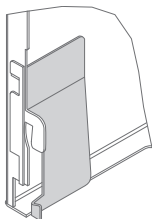

Covers include a steel spring clip to lock the cover in place.
Tip: Steel spring clips will not fit junctions manufactured prior to April 15, 2019.

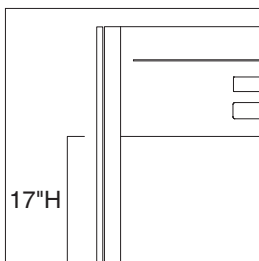

Horizontal package includes vertical trim to create a 17"H open base.

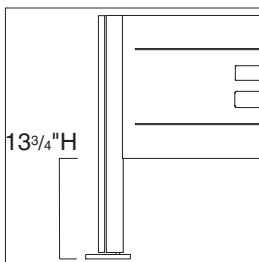

High-capacity horizontal package includes vertical trim to create a 13 3/4"H open base.

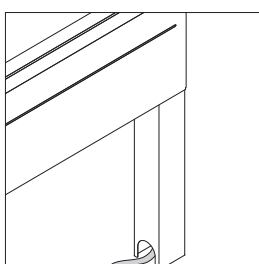

Infeed covers can be specified for horizontal packages to conceal data cables and power infeed.

Connections

Answer fence horizontal packages are unique to the Answer fence and are not compatible with Answer panel buildups.

Wiring & Cabling

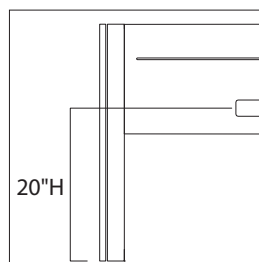

Power and data is always expressed at 20"H off the floor to center line of the receptacle with data above the power. The horizontal cover has cutouts to express the receptacle and data cutouts.

Powerkits are included with horizontal packages.

Powerkit can be omitted when not required.

Power is standard in non-PVC modular or hardware. Modular is available in 3+1, 2+2, or 3SN.

Data is specified in the Answer fence horizontal package with either modular furniture style cutout or single-gang (NEMA) style cutout.

All receptacles and trim rings are specified separately.



Fence receptacle filler (TSFRF) are available to fill unused receptacle openings. They are offered in packages of 20.



Data fillers (TS7DF) should be specified in furniture style data cutouts that are not being used. Field provided data filler should be used for any single-gang (NEMA) data cutout that is not being used.

Modular Power

Three wiring schematics are available; 3+1, 2+2, and three circuits with separate neutrals (3SN). All the components in an electrical distribution system must use the same wiring schematic. For safety the components are keyed, labeled, and color-coded to make it impossible to connect mismatched parts.

▶ Page 324

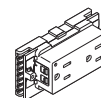

15 amp

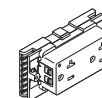

20 amp

15-amp or 20-amp duplex receptacles snap into powerkits on both sides of the fence.

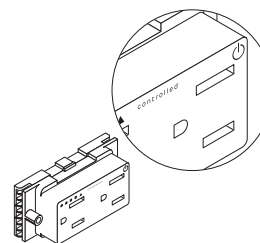

Controlled receptacle must be indicated when tying into the building management system. Duplex receptacles have an option for a factory permanent, pad stamp power icon symbol with the word controlled per compliance with the Energy Code.

Answer Fence Horizontal Packages, continued



USB receptacles are available in three wiring schematics with multiple line options, snap into powerkits on both sides of the fence. USB receptacles offer easy access to two charging ports. Each port provides one ampere of output. USB receptacles conveniently charge a wide range of electronic devices. Some devices may not be compatible.

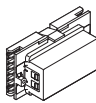

Blank receptacles can be used to fill cutout locations where power is not expressed.

Tip: Unused receptacle cutout openings can also be filled using a fence receptacle filler (TSFRF).

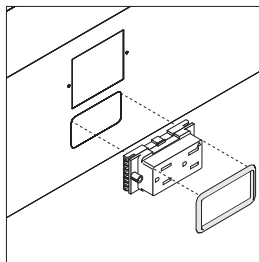

A receptacle trim ring (TS7RCT) is required at each power cutout location for modular power configurations and is specified separately.

Hardwire Power

Chicago electrical code requires the power distribution network to be hardwired on site. These installations require hard-wired powerkits.

Power tray is included in hardwired powerkit to secure junction boxes and to attach to horizontal package.

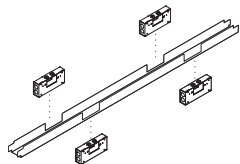

Junction boxes are mounted below the power tray and included with the powerkit.

Junction box can accommodate two receptacles back to back. Electrician can use Leviton 5325 or equivalent receptacles.

Electrician must make all hardwire connections in the field. Electrician must supply all conduits, wires, nuts, and connection to building power supply.

Receptacle trim rings are not required for hardwire power. The electrician will provide the receptacle and faceplate.

Surface Materials

Horizontal covers

- Paint

Horizontal bar

- Black paint

Answer Fence Infeed Covers

Infeed covers are available for use with standard and high-capacity fence to conceal power infeed and data cable routing.

► Specifying, page 339

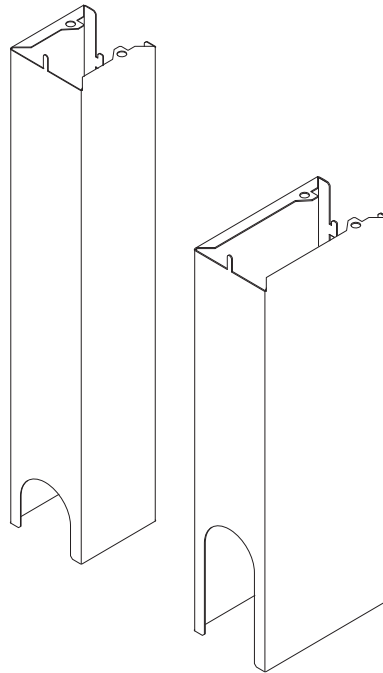

Product Details

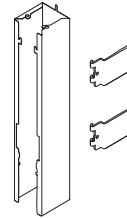

Infeed cover includes metal cover, attachment bracket, and hardware.

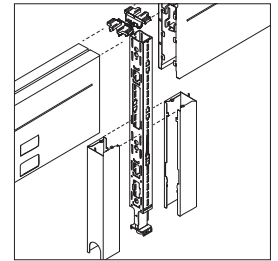

Infeed cover takes the place of inside vertical trim.

Infeed cover can be retrofitted on any fence junction.

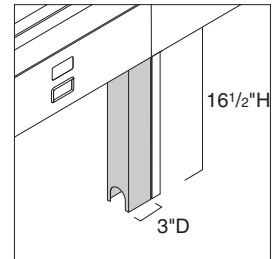

Infeed cover for standard fence is 3\"/>

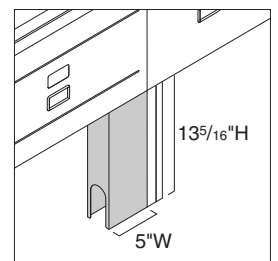

Infeed cover for high-capacity fence is 5\"/>

Surface Materials

Infeed cover

- Paint

Actual Dimension

Depth	2 ⁷ / ₈ "
Width	3" or 5"
Height	13 ⁵ / ₁₆ " or 16 ¹ / ₂ "

Answer Fence Power Distribution and Access

Power Harnesses

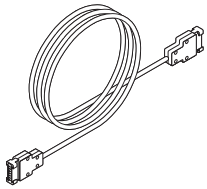

► Specifying, page 342

Product Details

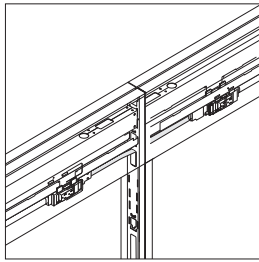

Power harnesses are required to connect powerkits between fence sections.

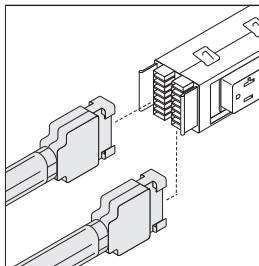

Harnesses plug into connection points on the powerkit. Every powerkit has multiple connection points to allow branching of power.

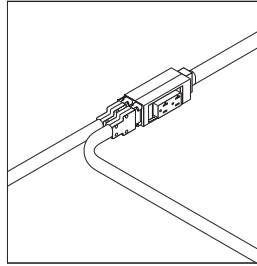

T-connection is formed by connecting two harnesses to a power block.

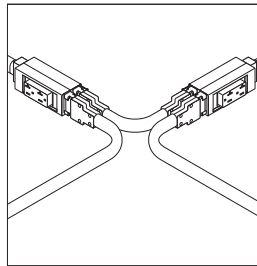

X-connection is formed by connecting two harnesses to two successive power blocks.

Power harnesses are non-PVC.

Harness Application Length

Harness Length	Application
20"W	In-line
23"W	L, T, X, V, and Y corner junctions
50"W	24"W fence pass-through
56"W	30"W fence pass-through
62"W	36"W fence pass-through
68"W	42"W fence pass-through
74"W	48"W fence pass-through
86"W	60"W fence pass-through
98"W	72"W fence pass-through

Multipurpose Power Infeeds

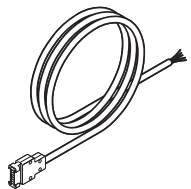

► Specifying, page 343

Product Details

Multipurpose power infeed is shielded to allow power and communication routing side by side. Available in 6', 12', and 24' lengths.

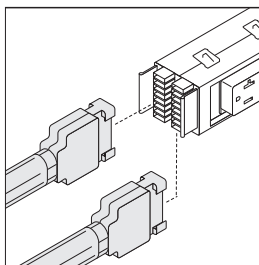

Multipurpose power infeeds bring power into the fence and make a modular connection to a powerkit.

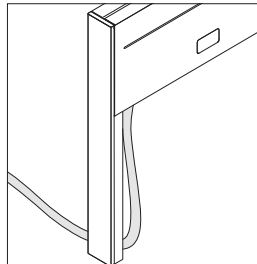

Multipurpose infeed enters below the horizontal package.

Multipurpose power infeeds can be used with ceiling- and floor-access lay-in utility packages and utility poles. Specify power harness separately.

Multipurpose power infeeds may be specified in a non-PVC version. For those trying to gain the LEED Innovation in Design credit, non-PVC should be selected.

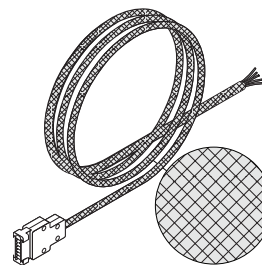

Multipurpose infeed conduit cover is aesthetic only and conceals the metallic portion of the multipurpose infeed.

Duplex Receptacle

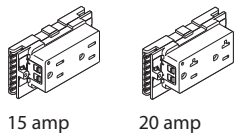

15 amp 20 amp
▶ Specifying, page 344

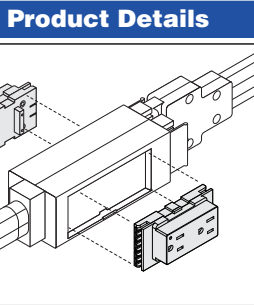

15-amp or 20-amp receptacles, ordered separately, snap into both faces of power block in the field.

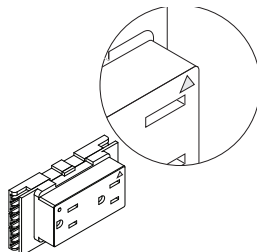

Orange triangle indicates to users the receptacles that are connected to isolated grounds.

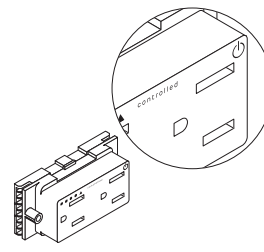

Controlled receptacle must be indicated when tying into the building management system. Duplex receptacles have an option for a factory permanent, pad stamp power icon symbol with the word controlled per compliance with the Energy Code.

Surface Materials

- Duplex Receptacle**
- 6000 Black
 - 6009 Arctic White
 - 6249 Platinum Solid
 - 6527 Merle
 - 6654 Sand
 - 6697 Fog
 - 6B03 Red

USB Receptacle



▶ Specifying, page 345

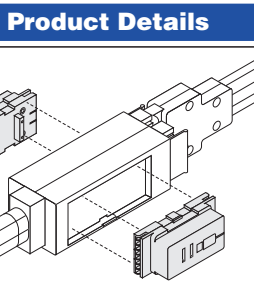

USB receptacles, ordered separately, snap into both faces of power block in the field.

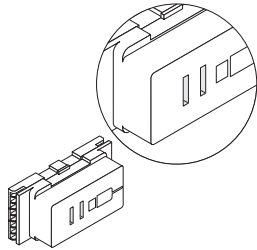

USB receptacles, are available in three wiring schematics with multiple line options. USB receptacles offer easy access to two charging ports. Each port provides one amperage of output. USB receptacles conveniently charge a wide range of electronic devices. Some devices may not be compatible.

Surface Materials

- USB Receptacle**
- 6000 Black
 - 6009 Arctic White
 - 6249 Platinum Solid
 - 6527 Merle
 - 6654 Sand
 - 6697 Fog
 - 6B03 Red

Blank Receptacle

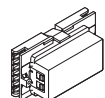

▶ Specifying, page 345

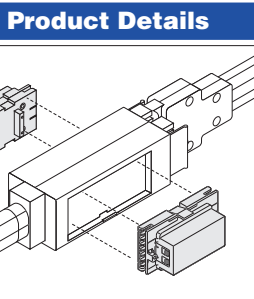

Blank receptacles can be used to fill cutout locations where power is not expressed.

Surface Materials

- Blank Cut-Out Cover**
- 6000 Black
 - 6009 Arctic White
 - 6249 Platinum Solid
 - 6527 Merle
 - 6654 Sand
 - 6697 Fog

Receptacle Trim Ring



► Specifying, page 346

Product Details

Receptacle trim ring is used with each receptacle, USB receptacle, or blank receptacle to cover the edge of the cutout and create a precise transition between the cutout and the receptacle.

Surface Materials

Receptacle Trim Ring

- 6000 Black
- 6009 Arctic White
- 6249 Platinum Solid
- 6527 Merle
- 6654 Sand
- 6697 Fog

Fence Receptacle Filler



► Specifying, page 346

Product Details

Filler receptacle fillers are available to fill unused receptacle openings in fence covers. They are offered in packages of 20.

Surface Materials

Fence Receptacle Filler

- 6000 Black
- 6009 Arctic White
- 6249 Platinum Solid
- 6527 Merle
- 6654 Sand
- 6697 Fog

Data Filler



► Specifying, page 346

Product Details

Data fillers are available to fill unused furniture style data openings. They are offered in packages of 20.

Surface Materials

Data Filler

- 6000 Black
- 6009 Arctic White
- 6249 Platinum Solid
- 6527 Merle
- 6654 Sand
- 6697 Fog

Grommet for Junction



► Specifying, page 347

Product Details

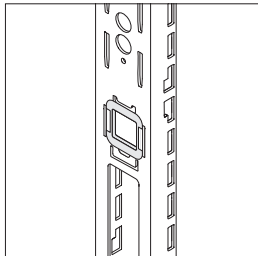

Grommet for junction can be added in the field to finish the exposed metal edges of horizontal cable pass-through openings.

Surface Materials

- Black plastic only

Answer Fence End-of-Run Junction with Utility Pole

Answer Fence End-of-Run Junction with Utility Pole

Utility pole for fence with end-of-run junctions brings power and cabling from the ceiling and introduces it into the fence. It includes a junction and replaces the need to order one separately.
 ▶ Specifying, page 340

Ceiling trim plate measures 7" x 7" when installed.

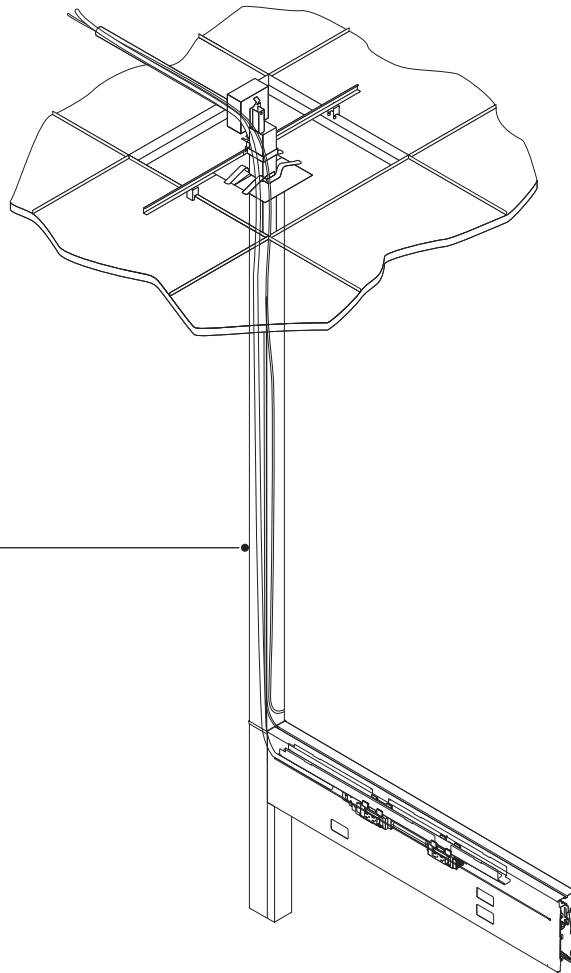

Utility pole extends beyond the footprint of the fence.

Product Details

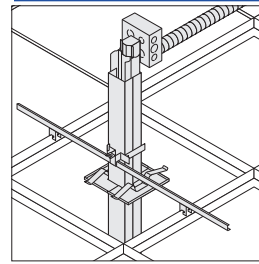

Ceiling attachment kit secures the top of the utility pole to the suspended ceiling grid. Hardwired connection to the building's power can be made in the junction box.

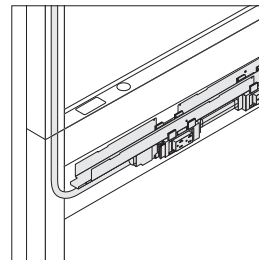

Power harness for use with utility pole is available to bring power down from the ceiling and into the fence to make a modular connection to a powerkit.
Tip: Power harnesses are ordered separately from the utility pole.

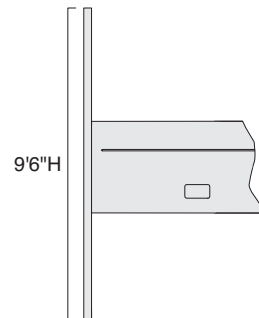

Ceiling heights up to 9'6" can be accommodated.

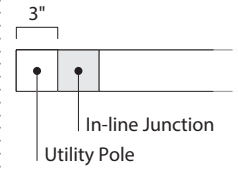

End-of-run application uses an in-line junction. Utility pole extends 3" beyond the footprint of the fence.

Utility pole is always shipped with junction. Don't double order.

Wiring & Cabling

Three wiring schematics are available—3+1, 2+2, and three circuits with separate neutrals (3SN). All the components in an electrical distribution system must use the same wiring schematic. For safety the components are keyed, labeled, and color-coded to make it impossible to connect mismatched parts.
 ▶ Page 324

All Answer electrical components are listed by Underwriters Laboratory (UL) and certified by the Canadian Standards Association (CSA).

Local electrical codes vary. Consult a qualified electrical contractor or engineer for the proper installation of all electrical components.

Chicago and New York have special requirements.

Answer Fence Utility Pole—L, T, or X Junctions

Utility pole—L, T, or X brings power and cabling from the ceiling and introduces it into the fence. Junction is not included as utility pole connects into the existing fence junction.
 ▶ Specifying, page 341

Ceiling trim plate measures 7" x 7" when installed.

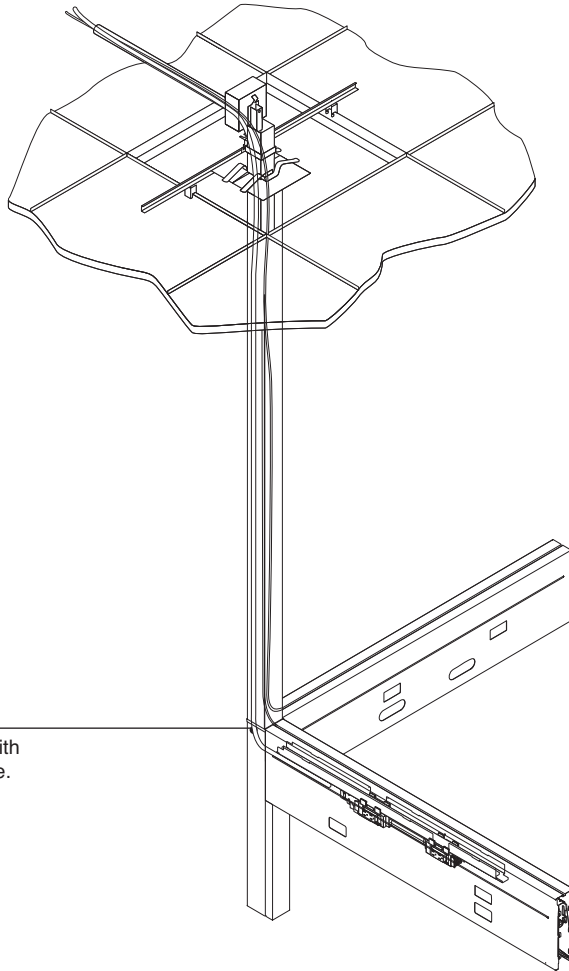

Utility pole is flush with the footprint of the fence.

Product Details

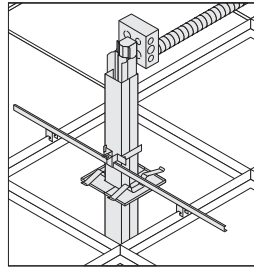

Ceiling attachment kit secures the top of the utility pole to the suspended ceiling grid. Hardwired connection to the building's power can be made in the junction box.

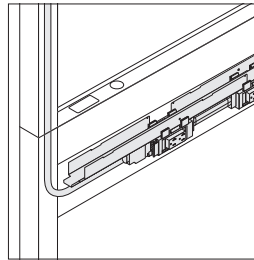

Power harness for use with utility pole is available to bring power down from the ceiling and into the fence to make a modular connection to a powerkit.

Tip: Power harnesses are ordered separately from the utility pole.

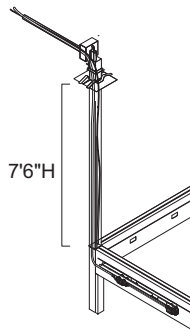

Utility pole can extend to 7'6" above the fence.

Connections

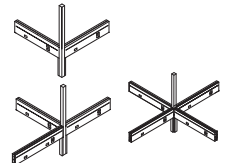

Utility pole works with fence. It can be used at an L, T, or X configuration. It cannot be used in an end-of-run, V, Y, or in-line configuration. Utility pole is not shipped with a junction.

Wiring & Cabling

Three wiring schematics are available—3+1, 2+2, and three circuits with separate neutrals (3SN). All the components in an electrical distribution system must use the same wiring schematic. For safety the components are keyed, labeled, and color-coded to make it impossible to connect mismatched parts.

All Answer electrical components are listed by Underwriters Laboratory (UL) and certified by the Canadian Standards Association (CSA).

Local electrical codes vary. Consult a qualified electrical contractor or engineer for the proper installation of all electrical components.

Chicago and New York have special requirements.

Universal Screens and Aligners

Universal screens provide a tackable boundary element along the Answer fence. They are available in two heights to accommodate varying levels of privacy. *Tip: Answer fence only accepts universal screens.*

- ▶ Specifying, page 348

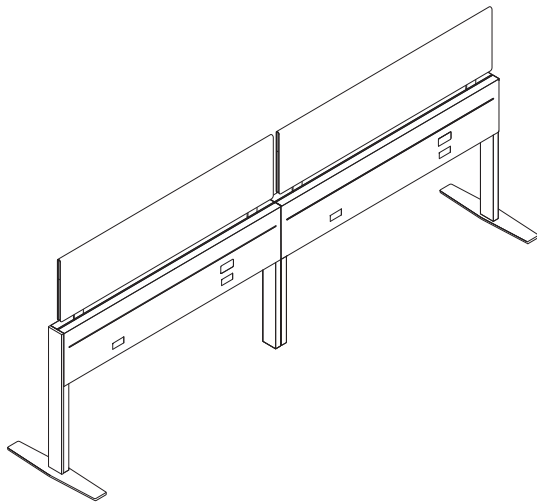

Product Details

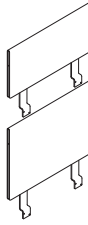

Universal screens are tackable and available in 13½"H and 19½"H, and have widths from 24"W to 96"W.

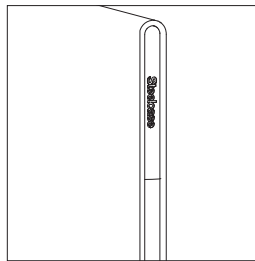

The edge of the screen is comprised of two different materials. The upper segment is merle plastic. The lower portion is PET which can be specified in medium heather grey to provide contrast or dark heather grey for a uniform visual.

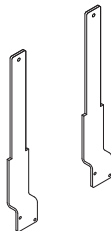

Brackets are included with screens. Two brackets are used on all screens.

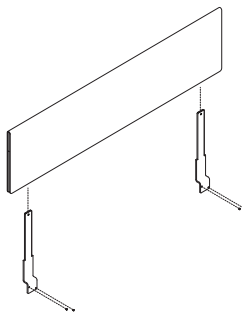

Universal screen slides onto brackets.

Screen brackets install on horizontal connecting bar prior to steel cover installation.

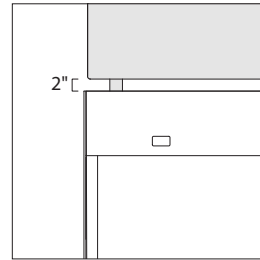

Gap is 2" between universal screen and mounting surface.

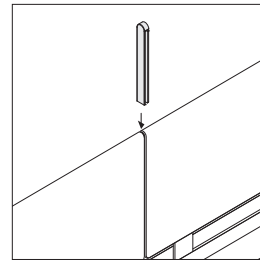

When fabric screens are placed directly adjacent to each other in-line, a small aligner can be placed in between the screens at the top to connect them for planar alignment. Aligners are ordered separately in packages of 10.

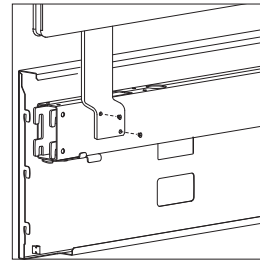

Universal screen can install anywhere along horizontal connecting bar with included self-tapping screws.

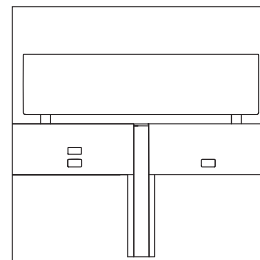

Universal screen can span over a junction.

Surface Materials

Screen

- Fabric
- ▶ See *Surface Materials*, page 358.

Brackets

- 7360 Merle

Edge (lower segment)

- P630 Medium Heather Grey PET
- P631 Dark Heather Grey PET

Actual Dimensions

Height	13½" or 19½"
Width	24", 30", 36", 42", 48", 54", 60", 66", 72", 78", 84", 90", or 96"

Tip: 13½"H screen aligns with a 42" overall height from the floor. 19½" screen aligns with a 48" overall height from the floor.

Sarto Fence Screens

Sarto fence screens provide a light scale tackable boundary element along the Answer fence. They are available in two modular heights to accommodate varying levels of privacy. *Tip: Answer fence only accepts Universal or Sarto screens.*

► Specifying, page 350

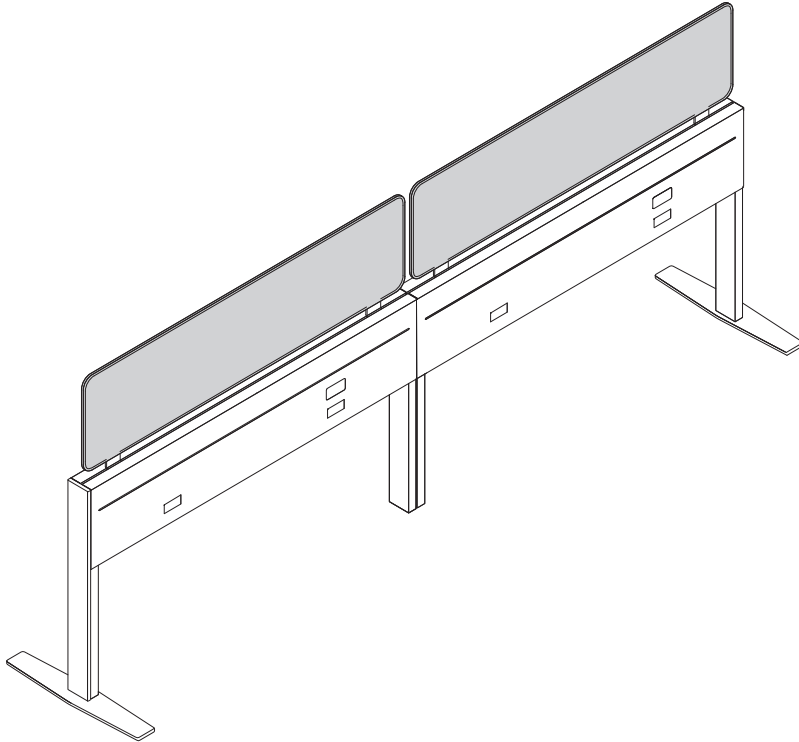

Actual Dimensions

Screen Height	12½" or 18½"
Overall Height	13½" or 19½"
Width	24", 30", 36", 42", 48", 54", 60", 66", 72", 78", 84", 90", or 96"

Tip: Modular 13½"H screen aligns with a 42" overall height from the floor. Modular 19½"H screen aligns with a 48" overall height from the floor.

Tip: Parametric specifications are available for Sarto fence screens.

Tip: Parametric specifications define actual screen height and width. Overall height will be about inch larger than specified height due to gap between screen and mounting surface. Newly ordered parametric screens may not align exactly with previously specified modular sizes, even if the same dimension is specified. It is highly recommended to use CET SmartTools to verify all dimensions.

Product Details

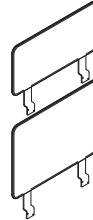

Sarto screens are tackable. They are available in two modular heights, 13½"H and 19½"H, and have widths ranging from 24"W to 96"W. Screens can also be specified parametrically.

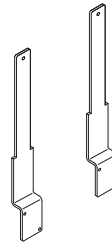

Brackets and hard stops are included with screens. Two brackets are used on screens narrower than 60"W. Three brackets are used on screens 60"W and larger.

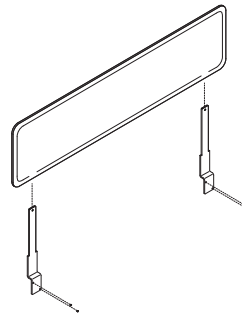

Sarto screen slides onto brackets after hard stops are installed on the brackets.

Screen brackets install on horizontal connecting bar prior to steel cover installation.

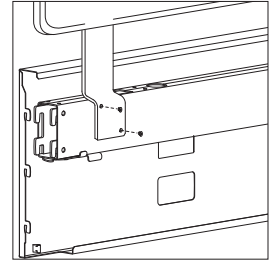

Sarto screen can install anywhere along horizontal connecting bar with included self-tapping screws.

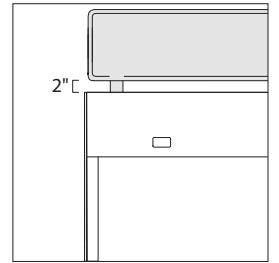

Gap is 2" between Sarto screen and mounting surface.

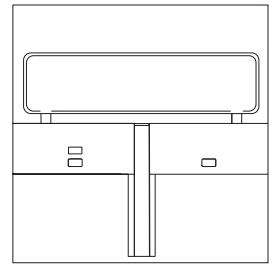

Sarto modular screen can span over a junction, provided there is no conflict between the brackets and the junction. Third bracket on longer screens may conflict with the junction. Please consult CET SmartTools for confirmation before finalizing specification.

Surface Materials

Screen

- Fabric
- See *Surface Materials*, page 358.

Brackets and hard stops

- 7360 Merle

Answer Fence Frameless Glass Screens with Recessed Attachment

Answer Fence Frameless Glass Screens with Recessed Attachment

Frameless glass screen with recessed attachment can be added to the top of a fence segment to help define space and provide privacy while still providing access to natural light and promoting communications between adjacent workers.
 ▶ Specifying, page 352

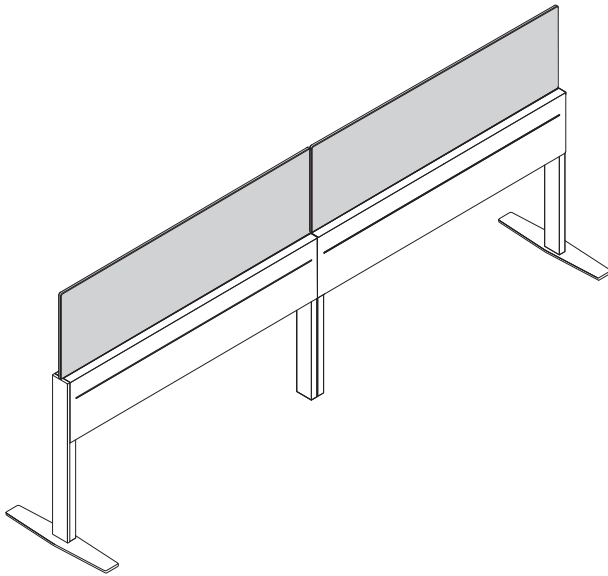

Product Details

Frameless glass screen with recessed attachment is secured to horizontal connecting bar by the supports below the cover. Two brackets are used on 24"W - 48"W fence segments. Three brackets are used on 60"W and 72"W segments.

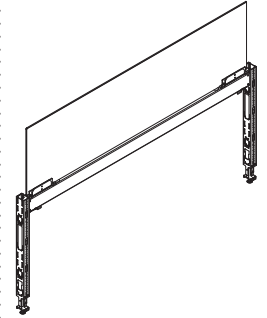

Glass is notched at junction.

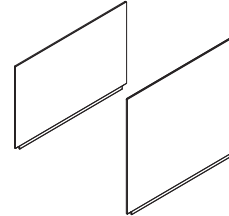

Frameless glass screens are available in 13½" and 19½" heights.

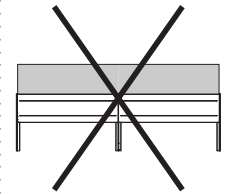

Frameless glass screens cannot span over a junction.

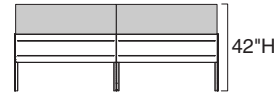

13½"H screens align at 42"H datums.

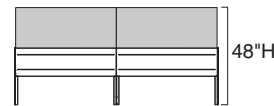

19½"H screens align at 48"H datums.

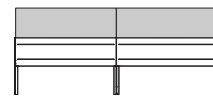

Frameless glass screens must be installed on module and must be the same width as the fence segment they are connected to.

Surface Materials

- Glass**
- 6500 Clear
 - 6530 Frosted

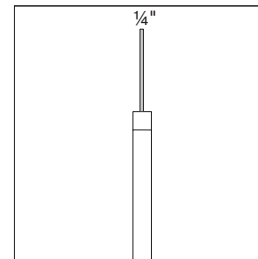

Glass is ¼" thick and fits through standard gap fence covers.

Actual Dimensions

Height	13½" or 19½"
Overall Height	15.912" or 22.092"
Width	24", 30", 36", 42", 48", 60", or 72"

Tip: 13½"H screen aligns with a 42" datum from the floor. 19½" screen aligns with a 48" datum from the floor.

Answer Fence Boundary Screen

Boundary screens provide light scale space division and privacy for a variety of worksettings.

Boundary screens provide support to the fence.

Answer boundary screens attach to the Answer fence at the end-of-run to provide additional shielded privacy.
 ▶ Specifying, page 354

Answer fence boundary screens have a thickness of $1\frac{3}{16}$ ".

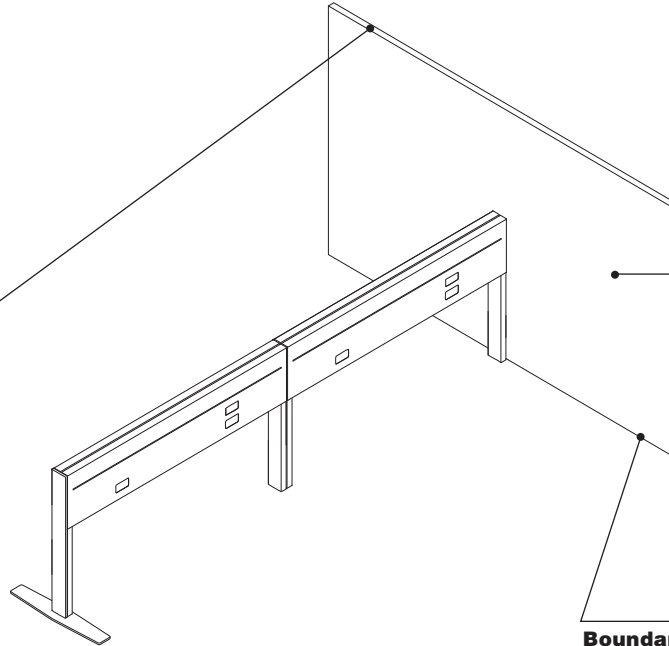

Screens are available in laminate or wood veneer.

Boundary screens come standard with adjustable glides, with a range of $1\frac{1}{2}$ ". The glides are located $1\frac{1}{2}$ " from the outside of each edge.

Actual Dimensions

Height	42" and 48"
Single-Sided Width	27", 33", and 39"
Spanning Width	51", 57", 63", 69", and 75"
Thickness	$1\frac{3}{16}$ "

Tip: Answer fence boundary screen widths can also be specified parametrically.

Product Details

Fence boundary screens are available in two configurations—single-sided and spanning.

Fence boundary screens attach to fence using an end-of-run junction.

Answer fence boundary screens

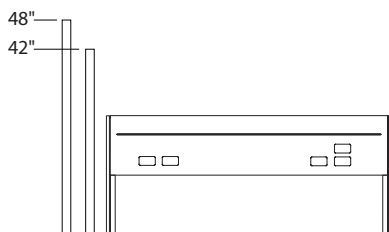

Fence boundary screens have modular heights and widths. Parametric widths are allowed from 27"W to 75"W increasing in 1/16" increments.

Answer fence boundary screens are available in two different configurations.

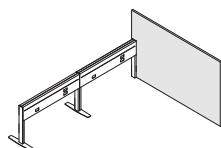

1. Single-sided boundary screens provide boundary to one side of an Answer fence and are specified as either left or right. Right handed application is shown above.

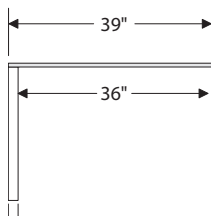

3" Answer fence thickness

Single-sided boundary screens will always include the 3" thickness of the Answer fence to which they attach. Minimum width for a single-sided boundary screen is 27" (24" inside, and 3" for the Answer fence thickness). The maximum width is 39" (36" inside, and 3" for Answer fence thickness).

The above image is shown with a right handed application. *Tip: The above image shows a 39" specified width. The planning width is 36".*

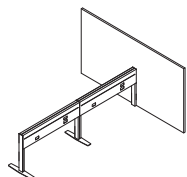

2. Spanning boundary screens use one screen segment to provide boundary of equal widths to both sides of Answer fence.

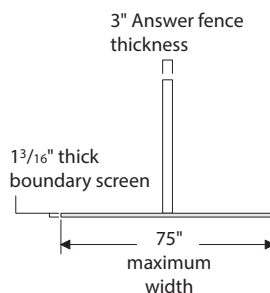

Spanning fence boundary screens always

extend in equal dimension from the fence to which they attach and include the 3" thickness on the Answer fence. Minimum width for a spanning boundary screen is 51" (48" inside, and 3" for the Answer fence thickness). The maximum width is 75" (72" inside and 3" for Answer fence thickness).

Tip: The above image shows a 75" specified width. The planning width is 72".

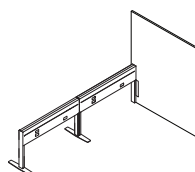

On boundary screens, there is a metal cover plate that covers the connection bracket that connects the boundary screen to the end-of-run junction. The cover is located 22" from the bottom of the screen and is 3"W and 14"H.

Surface Materials

Boundary screens

- Laminate
- Wood veneer

Edge on laminate

- Plastic

Bracket cover

- Paint

Tip: When specifying the paint finish for the bracket cover, select a finish that compliments the selected laminate or veneer finish.

Open Line laminates with grain direction

can only be applied vertically. Open Line laminates are not allowed on boundary screens that are greater than 59"W or have segments that are greater than 59"W.

On spanning boundary screens, wood grain laminates and veneers can be horizontal up to 75"W, and vertical up to 59"W.

All fence boundary screen sides will have the same finish applied.

Application Topics

Boundary screens attach at the end-of-run location of an Answer fence.

Boundary screens cannot attach to an Answer fence end-of-run junction where an Answer fence foot is being used.

One single-sided boundary screen may be attached at the end of the Answer fence. If the intent is to have a boundary screen in both directions of the fence, use spanning boundary screens.

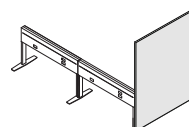

Single-sided boundary screens

are available left and right handed. This is determined by the user facing the attaching Answer fence. Left sided application is shown above.

Wiring Schematics

Details for the Electrician

Answer offers three different wiring schematics to allow you to match your specific wiring strategy to any typical building wiring plan.

Tip: All the components in an electrical system must use the same wiring schematic. The components are keyed and color coded to make it impossible to connect mismatched parts.

Black = Four-circuit, 3+1

Brown = Four-circuit, 2+2

Rust = Three-circuit, separate neutrals (3SN)

Shared neutrals = 10 gauge

Non-shared neutrals = 12 gauge

Hot wires = 12 gauge

Four-Circuit, 3+1

Circuit Panel 1

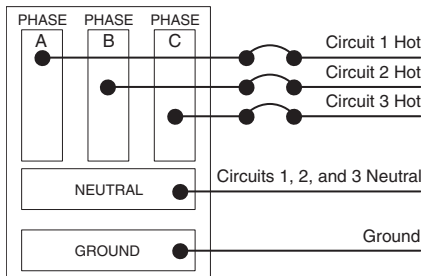

Circuit Panel 2

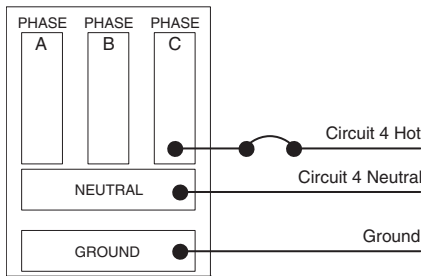

In the four-circuit 3+1 schematic, circuits 1, 2, and 3 are distributed from the first circuit panel and are supported with one shared neutral and one shared ground. Circuit 4 is distributed from a second circuit panel and is supported with a separate neutral and ground.

Single 3-Phase Circuit Panel

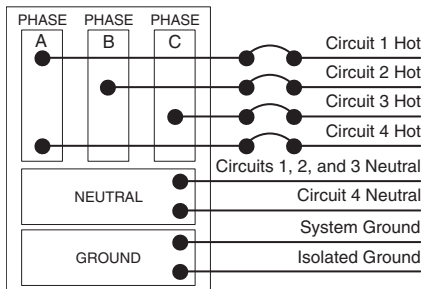

On a single 3-phase circuit panel, all four circuits are distributed as shown.

Four-Circuit, 2+2

Circuit Panel 1

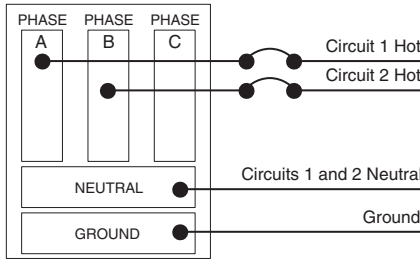

Circuit Panel 2

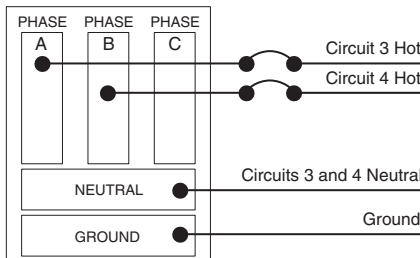

In the four-circuit 2+2 schematic, circuits 1 and 2 are distributed from two different phases from the first circuit panel and are supported with one shared neutral and one shared ground. Circuits 3 and 4 are distributed from a second circuit panel and supported by their own shared neutral and ground.

Single 3-Phase Circuit Panel

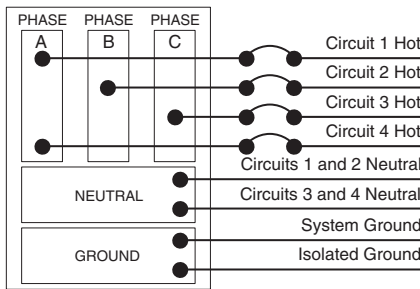

On a single 3-phase circuit panel, all four circuits are distributed as shown.

Split-Phase Circuit Panel

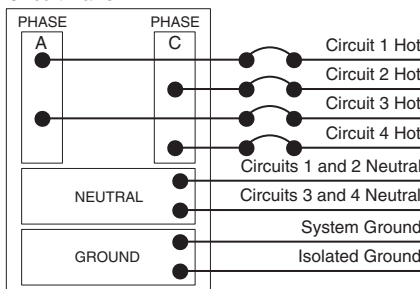

On a split-phase circuit panel, all four circuits are distributed as shown.

Three-Circuit, Separate Neutrals

Circuit Panel 1

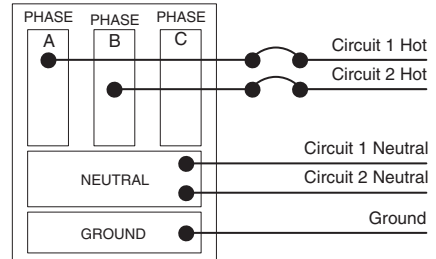

Circuit Panel 2

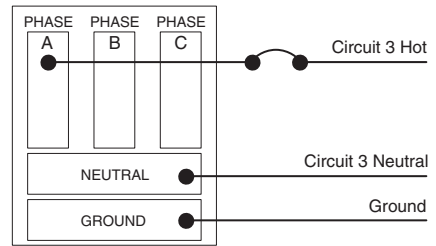

In the three-circuit, separate neutral schematic, circuits 1 and 2 are distributed from two different phases from the first circuit panel. Each circuit is supported with its own neutral and a common ground. Circuit 3 is distributed from the second circuit panel and is supported by its own neutral and ground.

Single 3-Phase Circuit Panel

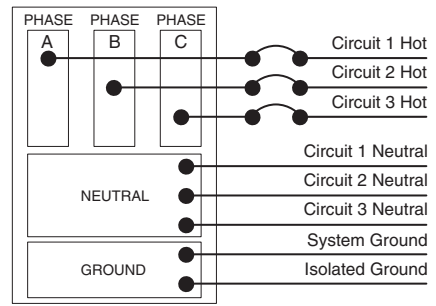

On a single 3-phase circuit panel, three circuits are distributed as shown.

Split-Phase Circuit Panel

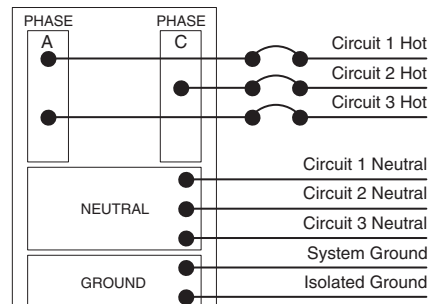

On a split-phase circuit panel, three circuits are distributed as shown.

When planning a power network, you must calculate the amperage requirements of all your electrical components so you can provide sufficient electricity to power them.

If your usage is not known in advance: The National Electrical Code (NEC) allows a maximum of 13 receptacles on each 20-amp circuit. This provides up to 30 receptacles for each 3-circuit power-in.

If your usage is known in advance:

Add up the amperage used by each piece of equipment in the workstation. Whenever you reach 60 amps (20 amps times 3 circuits) from items that are likely to be used at the same time, you have reached the limit for a single power-in. Specify another power-in and continue until all equipment is powered.

If the circuits will normally be subject to a continuous load (three or more hours of continuous use, such as lights or computers), the NEC requires that circuit capacity be "de-rated" by 20 percent. Therefore, treat circuits used for continuous loads as if they were rated at 16 amps instead of the regular 20 amps.

Try to anticipate future increases in power requirements and build some excess capacity into your plan.

▶ See table at right for typical and actual amperage usages for components.

To calculate amperage when the wattage of a device is known, divide watts by 120.

Some appliances, such as large copiers, coffee makers, or space heaters require most of the current available on a 20-amp circuit. It is recommended that such devices be supplied with their own receptacle/circuit, directly from the building. This leaves the capacity of the furniture circuits available for the more dynamic requirements of the office equipment.

Local electrical codes vary. Consult a qualified electrical contractor or engineer for the proper planning of electrical circuits in your locale.

Approximate power consumption for common devices

• Device	• Wattage	• Amperage	• Voltage	• Number of Devices Supported on Single 20 Amp Circuit
Laptop (Low)	30	0.25	120	64
Laptop (High)	100	0.83	120	19
CPU/Desktop Computer (Low)	65	0.54	120	30
CPU/Desktop Computer (High)	150	1.25	120	13
Monitor (Low)	15	0.13	120	128
Monitor (High)	80	0.67	120	24
Phone	5	0.04	120	384
High Power Tablet	10	0.08	120	192
Lower Power Tablet	45	0.38	120	43
Desktop Printer	40	0.33	120	48
42" LCD Screen	120	1.00	120	16
Projector (Small)	50	0.42	120	38
Projector (Medium)	250	2.08	120	8
Projector (Large)	800	6.67	120	2
Desktop Lamp	20	0.17	120	96
Large Printer/Copier	1600	13.33	120	1
Small Printer/Copier	800	6.67	120	2
Paper Shredder (Small)	250	2.08	120	8
Paper Shredder (Large)	800	6.67	120	2
Desktop Fan	25	0.21	120	77
Standing Fan	125	1.04	120	15
Coffee Maker (Low)	500	4.17	120	4
Coffee Maker (High)	1500	12.50	120	1
Microwave (Low)	600	5.00	120	3
Microwave (High)	1000	8.33	120	2
Refrigerator (Low)	200	1.67	120	10
Refrigerator (High)	1500	12.50	120	1
Vacuum (Low)	200	1.67	120	10
Vacuum (High)	1500	12.50	120	1
Space Heater (Low)	400	3.33	120	5
Space Heater (High)	1500	12.50	120	1
Height-Adjustable Desk (Low Power Consumption)*	200	1.67	120	10
Height-Adjustable Desk (High Power Consumption)*	550	4.58	120	3

Tip: These calculations are estimations and are meant solely for informational purposes. It is important to conduct proper power planning for each installation to prevent overloading a circuit.

** Refer to the Height-Adjustable Desks Specification Guide for specific product information.*

Cable Capacities

Test and verify capacities for your individual situation. We recommend

that testing be conducted using your specific cable, as well as the furniture configuration you are considering. Cable capacities in this table are based on actual cable studies performed by an independent contractor following EIA/TIA codes and practices and can be taken as an accurate assessment of maximum practical capacity. Actual cable capacities may vary slightly depending on which manufacturer produced the cable and the specific field conditions.

Cable capacities are based on Category 6 and Category 6a cables at 55% fill capacity for cable study performed on junctions manufactured on or after October 10, 2011.

Tip: Tests were performed on junctions with tall sleeves installed.

Cables Tested

A CommScope Systemax Gigaspeed 1071E Series Category 6 Cable
OD=0.23"

B CommScope Systemax X10D 1091B Series Category 6A Cable
OD=0.285"

Power harnesses reduce cable capacity.

An average of 10-15 cables will be reduced per harness used. However, this number varies according to installation practices and the type of cables used.

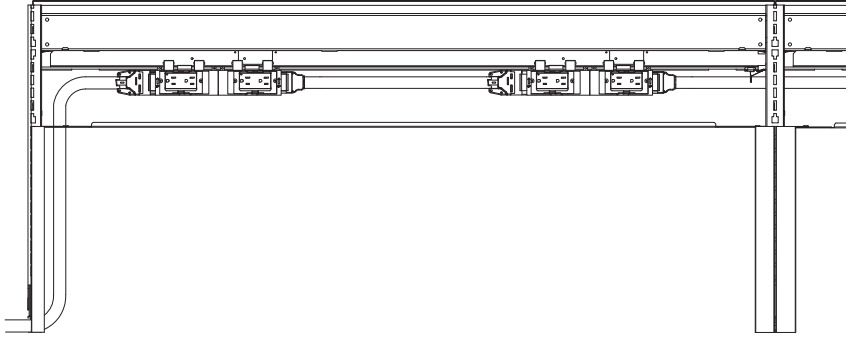
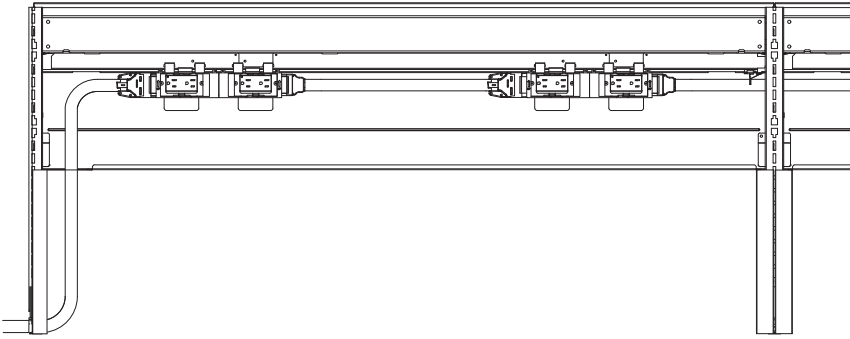
	A	B
<p>Standard Fence Data Capacity</p> 	39	29
<p>High-Capacity Fence Data Capacity</p> 	84	54

Answer Fence Stability Guidelines

Minimum Run

The minimum Answer fence run is two fence sections for in-line, L, and V configurations, and three fence sections for T, Y, and zig-zag configurations. There is no maximum run provided the following guidelines are followed.

Universal fence screens or frameless glass screens with recessed attachment can be added to any fence section and do not impact stability guidelines.

In-line application

- A fence foot or spanning boundary screen is required at each end
- Minimum run for in-line applications with power is 8'
- Minimum run for in-line applications without power is 10'

Tip: Single-sided boundary screens do not provide sufficient support and cannot be used in minimum run fence applications.

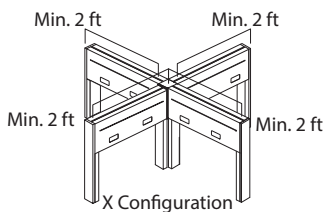
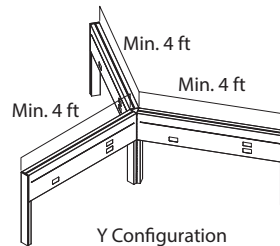
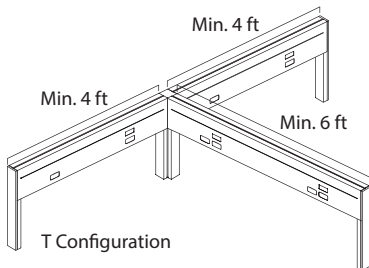
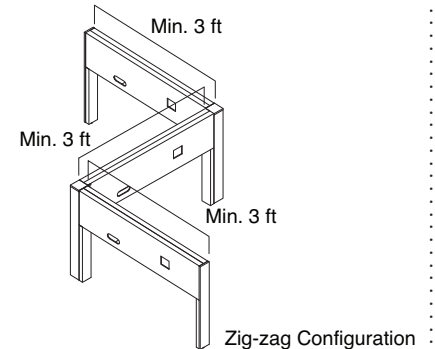
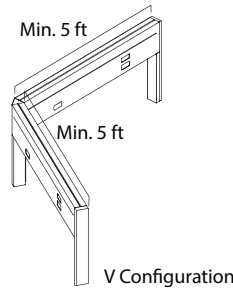
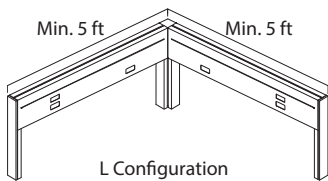
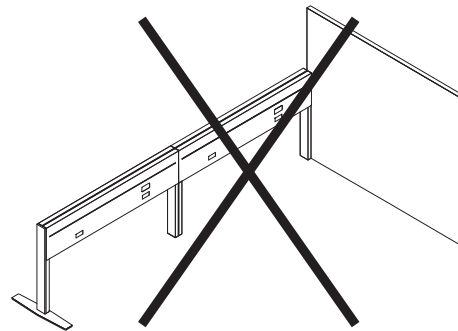
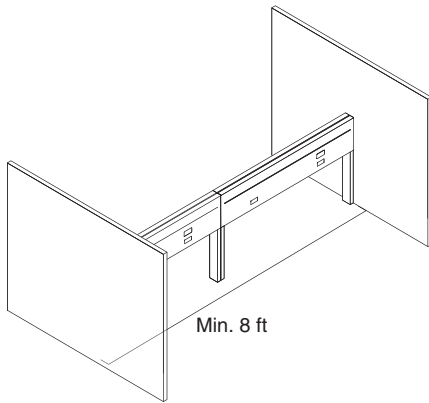
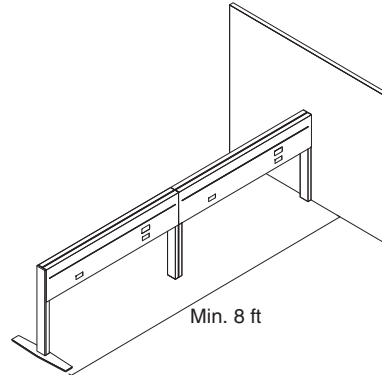
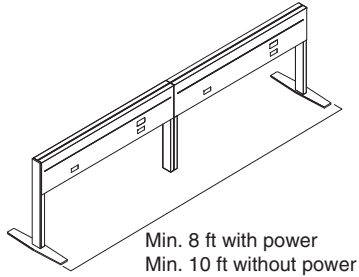

Answer Fence Stability Guidelines, continued

Single-Sided Planning

- A single-sided support is required every other junction.
- Maximum distance between adjacent supports is 10'.
- A single-sided support is required at both ends of the spine.
- Allowable single-sided supports are:
 - End-of-run boundary screen - minimum 36"W x 42"H
 - L, T, or V junction with 48"W perpendicular fence segment

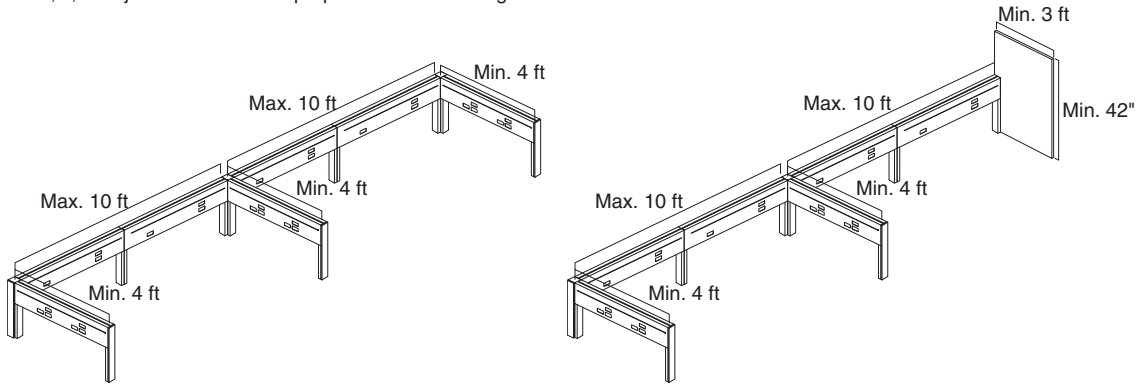

Double-Sided Planning

- A double-sided support is required every other junction.
- Maximum distance between adjacent supports is 12'.
- Allowable single-sided supports are:
 - Fence foot
 - 51"W x 42"H minimum spanning end-of-run boundary screen
 - 24"W minimum end-of-run T returns
 - 24"W minimum X or Y

Tip: Applications can use a mix of single- and double-sided supports, but must follow single-sided planning application rules.

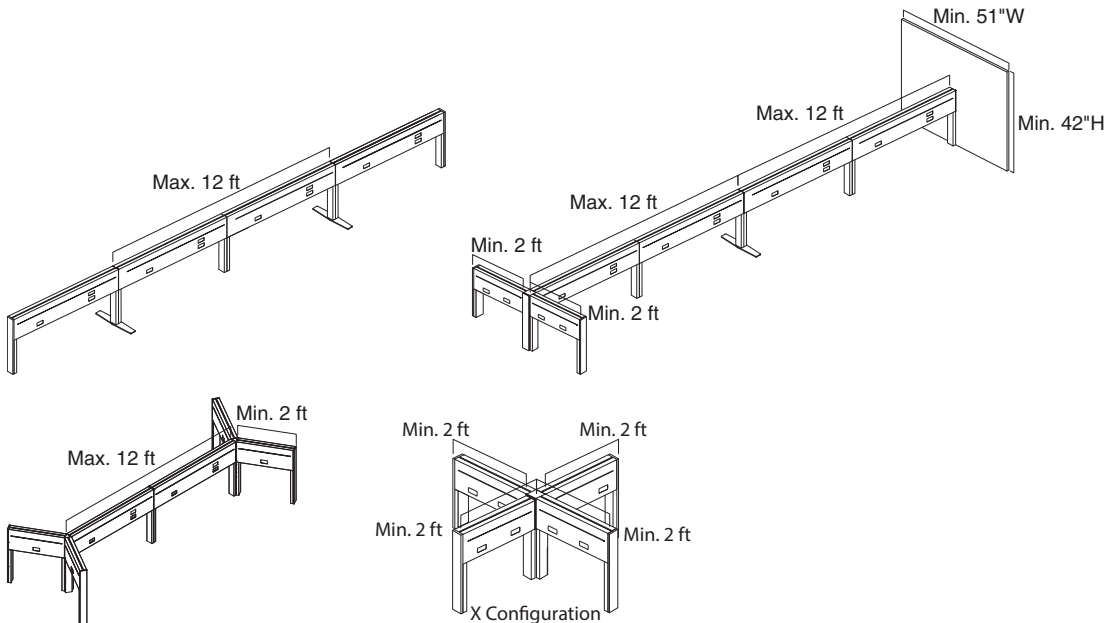

120 Zig-Zag Planning

- For minimum runs of V and zig-zag applications, see "Minimum Run" on page 327.
- There is no maximum run for 120 zig-zag applications.
- For 120 zig-zag applications three or more segments long, no additional supports are needed; the 120 zig-zag runs are self supporting.

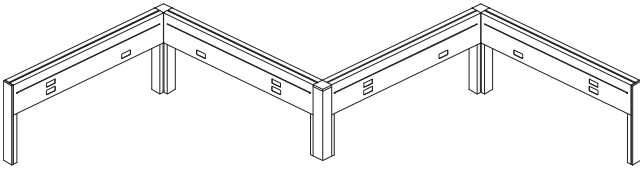

Specifying Answer Fence

Answer Fence Junctions	332
Answer Fence Foot	336
Answer Fence Horizontal Packages	337
Answer Fence High-Capacity Horizontal Packages	338
Answer Fence Infeed Covers	339
Answer Fence End-of-Run Junction with Utility Pole	340
Answer Fence Utility Pole—L, T, or X Application	341
Power Harnesses	342
Multipurpose Power Infeeds	343
Power	344
Universal Screens and Aligners	348
Sarto Fence Screens	350
Answer Fence Frameless Glass Screens with Recessed Attachment	352
Answer Fence Boundary Screens	354

Answer Fence Junctions

In-Line Fence Junction



Standard Includes		Required to Specify
<ul style="list-style-type: none"> ▶ Need help? Product details, page 306 	<ul style="list-style-type: none"> • Junction • Aligner 	Style number

Specification Information	
Style Number	U.S. Price
TSF27IJ	\$119

End-of-Run Fence Junction



Tip: End-of-run trim adds 1/2" to footprint.

Standard Includes		Required to Specify	
<ul style="list-style-type: none"> ▶ Need help? Product details, page 306 	<ul style="list-style-type: none"> • Junction • Outside vertical trim, if selected: paint price group 1 • Aligner 	1 Style number	2 Paint color number for outside vertical trim
		3 Options, if selected (see below)	▶ See <i>Surface Materials</i> , page 358.

Options	U.S. Price	Required to Specify
Surface Materials <ul style="list-style-type: none"> • Outside vertical trim • Paint price group 1 • Paint price group 2 • Paint price group 3 	No cost +\$17 +\$37	Specify paint color number. Specify paint color number. Specify paint color number.
Trim Omit outside vertical trim	-\$93	Specify <i>omit outside vertical trim</i> .

Specification Information	
Style Number	U.S. Base Price
TSF27EJ	\$168



For Canadian Pricing
 Multiply U.S. Price by the Canadian price factor.
 ▶ See page 1 for details.

L and T Fence Junctions

Standard Includes		Required to Specify
<ul style="list-style-type: none"> ▶ Need help? Product details, page 306 	<ul style="list-style-type: none"> • Junction • Inside corner light seal(s) • Outside vertical trim: paint price group 1 • Junction cap: paint to match outside vertical trim • Aligner(s) 	<ul style="list-style-type: none"> 1 Style number 2 Paint color number for outside vertical trim 3 Options, if selected (see below) ▶ See <i>Surface Materials</i>, page 358.

Options	U.S. Price	Required to Specify
Surface Materials <ul style="list-style-type: none"> • Outside vertical trim • Paint price group 1 • Paint price group 2 • Paint price group 3 	<ul style="list-style-type: none"> No cost +\$12 +\$26 	<ul style="list-style-type: none"> Specify paint color number. Specify paint color number. Specify paint color number.

Specification Information

L Junction

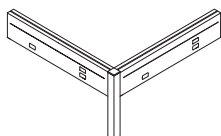

Style Number	U.S. Base Price
TSF27LJ	\$263

T Junction

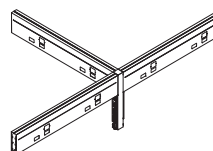

Style Number	U.S. Base Price
TSF27TJ	\$263

X Fence Junction

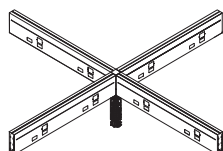

Standard Includes		Required to Specify
<ul style="list-style-type: none"> ▶ Need help? Product details, page 306 	<ul style="list-style-type: none"> • Junction • Inside corner light seals • Junction cap: paint • Aligners 	<ul style="list-style-type: none"> 1 Style number 2 Paint color number for junction cap ▶ See <i>Surface Materials</i>, page 358.

Specification Information

Style Number	U.S. Price
TSF27XJ	\$263



For Canadian Pricing

Multiply U.S. Price by the Canadian price factor.

▶ See page 1 for details.

V Fence Junction

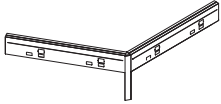

Standard Includes		Required to Specify
<ul style="list-style-type: none"> ▶ Need help? Product details, page 306 	<ul style="list-style-type: none"> • Junction • Outside vertical trim: paint price group 1 • Junction cap: paint to match outside vertical trim • Aligner(s) 	<ul style="list-style-type: none"> 1 Style number 2 Paint color number for outside vertical trim 3 Options, if selected (see below) ▶ See <i>Surface Materials</i>, page 358.

Options	U.S. Price	Required to Specify
Surface Materials <ul style="list-style-type: none"> • Outside vertical trim • Paint price group 1 • Paint price group 2 • Paint price group 3 	<ul style="list-style-type: none"> No cost +\$12 +\$26 	<ul style="list-style-type: none"> Specify paint color number. Specify paint color number. Specify paint color number.

Specification Information	
Style Number	U.S. Base Price
TSF27VJ	\$398

Y Fence Junction

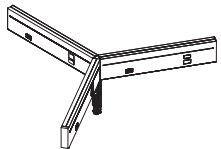

Standard Includes		Required to Specify
<ul style="list-style-type: none"> ▶ Need help? Product details, page 306 	<ul style="list-style-type: none"> • Junction • Junction cap: paint • Aligner(s) 	<ul style="list-style-type: none"> 1 Style number 2 Paint color number for junction cap ▶ See <i>Surface Materials</i>, page 358.

Specification Information	
Style Number	U.S. Price
TSF27YJ	\$398



For Canadian Pricing
 Multiply U.S. Price by the Canadian price factor.
 ▶ See page 1 for details.

Floor Anchor Bracket



Tip: Floor anchor bolts are not included.

Standard Includes	Required to Specify
<ul style="list-style-type: none"> ▶ Need help? Product details, page 307 • Two-piece floor anchor bracket: black paint only 	Style number

Specification Information

Style Number	U.S. Price
CBRKTS	\$70

Gripper Glide Caps



Standard Includes	Required to Specify
<ul style="list-style-type: none"> ▶ Need help? Product details, page 307 • Package of 10 gripper glide caps: soft black plastic only 	Style number

Specification Information

Style Number	U.S. Price
TS7GGC10	\$70



For Canadian Pricing
 Multiply U.S. Price by the Canadian price factor.
 ▶ See page 1 for details.

Answer Fence Foot

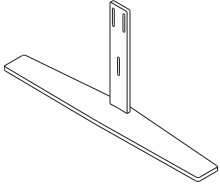

Standard Includes		Required to Specify
-------------------	--	---------------------

- | | | |
|--|--|--|
| <ul style="list-style-type: none"> ▶ Need help? Product details, page 308 | <ul style="list-style-type: none"> • Fence foot: paint price group 1 • Attachment hardware | <ul style="list-style-type: none"> 1 Style number 2 Paint color number for foot 3 Options, if selected (see below) ▶ See <i>Surface Materials</i>, page 358. |
|--|--|--|

Options	U.S. Price	Required to Specify
---------	------------	---------------------

- | | | |
|--|---|---|
| Surface Materials <ul style="list-style-type: none"> • Paint price group 1 • Paint price group 2 • Paint price group 3 | <ul style="list-style-type: none"> No cost +\$17 +\$37 | <ul style="list-style-type: none"> Specify paint color number. Specify paint color number. Specify paint color number. |
|--|---|---|

Specification Information	
---------------------------	--

Style Number	U.S. Base Price
TSFF	\$321



For Canadian Pricing

Multiply U.S. Price by the Canadian price factor.

▶ See page 1 for details.

Answer Fence Horizontal Packages

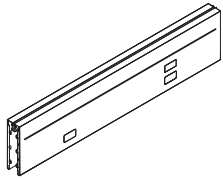

Tip: Horizontal packages are only available with steel covers.

Tip: Power and data is available only at 20" off the floor.

Tip: For modular power, receptacle trim rings (TS7RCT) must be specified separately at each power cutout location.

Tip: For modular power, receptacles are specified separately and are available in 15 amp, 20 amp, and USB.

Tip: For modular power, specify a fence receptacle filler (TSFRF) or a blank receptacle (TSFBCC) to fill cutout locations where power is not expressed.

Tip: 24"W horizontal package with hardwired power cannot support NEMA data cutouts or back-to-back data.

Tip: If no power option is selected, data cutouts will default to no cutouts.

Standard Includes		Required to Specify
<ul style="list-style-type: none"> ▶ Need help? Product details, page 310 	<ul style="list-style-type: none"> • 10"H steel cover, set of two: paint price group 1 • Inside vertical trim: paint price group 1 • Horizontal bar: black paint • Powerkit 	<ol style="list-style-type: none"> 1 Style number 2 Paint color number for steel cover 3 Paint color number for inside vertical trim 4 Options, if selected (see below) <ul style="list-style-type: none"> ▶ See <i>Surface Materials</i>, page 358.

Options	U.S. Price	Required to Specify
Surface Materials Cover <ul style="list-style-type: none"> • Paint price group 1 • Paint price group 2 <ul style="list-style-type: none"> – 24"W, 30"W, 36"W, and 42"W – 48"W, 60"W, and 72"W • Paint price group 3 <ul style="list-style-type: none"> – 24"W, 30"W, 36"W, and 42"W – 48"W, 60"W, and 72"W 	No cost +\$ 75 +\$ 79 +\$122 +\$129	Specify paint color number. Specify paint color number. Specify paint color number. Specify paint color number.
Inside vertical trim <ul style="list-style-type: none"> • Paint price group 1 • Paint price group 2 • Paint price group 3 	No cost +\$ 17 +\$ 36	Specify paint color number. Specify paint color number. Specify paint color number.
Vertical Trim <ul style="list-style-type: none"> • Two vertical trims • One infeed cover, one vertical trim • Two infeed covers 	No cost +\$102 +\$204	Specify with two vertical trims. Specify with one infeed cover, one vertical trim. Specify with two infeed covers.
Cover Cutouts <ul style="list-style-type: none"> • Cutouts one side, plain one side • Cutouts both sides • Plain both sides 	No cost No cost No cost	Specify with cutouts one side, plain one side. Specify with cutouts both sides. Specify with plain both sides.
Power Schematic <ul style="list-style-type: none"> • 4-circuit, 3+1 wiring schematic • 4-circuit, 2+2 wiring schematic • 3-circuit, separate neutrals (3SN) wiring schematic • 24" hardwire • 30" hardwire • 36" hardwire • 42" hardwire • 48" hardwire • 60" hardwire • 72" hardwire • No power (24"W–48"W) • No power (60"W–72"W) 	No cost No cost No cost –\$153 –\$153 –\$153 –\$153 –\$153 –\$272 –\$272 –\$301 –\$456	Specify with 4-circuit, 3+1 wiring schematic. Specify with 4-circuit, 2+2 wiring schematic. Specify with 3-circuit, separate neutrals (3SN) wiring schematic. Specify with 24" hardwire. Specify with 30" hardwire. Specify with 36" hardwire. Specify with 42" hardwire. Specify with 48" hardwire. Specify with 60" hardwire. Specify with 72" hardwire. Specify with no power. Specify with no power.
Data Cutout <ul style="list-style-type: none"> • No cutouts • Furniture style data • NEMA data 	No cost No cost No cost	Specify with no cutouts. Specify with Furniture style data. Specify with NEMA data.

Specification Information

Style Number	Width	U.S. Base Price
TSF24HS	24"	\$ 699
TSF30HS	30"	\$ 735
TSF36HS	36"	\$ 751
TSF42HS	42"	\$ 780
TSF48HS	48"	\$ 817
TSF60HS	60"	\$1049
TSF72HS	72"	\$1177

 **For Canadian Pricing**
 Multiply U.S. Price by the Canadian price factor.
 ▶ See page 1 for details.

Answer Fence High-Capacity Horizontal Packages

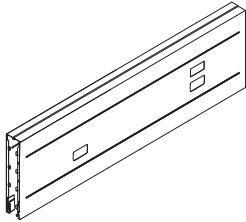

Tip: High-capacity horizontal packages are only available with steel covers.

Tip: Power and data is available only at 20" off the floor.

Tip: For modular power, receptacle trim rings (TS7RCT) must be specified separately at each power cutout location.

Tip: For modular power, receptacles are specified separately and are available in 15 amp, 20 amp, and USB.

Tip: For modular power, specify a fence receptacle filler (TSFRF) or a blank receptacle (TSFBCC) to fill cutout locations where power is not expressed.

Tip: 24"W horizontal package with hardwired power cannot support NEMA data cutouts or back-to-back data.

Tip: If no power option is selected, data cutouts will default to no cutouts.

Standard Includes		Required to Specify
<ul style="list-style-type: none"> ▶ Need help? Product details, page 310 	<ul style="list-style-type: none"> • 13¼"H steel cover, set of two: paint price group 1 • Inside vertical trim: paint price group 1 • Horizontal bar: black paint • Powerkit 	<ol style="list-style-type: none"> 1 Style number 2 Paint color number for steel cover 3 Paint color number for inside vertical trim 4 Options, if selected (see below) <ul style="list-style-type: none"> ▶ See <i>Surface Materials</i>, page 358.

Options	U.S. Price	Required to Specify
Surface Materials <ul style="list-style-type: none"> • Paint price group 1 • Paint price group 2 • Paint price group 3 	<ul style="list-style-type: none"> No cost +\$ 75 +\$122 	<ul style="list-style-type: none"> Specify paint color number. Specify paint color number. Specify paint color number.
Inside vertical trim <ul style="list-style-type: none"> • Paint price group 1 • Paint price group 2 • Paint price group 3 	<ul style="list-style-type: none"> No cost +\$ 17 +\$ 36 	<ul style="list-style-type: none"> Specify paint color number. Specify paint color number. Specify paint color number.
Vertical Trim <ul style="list-style-type: none"> • Two vertical trims • One infeed cover, one vertical trim • Two infeed covers 	<ul style="list-style-type: none"> No cost +\$147 +\$294 	<ul style="list-style-type: none"> Specify with two vertical trims. Specify with one infeed cover, one vertical trim. Specify with two infeed covers.
Cover Cutouts <ul style="list-style-type: none"> • Cutouts one side, plain one side • Cutouts both sides • Plain both sides 	<ul style="list-style-type: none"> No cost No cost No cost 	<ul style="list-style-type: none"> Specify with cutouts one side, plain one side. Specify with cutouts both sides. Specify with plain both sides.
Power Schematic <ul style="list-style-type: none"> • 4-circuit, 3+1 wiring schematic • 4-circuit, 2+2 wiring schematic • 3-circuit, separate neutrals (3SN) wiring schematic • 24" hardwire • 30" hardwire • 36" hardwire • 42" hardwire • 48" hardwire • 60" hardwire • 72" hardwire • No power (24"W–48"W) • No power (60"W–72"W) 	<ul style="list-style-type: none"> No cost No cost No cost –\$153 –\$153 –\$153 –\$153 –\$153 –\$272 –\$272 –\$301 –\$456 	<ul style="list-style-type: none"> Specify with 4-circuit, 3+1 wiring schematic. Specify with 4-circuit, 2+2 wiring schematic. Specify with 3-circuit, separate neutrals (3SN) wiring schematic. Specify with 24" hardwire. Specify with 30" hardwire. Specify with 36" hardwire. Specify with 42" hardwire. Specify with 48" hardwire. Specify with 60" hardwire. Specify with 72" hardwire. Specify with no power. Specify with no power.
Data Cutout <ul style="list-style-type: none"> • No cutouts • Furniture style data • NEMA data 	<ul style="list-style-type: none"> No cost No cost No cost 	<ul style="list-style-type: none"> Specify with no cutouts. Specify with Furniture style data. Specify with NEMA data.

Specification Information		
Style Number	Width	U.S. Base Price
TSF24HSHC	24"	\$ 827
TSF30HSHC	30"	\$ 865
TSF36HSHC	36"	\$ 889
TSF42HSHC	42"	\$ 920
TSF48HSHC	48"	\$ 963
TSF60HSHC	60"	\$1232
TSF72HSHC	72"	\$1375

 **For Canadian Pricing**
 Multiply U.S. Price by the Canadian price factor.
 ▶ See page 1 for details.

Infeed Covers

Standard Infeed Cover



Tip: Standard infeed cover can only be used with standard fence horizontal package.

Tip: Multi-purpose power infeed is sold separately.

Standard Includes		Required to Specify		
<ul style="list-style-type: none"> ▶ Need help? Product details, page 313 	<ul style="list-style-type: none"> • Infeed cover: paint price group 1 	<ul style="list-style-type: none"> 1 Style number 2 Paint color number for cover 3 Options, if selected (see below) 	<ul style="list-style-type: none"> ▶ See <i>Surface Materials</i>, page 358. 	
Options		U.S. Price	Required to Specify	
Surface Materials	<ul style="list-style-type: none"> • Paint price group 1 • Paint price group 2 • Paint price group 3 	No cost +\$17 +\$36	Specify paint color number. Specify paint color number. Specify paint color number.	
Specification Information				
Dimensions			Style Number	U.S. Base Price
D	W	H		
3"	3"	16½"	TSFBCIC	\$115

High-Capacity Infeed Cover



Tip: High-capacity infeed cover can only be used with high-capacity horizontal package.

Tip: Multi-purpose power infeed is sold separately.

Standard Includes		Required to Specify		
<ul style="list-style-type: none"> ▶ Need help? Product details, page 313 	<ul style="list-style-type: none"> • Infeed cover: paint price group 1 	<ul style="list-style-type: none"> 1 Style number 2 Paint color number for cover 3 Options, if selected (see below) 	<ul style="list-style-type: none"> ▶ See <i>Surface Materials</i>, page 358. 	
Options		U.S. Price	Required to Specify	
Surface Materials	<ul style="list-style-type: none"> • Paint price group 1 • Paint price group 2 • Paint price group 3 	No cost +\$17 +\$36	Specify paint color number. Specify paint color number. Specify paint color number.	
Specification Information				
Dimensions			Style Number	U.S. Base Price
D	W	H		
3"	5"	13¼"	TSFHCIC	\$161



For Canadian Pricing

Multiply U.S. Price by the Canadian price factor.

▶ See page 1 for details.

Answer Fence End-of-Run Junction with Utility Pole

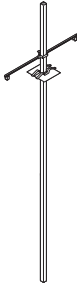

Tip: Order multipurpose power infeed separately.
 ▶ Page 343

Standard Includes		Required to Specify
▶ Need help? Product details, page 317	<ul style="list-style-type: none"> Fence end-of-run junction with vertical trim Inside vertical trim: paint price group 1 Upright trim: paint price group 1 Ceiling trim plate: white paint only Mounting brackets 	1 Style number 2 Paint color number for inside vertical trim 3 Paint color number for upright trim 4 Options, if selected (see below) ▶ See <i>Surface Materials</i> , page 358.

Options	U.S. Price	Required to Specify
Surface Materials Trim Inside vertical trim <ul style="list-style-type: none"> Paint price group 1 Paint price group 2 Paint price group 3 	No cost +\$12 +\$26	Specify paint color number. Specify paint color number. Specify paint color number.
Upright trim <ul style="list-style-type: none"> Paint price group 1 Paint price group 2 Paint price group 3 	No cost +\$12 +\$26	Specify paint color number. Specify paint color number. Specify paint color number.

Specification Information	
Style Number	U.S. Base Price
TSFERUP	\$634

 **For Canadian Pricing**
 Multiply U.S. Price by the Canadian price factor.
 ▶ See page 1 for details.

Answer Fence Utility Pole—L, T, or X Application

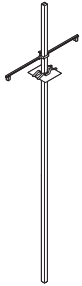

Tip: Works with L, T, or X fence junctions.

Tip: Does not include junction. Junction is ordered separately.

Tip: Order multipurpose power infeed separately.
▶ Page 343

Standard Includes		Required to Specify
-------------------	--	---------------------

▶ Need help? Product details, page 318	<ul style="list-style-type: none"> Utility pole: paint price group 1 Ceiling trim plate: white paint only Mounting brackets 	1 Style number 2 Paint color number for utility pole 3 Options, if selected (see below) ▶ See <i>Surface Materials</i> , page 358.
--	--	---

Options	U.S. Price	Required to Specify
---------	------------	---------------------

Surface Materials	<ul style="list-style-type: none"> Paint price group 1 Paint price group 2 Paint price group 3 	No cost +\$17 +\$37 Specify paint color number. Specify paint color number. Specify paint color number.
--------------------------	---	--

Specification Information		
---------------------------	--	--

Configuration	Style Number	U.S. Base Price
L, T, or X junctions	TS7TJUP	\$292

 **For Canadian Pricing**
 Multiply U.S. Price by the Canadian price factor.
 ▶ See page 1 for details.

Power Harnesses

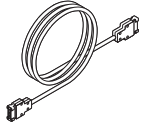

Tip: 20" length is specified for in-line application; 23" length is specified for L, T, X, V, and Y junctions.

Standard Includes	Required to Specify
<ul style="list-style-type: none"> ▶ Need help? Product details, page 314 • Conduit with two modular connectors: black 	Style number

Specification Information

Non-PVC		
Length	Style Number	U.S. Price

4-Circuit, 3+1 Wiring Schematic

20"	TSF20MHXN	\$197
23"	TSF23MHXN	\$197
50"	TSFPT50XN	\$271
56"	TSFPT56XN	\$271
62"	TSFPT62XN	\$271
68"	TSFPT68XN	\$271
74"	TSFPT74XN	\$271
86"	TSFPT86XN	\$303
98"	TSFPT98XN	\$303
:	:	:

4-Circuit, 2+2 Wiring Schematic

20"	TSF20MHYN	\$197
23"	TSF23MHYN	\$197
50"	TSFPT50YN	\$271
56"	TSFPT56YN	\$271
62"	TSFPT62YN	\$271
68"	TSFPT68YN	\$271
74"	TSFPT74YN	\$271
86"	TSFPT86YN	\$303
98"	TSFPT98YN	\$303
:	:	:

3-Circuit, Separate Neutrals (3SN) Wiring Schematic

20"	TSF20MHZN	\$197
23"	TSF23MHZN	\$197
50"	TSFPT50ZN	\$271
56"	TSFPT56ZN	\$271
62"	TSFPT62ZN	\$271
68"	TSFPT68ZN	\$271
74"	TSFPT74ZN	\$271
86"	TSFPT86ZN	\$303
98"	TSFPT98ZN	\$303
:	:	:



For Canadian Pricing
 Multiply U.S. Price by the Canadian price factor.
 ▶ See page 1 for details.

Multipurpose Power Infeeds

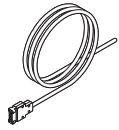

Standard Includes	Required to Specify
<ul style="list-style-type: none"> ▶ Need help? Product details, page 314 • Multipurpose power infeed with modular connector • Insulated color-coded wires for hardwired connection to building power source 	Style number

Specification Information

Specification Information			Non-PVC		
Length	Style Number	U.S. Price	Length	Style Number	U.S. Price
4-Circuit, 3+1 Wiring Schematic			4-Circuit, 3+1 Wiring Schematic		
6'	TS76UPHX	\$426	6'	TS76UPHXN	\$426
12'	TS712UPHX	\$549	12'	TS712UPHXN	\$565
24'	TS724UPHX	\$797	24'	TS724UPHXN	\$819
4-Circuit, 2+2 Wiring Schematic			4-Circuit, 2+2 Wiring Schematic		
6'	TS76UPHY	\$426	6'	TS76UPHYN	\$426
12'	TS712UPHY	\$549	12'	TS712UPHYN	\$565
24'	TS724UPHY	\$797	24'	TS724UPHYN	\$819
3-Circuit, Separate Neutrals (3SN) Wiring Schematic			3-Circuit, Separate Neutrals (3SN) Wiring Schematic		
6'	TS76UPHZ	\$426	6'	TS76UPHZN	\$426
12'	TS712UPHZ	\$549	12'	TS712UPHZN	\$565
24'	TS724UPHZ	\$797	24'	TS724UPHZN	\$819

Multipurpose Infeed Conduit Covers

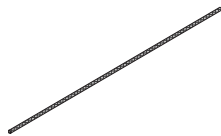

Standard Includes	Required to Specify
<ul style="list-style-type: none"> ▶ Need help? Product details, page 314 • Power infeed cover: black fabric • Cover for 1/2" conduit: black fabric 	Style number

Specification Information

Length	Style Number	U.S. Price
6'	TS7BFCC6	\$ 96
12'	TS7BFCC12	\$197
24'	TS7BFCC24	\$395

For Canadian Pricing
 Multiply U.S. Price by the Canadian price factor.
 ▶ See page 1 for details.

Power

Duplex Receptacle



15 amp



20 amp

Tip: Receptacle trim ring is required for each receptacle, USB receptacle, or blank receptacle cutout location (ordered separately).

Standard Includes		Required to Specify
<ul style="list-style-type: none"> ▶ Need help? Product details, page 315 	<ul style="list-style-type: none"> • Receptacle: plastic 	<ol style="list-style-type: none"> 1 Style number 2 Plastic color number for receptacle 3 Wiring schematic (see below under Required Selections) 4 Line (see below under Required Selections) 5 Ground type (see below under Required Selections) 6 Amp type (see below under Required Selections) 7 Options, if selected (see below) <ul style="list-style-type: none"> ▶ See <i>Surface Materials</i>, page 358.

	Required Selections	U.S. Price	Required to Specify
Wiring Schematic	<ul style="list-style-type: none"> • 3+1 • 2+2 • 3SN 	<p>No cost</p> <p>No cost</p> <p>No cost</p>	<p>Specify <i>with 3+1.</i></p> <p>Specify <i>with 2+2.</i></p> <p>Specify <i>with 3SN.</i></p>
Line	<ul style="list-style-type: none"> • Line 1 • Line 2 • Line 3 • Line 4 	<p>No cost</p> <p>No cost</p> <p>No cost</p> <p>No cost</p>	<p>Specify <i>with line 1.</i></p> <p>Specify <i>with line 2.</i></p> <p>Specify <i>with line 3.</i></p> <p>Specify <i>with line 4.</i></p>
Ground Type	<ul style="list-style-type: none"> • System • Isolated 	<p>No cost</p> <p>No cost</p>	<p>Specify <i>with system ground.</i></p> <p>Specify <i>with isolated ground.</i></p>
Amp Type	<ul style="list-style-type: none"> • 15 amp • 20 amp 	<p>No cost</p> <p>+\$38</p>	<p>Specify <i>with 15 amp.</i></p> <p>Specify <i>with 20 amp.</i></p>

	Options	U.S. Price	Required to Specify
Controlled Stamp	<ul style="list-style-type: none"> • No stamp • Controlled stamp 	<p>No cost</p> <p>+\$ 5</p>	<p>Specify <i>with no stamp.</i></p> <p>Specify <i>with controlled stamp.</i></p>

Specification Information	
Style Number	U.S. Base Price
TS7RC	\$69
.	.



For Canadian Pricing
 Multiply U.S. Price by the Canadian price factor.
 ▶ See page 1 for details.

USB Receptacle



Tip: Receptacle trim ring is required for each receptacle, USB receptacle, or blank receptacle cutout location (ordered separately).

Standard Includes		Required to Specify
▶ Need help? Product details, page 315	<ul style="list-style-type: none"> • USB receptacle: plastic 	<ol style="list-style-type: none"> 1 Style number 2 Plastic color number for receptacle 3 Wiring schematic (see below under Required Selections) 4 Line (see below under Required Selections) <p>▶ See <i>Surface Materials</i>, page 358.</p>

Required Selections	U.S. Price	Required to Specify
Wiring Schematic	<ul style="list-style-type: none"> • 3+1 No cost • 2+2 No cost • 3SN No cost 	Specify with 3+1. Specify with 2+2. Specify with 3SN.
Line	<ul style="list-style-type: none"> • Line 1 No cost • Line 2 No cost • Line 3 No cost • Line 4 (Available in 3+1 and 2+2 only) No cost 	Specify with line 1. Specify with line 2. Specify with line 3. Specify with line 4.

Specification Information	
Style Number	U.S. Price
TS7USB	\$162

Blank Receptacle

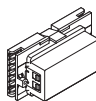

Tip: Receptacle trim ring is required for each receptacle, USB receptacle, or blank receptacle cutout location (ordered separately)

Standard Includes		Required to Specify
▶ Need help? Product details, page 315	<ul style="list-style-type: none"> • Cover cut-out: plastic 	<ol style="list-style-type: none"> 1 Style number 2 Plastic color number for cut-out cover 3 Wiring schematic, if selected (see below under Required Selections) <p>▶ See <i>Surface Materials</i>, page 358.</p>

Required Selections	U.S. Price	Required to Specify
Wiring Schematic	<ul style="list-style-type: none"> • 3+1 No cost • 2+2 No cost • 3SN No cost 	Specify with 3+1. Specify with 2+2. Specify with 3SN.

Specification Information	
Style Number	U.S. Price
TSFBCC	\$13



For Canadian Pricing
 Multiply U.S. Price by the Canadian price factor.
 ▶ See page 1 for details.

Receptacle Trim Ring



Tip: Receptacle trim ring is required for each receptacle, USB receptacle, or blank receptacle cutout location (ordered separate).

Standard Includes		Required to Specify
▶ Need help? Product details, page 316	• Receptacle trim ring: plastic	1 Style number 2 Plastic color number for receptacle trim ring ▶ See <i>Surface Materials</i> , page 358.
Specification Information		
• Style Number	• U.S. Price	
TS7RCT	\$17	

Fence Receptacle Fillers



Tip: Fence receptacle filler package fills unused receptacle openings.

Standard Includes		Required to Specify
▶ Need help? Product details, page 316	• Package of 20 receptacle fillers: plastic	1 Style number 2 Plastic color number for receptacle fillers ▶ See <i>Surface Materials</i> , page 358.
Specification Information		
• Style Number	• U.S. Price	
TSFRF	\$148	

Data Fillers



Tip: Data filler fills unused data openings.

Standard Includes		Required to Specify
▶ Need help? Product details, page 316	• Package of 20 fillers: plastic	1 Style number 2 Plastic color number for data filler ▶ See <i>Surface Materials</i> , page 358.
Specification Information		
• Style Number	• U.S. Price	
TS7DF	\$121	



For Canadian Pricing
Multiply U.S. Price by the Canadian price factor.
▶ See page 1 for details.

Grommets for Junction



Standard Includes	Required to Specify
-------------------	---------------------

▶ Need help? Product details, page 316	• Package of 25: black plastic only Style number
--	---

Specification Information	
• Style • Number	• U.S. • Price

• Style • Number	• U.S. • Price
TS7JSLVE	\$166

Answer Fence



For Canadian Pricing
Multiply U.S. Price by the
Canadian price factor.
▶ See page 1 for details.

Universal Screens and Aligners

Universal Screens

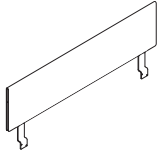

Standard Includes	Required to Specify
<ul style="list-style-type: none"> ▶ Need help? Product details, page 319 • Screen: fabric price group 1 • Brackets: 7360 Merle • Edge: PET 	<ol style="list-style-type: none"> 1 Style number 2 Width (see below under Required Selections) 3 Height (see below under Required Selections) 4 Fabric color number for screen 5 Edge color: <ul style="list-style-type: none"> P630 Medium Heather Grey PET P631 Dark Heather Grey PET 6 Options, if selected (see below) <p>▶ See <i>Surface Materials</i>, page 358.</p>

Width	Required Selections	U.S. Price	Required to Specify
Width	• 24"W	Prices at right	Specify width.
	• 30"W	Prices at right	Specify width.
	• 36"W	Prices at right	Specify width.
	• 42"W	Prices at right	Specify width.
	• 48"W	Prices at right	Specify width.
	• 54"W	Prices at right	Specify width.
	• 60"W	Prices at right	Specify width.
	• 66"W	Prices at right	Specify width.
	• 72"W	Prices at right	Specify width.
	• 78"W	Prices at right	Specify width.
	• 84"W	Prices at right	Specify width.
• 90"W	Prices at right	Specify width.	
• 96"W	Prices at right	Specify width.	
Height	• 13 ¹ / ₂ "H	Prices at right	Specify height.
	• 19 ¹ / ₂ "H	Prices at right	Specify height.

Surface Materials	Options	U.S. Price	Required to Specify
Surface Materials	• Fabric price group 2	+\$ 53	Specify fabric color number.
	• Fabric price group 3	+\$142	Specify fabric color number.
	• Fabric price group 4	+\$178	Specify fabric color number.
	• Fabric price group 5	+\$219	Specify fabric color number.
	• Fabric price group 6	+\$256	Specify fabric color number.
	• Fabric price group 7	+\$296	Specify fabric color number.
	• Fabric price group 8	+\$332	Specify fabric color number.
	• Fabric price group 9	+\$371	Specify fabric color number.
	• Fabric price group 10	+\$408	Specify fabric color number.
	• Customer's Own Material (COM)	+\$ 25	Specify fabric color number.
			▶ See <i>Surface Materials Reference Manual</i> .

Related Products	• Aligners	▶ Page 349
-------------------------	------------	------------



For Canadian Pricing
 Multiply U.S. Price by the Canadian price factor.
 ▶ See page 1 for details.

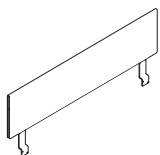

Specification Information

• Style Number	• Height	• U.S. Base Prices							
		24"W	30"W	36"W	42"W	48"W	54"W	60"W	66"W
TSFSC	13½"	\$661	\$710	\$762	\$809	\$ 858	\$ 905	\$ 955	\$1008
	19½"	\$762	\$835	\$912	\$989	\$1067	\$1143	\$1221	\$1296

► **Specification Information, continued from above**

• Style Number	• Height	• U.S. Base Prices				
		72"W	78"W	84"W	90"W	96"W
TSFSC	13½"	\$1052	\$1099	\$1145	\$1193	\$1244
	19½"	\$1375	\$1447	\$1523	\$1595	\$1669

Aligners



Tip: Aligners are for use with Universal screens only.

Standard Includes	Required to Specify
-------------------	---------------------

► Need help? Product details, page 319	• Aligner, package of 10: 6527 Merle Style number
--	--

Specification Information

• Style Number	• U.S. Price
UFAL	\$39



For Canadian Pricing

Multiply U.S. Price by the Canadian price factor.

► See page 1 for details.

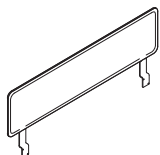

Specification Information											
Style Number	Height	Screen Type	U.S. Base Prices								
			Modular Width	24"W	30"W	36"W	42"W	48"W	54"W	60"W	
			Parametric Width	24"W	24 ¹ / ₁₆ "W-	30 ¹ / ₁₆ "W-	36 ¹ / ₁₆ "W-	42 ¹ / ₁₆ "W-	48 ¹ / ₁₆ "W-	54 ¹ / ₁₆ "W-	60"W
TSFPSC	13 ¹ / ₂ "			\$484	\$519	\$557	\$593	\$627	\$663	\$698	
	14"-19 ¹ / ₂ "			\$557	\$615	\$669	\$724	\$780	\$835	\$894	

► Specification Information, continued from above

Style Number	Height	Screen Type	U.S. Base Prices							
			Modular Width	66"W	72"W	78"W	84"W	90"W	96"W	
			Parametric Width	60 ¹ / ₁₆ "W-	66 ¹ / ₁₆ "W-	72 ¹ / ₁₆ "W-	78 ¹ / ₁₆ "W-	84 ¹ / ₁₆ "W-	90 ¹ / ₁₆ "W-	96"W
TSFPSC	13 ¹ / ₂ "			\$735	\$ 771	\$ 805	\$ 841	\$ 912	\$ 915	
	14"-19 ¹ / ₂ "			\$948	\$1006	\$1062	\$1117	\$1219	\$1229	

 **For Canadian Pricing**
 Multiply U.S. Price by the Canadian price factor.
 ► See page 1 for details.

Frameless Glass Screens with Recessed Attachment

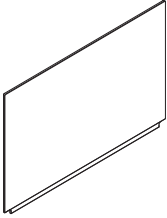

Standard Includes		Required to Specify
▶ Need help? Product details, page 321	<ul style="list-style-type: none"> • Glass screen: 6500 Clear Glass • Two supports for 24" - 48" wide • Three supports for 60" - 72" wide 	1 Style number 2 Options, if selected (see below) ▶ See <i>Surface Materials</i> , page 358.

Options	U.S. Price	Required to Specify
Glass	No cost Prices below	Specify with 6500 Clear Glass. Specify with 6530 Frosted Glass.

Specification Information			
Dimensions	Style	U.S.	Option
Width	Number	Base Price	(Add \$ to Base Price) Frosted Glass
·	·	·	·
·	·	·	·
·	·	·	·

13½"H Glass Screens

24"	TSF1324RFG	\$ 677	+\$ 92
30"	TSF1330RFG	\$ 727	+\$121
36"	TSF1336RFG	\$ 783	+\$185
42"	TSF1342RFG	\$ 835	+\$272
48"	TSF1348RFG	\$ 882	+\$302
60"	TSF1360RFG	\$1017	+\$389
72"	TSF1372RFG	\$1135	+\$467
·	·	·	·

19½"H Glass Screens

24"	TSF1924RFG	\$ 778	+\$139
30"	TSF1930RFG	\$ 825	+\$178
36"	TSF1936RFG	\$ 899	+\$262
42"	TSF1942RFG	\$ 977	+\$371
48"	TSF1948RFG	\$1046	+\$416
60"	TSF1960RFG	\$1238	+\$525
72"	TSF1972RFG	\$1405	+\$622
·	·	·	·



For Canadian Pricing
 Multiply U.S. Price by the Canadian price factor.
 ▶ See page 1 for details.

Answer Fence Boundary Screens

Straight, Single-Connect

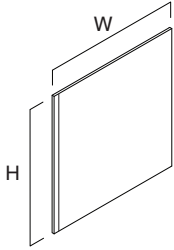

Standard Includes	Required to Specify
-------------------	---------------------

- | | | |
|--|--|---|
| <ul style="list-style-type: none"> ▶ Need help? Product details, page 322 | <ul style="list-style-type: none"> • Screen: High-Pressure Laminate price group 1 or composite veneer group 1 • Edge on laminate screen, if selected: plastic • Height: 42"H or 48"H • Width: <ul style="list-style-type: none"> - Single-sided: 27"W–39"W - Spanning : 51"W–75"W • Connecting panel cover: paint price group 1 • 1/2" adjustable glides • Attachment hardware | <ol style="list-style-type: none"> 1 Style number 2 Screen size type (see below under Required Selections) 3 Screen height(s) 4 Screen width(s) 5 Handedness: on single-sided screens, if selected (see below under Required Selections) 6 High-Pressure Laminate or composite veneer color for screen 7 Plastic color number for edge on laminate screen, if selected 8 Grain direction 9 Paint color number for connecting panel cover 10 Options, if selected (see below) <p>▶ See <i>Surface Materials</i>, page 358.</p> |
|--|--|---|

Tip: When specifying a boundary screen for Answer fence order end-of-run junction with omit outside vertical trim.

Tip: When specifying the paint finish for the bracket cover, select a finish that compliments the selected laminate or veneer finish.

For laminate price group 2 and group 3 pricing, please refer to the electronic catalog or SmartTools.

Required Selections	U.S. Price	Required to Specify
---------------------	------------	---------------------

Screen Size Type	<ul style="list-style-type: none"> • Modular • Parametric 	No cost No cost	Specify <i>with modular</i> . Specify <i>with parametric</i> .
Handedness (Single-Sided Screens Only)	<ul style="list-style-type: none"> • Right handed • Left handed 	No cost No cost	Specify <i>with single-sided right</i> . Specify <i>with single-sided left</i> .

Options	U.S. Price	Required to Specify
---------	------------	---------------------

Surface Materials	Screen <ul style="list-style-type: none"> • Laminate price group 2 • Laminate price group 3 • Open Line laminate • Composite veneer group 1 • Composite veneer group 2 • Wood group 1 • Wood group 2 • Wood group 3 • Customiz stain 	See information at left See information at left +\$220 plus cost of laminate Prices at right +\$212 Prices at right +\$233 +\$827 No cost	Specify laminate color number. Specify laminate color number. ▶ See <i>Surface Materials Reference Manual</i> . Specify composite veneer color number. Specify composite veneer color number. Specify wood color number. Specify wood color number. Specify wood color number. Specify <i>with Customiz stain</i> .
	Connecting panel cover <ul style="list-style-type: none"> • Paint price group 2 • Paint price group 3 	+\$ 17 +\$ 37	Specify paint color number. Specify paint color number.
	Laminate wood grain direction <ul style="list-style-type: none"> • No direction • Horizontal • Vertical 	No cost No cost No cost	Specify <i>with no direction</i> . Specify <i>with horizontal grain direction</i> . Specify <i>with vertical grain direction</i> .
	Wood veneer grain direction <ul style="list-style-type: none"> • No direction • Horizontal • Vertical 	No cost No cost No cost	Specify <i>with no direction</i> . Specify <i>with horizontal grain direction</i> . Specify <i>with vertical grain direction</i> .



For Canadian Pricing
 Multiply U.S. Price by the Canadian price factor.
 ▶ See page 1 for details.

Specification Information

Style Number	Dimensions H	Screen Type	U.S. Base Prices							
			Modular Width	27"W	33"W	39"W	51"W	57"W	63"W	69"W
		Parametric Width	27"W – 32 ¹⁵ / ₁₆ "W	33"W – 38 ¹⁵ / ₁₆ "W	39"W – 44 ¹⁵ / ₁₆ "W	51"W – 56 ¹⁵ / ₁₆ "W	57"W – 62 ¹⁵ / ₁₆ "W	63"W – 68 ¹⁵ / ₁₆ "W	69"W – 74 ¹⁵ / ₁₆ "W	75"W

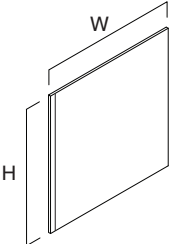

Straight Single-Connect Boundary Screen—Single-Sided

High-Pressure Laminate										
TSFSCSSD	42"H		\$ 804	\$ 985	\$1166	N.A.	N.A.	N.A.	N.A.	N.A.
	48"H		\$ 819	\$1015	\$1213	N.A.	N.A.	N.A.	N.A.	N.A.
Composite Veneer										
TSFSCSSD	42"H		\$1227	\$1545	\$1863	N.A.	N.A.	N.A.	N.A.	N.A.
	48"H		\$1319	\$1659	\$2000	N.A.	N.A.	N.A.	N.A.	N.A.
Wood Veneer										
TSFSCSSD	42"H		\$1269	\$1601	\$1933	N.A.	N.A.	N.A.	N.A.	N.A.
	48"H		\$1369	\$1723	\$2079	N.A.	N.A.	N.A.	N.A.	N.A.

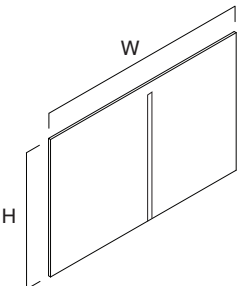

Straight Single-Connect Boundary Screen—Spanning

High-Pressure Laminate										
TSFSCSPN	42"H		N.A.	N.A.	N.A.	\$1530	\$1711	\$1892	\$2075	\$2259
	48"H		N.A.	N.A.	N.A.	\$1606	\$1803	\$2000	\$2195	\$2395
Composite Veneer										
TSFSCSPN	42"H		N.A.	N.A.	N.A.	\$2498	\$2816	\$3136	\$3454	\$3775
	48"H		N.A.	N.A.	N.A.	\$2682	\$3023	\$3364	\$3703	\$4046
Wood Veneer										
TSFSCSPN	42"H		N.A.	N.A.	N.A.	\$2596	\$2926	\$3260	\$3592	\$3927
	48"H		N.A.	N.A.	N.A.	\$2790	\$3145	\$3500	\$3853	\$4212

Surface Materials

Surface Materials	358
Specification Guidelines for Directional Fabrics	364
Paint Color Availability Matrix	366
Laminate Color Availability Matrix	368
Recommended Worksurface Edge Finishes	370
Directional Laminate Grain Directions	371
Wood Veneer Grain Directions	372

Surface Materials

This listing includes all the surface material choices that are available for the products in this specification guide.

Resources

For more information about surface materials, refer to the following resources:

Additional surface materials specification tools are available to assist you in the specification process—the Surface Materials Binders.

The global surface materials palette is a core collection of finishes that is available across multiple geographies (Americas/ EMEA – Europe, Middle East, and Africa/ APAC – Asia Pacific) and on global product lines, where applicable. For a list of finishes included in the offering, see the Surface Materials Reference Manual. Additional details, like product approvals by geography and finish number conversions, can also be found in the Surface Materials Reference Manual or see steelcase.com/surface-materials under the Select Surface section.

Surface Materials

Binders include:

- Surface Materials Reference Manual
- A complete set of swatch cards for hard surfaces, vertical surface fabrics, and seating upholstery

Paint

Tip: All products may not be available in all colors listed below.

► See page 366 for an overview of the paint colors available on each component.

Applies to:

- Power access door
- 4799 Platinum Metallic
- 7241 Arctic White
- 7360 Merle
- 8043 Clear Anodized Aluminum

ⓔ = Excluded

Steelcase Surfaces

Price Group 1

Smooth Paint

- 4238 Mocha
- 4239 Clay
- 4240 Chalk
- 4242 Milk

Textured Paint

- 7207 Black
- 7225 Sand
- 7237 Slate
- 7238 Fieldstone
- 7239 Midnight ⓔ
- 7241 Arctic White
- 7243 Seagull
- 7250 Sterling Dark Solid
- 7360 Merle

Price Group 2

Smooth Metallic Paint

- 4750 Champagne Metallic
- 4798 Sterling Metallic ⓔ
- 4799 Platinum Metallic
- 4803 Near Black Metallic

Smooth Paint

- 0835 Black
- 4700 Warm White

Applies to:

- Universal privacy screens

Price Group 1

Textured Paint

- 7241 Arctic White
- 7360 Merle

Price Group 2

Smooth Metallic Paint

- 4799 Platinum Metallic

Applies to:

- Sarto screen brackets
- Universal privacy/modesty screen brackets

Price Group 1

Textured Paint

- 7360 Merle

Applies to:

- Sarto beam screen bracket cover
- Universal beam screen bracket cover

Price Group 2

Smooth Metallic Paint

- 4799 Platinum Metallic

Applies to:

- Power access door

Price Group 1

Textured Paint

- 7207 Black
- 7241 Arctic White
- 7360 Merle

Price Group 2

Smooth Metallic Paint

- 4799 Platinum Metallic

Applies to:

- 2 1/2" round grommet

Price Group 1

Smooth Paint

- 7241 Arctic White

Textured Paint

- 7360 Merle

Price Group 2

Standard Paint

- 0835 Black

Smooth Metallic Paint

- 4799 Platinum Metallic

Applies to:

- Wood and laminate skin trims

Price Group 1

Smooth Paint

- 4238 Mocha
- 4239 Clay
- 4240 Chalk
- 4242 Milk

Price Group 2

Textured Paint

- 7207 Black
- 7225 Sand
- 7237 Slate
- 7241 Arctic White
- 7243 Seagull
- 7250 Sterling Dark Solid
- 7360 Merle

Smooth Metallic Paint

- 4799 Platinum Metallic

Price Group 3

Applies to:

- Answer beam
- Answer fence
- High-density storage
- Universal worksurface supports
- Universal storage

Accent paint

- 1ATG Rose Quartz
- 4AV3 Blue Jay
- 4AV4 Baltic
- 4AX1 Citron
- 4AY2 Chili
- 4AZ5 Marlin
- 4CL1 Dark Olivine
- 4CL2 Ice Blue
- 4CL3 Aura
- 4CL4 Sea Glass
- 4CL5 Light Matcha
- 4CL6 Terra
- 4CL7 Sandstone
- 4CL8 Smokey Plum
- 4CZ5 Honey
- 4CZ6 Lagoon
- 4CZ8 Light Peacock

Coatings

- 1ATT Cast Shadow

Lux Coatings

- 4B20 Obsidian
- 4B22 Matte Brass
- 4B23 Burnished Bronze
- 4B24 Night Bronze
- 4B25 Matte Copper
- 4B26 Smoked Mica
- 4B29 Cast Iron

Custom Surfaces

Price Group 3

PerfectMatch

PerfectMatch is a service that allows you to create your own paint color. Refer to the *Surface Materials Reference Manual* for more information about this program.

Accessory Paint

Steelcase Surfaces

Tip: All products may not be available in all colors listed below.

Applies to:

- Power access door
- 8043 Clear Anodized Aluminum

Glass

Steelcase Surfaces

Applies to:

- Frameless glass screens
- 6500 Clear Glass
- 6530 Frosted Glass

Laminate

Steelcase Surfaces

High-Pressure Laminate

Price Group 1

Fiber Laminate

- 2850 Vanadium Fiber
- 2854 Vellum Fiber ⓔ
- 2860 Granite Fiber
- 2862 Stucco Fiber ⓔ

Micro Laminate

- 2920 Marl Micro
- 2921 Gypsum Micro
- 2922 Clay Micro

Patina Laminate

- 2870 Blonde Bronze Patina
- 2873 Instant Iron Patina

Solid Laminate

- 2722 Cream ⓔ
- 2730 Arctic White
- 2746 Black
- 2759 Warm White
- 2811 Mist ⓔ
- 2883 Seagull
- 2884 Milk
- 2885 Dune
- 2HAA Persian Salt
- 2HAB Rose
- 2HAC Indigo
- 2HAD Green Citrine ⓔ
- 2HAE Dark Olivine
- 2HAF Cloudy
- 2HMG Merle
- 2HWU Clay
- 2HVV Chalk

Speckle Laminate

- 2820 Coffee Speckle **E**
- 2823 Driftwood Speckle
- 2824 Smoke Speckle
- 2825 Vanadium Speckle

*Not available on Universal worksurfaces or boundary screens.

Tip: Some wood veneer finishes and woodgrain laminates share the same name. Because of the difference in materials, veneers and laminates of the same name are not an exact match but do coordinate with each other.

▶ See page 368 for an overview of the laminate colors available on each product line.

Woodgrain Laminate

- 2406 Clear Cherry **E**
- 2409 Clear Maple
- 2410 Graphite Walnut
- 2412 Natural Cherry
- 2422 Medium Cherry **E**
- 2511 Winter on Maple **E**
- 2535 Virginia Walnut
- 2536 Blackwood
- 2538 Clear Walnut
- 2592 Blonde on Maple **E**
- 2714 Natural Walnut **E**
- 2897 Desert Oak
- 2HAK Clear Oak
- 2HAN Ash Noce
- 2HAT Acacia
- 2HAW Ash Wenge
- 2HBN Bisque Noce
- 2HBW Bisque Wenge
- 2HCN Clay Noce
- 2HCW Clay Wenge
- 2HSN Storm Noce
- 2HSW Storm Wenge
- 2HWA Grey Kingswood
- 2HWB Planked Walnut
- 2HWD Resolute Walnut
- 2HWE Natural Recon
- 2HWF Smoked Walnut **E**
- 2HZA Waxed Maple
- 2HZB Natural Ash
- 2HZC Aged Ash
- 2HZD Ashwood Oak
- 2HZE Ashwood Beige
- 2HZF White Washed Birchply

Tip: Woodgrain Laminates are not available as matched sets. The grain patterns will not align. These are not recommended for fully segmented skin applications.

Price Group 2

Textured Laminate

- 2TH2 Fawn Cypress
- 2TH4 Saddle Oak
- 2TH5 Veranda Teak
- 2TH7 Walnut Heights
- 2UH1 Reclaimed Aggregate
- 2UH2 Reclaimed Gravel
- 2UH4 Cement*
- 2UH6 Sheetrock

*2UH4 Cement has limited availability, determined by product sizing and/or options.

E = Excluded

Applies to:

- Universal worksurfaces

Price Group 3

Solid Laminate

- 24H1 Satin White
- 24H2 Satin Black
- 24H3 Satin Stone
- 24H4 Satin Mocha

Custom Surfaces

Open Line Laminate (OLL)

This service allows you to order non-standard laminate at an additional processing fee of \$111 U.S. per unit, plus the cost of the laminate.

High-Pressure Laminate pricing does not include premium or digitally printed patterns from any suppliers. Laminate cost may also vary for basic or standard laminates from other suppliers. Please contact the OLL consultant at 616.475.2426 for pricing. The cost of the laminate will be added to your invoice as a separate line on the acknowledgement.

When processing orders for Open Line laminate on Universal worksurfaces and Universal Storage tops, specify 2900 in the laminate finish field and enter the OLL manufacturer information. Enter the required edge finish as you would a standard laminate.

Laminate Approval and Material Requirements

To confirm whether a particular laminate has already been tested for use on a specific Steelcase product or to determine material square foot requirements:
• Visit www.steelcase.com

For additional information, refer to the *Steelcase Surface Materials Reference Manual*.

Steelcase Surfaces

Low-Pressure Laminate

Fiber Laminate

- 2L50 Vanadium Fiber LPL

Solid Laminate

- 247L Black V2 LPL
- 2L30 Arctic White LPL
- 2L83 Seagull LPL
- 2L84 Milk LPL
- 2L85 Dune LPL
- 2HMG Merle LPL

Woodgrain Laminate

- 25L1 Winter on Maple LPL **E**
- 25L5 Virginia Walnut LPL
- 25L6 Blackwood LPL
- 25L8 Clear Walnut LPL
- 26L1 Natural Cherry V2 LPL
- 2L09 Clear Maple LPL
- 2LAK Clear Oak LPL
- 2LAN Ash Noce LPL
- 2LAT Acacia LPL
- 2LAW Ash Wenge LPL
- 2LBN Bisque Noce LPL
- 2LBW Bisque Wenge LPL
- 2LCN Clay Noce LPL
- 2LCW Clay Wenge LPL
- 2LSN Storm Noce LPL
- 2LSW Storm Wenge LPL
- 2LWA Grey Kingswood
- 2LWB Planked Walnut
- 2LWD Resolute Walnut
- 2LWF Smoked Walnut **E**
- 2LWG Natural Recon
- 2TL2 Fawn Cypress

Wood

Applies to:

- Boundary screens
- Universal worksurfaces and tables—wood veneer
- High-Density storage
- Answer pedestal tops and fronts
- Universal storage tops and fronts
- Wood skins and trims
- Infills for FrameOne legs

Tip: Wood is not offered as a finish on the value package for High-Density storage cases.

Steelcase carefully selects veneer and solid wood for consistent color and grain structure. Wood is a natural material and variations will occur in color, grain and texture. These variations are part of the inherent natural beauty of wood and are not considered defects.

All wood products will darken with age and exposure to ultraviolet light. This is especially apparent with cherry and maple veneer. We recommend that desk accessories be rearranged periodically to ensure even aging of wood surfaces.

When storing your wood furniture, please follow the following guidelines:

- Do not store products in trailers
- Store products in areas that simulate office temperatures (60°F to 90°F)
- Store products in areas that maintain constant, office-like humidity levels
- Keep product away from light. Cover products to make sure they are not exposed to light.

Surface Materials, continued

Steelcase Surfaces

Veneers are matched for proper balance and consistency. Veneers are available flat cut or quarter cut, except for Oak, which is rift cut. Refer to the *Surface Materials Reference Manual* for descriptions of each cut.
Tip: Answer panel wood trims are only available with quarter-cut finishes with the exception of maple finishes. Maple on wood trims is only available with flat-cut finishes. For ordering simplicity, both flat-cut and quarter-cut finishes can be specified on panel trims. However, for all finishes except maple, if a flat-cut finish is selected, the trims will have the coordinating quarter-cut finish. For maple finishes, if quarter-cut is selected, the trims will have the coordinating flat-cut finish. Blending panel trims with other wood products that have flat-cut finishes may be visually acceptable for most applications. If a more exact match is desired for non-maple finishes, please specify quarter-cut finishes for the entire project. If a more exact match is desired for maple finishes, please specify flat-cut finishes for the entire project.

Open-pore finish is a medium gloss finish that leaves the wood grain texture visible to the eye and distinguishable to the touch.

Veneer

Wood Group 1

Flat-Cut Open-Pore

- 3062 FC/OP Graphite Walnut
- 3402 FC/OP Clear Cherry (Aged)
- 3412 FC/OP Natural Cherry **E**
- 3422 FC/OP Medium Cherry
- 3522 FC/OP Clear Maple
- 3702 FC/OP Clear Walnut
- 3712 FC/OP Natural Walnut
- 3752 FC/OP Medium Walnut **E**
- 3762 FC/OP Dark Walnut
- 3772 FC/OP Medium Mahogany on Walnut

Flat-Cut Open-Pore, Natural Veneer

- 3342 FC/OP Black Walnut
- 35A2 FC/OP Blanch Maple
- 37A2 FC/OP Thunder Walnut

Quarter-Cut Open-Pore

- 3042 QC/OP Ash **E**
- 3222 QC/OP Clear Maple
- 3302 QC/OP Clear Walnut
- 3312 QC/OP Natural Walnut
- 3352 QC/OP Medium Walnut **E**
- 3362 QC/OP Dark Walnut
- 3372 QC/OP Medium Mahogany on Walnut
- 3382 QC/OP Graphite Walnut

Quarter-Cut Open-Pore, Natural Veneer

- 32A2 QC/OP Blanch Maple
- 33A2 QC/OP Thunder Walnut
- 3392 QC/OP Black Walnut

E = Excluded

Rift-Cut Open-Pore

- 3602 RC/OP Desert Oak

Rift-Cut Open-Pore, Natural Veneer

- 36A2 RC/OP Volcanic Oak

Wood Group 3

Flat-Cut Open-Pore, Natural Veneer

- 3082 FC/OP Washed Walnut

Wood Group 1

Open-Pore Planked Veneer

- 3P41 OP Planked Cherry
- 3P51 OP Planked Maple
- 3P61 OP Planked Oak
- 3P71 OP Planked Walnut
- 3VFX OP Unmarked Oak

Tip: Known for its uniqueness, planked veneer has intentional and natural variations that include, but are not limited to: character marks, grain pattern, color, and natural color aging.

Premium Veneers

A selection of Premium veneers in this collection are available on most Steelcase brand products. The collection will be available as close to standard leadtimes as possible. However, because adequate supplies of veneer and solids must be secured, all orders will be scheduled individually. Leadtimes will vary based on Premium veneer and Premium solids availability at the time the order is placed. The collection is available as Wood Group 3 as part of our Select Surfaces program and supported like standard veneers to make ordering easy. Please see the Steelcase surface materials section on *village.steelcase.com* for sample information and product line availability. All premium veneers are in clear-coat.

Wood Group 3

Quarter-Cut Open-Pore

- 3832 QC/OP Figured Anegre

Select Surfaces

For information on products within Select Surfaces, including accent paints and fabrics from Designtex, Gabriel, Kvadrat, and Pollack, please refer to the *Surface Materials Reference Manual* or visit *steelcase.com/surface-materials* under the Select Surfaces section.

Composite Veneer

Composite veneers are an engineered wood intended to create specific grain patterns and characteristics. They are pre-stained and finished with Steelcase's Clarity water-borne UV topcoat, which protects the environment while providing durability and clarity. Only open-pore finishes are available on composite wood. Composite veneer and matching edge bands are available on most Steelcase brand products. Composites, for use as a solid nosing substitute, are not available. Steelcase does not recommend mixing composite veneers with natural solid nosings because composite and natural wood grain and color matching are rarely compatible. Composite veneers are available as Select Surfaces as Wood Group 1 pricing.

Composite Veneer Group 1

Composite Flat-Cut Open-Pore

- 3JJX FC/OP Walnut Composite
- 3LAX FC/OP Graphite on Oak Composite
- 3LCX FC/OP Medium Cherry on Cherry Composite

Composite Quarter-Cut Open-Pore

- 3F8X QC/OP European Walnut Composite
- 3HGX QC/OP Oak Composite
- 3HVX QC/OP Walnut Composite
- 3LBX QC/OP Clear Walnut on Walnut Composite
- 3LDX QC/OP Natural Walnut on Walnut Composite

Composite Veneer Group 2

Composite Flat-Cut Open-Pore

- 3LHX FC/OP Espresso on Walnut Composite

Composite Quarter-Cut Open-Pore

- 3LEX QC/OP Desert Oak on Oak Composite
- 3LGX QC/OP Clear Walnut on Walnut Composite
- 3LJX QC/OP Ebony on Walnut Composite

Custom Surfaces

Customiz stain is a service that allows you to create your own stain colors and finishes on standard veneer. Customiz stain color is available on all product lines that offer wood veneer.

A \$500 stain-matching fee applies on CUSTOMIZ requests (Exception: The \$500 fee does not apply on matches to Coalesse standard finishes or for a low-gloss finish request on a standard color). The \$500 fee covers the cost of formulating the Customiz color finish and applies regardless of whether or not an order for product is placed.

In addition, an approval form must be signed to indicate customer acceptance of Customiz match. A \$1,500 initiation fee will be charged prior to first order entry. This initiation fee activates the finish for unlimited use on any Steelcase product for an 18 month time period. After the 18 month time period has lapsed, the Customiz finish may be reactivated for another 18 months for a \$1,000 fee at any point within five years after the \$1,500 initiation fee was paid. If the finish is not reactivated within five years after the \$1,500 initiation fee was paid, the finish will be culled and the customer will need to pay the \$1,500 initiation fee again. All style number related Customiz charges products are no cost as of April 2014. The matching and initiation fees are not discountable.

Customiz stain takes 10 days to formulate. Consult the *Surface Materials Reference Manual* for more information. Custom veneers are also available and must be quoted by Steelcase specials group. Customiz stain on custom veneers takes 2 to 4 weeks to formulate.

Requirements and information on ordering a Customiz stain color are found in the *Surface Materials Reference Manual*.

Plastic

Steelcase Surfaces

Applies to:

- Power receptacles
- 6000 Black
- 6009 Arctic White
- 6249 Platinum Solid
- 6527 Merle
- 6654 Sand
- 6655 Warm White
- 6697 Fog
- 6B03 Red

Applies to:

- Power accessories
- 6000 Black
- 6009 Arctic White
- 6249 Platinum Solid
- 6527 Merle
- 6654 Sand
- 6655 Warm White
- 6697 Fog

Applies to:

- 3 mm and 1 mm front edge profile on Universal systems worksurfaces and tables
- 1 mm square edge profile on Universal storage laminate tops
- Boundary screens
- HD storage

- | | |
|-------------------------------|----------------------|
| 6000 Black | 6635 Dawn E |
| 6009 Arctic White | 6636 Mist |
| 6034 Natural Cherry | 6654 Sand |
| 6036 Medium Cherry | 6655 Warm White |
| 6037 Winter on Maple | 6695 Midnight |
| 6038 Blonde on Maple E | 6697 Fog |
| 6041 Natural Walnut E | 6698 Fieldstone |
| 6052 Milk | 66WA Grey Kingswood |
| 6053 Seagull | 66WB Planked Walnut |
| 6128 Taupe* | 66WD Resolute Walnut |
| 6169 Stone | 66WE Natural Recon |
| 6170 Mocha | 66WF Smoked Walnut |
| 61AA Persian Salt | 66WU Clay |
| 61AB Rose | 66WV Chalk |
| 61AC Indigo | 6703 Ash Wenge |
| 61AD Green Citrine E | 6704 Storm Wenge |
| 61AE Dark Olivine | 6705 Bisque Wenge |
| 61AF Cloudy | 6706 Clay Wenge |
| 6213 Acacia | 6707 Ash Noce |
| 6219 Clear Oak | 6708 Bisque Noce |
| 6231 Graphite Walnut | 6709 Clay Noce |
| 6237 Clear Maple | 6710 Storm Noce |
| 6242 Virginia Walnut | 6T02 Fawn Cypress |
| 6243 Blackwood | 6T04 Saddle Oak |
| 6245 Clear Walnut | 6T05 Veranda Teak |
| 6249 Platinum Solid | 6T07 Walnut Heights |
| 6271 Plywood | 6T08 Aggregate |
| 6527 Merle | 6T09 Gravel |
| 6619 Ice E | 6T10 Cement |
| 6631 Cream E | 6T12 Sheetrock |

*6128 Taupe applies to HD storage only

Tip: Light color plastic edges are susceptible to degradation due to normal wear and tear. Staining (e.g., ball point pen or clothing dyes such as blue jeans) and dirt effects are more pronounced in light colors and are not considered defects.

E = Excluded

Metal

Steelcase Surfaces

Applies to:

- 2 1/2" round grommet
- 9201 Polished Chrome
- 9211 Nickel

Applies to:

- Universal storage pulls
- 0835 Black
- 9201 Polished Chrome
- 9211 Nickel
- 9212 Silver

Applies to:

- Nile pulls
- 0835 Black
- 4799 Platinum Metallic
- 7280 Smooth Bronze
- 9201 Polished Chrome
- 9211 Nickel

Upholstery

Applies to:

- Universal screens
- Tip: Designtex: Gamut and Designtex: Crossweave are also available on Universal screens. Designtex: Gamut and Designtex: Crossweave are part of the Select Surfaces program.*
- ▶ See Surface Materials Reference Guide for more information on the Select Surfaces program.

Steelcase Surfaces

Price Group 1

- Abacus **E****
- P123 Portico
 - P124 Opus
 - P125 Cusp
 - P126 Artifact

Buzz2

- 5F03 Tomato
- 5F04 Red **E**
- 5F05 Burgundy
- 5F06 Sky **E**
- 5F07 Blue
- 5F08 Navy
- 5F15 Stone
- 5F16 Grey
- 5F17 Black
- 5G50 Dunegrass
- 5G51 Sable
- 5G55 Pumpkin
- 5G57 Rouge
- 5G59 Meadow
- 5G61 Cyan
- 5G62 Atlantic
- 5G63 Crocus
- 5G64 Alpine
- 5G65 Tornado

Price Group 2

Code

- 5FA1 Fossil
- 5FA2 Gabbro
- 5FA3 Reed
- 5FA4 Bluff
- 5FA5 Sea Salt
- 5FA6 Cannon
- 5FA7 Tussah
- 5FA9 Ecru
- 5FB1 Bamboo

Cogent: Connect

- 5S15 Coconut
- 5S16 Turmeric/Honey
- 5S17 Tangerine
- 5S18 Scarlet
- 5S19 Concord
- 5S21 Blue Jay
- 5S23 Wasabi
- 5S24 Nickel
- 5S25 Graphite
- 5S27 Malt
- 5S28 Root Beer
- 5S93 Indigo/Blueprint
- 5S94 Lizard/Jungle
- 5S95 Sailor
- 5S96 Quicksilver
- 5S99 Lipstick/Merlot
- 5SD0 Royal Blue
- 5SD1 Aubergine
- 5SD2 Peacock
- 5SD3 Lagoon
- 5SD4 Saffron
- 5SD5 Citrine
- 5SD6 Rose Quartz
- 5SD7 Sea Salt
- 5SF3 Storm Cloud
- 5SF4 Olivine

Dovetail by Designtex

- 5H39 Light Mocha
- 5H40 Pebble
- 5H41 Warm White
- 5H42 Sandstone
- 5H43 Honeycomb
- 5H44 Terra
- 5H45 Honeydew
- 5H46 Denim
- 5H47 Storm
- 5H48 Ice Blue
- 5H49 Aura
- 5H50 Darkest Grey

Intersection

- P211 Summit
- P212 Chalk
- P213 Lace

Latch

- P601 Clam
- P602 Eggshell
- P603 Zen
- P604 Cool Gray
- P605 Armor
- P606 Sentinel
- P608 Billow
- P609 Nimbus

SoftNext

- 5H27 Obsidian
- 5H28 Foggy Night
- 5H29 Greystone
- 5H30 Mocha
- 5H31 Clay
- 5H32 Sandstone
- 5H33 Chalk
- 5H34 Midnight
- 5H35 Blue Mica
- 5H36 Jade
- 5H37 Burnt Umber
- 5H38 Cinnabar

Stencil

- P455 Midnight
- P456 Mulberry
- P457 Cracked Pepper
- P458 Denim
- P459 Chartreuse
- P460 Bittersweet
- P461 Mauvelous
- P462 Bermuda
- P463 Concrete
- P464 Orchid
- P465 Parchment
- P466 Silk
- P467 Sea Salt
- P468 Honeydew
- P469 Sepia

Price Group 3

Billiard Multi-Use by Designtex

- 5H11 Poppy
- 5H12 Tangelo
- 5H13 Citrine/Citron
- 5H14 Avocado
- 5H16 Indigo
- 5H17 Mallard
- 5H18 Teak
- 5H19 Cumulus
- 5H20 Pewter
- 5H21 Gunmetal
- 5H22 Ink
- 5H23 Rose Quartz
- 5H24 Sea Salt
- 5H25 Storm Cloud
- 5H26 Olivine

Select Surfaces

For information on products within Select Surfaces, including accent paints and fabrics from Designtex, Gabriel, Kvadrat, and Pollack, please refer to the *Surface Materials Reference Manual* or visit steelcase.com/surface-materials under the Select Surfaces section.

Surface Materials, continued

Applies to:
• Fabric skins

Steelcase Surfaces

Price Group A

Sprite

- 5540 Khaki
- 5541 Snow
- 5543 Linen
- 5544 Sherbet
- 5545 Powder
- 5547 Sky

Price Group 1

Abacus E

- P123 Portico
- P124 Opus
- P125 Cusp
- P126 Artifact

Alloy

- P525 Polar
- P526 Skim
- P527 Bubbly
- P528 Tern
- P529 Shore
- P530 Asti
- P531 Silver
- P532 Oxide
- P533 Element
- P534 Construct
- P535 Currency
- P536 Iron

Boccie

- P200 New Rice
- P201 New Almond
- P203 New Camel
- P204 New Opal
- P205 New Mist
- P206 New Plum
- P208 New Spearmint
- P209 New Sky

Buzz2

- 5F03 Tomato
- 5F04 Red E
- 5F05 Burgundy
- 5F06 Sky E
- 5F07 Blue
- 5F08 Navy
- 5F15 Stone
- 5F16 Grey
- 5F17 Black
- 5G50 Dunegrass
- 5G51 Sable
- 5G55 Pumpkin
- 5G57 Rouge
- 5G59 Meadow
- 5G61 Cyan
- 5G62 Atlantic
- 5G63 Crocus
- 5G64 Alpine
- 5G65 Tornado

Charm

- P505 Shell
- P506 Mimosa
- P507 Birch
- P508 Sparkle
- P510 Debut
- P511 Clover
- P513 Twilight

Optic

- P540 Hazel
- P541 Twinkle
- P542 Orion
- P547 Bath
- P548 Whisper
- P549 Breezy
- P551 Glimmer

Pianista

- P420 Sand
- P421 Mist
- P422 Rain
- P423 Natural
- P424 Café
- P425 Denim
- P426 Carbon
- P427 Stone
- P428 Flax
- P429 Oat
- P430 Wheat
- P431 Maize

Rhythm

- P555 Allegro
- P556 Tempo
- P557 Refrain
- P560 Melody
- P562 Opus

Tinsel

- P515 Sugar
- P516 Lit
- P517 Ego
- P518 Fizz
- P519 Muse
- P520 Depth
- P521 Bliss
- P522 Grow
- P523 Dolce
- P524 Boost

Price Group 2

Bariolage

- G200 New Etude
- G201 New Andante E
- G202 New Cantata E
- G203 New Adagio
- G205 New Ballata

Code

- 5FA1 Fossil
- 5FA2 Gabbro
- 5FA3 Reed
- 5FA4 Bluff
- 5FA5 Sea Salt
- 5FA6 Cannon
- 5FA7 Tussah
- 5FA9 Ecru
- 5FB1 Bamboo

Dovetail by DesignTex

- 5H39 Light Mocha
- 5H40 Pebble
- 5H41 Warm White
- 5H42 Sandstone
- 5H43 Honeycomb
- 5H44 Terra
- 5H45 Honeydew
- 5H46 Denim
- 5H47 Storm
- 5H48 Ice Blue
- 5H49 Aura
- 5H50 Darkest Grey

Flip: Orbit

- 5F85 Mud Pie E
- 5F87 Petoskey
- 5F89 Papyrus
- 5F91 Blizzard
- 5F92 Briquette

Flip: TexHex

- 5F75 Mud Pie E
- 5F77 Petoskey
- 5F79 Papyrus
- 5F97 Blizzard
- 5F98 Briquette

Fresco

- G001 Sandrift
- G002 Mistiblu
- G003 Faon

Intersection

- P211 Summit
- P212 Chalk
- P213 Lace

Latch

- P600 Seashell
- P601 Clam
- P602 Eggshell
- P603 Zen
- P604 Cool Gray
- P605 Armor
- P606 Sentinel
- P608 Billow
- P609 Nimbus

SoftNext

- 5H27 Obsidian
- 5H28 Foggy Night
- 5H29 Greystone
- 5H30 Mocha
- 5H31 Clay
- 5H32 Sandstone
- 5H33 Chalk
- 5H34 Midnight
- 5H35 Blue Mica
- 5H36 Jade
- 5H37 Burnt Umber
- 5H38 Cinnabar

Stencil

- P455 Midnight
- P456 Mulberry
- P457 Cracked Pepper
- P458 Denim
- P459 Chartreuse
- P460 Bittersweet
- P461 Mauvelous
- P462 Bermuda
- P463 Concrete
- P464 Orchid
- P465 Parchment
- P466 Silk
- P467 Sea Salt
- P468 Honeydew
- P469 Sepia

Price Group 3

Billiard Multi-Use by DesignTex

- 5H11 Poppy
- 5H12 Tangelo
- 5H13 Citrine/Citron
- 5H14 Avocado
- 5H16 Indigo
- 5H17 Mallard
- 5H18 Teak
- 5H19 Cumulus
- 5H20 Pewter
- 5H21 Gunmetal
- 5H22 Ink
- 5H23 Rose Quartz
- 5H24 Sea Salt
- 5H25 Storm Cloud
- 5H26 Olivine

Select Surfaces

For information on products within Select Surfaces, including accent paints and fabrics from DesignTex, Gabriel, Kvadrat, and Pollack, please refer to the *Surface Materials Reference Manual* or visit steelcase.com/surface-materials under the Select Surfaces section.

Custom Surfaces

Price Group COM (Customer's Own Material)

Fabric Approval and Yardage

To confirm whether a particular COM material has already been tested for use on a specific Steelcase product or to determine actual yardage requirements:
• Visit www.steelcase.com

For additional information regarding Customer's Own Material, call 1.888.STEELCASE (1.888.783.3522) or send an e-mail to lineone@steelcase.com.

► See *Surface Materials Reference Manual* for a listing of available seating upholstery colors.

E = Excluded

- Applies to:
- High-Density storage magnetic board

Price Group 2

Cogent: Connect

Price Group 3

Billiard Multi-Use by Designtex

- Applies to:
- Sarto screens

Price Group A

Sprite

Price Group 1

- Abacus **E**
- Alloy
- Boccie
- Buzz2
- Charm
- Link
- Optic
- Pianista
- Rhythm

Price Group 2

- Bariolage
- Cogent: Connect
- Dovetail by Designtex
- Flip: Orbit
- Flip: TexHex
- Fresco
- Latch
- SoftNext
- Stencil

E = Excluded

Specification Guidelines for Directional Fabrics

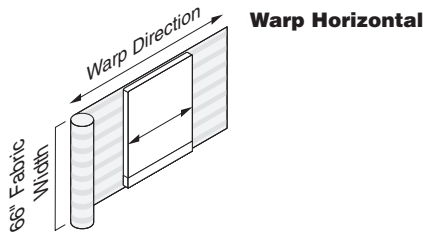

Warp Horizontal

The standard application direction of fabric on Answer panels, skins, and Hutch kit tackboard is warp horizontal. Standard Steelcase fabrics were designed for this application direction.

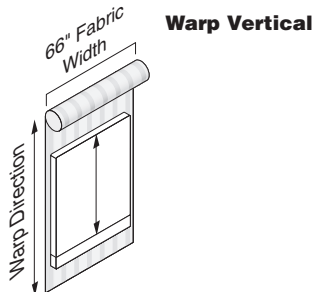

Warp Vertical

The optional application direction of fabrics on Answer panels, skins, and Hutch kit tackboard is warp vertical. This is most commonly used on COMs designed for warp vertical application.

For more information about the warp direction of fabrics, see the *Surface Materials Reference Manual*.

Paint Color Availability Matrix

Legend

- = Not available
- = Available
- = Available with exceptions
- ⓔ = Excluded

	Paint Price Group 1 (Smooth)				Paint Price Group 1 (Textured)								Paint Price Group 2 (Smooth)		Paint Price Group 2 (Metallic)				
	4238	4239	4240	4242	7207	7225	7237	7238	7239	7241	7243	7250	7360	0835	4750	4798	4799	4803	
	Mocha	Clay	Chalk	Milk	Black	Sand	Slate	Fieldstone	Midnight ⓔ	Arctic White	Seagull	Sterling Dark Solid	Merle	Black	Champagne Metallic	Sterling Metallic ⓔ	Platinum Metallic	Near Black Metallic	
Beam																			
Beam trim components	■	■	■	■	■	■	■	■	■	■	■	■	■	■	■	■	■	■	
Skins and Related Products																			
Steel skins	■	■	■	■	■	■	■	■	■	■	■	■	■	■	■	■	■	■	
Laminate skin trim	■	■	■	■	■	■	■	•	•	■	■	■	■	•	•	•	■	•	
Wood skin trim	■	■	■	■	■	■	■	•	•	■	■	■	■	•	•	•	■	•	
Worksurfaces, Desks, and Tables																			
Power access door	•	•	•	•	■	•	•	•	•	■	•	•	■	•	•	•	■	•	
Cantilevers	■	■	■	■	■	■	■	■	■	■	■	■	■	■	■	■	■	■	
Post legs and double post legs	■	■	■	■	■	■	■	■	■	■	■	■	■	■	■	■	■	□	
FrameOne legs and supports	■	■	■	■	■	■	■	■	■	■	■	■	■	■	■	■	■	■	
High-Density storage	■	■	■	■	■	■	■	■	■	■	■	■	■	■	■	■	■	■	
Fence																			
Junctions	■	■	■	■	■	■	■	■	■	■	■	■	■	■	■	■	■	■	
Horizontal packages	■	■	■	■	■	■	■	■	■	■	■	■	■	■	■	■	■	■	
Infeed covers	■	■	■	■	■	■	■	■	■	■	■	■	■	■	■	■	■	■	
Worksurface Screens																			
Universal beam screen bracket cover	•	•	•	•	•	•	•	•	•	•	•	•	•	•	•	•	■	•	
Universal privacy/modesty screen brackets	•	•	•	•	•	•	•	•	•	•	•	•	■	•	•	•	•	•	
Universal privacy screen screen brackets	•	•	•	•	•	•	•	•	■	•	•	•	■	•	•	•	■	•	
Sarto beam and fence screen brackets and hard stops	•	•	•	•	•	•	•	•	•	•	•	•	■	•	•	•	•	•	
Sarto beam screen bracket cover	•	•	•	•	•	•	•	•	•	•	•	•	•	•	•	•	■	•	
Sarto privacy/modesty screen brackets	•	•	•	•	•	•	•	•	•	•	•	•	■	•	•	•	•	•	
Sarto privacy screen brackets	•	•	•	•	•	•	•	•	•	•	•	•	■	•	•	•	•	•	

Paint Price Group 3 (Accent Paints)	
1ATG	Rose Quartz
4AV3	Blue Jay
4AV4	Baltic
4AX1	Citron
4AY2	Chili
4AZ5	Marlin
4CL1	Dark Olivine
4CL2	Ice Blue
4CL3	Aura
4CL4	Sea Glass
4CL5	Light Matcha
4CL6	Terra
4CL7	Sandstone
4CL8	Smokey Plum
4CZ5	Honey
4CZ6	Lagoon
4CZ8	Light Peacock
Paint Price Group 3 (Coatings)	
1ATT	Cast Shadow
Paint Price Group 3 (Lux Coatings)	
4B20	Obsidian
4B22	Matte Brass
4B23	Burnished Bronze
4B24	Night Bronze
4B25	Matte Copper
4B26	Smoked Mica
4B29	Cast Iron

Laminate Color Availability Matrix

Legend

- = Not available
- = Available
- = Available with exceptions
- ⓔ = Excluded

	Universal storage tops	Univ laminate cases, tops, doors, and drawers	High-Density storage	Answer laminate skins	Infills for FrameOne legs	Storage tops, shelves, and accessories	Boundary screens
--	------------------------	---	----------------------	-----------------------	---------------------------	--	------------------

High-Pressure Laminates (HPL)

Fiber

2850 Vanadium Fiber	■	•	■	■	■	■	■
2854 Vellum Fiber ⓔ	■	•	■	■	■	■	■
2860 Granite Fiber	■	•	■	■	■	■	■
2862 Stucco Fiber ⓔ	■	•	■	■	■	■	■

Micro

2920 Marl Micro	■	•	■	■	■	■	■
2921 Gypsum Micro	■	•	■	■	■	■	■
2922 Clay Micro	■	•	■	■	■	■	■

Patina

2870 Blonde Bronze Patina	■	•	■	■	■	■	■
2873 Instant Iron Patina	■	•	■	■	■	■	■

Solid

24H1 Satin White	•	•	•	•	•	•	•
24H2 Satin Black	•	•	•	•	•	•	•
24H3 Satin Stone	•	•	•	•	•	•	•
24H4 Satin Mocha	•	•	•	•	•	•	•
2722 Cream ⓔ	■	•	■	■	■	■	■
2730 Arctic White	■	•	■	■	■	■	■
2746 Black	■	•	■	■	■	■	■
2759 Warm White	■	•	■	■	■	■	■
2811 Mist ⓔ	■	•	■	■	■	■	■
2883 Seagull	■	•	■	■	■	■	■
2884 Milk	■	•	■	■	■	■	■
2885 Dune	■	•	■	■	■	■	■
2HAA Persian Salt	■	•	■	■	■	■	■
2HAB Rose	■	•	■	■	■	■	■
2HAC Indigo	■	•	■	■	■	■	■
2HAD Green Citrine ⓔ	■	•	■	■	■	■	■
2HAE Dark Olivine	■	•	■	■	■	■	■
2HAF Cloudy	■	•	■	■	■	■	■
2HMG Merle	■	•	■	■	■	■	■
2HWU Clay	■	•	■	■	■	■	■
2HWV Chalk	■	•	■	■	■	■	■

	Universal storage tops	Univ laminate cases, tops, doors, and drawers	High-Density storage	Answer laminate skins	Infills for FrameOne legs	Storage tops, shelves, and accessories	Boundary screens
--	------------------------	---	----------------------	-----------------------	---------------------------	--	------------------

High-Pressure Laminates (HPL), continued

Speckle

2820 Coffee Speckle ⓔ	■	•	■	■	■	■	■
2823 Driftwood Speckle	■	•	■	■	■	■	■
2824 Smoke Speckle	■	•	■	■	■	■	■
2825 Vanadium Speckle	■	•	■	■	■	■	■

▶ Continued on next page

Legend

- = Not available
- = Available
- = Available with exceptions
- ⓔ = Excluded

▶ Continued from previous page

Textured

	Universal storage tops	Univ laminate cases, tops, doors, and drawers	High-Density storage	Answer laminate skins	Infills for FrameOne legs	Storage tops, shelves, and accessories	Boundary screens
2TH2 Fawn Cypress	■	•	■	■	■	■	■
2TH4 Saddle Oak	■	•	■	■	■	■	■
2TH5 Veranda Teak	■	•	■	■	■	■	■
2TH7 Walnut Heights	■	•	■	■	■	■	■
2UH1 Reclaimed Aggregate	■	•	■	■	■	■	■
2UH2 Reclaimed Gravel	■	•	■	■	■	■	■
2UH4 Cement	■	•	■	■	■	■	■
2UH6 Sheetrock	■	•	■	■	■	■	■

Woodgrain

2406 Clear Cherry ⓔ	■	•	■	■	■	■	■
2409 Clear Maple	■	•	■	■	■	■	■
2410 Graphite Walnut	■	•	■	■	■	■	■
2412 Natural Cherry	■	•	■	■	■	■	■
2422 Medium Cherry ⓔ	■	•	■	■	■	■	■
2511 Winter on Maple ⓔ	■	•	■	■	■	■	■
2535 Virginia Walnut	■	•	■	■	■	■	■
2536 Blackwood	■	•	■	■	■	■	■
2538 Clear Walnut	■	•	■	■	■	■	■
2592 Blonde on Maple ⓔ	■	•	■	■	■	■	■
2714 Natural Walnut ⓔ	■	•	■	■	■	■	■
2897 Desert Oak	•	•	■	•	•	•	•
2HAK Clear Oak	■	•	■	■	■	■	■
2HAN Ash Noce	■	•	■	■	■	■	■
2HAT Acacia	■	•	■	■	■	■	■
2HAW Ash Wenge	■	•	■	■	■	■	■
2HBN Bisque Noce	■	•	■	■	■	■	■
2HBW Bisque Wenge	■	•	■	■	■	■	■
2HCN Clay Noce	■	•	■	■	■	■	■
2HCW Clay Wenge	■	•	■	■	■	■	■
2HSN Storm Noce	■	•	■	■	■	■	■
2HSW Storm Wenge	■	•	■	■	■	■	■
2HWA Grey Kingswood	■	•	■	■	■	■	■
2HWB Planked Walnut	■	•	■	■	■	■	■
2HWD Resolute Walnut	■	•	■	■	■	■	■
2HWE Natural Recon	■	•	■	■	■	■	■
2HWF Smoked Walnut ⓔ	■	•	■	■	■	■	■

Recommended Worksurface Edge Finishes

Recommended Edge Colors—High-Pressure Laminate

Edges

The recommended edge color will complement the laminate color you specify. Edge color is specified separately.

Laminate Color	Recommended 3 mm or 1 mm Edge Color
----------------	-------------------------------------

Fiber Laminate

2850 Vanadium Fiber	6654 Sand
2854 Vellum Fiber E	6655 Warm White
2860 Granite Fiber	6000 Black
2862 Stucco Fiber E	6053 Seagull

Micro Laminate

2920 Marl Micro	6053 Seagull
2921 Gypsum Micro	6654 Sand
2922 Clay Micro	6654 Sand

Patina Laminate

2870 Blonde Bronze Patina	6654 Sand
2873 Instant Iron Patina	6527 Merle

Solid Laminate

24H1 Satin White	6009 Arctic White
24H2 Satin Black	6000 Black
24H3 Satin Stone	6169 Stone
24H4 Satin Mocha	6170 Mocha
2722 Cream E	6631 Cream E
2730 Arctic White	6009 Arctic White
2746 Black	6000 Black
2759 Warm White	6655 Warm White
2811 Mist E	6636 Mist
2883 Seagull	6053 Seagull
2884 Milk	6052 Milk
2885 Dune	6654 Sand
2HAA Persian Salt	61AA Persian Salt
2HAB Rose	61AB Rose
2HAC Indigo	61AC Indigo
2HAD Green Citrine E	61AD Green Citrine E
2HAE Dark Olivine	61AE Dark Olivine
2HAF Cloudy	61AF Cloudy
2HMG Merle	6527 Merle
2HWU Clay	66WU Clay
2HWV Chalk	66WV Chalk

Speckle Laminate

2820 Coffee Speckle E	6631 Cream E
2823 Driftwood Speckle	6631 Cream E
2824 Smoke Speckle	6636 Mist
2825 Vanadium Speckle	6619 Ice E

Laminate Color	Recommended 3 mm or 1 mm Edge Color
----------------	-------------------------------------

Textured Laminate

2TH2 Fawn Cypress	6T02 Fawn Cypress
2TH4 Saddle Oak	6T04 Saddle Oak
2TH5 Veranda Teak	6T05 Veranda Teak
2TH7 Walnut Heights	6T07 Walnut Heights
2UH1 Reclaimed Aggregate	6T08 Aggregate
2UH2 Reclaimed Gravel	6T09 Gravel
2UH4 Cement	6T10 Cement
2UH6 Sheetrock	6T12 Sheetrock

Woodgrain Laminate

2406 Clear Cherry E	6234 Clear Cherry
2409 Clear Maple	6237 Clear Maple
2410 Graphite Walnut	6231 Graphite Walnut
2412 Natural Cherry	6034 Natural Cherry
2422 Medium Cherry E	6036 Medium Cherry
2511 Winter on Maple E	6037 Winter on Maple
2535 Virginia Walnut	6242 Virginia Walnut
2536 Blackwood	6243 Blackwood
2538 Clear Walnut	6245 Clear Walnut
2592 Blonde on Maple E	6038 Blonde on Maple E
2714 Natural Walnut E	6041 Natural Walnut E
2897 Desert Oak	6128 Taupe
2HAK Clear Oak	6219 Clear Oak
2HAN Ash Noce	6707 Ash Noce
2HAT Acacia	6213 Acacia
2HAW Ash Wenge	6703 Ash Wenge
2HBN Bisque Noce	6708 Bisque Noce
2HBW Bisque Wenge	6705 Bisque Wenge
2HCN Clay Noce	6709 Clay Noce
2HCW Clay Wenge	6706 Clay Wenge
2HSN Storm Noce	6710 Storm Noce
2HSW Storm Wenge	6704 Storm Wenge
2HWA Grey Kingswood	66WA Grey Kingswood
2HWB Planked Walnut	66WB Planked Walnut
2HWD Resolute Walnut	66WD Resolute Walnut
2HWE Natural Recon	66WE Natural Recon
2HWF Smoked Walnut E	66WF Smoked Walnut
2HZA Waxed Maple	6X50 Waxed Maple
2HZB Natural Ash	6X51 Natural Ash
2HZC Aged Ash	6X10 Aged Ash
2HZD Ashwood Oak	6X52 Ashwood Oak
2HZE Ashwood Beige	6X53 Ashwood Beige
2HZF White Washed Birchply	6X54 White Washed Birchply

E = Excluded

Directional Laminate Grain Directions

Directional laminates are standard with the grain directions shown.

Universal Systems Worksurfaces—High-Pressure Laminate



Straight
Worksurface



Straight, 120°
Worksurface



Tapered
Worksurface



Taper-Flat
Worksurface



Single-Tapered
Worksurface



Corner, 120°
Worksurface

Wood Veneer Grain Directions

The appearance of wood veneer may change slightly depending on the angle from which it is viewed. This natural phenomenon is called polarization, and it can be seen on natural veneer, and to a lesser extent on composite veneer. Polarization is often noticed on worksurfaces installed at a 90-degree angle with each other. Please refer to the following illustrations for an understanding of grain direction on your installation.

Universal Systems Worksurfaces—Wood Veneer

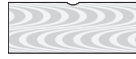

Straight
Worksurface

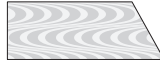

Straight, 120°
Worksurface



Corner, 120°
Worksurface

Resources

Lock and Keying	374
Style Number Index	376

Lock and Keying

High-density storage

are available with field-installed lock plugs only. Lock cylinders are required to be ordered separately.

Field-Installed Keying

Field-installed locks are only available on products that include factory-installed lock mechanisms.

Specify "plug" when specifying furniture, and the product will ship with a plastic plug in place of the lock cylinder.

Front-removable lock cylinders must be specified separately. You must also order a special lock tool to install or remove lock cylinders in the field.

Tip: Lock tools are reusable. You do not need to order additional lock tools with every furniture order.

Lock cylinders will be shipped separately so that you can install the locks when you are ready.



Three keying choices

are available for field installation—random (standard), specific, and consecutive. All three are also available with master keying, which means that all locks can be opened with a single master key.





Key random means that the locks will be assigned arbitrarily at the factory with key numbers ranging from FR305 to FR999 (Master keying numbers: XF1001 to XF3000).

Tip: Random keying can mean that different furniture units will have the same key number. If you must have all locks keyed differently, you should specify key specific or key consecutive lock cylinders.

Key Random

 FR305
 FR421
 FR305

or



 XF1011 }
 XF1042 }  XF
 XF1011 } Master Key

Key specific means that you can specify any key number from FR305 to FR999 (Master keying numbers: XF1001 to XF3000). This option can be used to key all the furniture units in a workstation or department the same.





Tip: Designate the quantity per key number in your specification.

▶ See example at right.

Key Specific



 FR350
 FR350
 FR350

or





 XF1020 }
 XF1020 }  XF
 XF1020 } Master Key

Key consecutive means that you can specify lock numbers in a consecutive order to ensure that no two locks have the same key number until the key sequence repeats. You must select a beginning key number from FR305 to FR999 (Master keying numbers: XF1001 to XF3000).

Key Consecutive

 FR350
 FR351
 FR352

or

 XF1020 }
 XF1021 }  XF
 XF1022 } Master Key

Example of a typical lock cylinder specification is shown below:

10	LOCKFR FR320
5	LOCKFR FR350
15	LOCKXF XF1100
<hr/>	
30	Total
1	877102003SR standard lock tool
1	877102002SR master lock tool

Field-Installed Lock Cylinders

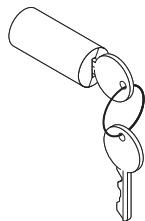

Tip: Lock price is included in price of furniture with locks.

Tip: For replacement lock cylinders, refer to Service Parts.

Standard Includes	Required to Specify
-------------------	---------------------

- | | |
|---|--|
| <ul style="list-style-type: none"> • Lock cylinder • Two keys | <ol style="list-style-type: none"> 1 Style number 2 Lock finish <ul style="list-style-type: none"> 9201 Polished Chrome 9250 Ember Chrome 3 Options, if selected (see below) |
|---|--|

Options	U.S. Price	Required to Specify
---------	------------	---------------------

Key specific	No cost	Select key number from FR305–FR999.
Key consecutive	No cost	Specify <i>key consecutive</i> and select beginning key number from FR305–FR999.
Master key random	+\$39 each	Specify <i>master key random</i> .
Master key specific	+\$39 each	Specify key number from XF1001–XF3000.
Master key consecutive	+\$39 each	Specify <i>master key consecutive</i> and select beginning key number from XF1001–XF3000.

Specification Information	
---------------------------	--

<ul style="list-style-type: none"> • Style Number • U.S. Base Price 	<ul style="list-style-type: none"> • U.S. Base Price
---	--

FR Series (Standard Keying System)—Lock Cylinder

LOCKFR	No cost
---------------	---------

Standard Lock Tool

877102003SR	\$39
--------------------	------

XF Series (Master Keying System)—Lock Cylinder

LOCKXF	No additional cost. Price included in price of furniture with master-keyed locks.
---------------	---

Master Lock Tool

877102002SR	\$39
--------------------	------

Tip: You can change lock cylinders in the field by using the appropriate lock tool.

 **For Canadian Pricing**
 Multiply U.S. Price by the Canadian price factor.
 ▶ See page 1 for details.

Style Number Index

Style Number	Page	Description	Style Number	Page	Description
877102002SR	375	Master Lock Tool	TS712UPHZN	210, 343	Mul. Pwr Infeed
877102003SR	375	Standard Lock Tool	TS714WSP	272	U Support Plate
98863	218	Dx Cable Grom	TS720WSP	272	U Support Plate
AWAG2	270	2½" Round Grommet	TS724BT	183	Base Trim
BSMC	296	WS Whiteboard Bracket	TS724BTH	184	Hardwire Base Trim
BSVB1	297	BS Whiteboard Bracket	TS724CT	206	Cable Tray
BSVB2	297	BS Whiteboard Bracket	TS724OBK	183	Open Base Conv Kit
CBRKTS	174, 335	Flr Anchor Bracket	TS724UPHX	210, 343	Mpp Power Infeed
CRSTBC	286	Storage to Beam Connector	TS724UPHXN	210, 343	Mpp Power Infeed
DVSS2912	251	Divisio Side Screen	TS724UPHY	210, 343	Mpp Power Infeed
HDSTG	290	High-Density Storage	TS724UPHYN	210, 343	Mpp Power Infeed
HDSTGV	293	High-Density Storage Value Package	TS724UPHZ	210, 343	Mpp Power Infeed
HDWS	294	Worksurface Support Bracket	TS724UPHZN	210, 343	Mpp Power Infeed
LOCKFR	375	Lock Cylinder	TS730BT	183	Base Trim
LOCKXF	375	Lock Cylinder	TS730BTH	184	Hardwire Base Trim
PSCB	250	Sarto Alnmt Clip	TS730CT	206	Cable Tray
PSPM	247	Sarto Privacy Screens	TS730OBK	183	Open Base Conv Kit
PSPS	249	Sarto Privacy Screens	TS736BT	183	Base Trim
RATCL18108P	282	Square Edge Top	TS736BTH	184	Hardwire Base Trim
RATCL1860P	282	Square Edge Top	TS736CT	206	Cable Tray
RATCL1866P	282	Square Edge Top	TS736OBK	183	Open Base Conv Kit
RATCL1872P	282	Square Edge Top	TS742BT	183	Base Trim
RATCL1878P	282	Square Edge Top	TS742BTH	184	Hardwire Base Trim
RATCL1884P	282	Square Edge Top	TS742CT	206	Cable Tray
RATCL1890P	282	Square Edge Top	TS742OBK	183	Open Base Conv Kit
RATCL1896P	282	Square Edge Top	TS743MHX	208	Modular Harness
RATCL24108P	282	Square Edge Top	TS743MHXN	208	Modular Harness
RATCL2460P	282	Square Edge Top	TS743MHY	208	Modular Harness
RATCL2466P	282	Square Edge Top	TS743MHYN	208	Modular Harness
RATCL2472P	282	Square Edge Top	TS743MHZ	208	Modular Harness
RATCL2490P	282	Square Edge Top	TS743MHZN	208	Modular Harness
RATCL2496P	282	Square Edge Top	TS748BT	183	Base Trim
RATCL3636P	282	Square Edge Top	TS748BTH	184	Hardwire Base Trim
RATCL3672P	282	Square Edge Top	TS748CT	206	Cable Tray
RATCL4836P	282	Square Edge Top	TS748OBK	183	Open Base Conv Kit
RATCL4872P	282	Square Edge Top	TS754ICLS	181	Inside Cnr Light Seal
RATL1830P	282	Square Edge Top	TS760BT	183	Base Trim
RATL1836P	282	Square Edge Top	TS760BTH	184	Hardwire Base Trim
RATL1842P	282	Square Edge Top	TS760CT	206	Cable Tray
RATL2430P	282	Square Edge Top	TS760OBK	183	Open Base Conv Kit
RATL2436P	282	Square Edge Top	TS766ICLS	181	Inside Cnr Light Seal
TS7120JB3	180	120° Jct Block	TS766PSFX	202	Base Power Infeed
TS7120JB4	180	120° Jct Block	TS766PSFY	202	Base Power Infeed
TS7120JB5	180	120° Jct Block	TS766PSFZ	202	Base Power Infeed
TS712BPSFX	202	Bs Pwr Infeed	TS766BPX	202	Base Power Infeed
TS712BPSFY	202	Bs Pwr Infeed	TS766BPY	202	Base Power Infeed
TS712BPSFZ	202	Bs Pwr Infeed	TS766BPZ	202	Base Power Infeed
TS712BPX	202	Bs Pwr Infeed	TS76UPHX	210, 343	Mpp Power Infeed
TS712BPY	202	Bs Pwr Infeed	TS76UPHXN	210, 343	Mpp Power Infeed
TS712BPZ	202	Bs Pwr Infeed	TS76UPHY	210, 343	Mpp Power Infeed
TS712UPHX	210, 343	Mul. Pwr Infeed	TS76UPHYN	210, 343	Mpp Power Infeed
TS712UPHXN	210, 343	Mul. Pwr Infeed	TS76UPHZ	210, 343	Mpp Power Infeed
TS712UPHY	210, 343	Mul. Pwr Infeed	TS76UPHZN	210, 343	Mpp Power Infeed
TS712UPHYN	210, 343	Mul. Pwr Infeed	TS772BT	183	Base Trim
TS712UPHZ	210, 343	Mul. Pwr Infeed	TS772BTH	184	Hardwire Base Trim

Style Number	Page	Description	Style Number	Page	Description
TS772CT	206	Cable Tray	TS7BPNY72Z	203	Bs Pwr Infeed - NYC
TS7720BK	183	Open Base Conv Kit	TS7BPNY72ZN	203	Bs Pwr Infeed - NYC
TS778ICLS	181	Inside Cnr Light Seal	TS7CPK24	209	Hardwired Pwrkit
TS780MHX	208	Modular Harness	TS7CPK30	209	Hardwired Pwrkit
TS780MHXN	208	Modular Harness	TS7CPK36	209	Hardwired Pwrkit
TS780MHY	208	Modular Harness	TS7CPK42	209	Hardwired Pwrkit
TS780MHYN	208	Modular Harness	TS7CPK48	209	Hardwired Pwrkit
TS780MHZ	208	Modular Harness	TS7CPK60	209	Hardwired Pwrkit
TS780MHZN	208	Modular Harness	TS7CPK72	209	Hardwired Pwrkit
TS790JB3	180	90° Jct Block, Pkg of 3	TS7DF	216, 346	Data Filler
TS790JB4	180	90° Jct Block, Pkg of 4	TS7FSLVE	217	Fd-Thru Horiz Cbl Slv
TS790JB5	180	90° Jct Block, Pkg of 5	TS7GGC10	180, 335	Gripper Glide Caps
TS7BFCC12	210, 343	Infeed Conduit Cover	TS7HSLVE	218	Grm for Hor Bar & Jct
TS7BFCC24	210, 343	Infeed Conduit Cover	TS7JSLVE	218, 347	Grommet for Jct
TS7BFCC6	210, 343	Infeed Conduit Cover	TS7JTSLVE	217	Jct Tall Sleeve
TS7BPNY24X	203	Bs Pwr Infeed - NYC	TS7PF	186	Panel and Beam Foot
TS7BPNY24XN	203	Bs Pwr Infeed - NYC	TS7PK24X	204	4-Cir, 3+1 Wrg, Pwrkit
TS7BPNY24Y	203	Bs Pwr Infeed - NYC	TS7PK24XN	204	4-Cir, 3+1 Wrg, Pwrkit
TS7BPNY24YN	203	Bs Pwr Infeed - NYC	TS7PK24Y	204	4-Cir, 2+2 Wrg, Pwrkt
TS7BPNY24Z	203	Bs Pwr Infeed - NYC	TS7PK24YN	204	4-Cir, 2+2 Wrg, Pwrkt
TS7BPNY24ZN	203	Bs Pwr Infeed - NYC	TS7PK24Z	204	3-Cir, 3SN Wrg, Pwrkt
TS7BPNY30X	203	Bs Pwr Infeed - NYC	TS7PK24ZN	204	3-Cir, 3SN Wrg, Pwrkt
TS7BPNY30XN	203	Bs Pwr Infeed - NYC	TS7PK30X	204	4-Cir, 3+1 Wrg, Pwrkit
TS7BPNY30Y	203	Bs Pwr Infeed - NYC	TS7PK30XN	204	4-Cir, 3+1 Wrg, Pwrkit
TS7BPNY30YN	203	Bs Pwr Infeed - NYC	TS7PK30Y	204	4-Cir, 2+2 Wrg, Pwrkt
TS7BPNY30Z	203	Bs Pwr Infeed - NYC	TS7PK30YN	204	4-Cir, 2+2 Wrg, Pwrkt
TS7BPNY30ZN	203	Bs Pwr Infeed - NYC	TS7PK30Z	204	3-Cir, 3SN Wrg, Pwrkt
TS7BPNY36X	203	Bs Pwr Infeed - NYC	TS7PK30ZN	204	3-Cir, 3SN Wrg, Pwrkt
TS7BPNY36XN	203	Bs Pwr Infeed - NYC	TS7PK36X	204	4-Cir, 3+1 Wrg, Pwrkit
TS7BPNY36Y	203	Bs Pwr Infeed - NYC	TS7PK36XN	204	4-Cir, 3+1 Wrg, Pwrkt
TS7BPNY36YN	203	Bs Pwr Infeed - NYC	TS7PK36Y	204	4-Cir, 2+2 Wrg, Pwrkt
TS7BPNY36Z	203	Bs Pwr Infeed - NYC	TS7PK36YN	204	4-Cir, 2+2 Wrg, Pwrkt
TS7BPNY36ZN	203	Bs Pwr Infeed - NYC	TS7PK36Z	204	3-Cir, 3SN Wrg, Pwrkt
TS7BPNY42X	203	Bs Pwr Infeed - NYC	TS7PK36ZN	204	3-Cir, 3SN Wrg, Pwrkt
TS7BPNY42XN	203	Bs Pwr Infeed - NYC	TS7PK42X	204	4-Cir, 3+1 Wrg, Pwrkit
TS7BPNY42Y	203	Bs Pwr Infeed - NYC	TS7PK42XN	204	4-Cir, 3+1 Wrg, Pwrkit
TS7BPNY42YN	203	Bs Pwr Infeed - NYC	TS7PK42Y	204	4-Cir, 2+2 Wrg, Pwrkt
TS7BPNY42Z	203	Bs Pwr Infeed - NYC	TS7PK42YN	204	4-Cir, 2+2 Wrg, Pwrkt
TS7BPNY42ZN	203	Bs Pwr Infeed - NYC	TS7PK42Z	204	3-Cir, 3SN Wrg, Pwrkt
TS7BPNY48X	203	Bs Pwr Infeed - NYC	TS7PK42ZN	204	3-Cir, 3SN Wrg, Pwrkt
TS7BPNY48XN	203	Bs Pwr Infeed - NYC	TS7PK48X	204	4-Cir, 3+1 Wrg, Pwrkit
TS7BPNY48Y	203	Bs Pwr Infeed - NYC	TS7PK48XN	204	4-Cir, 3+1 Wrg, Pwrkit
TS7BPNY48YN	203	Bs Pwr Infeed - NYC	TS7PK48Y	204	4-Cir, 2+2 Wrg, Pwrkt
TS7BPNY48Z	203	Bs Pwr Infeed - NYC	TS7PK48YN	204	4-Cir, 2+2 Wrg, Pwrkt
TS7BPNY48ZN	203	Bs Pwr Infeed - NYC	TS7PK48Z	204	3-Cir, 3SN Wrg, Pwrkt
TS7BPNY60X	203	Bs Pwr Infeed - NYC	TS7PK48ZN	204	3-Cir, 3SN Wrg, Pwrkt
TS7BPNY60XN	203	Bs Pwr Infeed - NYC	TS7PK60X	204	4-Cir, 3+1 Wrg, Pwrkit
TS7BPNY60Y	203	Bs Pwr Infeed - NYC	TS7PK60XN	204	4-Cir, 3+1 Wrg, Pwrkit
TS7BPNY60YN	203	Bs Pwr Infeed - NYC	TS7PK60Y	204	4-Cir, 2+2 Wrg, Pwrkt
TS7BPNY60Z	203	Bs Pwr Infeed - NYC	TS7PK60YN	204	4-Cir, 2+2 Wrg, Pwrkt
TS7BPNY60ZN	203	Bs Pwr Infeed - NYC	TS7PK60Z	204	3-Cir, 3SN Wrg, Pwrkt
TS7BPNY72X	203	Bs Pwr Infeed - NYC	TS7PK60ZN	204	3-Cir, 3SN Wrg, Pwrkt
TS7BPNY72XN	203	Bs Pwr Infeed - NYC	TS7PK72X	204	4-Cir, 3+1 Wrg, Pwrkit
TS7BPNY72Y	203	Bs Pwr Infeed - NYC	TS7PK72XN	204	4-Cir, 3+1 Wrg, Pwrkit
TS7BPNY72YN	203	Bs Pwr Infeed - NYC	TS7PK72Y	204	4-Cir, 2+2 Wrg, Pwrkt

Style Number Index, continued

Style Number	Page	Description	Style Number	Page	Description
TS7PK72YN	204	4-Cir, 2+2 Wrg, Pwrkt	TS7WKSPT51	273	Reinforcing Chan
TS7PK72Z	204	3-Cir, 3SN Wrg, Pwrkt	TS7WKSPT54	273	Reinforcing Chan
TS7PK72ZN	204	3-Cir, 3SN Wrg, Pwrkt	TS7WKSPT60	273	Reinforcing Chan
TS7PT24X	205	4-Cir, 3+1, P-T Pwrkt	TS7WKSPT63	273	Reinforcing Chan
TS7PT24XN	205	4-Cir, 3+1, P-T Pwrkt	TS7WKSPT66	273	Reinforcing Chan
TS7PT24Y	205	4-Cir, 2+2, P-T Pwrkt	TS7WKSPT72	273	Reinforcing Chan
TS7PT24YN	205	4-Cir, 2+2, P-T Pwrkt	TSAEGROM	270	Grommet Pkg
TS7PT24Z	205	3-Cir, 3SN, P-T Pwrkt	TSB020CTCHT	178	T Cor C-O-H Trim
TS7PT24ZN	205	3-Cir, 3SN, P-T Pwrkt	TSB15H	284	Mid Storage Support
TS7PT30X	205	4-Cir, 3+1, P-T Pwrkt	TSB1610H	274	Worksurface Support Bracket
TS7PT30XN	205	4-Cir, 3+1, P-T Pwrkt	TSB1615H	274	Worksurface Support Bracket
TS7PT30Y	205	4-Cir, 2+2, P-T Pwrkt	TSB202CTCHT	178	T Cor C-O-H Trim
TS7PT30YN	205	4-Cir, 2+2, P-T Pwrkt	TSB20CLCHT	178	L Cnr C-O-H Trim
TS7PT30Z	205	3-Cir, 3SN, P-T Pwrkt	TSB20CXCHT	179	X C-O-H Trim
TS7PT30ZN	205	3-Cir, 3SN, P-T Pwrkt	TSB2424CXJ	173	X C-O-H Jct
TS7PT36X	205	4-Cir, 3+1, P-T Pwrkt	TSB242CTCHT	178	T Cor C-O-H Trim
TS7PT36XN	205	4-Cir, 3+1, P-T Pwrkt	TSB242CTJ	172	T C-O-H Jct
TS7PT36Y	205	4-Cir, 2+2, P-T Pwrkt	TSB2444CXJ	173	X C-O-H Jct
TS7PT36YN	205	4-Cir, 2+2, P-T Pwrkt	TSB24CLCHT	178	L Cnr C-O-H Trim
TS7PT36Z	205	3-Cir, 3SN, P-T Pwrkt	TSB24CLJ	171	L C-O-H Jct
TS7PT36ZN	205	3-Cir, 3SN, P-T Pwrkt	TSB24CXCHT	179	X C-O-H Trim
TS7PT42X	205	4-Cir, 3+1, P-T Pwrkt	TSB24HF	182	Base Horiz Frame Pkg
TS7PT42XN	205	4-Cir, 3+1, P-T Pwrkt	TSB24HS	191	Steel Skin
TS7PT42Y	205	4-Cir, 2+2, P-T Pwrkt	TSB24HSBOB	193	Steel Skin Big Open Base
TS7PT42YN	205	4-Cir, 2+2, P-T Pwrkt	TSB24HSF	192	Steel Skin To The Floor
TS7PT42Z	205	3-Cir, 3SN, P-T Pwrkt	TSB24LS	194	Lam Skin
TS7PT42ZN	205	3-Cir, 3SN, P-T Pwrkt	TSB24LSF	195	Lam Skin To The Floor
TS7PT48X	205	4-Cir, 3+1, P-T Pwrkt	TSB24TC	185	Top Cap Rail
TS7PT48XN	205	4-Cir, 3+1, P-T Pwrkt	TSB24TK	188	F-Cvrd Skin
TS7PT48Y	205	4-Cir, 2+2, P-T Pwrkt	TSB24TKBOB	190	F-Cvrd Skin Big Open Base
TS7PT48YN	205	4-Cir, 2+2, P-T Pwrkt	TSB24TKF	189	F-Cvrd Skin To The Floor
TS7PT48Z	205	3-Cir, 3SN, P-T Pwrkt	TSB24WS	196	Wood Skin
TS7PT48ZN	205	3-Cir, 3SN, P-T Pwrkt	TSB24WSF	197	Wood Skin To The Floor
TS7PT60X	205	4-Cir, 3+1, P-T Pwrkt	TSB2525CXJ	173	X C-O-H Jct
TS7PT60XN	205	4-Cir, 3+1, P-T Pwrkt	TSB252CTCHT	178	T Cor C-O-H Trim
TS7PT60Y	205	4-Cir, 2+2, P-T Pwrkt	TSB252CTJ	172	T C-O-H Jct
TS7PT60YN	205	4-Cir, 2+2, P-T Pwrkt	TSB2555CXJ	173	X C-O-H Jct
TS7PT60Z	205	3-Cir, 3SN, P-T Pwrkt	TSB25CLCHT	178	L Cnr C-O-H Trim
TS7PT60ZN	205	3-Cir, 3SN, P-T Pwrkt	TSB25CLJ	171	L C-O-H Jct
TS7PT72X	205	4-Cir, 3+1, P-T Pwrkt	TSB25CXCHT	179	X C-O-H Trim
TS7PT72XN	205	4-Cir, 3+1, P-T Pwrkt	TSB2626CXJ	173	X C-O-H Jct
TS7PT72Y	205	4-Cir, 2+2, P-T Pwrkt	TSB262CTCHT	178	T Cor C-O-H Trim
TS7PT72YN	205	4-Cir, 2+2, P-T Pwrkt	TSB262CTJ	172	T C-O-H Jct
TS7PT72Z	205	3-Cir, 3SN, P-T Pwrkt	TSB2666CXJ	173	X C-O-H Jct
TS7PT72ZN	205	3-Cir, 3SN, P-T Pwrkt	TSB26CLCHT	178	L Cnr C-O-H Trim
TS7RC	211, 344	Receptacle	TSB26CLJ	171	L C-O-H Jct
TS7RCT	214, 346	Receptacle Trim Rin	TSB26CXCHT	179	X C-O-H Trim
TS7SBNJ	174	Jct Stabilizer Bracket	TSB2828CXJ	173	X C-O-H Jct
TS7TIEPLATE	273	U Tie Plates	TSB282CTCHT	178	T Cor C-O-H Trim
TS7TJUP	341	L, T, or X Jct Util Pole	TSB282CTJ	172	T C-O-H Jct
TS7UFPLATE	215	Face Plate	TSB2888CXJ	173	X C-O-H Jct
TS7USB	212, 345	USB Receptacle	TSB28CLCHT	178	L Cnr C-O-H Trim
TS7WKSPT	273	Reinforcing Chan	TSB28CLJ	171	L C-O-H Jct
TS7WKSPT39	273	Reinforcing Chan	TSB28CXCHT	179	X C-O-H Trim
TS7WKSPT48	273	Reinforcing Chan	TSB28EJ	169	EOR Jct

Style Number	Page	Description	Style Number	Page	Description
TSB28EVTP	175	EOR Trim	TSB42TC	185	Top Cap Rail
TSB28IJ	166	In-Line Jct	TSB42TK	188	F-Cvrd Skin
TSB28JP	180	Jct Post	TSB42TKBOB	190	F-Cvrd Skin Big Open Base
TSB28LJ	167	L Jct	TSB42TKF	189	F-Cvrd Skin To The Floor
TSB28LUP	200	L/In-Line Jct w/Util Ple	TSB42WS	196	Wood Skin
TSB28LVT	176	L Vrtl Trim	TSB42WSF	197	Wood Skin To The Floor
TSB28TJ	167	T Jct	TSB48HF	182	Base Horiz Frame Pkg
TSB28TUP	200	T Jct w/Util Pole	TSB48HS	191	Steel Skin
TSB28TVT	176	T Vrtl Trim	TSB48HSBOB	193	Steel Skin Big Open Base
TSB28VJ	170	V Jct	TSB48HSF	192	Steel Skin To The Floor
TSB28VVT	177	V Vrtl Trim	TSB48LS	194	Lam Skin
TSB28XJ	168	X Jct	TSB48LSF	195	Lam Skin To The Floor
TSB28XUP	200	X Util Pole	TSB48TC	185	Top Cap Rail
TSB28YJ	170	Y Jct	TSB48TK	188	F-Cvrd Skin
TSB2H	284	Mid Storage Support	TSB48TKBOB	190	F-Cvrd Skin Big Open Base
TSB2Q2CTCHT	178	L Cnr C-O-H Trim	TSB48TKF	189	F-Cvrd Skin To The Floor
TSB2Q2CTJ	172	T C-O-H Jct	TSB48WS	196	Wood Skin
TSB2Q2QCXJ	173	X C-O-H Jct	TSB48WSF	197	Wood Skin To The Floor
TSB2QCLCHT	178	L Cnr C-O-H Trim	TSB525CTCHT	178	T Cor C-O-H Trim
TSB2QCLJ	171	L C-O-H Jct RH	TSB525CTJ	172	T C-O-H Jct
TSB2QCXCHT	179	X C-O-H Trim	TSB52CLJ	171	L C-O-H Jct
TSB2QQCXJ	173	X C-O-H Jct	TSB54TC	185	Top Cap Rail
TSB30HF	182	Base Horiz Frame Pkg	TSB60HF	182	Base Horiz Frame Pkg
TSB30HS	191	Steel Skin	TSB60HS	191	Steel Skin
TSB30HSBOB	193	Steel Skin Big Open Base	TSB60HSBOB	193	Steel Skin Big Open Base
TSB30HSF	192	Steel Skin To The Floor	TSB60HSF	192	Steel Skin To The Floor
TSB30LS	194	Lam Skin	TSB60TC	185	Top Cap Rail
TSB30LSF	195	Lam Skin To The Floor	TSB60TK	188	F-Cvrd Skin
TSB30TC	185	Top Cap Rail	TSB60TKBOB	190	F-Cvrd Skin Big Open Base
TSB30TK	188	F-Cvrd Skin	TSB60TKF	189	F-Cvrd Skin To The Floor
TSB30TKBOB	190	F-Cvrd Skin Big Open Base	TSB626CTCHT	178	T Cor C-O-H Trim
TSB30TKF	189	F-Cvrd Skin To The Floor	TSB626CTJ	172	T C-O-H Jct
TSB30WS	196	Wood Skin	TSB62CLJ	171	L C-O-H Jct
TSB30WSF	197	Wood Skin To The Floor	TSB66TC	185	Top Cap Rail
TSB36HF	182	Base Horiz Frame Pkg	TSB72HF	182	Base Horiz Frame Pkg
TSB36HS	191	Steel Skin	TSB72HS	191	Steel Skin
TSB36HSBOB	193	Steel Skin Big Open Base	TSB72HSBOB	193	Steel Skin Big Open Base
TSB36HSF	192	Steel Skin To The Floor	TSB72HSF	192	Steel Skin To The Floor
TSB36LS	194	Lam Skin	TSB72TC	185	Top Cap Rail
TSB36LSF	195	Lam Skin To The Floor	TSB72TK	188	F-Cvrd Skin
TSB36TC	185	Top Cap Rail	TSB72TKBOB	190	F-Cvrd Skin Big Open Base
TSB36TK	188	F-Cvrd Skin	TSB72TKF	189	F-Cvrd Skin To The Floor
TSB36TKBOB	190	F-Cvrd Skin Big Open Base	TSB78TC	185	Top Cap Rail
TSB36TKF	189	F-Cvrd Skin To The Floor	TSB828CTCHT	178	T Cor C-O-H Trim
TSB36WS	196	Wood Skin	TSB828CTJ	172	T C-O-H Jct
TSB36WSF	197	Wood Skin To The Floor	TSB82CLJ	171	L C-O-H Jct
TSB424CTCHT	178	T Cor C-O-H Trim	TSB84TC	185	Top Cap Rail
TSB424CTJ	172	T C-O-H Jct	TSB90TC	185	Top Cap Rail
TSB42CLJ	171	L C-O-H Jct	TSB96TC	185	Top Cap Rail
TSB42HF	182	Base Horiz Frame Pkg	TSBAWAK	285	Cabinet Attachment Kit
TSB42HS	191	Steel Skin	TSBBOBTRM	184	Conversion Kit Big Open Base
TSB42HSBOB	193	Steel Skin Big Open Base	TSBBSCI	237	Ans Boundary Screenz
TSB42HSF	192	Steel Skin To The Floor	TSBBST	233	Ans Boundary Screen
TSB42LS	194	Lam Skin	TSBBSX	234	Ans Boundry Screen
TSB42LSF	195	Lam Skin To The Floor	TSBERUP	201	EOR Jct w/Util Pole

Style Number Index, continued

Style Number	Page	Description	Style Number	Page	Description
TSBFC24LH	274	FO Closed Loop	TSBTJC	181	T Jct Cap
TSBFC24RH	274	FO Closed Loop	TSBTJCCH	181	T C-O-H Cap
TSBFC30LH	274	FO Closed Loop	TSBUCANT	272	U On-Mod CANT
TSBFC30RH	274	FO Closed Loop	TSBUWCM	207	Cable Manager
TSBFH24LHB	274	FO Half Loop	TSBVJC	181	V Jct Cap
TSBFH24RHB	274	FO Half Loop	TSBXJC	181	X Jct Cap
TSBFH30LHB	274	FO Half Loop	TSBYJC	181	Y Jct Cap
TSBFH30RHB	274	FO Half Loop	TSF1324RFG	352	Frameless Glass Screen
TSBFQ24LH	274	FO Open Loop	TSF1330RFG	352	Frameless Glass Screen
TSBFQ24RH	274	FO Open Loop	TSF1336RFG	352	Frameless Glass Screen
TSBFQ30LH	274	FO Open Loop	TSF1342RFG	352	Frameless Glass Screen
TSBFQ30RH	274	FO Open Loop	TSF1348RFG	352	Frameless Glass Screen
TSBJIBS	235	On Mod Boundary Screen Jct	TSF1360RFG	352	Frameless Glass Screen
TSBLJC	181	L Jct Cap	TSF1372RFG	352	Frameless Glass Screen
TSBLJCCHL	181	L C-O-H Jct Cap LH	TSF1924RFG	352	Frameless Glass Screen
TSBLJCCHR	181	L C-O-H Jct Cap RH	TSF1930RFG	352	Frameless Glass Screen
TSBPSC	245	Sarto Beam Screens	TSF1936RFG	352	Frameless Glass Screen
TSBQ2CLJ	171	L C-O-H Jct LH	TSF1942RFG	352	Frameless Glass Screen
TSBQ2QCTCHT	178	T Cor C-O-H Trim	TSF1948RFG	352	Frameless Glass Screen
TSBQ2QCTJ	172	T C-O-H Jct	TSF1960RFG	352	Frameless Glass Screen
TSBRF	216	Filler Pkg Pwr	TSF1972RFG	352	Frameless Glass Screen
TSBSC	239	Centered Beam Screen	TSF20MHXN	342	Modular Harness
TSBSCLSPT	228-230	Ans Boundary Screen	TSF20MHYN	342	Modular Harness
TSBSCLSSD	225-227	Ans Boundary Screen	TSF20MHZN	342	Modular Harness
TSBSCSPN	222	Ans Boundary Screen	TSF23MHXN	342	Modular Harness
TSBSCSPT	223	Ans Boundary Screen	TSF23MHYN	342	Modular Harness
TSBSCSSD	221	Ans Boundary Screen	TSF23MHZN	342	Modular Harness
TSBST1830	281	Square Edge Top	TSF24HS	337	Base Horiz Frame Pkg
TSBST1836	281	Square Edge Top	TSF24HSHC	338	Base Horiz Frame Pkg
TSBST1842	281	Square Edge Top	TSF27EJ	332	EOR Jct Cap
TSBST1848	281	Square Edge Top	TSF27IJ	332	In Line Jct
TSBST1854	281	Square Edge Top	TSF27LJ	333	L Jct
TSBST1860	281	Square Edge Top	TSF27TJ	333	T Jct
TSBST1866	281	Square Edge Top	TSF27VJ	334	V Jct
TSBST1872	281	Square Edge Top	TSF27XJ	333	X Jct
TSBST1878	281	Square Edge Top	TSF27YJ	334	Y Jct
TSBST1884	281	Square Edge Top	TSF30HS	337	Base Horiz Frame Pkg
TSBST1890	281	Square Edge Top	TSF30HSHC	338	Base Horiz Frame Pkg
TSBST1896	281	Square Edge Top	TSF36HS	337	Base Horiz Frame Pkg
TSBST2430	281	Square Edge Top	TSF36HSHC	338	Base Horiz Frame Pkg
TSBST2436	281	Square Edge Top	TSF42HS	337	Base Horiz Frame Pkg
TSBST2442	281	Square Edge Top	TSF42HSHC	338	Base Horiz Frame Pkg
TSBST2448	281	Square Edge Top	TSF48HS	337	Base Horiz Frame Pkg
TSBST2454	281	Square Edge Top	TSF48HSHC	338	Base Horiz Frame Pkg
TSBST2460	281	Square Edge Top	TSF60HS	337	Base Horiz Frame Pkg
TSBST2466	281	Square Edge Top	TSF60HSHC	338	Base Horiz Frame Pkg
TSBST2472	281	Square Edge Top	TSF72HS	337	Fence Horiz Pkg
TSBST2478	281	Square Edge Top	TSF72HSHC	338	Base Horiz Frame Pkg
TSBST2484	281	Square Edge Top	TSFBCC	213, 345	Blank Cut-Out Cover
TSBST2490	281	Square Edge Top	TSFBCIC	339	Infeed Cover
TSBST2496	281	Square Edge Top	TSFERUP	340	EOR Jct Util Pole
TSBSTC	283	Stanchion Kit	TSFF	336	Fence Foot
TSBSTS	283	Stanchion Kit	TSFHCIC	339	Infeed Cover
TSBTB1	272	Sngl Thr Brkt	TSFPSC	351	Sarto Screen
TSBTB2	272	Sngl Thr Brkt	TSFPT50XN	342	Modular Harness

Style Number	Page	Description	Style Number	Page	Description
TSFPT50YN	342	Modular Harness	UPL4	276	U Post Leg
TSFPT50ZN	342	Modular Harness	UPL4C	276	U Post Leg
TSFPT56XN	342	Modular Harness	UPL4M	276	U Post Leg
TSFPT56YN	342	Modular Harness	UPLC	276	U Post Leg
TSFPT56ZN	342	Modular Harness	USE2448LH	263	120° Straight Wksf
TSFPT62XN	342	Modular Harness	USE2448RH	263	120° Straight Wksf
TSFPT62YN	342	Modular Harness	USE2460LH	263	120° Straight Wksf
TSFPT62ZN	342	Modular Harness	USE2460RH	263	120° Straight Wksf
TSFPT68XN	342	Modular Harness	USE2472LH	263	120° Straight Wksf
TSFPT68YN	342	Modular Harness	USE2472RH	263	120° Straight Wksf
TSFPT68ZN	342	Modular Harness	USE3048LH	263	120° Straight Wksf
TSFPT74XN	342	Modular Harness	USE3048RH	263	120° Straight Wksf
TSFPT74YN	342	Modular Harness	USE3060LH	263	120° Straight Wksf
TSFPT74ZN	342	Modular Harness	USE3060RH	263	120° Straight Wksf
TSFPT86XN	342	Modular Harness	USE3072LH	263	120° Straight Wksf
TSFPT86YN	342	Modular Harness	USE3072RH	263	120° Straight Wksf
TSFPT86ZN	342	Modular Harness	UST1260	266	U Sgl-Tprd WS CD
TSFPT98XN	342	Modular Harness	UST1272	266	U Sgl-Tprd WS CD
TSFPT98YN	342	Modular Harness	UST2160	266	U Sgl-Tprd WS CD
TSFPT98ZN	342	Modular Harness	UST2172	266	U Sgl-Tprd WS CD
TSFRF	346	Fence Receptacle Filler	UST2360	266	U Sgl-Tprd WS CD
TSFSC	349	Universal Screens	UST2372	266	U Sgl-Tprd WS CD
TSFSCSPN	355	Ans Boundary Screen	UST3260	266	U Sgl-Tprd WS CD
TSFSCSSD	355	Ans Boundary Screen	UST3272	266	U Sgl-Tprd WS CD
UB223636	267	U 120° WS CD	USWS	257	U Str WS PM
UB224242	267	U 120° WS CD	USWSK	257	U Str WS PM
UB224848	267	U 120° WS CD	USWSS	261	U Str WS PM
UB333636	267	U 120° WS CD	USWSSW	257	Strgt Wkf w/Sft Eg PM
UB334242	267	U 120° WS CD	USWSSWS	261	Strgt Wkf w/Sft Eg PM
UB334848	267	U 120° WS CD	USWSVB	297	WS Bracket
UCL	277	U Dbl Post C-Leg	UTT1248	264	U Taprd WS CD
UDPL	277	U Dbl Post Leg	UTT1260	264	U Taprd WS CD
UFAL	239, 349	Aligners	UTT1272	264	U Taprd WS CD
UFC24	274	FO Closed Loop	UTT2148	264	U Taprd WS CD
UFC24NF	275	Infill for FO Legs	UTT2160	264	U Taprd WS CD
UFC24T	274	FO Closed Loop	UTT2172	264	U Taprd WS CD
UFC30	274	FO Closed Loop	UTT2348	264	U Taprd WS CD
UFC30NF	275	Infill for FO Legs	UTT2360	264	U Taprd WS CD
UFC30T	274	FO Closed Loop	UTT2372	264	U Taprd WS CD
UFP	274	FO Post Loop	UTT3248	264	U Taprd WS CD
UFPM	240	Uni Prv/ Mod Screen	UTT3260	264	U Taprd WS CD
UFPS	243	Uni Prv Screen	UTT3272	264	U Taprd WS CD
UFQ24	274	FO Open Loop	UTTF1260	265	U Taper-Flat WS CD
UFQ24NF	275	Infill for FO Legs	UTTF1272	265	U Taper-Flat WS CD
UFQ24T	274	FO Open Loop	UTTF1360	265	U Taper-Flat WS CD
UFQ30	274	FO Open Loop	UTTF1372	265	U Taper-Flat WS CD
UFQ30NF	275	Infill for FO Legs	UTTF2160	265	U Taper-Flat WS CD
UFQ30T	274	FO Open Loop	UTTF2172	265	U Taper-Flat WS CD
UHPL	276	U Post Leg	UTTF2360	265	U Taper-Flat WS CD
UNPL	276	U Post Leg	UTTF2372	265	U Taper-Flat WS CD
UNPL4	276	U Post Leg	UTTF3160	265	U Taper-Flat WS CD
UNPL4C	276	U Post Leg	UTTF3172	265	U Taper-Flat WS CD
UNPL4M	276	U Post Leg	UTTF3260	265	U Taper-Flat WS CD
UNPLC	276	U Post Leg	UTTF3272	265	U Taper-Flat WS CD
UPL	276	U Post Leg	UTTRC	269	Cord and Plug

Style Number Index, continued

Style Number	Page	Description
UTTRHW	269	Hardwire Power
UTTRM	269	Modular Power
VWB2	296	Personal Whiteboard
WST1260	266	U Sgl-Taprd WS FD
WST1272	266	U Sgl-Taprd WS FD
WST2160	266	U Sgl-Taprd WS FD
WST2172	266	U Sgl-Taprd WS FD
WST2360	266	U Sgl-Taprd WS FD
WST2372	266	U Sgl-Taprd WS FD
WST3260	266	U Sgl-Taprd WS FD
WST3272	266	U Sgl-Taprd WS FD
WTT1248	264	U Sgl-Taprd WS FD
WTT1260	264	U Sgl-Taprd WS FD
WTT1272	264	U Sgl-Taprd WS FD
WTT2148	264	U Sgl-Taprd WS FD
WTT2160	264	U Sgl-Taprd WS FD
WTT2172	264	U Sgl-Taprd WS FD
WTT2348	264	U Sgl-Taprd WS FD
WTT2360	264	U Sgl-Taprd WS FD
WTT2372	264	U Sgl-Taprd WS FD
WTT3248	264	U Sgl-Taprd WS FD
WTT3260	264	U Sgl-Taprd WS FD
WTT3272	264	U Sgl-Taprd WS FD
WTTF1260	265	U Taper-Flat WS—FD
WTTF1272	265	U Taper-Flat WS—FD
WTTF1360	265	U Taper-Flat WS—FD
WTTF1372	265	U Taper-Flat WS—FD
WTTF2160	265	U Taper-Flat WS—FD
WTTF2172	265	U Taper-Flat WS—FD
WTTF2360	265	U Taper-Flat WS—FD
WTTF2372	265	U Taper-Flat WS—FD
WTTF3160	265	U Taper-Flat WS—FD
WTTF3172	265	U Taper-Flat WS—FD
WTTF3260	265	U Taper-Flat WS—FD
WTTF3272	265	U Taper-Flat WS—FD

Trademark List

™/® The following is a non-exhaustive list of trademarks and registered trademarks for products of Steelcase Inc. or one of its related corporate entities: Agree, Airtouch, Aisla, Alight, Amia, Answer, Apprise, Aspekt, Avenir, Await, B-Free, Ballet, Bassline, Bindu, Bivi, Bix, Bottomline, Brody, Buoy, Cachet, Campfire, Capa, CF Series, CG_1, Chord, Circa, Clipper, Cobi, Collaboration, Convene, Coupe, Cura, Currency, dash, Divisio, Duo, E-Table 2, Edge Series, Elbrook, Elective Elements, Embold, Empath, Everwall, Exponents, Folio, FrameOne, Gesture, Groupwork, Host, Hosu, i2i, Jenny, Kart, Kathryn, Kick, Lagunitas, Leap, Leela, LessThanFive, LiveBack, LiveSeat, Mackinac, Marien152, Max-Stacker, media:scape, Migration, Millbrae, Mineral, Mitra, Montage, Montara650, MoreThanFive, Move, Node, Ocular, Ology, Opus, Paperflo, Passerelle, Player, Pocket, Potrero415, QiVi, Radia, Regard, Relay, Reply, Ripple, Roam, Sarto, Scoop, Sebastopol, Senti Series, Senza, Shortcut, Sidewalk, Siento, Sieste, SILQ, Soffio, Sorrel, SOTO, Steelcase Eclipse, Steelcase Flex, Steelcase Karman, Steelcase Relay, Steelcase Rise, Steelcase Series, Surround, SW_1, Switch, Sync, Tava, Tenor, Think, Thoughtful, Thread, Together, Train, Trees, Turnstone, Umami, Underscore, V.I.A., Verb, Verge, Verlay, Victor2, Visalia, WorkValet, and X-tenz.

™/® The following are trademarks or registered trademarks of AMQ Solutions, LLC: 3F, Activ, Amobi, Bixby, Bodi, Cluvo, Concur, Embank, FL-X, Iline, Jaku, Kinex, Personality Plus, Revi, S-Series, Siya, Tektis, Tizu, Uptake, and Zilo.

™/® The following are trademarks or registered trademarks of Orangebox Ltd., Cardiff, UK: Air3, Aspect, Avi, Away from the Desk, Border, Campers & Dens, Coppice, Cubb, Kirm, On the QT, Ramsey, Skomer, Sully, Track-B, and Vale.

™/® The following are trademarks or registered trademarks of Viccarbe Habitat, S.L.: Aleta, Cambio, Designed in The Sun, Foro, Funda, Holy Day, Kelly, Last Minute, Noha, Savina, Sistema, Sistema, Viable, and Wrapp.

® The following are registered brands of Steelcase Inc. and its family of companies: Steelcase, AMQ, Coalesse, Designtex, Halcon, Orangebox, Smith System, and Viccarbe.

® The following registered trademarks are under license from AWI Licensing Company, Dover, DE: SoundScapes, DuraBrite, BioBlock, and Armstrong.

® The following registered trademarks are under license from Byrne Electrical, Rockford, MI: Interport, Mini-Port, Axil Z, and Ellora.

® The following is a registered trademark of DuPont, Wilmington, DE: Corian.

® The following is a registered trademark of Genlyte Thomas Company, Louisville, KY: Lightolier.

® The following is a registered trademark of Hilti Corporation, FL-9494 Schaan, Principality of Liechtenstein: Hilti.

® The following is a registered trademark of Leviton Manufacturing Company, Little Neck, NY: Decora.

® The following is a registered trademark of Mechanical Plastics Corp, Elmsford, NY: Toggler.

® The following is a registered trademark of Microsoft Corporation, Redmond, WA: Microsoft.

® The following are registered trademarks of Orangebox Ltd., Cardiff, UK: Orangebox.

® The following is a registered trademark of Panduit Corporation, Lockport, IL: Panduit.

® The following is a registered trademark of Trav (Press), Cuneo, Italy: Assisa.

® The following is a registered trademark of Virtual Ink, Boston, MA: mimioActive.

® The following registered trademarks are under license from Wilkhahn Furniture Products: Avera, Senzo, Versal, and Wilkhahn FS.

® The following are registered trademarks of Polyvision Corp: Flow, Motif, Polyvision, Sans, and Serif.

® The following is a registered trademark of Wilsonart International, Temple, TX: Chemsurf.

® The following is a registered trademark of Wiremold, West Hartford, CT: Wiremold.

® The following is a registered trademark of EMU Group S.P.A., Perugia, Italy: EMU.

® The following is a registered trademark of Security People, Inc.: Digilock.

® The following are registered trademarks of Natural Capital Partners Europe Limited: CarbonNeutral and the CarbonNeutral Certified logo.

™ The following is a trademark of Microsoft Corporation, Redmond, WA: Windows.

™ The following is a trademark of Rodman Industries, Inc., Oconomowoc, WI: ResinCore1.

™ The following is a trademark of Ultrafabrics, LLC, Elmsford, NY: Ultraleather.

™ The following trademarks are under license from Wilkhahn Furniture products: Cana, Linus, Logon, Picto, Range, Stitz, Thema, Timetable, and Tubis.

™ The following trademarks are under license from Walter Knoll: Andoo, Bob, Lazlo, Lox, Ribbon, and Together.

™ The following trademarks are under license from PP Mobler: Bar and Flag Halyard.

™ The following trademarks are under license from Carl Hansen: Elbow, Paddle, Shell, Wing, and Wishbone.

™ The following trademarks are under license from Cambridge Sound Management, LLC Cambridge, MA: QtPro Soundmasking, Qt Quiet Technology, and Sonet Qt.

™ The following is a trademark of Electri-Cable Assemblies, Shelton, CT: Interact.

™ The following is a trademark of Clestra Hauserman: IRYS.

™ The following is a trademark of Wiesner-Hager Möbel GmbH: Nooi.

™ The following are trademarks of Polyvision: Accord, a3, e3, Boundri, and Nota.

™ The following is a trademark of Bostock Company, Inc: SnapCab.

™ The following is a trademark of Williams-Sonoma, Inc: West Elm.

™ The following is a trademark of Elena Marquina Testor: nanimarquina.

™ The following is a trademark of Forbo International SA: Forbo.

Trademarks used herein are the property of Steelcase Inc. or their respective owners.