



Aisla

Specification Guide

Availability

Electronic price list updated with release 204.C (U.S.) and 158.C (Canada), dated June 15, 2026.

All specifications subject to change without notice. Reference the electronic catalog/Hedberg for current pricing.

Transitional products in this specification guide are **maintained for existing customers only** and are likely to be phased out over time. These products are indicated with a . Products that are scheduled to be culled are indicated with an , followed by the last order entry date.

Surface Materials

The surface materials team has announced the launch of the Finish Library, found at www.steelcase.com/finishlibrary/.

► For a list of all trademarks, refer to the last page of this specification guide. © 2026 Steelcase Inc.



For Canadian Pricing

Canadian factor can be found at www.steelcase.com/CADpricing/. Calculate in the following order to avoid rounding errors:

- Multiply the base price and each option by the Canadian factor.
- Round each to the nearest dollar.
- Add base and options for total list price.

Working with This Specification Guide

Ten Tips: How to Get the Most Out of This Book	2
Additional Resources	4

Statement of Line

6

Understanding Panels

Panel Visual Statement of Line	14
Key Panel Applications and Panel Logic	16
Panel Stability Guidelines	20
Panel Grain Directions	24
Aisla Panels	26
Aisla Powered Panels	30
Aisla Fabric-Wrapped Magnetic Panel	36

Understanding Storage

Aisla Cabinets	38
HIU Storage Style Number Logic	40
Aisla HIU Storage	42

Specifying Panels

Aisla Panels	48
Aisla Powered Panels	88
Aisla Fabric-Wrapped Magnetic Panel	130

Specifying Storage

Aisla Cabinets	132
Aisla HIU Storage	136

Surface Materials

163

Resources

171

Ten Tips: How to Get the Most Out of This Book

Tip 1

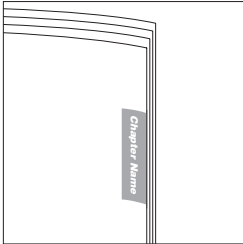

Watch the tabs on the right-hand edges of the pages. They'll always indicate which chapter you are in.

Tip 2

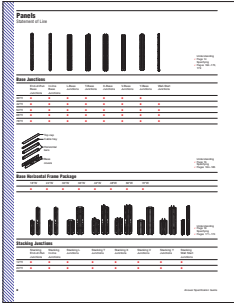

Use the Statement of Line pages for an overview of the available components, their sizes, and page references for additional information. Each *Understanding* chapter includes a statement of line after the table of contents.

Tip 3



Find cross references by looking for page numbers flagged with an arrow.

Tip 4

Study the product detail pages in the *Understanding* section to learn everything an expert knows about specific products. Each product detail page in this section contains the following features, where applicable:

- Product Drawing
- Actual Dimensions
- Product Details
- Connections
- Wiring and Cabling
- Surface Materials
- Application Topics

Product Drawing shows you what the product looks like and points out important features.

Product Details gives specific information on the product and how it is used.

Connections describes how the product is assembled or how it attaches to another product.

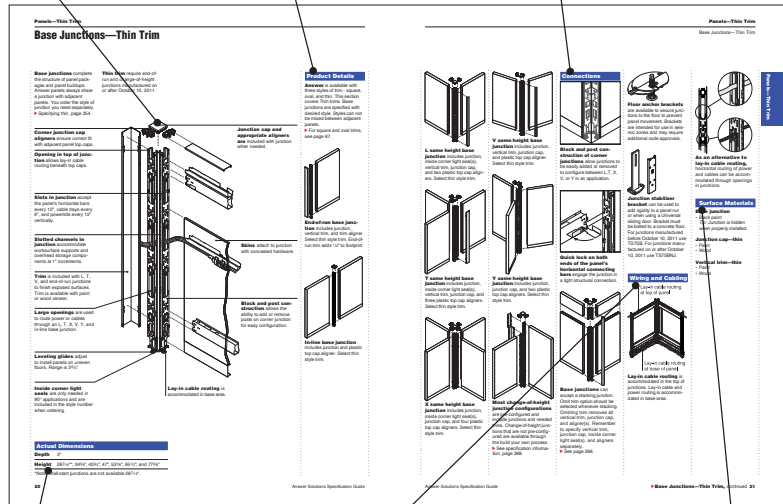

Actual Dimensions table lists the dimensions of the product.

Wiring and Cabling details the power and cable-management and cable routing capabilities of the product.

Surface Materials lists what material is used for each part of the product.

Tip 5

Refer to the specifying pages for all the information needed to order a product. Each product specifying page contains a variety of elements to help you complete a specification:

- Product Drawing
- Standard Includes
- Required to Specify
- Options
- Related Products
- Specification Information
- Dimensions
- Style Number
- Price

Standard Includes (under the red or dark grey band) provides a list of what comes standard with the product.

Required to Specify (under the red or dark grey band) itemizes the information that you must provide to order the standard product and the preferred sequence for specification.

Specification Information (under the teal or light grey band) provides product dimensions, style numbers, and prices for the standard product and any surface material choices that are available.

Product Drawing shows you what the product looks like.

Standard Includes

- Standard length (see note 1) (see 1) (see 1)
- Base trim with no backstops (see 1) (see 1)
- Base trim with backstops (see 1) (see 1)
- Base trim with backstops (see 1) (see 1)
- Base trim with backstops (see 1) (see 1)

Required to Specify

- Style Number
- Finish
- Color
- Material
- Profile
- Accessories

Specification Information

Style Number	Finish	Color	Material	Profile	Accessories
10	10101010	10	10	10	10
20	20101010	20	20	20	20
30	30101010	30	30	30	30
40	40101010	40	40	40	40
50	50101010	50	50	50	50
60	60101010	60	60	60	60
70	70101010	70	70	70	70
80	80101010	80	80	80	80
90	90101010	90	90	90	90
100	100101010	100	100	100	100

Options

Option	Unit Price	Required to Specify
Option 1	10.00	Specify with 10
Option 2	20.00	Specify with 20
Option 3	30.00	Specify with 30
Option 4	40.00	Specify with 40
Option 5	50.00	Specify with 50
Option 6	60.00	Specify with 60
Option 7	70.00	Specify with 70
Option 8	80.00	Specify with 80
Option 9	90.00	Specify with 90
Option 10	100.00	Specify with 100

Product Drawing

Tip 6

Required to Specify

Specify with *Customiz Stain*

Italic typeface on specifying pages usually identifies wording that you should use in your order.

i

Tip 7

To determine how many skins are needed to complete a panel, consult the table at the right.

Tip: Remember to order skins for both sides of the panel buildup.

Watch for tips throughout the text that give you explanations and helpful instructions.

Tip 8

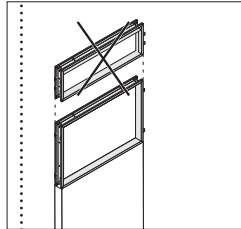

Learn what you cannot do by looking for drawings crossed out with an "X."

Tip 9

Use the surface materials listings in the Surface Materials section of this book to find surface material color numbers.

Tip 10

Style Number	Page
TS7042BL	131
TS7042S	130
TS7048BL	131
TS7048S	130
TS7060BL	131
TS7060S	130
TS7072BL	131

Refer to the style number index when you need a style number and you need to find the page that has more details about the product.

Additional Resources

Aisla products are supported with informational materials, tools, and software to help you plan, specify, and order an installation efficiently.

FSC CoC Certification
Steelcase Wood harvesting practices are just one of the steps in achieving Forest Stewardship Council Chain of Custody (FSC CoC) certification. FSC certified wood (veneer and core) is available on most Steelcase wood products through the Specials RFQ process.

Product brochures and planning tools can be ordered through your Steelcase area office by calling 1.800.784.0358 or through the Marketing Resources web site at village.steelcase.com.

Planning Ideas is your resource to help inspire, envision, and plan Steelcase wood solutions.
▶ See www.steelcase.com/resources/design-center/planning-ideas.

Wood Solutions Interactive Tool has everything you need to talk about wood solutions combined in one interactive tool. www.steelcase.com/woodinteractive

Printed Materials

Surface Materials Reference Manual

This publication provides:

- An explanation of the surface materials
- “Available on” matrices
- Surface material selection listing
- Technical data for surface materials
- Surface material care and cleaning instructions

Hard Surfaces Card

The card provides an overview of:

- Finish levels
- An explanation of Flat Cut, Rift Cut and Quarter Cut
- Veneer lay-up techniques on exterior surfaces
- Wood finishes
- Certifications

Form number 09-0000483

Computer Tools

Electronic Catalog

Accurate sales quotations and purchase orders for Steelcase products are created with specification software that uses Steelcase Electronic Catalog data. Use the data to specify and price style numbers and options for every Steelcase product. The data is updated bimonthly by Steelcase and provided to software programs including: the Hedberg Business System, SmartTools — Steelcase’s design and specification software (for more information on SmartTools, please email SmartTools@steelcase.com), the ProjectMatrix ProjectSymbols libraries, as well as 20-20 CAP Studio.

Furniture Symbol Graphic Data

Steelcase creates 2D and 3D furniture symbols (with attributes) for planning and initially specifying Steelcase products. This data is incorporated into several add-on software packages that work in either a Microstation or an AutoCAD drafting environment.

Digital Publications

You can access these digital publications at www.steelcase.com or village.steelcase.com.

Support

Steelcase Capabilities

Steelcase products are distributed, installed, and serviced through a network of more than 600 dealers worldwide. Steelcase is also represented with offices and corporate showrooms in 26 U.S. cities, 4 Canadian cities, and in France, Germany, Great Britain, and Japan. Every Steelcase product meets our exceptionally high standards of quality and durability and comes with the Steelcase assurance of excellence in service.

For ordering or product assistance,

please call your local dealer, the Steelcase Solutions Resource Team, or the Steelcase Solutions Fulfillment Team at 1.888.STEELCASE (1.888.783.3522) or send an e-mail to lineone@steelcase.com.

Call the Steelcase Solutions Resource Team prior to placing an order, when working on a bid, or when you need information about product applications and specifications.

Call the Steelcase Solutions Fulfillment Team if you have submitted an order to Steelcase and you need to speak to your Solutions Fulfillment Team Representative about the order. Also call if you have any post-shipment quality concerns or service parts questions.

For warranty information, please go to <http://www.steelcase.com/warranty/>.

Outside the U.S.A., Canada, Mexico, Puerto Rico, and the U.S. Virgin Islands, call 1.616.247.2500.

For information about Steelcase, the name of your nearest Steelcase dealer, or for product literature, call 1.800.333.9939 or visit our Web site: www.steelcase.com.

Sustainability

At Steelcase, we believe business can be a force for good. We create long-lasting products that are better for people and better for the planet. Our products and operations use life cycle thinking to meet our commitment to reducing climate change. This commitment is reinforced by practices such as designing to minimize global warming and other life cycle impacts, ensuring material health, and enabling end-of-use strategies. To learn more at a corporate level, visit: <https://www.steelcase.com/discover/steelcase/esg-overview/environmental/Product-Environmental-Profiles>, which provide key environmental attributes such as recycled content, embodied carbon and recyclability, as well as product certifications can be found by searching for Steelcase at *Origin.build*.

Statement of Line

Aisla Panels

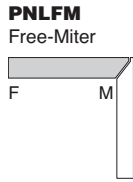
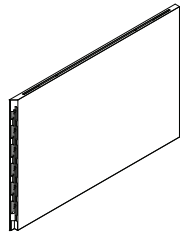

Understanding
▶ Page 26
Specifying
▶ Page 48

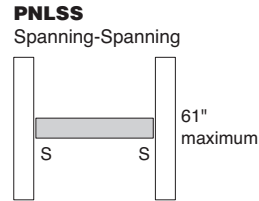
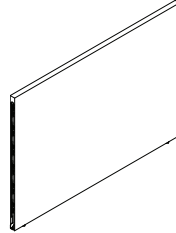

Understanding
▶ Page 26
Specifying
▶ Page 56

Aisla Panels — Free

18"W–96.5"W

42"H ●

48"H ●

Tip: Parametric width (18"W–96.5"W) is available in 1/16" increments.
Tip: **PNLFM** style shown. Section also includes styles **PNLFT**, **PNLFS**, and **PNLFI**.

Aisla Panels — Spanning

18"W–96.5"W

42"H ●

48"H ●

Tip: Parametric width (18"W–96.5"W) is available in 1/16" increments.
Tip: **PNLSS** style shown. Section also includes style **PNLST**.

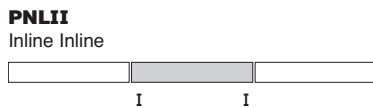
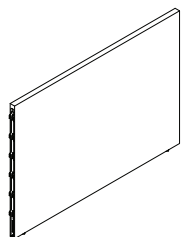

Understanding
▶ Page 26
Specifying
▶ Page 62

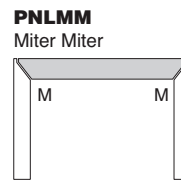
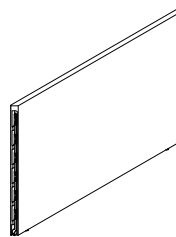

Understanding
▶ Page 26
Specifying
▶ Page 70

Aisla Panels — Inline

18"W–96.5"W

42"H ●

48"H ●

Tip: Parametric width (18"W–96.5"W) is available in 1/16" increments.
Tip: **PNLII** style shown. Section also includes styles **PNLIS**, **PNLIM**, and **PNLIT**.

Aisla Panels — Miter

18"W–96.5"W

42"H ●

48"H ●

Tip: Parametric width (18"W–96.5"W) is available in 1/16" increments.
Tip: **PNLMM** style shown. Section also includes styles **PNLMS** and **PNLMT**.

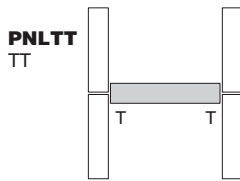
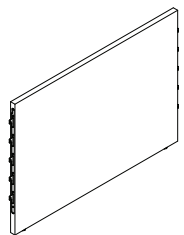

Understanding
▶ Page 26
Specifying
▶ Page 78

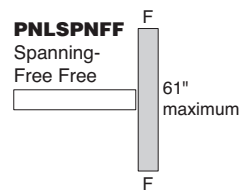
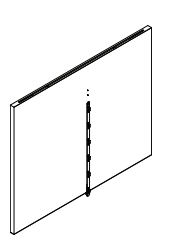

Understanding
▶ Page 26
Specifying
▶ Page 84

Aisla Panels — T

18"W–96.5"W

42"H ●

48"H ●

Tip: Parametric width (18"W–96.5"W) is available in 1/16" increments.
Tip: **PNLTT** style shown.

Aisla Spanning Panels — Free

36"W–61"W

42"H ●

48"H ●

Tip: Parametric width (36"W–61"W) is available in 1/16" increments.
Tip: **PNLSPNFF** style shown.

Aisla Powered Panels

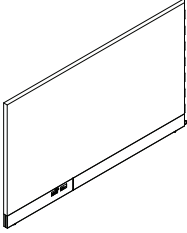

Understanding
 ▶ Page 30
 Specifying
 ▶ Page 88

Aisla Powered Panels — Free

	60.5"W	66.5"W	72.5"W	78.5"W	84.5"W	90.5"W	96.5"W
42"H	●	●	●	●	●	●	●
48"H	●	●	●	●	●	●	●

Tip: Section includes styles **PNLFMP**, **PNLFTP**, **PNLFSP**, and **PNLFIP**.

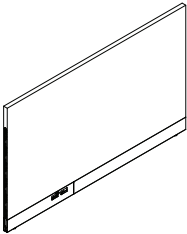

Understanding
 ▶ Page 30
 Specifying
 ▶ Page 96

Aisla Powered Panels — Spanning

	60.5"W	66.5"W	72.5"W	78.5"W	84.5"W	90.5"W	96.5"W
42"H	●	●	●	●	●	●	●
48"H	●	●	●	●	●	●	●

Tip: Section includes styles **PNLSSP** and **PNLSTP**.

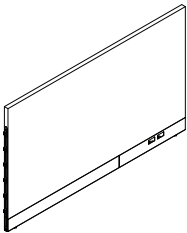

Understanding
 ▶ Page 30
 Specifying
 ▶ Page 102

Aisla Powered Panels — Inline

	60.5"W	66.5"W	72.5"W	78.5"W	84.5"W	90.5"W	96.5"W
42"H	●	●	●	●	●	●	●
48"H	●	●	●	●	●	●	●

Tip: Section includes styles **PNLIIP**, **PNLISP**, **PNLIMP**, and **PNLITP**.

Aisla Powered Panels, continued

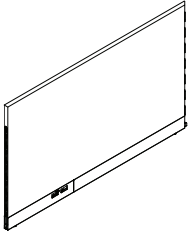

Understanding
 ▶ Page 30
 Specifying
 ▶ Page 110

Aisla Powered Panels — Miter

	60.5"W	66.5"W	72.5"W	78.5"W	84.5"W	90.5"W	96.5"W
42"H	●	●	●	●	●	●	●
48"H	●	●	●	●	●	●	●

*Tip: Section includes styles **PNLMMP**, **PNLMSP**, and **PNLMTP**.*

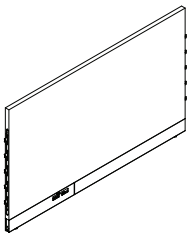

Understanding
 ▶ Page 30
 Specifying
 ▶ Page 118

Aisla Powered Panels — T

	60.5"W	66.5"W	72.5"W	78.5"W	84.5"W	90.5"W	96.5"W
42"H	●	●	●	●	●	●	●
48"H	●	●	●	●	●	●	●

*Tip: Section includes style **PNLTTP**.*

Aisla Powered Panels, continued

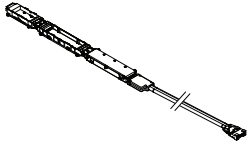

Specifying
▶ Page 123

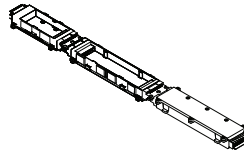

Specifying
▶ Page 124

Aisla Power Kit

Aisla Power Kit — No Whip

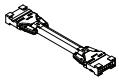

Specifying
▶ Page 125

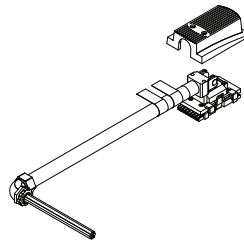

Specifying
▶ Page 126

Aisla Harness/Jumper Kit

Aisla Base Power Infeeds

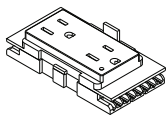

Specifying
▶ Page 127

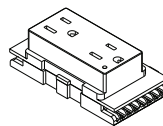

Specifying
▶ Page 128

Aisla Duplex Receptacles Finish to Floor (A-Height)

Aisla Duplex Receptacles (C-Height)

Aisla Fabric-Wrapped Magnetic Panel

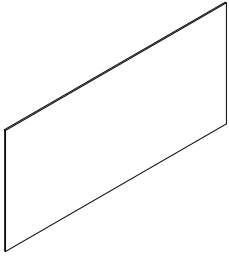

17.625"W–96.125"W

Understanding
 ▶ Page 36
 Specifying
 ▶ Page 130

12.875"H–25.1875"H ●

Tip: Parametric width (17.625"W–96.125"W) is available in 1/16" increments.
Tip: Parametric height (12.875"H–25.1875"H) is available in 1/16" increments.
Tip: Recommended modular height increments shown in SmartTools: 12.875", 19", and 25.1875".

Aisla Cabinets

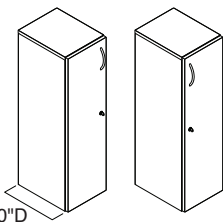

18"D and 30"D

Understanding
 ▶ Page 38
 Specifying
 ▶ Page 132

	12"W	18"W
42"H	●	●
48"H	●	●

Aisla HIU Storage

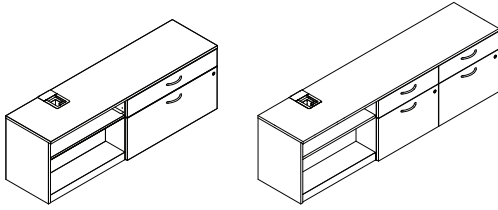

Understanding
 ▶ Page 42
 Specifying
 ▶ Page 136

Aisla HIU Credenzas—Parallel

	54"W	54.5"W	60"W	60.5"W	66"W	66.5"W	72"W	72.5"W
18"D	●	●	●	●	●	●	●	●
	78"W	78.5"W	84"W	84.5"W	90"W	90.5"W	96"W	96.5"W
18"D	●	●	●	●	●	●	●	●

Tip: HIU credenzas shown above are right handed. Left hand configurations also available.

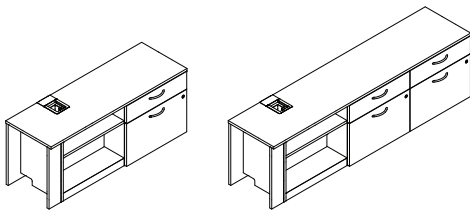

Understanding
 ▶ Page 42
 Specifying
 ▶ Page 144

Aisla HIU Credenzas—Perpendicular

	54"W	54.5"W	60"W	60.5"W	66"W	66.5"W	72"W	72.5"W
18"D	●	●	●	●	●	●	●	●
	78"W	78.5"W	84"W	84.5"W	90"W	90.5"W	96"W	96.5"W
18"D	●	●	●	●	●	●	●	●

Tip: HIU credenzas shown above are right handed. Left hand configurations also available.

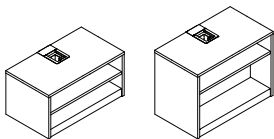

Understanding
 ▶ Page 42
 Specifying
 ▶ Page 152

Aisla HIU Low Storage—Parallel

	30"W	30.5"W
18"D	●	●

Tip: Right handed HIU low storage shown above. Left hand configurations also available.

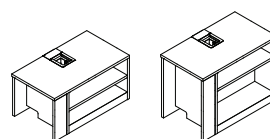

Understanding
 ▶ Page 42
 Specifying
 ▶ Page 156

Aisla HIU Low Storage—Perpendicular

	30"W	30.5"W
18"D	●	●

Tip: Right handed HIU low storage shown above. Left hand configurations also available.

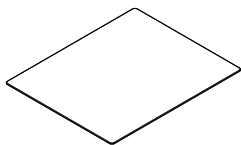

**Aisla Storage
Drawer Liner**

Understanding
▶ Page 42
Specifying
▶ Page 160

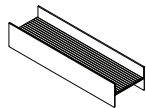

**Aisla Storage
Pencil Tray**

Understanding
▶ Page 42
Specifying
▶ Page 161

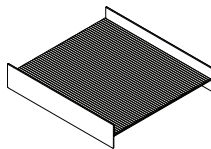

**Aisla Storage
Paper Tray**

Understanding
▶ Page 42
Specifying
▶ Page 162

Understanding

Panel Visual Statement of Line	14
Key Panel Applications and Panel Logic	16
Panel Stability Guidelines	20
Panel Grain Directions	24
Aisla Panels	26
Aisla Powered Panels	30
Aisla Fabric-Wrapped Magnetic Panel	36
Aisla Cabinets	38
HIU Storage Style Number Logic	40
Aisla HIU Storage	42

Panels Visual Statement of Line

PNLFM
Free/Miter

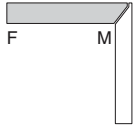

PNLSS
Spanning Spanning

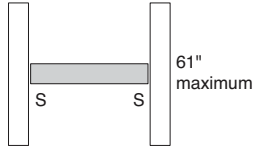

PNLIM
Inline Miter

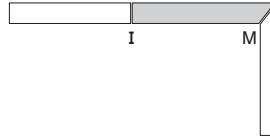

PNLFT
Free/T

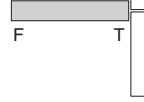

PNLMT
Miter T

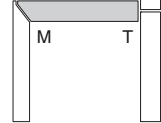

PNLMS
Miter Spanning

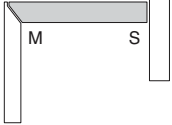

PNLFS
Free Spanning

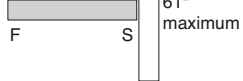

PNLIS
Inline Spanning

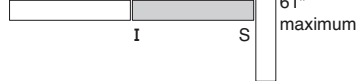

PNLMM
Miter Miter

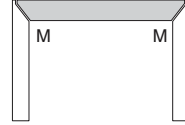

PNLFI
Free Inline

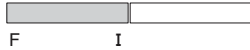

PNLIT
Inline T

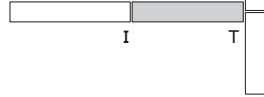

PNLST
Spanning T

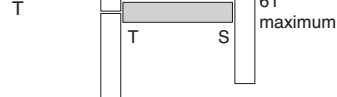

PNLII
Inline Inline

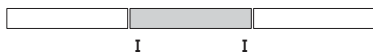

PNLTT
T T

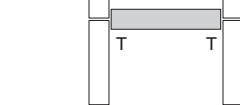

PNLSPNFF
Spanning Free Free

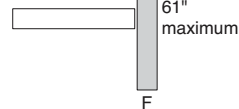

Panels are labeled by ends and sides.

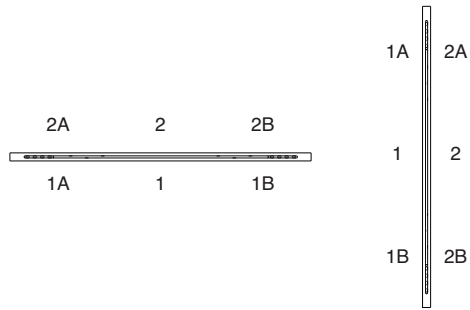

Each panel has a side 1 and a side 2. For each of the sides, there is an end A and an end B.

PNLIT

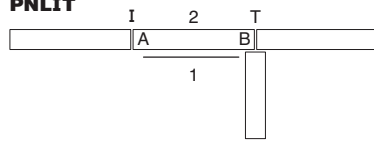

Shown is an example of labeling for an inline T panel style. The magnetic panel on side 1 is represented by the black line.

Key Panel Applications and Panel Logic

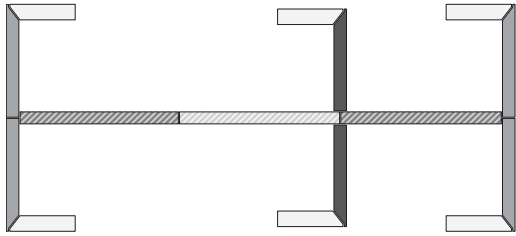

- = **PNLFM**
- ▨ = **PNLII**
- = **PNLIM**
- ▩ = **PNLIT**
- = **PNLMT**

Panels are planned and specified as non-powered or powered gallery panels. Generally, power runs down the spine of the application (highlighted in gray), however, any panels that connect inline can run power.

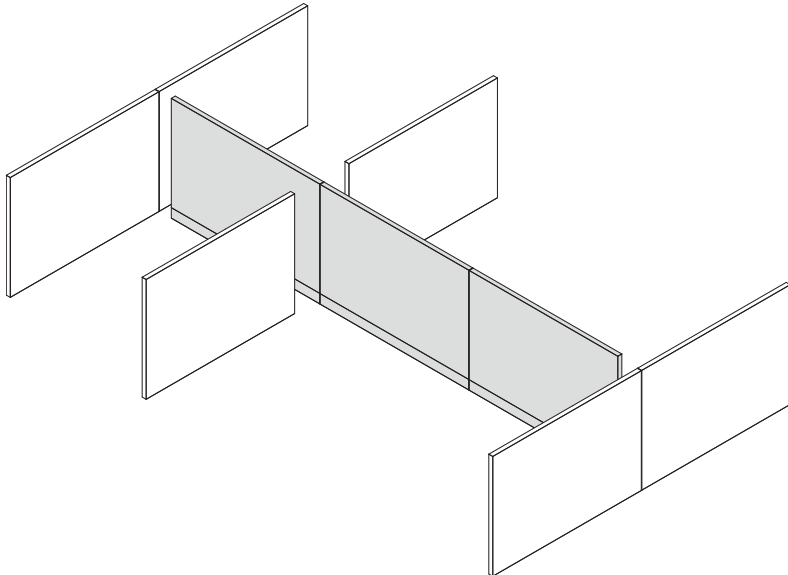

Power can only run through inline connections, it cannot turn a corner.

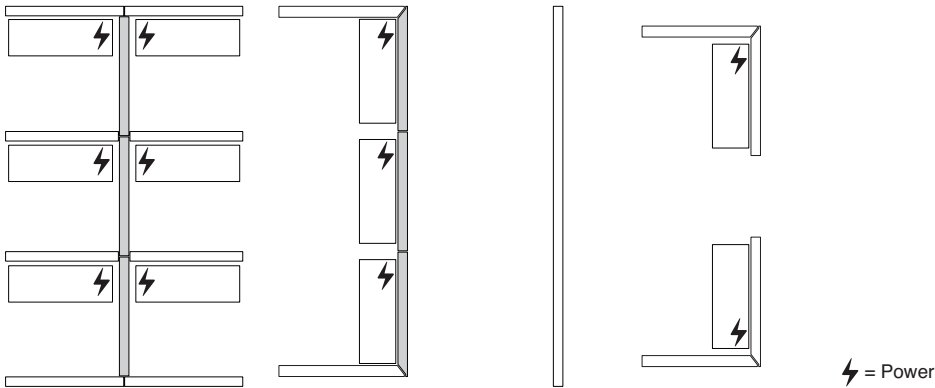

Double sided work-pack

- 4, 6, and 8 packs
- Benching and perpendicular configurations
- Two-sided power expression

Single sided work-pack

- 2, 3, and 4 packs
- Benching and perpendicular configurations
- One-sided power expression

Enclosed work-pack

- Reception and administration stations
- One-sided power expression
- Power and data chase to workstation

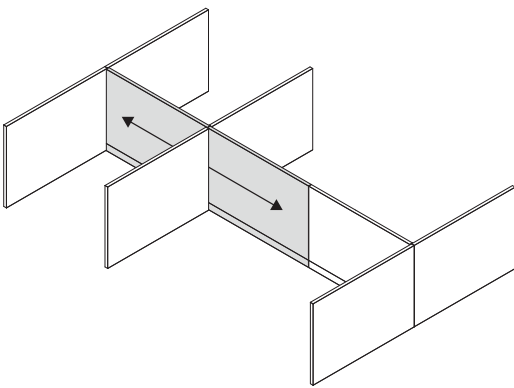

Aisla panel length changes automatically through SmartTools, utilizing integrated connections to maintain plan width.

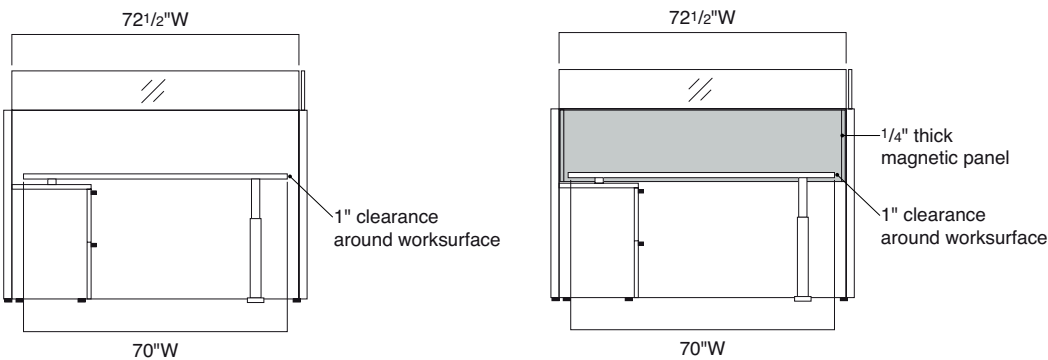

Panels are sized to account for the accent panel, whether it is present or not. An additional 1/2" is added to all panels to account for pinch points. Use SmartTools for planning rules.

Tip: Aisla integrated credenzas have the additional dimension accounted for in the integrated height-adjustable desk leg case.

Key Panel Applications and Panel Logic, continued

Panel and accessories style list:

Style Number	Style Description	Non-Powered	Powered
PNLFM	Panel Free/Miter	X	X
PNLFT	Panel Free/T	X	X
PNLFS	Panel Free Spanning	X	X
PNLFI	Panel Free Inline	X	X
PNLSS	Panel Spanning Spanning	X	X
PNLII	Panel Inline Inline	X	X
PNLIS	Panel Inline Spanning	X	X
PNLMM	Panel Miter Miter	X	X
PNLIM	Panel Inline Miter	X	X
PNLMS	Panel Miter Spanning	X	X
PNLIT	Panel Inline T	X	X
PNLTT	Panel T T	X	X
PNLST	Panel Spanning T	X	X
PNLMT	Panel Miter T	X	X
PNLSPNFF	Spanning Panel Free Free	X	N.A.
FWMPNL	Fabric-Wrapped Magnetic Panel	X	X

*Tip: For powered panels, add suffix **P** at the end of the style number.*

Tip: Cinch plate packages, including a plate and bolt, are automatically added to panel styles in SmartTools when needed. No need to specify separately.

Tip: Bumper connections automatically added to panel styles in SmartTools when needed for alignment between glass on panels. No need to specify separately.

Panel Stability Guidelines

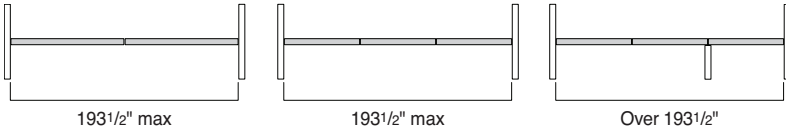

Inline panels may not exceed a maximum of 193¹/₂" of inline panels consecutively or no more than two connections between panels not exceeding 193¹/₂" without a T or end return.

L, U, and T panel applications have the stability restrictions outlined below. Accessories include glass, fabric-wrapped magnetic panel, and transaction top.

Powered/Non-Powered L Configurations/Applications

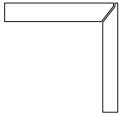

Without Accessories

42"H	Spine Width													
	18"	24"	30"	36"	42"	48"	54"	60"	66"	72"	78"	84"	90"	96"
Return 18"	X	X	X	X	X	X	X	X	X	X	X	X	X	X
Return 24"	X	X	X	X	X	X	X	X	X	X	X	X	X	X
Return 30"	X	X	X	X	X	X	X	X	X	X	X	X	X	X
Return 36"	X	X	X	X	X	X	X	X	X	X	X	X	X	X
Return 42"	X	X	X	X	X									
Return 48"	X	X	X	X										
Return 54"	X	X	X	X										
Return 60"	X	X	X	X										
Return 66"	X	X	X	X										
Return 72"	X	X	X	X										
Return 78"	X	X	X	X										
Return 84"	X	X	X	X										
Return 90"	X	X	X	X										
Return 96"	X	X	X	X										

48"H	Spine Width													
	18"	24"	30"	36"	42"	48"	54"	60"	66"	72"	78"	84"	90"	96"
Return 18"	X	X	X	X	X	X	X	X	X	X	X	X	X	X
Return 24"	X	X	X	X	X	X	X	X	X	X	X	X	X	X
Return 30"	X	X	X	X	X	X	X	X	X	X	X	X	X	X
Return 36"	X	X	X	X	X	X	X	X	X	X	X	X	X	X
Return 42"	X	X	X	X	X									
Return 48"	X	X	X	X										
Return 54"	X	X	X	X										
Return 60"	X	X	X	X										
Return 66"	X	X	X	X										
Return 72"	X	X	X	X										
Return 78"	X	X	X	X										
Return 84"	X	X	X	X										
Return 90"	X	X	X	X										
Return 96"	X	X	X	X										

With Accessories

42"H	Spine Width													
	18"	24"	30"	36"	42"	48"	54"	60"	66"	72"	78"	84"	90"	96"
Return 18"	X	X	X	X	X	X	X	X	X	X	X	X	X	X
Return 24"	X	X	X	X	X	X	X	X	X	X	X	X	X	X
Return 30"	X	X	X	X	X	X	X	X	X	X	X	X	X	X
Return 36"	X	X	X	X	X					X	X	X	X	X
Return 42"	X	X	X	X	X									
Return 48"	X	X	X											
Return 54"	X	X	X											
Return 60"	X	X	X											
Return 66"	X	X	X											
Return 72"	X	X	X	X										
Return 78"	X	X	X	X										
Return 84"	X	X	X	X										
Return 90"	X	X	X	X										
Return 96"	X	X	X	X										

48"H	Spine Width													
	18"	24"	30"	36"	42"	48"	54"	60"	66"	72"	78"	84"	90"	96"
Return 18"	X	X	X	X	X	X	X	X	X	X	X	X	X	X
Return 24"	X	X	X	X	X	X	X	X	X	X	X	X	X	X
Return 30"	X	X	X	X	X	X	X	X	X	X	X	X	X	X
Return 36"	X	X	X	X	X				X	X	X	X	X	X
Return 42"	X	X	X	X	X									
Return 48"	X	X	X											
Return 54"	X	X	X											
Return 60"	X	X	X											
Return 66"	X	X	X	X										
Return 72"	X	X	X	X										
Return 78"	X	X	X	X										
Return 84"	X	X	X	X										
Return 90"	X	X	X	X										
Return 96"	X	X	X	X										

Powered/Non-Powered U Configurations/Applications

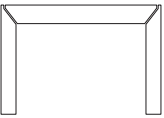

Without Accessories

Returns	42"H	Spine Width													
		18"	24"	30"	36"	42"	48"	54"	60"	66"	72"	78"	84"	90"	96"
18"	X	X	X	X	X	X	X	X	X	X	X	X	X	X	X
24"	X	X	X	X	X			X	X	X	X	X	X	X	X
30"	X	X	X	X	X										
36"	X	X	X	X	X										
42"	X	X	X	X	X										
48"	X	X	X	X	X										
54"	X	X	X	X	X										
60"	X	X	X	X	X										
66"	X	X	X	X	X										
72"	X	X	X	X	X										
78"	X	X	X	X	X										
84"	X	X	X	X	X										
90"	X	X	X	X	X										
96"	X	X	X	X	X										

Returns	48"H	Spine Width													
		18"	24"	30"	36"	42"	48"	54"	60"	66"	72"	78"	84"	90"	96"
18"	X	X	X	X	X	X	X	X	X	X	X	X	X	X	X
24"	X	X	X	X	X			X	X	X	X	X	X	X	X
30"	X	X	X	X	X										
36"	X	X	X	X	X										
42"	X	X	X	X	X										
48"	X	X	X	X	X										
54"	X	X	X	X	X										
60"	X	X	X	X	X										
66"	X	X	X	X	X										
72"	X	X	X	X	X										
78"	X	X	X	X	X										
84"	X	X	X	X	X										
90"	X	X	X	X	X										
96"	X	X	X	X	X										

With Accessories

Returns	42"H	Spine Width													
		18"	24"	30"	36"	42"	48"	54"	60"	66"	72"	78"	84"	90"	96"
18"	X	X	X	X	X	X	X	X	X	X	X	X	X	X	X
24"	X	X	X	X	X	X	X	X	X	X	X	X	X	X	X
30"	X	X	X	X	X							X	X	X	
36"	X	X	X	X	X										X
42"	X	X	X	X	X										
48"	X	X	X	X	X										
54"	X	X	X	X	X										
60"	X	X	X	X	X										
66"	X	X	X	X	X										
72"	X	X	X	X	X										
78"	X	X	X	X	X										
84"	X	X	X	X	X										
90"	X	X	X	X	X										
96"	X	X	X	X	X										

Returns	48"H	Spine Width													
		18"	24"	30"	36"	42"	48"	54"	60"	66"	72"	78"	84"	90"	96"
18"	X	X	X	X	X	X	X	X	X	X	X	X	X	X	X
24"	X	X	X	X	X	X	X	X	X	X	X	X	X	X	X
30"	X	X	X	X	X								X	X	X
36"	X	X	X	X	X										X
42"	X	X	X	X	X										
48"	X	X	X	X	X										
54"	X	X	X	X	X										
60"	X	X	X	X	X										
66"	X	X	X	X	X										
72"	X	X	X	X	X										
78"	X	X	X	X	X										
84"	X	X	X	X	X										
90"	X	X	X	X	X										
96"	X	X	X	X	X										

Powered/Non-Powered T Configurations/Applications

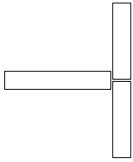

Without Accessories

42"H	Spine Width													
	18"	24"	30"	36"	42"	48"	54"	60"	66"	72"	78"	84"	90"	96"
18"	X	X	X											
24"	X	X	X											
30"	X	X	X											
36"	X	X	X											
42"	X	X	X											
48"	X	X	X											
54"	X	X	X											
60"	X	X	X	X										
66"	X	X	X	X										
72"	X	X	X	X										
78"	X	X	X	X	X									
84"	X	X	X	X	X									
90"	X	X	X	X	X									
96"	X	X	X	X	X									

48"H	Spine Width													
	18"	24"	30"	36"	42"	48"	54"	60"	66"	72"	78"	84"	90"	96"
18"	X	X	X											
24"	X	X	X											
30"	X	X	X											
36"	X	X	X											
42"	X	X	X											
48"	X	X	X	X										
54"	X	X	X	X										
60"	X	X	X	X	X									
66"	X	X	X	X	X	X								
72"	X	X	X	X	X	X								
78"	X	X	X	X	X	X								
84"	X	X	X	X	X	X								
90"	X	X	X	X	X	X	X							
96"	X	X	X	X	X	X	X							

With Accessories

42"H	Spine Width													
	18"	24"	30"	36"	42"	48"	54"	60"	66"	72"	78"	84"	90"	96"
18"	X	X	X	X	X	X	X	X	X	X	X	X	X	X
24"	X	X	X	X	X	X	X	X	X	X	X	X	X	X
30"	X	X	X											
36"	X	X	X											
42"	X	X	X	X										
48"	X	X	X	X										
54"	X	X	X	X	X									
60"	X	X	X	X	X									
66"	X	X	X	X	X									
72"	X	X	X	X	X	X								
78"	X	X	X	X	X	X								
84"	X	X	X	X	X	X								
90"	X	X	X	X	X	X								
96"	X	X	X	X	X	X								

48"H	Spine Width													
	18"	24"	30"	36"	42"	48"	54"	60"	66"	72"	78"	84"	90"	96"
18"	X	X	X	X	X	X	X	X	X	X	X	X	X	X
24"	X	X	X	X	X	X	X	X	X	X	X	X	X	X
30"	X	X	X											
36"	X	X	X	X										
42"	X	X	X	X										
48"	X	X	X	X	X									
54"	X	X	X	X	X									
60"	X	X	X	X	X	X								
66"	X	X	X	X	X	X								
72"	X	X	X	X	X	X								
78"	X	X	X	X	X	X								
84"	X	X	X	X	X	X	X							
90"	X	X	X	X	X	X	X							
96"	X	X	X	X	X	X	X							

Powered/Non-Powered Free Spanning and Inline Spanning Panels

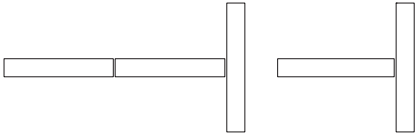

Without Accessories

42"H		Spine Width													
		18"	24"	30"	36"	42"	48"	54"	60"	66"	72"	78"	84"	90"	96"
Span T	18"	X	X	X	X	X	X	X	X	X	X	X	X	X	X
	24"	X	X	X	X	X	X	X	X	X	X	X	X	X	X
	30"	X	X	X	X	X									
	36"	X	X	X	X	X									
	42"	X	X	X	X	X									
	48"	X	X	X	X	X									
	54"	X	X	X	X	X									
	60"	X	X	X	X	X									
	66"	X	X	X	X	X	X	X	X	X	X	X	X	X	X
	72"	X	X	X	X	X	X	X	X	X	X	X	X	X	X
	78"	X	X	X	X	X	X	X	X	X	X	X	X	X	X
	84"	X	X	X	X	X	X	X	X	X	X	X	X	X	X
	90"	X	X	X	X	X	X	X	X	X	X	X	X	X	X
96"	X	X	X	X	X	X	X	X	X	X	X	X	X	X	

48"H		Spine Width													
		18"	24"	30"	36"	42"	48"	54"	60"	66"	72"	78"	84"	90"	96"
Span T	18"	X	X	X	X	X	X	X	X	X	X	X	X	X	X
	24"	X	X	X	X	X	X	X	X	X	X	X	X	X	X
	30"	X	X	X	X	X									
	36"	X	X	X	X	X									
	42"	X	X	X	X	X									
	48"	X	X	X	X	X									
	54"	X	X	X	X	X									
	60"	X	X	X	X	X									
	66"	X	X	X	X	X	X	X	X	X	X	X	X	X	X
	72"	X	X	X	X	X	X	X	X	X	X	X	X	X	X
	78"	X	X	X	X	X	X	X	X	X	X	X	X	X	X
	84"	X	X	X	X	X	X	X	X	X	X	X	X	X	X
	90"	X	X	X	X	X	X	X	X	X	X	X	X	X	X
96"	X	X	X	X	X	X	X	X	X	X	X	X	X	X	

With Accessories

42"H		Spine Width													
		18"	24"	30"	36"	42"	48"	54"	60"	66"	72"	78"	84"	90"	96"
Span T	18"	X	X	X	X	X	X	X	X	X	X	X	X	X	X
	24"	X	X	X	X	X	X	X	X	X	X	X	X	X	X
	30"	X	X	X	X	X									
	36"	X	X	X	X	X									
	42"	X	X	X	X	X									
	48"	X	X	X	X	X									
	54"	X	X	X	X	X									
	60"	X	X	X	X	X									
	66"	X	X	X	X	X	X	X	X	X	X	X	X	X	X
	72"	X	X	X	X	X	X	X	X	X	X	X	X	X	X
	78"	X	X	X	X	X	X	X	X	X	X	X	X	X	X
	84"	X	X	X	X	X	X	X	X	X	X	X	X	X	X
	90"	X	X	X	X	X	X	X	X	X	X	X	X	X	X
96"	X	X	X	X	X	X	X	X	X	X	X	X	X	X	

48"H		Spine Width													
		18"	24"	30"	36"	42"	48"	54"	60"	66"	72"	78"	84"	90"	96"
Span T	18"	X	X	X	X	X	X	X	X	X	X	X	X	X	X
	24"	X	X	X	X	X	X	X	X	X	X	X	X	X	X
	30"	X	X	X	X	X									
	36"	X	X	X	X	X									
	42"	X	X	X	X	X									
	48"	X	X	X	X	X									
	54"	X	X	X	X	X									
	60"	X	X	X	X	X									
	66"	X	X	X	X	X	X	X	X	X	X	X	X	X	X
	72"	X	X	X	X	X	X	X	X	X	X	X	X	X	X
	78"	X	X	X	X	X	X	X	X	X	X	X	X	X	X
	84"	X	X	X	X	X	X	X	X	X	X	X	X	X	X
	90"	X	X	X	X	X	X	X	X	X	X	X	X	X	X
96"	X	X	X	X	X	X	X	X	X	X	X	X	X	X	

Panel Grain Directions

Wood veneer grain directions

Wood is a natural, unique, and always changing material. No two pieces are the same. The appearance of each surface will vary based on a piece's individual grain pattern, underlying color, and characteristics (like gum pockets and pin knots). While the finishing process is identical for all pieces, each finished piece celebrates wood's individual beauty. Because wood contains standing fibers, similar to suede, the orientation of the grain pattern to a light source will cause it to reflect light differently and look a slightly different color. Two surfaces with grain directions that are at different angles to each other will look different. This natural phenomenon is called flash or polarization. This can happen within a piece as alternating veneer leaves are placed side by side or from piece to piece. Polarization is often noticed on worksurfaces installed at a 90° angle with each other.

Make a sketch of the grain direction for adjacent worksurfaces to ensure they are suitable for your installation.

Please refer to the illustrations at right for an understanding of grain direction on your installation.

Directional laminate grain directions

Directional laminates are standard with the grain directions shown.

Laminate patterns are not available with the short grain direction option.

Make a sketch of the grain direction for adjacent worksurfaces to ensure they are suitable for your installation.

Please refer to the illustrations below for an understanding of grain direction on your installation.

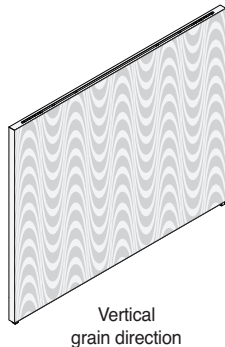
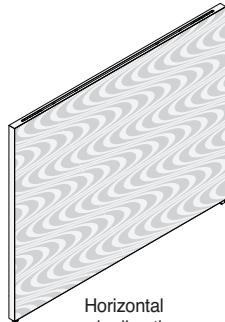

Panels can be specified in horizontal or vertical grain for laminate, composite veneer, or wood veneer.

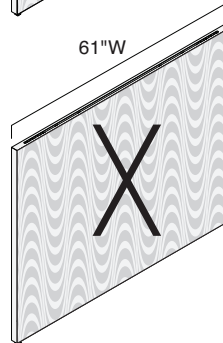
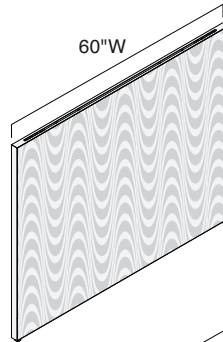

For directional laminates on panels, horizontal and vertical grain direction are available when the width is up to and including 60". When the width is greater than 60", only horizontal grain direction is allowed.

Aisla Panels

Aisla is a product line that looks and feels like a custom product, scaled to the quality and quantity of Steelcase yet is designed for a broad range of applications.
 ▶ Specifying, pages 48–84

Integrated glass, available as an option, has a height of 10" or 12".

Panel width is available parametrically from 18"–96.5" in 1/16" increments.

Panels have a wood core with a composite veneer, wood veneer, or laminate surface.

Panels have a 1 mm edge band on the top of the panel for visual aesthetics, and a 3 mm edge band on the side for durability.

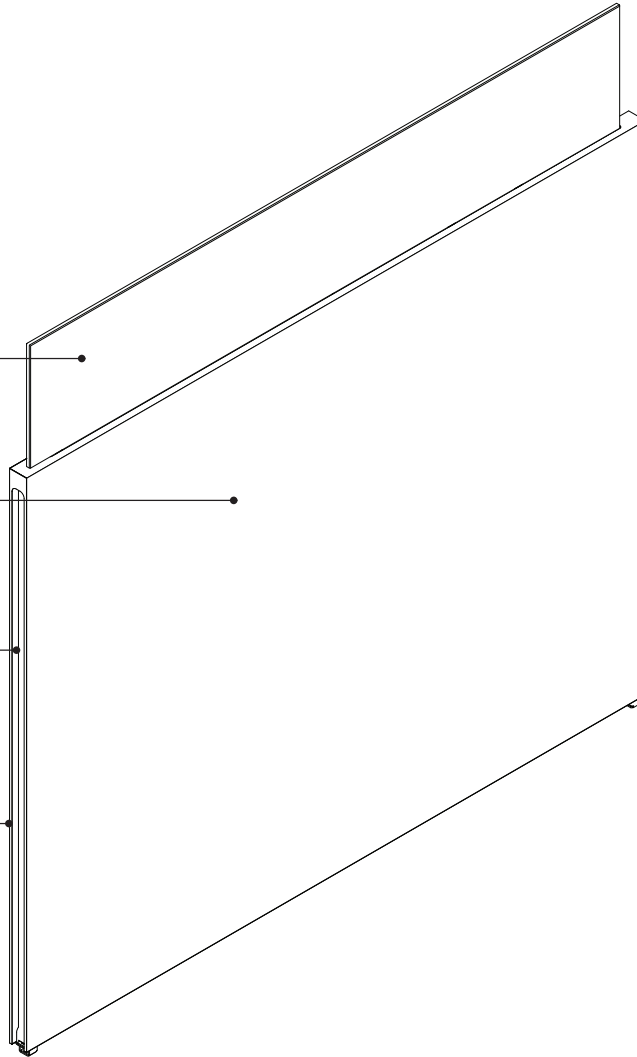

Actual Dimensions

Height	42" or 48"
Panel Width	Parametric from 18"–96.5" in 1/16" increments Spanning panel only parametric from 36"–61"W in 1/16" increments
Panel Thickness	1.5" nominal 1.6" High-Pressure Laminate 1.58" veneer

Product Details

18"W–96.5"W

42"H
and
48"H

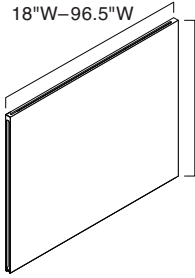

Panels are available in 42" or 48" modular heights, and 18"–96.5" parametric widths in 1/16" increments.
*Tip: Parametric width range for spanning panel **PNLSPNFF** is 36"–61"W in 1/16" increments.*

Panels can be planned in multiple different configurations. Three benchmark configurations are:

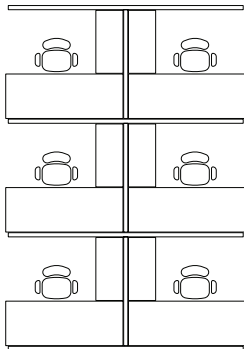

User and worksurface parallel to spine: benching application, with worksurface running along the spine, storage is perpendicular to spine.

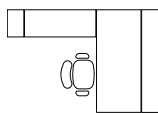
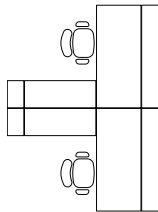

User and worksurface outward facing: generally with a transaction top and in a reception station.
Tip: Aisla can be planned in many different configurations, utilize SmartTools to find planning ideas and planning rules for all configuration needs.

User and worksurface perpendicular to spine: Aisla storage running along the spine.

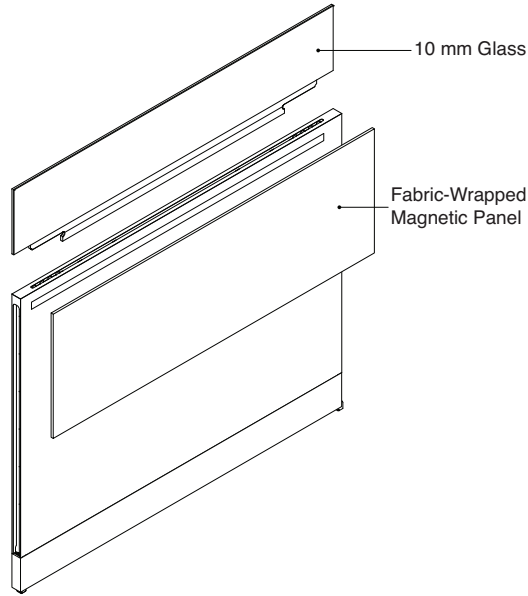
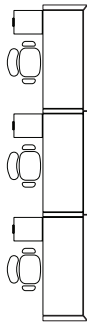
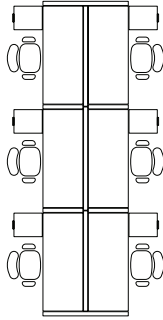

Glass is available as an option in 10" or 12" height on all panels 30"W and above.

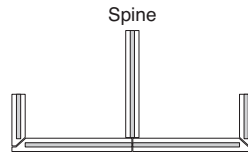

Glass is inset on miter corners or T connections. On inline panel connections, glass is touching via bumper.
Tip: Bumper styles and quantities automatically come with panel with T or inline connections and glass options in SmartTools to align glass between panels.

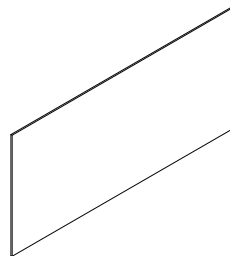

Fabric-wrapped magnetic panel is a thin steel panel wrapped in fabric to add texture and personalization to a workstation. Offered in standard vertical grade fabrics. Fabric is offered in vertical or horizontal direction.
Tip: When specifying with SmartTools, magnetic panels will snap to appropriate height and width when storage, height-adjustable desk, and panels are placed.
▶ See Migration Desking Collection in *Height-Adjustable Desks Specification Guide*.

Tip: Rare earth magnetics recommended on steel accent panel for trackability.

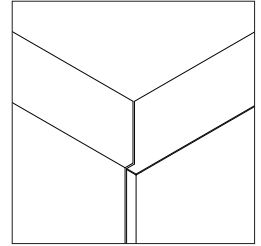
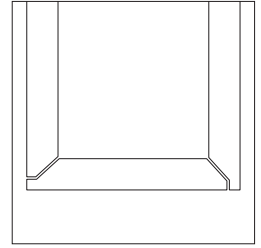

Miter matchstick corner can be specified on the panel, either on side 1 or side 2.

Optional fabric magnetic panel can be added to all the surrounding powered and non-powered panels.

Common customer supplied materials for bring your own material bracket:

Panel Width (inches)	Max Weight of COM Top (pounds)	1/2" Brass (pounds)	1/2" Glass (pounds)	1/2" Granite (pounds)	1/2" Marble (pounds)
30"	65.3	45.6	13.5	15.8	14.1
33"	55	50.2	14.9	17.3	15.5
36"	100.8	54.7	16.3	18.9	16.9
39"	90.5	59.3	17.6	20.5	18.3
42"	80.2	63.8	19	22.1	19.7
45"	69.9	68.4	20.3	23.6	21.2
48"	115.7	73	21.7	25.2	22.6
51"	105.4	77.5	23	26.8	24
54"	95.1	82.1	24.4	28.4	25.4
57"	84.8	86.6	25.7	29.9	26.8
60"	74.5	91.2	27.1	31.5	28.2
63"	232.4	95.8	28.4	33.1	29.6
66"	222.1	100.3	29.8	34.7	31
69"	211.8	104.9	31.2	36.2	32.4
72"	201.5	109.4	32.5	37.8	33.8
75"	191.2	114	33.9	39.4	35.3
78"	180.9	118.6	35.2	41	36.7
81"	170.7	123.1	36.6	42.5	38.1
84"	272.5	127.7	37.9	44.1	39.5
87"	262.2	132.2	39.3	45.7	40.9
90"	251.9	136.8	40.6	47.3	42.3
93"	241.6	141.4	42	48.8	43.7
96"	231.3	145.9	43.3	50.4	45.1

Tip: This bracket is not a Customer's Own Material bracket. Steelcase only provides the bracket in the specified finish, but is not involved in the material selection process. The material of the bracket is chosen by the customer, as long as it is under the weight limit.

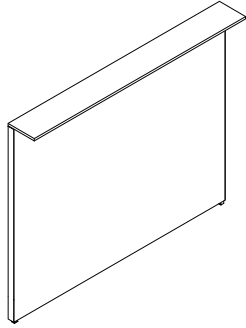

Transaction top is available on panels 30"W and above and comes in High-Pressure Laminate, composite veneer, wood veneer, and brackets and hardware for customer supplied material. Bring your own material bracket can accept any material if it is below the weight limit – example materials noted.



Horizontal grain direction

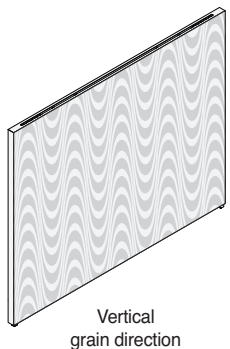

Vertical grain direction

Panels can be specified in horizontal or vertical grain for laminate, composite veneer, or veneer.

Tip: For directional laminates, horizontal and vertical grain direction are available when the width is up to and including 60". When the width is greater than 60", only horizontal grain direction is allowed.

Surface Materials

- Panel**
- Laminate
 - Composite veneer
 - Wood veneer
 - Open Line laminate (OLL)
 - Customiz stain

- Integrated glass top**
- 6500 Clear
 - 6501 Low Iron Clear
 - 6562 Bronze
 - 6563 Smoke

- Transaction top**
- Laminate
 - Composite veneer
 - Wood veneer
 - Open Line laminate (OLL)
 - Customiz stain

- Edge on laminate transaction top**
- Plastic

- Bracket on transaction top**
- Paint

Aisla Powered Panels

Aisla is a product line that looks and feels like a custom product, scaled to the quality and quantity of Steelcase yet is designed for a broad range of applications.
 ▶ Specifying, pages 88–128

Powered panel width is available in 6" increments starting at 60.5" up to 96.5".

Powered panels have a 1 mm edge band on the top of the panel for visual aesthetics, and a 3 mm edge band on the side for durability.

Powered panels are 1½" thick and can route power in the panel across a floor plan.

Powered panels have a wood core with a composite veneer, wood veneer, or laminate surface.

Panel shown is finished to floor, single sided power panel.

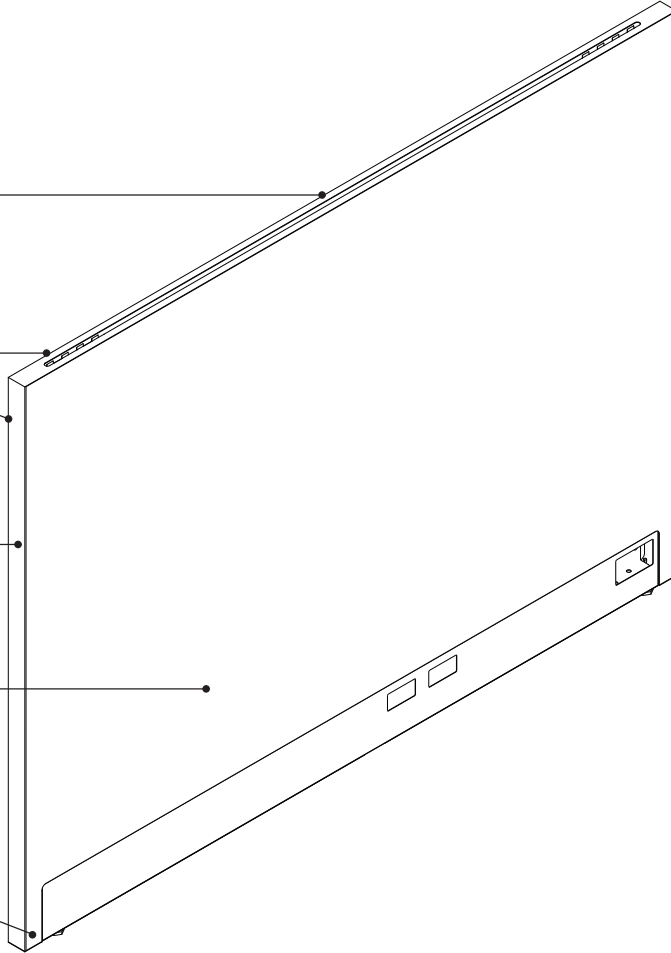

Actual Dimensions

Power Options	Dual sided — power expressed on both sides, base trim on both sides
	Single sided — power expressed on one side, base trim on both sides
	Finished to floor (aisle sided) — power expressed on both sides, base trim on one side, laminate, composite veneer, or wood veneer finished-to-floor on one side
Height	42" or 48"
Panel Width	60.5", 66.5", 72.5", 78.5", 84.5", 90.5", 96.5"
Panel Thickness	1.5" nominal
	1.6" High-Pressure Laminate
	1.58" veneer

Product Details

60.5"W–96.5"W

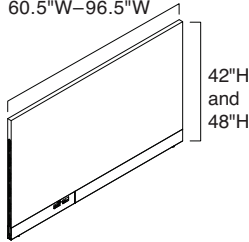

Panels are available in 42" or 48" modular heights, and 60.5"–96.5" modular widths in 6" increments.

Panels and powered panels can be planned in multiple different configurations. Three benchmark configurations are:

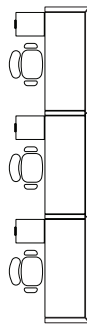
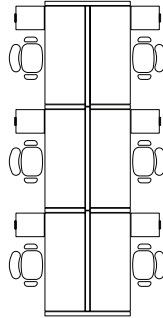
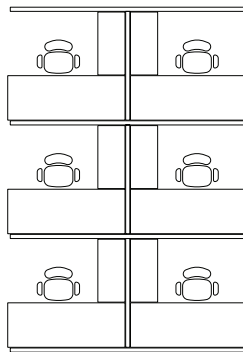

User and workspace parallel to spine: benching application, with worksurface running along the spine, storage is perpendicular to spine.

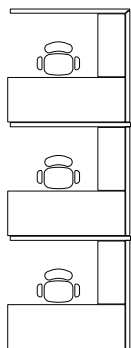

User and workspace perpendicular to spine: Aisla storage running along the spine.

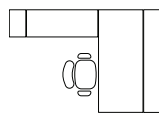
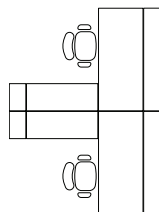

User and workspace outward facing: generally with a transaction top and in a reception station. *Tip: Aisla can be planned in many different configurations, utilize SmartTools to find planning ideas and planning rules for all configuration needs.*

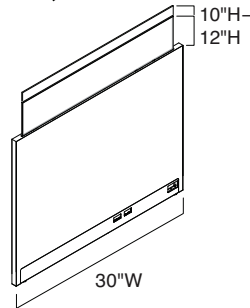
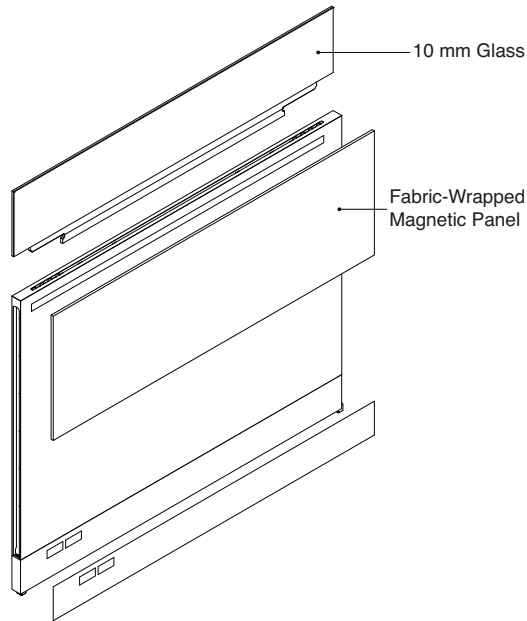

Glass is available as an option in 10" or 12" height on all panels 30"W and above.

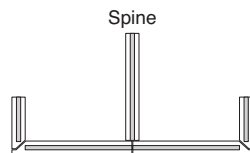

Glass is inset on miter corners or T connections. On inline panel connections, glass is touching via bumper. *Tip: Bumper styles and quantities automatically come with panel with T or inline connections and glass options in SmartTools to align glass between panels.*

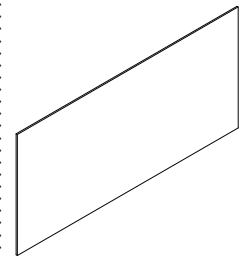

Fabric-wrapped magnetic panel is a thin steel panel wrapped in fabric to add texture and personalization to a workstation. Offered in standard vertical grade fabrics. Fabric is offered in vertical or horizontal direction.

Tip: When specifying with SmartTools, magnetic panels will snap to appropriate height and width when storage, height-adjustable desk, and panels are placed.

▶ See Migration Desking Collection in Height-Adjustable Desks Specification Guide.

Tip: Rare earth magnetics recommended on steel accent panel for trackability.

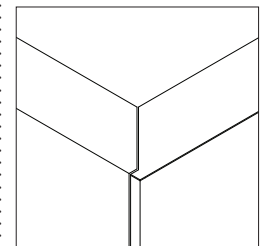
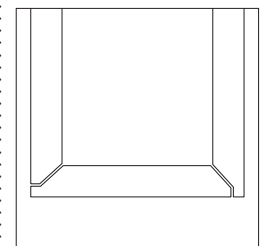

Miter matchstick corner can be specified on the panel, either on side 1 or side 2.

Optional fabric magnetic panel can be added to all the surrounding powered and non-powered panels.

Common customer supplied materials for bring your own material bracket:

Panel Width (inches)	Max Weight of COM Top (pounds)	1/2" Brass (pounds)	1/2" Glass (pounds)	1/2" Granite (pounds)	1/2" Marble (pounds)
30"	65.3	45.6	13.5	15.8	14.1
33"	55	50.2	14.9	17.3	15.5
36"	100.8	54.7	16.3	18.9	16.9
39"	90.5	59.3	17.6	20.5	18.3
42"	80.2	63.8	19	22.1	19.7
45"	69.9	68.4	20.3	23.6	21.2
48"	115.7	73	21.7	25.2	22.6
51"	105.4	77.5	23	26.8	24
54"	95.1	82.1	24.4	28.4	25.4
57"	84.8	86.6	25.7	29.9	26.8
60"	74.5	91.2	27.1	31.5	28.2
63"	232.4	95.8	28.4	33.1	29.6
66"	222.1	100.3	29.8	34.7	31
69"	211.8	104.9	31.2	36.2	32.4
72"	201.5	109.4	32.5	37.8	33.8
75"	191.2	114	33.9	39.4	35.3
78"	180.9	118.6	35.2	41	36.7
81"	170.7	123.1	36.6	42.5	38.1
84"	272.5	127.7	37.9	44.1	39.5
87"	262.2	132.2	39.3	45.7	40.9
90"	251.9	136.8	40.6	47.3	42.3
93"	241.6	141.4	42	48.8	43.7
96"	231.3	145.9	43.3	50.4	45.1

Tip: This bracket is not a Customer's Own Material bracket. Steelcase only provides the bracket in the specified finish, but is not involved in the material selection process. The material of the bracket is chosen by the customer, as long as it is under the weight limit.

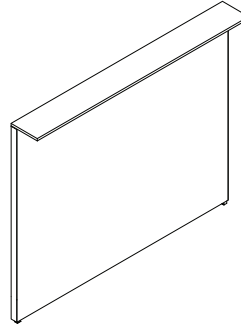

Transaction top is available on panels 30"W and above and comes in High-Pressure Laminate, composite veneer, wood veneer, and brackets and hardware for customer supplied material. Bring your own material bracket can accept any material if it is below the weight limit - example materials noted.

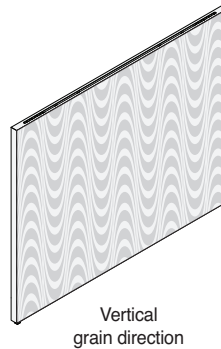
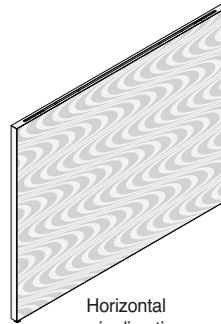

Panels can be specified in horizontal or vertical grain for laminate, composite veneer, or veneer.

Tip: For directional laminates, horizontal and vertical grain direction are available when the width is up to and including 60". When the width is greater than 60", only horizontal grain direction is allowed.

Power base trims are specified with powered panels. Power kits including power blocks (receptacle holders) and connectors (connecting power blocks to harnesses) are specified separately. Utilize SmartTools for easy specifying.

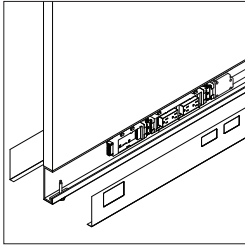

Dual and single sided power

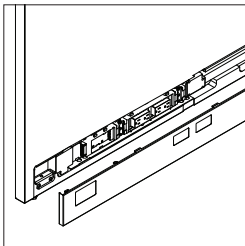

Finished to floor (aisle sided) power

Power is integrated into the base of the panel. Two duplex receptacles are available per workstation. Power is offered on panels in:

- Dual sided — power expressed on both sides, base trim on both sides
- Single sided — power expressed on one side, base trim on both sides
- Aisle side — power expressed both sides, base trim on one side, and laminate, composite veneer, or wood veneer finished-to-floor one side

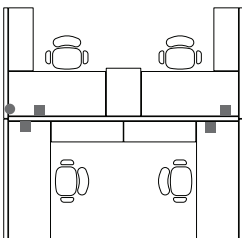

- = Infeed
- = Power block

Power blocks are configured to deliver contrasting functionalities. They are not sequential; instead, they operate in a complementary manner to achieve equilibrium across the system.

Surface Materials

Panel

- Laminate
- Composite veneer
- Wood veneer
- Open Line laminate (OLL)
- Customiz stain

Integrated glass top

- 6500 Clear
- 6501 Low Iron Clear
- 6562 Bronze
- 6563 Smoke

Transaction top

- Laminate
- Composite veneer
- Wood veneer
- Open Line laminate (OLL)
- Customiz stain

Edge on laminate transaction top

- Plastic

Bracket on transaction top

- Paint

Trim

- Paint

Duplex finish to floor (A height) receptacle

- 6000 Black

Duplex (C height) receptacle

- 6000 Black
- 6009 Arctic White
- 6249 Platinum Solid
- 6651 Tungsten
- 6652 Titanium
- 6654 Sand
- 6697 Fog
- 6B03 Red

Wiring Schematics

Details for the Electrician

Aisla offers two different wiring schematics to allow you to match your specific wiring strategy to any typical building wiring plan.

Tip: All the components in an electrical system must use the same wiring schematic. The components are keyed and color coded to make it impossible to connect mismatched parts.

Black = Four-circuit, 3+1

Brown = Four-circuit, 2+2

Shared neutrals = 10 gauge

Non-shared neutrals = 12 gauge

Hot wires = 12 gauge

Four-Circuit, 3+1

Circuit Panel 1

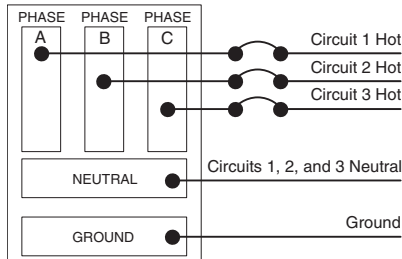

Circuit Panel 2

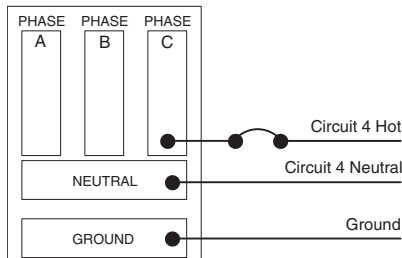

In the four-circuit 3+1 schematic, circuits 1, 2, and 3 are distributed from the first circuit panel and are supported with one shared neutral and one shared ground. Circuit 4 is distributed from a second circuit panel and is supported with a separate neutral and ground.

Single 3-Phase

Circuit Panel

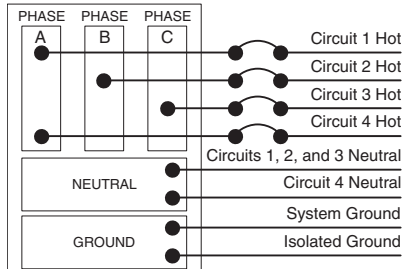

On a single 3-phase circuit panel, all four circuits are distributed as shown.

Four-Circuit, 2+2

Circuit Panel 1

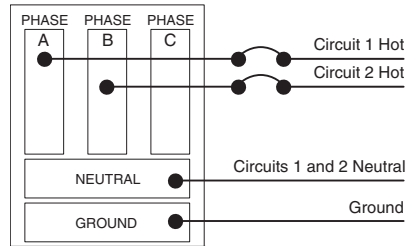

Circuit Panel 2

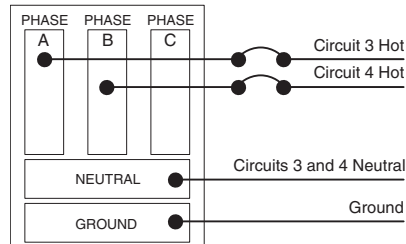

In the four-circuit 2+2 schematic, circuits 1 and 2 are distributed from two different phases from the first circuit panel and are supported with one shared neutral and one shared ground. Circuits 3 and 4 are distributed from a second circuit panel and supported by their own shared neutral and ground.

Single 3-Phase

Circuit Panel

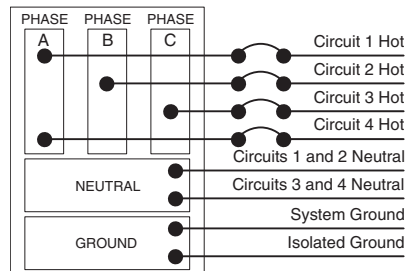

On a single 3-phase circuit panel, all four circuits are distributed as shown.

Split-Phase

Circuit Panel

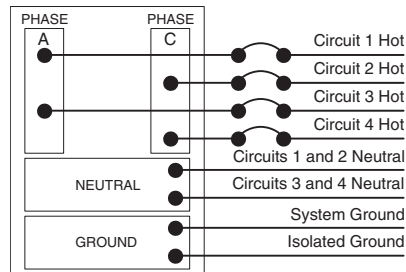

On a split-phase circuit panel, all four circuits are distributed as shown.

Special Requirements for Chicago

	Chicago Code	Specification:	Electrician will supply:
Panel Requirements Chicago code requires hardwiring of all electrical components.	Panel must be hardwired in the field. Electrician hardwires all receptacle boxes and conduits into panel bases in the field. <i>Tip: Panel depth prohibits use of standard device boxes for back-to-back receptacles in Chicago.</i>	<ul style="list-style-type: none">• Order panels with Chicago power option. <i>Tip: Chicago code doesn't require a special base cover with different receptacle locations.</i>• Receptacles in Chicago are supplied by electrician. <i>Tip: These panels only have one power location on each side, so these panels can accommodate two duplexes per side.</i>	<ul style="list-style-type: none">• Connection to building power supply• Wires• Fittings• Duplex receptacle (Leviton 5325-Decora style)• Electrical components

Aisla Fabric-Wrapped Magnetic Panel

Aisla fabric-wrapped magnetic panel is a thin steel panel wrapped in fabric to add texture and personalization to a workstation.

► Specifying, page 130

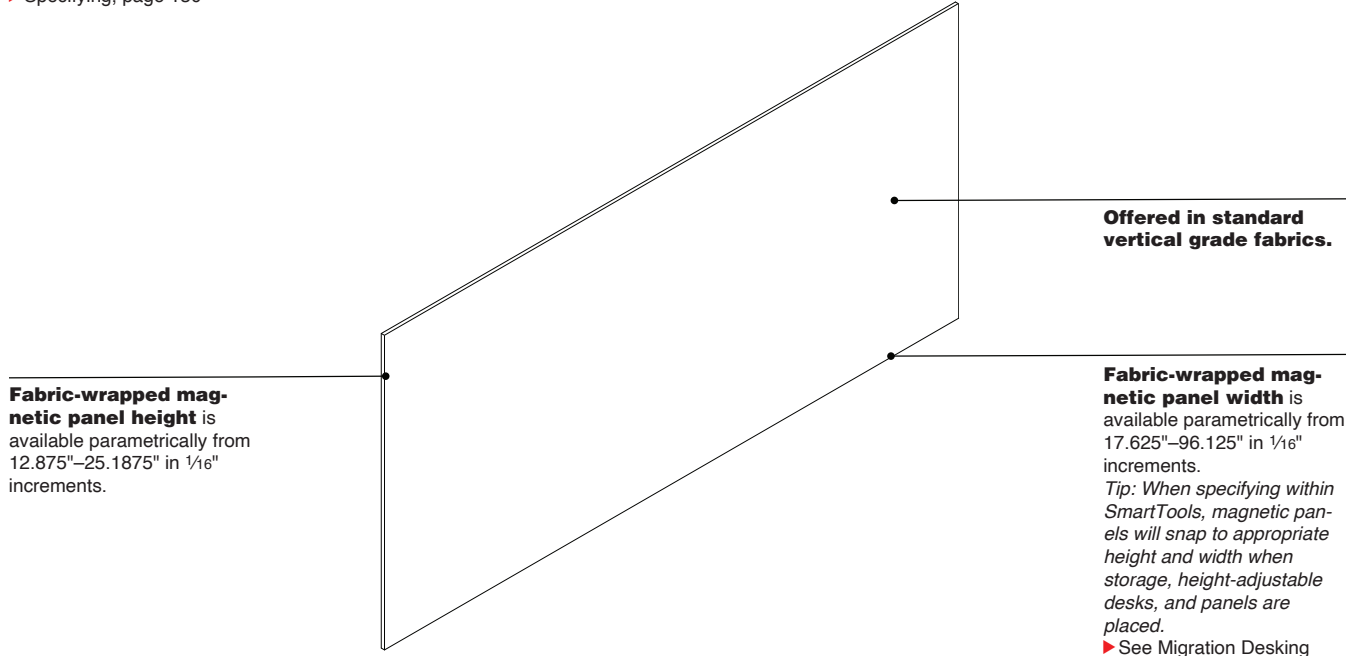

Fabric-wrapped magnetic panel height is available parametrically from 12.875"–25.1875" in 1/16" increments.

Offered in standard vertical grade fabrics.

Fabric-wrapped magnetic panel width is available parametrically from 17.625"–96.125" in 1/16" increments.

Tip: When specifying within SmartTools, magnetic panels will snap to appropriate height and width when storage, height-adjustable desks, and panels are placed.

► See Migration Desking Collection in *Height-Adjustable Desks Specification Guide*.

Actual Dimensions

Height	Parametric from 12.875"–25.1875" in 1/16" increments
Panel Width	Parametric from 17.625"–96.125" in 1/16" increments
Panel Thickness	1/4"

Aisla Cabinets

Aisla storage offering

will enrich the workstation with features that elevate the product experience.

► Specifying, page 132

Top detail is available in top over front or front over top configurations. Shown with front over top.

Mirror, available as an option, is 5⁷/₂₀"W x 15¹/₂"H.

Cabinets have left- or right-hinged door configurations.

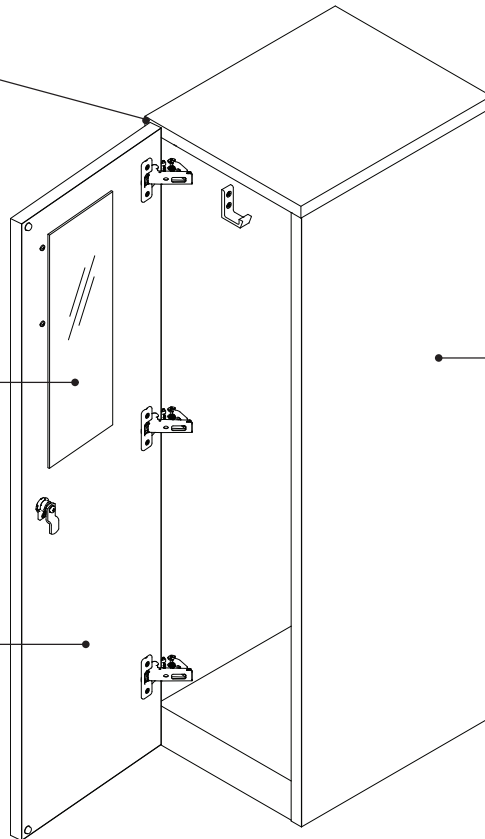

Cabinets are available in composite veneer, wood veneer, or laminate finishes.

Product Details

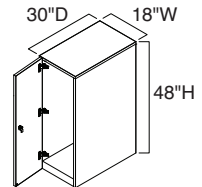
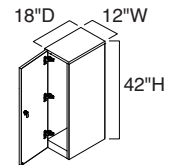

Aisla cabinets come in 42" or 48" heights, 18" or 30" depths, and 12" or 18" widths.

Tip: Cabinets must be attached to adjacent storage or panel for stability.

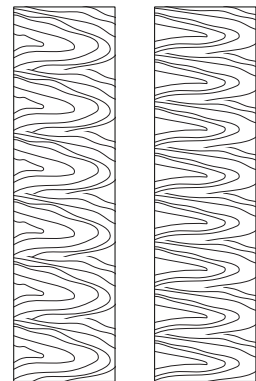

When specifying veneer cabinet headsets in vertical grain, the type of veneer you select will determine the cathedrals selected. Planked, rift cut, and quarter cut will all be acceptable. Flat cut will provide smaller 6"–8" cathedrals.

Actual Dimensions

Depth	18" or 30"
Width	12" or 18"
Height	42" or 48"

18"D Cabinets

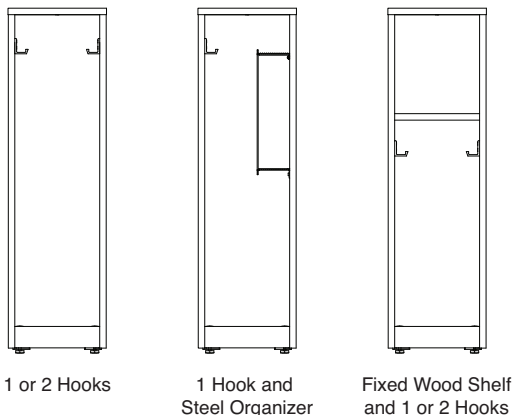

Interior configuration options for 18"D cabinets are hooks, steel organizer, and fixed wood shelf with hooks. Steel organizer is always placed opposite of the door.

30"D Cabinets

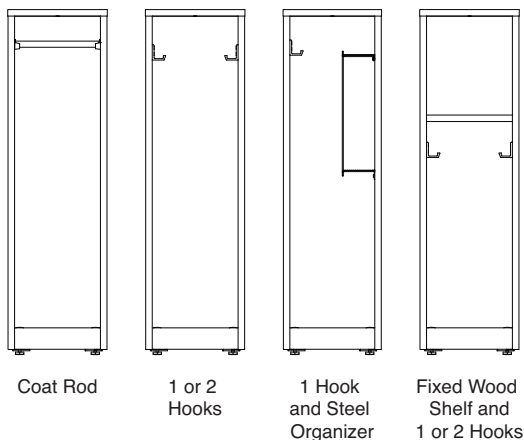

Interior configuration options for 30"D cabinets are: coat rod, hooks, steel organizer, and fixed wood shelf with hooks. Steel organizer is always placed opposite of the door.

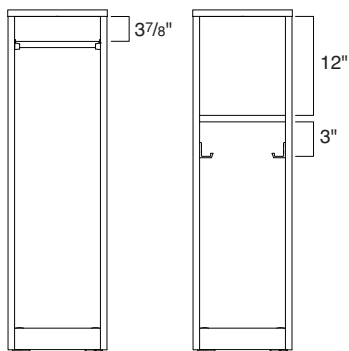

Coat rod is centered 37/8" below top panel. Shelf is always 12" below the top panel, and coat hooks are 3" below shelf.

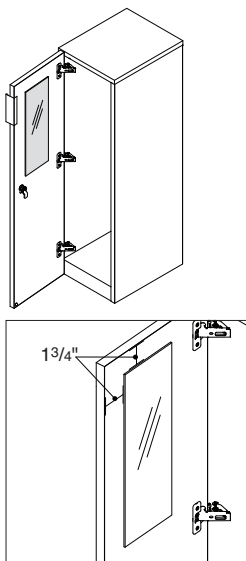

Mirror, available as an option on cabinets, is 57/20"W x 15 1/2"H and offset 1 3/4" from the cabinet door to accommodate pull fasteners.

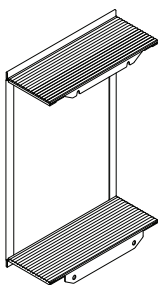

Cabinet organizer can be specified for cabinet interior. It is steel painted in 7360 Merle, and lined with Designtex Wannabe Rib Slate 5622-803.

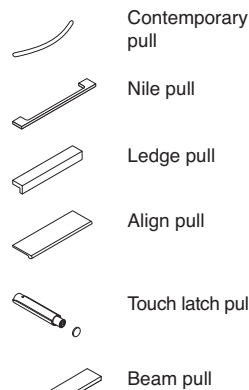

Pull options on cabinets are: contemporary, Nile, ledge, align, touch latch, and beam.

Surface Materials

- Top**
 - Laminate
 - Composite veneer
 - Wood veneer
 - Open Line laminate (OLL)
 - Customiz stain
- Case**
 - Laminate
 - Composite veneer
 - Wood veneer
 - Open Line laminate (OLL)
 - Customiz stain
- Headset**
 - Laminate
 - Composite veneer
 - Wood veneer
 - Open Line laminate (OLL)
 - Customiz stain

- Organizer**
 - 7360 Merle
- Lock**
 - 9201 Polished Chrome
 - 9250 Ember Chrome

- Contemporary pull**
 - 4803 Near Black Metallic
 - 7241 Arctic White
 - 7278 Dark Bronze
 - 7280 Smooth Bronze
 - 8043 Clear Anodized Aluminum
 - 9201 Polished Chrome
 - 9211 Nickel
 - 9212 Silver

- Nile pull**
 - 0835 Black
 - 4799 Platinum Metallic
 - 7280 Smooth Bronze
 - 9201 Polished Chrome
 - 9211 Nickel

- Ledge pull**
 - 4799 Platinum Metallic
 - 7207 Black
- Align pull**
 - 0835 Black
 - 4231 Arctic White
 - 4238 Mocha
 - 4239 Clay
 - 4240 Chalk
 - 4242 Milk Smooth
 - 4243 Merle Smooth
 - 4700 Warm White
 - 4728 Nickel Metallic
 - 4799 Platinum Metallic
 - 4803 Near Black Metallic
 - 4858 Seagull
 - 4B20 Obsidian
 - 4B22 Matte Brass
 - 4B23 Burnished Bronze
 - 4B24 Night Bronze
 - 4B25 Matte Copper
 - 4B26 Smoked Mica
 - 7241 Arctic White
 - 7278 Dark Bronze
 - 7280 Smooth Bronze
 - 8043 Clear Anodized Aluminum
- Beam pull**
 - 4728 Nickel Metallic
 - 4803 Near Black Metallic
 - 7241 Arctic White
 - 7278 Dark Bronze
 - 8043 Clear Anodized Aluminum

HIU Storage Style Number Logic

HIU storage and accessories style list:

Style Number	Style Description
WPCD15HIUBFPL	Credenza—1.5H HIU/BF Lateral File, Parallel, Right Hand
WPCD15BFHIUPL	Credenza—1.5H BF Lateral File/HIU, Parallel, Left Hand
WPCD15HIUBFBFPL	Credenza—1.5H HIU/BF Lateral File/BF Lateral File, Parallel, Right Hand
WPCD15BFBFHIUPL	Credenza—1.5H BF Lateral File/BF Lateral File/HIU, Parallel, Left Hand
WPCD15HIUBFPP	Credenza—1.5H HIU/BF Lateral File, Perpendicular, Right Hand
WPCD15BFHIUPP	Credenza—1.5H BF Lateral File/HIU, Perpendicular, Left Hand
WPCD15HIUBFBFPP	Credenza—1.5H HIU/BF Lateral File/BF Lateral File, Perpendicular, Right Hand
WPCD15BFBFHIUPP	Credenza—1.5H BF Lateral File/BF Lateral File/HIU, Perpendicular, Left Hand
WPHIU1HPLRH	Low Storage—1H HIU, Parallel, Right Hand
WPHIU1HPLLH	Low Storage—1H HIU, Parallel, Left Hand
WPHIU15HPLRH	Low Storage—1.5H HIU, Parallel, Right Hand
WPHIU15HPLLH	Low Storage—1.5H HIU, Parallel, Left Hand
WPHIU1HPPRH	Low Storage—1H HIU, Perpendicular, Right Hand
WPHIU1HPP LH	Low Storage—1H HIU, Perpendicular, Left Hand
WPHIU15HPPRH	Low Storage—1.5H HIU, Perpendicular, Right Hand
WPHIU15HPP LH	Low Storage—1.5H HIU, Perpendicular, Left Hand
WPDRLIN	Storage Drawer Liner
WPPNTR	Storage Pencil Tray
WPPRTR	Storage Paper Tray

WPCD15BFIUPL

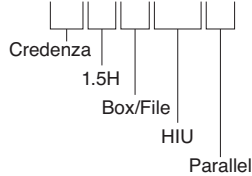

Style numbers are read left to right, highlighting the configuration type.

Aisla HIU Storage

Aisla offers fully integrated 1.5H HIU (height-adjustable integrated unit) credenzas and HIU low storage.

► Specifying, pages 136–162

All HIU storage has both left and right hand versions. Configurations shown here are right handed.

Integrated storage credenza is 18"D, HIU is always 30.5"W, and the storage component is available in box/file configurations from 54"–96½"W.

Soft close drawers are standard on credenzas.

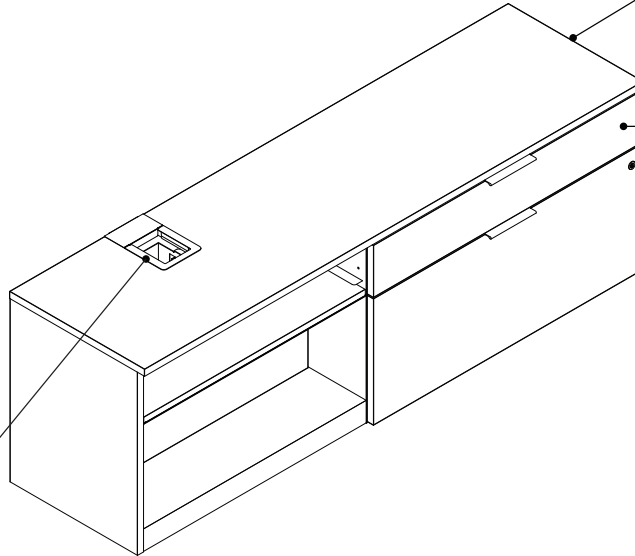

Aisla storage integrates with Migration Pro height-adjustable desks and Slim Leg HAD.

► See Migration Desking Collection in *Height-Adjustable Desks Specification Guide*.

► See Slim Leg HAD in *Currency Specification Guide*.

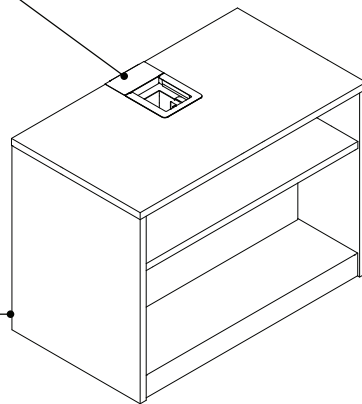

HIU low storage is available in 1H and 1.5H, blending with basic and extended height desks, and is compatible with Currency credenza for combined applications.

Plinth base on all storage has 5/8" clearance to floor for cables.

Actual Dimensions

	HIU Credenzas	HIU Low Storage
Depth	18"	18"
Width	54", 54.5", 60", 60.5", 66", 66.5", 72", 72.5", 78", 78.5", 84", 84.5", 90", 90.5", 96", 96.5"	30" or 30.5"

Product Details

Aisla storage can be planned in two configurations:

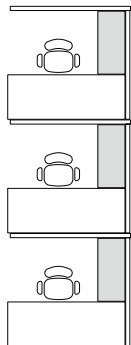
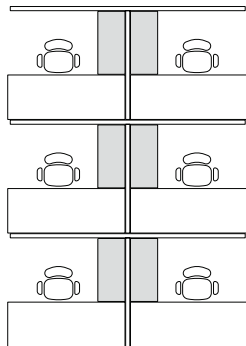

Parallel HIU credenzas and low storage

for parallel to the spine application planning.

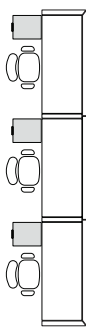
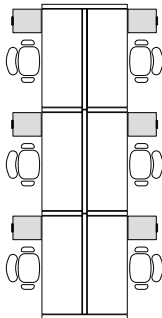

Perpendicular HIU credenzas and low storage for perpendicular to the spine application planning.

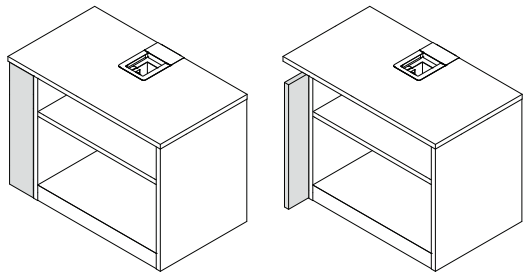

Perpendicular storage has a hinged power access panel on the HIU that allows for easy access to duplex receptacles and infeeds on the spine.

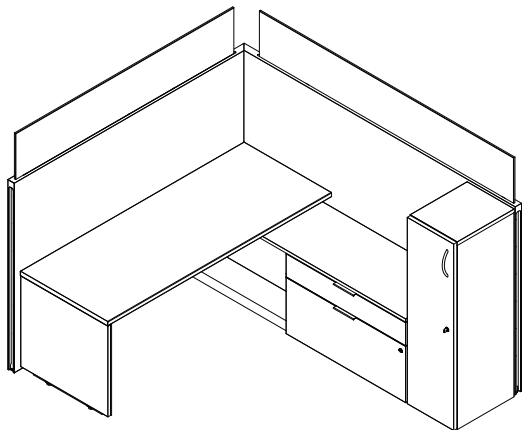

Aisla credenzas and low storage are designed to integrate seamlessly with the Slim Leg HAD lift column. Slim Leg HAD provides an elevated aesthetic where a visible height-adjustable desk leg is undesirable. This is a premium option in the open plan and complements the design of Aisla panels and storage, creating a highly aesthetic workstation. ▶ See Slim Leg HAD in *Currency Specification Guide*.

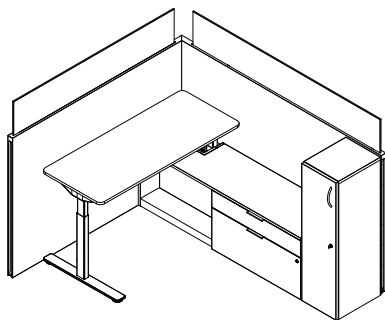

Basic Height Migration Pro Desk

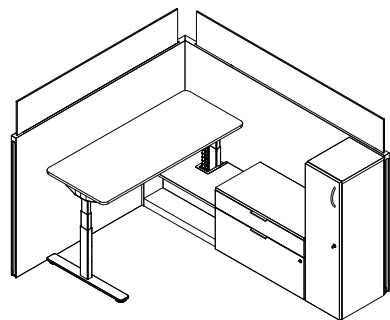

Extended Height Migration Pro Desk

The Migration collection of height-adjustable desks pairs as a standard solution with Aisla panels and storage. Migration height-adjustable desks provide more design flexibility with a painted base.

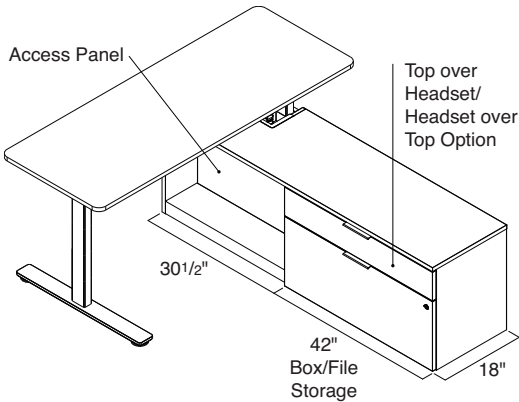

For Aisla HIU integration, both basic and extended height Migration Pro desks can be specified, as it features 1"H storage to accommodate for the extra low seated height that the extended height desk provides.

▶ See Migration Desking Collection in *Height-Adjustable Desks Specification Guide*.

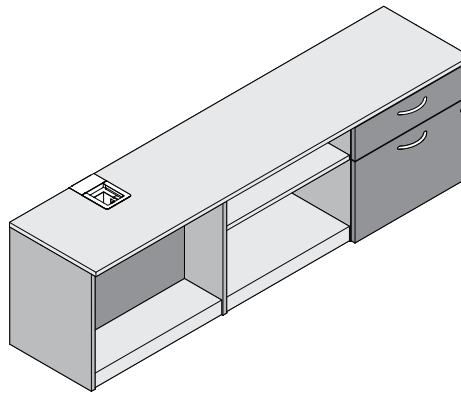

HIU credenza is 18"D, HIU is always 30.5"W, and the storage component is flexing to any size box/file configuration between 54"-96.5"W. Largest drawer size for box/file storage is 42", having a partition added for above 42".



-  = Top Grain Direction
-  = Case Grain Direction
-  = Headset Grain Direction

Grain direction can be specified separately for top, case, and headset.

To receive the same filch of veneer in an application, utilize the office set option available in Hedberg or SmartTools to place a number to the styles in the same application. Styles will receive the veneer from the same filch, providing a cohesive application.

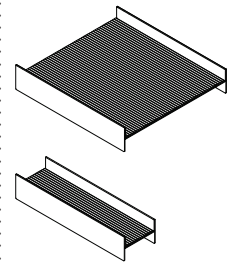

Paper and pencil trays are available as optional accessories. Steel painted in 7360 Merle and lined with Designtex Wannabe Rib Slate 5622-803.

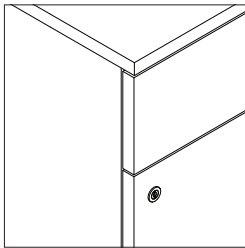



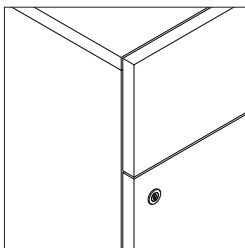

Top over front



Front over top

Aisla storage offers an option to have storage drawer fronts to be top over front or front over top. This is available on all storage, except for stand-alone HIU.

-  Contemporary pull
-  Nile pull
-  Ledge pull
-  Align pull
-  Beam pull

Pull options on HIU credenzas are: contemporary, Nile, ledge, align, and beam. Aisla is introducing the new align pull into the offering for a sleek new design that is ADA compliant.

Locks are available in polished chrome and ember chrome. Options for lock are keyed random, key plug only, master key random, master key plug, and no lock.

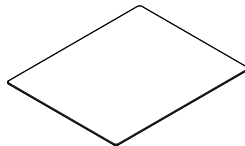

Drawer liners are included in price of HIU credenza for box drawers and can be deducted as an option. The liner is a sturdy metal sheet wrapped in 5H20 Billiard Cloth for a streamlined internal visual across all box drawers.

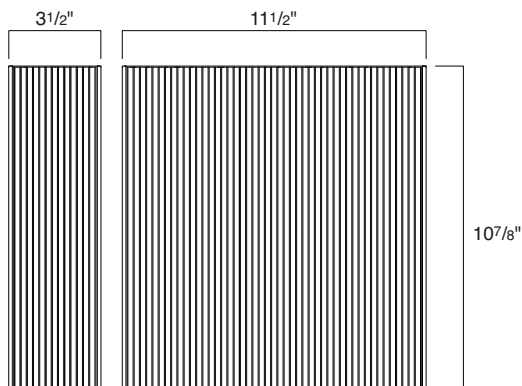

Pencil and paper trays are both 10 7/8" in length. Paper tray has a width of 11 1/2" and pencil tray is 3 1/2"W.

Drawers are full depth and measure 13.425" front to back. Internal dimension of the drawer is 12.339".

Soft close drawers are standard on all Aisla storage credenzas.

Undermount slides on drawers are standard on all drawers for clean aesthetic.

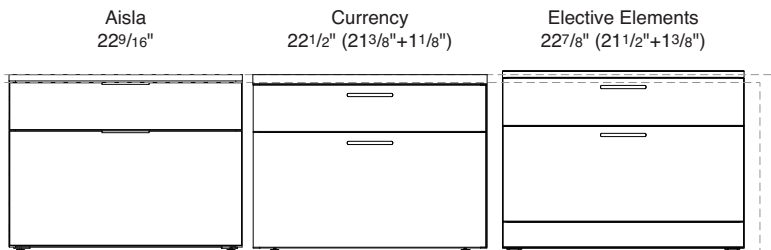

Aisla storage datums fall above Currency and below Elective Elements, but are glide adjustable to match alignment.

Surface Materials

Top

- Laminate
- Composite veneer
- Wood veneer
- Open Line laminate (OLL)
- Customiz stain

Case

- Laminate
- Composite veneer
- Wood veneer
- Open Line laminate (OLL)
- Customiz stain

Headset

- Laminate
- Composite veneer
- Wood veneer
- Open Line laminate (OLL)
- Customiz stain

Edge on laminate top

- Plastic

Contemporary pull

- 4803 Near Black Metallic
- 7241 Arctic White
- 7278 Dark Bronze
- 7280 Smooth Bronze
- 8043 Clear Anodized Aluminum
- 9201 Polished Chrome
- 9211 Nickel
- 9212 Silver

Nile pull

- 0835 Black
- 4799 Platinum Metallic
- 7280 Smooth Bronze
- 9201 Polished Chrome
- 9211 Nickel

Ledge pull

- 4799 Platinum Metallic
- 7207 Black

Align pull

- 0835 Black
- 4231 Arctic White
- 4238 Mocha
- 4239 Clay
- 4240 Chalk
- 4242 Milk Smooth
- 4243 Merle Smooth
- 4700 Warm White
- 4728 Nickel Metallic
- 4799 Platinum Metallic
- 4803 Near Black Metallic
- 4858 Seagull
- 4B20 Obsidian
- 4B22 Matte Brass
- 4B23 Burnished Bronze
- 4B24 Night Bronze
- 4B25 Matte Copper
- 4B26 Smoked Mica
- 7241 Arctic White
- 7278 Dark Bronze
- 7280 Smooth Bronze
- 8043 Clear Anodized Aluminum

Beam pull

- 4728 Nickel Metallic
- 4803 Near Black Metallic
- 7241 Arctic White
- 7278 Dark Bronze
- 8043 Clear Anodized Aluminum

Lock

- 9201 Polished Chrome
- 9250 Ember Chrome

Drawer liner

- 5H20 Billiard Cloth

Paper and pencil tray

- 7360 Merle



Specifying

Aisla Panels	48
Aisla Powered Panels	88
Aisla Fabric-Wrapped Magnetic Panel	130
Aisla Cabinets	132
Aisla HIU Storage	136

Aisla Panels—Free

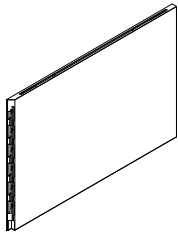

► Need help?
Product details,
page 26

Standard Includes

- Panel—free: High-Pressure Laminate price group 1
- 1 mm top edge band
- 3 mm side edge band
- Transaction top, if selected: High-Pressure Laminate price group 1
- Transaction top edge, if selected: plastic
- Transaction top bracket, if selected: paint price group 1
- Glass insert, if selected: glass price group 1

Required to Specify

- 1 Style number
 - 2 Width (see below under Required Selections)
 - 3 Height (see below under Required Selections)
 - 4 Connection—end A (see below under Required Selections)
 - 5 Connection—end B (see below under Required Selections)
 - 6 High-Pressure Laminate color for panel
 - 7 Glass color number for glass insert, if selected
 - 8 High-Pressure Laminate color for transaction top, if selected
 - 9 Plastic color number for transaction top edge, if selected
 - 10 Paint color number for transaction top bracket, if selected
 - 11 Options, if selected (see below)
- See *Surface Materials*, page 164

Tip: Parametric width (18"W–96.5"W) is available in 1/16" increments.

	Required Selections	U.S. Price	Required to Specify
Width	• 18"–96.5"	Prices at right	Specify width.
Height	• 42" • 48"	Prices at right Prices at right	Specify height. Specify height.
Connection	<p>End A</p> <ul style="list-style-type: none"> • Free • Inline • Spanning • T • Mitered side 1 • Mitered side 2 <p>End B</p> <ul style="list-style-type: none"> • Free • Inline • Spanning • T • Mitered side 1 • Mitered side 2 	<p>No cost</p> <p>+\$ 70</p> <p>+\$ 70</p> <p>+\$100</p> <p>+\$250</p> <p>+\$250</p> <p>No cost</p> <p>+\$ 70</p> <p>+\$ 70</p> <p>+\$100</p> <p>+\$250</p> <p>+\$250</p>	<p>Specify with end A free.</p> <p>Specify with end A inline.</p> <p>Specify with end A spanning.</p> <p>Specify with end A T.</p> <p>Specify with end A mitered side 1.</p> <p>Specify with end A mitered side 2.</p> <p>Specify with end B free.</p> <p>Specify with end B inline.</p> <p>Specify with end B spanning.</p> <p>Specify with end B T.</p> <p>Specify with end B mitered side 1.</p> <p>Specify with end B mitered side 2.</p>

	Options	U.S. Price	Required to Specify
Surface Materials	<p>Panel</p> <ul style="list-style-type: none"> • High-Pressure Laminate price group 1 • High-Pressure Laminate price group 2 • High-Pressure Laminate price group 3 • Open Line laminate (OLL) • Composite veneer group 1 • Composite veneer group 2 • Wood group 1 • Wood group 2 • Wood group 3 • Customiz stain <p>Integrated glass</p> <ul style="list-style-type: none"> • Glass price group 1 • Glass price group 3 • Glass price group 4 	<p>No cost</p> <p>Prices at right</p> <p>Prices at right</p> <p>Prices at right</p> <p>+\$111 plus cost of laminate</p> <p>Prices at right</p> <p>Prices at right</p> <p>Prices at right</p> <p>Prices at right</p> <p>Prices at right</p> <p>Prices at right</p> <p>Prices at right</p> <p>Prices at right</p> <p>Prices at right</p> <p>Prices at right</p> <p>Prices at right</p> <p>Prices at right</p>	<p>Specify laminate color number.</p> <p>Specify laminate color number.</p> <p>Specify laminate color number.</p> <p>► See <i>Surface Materials Reference Manual</i>.</p> <p>Specify composite veneer color number.</p> <p>Specify composite veneer color number.</p> <p>Specify wood color number.</p> <p>Specify wood color number.</p> <p>Specify wood color number.</p> <p>Specify with <i>customiz stain</i>.</p> <p>Specify with 6500 Clear Glass.</p> <p>Specify with 6501 Low Iron Clear Glass.</p> <p>Specify with 6562 Bronze or 6563 Smoke Glass.</p>

► Options, continued on next page

 **For Canadian Pricing**
Multiply U.S. Price by the Canadian price factor.
► See page 1 for details.

► Options, continued from previous page

	Options	U.S. Price	Required to Specify	
Surface Materials, continued	Transaction top			
	• High-Pressure Laminate price group 1	No cost	Specify laminate color number.	
	• High-Pressure Laminate price group 2	Prices at right	Specify laminate color number.	
	• High-Pressure Laminate price group 3	Prices at right	Specify laminate color number.	
	• Open Line laminate (OLL)	+\$111 plus cost of laminate	► See <i>Surface Materials Reference Manual</i> .	
	• Composite veneer group 1	Prices at right	Specify composite veneer color number.	
	• Composite veneer group 2	Prices at right	Specify composite veneer color number.	
	• Wood group 1	Prices at right	Specify wood color number.	
	• Wood group 2	Prices at right	Specify wood color number.	
	• Wood group 3	Prices at right	Specify wood color number.	
• Customiz stain	Prices at right	Specify with <i>customiz stain</i> .		
	Transaction top edge			
	• Plastic	No cost	Specify plastic color number.	
	Transaction top bracket			
	• Paint price group 1	Prices at right	Specify paint color number.	
	• Paint price group 2	Prices at right	Specify paint color number.	
	• Paint price group 3	Prices at right	Specify paint color number.	
Connection T	End A			
	• No T	No cost	Specify with <i>end A no T</i> .	
	• T side 1	No cost	Specify with <i>end A T side 1</i> .	
	• T side 2	No cost	Specify with <i>end A T side 2</i> .	
	• T side 1 and 2	No cost	Specify with <i>end A T side 1 and 2</i> .	
	• T adjacent side 1	No cost	Specify with <i>end A T adjacent side 1</i> .	
	• T adjacent side 2	No cost	Specify with <i>end A T adjacent side 2</i> .	
		End B		
	• No T	No cost	Specify with <i>end B no T</i> .	
	• T side 1	No cost	Specify with <i>end B T side 1</i> .	
• T side 2	No cost	Specify with <i>end B T side 2</i> .		
• T side 1 and 2	No cost	Specify with <i>end B T side 1 and 2</i> .		
• T adjacent side 1	No cost	Specify with <i>end B T adjacent side 1</i> .		
• T adjacent side 2	No cost	Specify with <i>end B T adjacent side 2</i> .		
Mitered Matchstick	End A			
	• No matchstick	No cost	Specify with <i>end A no matchstick</i> .	
	• With matchstick	No cost	Specify with <i>end A matchstick</i> .	
		End B		
	• No matchstick	No cost	Specify with <i>end B no matchstick</i> .	
	• With matchstick	No cost	Specify with <i>end B matchstick</i> .	
Accent Panel	• No panel	No cost	Specify with <i>no panel</i> .	
	• Fabric panel side 1	No cost	Specify with <i>fabric panel side 1</i> .	
	• Fabric panel side 2	No cost	Specify with <i>fabric panel side 2</i> .	
	• Fabric panel side 1 and 2	No cost	Specify with <i>fabric panel side 1 and 2</i> .	
Top Accessory	• No accessory	No cost	Specify with <i>no accessory</i> .	
	• Integrated glass	Prices at right	Specify with <i>integrated glass</i> .	
	• 10"D transaction top side 1	Prices at right	Specify with <i>10"D transaction top side 1</i> .	
	• 10"D transaction top side 2	Prices at right	Specify with <i>10"D transaction top side 2</i> .	
	• Transaction top bracket only side 1	Prices at right	Specify with <i>transaction top bracket only side 1</i> .	
	• Transaction top bracket only side 2	Prices at right	Specify with <i>transaction top bracket only side 2</i> .	
Glass Height	• 10"	Prices at right	Specify glass height.	
	• 12"	Prices at right	Specify glass height.	

Tip: This option is only available when connection end A is inline or T.

Tip: This option is only available when connection end B is inline or T.

Tip: This option is only available when connection end A is mitered.

Tip: This option is only available when connection end B is mitered.

► Options, continued on next page

 **For Canadian Pricing**
 Multiply U.S. Price by the Canadian price factor.
 ► See page 1 for details.

► Options, continued from previous page

Tip: For directional laminates, horizontal and vertical grain direction are available when width is up to and including 60". When width is greater than 60", only horizontal grain direction is allowed.

Options	U.S. Price	Required to Specify
Grain Direction		
Panel		
• No grain direction	No cost	Specify with no grain direction.
• Horizontal	No cost	Specify with horizontal grain direction.
• Vertical	No cost	Specify with vertical grain direction.
Transaction top		
• No grain direction	No cost	Specify with no grain direction.
• Long grain	No cost	Specify with long grain direction.
• Short grain	No cost	Specify with short grain direction.
Related Products		
• Aisla powered panels		► Page 88
• Aisla cabinets		► Page 132
• Aisla fabric-wrapped magnetic panel		► Page 130

Integrated Glass Option with Finish Upcharges

Tip: Glass price group 3 or glass price group 4 upcharge is in addition to glass price group 1 cost.

Height— Modular	Width— Parametric	Options (Add \$ to Base Price)		
		Glass Price Group 1	Glass Price Group 3	Glass Price Group 4
10"	18"—23.9375"	N.A.	N.A.	N.A.
10"	24"—29.9375"	N.A.	N.A.	N.A.
10"	30"—35.9375"	+\$ 293	+\$179	+\$351
10"	36"—41.9375"	+\$ 320	+\$193	+\$376
10"	42"—47.9375"	+\$ 357	+\$203	+\$402
10"	48"—53.9375"	+\$ 404	+\$229	+\$431
10"	54"—59.9375"	+\$ 480	+\$245	+\$461
10"	60"—65.9375"	+\$ 566	+\$259	+\$493
10"	66"—71.9375"	+\$ 637	+\$272	+\$527
10"	72"—77.9375"	+\$ 749	+\$286	+\$564
10"	78"—83.9375"	+\$ 860	+\$300	+\$604
10"	84"—89.9375"	+\$1040	+\$339	+\$646
10"	90"—95.9375"	+\$1220	+\$352	+\$691
10"	96"—96.5"	+\$1364	+\$376	+\$740
12"	18"—23.9375"	N.A.	N.A.	N.A.
12"	24"—29.9375"	N.A.	N.A.	N.A.
12"	30"—35.9375"	+\$ 325	+\$197	+\$380
12"	36"—41.9375"	+\$ 355	+\$212	+\$406
12"	42"—47.9375"	+\$ 397	+\$223	+\$435
12"	48"—53.9375"	+\$ 449	+\$252	+\$465
12"	54"—59.9375"	+\$ 533	+\$270	+\$498
12"	60"—65.9375"	+\$ 629	+\$285	+\$532
12"	66"—71.9375"	+\$ 708	+\$299	+\$570
12"	72"—77.9375"	+\$ 832	+\$315	+\$610
12"	78"—83.9375"	+\$ 956	+\$330	+\$652
12"	84"—89.9375"	+\$1155	+\$373	+\$698
12"	90"—95.9375"	+\$1355	+\$387	+\$747
12"	96"—96.5"	+\$1515	+\$414	+\$799

► Options, continued on next page



For Canadian Pricing
Multiply U.S. Price by the Canadian price factor.
► See page 1 for details.

► Options, continued from previous page

10"D Transaction Top Option with Finish Upcharges

Depth— Modular	Width— Parametric	Options (Add \$ to Base Price)								
		High-Pressure Laminate			Composite Veneer		Wood			Customiz Stain
		Price Group 1	Price Group 2	Price Group 3	Group 1	Group 2	Group 1	Group 2	Group 3	
10"	18"—23.9375"	N.A.	N.A.	N.A.	N.A.	N.A.	N.A.	N.A.	N.A.	N.A.
10"	24"—29.9375"	N.A.	N.A.	N.A.	N.A.	N.A.	N.A.	N.A.	N.A.	N.A.
10"	30"—35.9375"	+\$440	+\$ 66	+\$142	+\$229	+\$330	+\$ 715	+\$ 888	+\$1087	+\$229
10"	36"—41.9375"	+\$468	+\$ 70	+\$151	+\$244	+\$351	+\$ 760	+\$ 945	+\$1157	+\$244
10"	42"—47.9375"	+\$498	+\$ 75	+\$161	+\$260	+\$373	+\$ 809	+\$1005	+\$1231	+\$260
10"	48"—53.9375"	+\$530	+\$ 80	+\$171	+\$276	+\$397	+\$ 861	+\$1069	+\$1309	+\$276
10"	54"—59.9375"	+\$564	+\$ 85	+\$182	+\$294	+\$422	+\$ 916	+\$1138	+\$1393	+\$294
10"	60"—65.9375"	+\$600	+\$ 90	+\$193	+\$313	+\$449	+\$ 974	+\$1210	+\$1482	+\$313
10"	66"—71.9375"	+\$638	+\$ 96	+\$206	+\$332	+\$478	+\$1036	+\$1287	+\$1576	+\$332
10"	72"—77.9375"	+\$679	+\$102	+\$219	+\$354	+\$509	+\$1102	+\$1370	+\$1677	+\$354
10"	78"—83.9375"	+\$720	+\$108	+\$232	+\$375	+\$539	+\$1169	+\$1452	+\$1777	+\$375
10"	84"—89.9375"	+\$763	+\$114	+\$246	+\$397	+\$571	+\$1239	+\$1539	+\$1884	+\$397
10"	90"—95.9375"	+\$809	+\$121	+\$261	+\$421	+\$606	+\$1313	+\$1631	+\$1997	+\$421
10"	96"—96.5"	+\$857	+\$129	+\$276	+\$447	+\$642	+\$1392	+\$1729	+\$2117	+\$447

Tip: High-Pressure Laminate price groups 2 and 3, composite veneer, wood, and customiz stain upcharges are in addition to the High-Pressure price group 1 upcharge.

Transaction Top Bracket Option with Finish Upcharges

Height— Modular	Width— Parametric	Options (Add \$ to Base Price)		
		Paint Price Group 1	Paint Price Group 2	Paint Price Group 3
10"	18"—23.9375"	N.A.	N.A.	N.A.
10"	24"—29.9375"	N.A.	N.A.	N.A.
10"	30"—35.9375"	+\$257	+\$39	+\$ 44
10"	36"—41.9375"	+\$279	+\$42	+\$ 48
10"	42"—47.9375"	+\$304	+\$46	+\$ 52
10"	48"—53.9375"	+\$330	+\$50	+\$ 57
10"	54"—59.9375"	+\$359	+\$54	+\$ 62
10"	60"—65.9375"	+\$390	+\$59	+\$ 67
10"	66"—71.9375"	+\$421	+\$63	+\$ 73
10"	72"—77.9375"	+\$455	+\$68	+\$ 78
10"	78"—83.9375"	+\$491	+\$74	+\$ 85
10"	84"—89.9375"	+\$531	+\$80	+\$ 92
10"	90"—95.9375"	+\$573	+\$86	+\$ 99
10"	96"—96.5"	+\$619	+\$93	+\$107

Tip: Paint price groups 2 and 3 upcharges are in addition to the paint price group 1 upcharge.

► Specification Information, on next page

Aisla Panels—Free, continued

► Options, on previous page

Specification Information

Style Number	Dimensions		U.S. Base Price	Options (Add \$ to Base Price)						Customiz Stain
	Modular Height	Parametric Width		High-Pressure Laminate	Composite Veneer	Wood				
				Price	Price	Price	Price	Price	Price	Price
				Group 2	Group 3	Group 1	Group 2	Group 1	Group 2	Group 3

Panel—Free/Miter

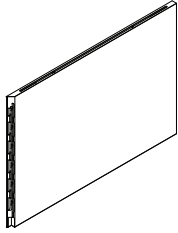

PNLFM	42"	18"-23.9375"	\$ 683	+\$ 93	+\$140	+\$ 376	+\$ 441	+\$ 579	+\$ 730	+\$ 896	+\$ 376
	42"	24"-29.9375"	\$ 803	+\$105	+\$158	+\$ 424	+\$ 498	+\$ 654	+\$ 824	+\$1012	+\$ 424
	42"	30"-35.9375"	\$ 945	+\$120	+\$179	+\$ 482	+\$ 565	+\$ 742	+\$ 935	+\$1148	+\$ 482
	42"	36"-41.9375"	\$1112	+\$136	+\$204	+\$ 549	+\$ 644	+\$ 845	+\$1066	+\$1308	+\$ 549
	42"	42"-47.9375"	\$1308	+\$156	+\$234	+\$ 628	+\$ 737	+\$ 967	+\$1219	+\$1497	+\$ 628
	42"	48"-53.9375"	\$1539	+\$179	+\$268	+\$ 721	+\$ 846	+\$1110	+\$1400	+\$1719	+\$ 721
	42"	54"-59.9375"	\$1811	+\$206	+\$309	+\$ 830	+\$ 975	+\$1278	+\$1612	+\$1980	+\$ 830
	42"	60"-65.9375"	\$2130	+\$238	+\$357	+\$ 959	+\$1126	+\$1477	+\$1862	+\$2287	+\$ 959
	42"	66"-71.9375"	\$2343	+\$259	+\$389	+\$1045	+\$1227	+\$1609	+\$2029	+\$2491	+\$1045
	42"	72"-77.9375"	\$2577	+\$283	+\$424	+\$1139	+\$1338	+\$1754	+\$2212	+\$2716	+\$1139
	42"	78"-83.9375"	\$2783	+\$303	+\$455	+\$1222	+\$1435	+\$1882	+\$2374	+\$2914	+\$1222
	42"	84"-89.9375"	\$3006	+\$326	+\$488	+\$1312	+\$1541	+\$2020	+\$2548	+\$3128	+\$1312
	42"	90"-95.9375"	\$3247	+\$350	+\$524	+\$1409	+\$1654	+\$2170	+\$2736	+\$3359	+\$1409
	42"	96"-96.5"	\$3506	+\$376	+\$563	+\$1514	+\$1777	+\$2331	+\$2939	+\$3609	+\$1514
	48"	18"-23.9375"	\$ 750	+\$100	+\$150	+\$ 403	+\$ 473	+\$ 621	+\$ 783	+\$ 961	+\$ 403
	48"	24"-29.9375"	\$ 883	+\$113	+\$170	+\$ 456	+\$ 536	+\$ 703	+\$ 886	+\$1088	+\$ 456
	48"	30"-35.9375"	\$1038	+\$129	+\$193	+\$ 519	+\$ 610	+\$ 799	+\$1008	+\$1238	+\$ 519
	48"	36"-41.9375"	\$1221	+\$147	+\$221	+\$ 593	+\$ 696	+\$ 913	+\$1151	+\$1414	+\$ 593
	48"	42"-47.9375"	\$1437	+\$169	+\$253	+\$ 680	+\$ 798	+\$1047	+\$1320	+\$1621	+\$ 680
	48"	48"-53.9375"	\$1691	+\$194	+\$291	+\$ 782	+\$ 918	+\$1204	+\$1519	+\$1865	+\$ 782
	48"	54"-59.9375"	\$1989	+\$224	+\$336	+\$ 902	+\$1059	+\$1389	+\$1752	+\$2151	+\$ 902
	48"	60"-65.9375"	\$2340	+\$259	+\$389	+\$1044	+\$1225	+\$1607	+\$2027	+\$2488	+\$1044
	48"	66"-71.9375"	\$2574	+\$282	+\$424	+\$1138	+\$1336	+\$1752	+\$2210	+\$2713	+\$1138
	48"	72"-77.9375"	\$2831	+\$308	+\$462	+\$1242	+\$1458	+\$1912	+\$2411	+\$2960	+\$1242
	48"	78"-83.9375"	\$3058	+\$331	+\$496	+\$1333	+\$1565	+\$2052	+\$2588	+\$3178	+\$1333
	48"	84"-89.9375"	\$3303	+\$355	+\$533	+\$1432	+\$1681	+\$2204	+\$2780	+\$3413	+\$1432
	48"	90"-95.9375"	\$3567	+\$382	+\$573	+\$1538	+\$1806	+\$2368	+\$2987	+\$3667	+\$1538
	48"	96"-96.5"	\$3852	+\$410	+\$615	+\$1653	+\$1941	+\$2545	+\$3210	+\$3941	+\$1653

► Specification Information, continued on next page

► Specification Information, continued from previous page

Specification Information											
Style Number	Dimensions		U.S. Base Price	Options (Add \$ to Base Price)						Customiz Stain	
	Modular Height	Parametric Width		High-Pressure Laminate	Composite Veneer	Wood					
				Price Group 2	Price Group 3	Price Group 1	Price Group 2	Price Group 1	Price Group 2	Price Group 3	

Panel—Free/T

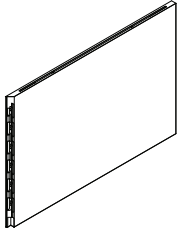

PNLFT	42"	18"—23.9375"	\$ 683	+\$ 78	+\$117	+\$ 315	+\$ 370	+\$ 486	+\$ 613	+\$ 752	+\$ 315
	42"	24"—29.9375"	\$ 803	+\$ 90	+\$135	+\$ 364	+\$ 427	+\$ 560	+\$ 707	+\$ 868	+\$ 364
	42"	30"—35.9375"	\$ 945	+\$105	+\$157	+\$ 421	+\$ 494	+\$ 648	+\$ 818	+\$1004	+\$ 421
	42"	36"—41.9375"	\$1112	+\$121	+\$182	+\$ 488	+\$ 573	+\$ 752	+\$ 948	+\$1164	+\$ 488
	42"	42"—47.9375"	\$1308	+\$141	+\$211	+\$ 567	+\$ 666	+\$ 874	+\$1102	+\$1353	+\$ 567
	42"	48"—53.9375"	\$1539	+\$164	+\$246	+\$ 660	+\$ 775	+\$1017	+\$1282	+\$1575	+\$ 660
	42"	54"—59.9375"	\$1811	+\$191	+\$287	+\$ 770	+\$ 904	+\$1185	+\$1495	+\$1836	+\$ 770
	42"	60"—65.9375"	\$2130	+\$223	+\$335	+\$ 899	+\$1055	+\$1384	+\$1745	+\$2143	+\$ 899
	42"	66"—71.9375"	\$2343	+\$244	+\$366	+\$ 985	+\$1156	+\$1516	+\$1912	+\$2347	+\$ 985
	42"	72"—77.9375"	\$2577	+\$268	+\$402	+\$1079	+\$1267	+\$1661	+\$2095	+\$2572	+\$1079
	42"	78"—83.9375"	\$2783	+\$288	+\$433	+\$1162	+\$1364	+\$1789	+\$2256	+\$2770	+\$1162
	42"	84"—89.9375"	\$3006	+\$311	+\$466	+\$1252	+\$1470	+\$1927	+\$2431	+\$2984	+\$1252
	42"	90"—95.9375"	\$3247	+\$335	+\$502	+\$1349	+\$1583	+\$2076	+\$2619	+\$3215	+\$1349
	42"	96"—96.5"	\$3506	+\$361	+\$541	+\$1453	+\$1706	+\$2238	+\$2822	+\$3465	+\$1453
	48"	18"—23.9375"	\$ 750	+\$ 85	+\$128	+\$ 343	+\$ 402	+\$ 527	+\$ 665	+\$ 817	+\$ 343
	48"	24"—29.9375"	\$ 883	+\$ 98	+\$147	+\$ 396	+\$ 465	+\$ 610	+\$ 769	+\$ 944	+\$ 396
	48"	30"—35.9375"	\$1038	+\$114	+\$171	+\$ 459	+\$ 539	+\$ 706	+\$ 891	+\$1094	+\$ 459
	48"	36"—41.9375"	\$1221	+\$132	+\$198	+\$ 533	+\$ 625	+\$ 820	+\$1034	+\$1270	+\$ 533
	48"	42"—47.9375"	\$1437	+\$154	+\$231	+\$ 619	+\$ 727	+\$ 954	+\$1203	+\$1477	+\$ 619
	48"	48"—53.9375"	\$1691	+\$179	+\$269	+\$ 722	+\$ 847	+\$1111	+\$1401	+\$1720	+\$ 722
	48"	54"—59.9375"	\$1989	+\$209	+\$313	+\$ 842	+\$ 988	+\$1296	+\$1635	+\$2007	+\$ 842
	48"	60"—65.9375"	\$2340	+\$244	+\$366	+\$ 983	+\$1154	+\$1514	+\$1909	+\$2344	+\$ 983
	48"	66"—71.9375"	\$2574	+\$267	+\$401	+\$1078	+\$1265	+\$1659	+\$2092	+\$2569	+\$1078
	48"	72"—77.9375"	\$2831	+\$293	+\$440	+\$1181	+\$1387	+\$1819	+\$2294	+\$2816	+\$1181
	48"	78"—83.9375"	\$3058	+\$316	+\$474	+\$1273	+\$1494	+\$1959	+\$2471	+\$3034	+\$1273
	48"	84"—89.9375"	\$3303	+\$340	+\$510	+\$1371	+\$1610	+\$2111	+\$2663	+\$3269	+\$1371
	48"	90"—95.9375"	\$3567	+\$367	+\$550	+\$1478	+\$1735	+\$2275	+\$2869	+\$3523	+\$1478
	48"	96"—96.5"	\$3852	+\$395	+\$593	+\$1593	+\$1870	+\$2452	+\$3093	+\$3797	+\$1593

► Specification Information, continued on next page

Aisla Panels

► Specification Information, continued from previous page

Specification Information

Style Number	Dimensions		U.S. Base Price	Options (Add \$ to Base Price)						Customiz Stain
	Modular Height	Parametric Width		High-Pressure Laminate	Composite Veneer	Wood				
				Price	Price	Price	Price	Price	Price	Price
				Group 2	Group 3	Group 1	Group 2	Group 1	Group 2	Group 3

Panel—Free Spanning

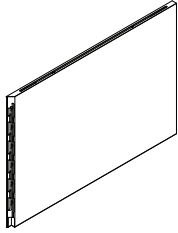

PNLFS	Modular Height	Parametric Width	U.S. Base Price	High-Pressure Laminate	Composite Veneer	Wood	Customiz Stain			
42"	18"-23.9375"	\$ 683	+\$ 75	+\$113	+\$ 303	+\$ 356	+\$ 467	+\$ 589	+\$ 723	+\$ 303
42"	24"-29.9375"	\$ 803	+\$ 87	+\$131	+\$ 352	+\$ 413	+\$ 542	+\$ 683	+\$ 839	+\$ 352
42"	30"-35.9375"	\$ 945	+\$102	+\$152	+\$ 409	+\$ 480	+\$ 630	+\$ 794	+\$ 975	+\$ 409
42"	36"-41.9375"	\$1112	+\$118	+\$177	+\$ 476	+\$ 559	+\$ 733	+\$ 925	+\$1135	+\$ 476
42"	42"-47.9375"	\$1308	+\$138	+\$207	+\$ 555	+\$ 652	+\$ 855	+\$1078	+\$1324	+\$ 555
42"	48"-53.9375"	\$1539	+\$161	+\$241	+\$ 648	+\$ 761	+\$ 998	+\$1259	+\$1546	+\$ 648
42"	54"-59.9375"	\$1811	+\$188	+\$282	+\$ 758	+\$ 890	+\$1167	+\$1472	+\$1807	+\$ 758
42"	60"-65.9375"	\$2130	+\$220	+\$330	+\$ 887	+\$1041	+\$1365	+\$1722	+\$2114	+\$ 887
42"	66"-71.9375"	\$2343	+\$241	+\$362	+\$ 972	+\$1142	+\$1497	+\$1888	+\$2318	+\$ 972
42"	72"-77.9375"	\$2577	+\$265	+\$397	+\$1067	+\$1253	+\$1643	+\$2072	+\$2543	+\$1067
42"	78"-83.9375"	\$2783	+\$285	+\$428	+\$1150	+\$1350	+\$1770	+\$2233	+\$2742	+\$1150
42"	84"-89.9375"	\$3006	+\$308	+\$461	+\$1240	+\$1455	+\$1909	+\$2407	+\$2955	+\$1240
42"	90"-95.9375"	\$3247	+\$332	+\$497	+\$1337	+\$1569	+\$2058	+\$2595	+\$3187	+\$1337
42"	96"-96.5"	\$3506	+\$358	+\$536	+\$1441	+\$1692	+\$2219	+\$2799	+\$3436	+\$1441
48"	18"-23.9375"	\$ 750	+\$ 82	+\$123	+\$ 331	+\$ 388	+\$ 509	+\$ 642	+\$ 788	+\$ 331
48"	24"-29.9375"	\$ 883	+\$ 95	+\$143	+\$ 384	+\$ 451	+\$ 591	+\$ 745	+\$ 915	+\$ 384
48"	30"-35.9375"	\$1038	+\$111	+\$166	+\$ 447	+\$ 524	+\$ 688	+\$ 867	+\$1065	+\$ 447
48"	36"-41.9375"	\$1221	+\$129	+\$194	+\$ 520	+\$ 611	+\$ 801	+\$1011	+\$1241	+\$ 520
48"	42"-47.9375"	\$1437	+\$151	+\$226	+\$ 607	+\$ 713	+\$ 935	+\$1179	+\$1448	+\$ 607
48"	48"-53.9375"	\$1691	+\$176	+\$264	+\$ 710	+\$ 833	+\$1092	+\$1378	+\$1692	+\$ 710
48"	54"-59.9375"	\$1989	+\$206	+\$309	+\$ 830	+\$ 974	+\$1278	+\$1611	+\$1978	+\$ 830
48"	60"-65.9375"	\$2340	+\$241	+\$362	+\$ 971	+\$1140	+\$1495	+\$1886	+\$2315	+\$ 971
48"	66"-71.9375"	\$2574	+\$264	+\$397	+\$1066	+\$1251	+\$1641	+\$2069	+\$2540	+\$1066
48"	72"-77.9375"	\$2831	+\$290	+\$435	+\$1169	+\$1373	+\$1800	+\$2270	+\$2788	+\$1169
48"	78"-83.9375"	\$3058	+\$313	+\$469	+\$1261	+\$1480	+\$1941	+\$2448	+\$3005	+\$1261
48"	84"-89.9375"	\$3303	+\$337	+\$506	+\$1359	+\$1596	+\$2093	+\$2639	+\$3240	+\$1359
48"	90"-95.9375"	\$3567	+\$364	+\$546	+\$1466	+\$1721	+\$2256	+\$2846	+\$3494	+\$1466
48"	96"-96.5"	\$3852	+\$392	+\$588	+\$1581	+\$1856	+\$2434	+\$3069	+\$3768	+\$1581

► Specification Information, continued on next page

► Specification Information, continued from previous page

Specification Information											
Style Number	Dimensions		U.S. Base Price	Options (Add \$ to Base Price)						Customiz Stain	
	Modular Height	Parametric Width		High-Pressure Laminate	Composite Veneer	Wood					
				Price	Price	Price	Price	Price	Price	Price	
				Group 2	Group 3	Group 1	Group 2	Group 1	Group 2	Group 3	

Panel—Free Inline

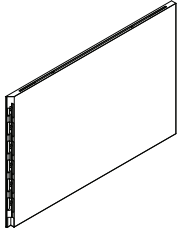

PNLFI	42"	18"—23.9375"	\$ 683	+\$ 75	+\$113	+\$ 303	+\$ 356	+\$ 467	+\$ 589	+\$ 723	+\$ 303
	42"	24"—29.9375"	\$ 803	+\$ 87	+\$131	+\$ 352	+\$ 413	+\$ 542	+\$ 683	+\$ 839	+\$ 352
	42"	30"—35.9375"	\$ 945	+\$102	+\$152	+\$ 409	+\$ 480	+\$ 630	+\$ 794	+\$ 975	+\$ 409
	42"	36"—41.9375"	\$1112	+\$118	+\$177	+\$ 476	+\$ 559	+\$ 733	+\$ 925	+\$1135	+\$ 476
	42"	42"—47.9375"	\$1308	+\$138	+\$207	+\$ 555	+\$ 652	+\$ 855	+\$1078	+\$1324	+\$ 555
	42"	48"—53.9375"	\$1539	+\$161	+\$241	+\$ 648	+\$ 761	+\$ 998	+\$1259	+\$1546	+\$ 648
	42"	54"—59.9375"	\$1811	+\$188	+\$282	+\$ 758	+\$ 890	+\$1167	+\$1472	+\$1807	+\$ 758
	42"	60"—65.9375"	\$2130	+\$220	+\$330	+\$ 887	+\$1041	+\$1365	+\$1722	+\$2114	+\$ 887
	42"	66"—71.9375"	\$2343	+\$241	+\$362	+\$ 972	+\$1142	+\$1497	+\$1888	+\$2318	+\$ 972
	42"	72"—77.9375"	\$2577	+\$265	+\$397	+\$1067	+\$1253	+\$1643	+\$2072	+\$2543	+\$1067
	42"	78"—83.9375"	\$2783	+\$285	+\$428	+\$1150	+\$1350	+\$1770	+\$2233	+\$2742	+\$1150
	42"	84"—89.9375"	\$3006	+\$308	+\$461	+\$1240	+\$1455	+\$1909	+\$2407	+\$2955	+\$1240
	42"	90"—95.9375"	\$3247	+\$332	+\$497	+\$1337	+\$1569	+\$2058	+\$2595	+\$3187	+\$1337
	42"	96"—96.5"	\$3506	+\$358	+\$536	+\$1441	+\$1692	+\$2219	+\$2799	+\$3436	+\$1441
	48"	18"—23.9375"	\$ 750	+\$ 82	+\$123	+\$ 331	+\$ 388	+\$ 509	+\$ 642	+\$ 788	+\$ 331
	48"	24"—29.9375"	\$ 883	+\$ 95	+\$143	+\$ 384	+\$ 451	+\$ 591	+\$ 745	+\$ 915	+\$ 384
	48"	30"—35.9375"	\$1038	+\$111	+\$166	+\$ 447	+\$ 524	+\$ 688	+\$ 867	+\$1065	+\$ 447
	48"	36"—41.9375"	\$1221	+\$129	+\$194	+\$ 520	+\$ 611	+\$ 801	+\$1011	+\$1241	+\$ 520
	48"	42"—47.9375"	\$1437	+\$151	+\$226	+\$ 607	+\$ 713	+\$ 935	+\$1179	+\$1448	+\$ 607
	48"	48"—53.9375"	\$1691	+\$176	+\$264	+\$ 710	+\$ 833	+\$1092	+\$1378	+\$1692	+\$ 710
	48"	54"—59.9375"	\$1989	+\$206	+\$309	+\$ 830	+\$ 974	+\$1278	+\$1611	+\$1978	+\$ 830
	48"	60"—65.9375"	\$2340	+\$241	+\$362	+\$ 971	+\$1140	+\$1495	+\$1886	+\$2315	+\$ 971
	48"	66"—71.9375"	\$2574	+\$264	+\$397	+\$1066	+\$1251	+\$1641	+\$2069	+\$2540	+\$1066
	48"	72"—77.9375"	\$2831	+\$290	+\$435	+\$1169	+\$1373	+\$1800	+\$2270	+\$2788	+\$1169
	48"	78"—83.9375"	\$3058	+\$313	+\$469	+\$1261	+\$1480	+\$1941	+\$2448	+\$3005	+\$1261
	48"	84"—89.9375"	\$3303	+\$337	+\$506	+\$1359	+\$1596	+\$2093	+\$2639	+\$3240	+\$1359
	48"	90"—95.9375"	\$3567	+\$364	+\$546	+\$1466	+\$1721	+\$2256	+\$2846	+\$3494	+\$1466
	48"	96"—96.5"	\$3852	+\$392	+\$588	+\$1581	+\$1856	+\$2434	+\$3069	+\$3768	+\$1581

Aisla Panels—Spanning

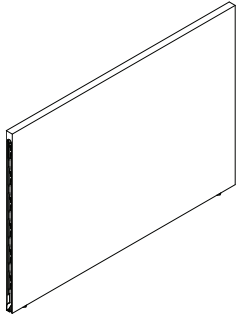

► Need help?
Product details,
page 26

Standard Includes

- Panel—spanning: High-Pressure Laminate price group 1
- 1 mm top edge band
- 3 mm side edge band
- Transaction top, if selected: High-Pressure Laminate price group 1
- Transaction top edge, if selected: plastic
- Transaction top bracket, if selected: paint price group 1
- Glass insert, if selected: glass price group 1

Required to Specify

- 1 Style number
 - 2 Width (see below under Required Selections)
 - 3 Height (see below under Required Selections)
 - 4 Connection—end A (see below under Required Selections)
 - 5 Connection—end B (see below under Required Selections)
 - 6 High-Pressure Laminate color for panel
 - 7 Glass color number for glass insert, if selected
 - 8 High-Pressure Laminate color for transaction top, if selected
 - 9 Plastic color number for transaction top edge, if selected
 - 10 Paint color number for transaction top bracket, if selected
 - 11 Options, if selected (see below)
- See *Surface Materials*, page 164

Tip: Parametric width (18"W–96.5"W) is available in 1/16" increments.

	Required Selections	U.S. Price	Required to Specify
Width	• 18"–96.5"	Prices at right	Specify width.
Height	• 42" • 48"	Prices at right Prices at right	Specify height. Specify height.
Connection	End A • Spanning • T	+\$ 70 +\$100	Specify with end A spanning. Specify with end A T.
	End B • Spanning • T	+\$ 70 +\$100	Specify with end B spanning. Specify with end B T.

	Options	U.S. Price	Required to Specify
Surface Materials	Panel • High-Pressure Laminate price group 1 • High-Pressure Laminate price group 2 • High-Pressure Laminate price group 3 • Open Line laminate (OLL) • Composite veneer group 1 • Composite veneer group 2 • Wood group 1 • Wood group 2 • Wood group 3 • Customiz stain	No cost Prices at right Prices at right +\$111 plus cost of laminate Prices at right Prices at right Prices at right Prices at right Prices at right Prices at right	Specify laminate color number. Specify laminate color number. Specify laminate color number. ► See <i>Surface Materials Reference Manual</i> . Specify composite veneer color number. Specify composite veneer color number. Specify wood color number. Specify wood color number. Specify wood color number. Specify with customiz stain.
	Integrated glass • Glass price group 1 • Glass price group 3 • Glass price group 4	Prices at right Prices at right Prices at right	Specify with 6500 Clear Glass. Specify with 6501 Low Iron Clear Glass. Specify with 6562 Bronze or 6563 Smoke Glass.

► Options, continued on next page



For Canadian Pricing
Multiply U.S. Price by the Canadian price factor.
► See page 1 for details.

► Options, continued from previous page

	Options	U.S. Price	Required to Specify
Surface Materials, Continued	Transaction top		
	• High-Pressure Laminate price group 1	No cost	Specify laminate color number.
	• High-Pressure Laminate price group 2	Prices at right	Specify laminate color number.
	• High-Pressure Laminate price group 3	Prices at right	Specify laminate color number.
	• Composite veneer group 1	Prices at right	Specify composite veneer color number.
	• Composite veneer group 2	Prices at right	Specify composite veneer color number.
	• Wood group 1	Prices at right	Specify wood color number.
	• Wood group 2	Prices at right	Specify wood color number.
	• Wood group 3	Prices at right	Specify wood color number.
	• Customiz stain	Prices at right	Specify <i>with customiz stain</i> .
	Transaction top edge		
	• Plastic	No cost	Specify plastic color number.
	Transaction top bracket		
	• Paint price group 1	Prices at right	Specify paint color number.
	• Paint price group 2	Prices at right	Specify paint color number.
	• Paint price group 3	Prices at right	Specify paint color number.
Connection T	End A		
	• T adjacent side 1	No cost	Specify <i>with end A T adjacent side 1</i> .
	• T adjacent side 2	No cost	Specify <i>with end A T adjacent side 2</i> .
	End B		
	• T adjacent side 1	No cost	Specify <i>with end B T adjacent side 1</i> .
	• T adjacent side 2	No cost	Specify <i>with end B T adjacent side 2</i> .
Accent Panel	• No panel	No cost	Specify <i>with no panel</i> .
	• Fabric panel side 1	No cost	Specify <i>with fabric panel side 1</i> .
	• Fabric panel side 2	No cost	Specify <i>with fabric panel side 2</i> .
	• Fabric panel side 1 and 2	No cost	Specify <i>with fabric panel side 1 and 2</i> .
Top Accessory	• No accessory	No cost	Specify <i>with no accessory</i> .
	• Integrated glass	Prices at right	Specify <i>with integrated glass</i> .
	• 10"D transaction top side 1	Prices at right	Specify <i>with 10"D transaction top side 1</i> .
	• 10"D transaction top side 2	Prices at right	Specify <i>with 10"D transaction top side 2</i> .
	• Transaction top bracket only side 1	Prices at right	Specify <i>with transaction top bracket only side 1</i> .
	• Transaction top bracket only side 2	Prices at right	Specify <i>with transaction top bracket only side 2</i> .
Glass Height	• 10"	Prices at right	Specify glass height.
	• 12"	Prices at right	Specify glass height.
Grain Direction	Panel		
	• No grain direction	No cost	Specify <i>with no grain direction</i> .
	• Horizontal	No cost	Specify <i>with horizontal grain direction</i> .
	• Vertical	No cost	Specify <i>with vertical grain direction</i> .
	Transaction top		
	• No grain direction	No cost	Specify <i>with no grain direction</i> .
• Long grain	No cost	Specify <i>with long grain direction</i> .	
• Short grain	No cost	Specify <i>with short grain direction</i> .	
Related Products	• Aisla powered panels		► Page 88
	• Aisla cabinets		► Page 132
	• Aisla fabric-wrapped magnetic panel		► Page 130

Tip: This option is only available when connection end A is T.

Tip: This option is only available when connection end B is T.

Tip: For directional laminates, horizontal and vertical grain direction are available when width is up to and including 60". When width is greater than 60", only horizontal grain direction is allowed.

► Options, continued on next page



For Canadian Pricing
Multiply U.S. Price by the Canadian price factor.
► See page 1 for details.

► Options, continued from previous page

Integrated Glass Option with Finish Upcharges

Tip: Glass price group 3 or glass price group 4 upcharge is in addition to glass price group 1 cost.

Height— Modular	Width— Parametric	Options (Add \$ to Base Price)		
		Glass Price Group 1	Glass Price Group 3	Glass Price Group 4
10"	18"—23.9375"	N.A.	N.A.	N.A.
10"	24"—29.9375"	N.A.	N.A.	N.A.
10"	30"—35.9375"	+\$ 293	+\$179	+\$351
10"	36"—41.9375"	+\$ 320	+\$193	+\$376
10"	42"—47.9375"	+\$ 357	+\$203	+\$402
10"	48"—53.9375"	+\$ 404	+\$229	+\$431
10"	54"—59.9375"	+\$ 480	+\$245	+\$461
10"	60"—65.9375"	+\$ 566	+\$259	+\$493
10"	66"—71.9375"	+\$ 637	+\$272	+\$527
10"	72"—77.9375"	+\$ 749	+\$286	+\$564
10"	78"—83.9375"	+\$ 860	+\$300	+\$604
10"	84"—89.9375"	+\$1040	+\$339	+\$646
10"	90"—95.9375"	+\$1220	+\$352	+\$691
10"	96"—96.5"	+\$1364	+\$376	+\$740
12"	18"—23.9375"	N.A.	N.A.	N.A.
12"	24"—29.9375"	N.A.	N.A.	N.A.
12"	30"—35.9375"	+\$ 325	+\$197	+\$380
12"	36"—41.9375"	+\$ 355	+\$212	+\$406
12"	42"—47.9375"	+\$ 397	+\$223	+\$435
12"	48"—53.9375"	+\$ 449	+\$252	+\$465
12"	54"—59.9375"	+\$ 533	+\$270	+\$498
12"	60"—65.9375"	+\$ 629	+\$285	+\$532
12"	66"—71.9375"	+\$ 708	+\$299	+\$570
12"	72"—77.9375"	+\$ 832	+\$315	+\$610
12"	78"—83.9375"	+\$ 956	+\$330	+\$652
12"	84"—89.9375"	+\$1155	+\$373	+\$698
12"	90"—95.9375"	+\$1355	+\$387	+\$747
12"	96"—96.5"	+\$1515	+\$414	+\$799

► Options, continued on next page



For Canadian Pricing
 Multiply U.S. Price by the
 Canadian price factor.
 ► See page 1 for details.

► Options, continued from previous page

10"D Transaction Top Option with Finish Upcharges

Depth— Modular	Width— Parametric	Options (Add \$ to Base Price)								
		High-Pressure Laminate			Composite Veneer		Wood			Customiz Stain
		Price Group 1	Price Group 2	Price Group 3	Group 1	Group 2	Group 1	Group 2	Group 3	
10"	18"—23.9375"	N.A.	N.A.	N.A.	N.A.	N.A.	N.A.	N.A.	N.A.	N.A.
10"	24"—29.9375"	N.A.	N.A.	N.A.	N.A.	N.A.	N.A.	N.A.	N.A.	N.A.
10"	30"—35.9375"	+\$440	+\$ 66	+\$142	+\$229	+\$330	+\$ 715	+\$ 888	+\$1087	+\$229
10"	36"—41.9375"	+\$468	+\$ 70	+\$151	+\$244	+\$351	+\$ 760	+\$ 945	+\$1157	+\$244
10"	42"—47.9375"	+\$498	+\$ 75	+\$161	+\$260	+\$373	+\$ 809	+\$1005	+\$1231	+\$260
10"	48"—53.9375"	+\$530	+\$ 80	+\$171	+\$276	+\$397	+\$ 861	+\$1069	+\$1309	+\$276
10"	54"—59.9375"	+\$564	+\$ 85	+\$182	+\$294	+\$422	+\$ 916	+\$1138	+\$1393	+\$294
10"	60"—65.9375"	+\$600	+\$ 90	+\$193	+\$313	+\$449	+\$ 974	+\$1210	+\$1482	+\$313
10"	66"—71.9375"	+\$638	+\$ 96	+\$206	+\$332	+\$478	+\$1036	+\$1287	+\$1576	+\$332
10"	72"—77.9375"	+\$679	+\$102	+\$219	+\$354	+\$509	+\$1102	+\$1370	+\$1677	+\$354
10"	78"—83.9375"	+\$720	+\$108	+\$232	+\$375	+\$539	+\$1169	+\$1452	+\$1777	+\$375
10"	84"—89.9375"	+\$763	+\$114	+\$246	+\$397	+\$571	+\$1239	+\$1539	+\$1884	+\$397
10"	90"—95.9375"	+\$809	+\$121	+\$261	+\$421	+\$606	+\$1313	+\$1631	+\$1997	+\$421
10"	96"—96.5"	+\$857	+\$129	+\$276	+\$447	+\$642	+\$1392	+\$1729	+\$2117	+\$447

Tip: High-Pressure Laminate price groups 2 and 3, composite veneer, wood, and customiz stain upcharges are in addition to the High-Pressure price group 1 upcharge.

Transaction Top Bracket Option with Finish Upcharges

Depth— Modular	Width— Parametric	Options (Add \$ to Base Price)		
		Paint Price Group 1	Paint Price Group 2	Paint Price Group 3
		10"	18"—23.9375"	N.A.
10"	24"—29.9375"	N.A.	N.A.	N.A.
10"	30"—35.9375"	+\$257	+\$39	+\$ 44
10"	36"—41.9375"	+\$279	+\$42	+\$ 48
10"	42"—47.9375"	+\$304	+\$46	+\$ 52
10"	48"—53.9375"	+\$330	+\$50	+\$ 57
10"	54"—59.9375"	+\$359	+\$54	+\$ 62
10"	60"—65.9375"	+\$390	+\$59	+\$ 67
10"	66"—71.9375"	+\$421	+\$63	+\$ 73
10"	72"—77.9375"	+\$455	+\$68	+\$ 78
10"	78"—83.9375"	+\$491	+\$74	+\$ 85
10"	84"—89.9375"	+\$531	+\$80	+\$ 92
10"	90"—95.9375"	+\$573	+\$86	+\$ 99
10"	96"—96.5"	+\$619	+\$93	+\$107

Tip: Paint price groups 2 and 3 upcharges are in addition to the paint price group 1 upcharge.

► Specification Information, on next page

Aisla Panels—Spanning, continued

► Options, on previous page

Specification Information

Style Number	Dimensions		U.S. Base Price	Options (Add \$ to Base Price)						Customiz Stain
	Modular Height	Parametric Width		High-Pressure Laminate		Composite Veneer		Wood		
				Price	Price	Price	Price	Price	Price	Price
				Group 2	Group 3	Group 1	Group 2	Group 1	Group 2	Group 3

Panel—Spanning Spanning

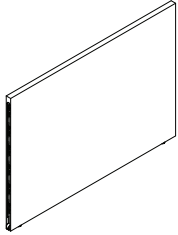

PNLSS	42"	18"-23.9375"	\$ 683	+\$ 82	+\$123	+\$ 332	+\$ 389	+\$ 511	+\$ 644	+\$ 791	+\$ 332
	42"	24"-29.9375"	\$ 803	+\$ 94	+\$141	+\$ 380	+\$ 446	+\$ 585	+\$ 738	+\$ 906	+\$ 380
	42"	30"-35.9375"	\$ 945	+\$109	+\$163	+\$ 437	+\$ 513	+\$ 673	+\$ 849	+\$1043	+\$ 437
	42"	36"-41.9375"	\$1112	+\$125	+\$188	+\$ 505	+\$ 592	+\$ 777	+\$ 980	+\$1203	+\$ 505
	42"	42"-47.9375"	\$1308	+\$145	+\$217	+\$ 584	+\$ 685	+\$ 898	+\$1133	+\$1391	+\$ 584
	42"	48"-53.9375"	\$1539	+\$168	+\$252	+\$ 677	+\$ 794	+\$1042	+\$1314	+\$1613	+\$ 677
	42"	54"-59.9375"	\$1811	+\$195	+\$293	+\$ 786	+\$ 923	+\$1210	+\$1526	+\$1874	+\$ 786
	42"	60"-65.9375"	\$2130	+\$227	+\$341	+\$ 915	+\$1074	+\$1408	+\$1776	+\$2181	+\$ 915
	42"	66"-71.9375"	\$2343	+\$248	+\$372	+\$1001	+\$1175	+\$1541	+\$1943	+\$2386	+\$1001
	42"	72"-77.9375"	\$2577	+\$272	+\$408	+\$1095	+\$1286	+\$1686	+\$2126	+\$2611	+\$1095
	42"	78"-83.9375"	\$2783	+\$292	+\$439	+\$1178	+\$1383	+\$1814	+\$2288	+\$2809	+\$1178
	42"	84"-89.9375"	\$3006	+\$315	+\$472	+\$1268	+\$1489	+\$1952	+\$2462	+\$3023	+\$1268
	42"	90"-95.9375"	\$3247	+\$339	+\$508	+\$1365	+\$1602	+\$2101	+\$2650	+\$3254	+\$1365
	42"	96"-96.5"	\$3506	+\$365	+\$547	+\$1469	+\$1725	+\$2262	+\$2853	+\$3503	+\$1469
	48"	18"-23.9375"	\$ 750	+\$ 89	+\$134	+\$ 359	+\$ 421	+\$ 552	+\$ 697	+\$ 855	+\$ 359
	48"	24"-29.9375"	\$ 883	+\$102	+\$153	+\$ 412	+\$ 484	+\$ 634	+\$ 800	+\$ 982	+\$ 412
	48"	30"-35.9375"	\$1038	+\$118	+\$177	+\$ 475	+\$ 557	+\$ 731	+\$ 922	+\$1132	+\$ 475
	48"	36"-41.9375"	\$1221	+\$136	+\$204	+\$ 549	+\$ 644	+\$ 845	+\$1065	+\$1308	+\$ 549
	48"	42"-47.9375"	\$1437	+\$158	+\$237	+\$ 636	+\$ 746	+\$ 979	+\$1234	+\$1515	+\$ 636
	48"	48"-53.9375"	\$1691	+\$183	+\$275	+\$ 738	+\$ 866	+\$1136	+\$1433	+\$1759	+\$ 738
	48"	54"-59.9375"	\$1989	+\$213	+\$319	+\$ 858	+\$1007	+\$1321	+\$1666	+\$2045	+\$ 858
	48"	60"-65.9375"	\$2340	+\$248	+\$372	+\$ 999	+\$1173	+\$1539	+\$1941	+\$2383	+\$ 999
	48"	66"-71.9375"	\$2574	+\$271	+\$407	+\$1094	+\$1284	+\$1684	+\$2124	+\$2608	+\$1094
	48"	72"-77.9375"	\$2831	+\$297	+\$446	+\$1197	+\$1406	+\$1844	+\$2325	+\$2855	+\$1197
	48"	78"-83.9375"	\$3058	+\$320	+\$480	+\$1289	+\$1513	+\$1984	+\$2502	+\$3072	+\$1289
	48"	84"-89.9375"	\$3303	+\$344	+\$516	+\$1387	+\$1629	+\$2136	+\$2694	+\$3307	+\$1387
	48"	90"-95.9375"	\$3567	+\$371	+\$556	+\$1494	+\$1754	+\$2300	+\$2901	+\$3561	+\$1494
	48"	96"-96.5"	\$3852	+\$399	+\$599	+\$1609	+\$1889	+\$2477	+\$3124	+\$3835	+\$1609

► Specification Information, continued on next page

► Specification Information, continued from previous page

Specification Information											
Style Number	Dimensions		U.S. Base Price	Options (Add \$ to Base Price)				Wood			Customiz Stain
	Modular Height	Parametric Width		High-Pressure Laminate	Composite Veneer	Wood		Price	Price	Price	
				Price	Price	Price	Price	Price	Price	Price	
				Group 2	Group 3	Group 1	Group 2	Group 1	Group 2	Group 3	

Panel—Spanning T

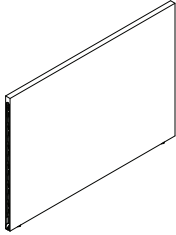

PNLST	42"	18"—23.9375"	\$ 683	+\$ 85	+\$128	+\$ 344	+\$ 404	+\$ 529	+\$ 667	+\$ 819	+\$ 344
	42"	24"—29.9375"	\$ 803	+\$ 97	+\$146	+\$ 392	+\$ 461	+\$ 604	+\$ 762	+\$ 935	+\$ 392
	42"	30"—35.9375"	\$ 945	+\$112	+\$167	+\$ 449	+\$ 528	+\$ 692	+\$ 873	+\$1071	+\$ 449
	42"	36"—41.9375"	\$1112	+\$128	+\$192	+\$ 517	+\$ 607	+\$ 795	+\$1003	+\$1232	+\$ 517
	42"	42"—47.9375"	\$1308	+\$148	+\$222	+\$ 596	+\$ 699	+\$ 917	+\$1157	+\$1420	+\$ 596
	42"	48"—53.9375"	\$1539	+\$171	+\$256	+\$ 689	+\$ 809	+\$1060	+\$1337	+\$1642	+\$ 689
	42"	54"—59.9375"	\$1811	+\$198	+\$297	+\$ 798	+\$ 937	+\$1229	+\$1550	+\$1903	+\$ 798
	42"	60"—65.9375"	\$2130	+\$230	+\$345	+\$ 927	+\$1088	+\$1427	+\$1800	+\$2210	+\$ 927
	42"	66"—71.9375"	\$2343	+\$251	+\$377	+\$1013	+\$1189	+\$1559	+\$1966	+\$2414	+\$1013
	42"	72"—77.9375"	\$2577	+\$275	+\$412	+\$1107	+\$1300	+\$1705	+\$2150	+\$2640	+\$1107
	42"	78"—83.9375"	\$2783	+\$295	+\$443	+\$1190	+\$1397	+\$1833	+\$2311	+\$2838	+\$1190
	42"	84"—89.9375"	\$3006	+\$318	+\$476	+\$1280	+\$1503	+\$1971	+\$2485	+\$3052	+\$1280
	42"	90"—95.9375"	\$3247	+\$342	+\$512	+\$1377	+\$1617	+\$2120	+\$2674	+\$3283	+\$1377
	42"	96"—96.5"	\$3506	+\$368	+\$551	+\$1482	+\$1739	+\$2281	+\$2877	+\$3532	+\$1482
	48"	18"—23.9375"	\$ 750	+\$ 92	+\$138	+\$ 371	+\$ 435	+\$ 571	+\$ 720	+\$ 884	+\$ 371
	48"	24"—29.9375"	\$ 883	+\$105	+\$158	+\$ 424	+\$ 498	+\$ 653	+\$ 824	+\$1011	+\$ 424
	48"	30"—35.9375"	\$1038	+\$121	+\$181	+\$ 487	+\$ 572	+\$ 750	+\$ 945	+\$1161	+\$ 487
	48"	36"—41.9375"	\$1221	+\$139	+\$209	+\$ 561	+\$ 658	+\$ 863	+\$1089	+\$1337	+\$ 561
	48"	42"—47.9375"	\$1437	+\$161	+\$241	+\$ 648	+\$ 760	+\$ 997	+\$1258	+\$1544	+\$ 648
	48"	48"—53.9375"	\$1691	+\$186	+\$279	+\$ 750	+\$ 880	+\$1154	+\$1456	+\$1788	+\$ 750
	48"	54"—59.9375"	\$1989	+\$216	+\$324	+\$ 870	+\$1022	+\$1340	+\$1689	+\$2074	+\$ 870
	48"	60"—65.9375"	\$2340	+\$251	+\$377	+\$1012	+\$1188	+\$1557	+\$1964	+\$2412	+\$1012
	48"	66"—71.9375"	\$2574	+\$274	+\$412	+\$1106	+\$1298	+\$1703	+\$2147	+\$2636	+\$1106
	48"	72"—77.9375"	\$2831	+\$300	+\$450	+\$1210	+\$1420	+\$1862	+\$2349	+\$2884	+\$1210
	48"	78"—83.9375"	\$3058	+\$323	+\$484	+\$1301	+\$1527	+\$2003	+\$2526	+\$3101	+\$1301
	48"	84"—89.9375"	\$3303	+\$347	+\$521	+\$1399	+\$1643	+\$2155	+\$2717	+\$3336	+\$1399
	48"	90"—95.9375"	\$3567	+\$374	+\$561	+\$1506	+\$1768	+\$2319	+\$2924	+\$3590	+\$1506
	48"	96"—96.5"	\$3852	+\$402	+\$603	+\$1621	+\$1903	+\$2496	+\$3147	+\$3864	+\$1621

Aisla Panels—Inline

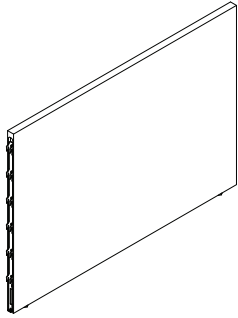

► Need help?
Product details,
page 26

Standard Includes

- Panel—Inline: High-Pressure Laminate price group 1
- 1 mm top edge band
- 3 mm side edge band
- Transaction top, if selected: High-Pressure Laminate price group 1
- Transaction top edge, if selected: plastic
- Transaction top bracket, if selected: paint price group 1
- Glass insert, if selected: glass price group 1

Required to Specify

- 1 Style number
 - 2 Width (see below under Required Selections)
 - 3 Height (see below under Required Selections)
 - 4 Connection—end A (see below under Required Selections)
 - 5 Connection—end B (see below under Required Selections)
 - 6 High-Pressure Laminate color for panel
 - 7 Glass color number for glass insert, if selected
 - 8 High-Pressure Laminate color for transaction top, if selected
 - 9 Plastic color number for transaction top edge, if selected
 - 10 Paint color number for transaction top bracket, if selected
 - 11 Options, if selected (see below)
- See *Surface Materials*, page 164

Tip: Parametric width (18"W–96.5"W) is available in 1/16" increments.

	Required Selections	U.S. Price	Required to Specify
Width	• 18"–96.5"	Prices at right	Specify width.
Height	• 42" • 48"	Prices at right Prices at right	Specify height. Specify height.
Connection	End A <ul style="list-style-type: none"> • Inline • Spanning • T • Mitered side 1 • Mitered side 2 End B <ul style="list-style-type: none"> • Inline • Spanning • T • Mitered side 1 • Mitered side 2 	+\$ 70 +\$ 70 +\$100 +\$250 +\$250 +\$ 70 +\$ 70 +\$100 +\$250 +\$250	Specify with end A inline. Specify with end A spanning. Specify with end A T. Specify with end A mitered side 1. Specify with end A mitered side 2. Specify with end B inline. Specify with end B spanning. Specify with end B T. Specify with end B mitered side 1. Specify with end B mitered side 2.

	Options	U.S. Price	Required to Specify
Surface Materials	Panel <ul style="list-style-type: none"> • High-Pressure Laminate price group 1 • High-Pressure Laminate price group 2 • High-Pressure Laminate price group 3 • Open Line laminate (OLL) • Composite veneer group 1 • Composite veneer group 2 • Wood group 1 • Wood group 2 • Wood group 3 • Customiz stain Integrated glass <ul style="list-style-type: none"> • Glass price group 1 • Glass price group 3 • Glass price group 4 	No cost Prices at right Prices at right +\$111 plus cost of laminate Prices at right Prices at right Prices at right Prices at right Prices at right Prices at right Prices at right Prices at right Prices at right	Specify laminate color number. Specify laminate color number. Specify laminate color number. ► See <i>Surface Materials Reference Manual</i> . Specify composite veneer color number. Specify composite veneer color number. Specify wood color number. Specify wood color number. Specify wood color number. Specify with <i>6500 Clear Glass</i> . Specify with <i>6501 Low Iron Clear Glass</i> . Specify with <i>6562 Bronze or 6563 Smoke Glass</i> .

► Options, continued on next page

 **For Canadian Pricing**
Multiply U.S. Price by the Canadian price factor.
► See page 1 for details.

► Options, continued from previous page

	Options	U.S. Price	Required to Specify	
Surface Materials, Continued	Transaction top			
	• High-Pressure Laminate price group 1	No cost	Specify laminate color number.	
	• High-Pressure Laminate price group 2	Prices at right	Specify laminate color number.	
	• High-Pressure Laminate price group 3	Prices at right	Specify laminate color number.	
	• Composite veneer group 1	Prices at right	Specify composite veneer color number.	
	• Composite veneer group 2	Prices at right	Specify composite veneer color number.	
	• Wood group 1	Prices at right	Specify wood color number.	
	• Wood group 2	Prices at right	Specify wood color number.	
	• Wood group 3	Prices at right	Specify wood color number.	
	• Customiz stain	Prices at right	Specify with <i>customiz stain</i> .	
	Transaction top edge			
	• Plastic	No cost	Specify plastic color number.	
	Transaction top bracket			
	• Paint price group 1	Prices at right	Specify paint color number.	
	• Paint price group 2	Prices at right	Specify paint color number.	
	• Paint price group 3	Prices at right	Specify paint color number.	
Connection T	End A			
	• No T	No cost	Specify with <i>end A no T</i> .	
	• T side 1	No cost	Specify with <i>end A T side 1</i> .	
	• T side 2	No cost	Specify with <i>end A T side 2</i> .	
	• T side 1 and 2	No cost	Specify with <i>end A T side 1 and 2</i> .	
	• T adjacent side 1	No cost	Specify with <i>end A T adjacent side 1</i> .	
	• T adjacent side 2	No cost	Specify with <i>end A T adjacent side 2</i> .	
		End B		
	• No T	No cost	Specify with <i>end B no T</i> .	
	• T side 1	No cost	Specify with <i>end B T side 1</i> .	
• T side 2	No cost	Specify with <i>end B T side 2</i> .		
• T side 1 and 2	No cost	Specify with <i>end B T side 1 and 2</i> .		
• T adjacent side 1	No cost	Specify with <i>end B T adjacent side 1</i> .		
• T adjacent side 2	No cost	Specify with <i>end B T adjacent side 2</i> .		
Mitered Matchstick	End A			
	• No matchstick	No cost	Specify with <i>end A no matchstick</i> .	
	• With matchstick	No cost	Specify with <i>end A matchstick</i> .	
		End B		
	• No matchstick	No cost	Specify with <i>end B no matchstick</i> .	
	• With matchstick	No cost	Specify with <i>end B matchstick</i> .	
Accent Panel	• No panel	No cost	Specify with <i>no panel</i> .	
	• Fabric panel side 1	No cost	Specify with <i>fabric panel side 1</i> .	
	• Fabric panel side 2	No cost	Specify with <i>fabric panel side 2</i> .	
	• Fabric panel side 1 and 2	No cost	Specify with <i>fabric panel side 1 and 2</i> .	
Top Accessory	• No accessory	No cost	Specify with <i>no accessory</i> .	
	• Integrated glass	Prices at right	Specify with <i>integrated glass</i> .	
	• 10"D transaction top side 1	Prices at right	Specify with <i>10"D transaction top side 1</i> .	
	• 10"D transaction top side 2	Prices at right	Specify with <i>10"D transaction top side 2</i> .	
	• Transaction top bracket only side 1	Prices at right	Specify with <i>transaction top bracket only side 1</i> .	
	• Transaction top bracket only side 2	Prices at right	Specify with <i>transaction top bracket only side 2</i> .	
Glass Height	• 10"	Prices at right	Specify glass height.	
	• 12"	Prices at right	Specify glass height.	

► Options, continued on next page



For Canadian Pricing

Multiply U.S. Price by the Canadian price factor.

► See page 1 for details.

► Options, continued from previous page

Tip: For directional laminates, horizontal and vertical grain direction are available when width is up to and including 60". When width is greater than 60", only horizontal grain direction is allowed.

Options	U.S. Price	Required to Specify
Grain Direction		
Panel		
• No grain direction	No cost	Specify with no grain direction.
• Horizontal	No cost	Specify with horizontal grain direction.
• Vertical	No cost	Specify with vertical grain direction.
Transaction top		
• No grain direction	No cost	Specify with no grain direction.
• Long grain	No cost	Specify with long grain direction.
• Short grain	No cost	Specify with short grain direction.
Related Products		
• Aisla powered panels		► Page 88
• Aisla cabinets		► Page 132
• Aisla fabric-wrapped magnetic panel		► Page 130

Integrated Glass Option with Finish Upcharges

Tip: Glass price group 3 or glass price group 4 upcharge is in addition to glass price group 1 cost.

Height— Modular	Width— Parametric	Options (Add \$ to Base Price)		
		Glass Price Group 1	Glass Price Group 3	Glass Price Group 4
10"	18"—23.9375"	N.A.	N.A.	N.A.
10"	24"—29.9375"	N.A.	N.A.	N.A.
10"	30"—35.9375"	+\$ 293	+\$179	+\$351
10"	36"—41.9375"	+\$ 320	+\$193	+\$376
10"	42"—47.9375"	+\$ 357	+\$203	+\$402
10"	48"—53.9375"	+\$ 404	+\$229	+\$431
10"	54"—59.9375"	+\$ 480	+\$245	+\$461
10"	60"—65.9375"	+\$ 566	+\$259	+\$493
10"	66"—71.9375"	+\$ 637	+\$272	+\$527
10"	72"—77.9375"	+\$ 749	+\$286	+\$564
10"	78"—83.9375"	+\$ 860	+\$300	+\$604
10"	84"—89.9375"	+\$1040	+\$339	+\$646
10"	90"—95.9375"	+\$1220	+\$352	+\$691
10"	96"—96.5"	+\$1364	+\$376	+\$740
12"	18"—23.9375"	N.A.	N.A.	N.A.
12"	24"—29.9375"	N.A.	N.A.	N.A.
12"	30"—35.9375"	+\$ 325	+\$197	+\$380
12"	36"—41.9375"	+\$ 355	+\$212	+\$406
12"	42"—47.9375"	+\$ 397	+\$223	+\$435
12"	48"—53.9375"	+\$ 449	+\$252	+\$465
12"	54"—59.9375"	+\$ 533	+\$270	+\$498
12"	60"—65.9375"	+\$ 629	+\$285	+\$532
12"	66"—71.9375"	+\$ 708	+\$299	+\$570
12"	72"—77.9375"	+\$ 832	+\$315	+\$610
12"	78"—83.9375"	+\$ 956	+\$330	+\$652
12"	84"—89.9375"	+\$1155	+\$373	+\$698
12"	90"—95.9375"	+\$1355	+\$387	+\$747
12"	96"—96.5"	+\$1515	+\$414	+\$799

► Options, continued on next page

 **For Canadian Pricing**
Multiply U.S. Price by the Canadian price factor.
► See page 1 for details.

► Options, continued from previous page

10"D Transaction Top Option with Finish Upcharges

Depth— Modular	Width— Parametric	Options (Add \$ to Base Price)								
		High-Pressure Laminate			Composite Veneer		Wood			Customiz Stain
		Price Group 1	Price Group 2	Price Group 3	Group 1	Group 2	Group 1	Group 2	Group 3	
10"	18"—23.9375"	N.A.	N.A.	N.A.	N.A.	N.A.	N.A.	N.A.	N.A.	N.A.
10"	24"—29.9375"	N.A.	N.A.	N.A.	N.A.	N.A.	N.A.	N.A.	N.A.	N.A.
10"	30"—35.9375"	+\$440	+\$ 66	+\$142	+\$229	+\$330	+\$ 715	+\$ 888	+\$1087	+\$229
10"	36"—41.9375"	+\$468	+\$ 70	+\$151	+\$244	+\$351	+\$ 760	+\$ 945	+\$1157	+\$244
10"	42"—47.9375"	+\$498	+\$ 75	+\$161	+\$260	+\$373	+\$ 809	+\$1005	+\$1231	+\$260
10"	48"—53.9375"	+\$530	+\$ 80	+\$171	+\$276	+\$397	+\$ 861	+\$1069	+\$1309	+\$276
10"	54"—59.9375"	+\$564	+\$ 85	+\$182	+\$294	+\$422	+\$ 916	+\$1138	+\$1393	+\$294
10"	60"—65.9375"	+\$600	+\$ 90	+\$193	+\$313	+\$449	+\$ 974	+\$1210	+\$1482	+\$313
10"	66"—71.9375"	+\$638	+\$ 96	+\$206	+\$332	+\$478	+\$1036	+\$1287	+\$1576	+\$332
10"	72"—77.9375"	+\$679	+\$102	+\$219	+\$354	+\$509	+\$1102	+\$1370	+\$1677	+\$354
10"	78"—83.9375"	+\$720	+\$108	+\$232	+\$375	+\$539	+\$1169	+\$1452	+\$1777	+\$375
10"	84"—89.9375"	+\$763	+\$114	+\$246	+\$397	+\$571	+\$1239	+\$1539	+\$1884	+\$397
10"	90"—95.9375"	+\$809	+\$121	+\$261	+\$421	+\$606	+\$1313	+\$1631	+\$1997	+\$421
10"	96"—96.5"	+\$857	+\$129	+\$276	+\$447	+\$642	+\$1392	+\$1729	+\$2117	+\$447

Tip: High-Pressure Laminate price groups 2 and 3, composite veneer, wood, and customiz stain upcharges are in addition to the High-Pressure price group 1 upcharge.

Transaction Top Bracket Option with Finish Upcharges

Depth— Modular	Width— Parametric	Options (Add \$ to Base Price)		
		Paint Price Group 1	Paint Price Group 2	Paint Price Group 3
		10"	18"—23.9375"	N.A.
10"	24"—29.9375"	N.A.	N.A.	N.A.
10"	30"—35.9375"	+\$257	+\$39	+\$ 44
10"	36"—41.9375"	+\$279	+\$42	+\$ 48
10"	42"—47.9375"	+\$304	+\$46	+\$ 52
10"	48"—53.9375"	+\$330	+\$50	+\$ 57
10"	54"—59.9375"	+\$359	+\$54	+\$ 62
10"	60"—65.9375"	+\$390	+\$59	+\$ 67
10"	66"—71.9375"	+\$421	+\$63	+\$ 73
10"	72"—77.9375"	+\$455	+\$68	+\$ 78
10"	78"—83.9375"	+\$491	+\$74	+\$ 85
10"	84"—89.9375"	+\$531	+\$80	+\$ 92
10"	90"—95.9375"	+\$573	+\$86	+\$ 99
10"	96"—96.5"	+\$619	+\$93	+\$107

Tip: Paint price groups 2 and 3 upcharges are in addition to the paint price group 1 upcharge.

► Specification Information, on next page

Aisla Panels—Inline, continued

► Options, on previous page

Specification Information

Style Number	Dimensions		U.S. Base Price	Options (Add \$ to Base Price)						Customiz Stain	
	Modular Height	Parametric Width		High-Pressure Laminate			Composite Veneer		Wood		
				Price	Price	Price	Price	Price	Price	Price	
				Group 2	Group 3	Group 1	Group 2	Group 1	Group 2	Group 3	

Panel—Inline Inline

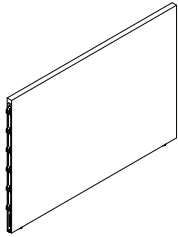

PNLII	Modular Height	Parametric Width	U.S. Base Price	High-Pressure Laminate Price	High-Pressure Laminate Price	High-Pressure Laminate Price	Composite Veneer Price	Composite Veneer Price	Wood Price	Wood Price	Wood Price	Customiz Stain
	42"	18"-23.9375"	\$ 683	+\$ 82	+\$123	+\$ 332	+\$ 389	+\$ 511	+\$ 644	+\$ 791	+\$ 332	
	42"	24"-29.9375"	\$ 803	+\$ 94	+\$141	+\$ 380	+\$ 446	+\$ 585	+\$ 738	+\$ 906	+\$ 380	
	42"	30"-35.9375"	\$ 945	+\$109	+\$163	+\$ 437	+\$ 513	+\$ 673	+\$ 849	+\$1043	+\$ 437	
	42"	36"-41.9375"	\$1112	+\$125	+\$188	+\$ 505	+\$ 592	+\$ 777	+\$ 980	+\$1203	+\$ 505	
	42"	42"-47.9375"	\$1308	+\$145	+\$217	+\$ 584	+\$ 685	+\$ 898	+\$1133	+\$1391	+\$ 584	
	42"	48"-53.9375"	\$1539	+\$168	+\$252	+\$ 677	+\$ 794	+\$1042	+\$1314	+\$1613	+\$ 677	
	42"	54"-59.9375"	\$1811	+\$195	+\$293	+\$ 786	+\$ 923	+\$1210	+\$1526	+\$1874	+\$ 786	
	42"	60"-65.9375"	\$2130	+\$227	+\$341	+\$ 915	+\$1074	+\$1408	+\$1776	+\$2181	+\$ 915	
	42"	66"-71.9375"	\$2343	+\$248	+\$372	+\$1001	+\$1175	+\$1541	+\$1943	+\$2386	+\$1001	
	42"	72"-77.9375"	\$2577	+\$272	+\$408	+\$1095	+\$1286	+\$1686	+\$2126	+\$2611	+\$1095	
	42"	78"-83.9375"	\$2783	+\$292	+\$439	+\$1178	+\$1383	+\$1814	+\$2288	+\$2809	+\$1178	
	42"	84"-89.9375"	\$3006	+\$315	+\$472	+\$1268	+\$1489	+\$1952	+\$2462	+\$3023	+\$1268	
	42"	90"-95.9375"	\$3247	+\$339	+\$508	+\$1365	+\$1602	+\$2101	+\$2650	+\$3254	+\$1365	
	42"	96"-96.5"	\$3506	+\$365	+\$547	+\$1469	+\$1725	+\$2262	+\$2853	+\$3503	+\$1469	
	48"	18"-23.9375"	\$ 750	+\$ 89	+\$134	+\$ 359	+\$ 421	+\$ 552	+\$ 697	+\$ 855	+\$ 359	
	48"	24"-29.9375"	\$ 883	+\$102	+\$153	+\$ 412	+\$ 484	+\$ 634	+\$ 800	+\$ 982	+\$ 412	
	48"	30"-35.9375"	\$1038	+\$118	+\$177	+\$ 475	+\$ 557	+\$ 731	+\$ 922	+\$1132	+\$ 475	
	48"	36"-41.9375"	\$1221	+\$136	+\$204	+\$ 549	+\$ 644	+\$ 845	+\$1065	+\$1308	+\$ 549	
	48"	42"-47.9375"	\$1437	+\$158	+\$237	+\$ 636	+\$ 746	+\$ 979	+\$1234	+\$1515	+\$ 636	
	48"	48"-53.9375"	\$1691	+\$183	+\$275	+\$ 738	+\$ 866	+\$1136	+\$1433	+\$1759	+\$ 738	
	48"	54"-59.9375"	\$1989	+\$213	+\$319	+\$ 858	+\$1007	+\$1321	+\$1666	+\$2045	+\$ 858	
	48"	60"-65.9375"	\$2340	+\$248	+\$372	+\$ 999	+\$1173	+\$1539	+\$1941	+\$2383	+\$ 999	
	48"	66"-71.9375"	\$2574	+\$271	+\$407	+\$1094	+\$1284	+\$1684	+\$2124	+\$2608	+\$1094	
	48"	72"-77.9375"	\$2831	+\$297	+\$446	+\$1197	+\$1406	+\$1844	+\$2325	+\$2855	+\$1197	
	48"	78"-83.9375"	\$3058	+\$320	+\$480	+\$1289	+\$1513	+\$1984	+\$2502	+\$3072	+\$1289	
	48"	84"-89.9375"	\$3303	+\$344	+\$516	+\$1387	+\$1629	+\$2136	+\$2694	+\$3307	+\$1387	
	48"	90"-95.9375"	\$3567	+\$371	+\$556	+\$1494	+\$1754	+\$2300	+\$2901	+\$3561	+\$1494	
	48"	96"-96.5"	\$3852	+\$399	+\$599	+\$1609	+\$1889	+\$2477	+\$3124	+\$3835	+\$1609	

► Specification Information, continued on next page

► Specification Information, continued from previous page

Specification Information

Style Number	Dimensions		U.S. Base Price	Options (Add \$ to Base Price)						Customiz Stain	
	Modular Height	Parametric Width		High-Pressure Laminate		Composite Veneer		Wood			
				Price Group 2	Price Group 3	Price Group 1	Price Group 2	Price Group 1	Price Group 2		Price Group 3

Panel—Inline Spanning

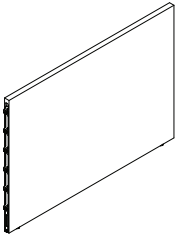

PNLIS	42"	18"—23.9375"	\$ 683	+\$ 82	+\$123	+\$ 332	+\$ 389	+\$ 511	+\$ 644	+\$ 791	+\$ 332
	42"	24"—29.9375"	\$ 803	+\$ 94	+\$141	+\$ 380	+\$ 446	+\$ 585	+\$ 738	+\$ 906	+\$ 380
	42"	30"—35.9375"	\$ 945	+\$109	+\$163	+\$ 437	+\$ 513	+\$ 673	+\$ 849	+\$1043	+\$ 437
	42"	36"—41.9375"	\$1112	+\$125	+\$188	+\$ 505	+\$ 592	+\$ 777	+\$ 980	+\$1203	+\$ 505
	42"	42"—47.9375"	\$1308	+\$145	+\$217	+\$ 584	+\$ 685	+\$ 898	+\$1133	+\$1391	+\$ 584
	42"	48"—53.9375"	\$1539	+\$168	+\$252	+\$ 677	+\$ 794	+\$1042	+\$1314	+\$1613	+\$ 677
	42"	54"—59.9375"	\$1811	+\$195	+\$293	+\$ 786	+\$ 923	+\$1210	+\$1526	+\$1874	+\$ 786
	42"	60"—65.9375"	\$2130	+\$227	+\$341	+\$ 915	+\$1074	+\$1408	+\$1776	+\$2181	+\$ 915
	42"	66"—71.9375"	\$2343	+\$248	+\$372	+\$1001	+\$1175	+\$1541	+\$1943	+\$2386	+\$1001
	42"	72"—77.9375"	\$2577	+\$272	+\$408	+\$1095	+\$1286	+\$1686	+\$2126	+\$2611	+\$1095
	42"	78"—83.9375"	\$2783	+\$292	+\$439	+\$1178	+\$1383	+\$1814	+\$2288	+\$2809	+\$1178
	42"	84"—89.9375"	\$3006	+\$315	+\$472	+\$1268	+\$1489	+\$1952	+\$2462	+\$3023	+\$1268
	42"	90"—95.9375"	\$3247	+\$339	+\$508	+\$1365	+\$1602	+\$2101	+\$2650	+\$3254	+\$1365
	42"	96"—96.5"	\$3506	+\$365	+\$547	+\$1469	+\$1725	+\$2262	+\$2853	+\$3503	+\$1469
	48"	18"—23.9375"	\$ 750	+\$ 89	+\$134	+\$ 359	+\$ 421	+\$ 552	+\$ 697	+\$ 855	+\$ 359
	48"	24"—29.9375"	\$ 883	+\$102	+\$153	+\$ 412	+\$ 484	+\$ 634	+\$ 800	+\$ 982	+\$ 412
	48"	30"—35.9375"	\$1038	+\$118	+\$177	+\$ 475	+\$ 557	+\$ 731	+\$ 922	+\$1132	+\$ 475
	48"	36"—41.9375"	\$1221	+\$136	+\$204	+\$ 549	+\$ 644	+\$ 845	+\$1065	+\$1308	+\$ 549
	48"	42"—47.9375"	\$1437	+\$158	+\$237	+\$ 636	+\$ 746	+\$ 979	+\$1234	+\$1515	+\$ 636
	48"	48"—53.9375"	\$1691	+\$183	+\$275	+\$ 738	+\$ 866	+\$1136	+\$1433	+\$1759	+\$ 738
	48"	54"—59.9375"	\$1989	+\$213	+\$319	+\$ 858	+\$1007	+\$1321	+\$1666	+\$2045	+\$ 858
	48"	60"—65.9375"	\$2340	+\$248	+\$372	+\$ 999	+\$1173	+\$1539	+\$1941	+\$2383	+\$ 999
	48"	66"—71.9375"	\$2574	+\$271	+\$407	+\$1094	+\$1284	+\$1684	+\$2124	+\$2608	+\$1094
	48"	72"—77.9375"	\$2831	+\$297	+\$446	+\$1197	+\$1406	+\$1844	+\$2325	+\$2855	+\$1197
	48"	78"—83.9375"	\$3058	+\$320	+\$480	+\$1289	+\$1513	+\$1984	+\$2502	+\$3072	+\$1289
	48"	84"—89.9375"	\$3303	+\$344	+\$516	+\$1387	+\$1629	+\$2136	+\$2694	+\$3307	+\$1387
	48"	90"—95.9375"	\$3567	+\$371	+\$556	+\$1494	+\$1754	+\$2300	+\$2901	+\$3561	+\$1494
	48"	96"—96.5"	\$3852	+\$399	+\$599	+\$1609	+\$1889	+\$2477	+\$3124	+\$3835	+\$1609

► Specification Information, continued on next page

► Specification Information, continued from previous page

Specification Information											
Style Number	Dimensions		U.S. Base Price	Options (Add \$ to Base Price)				Wood			Customiz Stain
	Modular Height	Parametric Width		High-Pressure Laminate	Composite Veneer	Wood		Price	Price	Price	
				Price	Price	Price	Price	Price	Price	Price	
				Group 2	Group 3	Group 1	Group 2	Group 1	Group 2	Group 3	

Panel—Inline Miter

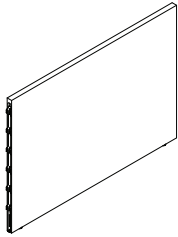

PNLIM	Modular Height	Parametric Width	U.S. Base Price	High-Pressure Laminate	Composite Veneer	Wood	Wood	Wood	Wood	Wood	Customiz Stain
42"	18"-23.9375"		\$ 683	+\$100	+\$150	+\$ 404	+\$ 474	+\$ 622	+\$ 785	+\$ 963	+\$ 404
42"	24"-29.9375"		\$ 803	+\$112	+\$168	+\$ 453	+\$ 532	+\$ 697	+\$ 879	+\$1079	+\$ 453
42"	30"-35.9375"		\$ 945	+\$127	+\$190	+\$ 510	+\$ 599	+\$ 785	+\$ 990	+\$1215	+\$ 510
42"	36"-41.9375"		\$1112	+\$143	+\$215	+\$ 577	+\$ 677	+\$ 888	+\$1120	+\$1376	+\$ 577
42"	42"-47.9375"		\$1308	+\$163	+\$244	+\$ 656	+\$ 770	+\$1010	+\$1274	+\$1564	+\$ 656
42"	48"-53.9375"		\$1539	+\$186	+\$279	+\$ 749	+\$ 880	+\$1153	+\$1455	+\$1786	+\$ 749
42"	54"-59.9375"		\$1811	+\$213	+\$320	+\$ 859	+\$1008	+\$1322	+\$1667	+\$2047	+\$ 859
42"	60"-65.9375"		\$2130	+\$245	+\$368	+\$ 987	+\$1159	+\$1520	+\$1917	+\$2354	+\$ 987
42"	66"-71.9375"		\$2343	+\$266	+\$399	+\$1073	+\$1260	+\$1652	+\$2084	+\$2559	+\$1073
42"	72"-77.9375"		\$2577	+\$290	+\$435	+\$1168	+\$1371	+\$1798	+\$2267	+\$2784	+\$1168
42"	78"-83.9375"		\$2783	+\$310	+\$466	+\$1251	+\$1468	+\$1926	+\$2429	+\$2982	+\$1251
42"	84"-89.9375"		\$3006	+\$333	+\$499	+\$1340	+\$1574	+\$2064	+\$2603	+\$3196	+\$1340
42"	90"-95.9375"		\$3247	+\$357	+\$535	+\$1437	+\$1688	+\$2213	+\$2791	+\$3427	+\$1437
42"	96"-96.5"		\$3506	+\$383	+\$574	+\$1542	+\$1810	+\$2374	+\$2994	+\$3676	+\$1542
48"	18"-23.9375"		\$ 750	+\$107	+\$161	+\$ 431	+\$ 506	+\$ 664	+\$ 837	+\$1028	+\$ 431
48"	24"-29.9375"		\$ 883	+\$120	+\$180	+\$ 485	+\$ 569	+\$ 746	+\$ 941	+\$1155	+\$ 485
48"	30"-35.9375"		\$1038	+\$136	+\$204	+\$ 547	+\$ 643	+\$ 843	+\$1063	+\$1305	+\$ 547
48"	36"-41.9375"		\$1221	+\$154	+\$231	+\$ 621	+\$ 729	+\$ 956	+\$1206	+\$1481	+\$ 621
48"	42"-47.9375"		\$1437	+\$176	+\$264	+\$ 708	+\$ 831	+\$1090	+\$1375	+\$1688	+\$ 708
48"	48"-53.9375"		\$1691	+\$201	+\$302	+\$ 810	+\$ 951	+\$1248	+\$1573	+\$1932	+\$ 810
48"	54"-59.9375"		\$1989	+\$231	+\$346	+\$ 931	+\$1093	+\$1433	+\$1807	+\$2218	+\$ 931
48"	60"-65.9375"		\$2340	+\$266	+\$399	+\$1072	+\$1259	+\$1650	+\$2081	+\$2556	+\$1072
48"	66"-71.9375"		\$2574	+\$289	+\$434	+\$1166	+\$1369	+\$1796	+\$2265	+\$2780	+\$1166
48"	72"-77.9375"		\$2831	+\$315	+\$473	+\$1270	+\$1491	+\$1955	+\$2466	+\$3028	+\$1270
48"	78"-83.9375"		\$3058	+\$338	+\$507	+\$1361	+\$1598	+\$2096	+\$2643	+\$3245	+\$1361
48"	84"-89.9375"		\$3303	+\$362	+\$543	+\$1460	+\$1714	+\$2248	+\$2835	+\$3480	+\$1460
48"	90"-95.9375"		\$3567	+\$389	+\$583	+\$1566	+\$1839	+\$2412	+\$3041	+\$3734	+\$1566
48"	96"-96.5"		\$3852	+\$417	+\$626	+\$1681	+\$1974	+\$2589	+\$3265	+\$4008	+\$1681

► Specification Information, continued on next page

► Specification Information, continued from previous page

Specification Information											
Style Number	Dimensions		U.S. Base Price	Options (Add \$ to Base Price)				Wood			Customiz Stain
	Modular Height	Parametric Width		High-Pressure Laminate	Composite Veneer	Wood		Price	Price	Price	
				Price Group 2	Price Group 3	Price Group 1	Price Group 2	Price Group 1	Price Group 2	Price Group 3	

Panel—Inline T

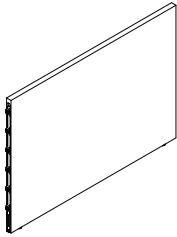

PNLIT	42"	18"—23.9375"	\$ 683	+\$ 85	+\$128	+\$ 344	+\$ 404	+\$ 529	+\$ 667	+\$ 819	+\$ 344
	42"	24"—29.9375"	\$ 803	+\$ 97	+\$146	+\$ 392	+\$ 461	+\$ 604	+\$ 762	+\$ 935	+\$ 392
	42"	30"—35.9375"	\$ 945	+\$112	+\$167	+\$ 449	+\$ 528	+\$ 692	+\$ 873	+\$1071	+\$ 449
	42"	36"—41.9375"	\$1112	+\$128	+\$192	+\$ 517	+\$ 607	+\$ 795	+\$1003	+\$1232	+\$ 517
	42"	42"—47.9375"	\$1308	+\$148	+\$222	+\$ 596	+\$ 699	+\$ 917	+\$1157	+\$1420	+\$ 596
	42"	48"—53.9375"	\$1539	+\$171	+\$256	+\$ 689	+\$ 809	+\$1060	+\$1337	+\$1642	+\$ 689
	42"	54"—59.9375"	\$1811	+\$198	+\$297	+\$ 798	+\$ 937	+\$1229	+\$1550	+\$1903	+\$ 798
	42"	60"—65.9375"	\$2130	+\$230	+\$345	+\$ 927	+\$1088	+\$1427	+\$1800	+\$2210	+\$ 927
	42"	66"—71.9375"	\$2343	+\$251	+\$377	+\$1013	+\$1189	+\$1559	+\$1966	+\$2414	+\$1013
	42"	72"—77.9375"	\$2577	+\$275	+\$412	+\$1107	+\$1300	+\$1705	+\$2150	+\$2640	+\$1107
	42"	78"—83.9375"	\$2783	+\$295	+\$443	+\$1190	+\$1397	+\$1833	+\$2311	+\$2838	+\$1190
	42"	84"—89.9375"	\$3006	+\$318	+\$476	+\$1280	+\$1503	+\$1971	+\$2485	+\$3052	+\$1280
	42"	90"—95.9375"	\$3247	+\$342	+\$512	+\$1377	+\$1617	+\$2120	+\$2674	+\$3283	+\$1377
	42"	96"—96.5"	\$3506	+\$368	+\$551	+\$1482	+\$1739	+\$2281	+\$2877	+\$3532	+\$1482
	48"	18"—23.9375"	\$ 750	+\$ 92	+\$138	+\$ 371	+\$ 435	+\$ 571	+\$ 720	+\$ 884	+\$ 371
	48"	24"—29.9375"	\$ 883	+\$105	+\$158	+\$ 424	+\$ 498	+\$ 653	+\$ 824	+\$1011	+\$ 424
	48"	30"—35.9375"	\$1038	+\$121	+\$181	+\$ 487	+\$ 572	+\$ 750	+\$ 945	+\$1161	+\$ 487
	48"	36"—41.9375"	\$1221	+\$139	+\$209	+\$ 561	+\$ 658	+\$ 863	+\$1089	+\$1337	+\$ 561
	48"	42"—47.9375"	\$1437	+\$161	+\$241	+\$ 648	+\$ 760	+\$ 997	+\$1258	+\$1544	+\$ 648
	48"	48"—53.9375"	\$1691	+\$186	+\$279	+\$ 750	+\$ 880	+\$1154	+\$1456	+\$1788	+\$ 750
	48"	54"—59.9375"	\$1989	+\$216	+\$324	+\$ 870	+\$1022	+\$1340	+\$1689	+\$2074	+\$ 870
	48"	60"—65.9375"	\$2340	+\$251	+\$377	+\$1012	+\$1188	+\$1557	+\$1964	+\$2412	+\$1012
	48"	66"—71.9375"	\$2574	+\$274	+\$412	+\$1106	+\$1298	+\$1703	+\$2147	+\$2636	+\$1106
	48"	72"—77.9375"	\$2831	+\$300	+\$450	+\$1210	+\$1420	+\$1862	+\$2349	+\$2884	+\$1210
	48"	78"—83.9375"	\$3058	+\$323	+\$484	+\$1301	+\$1527	+\$2003	+\$2526	+\$3101	+\$1301
	48"	84"—89.9375"	\$3303	+\$347	+\$521	+\$1399	+\$1643	+\$2155	+\$2717	+\$3336	+\$1399
	48"	90"—95.9375"	\$3567	+\$374	+\$561	+\$1506	+\$1768	+\$2319	+\$2924	+\$3590	+\$1506
	48"	96"—96.5"	\$3852	+\$402	+\$603	+\$1621	+\$1903	+\$2496	+\$3147	+\$3864	+\$1621

Aisla Panels—Miter

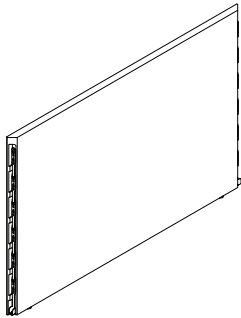

► Need help?
Product details,
page 26

Standard Includes

- Panel—Miter: High-Pressure Laminate price group 1
- 1 mm top edge band
- 3 mm side edge band
- Transaction top, if selected: High-Pressure Laminate price group 1
- Transaction top edge, if selected: plastic
- Transaction top bracket, if selected: paint price group 1
- Glass insert, if selected: glass price group 1

Required to Specify

- 1 Style number
 - 2 Width (see below under Required Selections)
 - 3 Height (see below under Required Selections)
 - 4 Connection—end A (see below under Required Selections)
 - 5 Connection—end B (see below under Required Selections)
 - 6 High-Pressure Laminate color for panel
 - 7 Glass color number for glass insert, if selected
 - 8 High-Pressure Laminate color for transaction top, if selected
 - 9 Plastic color number for transaction top edge, if selected
 - 10 Paint color number for transaction top bracket, if selected
 - 11 Options, if selected (see below)
- See *Surface Materials*, page 164

Tip: Parametric width (18"W–96.5"W) is available in 1/16" increments.

	Required Selections	U.S. Price	Required to Specify
Width	• 18"–96.5"	Prices at right	Specify width.

Height	• 42" • 48"	Prices at right Prices at right	Specify height. Specify height.
---------------	----------------	------------------------------------	------------------------------------

Connection	End A		
	• Spanning	+\$ 70	Specify with end A spanning.
• T	+\$100	Specify with end A T.	
• Mitered side 1	+\$250	Specify with end A mitered side 1.	
• Mitered side 2	+\$250	Specify with end A mitered side 2.	

	End B		
	• Spanning	+\$ 70	Specify with end B spanning.
	• T	+\$100	Specify with end B T.
	• Mitered side 1	+\$250	Specify with end B mitered side 1.
	• Mitered side 2	+\$250	Specify with end B mitered side 2.

	Options	U.S. Price	Required to Specify
--	---------	------------	---------------------

Surface Materials	Panel		
	• High-Pressure Laminate price group 1	No cost	Specify laminate color number.
	• High-Pressure Laminate price group 2	Prices at right	Specify laminate color number.
	• High-Pressure Laminate price group 3	Prices at right	Specify laminate color number.
	• Open Line laminate (OLL)	+\$111 plus cost of laminate	► See <i>Surface Materials Reference Manual</i> .
	• Composite veneer group 1	Prices at right	Specify composite veneer color number.
	• Composite veneer group 2	Prices at right	Specify composite veneer color number.
	• Wood group 1	Prices at right	Specify wood color number.
	• Wood group 2	Prices at right	Specify wood color number.
	• Wood group 3	Prices at right	Specify wood color number.
• Customiz stain	Prices at right	Specify with customiz stain.	

	Integrated glass		
	• Glass price group 1	Prices at right	Specify with 6500 Clear Glass.
	• Glass price group 3	Prices at right	Specify with 6501 Low Iron Clear Glass.
	• Glass price group 4	Prices at right	Specify with 6562 Bronze or 6563 Smoke Glass.

► Options, continued on next page



For Canadian Pricing
Multiply U.S. Price by the Canadian price factor.
► See page 1 for details.

► Options, continued from previous page

	Options	U.S. Price	Required to Specify
Surface Materials, Continued	Transaction top		
	• High-Pressure Laminate price group 1	No cost	Specify laminate color number.
	• High-Pressure Laminate price group 2	Prices at right	Specify laminate color number.
	• High-Pressure Laminate price group 3	Prices at right	Specify laminate color number.
	• Open Line laminate (OLL)	+\$111 plus cost of laminate	► See <i>Surface Materials Reference Manual</i> .
	• Composite veneer group 1	Prices at right	Specify composite veneer color number.
	• Composite veneer group 2	Prices at right	Specify composite veneer color number.
	• Wood group 1	Prices at right	Specify wood color number.
	• Wood group 2	Prices at right	Specify wood color number.
	• Wood group 3	Prices at right	Specify wood color number.
• Customiz stain	Prices at right	Specify with <i>customiz stain</i> .	
	Transaction top edge		
	• Plastic	No cost	Specify plastic color number.
	Transaction top bracket		
	• Paint price group 1	Prices at right	Specify paint color number.
	• Paint price group 2	Prices at right	Specify paint color number.
	• Paint price group 3	Prices at right	Specify paint color number.
Connection T	End A		
	• T adjacent side 1	No cost	Specify with <i>end A T adjacent side 1</i> .
	• T adjacent side 2	No cost	Specify with <i>end A T adjacent side 2</i> .
	End B		
	• T adjacent side 1	No cost	Specify with <i>end B T adjacent side 1</i> .
	• T adjacent side 2	No cost	Specify with <i>end B T adjacent side 2</i> .
Mitered Matchstick	End A		
	• No matchstick	No cost	Specify with <i>end A no matchstick</i> .
	• With matchstick	No cost	Specify with <i>end A matchstick</i> .
	End B		
	• No matchstick	No cost	Specify with <i>end B no matchstick</i> .
	• With matchstick	No cost	Specify with <i>end B matchstick</i> .
Accent Panel	• No panel	No cost	Specify with <i>no panel</i> .
	• Fabric panel side 1	No cost	Specify with <i>fabric panel side 1</i> .
	• Fabric panel side 2	No cost	Specify with <i>fabric panel side 2</i> .
	• Fabric panel side 1 and 2	No cost	Specify with <i>fabric panel side 1 and 2</i> .
	Top Accessory		
	• No accessory	No cost	Specify with <i>no accessory</i> .
	• Integrated glass	Prices at right	Specify with <i>integrated glass</i> .
	• 10"D transaction top side 1	Prices at right	Specify with <i>10"D transaction top side 1</i> .
	• 10"D transaction top side 2	Prices at right	Specify with <i>10"D transaction top side 2</i> .
	• Transaction top bracket only side 1	Prices at right	Specify with <i>transaction top bracket only side 1</i> .
	• Transaction top bracket only side 2	Prices at right	Specify with <i>transaction top bracket only side 2</i> .
Glass Height	• 10"	Prices at right	Specify glass height.
	• 12"	Prices at right	Specify glass height.
Grain Direction	Panel		
	• No grain direction	No cost	Specify with <i>no grain direction</i> .
	• Horizontal	No cost	Specify with <i>horizontal grain direction</i> .
	• Vertical	No cost	Specify with <i>vertical grain direction</i> .
	Transaction top		
	• No grain direction	No cost	Specify with <i>no grain direction</i> .
• Long grain	No cost	Specify with <i>long grain direction</i> .	
• Short grain	No cost	Specify with <i>short grain direction</i> .	
Related Products	• Aisla powered panels		► Page 88
	• Aisla cabinets		► Page 132
	• Aisla fabric-wrapped magnetic panel		► Page 130

Tip: This option is only available when connection end A is T.

Tip: This option is only available when connection end B is T.

Tip: This option is only available when connection end A is mitered.

Tip: This option is only available when connection end B is mitered.

Tip: For directional laminates, horizontal and vertical grain direction are available when width is up to and including 60". When width is greater than 60", only horizontal grain direction is allowed.



For Canadian Pricing
Multiply U.S. Price by the Canadian price factor.
► See page 1 for details.

► Options, continued on next page

► Options, continued from previous page

Integrated Glass Option with Finish Upcharges

Tip: Glass price group 3 or glass price group 4 upcharge is in addition to glass price group 1 cost.

Height— Modular	Width— Parametric	Options (Add \$ to Base Price)		
		Glass Price Group 1	Glass Price Group 3	Glass Price Group 4
10"	18"—23.9375"	N.A.	N.A.	N.A.
10"	24"—29.9375"	N.A.	N.A.	N.A.
10"	30"—35.9375"	+\$ 293	+\$179	+\$351
10"	36"—41.9375"	+\$ 320	+\$193	+\$376
10"	42"—47.9375"	+\$ 357	+\$203	+\$402
10"	48"—53.9375"	+\$ 404	+\$229	+\$431
10"	54"—59.9375"	+\$ 480	+\$245	+\$461
10"	60"—65.9375"	+\$ 566	+\$259	+\$493
10"	66"—71.9375"	+\$ 637	+\$272	+\$527
10"	72"—77.9375"	+\$ 749	+\$286	+\$564
10"	78"—83.9375"	+\$ 860	+\$300	+\$604
10"	84"—89.9375"	+\$1040	+\$339	+\$646
10"	90"—95.9375"	+\$1220	+\$352	+\$691
10"	96"—96.5"	+\$1364	+\$376	+\$740
12"	18"—23.9375"	N.A.	N.A.	N.A.
12"	24"—29.9375"	N.A.	N.A.	N.A.
12"	30"—35.9375"	+\$ 325	+\$197	+\$380
12"	36"—41.9375"	+\$ 355	+\$212	+\$406
12"	42"—47.9375"	+\$ 397	+\$223	+\$435
12"	48"—53.9375"	+\$ 449	+\$252	+\$465
12"	54"—59.9375"	+\$ 533	+\$270	+\$498
12"	60"—65.9375"	+\$ 629	+\$285	+\$532
12"	66"—71.9375"	+\$ 708	+\$299	+\$570
12"	72"—77.9375"	+\$ 832	+\$315	+\$610
12"	78"—83.9375"	+\$ 956	+\$330	+\$652
12"	84"—89.9375"	+\$1155	+\$373	+\$698
12"	90"—95.9375"	+\$1355	+\$387	+\$747
12"	96"—96.5"	+\$1515	+\$414	+\$799

► Options, continued on next page



For Canadian Pricing
 Multiply U.S. Price by the
 Canadian price factor.
 ► See page 1 for details.

► Options, continued from previous page

10"D Transaction Top Option with Finish Upcharges

Depth— Modular	Width— Parametric	Options (Add \$ to Base Price)								
		High-Pressure Laminate			Composite Veneer		Wood			Customiz Stain
		Price Group 1	Price Group 2	Price Group 3	Group 1	Group 2	Group 1	Group 2	Group 3	
10"	18"—23.9375"	N.A.	N.A.	N.A.	N.A.	N.A.	N.A.	N.A.	N.A.	N.A.
10"	24"—29.9375"	N.A.	N.A.	N.A.	N.A.	N.A.	N.A.	N.A.	N.A.	N.A.
10"	30"—35.9375"	+\$440	+\$ 66	+\$142	+\$229	+\$330	+\$ 715	+\$ 888	+\$1087	+\$229
10"	36"—41.9375"	+\$468	+\$ 70	+\$151	+\$244	+\$351	+\$ 760	+\$ 945	+\$1157	+\$244
10"	42"—47.9375"	+\$498	+\$ 75	+\$161	+\$260	+\$373	+\$ 809	+\$1005	+\$1231	+\$260
10"	48"—53.9375"	+\$530	+\$ 80	+\$171	+\$276	+\$397	+\$ 861	+\$1069	+\$1309	+\$276
10"	54"—59.9375"	+\$564	+\$ 85	+\$182	+\$294	+\$422	+\$ 916	+\$1138	+\$1393	+\$294
10"	60"—65.9375"	+\$600	+\$ 90	+\$193	+\$313	+\$449	+\$ 974	+\$1210	+\$1482	+\$313
10"	66"—71.9375"	+\$638	+\$ 96	+\$206	+\$332	+\$478	+\$1036	+\$1287	+\$1576	+\$332
10"	72"—77.9375"	+\$679	+\$102	+\$219	+\$354	+\$509	+\$1102	+\$1370	+\$1677	+\$354
10"	78"—83.9375"	+\$720	+\$108	+\$232	+\$375	+\$539	+\$1169	+\$1452	+\$1777	+\$375
10"	84"—89.9375"	+\$763	+\$114	+\$246	+\$397	+\$571	+\$1239	+\$1539	+\$1884	+\$397
10"	90"—95.9375"	+\$809	+\$121	+\$261	+\$421	+\$606	+\$1313	+\$1631	+\$1997	+\$421
10"	96"—96.5"	+\$857	+\$129	+\$276	+\$447	+\$642	+\$1392	+\$1729	+\$2117	+\$447

Tip: High-Pressure Laminate price groups 2 and 3, composite veneer, wood, and customiz stain upcharges are in addition to the High-Pressure price group 1 upcharge.

Transaction Top Bracket Option with Finish Upcharges

Depth— Modular	Width— Parametric	Options (Add \$ to Base Price)		
		Paint Price Group 1	Paint Price Group 2	Paint Price Group 3
		10"	18"—23.9375"	N.A.
10"	24"—29.9375"	N.A.	N.A.	N.A.
10"	30"—35.9375"	+\$257	+\$39	+\$ 44
10"	36"—41.9375"	+\$279	+\$42	+\$ 48
10"	42"—47.9375"	+\$304	+\$46	+\$ 52
10"	48"—53.9375"	+\$330	+\$50	+\$ 57
10"	54"—59.9375"	+\$359	+\$54	+\$ 62
10"	60"—65.9375"	+\$390	+\$59	+\$ 67
10"	66"—71.9375"	+\$421	+\$63	+\$ 73
10"	72"—77.9375"	+\$455	+\$68	+\$ 78
10"	78"—83.9375"	+\$491	+\$74	+\$ 85
10"	84"—89.9375"	+\$531	+\$80	+\$ 92
10"	90"—95.9375"	+\$573	+\$86	+\$ 99
10"	96"—96.5"	+\$619	+\$93	+\$107

Tip: Paint price groups 2 and 3 upcharges are in addition to the paint price group 1 upcharge.

► Specification Information, on next page

Aisla Panels—Miter, continued

► Options, on previous page

Specification Information

Style Number	Dimensions		U.S. Base Price	Options (Add \$ to Base Price)						Customiz Stain	
	Modular Height	Parametric Width		High-Pressure Laminate			Composite Veneer		Wood		
				Price	Price	Price	Price	Price	Price	Price	
				Group 2	Group 3	Group 1	Group 2	Group 1	Group 2	Group 3	

Panel—Miter Miter

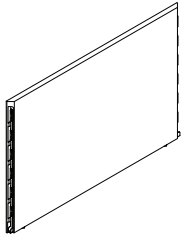

PNLMM	42"	18"-23.9375"	\$ 683	+\$118	+\$177	+\$ 477	+\$ 560	+\$ 734	+\$ 926	+\$1136	+\$ 477
	42"	24"-29.9375"	\$ 803	+\$130	+\$195	+\$ 525	+\$ 617	+\$ 809	+\$1020	+\$1252	+\$ 525
	42"	30"-35.9375"	\$ 945	+\$145	+\$217	+\$ 582	+\$ 684	+\$ 897	+\$1131	+\$1388	+\$ 582
	42"	36"-41.9375"	\$1112	+\$161	+\$242	+\$ 650	+\$ 763	+\$1000	+\$1261	+\$1549	+\$ 650
	42"	42"-47.9375"	\$1308	+\$181	+\$271	+\$ 729	+\$ 855	+\$1122	+\$1415	+\$1737	+\$ 729
	42"	48"-53.9375"	\$1539	+\$204	+\$306	+\$ 822	+\$ 965	+\$1265	+\$1595	+\$1959	+\$ 822
	42"	54"-59.9375"	\$1811	+\$231	+\$347	+\$ 931	+\$1093	+\$1434	+\$1808	+\$2220	+\$ 931
	42"	60"-65.9375"	\$2130	+\$263	+\$395	+\$1060	+\$1244	+\$1632	+\$2058	+\$2527	+\$1060
	42"	66"-71.9375"	\$2343	+\$284	+\$426	+\$1146	+\$1345	+\$1764	+\$2225	+\$2731	+\$1146
	42"	72"-77.9375"	\$2577	+\$308	+\$462	+\$1240	+\$1456	+\$1909	+\$2408	+\$2957	+\$1240
	42"	78"-83.9375"	\$2783	+\$328	+\$493	+\$1323	+\$1554	+\$2037	+\$2569	+\$3155	+\$1323
	42"	84"-89.9375"	\$3006	+\$351	+\$526	+\$1413	+\$1659	+\$2175	+\$2744	+\$3369	+\$1413
	42"	90"-95.9375"	\$3247	+\$375	+\$562	+\$1510	+\$1773	+\$2325	+\$2932	+\$3600	+\$1510
	42"	96"-96.5"	\$3506	+\$401	+\$601	+\$1615	+\$1896	+\$2486	+\$3135	+\$3849	+\$1615
	48"	18"-23.9375"	\$ 750	+\$125	+\$188	+\$ 504	+\$ 592	+\$ 776	+\$ 978	+\$1201	+\$ 504
	48"	24"-29.9375"	\$ 883	+\$138	+\$207	+\$ 557	+\$ 654	+\$ 858	+\$1082	+\$1328	+\$ 577
	48"	30"-35.9375"	\$1038	+\$154	+\$231	+\$ 620	+\$ 728	+\$ 954	+\$1204	+\$1478	+\$ 620
	48"	36"-41.9375"	\$1221	+\$172	+\$258	+\$ 694	+\$ 815	+\$1068	+\$1347	+\$1654	+\$ 694
	48"	42"-47.9375"	\$1437	+\$194	+\$291	+\$ 781	+\$ 917	+\$1202	+\$1516	+\$1861	+\$ 781
	48"	48"-53.9375"	\$1691	+\$219	+\$329	+\$ 883	+\$1037	+\$1359	+\$1714	+\$2105	+\$ 883
	48"	54"-59.9375"	\$1989	+\$249	+\$373	+\$1003	+\$1178	+\$1544	+\$1948	+\$2391	+\$1003
	48"	60"-65.9375"	\$2340	+\$284	+\$426	+\$1145	+\$1344	+\$1762	+\$2222	+\$2729	+\$1145
	48"	66"-71.9375"	\$2574	+\$307	+\$461	+\$1239	+\$1454	+\$1907	+\$2405	+\$2953	+\$1239
	48"	72"-77.9375"	\$2831	+\$333	+\$500	+\$1343	+\$1576	+\$2067	+\$2607	+\$3201	+\$1343
	48"	78"-83.9375"	\$3058	+\$356	+\$534	+\$1434	+\$1683	+\$2208	+\$2784	+\$3418	+\$1434
	48"	84"-89.9375"	\$3303	+\$380	+\$570	+\$1532	+\$1799	+\$2359	+\$2976	+\$3653	+\$1532
	48"	90"-95.9375"	\$3567	+\$407	+\$610	+\$1639	+\$1924	+\$2523	+\$3182	+\$3907	+\$1639
	48"	96"-96.5"	\$3852	+\$435	+\$653	+\$1754	+\$2059	+\$2700	+\$3406	+\$4181	+\$1754

► Specification Information, continued on next page

► Specification Information, continued from previous page

Specification Information											
Style Number	Dimensions		U.S. Base Price	Options (Add \$ to Base Price)						Customiz Stain	
	Modular Height	Parametric Width		High-Pressure Laminate	Composite Veneer	Wood					
				Price Group 2	Price Group 3	Price Group 1	Price Group 2	Price Group 1	Price Group 2	Price Group 3	

Panel—Miter Spanning

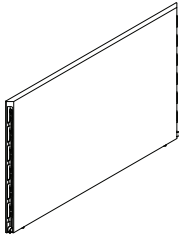

PNLMS	42"	18"-23.9375"	\$ 683	+\$100	+\$150	+\$ 404	+\$ 474	+\$ 622	+\$ 785	+\$ 963	+\$ 404
	42"	24"-29.9375"	\$ 803	+\$112	+\$168	+\$ 453	+\$ 532	+\$ 697	+\$ 879	+\$1079	+\$ 453
	42"	30"-35.9375"	\$ 945	+\$127	+\$190	+\$ 510	+\$ 599	+\$ 785	+\$ 990	+\$1215	+\$ 510
	42"	36"-41.9375"	\$1112	+\$143	+\$215	+\$ 577	+\$ 677	+\$ 888	+\$1120	+\$1376	+\$ 577
	42"	42"-47.9375"	\$1308	+\$163	+\$244	+\$ 656	+\$ 770	+\$1010	+\$1274	+\$1564	+\$ 656
	42"	48"-53.9375"	\$1539	+\$186	+\$279	+\$ 749	+\$ 880	+\$1153	+\$1455	+\$1786	+\$ 749
	42"	54"-59.9375"	\$1811	+\$213	+\$320	+\$ 859	+\$1008	+\$1322	+\$1667	+\$2047	+\$ 859
	42"	60"-65.9375"	\$2130	+\$245	+\$368	+\$ 987	+\$1159	+\$1520	+\$1917	+\$2354	+\$ 987
	42"	66"-71.9375"	\$2343	+\$266	+\$399	+\$1073	+\$1260	+\$1652	+\$2084	+\$2559	+\$1073
	42"	72"-77.9375"	\$2577	+\$290	+\$435	+\$1168	+\$1371	+\$1798	+\$2267	+\$2784	+\$1168
	42"	78"-83.9375"	\$2783	+\$310	+\$466	+\$1251	+\$1468	+\$1926	+\$2429	+\$2982	+\$1251
	42"	84"-89.9375"	\$3006	+\$333	+\$499	+\$1340	+\$1574	+\$2064	+\$2603	+\$3196	+\$1340
	42"	90"-95.9375"	\$3247	+\$357	+\$535	+\$1437	+\$1688	+\$2213	+\$2791	+\$3427	+\$1437
	42"	96"-96.5"	\$3506	+\$383	+\$574	+\$1542	+\$1810	+\$2374	+\$2994	+\$3676	+\$1542
	48"	18"-23.9375"	\$ 750	+\$107	+\$161	+\$ 431	+\$ 506	+\$ 664	+\$ 837	+\$1028	+\$ 431
	48"	24"-29.9375"	\$ 883	+\$120	+\$180	+\$ 485	+\$ 569	+\$ 746	+\$ 941	+\$1155	+\$ 485
	48"	30"-35.9375"	\$1038	+\$136	+\$204	+\$ 547	+\$ 643	+\$ 843	+\$1063	+\$1305	+\$ 547
	48"	36"-41.9375"	\$1221	+\$154	+\$231	+\$ 621	+\$ 729	+\$ 956	+\$1206	+\$1481	+\$ 621
	48"	42"-47.9375"	\$1437	+\$176	+\$264	+\$ 708	+\$ 831	+\$1090	+\$1375	+\$1688	+\$ 708
	48"	48"-53.9375"	\$1691	+\$201	+\$302	+\$ 810	+\$ 951	+\$1248	+\$1573	+\$1932	+\$ 810
	48"	54"-59.9375"	\$1989	+\$231	+\$346	+\$ 931	+\$1093	+\$1433	+\$1807	+\$2218	+\$ 931
	48"	60"-65.9375"	\$2340	+\$266	+\$399	+\$1072	+\$1259	+\$1650	+\$2081	+\$2556	+\$1072
	48"	66"-71.9375"	\$2574	+\$289	+\$434	+\$1166	+\$1369	+\$1796	+\$2265	+\$2780	+\$1166
	48"	72"-77.9375"	\$2831	+\$315	+\$473	+\$1270	+\$1491	+\$1955	+\$2466	+\$3028	+\$1270
	48"	78"-83.9375"	\$3058	+\$338	+\$507	+\$1361	+\$1598	+\$2096	+\$2643	+\$3245	+\$1361
	48"	84"-89.9375"	\$3303	+\$362	+\$543	+\$1460	+\$1714	+\$2248	+\$2835	+\$3480	+\$1460
	48"	90"-95.9375"	\$3567	+\$389	+\$583	+\$1566	+\$1839	+\$2412	+\$3041	+\$3734	+\$1566
	48"	96"-96.5"	\$3852	+\$417	+\$626	+\$1681	+\$1974	+\$2589	+\$3265	+\$4008	+\$1681

► Specification Information, continued on next page

Aisla Panels—Miter, continued

► Specification Information, continued from previous page

Specification Information

Style Number	Dimensions		U.S. Base Price	Options (Add \$ to Base Price)						Customiz Stain	
	Modular Height	Parametric Width		High-Pressure Laminate	Composite Veneer	Wood					
				Price	Price	Price	Price	Price	Price	Price	
				Group 2	Group 3	Group 1	Group 2	Group 1	Group 2	Group 3	

Panel—Miter T

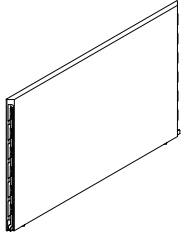

PNLMT	Modular Height	Parametric Width	U.S. Base Price	High-Pressure Laminate	Composite Veneer	Wood	Customiz Stain
42"	18"-23.9375"	\$ 683	+\$103	+\$155	+\$ 416	+\$ 489	+\$ 416
42"	24"-29.9375"	\$ 803	+\$115	+\$173	+\$ 465	+\$ 546	+\$ 465
42"	30"-35.9375"	\$ 945	+\$130	+\$194	+\$ 522	+\$ 613	+\$ 522
42"	36"-41.9375"	\$1112	+\$146	+\$219	+\$ 589	+\$ 692	+\$ 589
42"	42"-47.9375"	\$1308	+\$166	+\$249	+\$ 668	+\$ 785	+\$ 668
42"	48"-53.9375"	\$1539	+\$189	+\$283	+\$ 761	+\$ 894	+\$ 761
42"	54"-59.9375"	\$1811	+\$216	+\$324	+\$ 871	+\$1022	+\$ 871
42"	60"-65.9375"	\$2130	+\$248	+\$372	+\$ 999	+\$1173	+\$ 999
42"	66"-71.9375"	\$2343	+\$269	+\$404	+\$1085	+\$1274	+\$1085
42"	72"-77.9375"	\$2577	+\$293	+\$439	+\$1180	+\$1385	+\$1180
42"	78"-83.9375"	\$2783	+\$313	+\$470	+\$1263	+\$1483	+\$1263
42"	84"-89.9375"	\$3006	+\$336	+\$503	+\$1353	+\$1588	+\$1353
42"	90"-95.9375"	\$3247	+\$360	+\$539	+\$1449	+\$1702	+\$1449
42"	96"-96.5"	\$3506	+\$386	+\$578	+\$1554	+\$1825	+\$1554
48"	18"-23.9375"	\$ 750	+\$110	+\$165	+\$ 443	+\$ 521	+\$ 443
48"	24"-29.9375"	\$ 883	+\$123	+\$185	+\$ 497	+\$ 583	+\$ 497
48"	30"-35.9375"	\$1038	+\$139	+\$208	+\$ 559	+\$ 657	+\$ 559
48"	36"-41.9375"	\$1221	+\$157	+\$236	+\$ 633	+\$ 744	+\$ 633
48"	42"-47.9375"	\$1437	+\$179	+\$268	+\$ 720	+\$ 846	+\$ 720
48"	48"-53.9375"	\$1691	+\$204	+\$306	+\$ 822	+\$ 966	+\$ 822
48"	54"-59.9375"	\$1989	+\$234	+\$351	+\$ 943	+\$1107	+\$ 943
48"	60"-65.9375"	\$2340	+\$269	+\$404	+\$1084	+\$1273	+\$1084
48"	66"-71.9375"	\$2574	+\$292	+\$439	+\$1178	+\$1383	+\$1178
48"	72"-77.9375"	\$2831	+\$318	+\$477	+\$1282	+\$1505	+\$1282
48"	78"-83.9375"	\$3058	+\$341	+\$511	+\$1373	+\$1612	+\$1373
48"	84"-89.9375"	\$3303	+\$365	+\$548	+\$1472	+\$1728	+\$1472
48"	90"-95.9375"	\$3567	+\$392	+\$588	+\$1578	+\$1853	+\$1578
48"	96"-96.5"	\$3852	+\$420	+\$630	+\$1693	+\$1988	+\$1693

Aisla Panels—T

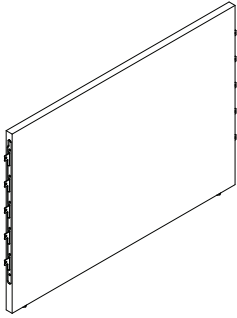

► Need help?
Product details,
page 26

Standard Includes

- Panel—T: High-Pressure Laminate price group 1
- 1 mm top edge band
- 3 mm side edge band
- Transaction top, if selected: High-Pressure Laminate price group 1
- Transaction top edge, if selected: plastic
- Transaction top bracket, if selected: paint price group 1
- Glass insert, if selected: glass price group 1

Required to Specify

- 1 Style number
 - 2 Width (see below under Required Selections)
 - 3 Height (see below under Required Selections)
 - 4 Connection—end A (see below under Required Selections)
 - 5 Connection—end B (see below under Required Selections)
 - 6 High-Pressure Laminate color for panel
 - 7 Glass color number for glass insert, if selected
 - 8 High-Pressure Laminate color for transaction top, if selected
 - 9 Plastic color number for transaction top edge, if selected
 - 10 Paint color number for transaction top bracket, if selected
 - 11 Options, if selected (see below)
- See *Surface Materials*, page 164

Tip: Parametric width (18"W–96.5"W) is available in 1/16" increments.

	Required Selections	U.S. Price	Required to Specify
Width	• 18"–96.5"	Prices at right	Specify width.
Height	• 42" • 48"	Prices at right Prices at right	Specify height. Specify height.
Connection	End A • T	+\$100	Specify <i>with end A T</i> .
	End B • T	+\$100	Specify <i>with end B T</i> .

	Options	U.S. Price	Required to Specify
Surface Materials	Panel • High-Pressure Laminate price group 1 • High-Pressure Laminate price group 2 • High-Pressure Laminate price group 3 • Open Line laminate (OLL) • Composite veneer group 1 • Composite veneer group 2 • Wood group 1 • Wood group 2 • Wood group 3 • Customiz stain	No cost Prices at right Prices at right +\$111 plus cost of laminate Prices at right Prices at right Prices at right Prices at right Prices at right Prices at right	Specify laminate color number. Specify laminate color number. Specify laminate color number. ► See <i>Surface Materials Reference Manual</i> . Specify composite veneer color number. Specify composite veneer color number. Specify wood color number. Specify wood color number. Specify wood color number. Specify <i>with customiz stain</i> .
	Integrated glass • Glass price group 1 • Glass price group 3 • Glass price group 4	Prices at right Prices at right Prices at right	Specify <i>with 6500 Clear Glass</i> . Specify <i>with 6501 Low Iron Clear Glass</i> . Specify <i>with 6562 Bronze or 6563 Smoke Glass</i> .

► Options, continued on next page



For Canadian Pricing

Multiply U.S. Price by the Canadian price factor.

► See page 1 for details.

► Options, continued from previous page

	Options	U.S. Price	Required to Specify
Surface Materials, Continued	Transaction top		
	• High-Pressure Laminate price group 1	No cost	Specify laminate color number.
	• High-Pressure Laminate price group 2	Prices at right	Specify laminate color number.
	• High-Pressure Laminate price group 3	Prices at right	Specify laminate color number.
	• Open Line laminate (OLL)	+\$111 plus cost of laminate	► See <i>Surface Materials Reference Manual</i> .
	• Composite veneer group 1	Prices at right	Specify composite veneer color number.
	• Composite veneer group 2	Prices at right	Specify composite veneer color number.
	• Wood group 1	Prices at right	Specify wood color number.
	• Wood group 2	Prices at right	Specify wood color number.
	• Wood group 3	Prices at right	Specify wood color number.
	• Customiz stain	Prices at right	Specify with <i>customiz stain</i> .
	Transaction top edge		
	• Plastic	No cost	Specify plastic color number.
Transaction top bracket			
• Paint price group 1	Prices at right	Specify paint color number.	
• Paint price group 2	Prices at right	Specify paint color number.	
• Paint price group 3	Prices at right	Specify paint color number.	
Connection T	End A		
	• T adjacent side 1	No cost	Specify with <i>end A T adjacent side 1</i> .
	• T adjacent side 2	No cost	Specify with <i>end A T adjacent side 2</i> .
	End B		
	• T adjacent side 1	No cost	Specify with <i>end B T adjacent side 1</i> .
	• T adjacent side 2	No cost	Specify with <i>end B T adjacent side 2</i> .
Accent Panel	• No panel	No cost	Specify with <i>no panel</i> .
	• Fabric panel side 1	No cost	Specify with <i>fabric panel side 1</i> .
	• Fabric panel side 2	No cost	Specify with <i>fabric panel side 2</i> .
	• Fabric panel side 1 and 2	No cost	Specify with <i>fabric panel side 1 and 2</i> .
Top Accessory	• No accessory	No cost	Specify with <i>no accessory</i> .
	• Integrated glass	Prices at right	Specify with <i>integrated glass</i> .
	• 10"D transaction top side 1	Prices at right	Specify with <i>10"D transaction top side 1</i> .
	• 10"D transaction top side 2	Prices at right	Specify with <i>10"D transaction top side 2</i> .
	• Transaction top bracket only side 1	Prices at right	Specify with <i>transaction top bracket only side 1</i> .
	• Transaction top bracket only side 2	Prices at right	Specify with <i>transaction top bracket only side 2</i> .
Glass Height	• 10"	Prices at right	Specify glass height.
	• 12"	Prices at right	Specify glass height.
Grain Direction	Panel		
	• No grain direction	No cost	Specify with <i>no grain direction</i> .
	• Horizontal	No cost	Specify with <i>horizontal grain direction</i> .
	• Vertical	No cost	Specify with <i>vertical grain direction</i> .
	Transaction top		
	• No grain direction	No cost	Specify with <i>no grain direction</i> .
• Long grain	No cost	Specify with <i>long grain direction</i> .	
• Short grain	No cost	Specify with <i>short grain direction</i> .	
Related Products	• Aisla powered panels		► Page 88
	• Aisla cabinets		► Page 132
	• Aisla fabric-wrapped magnetic panel		► Page 130

► Options, continued on next page

**For Canadian Pricing**

Multiply U.S. Price by the Canadian price factor.

► See page 1 for details.

► Options, continued from previous page

Integrated Glass Option with Finish Upcharges

Tip: Glass price group 3 or glass price group 4 upcharge is in addition to glass price group 1 cost.

Height— Modular	Width— Parametric	Options (Add \$ to Base Price)		
		Glass Price Group 1	Glass Price Group 3	Glass Price Group 4
10"	18"—23.9375"	N.A.	N.A.	N.A.
10"	24"—29.9375"	N.A.	N.A.	N.A.
10"	30"—35.9375"	+\$ 293	+\$179	+\$351
10"	36"—41.9375"	+\$ 320	+\$193	+\$376
10"	42"—47.9375"	+\$ 357	+\$203	+\$402
10"	48"—53.9375"	+\$ 404	+\$229	+\$431
10"	54"—59.9375"	+\$ 480	+\$245	+\$461
10"	60"—65.9375"	+\$ 566	+\$259	+\$493
10"	66"—71.9375"	+\$ 637	+\$272	+\$527
10"	72"—77.9375"	+\$ 749	+\$286	+\$564
10"	78"—83.9375"	+\$ 860	+\$300	+\$604
10"	84"—89.9375"	+\$1040	+\$339	+\$646
10"	90"—95.9375"	+\$1220	+\$352	+\$691
10"	96"—96.5"	+\$1364	+\$376	+\$740
12"	18"—23.9375"	N.A.	N.A.	N.A.
12"	24"—29.9375"	N.A.	N.A.	N.A.
12"	30"—35.9375"	+\$ 325	+\$197	+\$380
12"	36"—41.9375"	+\$ 355	+\$212	+\$406
12"	42"—47.9375"	+\$ 397	+\$223	+\$435
12"	48"—53.9375"	+\$ 449	+\$252	+\$465
12"	54"—59.9375"	+\$ 533	+\$270	+\$498
12"	60"—65.9375"	+\$ 629	+\$285	+\$532
12"	66"—71.9375"	+\$ 708	+\$299	+\$570
12"	72"—77.9375"	+\$ 832	+\$315	+\$610
12"	78"—83.9375"	+\$ 956	+\$330	+\$652
12"	84"—89.9375"	+\$1155	+\$373	+\$698
12"	90"—95.9375"	+\$1355	+\$387	+\$747
12"	96"—96.5"	+\$1515	+\$414	+\$799

► Options, continued on next page



For Canadian Pricing
 Multiply U.S. Price by the
 Canadian price factor.
 ► See page 1 for details.

► Options, continued from previous page

10"D Transaction Top Option with Finish Upcharges

Depth— Modular	Width— Parametric	Options (Add \$ to Base Price)								
		High-Pressure Laminate			Composite Veneer		Wood			Customiz Stain
		Price Group 1	Price Group 2	Price Group 3	Group 1	Group 2	Group 1	Group 2	Group 3	
10"	18"—23.9375"	N.A.	N.A.	N.A.	N.A.	N.A.	N.A.	N.A.	N.A.	N.A.
10"	24"—29.9375"	N.A.	N.A.	N.A.	N.A.	N.A.	N.A.	N.A.	N.A.	N.A.
10"	30"—35.9375"	+\$440	+\$ 66	+\$142	+\$229	+\$330	+\$ 715	+\$ 888	+\$1087	+\$229
10"	36"—41.9375"	+\$468	+\$ 70	+\$151	+\$244	+\$351	+\$ 760	+\$ 945	+\$1157	+\$244
10"	42"—47.9375"	+\$498	+\$ 75	+\$161	+\$260	+\$373	+\$ 809	+\$1005	+\$1231	+\$260
10"	48"—53.9375"	+\$530	+\$ 80	+\$171	+\$276	+\$397	+\$ 861	+\$1069	+\$1309	+\$276
10"	54"—59.9375"	+\$564	+\$ 85	+\$182	+\$294	+\$422	+\$ 916	+\$1138	+\$1393	+\$294
10"	60"—65.9375"	+\$600	+\$ 90	+\$193	+\$313	+\$449	+\$ 974	+\$1210	+\$1482	+\$313
10"	66"—71.9375"	+\$638	+\$ 96	+\$206	+\$332	+\$478	+\$1036	+\$1287	+\$1576	+\$332
10"	72"—77.9375"	+\$679	+\$102	+\$219	+\$354	+\$509	+\$1102	+\$1370	+\$1677	+\$354
10"	78"—83.9375"	+\$720	+\$108	+\$232	+\$375	+\$539	+\$1169	+\$1452	+\$1777	+\$375
10"	84"—89.9375"	+\$763	+\$114	+\$246	+\$397	+\$571	+\$1239	+\$1539	+\$1884	+\$397
10"	90"—95.9375"	+\$809	+\$121	+\$261	+\$421	+\$606	+\$1313	+\$1631	+\$1997	+\$421
10"	96"—96.5"	+\$857	+\$129	+\$276	+\$447	+\$642	+\$1392	+\$1729	+\$2117	+\$447

Tip: High-Pressure Laminate price groups 2 and 3, composite veneer, wood, and customiz stain upcharges are in addition to the High-Pressure price group 1 upcharge.

Transaction Top Bracket Option with Finish Upcharges

Depth— Modular	Width— Parametric	Options (Add \$ to Base Price)		
		Paint Price Group 1	Paint Price Group 2	Paint Price Group 3
		10"	18"—23.9375"	N.A.
10"	24"—29.9375"	N.A.	N.A.	N.A.
10"	30"—35.9375"	+\$257	+\$39	+\$ 44
10"	36"—41.9375"	+\$279	+\$42	+\$ 48
10"	42"—47.9375"	+\$304	+\$46	+\$ 52
10"	48"—53.9375"	+\$330	+\$50	+\$ 57
10"	54"—59.9375"	+\$359	+\$54	+\$ 62
10"	60"—65.9375"	+\$390	+\$59	+\$ 67
10"	66"—71.9375"	+\$421	+\$63	+\$ 73
10"	72"—77.9375"	+\$455	+\$68	+\$ 78
10"	78"—83.9375"	+\$491	+\$74	+\$ 85
10"	84"—89.9375"	+\$531	+\$80	+\$ 92
10"	90"—95.9375"	+\$573	+\$86	+\$ 99
10"	96"—96.5"	+\$619	+\$93	+\$107

Tip: Paint price groups 2 and 3 upcharges are in addition to the paint price group 1 upcharge.

► Specification Information, on next page

Aisla Panels—T, continued

► Options, on previous page

Specification Information

Style Number	Dimensions		U.S. Base Price	Options (Add \$ to Base Price)						Customiz Stain	
	Modular Height	Parametric Width		High-Pressure Laminate	Composite Veneer	Wood					
				Price	Price	Price	Price	Price	Price	Price	
				Group 2	Group 3	Group 1	Group 2	Group 1	Group 2	Group 3	

Panel—T T

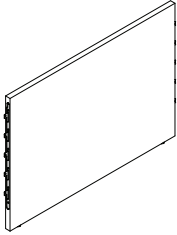

PNLTT	Modular Height	Parametric Width	U.S. Base Price	High-Pressure Laminate	Composite Veneer	Wood	Customiz Stain			
42"	18"-23.9375"	\$ 683	+\$ 88	+\$132	+\$ 356	+\$ 418	+\$ 548	+\$ 691	+\$ 848	+\$ 356
42"	24"-29.9375"	\$ 803	+\$100	+\$150	+\$ 404	+\$ 475	+\$ 623	+\$ 785	+\$ 964	+\$ 404
42"	30"-35.9375"	\$ 945	+\$115	+\$172	+\$ 461	+\$ 542	+\$ 710	+\$ 896	+\$1100	+\$ 461
42"	36"-41.9375"	\$1112	+\$131	+\$197	+\$ 529	+\$ 621	+\$ 814	+\$1027	+\$1260	+\$ 529
42"	42"-47.9375"	\$1308	+\$151	+\$226	+\$ 608	+\$ 714	+\$ 936	+\$1180	+\$1449	+\$ 608
42"	48"-53.9375"	\$1539	+\$174	+\$261	+\$ 701	+\$ 823	+\$1079	+\$1361	+\$1671	+\$ 701
42"	54"-59.9375"	\$1811	+\$201	+\$302	+\$ 810	+\$ 951	+\$1247	+\$1573	+\$1932	+\$ 810
42"	60"-65.9375"	\$2130	+\$233	+\$350	+\$ 939	+\$1102	+\$1446	+\$1823	+\$2239	+\$ 939
42"	66"-71.9375"	\$2343	+\$254	+\$381	+\$1025	+\$1203	+\$1578	+\$1990	+\$2443	+\$1025
42"	72"-77.9375"	\$2577	+\$278	+\$417	+\$1119	+\$1314	+\$1723	+\$2173	+\$2668	+\$1119
42"	78"-83.9375"	\$2783	+\$298	+\$448	+\$1202	+\$1412	+\$1851	+\$2335	+\$2866	+\$1202
42"	84"-89.9375"	\$3006	+\$321	+\$481	+\$1292	+\$1517	+\$1989	+\$2509	+\$3080	+\$1292
42"	90"-95.9375"	\$3247	+\$345	+\$517	+\$1389	+\$1631	+\$2139	+\$2697	+\$3311	+\$1389
42"	96"-96.5"	\$3506	+\$371	+\$556	+\$1494	+\$1754	+\$2300	+\$2900	+\$3561	+\$1494
48"	18"-23.9375"	\$ 750	+\$ 95	+\$143	+\$ 383	+\$ 450	+\$ 590	+\$ 744	+\$ 913	+\$ 383
48"	24"-29.9375"	\$ 883	+\$108	+\$162	+\$ 436	+\$ 512	+\$ 672	+\$ 847	+\$1040	+\$ 436
48"	30"-35.9375"	\$1038	+\$124	+\$186	+\$ 499	+\$ 586	+\$ 768	+\$ 969	+\$1190	+\$ 499
48"	36"-41.9375"	\$1221	+\$142	+\$213	+\$ 573	+\$ 673	+\$ 882	+\$1112	+\$1366	+\$ 573
48"	42"-47.9375"	\$1437	+\$164	+\$246	+\$ 660	+\$ 775	+\$1016	+\$1281	+\$1573	+\$ 660
48"	48"-53.9375"	\$1691	+\$189	+\$284	+\$ 762	+\$ 895	+\$1173	+\$1479	+\$1816	+\$ 762
48"	54"-59.9375"	\$1989	+\$219	+\$328	+\$ 882	+\$1036	+\$1358	+\$1713	+\$2103	+\$ 882
48"	60"-65.9375"	\$2340	+\$254	+\$381	+\$1024	+\$1202	+\$1576	+\$1988	+\$2440	+\$1024
48"	66"-71.9375"	\$2574	+\$277	+\$416	+\$1118	+\$1313	+\$1721	+\$2171	+\$2665	+\$1118
48"	72"-77.9375"	\$2831	+\$303	+\$455	+\$1222	+\$1434	+\$1881	+\$2372	+\$2912	+\$1222
48"	78"-83.9375"	\$3058	+\$326	+\$489	+\$1313	+\$1541	+\$2021	+\$2549	+\$3130	+\$1313
48"	84"-89.9375"	\$3303	+\$350	+\$525	+\$1412	+\$1657	+\$2173	+\$2741	+\$3365	+\$1412
48"	90"-95.9375"	\$3567	+\$377	+\$565	+\$1518	+\$1782	+\$2337	+\$2948	+\$3619	+\$1518
48"	96"-96.5"	\$3852	+\$405	+\$608	+\$1633	+\$1917	+\$2514	+\$3171	+\$3893	+\$1633

Aisla Spanning Panels—Free

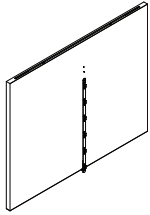

► Need help?
Product details,
page 26

Standard Includes

- Spanning panel—free: High-Pressure Laminate price group 1
- 1 mm top edge band
- 3 mm side edge band
- Transaction top, if selected: High-Pressure Laminate price group 1
- Transaction top edge, if selected: plastic
- Transaction top bracket, if selected: paint price group 1
- Glass insert, if selected: glass price group 1

Required to Specify

- 1 Style number
 - 2 Width (see below under Required Selections)
 - 3 Height (see below under Required Selections)
 - 4 Connection—end A (see below under Required Selections)
 - 5 Connection—middle (See below under Required Selections)
 - 6 Connection—end B (see below under Required Selections)
 - 7 High-Pressure Laminate color for panel
 - 8 Glass color number for glass insert, if selected
 - 9 High-Pressure Laminate color for transaction top, if selected
 - 10 Plastic color number for transaction top edge, if selected
 - 11 Paint color number for transaction top bracket, if selected
 - 12 Options, if selected (see below)
- See *Surface Materials*, page 164

Tip: Parametric width (36"W–61"W) is available in 1/16" increments.

	Required Selections	U.S. Price	Required to Specify
Width	• 36"–61"	Prices at right	Specify width.
Height	• 42" • 48"	Prices at right Prices at right	Specify height. Specify height.
Connection	End A • Free	No cost	Specify with end A free.
	Middle • Side 1 • Side 2	No cost No cost	Specify with middle side 1. Specify with middle side 2.
	End B • Free	No cost	Specify with end B free.

	Options	U.S. Price	Required to Specify
Surface Materials	Panel • High-Pressure Laminate price group 1 • High-Pressure Laminate price group 2 • High-Pressure Laminate price group 3 • Open Line laminate (OLL) • Composite veneer group 1 • Composite veneer group 2 • Wood group 1 • Wood group 2 • Wood group 3 • Customiz stain	No cost Prices at right Prices at right Prices at right +\$111 plus cost of laminate Prices at right Prices at right Prices at right Prices at right Prices at right Prices at right	Specify laminate color number. Specify laminate color number. Specify laminate color number. ► See <i>Surface Materials Reference Manual</i> . Specify composite veneer color number. Specify composite veneer color number. Specify wood color number. Specify wood color number. Specify wood color number. Specify with customiz stain.
	Integrated glass • Glass price group 1 • Glass price group 3 • Glass price group 4	Prices at right Prices at right Prices at right	Specify with 6500 Clear Glass. Specify with 6501 Low Iron Clear Glass. Specify with 6562 Bronze or 6563 Smoke Glass.

► Options, continued on next page



For Canadian Pricing
Multiply U.S. Price by the Canadian price factor.
► See page 1 for details.

► Options, continued from previous page

	Options	U.S. Price	Required to Specify
Surface Materials, Continued	Transaction top		
	• High-Pressure Laminate price group 1	No cost	Specify laminate color number.
	• High-Pressure Laminate price group 2	Prices at right	Specify laminate color number.
	• High-Pressure Laminate price group 3	Prices at right	Specify laminate color number.
	• Open Line laminate (OLL)	+\$111 plus cost of laminate	► See <i>Surface Materials Reference Manual</i> .
	• Composite veneer group 1	Prices at right	Specify composite veneer color number.
	• Composite veneer group 2	Prices at right	Specify composite veneer color number.
	• Wood group 1	Prices at right	Specify wood color number.
	• Wood group 2	Prices at right	Specify wood color number.
	• Wood group 3	Prices at right	Specify wood color number.
• Customiz stain	Prices at right	Specify with <i>customiz stain</i> .	
	Transaction top edge		
	• Plastic	No cost	Specify plastic color number.
	Transaction top bracket		
	• Paint price group 1	Prices at right	Specify paint color number.
	• Paint price group 2	Prices at right	Specify paint color number.
	• Paint price group 3	Prices at right	Specify paint color number.
Accent Panel	• No panel	No cost	Specify with <i>no panel</i> .
	• Fabric panel side 1	No cost	Specify with <i>fabric panel side 1</i> .
	• Fabric panel side 2	No cost	Specify with <i>fabric panel side 2</i> .
	• Fabric panel side 1 and 2	No cost	Specify with <i>fabric panel side 1 and 2</i> .
Top Accessory	• No accessory	No cost	Specify with <i>no accessory</i> .
	• Integrated glass	Prices at right	Specify with <i>integrated glass</i> .
	• 10"D transaction top side 1	Prices at right	Specify with <i>10"D transaction top side 1</i> .
	• 10"D transaction top side 2	Prices at right	Specify with <i>10"D transaction top side 2</i> .
	• Transaction top bracket only side 1	Prices at right	Specify with <i>transaction top bracket only side 1</i> .
	• Transaction top bracket only side 2	Prices at right	Specify with <i>transaction top bracket only side 2</i> .
Glass Height	• 10"	Prices at right	Specify glass height.
	• 12"	Prices at right	Specify glass height.
Grain Direction	Panel		
	• No grain direction	No cost	Specify with <i>no grain direction</i> .
	• Horizontal	No cost	Specify with <i>horizontal grain direction</i> .
	• Vertical	No cost	Specify with <i>vertical grain direction</i> .
	Transaction top		
	• No grain direction	No cost	Specify with <i>no grain direction</i> .
	• Long grain	No cost	Specify with <i>long grain direction</i> .
	• Short grain	No cost	Specify with <i>short grain direction</i> .
Related Products	• Aisla powered panels		► Page 88
	• Aisla cabinets		► Page 132
	• Aisla fabric-wrapped magnetic panel		► Page 130

Tip: For directional laminates, horizontal and vertical grain direction are available when width is up to and including 60". When width is greater than 60", only horizontal grain direction is allowed.

► Options, continued on next page



For Canadian Pricing
Multiply U.S. Price by the Canadian price factor.
► See page 1 for details.

► Options, continued from previous page

Integrated Glass Option with Finish Upcharges

Tip: Glass price group 3 or glass price group 4 upcharge is in addition to glass price group 1 cost.

Height— Modular	Width— Parametric	Options (Add \$ to Base Price)		
		Glass Price Group 1	Glass Price Group 3	Glass Price Group 4
10"	36"—41.9375"	+\$320	+\$193	+\$376
10"	42"—47.9375"	+\$357	+\$203	+\$402
10"	48"—53.9375"	+\$404	+\$229	+\$431
10"	54"—59.9375"	+\$480	+\$245	+\$461
10"	60"—61"	+\$566	+\$259	+\$493
12"	36"—41.9375"	+\$355	+\$212	+\$406
12"	42"—47.9375"	+\$397	+\$223	+\$435
12"	48"—53.9375"	+\$449	+\$252	+\$465
12"	54"—59.9375"	+\$533	+\$270	+\$498
12"	60"—61"	+\$629	+\$285	+\$532

10"D Transaction Top Option with Finish Upcharges

Depth— Modular	Width— Parametric	Options (Add \$ to Base Price)								
		High-Pressure Laminate			Composite Veneer		Wood			Customiz Stain
		Price Group 1	Price Group 2	Price Group 3	Group 1	Group 2	Group 1	Group 2	Group 3	
10"	36"—41.9375"	+\$468	+\$70	+\$151	+\$244	+\$351	+\$760	+\$ 945	+\$1157	+\$244
10"	42"—47.9375"	+\$498	+\$75	+\$161	+\$260	+\$373	+\$809	+\$1005	+\$1231	+\$260
10"	48"—53.9375"	+\$530	+\$80	+\$171	+\$276	+\$397	+\$861	+\$1069	+\$1309	+\$276
10"	54"—59.9375"	+\$564	+\$85	+\$182	+\$294	+\$422	+\$916	+\$1138	+\$1393	+\$294
10"	60"—61"	+\$600	+\$90	+\$193	+\$313	+\$449	+\$974	+\$1210	+\$1482	+\$313

Tip: High-Pressure Laminate price groups 2 and 3, composite veneer, wood, and customiz stain upcharges are in addition to the High-Pressure price group 1 upcharge.

Transaction Top Bracket Option with Finish Upcharges

Depth— Modular	Width— Parametric	Options (Add \$ to Base Price)		
		Paint Price Group 1	Paint Price Group 2	Paint Price Group 3
10"	36"—41.9375"	+\$279	+\$42	+\$48
10"	42"—47.9375"	+\$304	+\$46	+\$52
10"	48"—53.9375"	+\$330	+\$50	+\$57
10"	54"—59.9375"	+\$359	+\$54	+\$62
10"	60"—61"	+\$390	+\$59	+\$67

Tip: Paint price groups 2 and 3 upcharges are in addition to the paint price group 1 upcharge.

Specification Information

Style Number	Dimensions		U.S. Base Price	Options (Add \$ to Base Price)						Customiz Stain	
	Modular Height	Parametric Width		High-Pressure Laminate	Composite Veneer	Wood					
				Price Group 2	Price Group 3	Price Group 1	Price Group 2	Price Group 1	Price Group 2	Price Group 3	

Spanning Panel—Free Free

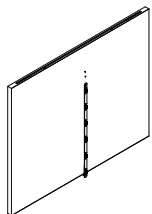

PNLSPNFF	Modular Height	Parametric Width	U.S. Base Price	High-Pressure Laminate	Composite Veneer	Wood	Wood	Wood	Wood	Wood	Wood
42"	36"-41.9375"		\$1112	+\$118	+\$177	+\$476	+\$ 559	+\$ 733	+\$ 925	+\$1135	+\$476
42"	42"-47.9375"		\$1308	+\$138	+\$207	+\$555	+\$ 652	+\$ 855	+\$1078	+\$1324	+\$555
42"	48"-53.9375"		\$1539	+\$161	+\$241	+\$648	+\$ 761	+\$ 998	+\$1259	+\$1546	+\$648
42"	54"-59.9375"		\$1811	+\$188	+\$282	+\$758	+\$ 890	+\$1167	+\$1472	+\$1807	+\$758
42"	60"-61"		\$2130	+\$220	+\$330	+\$887	+\$1041	+\$1365	+\$1722	+\$2114	+\$887
48"	36"-41.9375"		\$1221	+\$129	+\$194	+\$520	+\$ 611	+\$ 801	+\$1011	+\$1241	+\$520
48"	42"-47.9375"		\$1437	+\$151	+\$226	+\$607	+\$ 713	+\$ 935	+\$1179	+\$1448	+\$607
48"	48"-53.9375"		\$1691	+\$176	+\$264	+\$710	+\$ 833	+\$1092	+\$1378	+\$1692	+\$710
48"	54"-59.9375"		\$1989	+\$206	+\$309	+\$830	+\$ 974	+\$1278	+\$1611	+\$1978	+\$830
48"	60"-61"		\$2340	+\$241	+\$362	+\$971	+\$1140	+\$1495	+\$1886	+\$2315	+\$971



For Canadian Pricing
Multiply U.S. Price by the Canadian price factor.
▶ See page 1 for details.

Aisla Powered Panels—Free

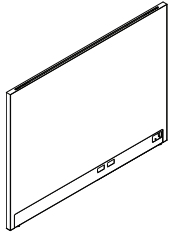

► Need help?
Product details,
page 30

Standard Includes

- Powered panel—free: High-Pressure Laminate price group 1
- 1 mm top edge band
- 3 mm side edge band
- Transaction top, if selected: High-Pressure Laminate price group 1
- Transaction top edge, if selected: plastic
- Transaction top bracket, if selected: paint price group 1
- Glass insert, if selected: glass price group 1
- Trim: paint price group 1

Required to Specify

- 1 Style number
 - 2 Width (see below under Required Selections)
 - 3 Height (see below under Required Selections)
 - 4 Connection—end A (see below under Required Selections)
 - 5 Connection—end B (see below under Required Selections)
 - 6 High-Pressure Laminate color for panel
 - 7 Glass color number for glass insert, if selected
 - 8 High-Pressure Laminate color for transaction top, if selected
 - 9 Plastic color number for transaction top edge, if selected
 - 10 Paint color number for transaction top bracket, if selected
 - 11 Paint color number for trim
 - 12 Options, if selected (see below)
- See *Surface Materials*, page 164

	Required Selections	U.S. Price	Required to Specify
Width	<ul style="list-style-type: none"> • 60.5" • 66.5" • 72.5" • 78.5" • 84.5" • 90.5" • 96.5" 	Prices at right Prices at right Prices at right Prices at right Prices at right Prices at right Prices at right	Specify width. Specify width. Specify width. Specify width. Specify width. Specify width. Specify width.
Height	<ul style="list-style-type: none"> • 42" • 48" 	Prices at right Prices at right	Specify height. Specify height.
Connection	End A <ul style="list-style-type: none"> • Free • Inline • Spanning • T • Mitered side 1 • Mitered side 2 	No cost +\$ 70 +\$ 70 +\$100 +\$250 +\$250	Specify <i>with end A free</i> . Specify <i>with end A inline</i> . Specify <i>with end A spanning</i> . Specify <i>with end A T</i> . Specify <i>with end A mitered side 1</i> . Specify <i>with end A mitered side 2</i> .
	End B <ul style="list-style-type: none"> • Free • Inline • Spanning • T • Mitered side 1 • Mitered side 2 	No cost +\$ 70 +\$ 70 +\$100 +\$250 +\$250	Specify <i>with end B free</i> . Specify <i>with end B inline</i> . Specify <i>with end B spanning</i> . Specify <i>with end B T</i> . Specify <i>with end B mitered side 1</i> . Specify <i>with end B mitered side 2</i> .

	Options	U.S. Price	Required to Specify
Surface Materials	Panel <ul style="list-style-type: none"> • High-Pressure Laminate price group 1 • High-Pressure Laminate price group 2 • High-Pressure Laminate price group 3 • Open Line laminate (OLL) • Composite veneer group 1 • Composite veneer group 2 • Wood group 1 • Wood group 2 • Wood group 3 • Customiz stain 	No cost Prices at right Prices at right +\$111 plus cost of laminate Prices at right Prices at right Prices at right Prices at right Prices at right Prices at right	Specify laminate color number. Specify laminate color number. Specify laminate color number. ► See <i>Surface Materials Reference Manual</i> . Specify composite veneer color number. Specify composite veneer color number. Specify wood color number. Specify wood color number. Specify wood color number. Specify <i>with customiz stain</i> .

 **For Canadian Pricing**
Multiply U.S. Price by the Canadian price factor.
► See page 1 for details.

► **Options, continued on next page**

► Options, continued from previous page

	Options	U.S. Price	Required to Specify
Surface Materials, continued	Integrated glass		
	• Glass price group 1	Prices at right	Specify with 6500 Clear Glass.
	• Glass price group 3	Prices at right	Specify with 6501 Low Iron Clear Glass.
	• Glass price group 4	Prices at right	Specify with 6562 Bronze or 6563 Smoke Glass.
	Transaction top		
	• High-Pressure Laminate price group 1	No cost	Specify laminate color number.
	• High-Pressure Laminate price group 2	Prices at right	Specify laminate color number.
	• High-Pressure Laminate price group 3	Prices at right	Specify laminate color number.
	• Composite veneer group 1	Prices at right	Specify composite veneer color number.
	• Composite veneer group 2	Prices at right	Specify composite veneer color number.
• Wood group 1	Prices at right	Specify wood color number.	
• Wood group 2	Prices at right	Specify wood color number.	
• Wood group 3	Prices at right	Specify wood color number.	
• Customiz stain	Prices at right	Specify with customiz stain.	
Transaction top edge			
• Plastic	No cost	Specify plastic color number.	
Transaction top bracket			
• Paint price group 1	Prices at right	Specify paint color number.	
• Paint price group 2	Prices at right	Specify paint color number.	
• Paint price group 3	Prices at right	Specify paint color number.	
Trim			
• Paint price group 1	No cost	Specify paint color number.	
• Paint price group 2	+\$200	Specify paint color number.	
• Paint price group 3	+\$250	Specify paint color number.	
Connection T	End A		
	• No T	No cost	Specify with end A no T.
	• T side 1	No cost	Specify with end A T side 1.
	• T side 2	No cost	Specify with end A T side 2.
	• T side 1 and 2	No cost	Specify with end A T side 1 and 2.
	• T adjacent side 1	No cost	Specify with end A T adjacent side 1.
	• T adjacent side 2	No cost	Specify with end A T adjacent side 2.
	End B		
	• No T	No cost	Specify with end B no T.
	• T side 1	No cost	Specify with end B T side 1.
• T side 2	No cost	Specify with end B T side 2.	
• T side 1 and 2	No cost	Specify with end B T side 1 and 2.	
• T adjacent side 1	No cost	Specify with end B T adjacent side 1.	
• T adjacent side 2	No cost	Specify with end B T adjacent side 2.	
Mitered Matchstick	End A		
	• No matchstick	No cost	Specify with end A no matchstick.
	• With matchstick	No cost	Specify with end A matchstick.
	End B		
• No matchstick	No cost	Specify with end B no matchstick.	
• With matchstick	No cost	Specify with end B matchstick.	
Accent Panel	• No panel	No cost	Specify with no panel.
	• Fabric panel side 1	No cost	Specify with fabric panel side 1.
	• Fabric panel side 2	No cost	Specify with fabric panel side 2.
	• Fabric panel side 1 and 2	No cost	Specify with fabric panel side 1 and 2.

Tip: This option is only available when connection end A is inline or T.

Tip: This option is only available when connection end B is inline or T.

Tip: This option is only available when connection end A is mitered.

Tip: This option is only available when connection end B is mitered.

► Options, continued on next page



For Canadian Pricing

Multiply U.S. Price by the Canadian price factor.

► See page 1 for details.

► Options, continued from previous page

	Options	U.S. Price	Required to Specify
Top Accessory	<ul style="list-style-type: none"> No accessory Integrated glass 10"D transaction top side 1 10"D transaction top side 2 Transaction top bracket only side 1 Transaction top bracket only side 2 	<ul style="list-style-type: none"> No cost Prices at right Prices at right Prices at right Prices at right Prices at right 	<ul style="list-style-type: none"> Specify with no accessory. Specify with integrated glass. Specify with 10"D transaction top side 1. Specify with 10"D transaction top side 2. Specify with transaction top bracket only side 1. Specify with transaction top bracket only side 2.
Glass Height	<ul style="list-style-type: none"> 10" 12" 	<ul style="list-style-type: none"> Prices at right Prices at right 	<ul style="list-style-type: none"> Specify glass height. Specify glass height.
Grain Direction	<p>Panel</p> <ul style="list-style-type: none"> No grain direction Horizontal Vertical <p>Transaction top</p> <ul style="list-style-type: none"> No grain direction Long grain Short grain 	<ul style="list-style-type: none"> No cost No cost No cost No cost No cost No cost 	<ul style="list-style-type: none"> Specify with no grain direction. Specify with horizontal grain direction. Specify with vertical grain direction. Specify with no grain direction. Specify with long grain direction. Specify with short grain direction.
Power Location	<ul style="list-style-type: none"> Side 1, end A Side 1, end B Side 2, end A Side 2, end B Side 1 and 2, end A Side 1 and 2, end B 	<ul style="list-style-type: none"> +\$ 776 +\$ 776 +\$ 776 +\$ 776 +\$1970 +\$1970 	<ul style="list-style-type: none"> Specify with power side 1, end A. Specify with power side 1, end B. Specify with power side 2, end A. Specify with power side 2, end B. Specify with power side 1 and 2, end A. Specify with power side 1 and 2, end B.
Power Install	<ul style="list-style-type: none"> Side 1 Side 2 	<ul style="list-style-type: none"> No cost No cost 	<ul style="list-style-type: none"> Specify with install side 1. Specify with install side 2.
Infeed	<ul style="list-style-type: none"> No infeed Infeed 	<ul style="list-style-type: none"> No cost No cost 	<ul style="list-style-type: none"> Specify with no infeed. Specify with infeed.
Panel Base	<ul style="list-style-type: none"> Base trim Finish to floor 	<ul style="list-style-type: none"> No cost No cost 	<ul style="list-style-type: none"> Specify with base trim. Specify with finish to floor.
Power	<ul style="list-style-type: none"> Standard power Chicago power 	<ul style="list-style-type: none"> No cost No cost 	<ul style="list-style-type: none"> Specify with standard power. Specify with Chicago power.
Related Products	<ul style="list-style-type: none"> Aisla powered panels Aisla cabinets Aisla fabric-wrapped magnetic panel 		<ul style="list-style-type: none"> ► Page 88 ► Page 132 ► Page 130

Tip: Finish to floor option is not available if power location is side 1 and 2, end A or side 1 and 2, end B.

Tip: If finish to floor option is specified, only standard power is available.

► Options, continued on next page



For Canadian Pricing
 Multiply U.S. Price by the Canadian price factor.
 ► See page 1 for details.

► Options, continued from previous page

Integrated Glass Option with Finish Upcharges

Tip: Glass price group 3 or glass price group 4 upcharge is in addition to glass price group 1 cost.

Height— Modular	Width— Modular	Options (Add \$ to Base Price)		
		Glass Price Group 1	Glass Price Group 3	Glass Price Group 4
10"	60.5"	+\$ 566	+\$259	+\$493
10"	66.5"	+\$ 637	+\$272	+\$527
10"	72.5"	+\$ 749	+\$286	+\$564
10"	78.5"	+\$ 860	+\$300	+\$604
10"	84.5"	+\$1040	+\$339	+\$646
10"	90.5"	+\$1220	+\$352	+\$691
10"	96.5"	+\$1364	+\$376	+\$740
12"	60.5"	+\$ 629	+\$285	+\$532
12"	66.5"	+\$ 708	+\$299	+\$570
12"	72.5"	+\$ 832	+\$315	+\$610
12"	78.5"	+\$ 956	+\$330	+\$652
12"	84.5"	+\$1155	+\$373	+\$698
12"	90.5"	+\$1355	+\$387	+\$747
12"	96.5"	+\$1515	+\$414	+\$799

10"D Transaction Top Option with Finish Upcharges

Depth— Modular	Width— Modular	Options (Add \$ to Base Price)								
		High-Pressure Laminate			Composite Veneer		Wood			Customiz Stain
		Price Group 1	Price Group 2	Price Group 3	Group 1	Group 2	Group 1	Group 2	Group 3	
10"	60.5"	+\$600	+\$ 90	+\$193	+\$313	+\$449	+\$ 974	+\$1210	+\$1482	+\$313
10"	66.5"	+\$638	+\$ 96	+\$206	+\$332	+\$478	+\$1036	+\$1287	+\$1576	+\$332
10"	72.5"	+\$679	+\$102	+\$219	+\$354	+\$509	+\$1102	+\$1370	+\$1677	+\$354
10"	78.5"	+\$720	+\$108	+\$232	+\$375	+\$539	+\$1169	+\$1452	+\$1777	+\$375
10"	84.5"	+\$763	+\$114	+\$246	+\$397	+\$571	+\$1239	+\$1539	+\$1884	+\$397
10"	90.5"	+\$809	+\$121	+\$261	+\$421	+\$606	+\$1313	+\$1631	+\$1997	+\$421
10"	96.5"	+\$857	+\$129	+\$276	+\$447	+\$642	+\$1392	+\$1729	+\$2117	+\$447

Tip: High-Pressure Laminate price groups 2 and 3, composite veneer, wood, and customiz stain upcharges are in addition to the High-Pressure price group 1 upcharge.

► Options, continued on next page



For Canadian Pricing

Multiply U.S. Price by the Canadian price factor.

► See page 1 for details.

► Options, continued from previous page

Transaction Top Bracket Option with Finish Upcharges

Depth— Modular	Width— Modular	Options (Add \$ to Base Price)		
		Paint Price Group 1	Paint Price Group 2	Paint Price Group 3
10"	60.5"	+\$390	+\$59	+\$ 67
10"	66.5"	+\$421	+\$63	+\$ 73
10"	72.5"	+\$455	+\$68	+\$ 78
10"	78.5"	+\$491	+\$74	+\$ 85
10"	84.5"	+\$531	+\$80	+\$ 92
10"	90.5"	+\$573	+\$86	+\$ 99
10"	96.5"	+\$619	+\$93	+\$107

Tip: Paint price groups 2 and 3 upcharges are in addition to the paint price group 1 upcharge.

Specification Information

Style Number	Dimensions		U.S. Base Price	Options (Add \$ to Base Price)				Wood			Customiz Stain
	Modular Height	Parametric Width		High-Pressure Laminate	Composite Veneer	Price Group 1	Price Group 2	Price Group 1	Price Group 2	Price Group 3	

Powered Panel—Free/Miter

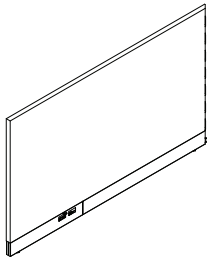

PNLFMP	Modular Height	Parametric Width	U.S. Base Price	High-Pressure Laminate	Composite Veneer	Price Group 1	Price Group 2	Price Group 1	Price Group 2	Price Group 3	Customiz Stain
42"	60.5"	60.5"	\$2130	+\$238	+\$357	+\$ 959	+\$1126	+\$1477	+\$1862	+\$2287	+\$ 959
42"	66.5"	66.5"	\$2343	+\$259	+\$389	+\$1045	+\$1227	+\$1609	+\$2029	+\$2491	+\$1045
42"	72.5"	72.5"	\$2577	+\$283	+\$424	+\$1139	+\$1338	+\$1754	+\$2212	+\$2716	+\$1139
42"	78.5"	78.5"	\$2783	+\$303	+\$455	+\$1222	+\$1435	+\$1882	+\$2374	+\$2914	+\$1222
42"	84.5"	84.5"	\$3006	+\$326	+\$488	+\$1312	+\$1541	+\$2020	+\$2548	+\$3128	+\$1312
42"	90.5"	90.5"	\$3247	+\$350	+\$524	+\$1409	+\$1654	+\$2170	+\$2736	+\$3359	+\$1409
42"	96.5"	96.5"	\$3506	+\$376	+\$563	+\$1514	+\$1777	+\$2331	+\$2939	+\$3609	+\$1514
48"	60.5"	60.5"	\$2340	+\$259	+\$389	+\$1044	+\$1225	+\$1607	+\$2027	+\$2488	+\$1044
48"	66.5"	66.5"	\$2574	+\$282	+\$424	+\$1138	+\$1336	+\$1752	+\$2210	+\$2713	+\$1138
48"	72.5"	72.5"	\$2831	+\$308	+\$462	+\$1242	+\$1458	+\$1912	+\$2411	+\$2960	+\$1242
48"	78.5"	78.5"	\$3058	+\$331	+\$496	+\$1333	+\$1565	+\$2052	+\$2588	+\$3178	+\$1333
48"	84.5"	84.5"	\$3303	+\$355	+\$533	+\$1432	+\$1681	+\$2204	+\$2780	+\$3413	+\$1432
48"	90.5"	90.5"	\$3567	+\$382	+\$573	+\$1538	+\$1806	+\$2368	+\$2987	+\$3667	+\$1538
48"	96.5"	96.5"	\$3852	+\$410	+\$615	+\$1653	+\$1941	+\$2545	+\$3210	+\$3941	+\$1653

► Specification Information, continued on next page

► Specification Information, continued from previous page

Specification Information											
Style Number	Dimensions		U.S. Base Price	Options (Add \$ to Base Price)						Customiz Stain	
	Modular Height	Parametric Width		High-Pressure Laminate	Composite Veneer	Wood					
				Price	Price	Price	Price	Price	Price	Price	
				Group 2	Group 3	Group 1	Group 2	Group 1	Group 2	Group 3	

Powered Panel—Free/T

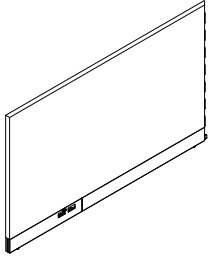

PNLFTP	Modular Height	Parametric Width	U.S. Base Price	High-Pressure Laminate	Composite Veneer	Wood	Customiz Stain
42"	60.5"		\$2130	+\$223	+\$335	+\$ 899	+\$ 899
42"	66.5"		\$2343	+\$244	+\$366	+\$ 985	+\$ 985
42"	72.5"		\$2577	+\$268	+\$402	+\$1079	+\$1079
42"	78.5"		\$2783	+\$288	+\$433	+\$1162	+\$1162
42"	84.5"		\$3006	+\$311	+\$466	+\$1252	+\$1252
42"	90.5"		\$3247	+\$335	+\$502	+\$1349	+\$1349
42"	96.5"		\$3506	+\$361	+\$541	+\$1453	+\$1453
48"	60.5"		\$2340	+\$244	+\$366	+\$ 983	+\$ 983
48"	66.5"		\$2574	+\$267	+\$401	+\$1078	+\$1078
48"	72.5"		\$2831	+\$293	+\$440	+\$1181	+\$1181
48"	78.5"		\$3058	+\$316	+\$474	+\$1273	+\$1273
48"	84.5"		\$3303	+\$340	+\$510	+\$1371	+\$1371
48"	90.5"		\$3567	+\$367	+\$550	+\$1478	+\$1478
48"	96.5"		\$3852	+\$395	+\$593	+\$1593	+\$1593

► Specification Information, continued on next page

 **For Canadian Pricing**
 Multiply U.S. Price by the Canadian price factor.
 ► See page 1 for details.

► Specification Information, continued from previous page

Specification Information

Style Number	Dimensions		U.S. Base Price	Options (Add \$ to Base Price)				Wood			Customiz Stain
	Modular Height	Parametric Width		High-Pressure Laminate	Composite Veneer	Wood	Price	Price	Price		
				Price	Price	Price	Price	Price	Price	Price	
				Group 2	Group 3	Group 1	Group 2	Group 1	Group 2	Group 3	

Powered Panel—Free Spanning

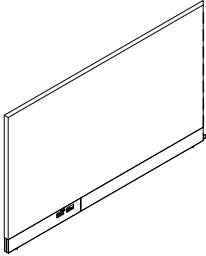

PNLFSP	Modular Height	Parametric Width	U.S. Base Price	High-Pressure Laminate	Composite Veneer	Wood	Price	Price	Price	Price	Price
	42"	60.5"	\$2130	+\$220	+\$330	+\$ 887	+\$1041	+\$1365	+\$1722	+\$2114	+\$ 887
	42"	66.5"	\$2343	+\$241	+\$362	+\$ 972	+\$1142	+\$1497	+\$1888	+\$2318	+\$ 972
	42"	72.5"	\$2577	+\$265	+\$397	+\$1067	+\$1253	+\$1643	+\$2072	+\$2543	+\$1067
	42"	78.5"	\$2783	+\$285	+\$428	+\$1150	+\$1350	+\$1770	+\$2233	+\$2742	+\$1150
	42"	84.5"	\$3006	+\$308	+\$461	+\$1240	+\$1455	+\$1909	+\$2407	+\$2955	+\$1240
	42"	90.5"	\$3247	+\$332	+\$497	+\$1337	+\$1569	+\$2058	+\$2595	+\$3187	+\$1337
	42"	96.5"	\$3506	+\$358	+\$536	+\$1441	+\$1692	+\$2219	+\$2799	+\$3436	+\$1441
	48"	60.5"	\$2340	+\$241	+\$362	+\$ 971	+\$1140	+\$1495	+\$1886	+\$2315	+\$ 971
	48"	66.5"	\$2574	+\$264	+\$397	+\$1066	+\$1251	+\$1641	+\$2069	+\$2540	+\$1066
	48"	72.5"	\$2831	+\$290	+\$435	+\$1169	+\$1373	+\$1800	+\$2270	+\$2788	+\$1169
	48"	78.5"	\$3058	+\$313	+\$469	+\$1261	+\$1480	+\$1941	+\$2448	+\$3005	+\$1261
	48"	84.5"	\$3303	+\$337	+\$506	+\$1359	+\$1596	+\$2093	+\$2639	+\$3240	+\$1359
	48"	90.5"	\$3567	+\$364	+\$546	+\$1466	+\$1721	+\$2256	+\$2846	+\$3494	+\$1466
	48"	96.5"	\$3852	+\$392	+\$588	+\$1581	+\$1856	+\$2434	+\$3069	+\$3768	+\$1581

► Specification Information, continued on next page



For Canadian Pricing

Multiply U.S. Price by the Canadian price factor.

► See page 1 for details.

► Specification Information, continued from previous page

Specification Information

Style Number	Dimensions		U.S. Base Price	Options (Add \$ to Base Price)						Customiz Stain	
	Modular Height	Parametric Width		High-Pressure Laminate	Composite Veneer	Wood					
				Price Group 2	Price Group 3	Price Group 1	Price Group 2	Price Group 1	Price Group 2	Price Group 3	

Powered Panel—Free Inline

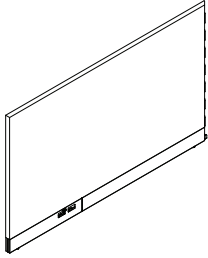

PNLFIP	Modular Height	Parametric Width	U.S. Base Price	High-Pressure Laminate	Composite Veneer	Wood	Wood	Wood	Wood	Wood	Customiz Stain
	42"	60.5"	\$2130	+\$220	+\$330	+\$ 887	+\$1041	+\$1365	+\$1722	+\$2114	+\$ 887
	42"	66.5"	\$2343	+\$241	+\$362	+\$ 972	+\$1142	+\$1497	+\$1888	+\$2318	+\$ 972
	42"	72.5"	\$2577	+\$265	+\$397	+\$1067	+\$1253	+\$1643	+\$2072	+\$2543	+\$1067
	42"	78.5"	\$2783	+\$285	+\$428	+\$1150	+\$1350	+\$1770	+\$2233	+\$2742	+\$1150
	42"	84.5"	\$3006	+\$308	+\$461	+\$1240	+\$1455	+\$1909	+\$2407	+\$2955	+\$1240
	42"	90.5"	\$3247	+\$332	+\$497	+\$1337	+\$1569	+\$2058	+\$2595	+\$3187	+\$1337
	42"	96.5"	\$3506	+\$358	+\$536	+\$1441	+\$1692	+\$2219	+\$2799	+\$3436	+\$1441
	48"	60.5"	\$2340	+\$241	+\$362	+\$ 971	+\$1140	+\$1495	+\$1886	+\$2315	+\$ 971
	48"	66.5"	\$2574	+\$264	+\$397	+\$1066	+\$1251	+\$1641	+\$2069	+\$2540	+\$1066
	48"	72.5"	\$2831	+\$290	+\$435	+\$1169	+\$1373	+\$1800	+\$2270	+\$2788	+\$1169
	48"	78.5"	\$3058	+\$313	+\$469	+\$1261	+\$1480	+\$1941	+\$2448	+\$3005	+\$1261
	48"	84.5"	\$3303	+\$337	+\$506	+\$1359	+\$1596	+\$2093	+\$2639	+\$3240	+\$1359
	48"	90.5"	\$3567	+\$364	+\$546	+\$1466	+\$1721	+\$2256	+\$2846	+\$3494	+\$1466
	48"	96.5"	\$3852	+\$392	+\$588	+\$1581	+\$1856	+\$2434	+\$3069	+\$3768	+\$1581

 **For Canadian Pricing**
 Multiply U.S. Price by the Canadian price factor.
 ► See page 1 for details.

Aisla Powered Panels—Spanning

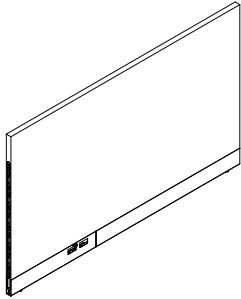

► Need help?
Product details,
page 30

Standard Includes

- Powered panel—spanning: High-Pressure Laminate price group 1
- 1 mm top edge band
- 3 mm side edge band
- Transaction top, if selected: High-Pressure Laminate price group 1
- Transaction top edge, if selected: plastic
- Transaction top bracket, if selected: paint price group 1
- Glass insert, if selected: glass price group 1
- Trim: paint price group 1

Required to Specify

- 1 Style number
 - 2 Width (see below under Required Selections)
 - 3 Height (see below under Required Selections)
 - 4 Connection—end A (see below under Required Selections)
 - 5 Connection—end B (see below under Required Selections)
 - 6 High-Pressure Laminate color for panel
 - 7 Glass color number for glass insert, if selected
 - 8 High-Pressure Laminate color for transaction top, if selected
 - 9 Plastic color number for transaction top edge, if selected
 - 10 Paint color number for transaction top bracket, if selected
 - 11 Paint color number for trim
 - 12 Options, if selected (see below)
- See *Surface Materials*, page 164

	Required Selections	U.S. Price	Required to Specify
Width	<ul style="list-style-type: none"> • 60.5" • 66.5" • 72.5" • 78.5" • 84.5" • 90.5" • 96.5" 	Prices at right Prices at right Prices at right Prices at right Prices at right Prices at right Prices at right	Specify width. Specify width. Specify width. Specify width. Specify width. Specify width. Specify width.

Height	<ul style="list-style-type: none"> • 42" • 48" 	Prices at right Prices at right	Specify height. Specify height.
---------------	--	------------------------------------	------------------------------------

Connection	End A		
	<ul style="list-style-type: none"> • Spanning • T 	+\$ 70 +\$100	Specify <i>with end A spanning</i> . Specify <i>with end A T</i> .

Connection	End B		
	<ul style="list-style-type: none"> • Spanning • T 	+\$ 70 +\$100	Specify <i>with end B spanning</i> . Specify <i>with end B T</i> .

	Options	U.S. Price	Required to Specify
Surface Materials	Panel		
	• High-Pressure Laminate price group 1	No cost	Specify laminate color number.
	• High-Pressure Laminate price group 2	Prices at right	Specify laminate color number.
	• High-Pressure Laminate price group 3	Prices at right	Specify laminate color number.
	• Open Line laminate (OLL)	+\$111 plus cost of laminate	► See <i>Surface Materials Reference Manual</i> .
	• Composite veneer group 1	Prices at right	Specify composite veneer color number.
	• Composite veneer group 2	Prices at right	Specify composite veneer color number.
	• Wood group 1	Prices at right	Specify wood color number.
	• Wood group 2	Prices at right	Specify wood color number.
	• Wood group 3	Prices at right	Specify wood color number.
• Customiz stain	Prices at right	Specify <i>with customiz stain</i> .	
Integrated glass	• Glass price group 1	Prices at right	Specify <i>with 6500 Clear Glass</i> .
	• Glass price group 3	Prices at right	Specify <i>with 6501 Low Iron Clear Glass</i> .
	• Glass price group 4	Prices at right	Specify <i>with 6562 Bronze or 6563 Smoke Glass</i> .



For Canadian Pricing
Multiply U.S. Price by the Canadian price factor.
► See page 1 for details.

► Options, continued on next page

► Options, continued from previous page

	Options	U.S. Price	Required to Specify
Surface Materials, continued	Transaction top		
	• High-Pressure Laminate price group 1	No cost	Specify laminate color number.
	• High-Pressure Laminate price group 2	Prices at right	Specify laminate color number.
	• High-Pressure Laminate price group 3	Prices at right	Specify laminate color number.
	• Open Line laminate (OLL)	+\$ 111 plus cost of laminate	► See <i>Surface Materials Reference Manual</i> .
	• Composite veneer group 1	Prices at right	Specify composite veneer color number.
	• Composite veneer group 2	Prices at right	Specify composite veneer color number.
	• Wood group 1	Prices at right	Specify wood color number.
	• Wood group 2	Prices at right	Specify wood color number.
	• Wood group 3	Prices at right	Specify wood color number.
	• Customiz stain	Prices at right	Specify with <i>customiz stain</i> .
	Transaction top edge		
	• Plastic	No cost	Specify plastic color number.
	Transaction top bracket		
	• Paint price group 1	Prices at right	Specify paint color number.
• Paint price group 2	Prices at right	Specify paint color number.	
• Paint price group 3	Prices at right	Specify paint color number.	
Trim			
• Paint price group 1	No cost	Specify paint color number.	
• Paint price group 2	+\$ 200	Specify paint color number.	
• Paint price group 3	+\$ 250	Specify paint color number.	
Connection T	End A		
	• T adjacent side 1	No cost	Specify with <i>end A T adjacent side 1</i> .
	• T adjacent side 2	No cost	Specify with <i>end A T adjacent side 2</i> .
	End B		
	• T adjacent side 1	No cost	Specify with <i>end B T adjacent side 1</i> .
	• T adjacent side 2	No cost	Specify with <i>end B T adjacent side 2</i> .
Accent Panel	• No panel	No cost	Specify with <i>no panel</i> .
	• Fabric panel side 1	No cost	Specify with <i>fabric panel side 1</i> .
	• Fabric panel side 2	No cost	Specify with <i>fabric panel side 2</i> .
	• Fabric panel side 1 and 2	No cost	Specify with <i>fabric panel side 1 and 2</i> .
Top Accessory	• No accessory	No cost	Specify with <i>no accessory</i> .
	• Integrated glass	Prices at right	Specify with <i>integrated glass</i> .
	• 10"D transaction top side 1	Prices at right	Specify with <i>10"D transaction top side 1</i> .
	• 10"D transaction top side 2	Prices at right	Specify with <i>10"D transaction top side 2</i> .
	• Transaction top bracket only side 1	Prices at right	Specify with <i>transaction top bracket only side 1</i> .
• Transaction top bracket only side 2	Prices at right	Specify with <i>transaction top bracket only side 2</i> .	
Glass Height	• 10"	Prices at right	Specify glass height.
	• 12"	Prices at right	Specify glass height.
Grain Direction	Panel		
	• No grain direction	No cost	Specify with <i>no grain direction</i> .
	• Horizontal	No cost	Specify with <i>horizontal grain direction</i> .
	• Vertical	No cost	Specify with <i>vertical grain direction</i> .
	Transaction top		
	• No grain direction	No cost	Specify with <i>no grain direction</i> .
• Long grain	No cost	Specify with <i>long grain direction</i> .	
• Short grain	No cost	Specify with <i>short grain direction</i> .	
Power Location	• Side 1, end A	+\$ 776	Specify with <i>power side 1, end A</i> .
	• Side 1, end B	+\$ 776	Specify with <i>power side 1, end B</i> .
	• Side 2, end A	+\$ 776	Specify with <i>power side 2, end A</i> .
	• Side 2, end B	+\$ 776	Specify with <i>power side 2, end B</i> .
	• Side 1 and 2, end A	+\$1970	Specify with <i>power side 1 and 2, end A</i> .
	• Side 1 and 2, end B	+\$1970	Specify with <i>power side 1 and 2, end B</i> .

Tip: This option is only available when connection end A is T.

Tip: This option is only available when connection end B is T.

 **For Canadian Pricing**
Multiply U.S. Price by the Canadian price factor.
► See page 1 for details.

► Options, continued on next page

► Options, continued from previous page

	Options	U.S. Price	Required to Specify
Power Install	<ul style="list-style-type: none"> • Side 1 • Side 2 	No cost No cost	Specify with <i>install side 1</i> . Specify with <i>install side 2</i> .
Infeed	<ul style="list-style-type: none"> • No infeed • Infeed 	No cost No cost	Specify with <i>no infeed</i> . Specify with <i>infeed</i> .
Panel Base	<ul style="list-style-type: none"> • Base trim • Finish to floor 	No cost No cost	Specify with <i>base trim</i> . Specify with <i>finish to floor</i> .
Power	<ul style="list-style-type: none"> • Standard power • Chicago power 	No cost No cost	Specify with <i>standard power</i> . Specify with <i>Chicago power</i> .
Related Products	<ul style="list-style-type: none"> • Aisla panels • Aisla cabinets • Aisla fabric-wrapped magnetic panel 		<ul style="list-style-type: none"> ► Page 48 ► Page 132 ► Page 130

Tip: Finish to floor option is not available if power location is side 1 and 2, end A or side 1 and 2, end B.

Tip: If finish to floor option is specified, only standard power is available.

Integrated Glass Option with Finish Upcharges

Height— Modular	Width— Modular	Options (Add \$ to Base Price)		
		Glass Price Group 1	Glass Price Group 3	Glass Price Group 4
10"	60.5"	+\$ 566	+\$259	+\$493
10"	66.5"	+\$ 637	+\$272	+\$527
10"	72.5"	+\$ 749	+\$286	+\$564
10"	78.5"	+\$ 860	+\$300	+\$604
10"	84.5"	+\$1040	+\$339	+\$646
10"	90.5"	+\$1220	+\$352	+\$691
10"	96.5"	+\$1364	+\$376	+\$740
12"	60.5"	+\$ 629	+\$285	+\$532
12"	66.5"	+\$ 708	+\$299	+\$570
12"	72.5"	+\$ 832	+\$315	+\$610
12"	78.5"	+\$ 956	+\$330	+\$652
12"	84.5"	+\$1155	+\$373	+\$698
12"	90.5"	+\$1355	+\$387	+\$747
12"	96.5"	+\$1515	+\$414	+\$799

Tip: Glass price group 3 or glass price group 4 upcharge is in addition to glass price group 1 cost.

► Options, continued on next page



For Canadian Pricing
Multiply U.S. Price by the Canadian price factor.
► See page 1 for details.

► Options, continued from previous page

10"D Transaction Top Option with Finish Upcharges

Depth— Modular	Width— Modular	Options (Add \$ to Base Price)								
		High-Pressure Laminate			Composite Veneer		Wood			Customiz Stain
		Price Group 1	Price Group 2	Price Group 3	Group 1	Group 2	Group 1	Group 2	Group 3	
10"	60.5"	+\$600	+\$ 90	+\$193	+\$313	+\$449	+\$ 974	+\$1210	+\$1482	
10"	66.5"	+\$638	+\$ 96	+\$206	+\$332	+\$478	+\$1036	+\$1287	+\$1576	+\$332
10"	72.5"	+\$679	+\$102	+\$219	+\$354	+\$509	+\$1102	+\$1370	+\$1677	+\$354
10"	78.5"	+\$720	+\$108	+\$232	+\$375	+\$539	+\$1169	+\$1452	+\$1777	+\$375
10"	84.5"	+\$763	+\$114	+\$246	+\$397	+\$571	+\$1239	+\$1539	+\$1884	+\$397
10"	90.5"	+\$809	+\$121	+\$261	+\$421	+\$606	+\$1313	+\$1631	+\$1997	+\$421
10"	96.5"	+\$857	+\$129	+\$276	+\$447	+\$642	+\$1392	+\$1729	+\$2117	+\$447

Tip: High-Pressure Laminate price groups 2 and 3, composite veneer, wood, and customiz stain upcharges are in addition to the High-Pressure price group 1 upcharge.

Transaction Top Bracket Option with Finish Upcharges

Depth— Modular	Width— Modular	Options (Add \$ to Base Price)		
		Paint Price Group 1	Paint Price Group 2	Paint Price Group 3
		10"	60.5"	+\$390
10"	66.5"	+\$421	+\$63	+\$ 73
10"	72.5"	+\$455	+\$68	+\$ 78
10"	78.5"	+\$491	+\$74	+\$ 85
10"	84.5"	+\$531	+\$80	+\$ 92
10"	90.5"	+\$573	+\$86	+\$ 99
10"	96.5"	+\$619	+\$93	+\$107

Tip: Paint price groups 2 and 3 upcharges are in addition to the paint price group 1 upcharge.

► Specification Information, on next page

 **For Canadian Pricing**
Multiply U.S. Price by the
Canadian price factor.
► See page 1 for details.

Aisla Powered Panels—Spanning, continued

► Options, on previous page

Specification Information

Style Number	Dimensions		U.S. Base Price	Options (Add \$ to Base Price)				Wood			Customiz Stain
	Modular Height	Parametric Width		High-Pressure Laminate	Composite Veneer	Wood	Price	Price	Price		
				Price	Price	Price	Price	Price	Price	Price	
				Group 2	Group 3	Group 1	Group 2	Group 1	Group 2	Group 3	

Powered Panel—Spanning Spanning

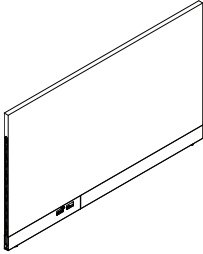

PNLSSP	Modular Height	Parametric Width	U.S. Base Price	High-Pressure Laminate	Composite Veneer	Wood	Price	Price	Price	Price	Price
	42"	60.5"	\$2130	+\$227	+\$341	+\$ 915	+\$1074	+\$1408	+\$1776	+\$2181	+\$ 915
	42"	66.5"	\$2343	+\$248	+\$372	+\$1001	+\$1175	+\$1541	+\$1943	+\$2386	+\$1001
	42"	72.5"	\$2577	+\$272	+\$408	+\$1095	+\$1286	+\$1686	+\$2126	+\$2611	+\$1095
	42"	78.5"	\$2783	+\$292	+\$439	+\$1178	+\$1383	+\$1814	+\$2288	+\$2809	+\$1178
	42"	84.5"	\$3006	+\$315	+\$472	+\$1268	+\$1489	+\$1952	+\$2462	+\$3023	+\$1268
	42"	90.5"	\$3247	+\$339	+\$508	+\$1365	+\$1602	+\$2101	+\$2650	+\$3254	+\$1365
	42"	96.5"	\$3506	+\$365	+\$547	+\$1469	+\$1725	+\$2262	+\$2853	+\$3503	+\$1469
	48"	60.5"	\$2340	+\$248	+\$372	+\$ 999	+\$1173	+\$1539	+\$1941	+\$2383	+\$ 999
	48"	66.5"	\$2574	+\$271	+\$407	+\$1094	+\$1284	+\$1684	+\$2124	+\$2608	+\$1094
	48"	72.5"	\$2831	+\$297	+\$446	+\$1197	+\$1406	+\$1844	+\$2325	+\$2855	+\$1197
	48"	78.5"	\$3058	+\$320	+\$480	+\$1289	+\$1513	+\$1984	+\$2502	+\$3072	+\$1289
	48"	84.5"	\$3303	+\$344	+\$516	+\$1387	+\$1629	+\$2136	+\$2694	+\$3307	+\$1387
	48"	90.5"	\$3567	+\$371	+\$556	+\$1494	+\$1754	+\$2300	+\$2901	+\$3561	+\$1494
	48"	96.5"	\$3852	+\$399	+\$599	+\$1609	+\$1889	+\$2477	+\$3124	+\$3835	+\$1609

► Specification Information, continued on next page



For Canadian Pricing

Multiply U.S. Price by the Canadian price factor.

► See page 1 for details.

► Specification Information, continued from previous page

Specification Information											
Style Number	Dimensions		U.S. Base Price	Options (Add \$ to Base Price)						Customiz Stain	
	Modular Height	Parametric Width		High-Pressure Laminate	Composite Veneer	Wood					
				Price	Price	Price	Price	Price	Price	Price	
				Group 2	Group 3	Group 1	Group 2	Group 1	Group 2	Group 3	

Powered Panel—Spanning T

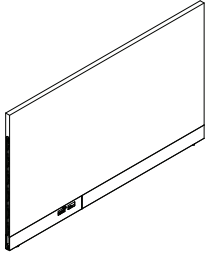

PNLSTP	Modular Height	Parametric Width	U.S. Base Price	High-Pressure Laminate	Composite Veneer	Wood	Customiz Stain
	42"	60.5"	\$2130	+\$230	+\$345	+\$ 927	+\$ 927
	42"	66.5"	\$2343	+\$251	+\$377	+\$1013	+\$1013
	42"	72.5"	\$2577	+\$275	+\$412	+\$1107	+\$1107
	42"	78.5"	\$2783	+\$295	+\$443	+\$1190	+\$1190
	42"	84.5"	\$3006	+\$318	+\$476	+\$1280	+\$1280
	42"	90.5"	\$3247	+\$342	+\$512	+\$1377	+\$1377
	42"	96.5"	\$3506	+\$368	+\$551	+\$1482	+\$1482
	48"	60.5"	\$2340	+\$251	+\$377	+\$1012	+\$1012
	48"	66.5"	\$2574	+\$274	+\$412	+\$1106	+\$1106
	48"	72.5"	\$2831	+\$300	+\$450	+\$1210	+\$1210
	48"	78.5"	\$3058	+\$323	+\$484	+\$1301	+\$1301
	48"	84.5"	\$3303	+\$347	+\$521	+\$1399	+\$1399
	48"	90.5"	\$3567	+\$374	+\$561	+\$1506	+\$1506
	48"	96.5"	\$3852	+\$402	+\$603	+\$1621	+\$1621

 **For Canadian Pricing**
Multiply U.S. Price by the Canadian price factor.
► See page 1 for details.

Aisla Powered Panels—Inline

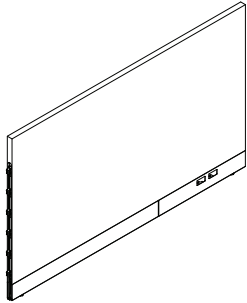

► Need help?
Product details,
page 30

Standard Includes

- Powered panel—Inline: High-Pressure Laminate price group 1
- 1 mm top edge band
- 3 mm side edge band
- Transaction top, if selected: High-Pressure Laminate price group 1
- Transaction top edge, if selected: plastic
- Transaction top bracket, if selected: paint price group 1
- Glass insert, if selected: glass price group 1
- Trim: paint price group 1

Required to Specify

- 1 Style number
- 2 Width (see below under Required Selections)
- 3 Height (see below under Required Selections)
- 4 Connection—end A (see below under Required Selections)
- 5 Connection—end B (see below under Required Selections)
- 6 High-Pressure Laminate color for panel
- 7 Glass color number for glass insert, if selected
- 8 High-Pressure Laminate color for transaction top, if selected
- 9 Plastic color number for transaction top edge, if selected
- 10 Paint color number for transaction top bracket, if selected
- 11 Paint color number for trim
- 12 Options, if selected (see below)
 - See *Surface Materials*, page 164

	Required Selections	U.S. Price	Required to Specify
Width	<ul style="list-style-type: none"> • 60.5" • 66.5" • 72.5" • 78.5" • 84.5" • 90.5" • 96.5" 	<ul style="list-style-type: none"> Prices at right Prices at right Prices at right Prices at right Prices at right Prices at right Prices at right 	<ul style="list-style-type: none"> Specify width. Specify width. Specify width. Specify width. Specify width. Specify width. Specify width.
Height	<ul style="list-style-type: none"> • 42" • 48" 	<ul style="list-style-type: none"> Prices at right Prices at right 	<ul style="list-style-type: none"> Specify height. Specify height.
Connection	<p>End A</p> <ul style="list-style-type: none"> • Inline • Spanning • T • Mitered side 1 • Mitered side 2 <p>End B</p> <ul style="list-style-type: none"> • Inline • Spanning • T • Mitered side 1 • Mitered side 2 	<ul style="list-style-type: none"> +\$ 70 +\$ 70 +\$100 +\$250 +\$250 <ul style="list-style-type: none"> +\$ 70 +\$ 70 +\$100 +\$250 +\$250 	<ul style="list-style-type: none"> Specify <i>with end A inline</i>. Specify <i>with end A spanning</i>. Specify <i>with end A T</i>. Specify <i>with end A mitered side 1</i>. Specify <i>with end A mitered side 2</i>. <ul style="list-style-type: none"> Specify <i>with end B inline</i>. Specify <i>with end B spanning</i>. Specify <i>with end B T</i>. Specify <i>with end B mitered side 1</i>. Specify <i>with end B mitered side 2</i>.



For Canadian Pricing

Multiply U.S. Price by the Canadian price factor.

► See page 1 for details.

	Options	U.S. Price	Required to Specify
Surface Materials	Panel		
	• High-Pressure Laminate price group 1	No cost	Specify laminate color number.
	• High-Pressure Laminate price group 2	Prices at right	Specify laminate color number.
	• High-Pressure Laminate price group 3	Prices at right	Specify laminate color number.
	• Open Line laminate (OLL)	+\$111 plus cost of laminate	▶ See <i>Surface Materials Reference Manual</i> .
	• Composite veneer group 1	Prices at right	Specify composite veneer color number.
	• Composite veneer group 2	Prices at right	Specify composite veneer color number.
	• Wood group 1	Prices at right	Specify wood color number.
	• Wood group 2	Prices at right	Specify wood color number.
	• Wood group 3	Prices at right	Specify wood color number.
	• Customiz stain	Prices at right	Specify with <i>customiz stain</i> .
	Integrated glass		
	• Glass price group 1	Prices at right	Specify with <i>6500 Clear Glass</i> .
	• Glass price group 3	Prices at right	Specify with <i>6501 Low Iron Clear Glass</i> .
	• Glass price group 4	Prices at right	Specify with <i>6562 Bronze or 6563 Smoke Glass</i> .
	Transaction top		
	• High-Pressure Laminate price group 1	No cost	Specify laminate color number.
	• High-Pressure Laminate price group 2	Prices at right	Specify laminate color number.
	• High-Pressure Laminate price group 3	Prices at right	Specify laminate color number.
	• Open Line laminate (OLL)	+\$111 plus cost of laminate	▶ See <i>Surface Materials Reference Manual</i> .
• Composite veneer group 1	Prices at right	Specify composite veneer color number.	
• Composite veneer group 2	Prices at right	Specify composite veneer color number.	
• Wood group 1	Prices at right	Specify wood color number.	
• Wood group 2	Prices at right	Specify wood color number.	
• Wood group 3	Prices at right	Specify wood color number.	
• Customiz stain	Prices at right	Specify with <i>customiz stain</i> .	
Transaction top edge			
• Plastic	No cost	Specify plastic color number.	
Transaction top bracket			
• Paint price group 1	Prices at right	Specify paint color number.	
• Paint price group 2	Prices at right	Specify paint color number.	
• Paint price group 3	Prices at right	Specify paint color number.	
Trim			
• Paint price group 1	No cost	Specify paint color number.	
• Paint price group 2	+\$200	Specify paint color number.	
• Paint price group 3	+\$250	Specify paint color number.	
Connection T	End A		
	• No T	No cost	Specify with <i>end A no T</i> .
	• T side 1	No cost	Specify with <i>end A T side 1</i> .
	• T side 2	No cost	Specify with <i>end A T side 2</i> .
	• T side 1 and 2	No cost	Specify with <i>end A T side 1 and 2</i> .
	• T adjacent side 1	No cost	Specify with <i>end A T adjacent side 1</i> .
	• T adjacent side 2	No cost	Specify with <i>end A T adjacent side 2</i> .
	End B		
	• No T	No cost	Specify with <i>end B no T</i> .
	• T side 1	No cost	Specify with <i>end B T side 1</i> .
	• T side 2	No cost	Specify with <i>end B T side 2</i> .
	• T side 1 and 2	No cost	Specify with <i>end B T side 1 and 2</i> .
	• T adjacent side 1	No cost	Specify with <i>end B T adjacent side 1</i> .
	• T adjacent side 2	No cost	Specify with <i>end B T adjacent side 2</i> .

Tip: This option is only available when connection end A is inline or T.

Tip: This option is only available when connection end B is inline or T.



For Canadian Pricing
Multiply U.S. Price by the Canadian price factor.
▶ See page 1 for details.

▶ Options, continued on next page

► Options, continued from previous page

Tip: This option is only available when connection end A is mitered.

Tip: This option is only available when connection end B is mitered.

	Options	U.S. Price	Required to Specify
Mitered Matchstick	End A		
	• No matchstick • With matchstick	No cost No cost	Specify with end A no matchstick. Specify with end A matchstick.
	End B		
	• No matchstick • With matchstick	No cost No cost	Specify with end B no matchstick. Specify with end B matchstick.
Accent Panel	• No panel	No cost	Specify with no panel.
	• Fabric panel side 1	No cost	Specify with fabric panel side 1.
	• Fabric panel side 2	No cost	Specify with fabric panel side 2.
	• Fabric panel side 1 and 2	No cost	Specify with fabric panel side 1 and 2.
Top Accessory	• No accessory	No cost	Specify with no accessory.
	• Integrated glass	Prices at right	Specify with integrated glass.
	• 10"D transaction top side 1	Prices at right	Specify with 10"D transaction top side 1.
	• 10"D transaction top side 2	Prices at right	Specify with 10"D transaction top side 2.
	• Transaction top bracket only side 1	Prices at right	Specify with transaction top bracket only side 1.
	• Transaction top bracket only side 2	Prices at right	Specify with transaction top bracket only side 2.
Glass Height	• 10"	Prices at right	Specify glass height.
	• 12"	Prices at right	Specify glass height.
Grain Direction	Panel		
	• No grain direction • Horizontal • Vertical	No cost No cost No cost	Specify with no grain direction. Specify with horizontal grain direction. Specify with vertical grain direction.
	Transaction top		
	• No grain direction • Long grain • Short grain	No cost No cost No cost	Specify with no grain direction. Specify with long grain direction. Specify with short grain direction.
Power Location	• Side 1, end A	+\$ 776	Specify with power side 1, end A.
	• Side 1, end B	+\$ 776	Specify with power side 1, end B.
	• Side 2, end A	+\$ 776	Specify with power side 2, end A.
	• Side 2, end B	+\$ 776	Specify with power side 2, end B.
	• Side 1 and 2, end A	+\$1970	Specify with power side 1 and 2, end A.
	• Side 1 and 2, end B	+\$1970	Specify with power side 1 and 2, end B.
Power Install	• Side 1	No cost	Specify with install side 1.
	• Side 2	No cost	Specify with install side 2.
Infeed	• No infeed	No cost	Specify with no infeed.
	• Infeed	No cost	Specify with infeed.
Panel Base	• Base trim	No cost	Specify with base trim.
	• Finish to floor	No cost	Specify with finish to floor.
Power	• Standard power	No cost	Specify with standard power.
	• Chicago power	No cost	Specify with Chicago power.
Related Products	• Aisla panels		► Page 48
	• Aisla cabinets		► Page 132
	• Aisla fabric-wrapped magnetic panel		► Page 130

Tip: Finish to floor option is not available if power location is side 1 and 2, end A or side 1 and 2, end B.

Tip: If finish to floor option is specified, only standard power is available.

► Options, continued on next page



For Canadian Pricing
Multiply U.S. Price by the Canadian price factor.
► See page 1 for details.

► Options, continued from previous page

Tip: Glass price group 3 and glass price group 4 upcharges are in addition to glass price group 1 upcharge.

Integrated Glass Option with Finish Upcharges

Height— Modular	Width— Modular	Options (Add \$ to Base Price)		
		Glass Price Group 1	Glass Price Group 3	Glass Price Group 4
10"	60.5"	+\$ 566	+\$259	+\$493
10"	66.5"	+\$ 637	+\$272	+\$527
10"	72.5"	+\$ 749	+\$286	+\$564
10"	78.5"	+\$ 860	+\$300	+\$604
10"	84.5"	+\$1040	+\$339	+\$646
10"	90.5"	+\$1220	+\$352	+\$691
10"	96.5"	+\$1364	+\$376	+\$740
12"	60.5"	+\$ 629	+\$285	+\$532
12"	66.5"	+\$ 708	+\$299	+\$570
12"	72.5"	+\$ 832	+\$315	+\$610
12"	78.5"	+\$ 956	+\$330	+\$652
12"	84.5"	+\$1155	+\$373	+\$698
12"	90.5"	+\$1355	+\$387	+\$747
12"	96.5"	+\$1515	+\$414	+\$799

Aisla Powered
Panels

10"D Transaction Top Option with Finish Upcharges

Depth— Modular	Width— Modular	Options (Add \$ to Base Price)								
		High-Pressure Laminate			Composite Veneer		Wood			Customiz Stain
		Price Group 1	Price Group 2	Price Group 3	Group 1	Group 2	Group 1	Group 2	Group 3	
10"	60.5"	+\$600	+\$ 90	+\$193	+\$313	+\$449	+\$ 974	+\$1210	+\$1482	+\$313
10"	66.5"	+\$638	+\$ 96	+\$206	+\$332	+\$478	+\$1036	+\$1287	+\$1576	+\$332
10"	72.5"	+\$679	+\$102	+\$219	+\$354	+\$509	+\$1102	+\$1370	+\$1677	+\$354
10"	78.5"	+\$720	+\$108	+\$232	+\$375	+\$539	+\$1169	+\$1452	+\$1777	+\$375
10"	84.5"	+\$763	+\$114	+\$246	+\$397	+\$571	+\$1239	+\$1539	+\$1884	+\$397
10"	90.5"	+\$809	+\$121	+\$261	+\$421	+\$606	+\$1313	+\$1631	+\$1997	+\$421
10"	96.5"	+\$857	+\$129	+\$276	+\$447	+\$642	+\$1392	+\$1729	+\$2117	+\$447

Tip: High-Pressure Laminate price groups 2 and 3, composite veneer, wood, and customiz stain upcharges are in addition to the High-Pressure price group 1 upcharge.

► Options, continued on next page



For Canadian Pricing
Multiply U.S. Price by the
Canadian price factor.
► See page 1 for details.

► Options, continued from previous page

Transaction Top Bracket Option with Finish Upcharges

Depth— Modular	Width— Modular	Options (Add \$ to Base Price)		
		Paint Price Group 1	Paint Price Group 2	Paint Price Group 3
10"	60.5"	+\$390	+\$59	+\$ 67
10"	66.5"	+\$421	+\$63	+\$ 73
10"	72.5"	+\$455	+\$68	+\$ 78
10"	78.5"	+\$491	+\$74	+\$ 85
10"	84.5"	+\$531	+\$80	+\$ 92
10"	90.5"	+\$573	+\$86	+\$ 99
10"	96.5"	+\$619	+\$93	+\$107

Tip: Paint price groups 2 and 3 upcharges are in addition to the paint price group 1 upcharge.

Specification Information

Style Number	Dimensions		U.S. Base Price	Options (Add \$ to Base Price)				Wood			Customiz Stain
	Modular Height	Parametric Width		High-Pressure Laminate	Composite Veneer	Price Group 1	Price Group 2	Price Group 3			

Powered Panel—Inline Inline

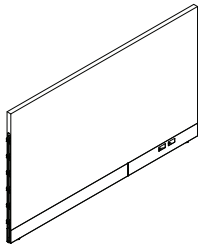

PNLIIP	Depth	Width	Base Price	High-Pressure Laminate	Composite Veneer	Wood Price Group 1	Wood Price Group 2	Wood Price Group 3	Customiz Stain		
	42"	60.5"	\$2130	+\$227	+\$341	+\$ 915	+\$1074	+\$1408	+\$1776	+\$2181	+\$ 915
	42"	66.5"	\$2343	+\$248	+\$372	+\$1001	+\$1175	+\$1541	+\$1943	+\$2386	+\$1001
	42"	72.5"	\$2577	+\$272	+\$408	+\$1095	+\$1286	+\$1686	+\$2126	+\$2611	+\$1095
	42"	78.5"	\$2783	+\$292	+\$439	+\$1178	+\$1383	+\$1814	+\$2288	+\$2809	+\$1178
	42"	84.5"	\$3006	+\$315	+\$472	+\$1268	+\$1489	+\$1952	+\$2462	+\$3023	+\$1268
	42"	90.5"	\$3247	+\$339	+\$508	+\$1365	+\$1602	+\$2101	+\$2650	+\$3254	+\$1365
	42"	96.5"	\$3506	+\$365	+\$547	+\$1469	+\$1725	+\$2262	+\$2853	+\$3503	+\$1469
	48"	60.5"	\$2340	+\$248	+\$372	+\$ 999	+\$1173	+\$1539	+\$1941	+\$2383	+\$ 999
	48"	66.5"	\$2574	+\$271	+\$407	+\$1094	+\$1284	+\$1684	+\$2124	+\$2608	+\$1094
	48"	72.5"	\$2831	+\$297	+\$446	+\$1197	+\$1406	+\$1844	+\$2325	+\$2855	+\$1197
	48"	78.5"	\$3058	+\$320	+\$480	+\$1289	+\$1513	+\$1984	+\$2502	+\$3072	+\$1289
	48"	84.5"	\$3303	+\$344	+\$516	+\$1387	+\$1629	+\$2136	+\$2694	+\$3307	+\$1387
	48"	90.5"	\$3567	+\$371	+\$556	+\$1494	+\$1754	+\$2300	+\$2901	+\$3561	+\$1494
	48"	96.5"	\$3852	+\$399	+\$599	+\$1609	+\$1889	+\$2477	+\$3124	+\$3835	+\$1609

► Specification Information, continued on next page

► Specification Information, continued from previous page

Specification Information

Style Number	Dimensions		U.S. Base Price	Options (Add \$ to Base Price)						Customiz Stain
	Modular Height	Parametric Width		High-Pressure Laminate		Composite Veneer		Wood		
				Price Group 2	Price Group 3	Price Group 1	Price Group 2	Price Group 1	Price Group 2	

Powered Panel—Inline Spanning

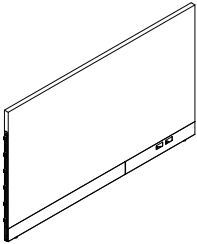

PNLISP	Modular Height	Parametric Width	U.S. Base Price	High-Pressure Laminate Price Group 2	High-Pressure Laminate Price Group 3	Composite Veneer Price Group 1	Composite Veneer Price Group 2	Wood Price Group 1	Wood Price Group 2	Wood Price Group 3	Customiz Stain
	42"	60.5"	\$2130	+\$227	+\$341	+\$ 915	+\$1074	+\$1408	+\$1776	+\$2181	+\$ 915
	42"	66.5"	\$2343	+\$248	+\$372	+\$1001	+\$1175	+\$1541	+\$1943	+\$2386	+\$1001
	42"	72.5"	\$2577	+\$272	+\$408	+\$1095	+\$1286	+\$1686	+\$2126	+\$2611	+\$1095
	42"	78.5"	\$2783	+\$292	+\$439	+\$1178	+\$1383	+\$1814	+\$2288	+\$2809	+\$1178
	42"	84.5"	\$3006	+\$315	+\$472	+\$1268	+\$1489	+\$1952	+\$2462	+\$3023	+\$1268
	42"	90.5"	\$3247	+\$339	+\$508	+\$1365	+\$1602	+\$2101	+\$2650	+\$3254	+\$1365
	42"	96.5"	\$3506	+\$365	+\$547	+\$1469	+\$1725	+\$2262	+\$2853	+\$3503	+\$1469
	48"	60.5"	\$2340	+\$248	+\$372	+\$ 999	+\$1173	+\$1539	+\$1941	+\$2383	+\$ 999
	48"	66.5"	\$2574	+\$271	+\$407	+\$1094	+\$1284	+\$1684	+\$2124	+\$2608	+\$1094
	48"	72.5"	\$2831	+\$297	+\$446	+\$1197	+\$1406	+\$1844	+\$2325	+\$2855	+\$1197
	48"	78.5"	\$3058	+\$320	+\$480	+\$1289	+\$1513	+\$1984	+\$2502	+\$3072	+\$1289
	48"	84.5"	\$3303	+\$344	+\$516	+\$1387	+\$1629	+\$2136	+\$2694	+\$3307	+\$1387
	48"	90.5"	\$3567	+\$371	+\$556	+\$1494	+\$1754	+\$2300	+\$2901	+\$3561	+\$1494
	48"	96.5"	\$3852	+\$399	+\$599	+\$1609	+\$1889	+\$2477	+\$3124	+\$3835	+\$1609

► Specification Information, continued on next page



For Canadian Pricing
Multiply U.S. Price by the Canadian price factor.
► See page 1 for details.

► **Specification Information, continued from previous page**

Specification Information

Style Number	Dimensions		U.S. Base Price	Options (Add \$ to Base Price)				Wood			Customiz Stain
	Modular Height	Parametric Width		High-Pressure Laminate	Composite Veneer	Wood	Price	Price	Price		
				Price	Price	Price	Price	Price	Price	Price	
				Group 2	Group 3	Group 1	Group 2	Group 1	Group 2	Group 3	

Powered Panel—Inline Miter

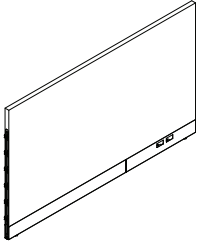

PNLIMP	Modular Height	Parametric Width	U.S. Base Price	High-Pressure Laminate	Composite Veneer	Wood	Price	Price	Price	Price	Price
	42"	60.5"	\$2130	+\$245	+\$368	+\$ 987	+\$1159	+\$1520	+\$1917	+\$2354	+\$ 987
	42"	66.5"	\$2343	+\$266	+\$399	+\$1073	+\$1260	+\$1652	+\$2084	+\$2559	+\$1073
	42"	72.5"	\$2577	+\$290	+\$435	+\$1168	+\$1371	+\$1798	+\$2267	+\$2784	+\$1168
	42"	78.5"	\$2783	+\$310	+\$466	+\$1251	+\$1468	+\$1926	+\$2429	+\$2982	+\$1251
	42"	84.5"	\$3006	+\$333	+\$499	+\$1340	+\$1574	+\$2064	+\$2603	+\$3196	+\$1340
	42"	90.5"	\$3247	+\$357	+\$535	+\$1437	+\$1688	+\$2213	+\$2791	+\$3427	+\$1437
	42"	96.5"	\$3506	+\$383	+\$574	+\$1542	+\$1810	+\$2374	+\$2994	+\$3676	+\$1542
	48"	60.5"	\$2340	+\$266	+\$399	+\$1072	+\$1259	+\$1650	+\$2081	+\$2556	+\$1072
	48"	66.5"	\$2574	+\$289	+\$434	+\$1166	+\$1369	+\$1796	+\$2265	+\$2780	+\$1166
	48"	72.5"	\$2831	+\$315	+\$473	+\$1270	+\$1491	+\$1955	+\$2466	+\$3028	+\$1270
	48"	78.5"	\$3058	+\$338	+\$507	+\$1361	+\$1598	+\$2096	+\$2643	+\$3245	+\$1361
	48"	84.5"	\$3303	+\$362	+\$543	+\$1460	+\$1714	+\$2248	+\$2835	+\$3480	+\$1460
	48"	90.5"	\$3567	+\$389	+\$583	+\$1566	+\$1839	+\$2412	+\$3041	+\$3734	+\$1566
	48"	96.5"	\$3852	+\$417	+\$626	+\$1681	+\$1974	+\$2589	+\$3265	+\$4008	+\$1681

► **Specification Information continued on next page**



For Canadian Pricing

Multiply U.S. Price by the Canadian price factor.

► See page 1 for details.

► Specification Information, continued from previous page

Specification Information

Style Number	Dimensions		U.S. Base Price	Options (Add \$ to Base Price)						Customiz Stain	
	Modular Height	Parametric Width		High-Pressure Laminate	Composite Veneer	Wood					
				Price Group 2	Price Group 3	Price Group 1	Price Group 2	Price Group 1	Price Group 2	Price Group 3	

Powered Panel—Inline T

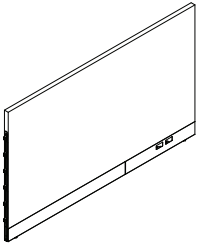

PNLITP	Modular Height	Parametric Width	U.S. Base Price	High-Pressure Laminate	Composite Veneer	Wood	Customiz Stain
	42"	60.5"	\$2130	+\$230	+\$345	+\$ 927	+\$ 927
	42"	66.5"	\$2343	+\$251	+\$377	+\$1013	+\$1013
	42"	72.5"	\$2577	+\$275	+\$412	+\$1107	+\$1107
	42"	78.5"	\$2783	+\$295	+\$443	+\$1190	+\$1190
	42"	84.5"	\$3006	+\$318	+\$476	+\$1280	+\$1280
	42"	90.5"	\$3247	+\$342	+\$512	+\$1377	+\$1377
	42"	96.5"	\$3506	+\$368	+\$551	+\$1482	+\$1482
	48"	60.5"	\$2340	+\$251	+\$377	+\$1012	+\$1012
	48"	66.5"	\$2574	+\$274	+\$412	+\$1106	+\$1106
	48"	72.5"	\$2831	+\$300	+\$450	+\$1210	+\$1210
	48"	78.5"	\$3058	+\$323	+\$484	+\$1301	+\$1301
	48"	84.5"	\$3303	+\$347	+\$521	+\$1399	+\$1399
	48"	90.5"	\$3567	+\$374	+\$561	+\$1506	+\$1506
	48"	96.5"	\$3852	+\$402	+\$603	+\$1621	+\$1621



For Canadian Pricing
 Multiply U.S. Price by the
 Canadian price factor.
 ► See page 1 for details.

Aisla Powered Panels—Miter

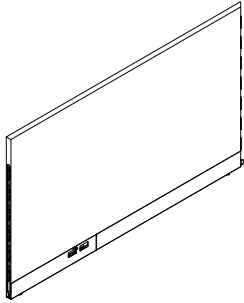

► Need help?
Product details,
page 30

Standard Includes

- Powered panel—miter: High-Pressure Laminate price group 1
- 1 mm top edge band
- 3 mm side edge band
- Transaction top, if selected: High-Pressure Laminate price group 1
- Transaction top edge, if selected: plastic
- Transaction top bracket, if selected: paint price group 1
- Glass insert, if selected: glass price group 1
- Trim: paint price group 1

Required to Specify

- 1 Style number
 - 2 Width (see below under Required Selections)
 - 3 Height (see below under Required Selections)
 - 4 Connection—end A (see below under Required Selections)
 - 5 Connection—end B (see below under Required Selections)
 - 6 High-Pressure Laminate color for panel
 - 7 Glass color number for glass insert, if selected
 - 8 High-Pressure Laminate color for transaction top, if selected
 - 9 Plastic color number for transaction top edge, if selected
 - 10 Paint color number for transaction top bracket, if selected
 - 11 Paint color number for trim
 - 12 Options, if selected (see below)
- See *Surface Materials*, page 164

	Required Selections	U.S. Price	Required to Specify
Width	<ul style="list-style-type: none"> • 60.5" • 66.5" • 72.5" • 78.5" • 84.5" • 90.5" • 96.5" 	<ul style="list-style-type: none"> Prices at right Prices at right Prices at right Prices at right Prices at right Prices at right Prices at right 	<ul style="list-style-type: none"> Specify width. Specify width. Specify width. Specify width. Specify width. Specify width. Specify width.
Height	<ul style="list-style-type: none"> • 42" • 48" 	<ul style="list-style-type: none"> Prices at right Prices at right 	<ul style="list-style-type: none"> Specify height. Specify height.
Connection	<p>End A</p> <ul style="list-style-type: none"> • Spanning • T • Mitered side 1 • Mitered side 2 <p>End B</p> <ul style="list-style-type: none"> • Spanning • T • Mitered side 1 • Mitered side 2 	<ul style="list-style-type: none"> +\$ 70 +\$100 +\$250 +\$250 +\$ 70 +\$100 +\$250 +\$250 	<ul style="list-style-type: none"> Specify with end A spanning. Specify with end A T. Specify with end A mitered side 1. Specify with end A mitered side 2. Specify with end B spanning. Specify with end B T. Specify with end B mitered side 1. Specify with end B mitered side 2.

	Options	U.S. Price	Required to Specify
Surface Materials	<p>Panel</p> <ul style="list-style-type: none"> • High-Pressure Laminate price group 1 • High-Pressure Laminate price group 2 • High-Pressure Laminate price group 3 • Open Line laminate (OLL) • Composite veneer group 1 • Composite veneer group 2 • Wood group 1 • Wood group 2 • Wood group 3 • Customiz stain <p>Integrated glass</p> <ul style="list-style-type: none"> • Glass price group 1 • Glass price group 3 • Glass price group 4 	<ul style="list-style-type: none"> No cost Prices at right Prices at right Prices at right +\$111 plus cost of laminate Prices at right Prices at right Prices at right Prices at right Prices at right Prices at right Prices at right Prices at right Prices at right Prices at right 	<ul style="list-style-type: none"> Specify laminate color number. Specify laminate color number. Specify laminate color number. ► See <i>Surface Materials Reference Manual</i>. Specify composite veneer color number. Specify composite veneer color number. Specify wood color number. Specify wood color number. Specify wood color number. Specify with customiz stain. Specify with 6500 Clear Glass. Specify with 6501 Low Iron Clear Glass. Specify with 6562 Bronze or 6563 Smoke Glass.



For Canadian Pricing
Multiply U.S. Price by the Canadian price factor.
► See page 1 for details.

► Options, continued on next page

► Options, continued from previous page

	Options	U.S. Price	Required to Specify
Surface Materials, continued	Transaction top		
	• High-Pressure Laminate price group 1	No cost	Specify laminate color number.
	• High-Pressure Laminate price group 2	Prices at right	Specify laminate color number.
	• High-Pressure Laminate price group 3	Prices at right	Specify laminate color number.
	• Open Line laminate (OLL)	+\$111 plus cost of laminate	► See <i>Surface Materials Reference Manual</i> .
	• Composite veneer group 1	Prices at right	Specify composite veneer color number.
	• Composite veneer group 2	Prices at right	Specify composite veneer color number.
	• Wood group 1	Prices at right	Specify wood color number.
	• Wood group 2	Prices at right	Specify wood color number.
	• Wood group 3	Prices at right	Specify wood color number.
	• Customiz stain	Prices at right	Specify with <i>customiz stain</i> .
	Transaction top edge		
	• Plastic	No cost	Specify plastic color number.
Transaction top bracket			
• Paint price group 1	Prices at right	Specify paint color number.	
• Paint price group 2	Prices at right	Specify paint color number.	
• Paint price group 3	Prices at right	Specify paint color number.	
Trim			
• Paint price group 1	No cost	Specify paint color number.	
• Paint price group 2	+\$200	Specify paint color number.	
• Paint price group 3	+\$250	Specify paint color number.	
Connection T	End A		
	• T adjacent side 1	No cost	Specify with <i>end A T adjacent side 1</i> .
	• T adjacent side 2	No cost	Specify with <i>end A T adjacent side 2</i> .
	End B		
• T adjacent side 1	No cost	Specify with <i>end B T adjacent side 1</i> .	
• T adjacent side 2	No cost	Specify with <i>end B T adjacent side 2</i> .	
Mitered Matchstick	End A		
	• No matchstick	No cost	Specify with <i>end A no matchstick</i> .
	• With matchstick	No cost	Specify with <i>end A matchstick</i> .
	End B		
• No matchstick	No cost	Specify with <i>end B no matchstick</i> .	
• With matchstick	No cost	Specify with <i>end B matchstick</i> .	
Accent Panel	• No panel	No cost	Specify with <i>no panel</i> .
	• Fabric panel side 1	No cost	Specify with <i>fabric panel side 1</i> .
	• Fabric panel side 2	No cost	Specify with <i>fabric panel side 2</i> .
	• Fabric panel side 1 and 2	No cost	Specify with <i>fabric panel side 1 and 2</i> .
	Top Accessory		
• No accessory	No cost	Specify with <i>no accessory</i> .	
• Integrated glass	Prices at right	Specify with <i>integrated glass</i> .	
• 10"D transaction top side 1	Prices at right	Specify with <i>10"D transaction top side 1</i> .	
• 10"D transaction top side 2	Prices at right	Specify with <i>10"D transaction top side 2</i> .	
• Transaction top bracket only side 1	Prices at right	Specify with <i>transaction top bracket only side 1</i> .	
• Transaction top bracket only side 2	Prices at right	Specify with <i>transaction top bracket only side 2</i> .	
Glass Height	• 10"	Prices at right	Specify glass height.
	• 12"	Prices at right	Specify glass height.
Grain Direction	Panel		
	• No grain direction	No cost	Specify with <i>no grain direction</i> .
	• Horizontal	No cost	Specify with <i>horizontal grain direction</i> .
	• Vertical	No cost	Specify with <i>vertical grain direction</i> .
	Transaction top		
• No grain direction	No cost	Specify with <i>no grain direction</i> .	
• Long grain	No cost	Specify with <i>long grain direction</i> .	
• Short grain	No cost	Specify with <i>short grain direction</i> .	

Tip: This option is only available when connection end A is T.

Tip: This option is only available when connection end B is T.

Tip: This option is only available when connection end A is mitered.

Tip: This option is only available when connection end B is mitered.

 **For Canadian Pricing**
Multiply U.S. Price by the Canadian price factor.
► See page 1 for details.

► Options, continued on next page

► Options, continued from previous page

	Options	U.S. Price	Required to Specify
Power Location	• Side 1, end A	+\$ 776	Specify with power side 1, end A.
	• Side 1, end B	+\$ 776	Specify with power side 1, end B.
	• Side 2, end A	+\$ 776	Specify with power side 2, end A.
	• Side 2, end B	+\$ 776	Specify with power side 2, end B.
	• Side 1 and 2, end A	+\$1970	Specify with power side 1 and 2, end A.
	• Side 1 and 2, end B	+\$1970	Specify with power side 1 and 2, end B.
Power Install	• Side 1	No cost	Specify with install side 1.
	• Side 2	No cost	Specify with install side 2.
Infeed	• No infeed	No cost	Specify with no infeed.
	• Infeed	No cost	Specify with infeed.
Panel Base	• Base trim	No cost	Specify with base trim.
	• Finish to floor	No cost	Specify with finish to floor.
Power	• Standard power	No cost	Specify with standard power.
	• Chicago power	No cost	Specify with Chicago power.
Related Products	• Aisla panels		► Page 48
	• Aisla cabinets		► Page 132
	• Aisla fabric-wrapped magnetic panel		► Page 130

Tip: Finish to floor option is not available if power location is side 1 and 2, end A or side 1 and 2, end B.

Tip: If finish to floor option is specified, only standard power is available.

Integrated Glass Option with Finish Upcharges

• Height— Modular	• Width— Modular	• Options (Add \$ to Base Price)		
		• Glass Price Group 1	• Glass Price Group 3	• Glass Price Group 4
10"	60.5"	+\$ 566	+\$259	+\$493
10"	66.5"	+\$ 637	+\$272	+\$527
10"	72.5"	+\$ 749	+\$286	+\$564
10"	78.5"	+\$ 860	+\$300	+\$604
10"	84.5"	+\$1040	+\$339	+\$646
10"	90.5"	+\$1220	+\$352	+\$691
10"	96.5"	+\$1364	+\$376	+\$740
12"	60.5"	+\$ 629	+\$285	+\$532
12"	66.5"	+\$ 708	+\$299	+\$570
12"	72.5"	+\$ 832	+\$315	+\$610
12"	78.5"	+\$ 956	+\$330	+\$652
12"	84.5"	+\$1155	+\$373	+\$698
12"	90.5"	+\$1355	+\$387	+\$747
12"	96.5"	+\$1515	+\$414	+\$799

► Options, continued on next page

Tip: Glass price group 3 or glass price group 4 upcharge is in addition to glass price group 1 cost.



For Canadian Pricing
Multiply U.S. Price by the Canadian price factor.
► See page 1 for details.

► Options, continued from previous page

10"D Transaction Top Option with Finish Upcharges

Depth— Modular	Width— Modular	Options (Add \$ to Base Price)								
		High-Pressure Laminate			Composite Veneer		Wood			Customiz Stain
		Price Group 1	Price Group 2	Price Group 3	Group 1	Group 2	Group 1	Group 2	Group 3	
10"	60.5"	+\$600	+\$ 90	+\$193	+\$313	+\$449	+\$ 974	+\$1210	+\$1482	
10"	66.5"	+\$638	+\$ 96	+\$206	+\$332	+\$478	+\$1036	+\$1287	+\$1576	+\$332
10"	72.5"	+\$679	+\$102	+\$219	+\$354	+\$509	+\$1102	+\$1370	+\$1677	+\$354
10"	78.5"	+\$720	+\$108	+\$232	+\$375	+\$539	+\$1169	+\$1452	+\$1777	+\$375
10"	84.5"	+\$763	+\$114	+\$246	+\$397	+\$571	+\$1239	+\$1539	+\$1884	+\$397
10"	90.5"	+\$809	+\$121	+\$261	+\$421	+\$606	+\$1313	+\$1631	+\$1997	+\$421
10"	96.5"	+\$857	+\$129	+\$276	+\$447	+\$642	+\$1392	+\$1729	+\$2117	+\$447

Tip: High-Pressure Laminate price groups 2 and 3, composite veneer, wood, and customiz stain upcharges are in addition to the High-Pressure price group 1 upcharge.

Transaction Top Bracket Option with Finish Upcharges

Depth— Modular	Width— Modular	Options (Add \$ to Base Price)		
		Paint Price Group 1	Paint Price Group 2	Paint Price Group 3
		10"	60.5"	+\$390
10"	66.5"	+\$421	+\$63	+\$ 73
10"	72.5"	+\$455	+\$68	+\$ 78
10"	78.5"	+\$491	+\$74	+\$ 85
10"	84.5"	+\$531	+\$80	+\$ 92
10"	90.5"	+\$573	+\$86	+\$ 99
10"	96.5"	+\$619	+\$93	+\$107

Tip: Paint price groups 2 and 3 upcharges are in addition to the paint price group 1 upcharge.

► Specification Information, on next page

 **For Canadian Pricing**
Multiply U.S. Price by the
Canadian price factor.
► See page 1 for details.

Aisla Powered Panels—Miter, continued

► Options, on previous page

Specification Information

Style Number	Dimensions		U.S. Base Price	Options (Add \$ to Base Price)				Wood			Customiz Stain
	Modular Height	Parametric Width		High-Pressure Laminate	Composite Veneer	Wood	Price	Price	Price		
				Price	Price	Price	Price	Price	Price	Price	
				Group 2	Group 3	Group 1	Group 2	Group 1	Group 2	Group 3	

Powered Panel—Miter Miter

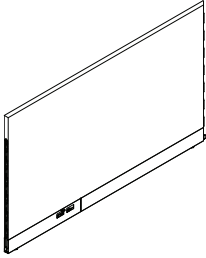

PNLMMP	Modular Height	Parametric Width	U.S. Base Price	High-Pressure Laminate	Composite Veneer	Wood	Price	Price	Price	Price	Price
	42"	60.5"	\$2130	+\$263	+\$395	+\$1060	+\$1244	+\$1632	+\$2058	+\$2527	+\$1060
	42"	66.5"	\$2343	+\$284	+\$426	+\$1146	+\$1345	+\$1764	+\$2225	+\$2731	+\$1146
	42"	72.5"	\$2577	+\$308	+\$462	+\$1240	+\$1456	+\$1909	+\$2408	+\$2957	+\$1240
	42"	78.5"	\$2783	+\$328	+\$493	+\$1323	+\$1554	+\$2037	+\$2569	+\$3155	+\$1323
	42"	84.5"	\$3006	+\$351	+\$526	+\$1413	+\$1659	+\$2175	+\$2744	+\$3369	+\$1413
	42"	90.5"	\$3247	+\$375	+\$562	+\$1510	+\$1773	+\$2325	+\$2932	+\$3600	+\$1510
	42"	96.5"	\$3506	+\$401	+\$601	+\$1615	+\$1896	+\$2486	+\$3135	+\$3849	+\$1615
	48"	60.5"	\$2340	+\$284	+\$426	+\$1145	+\$1344	+\$1762	+\$2222	+\$2729	+\$1145
	48"	66.5"	\$2574	+\$307	+\$461	+\$1239	+\$1454	+\$1907	+\$2405	+\$2953	+\$1239
	48"	72.5"	\$2831	+\$333	+\$500	+\$1343	+\$1576	+\$2067	+\$2607	+\$3201	+\$1343
	48"	78.5"	\$3058	+\$356	+\$534	+\$1434	+\$1683	+\$2208	+\$2784	+\$3418	+\$1434
	48"	84.5"	\$3303	+\$380	+\$570	+\$1532	+\$1799	+\$2359	+\$2976	+\$3653	+\$1532
	48"	90.5"	\$3567	+\$407	+\$610	+\$1639	+\$1924	+\$2523	+\$3182	+\$3907	+\$1639
	48"	96.5"	\$3852	+\$435	+\$653	+\$1754	+\$2059	+\$2700	+\$3406	+\$4181	+\$1754

► Specification Information, continued on next page



For Canadian Pricing

Multiply U.S. Price by the Canadian price factor.

► See page 1 for details.

► Specification Information, continued from previous page

Specification Information											
Style Number	Dimensions		U.S. Base Price	Options (Add \$ to Base Price)						Customiz Stain	
	Modular Height	Parametric Width		High-Pressure Laminate	Composite Veneer	Wood					
				Price Group 2	Price Group 3	Price Group 1	Price Group 2	Price Group 1	Price Group 2	Price Group 3	

Powered Panel—Miter Spanning

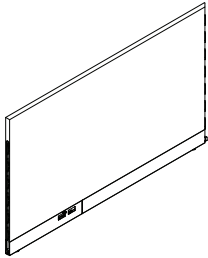

PNLMSP	Modular Height	Parametric Width	U.S. Base Price	High-Pressure Laminate	Composite Veneer	Wood	Wood	Wood	Wood	Wood	Customiz Stain
42"	60.5"		\$2130	+\$245	+\$368	+\$ 987	+\$1159	+\$1520	+\$1917	+\$2354	+\$ 987
42"	66.5"		\$2343	+\$266	+\$399	+\$1073	+\$1260	+\$1652	+\$2084	+\$2559	+\$1073
42"	72.5"		\$2577	+\$290	+\$435	+\$1168	+\$1371	+\$1798	+\$2267	+\$2784	+\$1168
42"	78.5"		\$2783	+\$310	+\$466	+\$1251	+\$1468	+\$1926	+\$2429	+\$2982	+\$1251
42"	84.5"		\$3006	+\$333	+\$499	+\$1340	+\$1574	+\$2064	+\$2603	+\$3196	+\$1340
42"	90.5"		\$3247	+\$357	+\$535	+\$1437	+\$1688	+\$2213	+\$2791	+\$3427	+\$1437
42"	96.5"		\$3506	+\$383	+\$574	+\$1542	+\$1810	+\$2374	+\$2994	+\$3676	+\$1542
48"	60.5"		\$2340	+\$266	+\$399	+\$1072	+\$1259	+\$1650	+\$2081	+\$2556	+\$1072
48"	66.5"		\$2574	+\$289	+\$434	+\$1166	+\$1369	+\$1796	+\$2265	+\$2780	+\$1166
48"	72.5"		\$2831	+\$315	+\$473	+\$1270	+\$1491	+\$1955	+\$2466	+\$3028	+\$1270
48"	78.5"		\$3058	+\$338	+\$507	+\$1361	+\$1598	+\$2096	+\$2643	+\$3245	+\$1361
48"	84.5"		\$3303	+\$362	+\$543	+\$1460	+\$1714	+\$2248	+\$2835	+\$3480	+\$1460
48"	90.5"		\$3567	+\$389	+\$583	+\$1566	+\$1839	+\$2412	+\$3041	+\$3734	+\$1566
48"	96.5"		\$3852	+\$417	+\$626	+\$1681	+\$1974	+\$2589	+\$3265	+\$4008	+\$1681

► Specification Information, continued on next page

 **For Canadian Pricing**
Multiply U.S. Price by the Canadian price factor.
► See page 1 for details.

► Specification Information, continued from previous page

Specification Information

Style Number	Dimensions		U.S. Base Price	Options (Add \$ to Base Price)						Customiz Stain	
	Modular Height	Parametric Width		High-Pressure Laminate	Composite Veneer	Wood					
				Price	Price	Price	Price	Price	Price	Price	
				Group 2	Group 3	Group 1	Group 2	Group 1	Group 2	Group 3	

Powered Panel—Miter T

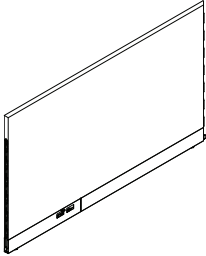

PNLMTP	Modular Height	Parametric Width	U.S. Base Price	High-Pressure Laminate	Composite Veneer	Wood	Customiz Stain			
42"	60.5"	\$2130	+\$248	+\$372	+\$ 999	+\$1173	+\$1539	+\$1941	+\$2383	+\$ 999
42"	66.5"	\$2343	+\$269	+\$404	+\$1085	+\$1274	+\$1671	+\$2107	+\$2587	+\$1085
42"	72.5"	\$2577	+\$293	+\$439	+\$1180	+\$1385	+\$1816	+\$2291	+\$2812	+\$1180
42"	78.5"	\$2783	+\$313	+\$470	+\$1263	+\$1483	+\$1944	+\$2452	+\$3011	+\$1263
42"	84.5"	\$3006	+\$336	+\$503	+\$1353	+\$1588	+\$2082	+\$2626	+\$3224	+\$1353
42"	90.5"	\$3247	+\$360	+\$539	+\$1449	+\$1702	+\$2232	+\$2814	+\$3456	+\$1449
42"	96.5"	\$3506	+\$386	+\$578	+\$1554	+\$1825	+\$2393	+\$3018	+\$3705	+\$1554
48"	60.5"	\$2340	+\$269	+\$404	+\$1084	+\$1273	+\$1669	+\$2105	+\$2584	+\$1084
48"	66.5"	\$2574	+\$292	+\$439	+\$1178	+\$1383	+\$1814	+\$2288	+\$2809	+\$1178
48"	72.5"	\$2831	+\$318	+\$477	+\$1282	+\$1505	+\$1974	+\$2489	+\$3057	+\$1282
48"	78.5"	\$3058	+\$341	+\$511	+\$1373	+\$1612	+\$2114	+\$2667	+\$3274	+\$1373
48"	84.5"	\$3303	+\$365	+\$548	+\$1472	+\$1728	+\$2266	+\$2858	+\$3509	+\$1472
48"	90.5"	\$3567	+\$392	+\$588	+\$1578	+\$1853	+\$2430	+\$3065	+\$3763	+\$1578
48"	96.5"	\$3852	+\$420	+\$630	+\$1693	+\$1988	+\$2607	+\$3288	+\$4037	+\$1693



For Canadian Pricing
 Multiply U.S. Price by the Canadian price factor.
 ► See page 1 for details.

Aisla Powered Panels—T

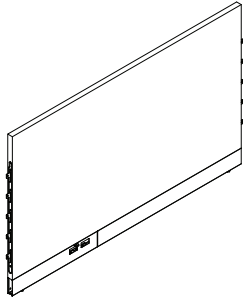

► Need help?
Product details,
page 30

Standard Includes

- Panel—T: High-Pressure Laminate price group 1
- 1 mm top edge band
- 3 mm side edge band
- Transaction top, if selected: High-Pressure Laminate price group 1
- Transaction top edge, if selected: plastic
- Transaction top bracket, if selected: paint price group 1
- Glass insert, if selected: glass price group 1
- Trim: paint price group 1

Required to Specify

- 1 Style number
 - 2 Width (see below under Required Selections)
 - 3 Height (see below under Required Selections)
 - 4 Connection—end A (see below under Required Selections)
 - 5 Connection—end B (see below under Required Selections)
 - 6 High-Pressure Laminate color for panel
 - 7 Glass color number for glass insert, if selected
 - 8 High-Pressure Laminate color for transaction top, if selected
 - 9 Plastic color number for transaction top edge, if selected
 - 10 Paint color number for transaction top bracket, if selected
 - 11 Options, if selected (see below)
 - 12 Paint color number for trim
- See *Surface Materials*, page 164

	Required Selections	U.S. Price	Required to Specify
Width	<ul style="list-style-type: none"> • 60.5" • 66.5" • 72.5" • 78.5" • 84.5" • 90.5" • 96.5" 	<ul style="list-style-type: none"> Prices at right Prices at right Prices at right Prices at right Prices at right Prices at right Prices at right 	<ul style="list-style-type: none"> Specify width. Specify width. Specify width. Specify width. Specify width. Specify width. Specify width.
Height	<ul style="list-style-type: none"> • 42" • 48" 	<ul style="list-style-type: none"> Prices at right Prices at right 	<ul style="list-style-type: none"> Specify height. Specify height.

Connection	End A		
	• T	+\$100	Specify <i>with end A T</i> .
	End B		
	• T	+\$100	Specify <i>with end B T</i> .

	Options	U.S. Price	Required to Specify	
Surface Materials	Panel			
	• High-Pressure Laminate price group 1	No cost	Specify laminate color number.	
	• High-Pressure Laminate price group 2	Prices at right	Specify laminate color number.	
	• High-Pressure Laminate price group 3	Prices at right	Specify laminate color number.	
	• Open Line laminate (OLL)	+\$111 plus cost of laminate	► See <i>Surface Materials Reference Manual</i> .	
	• Composite veneer group 1	Prices at right	Specify composite veneer color number.	
	• Composite veneer group 2	Prices at right	Specify composite veneer color number.	
	• Wood group 1	Prices at right	Specify wood color number.	
	• Wood group 2	Prices at right	Specify wood color number.	
	• Wood group 3	Prices at right	Specify wood color number.	
	• Customiz stain	Prices at right	Specify <i>with customiz stain</i> .	
		Integrated glass		
		• Glass price group 1	Prices at right	Specify <i>with 6500 Clear Glass</i> .
	• Glass price group 3	Prices at right	Specify <i>with 6501 Low Iron Clear Glass</i> .	
	• Glass price group 4	Prices at right	Specify <i>with 6562 Bronze or 6563 Smoke Glass</i> .	

► Options, continued on next page



For Canadian Pricing
Multiply U.S. Price by the Canadian price factor.
► See page 1 for details.

► Options, continued from previous page

	Options	U.S. Price	Required to Specify
Surface Materials, continued	Transaction top		
	• High-Pressure Laminate price group 1	No cost	Specify laminate color number.
	• High-Pressure Laminate price group 2	Prices at right	Specify laminate color number.
	• High-Pressure Laminate price group 3	Prices at right	Specify laminate color number.
	• Open Line laminate (OLL)	+\$111 plus cost of laminate	► See <i>Surface Materials Reference Manual</i> .
	• Composite veneer group 1	Prices at right	Specify composite veneer color number.
	• Composite veneer group 2	Prices at right	Specify composite veneer color number.
	• Wood group 1	Prices at right	Specify wood color number.
	• Wood group 2	Prices at right	Specify wood color number.
	• Wood group 3	Prices at right	Specify wood color number.
	• Customiz stain	Prices at right	Specify with <i>customiz stain</i> .
	Transaction top edge		
	• Plastic	No cost	Specify plastic color number.
Transaction top bracket			
• Paint price group 1	Prices at right	Specify paint color number.	
• Paint price group 2	Prices at right	Specify paint color number.	
• Paint price group 3	Prices at right	Specify paint color number.	
Trim			
• Paint price group 1	No cost	Specify paint color number.	
• Paint price group 2	+\$200	Specify paint color number.	
• Paint price group 3	+\$250	Specify paint color number.	
Connection T	End A		
	• T adjacent side 1	No cost	Specify with <i>end A T adjacent side 1</i> .
	• T adjacent side 2	No cost	Specify with <i>end A T adjacent side 2</i> .
	End B		
• T adjacent side 1	No cost	Specify with <i>end B T adjacent side 1</i> .	
• T adjacent side 2	No cost	Specify with <i>end B T adjacent side 2</i> .	
Accent Panel	• No panel	No cost	Specify with <i>no panel</i> .
	• Fabric panel side 1	No cost	Specify with <i>fabric panel side 1</i> .
	• Fabric panel side 2	No cost	Specify with <i>fabric panel side 2</i> .
	• Fabric panel side 1 and 2	No cost	Specify with <i>fabric panel side 1 and 2</i> .
Top Accessory	• No accessory	No cost	Specify with <i>no accessory</i> .
	• Integrated glass	Prices at right	Specify with <i>integrated glass</i> .
	• 10"D transaction top side 1	Prices at right	Specify with <i>10"D transaction top side 1</i> .
	• 10"D transaction top side 2	Prices at right	Specify with <i>10"D transaction top side 2</i> .
	• Transaction top bracket only side 1	Prices at right	Specify with <i>transaction top bracket only side 1</i> .
• Transaction top bracket only side 2	Prices at right	Specify with <i>transaction top bracket only side 2</i> .	
Glass Height	• 10"	Prices at right	Specify glass height.
	• 12"	Prices at right	Specify glass height.
Grain Direction	Panel		
	• No grain direction	No cost	Specify with <i>no grain direction</i> .
	• Horizontal	No cost	Specify with <i>horizontal grain direction</i> .
	• Vertical	No cost	Specify with <i>vertical grain direction</i> .
	Transaction top		
	• No grain direction	No cost	Specify with <i>no grain direction</i> .
• Long grain	No cost	Specify with <i>long grain direction</i> .	
• Short grain	No cost	Specify with <i>short grain direction</i> .	

► Options, continued on next page

**For Canadian Pricing**

Multiply U.S. Price by the Canadian price factor.

► See page 1 for details.

► Options, continued from previous page

	Options	U.S. Price	Required to Specify
Power Location	• Side 1, end A	+\$ 776	Specify with power side 1, end A.
	• Side 1, end B	+\$ 776	Specify with power side 1, end B.
	• Side 2, end A	+\$ 776	Specify with power side 2, end A.
	• Side 2, end B	+\$ 776	Specify with power side 2, end B.
	• Side 1 and 2, end A	+\$1970	Specify with power side 1 and 2, end A.
	• Side 1 and 2, end B	+\$1970	Specify with power side 1 and 2, end B.
Power Install	• Side 1	No cost	Specify with install side 1.
	• Side 2	No cost	Specify with install side 2.
Infeed	• No infeed	No cost	Specify with no infeed.
	• Infeed	No cost	Specify with infeed.
Panel Base	• Base trim	No cost	Specify with base trim.
	• Finish to floor	No cost	Specify with finish to floor.
Power	• Standard power	No cost	Specify with standard power.
	• Chicago power	No cost	Specify with Chicago power.
Related Products	• Aisla panels		► Page 48
	• Aisla cabinets		► Page 132
	• Aisla fabric-wrapped magnetic panel		► Page 130

Tip: Finish to floor option is not available if power location is side 1 and 2, end A or side 1 and 2, end B.

Tip: If finish to floor option is specified, only standard power is available.

Integrated Glass Option with Finish Upcharges

• Height— Modular	• Width— Modular	• Options (Add \$ to Base Price)		
		• Glass Price Group 1	• Glass Price Group 3	• Glass Price Group 4
10"	60.5"	+\$ 566	+\$259	+\$493
10"	66.5"	+\$ 637	+\$272	+\$527
10"	72.5"	+\$ 749	+\$286	+\$564
10"	78.5"	+\$ 860	+\$300	+\$604
10"	84.5"	+\$1040	+\$339	+\$646
10"	90.5"	+\$1220	+\$352	+\$691
10"	96.5"	+\$1364	+\$376	+\$740
12"	60.5"	+\$ 629	+\$285	+\$532
12"	66.5"	+\$ 708	+\$299	+\$570
12"	72.5"	+\$ 832	+\$315	+\$610
12"	78.5"	+\$ 956	+\$330	+\$652
12"	84.5"	+\$1155	+\$373	+\$698
12"	90.5"	+\$1355	+\$387	+\$747
12"	96.5"	+\$1515	+\$414	+\$799
:	:	:	:	:

► Options, continued on next page

Tip: Glass price group 3 or glass price group 4 upcharge is in addition to glass price group 1 cost.



For Canadian Pricing
Multiply U.S. Price by the Canadian price factor.
► See page 1 for details.

► Options, continued from previous page

10"D Transaction Top Option with Finish Upcharges

Depth— Modular	Width— Modular	Options (Add \$ to Base Price)								
		High-Pressure Laminate			Composite Veneer		Wood			Customiz Stain
		Price Group 1	Price Group 2	Price Group 3	Group 1	Group 2	Group 1	Group 2	Group 3	
10"	60.5"	+\$600	+\$ 90	+\$193	+\$313	+\$449	+\$ 974	+\$1210	+\$1482	+\$313
10"	66.5"	+\$638	+\$ 96	+\$206	+\$332	+\$478	+\$1036	+\$1287	+\$1576	+\$332
10"	72.5"	+\$679	+\$102	+\$219	+\$354	+\$509	+\$1102	+\$1370	+\$1677	+\$354
10"	78.5"	+\$720	+\$108	+\$232	+\$375	+\$539	+\$1169	+\$1452	+\$1777	+\$375
10"	84.5"	+\$763	+\$114	+\$246	+\$397	+\$571	+\$1239	+\$1539	+\$1884	+\$397
10"	90.5"	+\$809	+\$121	+\$261	+\$421	+\$606	+\$1313	+\$1631	+\$1997	+\$421
10"	96.5"	+\$857	+\$129	+\$276	+\$447	+\$642	+\$1392	+\$1729	+\$2117	+\$447

Tip: High-Pressure Laminate price groups 2 and 3, composite veneer, wood, and customiz stain upcharges are in addition to the High-Pressure price group 1 upcharge.

Transaction Top Bracket Option with Finish Upcharges

Depth— Modular	Width— Modular	Options (Add \$ to Base Price)		
		Paint Price Group 1	Paint Price Group 2	Paint Price Group 3
		10"	60.5"	+\$390
10"	66.5"	+\$421	+\$63	+\$ 73
10"	72.5"	+\$455	+\$68	+\$ 78
10"	78.5"	+\$491	+\$74	+\$ 85
10"	84.5"	+\$531	+\$80	+\$ 92
10"	90.5"	+\$573	+\$86	+\$ 99
10"	96.5"	+\$619	+\$93	+\$107

Tip: Paint price groups 2 and 3 upcharges are in addition to the paint price group 1 upcharge.

► Specification Information, on next page

 **For Canadian Pricing**
 Multiply U.S. Price by the
 Canadian price factor.
 ► See page 1 for details.

Aisla Powered Panels—T, continued

► Options, on previous page

Specification Information

Style Number	Dimensions		U.S. Base Price	Options (Add \$ to Base Price)				Wood			Customiz Stain
	Modular Height	Parametric Width		High-Pressure Laminate	Composite Veneer	Wood		Price	Price	Price	
				Price	Price	Price	Price	Price	Price	Price	
				Group 2	Group 3	Group 1	Group 2	Group 1	Group 2	Group 3	

Powered Panel—T T

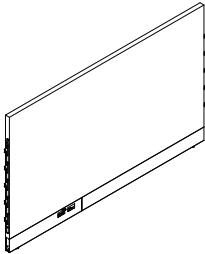

PNLTTP	Modular Height	Parametric Width	U.S. Base Price	High-Pressure Laminate	Composite Veneer	Wood	Wood	Wood	Wood	Wood	Customiz Stain
	42"	60.5"	\$2130	+\$233	+\$350	+\$ 939	+\$1102	+\$1446	+\$1823	+\$2239	+\$ 939
	42"	66.5"	\$2343	+\$254	+\$371	+\$1025	+\$1203	+\$1578	+\$1990	+\$2443	+\$1025
	42"	72.5"	\$2577	+\$278	+\$417	+\$1119	+\$1314	+\$1723	+\$2173	+\$2668	+\$1119
	42"	78.5"	\$2783	+\$298	+\$448	+\$1202	+\$1412	+\$1851	+\$2335	+\$2866	+\$1202
	42"	84.5"	\$3006	+\$321	+\$481	+\$1292	+\$1517	+\$1989	+\$2509	+\$3080	+\$1292
	42"	90.5"	\$3247	+\$345	+\$517	+\$1389	+\$1631	+\$2139	+\$2697	+\$3311	+\$1389
	42"	96.5"	\$3506	+\$371	+\$556	+\$1494	+\$1754	+\$2300	+\$2900	+\$3561	+\$1494
	48"	60.5"	\$2340	+\$254	+\$381	+\$1024	+\$1202	+\$1576	+\$1988	+\$2440	+\$1024
	48"	66.5"	\$2574	+\$277	+\$416	+\$1118	+\$1313	+\$1721	+\$2171	+\$2665	+\$1118
	48"	72.5"	\$2831	+\$303	+\$455	+\$1222	+\$1434	+\$1881	+\$2372	+\$2912	+\$1222
	48"	78.5"	\$3058	+\$326	+\$489	+\$1313	+\$1541	+\$2021	+\$2549	+\$3130	+\$1313
	48"	84.5"	\$3303	+\$350	+\$525	+\$1412	+\$1657	+\$2173	+\$2741	+\$3365	+\$1412
	48"	90.5"	\$3567	+\$377	+\$565	+\$1518	+\$1782	+\$2337	+\$2948	+\$3619	+\$1518
	48"	96.5"	\$3852	+\$405	+\$608	+\$1633	+\$1917	+\$2514	+\$3171	+\$3893	+\$1633



For Canadian Pricing

Multiply U.S. Price by the Canadian price factor.

► See page 1 for details.

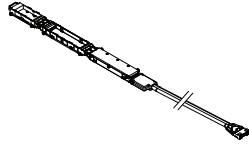

Standard Includes	Required to Specify
<ul style="list-style-type: none"> Power kit: black plastic only 	<ol style="list-style-type: none"> Style number Width – panel (see below under Required Selections) Panel base (see below under Required Selections) Wiring (see below under Required Selections) Options, if selected (see below)

Required Selections	U.S. Price	Required to Specify
Width – Panel <ul style="list-style-type: none"> 60.5" 66.5" 72.5" 78.5" 84.5" 90.5" 96.5" 	<ul style="list-style-type: none"> No cost No cost No cost No cost No cost No cost No cost 	<ul style="list-style-type: none"> Specify width. Specify width. Specify width. Specify width. Specify width. Specify width. Specify width.
Panel Base <ul style="list-style-type: none"> Base trim Finish to floor 	<ul style="list-style-type: none"> No cost No cost 	<ul style="list-style-type: none"> Specify <i>with base trim.</i> Specify <i>with finish to floor.</i>
Wiring <ul style="list-style-type: none"> 3+1 2+2 	<ul style="list-style-type: none"> No cost No cost 	<ul style="list-style-type: none"> Specify <i>with 3+1.</i> Specify <i>with 2+2.</i>

Options	U.S. Price	Required to Specify
Infeed <ul style="list-style-type: none"> No infeed Infeed 	<ul style="list-style-type: none"> No cost No cost 	<ul style="list-style-type: none"> Specify <i>with no infeed.</i> Specify <i>with infeed.</i>

Related Products • Aisla powered panels ▶ Page 88

Specification Information	
Style Number	U.S. Price
PWRKIT	\$194

For Canadian Pricing
 Multiply U.S. Price by the Canadian price factor.
 ▶ See page 1 for details.

Aisla Power Kit—No Whip

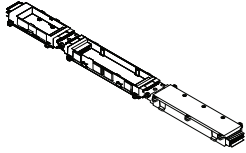

Standard Includes	Required to Specify
-------------------	---------------------

<ul style="list-style-type: none"> Power kit – no whip: black plastic only 	<ol style="list-style-type: none"> Style number Panel base (see below under Required Selections) Wiring (see below under Required Selections) Options, if selected (see below)
---	--

Panel Base	Required Selections	U.S. Price	Required to Specify
------------	---------------------	------------	---------------------

Panel Base	• Base trim	No cost	Specify <i>with base trim.</i>
	• Finish to floor	No cost	Specify <i>with finish to floor.</i>

Wiring	• 3+1	No cost	Specify <i>with 3+1.</i>
	• 2+2	No cost	Specify <i>with 2+2.</i>

Infeed	Options	U.S. Price	Required to Specify
--------	---------	------------	---------------------

Infeed	• No infeed	No cost	Specify <i>with no infeed.</i>
	• Infeed	No cost	Specify <i>with infeed.</i>

Related Products	• Aisla powered panels		▶ Page 88
-------------------------	------------------------	--	-----------

Specification Information

Style Number	U.S. Price
PWRKITNW	\$154



For Canadian Pricing

Multiply U.S. Price by the Canadian price factor.

▶ See page 1 for details.

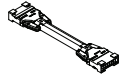

Tip: Jumper length is determined when planning in SmartTools.

Standard Includes	Required to Specify
-------------------	---------------------

<ul style="list-style-type: none"> Harness/jumper kit: black plastic only 	<ol style="list-style-type: none"> Style number Length (see below under Required Selections) Wiring (see below under Required Selections)
--	--

Length	Required Selections	U.S. Price	Required to Specify
--------	---------------------	------------	---------------------

Length	• 11"	Price below	Specify length.
	• 12"	Price below	Specify length.
	• 18"	Price below	Specify length.
	• 19"	Price below	Specify length.
	• 31"	Price below	Specify length.
	• 33"	Price below	Specify length.
	• 38"	Price below	Specify length.
	• 40"	Price below	Specify length.

Wiring	• 3+1	No cost	Specify with 3+1.
	• 2+2	No cost	Specify with 2+2.

Related Products	• Aisla powered panels	▶ Page 88
-------------------------	------------------------	-----------

Specification Information

Style Number	Dimension Length	U.S. Price
HJKIT	11"	\$219
	12"	\$227
	18"	\$227
	19"	\$227
	31"	\$227
	33"	\$227
	38"	\$227
	40"	\$260

Aisla Powered Panels

For Canadian Pricing
 Multiply U.S. Price by the Canadian price factor.
 ▶ See page 1 for details.

Aisla Base Power Infeeds

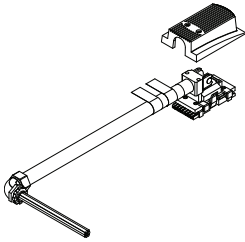

Standard Includes	Required to Specify
-------------------	---------------------

- Base power infeed: black plastic only

- 1 Style number
- 2 Length (see below under Required Selections)
- 3 Power (see below under Required Selections)
- 4 Wiring (see below under Required Selections)

	Required Selections	U.S. Price	Required to Specify
--	---------------------	------------	---------------------

Length	<ul style="list-style-type: none"> • 72" • 144" 	Price below Price below	Specify length. Specify length.
Power	<ul style="list-style-type: none"> • Standard • New York • San Francisco 	No cost No cost No cost	Specify <i>with standard power</i> . Specify <i>with New York power</i> . Specify <i>with San Francisco power</i> .
Wiring	<ul style="list-style-type: none"> • 3+1 • 2+2 	No cost No cost	Specify <i>with 3+1</i> . Specify <i>with 2+2</i> .
Related Products	<ul style="list-style-type: none"> • Aisla powered panels 		▶ Page 88

Specification Information		
Style Number	Dimensions Length	U.S. Price

BSPWERINFD	72"	\$399
	144"	\$426



For Canadian Pricing
Multiply U.S. Price by the Canadian price factor.
▶ See page 1 for details.

Aisla Duplex Receptacles Finish to Floor (A Height)

Aisla Duplex Receptacles
Finish to Floor (A Height)

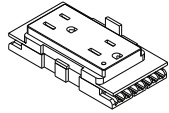

Aisla Powered Panels

Standard Includes	Required to Specify
<ul style="list-style-type: none"> Duplex receptacles finish to floor (A height): 6000 Black 	<ol style="list-style-type: none"> Style number Wiring (see below under Required Selections) Line number (see below under Required Selections) Ground type (see below under Required Selections) Options, if selected (see below)

	Required Selections	U.S. Price	Required to Specify
Wiring	<ul style="list-style-type: none"> 3+1 2+2 	No cost No cost	Specify with 3+1. Specify with 2+2.
Line Number	<ul style="list-style-type: none"> Line 1 Line 2 Line 3 Line 4 	No cost No cost No cost No cost	Specify with line 1. Specify with line 2. Specify with line 3. Specify with line 4.
Ground Type	<ul style="list-style-type: none"> System Isolated 	No cost +\$8	Specify with system ground. Specify with isolated ground.

	Options	U.S. Price	Required to Specify
Controlled Stamp	<ul style="list-style-type: none"> No stamp With controlled stamp 	No cost No cost	Specify with no stamp. Specify with controlled stamp.
Related Products	<ul style="list-style-type: none"> Aisla powered panels 		▶ Page 88

Specification Information	
Style Number	U.S. Base Price
DPLXA	\$65
.	.

For Canadian Pricing
Multiply U.S. Price by the Canadian price factor.
▶ See page 1 for details.

Aisla Duplex Receptacles (C Height)

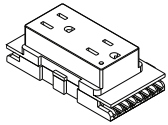

Standard Includes	Required to Specify
-------------------	---------------------

- Duplex receptacles (C height): plastic

- 1 Style number
 - 2 Wiring (see below under Required Selections)
 - 3 Line number (see below under Required Selections)
 - 4 Ground type (see below under Required Selections)
 - 5 Plastic color number for receptacle
 - 6 Options, if selected (see below)
- ▶ See Surface Materials, page 164

	Required Selections	U.S. Price	Required to Specify
Wiring	<ul style="list-style-type: none"> • 3+1 • 2+2 	<p>No cost</p> <p>No cost</p>	<p>Specify <i>with 3+1.</i></p> <p>Specify <i>with 2+2.</i></p>
Line Number	<ul style="list-style-type: none"> • Line 1 • Line 2 • Line 3 • Line 4 	<p>No cost</p> <p>No cost</p> <p>No cost</p> <p>No cost</p>	<p>Specify <i>with line 1.</i></p> <p>Specify <i>with line 2.</i></p> <p>Specify <i>with line 3.</i></p> <p>Specify <i>with line 4.</i></p>
Ground Type	<ul style="list-style-type: none"> • System • Isolated 	<p>No cost</p> <p>+\$8</p>	<p>Specify <i>with system ground.</i></p> <p>Specify <i>with isolated ground.</i></p>

	Options	U.S. Price	Required to Specify
Controlled Stamp	<ul style="list-style-type: none"> • No stamp • With controlled stamp 	<p>No cost</p> <p>No cost</p>	<p>Specify <i>with no stamp.</i></p> <p>Specify <i>with controlled stamp.</i></p>
Related Products	<ul style="list-style-type: none"> • Aisla powered panels 		▶ Page 88

Specification Information

Style Number	U.S. Base Price
DPLXC	\$65



For Canadian Pricing
 Multiply U.S. Price by the Canadian price factor.
 ▶ See page 1 for details.

Aisla Fabric-Wrapped Magnetic Panel

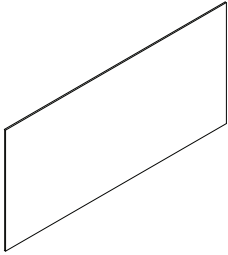

Tip: Parametric width and height are available in 1/16" increments.

Standard Includes		Required to Specify	
<ul style="list-style-type: none"> ▶ Need help? Product details, page 36 	<ul style="list-style-type: none"> • Fabric-wrapped magnetic panel: fabric price group 1 • Thickness: 1/4" 	<ol style="list-style-type: none"> 1 Style number 2 Width (see below under Required Selections) 3 Height (see below under Required Selections) 4 Fabric color number for panel 5 Options, if selected (see below) 	<ul style="list-style-type: none"> ▶ See <i>Surface Materials</i>, page 164

	Required Selections	U.S. Price	Required to Specify
Width	• 17.625" – 96.125"	Prices at right	Specify width.
Height	• 12.875" – 25.1875"	Prices at right	Specify height.

	Options	U.S. Price	Required to Specify
Surface Materials	Panel <ul style="list-style-type: none"> • Fabric price group 1 • Fabric price group 2 • Fabric price group 3 • Fabric price group 4 • Fabric price group 5 • Fabric price group 6 • Fabric price group 7 • Fabric price group 8 • Fabric price group 9 • Fabric price group 10 • Customer's Own Material (COM) 	No cost Prices at right Prices at right Prices at right Prices at right Prices at right Prices at right Prices at right Prices at right Prices at right Prices at right +\$24	Specify fabric color number. Specify fabric color number. Specify fabric color number. Specify fabric color number. Specify fabric color number. Specify fabric color number. Specify fabric color number. Specify fabric color number. Specify fabric color number. Specify fabric color number. Specify fabric color number. Specify fabric color number. ▶ See <i>Surface Materials Reference Manual</i> .
Fabric Direction	<ul style="list-style-type: none"> • Horizontal • Vertical 	No cost No cost	Specify <i>with horizontal application</i> . Specify <i>with vertical application</i> .
Related Products	<ul style="list-style-type: none"> • Aisla panels • Aisla powered panels 		<ul style="list-style-type: none"> ▶ Page 48 ▶ Page 88



For Canadian Pricing
 Multiply U.S. Price by the Canadian price factor.
 ▶ See page 1 for details.

Specification Information

Style Number	Dimensions Parametric Height	Parametric Width	U.S. Base Price	Options (Add \$ to Base Price)									
				Fabric Price Group 2	Fabric Price Group 3	Fabric Price Group 4	Fabric Price Group 5	Fabric Price Group 6	Fabric Price Group 7	Fabric Price Group 8	Fabric Price Group 9	Fabric Price Group 10	

Aisla Fabric-Wrapped Magnetic Panel

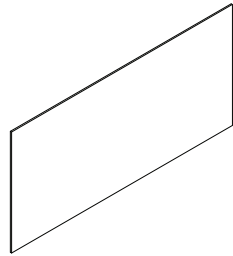

Aisla Magnetic Panel

FWMPNL	12.875"-25.1875"	17.625"-23.9375"	\$ 118	+\$15	+\$29	+\$36	+\$ 41	+\$ 49	+\$ 55	+\$ 63	+\$ 71	+\$ 85
	12.875"-25.1875"	24"-29.9375"	\$ 142	+\$16	+\$31	+\$39	+\$ 44	+\$ 53	+\$ 59	+\$ 68	+\$ 77	+\$ 92
	12.875"-25.1875"	30"-35.9375"	\$ 171	+\$17	+\$34	+\$42	+\$ 48	+\$ 57	+\$ 64	+\$ 73	+\$ 83	+\$ 99
	12.875"-25.1875"	36"-41.9375"	\$ 206	+\$19	+\$37	+\$45	+\$ 52	+\$ 62	+\$ 69	+\$ 79	+\$ 89	+\$107
	12.875"-25.1875"	42"-47.9375"	\$ 249	+\$20	+\$39	+\$49	+\$ 56	+\$ 67	+\$ 75	+\$ 86	+\$ 97	+\$116
	12.875"-25.1875"	48"-53.9375"	\$ 300	+\$22	+\$43	+\$53	+\$ 60	+\$ 72	+\$ 81	+\$ 93	+\$104	+\$125
	12.875"-25.1875"	54"-59.9375"	\$ 361	+\$24	+\$46	+\$57	+\$ 65	+\$ 78	+\$ 87	+\$100	+\$113	+\$135
	12.875"-25.1875"	60"-65.9375"	\$ 435	+\$26	+\$50	+\$62	+\$ 70	+\$ 84	+\$ 94	+\$108	+\$122	+\$146
	12.875"-25.1875"	66"-71.9375"	\$ 511	+\$28	+\$54	+\$67	+\$ 76	+\$ 91	+\$102	+\$117	+\$131	+\$157
	12.875"-25.1875"	72"-77.9375"	\$ 587	+\$30	+\$58	+\$72	+\$ 82	+\$ 98	+\$110	+\$126	+\$142	+\$170
	12.875"-25.1875"	78"-83.9375"	\$ 690	+\$32	+\$63	+\$78	+\$ 89	+\$106	+\$119	+\$136	+\$153	+\$184
	12.875"-25.1875"	84"-89.9375"	\$ 793	+\$35	+\$68	+\$84	+\$ 96	+\$114	+\$128	+\$147	+\$166	+\$198
	12.875"-25.1875"	90"-95.9375"	\$1070	+\$38	+\$73	+\$91	+\$103	+\$123	+\$138	+\$159	+\$179	+\$214
	12.875"-25.1875"	96"-96.125"	\$1241	+\$41	+\$79	+\$98	+\$112	+\$133	+\$150	+\$171	+\$193	+\$231

 **For Canadian Pricing**
Multiply U.S. Price by the
Canadian price factor.
▶ See page 1 for details.

► Options, continued from previous page

	Options	U.S. Price	Required to Specify	
Surface Materials, continued	Headset			
	• High-Pressure Laminate price group 1	No cost	Specify laminate color number.	
	• High-Pressure Laminate price group 2	Prices at right	Specify laminate color number.	
	• High-Pressure Laminate price group 3	Prices at right	Specify laminate color number.	
	• Open Line laminate (OLL)	+\$111 plus cost of laminate	► See <i>Surface Materials Reference Manual</i> .	
	• Composite veneer group 1	Prices at right	Specify composite veneer color number.	
	• Composite veneer group 2	Prices at right	Specify composite veneer color number.	
	• Wood group 1	Prices at right	Specify wood color number.	
	• Wood group 2	Prices at right	Specify wood color number.	
	• Wood group 3	Prices at right	Specify wood color number.	
	• Customiz stain	Prices at right	Specify <i>with customiz stain</i> .	
		Pulls		
		• Paint price group 1	No cost	Specify paint color number.
	• Paint price group 2	No cost	Specify paint color number.	
	• Paint price group 3	No cost	Specify paint color number.	
Interior Configuration	• One coat hook	No cost	Specify <i>with one coat hook</i> .	
	• Two coat hooks	No cost	Specify <i>with two coat hooks</i> .	
	• One coat hook, organizer	+\$159	Specify <i>with one coat hook, organizer</i> .	
	• One coat hook, fixed shelf	No cost	Specify <i>with one coat hook, fixed shelf</i> .	
	• Two coat hooks, fixed shelf	No cost	Specify <i>with two coat hooks, fixed shelf</i> .	
	• Coat rod	No cost	Specify <i>with coat rod</i> .	
Mirror	• No mirror	No cost	Specify <i>with no mirror</i> .	
	• Mirror	+\$115	Specify <i>with mirror</i> .	
Lock	• No lock	No cost	Specify <i>with no lock</i> .	
	• With lock	No cost	Specify <i>with lock</i> .	
Key	• Key random	No cost	Specify <i>with key random</i> .	
	• Key plug	No cost	Specify <i>with key plug</i> .	
	• Master key random	+\$ 39	Specify <i>with master key random</i> .	
	• Master key plug	+\$ 39	Specify <i>with master key plug</i> .	
Pull	• Touch latch pull	No cost	Specify <i>with touch latch pull</i> .	
	• Contemporary pull	No cost	Specify <i>with contemporary pull</i> .	
	• Ledge pull	No cost	Specify <i>with ledge pull</i> .	
	• Nile pull	+\$ 39	Specify <i>with nile pull</i> .	
	• Beam pull	+\$ 60	Specify <i>with beam pull</i> .	
	• Align pull	+\$ 65	Specify <i>with align pull</i> .	
Grain Direction	Top			
	• No grain direction	No cost	Specify <i>with no grain direction</i> .	
	• Long grain	No cost	Specify <i>with long grain direction</i> .	
	• Short grain	No cost	Specify <i>with short grain direction</i> .	
		Case		
	• No grain direction	No cost	Specify <i>with no grain direction</i> .	
	• Horizontal	No cost	Specify <i>with horizontal grain direction</i> .	
	• Vertical	No cost	Specify <i>with vertical grain direction</i> .	
		Headset		
	• No grain direction	No cost	Specify <i>with no grain direction</i> .	
• Horizontal	No cost	Specify <i>with horizontal grain direction</i> .		
• Vertical	No cost	Specify <i>with vertical grain direction</i> .		
Related Products	• Aisla panels		► Page 48	
	• Aisla powered panels		► Page 88	
	• Aisla fabric-wrapped magnetic panel		► Page 130	

Tip: Coat rod is only available when depth is 30".



For Canadian Pricing
Multiply U.S. Price by the Canadian price factor.
► See page 1 for details.

► Options, continued on next page

► Options, continued from previous page

Case Finish Upcharges

Depth— Modular	Height— Modular	Width— Modular	Options (Add \$ to Base Price)								
			High-Pressure Laminate			Composite Veneer		Wood			Customiz Stain
			Price Group 1	Price Group 2	Price Group 3	Group 1	Group 2	Group 1	Group 2	Group 3	
18"	42"	12"	+\$ 935	+\$1029	+\$1131	+\$1380	+\$1449	+\$1594	+\$1754	+\$1929	+\$1380
18"	42"	18"	+\$1075	+\$1183	+\$1301	+\$1587	+\$1667	+\$1833	+\$2017	+\$2218	+\$1587
18"	48"	12"	+\$1237	+\$1360	+\$1496	+\$1825	+\$1917	+\$2108	+\$2319	+\$2551	+\$1825
18"	48"	18"	+\$1422	+\$1564	+\$1721	+\$2099	+\$2204	+\$2425	+\$2667	+\$2934	+\$2099
30"	42"	12"	+\$1066	+\$1172	+\$1290	+\$1573	+\$1652	+\$1817	+\$1999	+\$2199	+\$1573
30"	42"	18"	+\$1215	+\$1337	+\$1470	+\$1794	+\$1883	+\$2072	+\$2279	+\$2507	+\$1794
30"	48"	12"	+\$1385	+\$1524	+\$1676	+\$2045	+\$2147	+\$2362	+\$2598	+\$2858	+\$2045
30"	48"	18"	+\$1579	+\$1737	+\$1911	+\$2331	+\$2448	+\$2693	+\$2962	+\$3258	+\$2331

Headset Finish Upcharges

Depth— Modular	Height— Modular	Width— Modular	Options (Add \$ to Base Price)								
			High-Pressure Laminate			Composite Veneer		Wood			Customiz Stain
			Price Group 1	Price Group 2	Price Group 3	Group 1	Group 2	Group 1	Group 2	Group 3	
18"	42"	12"	+\$ 935	+\$1029	+\$1131	+\$1380	+\$1449	+\$1594	+\$1754	+\$1929	+\$1380
18"	42"	18"	+\$1075	+\$1183	+\$1301	+\$1587	+\$1667	+\$1833	+\$2017	+\$2218	+\$1587
18"	48"	12"	+\$1237	+\$1360	+\$1496	+\$1825	+\$1917	+\$2108	+\$2319	+\$2551	+\$1825
18"	48"	18"	+\$1422	+\$1564	+\$1721	+\$2099	+\$2204	+\$2425	+\$2667	+\$2934	+\$2099
30"	42"	12"	+\$1066	+\$1172	+\$1290	+\$1573	+\$1652	+\$1817	+\$1999	+\$2199	+\$1573
30"	42"	18"	+\$1215	+\$1337	+\$1470	+\$1794	+\$1883	+\$2072	+\$2279	+\$2507	+\$1794
30"	48"	12"	+\$1385	+\$1524	+\$1676	+\$2045	+\$2147	+\$2362	+\$2598	+\$2858	+\$2045
30"	48"	18"	+\$1579	+\$1737	+\$1911	+\$2331	+\$2448	+\$2693	+\$2962	+\$3258	+\$2331



For Canadian Pricing

Multiply U.S. Price by the Canadian price factor.

► See page 1 for details.

Specification Information

Style Number	Dimensions			U.S. Base Prices									Customiz Stain
	Modular Depth	Modular Height	Modular Width	High-Pressure Laminate			Composite Veneer		Wood				
				Price Group 1	Price Group 2	Price Group 3	Price Group 1	Price Group 2	Price Group 1	Price Group 2	Price Group 3		

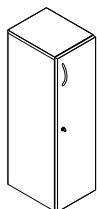

Cabinet — Hinged Right

WPCBRH	Modular Depth	Modular Height	Modular Width	Price Group 1	Price Group 2	Price Group 3	Price Group 1	Price Group 2	Price Group 1	Price Group 2	Price Group 3	Price Group 3
	18"	42"	12"	\$ 935	\$1029	\$1131	\$1380	\$1449	\$1594	\$1754	\$1929	\$1380
	18"	42"	18"	\$1075	\$1183	\$1301	\$1587	\$1667	\$1833	\$2017	\$2218	\$1587
	18"	48"	12"	\$1237	\$1360	\$1496	\$1825	\$1917	\$2108	\$2319	\$2551	\$1825
	18"	48"	18"	\$1422	\$1564	\$1721	\$2099	\$2204	\$2425	\$2667	\$2934	\$2099
	30"	42"	12"	\$1066	\$1172	\$1290	\$1573	\$1652	\$1817	\$1999	\$2199	\$1573
	30"	42"	18"	\$1215	\$1337	\$1470	\$1794	\$1883	\$2072	\$2279	\$2507	\$1794
	30"	48"	12"	\$1385	\$1524	\$1676	\$2045	\$2147	\$2362	\$2598	\$2858	\$2045
	30"	48"	18"	\$1579	\$1737	\$1911	\$2331	\$2448	\$2693	\$2962	\$3258	\$2331

Aisla Cabinets

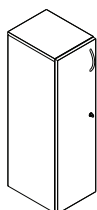

Cabinet — Hinged Left

WPCBLH	Modular Depth	Modular Height	Modular Width	Price Group 1	Price Group 2	Price Group 3	Price Group 1	Price Group 2	Price Group 1	Price Group 2	Price Group 3	Price Group 3
	18"	42"	12"	\$ 935	\$1029	\$1131	\$1380	\$1449	\$1594	\$1754	\$1929	\$1380
	18"	42"	18"	\$1075	\$1183	\$1301	\$1587	\$1667	\$1833	\$2017	\$2218	\$1587
	18"	48"	12"	\$1237	\$1360	\$1496	\$1825	\$1917	\$2108	\$2319	\$2551	\$1825
	18"	48"	18"	\$1422	\$1564	\$1721	\$2099	\$2204	\$2425	\$2667	\$2934	\$2099
	30"	42"	12"	\$1066	\$1172	\$1290	\$1573	\$1652	\$1817	\$1999	\$2199	\$1573
	30"	42"	18"	\$1215	\$1337	\$1470	\$1794	\$1883	\$2072	\$2279	\$2507	\$1794
	30"	48"	12"	\$1385	\$1524	\$1676	\$2045	\$2147	\$2362	\$2598	\$2858	\$2045
	30"	48"	18"	\$1579	\$1737	\$1911	\$2331	\$2448	\$2693	\$2962	\$3258	\$2331



For Canadian Pricing
 Multiply U.S. Price by the Canadian price factor.
 ▶ See page 1 for details.

Aisla HIU Credenzas—Parallel

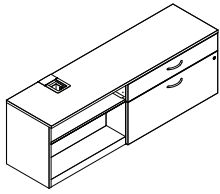

► Need help?
Product details,
page 42

Standard Includes

- HIU credenza—parallel:
 - Top: High-Pressure Laminate price group 1
 - Case: High-Pressure Laminate price group 1
 - Headset: High-Pressure Laminate price group 1
- Wood shelf, if selected: High-Pressure Laminate price group 1
- Metal shelf, if selected: paint price group 1
- Top edge, if laminate top is specified: plastic price group 1

Required to Specify

- 1 Style number
- 2 Width (see below under Required Selections)
- 3 Width - left storage (see below under Required Selections)
- 4 Width - right storage (see below under Required Selections)
- 5 Desk application (see below under Required Selections)
- 6 Top detail (see below under Required Selections)
- 7 High-Pressure Laminate color for top
- 8 High-Pressure Laminate color for case
- 9 High-Pressure Laminate color for headset
- 10 Plastic color number for edge
- 11 High-Pressure Laminate color number for wood shelf, if selected
- 12 Paint color number for metal shelf, if selected
- 13 Paint color number for pull
- 14 Paint color number for grommet
- 15 Options, if selected (see below)
 - See *Surface Materials*, page 164

	Required Selections	U.S. Price	Required to Specify
Width	<ul style="list-style-type: none"> • 54" • 54.5" • 60" • 60.5" • 66" • 66.5" • 72" • 72.5" • 78" • 78.5" • 84" • 84.5" • 90" • 90.5" • 96" • 96.5" 	<ul style="list-style-type: none"> Prices at right Prices at right Prices at right Prices at right Prices at right Prices at right Prices at right Prices at right Prices at right Prices at right Prices at right Prices at right Prices at right Prices at right Prices at right Prices at right 	<ul style="list-style-type: none"> Specify width. Specify width. Specify width. Specify width. Specify width. Specify width. Specify width. Specify width. Specify width. Specify width. Specify width. Specify width. Specify width. Specify width. Specify width.
Width—Left Storage	<ul style="list-style-type: none"> • 24" • 30" • 36" • 42" 	<ul style="list-style-type: none"> No cost No cost No cost No cost 	<ul style="list-style-type: none"> Specify width. Specify width. Specify width. Specify width.
Width—Right Storage	<ul style="list-style-type: none"> • 24" • 30" • 36" • 42" 	<ul style="list-style-type: none"> No cost No cost No cost No cost 	<ul style="list-style-type: none"> Specify width. Specify width. Specify width. Specify width.
Desk Application	<ul style="list-style-type: none"> • Migration Pro • Slim Leg HAD 	<ul style="list-style-type: none"> No cost No cost 	<ul style="list-style-type: none"> Specify with <i>Migration Pro</i>. Specify with <i>Slim Leg HAD</i>.
Top Detail	<ul style="list-style-type: none"> • Top over front • Front over top 	<ul style="list-style-type: none"> No cost No cost 	<ul style="list-style-type: none"> Specify with <i>top over front</i>. Specify with <i>front over top</i>.

Tip: Option only available for HIU credenzas that have two box/file storage units.



For Canadian Pricing

Multiply U.S. Price by the Canadian price factor.

► See page 1 for details.

	Options	U.S. Price	Required to Specify
Surface Materials	Top		
	• High-Pressure Laminate price group 1	No cost	Specify laminate color number.
	• High-Pressure Laminate price group 2	Prices at right	Specify laminate color number.
	• High-Pressure Laminate price group 3	Prices at right	Specify laminate color number.
	• Open Line laminate (OLL)	+\$111 plus cost of laminate	Specify laminate color number. ▶ See <i>Surface Materials Reference Manual</i> .
	• Composite veneer group 1	Prices at right	Specify composite veneer color number.
	• Composite veneer group 2	Prices at right	Specify composite veneer color number.
	• Wood group 1	Prices at right	Specify wood color number.
	• Wood group 2	Prices at right	Specify wood color number.
	• Wood group 3	Prices at right	Specify wood color number.
	• Customiz stain	Prices at right	Specify with <i>Customiz stain</i> .
	Case		
	• High-Pressure Laminate price group 1	No cost	Specify laminate color number.
	• High-Pressure Laminate price group 2	Prices at right	Specify laminate color number.
	• High-Pressure Laminate price group 3	Prices at right	Specify laminate color number.
• Open Line laminate (OLL)	+\$111 plus cost of laminate	Specify laminate color number. ▶ See <i>Surface Materials Reference Manual</i> .	
• Composite veneer group 1	Prices at right	Specify composite veneer color number.	
• Composite veneer group 2	Prices at right	Specify composite veneer color number.	
• Wood group 1	Prices at right	Specify wood color number.	
• Wood group 2	Prices at right	Specify wood color number.	
• Wood group 3	Prices at right	Specify wood color number.	
• Customiz stain	Prices at right	Specify with <i>Customiz stain</i> .	
Headset			
• High-Pressure Laminate price group 1	No cost	Specify laminate color number.	
• High-Pressure Laminate price group 2	Prices at right	Specify laminate color number.	
• High-Pressure Laminate price group 3	Prices at right	Specify laminate color number.	
• Open Line laminate (OLL)	+\$111 plus cost of laminate	Specify laminate color number. ▶ See <i>Surface Materials Reference Manual</i> .	
• Composite veneer group 1	Prices at right	Specify composite veneer color number.	
• Composite veneer group 2	Prices at right	Specify composite veneer color number.	
• Wood group 1	Prices at right	Specify wood color number.	
• Wood group 2	Prices at right	Specify wood color number.	
• Wood group 3	Prices at right	Specify wood color number.	
• Customiz stain	Prices at right	Specify with <i>Customiz stain</i> .	
Wood shelf			
• High-Pressure Laminate price group 1	No cost	Specify laminate color number.	
• High-Pressure Laminate price group 2	+\$ 25	Specify laminate color number.	
• High-Pressure Laminate price group 3	+\$ 29	Specify laminate color number.	
• Open Line laminate (OLL)	No cost	Specify laminate color number. ▶ See <i>Surface Materials Reference Manual</i> .	
• Composite veneer group 1	+\$ 35	Specify composite veneer color number.	
• Composite veneer group 2	+\$ 37	Specify composite veneer color number.	
• Wood group 1	+\$ 41	Specify wood color number.	
• Wood group 2	+\$ 45	Specify wood color number.	
• Wood group 3	+\$ 49	Specify wood color number.	
• Customiz stain	+\$ 35	Specify with <i>Customiz stain</i> .	

▶ Options, continued on next page



For Canadian Pricing
Multiply U.S. Price by the Canadian price factor.
▶ See page 1 for details.

► Options, continued from previous page

	Options	U.S. Price	Required to Specify
Surface Materials, continued	Metal shelf		
	• Paint price group 1	No cost	Specify paint color number.
	• Paint price group 2	+\$ 30	Specify paint color number.
	• Paint price group 3	+\$ 35	Specify paint color number.
	• Anodized aluminum	+\$ 40	Specify with 8043 Clear Anodized Aluminum.
	• Polished chrome	+\$ 46	Specify with 9201 Polished Chrome.
	• Nickel	+\$ 60	Specify with 9211 Nickel.
	• Silver	+\$ 60	Specify with 9212 Silver.
	Pull		
	• Paint price group 1	No cost	Specify paint color number.
	• Paint price group 2	No cost	Specify paint color number.
	• Paint price group 3	No cost	Specify paint color number.
	• Anodized aluminum	No cost	Specify with 8043 Clear Anodized Aluminum.
	• Polished chrome	No cost	Specify with 9201 Polished Chrome.
	• Nickel	No cost	Specify with 9211 Nickel.
• Silver	No cost	Specify with 9212 Silver.	
Grommet			
• Paint price group 1	No cost	Specify paint color number.	
• Paint price group 2	No cost	Specify paint color number.	
• Paint price group 3	No cost	Specify paint color number.	
Lock			
• 9201 Polished Chrome	No cost	Specify with 9201 Polished Chrome.	
• 9250 Ember Chrome	No cost	Specify with 9250 Ember Chrome.	
Grain Direction	Top		
	• No grain direction	No cost	Specify with no grain direction.
	• Long grain	No cost	Specify with long grain direction.
	• Short grain	No cost	Specify with short grain direction.
	Case		
	• No grain direction	No cost	Specify with no grain direction.
	• Horizontal	No cost	Specify with horizontal grain direction.
	• Vertical	No cost	Specify with vertical grain direction.
	Headset		
• No grain direction	No cost	Specify with no grain direction.	
• Horizontal	No cost	Specify with horizontal grain direction.	
• Vertical	No cost	Specify with vertical grain direction.	
Back Panel	• No back panel	No cost	Specify with no back panel.
	• With back panel	No cost	Specify with back panel.
Adjustable Shelf	• No HIU shelf	No cost	Specify with no HIU shelf.
	• Wood HIU shelf	No cost	Specify with wood HIU shelf.
	• Metal HIU shelf	No cost	Specify with metal HIU shelf.
Liner	• No drawer liner	No cost	Specify with no drawer liner.
	• With drawer liner	+\$ 35	Specify with drawer liner.
Tray	• No tray	No cost	Specify with no tray.
	• Pencil tray	+\$ 79	Specify with pencil tray.
	• Paper tray	+\$ 99	Specify with paper tray.
	• Paper and pencil tray	+\$178	Specify with paper and pencil tray.
	Lock		
• No lock	No cost	Specify with no lock.	
• With lock	No cost	Specify with lock.	

Tip: Pull finish availability varies depending on pull type. See surface materials section for more details.

Tip: Drawer liner upcharge listed is per box/file storage unit.

► Options, continued on next page



For Canadian Pricing
Multiply U.S. Price by the Canadian price factor.
► See page 1 for details.

► Options, continued from previous page

	Options	U.S. Price	Required to Specify
Key	• Key random	No cost	Specify with <i>key random</i> .
	• Key plug	No cost	Specify with <i>key plug</i> .
	• Master key random	+\$39	Specify with <i>master key random</i> .
	• Master key plug	+\$39	Specify with <i>master key plug</i> .
Pull	• Contemporary pull	No cost	Specify with <i>contemporary pull</i> .
	• Ledge pull	No cost	Specify with <i>ledge pull</i> .
	• Nile pull	+\$39	Specify with <i>nile pull</i> .
	• Beam pull	+\$60	Specify with <i>beam pull</i> .
	• Align pull	+\$65	Specify with <i>align pull</i> .
Related Products	• Aisla panels		► Page 48
	• Aisla powered panels		► Page 88
	• Aisla fabric wrapped magnetic panel		► Page 130
	• Aisla cabinets		► Page 132

► Specification Information, on next page



For Canadian Pricing
Multiply U.S. Price by the
Canadian price factor.
► See page 1 for details.

Aisla HIU Credenzas—Parallel, continued

► Options, on previous page

Specification Information

•Style Number	•Dimensions		•U.S. Base Price	•Finish Upcharges	•High-Pressure Laminate			•Composite Veneer		•Wood			•Customiz Stain
	D	W			•Price Group 1	•Price Group 2	•Price Group 3	•Price Group 1	•Price Group 2	•Price Group 1	•Price Group 2	•Price Group 3	

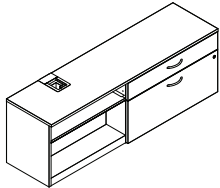

1.5-High Parallel Credenza—HIU, One Box Drawer, and One File Drawer—Right Hand

WPCD15HIUBFPL	18"	54"	\$5835	Top	No cost	+\$ 97	+\$199	+\$307	+\$419	+\$537	+\$662	+\$792	+\$307
				Case	No cost	+\$ 97	+\$199	+\$307	+\$419	+\$537	+\$662	+\$792	+\$307
				Headset	No cost	+\$ 97	+\$199	+\$307	+\$419	+\$537	+\$662	+\$792	+\$307
	18"	54.5"	\$5835	Top	No cost	+\$ 97	+\$199	+\$307	+\$419	+\$537	+\$662	+\$792	+\$307
				Case	No cost	+\$ 97	+\$199	+\$307	+\$419	+\$537	+\$662	+\$792	+\$307
				Headset	No cost	+\$ 97	+\$199	+\$307	+\$419	+\$537	+\$662	+\$792	+\$307
	18"	60"	\$6185	Top	No cost	+\$103	+\$211	+\$325	+\$444	+\$570	+\$701	+\$839	+\$325
				Case	No cost	+\$103	+\$211	+\$325	+\$444	+\$570	+\$701	+\$839	+\$325
				Headset	No cost	+\$103	+\$211	+\$325	+\$444	+\$570	+\$701	+\$839	+\$325
	18"	60.5"	\$6185	Top	No cost	+\$103	+\$211	+\$325	+\$444	+\$570	+\$701	+\$839	+\$325
				Case	No cost	+\$103	+\$211	+\$325	+\$444	+\$570	+\$701	+\$839	+\$325
				Headset	No cost	+\$103	+\$211	+\$325	+\$444	+\$570	+\$701	+\$839	+\$325
	18"	66"	\$6557	Top	No cost	+\$109	+\$224	+\$344	+\$471	+\$604	+\$743	+\$890	+\$344
				Case	No cost	+\$109	+\$224	+\$344	+\$471	+\$604	+\$743	+\$890	+\$344
				Headset	No cost	+\$109	+\$224	+\$344	+\$471	+\$604	+\$743	+\$890	+\$344
	18"	66.5"	\$6557	Top	No cost	+\$109	+\$224	+\$344	+\$471	+\$604	+\$743	+\$890	+\$344
				Case	No cost	+\$109	+\$224	+\$344	+\$471	+\$604	+\$743	+\$890	+\$344
				Headset	No cost	+\$109	+\$224	+\$344	+\$471	+\$604	+\$743	+\$890	+\$344
	18"	72"	\$6950	Top	No cost	+\$116	+\$237	+\$365	+\$499	+\$640	+\$788	+\$943	+\$365
				Case	No cost	+\$116	+\$237	+\$365	+\$499	+\$640	+\$788	+\$943	+\$365
				Headset	No cost	+\$116	+\$237	+\$365	+\$499	+\$640	+\$788	+\$943	+\$365
	18"	72.5"	\$6950	Top	No cost	+\$116	+\$237	+\$365	+\$499	+\$640	+\$788	+\$943	+\$365
				Case	No cost	+\$116	+\$237	+\$365	+\$499	+\$640	+\$788	+\$943	+\$365
				Headset	No cost	+\$116	+\$237	+\$365	+\$499	+\$640	+\$788	+\$943	+\$365



For Canadian Pricing

Multiply U.S. Price by the Canadian price factor.

► See page 1 for details.

Specification Information

Style Number	Dimensions		U.S. Base Price	Finish Upcharges	High-Pressure Laminate			Composite Veneer		Wood			Customiz Stain
	D	W			Price Group 1	Price Group 2	Price Group 3	Price Group 1	Price Group 2	Price Group 1	Price Group 2	Price Group 3	

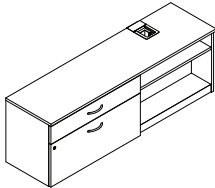

1.5-High Parallel HIU Credenza—One Box Drawer, One File Drawer, and HIU—Left Hand

WPCD15BFHIUPL	18"	54"	\$5835	Top	No cost	+\$ 97	+\$199	+\$307	+\$419	+\$537	+\$662	+\$792	+\$307
				Case	No cost	+\$ 97	+\$199	+\$307	+\$419	+\$537	+\$662	+\$792	+\$307
				Headset	No cost	+\$ 97	+\$199	+\$307	+\$419	+\$537	+\$662	+\$792	+\$307
	18"	54.5"	\$5835	Top	No cost	+\$ 97	+\$199	+\$307	+\$419	+\$537	+\$662	+\$792	+\$307
				Case	No cost	+\$ 97	+\$199	+\$307	+\$419	+\$537	+\$662	+\$792	+\$307
				Headset	No cost	+\$ 97	+\$199	+\$307	+\$419	+\$537	+\$662	+\$792	+\$307
	18"	60"	\$6185	Top	No cost	+\$103	+\$211	+\$325	+\$444	+\$570	+\$701	+\$839	+\$325
				Case	No cost	+\$103	+\$211	+\$325	+\$444	+\$570	+\$701	+\$839	+\$325
				Headset	No cost	+\$103	+\$211	+\$325	+\$444	+\$570	+\$701	+\$839	+\$325
	18"	60.5"	\$6185	Top	No cost	+\$103	+\$211	+\$325	+\$444	+\$570	+\$701	+\$839	+\$325
				Case	No cost	+\$103	+\$211	+\$325	+\$444	+\$570	+\$701	+\$839	+\$325
				Headset	No cost	+\$103	+\$211	+\$325	+\$444	+\$570	+\$701	+\$839	+\$325
	18"	66"	\$6557	Top	No cost	+\$109	+\$224	+\$344	+\$471	+\$604	+\$743	+\$890	+\$344
				Case	No cost	+\$109	+\$224	+\$344	+\$471	+\$604	+\$743	+\$890	+\$344
				Headset	No cost	+\$109	+\$224	+\$344	+\$471	+\$604	+\$743	+\$890	+\$344
	18"	66.5"	\$6557	Top	No cost	+\$109	+\$224	+\$344	+\$471	+\$604	+\$743	+\$890	+\$344
				Case	No cost	+\$109	+\$224	+\$344	+\$471	+\$604	+\$743	+\$890	+\$344
				Headset	No cost	+\$109	+\$224	+\$344	+\$471	+\$604	+\$743	+\$890	+\$344
	18"	72"	\$6950	Top	No cost	+\$116	+\$237	+\$365	+\$499	+\$640	+\$788	+\$943	+\$365
				Case	No cost	+\$116	+\$237	+\$365	+\$499	+\$640	+\$788	+\$943	+\$365
				Headset	No cost	+\$116	+\$237	+\$365	+\$499	+\$640	+\$788	+\$943	+\$365
	18"	72.5"	\$6950	Top	No cost	+\$116	+\$237	+\$365	+\$499	+\$640	+\$788	+\$943	+\$365
				Case	No cost	+\$116	+\$237	+\$365	+\$499	+\$640	+\$788	+\$943	+\$365
				Headset	No cost	+\$116	+\$237	+\$365	+\$499	+\$640	+\$788	+\$943	+\$365

► Specification Information, continued on next page



For Canadian Pricing
Multiply U.S. Price by the Canadian price factor.
► See page 1 for details.

► **Specification Information, continued from previous page**

Specification Information

•Style Number	•Dimensions		•U.S. Base Price	•Finish Upcharges	•High-Pressure Laminate			•Composite Veneer		•Wood			•Customiz Stain
	D	W			•Price Group 1	•Price Group 2	•Price Group 3	•Price Group 1	•Price Group 2	•Price Group 1	•Price Group 2	•Price Group 3	

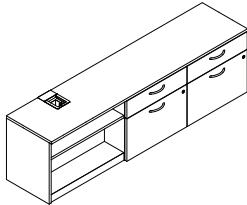

1.5-High Parallel Credenza—HIU, Two Box Drawers, and Two File Drawers—Right Hand

WPCD15HIUBFBFPL	18"	78"	\$ 9125	Top	No cost	+\$152	+\$312	+\$479	+\$655	+\$ 840	+\$1034	+\$1238	+\$479
				Case	No cost	+\$152	+\$312	+\$479	+\$655	+\$ 840	+\$1034	+\$1238	+\$479
				Headset	No cost	+\$152	+\$312	+\$479	+\$655	+\$ 840	+\$1034	+\$1238	+\$479
	18"	78.5"	\$ 9125	Top	No cost	+\$152	+\$312	+\$479	+\$655	+\$ 840	+\$1034	+\$1238	+\$479
				Case	No cost	+\$152	+\$312	+\$479	+\$655	+\$ 840	+\$1034	+\$1238	+\$479
				Headset	No cost	+\$152	+\$312	+\$479	+\$655	+\$ 840	+\$1034	+\$1238	+\$479
	18"	84"	\$ 9854	Top	No cost	+\$164	+\$337	+\$518	+\$708	+\$ 908	+\$1117	+\$1337	+\$518
				Case	No cost	+\$164	+\$337	+\$518	+\$708	+\$ 908	+\$1117	+\$1337	+\$518
				Headset	No cost	+\$164	+\$337	+\$518	+\$708	+\$ 908	+\$1117	+\$1337	+\$518
	18"	84.5"	\$ 9854	Top	No cost	+\$164	+\$337	+\$518	+\$708	+\$ 908	+\$1117	+\$1337	+\$518
				Case	No cost	+\$164	+\$337	+\$518	+\$708	+\$ 908	+\$1117	+\$1337	+\$518
				Headset	No cost	+\$164	+\$337	+\$518	+\$708	+\$ 908	+\$1117	+\$1337	+\$518
	18"	90"	\$10,643	Top	No cost	+\$177	+\$364	+\$559	+\$765	+\$ 980	+\$1207	+\$1444	+\$559
				Case	No cost	+\$177	+\$364	+\$559	+\$765	+\$ 980	+\$1207	+\$1444	+\$559
				Headset	No cost	+\$177	+\$364	+\$559	+\$765	+\$ 980	+\$1207	+\$1444	+\$559
	18"	90.5"	\$10,643	Top	No cost	+\$177	+\$364	+\$559	+\$765	+\$ 980	+\$1207	+\$1444	+\$559
				Case	No cost	+\$177	+\$364	+\$559	+\$765	+\$ 980	+\$1207	+\$1444	+\$559
				Headset	No cost	+\$177	+\$364	+\$559	+\$765	+\$ 980	+\$1207	+\$1444	+\$559
	18"	96"	\$11,494	Top	No cost	+\$192	+\$393	+\$604	+\$826	+\$1059	+\$1303	+\$1560	+\$604
				Case	No cost	+\$192	+\$393	+\$604	+\$826	+\$1059	+\$1303	+\$1560	+\$604
				Headset	No cost	+\$192	+\$393	+\$604	+\$826	+\$1059	+\$1303	+\$1560	+\$604
	18"	96.5"	\$11,494	Top	No cost	+\$192	+\$393	+\$604	+\$826	+\$1059	+\$1303	+\$1560	+\$604
				Case	No cost	+\$192	+\$393	+\$604	+\$826	+\$1059	+\$1303	+\$1560	+\$604
				Headset	No cost	+\$192	+\$393	+\$604	+\$826	+\$1059	+\$1303	+\$1560	+\$604



For Canadian Pricing

Multiply U.S. Price by the Canadian price factor.

► See page 1 for details.

Specification Information

Style Number	Dimensions D W		U.S. Base Price	Finish Upcharges	High-Pressure Laminate			Composite Veneer		Wood			Customiz Stain
					Price Group 1	Price Group 2	Price Group 3	Price Group 1	Price Group 2	Price Group 1	Price Group 2	Price Group 3	

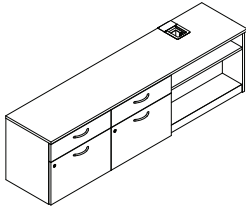

1.5-High Parallel HIU Credenza—Two Box Drawers, Two File Drawers, and HIU—Left Hand

WPCD15BFBHIUPL	18"	78"	\$ 9125	Top	No cost	+\$152	+\$312	+\$479	+\$655	+\$840	+\$1034	+\$1238	+\$479
				Case	No cost	+\$152	+\$312	+\$479	+\$655	+\$840	+\$1034	+\$1238	+\$479
				Headset	No cost	+\$152	+\$312	+\$479	+\$655	+\$840	+\$1034	+\$1238	+\$479
	18"	78.5"	\$ 9125	Top	No cost	+\$152	+\$312	+\$479	+\$655	+\$840	+\$1034	+\$1238	+\$479
				Case	No cost	+\$152	+\$312	+\$479	+\$655	+\$840	+\$1034	+\$1238	+\$479
				Headset	No cost	+\$152	+\$312	+\$479	+\$655	+\$840	+\$1034	+\$1238	+\$479
	18"	84"	\$ 9854	Top	No cost	+\$164	+\$337	+\$518	+\$708	+\$908	+\$1117	+\$1337	+\$518
				Case	No cost	+\$164	+\$337	+\$518	+\$708	+\$908	+\$1117	+\$1337	+\$518
				Headset	No cost	+\$164	+\$337	+\$518	+\$708	+\$908	+\$1117	+\$1337	+\$518
	18"	84.5"	\$ 9854	Top	No cost	+\$164	+\$337	+\$518	+\$708	+\$908	+\$1117	+\$1337	+\$518
				Case	No cost	+\$164	+\$337	+\$518	+\$708	+\$908	+\$1117	+\$1337	+\$518
				Headset	No cost	+\$164	+\$337	+\$518	+\$708	+\$908	+\$1117	+\$1337	+\$518
	18"	90"	\$10,643	Top	No cost	+\$177	+\$364	+\$559	+\$765	+\$980	+\$1207	+\$1444	+\$559
				Case	No cost	+\$177	+\$364	+\$559	+\$765	+\$980	+\$1207	+\$1444	+\$559
				Headset	No cost	+\$177	+\$364	+\$559	+\$765	+\$980	+\$1207	+\$1444	+\$559
	18"	90.5"	\$10,643	Top	No cost	+\$177	+\$364	+\$559	+\$765	+\$980	+\$1207	+\$1444	+\$559
				Case	No cost	+\$177	+\$364	+\$559	+\$765	+\$980	+\$1207	+\$1444	+\$559
				Headset	No cost	+\$177	+\$364	+\$559	+\$765	+\$980	+\$1207	+\$1444	+\$559
	18"	96"	\$11,494	Top	No cost	+\$192	+\$393	+\$604	+\$826	+\$1059	+\$1303	+\$1560	+\$604
				Case	No cost	+\$192	+\$393	+\$604	+\$826	+\$1059	+\$1303	+\$1560	+\$604
				Headset	No cost	+\$192	+\$393	+\$604	+\$826	+\$1059	+\$1303	+\$1560	+\$604
	18"	96.5"	\$11,494	Top	No cost	+\$192	+\$393	+\$604	+\$826	+\$1059	+\$1303	+\$1560	+\$604
				Case	No cost	+\$192	+\$393	+\$604	+\$826	+\$1059	+\$1303	+\$1560	+\$604
				Headset	No cost	+\$192	+\$393	+\$604	+\$826	+\$1059	+\$1303	+\$1560	+\$604

Aisla HIU Credenzas

 **For Canadian Pricing**
Multiply U.S. Price by the Canadian price factor.
▶ See page 1 for details.

Aisla HIU Credenzas—Perpendicular

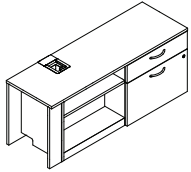

► Need help?
Product details,
page 42

Standard Includes

- HIU credenza—perpendicular:
 - Top: High-Pressure Laminate price group 1
 - Case: High-Pressure Laminate price group 1
 - Headset: High-Pressure Laminate price group 1
- Wood shelf, if selected: High-Pressure Laminate price group 1
- Metal shelf, if selected: paint price group 1
- Top edge, if laminate top is specified: plastic price group 1

Required to Specify

- 1 Style number
- 2 Width (see below under Required Selections)
- 3 Width - left storage (see below under Required Selections)
- 4 Width - right storage (see below under Required Selections)
- 5 Desk application (see below under Required Selections)
- 6 Top detail (see below under Required Selections)
- 7 High-Pressure Laminate color for top
- 8 High-Pressure Laminate color for case
- 9 High-Pressure Laminate color for headset
- 10 Plastic color number for edge
- 11 High-Pressure Laminate color number for wood shelf, if selected
- 12 Paint color number for metal shelf, if selected
- 13 Paint color number for pull
- 14 Paint color number for grommet
- 15 Options, if selected (see below)
 - See *Surface Materials*, page 164

	Required Selections	U.S. Price	Required to Specify
Width	<ul style="list-style-type: none"> • 54" • 54.5" • 60" • 60.5" • 66" • 66.5" • 72" • 72.5" • 78" • 78.5" • 84" • 84.5" • 90" • 90.5" • 96" • 96.5" 	<ul style="list-style-type: none"> Prices at right Prices at right Prices at right Prices at right Prices at right Prices at right Prices at right Prices at right Prices at right Prices at right Prices at right Prices at right Prices at right Prices at right Prices at right Prices at right 	<ul style="list-style-type: none"> Specify width. Specify width. Specify width. Specify width. Specify width. Specify width. Specify width. Specify width. Specify width. Specify width. Specify width. Specify width. Specify width. Specify width. Specify width.
Width—Left Storage	<ul style="list-style-type: none"> • 24" • 30" • 36" • 42" 	<ul style="list-style-type: none"> No cost No cost No cost No cost 	<ul style="list-style-type: none"> Specify width. Specify width. Specify width. Specify width.
Width—Right Storage	<ul style="list-style-type: none"> • 24" • 30" • 36" • 42" 	<ul style="list-style-type: none"> No cost No cost No cost No cost 	<ul style="list-style-type: none"> Specify width. Specify width. Specify width. Specify width.
Desk Application	<ul style="list-style-type: none"> • Migration Pro • Slim Leg HAD 	<ul style="list-style-type: none"> No cost No cost 	<ul style="list-style-type: none"> Specify with <i>Migration Pro</i>. Specify with <i>Slim Leg HAD</i>.
Top Detail	<ul style="list-style-type: none"> • Top over front • Front over top 	<ul style="list-style-type: none"> No cost No cost 	<ul style="list-style-type: none"> Specify with <i>top over front</i>. Specify with <i>front over top</i>.

Tip: Option only available for HIU credenzas that have two box/file storage units.



For Canadian Pricing
Multiply U.S. Price by the Canadian price factor.
► See page 1 for details.

	Options	U.S. Price	Required to Specify
Surface Materials	Top		
	• High-Pressure Laminate price group 1	No cost	Specify laminate color number.
	• High-Pressure Laminate price group 2	Prices at right	Specify laminate color number.
	• High-Pressure Laminate price group 3	Prices at right	Specify laminate color number.
	• Open Line laminate (OLL)	+\$111 plus cost of laminate	Specify laminate color number. ▶ See <i>Surface Materials Reference Manual</i> .
	• Composite veneer group 1	Prices at right	Specify composite veneer color number.
	• Composite veneer group 2	Prices at right	Specify composite veneer color number.
	• Wood group 1	Prices at right	Specify wood color number.
	• Wood group 2	Prices at right	Specify wood color number.
	• Wood group 3	Prices at right	Specify wood color number.
	• Customiz stain	Prices at right	Specify with <i>Customiz stain</i> .
	Case		
	• High-Pressure Laminate price group 1	No cost	Specify laminate color number.
	• High-Pressure Laminate price group 2	Prices at right	Specify laminate color number.
	• High-Pressure Laminate price group 3	Prices at right	Specify laminate color number.
	• Open Line laminate (OLL)	+\$111 plus cost of laminate	Specify laminate color number. ▶ See <i>Surface Materials Reference Manual</i> .
	• Composite veneer group 1	Prices at right	Specify composite veneer color number.
	• Composite veneer group 2	Prices at right	Specify composite veneer color number.
	• Wood group 1	Prices at right	Specify wood color number.
	• Wood group 2	Prices at right	Specify wood color number.
	• Wood group 3	Prices at right	Specify wood color number.
	• Customiz stain	Prices at right	Specify with <i>Customiz stain</i> .
	Headset		
	• High-Pressure Laminate price group 1	No cost	Specify laminate color number.
	• High-Pressure Laminate price group 2	Prices at right	Specify laminate color number.
	• High-Pressure Laminate price group 3	Prices at right	Specify laminate color number.
	• Open Line laminate (OLL)	+\$111 plus cost of laminate	Specify laminate color number. ▶ See <i>Surface Materials Reference Manual</i> .
	• Composite veneer group 1	Prices at right	Specify composite veneer color number.
	• Composite veneer group 2	Prices at right	Specify composite veneer color number.
	• Wood group 1	Prices at right	Specify wood color number.
	• Wood group 2	Prices at right	Specify wood color number.
	• Wood group 3	Prices at right	Specify wood color number.
	• Customiz stain	Prices at right	Specify with <i>Customiz stain</i> .
	Wood shelf		
	• High-Pressure Laminate price group 1	No cost	Specify laminate color number.
	• High-Pressure Laminate price group 2	+\$ 25	Specify laminate color number.
	• High-Pressure Laminate price group 3	+\$ 29	Specify laminate color number.
• Open Line laminate (OLL)	No cost	Specify laminate color number. ▶ See <i>Surface Materials Reference Manual</i> .	
• Composite veneer group 1	+\$ 35	Specify composite veneer color number.	
• Composite veneer group 2	+\$ 37	Specify composite veneer color number.	
• Wood group 1	+\$ 41	Specify wood color number.	
• Wood group 2	+\$ 45	Specify wood color number.	
• Wood group 3	+\$ 49	Specify wood color number.	
• Customiz stain	+\$ 35	Specify with <i>Customiz stain</i> .	

▶ Options, continued on next page



For Canadian Pricing
Multiply U.S. Price by the Canadian price factor.
▶ See page 1 for details.

► Options, continued from previous page

	Options	U.S. Price	Required to Specify
Surface Materials, continued	Metal shelf		
	• Paint price group 1	No cost	Specify paint color number.
	• Paint price group 2	+\$ 30	Specify paint color number.
	• Paint price group 3	+\$ 35	Specify paint color number.
	• Anodized aluminum	+\$ 40	Specify with 8043 Clear Anodized Aluminum.
	• Polished chrome	+\$ 46	Specify with 9201 Polished Chrome.
	• Nickel	+\$ 60	Specify with 9211 Nickel.
	• Silver	+\$ 60	Specify with 9212 Silver.
	Pull		
	• Paint price group 1	No cost	Specify paint color number.
	• Paint price group 2	No cost	Specify paint color number.
	• Paint price group 3	No cost	Specify paint color number.
	• Anodized Aluminum	No cost	Specify with 8043 Clear Anodized Aluminum.
	• Polished Chrome	No cost	Specify with 9201 Polished Chrome.
	• Nickel	No cost	Specify with 9211 Nickel.
• Silver	No cost	Specify with 9212 Silver.	
Grommet			
• Paint price group 1	No cost	Specify paint color number.	
• Paint price group 2	No cost	Specify paint color number.	
• Paint price group 3	No cost	Specify paint color number.	
Lock			
• 9201 Polished Chrome	No cost	Specify with 9201 Polished Chrome.	
• 9250 Ember Chrome	No cost	Specify with 9250 Ember Chrome.	
Grain Direction	Top		
	• No grain direction	No cost	Specify with no grain direction.
	• Long grain	No cost	Specify with long grain direction.
	• Short grain	No cost	Specify with short grain direction.
	Case		
	• No grain direction	No cost	Specify with no grain direction.
	• Horizontal	No cost	Specify with horizontal grain direction.
	• Vertical	No cost	Specify with vertical grain direction.
	Headset		
• No grain direction	No cost	Specify with no grain direction.	
• Horizontal	No cost	Specify with horizontal grain direction.	
• Vertical	No cost	Specify with vertical grain direction.	
Back Panel	• No back panel	No cost	Specify with no back panel.
	• With back panel	No cost	Specify with back panel.
Adjustable Shelf	• No HIU shelf	No cost	Specify with no HIU shelf.
	• Wood HIU shelf	No cost	Specify with wood HIU shelf.
	• Metal HIU shelf	No cost	Specify with metal HIU shelf.
Liner	• No drawer liner	No cost	Specify with no drawer liner.
	• With drawer liner	+\$ 35	Specify with drawer liner.
Tray	• No tray	No cost	Specify with no tray.
	• Pencil tray	+\$ 79	Specify with pencil tray.
	• Paper tray	+\$ 99	Specify with paper tray.
	• Paper and pencil tray	+\$178	Specify with paper and pencil tray.
	Lock		
• No lock	No cost	Specify with no lock.	
• With lock	No cost	Specify with lock.	

Tip: Pull finish availability varies depending on pull type. See surface materials section for more details.

Tip: Drawer liner upcharge listed is per box/file storage unit.

► Options, continued on next page



For Canadian Pricing
Multiply U.S. Price by the Canadian price factor.
► See page 1 for details.

► **Options, continued from previous page**

	Options	U.S. Price	Required to Specify
Key	• Key random	No cost	Specify <i>with key random</i> .
	• Key plug	No cost	Specify <i>with key plug</i> .
	• Master key random	+\$39	Specify <i>with master key random</i> .
	• Master key plug	+\$39	Specify <i>with master key plug</i> .
Pull	• Contemporary pull	No cost	Specify <i>with contemporary pull</i> .
	• Ledge pull	No cost	Specify <i>with ledge pull</i> .
	• Nile pull	+\$39	Specify <i>with nile pull</i> .
	• Beam pull	+\$60	Specify <i>with beam pull</i> .
	• Align pull	+\$65	Specify <i>with align pull</i> .
Related Products	• Aisla panels		► Page 48
	• Aisla powered panels		► Page 88
	• Aisla fabric wrapped magnetic panel		► Page 130
	• Aisla cabinets		► Page 132

► **Specification Information, on next page**



For Canadian Pricing
Multiply U.S. Price by the
Canadian price factor.
► See page 1 for details.

► Options, on previous page

Specification Information

•Style Number	•Dimensions		•U.S. Base Price	•Finish Upcharges	•High-Pressure Laminate			•Composite Veneer		•Wood			•Customiz Stain
	D	W			•Price Group 1	•Price Group 2	•Price Group 3	•Price Group 1	•Price Group 2	•Price Group 1	•Price Group 2	•Price Group 3	

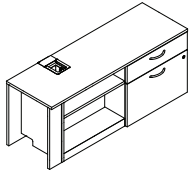

1.5-High Perpendicular Credenza—HIU, One Box Drawer, and One File Drawer—Right Hand

WPCD15HIUBFPP	18"	54"	\$5835	Top	No cost	+\$ 97	+\$199	+\$307	+\$419	+\$537	+\$662	+\$792	+\$307
				Case	No cost	+\$ 97	+\$199	+\$307	+\$419	+\$537	+\$662	+\$792	+\$307
				Headset	No cost	+\$ 97	+\$199	+\$307	+\$419	+\$537	+\$662	+\$792	+\$307
	18"	54.5"	\$5835	Top	No cost	+\$ 97	+\$199	+\$307	+\$419	+\$537	+\$662	+\$792	+\$307
Case				No cost	+\$ 97	+\$199	+\$307	+\$419	+\$537	+\$662	+\$792	+\$307	
Headset				No cost	+\$ 97	+\$199	+\$307	+\$419	+\$537	+\$662	+\$792	+\$307	
	18"	60"	\$6185	Top	No cost	+\$103	+\$211	+\$325	+\$444	+\$570	+\$701	+\$839	+\$325
Case				No cost	+\$103	+\$211	+\$325	+\$444	+\$570	+\$701	+\$839	+\$325	
Headset				No cost	+\$103	+\$211	+\$325	+\$444	+\$570	+\$701	+\$839	+\$325	
	18"	60.5"	\$6185	Top	No cost	+\$103	+\$211	+\$325	+\$444	+\$570	+\$701	+\$839	+\$325
Case				No cost	+\$103	+\$211	+\$325	+\$444	+\$570	+\$701	+\$839	+\$325	
Headset				No cost	+\$103	+\$211	+\$325	+\$444	+\$570	+\$701	+\$839	+\$325	
	18"	66"	\$6557	Top	No cost	+\$109	+\$224	+\$344	+\$471	+\$604	+\$743	+\$890	+\$344
Case				No cost	+\$109	+\$224	+\$344	+\$471	+\$604	+\$743	+\$890	+\$344	
Headset				No cost	+\$109	+\$224	+\$344	+\$471	+\$604	+\$743	+\$890	+\$344	
	18"	66.5"	\$6557	Top	No cost	+\$109	+\$224	+\$344	+\$471	+\$604	+\$743	+\$890	+\$344
Case				No cost	+\$109	+\$224	+\$344	+\$471	+\$604	+\$743	+\$890	+\$344	
Headset				No cost	+\$109	+\$224	+\$344	+\$471	+\$604	+\$743	+\$890	+\$344	
	18"	72"	\$6950	Top	No cost	+\$116	+\$237	+\$365	+\$499	+\$640	+\$788	+\$943	+\$365
Case				No cost	+\$116	+\$237	+\$365	+\$499	+\$640	+\$788	+\$943	+\$365	
Headset				No cost	+\$116	+\$237	+\$365	+\$499	+\$640	+\$788	+\$943	+\$365	
	18"	72.5"	\$6950	Top	No cost	+\$116	+\$237	+\$365	+\$499	+\$640	+\$788	+\$943	+\$365
Case				No cost	+\$116	+\$237	+\$365	+\$499	+\$640	+\$788	+\$943	+\$365	
Headset				No cost	+\$116	+\$237	+\$365	+\$499	+\$640	+\$788	+\$943	+\$365	



For Canadian Pricing

Multiply U.S. Price by the Canadian price factor.

► See page 1 for details.

Specification Information

Style Number	Dimensions D W		U.S. Base Price	Finish Upcharges	High-Pressure Laminate			Composite Veneer		Wood			Customiz Stain
					Price Group 1	Price Group 2	Price Group 3	Price Group 1	Price Group 2	Price Group 1	Price Group 2	Price Group 3	

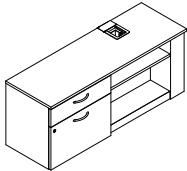

1.5-High Perpendicular HIU Credenza—One Box Drawer, One File Drawer, and HIU—Left Hand

WPCD15BFHIUPP	18"	54"	\$5835	Top	No cost	+\$ 97	+\$199	+\$307	+\$419	+\$537	+\$662	+\$792	+\$307
				Case	No cost	+\$ 97	+\$199	+\$307	+\$419	+\$537	+\$662	+\$792	+\$307
				Headset	No cost	+\$ 97	+\$199	+\$307	+\$419	+\$537	+\$662	+\$792	+\$307
	18"	54.5"	\$5835	Top	No cost	+\$ 97	+\$199	+\$307	+\$419	+\$537	+\$662	+\$792	+\$307
				Case	No cost	+\$ 97	+\$199	+\$307	+\$419	+\$537	+\$662	+\$792	+\$307
				Headset	No cost	+\$ 97	+\$199	+\$307	+\$419	+\$537	+\$662	+\$792	+\$307
	18"	60"	\$6185	Top	No cost	+\$103	+\$211	+\$325	+\$444	+\$570	+\$701	+\$839	+\$325
				Case	No cost	+\$103	+\$211	+\$325	+\$444	+\$570	+\$701	+\$839	+\$325
				Headset	No cost	+\$103	+\$211	+\$325	+\$444	+\$570	+\$701	+\$839	+\$325
	18"	60.5"	\$6185	Top	No cost	+\$103	+\$211	+\$325	+\$444	+\$570	+\$701	+\$839	+\$325
				Case	No cost	+\$103	+\$211	+\$325	+\$444	+\$570	+\$701	+\$839	+\$325
				Headset	No cost	+\$103	+\$211	+\$325	+\$444	+\$570	+\$701	+\$839	+\$325
	18"	66"	\$6557	Top	No cost	+\$109	+\$224	+\$344	+\$471	+\$604	+\$743	+\$890	+\$344
				Case	No cost	+\$109	+\$224	+\$344	+\$471	+\$604	+\$743	+\$890	+\$344
				Headset	No cost	+\$109	+\$224	+\$344	+\$471	+\$604	+\$743	+\$890	+\$344
	18"	66.5"	\$6557	Top	No cost	+\$109	+\$224	+\$344	+\$471	+\$604	+\$743	+\$890	+\$344
				Case	No cost	+\$109	+\$224	+\$344	+\$471	+\$604	+\$743	+\$890	+\$344
				Headset	No cost	+\$109	+\$224	+\$344	+\$471	+\$604	+\$743	+\$890	+\$344
	18"	72"	\$6950	Top	No cost	+\$116	+\$237	+\$365	+\$499	+\$640	+\$788	+\$943	+\$365
				Case	No cost	+\$116	+\$237	+\$365	+\$499	+\$640	+\$788	+\$943	+\$365
				Headset	No cost	+\$116	+\$237	+\$365	+\$499	+\$640	+\$788	+\$943	+\$365
	18"	72.5"	\$6950	Top	No cost	+\$116	+\$237	+\$365	+\$499	+\$640	+\$788	+\$943	+\$365
				Case	No cost	+\$116	+\$237	+\$365	+\$499	+\$640	+\$788	+\$943	+\$365
				Headset	No cost	+\$116	+\$237	+\$365	+\$499	+\$640	+\$788	+\$943	+\$365

► Specification Information, continued on next page



For Canadian Pricing
Multiply U.S. Price by the Canadian price factor.
► See page 1 for details.

► Specification Information, continued from previous page

Specification Information

•Style Number	•Dimensions		•U.S. Base Price	•Finish Upcharges	•High-Pressure Laminate			•Composite Veneer		•Wood			•Customiz Stain
	D	W			•Price Group 1	•Price Group 2	•Price Group 3	•Price Group 1	•Price Group 2	•Price Group 1	•Price Group 2	•Price Group 3	

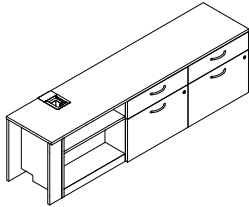

1.5-High Perpendicular Credenza—HIU, Two Box Drawers, and Two File Drawers—Right Hand

WPCD15HIUBFBFPP	18"	78"	\$ 9125	Top	No cost	+\$152	+\$312	+\$479	+\$655	+\$ 840	+\$1034	+\$1238	+\$479
				Case	No cost	+\$152	+\$312	+\$479	+\$655	+\$ 840	+\$1034	+\$1238	+\$479
				Headset	No cost	+\$152	+\$312	+\$479	+\$655	+\$ 840	+\$1034	+\$1238	+\$479
	18"	78.5"	\$ 9125	Top	No cost	+\$152	+\$312	+\$479	+\$655	+\$ 840	+\$1034	+\$1238	+\$479
				Case	No cost	+\$152	+\$312	+\$479	+\$655	+\$ 840	+\$1034	+\$1238	+\$479
				Headset	No cost	+\$152	+\$312	+\$479	+\$655	+\$ 840	+\$1034	+\$1238	+\$479
	18"	84"	\$ 9854	Top	No cost	+\$164	+\$337	+\$518	+\$708	+\$ 908	+\$1117	+\$1337	+\$518
				Case	No cost	+\$164	+\$337	+\$518	+\$708	+\$ 908	+\$1117	+\$1337	+\$518
				Headset	No cost	+\$164	+\$337	+\$518	+\$708	+\$ 908	+\$1117	+\$1337	+\$518
	18"	84.5"	\$ 9854	Top	No cost	+\$164	+\$337	+\$518	+\$708	+\$ 908	+\$1117	+\$1337	+\$518
				Case	No cost	+\$164	+\$337	+\$518	+\$708	+\$ 908	+\$1117	+\$1337	+\$518
				Headset	No cost	+\$164	+\$337	+\$518	+\$708	+\$ 908	+\$1117	+\$1337	+\$518
	18"	90"	\$10,643	Top	No cost	+\$177	+\$364	+\$559	+\$765	+\$ 980	+\$1207	+\$1444	+\$559
				Case	No cost	+\$177	+\$364	+\$559	+\$765	+\$ 980	+\$1207	+\$1444	+\$559
				Headset	No cost	+\$177	+\$364	+\$559	+\$765	+\$ 980	+\$1207	+\$1444	+\$559
	18"	90.5"	\$10,643	Top	No cost	+\$177	+\$364	+\$559	+\$765	+\$ 980	+\$1207	+\$1444	+\$559
				Case	No cost	+\$177	+\$364	+\$559	+\$765	+\$ 980	+\$1207	+\$1444	+\$559
				Headset	No cost	+\$177	+\$364	+\$559	+\$765	+\$ 980	+\$1207	+\$1444	+\$559
	18"	96"	\$11,494	Top	No cost	+\$192	+\$393	+\$604	+\$826	+\$1059	+\$1303	+\$1560	+\$604
				Case	No cost	+\$192	+\$393	+\$604	+\$826	+\$1059	+\$1303	+\$1560	+\$604
				Headset	No cost	+\$192	+\$393	+\$604	+\$826	+\$1059	+\$1303	+\$1560	+\$604
	18"	96.5"	\$11,494	Top	No cost	+\$192	+\$393	+\$604	+\$826	+\$1059	+\$1303	+\$1560	+\$604
				Case	No cost	+\$192	+\$393	+\$604	+\$826	+\$1059	+\$1303	+\$1560	+\$604
				Headset	No cost	+\$192	+\$393	+\$604	+\$826	+\$1059	+\$1303	+\$1560	+\$604



For Canadian Pricing

Multiply U.S. Price by the Canadian price factor.

► See page 1 for details.

Specification Information

Style Number	Dimensions D W		U.S. Base Price	Finish Upcharges	High-Pressure Laminate			Composite Veneer		Wood			Customiz Stain
					Price Group 1	Price Group 2	Price Group 3	Price Group 1	Price Group 2	Price Group 1	Price Group 2	Price Group 3	

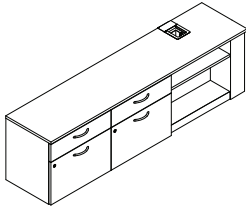

1.5-High Perpendicular HIU Credenza—Two Box Drawers, Two File Drawers, and HIU—Left Hand

WPCD15BFBHIU	18"	78"	\$ 9125	Top	No cost	+\$152	+\$312	+\$479	+\$655	+\$ 840	+\$1034	+\$1238	+\$479
				Case	No cost	+\$152	+\$312	+\$479	+\$655	+\$ 840	+\$1034	+\$1238	+\$479
				Headset	No cost	+\$152	+\$312	+\$479	+\$655	+\$ 840	+\$1034	+\$1238	+\$479
	18"	78.5"	\$ 9125	Top	No cost	+\$152	+\$312	+\$479	+\$655	+\$ 840	+\$1034	+\$1238	+\$479
				Case	No cost	+\$152	+\$312	+\$479	+\$655	+\$ 840	+\$1034	+\$1238	+\$479
				Headset	No cost	+\$152	+\$312	+\$479	+\$655	+\$ 840	+\$1034	+\$1238	+\$479
	18"	84"	\$ 9854	Top	No cost	+\$164	+\$337	+\$518	+\$708	+\$ 908	+\$1117	+\$1337	+\$518
				Case	No cost	+\$164	+\$337	+\$518	+\$708	+\$ 908	+\$1117	+\$1337	+\$518
				Headset	No cost	+\$164	+\$337	+\$518	+\$708	+\$ 908	+\$1117	+\$1337	+\$518
	18"	84.5"	\$ 9854	Top	No cost	+\$164	+\$337	+\$518	+\$708	+\$ 908	+\$1117	+\$1337	+\$518
				Case	No cost	+\$164	+\$337	+\$518	+\$708	+\$ 908	+\$1117	+\$1337	+\$518
				Headset	No cost	+\$164	+\$337	+\$518	+\$708	+\$ 908	+\$1117	+\$1337	+\$518
	18"	90"	\$10,643	Top	No cost	+\$177	+\$364	+\$559	+\$765	+\$ 980	+\$1207	+\$1444	+\$559
				Case	No cost	+\$177	+\$364	+\$559	+\$765	+\$ 980	+\$1207	+\$1444	+\$559
				Headset	No cost	+\$177	+\$364	+\$559	+\$765	+\$ 980	+\$1207	+\$1444	+\$559
	18"	90.5"	\$10,643	Top	No cost	+\$177	+\$364	+\$559	+\$765	+\$ 980	+\$1207	+\$1444	+\$559
				Case	No cost	+\$177	+\$364	+\$559	+\$765	+\$ 980	+\$1207	+\$1444	+\$559
				Headset	No cost	+\$177	+\$364	+\$559	+\$765	+\$ 980	+\$1207	+\$1444	+\$559
	18"	96"	\$11,494	Top	No cost	+\$192	+\$393	+\$604	+\$826	+\$1059	+\$1303	+\$1560	+\$604
				Case	No cost	+\$192	+\$393	+\$604	+\$826	+\$1059	+\$1303	+\$1560	+\$604
				Headset	No cost	+\$192	+\$393	+\$604	+\$826	+\$1059	+\$1303	+\$1560	+\$604
	18"	96.5"	\$11,494	Top	No cost	+\$192	+\$393	+\$604	+\$826	+\$1059	+\$1303	+\$1560	+\$604
				Case	No cost	+\$192	+\$393	+\$604	+\$826	+\$1059	+\$1303	+\$1560	+\$604
				Headset	No cost	+\$192	+\$393	+\$604	+\$826	+\$1059	+\$1303	+\$1560	+\$604

Aisla HIU Credenzas

 **For Canadian Pricing**
Multiply U.S. Price by the Canadian price factor.
▶ See page 1 for details.

Aisla HIU Low Storage—Parallel

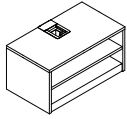

	Standard Includes	Required to Specify
<p>► Need help? Product details, page 42</p>	<ul style="list-style-type: none"> • HIU low storage—parallel: <ul style="list-style-type: none"> – Top: High-Pressure Laminate price group 1 – Case: High-Pressure Laminate price group 1 • Wood shelf, if selected: High-Pressure Laminate price group 1 • Metal shelf, if selected: paint price group 1 • Top edge, if laminate top is specified: plastic price group 1 	<ol style="list-style-type: none"> 1 Style number 2 Width (see below under Required Selections) 3 Desk application (see below under Required Selections) 4 High-Pressure Laminate color for top 5 High-Pressure Laminate color for case 6 Plastic color number for edge 7 High-Pressure Laminate color number for wood shelf, if selected 8 Paint color number for metal shelf, if selected 9 Paint color number for grommet 10 Options, if selected (see below) <p>► See <i>Surface Materials</i>, page 164</p>

	Required Selections	U.S. Price	Required to Specify
Width	<ul style="list-style-type: none"> • 30" • 30.5" 	Prices at right Prices at right	Specify width. Specify width.
Desk Application	<ul style="list-style-type: none"> • Migration Pro • Slim Leg HAD 	No cost No cost	Specify with <i>Migration Pro</i> . Specify with <i>Slim Leg HAD</i> .

	Options	U.S. Price	Required to Specify
Surface Materials	Top		
	• High-Pressure Laminate price group 1	No cost	Specify laminate color number.
	• High-Pressure Laminate price group 2	Prices at right	Specify laminate color number.
	• High-Pressure Laminate price group 3	Prices at right	Specify laminate color number.
	• Open Line laminate (OLL)	+\$111 plus cost of laminate	Specify laminate color number. ► See <i>Surface Materials Reference Manual</i> .
	• Composite veneer group 1	Prices at right	Specify composite veneer color number.
	• Composite veneer group 2	Prices at right	Specify composite veneer color number.
	• Wood group 1	Prices at right	Specify wood color number.
	• Wood group 2	Prices at right	Specify wood color number.
	• Wood group 3	Prices at right	Specify wood color number.
	• Customiz stain	Prices at right	Specify with <i>Customiz stain</i> .
	Case		
	• High-Pressure Laminate price group 1	No cost	Specify laminate color number.
	• High-Pressure Laminate price group 2	Prices at right	Specify laminate color number.
• High-Pressure Laminate price group 3	Prices at right	Specify laminate color number.	
• Open Line laminate (OLL)	+\$111 plus cost of laminate	Specify laminate color number. ► See <i>Surface Materials Reference Manual</i> .	
• Composite veneer group 1	Prices at right	Specify composite veneer color number.	
• Composite veneer group 2	Prices at right	Specify composite veneer color number.	
• Wood group 1	Prices at right	Specify wood color number.	
• Wood group 2	Prices at right	Specify wood color number.	
• Wood group 3	Prices at right	Specify wood color number.	
• Customiz stain	Prices at right	Specify with <i>Customiz stain</i> .	

► Options, continued on next page



For Canadian Pricing
Multiply U.S. Price by the Canadian price factor.
► See page 1 for details.

► Options, continued from previous page

	Options	U.S. Price	Required to Specify
Surface Materials, continued	Wood shelf		
	• High-Pressure Laminate price group 1	No cost	Specify laminate color number.
	• High-Pressure Laminate price group 2	+\$25	Specify laminate color number.
	• High-Pressure Laminate price group 3	+\$29	Specify laminate color number.
	• Open Line laminate (OLL)	No cost	Specify laminate color number. ► See <i>Surface Materials Reference Manual</i> .
	• Composite veneer group 1	+\$35	Specify composite veneer color number.
	• Composite veneer group 2	+\$37	Specify composite veneer color number.
	• Wood group 1	+\$41	Specify wood color number.
	• Wood group 2	+\$45	Specify wood color number.
	• Wood group 3	+\$49	Specify wood color number.
	• Customiz stain	+\$35	Specify with <i>Customiz stain</i> .
	Metal shelf		
	• Paint price group 1	No cost	Specify paint color number.
	• Paint price group 2	+\$30	Specify paint color number.
	• Paint price group 3	+\$35	Specify paint color number.
• Anodized aluminum	+\$40	Specify with <i>8043 Clear Anodized Aluminum</i> .	
• Polished chrome	+\$46	Specify with <i>9201 Polished Chrome</i> .	
• Nickel	+\$60	Specify with <i>9211 Nickel</i> .	
• Silver	+\$60	Specify with <i>9212 Silver</i> .	
Grommet			
• Paint price group 1	No cost	Specify paint color number.	
• Paint price group 2	No cost	Specify paint color number.	
• Paint price group 3	No cost	Specify paint color number.	
Grain Direction	Top		
	• No grain direction	No cost	Specify with <i>no grain direction</i> .
	• Long grain	No cost	Specify with <i>long grain direction</i> .
	• Short grain	No cost	Specify with <i>short grain direction</i> .
	Case		
	• No grain direction	No cost	Specify with <i>no grain direction</i> .
	• Horizontal	No cost	Specify with <i>horizontal grain direction</i> .
	• Vertical	No cost	Specify with <i>vertical grain direction</i> .
Back Panel	• No back panel	No cost	Specify with <i>no back panel</i> .
	• With back panel	No cost	Specify with <i>back panel</i> .
Adjustable Shelf	• No HIU shelf	No cost	Specify with <i>no HIU shelf</i> .
	• Wood HIU shelf	No cost	Specify with <i>wood HIU shelf</i> .
	• Metal HIU shelf	No cost	Specify with <i>metal HIU shelf</i> .
Related Products	• Aisla panels		► Page 48
	• Aisla powered panels		► Page 88
	• Aisla fabric wrapped magnetic panel		► Page 130
	• Aisla cabinets		► Page 132

► Specification Information, on next page

Aisla HIU Low Storage



For Canadian Pricing
Multiply U.S. Price by the Canadian price factor.
► See page 1 for details.

Aisla HIU Low Storage—Parallel, continued

► Options, on previous page

Specification Information

Style Number	Dimensions D W		U.S. Base Price	Finish Upcharges	High-Pressure Laminate			Composite Veneer		Wood			Customiz Stain
					Price Group 1	Price Group 2	Price Group 3	Price Group 1	Price Group 2	Price Group 1	Price Group 2	Price Group 3	

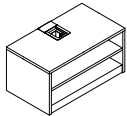

1-High Parallel Low Storage—HIU—Right Hand

WPHIU1HPLRH	18"	30"	\$3200	Top	No cost	+\$53	+\$109	+\$168	+\$230	+\$295	+\$363	+\$434	+\$168
				Case	No cost	+\$53	+\$109	+\$168	+\$230	+\$295	+\$363	+\$434	+\$168
				Headset	No cost	+\$53	+\$109	+\$168	+\$230	+\$295	+\$363	+\$434	+\$168
	18"	30.5"	\$3200	Top	No cost	+\$53	+\$109	+\$168	+\$230	+\$295	+\$363	+\$434	+\$168
Case				No cost	+\$53	+\$109	+\$168	+\$230	+\$295	+\$363	+\$434	+\$168	
Headset				No cost	+\$53	+\$109	+\$168	+\$230	+\$295	+\$363	+\$434	+\$168	

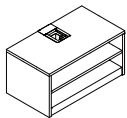

1-High Parallel Low Storage—HIU—Left Hand

WPHIU1HPLLH	18"	30"	\$3200	Top	No cost	+\$53	+\$109	+\$168	+\$230	+\$295	+\$363	+\$434	+\$168
				Case	No cost	+\$53	+\$109	+\$168	+\$230	+\$295	+\$363	+\$434	+\$168
				Headset	No cost	+\$53	+\$109	+\$168	+\$230	+\$295	+\$363	+\$434	+\$168
	18"	30.5"	\$3200	Top	No cost	+\$53	+\$109	+\$168	+\$230	+\$295	+\$363	+\$434	+\$168
Case				No cost	+\$53	+\$109	+\$168	+\$230	+\$295	+\$363	+\$434	+\$168	
Headset				No cost	+\$53	+\$109	+\$168	+\$230	+\$295	+\$363	+\$434	+\$168	



For Canadian Pricing

Multiply U.S. Price by the Canadian price factor.

► See page 1 for details.

Specification Information

Style Number	Dimensions D W		U.S. Base Price	Finish Upcharges	High-Pressure Laminate			Composite Veneer		Wood			Customiz Stain
					Price Group 1	Price Group 2	Price Group 3	Price Group 1	Price Group 2	Price Group 1	Price Group 2	Price Group 3	

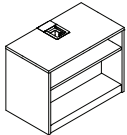

1.5-High Parallel Low Storage—HIU—Right Hand

WPHIU15HPLRH	18"	30"	\$3680	Top	No cost	+\$61	+\$126	+\$193	+\$264	+\$339	+\$417	+\$499	+\$193
				Case	No cost	+\$61	+\$126	+\$193	+\$264	+\$339	+\$417	+\$499	+\$193
				Headset	No cost	+\$61	+\$126	+\$193	+\$264	+\$339	+\$417	+\$499	+\$193
	18"	30.5"	\$3680	Top	No cost	+\$61	+\$126	+\$193	+\$264	+\$339	+\$417	+\$499	+\$193
Case				No cost	+\$61	+\$126	+\$193	+\$264	+\$339	+\$417	+\$499	+\$193	
Headset				No cost	+\$61	+\$126	+\$193	+\$264	+\$339	+\$417	+\$499	+\$193	

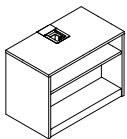

1.5-High Parallel Low Storage—HIU—Left Hand

WPHIU15HPLLH	18"	30"	\$3680	Top	No cost	+\$61	+\$126	+\$193	+\$264	+\$339	+\$417	+\$499	+\$193
				Case	No cost	+\$61	+\$126	+\$193	+\$264	+\$339	+\$417	+\$499	+\$193
				Headset	No cost	+\$61	+\$126	+\$193	+\$264	+\$339	+\$417	+\$499	+\$193
	18"	30.5"	\$3680	Top	No cost	+\$61	+\$126	+\$193	+\$264	+\$339	+\$417	+\$499	+\$193
Case				No cost	+\$61	+\$126	+\$193	+\$264	+\$339	+\$417	+\$499	+\$193	
Headset				No cost	+\$61	+\$126	+\$193	+\$264	+\$339	+\$417	+\$499	+\$193	

Aisla HIU Low Storage



For Canadian Pricing
Multiply U.S. Price by the Canadian price factor.
▶ See page 1 for details.

Aisla HIU Low Storage—Perpendicular

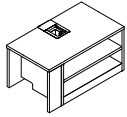

	Standard Includes	Required to Specify
<p>► Need help? Product details, page 42</p>	<ul style="list-style-type: none"> • HIU low storage—perpendicular: <ul style="list-style-type: none"> – Top: High-Pressure Laminate price group 1 – Case: High-Pressure Laminate price group 1 • Wood shelf, if selected: High-Pressure Laminate price group 1 • Metal shelf, if selected: paint price group 1 • Top edge, if laminate top is specified: plastic price group 1 	<ol style="list-style-type: none"> 1 Style number 2 Width (see below under Required Selections) 3 Desk application (see below under Required Selections) 4 High-Pressure Laminate color for top 5 High-Pressure Laminate color for case 6 Plastic color number for edge 7 High-Pressure Laminate color number for wood shelf, if selected 8 Paint color number for metal shelf, if selected 9 Paint color number for grommet 10 Options, if selected (see below) <p>► See <i>Surface Materials</i>, page 164</p>

	Required Selections	U.S. Price	Required to Specify
Width	<ul style="list-style-type: none"> • 30" • 30.5" 	Prices at right Prices at right	Specify width. Specify width.
Desk Application	<ul style="list-style-type: none"> • Migration Pro • Slim Leg HAD 	No cost No cost	Specify with <i>Migration Pro</i> . Specify with <i>Slim Leg HAD</i> .

	Options	U.S. Price	Required to Specify
Surface Materials	<p>Top</p> <ul style="list-style-type: none"> • High-Pressure Laminate price group 1 • High-Pressure Laminate price group 2 • High-Pressure Laminate price group 3 • Open Line laminate (OLL) • Composite veneer group 1 • Composite veneer group 2 • Wood group 1 • Wood group 2 • Wood group 3 • Customiz stain 	No cost Prices at right Prices at right Prices at right +\$111 plus cost of laminate Prices at right Prices at right Prices at right Prices at right Prices at right Prices at right	Specify laminate color number. Specify laminate color number. Specify laminate color number. Specify laminate color number. ► See <i>Surface Materials Reference Manual</i> . Specify composite veneer color number. Specify composite veneer color number. Specify wood color number. Specify wood color number. Specify wood color number. Specify with <i>Customiz stain</i> .
	<p>Case</p> <ul style="list-style-type: none"> • High-Pressure Laminate price group 1 • High-Pressure Laminate price group 2 • High-Pressure Laminate price group 3 • Open Line laminate (OLL) • Composite veneer group 1 • Composite veneer group 2 • Wood group 1 • Wood group 2 • Wood group 3 • Customiz stain 	No cost Prices at right Prices at right Prices at right +\$111 plus cost of laminate Prices at right Prices at right Prices at right Prices at right Prices at right Prices at right	Specify laminate color number. Specify laminate color number. Specify laminate color number. Specify laminate color number. Specify laminate color number. ► See <i>Surface Materials Reference Manual</i> . Specify composite veneer color number. Specify composite veneer color number. Specify wood color number. Specify wood color number. Specify wood color number. Specify with <i>Customiz stain</i> .

► Options, continued on next page



For Canadian Pricing
 Multiply U.S. Price by the Canadian price factor.
 ► See page 1 for details.

► Options, continued from previous page

	Options	U.S. Price	Required to Specify
Surface Materials, continued	Wood shelf		
	• High-Pressure Laminate price group 1	No cost	Specify laminate color number.
	• High-Pressure Laminate price group 2	+\$25	Specify laminate color number.
	• High-Pressure Laminate price group 3	+\$29	Specify laminate color number.
	• Open Line laminate (OLL)	No cost	Specify laminate color number. ► See <i>Surface Materials Reference Manual</i> .
	• Composite veneer group 1	+\$35	Specify composite veneer color number.
	• Composite veneer group 2	+\$37	Specify composite veneer color number.
	• Wood group 1	+\$41	Specify wood color number.
	• Wood group 2	+\$45	Specify wood color number.
	• Wood group 3	+\$49	Specify wood color number.
	• Customiz stain	+\$35	Specify with <i>Customiz stain</i> .
	Metal shelf		
	• Paint price group 1	No cost	Specify paint color number.
	• Paint price group 2	+\$30	Specify paint color number.
	• Paint price group 3	+\$35	Specify paint color number.
• Anodized aluminum	+\$40	Specify with <i>8043 Clear Anodized Aluminum</i> .	
• Polished chrome	+\$46	Specify with <i>9201 Polished Chrome</i> .	
• Nickel	+\$60	Specify with <i>9211 Nickel</i> .	
• Silver	+\$60	Specify with <i>9212 Silver</i> .	
Grommet			
• Paint price group 1	No cost	Specify paint color number.	
• Paint price group 2	No cost	Specify paint color number.	
• Paint price group 3	No cost	Specify paint color number.	
Grain Direction	Top		
	• No grain direction	No cost	Specify with <i>no grain direction</i> .
	• Long grain	No cost	Specify with <i>long grain direction</i> .
	• Short grain	No cost	Specify with <i>short grain direction</i> .
	Case		
	• No grain direction	No cost	Specify with <i>no grain direction</i> .
	• Horizontal	No cost	Specify with <i>horizontal grain direction</i> .
	• Vertical	No cost	Specify with <i>vertical grain direction</i> .
Back Panel	• No back panel	No cost	Specify with <i>no back panel</i> .
	• With back panel	No cost	Specify with <i>back panel</i> .
Adjustable Shelf	• No HIU shelf	No cost	Specify with <i>no HIU shelf</i> .
	• Wood HIU shelf	No cost	Specify with <i>wood HIU shelf</i> .
	• Metal HIU shelf	No cost	Specify with <i>metal HIU shelf</i> .
Related Products	• Aisla panels		► Page 48
	• Aisla powered panels		► Page 88
	• Aisla fabric wrapped magnetic panel		► Page 130
	• Aisla cabinets		► Page 132

► Specification Information, on next page

Aisla HIU Low Storage



For Canadian Pricing
Multiply U.S. Price by the Canadian price factor.
► See page 1 for details.

Aisla HIU Low Storage—Perpendicular, continued

► Options, on previous page

Specification Information

Style Number	Dimensions D W		U.S. Base Price	Finish Upcharges	High-Pressure Laminate			Composite Veneer		Wood			Customiz Stain
					Price Group 1	Price Group 2	Price Group 3	Price Group 1	Price Group 2	Price Group 1	Price Group 2	Price Group 3	

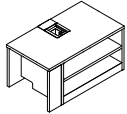

1-High Perpendicular Low Storage—HIU—Right Hand

WPHIU1HPPRH	18"	30"	\$3200	Top	No cost	+\$53	+\$109	+\$168	+\$230	+\$295	+\$363	+\$434	+\$168
				Case	No cost	+\$53	+\$109	+\$168	+\$230	+\$295	+\$363	+\$434	+\$168
				Headset	No cost	+\$53	+\$109	+\$168	+\$230	+\$295	+\$363	+\$434	+\$168
	18"	30.5"	\$3200	Top	No cost	+\$53	+\$109	+\$168	+\$230	+\$295	+\$363	+\$434	+\$168
				Case	No cost	+\$53	+\$109	+\$168	+\$230	+\$295	+\$363	+\$434	+\$168
				Headset	No cost	+\$53	+\$109	+\$168	+\$230	+\$295	+\$363	+\$434	+\$168

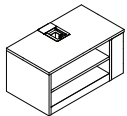

1-High Perpendicular Low Storage—HIU—Left Hand

WPHIU1HPPLH	18"	30"	\$3200	Top	No cost	+\$53	+\$109	+\$168	+\$230	+\$295	+\$363	+\$434	+\$168
				Case	No cost	+\$53	+\$109	+\$168	+\$230	+\$295	+\$363	+\$434	+\$168
				Headset	No cost	+\$53	+\$109	+\$168	+\$230	+\$295	+\$363	+\$434	+\$168
	18"	30.5"	\$3200	Top	No cost	+\$53	+\$109	+\$168	+\$230	+\$295	+\$363	+\$434	+\$168
				Case	No cost	+\$53	+\$109	+\$168	+\$230	+\$295	+\$363	+\$434	+\$168
				Headset	No cost	+\$53	+\$109	+\$168	+\$230	+\$295	+\$363	+\$434	+\$168



For Canadian Pricing

Multiply U.S. Price by the Canadian price factor.

► See page 1 for details.

Specification Information

Style Number	Dimensions D W		U.S. Base Price	Finish Upcharges	High-Pressure Laminate			Composite Veneer		Wood			Customiz Stain
					Price Group 1	Price Group 2	Price Group 3	Price Group 1	Price Group 2	Price Group 1	Price Group 2	Price Group 3	

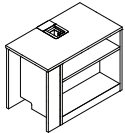

1.5-High Perpendicular Low Storage—HIU—Right Hand

WPHIU15HPPRH	18"	30"	\$3680	Top	No cost	+\$61	+\$126	+\$193	+\$264	+\$339	+\$417	+\$499	+\$193
				Case	No cost	+\$61	+\$126	+\$193	+\$264	+\$339	+\$417	+\$499	+\$193
				Headset	No cost	+\$61	+\$126	+\$193	+\$264	+\$339	+\$417	+\$499	+\$193
	18"	30.5"	\$3680	Top	No cost	+\$61	+\$126	+\$193	+\$264	+\$339	+\$417	+\$499	+\$193
				Case	No cost	+\$61	+\$126	+\$193	+\$264	+\$339	+\$417	+\$499	+\$193
				Headset	No cost	+\$61	+\$126	+\$193	+\$264	+\$339	+\$417	+\$499	+\$193

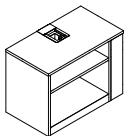

1.5-High Perpendicular Low Storage—HIU—Left Hand

WPHIU15HPPLH	18"	30"	\$3680	Top	No cost	+\$61	+\$126	+\$193	+\$264	+\$339	+\$417	+\$499	+\$193
				Case	No cost	+\$61	+\$126	+\$193	+\$264	+\$339	+\$417	+\$499	+\$193
				Headset	No cost	+\$61	+\$126	+\$193	+\$264	+\$339	+\$417	+\$499	+\$193
	18"	30.5"	\$3680	Top	No cost	+\$61	+\$126	+\$193	+\$264	+\$339	+\$417	+\$499	+\$193
				Case	No cost	+\$61	+\$126	+\$193	+\$264	+\$339	+\$417	+\$499	+\$193
				Headset	No cost	+\$61	+\$126	+\$193	+\$264	+\$339	+\$417	+\$499	+\$193

Aisla HIU Low Storage



For Canadian Pricing
Multiply U.S. Price by the Canadian price factor.
▶ See page 1 for details.

Aisla Storage Drawer Liner

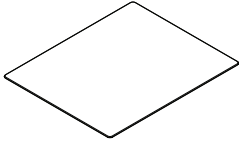

Standard Includes		Required to Specify
-------------------	--	---------------------

- | | | |
|---|---|---|
| <ul style="list-style-type: none"> ▶ Need help? Product details, page 42 | <ul style="list-style-type: none"> • Storage drawer liner: 5H20 Billiard Cloth | <ul style="list-style-type: none"> 1 Style number 2 Width (see below under Required Selections) |
|---|---|---|

	Required Selections	U.S. Price	Required to Specify
--	---------------------	------------	---------------------

Width	<ul style="list-style-type: none"> • 24" • 30" • 36" • 42" 	<ul style="list-style-type: none"> No cost No cost No cost No cost 	<ul style="list-style-type: none"> Specify width. Specify width. Specify width. Specify width.
--------------	--	--	--

Specification Information	
---------------------------	--

• Style Number	• U.S. Price
WPDLIN	\$35



For Canadian Pricing

Multiply U.S. Price by the Canadian price factor.

▶ See page 1 for details.

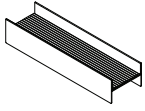

Standard Includes	Required to Specify
<ul style="list-style-type: none"> ▶ Need help? Product details, page 42 • Storage pencil tray: 7360 Merle 	Style number

Specification Information	
Style Number	U.S. Price
WPPNTR	\$79

Aisla HIU Low Storage

 **For Canadian Pricing**
 Multiply U.S. Price by the Canadian price factor.
 ▶ See page 1 for details.

Aisla Storage Paper Tray

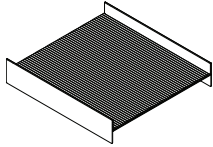

Standard Includes	Required to Specify
-------------------	---------------------

- | | |
|---|--|
| <ul style="list-style-type: none"> ▶ Need help? Product details, page 42 | <ul style="list-style-type: none"> • Storage paper tray: 7360 Merle |
|---|--|

Specification Information	
• Style Number	• U.S. Price

• Style Number	• U.S. Price
• WPPRTR	• \$99



For Canadian Pricing
 Multiply U.S. Price by the Canadian price factor.
 ▶ See page 1 for details.

Surface Materials

Surface Materials	164
Veneer Cut Guidelines	168
Color Availability Matrices	169

Surface Materials

This listing includes all the surface material choices that are available for the products in this specification guide.

Resources

For more information about surface materials, refer to the following resources:

Additional surface materials specification tools are available to assist you in the specification process—the Surface Materials Binders.

The global surface materials palette is a core collection of finishes that is available across multiple geographies (Americas/EMEA – Europe, Middle East, and Africa/APAC – Asia Pacific) and on global product lines, where applicable. For a list of finishes included in the offering, see the Surface Materials Reference Manual. Additional details, like product approvals by geography and finish number conversions, can also be found in the Surface Materials Reference Manual or see steelcase.com/surface-materials.

Surface Materials Binders include:

- Surface Materials Reference Manual
- A complete set of swatch cards for hard surfaces, vertical surface fabrics, and seating upholstery

Wood

Steelcase carefully selects veneer and solid wood for consistent color and grain structure. Wood is a natural material and variations will occur in color, grain and texture. These variations are part of the inherent natural beauty of wood and are not considered defects.

Wood veneers and solid wood finishes will not be an exact match to woodgrain laminates. We highly recommend ordering physical samples to understand visual differences.

Forest Stewardship Council (FSC) certified wood (veneer and core) is available on most Steelcase wood products through the Specials RFQ process.

All wood products will darken with age and exposure to ultraviolet light. This is especially apparent with cherry and maple veneer. We recommend that desk accessories be rearranged periodically to ensure even aging of wood surfaces.

When storing your wood furniture, please follow the following guidelines:

- Do not store products in trailers
- Store products in areas that simulate office temperatures (60°F to 90°F)
- Store products in areas that maintain constant, office-like humidity levels
- Keep product away from light. Cover products to make sure they are not exposed to light.

Ⓜ = Excluded

Steelcase Surfaces

Veneer

Veneers are matched for proper balance and consistency. Veneers are available or quarter cut, except for Oak, which is rift cut.

▶ Refer to the *Veneer Cut Guidelines* on page 168 for descriptions of each cut.

Open-pore finish is a medium gloss finish that leaves the wood grain texture visible to the eye and distinguishable to the touch.

Applies to:

- Aisla panels
- Aisla powered panels
- Panel transaction top
- Aisla cabinets
- Aisla HIU credenzas and low storage
- Aisla HIU storage wood HIU shelf

Veneer

Wood Group 1

Flat-cut open-pore

- 3062 FC/OP Graphite Walnut
- 3402 FC/OP Clear Cherry (Aged)
- 3412 FC/OP Natural Cherry Ⓜ
- 3422 FC/OP Medium Cherry
- 3522 FC/OP Clear Maple
- 3702 FC/OP Clear Walnut
- 3712 FC/OP Natural Walnut
- 3752 FC/OP Medium Walnut Ⓜ
- 3762 FC/OP Dark Walnut
- 3772 FC/OP Medium Mahogany on Walnut

Flat-Cut Open-Pore, Natural Veneer

- 3342 FC/OP Black Walnut
- 35A2 FC/OP Blanch Maple
- 37A2 FC/OP Thunder Walnut

Quarter-Cut Open-Pore

- 3042 QC/OP Ash Ⓜ
- 3222 QC/OP Clear Maple
- 3302 QC/OP Clear Walnut
- 3312 QC/OP Natural Walnut
- 3352 QC/OP Medium Walnut Ⓜ
- 3362 QC/OP Dark Walnut
- 3372 QC/OP Medium Mahogany on Walnut
- 3382 QC/OP Graphite Walnut

Quarter-Cut Open-Pore, Natural Veneer

- 32A2 QC/OP Blanch Maple
- 33A2 QC/OP Thunder Walnut
- 3392 QC/OP Black Walnut

Rift-Cut Open-Pore

- 3602 RC/OP Desert Oak

Rift-Cut Open-Pore, Natural Veneer

- 36A2 RC/OP Volcanic Oak

Wood Group 3

Flat-Cut Open-Pore, Natural Veneer

- 3082 FC/OP Washed Walnut

Wood Group 1

Open-Pore Planked Veneer

- 3P41 OP Planked Cherry
- 3P51 OP Planked Maple
- 3P61 OP Planked Oak
- 3P71 OP Planked Walnut
- 3VFX OP Unmarked Oak

Tip: Known for its uniqueness, planked veneer has intentional and natural variations that include, but are not limited to: character marks, grain pattern, color, and natural color aging.

Premium Veneers

A selection of Premium veneers in this collection are available on most Steelcase brand products. The collection will be available as close to standard leadtimes as possible. However, because adequate supplies of veneer and solids must be secured, all orders will be scheduled individually. Leadtimes will vary based on Premium veneer and Premium solids availability at the time the order is placed. The collection is available as Wood Group 3 as part of our Select Surface program, and supported like standard veneers to make ordering easy. Please see the Steelcase surface materials section on village.steelcase.com for sample information and product line availability. All premium veneers are in clear-coat.

Wood Group 3

Quarter-Cut Open-Pore

- 3832 QC/OP Figured Anegre

Select Surfaces

Composite Veneer

Composite veneers are an engineered wood intended to create specific grain patterns and characteristics. They are pre-stained and finished with Steelcase's Clarity water-borne UV topcoat, which protects the environment while providing durability and clarity. Only open-pore finishes are available on composite wood. Composite veneer and matching edge bands are available on most Steelcase brand products. Composites, for use as a solid nosing substitute, are not available. Steelcase does not recommend mixing composite veneers with natural solid nosings because composite and natural wood grain and color matching are rarely compatible. Composite veneers are available as Wood Group 1 pricing as part of our Select Surfaces program.

Applies to:

- Aisla panels
- Aisla powered panels
- Panel transaction top
- Aisla cabinets
- Aisla HIU credenzas and low storage
- Aisla HIU storage wood HIU shelf

Composite Veneer Group 1

Composite Flat-Cut Open-Pore

- 3JJX FC/OP Walnut Composite
- 3LAX FC/OP Graphite on Oak Composite
- 3LCX FC/OP Medium Cherry on Cherry Composite

Composite Quarter-Cut Open-Pore

- 3F8X QC/OP European Walnut Composite
- 3HGX QC/OP Oak Composite
- 3HVX QC/OP Walnut Composite
- 3LBX QC/OP Clear Walnut on Walnut Composite
- 3LDX QC/OP Natural Walnut on Walnut Composite

Composite Veneer Group 2

Composite Flat-Cut Open-Pore

- 3LHX FC/OP Espresso on Walnut Composite

Composite Quarter-Cut Open-Pore

- 3LEX QC/OP Desert Oak on Oak Composite
- 3LGX QC/OP Chai on Walnut Composite
- 3LJX QC/OP Ebony on Walnut Composite

Ⓔ = Excluded

Custom Surfaces

Customiz stain is a service that allows you to create your own stain colors and finishes on standard veneer. Customiz stain color is available on all product lines that offer wood veneer.

A \$500 stain-matching fee applies on CUSTOMIZ requests (Exception: The \$500 fee does not apply on matches to Coalesse standard finishes or for a low-gloss finish request on a standard color). The \$500 fee covers the cost of formulating the Customiz color finish and applies regardless of whether or not an order for product is placed.

In addition, an approval form must be signed to indicate customer acceptance of Customiz match. A \$1500 initiation fee will be charged prior to first order entry. This initiation fee activates the finish for unlimited use on any Steelcase product for an 18 month time period. After the 18 month time period has lapsed, the Customiz finish may be reactivated for another 18 months for a \$1000 fee at any point within five years after the \$1500 initiation fee was paid. If the finish is not reactivated within five years after the \$1500 initiation fee was paid, the finish will be culled and the customer will need to pay the \$1500 initiation fee again. All style number related Customiz charges products are no cost as of April 2014. The matching and initiation fees are not discountable.

Customiz stain takes 10 days to formulate. Consult the *Surface Materials Reference Manual* for more information. Custom veneers are also available and must be quoted by Steelcase special group. Customiz stain on custom veneers takes 2 to 4 weeks to formulate.

Requirements and information on ordering a Customiz stain color are found in the *Surface Materials Reference Manual*.

Laminate

Steelcase Surfaces

High-Pressure Laminate

Price Group 1

Applies to:

- Aisla panels
- Aisla powered panels
- Panel transaction top
- Aisla cabinets
- Aisla HIU credenzas and low storage
- Aisla HIU storage wood HIU shelf

Fiber Laminate

- 2850 Vanadium Fiber
- 2852 Tungsten Fiber Ⓔ
- 2854 Vellum Fiber Ⓔ
- 2860 Granite Fiber
- 2862 Stucco Fiber Ⓔ

Micro Laminate

- 2920 Marl Micro
- 2921 Gypsum Micro
- 2922 Clay Micro

Patina Laminate

- 2870 Blonde Bronze Patina
- 2873 Instant Iron Patina

Solid Laminate

- 2722 Cream Ⓔ
- 2730 Arctic White
- 2746 Black
- 2759 Warm White
- 2811 Mist Ⓔ
- 2883 Seagull
- 2884 Milk
- 2885 Dune
- 290N Northsea
- 2HAA Persian Salt
- 2HAB Rose
- 2HAC Indigo
- 2HAD Green Citrine Ⓔ
- 2HAE Dark Olivine
- 2HAF Cloudy
- 2HMG Merle
- 2HWU Clay
- 2HWW Chalk

Speckle Laminate

- 2820 Coffee Speckle Ⓔ
- 2823 Driftwood Speckle
- 2824 Smoke Speckle
- 2825 Vanadium Speckle

Tip: Some wood veneer finishes and woodgrain laminates share the same name. Because of the difference in materials, veneers and laminates of the same name are not an exact match but do coordinate with each other.

Woodgrain Laminate

- 2406 Clear Cherry **E**
- 2409 Clear Maple
- 2410 Graphite Walnut
- 2412 Natural Cherry
- 2422 Medium Cherry **E**
- 2511 Winter on Maple **E**
- 2535 Virginia Walnut
- 2536 Blackwood
- 2538 Clear Walnut
- 2592 Blonde on Maple **E**
- 2704 Fonthill Pear
- 2714 Natural Walnut **E**
- 2897 Desert Oak
- 2HAK Clear Oak
- 2HAN Ash Noce
- 2HAT Acacia
- 2HAW Ash Wenge
- 2HBN Bisque Noce
- 2HBW Bisque Wenge
- 2HCN Clay Noce
- 2HCW Clay Wenge
- 2HSN Storm Noce
- 2HSW Storm Wenge
- 2HWA Grey Kingswood
- 2HWB Planked Walnut
- 2HWD Resolute Walnut
- 2HWE Natural Recon
- 2HWF Smoked Walnut **E**
- 2HZA Waxed Maple
- 2HZB Natural Ash
- 2HZC Aged Ash
- 2HZD Ashwood Oak
- 2HZE Ashwood Beige
- 2HZF White Washed Birchply

Price Group 2

Textured Laminate

- 2TH2 Fawn Cypress
- 2TH4 Saddle Oak
- 2TH5 Veranda Teak
- 2TH7 Walnut Heights
- 2UH1 Reclaimed Aggregate
- 2UH2 Reclaimed Gravel
- 2UH4 Cement
- 2UH6 Sheetrock

Price Group 3

Solid Laminate

- 24H1 Satin White
- 24H2 Satin Black
- 24H3 Satin Stone
- 24H4 Satin Mocha

Custom Surfaces

Open Line Laminate (OLL)

This service allows you to order non-standard laminate at an additional processing fee of \$111 U.S. per unit, plus the cost of the laminate.

High-Pressure Laminate pricing does not include premium or digitally printed patterns from any suppliers. Laminate cost may also vary for basic or standard laminates from other suppliers. Please contact the OLL consultant at 616.475.2426 for pricing. The cost of the laminate will be added to your invoice as a separate line on the acknowledgement.

When processing orders for Open Line laminate, specify 2900 in the laminate finish field and enter the OLL manufacturer information. Specify appropriate 2K finish number for the edge finish.

Laminate Approval and Material Requirements

To confirm whether a particular laminate has already been tested for use on a specific Steelcase product or to determine material square foot requirements:

- Visit www.steelcase.com

For additional information, refer to the *Steelcase Surface Materials Reference Manual*.

Paint

Steelcase Surfaces

Applies to:

- Aisla panel
- Transaction top bracket
- Aisla HIU storage grommet
- Aisla HIU storage metal HIU shelf

Price Group 1

Smooth Paint

- 4231 Arctic White
- 4238 Mocha
- 4239 Clay
- 4240 Chalk
- 4242 Milk
- 4243 Merle Smooth
- 4858 Seagull

Textured Paint

- 7241 Arctic White

Price Group 2

Smooth Paint

- 0835 Black
- 4700 Warm White

Smooth Metallic Paint

- 4728 Nickel Metallic **E**
- 4799 Platinum Metallic **E**
- 4803 Near Black

Price Group 3

Lux Coatings

- 4B20 Obsidian
- 4B22 Matte Brass
- 4B23 Burnished Bronze
- 4B24 Night Bronze
- 4B25 Matte Copper
- 4B26 Smoked Mica

Applies to:

- Aisla powered panel base trim

Price Group 1

Smooth Paint

- 4238 Mocha
- 4239 Clay
- 4240 Chalk
- 4242 Milk Smooth

Textured Paint

- 7207 Black
- 7225 Sand
- 7237 Slate
- 7238 Fieldstone
- 7239 Midnight
- 7241 Arctic White
- 7243 Seagull
- 7250 Sterling Dark Solid
- 7360 Merle

Price Group 2

Smooth Paint

- 0835 Black
- 4700 Warm White

Smooth Metallic Paint

- 4728 Nickel Metallic **E**
- 4750 Champagne Metallic
- 4798 Sterling Metallic **E**
- 4799 Platinum Metallic
- 4803 Near Black Metallic

Price Group 3

Accent Paint

- 1ATG Rose Quartz
- 4AV3 Blue Jay
- 4AV4 Baltic
- 4AX1 Citron
- 4AY2 Chili
- 4AZ5 Marlin
- 4CL1 Dark Olivine
- 4CL2 Ice Blue
- 4CL3 Aura
- 4CL4 Sea Glass
- 4CL5 Light Matcha
- 4CL6 Terra
- 4CL7 Sandstone
- 4CL8 Smokey Plum
- 4CZ5 Honey
- 4CZ6 Lagoon

Lux Coatings

- 4B20 Obsidian
- 4B22 Matte Brass
- 4B23 Burnished Bronze
- 4B24 Night Bronze
- 4B25 Matte Copper
- 4B26 Smoked Mica

Plastic

Steelcase Surfaces

Applies to:

- Transaction top edge on panels and powered panels
- Aisla HIU storage top edge

- 6034 Natural Cherry
- 6036 Medium Cherry
- 6037 Winter on Maple
- 6038 Blonde on Maple **E**
- 6041 Natural Walnut **E**
- 60AL Scarlet
- 60UB Burnished Bronze
- 6169 Stone
- 6170 Mocha
- 61AA Persian Salt
- 61AB Rose
- 61AC Indigo
- 61AD Green Citrine **E**
- 61AE Dark Olivine
- 61AF Cloudy
- 6213 Acacia
- 6219 Clear Oak
- 6231 Graphite Walnut
- 6237 Clear Maple
- 6242 Virginia Walnut
- 6243 Blackwood
- 6245 Clear Walnut
- 6249 Platinum Solid
- 6271 Plywood
- 6677 Chocolate Walnut
- 66WA Grey Kingswood
- 66WB Planked Walnut
- 66WD Resolute Walnut
- 66WE Natural Recon
- 66WF Smoked Walnut
- 66WU Clay
- 66WV Chalk
- 6703 Ash Wenge
- 6704 Storm Wenge
- 6705 Bisque Wenge
- 6706 Clay Wenge
- 6707 Ash Noce
- 6708 Bisque Noce
- 6709 Clay Noce
- 6710 Storm Noce
- 6T02 Fawn Cypress
- 6T04 Saddle Oak
- 6T05 Veranda Teak
- 6T07 Walnut Heights
- 6T08 Aggregate
- 6T09 Gravel
- 6T10 Cement
- 6T12 Sheetrock

E = Excluded

Applies to:

- Aisla duplex receptacles finish to floor (A-height)
- 6000 Black

Applies to:

- Aisla duplex receptacles aisle side (C-height)
- 6000 Black
6009 Arctic White
6249 Platinum Solid
6651 Tungsten **E**
6652 Titanium **E**
6654 Sand
6697 Fog
6B03 Red

Plated Metal

Steelcase Surfaces

► See *Plated and Painted Metal Color Availability Matrix* on page 169 for color availability by product line.

- 8043 Anodized Aluminum
9201 Polished Chrome
9211 Nickel
9212 Silver
9250 Ember Chrome

Glass

Steelcase Surfaces

Applies to:

- Integrated glass on panels and powered panels

Price Group 1

- 6500 Clear

Price Group 3

- 6501 Low Iron Clear

Price Group 4

- 6562 Bronze
6563 Smoke

Vertical Surface Fabric

Applies to:

- Aisla fabric-wrapped magnetic panel

Steelcase Surfaces

Price Group 1

Abacus **E**

- P123 Portico
P124 Opus
P125 Cusp
P126 Artifact

Alloy

- P525 Polar
P526 Skim
P527 Bubbly
P528 Tern
P529 Shore
P530 Asti
P531 Silver
P532 Oxide
P533 Element
P534 Construct
P535 Currency
P536 Iron

Boccie

- P200 New Rice
P201 New Almond
P203 New Camel
P204 New Opal
P205 New Mist
P206 New Plum
P208 New Spearmint
P209 New Sky

Buzz2

- 5F03 Tomato
5F04 Red **E**
5F05 Burgundy
5F06 Sky **E**
5F07 Blue
5F08 Navy
5F15 Stone
5F16 Grey
5F17 Black
5G50 Dunegrass
5G51 Sable
5G55 Pumpkin
5G57 Rouge
5G59 Meadow
5G61 Cyan
5G62 Atlantic
5G63 Crocus
5G64 Alpine
5G65 Tornado

Charm

- P505 Shell
P506 Mimosa
P507 Birch
P508 Sparkle
P510 Debut
P511 Clover
P513 Twilight

Optic

- P540 Hazel
P541 Twinkle
P542 Orion
P547 Bath
P548 Whisper
P549 Breezy
P551 Glimmer

Pianista

- P420 Sand
P421 Mist
P422 Rain
P423 Natural
P424 Café
P425 Denim
P426 Carbon
P427 Stone
P428 Flax
P429 Oat
P430 Wheat
P431 Maize

Rhythm

- P555 Allegro
P556 Tempo
P557 Refrain
P560 Melody
P562 Opus

Tinsel

- P515 Sugar
P516 Lit
P517 Ego
P518 Fizz
P519 Muse
P520 Depth
P521 Bliss
P522 Grow
P523 Dolce
P524 Boost

Price Group 2

Bariolage

- G200 New Etude
G201 New Andante **E**
G202 New Cantata **E**
G203 New Adagio
G204 New Melody
G205 New Ballata

Code

- 5FA1 Fossil
5FA2 Gabbro
5FA3 Reed
5FA4 Bluff
5FA5 Sea Salt
5FA6 Cannon
5FA7 Tussah
5FA9 Ecru
5FB1 Bamboo

Dovetail by Designtex

- 5H39 Light Mocha
5H40 Pebble
5H41 Warm White
5H42 Sandstone
5H43 Honeycomb
5H44 Terra
5H45 Honeydew
5H46 Denim
5H47 Storm
5H48 Ice Blue
5H49 Aura
5H50 Darkest Grey

Flip: Orbit

- 5F85 Mud Pie **E**
5F87 Petoskey
5F89 Papyrus
5F91 Blizzard
5F92 Briquette

Flip: TexHex

- 5F75 Mud Pie **E**
5F77 Petoskey
5F79 Papyrus
5F97 Blizzard
5F98 Briquette

Fresco

- G001 Sandrift
G002 Mistblu
G003 Faon

Intersection

- P211 Summit
P212 Chalk
P213 Lace

Latch

- P600 Seashell
P601 Clam
P602 Eggshell
P603 Zen
P604 Cool Gray
P605 Armor
P606 Sentinel
P608 Billow
P609 Nimbus

SoftNext

- 5H27 Obsidian
5H28 Foggy Night
5H29 Greystone
5H30 Mocha
5H31 Clay
5H32 Sandstone
5H33 Chalk
5H34 Midnight
5H35 Blue Mica
5H36 Jade
5H37 Burnt Umber
5H38 Cinnabar

Stencil

- P455 Midnight
P456 Mulberry
P457 Cracked Pepper
P458 Denim
P459 Chartreuse
P460 Bittersweet
P461 Mauvelous
P462 Bermuda
P463 Concrete
P464 Orchid
P465 Parchment
P466 Silk
P467 Sea Salt
P468 Honeydew
P469 Sepia

Price Group 3

Billiard Multi-Use by Designtex

- 5H11 Poppy
5H12 Tangelo
5H13 Citrine/Citron
5H14 Avocado
5H16 Indigo
5H17 Mallard
5H18 Teak
5H19 Cumulus
5H20 Pewter
5H21 Gunmetal
5H22 Ink
5H23 Rose Quartz
5H24 Sea Salt
5H25 Storm Cloud
5H26 Olivine

Custom Surfaces

Price Group COM (Customer's Own Material)

Fabric Approval and Yardage

To confirm whether a particular COM material has already been tested for use on a specific Steelcase product or to determine actual yardage requirements:

- Visit www.steelcase.com

For additional information regarding Customer's Own Material, call 1.888.STEELCASE (1.888.783.3522) or send an e-mail to lineone@steelcase.com.

E = Excluded

Veneer Cut Guidelines

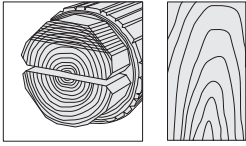

Flat Cut

Veneer is cut parallel to the flat side of the cant at a tangent to the growth rings of the tree. This produces a cathedral or oval pattern. On average, there is a 6-8" wide leaf width. On an 18" wide surface, there will likely be three leaves showing a repeated pattern.

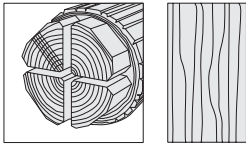

Quarter Cut

Veneer is cut from quarter sections of the log which are produced by cutting each cant in half. Cutting lines are at an angle of approximately 90 degrees to the growth rings at the center of the quarter. This produces a straight grain or ribbon pattern. On average, leaves are 2½-4" wide.

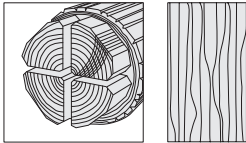

Rift Cut

This veneer cut is specifically for oak. Cutting lines are an arc approximately perpendicular to the growth rings. This produces a comb-like straight grain or ribbon pattern. On average, leaves are 2½-4" wide.

Color Availability Matrices

Plated and Painted Metal

Not every plated metal color is available on every metal component. This matrix gives you an overview of which plated metal colors are available on each component.

Legend

- = Not available
- = Available
- = Available with exceptions
- ⓔ = Excluded

	0835 Black	4231 Arctic White	4238 Mocha	4239 Clay	4240 Chalk	4242 Milk Smooth	4243 Merle Smooth	4700 Warm White	4728 Nickel Metallic ⓔ	4799 Platinum Metallic ⓔ	4803 Near Black Metallic	4858 Seagull	4820 Obsidian	4822 Matte Brass	4823 Burnished Bronze	4824 Night Bronze	4825 Matte Copper	4826 Smoked Mica	7207 Black	7241 Arctic White	7278 Dark Bronze	7280 Smooth Bronze	8043 Clear Anodized Aluminum	9201 Polished Chrome	9211 Nickel	9212 Silver	9250 Ember Chrome	
Aisla																												
Locks	•	•	•	•	•	•	•	•	•	•	•	•	•	•	•	•	•	•	•	•	•	•	•	■	•	•	•	■
Transaction top bracket	■	■	■	■	■	■	■	■	■	■	■	■	■	■	■	■	■	■	■	•	■	■	•	•	•	•	•	•
HIU storage grommet	■	■	■	■	■	■	■	■	■	■	■	■	■	■	■	■	■	■	■	•	■	■	•	•	•	•	•	•
Metal HIU shelf	■	■	■	■	■	■	■	■	■	■	■	■	■	■	■	■	■	■	•	■	■	•	■	■	■	■	■	•
Nile pull	■	•	•	•	•	•	•	•	•	■	•	•	•	•	•	•	•	•	•	•	•	■	•	■	■	•	•	•
Ledge pull	•	•	•	•	•	•	•	•	•	■	•	•	•	•	•	•	•	•	■	•	•	•	•	•	•	•	•	•
Beam pull	•	•	•	•	•	•	•	•	■	•	■	•	•	•	•	•	•	•	•	■	■	•	■	•	•	•	•	•
Contemporary pull	•	•	•	•	•	•	•	•	•	•	■	•	•	•	•	•	•	•	•	■	■	■	■	■	■	■	■	•
Align pull	■	■	■	■	■	■	■	■	■	■	■	■	■	■	■	■	■	■	•	■	■	■	■	■	■	■	■	•



Resources

Lock and Keying	172
Style Number Index	174

Lock and Keying

Aisla products are available with field-installed lock plugs only. Lock cylinders are ordered separately.

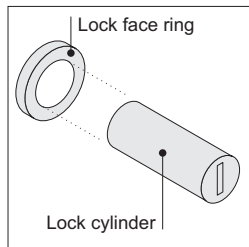

Locks consist of a factory- or field-installed lock cylinder and a factory-installed lock face ring.

Two types of locks are available — the standard keying system (FR series) and the master keying system (XF series). All the locks in the XF series can be opened with a single master key.

Factory-Installed Keying

Factory-installed locks are always key random (standard) or master key random (optional on some product lines). Key random means that the locks will be assigned arbitrarily at the factory with key numbers ranging from FR305 to FR999 (Master keying numbers: XF1001 to XF3000). All locks within a unit will be keyed alike.

Tip: Random keying can mean that different furniture units will have the same key number. If you must have all locks keyed differently, you should specify field-installed, key specific or key consecutive lock cylinders.
▶ See below.

Key Random

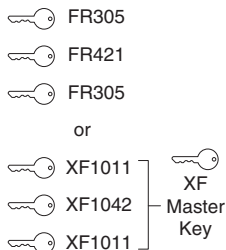

Required to Specify

Master key random +\$39 Specify with master key random.

Field-Installed Keying

Field-installed locks are only available on products that include factory-installed lock mechanisms.

Specify "plug" when specifying furniture, and the product will ship with a plastic plug in place of the lock cylinder.

Front-removable lock cylinders must be specified separately. You must also order a special lock tool to install or remove lock cylinders in the field.

Tip: Lock tools are reusable. You do not need to order additional lock tools with every furniture order.

Lock cylinders will be shipped separately so that you can install the locks when you are ready.

Three keying choices are available for field installation — random (standard), specific, and consecutive. All three are also available with master keying, which means that all locks can be opened with a single master key.

Key random means that the locks will be assigned arbitrarily at the factory with key numbers ranging from FR305 to FR999 (Master keying numbers: XF1001 to XF3000).

Tip: Random keying can mean that different furniture units will have the same key number. If you must have all locks keyed differently, you should specify key specific or key consecutive lock cylinders.

Key Random

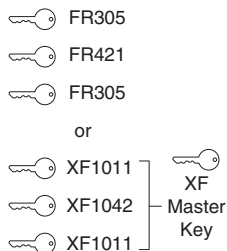

Key specific means that you can specify any key number from FR305 to FR999 (Master keying numbers: XF1001 to XF3000). This option can be used to key all the furniture units in a workstation or department the same.

Tip: Designate the quantity per key number in your specification.

▶ See example at right.

Key Specific

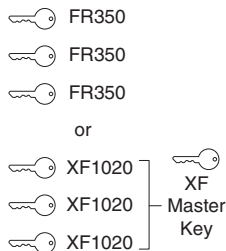

Key consecutive means that you can specify lock numbers in a consecutive order to ensure that no two locks have the same key number until the key sequence repeats. You must select a beginning key number from FR305 to FR999 (Master keying numbers: XF1001 to XF3000).

Key Consecutive

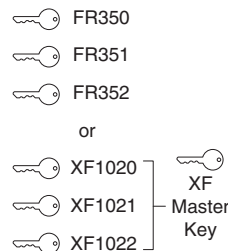

Example of a typical lock cylinder specification is shown below:

10	LOCKFR FR320
5	LOCKFR FR350
15	LOCKXF XF1100
30	Total
1	877102003SR standard lock tool
1	877102002SR master lock tool



For Canadian Pricing

Multiply U.S. Price by the Canadian price factor.
▶ See page 1 for details.

Field-Installed Lock Cylinders

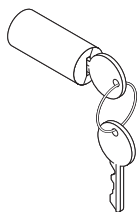

Tip: Lock price is included in price of furniture with locks.

Tip: For replacement lock cylinders, refer to Service Parts.

Tip: You can change lock cylinders in the field by using the appropriate lock tool.

Standard Includes	Required to Specify
-------------------	---------------------

- | | |
|---|--|
| <ul style="list-style-type: none"> • Lock cylinder, keyed random • Two keys | <ul style="list-style-type: none"> 1 Style number 2 Lock finish <ul style="list-style-type: none"> 9201 Polished Chrome 9250 Ember Chrome 3 Options, if selected (see below) |
|---|--|

Options	U.S. Price	Required to Specify
---------	------------	---------------------

Key specific	No cost	Select key number from FR305–FR999.
Key consecutive	No cost	Specify <i>key consecutive</i> and must select beginning key number from FR305–FR999.
Master key random	+\$39 each	Specify <i>master key random</i> .
Master key specific	+\$39 each	Specify key number from XF1001–XF3000.
Master key consecutive	+\$39 each	Specify <i>master key consecutive</i> and must select beginning key number from XF1001–XF3000.

Specification Information	
---------------------------	--

Style Number	U.S. Base Price

FR Series (Standard Keying System)—Lock Cylinder

LOCKFR	No cost

Standard Lock Tool

877102003SR	\$39

XF Series (Master Keying System)—Lock Cylinder

LOCKXF	No additional cost. Price included in price of furniture with master-keyed locks.

Master Lock Tool

877102002SR	\$39



For Canadian Pricing
 Multiply U.S. Price by the Canadian price factor.
 ▶ See page 1 for details.

Style Number Index

Style Number	Page	Description
877102002SR	173	Master Lock Tool
877102003SR	173	Standard Lock Tool
BSPWERINFD	126	Aisla Base Power Infeeds
DPLXA	127	Aisla Duplex Rcptcls Finish to Floor (A Hght)
DPLXC	128	Aisla Duplex Rcptcls Aisle Side (C Hght)
FWMPNL	131	Aisla Fabric-Wrapped Magnetic Panel
HJKIT	125	Aisla Harness/Jumper Kit
LOCKFR	173	Lock Cylinder
LOCKXF	173	Lock Cylinder
PNLFI	55	Aisla Panel Free/Inline
PNLFIP	95	Aisla Powered Panel Free/Inline
PNLFM	52	Aisla Panel Free/Miter
PNLFMP	92	Aisla Powered Panel Free/Miter
PNLFS	54	Aisla Panel Free/Spanning
PNLFSP	94	Aisla Powered Panel Free/Spanning
PNLFT	53	Aisla Panel Free/T
PNLFTP	93	Aisla Powered Panel Free/T
PNLII	66	Aisla Panel Inline/Inline
PNLIIP	106	Aisla Powered Panel Inline/Inline
PNLIM	68	Aisla Panel Inline/Miter
PNLIMP	108	Aisla Powered Panel Inline/Miter
PNLIS	67	Aisla Panel Inline/Spanning
PNLISP	107	Aisla Powered Panel Inline/Spanning
PNLIT	69	Aisla Panel Inline/T
PNLITP	109	Aisla Powered Panel Inline/T
PNLMM	74	Aisla Panel Miter/Miter
PNLMMP	114	Aisla Powered Panel Miter/Miter
PNLMS	75	Aisla Panel Miter/Spanning
PNLMSP	115	Aisla Powered Panel Miter/Spanning
PNLMT	76	Aisla Panel Miter/T
PNLMTP	116	Aisla Powered Panel Miter/T
PNLSPNFF	87	Aisla Spanning Panel Free/Free
PNLSS	60	Aisla Panel Spanning/Spanning
PNLSSP	100	Aisla Powered Panel Spanning/Spanning
PNLST	61	Aisla Panel Spanning/T
PNLSTP	101	Aisla Powered Panel Spanning/T
PNLTT	82	Aisla Panel T/T
PNLTTP	122	Aisla Powered Panel T/T
PWRKIT	123	Aisla Power Kit
PWRKITNW	124	Aisla Power Kit - No Whip
WPCBLH	135	Aisla Cabinet - Hinged Left
WPCBRH	135	Aisla Cabinet - Hinged Right
WPCD15BFBFHIUPL	143	Credenza—1.5H BF Lateral File/BF Lateral File/HIU, Parallel, LH
WPCD15BFBFHIUPP	151	Credenza—1.5H BF Lateral File/BF Lateral File/HIU, Perpendicular, LH
WPCD15BFIUPL	141	Credenza—1.5H BF Lateral File/HIU, Parallel, LH
WPCD15BFIUPP	149	Credenza—1.5H BF Lateral File/HIU, Perpendicular, LH
WPCD15HIUBFBFPL	142	Credenza—1.5H HIU/BF Lateral File/BF Lateral File, Parallel, RH
WPCD15HIUBFBFPP	150	Credenza—1.5H HIU/BF Lateral File/BF Lateral File, Perpendicular, RH

Style Number	Page	Description
WPCD15HIUBFPL	140	Credenza—1.5H HIU/BF Lateral File, Parallel, RH
WPCD15HIUBFPP	148	Credenza—1.5H HIU/BF Lateral File, Perpendicular, RH
WPDRLIN	160	Storage Drawer Liner
WPHIU15HPLLH	155	Low Storage—1.5H HIU, Parallel, LH
WPHIU15HPLRH	155	Low Storage—1.5H HIU, Parallel, RH
WPHIU15HPPLH	159	Low Storage—1.5H HIU, Perpendicular, LH
WPHIU15HPPRH	159	Low Storage—1.5H HIU, Perpendicular, RH
WPHIU1HPLLH	154	Low Storage—1H HIU, Parallel, LH
WPHIU1HPLRH	154	Low Storage—1H HIU, Parallel, RH
WPHIU1HPPLH	158	Low Storage—1H HIU, Perpendicular, LH
WPHIU1HPPRH	158	Low Storage—1H HIU, Perpendicular, RH
WPPNTR	161	Storage Pencil Tray
WPPRTR	162	Storage Paper Tray

Trademark List

™/® The following is a non-exhaustive list of trademarks and registered trademarks for products of Steelcase Inc. or one of its related corporate entities: Agree, Airtouch, Aisla, Alight, Amia, Answer, Apprise, Aspekt, Avenir, Await, B-Free, Ballet, Bassline, Bindu, Bivi, Bix, Bottomline, Brody, Buoy, Cachet, Campfire, Capa, CF Series, CG_1, Chord, Circa, Clipper, Cobi, Collaboration, Convene, Coupe, Cura, Currency, dash, Divisio, Duo, E-Table 2, Edge Series, Elbrook, Elective Elements, Embold, Empath, Everwall, Exponents, Folio, FrameOne, Gesture, Groupwork, Host, Hosu, i2i, Jenny, Kart, Kathryn, Kick, Lagunitas, Leap, Leela, LessThanFive, LiveBack, LiveSeat, Mackinac, Marien152, Max-Stacker, media:scape, Migration, Millbrae, Mineral, Mitra, Montage, Montara650, MoreThanFive, Move, Node, Ocular, Ology, Opus, Paperflo, Passerelle, Player, Pocket, Potrero415, QiVi, Radia, Regard, Relay, Reply, Ripple, Roam, Sarto, Scoop, Sebastopol, Senti Series, Senza, Shortcut, Sidewalk, Siento, Sieste, SILQ, Soffio, Sorrel, SOTO, Steelcase Eclipse, Steelcase Flex, Steelcase Karman, Steelcase Relay, Steelcase Rise, Steelcase Series, Surround, SW_1, Switch, Sync, Tava, Tenor, Think, Thoughtful, Thread, Together, Train, Trees, Turnstone, Umami, Underscore, V.I.A., Verb, Verge, Verlay, Victor2, Visalia, WorkValet, and X-tenz.

™/® The following are trademarks or registered trademarks of AMQ Solutions, LLC: 3F, Activ, Amobi, Bixby, Bodi, Cluvo, Concur, Embank, FL-X, Iline, Jaku, Kinex, Personality Plus, Revi, S-Series, Siya, Tektis, Tizu, Uptake, and Zilo.

™/® The following are trademarks or registered trademarks of Orangebox Ltd., Cardiff, UK: Air3, Aspect, Avi, Away from the Desk, Border, Campers & Dens, Coppice, Cubb, Kirm, On the QT, Ramsey, Skomer, Sully, Track-B, and Vale.

™/® The following are trademarks or registered trademarks of Viccarbe Habitat, S.L.: Aleta, Cambio, Designed in The Sun, Foro, Funda, Holy Day, Kelly, Last Minute, Noha, Savina, Sistema, Sistema, Viable, and Wrapp.

® The following are registered brands of Steelcase Inc. and its family of companies: Steelcase, AMQ, Coalesse, Designtex, Halcon, Orangebox, Smith System, and Viccarbe.

® The following registered trademarks are under license from AWI Licensing Company, Dover, DE: SoundScapes, DuraBrite, BioBlock, and Armstrong.

® The following registered trademarks are under license from Byrne Electrical, Rockford, MI: Interport, Mini-Port, Axil Z, and Ellora.

® The following is a registered trademark of DuPont, Wilmington, DE: Corian.

® The following is a registered trademark of Genlyte Thomas Company, Louisville, KY: Lightolier.

® The following is a registered trademark of Hilti Corporation, FL-9494 Schaan, Principality of Liechtenstein: Hilti.

® The following is a registered trademark of Leviton Manufacturing Company, Little Neck, NY: Decora.

® The following is a registered trademark of Mechanical Plastics Corp, Elmsford, NY: Toggler.

® The following is a registered trademark of Microsoft Corporation, Redmond, WA: Microsoft.

® The following are registered trademarks of Orangebox Ltd., Cardiff, UK: Orangebox.

® The following is a registered trademark of Panduit Corporation, Lockport, IL: Panduit.

® The following is a registered trademark of Trav (Press), Cuneo, Italy: Assisa.

® The following is a registered trademark of Virtual Ink, Boston, MA: mimioActive.

® The following registered trademarks are under license from Wilkhahn Furniture Products: Avera, Senzo, Versal, and Wilkhahn FS.

® The following are registered trademarks of Polyvision Corp: Flow, Motif, Polyvision, Sans, and Serif.

® The following is a registered trademark of Wilsonart International, Temple, TX: Chemsurf.

® The following is a registered trademark of Wiremold, West Hartford, CT: Wiremold.

® The following is a registered trademark of EMU Group S.P.A., Perugia, Italy: EMU.

® The following is a registered trademark of Security People, Inc.: Digilock.

® The following are registered trademarks of Natural Capital Partners Europe Limited: CarbonNeutral and the CarbonNeutral Certified logo.

™ The following is a trademark of Microsoft Corporation, Redmond, WA: Windows.

™ The following is a trademark of Rodman Industries, Inc., Oconomowoc, WI: ResinCore1.

™ The following is a trademark of Ultrafabrics, LLC, Elmsford, NY: Ultraleather.

™ The following trademarks are under license from Wilkhahn Furniture products: Cana, Linus, Logon, Picto, Range, Stitz, Thema, Timetable, and Tubis.

™ The following trademarks are under license from Walter Knoll: Andoo, Bob, Lazlo, Lox, Ribbon, and Together.

™ The following trademarks are under license from PP Mobler: Bar and Flag Halyard.

™ The following trademarks are under license from Carl Hansen: Elbow, Paddle, Shell, Wing, and Wishbone.

™ The following trademarks are under license from Cambridge Sound Management, LLC Cambridge, MA: QtPro Soundmasking, Qt Quiet Technology, and Sonet Qt.

™ The following is a trademark of Electri-Cable Assemblies, Shelton, CT: Interact.

™ The following is a trademark of Clestra Hauserman: IRYS.

™ The following is a trademark of Wiesner-Hager Möbel GmbH: Nooi.

™ The following are trademarks of Polyvision: Accord, a3, e3, Boundri, and Nota.

™ The following is a trademark of Bostock Company, Inc: SnapCab.

™ The following is a trademark of Williams-Sonoma, Inc: West Elm.

™ The following is a trademark of Elena Marquina Testor: nanimarquina.

™ The following is a trademark of Forbo International SA: Forbo.

Trademarks used herein are the property of Steelcase Inc. or their respective owners.