Coalesse Seating and Occasional Tables

Volume 5a

► For more detailed product information, see the *Coalesse Specification Guides* or consult your Steelcase dealer.

Terms and Conditions	2
Discount Matrix	6
Sample Order Form	12
Steelcase Showrooms and Manufacturing Locations	14

Seating/Occasional Tables	15
Lounge Seating	31
Guest/Side/Stack Seating	133
Collaboration Seating	159
Occasional Tables	167

Surface Materials	177
Resources	215

► For a list of all trademarks, refer to the last page of this specification guide.

Terms and Conditions

Customer Information

For more information, please contact your participating Steelcase GSA dealer.

For more information, please contact your participating Steelcase GSA dealer.

For more information, please contact your participating Steelcase GSA dealer.

For more information, please contact your participating Steelcase GSA dealer.

For more information, please contact your participating Steelcase GSA dealer.

For more information, please contact your participating Steelcase GSA dealer.

For more information, please contact your participating Steelcase GSA dealer.

For more information, please contact your participating Steelcase GSA dealer.

For more information, please contact your participating Steelcase GSA dealer.

For more information, please contact your participating Steelcase GSA dealer.

Sample Order Form

Sample Order Form

ORDER FOR SUPPLIES OR SERVICES	PAGE _____ OF _____ PAGES
--------------------------------	---------------------------

IMPORTANT: Mark all packages and papers with contract and/or order numbers.

DATE OF ORDER 1 4-15-24	CONTRACT NO. (If any) 2 47QSMS24D0034	ORDER NO. 3 10 - 000	REQUISITION/REFERENCE NO.
-----------------------------------	---	--------------------------------	---------------------------

ISSUING OFFICE (Address correspondence to) 4 GSA 1 Town Street City, State, Zip Name and Telephone Number	SHIP TO: (Consignee and address, ZIP Code) 5 GSA 2 Town Street City, State, Zip Name and Telephone Number
--	--

TO: CONTRACTOR (Name, address and ZIP Code) 6 Steelcase Inc. c/o Participating Dealer 901 44th Street, SE Grand Rapids, MI 49508 Attn: Solutions Fullfillment Team CH-2W-SS (GSA)	Cage Code: 39880	TYPE OF ORDER <input type="checkbox"/> A. PURCHASE — Reference your _____ Please furnish the following on the terms and conditions specified on both sides of this order and on the attached sheets, if any, including delivery as indicated. This purchase is negotiated under authority of: _____ <input type="checkbox"/> B. DELIVERY — Except for billing instructions on the reverse, this delivery order is subject to instructions contained on this side only of this form and is issued subject to the terms and conditions of the above-numbered contract.
--	------------------	---

ACCOUNTING AND APPROPRIATION DATA	REQUISITIONING OFFICE
	BUSINESS CLASSIFICATION (Check appropriate box(es)) 20 <input type="checkbox"/> SMALL <input checked="" type="checkbox"/> OTHER THAN SMALL <input type="checkbox"/> DIS-ADVANTAGED <input type="checkbox"/> WOMEN-OWNED

FCA DESTINATION 7	GOVERNMENT NO.	DELIVER TO FCA DESTINATION ON OR BEFORE (Date) 8 ARO date	DISCOUNT TERMS 9 Net 30 days
PLACE OF INSPECTION AND ACCEPTANCE			

(See reverse for Rejections)

ITEM NO. (A)	SUPPLIES OR SERVICES (B)	QUANTITY ORDERED (C)	UNIT (D)	UNIT PRICE (E)	AMOUNT (F)	QUANTITY ACCEPTED (G)
1	10 One lot of Steelcase Office Furniture: See attached specifications	13 1		14 \$000	15 \$000	
2	11 Design: \$65.49/hour	2 hrs		\$000	\$000	
3	12 Installation	1		\$000	\$000	

SEE BILLING INSTRUCTIONS ON REVERSE	SHIPPING POINT	GROSS SHIPPING WEIGHT	INVOICE NO.			(H) TOT. (Cont. pages) ◀
	MAIL INVOICE TO: (Include ZIP Code) 17 GSA, 3 Town Street, City, State, Zip			16	\$000	(i). GRAND TOTAL ◀

UNITED STATES OF AMERICA BY (Signature) ▶ 18 Contracting Officer signature and telephone no.	NAME (Typed) 19 John Doe, Department Manager TITLE: CONTRACTING/ORDERING OFFICER
--	---

NSN 7540_01_152_8083

50347-101

OPTIONAL FORM 347 (10-83)
Prescribed by GSA
FAR (48 CFR) 53.213 (e)

- 1 Order date
- 2 Contract number
- 3 Order number
- 4 Issuing office: Requester name and telephone number
- 5 Shipping address: Contact name and telephone number
- 6 Contractor:
Steelcase Inc.
c/o Participating Dealer
901 - 44th Street, S.E.
Grand Rapids, MI 49508
Attn: Solutions Fulfillment Team
- 7 FCA destination
- 8 ARO date (After Receipt of Order)
- 9 Terms: Net 30 days
- 10 Complete product description, including SIN number, style number, all applicable surface materials.
- 11 Separate line for design
- 12 Separate line for installation
- 13 Quantity ordered
- 14 Individual unit price
- 15 Amount (quantity x unit price)
- 16 Total cost
- 17 Invoice address
- 18 Authorized contracting officer signature and telephone number
- 19 Authorized contracting officer name and title (typed)
- 20 Steelcase is the seller of record and is not registered as "small," "disadvantaged," or "woman-owned." If one of these boxes is checked in error, a modification will be required.

Please note on order that all invoice payments must be sent to:

Steelcase Inc.
62087 Collection Center Dr.
Chicago, IL 60693-0620

Storage and Delays

(Open Market) In the event that the site is not accessible, or safe and adequate storage space is not available during installation, the furnishings will be stored until delivery or installation can be accomplished. Pricing for storage will be negotiated on a project-by-project basis. Invoices will be sent to the local government purchasing facility upon delivery of the furniture to a designated storage facility. Steelcase shall provide notice to the Government purchasing facility that the furnishings are available for inspection by the Government at the Storage facility. Upon this notice, the Government, or representative for the Government, must inspect and accept the furniture prior to payment of any invoice. The inspection and acceptance must be completed within 15 days. Payment will be made by the Government 30 days after acceptance of the furniture.

Steelcase Showrooms and Manufacturing Locations

Showrooms

Atlanta

Steelcase Inc.
Suite 280
1545 Peachtree Street NE
Atlanta, GA 30309
Phone: (404) 523-2201

Chicago

Steelcase Worklife Chicago
Suite 300
222 Merchandise Mart
Chicago, IL 60654-1174
Phone: (312) 321-3720

Dallas

Steelcase Inc.
1616 Hi Line Drive
Dallas, TX 75207
Phone: (214) 871-3044

Grand Rapids

Steelcase Inc.
901 44th Street, SE
Grand Rapids, MI 49508-7594
Phone: (616) 247-2710

New York

Steelcase Worklife New York
4 Columbus Circle
New York, NY 10019-1100
Phone: (212) 445-8800

Philadelphia

Steelcase Inc.
One Liberty Place
1650 Market Street, 3rd Floor
Philadelphia, PA 19103-7307
Phone: (215) 561-5331

San Francisco

Steelcase Inc.
Suite 110
475 Brannan Street
San Francisco, CA 94107
Phone: (415) 344-6700

Washington D.C.

Steelcase Inc.
1000 F St NW #1000
Washington, DC 20004

Los Angeles

1150 S Olive St
Los Angeles, CA 90015
Phone: (310) 633-2200

Manufacturing Sites

Amex de Mexico

Calle 5 Sur No.160
Ciudad Industrial
Tijuana, Mexico B.C. 22500
Phone: 52-662-342-6234

Athens

214 Durham Drive
Athens, AL 35611
Phone: (256) 232-8112

Grand Rapids Wood Furniture

4100 68th Street SE
Caledonia, MI 49316
Phone: (616) 698-5735

Kentwood Distribution Center

4384 52nd Street SE
Kentwood, MI 49512-9673

Kentwood West

4360 52nd Street SE
Kentwood, MI 49512

Worktools

901 44th Street SE
Grand Rapids, MI 49508
Phone: (616) 247-2710

Reynosa Plant

Ave. Prologis S/N Ed. 8 Suite
801 Prologis Park Pharr Bridge
Reynosa,
Tamaulipas, Mx CP. 88780
Phone: 52-899-263-9000

Seating/Occasional Tables

Statement of Line 16

Lounge Seating (SIN 33721)	31
Guest/Side/Stack Seating (SIN 33721)	133
Collaboration Seating (SIN 33721)	159
Occasional Tables (SIN 33721)	167

Statement of Line

Lounge Seating

Await Lounge System

Specifying
▶ Page 32

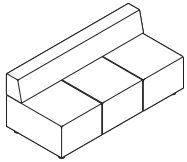

Three-Seat Lounge

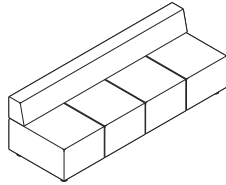

Four-Seat Lounge

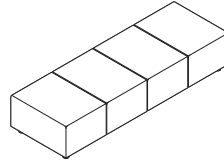

Four-Seat Bench



Mobile Ottoman

Await Lounge System Connector Benches and Tables

Specifying
▶ Pages 34 and 35

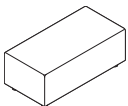

1-Section Connector Bench

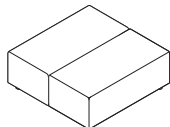

2-Section Connector Bench

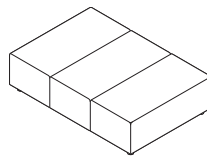

3-Section Connector Bench

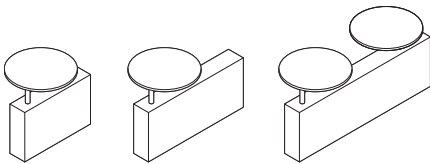

Connector Tables

Bix Lounge System Lounge Chairs

Specifying
▶ Page 38

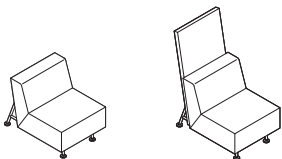

Bix Lounge System Sled Lounge Chairs

Specifying
▶ Page 39

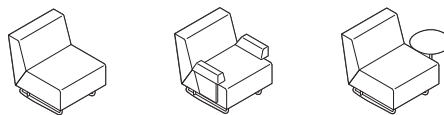

Statement of Line

Lounge Seating, continued

Bix Lounge System Sectional Seating

Specifying
▶ Page 40

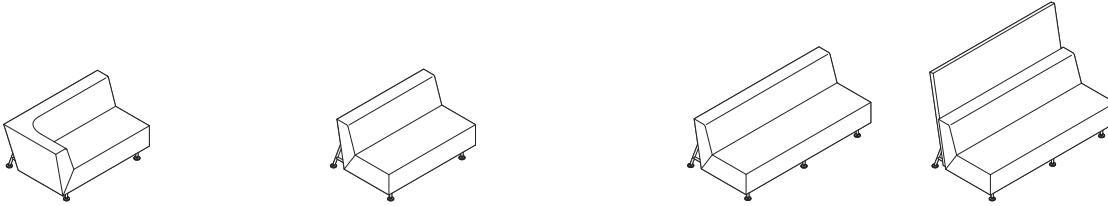

Bix Lounge System Benches

Specifying
▶ Page 43

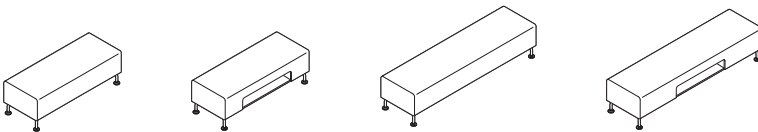

Bob Lounge Chairs

Specifying
▶ Page 48

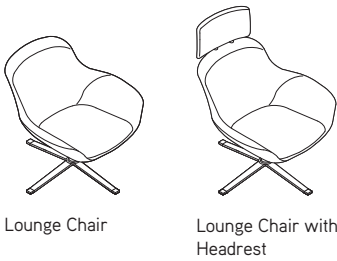

Statement of Line *continued*

Lounge Seating, continued

Circa Lounge System

Specifying
▶ Page 50

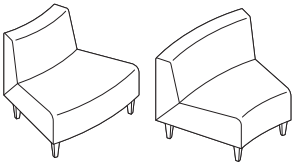

30° Outside/Inside
Facing Wedge
1-Seat Lounge

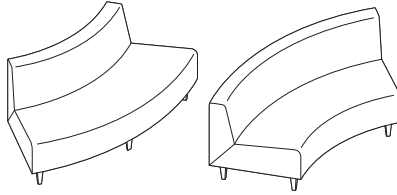

60° Wedge
2-Seat Lounge

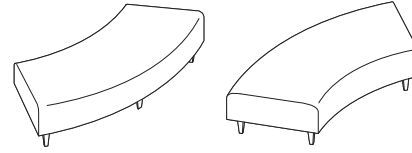

Wedge Bench

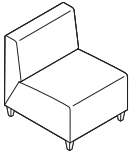

Straight Seat
1-Seat Lounge

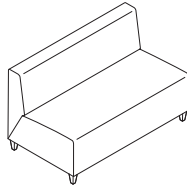

Straight
2-Seat Lounge

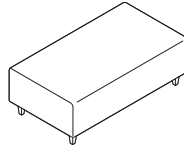

Straight Bench

Circa Lounge System Upholstered Modular Arm Rests and Ottoman

Specifying
▶ Page 54



Straight Armrest
Intermediate without Legs

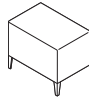

Straight Armrest
End-of-Run with Two Legs



15° Inside Armrest
Intermediate without Legs

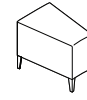

15° Inside Armrest
End-of-Run with Two Legs



15° Outside Armrest
Intermediate without Legs



15° Outside Armrest
End-of-Run with Two Legs

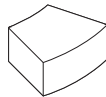

30° Inside Armrest
Intermediate without Legs

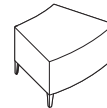

30° Inside Armrest
End-of-Run with Two Legs

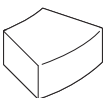

30° Outside Armrest
Intermediate without Legs

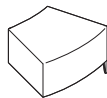

30° Outside Armrest
End-of-Run with Two Legs

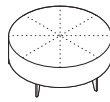

Round Ottoman

Statement of Line

Lounge Seating, continued

Circa Lounge System Modular Tables

Specifying
▶ Page 56

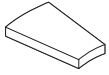

15° Low Wedge Table, Ganging

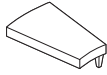

15° Low Wedge Table, End-of-Run, Two Legs

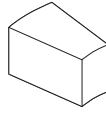

15° High Wedge Table, Ganging

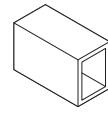

Straight High Table, Ganging

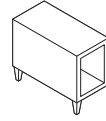

Straight High Table, End-of-Run, Two Legs

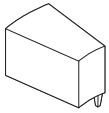

15° High Wedge Table, End-of-Run, Two Legs

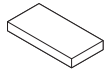

Straight Low Table, Ganging

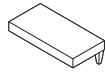

Straight Low Table, End-of-Run, Two Legs

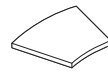

30° Low Wedge Table, Ganging



30° Low Wedge Table, End-of-Run, Two Legs



30° End-of-Run with One Leg

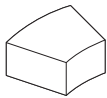

30° High Wedge Table, Ganging

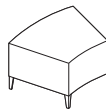

30° High Wedge Table, End-of-Run, Two Legs

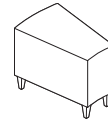

High Wedge

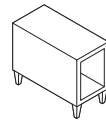

High Straight

Circa Lounge System Freestanding Round Table

Specifying
▶ Page 59

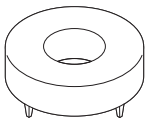

Round

Coupe Lounge Seating

Specifying
▶ Page 61

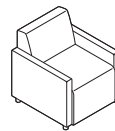

Lounge Chair

Coupe Grande/Mobile Lounge Seating

Specifying
▶ Page 62

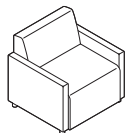

Grande Lounge Chair

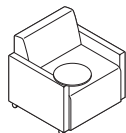

Grande Mobile Lounge Chair

Joel Lounge Chair

Specifying
▶ Page 64

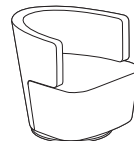

Statement of Line *continued*

Lounge Seating, continued

Ripple Bench

Specifying
▶ Page 66

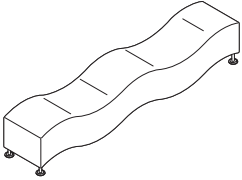

Upholstered
Wave Seat

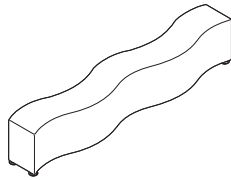

Upholstered
Flat Seat

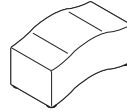

Little Ripple
Wave Seat

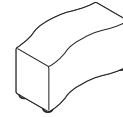

Little Ripple
Flat Seat

Sidewalk Lounge Seating

Specifying
▶ Page 68

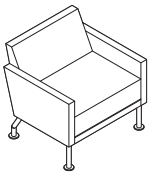

Low-Back Lounge Chair

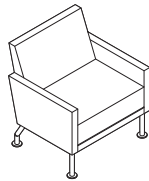

High-Back Lounge Chair

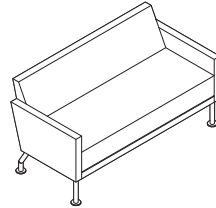

Two-Seat Lounge

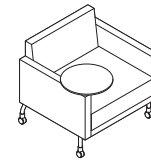

Mobile Low-Back Lounge
Chair with Tablet

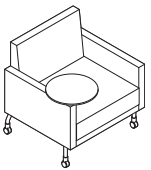

Mobile High-Back Lounge
Chair with Tablet



Arm Bolster

Sidewalk Collaborative Lounge Seating

Specifying
▶ Page 71

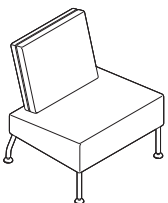

Lounge Chair

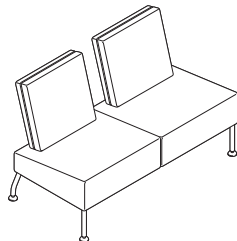

Two-Seat Lounge

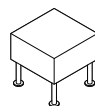

Ottoman

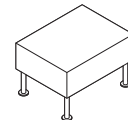
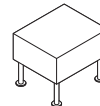

Statement of Line

Lounge Seating, continued

Sidewalk Lounge Seating Benches/Ottoman

Specifying
▶ Page 72

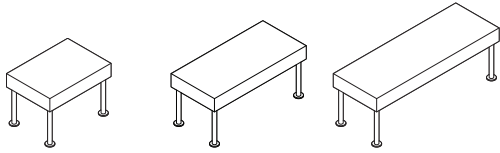

Benches

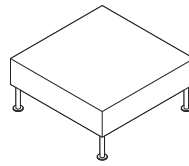

Ottoman

Davos Lounge Seating

Specifying
▶ Page 73

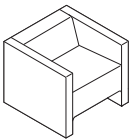

Lounge Chair

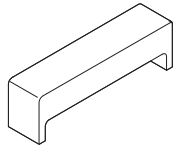

Large Bench

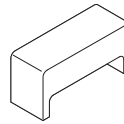

Medium Bench



Small Bench

Hosu Lounge Seating

Specifying
▶ Page 74

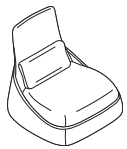

Lounge Chair with
Lumbar Pillow

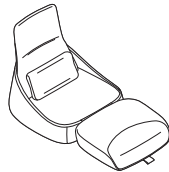

Lounge Chair with Ottoman
and Lumbar Pillow

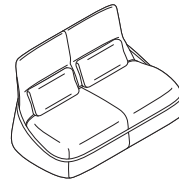

Two-Seat Lounge with
Two Lumbar Pillows

Millbrae Lifestyle Lounge Seating

Specifying
▶ Page 76

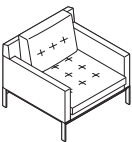

Lounge

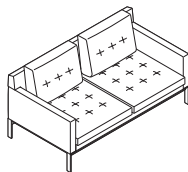

Two-Seat Lounge

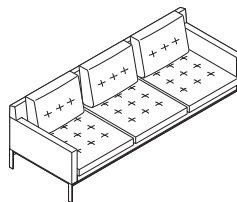

Three-Seat Lounge



Round Arm Bolster



Square Arm Bolster

Lounge Seating, continued

Millbrae Contract Lounge Seating

Specifying
▶ Page 76



Lounge
without Arms

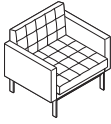

Lounge
with Arms



Lounge
with Left Arm Facing

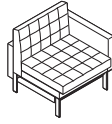

Lounge
with Right Arm Facing

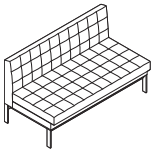

Two-Seat Lounge
without Arms

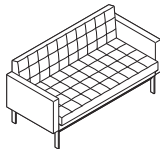

Two-Seat Lounge
with Arms

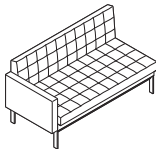

Two-Seat Lounge
with Left Arm Facing

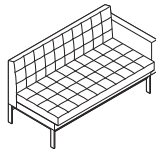

Two-Seat Lounge
with Right Arm Facing

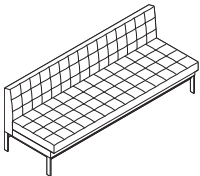

Three-Seat Lounge
without Arms

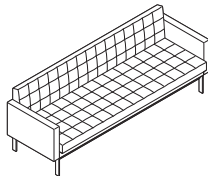

Three-Seat Lounge
with Arms

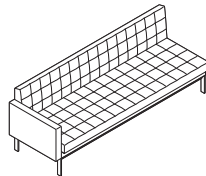

Three-Seat Lounge
with Left Arm Facing

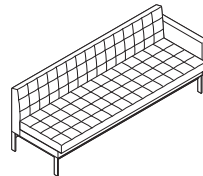

Three-Seat Lounge
with Right Arm Facing

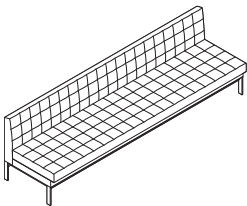

Four-Seat Lounge
without Arms

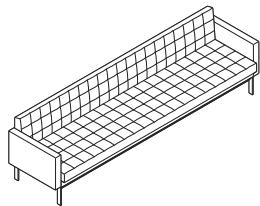

Four-Seat Lounge
with Arms

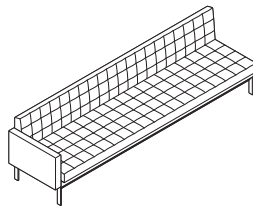

Four-Seat Lounge
with Left Arm Facing

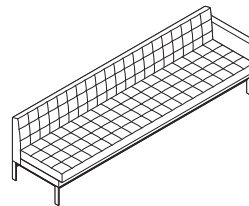

Four-Seat Lounge
with Right Arm Facing

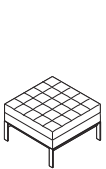

One-Seat
Bench

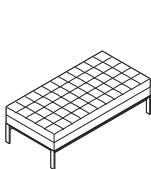

Two-Seat Bench

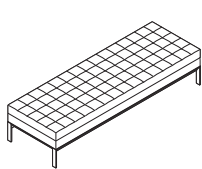

Three-Seat Bench

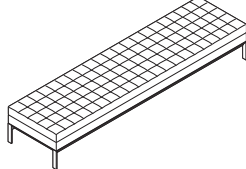

Four-Seat Bench

Statement of Line

Lounge Seating, continued

Lagunitas Lounge System

Specifying
▶ Pages 82-111

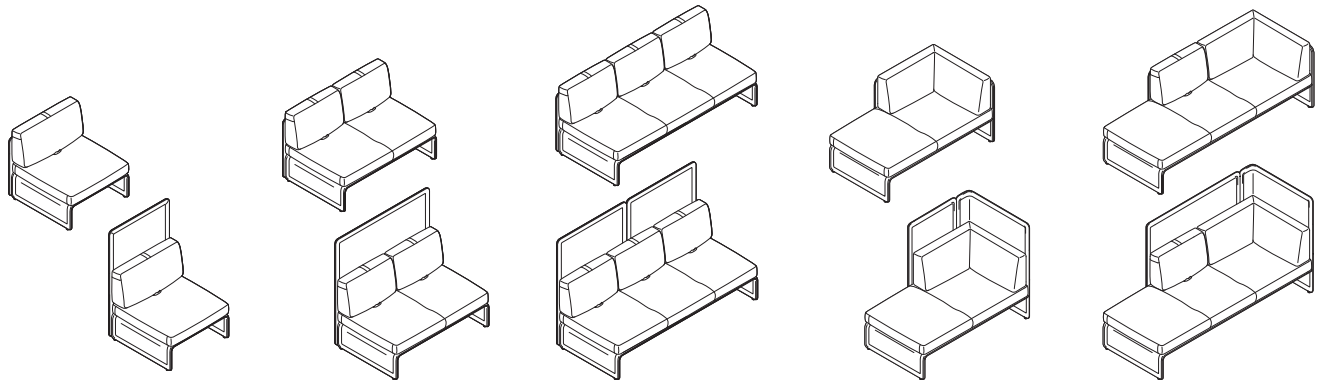

1-Seat Lounges

2-Seat Lounges

3-Seat Lounges

2-Seat Chaises

3-Seat Chaises

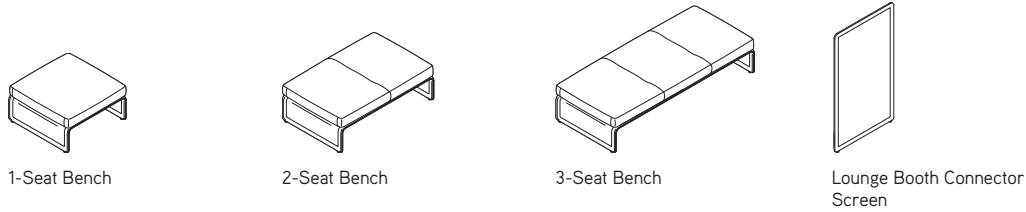

1-Seat Bench

2-Seat Bench

3-Seat Bench

Lounge Booth Connector
Screen

Lagunitas Focus Nook

Specifying
▶ Page 112

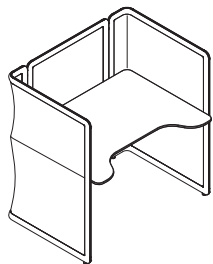

Statement of Line *continued*

Lounge Seating, continued

Passerelle Lounge Seating

Specifying
▶ Pages 114-116

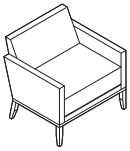

Lounge Chair

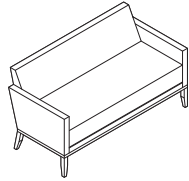

2-Seat Lounge

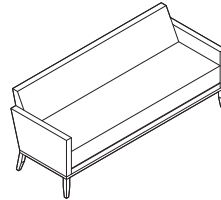

3-Seat Lounge



Arm Bolster

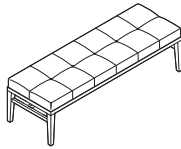
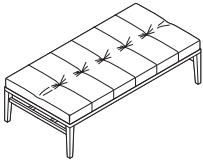

Benches

Switch Lounge Seating

Specifying
▶ Page 118



Lounge Chair

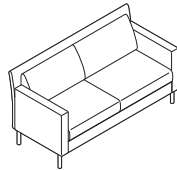

Two-Seat Lounge

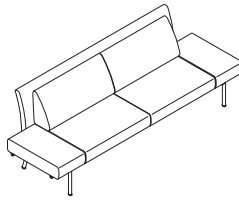

Two-Seat Lounge with
Extensions

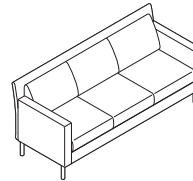

Three-Seat Lounge



Arm Bolster

SW_1 Lounge Seating

Specifying
▶ Page 120



Low-Back Collaborative
Lounge Chair



High-Back Collaborative
Lounge Chair



Ottoman

Statement of Line

Lounge Seating, continued

Together Bench

Specifying
▶ Page 124

70½"D 96¼"W 31"H

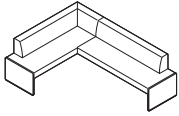

Left Corner with Back 8" Offset

97¼"D 96¼"W 31"H

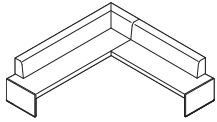

70½"D 96¼"W 31"H

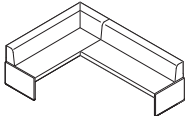

Left Corner with Back 1½" Offset

97¼"D 96¼"W 31"H

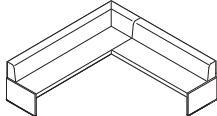

70½"D 123"W 31"H

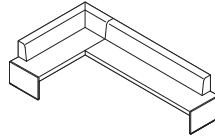

70½"D 123"W 31"H

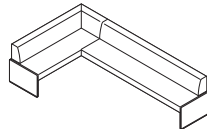

97¼"D 123"W 31"H

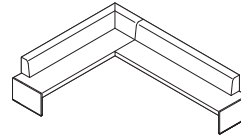

97¼"D 123"W 31"H

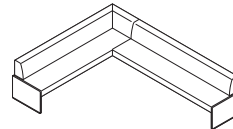

70½"D 96¼"W 31"H

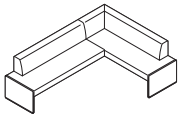

Right Corner with Back 8" Offset

97¼"D 96¼"W 31"H

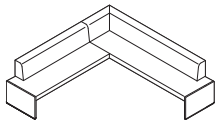

70½"D 123"W 31"H

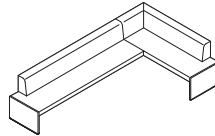

70½"D 123"W 31"H

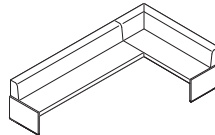

97¼"D 123"W 31"H

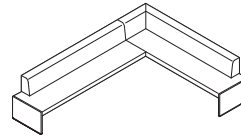

97¼"D 123"W 31"H

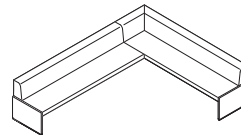

70½"D 96¼"W 31"H

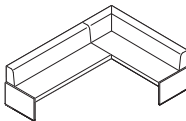

Right Corner with Back 1.5" Offset

97¼"D 96¼"W 31"H

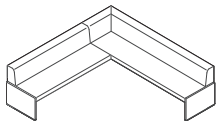

70½"D 123"W 31"H

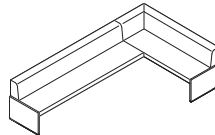

Straight with 1.5" Offset Back

97¼"D 123"W 31"H

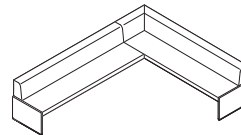

26¾"D 71"W 31"H

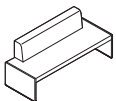

Straight with 8" Offset Back

26¾"D 97¾"W 31"H

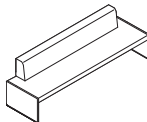

26¾"D 97¾"W 18½"H

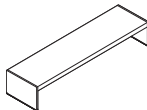

Straight without Back

26¾"D 71"W 31"H

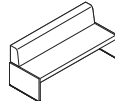

26¾"D 71"W 18½"H

Statement of Line *continued*

Lounge Seating, continued

Visalia Lounge Seating

Specifying
▶ Page 130

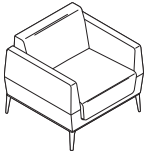

Lounge Chair

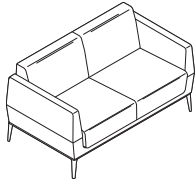

Two-Seat Lounge

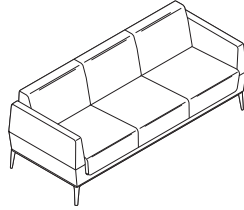

Three-Seat Lounge

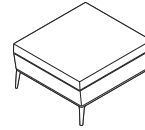

Ottoman

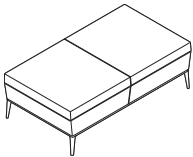

Bench

Guest/Side/Stack Seating

Bindu Chairs

Specifying
▶ Page 134

Bob Chair

Specifying
▶ Page 135



Low-Back Chair



Mid-Back Chair



Guest Chair

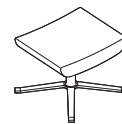

Ottoman

Statement of Line

Guest/Side/Stack Seating, continued

Enea Café Wood Stools

Specifying
▶ Page 136



Café Wood Counter-Height Stool Upholstered Seat



Café Wood Bar-Height Stool Upholstered Seat



Café Wood Counter-Height Stool



Café Wood Bar-Height Stool

Enea Lottus Seating

Specifying
▶ Pages 138-144



Armless Chair



Cantilever Arm Chair



Aluminum Loop Arm Chair



Counter-Height Sled Base Stool



Bar-Height Sled Base Stool

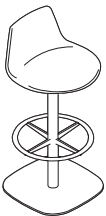

Counter-Height Post Base Stool

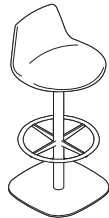

Base-Height Post Base Stool

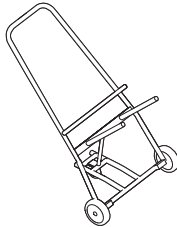

Dolly

Kathryn Chairs

Specifying
▶ Page 146

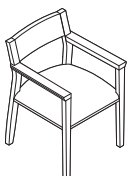

Open Wood Back

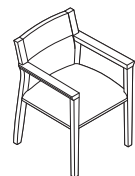

Upholstered Wood Back Panel

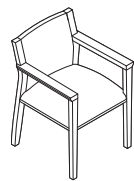

Fully Upholstered Back

Statement of Line *continued*

Guest/Side/Stack Seating, continued

Switch Stools

Specifying
▶ Page 148

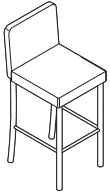

Counter-Height Stool

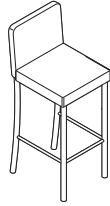

Bar-Height Stool

Montara650 Chairs and Stools

Specifying
▶ Pages 150-154



Wood Shell, Wood Shell with Upholstered Seat, Wood Shell with $\frac{3}{4}$ Upholstery, and Fully Upholstered



Wood Shell with Upholstered Seat, Wood Shell with $\frac{3}{4}$ Upholstery, and Fully Upholstered



Counter-Height or Bar-Height Stool: Wood Shell, Wood Shell with Upholstered Seat, and Fully Upholstered

Montara650 Rocker

Specifying
▶ Page 156



Wood Shell with Upholstered Seat, Wood Shell with $\frac{3}{4}$ Upholstery, and Fully Upholstered

Wrapp Chairs

Specifying
▶ Page 158



Four-Leg Chair

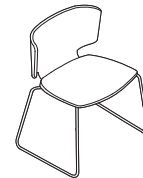

Sled-Base Chair

Statement of Line

Collaboration Seating

Bindu Conference Seating

Specifying
▶ Page 160



Mid-Back Conference
Chair



High-Back Conference
Chair

Chord Conference Seating

Specifying
▶ Page 162



Conference Narrow

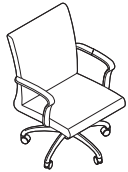

Mid-Back



High-Back Narrow



High-Back/Large Scale

SW_1 Conference Seating

Specifying
▶ Page 164



Conference Chair
with 4-Star Base



Conference Chair
with 5-Star Base

Statement of Line *continued*

Occasional Tables

Await Occasional Tables

Specifying
▶ Page 168

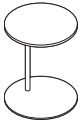

Freestanding
Low Round

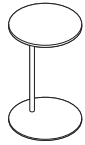

Freestanding
High Round

Enea Lottus Tables

Specifying
▶ Pages 169–173

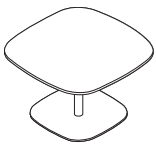

Occasional



Conference



Café Counter Height

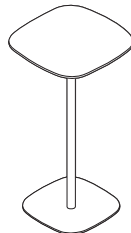

Café Bar Height

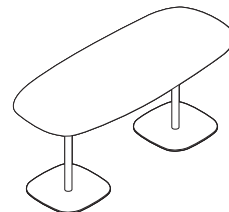

Rectangular

Sebastopol Occasional Tables

Specifying
▶ Page 174

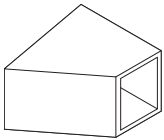

16" High Tables

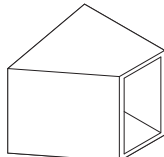
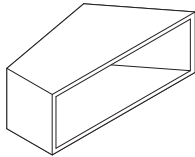

22" High Tables

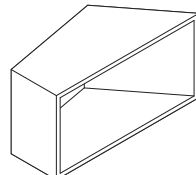

Trees Occasional Tables

Specifying
▶ Page 175

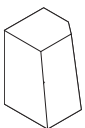

Bevel High-
Embossed Wood

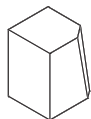

Bevel Medium-
Embossed Wood

Lounge Seating

Await	32
Bix	38
Bob Chairs	48
Circa	50
Coupe	61
Coupe Grande/Mobile	62
Joel Lounge	64
Ripple	66
Sidewalk	68
Davos	73
Hosu	74
Millbrae	76
Lagunitas	82
Lagunitas Focus Nook	112
Passerelle	114
Switch	118
SW_1	120
Together Bench	124
Visalia	130

Await Lounge System

DESIGN E00S

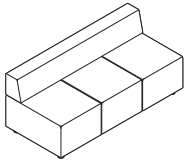

Tip: Recommended leathers are Elmosoft group 1 and Elmorustical group 2.

Tip: Special color match, consult Customer Service.

Tip: For Customer's Own Material or Leather, see necessary requirements, important processing instructions, and ordering information.
 ▶ Page 180

Tip: Contrasting option available only on lounges.

Tip: Please include sketch for ganging.

Tip: Fabrics and leathers will appear loose with comfort wrinkles when upholstered.

Standard Includes	Required to Specify
-------------------	---------------------

<ul style="list-style-type: none"> ▶ Need help? Product details, see <i>Coalesse Seating and Outdoor Specification Guide</i> 	<ul style="list-style-type: none"> • Frame: unibody construction with finger-jointed plywood • Multiple densities of polyurethane foam and polyester foam and polyester fiber • Lounge: <ul style="list-style-type: none"> - Seat and back: fabric or leather - Legs: black high-density polyurethane resin - Glides: non-adjustable • Ottoman: <ul style="list-style-type: none"> - Seat: fabric or leather - Casters: non-locking 	<ol style="list-style-type: none"> 1 Style number 2 Number of fabrics if contrasting fabric style number is selected 3 Fabric or leather color number for upholstery on seat and back 4 Options, if selected (see below) <p>▶ See <i>Surface Materials</i>, page 178.</p>
---	--	---

Options	Price	Required to Specify
---------	-------	---------------------

Surface Materials <ul style="list-style-type: none"> • Contrasting fabric <hr/> Acrylic backer <ul style="list-style-type: none"> • 3-seat lounge • Four-seat lounge • Four-seat bench • Ottoman 	<p>+\$182 per fabric</p> <hr/> <p>+\$ 84 +\$105 +\$ 74 +\$ 24</p>	<p>Add suffix K to the style number and select fabric color number.</p> <hr/> <p>Specify with <i>acrylic backer</i>. Specify with <i>acrylic backer</i>. Specify with <i>acrylic backer</i>. Specify with <i>acrylic backer</i>. ▶ See <i>Surface Materials</i>, page 178.</p>
Floor Mount Legs <ul style="list-style-type: none"> • Floor mount legs 	<p>+\$196 per unit</p>	<p>Specify with <i>floor mount legs</i></p>
Related Products <ul style="list-style-type: none"> • Connector benches • Occasional tables 		<p>▶ Page 34 ▶ Page 168</p>

Await Lounge System

DESIGN EOOS

Specification Information

Style Number	Base Prices										Leather Groups:		
	Fabric Groups:										COL	1	2
	COM	1	2	3	4	5	6	7	8	9	10		

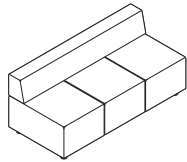

Overall: 30"D 66"W 27"H
 Inside: 22"D 66"W 27"H
 Seat: 16½"H
 Arm: 10½"H

3-Seat Lounge

460-3	\$5370	\$5370	\$5539	\$5680	\$5847	\$6100	\$6413	\$6771	\$7151	\$7486	\$7844	\$5821	\$ 9340	\$10,031
--------------	--------	--------	--------	--------	--------	--------	--------	--------	--------	--------	--------	--------	---------	----------

COM/yds = 5¾, COL/sq ft = 147

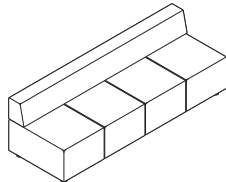

Overall: 30"D 88"W 27"H
 Inside: 22"D 88"W 27"H
 Seat: 16½"H
 Arm: 10½"H

Four-Seat Lounge

460-4	\$6617	\$6617	\$6831	\$7008	\$7219	\$7538	\$7933	\$8384	\$8863	\$9285	\$9737	\$7068	\$11,532	\$12,393
--------------	--------	--------	--------	--------	--------	--------	--------	--------	--------	--------	--------	--------	----------	----------

COM/yds = 7¼, COL/sq ft = 185

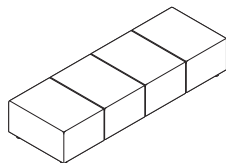

Overall: 30"D 88"W 16½"H
 Seat: 16½"H

Four-Seat Bench

460-4B	\$4850	\$4850	\$5013	\$5147	\$5307	\$5549	\$5849	\$6191	\$6554	\$6874	\$7217	\$5301	\$ 8667	\$ 9320
---------------	--------	--------	--------	--------	--------	--------	--------	--------	--------	--------	--------	--------	---------	---------

COM/yds = 5½, COL/sq ft = 100



Overall: 22"D 22"W 16½"H

Mobile Ottoman

460-H	\$1183	\$1183	\$1228	\$1264	\$1308	\$1374	\$1456	\$1549	\$1648	\$1735	\$1829	\$1634	\$ 2495	\$ 2667
--------------	--------	--------	--------	--------	--------	--------	--------	--------	--------	--------	--------	--------	---------	---------

COM/yds = 1½, COL/sq ft = 33

Lounge Seating

Await Lounge System Connector Benches

DESIGN E00S

Tip: Recommended leathers are Elmosoft group 1 and Elmorustical group 2.

Tip: Special color match, consult Customer Service.

Tip: For Customer's Own Material or Leather, see necessary requirements, important processing instructions, and ordering information.

► Page 180

Tip: Please include sketch for ganging.

Tip: Fabrics and leathers will appear loose with comfort wrinkles when upholstered.

Standard Includes		Required to Specify			
► Need help?	<ul style="list-style-type: none"> Bench: fabric or leather Frame: unibody construction with finger-jointed plywood Multiple densities of polyurethane foam Fixed seat Top and double needle stitching on seams Legs: black high-density polyurethane resin Glides 	1 Style number	2 Fabric or leather color number for upholstery on bench		
Product details, see <i>Coalesse Seating and Outdoor Specification Guide</i>		3 Options, if selected (see below)	► See <i>Surface Materials</i> , page 178.		
Options		Price		Required to Specify	
Surface Materials	Acrylic backer			Specify with acrylic backer.	
	• One-section connector bench	+\$ 34		Specify with acrylic backer.	
	• Two-section connector bench	+\$ 50		Specify with acrylic backer.	
	• Three-section connector bench	+\$ 76		► See <i>Surface Materials</i> , page 178.	
Floor Mount Legs	• Field-installed Floor mount legs	+\$196 per unit		Specify with floor mount legs.	
Related Products	• Occasional tables			► Page 168	

Specification Information

Style Number	Base Prices												Leather Groups:		
	Fabric Groups:													COL	1
	COM	1	2	3	4	5	6	7	8	9	10				

One-Section Connector Bench

461-1B	\$2187	\$2187	\$2255	\$2309	\$2375	\$2474	\$2597	\$2736	\$2885	\$3015	\$3156	\$2638	\$3972	\$4231
COM/yds = 2¼, COL/sq ft = 53														

Two-Section Connector Bench

461-2B	\$3363	\$3363	\$3477	\$3567	\$3677	\$3842	\$4047	\$4278	\$4527	\$4743	\$4978	\$3814	\$6079	\$6524
COM/yds = 3¾, COL/sq ft = 105														

Three-Section Connector Bench

461-3B	\$4692	\$4692	\$4844	\$4964	\$5111	\$5331	\$5604	\$5912	\$6244	\$6532	\$6846	\$5143	\$8339	\$8962
COM/yds = 5½, COL/sq ft = 145														

Ganging Kit

460-GANGPKG	\$ 75
--------------------	-------

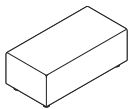

Overall: 44"D 22"W 16½"H

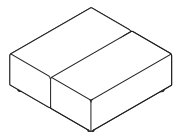

Overall: 44"D 44"W 16½"H

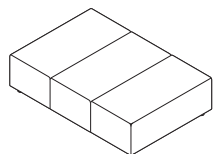

Overall: 44"D 66"W 16½"H

Await Lounge System Connector Tables

DESIGN EOOS

Tip: Await connector tables are not recommended to be used in end-of-run applications.

Tip: Await connector tables are not made for ganging to Await mobile ottoman.

Standard Includes	Required to Specify
<ul style="list-style-type: none"> Need help? Product details, see <i>Coalesse Seating and Outdoor Specification Guide</i> Connector table frame: panels are black, white, or gray Top: High-Pressure Laminate top with matching 3 mm edge band Glass top (tablet): <ul style="list-style-type: none"> - 1/2" thick - Radiused edges Ganging plate: 1/4" thick ganging plates attach to the bottom of units to the seating unit plates 	<ol style="list-style-type: none"> Style number Laminate top and tablets, if selected: <ul style="list-style-type: none"> 2746 Black 2730 Arctic White 290N North Sea Glass color number for top, if selected <ul style="list-style-type: none"> ▶ See <i>Coalesse Surface Materials Reference Guide</i>.

Related Products
<ul style="list-style-type: none"> Occasional tables ▶ Page 168 Lounge seating ▶ Page 32

Specification Information

Style Number	Prices							
	Laminate Top:			Glass Tablet:				
	No Tablet	Tablet	Power/Data	Clear Green/Frosted Glass Tablet	Acid Etched 6511 Glass Tablet	Acid Etched 6511 Tablet and Power/Data	Colored Glass Tablet	Colored Tablet and Power/Data

460-SE22	\$1008	\$2314	N.A.	\$2396	\$2428	N.A.	\$2676	N.A.
460-SE22PD	N.A.	N.A.	\$2747	N.A.	N.A.	\$2941	N.A.	\$3190

460-SE30	\$1153	\$2459	N.A.	\$2541	\$2581	N.A.	\$2821	N.A.
460-SE30PD	N.A.	N.A.	\$2903	N.A.	N.A.	\$3097	N.A.	\$3346

460-SE44	\$1416	\$4028	N.A.	\$4073	\$4144	N.A.	\$4632	N.A.
460-SE44PD	N.A.	N.A.	\$4456	N.A.	N.A.	\$4738	N.A.	\$5234

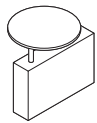

Overall: 20"D 4 1/2"W 15 3/4"H
With Tablet: 15 3/4" Dia. and 25 3/8"H

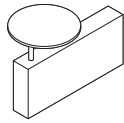

Overall: 28"D 4 1/2"W 15 3/4"H
With Tablet: 15 3/4" Dia. and 25 3/8"H

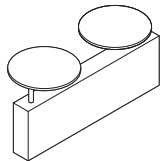

Overall: 42"D 4 1/2"W 25 3/8"H
With Tablets: 15 3/4" Dia. and 25 3/8"H

Lounge Seating

Await Ganging Diagrams by Model (Underside View)

DESIGN E00S

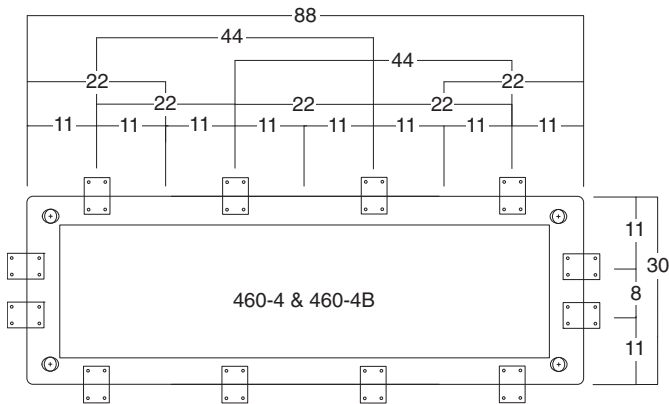
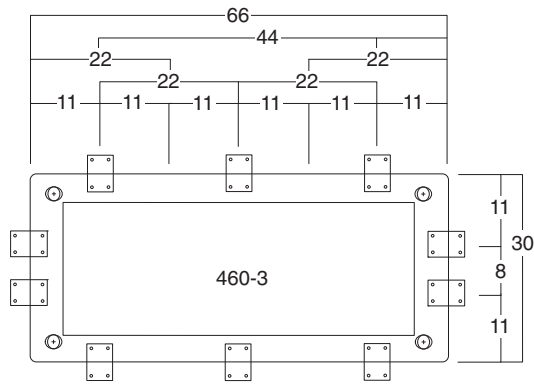
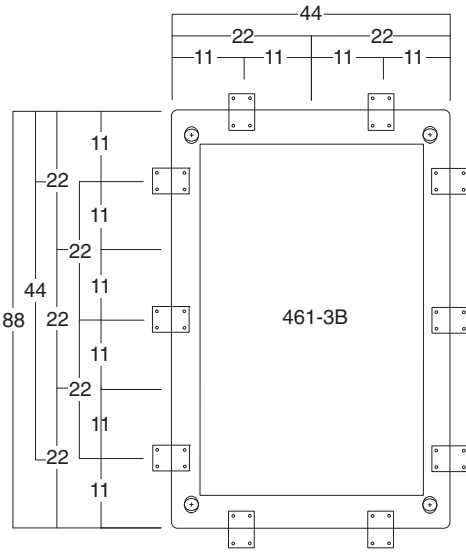
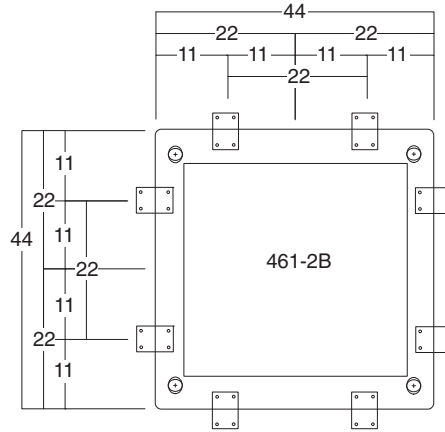
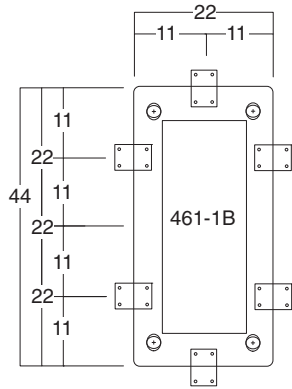

Await Multi-Fabric Diagram

TO: _____

FROM: _____

DATE: _____

FAX...888.413.5161

A Seat (upholstery selections default for entire unit if B is not selected):

B Back: _____

See specifying for contrasting fabric upcharge. List price based on highest fabric group usage.

Specify Model below:

460-3K

460-4K

Lounge Seating

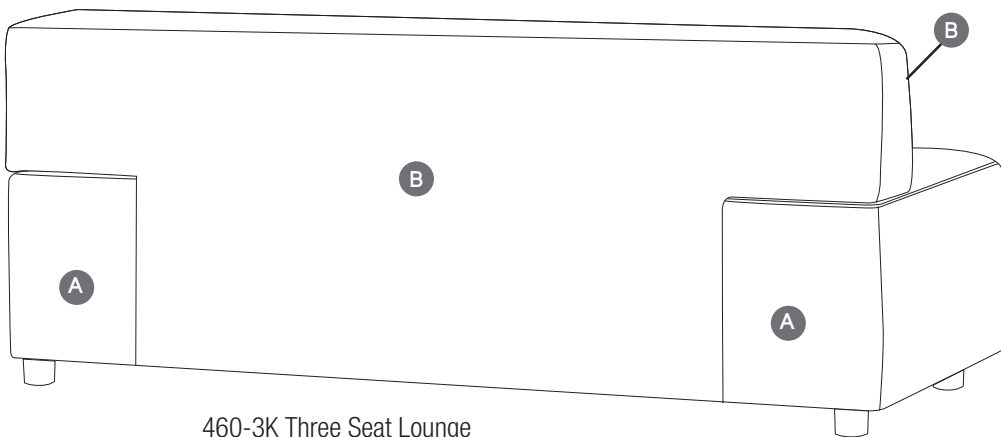
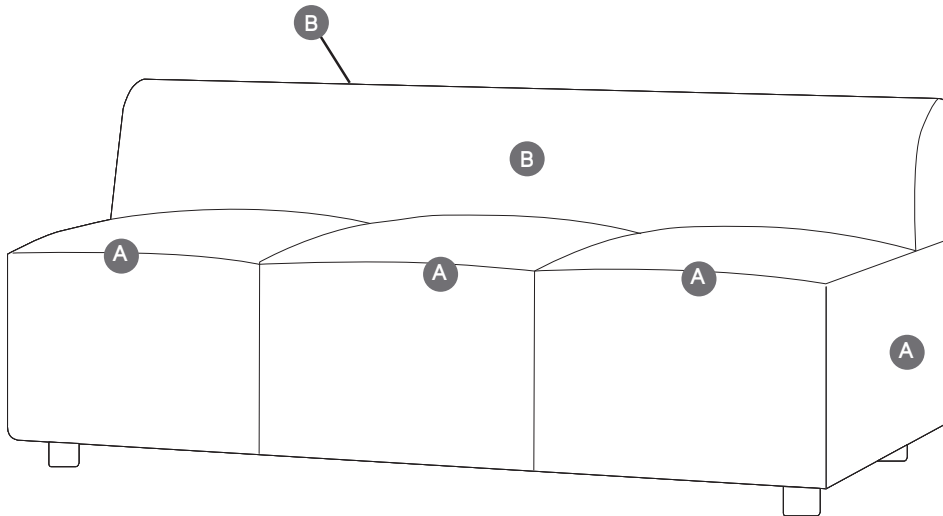

460-3K Three Seat Lounge

Bix Lounge System Lounge Chairs

DESIGN METRO DESIGN GROUP

Tip: Fabric for the seat and back is specified separate from the back screen, if selected. For a monochromatic look, specify the same fabric for both the seat and back and back screen.

Tip: Fabrics and leathers will appear loose with comfort wrinkles when upholstered.

Tip: When specifying fabric in different price groups, the highest price group prevails.

Tip: The COM yards and COL square footage listed on this page reflect the requirements for a single fabric that are based on non-directional 54"W material applied railroaded. For multi-fabric COM requirements, please refer to Multi-Fabric Yardage. ▶Page 46

Standard Includes Required to Specify

<p>▶Need help? Product details, see <i>Coalesse Seating and Outdoor Specification Guide</i></p>	<ul style="list-style-type: none"> • Seat, back, and arms, if selected: fabric or leather • Legs: paint • Adjustable glides: paint to match legs • Back screen, if selected: fabric 	<ol style="list-style-type: none"> 1 Style number 2 Number of fabrics if contrasting fabric style number is selected 3 Fabric or leather color number for seat, back, and arms, if selected 4 Paint color number for legs and glides 5 Fabric color number for back screen, if selected 6 Options, if selected (see below) <p>▶See <i>Surface Materials</i>, page 178.</p>
---	---	--

Options Price Required to Specify

<p>Surface Materials</p>	<ul style="list-style-type: none"> • Contrasting fabric <hr/> <p>Acrylic backer</p> <ul style="list-style-type: none"> • Lounge chair +\$ 52 • Lounge chair with arms +\$ 74 • Lounge chair with back screen +\$ 86 	<p>+\$182 per fabric</p> <hr/> <p>Specify with acrylic backer. Specify with acrylic backer. Specify with acrylic backer. ▶ See <i>Surface Materials</i>, page 178.</p>
<p>Seat Height</p>	<ul style="list-style-type: none"> • 18" seat height 	<p>+\$351</p> <p>Specify with 18" seat height.</p>
<p>Related Products</p>	<ul style="list-style-type: none"> • Sectional seating • Bench 	<p>▶ Page 40 ▶ Page 43</p>

Specification Information

Style Number	Base Prices										Leather Groups:			
	Fabric Groups:										COL	1	2	
	COM	1	2	3	4	5	6	7	8	9	10			

Lounge Chair

BL26XX	\$2632	\$2632	\$2801	\$2940	\$3109	\$3358	\$3670	\$4025	\$4403	\$4737	\$5092	\$3017	\$4237	\$4482
COM/yds = 2¾, COL/sq ft = 55														

Lounge Chair with Arms

BL26AA	\$3685	\$3685	\$3915	\$4105	\$4335	\$4675	\$5100	\$5584	\$6100	\$6555	\$7039	\$4221	\$5517	\$5816
COM/yds = 3¾, COL/sq ft = 73														

Lounge Chair with Back Screen

BLB26XX	\$3803	\$3803	\$3911	\$3999	\$4107	\$4265	\$4464	\$4689	\$4930	\$5143	\$5368	\$4358	\$6160	\$6559
Chair: COM/yds = 2¾, COL/sq ft = 55 Screen: COM/yds = 1¾														

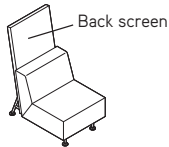
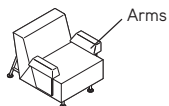
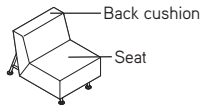

Bix Lounge System Sled Lounge Chairs

DESIGN METRO DESIGN GROUP

Tip: The COM yards and COL square footage listed on this page reflect the requirements for a single fabric that are based on non-directional 54"W material applied railroaded. For multi-fabric COM requirements, please refer to Multi-Fabric Yardage.
 ▶ Page 46

Tip: When specifying fabric in different price groups, the highest price group prevails.

Standard Includes	Required to Specify
▶ Need help? Product details, see <i>Coalesse Seating and Outdoor Specification Guide</i>	1 Style number 2 Number of fabrics if contrasting fabric style number is selected 3 Fabric or leather color number for seat, back, and arms, if selected 4 Paint color number for base and tablet, if selected 5 Options, if selected (see below) ▶ See <i>Surface Materials</i> , page 178.

Options	Price	Required to Specify
Surface Materials <ul style="list-style-type: none"> Contrasting fabric 	+\$182 per fabric	Add suffix K to the style number and select fabric color number.
Acrylic backer <ul style="list-style-type: none"> Lounge chair and lounge chair with tablet arm Lounge chair with arms 	+\$ 52 +\$ 74	Specify with acrylic backer. Specify with acrylic backer. ▶ See <i>Surface Materials</i> , page 178.
Related Products <ul style="list-style-type: none"> Bench 		▶ Page 43

Specification Information													
Style Number	Base Prices										Leather Groups:		
	Fabric Groups:										COL	1	2
COM	1	2	3	4	5	6	7	8	9	10			

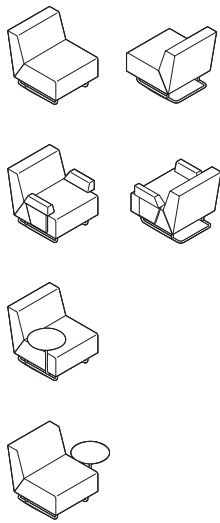

Sled Lounge Chair														
BLD26XX	\$2352	\$2352	\$2522	\$2660	\$2830	\$3078	\$3391	\$3746	\$4123	\$4458	\$4813	\$2632	\$3957	\$4202
COM/yds = 2¾, COL/sq ft = 55														

Sled Lounge Chair with Arms														
BLD26AA	\$3404	\$3404	\$3599	\$3635	\$3695	\$3887	\$4009	\$4153	\$4250	\$4428	\$4674	\$3774	\$5236	\$5535
COM/yds = 3¾, COL/sq ft = 73														

Sled Lounge Chair with Left-Hand Facing Tablet Arm														
BLD26TX	\$2840	\$2840	\$3010	\$3148	\$3318	\$3566	\$3879	\$4234	\$4611	\$4946	\$5301	\$3165	\$4445	\$4690
COM/yds = 2¾, COL/sq ft = 55														

Sled Lounge Chair with Right-Hand Facing Tablet Arm														
BLD26XT	\$2840	\$2840	\$3010	\$3148	\$3318	\$3566	\$3879	\$4234	\$4611	\$4946	\$5301	\$3165	\$4445	\$4690
COM/yds = 2¾, COL/sq ft = 55														

Lounge Seating

Bix Lounge System Sectional Seating

DESIGN METRO DESIGN GROUP

Tip: Fabric for the seat and back is specified separate from the back screen, if selected. For a monochromatic look, specify the same fabric for both the seat and back, and back screen.

Tip: The COM yards and COL square footage listed on these pages reflect the requirements for a single fabric that are based on non-directional 54"W material applied railroaded. For multi-fabric COM requirements, please refer to Multi-Fabric Yardage.
▶Page 46

Tip: When specifying fabric in different price groups, the highest price group prevails.

Tip: Fabrics and leathers will appear loose with comfort wrinkles when upholstered.

Standard Includes Required to Specify

▶Need help?
Product details, see *Coalesse Seating and Outdoor Specification Guide*

- Seat and back, if selected: fabric or leather
- Legs: paint
- Adjustable glides: paint to match legs
- Back screen, if selected: fabric

- 1 Style number
 - 2 Number of fabrics if contrasting fabric style number is selected
 - 3 Fabric or leather color number for seat and back, if selected
 - 4 Paint color number for legs and glides
 - 5 Fabric color number for back screen, if selected
 - 6 Options, if selected (see below)
- ▶See *Surface Materials*, page 178.

Options Price Required to Specify

Options	Price	Required to Specify
Surface Materials	• Contrasting fabric Acrylic backer • 48"W sections +\$ 84 • 48"W sections with back screen +\$129 • 54"W sections +\$129 • 72"W sections +\$112 • 72"W sections with back screen +\$195	Add suffix K to the style number and select fabric color number. Specify with acrylic backer. Specify with acrylic backer. Specify with acrylic backer. Specify with acrylic backer. Specify with acrylic backer. ▶See <i>Surface Materials</i> , page 178.
Seat Height	• 18" seat height +\$351	Specify with 18" seat height.
Related Products	• Bench	▶Page 43

Specification Information

Style Number	Base Prices										Leather Groups:	
	Fabric Groups:										COL	
	1	2	3	4	5	6	7	8	9	10	1	2

54"W Extended Corner Section–Left Section

BSE54LX	\$5310	\$5310	\$5744	\$6094	\$6528	\$7158	\$7956	\$8860	\$ 9818	\$10,672	\$11,576	\$6052	\$7826	\$8272
COM/yds = 7, COL/sq ft = 140														

54"W Extended Corner Section–Right Section

BSE54RX	\$5310	\$5310	\$5744	\$6094	\$6528	\$7158	\$7956	\$8860	\$ 9818	\$10,672	\$11,576	\$6052	\$7826	\$8272
COM/yds = 7, COL/sq ft = 140														

48"W Straight Section

BSS48XX	\$3904	\$3904	\$4028	\$4128	\$4252	\$4432	\$4660	\$4918	\$ 5192	\$ 5436	\$ 5694	\$4467	\$ 6121	\$6496
COM/yds = 4½, COL/sq ft = 90														

48"W Straight Section with Back Screen

BSSB48XX	\$5418	\$5418	\$5883	\$6258	\$6723	\$7398	\$8253	\$9221	\$10,248	\$ 11,163	\$12,131	\$ 6171	\$ 9178	\$9852
Chair: COM/yds = 4½, COL/sq ft = 90														
Screen: COM/yds = 3														

▶Specification Information, continued on next page

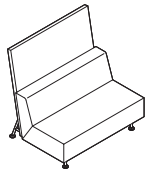
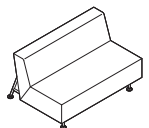
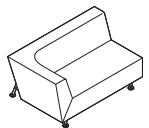
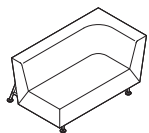

Bix Lounge System Sectional Seating

DESIGN METRO DESIGN GROUP

Tip: Straight sections are standard with a railroaded seat and back fabric direction.

▶ Page 47

Tip: Fabrics and leathers will appear loose with comfort wrinkles when upholstered.

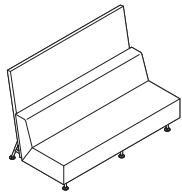
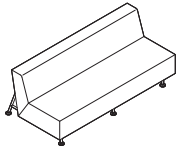

▶ Specification Information, continued from previous page

Specification Information

Style Number	Base Prices										Leather Groups:		
	Fabric Groups:										COL		
	1	2	3	4	5	6	7	8	9	10	1	2	

72"W Straight Section

BSS72XX	\$5552	\$5552	\$5955	\$6280	\$6683	\$7268	\$8009	\$8849	\$9738	\$10,531	\$11,371	\$6327	\$8374	\$8872
----------------	--------	--------	--------	--------	--------	--------	--------	--------	--------	----------	----------	--------	--------	--------

COM/yds = 6½, COL/sq ft = 130

72"W Straight Section with Back Screen

BSSB72XX	\$7596	\$7596	\$8268	\$8810	\$9481	\$10,456	\$11,691	\$13,090	\$14,573	\$15,895	\$17,293	\$8618	\$12,726	\$13,673
-----------------	--------	--------	--------	--------	--------	----------	----------	----------	----------	----------	----------	--------	----------	----------

Chair: COM/yds = 6½, COL/sq ft = 130
 Screen: COM/yds = 4½

Bix Multi-Fabric Diagram

DESIGN METRO DESIGN GROUP

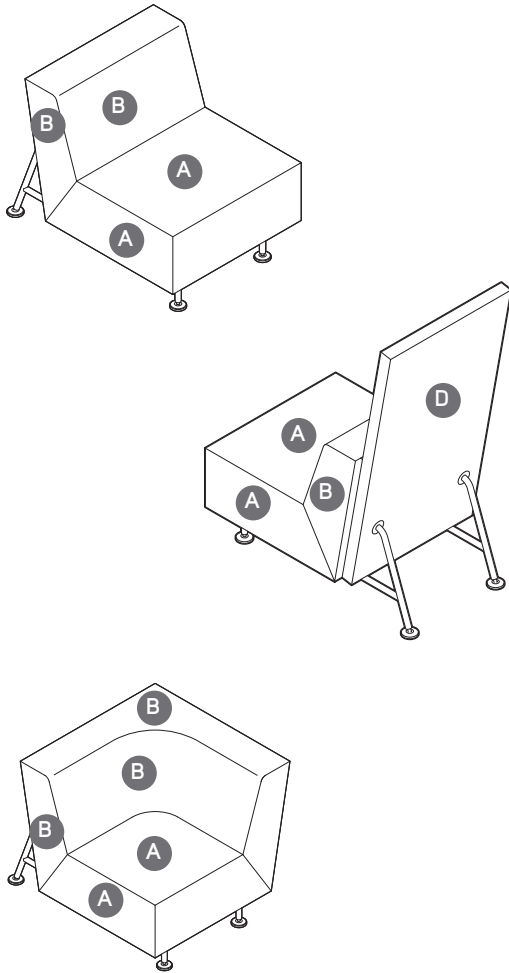

TO: _____

FROM: _____

DATE: _____

FAX...888.413.5161

A Seat (upholstery selections default for entire unit if B is not selected): _____

B Back: _____

C Arms (if applicable): _____

D Backscreen (if applicable): _____

**Back screen defined separately when ordered.*

See specifying for contrasting fabric upcharge. List price based on highest fabric group usage.

Bix Lounge System Benches

DESIGN METRO DESIGN GROUP

Tip: Fabrics and leathers will appear loose with comfort wrinkles when upholstered.

Tip: The COM yards and COL square footage listed on this page reflect the requirements for a single fabric that are based on non-directional 54"W material applied railroaded.

Standard Includes Required to Specify

<p>► Need help? Product details, see <i>Coalesse Seating and Outdoor Specification Guide</i></p>	<ul style="list-style-type: none"> • Seat: fabric or leather • Legs: paint • Adjustable glides: paint to match legs 	<p>1 Style number 2 Fabric or leather color number for seat 3 Paint color number for legs and glides 4 Options, if selected (see below) ► See <i>Surface Materials</i>, page 178.</p>
--	--	---

Options Price Required to Specify

<p>Surface Materials</p>	<p>Acrylic backer</p> <ul style="list-style-type: none"> • 48"W benches +\$ 34 • 72"W benches +\$ 47 	<p>Specify with acrylic backer. Specify with acrylic backer. ► See <i>Surface Materials</i>, page 178.</p>
<p>Seat Height</p>	<ul style="list-style-type: none"> • 18" seat height +\$351 	<p>Specify with 18" seat height.</p>
<p>Related Products</p>	<ul style="list-style-type: none"> • Lounge chairs • Sectional seating 	<p>► Page 38 ► Page 40</p>

Specification Information

Style Number	Base Prices										Leather Groups:			
	Fabric Groups:											COL	1	2
	COM	1	2	3	4	5	6	7	8	9	10			

48"W Bench

BB48	\$2358	\$2358	\$2419	\$2470	\$2531	\$2622	\$2735	\$2864	\$3002	\$3123	\$3252	\$2725	\$3847	\$4073
COM/yds = 2¼, COL/sq ft = 41														

72"W Bench

BB72	\$2854	\$2854	\$2936	\$3004	\$3085	\$3206	\$3357	\$3529	\$3713	\$3874	\$4046	\$3288	\$4727	\$5026
COM/yds = 3, COL/sq ft = 54														

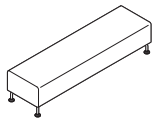
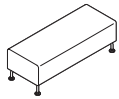

Bix Multi-Fabric Diagram

DESIGN METRO DESIGN GROUP

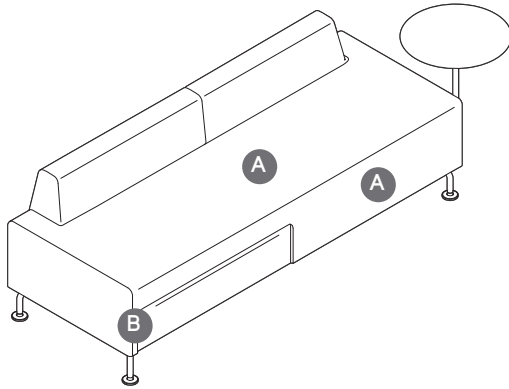

TO: _____

FROM: _____

DATE: _____

FAX....888.413.5161

A Seat (upholstery selections default for entire unit if B is not selected): _____

B Back: _____

See specifying for contrasting fabric upcharge. List price based on highest fabric group usage.

Bix Multi-Fabric Diagram

DESIGN METRO DESIGN GROUP

Bix Multi-Fabric Yardage

DESIGN METRO DESIGN GROUP

Multi-Fabric Yardage

DESCRIPTION	STYLE NUMBER	COM YDS*			
		SEAT	BACK	ARM(S)	BACK SCREEN
Lounge chair	BL26XX	1¾	1¾	N.A.	N.A.
Lounge chair with arms	BL26AA	1¾	1¾	1	N.A.
Lounge chair with back screen	BLB26XX	1¾	1¾	N.A.	1¾
Sled lounge chair	BLD26XX	1¾	1¾	N.A.	N.A.
Sled lounge chair with arms	BLD26AA	1¾	1¾	1	N.A.
Sled lounge chair with left-hand tablet arm	BLD26TX	1¾	1¾	N.A.	N.A.
Sled lounge chair with right-hand tablet arm	BLD26XT	1¾	1¾	N.A.	N.A.
54"W extended corner section-left section	BSE54LX	2½	3	N.A.	N.A.
54"W extended corner section-right section	BSE54RX	2½	3	N.A.	N.A.
48"W straight section	BSS48XX	2½	2½	N.A.	N.A.
48"W straight section with back screen	BSSB48XX	2½	2½	N.A.	3
72"W straight section	BSS72XX	4½	4½	N.A.	N.A.
72"W straight section with back screen	BSSB72XX	4½	4½	N.A.	5

*Fabric yardage is based on non-directional/solid fabrics. use conversion chart on the following page for repeat/printed fabric yardage.

Bix Multi-Fabric Yardage

DESIGN METRO DESIGN GROUP

Multi-Fabric Yardage

Non-standard fabric requirements

Yardage requirements shown are based on non-directional 54"W material applied railroaded. Coalesse will apply fabric railroaded unless instructed otherwise on the dealer's purchase order. The following conversion chart should be used to determine yardage requirements when COM has a repeat of 2" or more. Please contact Coalesse Customer Service for a yardage quotation if the fabric is less than 54" wide, has a repeat of more than 24", or if the fabric must be cut-right.

CONVERSION CHART

PRODUCT	REPEAT		
	2" - 8"	9" - 14"	15" - 24"
Bix	15%	30%	75%

Yardage quotations will also be provided for order of 10 or more pieces.

Pattern matching on Bix

Due to Coalesse's high standards for pattern matching, we reserve the right to apply the following upcharges for extra labor incurred by a pattern or material that poses such challenges.

Customers will be informed if an upcharge will be applied to their order during the approval process. Should Coalesse receive an order without prior approval, it will be held as pending until the customer accepts such charges. The upcharge will be applied per item where applicable.

Cutting direction guidelines

Cutting direction is based on the fabric width and the way the fabric is cut from the roll and applied to Coalesse products. There are two cutting directions: railroaded or cut-right.

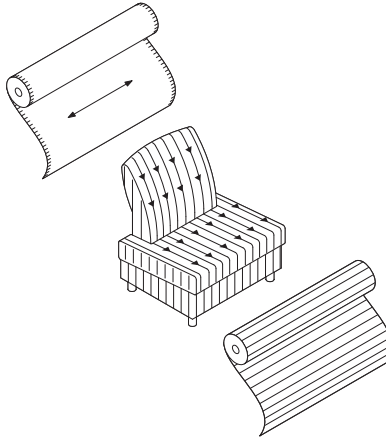

Horizontal or railroaded (across roll, warp horizontal) means fabric is cut across the roll; selvages are on the top and bottom.

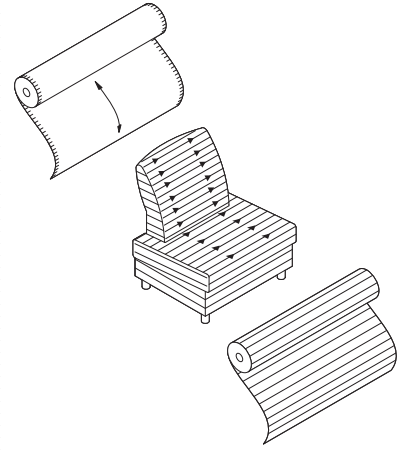

Vertical or cut-right (down roll, warp vertical) means fabric is cut in the same direction it is woven; selvages are on the left and right sides.

Coalesse reserves the right to railroad or apply fabric according to weave unless instructions specify otherwise. Fabrics are railroaded when possible to avoid seams in large upholstered areas and/or single cushion units. If a fabric is questionable, a cutting of adequate size showing full repeat (if any) should be sent to Coalesse for a fabric requirement quotation.

Bob Lounge Chairs by Walter Knoll

DESIGN PEARSON LLOYD

Tip: For Customer's Own Material or Leather, see necessary requirements, important processing instructions, and ordering information.
 ▶ Page 178.

Tip: Fabrics and leathers will appear loose with comfort wrinkles when upholstered.

Standard Includes	Required to Specify
▶ Need help? Product details, see <i>Coalesse Seating and Outdoor Specification Guide</i> <ul style="list-style-type: none"> • Base: 8040 Aluminum Matte Polished or group 1 paint • Swivel base for lounge chairs, if selected • Upholstery for chair: fabric or leather • Glides 	1 Style number 2 Paint or metal color for base 3 Number of fabrics if contrasting fabric style number is selected 4 Fabric or leather color number for upholstery 5 Options, if selected (see below) ▶ See <i>Surface Materials</i> , page 178.

Options	Price	Required to Specify
Surface Materials <ul style="list-style-type: none"> • Contrasting fabric 	+\$182 per fabric	Add suffix K to the style number and select fabric color number.
Acrylic backer <ul style="list-style-type: none"> • Lounge chair • Lounge chair with headrest • Ottoman 	+\$ 47 +\$ 50 +\$ 12	Specify with <i>acrylic backer</i> . Specify with <i>acrylic backer</i> . Specify with <i>acrylic backer</i> . ▶ See <i>Surface Materials</i> , page 178.
Base <ul style="list-style-type: none"> • Lounge chair with standard swivel mechanism • Aluminum matte polished • Group 1 paint • Group 3 paint • Lounge chair with return swivel mechanism • Aluminum matte polished 	No cost No cost +\$108 +\$360	Specify with <i>standard swivel</i> and select aluminum matte polished. Specify with <i>standard swivel</i> and select paint color number. Specify with <i>standard swivel</i> and select paint color number. Specify with <i>return swivel</i> and select aluminum matte polished.
Glides <ul style="list-style-type: none"> • Felted glides 	+\$ 22	Specify with <i>felted glides</i> .

Specification Information

Style Number	Base Prices										Leather Groups:		
	COM	1	2	3	4	5	6	7	8	9	10	COL	1

Lounge Chair

216	\$3427	\$3427	\$3524	\$3604	\$3700	\$3844	\$4023	\$4227	\$4444	\$4636	\$4840	\$3863	\$5561	\$5900
COM/yds = 3, COL/sq ft = 72														



Overall: 34¼"D 35"W 31¾"H
 Inside: 21¾"D 20"W 17¼"H
 Seat: 17"H
 Arm: 21¾"H

Lounge Chair with Headrest

221	\$4061	\$4061	\$4175	\$4268	\$4380	\$4548	\$4757	\$4995	\$5248	\$5472	\$5710	\$4497	\$6488	\$6883
COM/yds = 3½, COL/sq ft = 77														



Overall: 34¼"D 35"W 41¼"H
 Inside: 21¾"D 20"W 27½"H
 Seat: 17"H
 Arm: 21¾"H

▶ Specification Information, continued on next page

Bob Lounge Chairs by Walter Knoll

DESIGN PEARSON LLOYD

► Specification Information, continued from previous page

Specification Information

Style Number	Base Prices										Leather Groups:	
	Fabric Groups:										COL	
	1	2	3	4	5	6	7	8	9	10	1	2

Ottoman

221-H	\$1252	\$1252	\$1285	\$1312	\$1344	\$1392	\$1451	\$1519	\$1592	\$1656	\$1724	\$1688	\$2195	\$2306
COM/yds = 1, COL/sq ft = 22														



Overall: 18½"D 19¾"W 15¼"H

Circa Lounge System Upholstered Individual Lounge Units

DESIGN ALISON SPEAR, AIA

Tip: Fabrics and leathers will appear loose with comfort wrinkles when upholstered.

Tip: For contrasting fabric, pricing is based on highest group textile specified.

Tip: For Customer's Own Material or Leather, see necessary requirements, important processing instructions, and ordering information
▶Page 180

Tip: Benches are flat and 1-seat and 2-seat lounges are angled; therefore, seat angles will not be aligned when placed next to each other. A table is recommended between the units to minimize the difference.

Tip: All legs measure 6 1/2" in height.

Tip: The 60° inside and outside wedge lounges and benches have five legs (if not sharing legs). If metal legs are selected, the upcharge is per leg.

Standard Includes Required to Specify

▶ Need help? Product details, see <i>Coalesse Seating and Outdoor Specification Guide</i>	<ul style="list-style-type: none"> • Frame: unibody construction of hardwood plywood utilizing box joinery • Upholstery: multiple densities of polyurethane foam fixed seat and back with top stitch on seams • Legs: <ul style="list-style-type: none"> - Tapered leg, if selected: solid maple or walnut - Cylinder leg, if selected: solid oak 	1 Style number 2 Number of fabrics if contrasting fabric style number is selected 3 Fabric or leather color number for upholstery on seat and back 4 Wood leg type 5 Wood color number for legs 6 Options, if selected (see below) ▶ See <i>Surface Materials</i> , page 178.
--	---	---

Options Price Required to Specify

Surface Materials	<ul style="list-style-type: none"> • Contrasting fabric 	+\$182 per fabric	Add suffix K to the style number and select fabric color number.
	Acrylic backer		
	<ul style="list-style-type: none"> • 30° outside facing wedge 1-seat lounge 	+\$ 49	Specify with acrylic backer.
	<ul style="list-style-type: none"> • 30° inside facing wedge seat 1-seat lounge 	+\$ 50	Specify with acrylic backer.
	<ul style="list-style-type: none"> • 60° outside and inside wedge 2-seat lounge 	+\$ 88	Specify with acrylic backer.
	<ul style="list-style-type: none"> • 60° benches 	+\$ 60	Specify with acrylic backer.
	<ul style="list-style-type: none"> • Straight 1-seat lounge 	+\$ 34	Specify with acrylic backer.
	<ul style="list-style-type: none"> • Straight 2-seat lounge 	+\$ 74	Specify with acrylic backer.
	<ul style="list-style-type: none"> • Straight bench 	+\$ 47	Specify with acrylic backer. ▶ See <i>Surface Materials</i> , page 178.
Shared Leg Application	<ul style="list-style-type: none"> • Cylinder wood legs • Modern metal legs 	-\$276 -\$276	Specify with cylinder wood legs. Specify with modern metal legs.
Metal Legs	Tapered legs		
	<ul style="list-style-type: none"> • Group 1 paint 	+\$209 per leg	Specify with tapered metal legs and select paint color number. ▶ See <i>Surface Materials</i> , page 178.
	<ul style="list-style-type: none"> • Group 3 paint 	+\$237 per leg	Specify with tapered metal legs and select paint color number. ▶ See <i>Surface Materials</i> , page 178.
	Modern legs		
	<ul style="list-style-type: none"> • Group 1 paint 	+\$209 per leg	Specify with modern metal legs and select paint color number. ▶ See <i>Surface Materials</i> , page 178.
	<ul style="list-style-type: none"> • Group 3 paint 	+\$237 per leg	Specify with modern metal legs and select paint color number. ▶ See <i>Surface Materials</i> , page 178.

Specification Information

Style Number	Base Prices										Leather Groups:		
	Fabric Groups:										COL		
	COM	1	2	3	4	5	6	7	8	9	10	1	2

30° Outside Facing Wedge 1-Seat Lounge

451-3730FO

\$2136 \$2136 \$2235 \$2317 \$2413 \$2560 \$2742 \$2950 \$3171 \$3365 \$3573 \$2636 \$4783 \$5210

COM/yds = 3 1/4, COL/sq ft = 72

▶ Specification Information, continued on next page

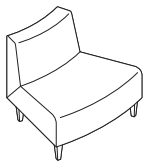

Overall: 28"D 36 3/4"W 29 1/2"H
 Inside: 20"D 36 3/4"W 12 1/4"H
 Seat: 17 1/4"H
 Angle Degree: 30°

Circa Lounge System Upholstered Individual Lounge Units

DESIGN ALISON SPEAR, AIA

► Specification Information, continued from previous page

Specification Information

Style Number	Base Prices										Leather Groups:		
	Fabric Groups:										COL	1	2
	COM	1	2	3	4	5	6	7	8	9	10		

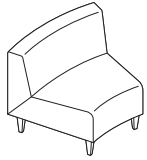

Overall: 28"D 36¾"W 29½"H
 Inside: 20"D 36¾"W 12¼"H
 Seat: 17¼"H
 Angle Degree: 30°

30° Inside Facing Wedge 1-Seat Lounge

451-3730FI

\$2136	\$2136	\$2235	\$2317	\$2413	\$2560	\$2742	\$2950	\$3171	\$3365	\$3573	\$2636	\$4783	\$5210
--------	--------	--------	--------	--------	--------	--------	--------	--------	--------	--------	--------	--------	--------

COM/yds = 3¼, COL/sq ft = 72

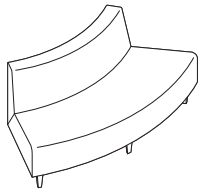

Overall: 28"D 71"W 29½"H
 Inside: 20"D 71"W 12¼"H
 Seat: 17¼"H
 Angle Degree: 60°

60° Outside Wedge 2-Seat Lounge

451-7460FO

\$3579	\$3579	\$3724	\$3844	\$3984	\$4199	\$4465	\$4769	\$5092	\$5375	\$5679	\$4066	\$8450	\$9298
--------	--------	--------	--------	--------	--------	--------	--------	--------	--------	--------	--------	--------	--------

COM/yds = 4½, COL/sq ft = 99

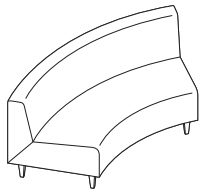

Overall: 28"D 71"W 29½"H
 Inside: 20"D 71"W 12¼"H
 Seat: 17¼"H
 Angle Degree: 60°

60° Inside Wedge 2-Seat Lounge

451-7460FI

\$3509	\$3509	\$3654	\$3774	\$3914	\$4129	\$4395	\$4699	\$5022	\$5305	\$5679	\$3996	\$8380	\$9228
--------	--------	--------	--------	--------	--------	--------	--------	--------	--------	--------	--------	--------	--------

COM/yds = 4¾, COL/sq ft = 105

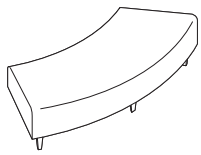

Overall: 28"D 71"W 17¼"H
 Seat: 17¼"H
 Angle Degree: 60°

60° Outside Wedge Bench

451-B7460FO

\$2695	\$2695	\$2787	\$2862	\$2951	\$3087	\$3255	\$3447	\$3651	\$3829	\$4021	\$3189	\$5165	\$5565
--------	--------	--------	--------	--------	--------	--------	--------	--------	--------	--------	--------	--------	--------

COM/yds = 3, COL/sq ft = 66

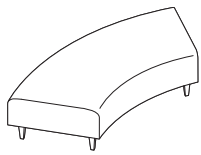

Overall: 28"D 71"W 17¼"H
 Seat: 17¼"H
 Angle Degree: 60°

60° Inside Wedge Bench

451-B7460FI

\$2695	\$2695	\$2787	\$2862	\$2951	\$3087	\$3255	\$3447	\$3651	\$3829	\$4021	\$3189	\$5165	\$5565
--------	--------	--------	--------	--------	--------	--------	--------	--------	--------	--------	--------	--------	--------

COM/yds = 3, COL/sq ft = 66

► Specification Information, continued on next page

Lounge Seating

Circa Lounge System Upholstered Individual Lounge Units *continued*

DESIGN ALISON SPEAR, AIA

► Specification Information, continued from previous page

Specification Information

Style Number	Base Prices										Leather Groups:		
	Fabric Groups:										COL	1	2
	COM	1	2	3	4	5	6	7	8	9	10		

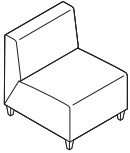

Overall: 28"D 25"W 29½"H
 Inside: 20"D 25"W 12¼"H
 Seat: 17¼"H
 Angle Degree: 0°

Straight 1-Seat Lounge

451-2500

\$1921	\$1921	\$1997	\$2060	\$2134	\$2247	\$2387	\$2547	\$2717	\$2866	\$3026	\$2415	\$4040	\$4367
COM/yds = 2½, COL/sq ft = 55													

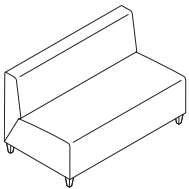

Overall: 28"D 50"W 29½"H
 Inside: 20"D 50"W 12¼"H
 Seat: 17¼"H
 Angle Degree: 0°

Straight 2-Seat Lounge

451-5000

\$2842	\$2842	\$2964	\$3065	\$3183	\$3364	\$3588	\$3844	\$4116	\$4354	\$4610	\$3336	\$6686	\$7339
COM/yds = 4, COL/sq ft = 83													

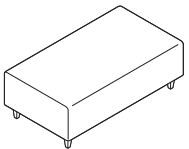

Overall: 28"D 50"W 17¼"H
 Seat: 17¼"H
 Angle Degree: 0°

Straight Bench

451-B5000

\$2454	\$2454	\$2546	\$2621	\$2710	\$2846	\$3014	\$3206	\$3410	\$3588	\$3780	\$2941	\$4931	\$5311
COM/yds = 3, COL/sq ft = 66													

Ganging Kit

451-GANGPKG

\$ 58	N.A.	N.A.	N.A.	N.A.	N.A.	N.A.	N.A.	N.A.	N.A.	N.A.	N.A.	N.A.	N.A.
-------	------	------	------	------	------	------	------	------	------	------	------	------	------

Tip: Please submit sketch for modular application. One package is required per two chairs.

Coalesse SIN 33721

Circa Lounge System Upholstered Individual Lounge Units

DESIGN ALISON SPEAR, AIA

Circa Lounge System Upholstered Modular Arm Rests—Straight, 15°, 30°, and Ottoman

DESIGN ALISON SPEAR, AIA

Tip: Fabrics and leathers will appear loose with comfort wrinkles when upholstered.

Tip: Cylinder wood and modern metal legs cannot be in shared position with armrests. The legs will always be on the lounge side.

Tip: For Customer's Own Material or Leather, see necessary requirements, important processing instructions, and ordering information
 ▶ Page 180

Standard Includes		Required to Specify
▶ Need help? Product details, see <i>Coalesse Seating and Outdoor Specification Guide</i>	<ul style="list-style-type: none"> • Frame: hardwood panels • Upholstery: multiple densities of polyurethane • Top stitch on seams • Legs: <ul style="list-style-type: none"> - Tapered leg, if selected: solid maple or walnut - Cylinder leg, if selected: solid oak 	1 Style number 2 Fabric or leather color number for arm rests 3 Wood leg type 4 Wood color number for legs 5 Options, if selected (see below) ▶ See <i>Surface Materials</i> , page 178.

Options	Price	Required to Specify
Surface Materials	<ul style="list-style-type: none"> • Contrasting fabric on ottoman +\$182 	Add suffix K to the style number and select fabric color number.
	Acrylic backer	Specify with <i>acrylic backer</i> .
	<ul style="list-style-type: none"> • Straight armrests and 15° armrests +\$ 28 • 30° armrests and ottoman +\$ 49 	▶ See <i>Surface Materials</i> , page 178. Specify with <i>acrylic backer</i> . ▶ See <i>Surface Materials</i> , page 178.
Metal Legs	Tapered legs	Specify with <i>tapered metal legs</i> and select paint color number.
	<ul style="list-style-type: none"> • Group 1 paint +\$209 per leg • Group 3 paint +\$237 per leg 	▶ See <i>Surface Materials</i> , page 178. Specify with <i>tapered metal legs</i> and select paint color number. ▶ See <i>Surface Materials</i> , page 178.
	Modern legs	Specify with <i>modern metal legs</i> and select paint color number.
	<ul style="list-style-type: none"> • Group 1 paint +\$209 per leg • Group 3 paint +\$237 per leg 	▶ See <i>Surface Materials</i> , page 178. Specify with <i>modern metal legs</i> and select paint color number. ▶ See <i>Surface Materials</i> , page 178.

Specification Information

Style Number	Base Prices										Leather Groups:			
	Fabric Groups:										COL	1	2	
	COM	1	2	3	4	5	6	7	8	9	10			

Straight Armrest—Intermediate without Legs

451-A1800G	\$1183	\$1183	\$1252	\$1309	\$1375	\$1477	\$1603	\$1747	\$1900	\$2034	\$2178	\$1619	\$2873	\$3126
COM/yds = 2¼, COL/sq ft = 50														

Straight Armrest—End of Run with Two Legs

451-A1800ER	\$1371	\$1371	\$1440	\$1497	\$1563	\$1665	\$1791	\$1935	\$2088	\$2222	\$2366	\$1807	\$3061	\$3314
COM/yds = 2¼, COL/sq ft = 50														

15° Inside Armrest—Intermediate without Legs

451-A1815FIG	\$1173	\$1173	\$1234	\$1285	\$1344	\$1434	\$1546	\$1674	\$1810	\$1929	\$2057	\$1609	\$2712	\$2933
COM/yds = 2, COL/sq ft = 44														

15° Inside Armrest—End of Run with Two Legs

451-A1815FIER	\$1441	\$1441	\$1502	\$1553	\$1612	\$1702	\$1814	\$1942	\$2078	\$2197	\$2325	\$1877	\$2980	\$3201
COM/yds = 2, COL/sq ft = 44														

▶ Specification Information, continued on next page



Overall: 28"D 18½"W 17"H



Overall: 28"D 18½"W 23½"H
 Tip: Specify left or right facing.



Overall: 28¾"D 18½"W 23½"H



Overall: 28¾"D 18½"W 23½"H
 Tip: Specify left or right facing.

Circa Lounge System Upholstered Modular Arm Rests—Straight, 15°, 30°, and Ottoman

DESIGN ALISON SPEAR, AIA

► Specification Information, continued from previous page

Specification Information

Style Number	Base Prices										Leather Groups:			
	Fabric Groups:										COL	1	2	
	COM	1	2	3	4	5	6	7	8	9	10			

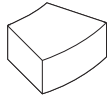

Overall: 29½"D 36¾"W 17"H

30° Inside Arm Rest—Intermediate without Legs

451-A3730FIG

\$1673	\$1673	\$1765	\$1840	\$1929	\$2065	\$2233	\$2425	\$2629	\$2807	\$2999	\$2109	\$3807	\$4146
--------	--------	--------	--------	--------	--------	--------	--------	--------	--------	--------	--------	--------	--------

COM/yds = 3, COL/sq ft = 66

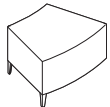

Overall: 29½"D 36¾"W 23½"H
Tip: Specify left or right facing.

30° Inside Arm Rest—End of Run with Two Legs

451-A3730FIER

\$1877	\$1877	\$1969	\$2044	\$2133	\$2269	\$2437	\$2629	\$2833	\$3011	\$3203	\$2313	\$4011	\$4350
--------	--------	--------	--------	--------	--------	--------	--------	--------	--------	--------	--------	--------	--------

COM/yds = 3, COL/sq ft = 66



Overall: 28¾"D 18½"W 17"H

15° Outside Armrest—Intermediate without Legs

451-A1815FOG

\$1173	\$1173	\$1234	\$1285	\$1344	\$1434	\$1546	\$1674	\$1810	\$1929	\$2057	\$1609	\$2712	\$2933
--------	--------	--------	--------	--------	--------	--------	--------	--------	--------	--------	--------	--------	--------

COM/yds = 2, COL/sq ft = 44



Overall: 28¾"D 18½"W 23½"H
Tip: Specify left or right facing.

15° Outside Armrest—End of Run with Two Legs

451-A1815FOER

\$1441	\$1441	\$1502	\$1553	\$1612	\$1702	\$1814	\$1942	\$2078	\$2197	\$2325	\$1877	\$2980	\$3201
--------	--------	--------	--------	--------	--------	--------	--------	--------	--------	--------	--------	--------	--------

COM/yds = 2, COL/sq ft = 44

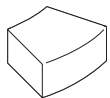

Overall: 29½"D 36¾"W 17"H

30° Outside Arm Rest—Intermediate without Legs

451-A3730FOG

\$1673	\$1673	\$1765	\$1840	\$1929	\$2065	\$2233	\$2425	\$2629	\$2807	\$2999	\$2109	\$3807	\$4146
--------	--------	--------	--------	--------	--------	--------	--------	--------	--------	--------	--------	--------	--------

COM/yds = 3, COL/sq ft = 66

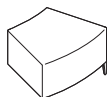

Overall: 29½"D 36¾"W 23½"H
Tip: Specify left or right facing.

30° Outside Arm Rest—End of Run with Two Legs

451-A3730FOER

\$1877	\$1877	\$1969	\$2044	\$2133	\$2269	\$2437	\$2629	\$2833	\$3011	\$3203	\$2313	\$4011	\$4350
--------	--------	--------	--------	--------	--------	--------	--------	--------	--------	--------	--------	--------	--------

COM/yds = 3, COL/sq ft = 66

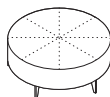

Overall: 42"Dia. 17"H

Round Ottoman with Five Legs

451-B42RD

\$2559	\$2559	\$2658	\$2740	\$2836	\$2983	\$3165	\$3373	\$3594	\$3788	\$3996	\$2995	\$4849	\$5209
--------	--------	--------	--------	--------	--------	--------	--------	--------	--------	--------	--------	--------	--------

COM/yds = 3¼, COL/sq ft = 72

Tip: Please submit sketch for modular application. One kit is required per two chairs.

Ganging Kit

451-GANGPKG

\$ 58	N.A.	N.A.	N.A.	N.A.	N.A.	N.A.	N.A.	N.A.	N.A.	N.A.	N.A.	N.A.	N.A.
-------	------	------	------	------	------	------	------	------	------	------	------	------	------

Circa Lounge System Modular Tables

DESIGN ALISON SPEAR, AIA

Standard Includes	Required to Specify
<ul style="list-style-type: none"> ▶ Need help? Product details, see <i>Coalesse Seating and Outdoor Specification Guide</i> • Table: hardwood veneer • Legs: <ul style="list-style-type: none"> - Tapered leg, if selected: solid maple or walnut - Cylinder leg, if selected: solid oak • Brackets and hardware, if ganging or end-of-run tables selected 	<ol style="list-style-type: none"> 1 Style number 2 Wood color number for table 3 Wood leg type 4 Wood color number for legs 5 Options, if selected (see below) <p>▶ See <i>Surface Materials</i>, page 178.</p>

Options	Price	Required to Specify
Surface Materials Table <ul style="list-style-type: none"> • Laminate with self edge 	Prices below and at right	Specify with <i>laminate</i> and select laminate color number. ▶ See <i>Surface Materials</i> , page 178.
Metal Legs Tapered legs <ul style="list-style-type: none"> • Group 1 paint 	+\$209 per leg	Specify with <i>tapered metal legs</i> and select paint color number. ▶ See <i>Surface Materials</i> , page 178.
Modern legs <ul style="list-style-type: none"> • Group 1 paint 	+\$209 per leg	Specify with <i>modern metal legs</i> and select paint color number. ▶ See <i>Surface Materials</i> , page 178.

Specification Information

Style Number	Base Prices	
	Laminate	Wood Veneer

15° Low Wedge Table, Ganging

45-T1815LG	\$1811	\$2084
------------	--------	--------

15° Low Wedge Table, End-of-Run, Two Legs

45-T1815LER	\$1941	\$2365
-------------	--------	--------

15° High Wedge Table, Ganging

45-T1815HG	\$2299	\$2877
------------	--------	--------

15 High Wedge Table, End-of-Run, Two Legs

45-T1815HER	\$2425	\$3145
-------------	--------	--------

15° High Wedge Table, Freestanding, Four Legs

45-T1815H	\$2552	\$3431
-----------	--------	--------

▶ Specification Information, continued on next page

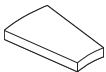

Overall: 28" D 18½" W 8½" H
Angle Degree: 15°

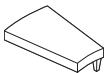

Overall: 28" D 18½" W 8½" H
Angle Degree: 15°

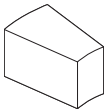

Overall: 28" D 18½" W 22½" H
Angle Degree: 15°

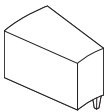

Overall: 28" D 18½" W 22½" H
Angle Degree: 15°

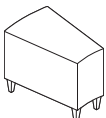

Overall: 28" D 18½" W 22½" H
Angle Degree: 15°

Circa Lounge System Modular Tables

DESIGN ALISON SPEAR, AIA

► Specification Information, continued from previous page

Specification Information

Style Number	Base Prices	
	Laminate	Wood Veneer

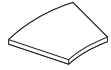

Overall: 29"D 36⁵/₈"W 2"H
(8¹/₂" from floor once assembled)

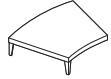

Overall: 29"D 36⁵/₈"W 8¹/₂"H

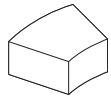

Overall: 29"D 36⁵/₈"W 16"H



Overall: 29"D 36⁵/₈"W 22¹/₂"H

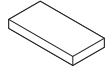

Overall: 27¹/₂"D 13¹/₂"W 8¹/₂"H
Angle Degree: 0°

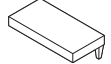

Overall: 27¹/₂"D 13¹/₂"W 8¹/₂"H
Angle Degree: 0°

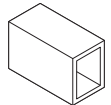

Overall: 27¹/₂"D 13¹/₂"W 22¹/₂"H
Angle Degree: 0°

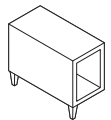

Overall: 27¹/₂"D 13¹/₂"W 22¹/₂"H
Angle Degree: 0°

30° Low Wedge Table, Ganging

45-T3730LG	\$2270	\$2552
------------	--------	--------

30° Low Wedge Table, End-of-Run, Two Legs

45-T3730LER	\$2400	\$2855
-------------	--------	--------

30° High Wedge Table, Ganging

45-T3730HG	\$3188	\$3637
------------	--------	--------

30° High Wedge Table, End-of-Run, Two Legs

45-T3730HER	\$3317	\$3933
-------------	--------	--------

Straight Low Table, Ganging

45-T1300LG	\$1808	\$2036
------------	--------	--------

Straight Low Table, End-of-Run, Two Legs

45-T1300LER	\$1941	\$2365
-------------	--------	--------

Straight High Table, Ganging

45-T1300HG	\$2660	\$3261
------------	--------	--------

Straight High Table, End-of-Run, Two Legs

45-T1300HER	\$3014	\$3818
-------------	--------	--------

► Specification Information, continued on next page

Circa Lounge System Modular Tables *continued*

DESIGN ALISON SPEAR, AIA

► Specification Information, continued from previous page

Specification Information

Style Number	Base Prices	
	Laminate	Wood Veneer

Straight High Table, Freestanding, Four Legs

45-T1300H	\$3141	\$4046
-----------	--------	--------

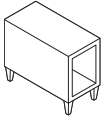

Overall: 27½"D 13½"W 22½"H
Angle Degree: 0°

30° End-of-Run, One Leg

45-T28HER	\$2501	\$3082
-----------	--------	--------



Overall: 13¾"D 27½"W 22¼"H
(8½" from floor once assembled)
Tip: Model 45-T28HER has only a single width tapered leg, no corner.

Options for Creating 90° Applications:

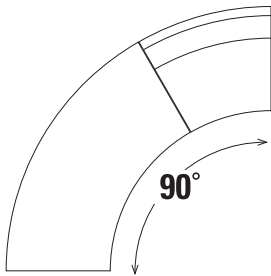

- (1) 30° Outside or Inside Facing Wedge Seat
- (1) 60° Wedge Bench

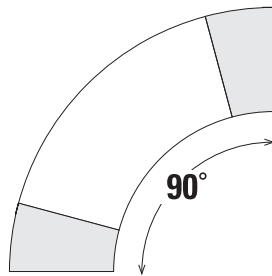

- (2) 15° Wedge Tables
- (1) 60° Wedge Bench

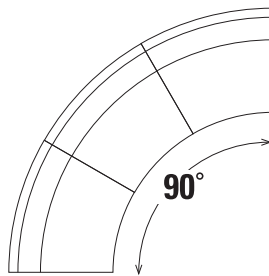

- (3) 30° Outside or Inside Facing Wedge Seats

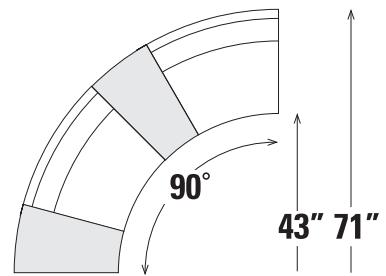

- (2) 30° Outside or Inside Facing Wedge Seats
- (2) 15° Wedge Tables

Circa Lounge System Freestanding Round Table

DESIGN ALISON SPEAR, AIA

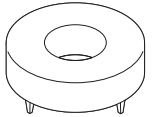

Overall: 42" dia. 15 3/4" H

Tip: Tapered wood and metal legs have a thin, blade aesthetic.

Tip: The round plate that houses the power/data module is powder coated to complement the power/data module finish. For the black anodized aluminum module, the round plate will be painted in 4710 Low Gloss Black. For the silver anodized aluminum module, the round plate will be painted 4799 Platinum.

Standard Includes		Required to Specify	
<ul style="list-style-type: none"> Need help? Product details, see <i>Coalesse Seating and Outdoor Specification Guide</i> 	<ul style="list-style-type: none"> Table: laminate Legs: <ul style="list-style-type: none"> - Tapered leg, if selected: solid maple or walnut - Cylinder leg, if selected: solid oak 	<ol style="list-style-type: none"> Style number Wood color number for table Wood leg type Wood color number for legs Options, if selected (see below) 	<ul style="list-style-type: none"> ▶ See <i>Surface Materials</i>, page 178.

Options	Price	Required to Specify	
Surface Materials <ul style="list-style-type: none"> Table <ul style="list-style-type: none"> Wood veneer Sunburst wood veneer 	<ul style="list-style-type: none"> Price below Price below 	<ul style="list-style-type: none"> Specify with <i>wood veneer</i> and select wood color number. ▶ See <i>Surface Materials</i>, page 178. Specify with <i>sunburst wood veneer</i> and select wood color number. ▶ See <i>Surface Materials</i>, page 178. 	
Metal Legs <ul style="list-style-type: none"> Tapered legs <ul style="list-style-type: none"> Group 1 paint Modern legs <ul style="list-style-type: none"> Group 1 paint 	<ul style="list-style-type: none"> +\$209 per leg +\$209 per leg 	<ul style="list-style-type: none"> Specify with <i>tapered metal legs</i> and select paint color number. ▶ See <i>Surface Materials</i>, page 178. Specify with <i>modern metal legs</i> and select paint color number. ▶ See <i>Surface Materials</i>, page 178. 	
Glass Insert <ul style="list-style-type: none"> Green tinted glass insert 3/4" thick with white enamel bottom square edge detail 	<ul style="list-style-type: none"> +\$409 	<ul style="list-style-type: none"> Specify with <i>glass insert</i>. 	
Power/Data Module <ul style="list-style-type: none"> Two power/two data ports black anodized aluminum or silver anodized aluminum 	<ul style="list-style-type: none"> +\$607 	<ul style="list-style-type: none"> Specify finish color number. 	

Specification Information

Style Number	Base Prices		
	Laminate	Wood Veneer	Sunburst Wood Veneer

Round Table, Freestanding, Four Legs

45-T42RD	\$4304	\$5730	\$6172
----------	--------	--------	--------

Circa Lounge System Multi-Fabric Diagram

DESIGN ALISON SPEAR, AIA

Applies to all Circa models including: Straight 1-Seat Lounge, Wedge, and Straight 2-Seat Lounge

TO: _____

FROM: _____

DATE: _____

FAX...888.413.5161

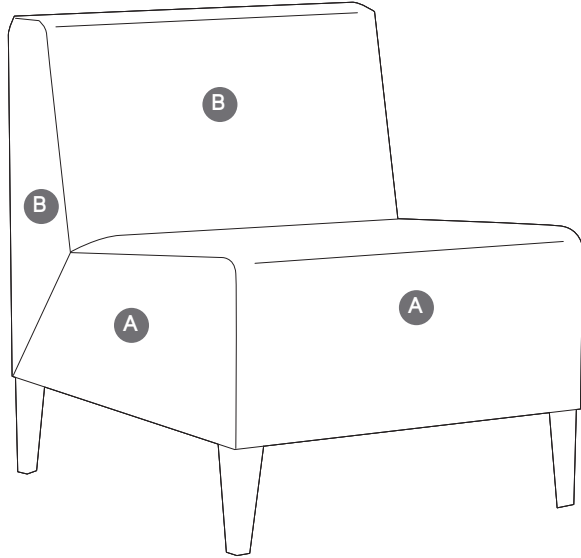

A Upholstery Selection (default for entire unit if B is not selected):

B Back: _____

See specifying for contrasting fabric upcharge. List price based on highest fabric group usage.

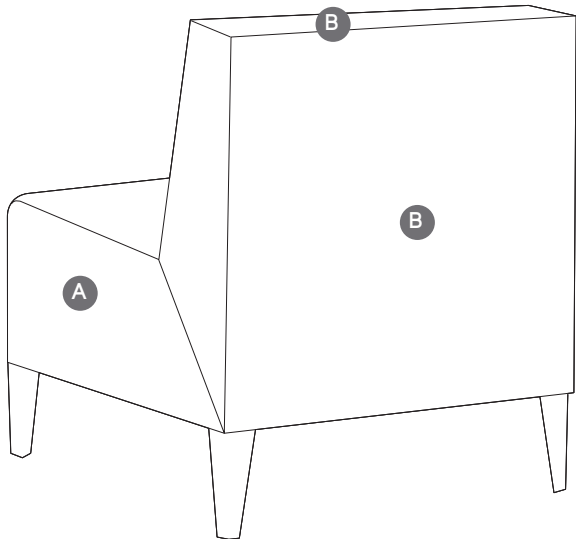

Specify model below:

- 451-7460FOK Outside Facing
- 451-7460FIK Inside Facing
- 451-5000K
- 451-2500K
- 451-3730FOK Outside Facing
- 451-3730FIK Inside Facing

Coupe

DESIGN DENNIE PIMENTAL / JOHN DUFFY

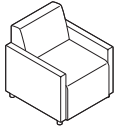

Overall: 28"D 26½"W 30"H
 Inside: 20"D 22"W 13"H
 Seat: 17"H
 Arm: 22"H

Tip: Fabrics and leathers will appear loose with comfort wrinkles when upholstered.

Tip: Recommended leathers are Elmosoft group 1 and Elmorustical group 2.

Tip: Special color match, consult Customer Service.

Tip: For Customer's Own Material or Leather, see necessary requirements, important processing instructions, and ordering information.

► Page 180

Standard Includes	Required to Specify
-------------------	---------------------

- | | | |
|---|--|--|
| <ul style="list-style-type: none"> ► Need help? Product details, see <i>Coalesse Seating and Outdoor Specification Guide</i> | <ul style="list-style-type: none"> • Frame: unibody construction of hardwood plywood utilizing box joinery • Legs: solid beech • Glides: non-adjustable • Upholstery: multiple densities of laminated polyurethane foam and polyester fiber on seat and back with top stitch sewing detail | <ol style="list-style-type: none"> 1 Style number 2 Wood color number for legs
► See <i>Hardwood and Veneer Matrix</i>, page 190 3 Fabric or leather color number for upholstery on seat and back 4 Options, if selected (see below)
► See <i>Surface Materials</i>, page 178. |
|---|--|--|

Options	Price	Required to Specify
---------	-------	---------------------

Surface Materials	Acrylic backer		
	• Lounge chair	+\$ 60	Specify with acrylic backer. ► See <i>Surface Materials</i> , page 178.
Legs	Brushed aluminum	+\$253	Specify with brushed aluminum legs. Specify with powder coat legs and select color: 4138 Graphite Gloss 4140 Arctic White Gloss 4142 Platinum Gloss 4144 Black Gloss 4148 Midnight Brown Gloss Specify with acrylic legs.
	• Powder coat	+\$203	
	• Acrylic: clear	+\$356	

Specification Information												
---------------------------	--	--	--	--	--	--	--	--	--	--	--	--

Style Number	Base Prices										Leather Groups:	
	Fabric Groups:										COL	
COM	1	2	3	4	5	6	7	8	9	10	1	2

Lounge Chair

470	\$2421	\$2421	\$2526	\$2613	\$2718	\$2875	\$3069	\$3291	\$3527	\$3736	\$3958	\$2897	\$5549	\$6077
-----	--------	--------	--------	--------	--------	--------	--------	--------	--------	--------	--------	--------	--------	--------

COM/yds = 4¼, COL/sq ft = 94

Coupe Grande/Mobile

DESIGN DENNIE PIMENTAL / JOHN DUFFY

Tip: Fabrics and leathers will appear loose with comfort wrinkles when upholstered.

Tip: Recommended leathers are Elmosoft group 1 and Elmorustical group 2.

Tip: Special color match, consult Customer Service.

Tip: For Customer's Own Material or Leather, see necessary requirements, important processing instructions, and ordering information.
▶ Page 180

Standard Includes		Required to Specify
▶ Need help? Product details, see <i>Coalesse Seating and Outdoor Specification Guide</i>	<ul style="list-style-type: none"> • Frame: unibody construction of hardwood plywood utilizing box joinery • Legs: solid beech • Glides: non-adjustable • Upholstery: multiple densities of laminated polyurethane foam and polyester fiber on seat and back with top stitch sewing detail • On 476M model: <ul style="list-style-type: none"> - Casters: swivel hard - Locking and non-locking wheels Tablet: <ul style="list-style-type: none"> - Laminate - 13½" diameter 	1 Style number 2 Wood color number for legs ▶ See <i>Hardwood and Veneer Matrix</i> , page 190 3 Fabric or leather color number for seat and back 4 Laminate color number for 476M tablet, if selected 5 Options, if selected (see below) ▶ See <i>Surface Materials</i> , page 178.

Options	Price	Required to Specify
Surface Materials • Acrylic backer • Lounge chair	+\$ 74	Specify with acrylic backer. ▶ See <i>Surface Materials</i> , page 178.
Casters (476M only) • Soft casters	No cost	Specify with soft casters.
Legs • Brushed aluminum • Powder coat • Acrylic: clear	+ \$253 + \$203 + \$356	Specify with brushed aluminum legs. Specify with powder coat legs and select color: 4138 Graphite Gloss 4140 Arctic White Gloss 4142 Platinum Gloss 4144 Black Gloss 4148 Midnight Brown Gloss Specify with acrylic legs.
Tablet (476M only) • Omit tablet	-\$248	Specify with remove tablet.

Specification Information													
Style Number	Base Prices										Leather Groups:		
	Fabric Groups:										COL	1	2
COM	1	2	3	4	5	6	7	8	9	10			

Lounge Chair

476	\$2832	\$2832	\$2956	\$3058	\$3182	\$3367	\$3595	\$3856	\$4134	\$4380	\$4641	\$3296	\$6453	\$7063
-----	--------	--------	--------	--------	--------	--------	--------	--------	--------	--------	--------	--------	--------	--------

COM/yds = 5, COL/sq ft = 110

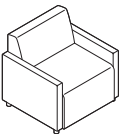

Overall: 28"D 31"W 30"H
 Inside: 20"D 25"W 13"H
 Seat: 17"H
 Arm: 22"H

Mobile Chair

476M	\$3628	\$3628	\$3752	\$3854	\$3978	\$4163	\$4391	\$4652	\$4930	\$5176	\$5437	\$4092	\$7234	\$7854
------	--------	--------	--------	--------	--------	--------	--------	--------	--------	--------	--------	--------	--------	--------

COM/yds = 5, COL/sq ft = 110

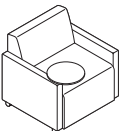

Overall: 28"D 31"W 30"H
 Inside: 20"D 25"W 13"H
 Seat: 17"H
 Arm: 22"H

Coalesse SIN 33721

Coupe Grande/Mobile

DESIGN DENNIE PIMENTAL / JOHN DUFFY

Lounge Seating

Joel Lounge by Walter Knoll

DESIGN E00S



Overall: 29"D x 30 1/4"W x 27 1/2"H
Seat: 16 1/4"H
Arm: 26 1/4"H
Inside: 21 1/2"D x 16 1/2"W x 11"H

Tip: Fabrics and leathers will appear loose with comfort wrinkles when upholstered.

Tip: For Customer's Own Material or Leather, see necessary requirements, important processing instructions, and ordering information.

► Page 180

Standard Includes		Required to Specify
► Need help? Product details, see <i>Coalesse Seating and Outdoor Specification Guide</i>	<ul style="list-style-type: none"> • Base frame: steel with molded rigid foam • Seat frame: plywood with molded foam • Base: chrome plated steel • Auto swivel return mechanism 	1 Style number 2 Number of fabrics if contrasting fabric style number is selected 3 Fabric or leather color number for upholstery 4 Options, if selected (see below) ► See <i>Surface Materials</i> , page 178.

Options	Price	Required to Specify
Surface Materials		
• Contrasting fabric	+\$182 per fabric	Add suffix K to the style number and select fabric color number.
Acrylic backer		
• Backer	+\$ 50	Specify with <i>acrylic backer</i> . ► See <i>Surface Materials</i> , page 178.

Specification Information														
Style Number	Base Prices										Leather Groups:			
	Fabric Groups:										COL			
	COM	1	2	3	4	5	6	7	8	9	10	1	2	
COWK100	\$2886	\$2886	\$2994	\$3084	\$3191	\$3352	\$3552	\$3781	\$4024	\$4238	\$4467	\$3305	\$5336	\$5594

COM/yds = 3 1/2, COL/sq ft = 77

Joel Lounge Multi-Fabric Diagram

DESIGN EOOS

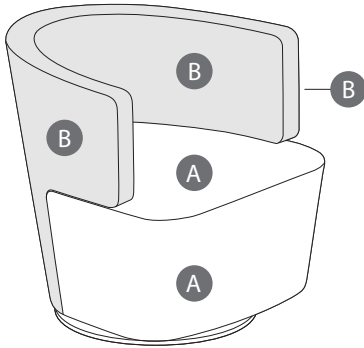

TO: _____

FROM: _____

DATE: _____

FAX....888.413.5161

A Seat (upholstery selections default for entire unit if B is not selected): _____

B Back: _____

Contrasting upcharge for each contrasting textile pricing based on highest group textile specified. See specifying for contrasting upcharge.

Ripple Benches

DESIGN LAURINDA SPEAR, FAIA

Tip: Fabrics and leathers will appear loose with comfort wrinkles when upholstered.

Tip: Pricing based on highest group textile specified.

Tip: Due to the design and construction techniques of Ripple lounge, only certain textiles can be successfully applied, therefore COM fabrics must be submitted to Coalesse for approval prior to order acceptance. Solid patterns with no repeat are recommended.

Tip: Recommended leathers are Elmosoft group 1 and Elmorustical group 2.

Tip: Special color match, consult Customer Service.

Tip: For Customer's Own Material or Leather, see necessary requirements, important processing instructions, and ordering information.

► Page 180

Tip: 96" is a three-seat lounge.

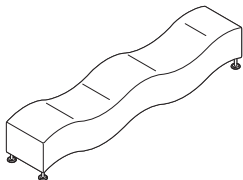

Overall: 19¼"D 97"W 19¼"H
Dip: 14"H

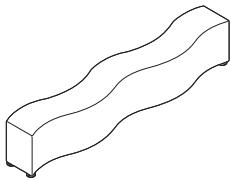

Overall: 19¼"D 97"W 19¼"H
Seat Surface: 19"H

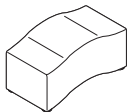

Overall: 19"D 35¾"W 19¼"H

Standard Includes		Required to Specify
► Need help? Product details, see <i>Coalesse Seating and Outdoor Specification Guide</i>	<ul style="list-style-type: none"> • Frame: unibody construction with finger jointed plywood • Upholstery: multiple densities of laminated polyurethane foam • Glides: height adjustable with stainless steel finish leveling polyurethane glides • Double needle stitch seams 	1 Style number 2 Number of fabrics if contrasting fabric style number is selected 3 Fabric or leather color number for upholstery on bench 4 Options, if selected (see below) ► See <i>Surface Materials</i> , page 178.

Options	Price	Required to Specify
Surface Materials	<ul style="list-style-type: none"> • Contrasting fabric 	+\$182 per fabric Add suffix K to the style number and select fabric color number.
	Acrylic backer <ul style="list-style-type: none"> • Wave and flat seats • Little Ripple wave and flat seats 	+\$105 +\$ 47 Specify with <i>acrylic backer</i> . Specify with <i>acrylic backer</i> . ► See <i>Surface Materials</i> , page 178.

Specification Information													
Style Number	Base Prices										Leather Groups:		
	Fabric Groups:										COL	1	2
COM	1	2	3	4	5	6	7	8	9	10			

Upholstered Wave Seat

490-B96VRT

\$3396 \$3396 \$3620 \$3806 \$4026 \$4360 \$4770 \$5243 \$5743 \$6183 \$6653 \$3895 \$8227 \$9078

COM/yds = 7½, COL/sq ft = 143

Upholstered Flat Seat

490-B96HRZ

\$3396 \$3396 \$3620 \$3806 \$4026 \$4360 \$4770 \$5243 \$5743 \$6183 \$6653 \$3895 \$8227 \$9078

COM/yds = 7½, COL/sq ft = 143

Little Ripple Wave Seat

490-B35VRT

\$1361 \$1361 \$1428 \$1484 \$1550 \$1650 \$1773 \$1915 \$2065 \$2197 \$2338 \$1848 \$3306 \$3595

COM/yds = 2¼, COL/sq ft = 50

► Specification Information, continued on next page

Ripple Benches

DESIGN LAURINDA SPEAR, FAIA

► Specification Information, continued from previous page

Specification Information

Style Number	Base Prices										Leather Groups:		
	Fabric Groups:										COL		
	COM	1	2	3	4	5	6	7	8	9	10	1	2

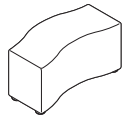

Overall: 19"D 35½"W 19"H

Little Ripple Flat Seat

490-B35HRZ														
	\$1361	\$1361	\$1428	\$1484	\$1550	\$1650	\$1773	\$1915	\$2065	\$2197	\$2338	\$1848	\$3306	\$3595
COM/yds = 2¼, COL/sq ft = 50														

Sidewalk Lounge/Mobile

DESIGN STUDIO B

Tip: Fabrics and leathers will appear loose with comfort wrinkles when upholstered.

Tip: Recommended leathers are Elmosoft group 1 and Elmorustical group 2.

Tip: Special color match, consult Customer Service.

Tip: Multi-fabric diagram available.

►Page 70

Tip: For Customer's Own Material or Leather, see necessary requirements, important processing instructions, and ordering information.

►Page 180

Tip: Specify tablet from facing position.

Tip: Tablet can be installed on mobile models only.

Tip: Cup holder must be specified with tablet.

Tip: Extra pivoter allows tablet to be moved side to side.

Standard Includes

- Need help? Product details, see *Coalesse Seating and Outdoor Specification Guide*
- Frame: unibody construction with finger jointed plywood
- Upholstery: multiple densities of polyurethane foam and polyester fiber on seat, back, and arms.
- Lounge:
 - Legs: silver powder coat steel legs with "go" glide
- Mobile:
 - 13½" diameter tablet: laminate
 - Legs: Silver powder coat steel legs with casters
 - Casters: four non-locking

Required to Specify

- 1 Style number
 - 2 Number of fabrics if contrasting fabric style number is selected
 - 3 Fabric or leather color number for upholstery on seat, back, and arms
 - 4 Options, if selected (see below)
- See *Surface Materials*, page 178.

Options

Options	Price	Required to Specify
Surface Materials	• Contrasting fabric +\$182 per fabric	Add suffix K to the style number and select fabric color number.
	Acrylic backer	
	• Lounge chair +\$ 55	Specify with acrylic backer.
	• Lounge two-seat chair +\$ 77	Specify with acrylic backer.
	• Arm bolster +\$ 10	Specify with acrylic backer.
		►See <i>Surface Materials</i> , page 178.
Cup Holder	• Cup holder +\$ 77	Specify with cup holder.
Tablet Side Storage	• Tablet side storage +\$114	Specify with tablet side storage and select left or right-facing.
Extra Pivoter	• Extra pivoter +\$274	Specify with extra pivoter.
Omit Tablet	• Omit tablet -\$239	Specify with omit tablet.
Glides	Lounge	
	• "No go" ½" polyethylene glide No cost	Specify with "no go".
	Mobile	
	• Go glides No cost	Specify with go glides.
Casters	• Locking casters No cost	Specify with locking casters.
Related Products	• Ottomans/benches • Sidewalk tables	►Page 72 ►See <i>GSA Volume 5b Specification Guide</i> .

Specification Information

Style Number	Base Prices											Leather Groups:		
	Fabric Groups:											COL	1	2
	COM	1	2	3	4	5	6	7	8	9	10			

Low-Back Lounge Chair

444	\$2415	\$2415	\$2532	\$2629	\$2746	\$2920	\$3135	\$3383	\$3645	\$3877	\$4123	\$2922	\$5736	\$6236
-----	--------	--------	--------	--------	--------	--------	--------	--------	--------	--------	--------	--------	--------	--------

COM/yds = 4, COL/sq ft = 88
 ►Specification Information, continued on next page

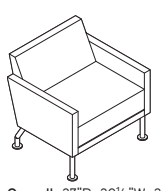

Overall: 27"D 30½"W 29"H
 Inside: 19"D 26"W 17"H
 Seat: 17½"H
 Arm: 23"H

Sidewalk Lounge/Mobile

DESIGN STUDIO B

► Specification Information, continued from previous page

Specification Information

Style Number	Base Prices										Leather Groups:		
	Fabric Groups:										COL	1	2
	COM	1	2	3	4	5	6	7	8	9	10		

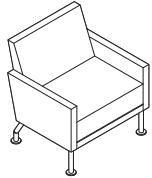

Overall: 27"D 30½"W 32"H
 Inside: 19"D 26"W 20"H
 Seat: 17½"H
 Arm: 23"H

High-Back Lounge Chair

446	\$2670	\$2670	\$2801	\$2911	\$3042	\$3238	\$3480	\$3759	\$4053	\$4315	\$4592	\$3192	\$6187	\$6690
-----	--------	--------	--------	--------	--------	--------	--------	--------	--------	--------	--------	--------	--------	--------

COM/yds = 4½, COL/sq ft = 99

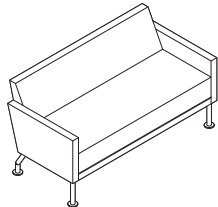

Overall: 27"D 56½"W 29"H
 Inside: 19"D 52"W 17"H
 Seat: 17½"H
 Arm: 23"H

2-Seat Lounge

444-2	\$3820	\$3820	\$3980	\$4114	\$4274	\$4514	\$4810	\$5150	\$5510	\$5830	\$6168	\$4342	\$8245	\$8807
-------	--------	--------	--------	--------	--------	--------	--------	--------	--------	--------	--------	--------	--------	--------

COM/yds = 5½, COL/sq ft = 121

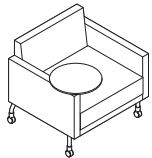

Overall: 27"D 30½"W 29"H
 Inside: 19"D 26"W 17"H
 Seat: 17½"H
 Arm: 22½"H

Low-Back Mobile Lounge Chair with Tablet

444M	\$3281	\$3281	\$3398	\$3495	\$3612	\$3786	\$4001	\$4249	\$4511	\$4743	\$4989	\$3780	\$6595	\$7155
------	--------	--------	--------	--------	--------	--------	--------	--------	--------	--------	--------	--------	--------	--------

COM/yds = 4, COL/sq ft = 88

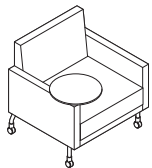

Overall: 27"D 30½"W 32"H
 Inside: 19"D 26"W 20"H
 Seat: 17½"H
 Arm: 22½"H

High-Back Mobile Lounge Chair with Tablet

446M	\$3542	\$3542	\$3673	\$3783	\$3914	\$4110	\$4352	\$4631	\$4925	\$5187	\$5464	\$4049	\$7226	\$7843
------	--------	--------	--------	--------	--------	--------	--------	--------	--------	--------	--------	--------	--------	--------

COM/yds = 4½, COL/sq ft = 99



Overall: 17½"H 5¾" Dia

Arm Bolster

440-B	\$ 438	\$ 438	\$ 470	\$ 496	\$ 527	\$ 574	\$ 632	\$ 698	\$ 769	\$ 831	\$ 898	\$ 974	\$1296	\$1732
-------	--------	--------	--------	--------	--------	--------	--------	--------	--------	--------	--------	--------	--------	--------

COM/yds = 1, COL/sq ft = 18

Sidewalk Multi-Fabric Diagram

DESIGN STUDIO B

TO: _____

FROM: _____

DATE: _____

FAX....888.413.5161

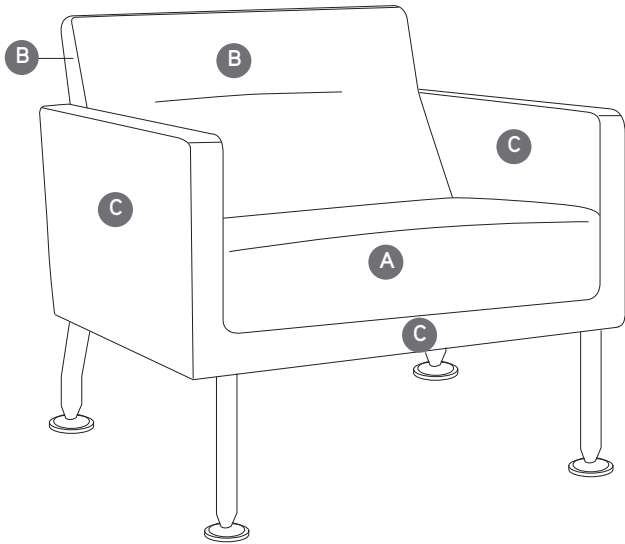

A Upholstery Selection (default for entire unit if B is not selected):

B Back: _____

C Arms: _____

Total list price upcharge for contrasting fabrics: \$ _____

See specifying for contrasting fabric upcharge. List price based on highest fabric group usage.

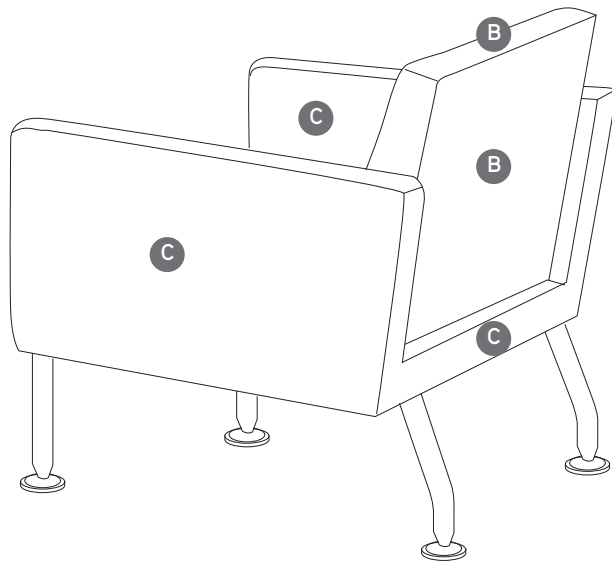

Specify Model below:

- 444K Sidewalk Low-Back Lounge Chair or Mobile
- 446K Sidewalk High-Back Lounge Chair or Mobile
- 444-2K Sidewalk 2-Seat Lounge

Sidewalk Collaborative

DESIGN STUDIO B

Standard Includes		Required to Specify
<ul style="list-style-type: none"> ▶ Need help? Product details, see <i>Coalesse Seating and Outdoor Specification Guide</i> 	<ul style="list-style-type: none"> • Frame: unibody construction with finger jointed plywood • Upholstery: multiple densities of polyurethane foam and polyester fiber on seat and back • Legs: silver powder coat steel with "go" glides 	<ul style="list-style-type: none"> 1 Style number 2 Fabric or leather color number for upholstery 3 Options, if selected (see below) ▶ See <i>Surface Materials</i>, page 178.

Options	Price	Required to Specify
Surface Materials <ul style="list-style-type: none"> • Acrylic backer • 17"D x 17"W and 17"D x 20"W ottomans • 20"D x 26"W Ottoman 	<ul style="list-style-type: none"> +\$20 +\$27 	<ul style="list-style-type: none"> Specify with acrylic backer. Specify with acrylic backer. ▶ See <i>Surface Materials</i>, page 178.
Glides <ul style="list-style-type: none"> • "No go" 1/2" polyethylene glides 	No cost	Specify with "no go" glides.

Specification Information													
Style Number	Base Prices										Leather Groups:		
	Fabric Groups:										COL	1	2
COM	1	2	3	4	5	6	7	8	9	10			

Ottoman

430-H1717	\$1379	\$1379	\$1423	\$1460	\$1503	\$1569	\$1649	\$1742	\$1840	\$1928	\$2020	\$1901	\$2327	\$2700
COM/yds = 1½, COL/sq ft = 22½														

430-H1720	\$1379	\$1379	\$1423	\$1460	\$1503	\$1569	\$1649	\$1742	\$1840	\$1928	\$2020	\$1901	\$2327	\$2700
COM/yds = 1½, COL/sq ft = 24														

430-H2026	\$1649	\$1649	\$1708	\$1756	\$1815	\$1902	\$2009	\$2133	\$2264	\$2380	\$2503	\$2148	\$2860	\$3242
COM/yds = 2, COL/sq ft = 36														

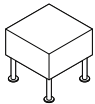

Overall: 17"D 17"W 17"H

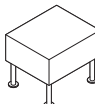

Overall: 17"D 20"W 17"H

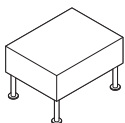

Overall: 20"D 26"W 17"H

Sidewalk Ottoman/Benches

DESIGN STUDIO B

Tip: Fabrics and leathers will appear loose with comfort wrinkles when upholstered.

Tip: Recommended leathers are Elmosoft group 1 and Elmorustical group 2.

Tip: Special color match, consult Customer Service.

Tip: For Customer's Own Material or Leather, see necessary requirements, important processing instructions, and ordering information.

▶ Page 180

Standard Includes		Required to Specify	
▶ Need help? Product details, see <i>Coalesse Seating and Outdoor Specification Guide</i>	<ul style="list-style-type: none"> • Frame: unibody construction with finger jointed plywood. • Upholstery: multiple densities of polyurethane foam and polyester fiber on ottoman/benches • Legs: silver powder coat steel with "go" glides 	1 Style number 2 Fabric or leather color number for upholstery on ottoman/benches 3 Options, if selected (see below) ▶ See <i>Surface Materials</i> , page 178.	
Options		Required to Specify	
Surface Materials	Acrylic backer <ul style="list-style-type: none"> • 17"D x 24"W bench +\$20 • 17"D x 36"W bench +\$27 • 17"D x 48"W bench +\$34 • Ottoman +\$47 	Specify with acrylic backer. Specify with acrylic backer. Specify with acrylic backer. Specify with acrylic backer. ▶ See <i>Surface Materials</i> , page 178.	
Glides	<ul style="list-style-type: none"> • "No go" 1/2" polyethylene glides 	No cost	Specify with "no go" glides.

Specification Information

Style Number	Base Prices										Leather Groups:			
	Fabric Groups:										COL	1	2	
	COM	1	2	3	4	5	6	7	8	9	10			

Benches

430-B1724

\$1494 \$1494 \$1529 \$1559 \$1594 \$1646 \$1710 \$1785 \$1863 \$1933 \$2007 \$2014 \$2523 \$2878

COM/yds = 1½, COL/sq ft = 27

430-B1736

\$1757 \$1757 \$1816 \$1864 \$1923 \$2010 \$2117 \$2241 \$2372 \$2488 \$2611 \$2267 \$2980 \$3378

COM/yds = 2, COL/sq ft = 36

430-B1748

\$2025 \$2025 \$2098 \$2159 \$2232 \$2341 \$2475 \$2630 \$2794 \$2939 \$3093 \$2524 \$3437 \$3835

COM/yds = 2½, COL/sq ft = 45

Ottoman

430-H3636

\$2048 \$2048 \$2128 \$2195 \$2275 \$2395 \$2543 \$2713 \$2893 \$3053 \$3222 \$2547 \$4484 \$4929

COM/yds = 2¾, COL/sq ft = 61

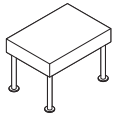

Overall: 17"D 24"W 17"H

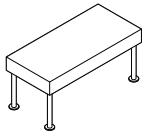

Overall: 17"D 36"W 17"H

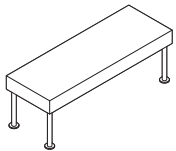

Overall: 17"D 48"W 17"H

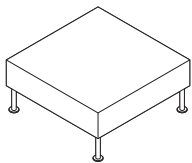

Overall: 36"D 36"W 17"H

Davos by Viccarbe

DESIGN JEFFREY BERNETT

Tip: For Customer's Own Material or Leather, see necessary requirements, important processing instructions, and ordering information.
 ▶ Page 180

Tip: Fabrics and leathers will appear loose with comfort wrinkles when upholstered.

Tip: K suffix must be specified for leather underside.

Tip: Models with fabric underside include black denim section to allow for proper air flow. If this aesthetic is not desired, select contrasting option with leather underside.

Standard Includes		Required to Specify
▶ Need help? Product details, see <i>Coalesse Seating and Outdoor Specification Guide</i>	<ul style="list-style-type: none"> Upholstery for chair or bench: fabric or leather Glides: non-adjustable metal 	1 Style number 2 Number of fabrics if contrasting fabric style number is selected 3 Fabric or leather color number for upholstery 4 Options, if selected (see below) ▶ See <i>Surface Materials</i> , page 178.

Options	Price	Required to Specify
Surface Materials	<ul style="list-style-type: none"> Contrasting fabric +\$182 per fabric 	Add suffix K to the style number and select fabric color number.
Acrylic backer		Specify with acrylic backer.
• Chair	+\$ 84	Specify with acrylic backer.
• Large bench	+\$ 50	Specify with acrylic backer.
• Medium bench	+\$ 39	Specify with acrylic backer.
• Small bench	+\$ 24	Specify with acrylic backer.
		▶ See <i>Surface Materials</i> , page 178.

Specification Information													
Style Number	Base Prices										Leather Groups:		
	Fabric Groups:										COL	1	2
COM	1	2	3	4	5	6	7	8	9	10			

Lounge Chair

CODAV	\$3286	\$3286	\$3437	\$3563	\$3712	\$3938	\$4217	\$4537	\$4876	\$5176	\$5496	\$3705	\$6014	\$6453
COM/yds = 5, COL/sq ft = 110														

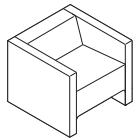

Overall: 30"D 30"W 25½"H
 Seat: 19"D 24"W 16½"H

Large Bench

CODAV60	\$2675	\$2675	\$2775	\$2856	\$2954	\$3102	\$3282	\$3490	\$3711	\$3906	\$4114	\$3094	\$4409	\$4653
COM/yds = 3¼, COL/sq ft = 71½														

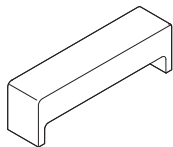

Overall: 13¼"D 59½"W 17½"H

Medium Bench

CODAV38	\$1923	\$1923	\$1992	\$2048	\$2116	\$2218	\$2343	\$2487	\$2640	\$2775	\$2919	\$2342	\$3535	\$3754
COM/yds = 2½, COL/sq ft = 55														

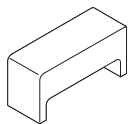

Overall: 13¼"D 38"W 17½"H

Small Bench

CODAV16	\$1234	\$1234	\$1287	\$1331	\$1384	\$1463	\$1560	\$1672	\$1791	\$1896	\$2008	\$1653	\$2575	\$2768
COM/yds = 1¾, COL/sq ft = 39														



Overall: 13¼"D 18½"W 17½"H

Lounge Seating

Hosu

DESIGN PATRICIA URQUIOLA

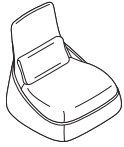

Tip: Fabrics and leathers will appear loose with comfort wrinkles when upholstered.

Tip: Recommended leathers are Elmosoft group 1 and Elmorustical group 2.

Tip: Frame design allows back to flex to support occupants back shape.

Tip: Due to the design and construction techniques of the Hosu lounge only certain textiles can be successfully applied, therefore all COM fabrics must be submitted to Coalesse for approval prior to order acceptance.

Tip: Hexa fabrics (fabric group 4) were specifically designed by Patricia Urquiola for Hosu lounge seating.
 ▶ See Coalesse Surface Materials Reference Guide for complete listing of Hexa fabrics.

Standard Includes		Required to Specify
▶ Need help? Product details, see <i>Coalesse Seating and Outdoor Specification Guide</i>	<ul style="list-style-type: none"> • Frame: plywood tab construction • Multiple densities of polyurethane foam and polyester fiber • Seat and back: fabric or leather • Wrap: made from ABS plastic • Footrest on fabric chair, if selected: leather • Footrest on leather chair, if selected: leather to match seat and back • Glides: non-adjustable • Pull tab on ottoman, if selected: Nylon strap • Grommet for wire pass-through on models COURQLO and COURQLOK, if selected • Pillow: fabric or leather 	<ol style="list-style-type: none"> 1 Style number 2 Number of fabrics if contrasting fabric style number is selected 3 Fabric or leather color number for upholstery on seat, back, and pillow 4 Leather color number for footrest, if selected 5 Color number for pull tab with ottoman, if selected: CL40 Red CL41 Blue CL42 Black 6 Options, if selected (see below) ▶ See <i>Surface Materials</i>, page 178.

Options	Price	Required to Specify
Surface Materials	Pillow for lounge chair and lounge chair with ottoman	
	<ul style="list-style-type: none"> • Fabric groups 1-5 No cost • Fabric group 6 +\$ 162 • Fabric group 7 +\$ 218 • Fabric group 8 +\$ 277 • Fabric group 9 +\$ 329 • Fabric group 10 +\$ 384 • Leather group 1 +\$ 518 • Leather group 2 +\$ 623 • Customer's Own Material (COM) No cost • Customer's Own Leather (COL) +\$ 419 	Specify fabric color number. Specify fabric color number. Specify fabric color number. Specify fabric color number. Specify fabric color number. Specify fabric color number. Specify leather color number. Specify leather color number. ▶ See <i>Surface Materials</i> , page 178. ▶ See <i>Surface Materials</i> , page 178.
	Pillows for two-seat lounge	
	<ul style="list-style-type: none"> • Fabric groups 1-5 No cost • Fabric group 6 +\$ 284 • Fabric group 7 +\$ 381 • Fabric group 8 +\$ 484 • Fabric group 9 +\$ 575 • Fabric group 10 +\$ 672 • Leather group 1 +\$ 918 • Leather group 2 +\$1109 • Customer's Own Material (COM) No cost • Customer's Own Leather (COL) +\$ 419 	Specify fabric color number. Specify fabric color number. Specify fabric color number. Specify fabric color number. Specify fabric color number. Specify fabric color number. Specify leather color number. Specify leather color number. ▶ See <i>Surface Materials</i> , page 178. ▶ See <i>Surface Materials</i> , page 178.
	<ul style="list-style-type: none"> • Contrasting fabric +\$ 182 per fabric 	Add suffix K to the style number and select fabric color number.
	Acrylic backer	
	<ul style="list-style-type: none"> • Lounge chair +\$ 60 • Lounge chair with ottoman +\$ 84 • 2-seat lounge +\$ 112 	Specify with acrylic backer. Specify with acrylic backer. Specify with acrylic backer. ▶ See <i>Surface Materials</i> , page 178.

Hosu

DESIGN PATRICIA URQUIOLA

Specification Information

Style Number	Base Prices										Leather Groups:		
	Fabric Groups:										COL	1	2
COM	1	2	3	4	5	6	7	8	9	10	COL	1	2

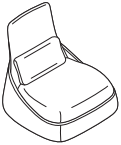

Overall: 35³/₈"D 34³/₈"W 35"H
 Inside: 24"D 31"W 14"H
 Pillow: 3"D 20¹/₈"W 10¹/₈"H

Lounge Chair with Lumbar Pillow

Style	COM	1	2	3	4	5	6	7	8	9	10	COL	1	2
COURQL	\$3310	\$3310	\$3421	\$3514	\$3625	\$3792	\$3998	\$4234	\$4484	\$4706	\$4942	\$3729	\$5420	\$5669

Lounge: COM/yds = 4¹/₄, COL/sq ft = 94
 Pillow: COM/yds = 1, COL/sq ft = 22

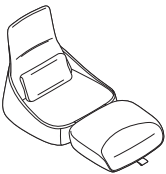

Overall: 35³/₈"D 34³/₈"W 35"H
 Overall extended: 57"L
 Inside: 24"D 31"W 14"H
 Inside extended: 48"L
 Pillow: 3"D 20¹/₈"W 10¹/₈"H
 Ottoman: 24"D 31"W 8¹/₂"H

Lounge Chair with Ottoman and Lumbar Pillow

Style	COM	1	2	3	4	5	6	7	8	9	10	COL	1	2
COURQLO	\$3990	\$3990	\$4141	\$4266	\$4417	\$4643	\$4921	\$5241	\$5579	\$5879	\$6198	\$4409	\$6836	\$7171

Lounge: COM/yds = 5³/₄, COL/sq ft = 126
 Pillow: COM/yds = 1, COL/sq ft = 22



Overall: 35³/₈"D 64¹/₈"W 35"H
 Inside: 24"D 57¹/₈"W 14"H
 Pillows: 3"D 24"W 10¹/₈"H

2-Seat Lounge with Two Lumbar Pillows

Style	COM	1	2	3	4	5	6	7	8	9	10	COL	1	2
COURQS	\$5294	\$5294	\$5471	\$5618	\$5795	\$6060	\$6387	\$6762	\$7159	\$7512	\$7886	\$5713	\$8480	\$8862

Lounge: COM/yds = 6³/₄, COL/sq ft = 143
 Pillows: COM/yds = 1³/₄, COL/sq ft = 39

Millbrae Lounge

DESIGN COALESSE DESIGN GROUP



Tip: Fabrics and leathers will appear loose with comfort wrinkles when upholstered.

Tip: For Customer's Own Material or Leather, see necessary requirements, important processing instructions, and ordering information.

► Page 180

Standard Includes		Required to Specify	
<p>► Need help? Product details, see <i>Coalesse Seating and Outdoor Specification Guide</i></p> <ul style="list-style-type: none"> • Frame: constructed with finger jointed plywood • Multiple densities of polyurethane foams and polyester fiber on seat and back: fabric or leather • The lifestyle collection has tufted pattern accents and separate back cushions with double needle top stitch: fabric or leather • The contract collection has quilted pattern accents with double needle top stitch: fabric or leather • Steel base: paint • Ganging kit with attachment hardware, if selected 		<ol style="list-style-type: none"> 1 Style number 2 Fabric or leather color number for seat, back, and arms 3 Paint color number for base 4 Options, if selected (see below) <p>► See <i>Surface Materials</i>, page 178.</p>	
Options		Price	Required to Specify
Surface Materials	<ul style="list-style-type: none"> • Contrasting fabric 	+\$ 182 per fabric	Add suffix K to the style number and select fabric color number. ► See <i>Surface Materials</i> , page 178
Acrylic backer lifestyle chairs			
	<ul style="list-style-type: none"> • Lounge chair • 2-seat lounge • 3-seat lounge 	+\$ 86 +\$ 144 +\$ 197	Specify with acrylic backer. Specify with acrylic backer. Specify with acrylic backer.
Acrylic backer contract chairs			
	<ul style="list-style-type: none"> • Lounge chair armless • Lounge chair with arms • Lounge chair left or right arm facing • 2-seat lounge armless • 2-seat lounge with arms • 2-seat lounge left or right arm facing • 3-seat lounge armless • 3-seat lounge with arms • 3-seat lounge left or right arm facing • Four-seat lounge armless • Four-seat lounge with arms • Four-seat lounge left or right arm facing • Bench • 2-seat bench • 3-seat bench • Four-seat bench 	+\$ 34 +\$ 55 +\$ 49 +\$ 55 +\$ 77 +\$ 70 +\$ 77 +\$ 98 +\$ 86 +\$ 98 +\$ 119 +\$ 106 +\$ 24 +\$ 34 +\$ 49 +\$ 55	Specify with acrylic backer. Specify with acrylic backer. Specify with acrylic backer. Specify with acrylic backer. Specify with acrylic backer. Specify with acrylic backer. Specify with acrylic backer. Specify with acrylic backer. Specify with acrylic backer. Specify with acrylic backer. Specify with acrylic backer. Specify with acrylic backer. Specify with acrylic backer. Specify with acrylic backer.
Bolsters			
	<ul style="list-style-type: none"> • Square or round bolster pillows 	+\$ 10	Specify with acrylic backer. ► See <i>Surface Materials</i> , page 178.
Base			
	<ul style="list-style-type: none"> • Group 3 paint 	+\$ 149	Specify paint color number.
Plated metal			
	<ul style="list-style-type: none"> • Lounge chair • 2-seat lounge • 3-seat lounge • Four-seat lounge • One-seat bench • 2-seat bench • 3-seat bench • Four-seat bench 	+\$1201 +\$1361 +\$2003 +\$2171 +\$1201 +\$1361 +\$2003 +\$2171	Specify with 9238 Brushed Nickel base. Specify with 9238 Brushed Nickel base. Specify with 9238 Brushed Nickel base. Specify with 9238 Brushed Nickel base. Specify with 9238 Brushed Nickel base. Specify with 9238 Brushed Nickel base. Specify with 9238 Brushed Nickel base. Specify with 9238 Brushed Nickel base.
Bolster/Pillow Attachment Rings	<ul style="list-style-type: none"> • Attachment rings for bolster/pillow attach to lounge attachment straps 	+\$ 98	Specify with attachment rings.
Lounge Attachment Straps	<ul style="list-style-type: none"> • Attachment straps for lounge attach to bolster/pillow attachment rings 	No cost	Specify with attachment straps for left and right sides.
Related Products	<ul style="list-style-type: none"> • Occasional tables 		► See <i>GSA Volume 5b Specification Guide</i> .

Tip: Attachment straps are standard on back cushions of Lifestyle lounge.

Millbrae Lounge

DESIGN COALESSE DESIGN GROUP

Specification Information

Style Number	Base Prices										Leather Groups:	
	Fabric Groups:										COL	
	1	2	3	4	5	6	7	8	9	10	1	2

Lifestyle Lounge Seating

Lounge

COMSL1	\$3888	\$3888	\$4045	\$4177	\$4331	\$4566	\$4856	\$5187	\$ 5540	\$ 5851	\$ 6181	\$4307	\$ 6579	\$ 6893
--------	--------	--------	--------	--------	--------	--------	--------	--------	---------	---------	---------	--------	---------	---------

COM/yds = 5¼, COL/sq ft = 115

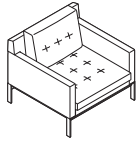

Overall: 35"D 35"W 28¾"H
Overall inside: 29"D 29"W 17"H
Inside to pillow: 22"D 29"W 17"H

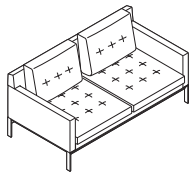

Overall: 35"D 64"W 28¾"H
Overall inside: 29"D 58"W 17"H
Inside to pillow: 22"D 58"W 17"H

2-Seat Lounge

COMSL2	\$5895	\$5895	\$6141	\$6348	\$6591	\$6960	\$7416	\$7935	\$ 8490	\$ 8979	\$ 9498	\$6314	\$10,136	\$10,631
--------	--------	--------	--------	--------	--------	--------	--------	--------	---------	---------	---------	--------	----------	----------

COM/yds = 8¼, COL/sq ft = 181

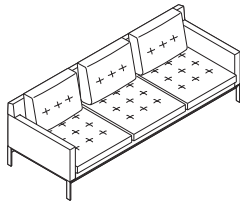

Overall: 35"D 92½"W 28¾"H
Overall inside: 29"D 87"W 17"H
Inside to pillow: 22"D 87"W 17"H

3-Seat Lounge

COMSL3	\$7378	\$7378	\$7692	\$7955	\$8264	\$8734	\$9314	\$9975	\$10,681	\$11,304	\$11,964	\$7797	\$12,791	\$13,421
--------	--------	--------	--------	--------	--------	--------	--------	--------	----------	----------	----------	--------	----------	----------

COM/yds = 10½, COL/sq ft = 231

Contract Lounge Chairs

Without Arms

COMFL1	\$3234	\$3234	\$3316	\$3385	\$3466	\$3589	\$3741	\$3914	\$ 4099	\$ 4262	\$ 4435	\$3653	\$ 4513	\$ 4661
--------	--------	--------	--------	--------	--------	--------	--------	--------	---------	---------	---------	--------	---------	---------

COM/yds = 2¾, COL/sq ft = 60



Overall: 30"D 26"W 31"H
Inside seat height: 22"D 17"H

With Arms

COMFLA1	\$3686	\$3686	\$3806	\$3906	\$4024	\$4203	\$4424	\$4676	\$ 4945	\$ 5182	\$ 5433	\$4105	\$ 5749	\$ 5990
---------	--------	--------	--------	--------	--------	--------	--------	--------	---------	---------	---------	--------	---------	---------

COM/yds = 4, COL/sq ft = 88



Overall: 30"D 32"W 31"H
Inside: 22"D 26½"W 17"H

With Left Arm Facing

COMFLLA1	\$3453	\$3453	\$3550	\$3632	\$3728	\$3873	\$4053	\$4257	\$ 4476	\$ 4668	\$ 4873	\$3872	\$ 5143	\$ 5338
----------	--------	--------	--------	--------	--------	--------	--------	--------	---------	---------	---------	--------	---------	---------

COM/yds = 3¾, COL/sq ft = 72



Overall: 30"D 29"W 31"H
Inside: 22"D 26½"W 17"H

With Right Arm Facing

COMFLRA1	\$3453	\$3453	\$3550	\$3632	\$3728	\$3873	\$4053	\$4257	\$ 4476	\$ 4668	\$ 4873	\$3872	\$ 5143	\$ 5338
----------	--------	--------	--------	--------	--------	--------	--------	--------	---------	---------	---------	--------	---------	---------

COM/yds = 3¾, COL/sq ft = 72

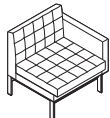

Overall: 30"D 29"W 31"H
Inside: 22"D 26½"W 17"H

► Specification Information, continued on next page

Millbrae Lounge *continued*

DESIGN COALESSE DESIGN GROUP

► Specification Information, continued from previous page

Specification Information

Style Number	Base Prices										Leather Groups:			
	Fabric Groups:										COL	1	2	
	COM	1	2	3	4	5	6	7	8	9	10			

Contract 2-Seat Lounges

Without Arms

COMFL2	\$5165	\$5165	\$5300	\$5413	\$5545	\$5746	\$5995	\$6278	\$6581	\$6848	\$7131	\$5584	\$7201	\$7442
--------	--------	--------	--------	--------	--------	--------	--------	--------	--------	--------	--------	--------	--------	--------

COM/yds = 4½, COL/sq ft = 99

With Arms

COMFLA2	\$5611	\$5611	\$5783	\$5927	\$6097	\$6354	\$6672	\$7033	\$7420	\$7761	\$8123	\$6030	\$8438	\$8768
---------	--------	--------	--------	--------	--------	--------	--------	--------	--------	--------	--------	--------	--------	--------

COM/yds = 5¾, COL/sq ft = 126

With Left Arm Facing

COMFLLA2	\$5379	\$5379	\$5529	\$5654	\$5801	\$6025	\$6301	\$6616	\$6952	\$7249	\$7563	\$5798	\$7806	\$8088
----------	--------	--------	--------	--------	--------	--------	--------	--------	--------	--------	--------	--------	--------	--------

COM/yds = 5, COL/sq ft = 110

With Right Arm Facing

COMFLRA2	\$5379	\$5379	\$5529	\$5654	\$5801	\$6025	\$6301	\$6616	\$6952	\$7249	\$7563	\$5798	\$7806	\$8088
----------	--------	--------	--------	--------	--------	--------	--------	--------	--------	--------	--------	--------	--------	--------

COM/yds = 5, COL/sq ft = 110

► Specification Information, continued on next page

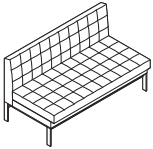

Overall: 30"D 52"W 31"H
Inside seat height: 22"D 17"H

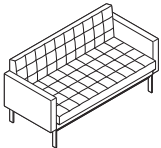

Overall: 30"D 58"W 31"H
Inside: 22"D 52½"W 17"H

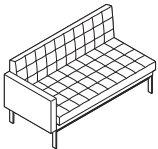

Overall: 30"D 55"W 31"H
Inside: 22"D 52¾"W 17"H

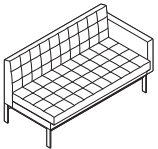

Overall: 30"D 55"W 31"H
Inside: 22"D 52¾"W 17"H

Millbrae Lounge

DESIGN COALESSE DESIGN GROUP

► Specification Information, continued from previous page

Specification Information

Style Number	Base Prices										Leather Groups:	
	Fabric Groups:										COL	
	1	2	3	4	5	6	7	8	9	10	1	2

Contract 3-Seat Lounges

Without Arms

COMFL3	\$6491	\$6491	\$6670	\$6821	\$6998	\$7266	\$7598	\$7975	\$8379	\$8734	\$ 9112	\$6910	\$ 9304	\$ 9634
---------------	--------	--------	--------	--------	--------	--------	--------	--------	--------	--------	---------	--------	---------	---------

COM/yds = 6, COL/sq ft = 132

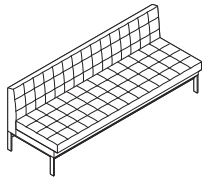

Overall: 30"D 78"W 31"H
Inside seat height: 22"D 17"H

With Arms

COMFLA3	\$6959	\$6959	\$7183	\$7371	\$7592	\$7928	\$8342	\$8814	\$9319	\$9763	\$10,235	\$7378	\$10,546	\$10,966
----------------	--------	--------	--------	--------	--------	--------	--------	--------	--------	--------	----------	--------	----------	----------

COM/yds = 7½, COL/sq ft = 159

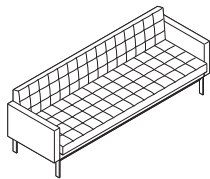

Overall: 30"D 84"W 31"H
Inside: 22"D 78½"W 17"H

With Left Arm Facing

COMFLLA3	\$6726	\$6726	\$6928	\$7097	\$7296	\$7598	\$7971	\$8396	\$8850	\$9250	\$ 9674	\$7145	\$ 9938	\$10,313
-----------------	--------	--------	--------	--------	--------	--------	--------	--------	--------	--------	---------	--------	---------	----------

COM/yds = 6¾, COL/sq ft = 148

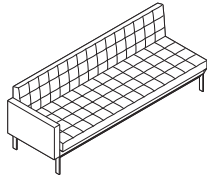

Overall: 30"D 81"W 31"H
Inside: 22"D 78¾"W 17"H

With Right Arm Facing

COMFLRA3	\$6726	\$6726	\$6928	\$7097	\$7296	\$7598	\$7971	\$8396	\$8850	\$9250	\$ 9674	\$7145	\$ 9938	\$10,313
-----------------	--------	--------	--------	--------	--------	--------	--------	--------	--------	--------	---------	--------	---------	----------

COM/yds = 6¾, COL/sq ft = 148

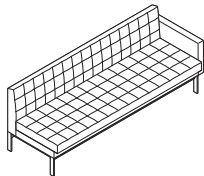

Overall: 30"D 81"W 31"H
Inside: 22"D 78¾"W 17"H

► Specification Information, continued on next page

Lounge Seating

Millbrae Lounge *continued*

DESIGN COALESSE DESIGN GROUP

► Specification Information, continued from previous page

Specification Information

Style Number	Base Prices										Leather Groups:			
	Fabric Groups:										COL	1	2	
	COM	1	2	3	4	5	6	7	8	9	10			

Contract Four-Seat Lounges

Without Arms

COMFL4	\$6973	\$6973	\$7205	\$7399	\$7627	\$7974	\$8402	\$8890	\$ 9411	\$ 9871	\$10,358	\$7392	\$10,546	\$10,966
--------	--------	--------	--------	--------	--------	--------	--------	--------	---------	---------	----------	--------	----------	----------

COM/yds = 7¾, COL/sq ft = 170

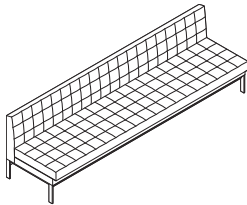

Overall: 30"D 104"W 31"H
Inside seat height: 22"D 17"H

With Arms

COMFLA4	\$7411	\$7411	\$7672	\$7892	\$8150	\$8541	\$9025	\$9575	\$10,164	\$10,682	\$11,233	\$7830	\$ 11,786	\$12,292
---------	--------	--------	--------	--------	--------	--------	--------	--------	----------	----------	----------	--------	-----------	----------

COM/yds = 8¾, COL/sq ft = 192

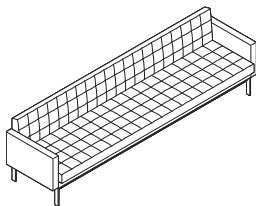

Overall: 30"D 110"W 31"H
Inside: 22"D 104½"W 17"H

With Left Arm Facing

COMFLLA4

	\$7193	\$7193	\$7439	\$7646	\$7889	\$8258	\$8714	\$9233	\$ 9788	\$10,277	\$10,796	\$ 7612	\$ 11,150	\$ 11,614
--	--------	--------	--------	--------	--------	--------	--------	--------	---------	----------	----------	---------	-----------	-----------

COM/yds = 8¾, COL/sq ft = 181

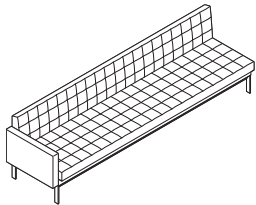

Overall: 30"D 107"W 31"H
Inside: 22"D 104¾"W 17"H

With Right Arm Facing

COMFLRA4

	\$7193	\$7193	\$7439	\$7646	\$7889	\$8258	\$8714	\$9233	\$ 9788	\$10,277	\$10,796	\$ 7612	\$ 11,150	\$ 11,614
--	--------	--------	--------	--------	--------	--------	--------	--------	---------	----------	----------	---------	-----------	-----------

COM/yds = 8¾, COL/sq ft = 181

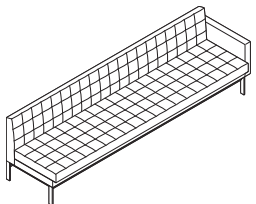

Overall: 30"D 107"W 31"H
Inside: 22"D 104¾"W 17"H

► Specification Information, continued on next page

Millbrae Lounge

DESIGN COALESSE DESIGN GROUP

► Specification Information, continued from previous page

Specification Information

Style Number	Base Prices										Leather Groups:			
	Fabric Groups:										COL	1	2	
	COM	1	2	3	4	5	6	7	8	9	10			

Contract Lounge Benches

One-Seat Bench

COMFLB1	\$2604	\$2604	\$2657	\$2701	\$2752	\$2830	\$2927	\$3037	\$3155	\$3259	\$3369	\$3023	\$3519	\$3624
COM/yds = 1¾, COL/sq ft = 39														

2-Seat Bench

COMFLB2	\$3619	\$3619	\$3701	\$3770	\$3851	\$3974	\$4126	\$4299	\$4484	\$4647	\$4805	\$4038	\$4898	\$5046
COM/yds = 2¾, COL/sq ft = 60														

3-Seat Bench

COMFLB3	\$4225	\$4225	\$4322	\$4404	\$4500	\$4645	\$4825	\$5029	\$5248	\$5440	\$5645	\$4644	\$5915	\$6110
COM/yds = 3¾, COL/sq ft = 72														

Four-Seat Bench

COMFLB4	\$4678	\$4678	\$4813	\$4926	\$5058	\$5259	\$5508	\$5791	\$6094	\$6361	\$6644	\$5097	\$6714	\$6955
COM/yds = 4½, COL/sq ft = 93														

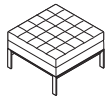

Overall: 26"D 26"W 16½"H

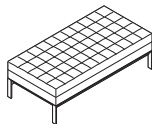

Overall: 26"D 52"W 16½"H

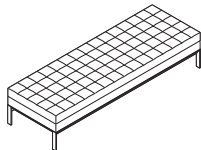

Overall: 26"D 78"W 16½"H

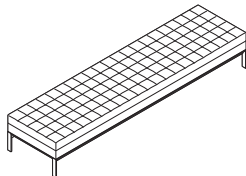

Overall: 26"D 104"W 16½"H



Overall: 18½"D 7"W 7"H

Contract Lounge Round Arm Bolster

COMLPRND	\$ 448	\$ 448	\$ 471	\$ 490	\$ 512	\$ 545	\$ 587	\$ 634	\$ 684	\$ 729	\$ 776	\$ 867	\$ 846	\$ 893
COM/yds = ¾, COL/sq ft = 17														



Overall: 18½"D 7"W 7"H

Contract Lounge Square Arm Bolster

COMLPSQR	\$ 448	\$ 448	\$ 478	\$ 503	\$ 533	\$ 578	\$ 633	\$ 696	\$ 763	\$ 822	\$ 885	\$ 867	\$ 963	\$1023
COM/yds = 1, COL/sq ft = 22														

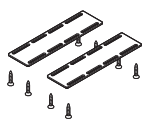

Contract Lounge Ganging Kit

COMF1	\$ 105	N.A.	N.A.	N.A.	N.A.	N.A.	N.A.	N.A.	N.A.	N.A.	N.A.	N.A.	N.A.	N.A.
-------	--------	------	------	------	------	------	------	------	------	------	------	------	------	------

Lagunitas Lounge System 1-Seat Lounges

DESIGN TOAN NGUYEN

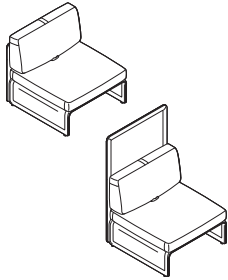

Standard Includes	Required to Specify
<p>► Need help? Product details, see <i>Coalesse Seating and Outdoor Specification Guide</i>.</p> <ul style="list-style-type: none"> • Screen: group 1 knit • Seat deck: group 1 knit to match screen • Non-contrasting seat cushion, articulating back cushion and pulls, back corner cushion, and end arm cushions: fabric or leather • Bracket: paint • Six adjustable glides • Ships assembled 	<ol style="list-style-type: none"> 1 Style number 2 Knit color number for screen 3 Fabric or leather color number for non-contrasting seat cushion, articulating back cushion and pulls, and end arm cushions, if selected 4 Paint color number for bracket: 4141 Platinum Matte 4710 Low Gloss Black 5 Options, if selected (see below) <p>► See <i>Coalesse Surface Materials Reference Guide</i>.</p>

Options	Price	Required to Specify
<p>Surface Materials</p> <p>Fabric screen</p> <ul style="list-style-type: none"> • 1-seat lounge with low-back screen +\$268 • 1-seat lounge with low-back screen and two side screens +\$497 • 1-seat lounge with high-back screen +\$307 • 1-seat lounge with high-back screen and two side screens +\$611 <hr/> <ul style="list-style-type: none"> • Contrasting fabric for screen +\$182 • Contrasting fabric for cushion +\$182 <hr/> <ul style="list-style-type: none"> • Contrasting fabric for top and bottom articulating back pulls +\$182 <hr/> <ul style="list-style-type: none"> • Fabric upcharges Prices at right <hr/> <p>Knit screen</p> <ul style="list-style-type: none"> • Group 1 knit screen No cost • Group 2 knit screen <ul style="list-style-type: none"> – 1-seat lounge with low-back screen +\$275 – 1-seat lounge with low-back screen and two side screens +\$590 – 1-seat lounge with high-back screen +\$314 – 1-seat lounge with high-back screen and two side screens +\$709 <hr/> <p>Acrylic backer</p> <ul style="list-style-type: none"> • 1-seat lounge with low-back screen +\$ 49 • 1-seat lounge with low-back screen and two side screens +\$102 • 1-seat lounge with high-back screen +\$ 81 • 1-seat lounge with high-back screen and two side screens +\$133 <hr/> <ul style="list-style-type: none"> • COM No cost <hr/> <ul style="list-style-type: none"> • COL +\$410 		<p>Specify with <i>screen type fabric</i>. Specify with <i>screen type fabric</i>.</p> <p>Specify with <i>screen type fabric</i>. Specify with <i>screen type fabric</i>.</p> <p>Specify with <i>contrasting fabric</i> and select fabric or leather color number. Specify with <i>contrasting fabric</i> and select fabric or leather color number.</p> <p>Specify with <i>contrasting fabric</i> and select fabric or leather color number.</p> <p>Specify fabric color number.</p> <p>Specify with <i>screen type knit</i> and select knit color number.</p> <p>Specify with <i>screen type knit</i> and select knit color number. Specify with <i>screen type knit</i> and select knit color number. Specify with <i>screen type knit</i> and select knit color number. Specify with <i>screen type knit</i> and select knit color number.</p> <p>Specify with <i>acrylic backer</i>. Specify with <i>acrylic backer</i>. Specify with <i>acrylic backer</i>. Specify with <i>acrylic backer</i>. ► See <i>Coalesse Surface Materials Reference Guide</i>.</p> <p>Specify with <i>COM</i> and select fabric color number. ► See <i>Coalesse Surface Materials Reference Guide</i>.</p> <p>Specify with <i>COL</i> and select leather color number. ► See <i>Coalesse Surface Materials Reference Guide</i>.</p>

► Options, continued on next page

Tip: If contrasting screen is selected, it is required to specify whether seat deck finish will match inner screen or outer screen.

Tip: Contrasting fabric for articulating back pulls upcharge is applied one time per style number.

Tip: When contrasting fabric for articulating back pulls is selected, only one contrasting fabric can be specified and will apply to all pulls.

Tip: For Customer's Own Material or Leather, see necessary requirements, important processing instructions and ordering information.

► See *Coalesse Surface Materials Reference Guide*.

Tip: For any portion of the product that requires a COM, the additional upcharge is a one time charge per product.

Tip: For any portion of the product that requires a COL, the additional upcharge is a one time charge per product.

Lagunitas Lounge System 1-Seat Lounges

DESIGN TOAN NGUYEN

Tip: For each USB port specified, there is one USB per port.

► Options, continued from previous page

	Options	Price	Required to Specify
Power/USB Configuration	• One power module: two power in 4710 Low Gloss Black paint	+\$456	Specify with one power module, with two power.
	• One power module: one USB A+C 20W/one power in 4710 Low Gloss Black paint	+\$605	Specify with one power module, with one power/one USB A+C 20W.

Related Products

- Bench
- Chaise
- Lagunitas tables
- Lounge booth connector screen and alignment connector

- Page 108
- Pages 100–104
- See *GSA Volume 5b Specification Guide*.
- Pages 110–111

► Specification Information, on next page

Lagunitas Lounge System 1-Seat Lounges *continued*

DESIGN TOAN NGUYEN

► Options, on previous page

Specification Information

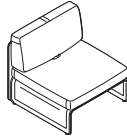

One articulating back
Overall: 32¾"W x 34"D x 32¾"H
Inside (Lounge): 32¾"W x 22½"D
Inside (Task): 32¾"W x 17¾"D
Seat: 16"H

Style Number Base Price

1-Seat Lounge with Low-Back Screen

COLAGLL11 \$4447

Fabric Upcharges

	Fabric Groups:										Leather Groups:	
	1	2	3	4	5	6	7	8	9	10	1	2
Articulating Back Pulls (if top and bottom contrasting pulls are selected)	No cost	+\$ 2	+\$ 14	+\$ 28	+\$ 48	+\$ 74	+\$103	+\$ 134	+\$ 162	+\$ 191	+\$ 250	+\$ 298
Seat Cushion	No cost	+\$10	+\$ 62	+\$124	+\$218	+\$334	+\$466	+\$ 607	+\$ 731	+\$ 864	+\$1074	+\$1284
Back Cushion	No cost	+\$13	+\$ 82	+\$164	+\$288	+\$441	+\$616	+\$ 802	+\$ 966	+\$1141	+\$1074	+\$1284
Inside Screen	No cost	+\$22	+\$125	+\$248	+\$432	+\$664	+\$927	+\$1207	+\$1453	+\$1715	N.A.	N.A.
Outside Screen	No cost	+\$21	+\$124	+\$247	+\$433	+\$664	+\$927	+\$1206	+\$1452	+\$1715	N.A.	N.A.

Tip: Articulating back pull fabric upcharges only apply when contrasting pulls are selected.

One Articulating Back: Seat Deck: 2.6 yards, Inside Screen: 1.4 yards, Outside Screen: 1.6 yards, Seat Cushion: 2.2 yards, 48.4 sq ft, Back Cushion: 2.2 yards, 48.4 sq ft, Contrasting Pulls on Articulating Back Cushion: 0.5 yards, 1.1 sq ft

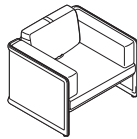

One articulating back and end arm cushions
Overall: 49¼"W x 34"D x 32¾"H
Seat: 16"H

Style Number Base Price

1-Seat Lounge with Low-Back Screen and Two Side Screens

COLAGLL13 \$7079

Fabric Upcharges

	Fabric Groups:										Leather Groups:	
	1	2	3	4	5	6	7	8	9	10	1	2
Articulating Back Pulls (if top and bottom contrasting pulls are selected)	No cost	+\$ 2	+\$ 14	+\$ 28	+\$ 48	+\$ 74	+\$ 103	+\$ 134	+\$ 162	+\$ 191	+\$ 250	+\$ 298
Seat Cushion	No cost	+\$10	+\$ 64	+\$128	+\$224	+\$344	+\$ 480	+\$ 625	+\$ 753	+\$ 889	+\$1272	+\$1520
Back Cushion	No cost	+\$24	+\$148	+\$296	+\$518	+\$795	+\$1111	+\$1446	+\$1741	+\$2057	+\$2685	+\$3210
Inside Screen	No cost	+\$27	+\$165	+\$329	+\$577	+\$885	+\$1236	+\$1609	+\$1938	+\$2289	N.A.	N.A.
Outside Screen	No cost	+\$29	+\$166	+\$330	+\$578	+\$887	+\$1238	+\$1612	+\$1940	+\$2291	N.A.	N.A.

Tip: Articulating back pull fabric upcharges only apply when contrasting pulls are selected.

One Articulating Back and End Arm Cushions: Arm: 0, Seat Deck: 1.8 yards, Inside Screen: 4.4 yards, Outside Screen: 5.1 yards, Seat Cushion: 2.6 yards, 57.2 sq ft, Back Cushion: 5.5 yards, 121 sq ft, Contrasting Pulls on Articulating Back Cushion: 0.5 yards, 1.1 sq ft

► Specification Information, continued on next page

Lagunitas Lounge System 1-Seat Lounges

DESIGN TOAN NGUYEN

► Specification Information, continued from previous page

Specification Information

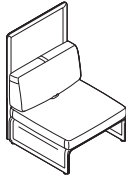

One articulating back
Overall: 32¾"W x 34"D x 50"H
Inside (Lounge): 32¾"W x 22½"D
Inside (Task): 32¾"W x 17¾"D
Seat: 16"H

Style Number Base Price

1-Seat Lounge with High-Back Screen

COLAGLH11 \$4810

Fabric Upcharges

	Fabric Groups:										Leather Groups:	
	1	2	3	4	5	6	7	8	9	10	1	2
Articulating Back Pulls (if top and bottom contrasting pulls are selected)	No cost	+\$ 2	+\$ 14	+\$ 28	+\$ 48	+\$ 74	+\$103	+\$ 134	+\$ 162	+\$ 191	+\$ 250	+\$ 298
Seat Cushion	No cost	+\$11	+\$ 63	+\$125	+\$218	+\$335	+\$467	+\$ 608	+\$ 732	+\$ 864	+\$1074	+\$1284
Back Cushion	No cost	+\$14	+\$ 83	+\$165	+\$288	+\$442	+\$617	+\$ 803	+\$ 967	+\$1142	+\$1074	+\$1284
Inside Screen	No cost	+\$17	+\$104	+\$207	+\$363	+\$558	+\$779	+\$1015	+\$1221	+\$1443	N.A.	N.A.
Outside Screen	No cost	+\$17	+\$103	+\$207	+\$364	+\$557	+\$779	+\$1014	+\$1221	+\$1443	N.A.	N.A.

Tip: Articulating back pulls fabric upcharges only apply when contrasting pulls are selected.

One Articulating Back: Seat Deck: 2.6 yards, Inside Screen: 1.4 yards, Outside Screen: 1.6 yards, Seat Cushion: 2.2 yards, 48.4 sq ft, Back Cushion: 2.2 yards, 48.4 sq ft, Contrasting Pulls on Articulating Back Cushion: 0.5 yards, 1.1 sq ft

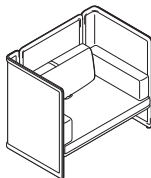

One articulating back and end arm cushions
Overall: 49¼"W x 34"D x 50"H
Seat: 16"H

Style Number Base Price

1-Seat Lounge with High-Back Screen and Two Side Screens

COLAGLH13 \$8747

Fabric Upcharges

	Fabric Groups:										Leather Groups:	
	1	2	3	4	5	6	7	8	9	10	1	2
Articulating Back Pulls (if top and bottom contrasting pulls are selected)	No cost	+\$ 2	+\$ 14	+\$ 28	+\$ 48	+\$ 74	+\$ 103	+\$ 134	+\$ 162	+\$ 191	+\$ 250	+\$ 298
Seat Cushion	No cost	+\$11	+\$ 64	+\$128	+\$224	+\$344	+\$ 481	+\$ 626	+\$ 753	+\$ 890	+\$1272	+\$1520
Back Cushion	No cost	+\$25	+\$148	+\$296	+\$518	+\$796	+\$1111	+\$1447	+\$1742	+\$2057	+\$2685	+\$3210
Inside Screen	No cost	+\$31	+\$183	+\$364	+\$637	+\$978	+\$1365	+\$1777	+\$2139	+\$2526	N.A.	N.A.
Outside Screen	No cost	+\$29	+\$182	+\$363	+\$637	+\$976	+\$1363	+\$1775	+\$2138	+\$2526	N.A.	N.A.

Tip: Articulating back pulls fabric upcharges only apply when contrasting pulls are selected.

One Articulating Back and End Arm Cushions: Arm: 0, Seat Deck: 1.8 yards, Inside Screen: 4.4 yards, Outside Screen: 5.1 yards, Seat Cushion: 2.6 yards, 57.2 sq ft, Back Cushion: 5.5 yards, 121 sq ft, Contrasting Pulls on Articulating Back Cushion: 0.5 yards, 1.1 sq ft

Lounge Seating

Lagunitas Lounge System 2-Seat Lounges

DESIGN TOAN NGUYEN

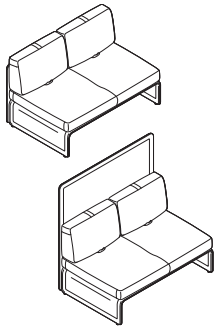

Standard Includes		Required to Specify
<ul style="list-style-type: none"> ▶ Need help? Product details, see <i>Coalesse Seating and Outdoor Specification Guide</i>. • Screen: group 1 knit • Seat deck: group 1 knit to match screen • Non-contrasting seat cushion, articulating back cushion and pulls, back corner cushion, and end arm cushions: fabric or leather • Bracket: paint • Six adjustable glides • Ships assembled 		<ol style="list-style-type: none"> 1 Style number 2 Handedness (see below under Required Selections) 3 Knit color number for screen 4 Fabric or leather color number for non-contrasting seat cushion, articulating back cushion and pulls, back corner cushion, and end arm cushions, if selected 5 Paint color number for bracket: 4141 Platinum Matte 4710 Low Gloss Black 6 Options, if selected (see below) <p>▶ See <i>Coalesse Surface Materials Reference Guide</i>.</p>

Required Sections	Price	Required to Specify
Handedness <ul style="list-style-type: none"> • Left-hand, 2-seat lounges only (seated position) • Right-hand, 2-seat lounges only (seated position) 	No cost	Specify with <i>left-hand configuration</i> .
	No cost	Specify with <i>right-hand configuration</i> .

Options	Price	Required to Specify
Surface Materials <ul style="list-style-type: none"> • Fabric screen • 2-seat lounge with low-back screen +\$229 • 2-seat lounge with low-back screen and one side screen +\$344 • 2-seat lounge with low-back screen and two side screens +\$456 • 2-seat lounge with high-back screen +\$268 • 2-seat lounge with high-back screen and one side screen +\$421 • 2-seat lounge with high-back screen and two side screens +\$572 		Specify with <i>screen type fabric</i> . Specify with <i>screen type fabric</i> .
<ul style="list-style-type: none"> • Contrasting fabric for screen +\$182 • Contrasting fabric for cushion +\$182 		Specify with <i>contrasting fabric</i> and select fabric or leather color number. Specify with <i>contrasting fabric</i> and select fabric or leather color number.
<ul style="list-style-type: none"> • Contrasting fabric for top and bottom articulating back pulls +\$182 		Specify with <i>contrasting fabric</i> and select fabric or leather color number.
<ul style="list-style-type: none"> • Fabric upcharges 	Prices at right	Specify fabric color number.
<ul style="list-style-type: none"> • Knit screen • Group 1 knit screen • Group 2 knit screen <ul style="list-style-type: none"> – 2-seat lounge with low-back screen +\$355 – 2-seat lounge with low-back screen and one side screen +\$551 – 2-seat lounge with low-back screen and two side screens +\$747 – 2-seat lounge with high-back screen +\$395 – 2-seat lounge with high-back screen and one side screen +\$632 – 2-seat lounge with high-back screen and two side screens +\$866 	No cost	Specify with <i>screen type knit</i> and select knit color number. Specify with <i>screen type knit</i> and select knit color number. Specify with <i>screen type knit</i> and select knit color number. Specify with <i>screen type knit</i> and select knit color number. Specify with <i>screen type knit</i> and select knit color number. Specify with <i>screen type knit</i> and select knit color number. Specify with <i>screen type knit</i> and select knit color number.

Tip: If contrasting screen is selected, it is required to specify whether seat deck finish will match inner screen or outer screen.

Tip: Contrasting fabric for articulating back pulls upcharge is applied one time per style number.

Tip: When contrasting fabric for articulating back pulls is selected, only one contrasting fabric can be specified and will apply to all pulls.

▶ Options, continued on next page

Lagunitas Lounge System 2-Seat Lounges

DESIGN TOAN NGUYEN

► Options, continued from previous page

	Options	Price	Required to Specify
Surface Materials, continued	Acrylic backer		
	• 2-seat lounge with low-back screen	+\$ 78	Specify with acrylic backer.
	• 2-seat lounge with low-back screen and one side screen	+\$ 121	Specify with acrylic backer.
	• 2-seat lounge with low-back screen and two side screens	+\$ 164	Specify with acrylic backer.
	• 2-seat lounge with high-back screen	+\$ 121	Specify with acrylic backer.
	• 2-seat lounge with low-back screen and one side screen	+\$ 183	Specify with acrylic backer.
	• 2-seat lounge with high-back screen and two side screens	+\$ 244	Specify with acrylic backer. ► See Coalesse Surface Materials Reference Guide.
	• COM	No cost	Specify with COM and select fabric color number. ► See Coalesse Surface Materials Reference Guide.
	• COL	+\$ 410	Specify with COL and select leather color number. ► See Coalesse Surface Materials Reference Guide.
Power/USB Configuration	• One power module: two power in 4710 Low Gloss Black paint	+\$ 456	Specify with one power module, with two power.
	• One power module: one USB A+C 20W/ one power in 4710 Low Gloss Black paint	+\$ 605	Specify with one power module, with one power/one USB A+C 20W.
	• Two power modules: two power each in 4710 Low Gloss Black paint	+\$ 912	Specify with two power modules, with two power.
	• Two power modules: one USB A+C 20W/ one power each in 4710 Low Gloss Black paint	+\$1210	Specify with two power modules, with one power/one USB A+C 20W.
Related Products	• Bench		► Page 108
	• Chaise		► Pages 100–104
	• Lagunitas tables		► See GSA Volume 5b Specification Guide.
	• Lounge booth connector screen and alignment connector		► Pages 110–111

Tip: For Customer's Own Material or Leather, see necessary requirements, important processing instructions and ordering information.
► See Coalesse Surface Materials Reference Guide.

Tip: For any portion of the product that requires a COM, the additional upcharge is a one time charge per product.

Tip: For any portion of the product that requires a COL, the additional upcharge is a one time charge per product.

Tip: For each USB port specified, there is one USB per port.

► Specification Information, on next page

Lagunitas Lounge System 2-Seat Lounges *continued*

DESIGN TOAN NGUYEN

► Options, on previous page

Specification Information

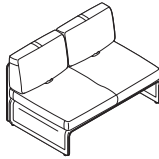

Two articulating backs
Overall: 51¼"W x 34"D x 32¾"H
Inside (Lounge): 51¼"W x 22½"D
Inside (Task): 51¼"W x 17¾"D
Seat: 16"H

Style Number Base Price

2-Seat Lounge with Low-Back Screen

COLAGLL21 \$6417

Fabric Upcharges

	Fabric Groups:										Leather Groups:	
	1	2	3	4	5	6	7	8	9	10	1	2
Articulating Back Pulls (if top and bottom contrasting pulls are selected)	No cost	+\$ 2	+\$ 14	+\$ 28	+\$ 48	+\$ 74	+\$103	+\$ 134	+\$ 162	+\$ 191	+\$ 250	+\$ 298
Seat Cushion	No cost	+\$13	+\$ 78	+\$154	+\$270	+\$415	+\$579	+\$ 754	+\$ 908	+\$1072	+\$1272	+\$1520
Back Cushion	No cost	+\$14	+\$ 81	+\$160	+\$281	+\$430	+\$601	+\$ 782	+\$ 941	+\$1112	+\$1806	+\$2160
Inside Screen	No cost	+\$21	+\$122	+\$243	+\$425	+\$652	+\$910	+\$1185	+\$1426	+\$1684	N.A.	N.A.
Outside Screen	No cost	+\$19	+\$120	+\$242	+\$424	+\$650	+\$908	+\$1183	+\$1425	+\$1683	N.A.	N.A.

Tip: Articulating back pull fabric upcharges only apply when contrasting pulls are selected.

Two Articulating Backs: Seat Deck: 3.4 yards, Inside Screen: 2 yards, Outside Screen: 2.2 yards, Seat Cushion: 2.6 yards, 57.2 sq ft, Back Cushion: 3.7 yards, 81.4 sq ft, Contrasting Pulls on Articulating Back Cushions: 0.5 yards, 2.2 sq ft

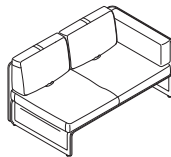

Two articulating backs
Overall: 59¾"W x 34"D x 32¾"H
Seat: 16"H

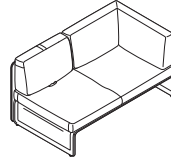

One articulating back and one corner cushion
Overall: 59¾"W x 34"D x 32¾"H
Seat: 16"H

Style Number Base Price

2-Seat Lounge with Low-Back Screen and One Side Screen

COLAGLL22 \$7466

Fabric Upcharges

	Fabric Groups:										Leather Groups:	
	1	2	3	4	5	6	7	8	9	10	1	2
Articulating Back Pulls (if top and bottom contrasting pulls are selected)	No cost	+\$ 2	+\$ 14	+\$ 28	+\$ 48	+\$ 74	+\$ 103	+\$ 134	+\$ 162	+\$ 191	+\$ 250	+\$ 298
Seat Cushion	No cost	+\$13	+\$ 76	+\$151	+\$264	+\$405	+\$ 565	+\$ 736	+\$ 886	+\$1047	+\$1272	+\$1520
Back Cushion	No cost	+\$21	+\$122	+\$243	+\$426	+\$654	+\$ 912	+\$1188	+\$1430	+\$1689	+\$2298	+\$2745
Inside Screen	No cost	+\$27	+\$161	+\$320	+\$560	+\$859	+\$1199	+\$1560	+\$1878	+\$2219	N.A.	N.A.
Outside Screen	No cost	+\$26	+\$160	+\$319	+\$559	+\$857	+\$1198	+\$1559	+\$1878	+\$2217	N.A.	N.A.

Tip: Articulating back pull fabric upcharges only apply when contrasting pulls are selected.

Two Articulating Backs: Arm: 0, Seat Deck: 2.7 yards, Inside Screen: 3.5 yards, Outside Screen: 3.9 yards, Seat Cushion: 2.6 yards, 57.2 sq ft, Back Cushion: 4.7 yards, 103.4 sq ft, Contrasting Pulls on Articulating Back Cushions: 0.5 yards, 2.2 sq ft

One Articulating Back and One Corner Cushion: Arm: 0, Seat Deck: 2.7 yards, Inside Screen: 3.5 yards, Outside Screen: 3.9 yards, Seat Cushion: 2.6 yards, 57.2 sq ft, Back Cushion: 4.7 yards, 103.4 sq ft, Contrasting Pulls on Articulating Back Cushion: 0.5 yards, 1.1 sq ft

► Specification Information, continued on next page

Lagunitas Lounge System 2-Seat Lounges

DESIGN TOAN NGUYEN

► Specification Information, continued from previous page

Specification Information

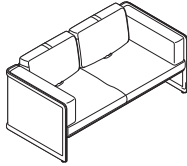

Two articulating backs
Overall: 67¾"W x 34"D x 32¾"H
Seat: 16"H

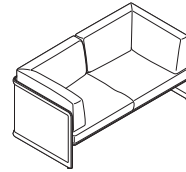

Two corner cushions
Overall: 67¾"W x 34"D x 32¾"H
Seat: 16"H

Style Number Base Price

2-Seat Lounge with Low-Back Screen and Two Side Screens

COLAGLL23 \$9149

Fabric Upcharges

	Fabric Groups:										Leather Groups:	
	1	2	3	4	5	6	7	8	9	10	1	2
Articulating Back Pulls (if top and bottom contrasting pulls are selected)	No cost	+\$ 2	+\$ 14	+\$ 28	+\$ 48	+\$ 74	+\$ 103	+\$ 134	+\$ 162	+\$ 191	+\$ 250	+\$ 298
Seat Cushion	No cost	+\$12	+\$ 72	+\$143	+\$251	+\$ 386	+\$ 539	+\$ 702	+\$ 845	+\$ 998	+\$1414	+\$1692
Back Cushion	No cost	+\$25	+\$157	+\$313	+\$549	+\$ 842	+\$1176	+\$1531	+\$1844	+\$2178	+\$3367	+\$4026
Inside Screen	No cost	+\$33	+\$199	+\$397	+\$695	+\$1067	+\$1489	+\$1939	+\$2335	+\$2758	N.A.	N.A.
Outside Screen	No cost	+\$32	+\$198	+\$397	+\$695	+\$1066	+\$1490	+\$1939	+\$2335	+\$2758	N.A.	N.A.

Tip: Articulating back pull fabric upcharges only apply when contrasting pulls are selected.

Two Articulating Backs: Arm: 0, Seat Deck: 1.6 yards, Inside Screen: 4.9 yards, Outside Screen: 5.6 yards, Seat Cushion: 2.9 yards, 63.8 sq ft, Back Cushion: 6.9 yards, 151.8 sq ft, Contrasting Pulls on Articulating Back Cushions: 0.5 yards, 2.2 sq ft

Two Corner Cushions: Arm: 0, Seat Deck: 1.6 yards, Inside Screen: 4.9 yards, Outside Screen: 5.6 yards, Seat Cushion: 2.9 yards, 63.8 sq ft, Back Cushion: 6.9 yards, 151.8 sq ft

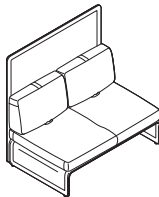

Two articulating backs
Overall: 51¼"W x 34"D x 50"H
Inside (Lounge): 51¼"W x 22½"D
Inside (Task): 51¼"W x 17¾"D
Seat: 16"H

Style Number Base Price

2-Seat Lounge with High-Back Screen

COLAGLH21 \$7425

Fabric Upcharges

	Fabric Groups:										Leather Groups:	
	1	2	3	4	5	6	7	8	9	10	1	2
Articulating Back Pulls (if top and bottom contrasting pulls are selected)	No cost	+\$ 2	+\$ 14	+\$ 28	+\$ 48	+\$ 74	+\$103	+\$ 134	+\$ 162	+\$ 191	+\$ 250	+\$ 298
Seat Cushion	No cost	+\$13	+\$ 77	+\$154	+\$270	+\$415	+\$579	+\$ 754	+\$ 908	+\$1072	+\$1272	+\$1520
Back Cushion	No cost	+\$13	+\$ 80	+\$159	+\$280	+\$429	+\$600	+\$ 781	+\$ 940	+\$1111	+\$1806	+\$2160
Inside Screen	No cost	+\$21	+\$126	+\$251	+\$440	+\$675	+\$942	+\$1227	+\$1477	+\$1745	N.A.	N.A.
Outside Screen	No cost	+\$21	+\$126	+\$252	+\$440	+\$675	+\$942	+\$1227	+\$1477	+\$1744	N.A.	N.A.

Tip: Articulating back pull fabric upcharges only apply when contrasting pulls are selected.

Two Articulating Backs: Seat Deck: 3.4 yards, Inside Screen: 2 yards, Outside Screen: 2.2 yards, Seat Cushion: 2.6 yards, 57.2 sq ft, Back Cushion: 3.7 yards, 81.4 sq ft, Contrasting Pulls on Articulating Back Cushions: 0.5 yards, 2.2 sq ft

► Specification Information, continued on next page

Lagunitas Lounge System 2-Seat Lounges *continued*

DESIGN TOAN NGUYEN

► Specification Information, continued from previous page

Specification Information

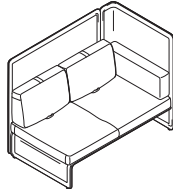

Two articulating backs
Overall: 59³/₈"W x 34"D x 50"H
Seat: 16"H

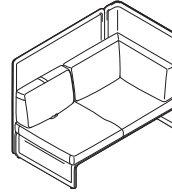

One articulating back and one corner cushion
Overall: 59³/₈"W x 34"D x 50"H
Seat: 16"H

Style Number Base Price

2-Seat Lounge with High-Back Screen and One Side Screen

COLAGLH22 \$9084

Fabric Upcharges

	Fabric Groups:										Leather Groups:	
	1	2	3	4	5	6	7	8	9	10	1	2
Articulating Back Pulls (if top and bottom contrasting pulls are selected)	No cost	+\$ 2	+\$ 14	+\$ 28	+\$ 48	+\$ 74	+\$ 103	+\$ 134	+\$ 162	+\$ 191	+\$ 250	+\$ 298
Seat Cushion	No cost	+\$13	+\$ 79	+\$158	+\$277	+\$425	+\$ 594	+\$ 773	+\$ 931	+\$1100	+\$1272	+\$1520
Back Cushion	No cost	+\$23	+\$133	+\$265	+\$464	+\$712	+\$ 994	+\$1294	+\$1558	+\$1840	+\$2298	+\$2745
Inside Screen	No cost	+\$28	+\$165	+\$329	+\$576	+\$883	+\$1233	+\$1605	+\$1932	+\$2282	N.A.	N.A.
Outside Screen	No cost	+\$28	+\$166	+\$329	+\$576	+\$883	+\$1233	+\$1605	+\$1932	+\$2282	N.A.	N.A.

Tip: Articulating back pull fabric upcharges only apply when contrasting pulls are selected.

Three Articulating Backs: Arm: 0, Seat Deck: 2.7 yards, Inside Screen: 3.5 yards, Outside Screen: 3.9 yards, Seat Cushion: 2.6 yards, 57.2 sq ft, Back Cushion: 4.7 yards, 103.4 sq ft, Contrasting Pulls on Articulating Back Cushions: 0.5 yards, 2.2 sq ft
One Articulating Back and One Corner Cushion: Arm: 0, Seat Deck: 2.7 yards, Inside Screen: 3.5 yards, Outside Screen: 3.9 yards, Seat Cushion: 2.6 yards, 57.2 sq ft, Back Cushion: 4.7 yards, 103.4 sq ft, Contrasting Pulls on Articulating Back Cushion: 0.5 yards, 1.1 sq ft

► Specification Information, continued on next page

Lagunitas Lounge System 2-Seat Lounges

DESIGN TOAN NGUYEN

► Specification Information, continued from previous page

Specification Information

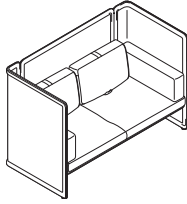

Two articulating backs
Overall: 67³/₄"W x 34"D x 50"H
Seat: 16"H

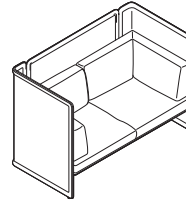

Two corner cushions
Overall: 67³/₄"W x 34"D x 50"H
Seat: 16"H

Style Number Base Price

2-Seat Lounge with High-Back Screen and Two Side Screens

COLAGLH23 \$11,061

Fabric Upcharges

	Fabric Groups:										Leather Groups:	
	1	2	3	4	5	6	7	8	9	10	1	2
Articulating Back Pulls (if top and bottom contrasting pulls are selected)	No cost	+\$ 2	+\$ 14	+\$ 28	+\$ 48	+\$ 74	+\$ 103	+\$ 134	+\$ 162	+\$ 191	+\$ 250	+\$ 298
Seat Cushion	No cost	+\$13	+\$ 74	+\$148	+\$259	+\$ 397	+\$ 554	+\$ 722	+\$ 869	+\$1026	+\$1414	+\$1692
Back Cushion	No cost	+\$27	+\$162	+\$322	+\$565	+\$ 866	+\$1209	+\$1575	+\$1896	+\$2240	+\$3367	+\$4026
Inside Screen	No cost	+\$33	+\$199	+\$397	+\$695	+\$1067	+\$1490	+\$1940	+\$2336	+\$2759	N.A.	N.A.
Outside Screen	No cost	+\$31	+\$197	+\$396	+\$694	+\$1066	+\$1489	+\$1938	+\$2334	+\$2757	N.A.	N.A.

Tip: Articulating back pull fabric upcharges only apply when contrasting pulls are selected.

Two Articulating Backs: Arm: 0, Seat Deck: 1.6 yards, Inside Screen: 4.9 yards, Outside Screen: 5.6 yards, Seat Cushion: 2.9 yards, 63.8 sq ft, Back Cushion: 6.9 yards, 151.8 sq ft, Contrasting Pulls on Articulating Back Cushions: 0.5 yards, 2.2 sq ft

Two Corner Cushions: Arm: 0, Seat Deck: 1.6 yards, Inside Screen: 4.9 yards, Outside Screen: 5.6 yards, Seat Cushion: 2.9 yards, 63.8 sq ft, Back Cushion: 6.9 yards, 151.8 sq ft

Lagunitas Lounge System 3-Seat Lounges

DESIGN TOAN NGUYEN

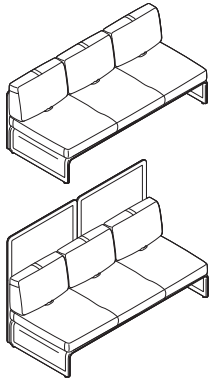

Standard Includes		Required to Specify
<ul style="list-style-type: none"> ▶ Need help? Product details, see <i>Coalesse Seating and Outdoor Specification Guide</i>. 	<ul style="list-style-type: none"> • Screen: group 1 knit • Seat deck: group 1 knit to match screen • Non-contrasting seat cushion, articulating back cushion and pulls, back corner cushion, and end arm cushions: fabric or leather • Bracket: paint • Eight adjustable glides • Ships assembled 	<ol style="list-style-type: none"> 1 Style number 2 Handedness (see below under Required Selections) 3 Knit color number for screen 4 Fabric or leather color number for non-contrasting seat cushion, articulating back cushion and pulls, back corner cushion, and end arm cushions, if selected 5 Paint color number for bracket: <ul style="list-style-type: none"> 4141 Platinum Matte 4710 Low Gloss Black 6 Options, if selected (see below) <p>▶ See <i>Coalesse Surface Materials Reference Guide</i>.</p>

	Required Sections	Price	Required to Specify
Handedness	• Left-hand, 3-seat lounges only (seated position)	No cost	Specify <i>left-hand configuration</i> .
	• Right-hand, 3-seat lounges only (seated position)	No cost	Specify <i>right-hand configuration</i> .

	Options	Price	Required to Specify	
Surface Materials	Fabric screen			
	• 3-seat lounge with low-back screen	+\$ 344	Specify <i>with screen type fabric</i> .	
	• 3-seat lounge with low-back screen and one side screen	+\$ 456	Specify <i>with screen type fabric</i> .	
	• 3-seat lounge with low-back screen and two side screens	+\$ 572	Specify <i>with screen type fabric</i> .	
	• 3-seat lounge with high-back screen	+\$ 384	Specify <i>with screen type fabric</i> .	
	• 3-seat lounge with high-back screen and one side screen	+\$ 497	Specify <i>with screen type fabric</i> .	
	• 3-seat lounge with high-back screen and two side screens	+\$ 651	Specify <i>with screen type fabric</i> .	
	• Contrasting fabric for screen	+\$ 182	Specify <i>with contrasting fabric</i> and select fabric or leather color number.	
	• Contrasting fabric for cushion	+\$ 182	Specify <i>with contrasting fabric</i> and select fabric or leather color number.	
	• Contrasting fabric for top and bottom articulating back pulls	+\$ 182	Specify <i>with contrasting fabric</i> and select fabric or leather color number.	
	• Fabric upcharges	Prices at right	Specify fabric color number.	
		Knit screen		
	• Group 1 knit screen	No cost	Specify <i>with screen type knit</i> and select knit color number.	
• Group 2 knit screen				
– 3-seat lounge with low-back screen	+\$ 434	Specify <i>with screen type knit</i> and select knit color number.		
– 3-seat lounge with low-back screen and one side screen	+\$ 669	Specify <i>with screen type knit</i> and select knit color number.		
– 3-seat lounge with low-back screen and two side screens	+\$ 903	Specify <i>with screen type knit</i> and select knit color number.		
– 3-seat lounge with high-back screen	+\$ 469	Specify <i>with screen type knit</i> and select knit color number.		
– 3-seat lounge with high-back screen and one side screen	+\$ 746	Specify <i>with screen type knit</i> and select knit color number.		
– 3-seat lounge with high-back screen and two side screens	+\$1022	Specify <i>with screen type knit</i> and select knit color number.		

▶ Options, continued on next page

Tip: If contrasting screen is selected, it is required to specify whether seat deck finish will match inner screen or outer screen.

Tip: Contrasting fabric for articulating back pulls upcharge is applied one time per style number.

Tip: When contrasting fabric for articulating back pulls is selected, only one contrasting fabric can be specified and will apply to all pulls.

Lagunitas Lounge System 3-Seat Lounges

DESIGN TOAN NGUYEN

► Options, continued from previous page

	Options	Price	Required to Specify
Surface Materials, continued	Acrylic backer		
	• 3-seat lounge with low-back screen	+\$ 107	Specify with acrylic backer.
	• 3-seat lounge with low-back screen and one side screen	+\$ 160	Specify with acrylic backer.
	• 3-seat lounge with low-back screen and two side screens	+\$ 217	Specify with acrylic backer.
	• 3-seat lounge with high-back screen	+\$ 183	Specify with acrylic backer.
	• 3-seat lounge with high-back screen and one side screen	+\$ 235	Specify with acrylic backer.
	• 3-seat lounge with high-back screen and two side screens	+\$ 293	Specify with acrylic backer. ► See Coalesse Surface Materials Reference Guide.
	• COM	No cost	Specify with COM and select fabric color number. ► See Coalesse Surface Materials Reference Guide.
	• COL	+\$ 410	Specify with COL and select leather color number. ► See Coalesse Surface Materials Reference Guide
	Power/USB Configuration	• One power module: two power in 4710 Low Gloss Black paint	+\$ 456
• One power module: one USB A+C 20W/one power in 4710 Low Gloss Black paint		+\$ 605	Specify with one power module, with one power/one USB A+C 20W.
• Two power modules: two power each in 4710 Low Gloss Black paint		+\$ 912	Specify with two power modules, with two power.
• Two power modules: one USB A+C 20W/one power each in 4710 Low Gloss Black paint		+\$1210	Specify with two power modules, with one power/one USB A+C 20W.
Related Products	• Bench		► Page 108
	• Chaise		► Pages 100–104
	• Lagunitas tables		► See GSA Volume 5b Specification Guide.
	• Lounge booth connector screen and alignment connector		► Pages 110–111

► Specification Information, on next page

Tip: For Customer's Own Material or Leather, see necessary requirements, important processing instructions and ordering information.
► See Coalesse Surface Materials Reference Guide.

Tip: For any portion of the product that requires a COM, the additional upcharge is a one time charge per product.

Tip: For any portion of the product that requires a COL, the additional upcharge is a one time charge per product.

Tip: For each USB port specified, there is one USB per port.

Lagunitas Lounge System 3-Seat Lounges *continued*

DESIGN TOAN NGUYEN

► Options, on previous page

Specification Information

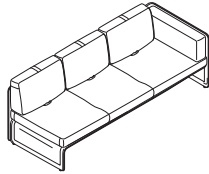

Three articulating backs
Overall: 76¾"W x 34"D x 32¾"H
Inside (Lounge): 76¾"W x 22½"D
Inside (Task): 76¾"W x 17¾"D
Seat: 16"H

Style Number Base Price

3-Seat Lounge with Low-Back Screen

COLAGLL31 \$8359

Fabric Upcharges

	Fabric Groups:										Leather Groups:	
	1	2	3	4	5	6	7	8	9	10	1	2
Articulating Back Pulls (if top and bottom contrasting pulls are selected)	No cost	+\$ 2	+\$ 14	+\$ 28	+\$ 48	+\$ 74	+\$ 103	+\$ 134	+\$ 162	+\$ 191	+\$ 250	+\$ 298
Seat Cushion	No cost	+\$17	+\$108	+\$216	+\$379	+\$582	+\$ 813	+\$1058	+\$1274	+\$1505	+\$1758	+\$2104
Back Cushion	No cost	+\$20	+\$126	+\$252	+\$441	+\$677	+\$ 946	+\$1231	+\$1483	+\$1752	+\$2685	+\$3210
Inside Screen	No cost	+\$29	+\$173	+\$344	+\$603	+\$925	+\$1291	+\$1681	+\$2024	+\$2390	N.A.	N.A.
Outside Screen	No cost	+\$29	+\$172	+\$344	+\$603	+\$924	+\$1290	+\$1681	+\$2023	+\$2390	N.A.	N.A.

Tip: Articulating back pull fabric upcharges only apply when contrasting pulls are selected.

Three Articulating Backs: Seat Deck: 3.6 yards, Inside Screen: 3.2 yards, Outside Screen: 3.7 yards, Seat Cushion: 3.6 yards, 79.2 sq ft, Back Cushion: 5.5 yards, 121 sq ft, Contrasting Pulls on Articulating Back Cushions: 0.5 yards, 3.3 sq ft

► Specification Information, continued on next page

Lagunitas Lounge System 3-Seat Lounges

DESIGN TOAN NGUYEN

► Specification Information, continued from previous page

Specification Information

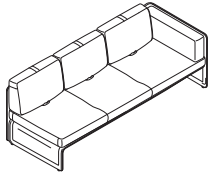

Three articulating backs
Overall: 85"W x 34"D x 32³/₈"H
Seat: 16"H

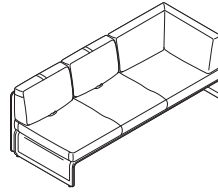

Two articulating backs and one corner cushion
Overall: 85"W x 34"D x 32³/₈"H
Seat: 16"H

Style Number Base Price

3-Seat Lounge with Low-Back Screen and One Side Screen

COLAGLL32 \$9872

Fabric Upcharges

	Fabric Groups:										Leather Groups:	
	1	2	3	4	5	6	7	8	9	10	1	2
Articulating Back Pulls (if top and bottom contrasting pulls are selected)	No cost	+\$ 2	+\$ 14	+\$ 28	+\$ 48	+\$ 74	+\$ 103	+\$ 134	+\$ 162	+\$ 191	+\$ 250	+\$ 298
Seat Cushion	No cost	+\$16	+\$ 96	+\$193	+\$338	+\$ 518	+\$ 724	+\$ 943	+\$1135	+\$1341	+\$1658	+\$1983
Back Cushion	No cost	+\$28	+\$173	+\$346	+\$607	+\$ 931	+\$1300	+\$1693	+\$2039	+\$2408	+\$3172	+\$3794
Inside Screen	No cost	+\$35	+\$209	+\$417	+\$730	+\$1120	+\$1564	+\$2036	+\$2452	+\$2896	N.A.	N.A.
Outside Screen	No cost	+\$34	+\$209	+\$416	+\$729	+\$1120	+\$1564	+\$2036	+\$2451	+\$2895	N.A.	N.A.

Tip: Articulating back pull fabric upcharges only apply when contrasting pulls are selected.

Three Articulating Backs: Arm: 0, Seat Deck: 2.3 yards, Inside Screen: 4.6 yards, Outside Screen: 5.4 yards, Seat Cushion: 3.4 yards, 74.8 sq ft, Back Cushion: 6.5 yards, 143 sq ft, Contrasting Pulls on Articulating Back Cushions: 0.5 yards, 3.3 sq ft

Two Articulating Backs and One Corner Cushion: Arm: 0, Seat Deck: 2.3 yards, Inside Screen: 4.6 yards, Outside Screen: 5.4 yards, Seat Cushion: 3.4 yards, 74.8 sq ft, Back Cushion: 6.5 yards, 143 sq ft, Contrasting Pulls on Articulating Back Cushions: 0.5 yards, 2.2 sq ft

► Specification Information, continued on next page

Lagunitas Lounge System 3-Seat Lounges *continued*

DESIGN TOAN NGUYEN

► Specification Information, continued from previous page

Specification Information

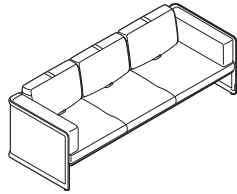

Three articulating backs
Overall: 93¼"W x 34"D x 32¾"H
Seat: 16"H

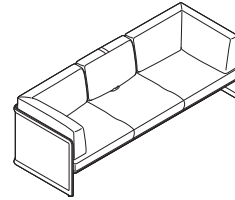

One articulating back and two corner cushions
Overall: 93¼"W x 34"D x 32¾"H
Seat: 16"H

Style Number Base Price

3-Seat Lounge with Low-Back Screen and Two Side Screens

COLAGLL33 \$10,925

Fabric Upcharges

	Fabric Groups:										Leather Groups:	
	1	2	3	4	5	6	7	8	9	10	1	2
Articulating Back Pulls (if top and bottom contrasting pulls are selected)	No cost	+\$ 2	+\$ 14	+\$ 28	+\$ 48	+\$ 74	+\$ 103	+\$ 134	+\$ 162	+\$ 191	+\$ 250	+\$ 298
Seat Cushion	No cost	+\$15	+\$ 97	+\$194	+\$341	+\$ 523	+\$ 731	+\$ 952	+\$1146	+\$1354	+\$1758	+\$2104
Back Cushion	No cost	+\$34	+\$207	+\$413	+\$724	+\$1111	+\$1552	+\$2020	+\$2433	+\$2847	+\$4247	+\$5079
Inside Screen	No cost	+\$40	+\$247	+\$493	+\$864	+\$1326	+\$1852	+\$2411	+\$2903	+\$3429	N.A.	N.A.
Outside Screen	No cost	+\$41	+\$247	+\$493	+\$864	+\$1326	+\$1851	+\$2411	+\$2903	+\$3429	N.A.	N.A.

Tip: Articulating back pull fabric upcharges only apply when contrasting pulls are selected.

Three Articulating Backs: Arm: 0, Seat Deck: 2 yards, Inside Screen: 6.1 yards, Outside Screen: 7.1 yards, Seat Cushion: 3.6 yards, 79.2 sq ft, Back Cushion: 8.7 yards, 191.4 sq ft, Contrasting Pulls on Articulating Back Cushions: 0.5 yards, 3.3 sq ft

One Articulating Back and Two Corner Cushions: Arm: 0, Seat Deck: 2 yards, Inside Screen: 6.1 yards, Outside Screen: 7.1 yards, Seat Cushion: 3.6 yards, 79.2 sq ft, Back Cushion: 8.7 yards, 191.4 sq ft, Contrasting Pulls on Articulating Back Cushion: 0.5 yards, 1.1 sq ft

► Specification Information, continued on next page

Lagunitas Lounge System 3-Seat Lounges

DESIGN TOAN NGUYEN

► Specification Information, continued from previous page

Specification Information

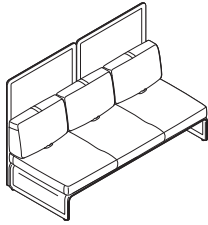

Three articulating backs
Overall: 76⁷/₈"W x 34"D x 50"H
Inside (Lounge): 76⁷/₈"W x 22¹/₂"D
Inside (Task): 76⁷/₈"W x 17³/₄"D
Seat: 16"H

Style Number Base Price

3-Seat Lounge with High-Back Screen

COLAGLH31 \$9693

Fabric Upcharges

	Fabric Groups:										Leather Groups:	
	1	2	3	4	5	6	7	8	9	10	1	2
Articulating Back Pulls (if top and bottom contrasting pulls are selected)	No cost	+\$ 2	+\$ 14	+\$ 28	+\$ 48	+\$ 74	+\$ 103	+\$ 134	+\$ 162	+\$ 191	+\$ 250	+\$ 298
Seat Cushion	No cost	+\$17	+\$108	+\$216	+\$379	+\$582	+\$ 813	+\$1058	+\$1274	+\$1505	+\$1758	+\$2104
Back Cushion	No cost	+\$20	+\$126	+\$252	+\$441	+\$677	+\$ 946	+\$1232	+\$1483	+\$1752	+\$2685	+\$3210
Inside Screen	No cost	+\$29	+\$174	+\$347	+\$607	+\$931	+\$1300	+\$1693	+\$2038	+\$2408	N.A.	N.A.
Outside Screen	No cost	+\$30	+\$174	+\$346	+\$607	+\$931	+\$1300	+\$1693	+\$2039	+\$2407	N.A.	N.A.

Tip: Articulating back pull fabric upcharges only apply when contrasting pulls are selected.

Three Articulating Backs: Seat Deck: 3.6 yards, Inside Screen: 3.2 yards, Outside Screen: 3.7 yards, Seat Cushion: 3.6 yards, 79.2 sq ft, Back Cushion: 5.5 yards, 121 sq ft, Contrasting Pulls on Articulating Back Cushions: 0.5 yards, 3.3 sq ft

► Specification Information, continued on next page

Lagunitas Lounge System 3-Seat Lounges *continued*

DESIGN TOAN NGUYEN

► Specification Information, continued from previous page

Specification Information

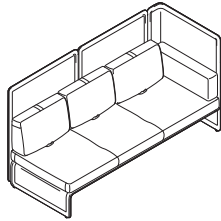

Three articulating backs
Overall: 85"W x 34½"D x 50"H
Seat: 16"H

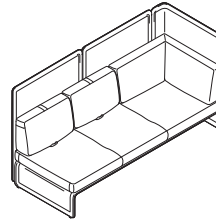

Two articulating backs with one corner cushion
Overall: 85"W x 34½"D x 50"H
Seat: 16"H

Style Number Base Price

3-Seat Lounge with High-Back Screen and One Side Screen

COLAGLH32 \$11,365

Fabric Upcharges

	Fabric Groups:										Leather Groups:	
	1	2	3	4	5	6	7	8	9	10	1	2
Articulating Back Pulls (if top and bottom contrasting pulls are selected)	No cost	+\$ 2	+\$ 14	+\$ 28	+\$ 48	+\$ 74	+\$ 103	+\$ 134	+\$ 162	+\$ 191	+\$ 250	+\$ 298
Seat Cushion	No cost	+\$15	+\$ 96	+\$193	+\$338	+\$ 518	+\$ 724	+\$ 943	+\$1135	+\$1341	+\$1658	+\$1983
Back Cushion	No cost	+\$29	+\$174	+\$347	+\$608	+\$ 932	+\$1301	+\$1694	+\$2040	+\$2409	+\$3172	+\$3794
Inside Screen	No cost	+\$35	+\$210	+\$419	+\$734	+\$1127	+\$1573	+\$2048	+\$2466	+\$2913	N.A.	N.A.
Outside Screen	No cost	+\$35	+\$211	+\$419	+\$734	+\$1126	+\$1574	+\$2048	+\$2466	+\$2913	N.A.	N.A.

Tip: Articulating back pull fabric upcharges only apply when contrasting pulls are selected.

Three Articulating Backs: Arm: 0, Seat Deck: 2.3 yards, Inside Screen: 4.6 yards, Outside Screen: 5.4 yards, Seat Cushion: 3.4 yards, 74.8 sq ft, Back Cushion: 6.5 yards, 143 sq ft, Contrasting Pulls on Articulating Back Cushions: 0.5 yards, 3.3 sq ft
Two Articulating Backs with One Corner Cushion: Arm: 0, Seat Deck: 2.3 yards, Inside Screen: 4.6 yards, Outside Screen: 5.4 yards, Seat Cushion: 3.4 yards, 74.8 sq ft, Back Cushion: 6.5 yards, 143 sq ft, Contrasting Pulls on Articulating Back Cushions: 0.5 yards, 2.2 sq ft

► Specification Information, continued on next page

Lagunitas Lounge System 3-Seat Lounges

DESIGN TOAN NGUYEN

► Specification Information, continued from previous page

Specification Information

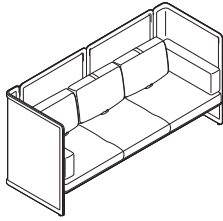

Three articulating backs
Overall: 93³/₈"W x 34"D x 50"H
Seat: 16"H

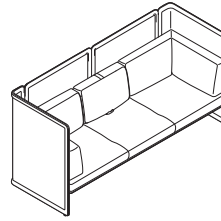

One articulating back and two corner cushions
Overall: 93³/₈"W x 34"D x 32³/₈"H
Seat: 16"H

Style Number Base Price

3-Seat Lounge with High-Back Screen and Two Side Screens

COLAGLH33 \$13,351

Fabric Upcharges

	Fabric Groups:										Leather Groups:	
	1	2	3	4	5	6	7	8	9	10	1	2
Articulating Back Pulls (if top and bottom contrasting pulls are selected)	No cost	+\$ 2	+\$ 14	+\$ 28	+\$ 48	+\$ 74	+\$ 103	+\$ 134	+\$ 162	+\$ 191	+\$ 250	+\$ 298
Seat Cushion	No cost	+\$16	+\$ 97	+\$194	+\$341	+\$ 523	+\$ 731	+\$ 952	+\$1146	+\$1354	+\$1758	+\$2104
Back Cushion	No cost	+\$34	+\$207	+\$413	+\$724	+\$1111	+\$1552	+\$2021	+\$2433	+\$2873	+\$4247	+\$5079
Inside Screen	No cost	+\$41	+\$248	+\$495	+\$868	+\$1333	+\$1861	+\$2423	+\$2918	+\$3446	N.A.	N.A.
Outside Screen	No cost	+\$39	+\$247	+\$495	+\$868	+\$1332	+\$1860	+\$2422	+\$2917	+\$3446	N.A.	N.A.

Tip: Articulating back pull fabric upcharges only apply when contrasting pulls are selected.

Three Articulating Backs: Arm: 0, Seat Deck: 2 yards, Inside Screen: 6.1 yards, Outside Screen: 7.1 yards, Seat Cushion: 3.6 yards, 79.2 sq ft, Back Cushion: 8.7 yards, 191.4 sq ft, Contrasting Pulls on Articulating Back Cushions: 0.5 yards, 3.3 sq ft

One Articulating Back and Two Corner Cushions: Arm: 0, Seat Deck: 2 yards, Inside Screen: 6.1 yards, Outside Screen: 7.1 yards, Seat Cushion: 3.6 yards, 79.2 sq ft, Back Cushion: 8.7 yards, 191.4 sq ft, Contrasting Pulls on Articulating Back Cushion: 0.5 yards, 1.1 sq ft

Lagunitas Lounge System 2-Seat Chaises

DESIGN TOAN NGUYEN

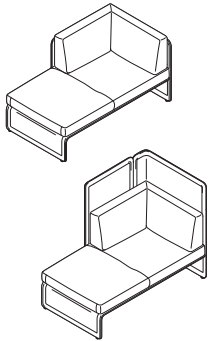

► Need help?
Product details, see *Coalesse Seating and Outdoor Specification Guide*

Standard Includes

- Screen: group 1 knit
- Seat deck: group 1 knit to match screen
- Non-contrasting seat cushion, articulating back cushion and pulls, back corner cushion, and end arm cushion, if selected: fabric or leather
- Bracket: paint
- Six adjustable glides
- Ships assembled

Required to Specify

- 1 Style number
 - 2 Handedness (see below under Required Selections)
 - 3 Knit color number for screen
 - 4 Fabric or leather color number for non-contrasting seat cushion, articulating back cushion and pull, back corner cushion, and end arm cushion, if selected
 - 5 Paint color number for bracket:
4141 Platinum Matte
4710 Low Gloss Black
 - 6 Options, if selected (see below)
- See *Surface Materials*, page 178

	Required Selections	Price	Required to Specify
Handedness	• Left-hand, 2-seat chaises only (seated position)	No cost	Specify with <i>left-hand configuration</i> .
	• Right-hand, 2-seat chaises only (seated position)	No cost	Specify with <i>right-hand configuration</i> .

	Options	Price	Required to Specify
Surface Materials	Fabric screen		
	• 2-seat chaise with one low-back screen and one right- or one left-hand screen	+\$344	Specify with <i>screen type fabric</i> .
	• 2-seat chaise with one high-back screen and one right- or one left-hand screen	+\$421	Specify with <i>screen type fabric</i> .
	• Contrasting fabric for screen	+\$182	Specify with <i>contrasting fabric</i> and select fabric or leather color number.
	• Contrasting fabric for cushion	+\$182	Specify with <i>contrasting fabric</i> and select fabric or leather color number.
	• Contrasting fabric for articulating back pulls	+\$182	Specify with <i>contrasting fabric</i> and select fabric or leather color number. ► See <i>Surface Materials</i> , page 178
	• Fabric upcharges	Prices at right	Specify fabric color number.
	Knit screen		
	• Group 1 knit screen	No cost	Specify with <i>screen type knit</i> and select knit color number.
	• Group 2 knit screen		
– 2-seat chaise with one low-back screen and one right- or one left-hand screen	+\$548	Specify with <i>screen type knit</i> and select knit color number.	
– 2-seat chaise with one high-back screen and one right- or one left-hand screen	+\$632	Specify with <i>screen type knit</i> and select knit color number.	
Acrylic backer			
• 2-seat chaise with one low-back screen and one right- or one left-hand screen	+\$102	Specify with <i>acrylic backer</i> .	
• 2-seat chaise with one high-back screen and one right- or one left-hand screen	+\$153	Specify with <i>acrylic backer</i> . ► See <i>Surface Materials</i> , page 178	
• COM	No cost	Specify with <i>COM</i> and select fabric color number. ► See <i>Surface Materials</i> , page 180	
• COL	+\$410	Specify with <i>COL</i> and select leather color number. ► See <i>Surface Materials</i> , page 180	

► Options, continued on next page

Tip: If contrasting screen is selected, it is required to specify whether seat deck finish will match inner screen or outer screen.

Tip: Contrasting fabric for articulating back pull upcharge is applied one time per style number.

Tip: For Customer's Own Material or Leather, see necessary requirements, important processing instructions and ordering information.
► See *Coalesse Surface Materials Reference Guide*.

Tip: For any portion of the product that requires a COM, the additional upcharge is a one time charge per product.

Tip: For any portion of the product that requires a COL, the additional upcharge is a one time charge per product.

Tip: Must combine seat deck and list screen pricing choice (knit group 1, knit group 2, or fabric) from either non-contrasting or contrasting pricing list with seat and back cushion list pricing (fabric and leather) from either non-contrasting or contrasting pricing list to obtain completed list price.

Lagunitas Lounge System 2-Seat Chaises

DESIGN TOAN NGUYEN

Tip: For each USB port specified, there is one USB per port.

► Options, continued from previous page

Options	Price	Required to Specify
Power/USB Configuration		
• One power module: two power in 4710 Black paint	+\$ 456	Specify with one power module, with two power.
• One power module: one USB A+C 20W /one power in 4710 Black paint	+\$ 605	Specify with one power module, with one power/one USB A+C 20W.
• Two power modules: two power each in 4710 Black paint	+\$ 912	Specify with two power modules, with two power.
• Two power modules: one USB A+C 20W /one power each in 4710 Black paint	+\$1210	Specify with two power modules, with one power/one USB A+C 20W.

Related Products

- Lagunitas tables
- Lounge
- Bench

- See GSA Volume 5b Specification Guide.
- Pages 82–92
- Page 108

Specification Information

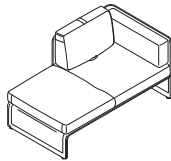

One articulating back
Overall: 59³/₈"W x 34"D x 32³/₈"H
Seat: 16"H

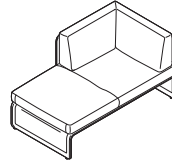

One corner cushion
Overall: 59³/₈"W x 34"D x 32³/₈"H
Seat: 16"H

Style Number	Base Price
--------------	------------

Tip: Handedness is determined while in the seated position. Illustration above shows left-hand chaise.

2-Seat Chaise with Low-Back Screen and One Side Screen

COLAGCL2 \$6130

Fabric Upcharges

	Fabric Groups:										Leather Groups:	
	1	2	3	4	5	6	7	8	9	10	1	2
Articulating Back Pulls (if contrasting pull selected)	No cost	+\$ 2	+\$ 14	+\$ 28	+\$ 48	+\$ 74	+\$ 103	+\$ 134	+\$ 162	+\$ 191	+\$ 250	+\$ 298
Seat Cushion	No cost	+\$13	+\$ 85	+\$171	+\$299	+\$460	+\$ 642	+\$ 836	+\$1007	+\$1189	+\$1454	+\$1740
Back Cushion	No cost	+\$14	+\$ 83	+\$166	+\$291	+\$447	+\$ 624	+\$ 812	+\$ 978	+\$1155	+\$1414	+\$1692
Inside Screen	No cost	+\$23	+\$143	+\$286	+\$502	+\$770	+\$1075	+\$1400	+\$1686	+\$1992	N.A.	N.A.
Outside Screen	No cost	+\$24	+\$144	+\$287	+\$503	+\$770	+\$1077	+\$1402	+\$1687	+\$1993	N.A.	N.A.

Tip: Articulating back pull fabric upcharges only apply when contrasting pull is selected.

One Articulating Back: Arm: 0, Seat Deck: 2.7 yards, Inside Screen: 2.7 yards, Outside Screen: 3.2 yards, Seat Cushion: 3 yards, 66 sq ft, Back Cushion: 2.9 yards, 63.8 sq ft

One Corner Cushion: Arm: 0, Seat Deck: 2.7 yards, Inside Screen: 2.7 yards, Outside Screen: 3.2 yards, Seat Cushion: 3 yards, 66 sq ft, Back Cushion: 2.9 yards, 63.8 sq ft

► Specification Information, continued on next page

Lagunitas Lounge System 2-Seat Chaises *continued*

DESIGN TOAN NGUYEN

► Specification Information, continued from previous page

Specification Information

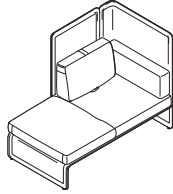

One articulating back
Overall: 59³/₈"W x 34"D x 50"H
Seat: 16"H

Tip: Handedness is determined while in the seated position. Illustration above shows left-hand chaise.

Style Number	Base Price
--------------	------------

2-Seat Chaise with High-Back Screen and One Side Screen

COLAGCH2	\$7176
----------	--------

Fabric Upcharges

	Fabric Groups:										Leather Groups:	
	1	2	3	4	5	6	7	8	9	10	1	2
Articulating Back Pulls (if contrasting pull selected)	No cost	+\$ 2	+\$ 14	+\$ 28	+\$ 48	+\$ 74	+\$ 103	+\$ 134	+\$ 162	+\$ 191	+\$ 250	+\$ 298
Seat Cushion	No cost	+\$14	+\$ 88	+\$176	+\$309	+\$474	+\$ 663	+\$ 863	+\$1039	+\$ 1228	+\$1454	+\$1740
Back Cushion	No cost	+\$14	+\$ 84	+\$168	+\$295	+\$452	+\$ 631	+\$ 822	+\$ 989	+\$ 1168	+\$1414	+\$1692
Inside Screen	No cost	+\$23	+\$147	+\$295	+\$517	+\$794	+\$1109	+\$1445	+\$1740	+\$2055	N.A.	N.A.
Outside Screen	No cost	+\$24	+\$148	+\$295	+\$517	+\$794	+\$1109	+\$1444	+\$1740	+\$2055	N.A.	N.A.

Tip: Articulating back pull fabric upcharges only apply when contrasting pull is selected.

One Articulating Back: Arm: 0, Seat Deck: 2.7 yards, Inside Screen: 2.7 yards, Outside Screen: 3.2 yards, Seat Cushion: 3 yards, 66 sq ft, Back Cushion: 2.9 yards, 63.8 sq ft

One Corner Cushion: Arm: 0, Seat Deck: 2.7 yards, Inside Screen: 2.7 yards, Outside Screen: 3.2 yards, Seat Cushion: 3 yards, 66 sq ft, Back Cushion: 2.9 yards, 63.8 sq ft

Coalesse SIN 33721

Lagunitas Lounge System 2-Seat Chaises

DESIGN TOAN NGUYEN

Lagunitas Lounge System 3-Seat Chaises

DESIGN TOAN NGUYEN

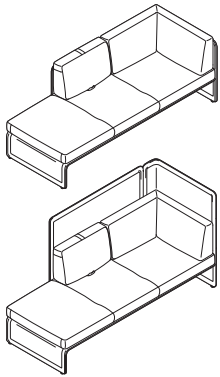

► Need help?
Product details, see *Coalesse Seating and Outdoor Specification Guide*

Standard Includes

- Screen: group 1 knit
- Seat deck: group 1 knit to match screen
- Non-contrasting seat cushion, articulating back cushion and pulls, back corner cushion, and end arm cushion, if selected: fabric or leather
- Bracket: paint
- Six adjustable glides
- Ships assembled

Required to Specify

- 1 Style number
 - 2 Handedness (see below under Required Selections)
 - 3 Knit color number for screen
 - 4 Fabric or leather color number for non-contrasting seat cushion, articulating back cushion and pull, back corner cushion, and end arm cushion, if selected
 - 5 Paint color number for bracket:
4141 Platinum Matte
4710 Low Gloss Black
 - 6 Options, if selected (see below)
- See *Surface Materials*, page 178

	Required Selections	Price	Required to Specify
Handedness	• Left-hand, 3-seat chaises only (seated position)	No cost	Specify with <i>left-hand configuration</i> .
	• Right-hand, 3-seat chaises only (seated position)	No cost	Specify with <i>right-hand configuration</i> .

	Options	Price	Required to Specify
Surface Materials	Fabric screen		
	• 3-seat chaise with one low-back screen and one right- or one left-hand screen	+\$456	Specify with <i>screen type fabric</i> .
	• 3-seat chaise with one high-back screen and one right- or one left-hand screen	+\$497	Specify with <i>screen type fabric</i> .
	• Contrasting fabric for screen	+\$182	Specify with <i>contrasting fabric</i> and select fabric or leather color number.
	• Contrasting fabric for cushion	+\$182	Specify with <i>contrasting fabric</i> and select fabric or leather color number.
	• Contrasting fabric for articulating back pulls	+\$182	Specify with <i>contrasting fabric</i> and select fabric or leather color number. ► See <i>Surface Materials</i> , page 178
	• Fabric upcharges	Prices at right	Specify fabric color number.
	Knit screen		
	• Group 1 knit screen	No cost	Specify with <i>screen type knit</i> and select knit color number.
	• Group 2 knit screen		
– 3-seat chaise with one low-back screen and one right- or one left-hand screen	+\$662	Specify with <i>screen type knit</i> and select knit color number.	
– 3-seat chaise with one high-back screen and one right- or one left-hand screen	+\$742	Specify with <i>screen type knit</i> and select knit color number.	
Acrylic backer			
• 3-seat chaise with one low-back screen and one right- or one left-hand screen	+\$133	Specify with <i>acrylic backer</i> .	
• 3-seat chaise with one high-back screen and one right- or one left-hand screen	+\$214	Specify with <i>acrylic backer</i> . ► See <i>Surface Materials</i> , page 178	
• COM	No cost	Specify with <i>COM</i> and select fabric color number. ► See <i>Surface Materials</i> , page 180	
• COL	+\$410	Specify with <i>COL</i> and select leather color number. ► See <i>Surface Materials</i> , page 180	

► Options, continued on next page

Tip: If contrasting screen is selected, it is required to specify whether seat deck finish will match inner screen or outer screen.

Tip: Contrasting fabric for articulating back pull upcharge is applied one time per style number.

Tip: For Customer's Own Material or Leather, see necessary requirements, important processing instructions and ordering information.
► See *Coalesse Surface Materials Reference Guide*.

Tip: For any portion of the product that requires a COM, the additional upcharge is a one time charge per product.

Tip: For any portion of the product that requires a COL, the additional upcharge is a one time charge per product.

Tip: Must combine seat deck and list screen pricing choice (knit group 1, knit group 2, or fabric) from either non-contrasting or contrasting pricing list with seat and back cushion list pricing (fabric and leather) from either non-contrasting or contrasting pricing list to obtain completed list price.

Lagunitas Lounge System 3-Seat Chaises

DESIGN TOAN NGUYEN

Tip: For each USB port specified, there is one USB per port.

► Options, continued from previous page

Options	Price	Required to Specify
Power/USB Configuration		
• One power module: two power in 4710 Black paint	+\$ 456	Specify with one power module, with two power.
• One power module: one USB A+C 20W /one power in 4710 Black paint	+\$ 605	Specify with one power module, with one power/one USB A+C 20W.
• Two power modules: two power each in 4710 Black paint	+\$ 912	Specify with two power modules, with two power.
• Two power modules: one USB A+C 20W /one power each in 4710 Black paint	+\$1210	Specify with two power modules, with one power/one USB A+C 20W.

Related Products

- Lagunitas tables
- Lounge
- Bench

- See GSA Volume 5b Specification Guide.
- Pages 82–92
- Page 108

Specification Information

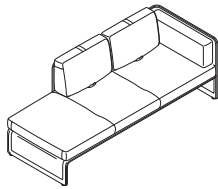

Two articulating backs
Overall: 85"W x 34"D x 32³/₈"H
Seat: 16"H

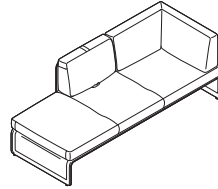

One articulating back and one corner cushion
Overall: 85"W x 34"D x 32³/₈"H
Seat: 16"H

Style Number	Base Price
--------------	------------

3-Seat Chaise with Low-Back Screen and One Side Screen

COLAGCL3 \$8190

Fabric Upcharges

	Fabric Groups:										Leather Groups:	
	1	2	3	4	5	6	7	8	9	10	1	2
Articulating Back Pulls (if contrasting pull selected)	No cost	+\$ 2	+\$ 14	+\$ 28	+\$ 48	+\$ 74	+\$ 103	+\$ 134	+\$ 162	+\$ 191	+\$ 250	+\$ 298
Seat Cushion	No cost	+\$16	+\$112	+\$225	+\$396	+\$610	+\$ 852	+\$1111	+\$1338	+\$1581	+\$1989	+\$2381
Back Cushion	No cost	+\$18	+\$125	+\$252	+\$444	+\$683	+\$ 956	+\$1245	+\$1500	+\$1772	+\$2298	+\$2745
Inside Screen	No cost	+\$24	+\$159	+\$321	+\$564	+\$867	+\$1212	+\$1580	+\$1903	+\$2248	N.A.	N.A.
Outside Screen	No cost	+\$24	+\$159	+\$321	+\$565	+\$868	+\$1213	+\$1579	+\$1902	+\$2247	N.A.	N.A.

Two Articulating Backs: Arm: 0, Seat Deck: 3.7 yards, Inside Screen: 3.5 yards, Outside Screen: 3.9 yards, Seat Cushion: 4.1 yards, 90.2 sq ft, Back Cushion: 4.7 yards, 103.4 sq ft

One Articulating Back and One Corner Cushion: Arm: 0, Seat Deck: 3.7 yards, Inside Screen: 3.5 yards, Outside Screen: 3.9 yards, Seat Cushion: 4.1 yards, 90.2 sq ft, Back Cushion: 4.7 yards, 103.4 sq ft

► Specification Information, continued on next page

Tip: Handedness is determined while in the seated position. Illustration above shows left-hand chaise.

Tip: Articulating back pull fabric upcharges only apply when contrasting pull is selected.

Lagunitas Lounge System 3-Seat Chaises *continued*

DESIGN TOAN NGUYEN

► Specification Information, continued from previous page

Specification Information

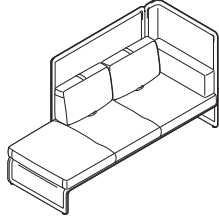

Two articulating backs
Overall: 85"W x 34"D x 50"H
Seat: 16"H

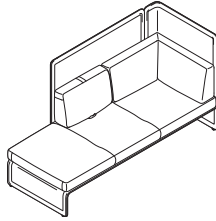

One articulating back and one corner cushion
Overall: 85"W x 34"D x 50"H
Seat: 16"H

Tip: Handedness is determined while in the seated position. Illustration above shows left-hand chaise.

Style Number	Base Price
--------------	------------

3-Seat Chaise with High-Back Screen and One Side Screen

COLAGCH3	\$9175
----------	--------

Fabric Upcharges

	Fabric Groups:										Leather Groups:	
	1	2	3	4	5	6	7	8	9	10	1	2
Articulating Back Pulls (if contrasting pull selected)	No cost	+\$ 2	+\$ 14	+\$ 28	+\$ 48	+\$ 74	+\$ 103	+\$ 134	+\$ 162	+\$ 191	+\$ 250	+\$ 298
Seat Cushion	No cost	+\$19	+\$114	+\$228	+\$399	+\$613	+\$ 855	+\$1114	+\$1341	+\$1584	+\$1989	+\$2381
Back Cushion	No cost	+\$21	+\$128	+\$255	+\$447	+\$686	+\$ 959	+\$1248	+\$1503	+\$1775	+\$2298	+\$2745
Inside Screen	No cost	+\$28	+\$167	+\$333	+\$583	+\$895	+\$1249	+\$1626	+\$1958	+\$2312	N.A.	N.A.
Outside Screen	No cost	+\$27	+\$167	+\$333	+\$583	+\$893	+\$1248	+\$1625	+\$1956	+\$2311	N.A.	N.A.

Tip: Articulating back pull fabric upcharges only apply when contrasting pull is selected.

Two Articulating Backs: Arm: 0, Seat Deck: 3.7 yards, Inside Screen: 3.5 yards, Outside Screen: 3.9 yards, Seat Cushion: 4.1 yards, 90.2 sq ft, Back Cushion: 4.7 yards, 103.4 sq ft

One Articulating Back and One Corner Cushion: Arm: 0, Seat Deck: 3.7 yards, Inside Screen: 3.5 yards, Outside Screen: 3.9 yards, Seat Cushion: 4.1 yards, 90.2 sq ft, Back Cushion: 4.7 yards, 103.4 sq ft

Coalesse SIN 33721

Lagunitas Lounge System 3-Seat Chaises

DESIGN TOAN NGUYEN

Lagunitas Lounge System Benches

DESIGN TOAN NGUYEN

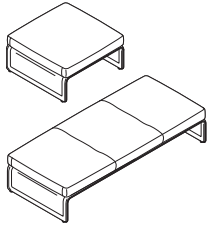

Standard Includes		Required to Specify
<ul style="list-style-type: none"> ▶ Need help? Product details, see <i>Coalesse Seating and Outdoor Specification Guide</i> 	<ul style="list-style-type: none"> • Seat deck: group 1 knit • Seat cushion: fabric or leather • Four adjustable glides • Ships assembled 	<ol style="list-style-type: none"> 1 Style number 2 Knit or fabric color number for seat deck 3 Fabric or leather color number for seat cushion 4 Options, if selected (see below) <ul style="list-style-type: none"> ▶ See <i>Surface Materials</i>, page 178

Options	Price	Required to Specify
Surface Materials Acrylic backer <ul style="list-style-type: none"> • 1-seat bench cushion +\$ 24 • 2-seat bench cushion +\$ 32 • 3-seat bench cushion +\$ 44 		Specify with <i>acrylic backer</i> . Specify with <i>acrylic backer</i> . Specify with <i>acrylic backer</i> . ▶ See <i>Surface Materials</i> , page 178
<ul style="list-style-type: none"> • Fabric seat deck 	Prices at right	Specify with <i>fabric seat deck</i> and select fabric color number.
Knit seat deck <ul style="list-style-type: none"> • Group 1 knit seat deck • Group 2 knit seat deck <ul style="list-style-type: none"> – 1-seat bench – 2-seat bench – 3-seat bench 	No cost +\$ 117 +\$ 158 +\$ 198	Specify with <i>screen type knit</i> and select fabric color number. Specify with <i>screen type knit</i> and select fabric color number. Specify with <i>screen type knit</i> and select fabric color number. Specify with <i>screen type knit</i> and select fabric color number.
<ul style="list-style-type: none"> • COM 	No cost	Specify with <i>COM</i> and select fabric color number. ▶ See <i>Surface Materials</i> , page 180
<ul style="list-style-type: none"> • COL 	+\$ 409	Specify with <i>COL</i> and select leather color number. ▶ See <i>Surface Materials</i> , page 180

Tip: For Customer's Own Material or Leather, see necessary requirements, important processing instructions and ordering information.
 ▶ See *Coalesse Surface Materials Reference Guide*.

Tip: For any portion of the product that requires a COM, the additional upcharge is a one time charge per product.

Tip: For any portion of the product that requires a COL, the additional upcharge is a one time charge per product.

Tip: Must combine seat deck and list screen pricing choice (knit group 1, knit group 2, or fabric) from either non-contrasting or contrasting pricing list with seat and back cushion list pricing (fabric and leather) from either non-contrasting or contrasting pricing list to obtain completed list price.

Power/USB Configuration	1-seat benches <ul style="list-style-type: none"> • One power module: two power in 4710 Black paint +\$ 456 • One power module: one USB A+C 20W/ one power in 4710 Black paint +\$ 605 	Specify with <i>one power module, with two power</i> . Specify with <i>one power module, with one power/one USB A+C 20W</i> .
	2- and 3-seat benches <ul style="list-style-type: none"> • Two power modules: two power each in 4710 Black paint +\$ 912 • Two power modules: one USB A+C 20W/ one power each in 4710 Black paint +\$1210 	Specify with <i>two power modules, with two power</i> . Specify with <i>two power modules, with one power/one USB A+C 20W</i> .
Related Products	<ul style="list-style-type: none"> • Lagunitas tables • Lounge • Chaise 	<ul style="list-style-type: none"> ▶ See <i>GSA Volume 5b Specification Guide</i>. ▶ Pages 82–92 ▶ Pages 100–104

Lagunitas Lounge System Benches

DESIGN TOAN NGUYEN

Specification Information

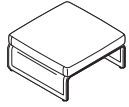

Overall: 32¾"W x 32¾"D x 16"H
Seat Deck: 2.8 yards
Seat Cushion: 2.6 yards, 57.2 sq ft

Style Number	Base Price
--------------	------------

1-Seat Bench

COLAGB1	\$2810
---------	--------

Fabric Upcharges

	Fabric Groups:										Leather Groups:	
	1	2	3	4	5	6	7	8	9	10	1	2
Seat Deck	+\$155	+\$160	+\$186	+\$217	+\$264	+\$323	+\$389	+\$ 460	+\$ 522	+\$ 589	N.A.	N.A.
Seat Cushion	No cost	+\$ 5	+\$ 31	+\$ 62	+\$109	+\$168	+\$234	+\$ 305	+\$ 367	+\$ 434	+\$1272	+\$1520

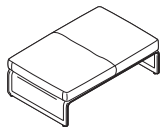

Overall: 51¼"W x 32¾"D x 16"H
Seat Deck: 3.1 yards
Seat Cushion: 3.2 yards, 70.4 sq ft

2-Seat Bench

COLAGB2	\$3358
---------	--------

Fabric Upcharges

	Fabric Groups:										Leather Groups:	
	1	2	3	4	5	6	7	8	9	10	1	2
Seat Deck	+\$154	+\$159	+\$185	+\$216	+\$263	+\$321	+\$388	+\$ 459	+\$ 521	+\$ 587	N.A.	N.A.
Seat Cushion	No cost	+\$ 14	+\$ 84	+\$168	+\$294	+\$452	+\$630	+\$ 820	+\$ 988	+\$1167	+\$1562	+\$1866

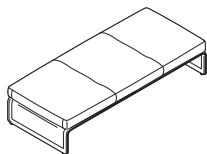

Overall: 76⅞"W x 32¾"D x 16"
Seat Deck: 3.5 yards
Seat Cushion: 4 yards, 88 sq ft

3-Seat Bench

COLAGB3	\$4121
---------	--------

Fabric Upcharges

	Fabric Groups:										Leather Groups:	
	1	2	3	4	5	6	7	8	9	10	1	2
Seat Deck	+\$155	+\$160	+\$186	+\$217	+\$264	+\$322	+\$389	+\$ 460	+\$ 522	+\$ 588	N.A.	N.A.
Seat Cushion	No cost	+\$ 17	+\$108	+\$216	+\$379	+\$583	+\$814	+\$1059	+\$1276	+\$1508	+\$1951	+\$2335

Lagunitas Lounge System Accessories

DESIGN TOAN NGUYEN

Lounge Booth Connector Screen



Screen: 38½"W x 50"H

Tip: Lounge booth connector screen joins two high screen lounges, enclosing one side of booth.

Standard Includes	Required to Specify
<ul style="list-style-type: none"> ▶ Need help? Product details, see <i>Coalesse Seating and Outdoor Specification Guide</i> • Screen: group 1 knit • Two bottom brackets: 4710 Low Gloss Black or 4141 Platinum Matte Paint • Two screen ganging alignment clips 	<ul style="list-style-type: none"> 1 Style number 2 Knit color number for screen 3 Paint color number for bracket 4 Options, if selected (see below) ▶ See <i>Surface Materials</i>, page 178

Options	Price	Required to Specify
Surface Materials	Knit screen	
• Group 1 knit screen	No cost	Specify with <i>screen type knit</i> and select knit color number.
• Group 2 knit screen	+\$132	Specify with <i>screen type knit</i> and select knit color number.
• Fabric screen	+\$307	Specify with <i>screen type fabric</i> .
• Contrasting fabric	+\$182	Specify with <i>contrasting fabric</i> and select fabric color number.
• Fabric upcharges	Prices below	Specify fabric color number.
• COM	No cost	Specify with <i>COM</i> and select fabric color number. ▶ See <i>Coalesse Surface Materials Reference Guide</i>

Specification Information

Style Number	Base Price
COLAGLBS	\$2063

Fabric Upcharges	Fabric Groups:									
	1	2	3	4	5	6	7	8	9	10
Inside Screen	No cost	+\$ 8	+\$44	+\$ 87	+\$152	+\$232	+\$324	+\$422	+\$ 508	+\$ 599
Outside Screen	No cost	+\$15	+\$95	+\$190	+\$333	+\$512	+\$715	+\$930	+\$1120	+\$1324

Booth Connector Screen: Inside Screen: 1.4 yards, Outside Screen: 1.6 yards

Lagunitas Lounge System Accessories

DESIGN TOAN NGUYEN

Alignment Connector

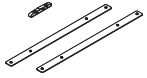

	Standard Includes	Required to Specify
▶ Need help? Product details, see <i>Coalesse Seating and Outdoor Specification Guide</i>	<ul style="list-style-type: none">• Screen and seat deck connector package: pin, bracket, and hardware• Ships ready to assemble	Style number

Related Products	
<ul style="list-style-type: none">• Lounge• Chaise	<ul style="list-style-type: none">▶ Pages 82-92▶ Pages 100-104

Specification Information	
Style Number	Price
COLAGCI	\$61

Lounge Seating

Lagunitas Focus Nook

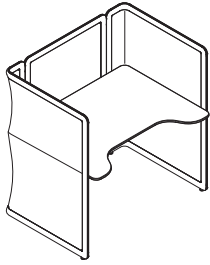

Tip: If a contrasting screen is specified, the fabric must be chosen from the same fabric family.

Tip: Grommets and power devices are specifiable on either the right or left side.

Tip: Power package must be specified when power and lighting grommet is specified.

Tip: Power simplex receptacles are tamper resistant.

Tip: When power module or power package in 4242 Milk Matte is specified, the 8' infeed cord will be white. When any other finish is specified, the infeed cord will be black.

Tip: Power/USB configuration upcharges are in addition to the power module or power package upcharge.

Standard Includes	Required to Specify
<ul style="list-style-type: none"> Need help? Product details, see <i>Coalesse Seating and Outdoor Specification Guide</i> Screen: group 1 knit Worksurface: <ul style="list-style-type: none"> Group 1 laminate with 3 mm flat plastic edge Brackets: 4710 Black Low Gloss Black paint Six adjustable glides Ships ready to assemble 	<ol style="list-style-type: none"> Style number Knit color number for screen Laminate color number for table top Plastic edge color number for laminate top, if selected Options, if selected (see below) <p>▶ See <i>Surface Materials</i>, page 178.</p>

Options	Price	Required to Specify
Surface Materials		
Fabric screen		
• Fabric screen	+\$611	Specify with screen type fabric.
• Contrasting fabric for screen	+\$182	Specify with contrasting fabric and select fabric color number.
• Fabric upcharges	Prices at right	Specify fabric color number.
Knit screen		
• Group 1 knit screen	No cost	Specify with screen type knit and select knit color number.
• Group 2 knit screen	+\$709	Specify with screen type knit and select knit color number.
• COM	No cost	Specify with COM and select fabric color number. ▶ See <i>Surface Materials</i> , page 178.
Worksurface		
• Group 2 laminate	Prices at right	Specify with group 2 laminate and select laminate color number.
• Group 3 laminate	Prices at right	Specify with group 3 laminate and select laminate color number.
• Group 1 composite veneer	Prices at right	Specify with group 1 composite veneer and select composite veneer color number.
• Group 2 composite veneer	Prices at right	Specify with group 2 composite veneer and select composite veneer color number.
• Group 1 wood veneer	Prices at right	Specify with group 1 wood veneer and select wood color number.
• Group 2 wood veneer	Prices at right	Specify with group 2 wood veneer and select wood color number.
2" Light Grommet	• 2" light grommet	+\$ 33 Specify with 2" grommet and select color number.
Power/USB Configuration	Power options (with three magnetic wire management brackets)	
	• Power module	+\$380 Specify with power module and select color number.
	• Power package (contains power module and below surface convenience plug for on-surface light)	+\$593 Specify with power package and select color number.
	Power/USB configurations	
	• Two TR simplex receptacles	No cost Specify with two power.
	• One TR simplex receptacle and two USB A charging ports	+\$149 Specify with one power, two USB A.
	• One TR simplex receptacle, one USB A charging port, and one USB C charging port	+\$149 Specify with one power, one USB A, one USB C.
Cable Management Tray	• Cable management tray	+\$181 Specify with tray and select color number.

Related Products	
<ul style="list-style-type: none"> Lagunitas lounge seating Lagunitas work and occasional tables 	<p>▶ Page 82</p> <p>▶ See <i>GSA Volume 5b Specification Guide</i>.</p>

Lagunitas Focus Nook

Specification Information

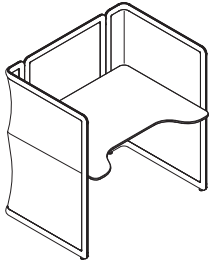

Knit Screen

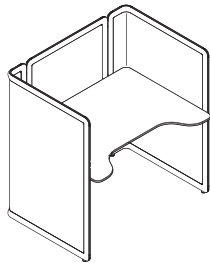

Fabric Screen

Style Number	Dimensions W D H			Base Prices					
				Flat Vinyl Edge on Laminate Top		Flat Wood Edge on Composite Veneer Top		Flat Wood Edge on Wood Top	
			Group 1	Groups 2 and 3	Group 1	Group 2	Group 1	Groups 2 and 3	
COLAGFN	49 1/4"	37"	50"	\$5745	\$5940	\$7208	\$7539	\$7354	\$7718

Fabric Upcharges

	Fabric Groups:									
	1	2	3	4	5	6	7	8	9	10
Inside Screen	No cost	+\$20	+\$122	+\$244	+\$427	+\$656	+\$ 916	+\$1193	+\$1436	+\$1696
Outside Screen	No cost	+\$29	+\$183	+\$367	+\$644	+\$989	+\$1382	+\$1799	+\$2167	+\$2560

Inside screen: 4.4 yds, Outside screen: 5.1 yds

Lounge Seating

Passerelle Lounge

DESIGN STUDIO B

Tip: Fabrics and leathers will appear loose with comfort wrinkles when upholstered.

Tip: Recommended leathers are Elmosoft group 1 and Elmorustical group 2.

Tip: Special color match, consult Customer Service.

Tip: For Customer's Own Material or Leather, see necessary requirements, important processing instructions, and ordering information
 ▶ See *Coalesse Surface Materials Reference Guide*.

Standard Includes		Required to Specify	
▶ Need help? Product details, see <i>Coalesse Seating and Outdoor Specification Guide</i>	<ul style="list-style-type: none"> • Frame: unibody construction with finger jointed plywood • Upholstery: multiple densities of polyurethane foam and polyester fiber on seat, back, and arms • Legs: solid maple with non-adjustable glides 	<ol style="list-style-type: none"> 1 Style number 2 Number of fabrics if contrasting fabric style number is selected 3 Fabric or leather color number for upholstery on seat, back, and arms 4 Wood color number for legs 5 Options, if selected (see below) ▶ See <i>Surface Materials</i> , page 178	
Options	Price	Required to Specify	
Surface Materials	<ul style="list-style-type: none"> • Contrasting fabric +\$182 per fabric <hr/> Acrylic backer <ul style="list-style-type: none"> • Lounge chair +\$ 50 • 2-seat lounge +\$ 70 • 3-seat lounge +\$ 84 • Arm bolster +\$ 10 	Add suffix K to the style number and select fabric color number. Specify with <i>acrylic backer</i> . Specify with <i>acrylic backer</i> . Specify with <i>acrylic backer</i> . Specify with <i>acrylic backer</i> . ▶ See <i>Surface Materials</i> , page 178	
Bolster/Pillow Attachment Rings	<ul style="list-style-type: none"> • Attachment rings for bolster/pillow attach to lounge attachment straps +\$ 98 	Specify with <i>attachment rings</i> .	
Lounge Attachment Straps	<ul style="list-style-type: none"> • Attachment straps for lounge attach to bolster/pillow attachment rings No cost 	Specify with <i>attachment straps for left and right sides</i> .	
Related Products	<ul style="list-style-type: none"> • Passerelle tables 	▶ See <i>GSA Volume 5b Specification Guide</i> .	

Specification Information

Style Number	Base Prices										Leather Groups:		
	Fabric Groups:										COL		
	COM	1	2	3	4	5	6	7	8	9	10	1	2

Lounge Chair

440-WB	\$2564	\$2564	\$2690	\$2794	\$2919	\$3106	\$3339	\$3604	\$3887	\$4136	\$4402	\$3086	\$5954	\$6489
--------	--------	--------	--------	--------	--------	--------	--------	--------	--------	--------	--------	--------	--------	--------

COM/yds = 4, COL/sq ft = 88

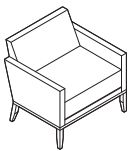

Overall: 27"D 30½"W 29"H
 Inside: 19"D 26"W 17"H
 Seat: 17½"H
 Arm: 23"H

2-Seat Lounge

440-2WB	\$4663	\$4663	\$4835	\$4979	\$5150	\$5408	\$5728	\$6093	\$6481	\$6824	\$7189	\$5193	\$9198	\$9789
---------	--------	--------	--------	--------	--------	--------	--------	--------	--------	--------	--------	--------	--------	--------

COM/yds = 5½, COL/sq ft = 121

▶ Specification Information, continued on next page

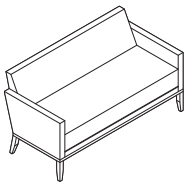

Overall: 27"D 56½"W 29"H
 Inside: 19"D 52"W 17"H
 Seat: 17½"H
 Arm: 23"H

Passerelle Lounge

DESIGN STUDIO B

► Specification Information, continued from previous page

Specification Information

Style Number	Base Prices										Leather Groups:	
	Fabric Groups:										COL	
	1	2	3	4	5	6	7	8	9	10	1	2

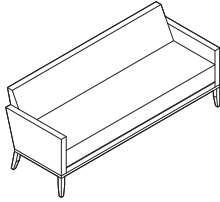

Overall: 27"D 72¾"W 29"H
 Inside: 19"D 68"W 17"H
 Seat: 17½"H
 Arm: 23"H



Overall: 17½"W 5¾"Dia

3-Seat Lounge

440-3WB	\$5270	\$5270	\$5482	\$5658	\$5868	\$6185	\$6578	\$7025	\$7502	\$7923	\$8371	\$5792	\$10,771	\$11,415
----------------	--------	--------	--------	--------	--------	--------	--------	--------	--------	--------	--------	--------	----------	----------

COM/yds = 6¾, COL/sq ft = 149

Arm Bolster

440-B	\$ 438	\$ 438	\$ 470	\$ 496	\$ 527	\$ 574	\$ 632	\$ 698	\$ 769	\$ 831	\$ 898	\$ 974	\$ 1296	\$ 1732
--------------	--------	--------	--------	--------	--------	--------	--------	--------	--------	--------	--------	--------	---------	---------

COM/yds = 1, COL/sq ft = 18

Passerelle Benches

DESIGN STUDIO B

Tip: Fabrics and leathers will appear loose with comfort wrinkles when upholstered.

Tip: For plain upholstery option or contrasting textiles, contact Customer Service.

Tip: Recommended leathers are Elmosoft group 1 and Elmorustical group 2.

Tip: Special color match, consult Customer Service.

Tip: For Customer's Own Material or Leather, see necessary requirements, important processing instructions, and ordering information
 ▶ See *Coalesse Surface Materials Reference Guide*.

Standard Includes		Required to Specify
▶ Need help? Product details, see <i>Coalesse Seating and Outdoor Specification Guide</i>	<ul style="list-style-type: none"> • Frame: solid maple • Upholstery: multiple densities of polyurethane foam • Legs: solid maple with non-adjustable glides • Button detail: tufted and double needled 	1 Style number 2 Fabric or leather color number for upholstery on bench 3 Wood color number for legs 4 Options, if selected (see below) ▶ See <i>Surface Materials</i> , page 178

Options	Price	Required to Specify
Surface Materials	Acrylic backer	
	• 20"D x 60"W bench	+ \$39
	• 30"D x 60"W bench	+ \$55
		Specify with acrylic backer. Specify with acrylic backer. ▶ See <i>Surface Materials</i> , page 178

Specification Information

Style Number	Base Prices										Leather Groups:		
	Fabric Groups:										COL		
	COM	1	2	3	4	5	6	7	8	9	10	1	2

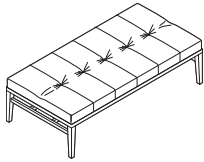

Overall: 30"D 60"W 17"H

440-B3060WB	\$3110	\$3110	\$3236	\$3340	\$3465	\$3652	\$3885	\$4150	\$4433	\$4682	\$4948	\$3646	\$6560	\$7128
COM/yds = 4, COL/sq ft = 88														

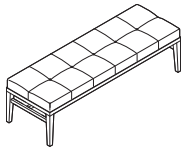

Overall: 20"D 60"W 17"H

440-B2060WB	\$2707	\$2707	\$2793	\$2865	\$2951	\$3080	\$3240	\$3422	\$3616	\$3788	\$3970	\$3237	\$5232	\$5627
COM/yds = 2¾, COL/sq ft = 61														

Coalesse SIN 33721

Passerelle Benches

DESIGN STUDIO B

Switch

DESIGN EOOS

Tip: Fabrics and leathers will appear loose with comfort wrinkles when upholstered.

Tip: Due to seat conversion arms are 4 1/2"W. Lowered arm has weight limit of 100 lb.

Tip: Recommended leathers are Elmosoft group 1 and Elmorustical group 2.

Tip: Loose cushions standard.

Tip: Arm bolsters must be specified separately.

Tip: Special color match, consult Customer Service.

Tip: For Customer's Own Material or Leather, see necessary requirements, important processing instructions, and ordering information
 ► See Coalesse Surface Materials Reference Guide.

Tip: 391-4 two seat with extensions, when extended: Both arms = 96"W overall One arm = 84"W overall Arms not extended = 71"W overall (closed).

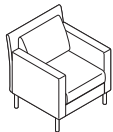

Overall: 29 1/2"D 28"W 32 1/2"H
Inside: 19"D 20"W 17"H
Seat: 17 1/2"H
Arm: 26"H

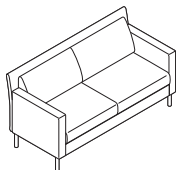

Overall: 24 1/2"D 62"W 33"H
Inside: 19"D 54 1/2"W 33"H
Seat: 19 1/2"H
Arm: 26 1/4"H

Standard Includes

- Need help? Product details, see *Coalesse Seating and Outdoor Specification Guide*
- Selected solid hardwood and wood veneer frame
- Two seat with extension: tubular steel frame with solid hardwood arms
 - Arms are 4.5" wide
- Upholstery: multiple densities of polyurethane foam and polyester fiber on seat back and arms
- Legs: matte chrome finish on steel
- Arm bolster, if selected: fabric or leather

Required to Specify

- 1 Style number
 - 2 Number of fabrics if contrasting fabric style number is selected
 - 3 Fabric or leather color number for upholstery on seat, back, and arms, or arm bolsters, if selected
 - 4 Options, if selected (see below)
- See *Surface Materials*, page 178

Options

Surface Materials	Options	Price
	• Contrasting fabric	+\$182 per fabric

Acrylic backer

• Lounge chair	+\$ 60
• 2-seat lounge	+\$112
• 3-seat lounge	+\$119
• 2-seat lounge with extensions	+\$134
• Arm bolster	+\$ 10

Required to Specify

Add suffix K to the style number and select fabric color number.

Specify with acrylic backer.
 Specify with acrylic backer.
 Specify with acrylic backer.
 Specify with acrylic backer.
 Specify with acrylic backer.
 ► See *Surface Materials*, page 178

Attachment Straps	Options	Price
	• 391	+\$195
	• 391-2	+\$390
	• 391-3	+\$585
	• 391-4	+\$390
	• Bolster	+\$101

Specify with attachment straps.
 Specify with attachment straps.
 Specify with attachment straps.
 Specify with attachment straps.
 Specify with attachment straps.

Related Products • Switch tables

► See *GSA Volume 5b Specification Guide*.

Specification Information

Style Number	Base Prices										Leather Groups:			
	Fabric Groups:										COL	1	2	
	COM	1	2	3	4	5	6	7	8	9	10			

Lounge Chair

391	\$3615	\$3615	\$3776	\$3911	\$4071	\$4313	\$4612	\$4954	\$5317	\$5638	\$5980	\$4110	\$ 7646	\$ 8656
COM/yds = 4 1/2, COL/sq ft = 99														

2-Seat Lounge

391-2	\$5681	\$5681	\$5950	\$6175	\$6441	\$6845	\$7343	\$7913	\$8518	\$9053	\$9623	\$6177	\$11,933	\$13,395
COM/yds = 7 1/2, COL/sq ft = 165														

► Specification Information, continued on next page

Switch

DESIGN EOOS

► Specification Information, continued from previous page

Specification Information

Style Number	Base Prices										Leather Groups:	
	Fabric Groups:										COL	
	1	2	3	4	5	6	7	8	9	10	1	2

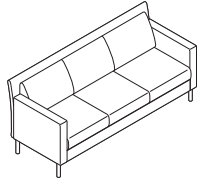

Overall: 30½"D 73"W 33"H
 Inside: 20"D 66"W 33"H
 Seat: 20"D 18½"W
 Arm: 26¼"H

3-Seat Lounge

391-3	\$7435	\$7435	\$7722	\$7962	\$8246	\$8677	\$9208	\$ 9816	\$10,462	\$11,032	\$11,640	\$7931	\$15,746	\$17,585
--------------	--------	--------	--------	--------	--------	--------	--------	---------	----------	----------	----------	--------	----------	----------

COM/yds = 8, COL/sq ft = 176

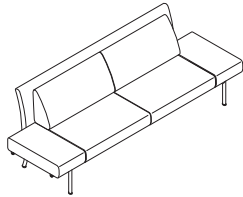

Lounge overall: 35"D 70½"W 33"H
 Overall extended: 35"D 95½"W 33"H
 Seat: 23"D 16½"W
 Arm: 29"D 26½"W
 One arm up: 77"H

2-Seat Lounge with Extensions

391-4	\$7919	\$7919	\$8242	\$8512	\$8832	\$9317	\$9914	\$10,598	\$11,325	\$11,966	\$12,650	\$8415	\$17,375	\$19,429
--------------	--------	--------	--------	--------	--------	--------	--------	----------	----------	----------	----------	--------	----------	----------

COM/yds = 9, COL/sq ft = 198



Overall: 17½"D 5¾"Dia

Arm Bolster

391-B	\$ 352	\$ 352	\$ 388	\$ 418	\$ 454	\$ 508	\$ 574	\$ 650	\$ 731	\$ 802	\$ 878	\$ 853	\$ 1189	\$ 1582
--------------	--------	--------	--------	--------	--------	--------	--------	--------	--------	--------	--------	--------	---------	---------

COM/yds = 1, COL/sq ft = 18

Lounge Seating

SW_1 Lounge Seating

DESIGN SCOTT WILSON & MINIMAL



Tip: For Customer's Own Material or Leather, see necessary requirements, important processing instructions, and ordering information
 ▶ See page 180

Standard Includes		Required to Specify
▶ Need help? Product details, see <i>Coalesse Seating and Outdoor Specification Guide</i>	<ul style="list-style-type: none"> • Seat: fabric or leather • Back: knit • Base: 8040 Aluminum Matte Polished • Frame: steel tube • Glides: aluminum with non marring plastic insert • Swivel return mechanism • Ottoman, if selected: fabric or leather 	1 Style number 2 Fabric or leather color number for seat or ottoman, if selected 3 Knit color number for back 4 Options, if selected (see below) ▶ See <i>Surface Materials</i> , page 178

Options	Price	Required to Specify
Surface Materials	<ul style="list-style-type: none"> • Contrasting fabric +\$ 182 	Specify with <i>contrasting fabric</i> and select fabric color number.
Acrylic backer	<ul style="list-style-type: none"> • Chairs +\$ 48 • Ottoman +\$ 18 	Specify with <i>acrylic backer</i> . Specify with <i>acrylic backer</i> . ▶ See <i>Surface Materials</i> , page 178
Lumbar pillow for lounge chairs	<ul style="list-style-type: none"> • Fabric group 1 No cost • Fabric group 2 +\$ 39 • Fabric group 3 +\$ 72 • Fabric group 4 +\$ 110 • Fabric group 5 +\$ 168 • Fabric group 6 +\$ 239 • Fabric group 7 +\$ 322 • Fabric group 8 +\$ 408 • Fabric group 9 +\$ 485 • Fabric group 10 +\$ 567 • Leather group 1 +\$ 337 • Leather group 2 +\$ 346 • Customer's Own Material (COM) No cost • Customer's Own Leather (COL) +\$ 419 	Specify fabric color number. Specify fabric color number. Specify fabric color number. Specify fabric color number. Specify fabric color number. Specify fabric color number. Specify fabric color number. Specify fabric color number. Specify fabric color number. Specify leather color number. Specify leather color number. Specify fabric color number. ▶ See <i>Surface Materials</i> , page 180 Specify leather color number. ▶ See <i>Surface Materials</i> , page 180
Lumbar Pillow	<ul style="list-style-type: none"> • No pillow No cost • Pillow +\$ 358 	Specify with <i>no pillow</i> . Specify with <i>pillow</i> .
Swivel Mechanism	<ul style="list-style-type: none"> • Swivel-only mechanism (omit return feature) No cost 	Specify with <i>swivel-only mechanism</i> .
Tablet	<ul style="list-style-type: none"> • No tablet No cost • Right tablet (seated position) +\$1071 • Left tablet (seated position) +\$1071 	Specify with <i>no tablet</i> . Specify with <i>right tablet</i> and select 6000 Black or 6052 Milk finish. Specify with <i>left tablet</i> and select 6000 Black or 6052 Milk finish.

Tip: Paint on lounge tablet arm support will complement 8040 Aluminum Matte polished base.



Top of Cushion to Bottom of Tablet: 8 1/2"H

Tip: Handedness is determined while in the seated position.

Related Products	<ul style="list-style-type: none"> • Collaborative and conference tables • Occasional tables • Collaboration seating 	▶ See <i>GSA Volume 5b Specification Guide</i> . ▶ See <i>GSA Volume 5b Specification Guide</i> . ▶ Page 159
-------------------------	---	--

SW_1 Lounge Seating

DESIGN SCOTT WILSON & MINIMAL

Specification Information

Style Number	Base Prices										Leather Groups:			
	Fabric Groups:										COL	1	2	
	COM	1	2	3	4	5	6	7	8	9	10			



Overall: 28¼"D 32¼"W 36¾"H
 Seat: 16"H
 Arm: 23"H

Low-Back Collaborative Lounge Chair

COW613	Seat	\$3454	\$3454	\$3485	\$3511	\$3542	\$3588	\$3645	\$3711	\$3780	\$3842	\$3907	\$3581	\$3877	\$ 3925
	Upper back	No cost	No cost	+\$ 55	+\$100	+\$154	+\$235	+\$335	+\$450	+\$571	+\$679	+\$793	+\$294	+\$982	+\$1103

COM/yds = 3, COL/sq ft = 60
 Pillow COM/yds = 1¼, COL/sq ft = 27½



Overall: 30"D 32¼"W 41¾"H
 Seat: 16"H
 Arm: 23"H

High-Back Collaborative Lounge Chair

COW713	Seat	\$4000	\$4000	\$4031	\$4057	\$4088	\$4134	\$4191	\$4257	\$4326	\$4388	\$4453	\$4127	\$4423	\$ 4471
	Upper back	No cost	No cost	+\$ 62	+\$114	+\$176	+\$268	+\$382	+\$514	+\$652	+\$776	+\$906	+\$294	+\$982	+\$1103

COM/yds = 3, COL/sq ft = 60
 Pillow COM/yds = 1¼, COL/sq ft = 27½



Overall: 20"D 23"W 14"H

Ottoman

COW210	\$1725	\$1725	\$1756	\$1782	\$1813	\$1859	\$1916	\$1982	\$2051	\$2113	\$2178	\$2144	\$2240	\$ 2300
	COM/yds = 1, COL/sq ft = 22													

Lounge Seating

SW_1 Multi-Fabric Diagram

DESIGN STUDIO B

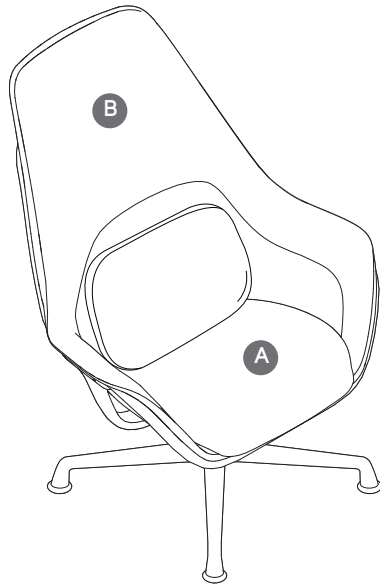

TO: _____

FROM: _____

DATE: _____

FAX...888.413.5161

A Seat: _____

B Arms/Back: _____

Contrasting fabric charges will apply. List price based on highest group textile specified.

Contrasting upcharge for each contrasting textile pricing based on highest group textile specified. See specifying for contrasting upcharge.

Specify Model below:

COW613 Low-Back Collaborative Lounge Chair

COW713 High-Back Collaborative Lounge Chair

SW_1 Multi-Fabric Diagram

DESIGN STUDIO B

Together Bench by Walter Knoll

DESIGN EOOS

Tip: Fabrics and leathers will appear loose with comfort wrinkles when upholstered.

Tip: For Customer's Own Material or Leather, see necessary requirements, important processing instructions, and ordering information
 ▶ See *Coalesse Surface Materials Reference Guide*.

Standard Includes		Required to Specify
▶ Need help? Product details, see <i>Coalesse Seating and Outdoor Specification Guide</i>	<ul style="list-style-type: none"> Upholstery for chair: fabric or leather Glides 	1 Style number 2 Number of fabrics if contrasting fabric style number is selected 3 Fabric or leather color number for upholstery 4 Options, if selected (see below) ▶ See <i>Surface Materials</i> , page 178

Surface Materials	Options	Price	Required to Specify
	<ul style="list-style-type: none"> Contrasting fabric 	+\$182 per fabric	Add suffix K to the style number and select fabric color number.
	Acrylic backer <ul style="list-style-type: none"> 71"W straight bench without back 97¾"W straight bench without back 26¾"D x 72"W and 70¾"W benches 26¾"D x 98¾"W and 97"10"W benches 69¾"D x 96¼"W benches 96½"D x 96¼"W and 69¾"D x 123"W benches 96½"D x 123"W bench 	+\$ 53 +\$ 60 +\$ 76 +\$ 88 +\$144 +\$165 +\$182	Specify with acrylic backer. Specify with acrylic backer. Specify with acrylic backer. Specify with acrylic backer. Specify with acrylic backer. Specify with acrylic backer. Specify with acrylic backer. ▶ See <i>Surface Materials</i> , page 178
Back Offset	<ul style="list-style-type: none"> Back offset 	No cost	Specify with back offset.

Specification Information

Style Number	Base Prices										Leather Groups:		
	Fabric Groups:										COL	1	2
COM	1	2	3	4	5	6	7	8	9	10			

Left Corner with Back, 8" Offset

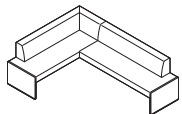

Overall: 70½"D 96¼"W 31"H
 Seat: 19"D 18½"H

COT09669L8

\$12,278	\$12,278	\$12,561	\$12,796	\$13,077	\$13,500	\$14,024	\$14,623	\$15,260	\$15,821	\$16,421	\$12,697	\$18,168	\$19,235
----------	----------	----------	----------	----------	----------	----------	----------	----------	----------	----------	----------	----------	----------

COM/yds = 9¾, COL/sq ft = 215

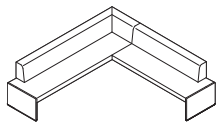

Overall: 97¼"D 96¼"W 31"H
 Seat: 19"D 18½"H

COT09696L8

\$13,260	\$13,260	\$13,572	\$13,831	\$14,141	\$14,607	\$15,185	\$15,846	\$16,548	\$17,166	\$17,828	\$13,679	\$19,720	\$20,896
----------	----------	----------	----------	----------	----------	----------	----------	----------	----------	----------	----------	----------	----------

COM/yds = 10¾, COL/sq ft = 237

▶ Specification Information, continued on next page

Together Bench by Walter Knoll

DESIGN EOOS

► Specification Information, continued from previous page

Specification Information

Style Number	Base Prices										Leather Groups:		
	Fabric Groups:										COL	1	2
	COM	1	2	3	4	5	6	7	8	9	10		

Left Corner with Back, 8" Offset, continued

COT012369L8

\$13,654 \$13,654 \$13,980 \$14,252 \$14,576 \$15,064 \$15,669 \$16,360 \$17,095 \$17,742 \$18,434 \$14,073 \$20,398 \$21,630
 COM/yds = 11¼, COL/sq ft = 248

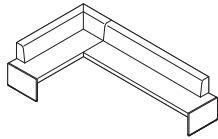

Overall: 70½"D 123"W 31"H
 Seat: 19"D 18½"H

COT012396L8

\$14,386 \$14,386 \$14,748 \$15,050 \$15,410 \$15,952 \$16,625 \$17,393 \$18,209 \$18,928 \$19,697 \$14,805 \$21,684 \$23,030
 COM/yds = 12½, COL/sq ft = 270

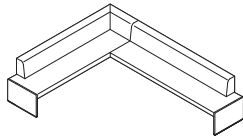

Overall: 97¼"D 123"W 31"H
 Seat: 19"D 18½"H

Left Corner with Back, 1½" Offset

COT09669L15

\$12,556 \$12,556 \$12,853 \$13,101 \$13,396 \$13,841 \$14,392 \$15,022 \$15,691 \$16,281 \$16,911 \$12,975 \$18,733 \$19,856
 COM/yds = 10¼, COL/sq ft = 226

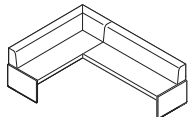

Overall: 70½"D 96¼"W 31"H
 Seat: 19"D 18½"H

COT09696L15

\$13,541 \$13,541 \$13,867 \$14,139 \$14,463 \$14,951 \$15,556 \$16,247 \$16,982 \$17,629 \$18,321 \$13,960 \$20,285 \$21,517
 COM/yds = 11¼, COL/sq ft = 248

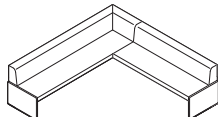

Overall: 97¼"D 96¼"W 31"H
 Seat: 19"D 18½"H

COT012369L15

\$13,928 \$13,928 \$14,268 \$14,552 \$14,890 \$15,400 \$16,032 \$16,754 \$17,521 \$18,197 \$18,920 \$14,347 \$20,960 \$22,247
 COM/yds = 11¾, COL/sq ft = 259

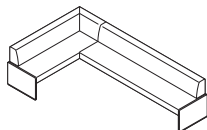

Overall: 70½"D 123"W 31"H
 Seat: 19"D 18½"H

COT012396L15

\$14,651 \$14,651 \$15,020 \$15,329 \$15,695 \$16,249 \$16,935 \$17,718 \$18,550 \$19,284 \$20,068 \$15,070 \$22,248 \$23,648
 COM/yds = 12¾, COL/sq ft = 281

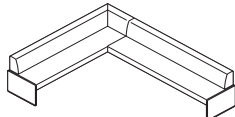

Overall: 97¼"D 123"W 31"H
 Seat: 19"D 18½"H

► Specification Information, continued on next page

Together Bench by Walter Knoll *continued*

DESIGN EOOS

Tip: For Customer's Own Material or Leather, see necessary requirements, important processing instructions, and ordering information
 ▶ See *Coalesse Surface Materials Reference Guide*.

Tip: Fabrics and leathers will appear loose with comfort wrinkles when upholstered.

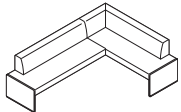

Overall: 70½"D 96¼"W 31"H
 Seat: 19"D 18½"H

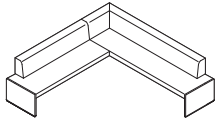

Overall: 97¼"D 96¼"W 31"H
 Seat: 19"D 18½"H

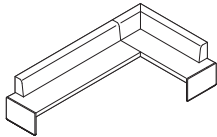

Overall: 70½"D 123"W 31"H
 Seat: 19"D 18½"H

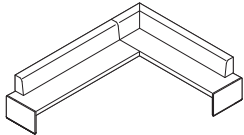

Overall: 97¼"D 123"W 31"H
 Seat: 19"D 18½"H

▶ Specification Information, continued from previous page

Specification Information

Style Number	Base Prices										Leather Groups:			
	Fabric Groups:										COL	1	2	
	COM	1	2	3	4	5	6	7	8	9	10			

Right Corner with Back, 8" Offset

COTO9669R8

	\$12,278	\$12,278	\$12,561	\$12,796	\$13,077	\$13,500	\$14,024	\$14,623	\$15,260	\$15,821	\$16,421	\$12,697	\$18,168	\$19,235
COM/yds = 9¾, COL/sq ft = 215														

COTO9696R8

	\$13,260	\$13,260	\$13,572	\$13,831	\$14,141	\$14,607	\$15,185	\$15,846	\$16,548	\$17,166	\$17,828	\$13,679	\$19,720	\$20,896
COM/yds = 10¾, COL/sq ft = 237														

COTO12369R8

	\$13,654	\$13,654	\$13,980	\$14,252	\$14,576	\$15,064	\$15,669	\$16,360	\$17,095	\$17,742	\$18,434	\$14,073	\$20,398	\$21,630
COM/yds = 11¼, COL/sq ft = 248														

COTO12396R8

	\$14,386	\$14,386	\$14,748	\$15,050	\$15,410	\$15,952	\$16,625	\$17,393	\$18,209	\$18,928	\$19,697	\$14,805	\$21,684	\$23,030
COM/yds = 12½, COL/sq ft = 270														

▶ Specification Information, continued on next page

Together Bench by Walter Knoll

DESIGN EOOS

► Specification Information, continued from previous page

Specification Information

Style Number	Base Prices										Leather Groups:		
	Fabric Groups:										COL	1	2
	COM	1	2	3	4	5	6	7	8	9	10		

Right Corner with Back, 1 1/2" Offset

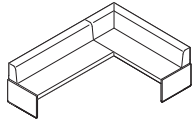

Overall: 70 1/2"D 96 1/4"W 31"H
Seat: 19"D 18 1/2"H

COT09669R15

\$12,556 \$12,556 \$12,853 \$13,101 \$13,396 \$13,841 \$14,392 \$15,022 \$15,691 \$16,281 \$16,911 \$12,975 \$18,733 \$19,856
COM/yds = 10 1/4, COL/sq ft = 226

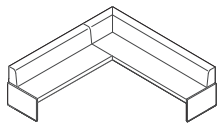

Overall: 97 1/4"D 96 1/4"W 31"H
Seat: 19"D 18 1/2"H

COT09696R15

\$13,541 \$13,541 \$13,867 \$14,139 \$14,463 \$14,951 \$15,556 \$16,247 \$16,982 \$17,629 \$18,321 \$13,960 \$20,285 \$21,517
COM/yds = 11 1/4, COL/sq ft = 248

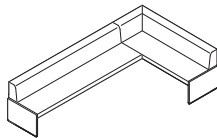

Overall: 70 1/2"D 123"W 31"H
Seat: 19"D 18 1/2"H

COT012369R15

\$13,928 \$13,928 \$14,268 \$14,552 \$14,890 \$15,400 \$16,032 \$16,754 \$17,521 \$18,197 \$18,920 \$14,347 \$20,960 \$22,247
COM/yds = 11 3/4, COL/sq ft = 259

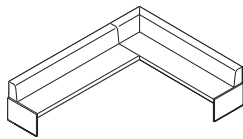

Overall: 97 1/4"D 123"W 31"H
Seat: 19"D 18 1/2"H

COT012396R15

\$14,651 \$14,651 \$15,020 \$15,329 \$15,695 \$16,249 \$16,935 \$17,718 \$18,550 \$19,284 \$20,068 \$15,070 \$22,248 \$23,648
COM/yds = 12 3/4, COL/sq ft = 281

► Specification Information, continued on next page

Together Bench by Walter Knoll *continued*

DESIGN EOOS

Tip: For Customer's Own Material or Leather, see necessary requirements, important processing instructions, and ordering information
 ▶ See Coalesse Surface Materials Reference Guide.

Tip: Fabrics and leathers will appear loose with comfort wrinkles when upholstered.

▶ Specification Information, continued from previous page

Specification Information

Style Number	Base Prices										Leather Groups:			
	Fabric Groups:										COL	1	2	
	COM	1	2	3	4	5	6	7	8	9	10	COL	1	2

Straight with Back, 8" Offset

COTO69WB8

	\$5958	\$5958	\$6096	\$6211	\$6347	\$6554	\$6809	\$7101	\$7411	\$7684	\$7977	\$6377	\$ 8998	\$ 9520
COM/yds = 4¾, COL/sq ft = 105														

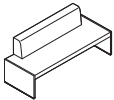

Overall: 26¾"D 72"W 31"H
 Seat: 19"D 18½"H

COTO96WB8

	\$6889	\$6889	\$7070	\$7221	\$7401	\$7672	\$8009	\$8393	\$8801	\$9160	\$9545	\$7308	\$10,786	\$11,471
COM/yds = 6¼, COL/sq ft = 138														

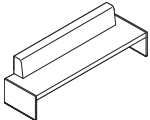

Overall: 26¾"D 98¾"W 31"H
 Seat: 19"D 18½"H

Straight with Back, 1½" Offset

COTO69WB15

	\$6219	\$6219	\$6364	\$6485	\$6629	\$6846	\$7115	\$7422	\$7748	\$8036	\$8344	\$6638	\$ 9402	\$ 9952
COM/yds = 5, COL/sq ft = 110														

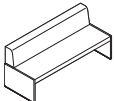

Overall: 26¾"D 70¾"W 31"H
 Seat: 19"D 18½"H

COTO96WB15

	\$7157	\$7157	\$7346	\$7503	\$7690	\$7972	\$8321	\$8721	\$9145	\$9519	\$9919	\$7576	\$11,192	\$11,904
COM/yds = 6½, COL/sq ft = 143														

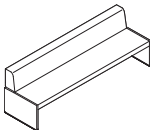

Overall: 26¾"D 97¾"W 31"H
 Seat: 19"D 18½"H

▶ Specification Information, continued on next page

Together Bench by Walter Knoll

DESIGN EOOS

► Specification Information, continued from previous page

Specification Information

Style Number	Base Prices										Leather Groups:		
	Fabric Groups:										COL	1	2
	COM	1	2	3	4	5	6	7	8	9	10		

Straight without Back

COT069	\$4275	\$4275	\$4391	\$4488	\$4603	\$4777	\$4992	\$5238	\$5499	\$5729	\$5975	\$4694	\$6888	\$7328
COM/yds = 4, COL/sq ft = 88														

COT096	\$4894	\$4894	\$5075	\$5226	\$5406	\$5677	\$6014	\$6398	\$6806	\$7165	\$7550	\$5313	\$7934	\$8456
COM/yds = 4¾, COL/sq ft = 105														

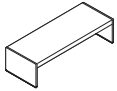

Overall: 26¾"D 71"W 18½"H
Seat: 18½"H

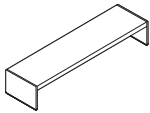

Overall: 26¾"D 97¾"W 18½"H
Seat: 18½"H

Visalia Lounge

DESIGN COALESSE DESIGN GROUP

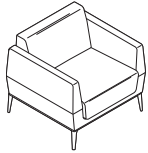

Tip: Fabrics and leathers will appear loose with comfort wrinkles when upholstered.

Tip: All cushions are attached.

Tip: Recommended leathers are Elmosoft group 1 and Elmorustical group 2.

Tip: Special color match, consult Customer Service.

Tip: For Customer's Own Material or Leather, see necessary requirements, important processing instructions, and ordering information
 ▶ See *Coalesse Surface Materials Reference Guide*.

Standard Includes	Required to Specify
-------------------	---------------------

▶ Need help? Product details, see *Coalesse Seating and Outdoor Specification Guide*

- Frame: unibody construction with finger jointed plywood
- Cast aluminum base: powder coat paint
- Upholstery: multiple densities of polyurethane foams and polyester fiber on seat and back
- Upper and lower upholstery accents with double needle top stitch, if selected

- 1 Style number
 - 2 Fabric or leather color number for seat, back, and arms
 - 3 Upholstery accent color number, if selected
 - 4 Paint color number for base:
 - 4138 Graphite Gloss Black Matte
 - 4141 Platinum Matte
 - 4144 Black Gloss
 - 4145 Milk Gloss
 - 4148 Midnight Brown Gloss
 - 4180 Graphite Matte
 - 4193 Midnight Brown Matte
 - 4242 Milk Matte
 - 4710 Low Gloss Black
 - 5 Options, if selected (see below)
- ▶ See *Surface Materials*, page 178

Required Selections	Price	Required to Specify
---------------------	-------	---------------------

Upholstery accent	Prices to right	Select accent upholstery.
-------------------	-----------------	---------------------------

Options	Price	Required to Specify
---------	-------	---------------------

Surface Materials	Base	Price	Required to Specify
	• Group 3 paint	+\$149	Specify paint color number.
	Acrylic backer		
	• Lounge chair with single fabric	+\$ 53	Specify with acrylic backer.
	• Lounge chair with two fabrics	+\$ 60	Specify with acrylic backer.
	• 2-seat lounge with single fabric	+\$ 74	Specify with acrylic backer.
	• 2-seat lounge with two fabrics	+\$ 81	Specify with acrylic backer.
	• 3-seat lounge with single fabric	+\$ 84	Specify with acrylic backer.
	• 3-seat lounge with two fabrics	+\$ 95	Specify with acrylic backer.
	• Ottomans with single fabric	+\$ 27	Specify with acrylic backer.
	• Ottomans with two fabrics	+\$ 27	Specify with acrylic backer.
	• 2-seat benches with single fabric	+\$ 34	Specify with acrylic backer.
	• 2-seat benches with two fabrics	+\$ 34	Specify with acrylic backer.

▶ See *Surface Materials*, page 178

Visalia Lounge

DESIGN COALESSE DESIGN GROUP

Specification Information

Lounge Chair

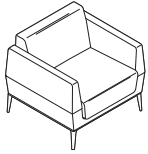

Overall: 29"D 31¾"W 28"H
 Seat height: 16¼"H
 Arm height to the floor: 23"H
 Inside: 19"D 23"W 16¼"H

Style Number

Upholstery

2-Seat Lounge

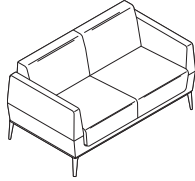

Overall: 29"D 53¾"W 28"H
 Seat height: 16¼"H
 Arm height to the floor: 23"H
 Inside: 19"D 45"W 16¼"H

3-Seat Lounge

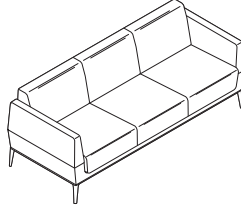

Overall: 29"D 73¾"W 28"H
 Seat height: 16¼"H
 Arm height to the floor: 23"H
 Inside: 19"D 65"W 16¼"H

Ottoman

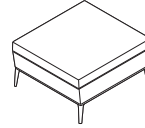

Overall: 29"D 30"W 16¼"H

Bench

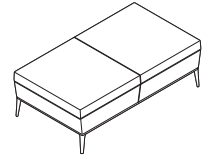

Overall: 29"D 52"W 16¼"H

Base Prices

Fabric Groups:

COM 1 2 3 4 5 6 7 8 9 10

Leather Groups:

COL 1 2

Lounge Seating

Lounge Chair with Single Fabric

COJHL100	\$3304	\$3304	\$3418	\$3514	\$3624	\$3797	\$4003	\$4243	\$4498	\$4723	\$4959	\$3723	\$4964	\$5159
	COM/yds = 3¾, COL/sq ft = 83													

Lounge Chair with Accent Upholstery

COJHLC100	Standard Upholstery	\$3385	\$3385	\$3475	\$3553	\$3640	\$3778	\$3943	\$4135	\$4339	\$4519	\$4708	\$3705	\$4932	\$5113
		COM/yds = 3, COL/sq ft = 66													
	Accent Upholstery	No cost	No cost	+\$ 30	+\$ 56	+\$ 85	+\$131	+\$186	+\$250	+\$318	+\$378	+\$441	+\$419	+\$515	+\$575
		COM/yds = 1, COL/sq ft = 22													

2-Seat Lounge with Single Fabric

COJHL200	\$5100	\$5100	\$5252	\$5380	\$5527	\$5758	\$6032	\$6352	\$6692	\$6992	\$7307	\$5519	\$7399	\$7668
	COM/yds = 5, COL/sq ft = 110													

2-Seat Lounge with Accent Upholstery

COJHLC200	Standard Upholstery	\$5181	\$5181	\$5316	\$5433	\$5564	\$5771	\$6018	\$6306	\$6612	\$6882	\$7166	\$5600	\$7481	\$7754
		COM/yds = 4½, COL/sq ft = 99													
	Accent Upholstery	No cost	No cost	+\$ 30	+\$ 56	+\$ 85	+\$131	+\$186	+\$250	+\$318	+\$378	+\$441	+\$419	+\$653	+\$727
		COM/yds = 1¼, COL/sq ft = 27													

3-Seat Lounge with Single Fabric

COJHL300	\$5880	\$5880	\$6063	\$6216	\$6393	\$6670	\$6999	\$7383	\$7791	\$8151	\$8529	\$6299	\$8845	\$9193
	COM/yds = 6, COL/sq ft = 132													

3-Seat Lounge with Accent Upholstery

COJHLC300	Standard Upholstery	\$5961	\$5961	\$6128	\$6269	\$6430	\$6684	\$6986	\$7338	\$7712	\$8042	\$8388	\$6380	\$8812	\$9144
		COM/yds = 5½, COL/sq ft = 121													
	Accent Upholstery	No cost	No cost	+\$ 53	+\$ 98	+\$149	+\$230	+\$326	+\$438	+\$557	+\$662	+\$ 772	+\$419	+\$897	+\$998
		COM/yds = 1¾, COL/sq ft = 39													

► Specification Information, continued on next page

Visalia Lounge *continued*

DESIGN COALESSE DESIGN GROUP

► Specification Information, continued from previous page

Specification Information

Lounge Chair

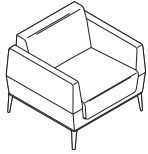

Overall: 29"D 31¾"W 28"H
 Seat height: 16¼"H
 Arm height to the floor: 23"H
 Inside: 19"D 23"W 16¼"H

Style Number

2-Seat Lounge

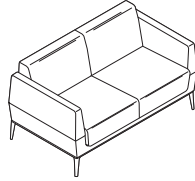

Overall: 29"D 53¾"W 28"H
 Seat height: 16¼"H
 Arm height to the floor: 23"H
 Inside: 19"D 45"W 16¼"H

3-Seat Lounge

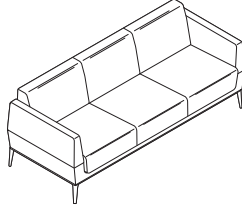

Overall: 29"D 73¾"W 28"H
 Seat height: 16¼"H
 Arm height to the floor: 23"H
 Inside: 19"D 65"W 16¼"H

Ottoman

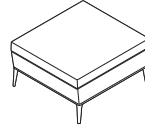

Overall: 29"D 30"W 16¼"H

Bench

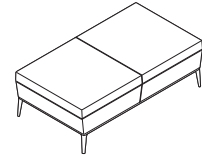

Overall: 29"D 52"W 16¼"H

Base Prices

Fabric Groups:

COM 1 2 3 4 5 6 7 8 9 10

Leather Groups:

COL 1 2

Ottoman with Single Fabric

COJHB100	\$1827	\$1827	\$1887	\$1938	\$1997	\$2088	\$2199	\$2327	\$2462	\$2582	\$2709	\$2246	\$2847	\$2969
	COM/yds = 2, COL/sq ft = 44													

Ottoman with Accent Upholstery

COJHBC100	Standard Upholstery	\$1908	\$1908	\$1918	\$1964	\$1993	\$2039	\$2094	\$2158	\$2226	\$2286	\$2349	\$2275	\$2436	\$2497
		COM/yds = 1, COL/sq ft = 22													
	Accent Upholstery	No cost	No cost	+\$ 30	+\$ 56	+\$ 85	+\$131	+\$186	+\$250	+\$318	+\$378	+\$ 441	+\$419	+\$515	+\$575
		COM/yds = 1, COL/sq ft = 22													

2-Seat Bench with Single Fabric

COJHB200	\$2672	\$2672	\$2762	\$2839	\$2927	\$3064	\$3230	\$3422	\$3625	\$3805	\$3995	\$3091	\$4048	\$4217
	COM/yds = 3, COL/sq ft = 50													

2-Seat Bench with Accent Upholstery

COJHBC200	Standard Upholstery	\$2753	\$2753	\$2768	\$2851	\$2902	\$2983	\$3079	\$3191	\$3310	\$3415	\$3525	\$3078	\$3677	\$3784
		COM/yds = 1¾, COL/sq ft = 39													
	Accent Upholstery	No cost	No cost	+\$ 30	+\$ 56	+\$ 85	+\$131	+\$186	+\$250	+\$318	+\$378	+\$ 441	+\$419	+\$653	+\$727
		COM/yds = 1, COL/sq ft = 22													

Guest/Side/Stack Seating

Bindu Chairs	134
Bob Chair	135
Enea Café Wood Stools	136
Enea Lottus Chairs	138
Enea Lottus Sled Stools	142
Enea Lottus Post Stools	144
Kathryn Chairs	146
Switch	148
Montara650	150
Montara650 Rocker	156
Wrapp Chairs	158

Bindu Chairs

DESIGN BRIAN KANE

Tip: Fabrics and leathers will appear loose with comfort wrinkles when upholstered.

Tip: Craft in upholstery cautions the use of stripes and patterns on Bindu. Please use fabric database when specifying.

Tip: For Customer's Own Material or Leather, see necessary requirements, important processing instructions, and ordering information
 ▶ See Coalesse Surface Materials Reference Guide.

Tip: For fabric with large pattern and specific pattern location is desired, contact Customer Service.

Standard Includes		Required to Specify
▶ Need help? Product details, see <i>Coalesse Seating and Outdoor Specification Guide</i>	<ul style="list-style-type: none"> Bent plywood frame Chair: fabric Molded polypropylene foam Frame: 4144 Black Gloss Glides: black, non-marring 	1 Style number 2 Fabric or leather color number for upholstery 3 Options, if selected (see below) ▶ See <i>Surface Materials</i> , page 178

Options	Price	Required to Specify
Surface Materials Acrylic backer • Backer	+\$ 47	Specify with acrylic backer. ▶ See <i>Surface Materials</i> , page 178
Base • 9207 polished trivalent chrome	+\$229	Specify with 9207 polished trivalent chrome.

Specification Information													
Style Number	Base Prices										Leather Groups:		
	Fabric Groups:										COL		
	COM	1	2	3	4	5	6	7	8	9	10	1	2

Low-Back Chair

CO200G	\$1833	\$1833	\$1937	\$2023	\$2126	\$2281	\$2474	\$2693	\$2927	\$3133	\$3352	\$2252	\$3876	\$4205
---------------	--------	--------	--------	--------	--------	--------	--------	--------	--------	--------	--------	--------	--------	--------

COM/yds = 3, COL/sq ft = 66



Overall: 25"D 24½"W 33¾"H
Inside: 18¾"D 18½"-19½"W 15"H
Seat: 17¾"H
Arm: 26¼"H

Mid-Back Chair

CO300G	\$2102	\$2102	\$2206	\$2292	\$2395	\$2550	\$2743	\$2962	\$3196	\$3402	\$3621	\$2521	\$4145	\$4474
---------------	--------	--------	--------	--------	--------	--------	--------	--------	--------	--------	--------	--------	--------	--------

COM/yds = 3, COL/sq ft = 66



Overall: 25"D 24½"W 37¾"H
Inside: 18¾"D 18½"-19½"W 21"H
Seat: 17¾"H
Arm: 26¼"H

Bob Chair by Walter Knoll

DESIGN PEARSON LLOYD

Tip: For Customer's Own Material or Leather, see necessary requirements, important processing instructions, and ordering information.
 ▶ Page 180

Tip: Fabrics and leathers will appear loose with comfort wrinkles when upholstered.

Standard Includes		Required to Specify
▶ Need help? Product details, see <i>Coalesse Seating and Outdoor Specification Guide</i>	<ul style="list-style-type: none"> Swivel base: 8040 Aluminum Matte Polished or group 1 paint Upholstery for chair: fabric or leather Glides 	1 Style number 2 Number of fabrics if contrasting fabric style number is selected 3 Fabric or leather color number for upholstery 4 Options, if selected (see below) ▶ See <i>Surface Materials</i> , page 178.

Options	Price	Required to Specify	
Surface Materials	<ul style="list-style-type: none"> Contrasting fabric 	+\$182 per fabric	Add suffix K to the style number and select fabric color number.
	Base		
	<ul style="list-style-type: none"> Aluminum matte polished Group 1 paint Group 3 paint 	No cost No cost +\$108	Specify with <i>aluminum matte polished</i> . Specify paint color number. Specify paint color number.
	Acrylic backer		
	<ul style="list-style-type: none"> Guest chair Ottoman 	+\$ 34 +\$ 12	Specify with <i>acrylic backer</i> . Specify with <i>acrylic backer</i> . ▶ See <i>Surface Materials</i> , page 178.
Glides	<ul style="list-style-type: none"> Felted glides 	+\$ 22	Specify with <i>felted glides</i> .
Related Products	<ul style="list-style-type: none"> Bob tables 		▶ See <i>GSA Volume 5b Specification Guide</i> .

Specification Information													
Style Number	Base Prices										Leather Groups:		
	Fabric Groups:										COL	1	2
COM	1	2	3	4	5	6	7	8	9	10			

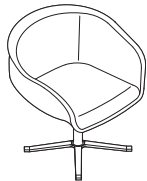

Overall: 25¼"D 27¼"W 29¾"H
 Inside: 18"D 18"W 12½"H
 Seat: 18½"H
 Arm: 26½"H



Overall: 18½"D 19¾"W 15¼"H

Guest Chair														
231	\$2806	\$2806	\$2872	\$2926	\$2990	\$3086	\$3204	\$3340	\$3486	\$3614	\$3750	\$3242	\$4345	\$4568
COM/yds = 2, COL/sq ft = 44														

Ottoman														
221-H	\$1252	\$1252	\$1285	\$1312	\$1344	\$1392	\$1451	\$1519	\$1592	\$1656	\$1724	\$1688	\$2195	\$2306
COM/yds = 1, COL/sq ft = 22														

Guest/ Side/Stack Seating

Enea Café Wood Stools

DESIGN JOSEP LLUSCA

Tip: Recommended leathers are Elmosoft group 1 and Elmorustical group 2.

Tip: Special color match, consult Customer Service.

Tip: For Customer's Own Material or Leather, see necessary requirements, important processing instructions, and ordering information
 ▶ See Coalesse Surface Materials Reference Guide.

Standard Includes	Required to Specify
<ul style="list-style-type: none"> • Legs: solid oak with natural finish • Footring: 9201 Polished Trivalent Chrome • Seat and seat casting: <ul style="list-style-type: none"> – Polypropylene seat with matching textured paint on seat casting, if selected – V3AK Rift-Cut Oak veneer plywood seat with 4062 Anthracite Grey textured paint on seat casting, if selected – Upholstered seat with textured paint on seat casting, if selected • Glides, non-adjustable: black plastic 	<ol style="list-style-type: none"> 1 Style number 2 Plastic color number for polypropylene seat, if selected 3 Fabric or leather color number for upholstered seat, if selected 4 Paint color number for seat casting, if upholstered seat selected: 4062 Anthracite Grey 7207 Black 7241 Arctic White 5 Options, if selected (see below) ▶ See Coalesse Surface Materials Reference Guide.

Options	Price	Required to Specify
Surface Materials <ul style="list-style-type: none"> • Acrylic backer • Backer 	+\$4	Specify with acrylic backer. ▶ See Coalesse Surface Materials Reference Guide.
Related Products <ul style="list-style-type: none"> • Café tables • Occasional tables • Guest seating 		▶ See Coalesse Tables, Storage, and Accessories Specification Guide. ▶ See Coalesse Tables, Storage, and Accessories Specification Guide. ▶ Coalesse Seating and Outdoor Specification Guide.

Specification Information

Style Number	Base Prices										Leather Groups:		Wood	Polypropylene	
	Fabric Groups:										COL				
	COM	1	2	3	4	5	6	7	8	9	10	1	2		



Overall: 14½"D 16½"W 27½"H
 Seat: 25¾"H

Café Wood Counter-Height Stool with Upholstered Seat

COH352W27	\$1200	\$1200	\$1231	\$1256	\$1287	\$1332	\$1389	\$1454	\$1522	\$1583	\$1648	\$1481	\$1709	\$1759	N.A.	N.A.
-----------	--------	--------	--------	--------	--------	--------	--------	--------	--------	--------	--------	--------	--------	--------	------	------



Overall: 15¾"D 16½"W 31½"H
 Seat: 29¾"H

Café Wood Bar-Height Stool with Upholstered Seat

COH352W31	\$1274	\$1274	\$1305	\$1330	\$1361	\$1406	\$1463	\$1528	\$1596	\$1657	\$1722	\$1555	\$1783	\$1833	N.A.	N.A.
-----------	--------	--------	--------	--------	--------	--------	--------	--------	--------	--------	--------	--------	--------	--------	------	------

▶ Specification Information, continued on next page

Enea Café Wood Stools

DESIGN JOSEP LLUSCA

► Specification Information, continued from previous page

Specification Information

Style Number	Base Prices										Leather Groups:		Wood	Polypropylene	
	Fabric Groups:										COL	1			2
	COM	1	2	3	4	5	6	7	8	9	10				



Overall: 14½"D 16½"W 27½"H
Seat: 25¾"H

Café Wood Counter-Height Stools

Wood Seat															
COH350W27	\$1142	N.A.	N.A.	N.A.	N.A.	N.A.	N.A.	N.A.	N.A.	N.A.	N.A.	N.A.	N.A.	N.A.	N.A.
Polypropylene Seat															
COH353W27	N.A.	N.A.	N.A.	N.A.	N.A.	N.A.	N.A.	N.A.	N.A.	N.A.	N.A.	N.A.	N.A.	N.A.	\$ 948



Overall: 15¾"D 16½"W 31½"H
Seat: 29¾"H

Café Wood Bar-Height Stools

Wood Seat															
COH350W31	\$1217	N.A.	N.A.	N.A.	N.A.	N.A.	N.A.	N.A.	N.A.	N.A.	N.A.	N.A.	N.A.	N.A.	N.A.
Polypropylene Seat															
COH353W31	N.A.	N.A.	N.A.	N.A.	N.A.	N.A.	N.A.	N.A.	N.A.	N.A.	N.A.	N.A.	N.A.	N.A.	\$1021

Guest/ Side/Stack Seating

Enea Lottus Chairs Armless

DESIGN LIEVORE ALTHERR MOLINA

Tip: For Customer's Own Material or Leather, see necessary requirements, important processing instructions, and ordering information.
 ▶Page 180

Standard Includes		Required to Specify
▶ Need help? Product details, see <i>Coalesse Seating and Outdoor Specification Guide</i>	<ul style="list-style-type: none"> • Base and frame constructed of steel tubing • Seat and back: polypropylene • Insert, if selected: polypropylene or upholstery 	1 Style number 2 Plastic color number for seat and back 3 Fabric or leather color number for upholstery insert, if selected 4 Paint color number for base and frame 5 Options, if selected (see below) ▶ See <i>Surface Materials</i> , page 178.

Options	Price	Required to Specify
Surface Materials Base <ul style="list-style-type: none"> • Group 1 paint • Group 3 paint 	No cost +\$108	Specify paint color number. Specify paint color number.
Acrylic backer <ul style="list-style-type: none"> • Chair with upholstered insert 	+\$ 7	Specify with acrylic backer. ▶ See <i>Surface Materials</i> , page 178.
Felt Glides <ul style="list-style-type: none"> • Glides 	No cost	Specify with felt glides.

Specification Information

Style Number	Base Prices										Leather Groups:		Poly-propylene	
	Fabric Groups:										COL	1		2
	COM	1	2	3	4	5	6	7	8	9	10			

Tip: Lottus chair with no insert stacks 10 high on floor. Lottus chair with polypropylene or upholstered insert stacks four high on floor. Lottus chairs stack six high with dolly.



Overall: 20¾"D 20¾"W 30½"H
 Seat: 18"H
 Seat Depth: 16½"D

Armless Chair with No Insert

COEL100	\$534	N.A.	N.A.	N.A.	N.A.	N.A.	N.A.	N.A.	N.A.	N.A.	N.A.	N.A.	N.A.	N.A.	N.A.
---------	-------	------	------	------	------	------	------	------	------	------	------	------	------	------	------



Overall: 20¾"D 20¾"W 30½"H
 Seat: 18"H
 Seat Depth: 16½"D

Armless Chair with Polypropylene Insert

COEL100INSERT	N.A.	N.A.	N.A.	N.A.	N.A.	N.A.	N.A.	N.A.	N.A.	N.A.	N.A.	N.A.	N.A.	N.A.	N.A.	\$596
---------------	------	------	------	------	------	------	------	------	------	------	------	------	------	------	------	-------



Overall: 20¾"D 20¾"W 30½"H
 Seat: 18"H
 Seat Depth: 16½"D

Armless Chair with Upholstered Insert

COEL100UPH	\$774	\$774	\$798	\$817	\$841	\$876	\$919	\$969	\$1022	\$1068	\$1118	\$1173	\$1142	\$1187	N.A.
------------	-------	-------	-------	-------	-------	-------	-------	-------	--------	--------	--------	--------	--------	--------	------

COM/yds = ¾, COL/sq ft = 15

▶ Specification Information, continued on next page

Enea Lottus Chairs Armless

DESIGN LIEVORE ALTHERR MOLINA

► Specification Information, continued from previous page

Specification Information

Style Number	Price
--------------	-------

Stacking Dolly

COELDOLLY	\$1121
-----------	--------

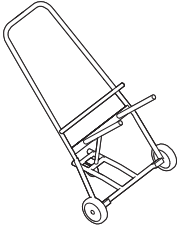

Overall: 27"D 25"W 46"H

Tip: Dolly can be used with any Enea Lottus chair.

Tip: Armless chairs, cantilever arm chairs, and loop arm chairs stack six high on dolly.

Enea Lottus Chairs Cantilever Arm

DESIGN LIEVORE ALTHERR MOLINA

Tip: Cantilever arm can hook on table to provide storing option.

Tip: Cantilever arm stacks six high.

Tip: Can specify arm cap in any plastic color for Lottus.

Tip: For Customer's Own Material or Leather, see necessary requirements, important processing instructions, and ordering information.
 ▶Page 180

Standard Includes		Required to Specify
▶ Need help? Product details, see <i>Coalesse Seating and Outdoor Specification Guide</i>	<ul style="list-style-type: none"> • Base and frame constructed of steel tubing • Seat and back: polypropylene • Arm cap: polypropylene • Insert, if selected: polypropylene or upholstery 	1 Style number 2 Plastic color number for seat, back, and arm cap 3 Fabric or leather color number for upholstery insert, if selected 4 Paint color number for base and frame 5 Options, if selected (see below) ▶ See <i>Surface Materials</i> , page 178.

Options	Price	Required to Specify
Surface Materials Base <ul style="list-style-type: none"> • Group 1 paint • Group 3 paint 	No cost +\$108	Specify paint color number. Specify paint color number.
Acrylic backer <ul style="list-style-type: none"> • Chair with upholstered insert 	+\$ 7	Specify with acrylic backer. ▶ See <i>Surface Materials</i> , page 178.
Felt Glides <ul style="list-style-type: none"> • Glides 	No cost	Specify with felt glides.

Specification Information

Style Number	Base Prices										Leather Groups:		Poly-propylene	
	Fabric Groups:										COL	1		2
	COM	1	2	3	4	5	6	7	8	9	10			

Cantilever Arm Chair with No Insert

COEL200	\$657	N.A.	N.A.	N.A.	N.A.	N.A.	N.A.	N.A.	N.A.	N.A.	N.A.	N.A.	N.A.	N.A.	N.A.
---------	-------	------	------	------	------	------	------	------	------	------	------	------	------	------	------



Overall: 20¾"D 23¾"W 30½"H
 Seat: 18"H
 Seat Depth: 16½"D
 Arm: 26"H

Cantilever Arm Chair with Polypropylene Insert

COEL200INSERT	N.A.	N.A.	N.A.	N.A.	N.A.	N.A.	N.A.	N.A.	N.A.	N.A.	N.A.	N.A.	N.A.	N.A.	N.A.	\$721
---------------	------	------	------	------	------	------	------	------	------	------	------	------	------	------	------	-------



Overall: 20¾"D 23¾"W 30½"H
 Seat: 18"H
 Seat Depth: 16½"D
 Arm: 26"H

Cantilever Arm Chair with Upholstered Insert

COEL200UPH	\$897	\$897	\$921	\$940	\$964	\$999	\$1042	\$1092	\$1145	\$1191	\$1241	\$1296	\$1265	\$1310	N.A.
------------	-------	-------	-------	-------	-------	-------	--------	--------	--------	--------	--------	--------	--------	--------	------

COM/yds = ¾, COL/sq ft = 15



Overall: 20¾"D 23¾"W 30½"H
 Seat: 18"H
 Seat Depth: 16½"D
 Arm: 26"H

Enea Lottus Chairs Aluminum Loop Arm

DESIGN LIEVORE ALTHERR MOLINA

Tip: Arm chair stacks six high.

Tip: For Customer's Own Material or Leather, see necessary requirements, important processing instructions, and ordering information.

▶Page 180

Standard Includes		Required to Specify
▶Need help? Product details, see <i>Coalesse Seating and Outdoor Specification Guide</i>	<ul style="list-style-type: none"> • Base and frame constructed of steel tubing • Seat and back: polypropylene • Arm: aluminum • Insert, if selected: polypropylene or upholstery 	<ol style="list-style-type: none"> 1 Style number 2 Plastic color number for seat, back, and arm cap 3 Fabric or leather color number for upholstery insert, if selected 4 Paint color number for base and frame 5 Options, if selected (see below) ▶See <i>Surface Materials</i> , page 178.

Options	Price	Required to Specify
Surface Materials	Base <ul style="list-style-type: none"> • Group 1 paint • Group 3 paint 	No cost +\$108
	Acrylic backer <ul style="list-style-type: none"> • Chair with upholstered insert 	+\$ 7
Felt Glides	<ul style="list-style-type: none"> • Glides 	No cost

Specification Information														
Style Number	Base Prices										Leather Groups:		Poly-propylene	
	Fabric Groups:										COL	1		2
	COM	1	2	3	4	5	6	7	8	9	10			

Aluminum Loop Arm Chair with No Insert

COEL300	\$712	N.A.	N.A.	N.A.	N.A.	N.A.	N.A.	N.A.	N.A.	N.A.	N.A.	N.A.	N.A.	N.A.	N.A.
---------	-------	------	------	------	------	------	------	------	------	------	------	------	------	------	------



Overall: 20³/₄"D 22"W 30¹/₂"H
Seat: 18"H
Seat Depth: 16¹/₂"D
Arm: 26"H

Aluminum Loop Arm Chair with Polypropylene Insert

COEL300INSERT	N.A.	N.A.	N.A.	N.A.	N.A.	N.A.	N.A.	N.A.	N.A.	N.A.	N.A.	N.A.	N.A.	N.A.	N.A.	\$770
---------------	------	------	------	------	------	------	------	------	------	------	------	------	------	------	------	-------



Overall: 20³/₄"D 22"W 30¹/₂"H
Seat: 18"H
Seat Depth: 16¹/₂"D
Arm: 26"H

Aluminum Loop Arm Chair with Upholstered Insert

COEL300UPH	\$948	\$948	\$972	\$991	\$1015	\$1050	\$1093	\$1143	\$1196	\$1242	\$1292	\$1367	\$1316	\$1361	N.A.
------------	-------	-------	-------	-------	--------	--------	--------	--------	--------	--------	--------	--------	--------	--------	------

COM/yds = 3/4, COL/sq ft = 15



Overall: 20³/₄"D 22"W 30¹/₂"H
Seat: 18"H
Seat Depth: 16¹/₂"D
Arm: 26"H

Enea Lottus Sled Stools Sled Base

DESIGN LIEVORE ALTHERR MOLINA

Tip: For Customer's Own Material or Leather, see necessary requirements, important processing instructions, and ordering information.
 ▶Page 180

Standard Includes		Required to Specify
▶ Need help? Product details, see <i>Coalesse Seating and Outdoor Specification Guide</i>	<ul style="list-style-type: none"> Base and frame constructed of painted steel tubing Seat and back: polypropylene Insert, if selected: polypropylene or upholstery 	1 Style number 2 Plastic color number for seat and back 3 Fabric or leather color number for upholstery insert, if selected 4 Paint color number for base and frame 5 Options, if selected (see below) ▶ See <i>Surface Materials</i> , page 178.

Options	Price	Required to Specify
Surface Materials Base <ul style="list-style-type: none"> Group 1 paint Group 3 paint 	No cost +\$108	Specify paint color number. Specify paint color number.
Acrylic backer <ul style="list-style-type: none"> Chair with upholstered insert 	+\$ 7	Specify with acrylic backer. ▶ See <i>Surface Materials</i> , page 178.

Specification Information													
Style Number	Base Prices										Leather Groups:		Poly-propylene
	Fabric Groups:										COL	1	
COM	1	2	3	4	5	6	7	8	9	10			

Sled-Base Counter-Height Stool with No Insert

COEL500	\$ 781	N.A.	N.A.	N.A.	N.A.	N.A.	N.A.	N.A.	N.A.	N.A.	N.A.	N.A.	N.A.	N.A.	N.A.	N.A.
---------	--------	------	------	------	------	------	------	------	------	------	------	------	------	------	------	------



Overall: 18"D 18 1/4"W 34 1/2"H
 Seat: 26 1/4"H
 Seat Depth: 13 7/9"D

Sled-Base Counter-Height Stool with Polypropylene Insert

COEL500INSERT	N.A.	N.A.	N.A.	N.A.	N.A.	N.A.	N.A.	N.A.	N.A.	N.A.	N.A.	N.A.	N.A.	N.A.	N.A.	N.A.	\$826
---------------	------	------	------	------	------	------	------	------	------	------	------	------	------	------	------	------	-------



Overall: 18"D 18 1/4"W 34 1/2"H
 Seat: 26 1/4"H
 Seat Depth: 13 7/9"D

Sled Base Counter-Height Stool with Upholstered Insert

COEL500UPH	\$1003	\$1003	\$1027	\$1046	\$1070	\$1105	\$1148	\$1198	\$1251	\$1297	\$1347	\$1422	\$1371	\$1416	N.A.
------------	--------	--------	--------	--------	--------	--------	--------	--------	--------	--------	--------	--------	--------	--------	------

COM/yds = 3/4, COL/sq ft = 15

▶ Specification Information, continued on next page



Overall: 18"D 18 1/4"W 34 1/2"H
 Seat: 26 1/4"H
 Seat Depth: 13 7/9"D

Enea Lottus Sled Stools Sled Base

DESIGN LIEVORE ALTHERR MOLINA

► Specification Information, continued from previous page

Specification Information

Style Number	Base Prices										Leather Groups:		Polypropylene	
	Fabric Groups:										COL	1		2
	COM	1	2	3	4	5	6	7	8	9	10			

Sled Base Bar-Height Stool with No Insert

COEL400	\$ 858	N.A.	N.A.	N.A.	N.A.	N.A.	N.A.	N.A.	N.A.	N.A.	N.A.	N.A.	N.A.	N.A.	N.A.
---------	--------	------	------	------	------	------	------	------	------	------	------	------	------	------	------



Overall: 18"D 18¼"W 38½"H
Seat: 30"H
Seat Depth: 137⁹⁄₁₆"D

Sled Base Bar-Height Stool with Polypropylene Insert

COEL400INSERT	N.A.	N.A.	N.A.	N.A.	N.A.	N.A.	N.A.	N.A.	N.A.	N.A.	N.A.	N.A.	N.A.	N.A.	N.A.	\$904
---------------	------	------	------	------	------	------	------	------	------	------	------	------	------	------	------	-------



Overall: 18"D 18¼"W 38½"H
Seat: 30"H
Seat Depth: 137⁹⁄₁₆"D

Sled Base Bar-Height Stool with Upholstered Insert

COEL400UPH	\$1082	\$1082	\$1106	\$1125	\$1149	\$1184	\$1227	\$1277	\$1330	\$1376	\$1426	\$1501	\$1450	\$1495	N.A.
------------	--------	--------	--------	--------	--------	--------	--------	--------	--------	--------	--------	--------	--------	--------	------

COM/yds = ¾, COL/sq ft = 15



Overall: 18"D 18¼"W 38½"H
Seat: 30"H
Seat Depth: 137⁹⁄₁₆"D

Guest/ Side/Stack Seating

Enea Lottus Post Stools Post Base

DESIGN LIEVORE ALTHERR MOLINA

Tip: Post stool seat swivels.

Tip: For Customer's Own Material or Leather, see necessary requirements, important processing instructions, and ordering information.

▶Page 180

Standard Includes

- ▶Need help? Product details, see *Coalesse Seating and Outdoor Specification Guide*
- Base and frame constructed of painted steel tubing
- Seat and back: polypropylene
- Insert, if selected: polypropylene or upholstery
- Foot ring: paint to match the base and frame

Required to Specify

- 1 Style number
 - 2 Plastic color number for seat and back
 - 3 Fabric or leather color number for upholstery insert, if selected
 - 4 Paint color number for base and frame
 - 5 Options, if selected (see below)
- ▶See *Surface Materials*, page 178.

Options

Surface Materials	Options	Price	Required to Specify
	Base		
	• Group 1 paint	No cost	Specify paint color number.
	• Group 3 paint	+\$149	Specify paint color number.
	Acrylic backer		
	• Chair with upholstered insert	+\$ 7	Specify with acrylic backer. ▶See <i>Surface Materials</i> , page 178.
	• Polished trivalent chrome ring	+\$ 95	Specify with trivalent chrome ring.

Specification Information

Style Number	Base Prices										Leather Groups:		Poly-propylene	
	Fabric Groups:										COL	1		2
	COM	1	2	3	4	5	6	7	8	9	10			

Post Base Counter-Height Stool with No Insert

COEL700	\$1508	N.A.	N.A.	N.A.	N.A.	N.A.	N.A.	N.A.	N.A.	N.A.	N.A.	N.A.	N.A.	N.A.	N.A.
---------	--------	------	------	------	------	------	------	------	------	------	------	------	------	------	------

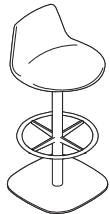

Overall: 19¾"D 19¾"W 34½"H
Seat: 26¼"H
Seat Depth: 13⅞"D

Post Base Counter-Height Stool with Polypropylene Insert

COEL700INSERT	N.A.	N.A.	N.A.	N.A.	N.A.	N.A.	N.A.	N.A.	N.A.	N.A.	N.A.	N.A.	N.A.	N.A.	N.A.	\$1550
---------------	------	------	------	------	------	------	------	------	------	------	------	------	------	------	------	--------

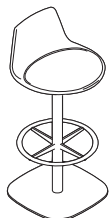

Overall: 19¾"D 19¾"W 34½"H
Seat: 26¼"H
Seat Depth: 13⅞"D

Post Base Counter-Height Stool with Upholstered Insert

COEL700UPH	\$1729	\$1729	\$1753	\$1772	\$1796	\$1831	\$1874	\$1924	\$1977	\$2023	\$2073	\$2148	\$2097	\$2142	N.A.
------------	--------	--------	--------	--------	--------	--------	--------	--------	--------	--------	--------	--------	--------	--------	------

COM/yds = ¾, COL/sq ft = 15

▶Specification Information, continued on next page

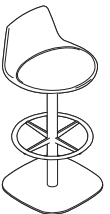

Overall: 19¾"D 19¾"W 34½"H
Seat: 26¼"H
Seat Depth: 13⅞"D

Enea Lottus Post Stools Post Base

DESIGN LIEVORE ALTHERR MOLINA

► Specification Information, continued from previous page

Specification Information

Style Number	Base Prices										Leather Groups:		Poly-propylene	
	Fabric Groups:										COL	1		2
	COM	1	2	3	4	5	6	7	8	9	10			

Post Base Bar-Height Stool with No Insert

COEL600	\$1525	N.A.	N.A.	N.A.	N.A.	N.A.	N.A.	N.A.	N.A.	N.A.	N.A.	N.A.	N.A.	N.A.	N.A.
---------	--------	------	------	------	------	------	------	------	------	------	------	------	------	------	------

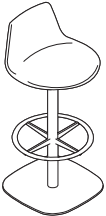

Overall: 19¾"D 19¾"W 38½"H
 Seat: 30"H
 Seat Depth: 137⁹⁄₁₆"D

Post Base Bar-Height Stool with Polypropylene Insert

COEL600INSERT	N.A.	N.A.	N.A.	N.A.	N.A.	N.A.	N.A.	N.A.	N.A.	N.A.	N.A.	N.A.	N.A.	N.A.	N.A.	\$1568
---------------	------	------	------	------	------	------	------	------	------	------	------	------	------	------	------	--------

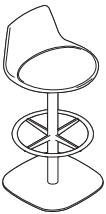

Overall: 19¾"D 19¾"W 38½"H
 Seat: 30"H
 Seat Depth: 137⁹⁄₁₆"D

Post Base Bar-Height Stool with Upholstered Insert

COEL600UPH	\$1747	\$1747	\$1771	\$1790	\$1814	\$1849	\$1892	\$1942	\$1995	\$2041	\$2091	\$2166	\$2115	\$2160	N.A.
------------	--------	--------	--------	--------	--------	--------	--------	--------	--------	--------	--------	--------	--------	--------	------

COM/yds = ¾, COL/sq ft = 15

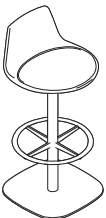

Overall: 19¾"D 19¾"W 38½"H
 Seat: 30"H
 Seat Depth: 137⁹⁄₁₆"D

Guest/ Side/Stack Seating

Kathryn Chairs

DESIGN STUDIO B

Tip: Fabrics and leathers will appear loose with comfort wrinkles when upholstered.

Tip: Recommended leathers are Elmosoft group 1 and Elmorustical group 2.

Tip: Special color match, consult Customer Service.

Tip: For Customer's Own Material or Leather, see necessary requirements, important processing instructions, and ordering information.

► Page 180

Overall: 22³/₄"D 22³/₂₀"W 32"H
Inside: 19"D 18¹/₂"W 14"H
Seat: 18"H
Arm: 26"H

Standard Includes

- Need help? Product details, see *Coalesse Seating and Outdoor Specification Guide*
- Frame: European beech hardwood
- Mortise and tenon joinery
- Upholstery: multiple densities of laminated polyurethane foam and polyester fiber
- Glides: non-adjustable

Required to Specify

- 1 Style number
 - 2 Number of fabrics if contrasting fabric style number is selected
 - 3 Fabric or leather color number for upholstery
 - 4 Wood color number for frame
- See *Hardwood and Veneer Matrix*, page 190
- 5 Options, if selected (see below)
- See *Surface Materials*, page 178.

Options

Surface Materials	Options	Price	Required to Specify
	• Contrasting fabric	+\$182 per fabric	Add suffix K to the style number and select fabric color number. Specify with <i>contrasting welt</i> and select fabric color number.
	• Contrasting welt	+\$208	
	Acrylic backer		Specify with <i>acrylic backer</i> . Specify with <i>acrylic backer</i> . ► See <i>Surface Materials</i> , page 178.
	• Chair with open back	+\$ 10	
	• Chair with upholstery	+\$ 20	

Specification Information

Style Number	Base Prices										Leather Groups:		
	Fabric Groups:											COL	
	COM	1	2	3	4	5	6	7	8	9	10	1	2

Wood with Open Back Chair

2540-1	\$1456	\$1456	\$1489	\$1515	\$1547	\$1596	\$1655	\$1724	\$1796	\$1860	\$1928	\$1907	\$2261	\$2359
--------	--------	--------	--------	--------	--------	--------	--------	--------	--------	--------	--------	--------	--------	--------

COM/yds = 1, COL/sq ft = 18

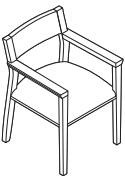

Wood/Upholstered with Panel Back Chair

2542-1	\$1531	\$1531	\$1581	\$1620	\$1668	\$1741	\$1830	\$1933	\$2041	\$2137	\$2239	\$1982	\$2553	\$2708
--------	--------	--------	--------	--------	--------	--------	--------	--------	--------	--------	--------	--------	--------	--------

COM/yds = 1½, COL/sq ft = 27

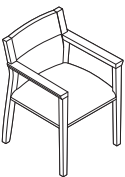

Fully Upholstered Back

2547-1	\$1725	\$1725	\$1775	\$1814	\$1862	\$1935	\$2024	\$2127	\$2235	\$2331	\$2433	\$2176	\$2747	\$2902
--------	--------	--------	--------	--------	--------	--------	--------	--------	--------	--------	--------	--------	--------	--------

COM/yds = 1½, COL/sq ft = 27

► Specification Information, continued on next page

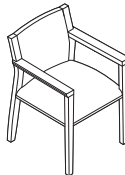

Kathryn Chairs

DESIGN STUDIO B

► Specification Information, continued from previous page

Specification Information

Style Number	Base Prices										Leather Groups:		
	Fabric Groups:										COL		
	COM	1	2	3	4	5	6	7	8	9	10	1	2

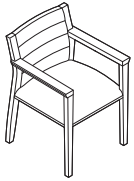

Fully Upholstered Back with Ribbed Upholstery

2547-1RIBD														
	\$1778	\$1778	\$1828	\$1867	\$1915	\$1988	\$2077	\$2180	\$2288	\$2384	\$2486	\$2229	\$2800	\$2955

Guest/Side/Stack Seating

Switch Stools without Arms

DESIGN EOOS

Tip: Fabrics and leathers will appear loose with comfort wrinkles when upholstered.

Tip: Recommended leathers are Elmosoft group 1 and Elmorustical group 2.

Tip: Special color match, consult Customer Service.

Tip: Pricing based on highest group textile specified.

Tip: For Customer's Own Material or Leather, see necessary requirements, important processing instructions, and ordering information.

▶ Page 180

Standard Includes

- ▶ Need help? Product details, see *Coalesse Seating and Outdoor Specification Guide*
- Frame: Constructed of steel tubing and bar stock
- Upholstery: back foam are molded around the frame components.
- Seat foam is molded with "comfort pockets"
- Legs: matte chrome (M) or polished chrome (PC) leg finish

Required to Specify

- 1 Style number
 - 2 Number of fabrics if contrasting fabric style number is selected
 - 3 Fabric or leather color number for upholstery
 - 4 Options, if selected (see below)
- ▶ See *Surface Materials*, page 178.

Options

Surface Materials	Options	Price	Required to Specify
	• Contrasting fabric	+\$182 per fabric	Add suffix K to the style number and select fabric color number.
	Acrylic backer		
	• Backer	+\$ 12	Specify with <i>acrylic backer</i> . ▶ See <i>Surface Materials</i> , page 178.
Related Products	• Guest seating		▶ See <i>Coalesse Seating and Outdoor Specification Guide</i> .
	• Occasional tables		▶ See <i>GSA Volume 5b Specification Guide</i> .

Specification Information

Style Number	Base Prices										Leather Groups:			
	Fabric Groups:										COL	1	2	
	COM	1	2	3	4	5	6	7	8	9	10			

Counter-Height Stools

1404M	\$1847	\$1847	\$1884	\$1914	\$1951	\$2005	\$2073	\$2150	\$2232	\$2305	\$2382	\$2343	\$3118	\$3284
1404PC	\$1882	\$1882	\$1919	\$1949	\$1986	\$2040	\$2108	\$2185	\$2267	\$2340	\$2417	\$2378	\$3153	\$3328

COM/yds = 1¼, COL/sq ft = 23

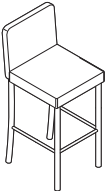

Overall: 19"D 16"W 38"H
Inside: 15"D 15"W 11¾"H
Seat: 27¾"H

Bar-Height Stools

1405M	\$1902	\$1902	\$1939	\$1969	\$2006	\$2060	\$2128	\$2205	\$2287	\$2360	\$2437	\$2393	\$3173	\$3339
1405PC	\$1956	\$1956	\$1993	\$2023	\$2060	\$2114	\$2182	\$2259	\$2341	\$2414	\$2491	\$2452	\$3227	\$3393

COM/yds = 1¼, COL/sq ft = 23

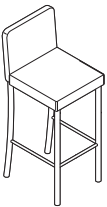

Overall: 19¾"D 16"W 41½"H
Inside: 15"D 15"W 11¾"H
Seat: 31¼"H

Coalesse SIN 33721

Switch

Stools without Arms

DESIGN EOOS

Montara650 Chairs

DESIGN LIEVORE ALTHERR MOLINA



Tip: Chairs stack six high.

Tip: Leathers will appear loose with comfort wrinkles when upholstered.

Tip: For Customer's Own Material or Leather, see necessary requirements, important processing instructions, and ordering information.

► Page 180

Standard Includes	Required to Specify
-------------------	---------------------

<ul style="list-style-type: none"> ► Need help? Product details, see <i>Coalesse Seating and Outdoor Specification Guide</i> 	<ul style="list-style-type: none"> • Seat and back: upholstery, if selected • Shell: wood shell, wood shell with upholstered seat, or ¾ upholstered with wood shell, if selected: wood veneer group 1 • Base: paint • Glides 	<ol style="list-style-type: none"> 1 Style number 2 Upholstery version (see below under Required Selections) 3 Contrasting fabric on ¾ or fully upholstered, if selected (see below under Required Selections) 4 Fabric and/or leather color number for seat and/or back, if selected 5 Wood finish on shell, if selected 6 Base type (see below under Required Selections) 7 Paint color number for base 8 Options, if selected (see below) <p>► See <i>Surface Materials</i>, page 178</p>
--	--	--

Required Selections	Price	Required to Specify
---------------------	-------	---------------------

Upholstery Version	<ul style="list-style-type: none"> • Wood shell • Wood shell with upholstered seat • Wood shell with ¾ upholstery • Fully upholstered 	<p>Prices at right</p> <p>Prices at right</p> <p>Prices at right</p> <p>Prices at right</p>	<p>Specify with <i>wood seat and back</i>.</p> <p>Specify with <i>upholstered seat, wood back</i>.</p> <p>Specify with <i>¾ upholstered</i>.</p> <p>Specify with <i>upholstered seat and back</i>.</p>
Contrasting Fabric on ¾ and Fully Upholstered	<ul style="list-style-type: none"> • Non contrasting fabric • Contrasting fabric 	<p>No cost</p> <p>+\$182</p>	<p>Specify with <i>non contrasting fabric</i>.</p> <p>Specify with <i>contrasting fabric</i>.</p>
Base Type	<ul style="list-style-type: none"> • 4-leg • Sled base • Sled base with cantilever arms • 4-leg base with loop arms 	<p>No cost</p> <p>+\$ 75</p> <p>+\$220</p> <p>+\$175</p>	<p>Specify with <i>4-leg</i>.</p> <p>Specify with <i>sled base</i>.</p> <p>Specify with <i>sled cantilever arm</i>.</p> <p>Specify with <i>4-leg loop arm</i>.</p>

Options	Price	Required to Specify
---------	-------	---------------------

Surface Materials	Base, armless <ul style="list-style-type: none"> • Group 1 paint • Group 2 paint • Polished trivalent chrome • Group 3 paint 	<p>No cost</p> <p>No cost</p> <p>+\$ 76</p> <p>+\$108</p>	<p>Specify paint color number.</p> <p>Specify paint color number.</p> <p>Specify with <i>polished trivalent chrome</i>.</p> <p>Specify paint color number.</p>
	Base, with arms <ul style="list-style-type: none"> • Group 1 paint • Group 2 paint • Group 3 paint • Polished trivalent chrome 	<p>No cost</p> <p>No cost</p> <p>+\$108</p> <p>+\$249</p>	<p>Specify paint color number.</p> <p>Specify paint color number.</p> <p>Specify paint color number.</p> <p>Specify with <i>polished trivalent chrome</i>.</p>
	Wood shell <ul style="list-style-type: none"> • Group 1 wood veneer • Group 2 wood veneer 	<p>No cost</p> <p>+\$ 97</p>	<p>Specify with <i>VP01 Oak Light, VP03 Black Oak, or VP05 White Oak</i>.</p> <p>Specify with <i>VP02 Smoked Oak or VP04 Grey Oak</i>.</p>
	Acrylic backer <ul style="list-style-type: none"> • Seat • Seat and back 	<p>+\$ 9</p> <p>+\$ 24</p>	<p>Specify with <i>acrylic backer</i>.</p> <p>Specify with <i>acrylic backer</i>.</p>

Related Products	<ul style="list-style-type: none"> • Tables • Stools 	<p>► See <i>GSA Volume 5b Specification Guide</i>.</p> <p>► Pages 154</p>
-------------------------	--	---

Montara650 Chairs

DESIGN LIEVORE ALTHERR MOLINA

Specification Information



4-leg, armless
Overall: 20½"W x 20½"D x 31"H
Seat: 17½"H



4-leg with loop arms
Overall: 24"W x 20½"D x 31"H
Seat: 17½"H
Arms: 25¼"H



Sled base, armless
Overall: 20½"W x 20½"D x 31"H
Seat: 17½"H



Sled base with cantilever arms
Overall: 22"W x 20½"D x 31"H
Seat: 17½"H
Arms: 25"H

Style
Number

Base Price

Wood Shell Chair

COSFZCH	Seat	\$785
---------	------	-------

Style
Number

Base Prices

Fabric Groups:
COM 1 2 3 4 5 6 7 8 9 10

Leather Groups:
COL 1 2

Wood Shell Chair with Upholstered Seat

COSFZCH	Seat	\$ 954	\$ 954	\$ 961	\$1011	\$1055	\$1120	\$1201	\$1294	\$1393	\$1480	\$1544	\$1309	\$1136	\$1185
---------	------	--------	--------	--------	--------	--------	--------	--------	--------	--------	--------	--------	--------	--------	--------

Wood Shell Chair with ¾ Upholstery

COSFZCH	Seat	\$1105	\$1105	\$ 1112	\$1162	\$1206	\$1271	\$1352	\$1445	\$1544	\$1631	\$1695	\$1460	\$1287	\$1336
	Back	+\$ 16	+\$ 16	+\$ 27	+\$ 49	+\$ 75	+\$114	+\$163	+\$219	+\$278	+\$331	+\$387	+\$121	+\$202	+\$251

Fully Upholstered Chair

COSFZCH	Seat	\$ 993	\$ 993	\$1000	\$1050	\$1094	\$1159	\$1240	\$1333	\$1432	\$1519	\$1583	\$1348	\$1175	\$1224
	Back	+\$ 24	+\$ 24	+\$ 42	+\$ 76	+\$115	+\$175	+\$250	+\$336	+\$427	+\$508	+\$594	+\$121	+\$449	+\$550

Guest/ Side/Stack Seating

Montara650 Lounge Chair

DESIGN LIEVORE ALTHERR MOLINA



Tip: Leathers will appear loose with comfort wrinkles when upholstered.

Tip: For Customer's Own Material or Leather, see necessary requirements, important processing instructions, and ordering information.

► See *Coalesse Surface Materials Reference Guide* and online fabric database at <http://fabric.coalesse.com>.

Standard Includes		Required to Specify
<p>► Need help? Product details, see <i>Coalesse Seating and Outdoor Specification Guide</i></p> <ul style="list-style-type: none"> • Seat and back upholstery, if selected • Shell: wood shell with ³/₄ upholstery or wood shell with upholstered seat, if selected: wood veneer group 1 • Sled base: group 1 paint • Glides 	<ol style="list-style-type: none"> 1 Style number 2 Upholstery version (see below under Required Selections) 3 Contrasting fabric on ³/₄ upholstered or fully upholstered, if selected (see below under Required Selections) 4 Fabric and/or leather color number for seat and/or back, if selected 5 Wood finish on shell, if selected 6 Paint color number for base 7 Options, if selected (see below) <p>► See <i>Coalesse Surface Materials Reference Guide</i>.</p>	

	Required Selections	Price	Required to Specify
Upholstery Version	<ul style="list-style-type: none"> • Wood shell with ³/₄ upholstery • Wood shell with upholstered seat • Fully upholstered 	<p>Prices at right</p> <p>Prices at right</p> <p>Prices at right</p>	<p>Specify with ³/₄ upholstered.</p> <p>Specify with upholstered seat and wood back.</p> <p>Specify with upholstered seat and back.</p>
Contrasting Fabric on Fully Upholstered	<ul style="list-style-type: none"> • Non contrasting fabric • Contrasting fabric 	<p>No cost</p> <p>+\$182</p>	<p>Specify with non contrasting fabric.</p> <p>Specify with contrasting fabric.</p>

	Options	Price	Required to Specify
Surface Materials	Base		
	<ul style="list-style-type: none"> • Group 3 paint • Polished trivalent chrome 	<p>+\$108</p> <p>+\$112</p>	<p>Specify paint color number.</p> <p>Specify with polished trivalent chrome.</p>
	Shell		
	<ul style="list-style-type: none"> • Group 1 wood veneer • Group 2 wood veneer 	<p>No cost</p> <p>+\$ 97</p>	<p>Specify with VP01 Oak Light, VP03 Black Oak, or VP05 White Oak.</p> <p>Specify with VP02 Smoked Oak or VP04 Grey Oak.</p>
	Acrylic backer		
	<ul style="list-style-type: none"> • Seat • Seat and back 	<p>+\$ 9</p> <p>+\$ 24</p>	<p>Specify with acrylic backer.</p> <p>Specify with acrylic backer.</p>

Related Products	
<ul style="list-style-type: none"> • Guest seating • Stools • Café tables • Occasional tables 	<p>► See <i>Coalesse Seating and Outdoor Specification Guide</i>.</p> <p>► See <i>Coalesse Seating and Outdoor Specification Guide</i>.</p> <p>► See <i>Coalesse Tables, Storage, and Accessories Specification Guide</i>.</p> <p>► See <i>Coalesse Tables, Storage, and Accessories Specification Guide</i>.</p>

Montara650 Lounge Chair

DESIGN LIEVORE ALTHERR MOLINA



Overall: 25½"D x 29"W x 21¼"H
Seat: 16"

Overall: 25½"D x 29"W x 21¼"H
Seat: 16"

Overall: 25½"D x 29"W x 21¼"H
Seat: 16"

Specification Information

Style Number	Base Prices													
	Fabric Groups:										Leather Groups:			
	COM	1	2	3	4	5	6	7	8	9	10	COL	1	2

Wood Shell Lounge Chair with Upholstered Seat

COSFZLC	Seat	\$1371	\$1371	\$1375	\$1401	\$1432	\$1479	\$1537	\$1603	\$1673	\$1736	\$1802	\$1710	\$1563	\$1620
---------	------	--------	--------	--------	--------	--------	--------	--------	--------	--------	--------	--------	--------	--------	--------

COM/yds = 1, COL/sq ft = 9

Wood Shell Lounge Chair with ¾ Upholstered Back

COSFZLC	Seat	\$1516	\$1516	\$1520	\$1546	\$1577	\$1624	\$1682	\$1748	\$1818	\$1881	\$1947	\$1855	\$1708	\$1765
---------	------	--------	--------	--------	--------	--------	--------	--------	--------	--------	--------	--------	--------	--------	--------

Back	+\$ 16	+\$ 16	+\$ 28	+\$ 51	+\$ 78	+\$119	+\$170	+\$228	+\$290	+\$344	+\$402	+\$117	+\$506	+\$618
------	--------	--------	--------	--------	--------	--------	--------	--------	--------	--------	--------	--------	--------	--------

COM/yds = 1, COL/sq ft = 17

Fully Upholstered Lounge Chair

COSFZLC	Seat	\$1408	\$1408	\$1412	\$1438	\$1469	\$1516	\$1574	\$1640	\$1710	\$1773	\$1839	\$1747	\$1600	\$1657
---------	------	--------	--------	--------	--------	--------	--------	--------	--------	--------	--------	--------	--------	--------	--------

Back	+\$ 30	+\$ 30	+\$ 57	+\$104	+\$160	+\$245	+\$350	+\$470	+\$597	+\$710	+\$830	+\$117	+\$604	+\$745
------	--------	--------	--------	--------	--------	--------	--------	--------	--------	--------	--------	--------	--------	--------

COM/yds = 2½, COL/sq ft = 32

Guest/ Side/Stack Seating

Montara650 Stools

DESIGN LIEVORE ALTHERR MOLINA

Tip: Leathers will appear loose with comfort wrinkles when upholstered.

Tip: For Customer's Own Material or Leather, see necessary requirements, important processing instructions, and ordering information.

► Page 180



Stool at bar height
Overall: 18¾"W x 19½"D x 39½"H
Seat: 30"H

Standard Includes	Required to Specify
-------------------	---------------------

<p>► Need help? Product details, see <i>Coalesse Seating and Outdoor Specification Guide</i></p>	<ul style="list-style-type: none"> • Seat and back upholstery, if selected • Shell: wood shell or wood shell with upholstered seat, if selected: wood veneer group 1 • Sled base: group 1 paint • Glides 	<ol style="list-style-type: none"> 1 Style number 2 Application (see below under Required Selections) 3 Upholstery version (see below under Required Selections) 4 Contrasting fabric on fully upholstered, if selected (see below under Required Selections) 5 Fabric and/or leather color number for seat and/or back, if selected 6 Wood finish on shell, if selected 7 Paint color number for base 8 Options, if selected (see below) <p>► See <i>Surface Materials</i>, page 178.</p>
--	--	--

Required Selections	Price	Required to Specify
---------------------	-------	---------------------

<p>Application</p> <ul style="list-style-type: none"> • Counter height • Bar height 	<p>No cost +\$ 75</p>	<p>Specify with <i>counter height</i>. Specify with <i>bar height</i>.</p>
<p>Upholstery Version</p> <ul style="list-style-type: none"> • Wood shell • Wood shell with upholstered seat • Fully upholstered 	<p>Price below Prices at right Prices at right</p>	<p>Specify with <i>wood seat and back</i>. Specify with <i>upholstered seat and wood back</i>. Specify with <i>upholstered seat and back</i>.</p>
<p>Contrasting Fabric on Fully Upholstered</p> <ul style="list-style-type: none"> • Non contrasting fabric • Contrasting fabric 	<p>No cost +\$182</p>	<p>Specify with <i>non contrasting fabric</i>. Specify with <i>contrasting fabric</i>.</p>

Options	Price	Required to Specify
---------	-------	---------------------

<p>Surface Materials</p> <p>Base</p> <ul style="list-style-type: none"> • Group 3 paint • Polished trivalent chrome <p>Shell</p> <ul style="list-style-type: none"> • Group 1 wood veneer • Group 2 wood veneer <p>Acrylic backer</p> <ul style="list-style-type: none"> • Seat • Seat and back 	<p>+\$108 +\$112</p> <p>No cost +\$ 97</p> <p>+\$ 9 +\$ 24</p>	<p>Specify paint color number. Specify with <i>polished trivalent chrome</i>.</p> <p>Specify with <i>VP01 Oak Light, VP03 Black Oak, or VP05 White Oak</i>. Specify with <i>VP02 Smoked Oak or VP04 Grey Oak</i>.</p> <p>Specify with <i>acrylic backer</i>. Specify with <i>acrylic backer</i>.</p>
<p>Related Products</p> <ul style="list-style-type: none"> • Tables • Chairs • Café tables • Occasional tables 		<p>► See <i>GSA Volume 5b Specification Guide</i>. ► Page 150 ► See <i>GSA Volume 5b Specification Guide</i>. ► See <i>GSA Volume 5b Specification Guide</i>.</p>

Specification Information

Style Number	Base Price
--------------	------------

Wood Shell Stool

COSFZST	\$1124
---------	--------

► Specification Information, continued on next page



Overall: 18½"W x 19½"D x 35½"H
Seat: 26"H

Montara650 Stools

DESIGN LIEVORE ALTHERR MOLINA

► Specification Information, continued from previous page

Specification Information

Style Number	Base Prices										Leather Groups:			
	Fabric Groups:										COL	1	2	
	COM	1	2	3	4	5	6	7	8	9	10			



Overall: 18½"W x 19½"D x 35½"H
Seat: 26"H

Wood Shell Stool with Upholstered Seat

COSFZST	Seat	\$1293	\$1293	\$1298	\$1319	\$1343	\$1380	\$1425	\$1478	\$1533	\$1582	\$1634	\$1648	\$1527	\$1587
COM/yds = ¾, COL/sq ft = 7															

Fully Upholstered Stool

COSFZST	Seat	\$1332	\$1332	\$1337	\$1358	\$1382	\$1419	\$1464	\$1517	\$1572	\$1621	\$1673	\$1687	\$1566	\$1626
	Back	+\$ 20	+\$ 20	+\$ 29	+\$ 52	+\$ 80	+\$122	+\$174	+\$234	+\$297	+\$353	+\$412	+\$436	+\$449	+\$550
COM/yds = 1¼, COL/sq ft = 18															

Guest/Side/Stack Seating

Montara650 Rocker

DESIGN LIEVORE ALTHERR MOLINA



Tip: Leathers will appear loose with comfort wrinkles when upholstered.

Tip: For Customer's Own Material or Leather, see necessary requirements, important processing instructions, and ordering information. See page 178.



With arms

Overall: 29"D x 28½"W x 30"H
 Seat: 16"
 Arm: 23½"

Standard Includes		Required to Specify
<ul style="list-style-type: none"> ▶ Need help? Product details, see <i>Coalesse Seating and Outdoor Specification Guide</i> 	<ul style="list-style-type: none"> • Seat and back upholstery, if selected • Shell: wood shell with ¾ upholstery or wood shell with upholstered seat, if selected: wood veneer group 1 • Base: group 1 paint • Runners: solid oak in clear finish 	<ol style="list-style-type: none"> 1 Style number 2 Upholstery version (see below under Required Selections) 3 Contrasting fabric on ¾ upholstered or fully upholstered, if selected (see below under Required Selections) 4 Fabric and/or leather color number for seat and/or back, if selected 5 Wood finish on shell, if selected 6 Paint color number for base 7 Options, if selected (see below) <p>▶ See <i>Surface Materials</i>, page 178.</p>

	Required Selections	Price	Required to Specify
Upholstery Version	<ul style="list-style-type: none"> • Wood shell with ¾ upholstery • Wood shell with upholstered seat • Fully upholstered 	Prices at right Prices at right Prices at right	Specify with ¾ upholstered. Specify with upholstered seat and wood back. Specify with upholstered seat and back.
Contrasting Fabric on ¾ and Fully Upholstered	<ul style="list-style-type: none"> • Non contrasting fabric • Contrasting fabric 	No cost +\$182	Specify with non contrasting fabric. Specify with contrasting fabric.
Arm Type	<ul style="list-style-type: none"> • Armless • With arms 	No cost +\$145	Specify with no arms. Specify with arms.

	Options	Price	Required to Specify
Surface Materials	Base, armless		
	<ul style="list-style-type: none"> • Group 3 paint • Polished trivalent chrome 	+\$108 +\$112	Specify paint color number. Specify with polished trivalent chrome.
	Base, with arms		
	<ul style="list-style-type: none"> • Group 3 paint • Polished trivalent chrome 	+\$108 +\$248	Specify paint color number. Specify with polished trivalent chrome.
	Wood shell		
	<ul style="list-style-type: none"> • Group 1 wood veneer • Group 2 wood veneer 	No cost +\$ 97	Specify with VP01 Oak Light, VP03 Black Oak, or VP05 White Oak. Specify with VP02 Smoked Oak or VP04 Grey Oak.
	Acrylic backer		
	<ul style="list-style-type: none"> • Seat • Seat and back 	+\$ 9 +\$ 24	Specify with acrylic backer. Specify with acrylic backer.
Related Products	<ul style="list-style-type: none"> • Guest seating • Stools • Café tables • Occasional tables 		▶ Page 150 ▶ Page 154 ▶ See <i>GSA Volume 5b Specification Guide</i> . ▶ See <i>GSA Volume 5b Specification Guide</i> .

Montara650 Rocker

DESIGN LIEVORE ALTHERR MOLINA



Overall: 29"D x 28 1/2"W x 30"H
Seat: 16"

Overall: 29"D x 28 1/2"W x 30"H
Seat: 16"

Overall: 29"D x 28 1/2"W x 30"H
Seat: 16"

Specification Information

Style Number	Base Prices										Leather Groups:		
	Fabric Groups:										COL		
	COM	1	2	3	4	5	6	7	8	9	10	1	2

Wood Shell Rocker with Upholstered Seat

COSFZRC	Seat	\$2079	\$2079	\$2083	\$2109	\$2140	\$2187	\$2245	\$2311	\$2381	\$2444	\$2510	\$2418	\$2271	\$2328
COM/yds = 1, COL/sq ft = 9															

Wood Shell Rocker with 3/4 Upholstered Back

COSFZRC	Seat	\$2224	\$2224	\$2228	\$2254	\$2285	\$2332	\$2390	\$2456	\$2526	\$2589	\$2655	\$2563	\$2416	\$2473
	Back	+\$ 16	+\$ 16	+\$ 28	+\$ 51	+\$ 78	+\$119	+\$170	+\$228	+\$290	+\$344	+\$402	+\$117	+\$506	+\$618
COM/yds = 1, COL/sq ft = 17															

Fully Upholstered Rocker

COSFZRC	Seat	\$2116	\$2116	\$2120	\$2146	\$2177	\$2224	\$2282	\$2348	\$2418	\$2481	\$2547	\$2455	\$2308	\$2365
	Back	+\$ 30	+\$ 30	+\$ 57	+\$104	+\$160	+\$245	+\$350	+\$470	+\$597	+\$710	+\$830	+\$117	+\$604	+\$745
COM/yds = 2 1/2, COL/sq ft = 32															

Wrapp Chairs by Viccarbe

DESIGN MARK KRUSIN

Tip: Fabrics and leathers will appear loose with comfort wrinkles when upholstered.

Tip: Stacking is not recommended as the frame will dent the foam on the seat on which it is being stacked.

Tip: For Customer's Own Material or Leather, see necessary requirements, important processing instructions, and ordering information
 ▶ See *Coalesse Surface Materials Reference Guide*.

Standard Includes		Required to Specify
▶ Need help? Product details, see <i>Coalesse Seating and Outdoor Specification Guide</i>	<ul style="list-style-type: none"> Upholstery for chair: fabric or leather Frame: polished trivalent chrome 	1 Style number 2 Number of fabrics if contrasting fabric style number is selected 3 Fabric or leather color number for upholstery 4 Options, if selected (see below) ▶ See <i>Coalesse Surface Materials Reference Guide</i> .

Options	Price	Required to Specify
Surface Materials	<ul style="list-style-type: none"> Contrasting fabric 	+ \$182 per fabric
	<ul style="list-style-type: none"> Acrylic backer Backer 	+ \$ 20
		Add suffix K to the style number and select fabric color number. Specify with <i>acrylic backer</i> . ▶ See <i>Coalesse Surface Materials Reference Guide</i> .

Specification Information													
Style Number	Base Prices										Leather Groups:		
	Fabric Groups:										COL		
	COM	1	2	3	4	5	6	7	8	9	10	1	2

Four-Leg Chair

COWRP4LEG

	\$1857	\$1857	\$1907	\$1948	\$1997	\$2071	\$2163	\$2268	\$2379	\$2477	\$2582	\$2276	\$3044	\$3206
COM/yds = 1½, COL/sq ft = 33														



Overall: 21"D 25¼"W 29½"H
 Inside: 16"D 19½"W 17½"H
 Seat: 17½"H

Sled-Base Chair

COWRPSLD

	\$1922	\$1922	\$1972	\$2013	\$2062	\$2136	\$2228	\$2333	\$2444	\$2542	\$2647	\$2341	\$3109	\$3271
COM/yds = 1½, COL/sq ft = 33														

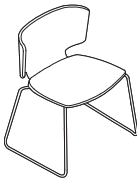

Overall: 20¼"D 24½"W 28¾"H
 Inside: 16"D 19½"W 17½"H
 Seat: 17½"H

Collaboration Seating



Bindu Conference Seating	160
Chord Conference Seating	162
SW_1 Conference Seating	164

Bindu Conference Seating

DESIGN BRIAN KANE

Tip: Fabrics and leathers will appear loose with comfort wrinkles when upholstered.

Tip: For Customer's Own Material or Leather, see necessary requirements, important processing instructions, and ordering information.
▶Page 180

Tip: Craft in upholstery cautions the use of stripes and patterns on Bindu. Please use fabric database when specifying.

Tip: For fabric with a large pattern and a specific pattern location is desired, contact Customer Service.

Standard Includes

- ▶Need help? Product details, see *Coalesse Seating and Outdoor Specification Guide*
- Bent plywood frame
- Chair: fabric
- Molded polypropylene foam
- Base: 6205 Black Resin
- Dual wheel hard casters, conference
- Back tilt lock

Required to Specify

- 1 Style number
- 2 Fabric or leather color number for upholstery
- 3 Options, if selected (see below)
- ▶See *Surface Materials*, page 178.

Options Price Required to Specify

Options	Price	Required to Specify
Surface Materials	<ul style="list-style-type: none"> • Acrylic backer +\$ 47 • Mid-back chair +\$ 49 • High-back chair 	Specify with acrylic backer. Specify with acrylic backer. ▶ See <i>Surface Materials</i> , page 178.
Base	<ul style="list-style-type: none"> • 8046 Polished Aluminum (available on CO300 & CO400) +\$229 	Specify with 8046 Polished Aluminum.
Casters	<ul style="list-style-type: none"> • Soft casters +\$ 36 	Specify with soft casters.

Specification Information

Style Number	Base Prices										Leather Groups:			
	Fabric Groups:										COL	1	2	
	COM	1	2	3	4	5	6	7	8	9	10			

Mid-Back Conference Chair

CO300	\$2189	\$2189	\$2293	\$2379	\$2482	\$2637	\$2830	\$3049	\$3283	\$3489	\$3708	\$2608	\$4232	\$4561
COM/yds = 3, COL/sq ft = 66														



Overall: 25"D 25"W 35½"-40¼"H
Inside: 18¾"D 18½"-19½"W 21"H
Seat: 16"-20½"H
Arm: 24¼"-29"H

High-Back Conference Chair

CO400	\$2555	\$2555	\$2668	\$2761	\$2873	\$3041	\$3250	\$3487	\$3741	\$3964	\$4201	\$2974	\$4740	\$5098
COM/yds = 3.25, COL/sq ft = 72														



Overall: 25"D 25"W 45½"-50¼"H
Inside: 18¾"D 18½"-19½"W 31"H
Seat: 16"-20½"H
Arm: 24¼"-29"H

Coalesse SIN 33721

Bindu Conference Seating

DESIGN BRIAN KANE

Chord Conference Seating

DESIGN MICHAEL SHIELDS

Tip: Fabrics and leathers will appear loose with comfort wrinkles when upholstered.

Tip: For Customer's Own Material or Leather, see necessary requirements, important processing instructions, and ordering information.
▶Page 180

Tip: Arm is cast from 100% recycled material then hand buffed to a mirror finish. Arm caps are molded in black.

Tip: List price based on highest fabric group usage.

Tip: Contrasting option available only on 798-P and 796-P.

Standard Includes		Required to Specify
▶Need help? Product details, see <i>Coalesse Seating and Outdoor Specification Guide</i>	<ul style="list-style-type: none"> • Frame: hardwood plywood assembled into unibody structures utilizing interlocking finger joinery • Cushioning: <ul style="list-style-type: none"> - back: multiple laminations of high-density polyurethane foam over an elastic sheet suspension system for lumbar support - seat: closed cell, contour molded urethane foam • Upholstery: <ul style="list-style-type: none"> - seams are double needle stitched with seam binding for extended durability - unique wrap around welt detail and is cut from the same fabric as specified on chair • Arms: resilient self-skinned urethane molded around carbon steel armature, black or aluminum arm with urethane cap, if selected • Chair controls: tilt-swivel with tilt tension, pneumatic height adjustment, and tilt lockout • Bases: five star black resin • Casters: black hooded dual wheel 	<ol style="list-style-type: none"> 1 Style number 2 Number of fabrics if contrasting fabric style number is selected 3 Fabric or leather color number for upholstery on seat and back 4 Options, if selected (see below) ▶See <i>Surface Materials</i> , page 178.

Options	Price	Required to Specify
Surface Materials		
Welt detail		
• Contrasting fabric welt	+\$ 96	Specify with <i>contrasting fabric welt</i> and select fabric color number.
• Contrasting leather welt	+\$139	Specify with <i>contrasting leather welt</i> and select fabric color number.
Contrasting fabric		
• Contrasting fabric	+\$182 per fabric	Add suffix K to the style number and select fabric color number.
Acrylic backer		
• Conference, midback, and high back large chairs	+\$ 28	Specify with <i>acrylic backer</i> .
• High back large chair	+\$ 34	Specify with <i>acrylic backer</i> .
• Midback with pillow chairs	+\$ 47	Specify with <i>acrylic backer</i> .
• High back with pillow chairs	+\$ 49	▶See <i>Surface Materials</i> , page 178.
Base		
• Polished aluminum with black, hooded dual wheel casters	+\$ 98	Specify with <i>polished aluminum base</i> .
Casters		
• Soft wheel casters	+\$ 71	Specify with <i>soft casters</i> .
Control		
• Knee-tilt with pneumatic height adjustment and tilt lockout	+\$243	Specify with <i>knee-tilt</i> .

Specification Information

Style Number	Base Prices										Leather Groups:		
	Fabric Groups:										COL		
	COM	1	2	3	4	5	6	7	8	9	10	1	2

Conference Narrow/Narrow with Urethane Arms														
795	\$1712	\$1712	\$1778	\$1833	\$1899	\$1997	\$2120	\$2259	\$2408	\$2539	\$2678	\$2176	\$3130	\$3333
COM/yds = 2, COL/sq ft = 36														

Conference Narrow/Narrow with Aluminum Arms														
795AU	\$2291	\$2291	\$2357	\$2412	\$2478	\$2576	\$2699	\$2838	\$2987	\$3118	\$3257	\$2755	\$3709	\$3912

▶Specification Information, continued on next page



Overall: 26½"D 26½"W 36"-39"H
 Inside: 18"D 20"W 18½"H
 Seat: 18½"-21½"H
 Arm: 25¾"-28¾"H

Chord Conference Seating

DESIGN MICHAEL SHIELDS

► Specification Information, continued from previous page

Specification Information

Style Number	Base Prices										Leather Groups:			
	Fabric Groups:										COL	1	2	
	COM	1	2	3	4	5	6	7	8	9	10			



Overall: 26½"D 26½"W 37½"-40½"H
 Inside: 19"D 21½"W 21½"H
 Seat: 21½"H
 Arm: 25¾"-28¾"H

Mid Back with Urethane Arms

796	\$1910	\$1910	\$1976	\$2031	\$2097	\$2195	\$2318	\$2457	\$2606	\$2737	\$2876	\$2374	\$3335	\$3529
-----	--------	--------	--------	--------	--------	--------	--------	--------	--------	--------	--------	--------	--------	--------

COM/yds = 2, COL/sq ft = 36

Mid Back with Aluminum Arms

796AU	\$2489	\$2489	\$2555	\$2610	\$2676	\$2774	\$2897	\$3036	\$3185	\$3316	\$3455	\$2953	\$3914	\$4108
-------	--------	--------	--------	--------	--------	--------	--------	--------	--------	--------	--------	--------	--------	--------



Overall: 26½"D 26½"W 37½"-40½"H
 Inside: 18½"D 21½"W 19"H
 Seat: 19"-22"H
 Arm: 25¾"-28¾"H

Mid Back/Pillow Upholstery with Urethane Arms

796-P	\$2364	\$2364	\$2463	\$2546	\$2645	\$2792	\$2976	\$3185	\$3408	\$3605	\$3813	\$2828	\$4308	\$4608
-------	--------	--------	--------	--------	--------	--------	--------	--------	--------	--------	--------	--------	--------	--------

COM/yds = 3, COL/sq ft = 54

Mid Back/Pillow Upholstery with Aluminum Arms

796-PAU	\$2943	\$2943	\$3095	\$3132	\$3165	\$3243	\$3296	\$3478	\$3590	\$3744	\$4005	\$3407	\$4887	\$5187
---------	--------	--------	--------	--------	--------	--------	--------	--------	--------	--------	--------	--------	--------	--------

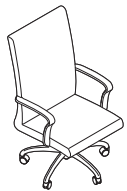

Overall: 26½"D 26½"W 46"-49"H
 Inside: 18"D 20"W 18½"H
 Seat: 18½"-21½"H
 Arm: 25¾"-28¾"H

High Back Narrow/Narrow with Urethane Arms

797	\$2377	\$2377	\$2443	\$2498	\$2564	\$2662	\$2785	\$2924	\$3073	\$3204	\$3343	\$2841	\$3560	\$3762
-----	--------	--------	--------	--------	--------	--------	--------	--------	--------	--------	--------	--------	--------	--------

COM/yds = 2, COL/sq ft = 36

High Back Narrow/Narrow with Aluminum Arms

797AU	\$2956	\$2956	\$3241	\$3022	\$3077	\$3143	\$3364	\$3503	\$3652	\$3783	\$3922	\$3420	\$4139	\$4341
-------	--------	--------	--------	--------	--------	--------	--------	--------	--------	--------	--------	--------	--------	--------

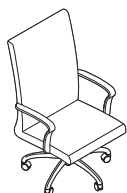

Overall: 26½"D 26½"W 46"-49"H
 Inside: 19"D 21½"W 18½"H
 Seat: 18½"-21½"H
 Arm: 25¾"-28¾"H

High Back/Large Scale with Urethane Arms

798	\$2396	\$2396	\$2471	\$2533	\$2607	\$2717	\$2855	\$3012	\$3179	\$3327	\$3483	\$2871	\$3572	\$3773
-----	--------	--------	--------	--------	--------	--------	--------	--------	--------	--------	--------	--------	--------	--------

COM/yds = 2, COL/sq ft = 44

High Back/Large Scale with Aluminum Arms

798AU	\$2975	\$2975	\$3050	\$3112	\$3186	\$3296	\$3434	\$3591	\$3758	\$3906	\$4062	\$3450	\$4151	\$4352
-------	--------	--------	--------	--------	--------	--------	--------	--------	--------	--------	--------	--------	--------	--------

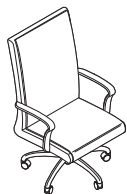

Overall: 26½"D 26½"W 46"-49"H
 Inside: 19"D 21½"W 19"H
 Seat: 19"-22"H
 Arm: 26¾"H-28¾"H

High Back/Large Scale with Pillow Upholstery with Urethane Arms

798-P	\$2561	\$2561	\$2660	\$2743	\$2842	\$2989	\$3173	\$3382	\$3605	\$3802	\$4010	\$3025	\$4506	\$4805
-------	--------	--------	--------	--------	--------	--------	--------	--------	--------	--------	--------	--------	--------	--------

COM/yds = 3, COL/sq ft = 66

High Back/Large Scale with Pillow Upholstery with Aluminum Arms

798-PAU	\$3140	\$3140	\$3239	\$3322	\$3421	\$3568	\$3752	\$3961	\$4184	\$4381	\$4589	\$3604	\$5085	\$5384
---------	--------	--------	--------	--------	--------	--------	--------	--------	--------	--------	--------	--------	--------	--------

SW_1 Conference Seating

DESIGN SCOTT WILSON & MINIMAL

Tip: For Customer's Own Material or Leather, see necessary requirements, important processing instructions, and ordering information.
 ▶ Page 180

Standard Includes		Required to Specify
▶ Need help? Product details, see <i>Coalesse Seating and Outdoor Specification Guide</i>	<ul style="list-style-type: none"> • Seat: fabric or leather • Back: knit • Base: 8040 Aluminum Matte Polished • Frame: steel tube • Glides on conference chair with 4-star base, if selected: aluminum with non marring plastic insert • Casters on conference chair with 5-star base, if selected: dual wheel hard casters, black only • Swivel return mechanism on conference chair with 4-star base, if selected • Swivel mechanism on conference chair with 5-star base, if selected 	1 Style number 2 Upholstery color number for seat 3 Knit color number for back 4 Options, if selected (see below) ▶ See <i>Surface Materials</i> , page 178

Options	Price	Required to Specify	
Surface Materials	<ul style="list-style-type: none"> • Contrasting fabric 	+\$182	Specify with <i>contrasting fabric</i> and select fabric color number.
	Acrylic backer <ul style="list-style-type: none"> • Backer 	+\$ 48	Specify with <i>acrylic backer</i> . ▶ See <i>Surface Materials</i> , page 178
Mechanism	<ul style="list-style-type: none"> • Full swivel (omit swivel-return feature) 	No cost	Specify with <i>swivel-only mechanism</i> .
Casters	<ul style="list-style-type: none"> • Black soft casters • Hard black casters with polished aluminum body • Soft black casters with polished aluminum body 	+\$ 39 +\$105 +\$144	Specify with <i>soft casters</i> . Specify with <i>hard polished aluminum casters</i> . Specify with <i>soft polished aluminum casters</i> .
Related Products	<ul style="list-style-type: none"> • Collaborative and conference tables • Occasional tables • Lounge seating 		▶ See <i>GSA Volume 5b Specification Guide</i> . ▶ See <i>GSA Volume 5b Specification Guide</i> . ▶ Page 120

Specification Information

Style Number	Base Prices										Leather Groups:		
	Fabric Groups:										COL		
	COM	1	2	3	4	5	6	7	8	9	10	1	2

Conference Chair with 4-Star Base

COW413	Seat	\$3085	\$3085	\$3116	\$3142	\$3173	\$3219	\$3276	\$3342	\$3411	\$3473	\$3538	\$3212	\$3508	\$3556
	Upper back	No cost	No cost	+\$ 47	+\$ 86	+\$ 88	+\$134	+\$191	+\$257	+\$326	+\$388	+\$453	+\$294	+\$982	+\$1103

COM/yds = 3, COL/sq ft = 60

Conference Chair with 5-Star Base

COW415	Seat	\$3085	\$3085	\$3116	\$3142	\$3173	\$3219	\$3276	\$3342	\$3411	\$3473	\$3538	\$3212	\$3508	\$3556
	Upper back	No cost	No cost	+\$ 47	+\$ 86	+\$ 88	+\$134	+\$191	+\$257	+\$326	+\$388	+\$453	+\$294	+\$982	+\$1103



Overall: 25¼"D 28"W 31½"H
 Seat: 18"H
 Arm: 25¼"H



Overall: 25¼"D 28"W 29½"H-33"H
 Seat: 16¼"H-19¾"H
 Arm: 23½"H-27"H

SW_1 Conference Seating Multi-Fabric Diagram

DESIGN SCOTT WILSON & MINIMAL

TO: _____

FROM: _____

DATE: _____

FAX....888.413.5161

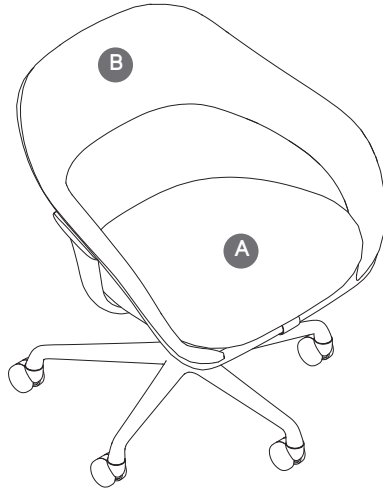

A Seat: _____

B Arms/Back: _____

Contrasting fabric charges will apply. List price based on highest group textile specified.

Contrasting upcharge for each contrasting textile pricing based on highest group textile specified. See specifying for contrasting upcharge.

Specify Model below:

COW413 Conference Chair with 4-Star Base

COW415 Conference Chair with 5-Star Base

Occasional Tables



Await	168
Enea Lottus	169
Sebastopol Occasional Tables	174
Trees	175

Await Occasional Tables

DESIGN E00S

Standard Includes		Required to Specify
<ul style="list-style-type: none"> ▶ Need help? Product details, see <i>Coalesse Tables, Storage, and Accessories Specification Guide</i> 	<ul style="list-style-type: none"> • Freestanding table frame: 4142 Platinum Gloss • Top: High-Pressure Laminate top with matching 3 mm edge band • Glass top: <ul style="list-style-type: none"> - 1/2" thick - Radiused edges 	<ol style="list-style-type: none"> 1 Style number 2 Laminate top and tablets, if selected: <ul style="list-style-type: none"> 2730 Arctic White 2746 Black 290N North Sea 3 Glass color number for top, if selected <p>▶ See <i>Coalesse Surface Materials Reference Guide</i>.</p>

Related Products	
<ul style="list-style-type: none"> • Lounge seating • Connector benches 	<ul style="list-style-type: none"> ▶ Page 38 ▶ Page 34

Specification Information

Style Number	Prices				
	Top Surface:				
	Laminate	Absolute Clear Green Glass	Absolute Clear Glass	Acid Etched 6511	Absolute Colored Glass

Round, Low, Freestanding Table

46-T1	\$1635	\$1951	\$1987	\$1987	\$2247
-------	--------	--------	--------	--------	--------

Round, High, Freestanding Table

46-T2	\$2133	\$2449	\$2485	\$2485	\$2745
-------	--------	--------	--------	--------	--------

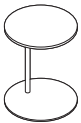

Overall: 15 3/4" Dia. 19"H

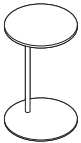

Overall: 15 3/4" Dia. 25"H

Enea Lottus Occasional Tables

DESIGN LIEVORE ALTHERR MOLINA

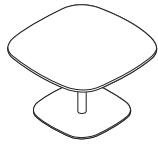

Standard Includes	Required to Specify
<ul style="list-style-type: none"> • Top: laminate or wood veneer with 1/2" thick phenolic core • Base and frame: steel tubing and base • Glides: non-skid 	<ol style="list-style-type: none"> 1 Style number 2 Laminate or wood veneer color number for top ▶ See Veneer Matrix, page 192. 3 Paint color number for base/frame 4 Options, if selected (see below) ▶ See <i>Surface Materials</i>, page 188.

Options	Price	Required to Specify
Surface Materials Base <ul style="list-style-type: none"> • Group 1 paint • Group 3 paint 	No cost +\$149	Specify paint color number. Specify paint color number.

Specification Information									
Dimensions			Style Number	Base Prices					
D	W	H		Top Surface:		Composite Veneer 1	Composite Veneer 2	Wood 1	Wood 2
			Laminate	Group 2 and 3 Laminate					
30"	30"	18"	COEL1830	\$1951	\$2183	\$2129	\$2296	\$2200	\$2383
36"	36"	18"	COEL1836	\$2268	\$2542	\$2480	\$2688	\$2562	\$2791
42"	42"	18"	COEL1842	\$2761	\$3016	\$2943	\$3179	\$3035	\$3295

Enea Lottus Conference Tables

DESIGN LIEVORE ALTHERR MOLINA



Standard Includes	Required to Specify
<ul style="list-style-type: none"> • Top: laminate or wood veneer with 1/2" thick phenolic core • Base and frame: steel tubing and base • Glides: non-skid 	<ol style="list-style-type: none"> 1 Style number 2 Laminate or wood veneer color number for top ▶ See Veneer Matrix, page 192. 3 Paint color number for base/frame 4 Options, if selected (see below) ▶ See <i>Surface Materials</i>, page 188.

Options	Price	Required to Specify
Surface Materials Base <ul style="list-style-type: none"> • Group 1 paint • Group 3 paint 	No cost +\$149	Specify paint color number. Specify paint color number.

Specification Information									
Dimensions			Style Number	Base Prices					
D	W	H		Top Surface:					
			Laminate		Group 2 and 3 Laminate	Composite Veneer 1	Composite Veneer 2	Wood 1	Wood 2
30"	30"	30"	COEL3030	\$2038	\$2270	\$2264	\$2436	\$2287	\$2476
36"	36"	30"	COEL3036	\$2350	\$2624	\$2617	\$2831	\$2644	\$2879
42"	42"	30"	COEL3042	\$2840	\$3101	\$3095	\$3334	\$3121	\$3383

Enea Lottus Café Counter Height Tables

DESIGN LIEVORE ALTHERR MOLINA

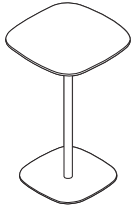

Standard Includes	Required to Specify
-------------------	---------------------

- Top: laminate or wood veneer with 1/2" thick phenolic core
- Base and frame: steel tubing and base
- Glides: non-skid

- 1 Style number
- 2 Laminate or wood veneer color number for top
▶ See Veneer Matrix, page 192.
- 3 Paint color number for base/frame
- 4 Options, if selected (see below)
▶ See *Surface Materials*, page 188.

Options	Price	Required to Specify
---------	-------	---------------------

Surface Materials

Base

- Group 1 paint
- Group 3 paint

No cost
+\$149

Specify paint color number.
Specify paint color number.

Specification Information									
---------------------------	--	--	--	--	--	--	--	--	--

Dimensions			Style Number	Base Prices					
D	W	H		Top Surface:					
				Laminate	Group 2 and 3 Laminate	Composite Veneer 1	Composite Veneer 2	Wood 1	Wood 2
24"	24"	36"	COEL3624	\$1689	\$1833	\$1829	\$1971	\$1843	\$1999
30"	30"	36"	COEL3630	\$2090	\$2327	\$2321	\$2498	\$2344	\$2539
36"	36"	36"	COEL3636	\$2410	\$2684	\$2677	\$2895	\$2704	\$2944
42"	42"	36"	COEL3642	\$2894	\$3155	\$3149	\$3392	\$3175	\$3442

Enea Lottus Café Bar Height Tables

DESIGN LIEVORE ALTHERR MOLINA

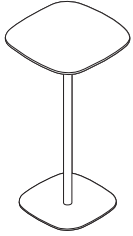

Standard Includes	Required to Specify
-------------------	---------------------

- Top: laminate or wood veneer with 1/2" thick phenolic core
- Base and frame: steel tubing and base
- Glides: non-skid

- 1 Style number
- 2 Laminate or wood veneer color number for top
▶ See Veneer Matrix, page 192.
- 3 Paint color number for base/frame
- 4 Options, if selected (see below)
▶ See *Surface Materials*, page 188.

Options	Price	Required to Specify
---------	-------	---------------------

Surface Materials	Base <ul style="list-style-type: none"> • Group 1 paint • Group 3 paint 	No cost +\$149	Specify paint color number. Specify paint color number.
--------------------------	--	-------------------	--

Specification Information									
---------------------------	--	--	--	--	--	--	--	--	--

Dimensions			Style Number	Base Prices					
D	W	H		Top Surface:					
			Laminate		Group 2 and 3 Laminate	Composite Veneer 1	Composite Veneer 2	Wood 1	Wood 2
24"	24"	42"	COEL4224	\$1735	\$1884	\$1880	\$2028	\$1895	\$2057
30"	30"	42"	COEL4230	\$2142	\$2374	\$2368	\$2547	\$2391	\$2588
36"	36"	42"	COEL4236	\$2454	\$2728	\$2721	\$2941	\$2748	\$2990
42"	42"	42"	COEL4242	\$3041	\$3302	\$3296	\$3550	\$3322	\$3601

Enea Lottus Rectangular Tables

DESIGN LIEVORE ALTHERR MOLINA

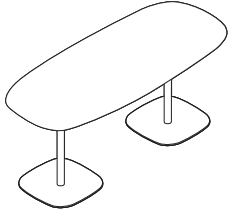

Standard Includes	Required to Specify
-------------------	---------------------

- Top: laminate or wood veneer with 1/2" thick phenolic core
- Base and frame: steel tubing and base
- Glides: non-skid

- 1 Style number
- 2 Laminate or wood veneer color number for top
▶ See Veneer Matrix, page 192.
- 3 Paint color number for base/frame
- 4 Options, if selected (see below)
▶ See *Surface Materials*, page 188.

Options	Price	Required to Specify
---------	-------	---------------------

Surface Materials

Base

- Group 1 paint
- Group 3 paint

No cost
+\$296

Specify paint color number.
Specify paint color number.

Specification Information									
---------------------------	--	--	--	--	--	--	--	--	--

Dimensions			Style Number	Base Prices					
D	W	H		Top Surface:					
			Laminate		Group 2 and 3 Laminate	Composite Veneer 1	Composite Veneer 2	Wood 1	Wood 2
30"	72"	30"	COEL303072	\$4585	\$5159	\$5145	\$5549	\$5201	\$5645
30"	72"	36"	COEL363072	\$4687	\$5261	\$5247	\$5656	\$5303	\$5753
30"	72"	42"	COEL423072	\$4788	\$5362	\$5348	\$5765	\$5404	\$5863

Sebastopol Occasional Tables

DESIGN EMILIA BORGTHORSDDOTTIR

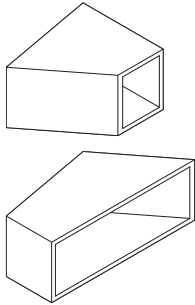

Tip: Optional grommet to accept PowerPod can be specified in milk white or black plastic.

Tip: If a grommet is specified with a PowerPod and the table is over a floor core, the floor core outlet cannot be flush to the floor, because the plug end will not allow the PowerPod to sit in the grommet. If the floor core is flush to the floor and the grommet and PowerPod are required, the table either cannot be set over the floor core, or a special plinth base will be required. Consult your specials representative for additional information on the plinth base.

Standard Includes		Required to Specify
<ul style="list-style-type: none"> ▶ Need help? Product details, see <i>Coalesse Seating and Outdoor Specification Guide</i> 	<ul style="list-style-type: none"> • Exterior surface: veneer group 1, oak, or walnut • Interior surface: glossy laminate • Glides: concealed adjustable glide with non-marking nylon pad 	<ol style="list-style-type: none"> 1 Style number 2 Exterior surface wood finish number 3 Interior surface glossy laminate: <ul style="list-style-type: none"> 2001 Smoky White 2002 Studio Gray 2003 Wrought Iron 2004 Black Pearl 2005 Liberty Red 4 Options, if selected (see below) <p>▶ See <i>Coalesse Surface Materials Reference Guide</i>.</p>

Options	Price	Required to Specify
Grommet <ul style="list-style-type: none"> • Grommet to accept PowerPod 	+ \$178	Specify <i>with grommet</i> and select finish color number either in milk white or black plastic.

Specification Information							
Dimensions			Style Number	Base Prices			
D	W	H		Top Surface:			
				Composite Veneer Group 1	Composite Veneer Group 2	Wood Group 1	Wood Group 2

16" High Tables

23"	27"	16"	COEB2723L	\$1964	\$2111	\$1964	\$2126
18"	41"	16"	COEB4118L	\$2324	\$2498	\$2324	\$2515

22" High Tables

23"	27"	22"	COEB2723H	\$2142	\$2304	\$2142	\$2320
18"	41"	22"	COEB4118H	\$2502	\$2691	\$2502	\$2710

Trees Occasional Tables

DESIGN NORMAN DIEKMAN

Tip: Tops come in the same wood and finish but with smooth surface.

Standard Includes		Required to Specify
<ul style="list-style-type: none"> ▶ Need help? Product details, see <i>Coalesse Tables, Storage, and Accessories Specification Guide</i> 	<ul style="list-style-type: none"> • Embossed wood is created under high pressure to add dimensionality and texture on all sides of the table <ul style="list-style-type: none"> - Interior frame is constructed from a combination of engineered lumber and hardwood veneers - Embossed hardwood veneer is applied to all vertical and slanted surfaces - Embossed wood in Natural EWNT 	1 Style number 2 Options, if selected (see below)

Options	Price	Required to Specify
Surface Materials <ul style="list-style-type: none"> • Bevel high embossed wood (Model 70-C-TPM) available in medium brown EWMB • Bevel medium embossed wood (Model 70-D-TPM) available in medium brown EWMB 	+\$108 +\$108	Specify with <i>medium brown</i> . Specify with <i>medium brown</i> .

Specification Information

Dimensions			Style	Base
D	W	H	Number	Price

Bevel High–Embossed Wood Table				
15½"	14"	23"	70-C-TPM	\$3781

Bevel Medium–Embossed Wood Table				
15½"	14"	19¾"	70-D-TPM	\$3684

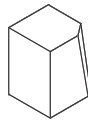
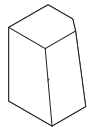

Surface Materials

► For more detailed Coalesse surface material information, see the *Coalesse Surface Materials Reference Guide* or consult your Steelcase dealer.

Surface Materials-Upholstery	178
Customer's Own Material	180
Upholstery Matrix	182
Surface Materials-Leather/Faux	184
Cut Yardage Net Price List	186
Leather and Faux Leather Matrix	187
Surface Materials-Wood	188
Solid Wood Matrix	190
Veneer Matrix	192
Surface Materials-Laminate	193
High-Pressure Laminate Matrix	194
Laminate Edge Band Matrix	198
Surface Materials-Glass	200
Glass Matrix	201
Surface Materials-Metal/Paint	202
Metal/Paint Matrix	204
Surface Materials-Miscellaneous	208
Ordering	210
Care and Maintenance	212

Surface Materials - Upholstery

Upholstery

All Coalesse textiles are priced by groups. Some Coalesse fabrics can be treated for flame retardancy, contact Customer Service. All Coalesse products are handcrafted making each unique. Certain fabrics and leathers will appear loose and may differ from like products due to comfort wrinkles when upholstered.

A contrasting welt is available on some products. Consult Customer Service for yardage or square feet requirements and prices. All stripes will be applied vertically unless customer specifies otherwise. Loose cushions on Coalesse products are not fully upholstered (not reversible).

Designtex, Maharam, Steelcase, and select Luna fabrics are graded in our pricing. Simply order Coalesse products with Designtex, Maharam, Steelcase, and select Luna specified. Designtex, Maharam, Steelcase, and select Luna fabrics are graded in on Coalesse products; however, Coalesse does not stock fabrics and can only respond based on Designtex, Maharam, Steelcase, and select Luna fabrics lead times. For current groups, refer to Coalesse website: www.Coalesse.com.

Special Fabric Applications

Backing

- Backing information is found on each product page. Select this option when ordering your product to have backing applied. Price varies by product according to yardage it requires.

Tip: Prices subject to change without notice and an additional 2 week lead time will apply for 54" wide fabrics. Wider fabrics will require 4 week additional lead time. Check fabric database to determine if backing is required at www.Coalesse.com.

Seating Upholstery

Coalesse fabrics are priced by groups from 1 through 10 and leathers 1 and 2. Fabrics and leathers may be purchased separately as cut yardage, see page 438. All products are handcrafted, making each unique. Certain fabrics and leathers will appear loose and may differ from like products due to wrinkles when upholstered. A contrasting welt is available on some products. Consult Customer Service for yardage or square feet requirements for pricing.

All stripes will be applied vertically unless customer specifies otherwise. Loose cushions on Coalesse products are not fully upholstered (not reversible).

Any Select Surface or COM textile should be reviewed with supplier to verify availability. In some cases a textile supplier may require minimums that exceed your furniture order requirements. In these situations, you will be contacted with an option to select a different textile or continue with your original textile selection as a COM-DTP. If you choose to continue with your textile selection as COM-DTP to allow you to order the minimum required, please ship only the textile needed to Coalesse for your furniture order.

SW_1 Knit

Applies to: SW_1 Collection

- 5KG0 Stone
- 5KG1 Grey
- 5KG2 Brown
- 5KG3 Black
- 5KG4 Ivory
- 5KG5 Coal
- 5KG6 Garnet
- 5KG7 Golden
- 5KG8 Royal

Lagunitas Knit

Applies to: Lagunitas focus nook and lounge system

Group 1

- 5K50 Stone
- 5K51 Grey
- 5K54 Black
- 5K58 Ivory
- 5K59 Coal

Group 2

- 5K52 Cement
- 5K53 Brown
- 5K55 Garnet
- 5K56 Golden
- 5K57 Royal
- 5K60 Glacier
- 5K61 Cadet
- 5K62 Grass
- 5K63 Forest
- 5K64 Amber
- 5K65 Terracotta
- 5K66 Crimson
- 5K67 Berry
- 5K68 Violet
- 5K69 Khaki

Hexa Upholstery

Applies to: Hosu Fabric Group 4

- CL50 Dark Grey
- CL51 Light Grey
- CL52 Blue
- CL55 Yellow
- CL70 Saffron
- CL71 Rose Quartz
- CL72 Lagoon
- CL73 Sea Salt
- CL74 Steam
- CL75 Ocean
- CL76 Sage

* Not available on Hosu

Surface Materials - Steelcase Upholstery

Steelcase Upholstery

Coalesse offers a select palette of Steelcase fabrics as standard. This provides the convenience of an integrated finish offering and ease of specification. See the Steelcase Standard Fabric Matrix for availability by product line. For a visual reference, please refer to the Steelcase Finish Library.

Group 1

Cogent: Connect

- 5S15 Coconut
- 5S16 Turmeric/Honey
- 5S17 Tangerine
- 5S18 Scarlet
- 5S19 Concord
- 5S21 Blue Jay
- 5S23 Wasabi
- 5S24 Nickel
- 5S25 Graphite
- 5S26 Licorice
- 5S27 Malt
- 5S28 Root Beer
- 5S93 Indigo/Blueprint
- 5S94 Lizard/Jungle
- 5S95 Sailor
- 5S96 Quicksilver
- 5S98 Canary
- 5S99 Lipstick/Merlot
- 5SD0 Royal Blue
- 5SD1 Aubergine
- 5SD2 Peacock
- 5SD3 Lagoon
- 5SD4 Saffron
- 5SD5 Citrine
- 5SD6 Rose Quartz
- 5SD7 Sea Salt
- 5SF3 Storm Cloud
- 5SF4 Olivine

Jacks

- 5B61 Taupe
- 5B62 Camel
- 5B64 Pewter
- 5B70 Midnight

Link

- 5A24 Blue
- 5A25 Navy
- 5A27 Black

Group 2

Dovetail by Designtex

- 5H39 Light Mocha
- 5H40 Pebble
- 5H41 Warm White
- 5H42 Sandstone
- 5H43 Honeycomb
- 5H44 Terra
- 5H45 Honeydew
- 5H46 Denim
- 5H47 Storm
- 5H48 Ice Blue
- 5H49 Aura
- 5H50 Darkest Grey

New Black

- 5J08 Jack
- 5J09 James
- 5J12 Harley

SoftNext

- 5H27 Obsidian
- 5H28 Foggy Night
- 5H29 Greystone
- 5H30 Mocha
- 5H31 Clay
- 5H32 Sandstone
- 5H33 Chalk
- 5H34 Midnight
- 5H35 Blue Mica
- 5H36 Jade
- 5H37 Burnt Umber
- 5H38 Cinnabar

Stand In

- 5621 Sleet
- 5622 Lunar
- 5623 Cyclone
- 5624 Eclipse
- 5625 Powder
- 5626 Chardonnay
- 5627 Graham
- 5628 Sediment
- 5629 Allspice
- 5630 Apple
- 5631 Lava
- 5632 Cayenne
- 5633 Plantain
- 5634 Parsley
- 5635 Scallion
- 5636 Atlantis
- 5691 Orca
- 5740 Burlap
- 5741 Porter
- 5742 Tusk
- 5743 Putty
- 5744 Blueberry
- 5745 Chartreuse
- 5746 Mango
- 5747 Sedona
- 5748 Juniper
- 5749 Peanut

Group 3

Billiard Multi-Use by Designtex

- 5H10 Bone
- 5H11 Poppy
- 5H12 Tangelo
- 5H13 Citrine/Citron
- 5H14 Avocado
- 5H15 Hunter
- 5H16 Indigo
- 5H17 Mallard
- 5H18 Teak
- 5H19 Cumulus
- 5H20 Pewter
- 5H21 Gunmetal
- 5H22 Ink
- 5H23 Rose Quartz
- 5H24 Sea Salt
- 5H25 Storm Cloud
- 5H26 Olivine

Group 4

Bo Peep

- 5G67 Bone
- 5G69 Brown Sugar
- 5G70 Chocolate
- 5G71 Candlelight
- 5G72 Honey Mustard
- 5G73 Marmalade
- 5G74 Picnic
- 5G75 Pinot
- 5G76 Bloom
- 5G77 Grapevine
- 5G78 Firefly
- 5G79 Artichoke
- 5G80 Serpent
- 5G81 Carolina
- 5G82 Blue Bonnet
- 5G83 Nautical
- 5G84 Gravel
- 5G85 Sharkskin
- 5G86 Kohl

Remix

- RE01 Rust
- RE03 Pebble
- RE04 Dark Chocolate
- RE06 Linen Beige
- RE08 Concrete
- RE09 Sky Blue
- RE10 Blue Jean
- RE11 Ivy Green
- RE13 Night Blue

Customer's Own Material

CUSTOMER'S OWN MATERIAL

Coalesse is pleased to cooperate with COM/COL selections. Prior to order placement for exact yardage requirements, a sample cutting of actual COM/COL must be submitted to Coalesse for approval only if fabric approval is not found in Coalesse fabric database. Identify the name and number of units on which the fabric/leather is to be applied. If COM has a repeat the sample should be large enough to show the entire repeat. Coalesse will not accept nor use any painted leathers. A painted leather is described as any suede or leather which is not aniline dyed with the same color throughout the thickness of the hide.

Even after preliminary approval, Coalesse reserves the right to reject COM/COL if necessary when the quality is not satisfactory for the item it is intended to be used on. Once COM/COL is accepted Coalesse assumes no responsibility for its overall appearance, flammability, normal durability, colorfastness, or any other quality, after upholstered on a Coalesse product.

COALESSE STANDARD TO BUY PROGRAM

The Customer's Own Material (COM) Program offers the opportunity for customers to select fabrics that are not offered through the standard Coalesse surface materials program for use on our products. Through the COM program, Coalesse will test your materials for application on Coalesse products. Once approved, you can place your order. Coalesse will facilitate the entire ordering process and give you a production schedule. Coalesse will order the COM fabric directly from the textile manufacturer. For up-to-date information regarding fabric test results for all COM fabrics and details regarding yardage requirements for most Seating lines, visit the fabric database at www.coalesse.com.

CUSTOMERS TO BUY SCHEDULING POLICY/COM/COL POLICY

COM/COL must be received at manufacturing location no later than 20 working days prior to the order scheduled delivery date. If COM/COL is not received in this time frame, scheduling will move the order's delivery date out to the best available ship date. Customer Service will notify the dealer via e-mail of the order's new scheduled delivery date. Project size order shipment may be affected due to size of order. If the COM/COL is received and the COM/COL requires backing, scheduling will move order out to best available ship date. Backing charges will apply. If COM/COL is received defective or short yardage/sq. ft., the replacement COM/COL order must be received within 3 days to maintain scheduled delivery date on order. It is the responsibility of the dealer to advise Coalesse on what to do with defective materials. In addition, customers may request Coalesse to order for COM/COL materials.

SQUARE FOOTAGE/ YARDAGE REQUIREMENTS

COM and COL price includes application of Customer's Own Material or Leather to frames. All COM and COL should be shipped freight prepaid to designated manufacturing location. Labels will be provided by your Customer Service representative to ensure clear textile identification.

Please have customers send COM/COL and add TAG: COM/ COL.

COM and COL must be identified as follows to prevent order delays:

1. Name and address (Should match purchase order)
2. Your furniture purchase order number/sales order
3. Style number to which fabric is to be applied
4. Supplier name and fabric name, number, and color

COL hides must be rolled for shipment to manufacturing location in a neat manner, avoiding creases and excessive roll marks. All leathers will be rejected if sent in a folded manner.

To determine COL square footage, see COL requirements for each product. Square footage requirements are based on an average hide size of 45-50 square feet of clean, usable leather. If the COL has a smaller average hide size, please consult Customer Service for quotation. Please note, leather is a natural product and all square footage requirements are estimations. The shape of the COL hides supplied and the usable, clean square footage may make it necessary for us to request more leather after COL is received.

Yardage requirements shown are based on 54" width plain material. If fabric design requires vertical/top out, Customer Service should be consulted for additional yards required. If fabric is under 54", refer to fabric database at www.coalesse.com.

EXCESS COM/COL POLICY

All excess COM/COL will be disposed of after order is completed unless prior arrangements have been made with Coalesse Customer Service. Fedex account number and address to ship to must be referenced. Excess WILL NOT be returned with shipment of furniture.

Customer's Own Material

Cutting Direction Guidelines

Cutting direction is based on the fabric width and the way the fabric is cut from the roll and applied to Coalesse products. There are two cutting directions: railroaded or horizontal.

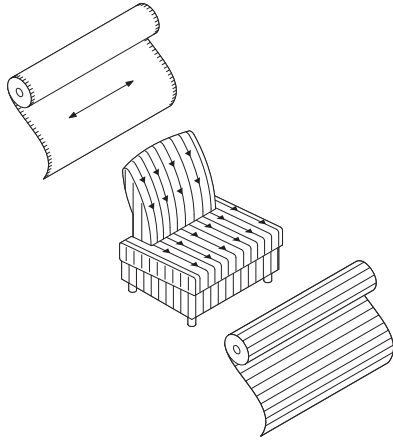

Horizontal or railroaded (across roll, warp horizontal) means fabric is cut across the roll; selvages are on the top and bottom.

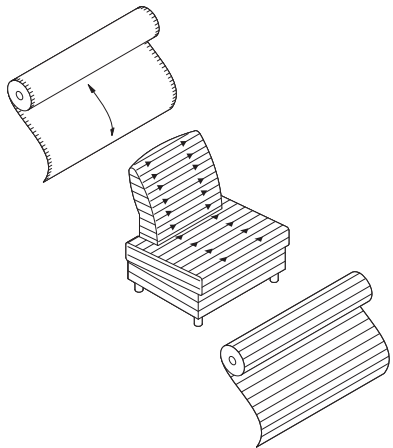

Vertical or top out (down roll, warp vertical) means fabric is cut in the same direction it is woven; selvages are on the left and right sides.

Steelcase Upholstery Matrix

Note: Coalesse reserves the right to reject fabrics when necessary if the quality or construction is not satisfactory for intended use. For most up to date information on fabric usage please check the fabric database on www.coalesse.com.

Legend

- = Not available
- = Available
- ▶ See specification pages in the *Coalesse Specification Guides* for details.

	Steelcase Fabrics									
	Jacks Group 1	Link Group 1	Cogent: Connect Group 1	Dovetail by DesignTex Group 2	New Black Group 2	SoftNext Group 2	Stand In Group 2	Billiard Multi-Use by DesignTex Group 3	Bo Peep Group 4	Remix Group 4
Await	■	■	•	■	■	■	■	■	■	■
Bindu	■	■	■	■	■	■	■	■	■	■
Bix Cushions	■	■	■	■	■	■	■	■	■	■
Bix Screen	■	■	■	■	■	■	■	■	■	■
Bob	■	■	■	■	■	■	■	■	■	■
Chord	■	■	■	■	■	■	■	■	■	■
Circa	■	■	•	■	■	■	■	■	■	■
Coupe	■	■	■	■	■	■	■	■	■	■
Davos	■	■	■	■	■	■	■	■	■	■
Elbow Chair CH20	•	•	•	•	•	•	•	•	•	•
Enea	■	■	■	■	■	■	■	■	■	■
Enea Lottus	■	■	■	■	■	■	■	■	■	■
Exponents, Benches	■	■	■	■	■	■	■	■	■	■
Hosu	■	■	■	■	■	■	■	■	■	■
Joel	■	■	■	■	■	■	■	■	■	■
Kathryn	■	■	■	■	■	■	■	■	■	■
Lounge Seating CH100 Series	•	•	•	•	•	•	•	•	•	•
Millbrae Contract	■	■	■	■	■	■	■	■	■	■
Millbrae Lifestyle	■	■	•	■	■	■	■	■	■	■

▶ Continued on next page

The above Steelcase fabrics are available as standard without a backer on select Coalesse product lines. For those product lines that are noted as unavailable, it may be specifiable with a backer as a Select Surface fabric. Additional Steelcase fabrics are available through the Select Surfaces program. Please consult the Coalesse Fabric Database for availability.

Disclaimer: Coalesse is pleased to provide this information. However, even after preliminary approval, Coalesse reserves the right to reject fabrics/leathers when necessary if the quality or construction is not satisfactory for the item it is intended for use on. Coalesse reserves the right to evaluate data daily and make any necessary changes or improvements to the information provided. Textile recommendations do not imply a warranty for the textiles. The textile manufacturer provides all warranties for textiles.

All trademarks and trade names are the property of the different manufacturers. All pricing quotes for product should be obtained from your local Sales Representative or a Coalesse Customer Service Representative. Recommendations such as backing and CAL 133 will require additional cost and may require additional lead-time. All specifications are subject to change without notice.

Steelcase Upholstery Matrix

Note: Coalesse reserves the right to reject fabrics when necessary if the quality or construction is not satisfactory for intended use. For most up to date information on fabric usage please check the fabric database on www.coalesse.com.

▶ Continued, from previous page

Legend

- = Not available
- = Available
- ▶ See specification pages in the *Coalesse Specification Guides* for details.

	Steelcase Fabrics									
	Jacks Group 1	Link Group 1	Cogent: Connect Group 1	Doveitail by Designtex Group 2	New Black Group 2	SoftNext Group 2	Stand In Group 2	Billiard Multi-Use by Designtex Group 3	Bo Peep Group 4	Remix Group 4
Lagunitas Cushion	■	■	■	■	■	■	■	■	■	■
Lox	■	■	•	•	■	•	■	•	■	•
Montara650	■	■	■	■	■	■	■	■	■	■
Passerelle	■	■	■	■	■	■	■	■	■	■
Ripple	■	■	•	■	■	■	■	■	■	■
Sidewalk	■	■	■	■	■	■	■	■	■	■
SW_1	■	■	■	■	■	■	•	■	■	■
Switch	■	■	■	■	■	■	■	■	■	■
Together	■	■	■	■	■	■	■	■	■	■
Visalia	■	■	■	■	■	■	■	■	■	■
Wrapp	■	■	•	■	■	■	■	■	■	■

The above Steelcase fabrics are available as standard without a backer on select Coalesse product lines. For those product lines that are noted as unavailable, it may be specifiable with a backer as a Select Surface fabric. Additional Steelcase fabrics are available through the Select Surfaces program. Please consult the Coalesse Fabric Database for availability.

Disclaimer: Coalesse is pleased to provide this information. However, even after preliminary approval, Coalesse reserves the right to reject fabrics/leathers when necessary if the quality or construction is not satisfactory for the item it is intended for use on. Coalesse reserves the right to evaluate data daily and make any necessary changes or improvements to the information provided. Textile recommendations do not imply a warranty for the textiles. The textile manufacturer provides all warranties for textiles. All trademarks and trade names are the property of the different manufacturers. All pricing quotes for product should be obtained from your local Sales Representative or a Coalesse Customer Service Representative. Recommendations such as backing and CAL 133 will require additional cost and may require additional lead-time. All specifications are subject to change without notice.

Surface Materials - Leather/Faux

Leather

ELMOSOFT, ELMORUSTICAL LEATHER CARE

Only the finest hides are used for Elmo leather. Expect some color variations from hide to hide due to the aniline state of the product. Color fading may occur if leather is exposed to direct or intense light. Care is required to allow this product to achieve the rich natural patina that beautiful natural leather develops. The hallmarks of this leather include some naturally occurring markings, such as healed scars, insect bites, stretch marks, and fat wrinkles. Elmorustical's leather treatment is very natural with little protection from spills or body oils. This rich leather will exhibit stains and oils through normal use. Coalesse is not responsible for discoloration, spotting, or staining on this leather.

Special Color Match Leather

Coalesse can provide a special color match in its leather to any supplier's leather color, paint color, carpet color, wallpaper color, etc. Sample to match must be submitted to Coalesse with purchase order. Sample for approval can be supplied if requested.

Note: Minimum order 2,500 sq. ft.

Special Fabric Applications

Backing

- Backing information is found on each product page. Select this option when ordering your product to have backing applied. Price varies by product according to yardage it requires.

Tip: Prices subject to change without notice and an additional 2 week lead time will apply for 54" wide fabrics. Wider fabrics will require 4 week additional lead time.

Cafe Leather

Group 1

Café Leather

L208	Black Tea
L209	Earl Grey
L210	Espresso Bean
L211	Mousse
L212	Candied Pecan
L213	Chai
L214	Blueberry Tart

Elmo Leather

Coalesse uses leathers that are provided by Elmo of Sweden. Elmosoft is a full grain, aniline dyed, semi-aniline finish. With Elmosoft leather, now recyclable and chromium-free, you have the opportunity to bid on green projects when requested. Elmosoft leathers are never corrected, buffed, or altered in any way. Coalesse purchases only original full grain leathers. The quality of this genuine leather can be felt in the hand immediately. Other leathers are often stiff because of the amount of pigment needed to cover the imperfections of an inferior hide. Using leather of a low quality affects the overall quality of the furniture it is upholstered on. You can feel confident in leather purchased from Coalesse.

Elmosoft

Group 1

Elmosoft

L110	Maritime Blue
L111	Midnight Blue
L112	Ebony
L113	Gunmetal
L114	Mica
L115	Dove Grey
L116	Plum Pleasure
L122	Truffle
L128	Red Birch
L133	Espresso
L134	Ruby
L139	Cinder
L140	Garnet
L143	Pecan
L144	Chamois
L146	Russet
L147	Saddle
L151	White
L709	Sugar
L711	Parchment
L717	Cameo
L723	Storm
L725	Teal
L727	Egyptian Blue
L728	Bright Blue
L730	Hunter
L743	Forest Green
L747	Cigar
L749	Beaver
L750	Bluffstone
L755	Peanut Butter
L758	Mustard
L762	Canvas
L763	Macadamia
L770	Cadet
L772	Timberwolf
L773	Chalice
L774	Oil
L775	Coyote

Elmorustical Leather and Elmotique

Elmorustical and Elmotique is a full top grain, aniline dyed leather.

Elmorustical has a grain which varies in structure and offers outstanding comfort. It is an aniline leather with all the distinct features of the natural hide.

Elmotique is a thinner aniline leather with a batique-effect and displays all the features possessed by the original hide.

Only the finest hides are used for Elmorustical and Elmotique leathers. Expect some color variations from hide to hide due to the aniline state of the product. Color fading may occur if leather is exposed to direct or intense light. Care is required to allow this product to achieve the rich natural patina that beautiful leather develops. The hallmarks of this leather include some naturally occurring markings such as healed scars, insect bites, stretch marks, and fat wrinkles. Elmorustical and Elmotique's leather treatment is very natural with little protection from spills or body oils. This rich leather will exhibit stains and oils through normal use. Coalesse is not responsible for discoloration, spotting, or staining on this leather.

Group 2

Elmorustical

L318	Loam
L319	Ebony
L321	Beige
L323	Buff
L325	Camel
L326	Charbrown
L330	Flame
L332	Honey
L334	Mist Green
L337	Russet
L338	Rust
L363	Tendrill
L364	Fog
L365	Sunflower
L366	Terra Cotta
L367	Cadet
L368	Marine
L369	Mallard
L370	Smoke
L371	Merlot
LD54	Twilight

Elmotique

L310	Sage Brush
L311	Flaxen
L312	Earth
L313	Clay
L314	Blue Mountain
L315	Juniper

Faux Leather

Coalesse offers a variety of faux leathers. Not all faux leathers are available on all products, check seating matrix to determine availability. **►Page 439**

Group 5

Brisa

(For a visual palette, please refer to the Steelcase Finish Library)

BR01	Black Onyx
BR04	Truffle
BR06	Ash
BR07	Sage
BR08	Celery
BR09	Sterling Blue
BR10	Night Navy
BR11	Cambridge Blue
BR12	Abbyss
BR14	Pompeia
BR16	Cinnabar
BR18	New Sand
BR20	White
BR21	Moccasin
BR22	Buckskin
BR24	Mineral
BR25	Skyway
BR26	Iron
BR27	Stormy
BR28	Esmeralda
BR29	Seaweed
BR30	Bone
BR31	Caramel
BR32	Bridle
BR33	Moon

Destiny

DY01	Black
DY02	Raisin
DY03	Blueberry
DY04	Chestnut
DY05	Cedar
DY06	Black Rose
DY07	Wine
DY09	Dune
DY10	Truffle
DY11	Oak
DY12	Newport
DY13	Evergreen
DY14	Storm
DY15	Juniper
DY16	Olive
DY17	Mocha
DY18	Ash
DY21	Butter
DY23	Deep Red
DY24	Eggshell
DY26	Parchment
DY27	Periwinkle
DY30	Royal Purple
DY31	Saddle
DY32	Cactus Green
DY33	Cypress
DY34	Mink
DY35	Football
DY36	Root

Surface Materials - Leather/Faux

Finesse

- AM00 White Cloud
- AM01 Gelato
- AM02 Winter White
- AM04 Mushroom
- AM06 Charbrown
- AM08 Iceberg
- AM09 Gravel
- AM10 Colonial Blue
- AM24 Rye
- AM25 Barley
- AM26 Stucco
- AM27 Beaver
- AM28 Otter
- AM65 Bordeaux
- AM66 Navy
- AM67 Cinder
- AM80 Cameo
- AM81 Oyster Grey
- AM83 Taupe
- AM85 Chestnut
- AM87 Indigo
- AM88 Bone
- AM89 Jet Black
- AM92 Burgundy
- AM93 Hunter Green
- AM98 Oxford Brown

Ovation

- O500 Dark Brown
- O501 Light Grey
- O502 Sage
- O503 Indigo
- O504 Lilac
- O505 Terra
- O506 Moss
- O507 Teal
- O508 Stone
- O509 Cappuccino

Panache

- P800 Ebony
- P801 Cactus
- P802 Sherwood
- P803 Teal Blue
- P804 Sweet Sage
- P805 Coffee
- P806 True Taupe
- P807 Cashew
- P808 Acorn
- P809 Redwood
- P810 Exotic Orchid
- P811 Maize
- P812 Chartreuse
- P813 Regal Blue

Prestige

- AFA1 Onyx
- AFB2 Soft White
- AFC3 Saxe Blue
- AFD3 Buff
- AFDG Antique White
- AFE1 Sandstone
- AFH1 Pecan
- AFH2 Buttercream
- AFI1 Havana
- AFI2 Brick
- AFK1 Parchment
- AFL8 French Grey
- AFP1 Willow
- AFP2 Boxwood Green
- AFPA Tree Moss
- AFPC Celadon
- AFS3 Wild Plum

Group 6

Destiny Perforated

- DP01 Black
- DP02 Raisin
- DP03 Blueberry
- DP04 Chestnut
- DP05 Cedar
- DP06 Black Rose
- DP07 Wine
- DP09 Dune
- DP10 Truffle
- DP11 Oak
- DP12 Newport
- DP13 Evergreen
- DP14 Storm
- DP15 Juniper
- DP16 Olive
- DP17 Mocha
- DP21 Butter
- DP23 Deep Red
- DP24 Eggshell
- DP26 Parchment
- DP27 Periwinkle
- DP30 Royal Purple
- DP31 Saddle
- DP32 Cactus Green
- DP33 Cypress
- DP34 Mink
- DP35 Football
- DP36 Root

Elegance

- EL01 Ivory
- EL02 Cream
- EL03 Char
- EL04 Saddle
- EL05 Dune
- EL06 Camel
- EL07 Sage
- EL08 Gray
- EL09 Walnut
- EL10 Burgundy
- EL11 Green
- EL12 Navy
- EL13 Black

Finesse Perforated

- AP00 White Cloud
- AP01 Gelato
- AP02 Winter White
- AP04 Mushroom
- AP06 Charbrown
- AP08 Iceberg
- AP09 Gravel
- AP10 Colonial Blue
- AP24 Rye
- AP25 Barley
- AP26 Stucco
- AP27 Beaver
- AP28 Otter
- AP65 Bordeaux
- AP66 Navy
- AP67 Cinder
- AP80 Cameo
- AP81 Oyster Grey
- AP83 Taupe
- AP85 Chestnut
- AP87 Indigo
- AP88 Bone
- AP89 Jet Black
- AP92 Burgundy
- AP93 Hunter Green
- AP98 Oxford Brown

Panache Perforated

- PR00 Ebony
- PR01 Cactus
- PR02 Sherwood
- PR03 Teal Blue
- PR04 Sweet Sage
- PR05 Coffee
- PR06 True Taupe
- PR07 Cashew
- PR08 Acorn
- PR09 Redwood
- PR10 Exotic Orchid
- PR11 Maize
- PR12 Chartreuse
- PR13 Regal Blue

Prestige Perforated

- APA1 Onyx
- APB2 Soft White
- APC3 Saxe Blue
- APD3 Buff
- APDG Antique White
- APE1 Sandstone
- APH1 Pecan
- APH2 Buttercream
- API1 Havana
- API2 Brick
- APK1 Parchment
- APL8 French Grey
- APP1 Willow
- APP2 Boxwood Green
- APPA Tree Moss
- APPC Celadon
- APSC Wild Plum

Cut Yardage Net Price List

Fabric Name	Under 60 Yards	60 Yards & Over	
Elegance®	\$126.00/yd	\$116.00/yd	
Finesse®	\$ 76.00/yd	\$ 75.00/yd	
Finesse® Perforated (min. 5 yards)	\$ 91.00/yd	\$ 90.00/yd	
Prestige®	\$ 82.00/yd	\$ 78.00/yd	
Prestige® Perforated (min. 5 yards)	\$ 99.00/yd	\$ 95.00/yd	
Destiny®	\$ 83.00/yd	\$ 80.00/yd	
Destiny® Perforated (min. 5 yards)	\$100.00/yd	\$ 96.00/yd	
Ovation	\$ 83.00/yd	\$ 78.00/yd	
Panache	\$ 83.00/yd	\$ 80.00/yd	
Leather Name	Under 500 sq. ft.	500–1000 sq. ft.	Over 1000 sq. ft.
Elmosoft	\$10.00/sq. ft.	\$ 9.00/sq. ft.	\$8.50/sq. ft.
Elmorustical*	\$16.00/sq. ft.	\$10.00/sq. ft.	\$9.50/sq. ft.

Ordering Information

- Minimum Order Requirements
 - Fabric: 1 yd.– 1/8 yd. increments.
 - Leather: 1 full hide (avg. sq. ft./hide - 50).
 - All orders will be filled in full hides only.
 - Overage will be invoiced accordingly.
 - Cancelled textile orders are subject to a 30% restocking fee. Order must be cancelled 5 days before ship date.
 - Special match leather: 2,500 sq. ft. minimum (Check delivery date)
 - The embossing techniques used on Novasuede Perforated to achieve these looks involve very high temperatures. Color and shade may vary slightly based on the fiber density being embossed.
- Due to the natural processes of dying, sanding and embossing necessary to achieve these special looks, actual production may vary slightly in appearance from the swatches shown.

Coalesse Textile Warranty

Coalesse textile merchandise is produced in accordance with Coalesse high standards. Coalesse does not guarantee, warrant or accept any responsibility whatsoever by reason of its fabrics or leathers fading, wearing, cracking, shrinking, stretching, tearing, seam slippage, alteration in color due to any finish treatment (flameproofing, stain repellent, etc.) or discoloration from liquid contact. Printed textiles are not warranted against irregularity in register. Coalesse is not responsible for dye lot differences or discrepancies in widths of fabrics. Coalesse does not guarantee, warrant or represent an exact color match to cuttings, tabs, memos or sample cards. Coalesse does not warrant exact matching of color or grain of leather. Leather hides may contain certain natural marks, scars, scratches, wrinkles and shade variations within hides, etc., considered by leather tanneries and Coalesse to be inherent characteristics part of the natural beauty of leather and the size or location of such markings cannot be controlled. In any event, upon inspection, Coalesse’s responsibility shall be limited to either replacement of merchandise or refund of purchase price at Coalesse’s option. The foregoing constitutes the sole and exclusive remedy of the customer. Coalesse is not responsible for the application or installation of our products. In no event shall Coalesse be responsible for any consequential damages or any charges, costs, expenses, or obligations other than as expressly herein set forth. Coalesse makes no other warranties, expressed or implied, as to any product sold by Coalesse. All other warranties (including any warranty of merchantability or fitness for any particular purpose) are hereby excluded.

Leather and Faux Leather Matrix

Note: Coalesse reserves the right to reject fabrics when necessary if the quality or construction is not satisfactory for intended use. For most up to date information on fabric usage, please check the fabric database on www.coalesse.com.

Legend

- = Not available
- = Available
- ☒ = Must be ordered as COM or COL
- ▣ = Available but will puddle
- ▶ See specification pages for details.

	Loke Leather	Café Leather Group 1	Elmosoft Group 1	Elmorustical Group 2	Elmoique Group 2	Destiny Group 5	Finesse Group 5	Ovation Group 5	Panache Group 5	Prestige Group 5	Brisa Group 5	Destiny Perforated Group 6	Elegance Group 6	Finesse Perforated Group 6	Panache Perforated Group 6	Prestige Perforated Group 6
Await	☒	■	■	■	•	■	■	■	■	■	■	■	■	■	■	■
Bindu	☒	■	■	■	•	■	■	■	■	■	■	■	■	■	■	■
Bix	•	■	■	■	•	■	■	■	■	■	■	•	■	•	•	•
Bob	•	■	■	■	•	■	■	■	■	■	■	•	■	•	■	•
Chord	☒	■	■	■	•	■	■	■	■	■	■	■	■	■	■	■
Circa	☒	■	■	■	•	■	■	■	■	■	■	■	■	■	■	■
Coupe	☒	■	■	■	•	■	■	■	■	■	■	■	■	■	■	■
Davos	•	■	■	■	•	■	■	■	■	■	■	•	■	•	•	•
Enea	☒	■	■	■	•	■	■	■	■	■	■	■	■	■	■	■
Enea Lottus	•	■	■	■	■	■	■	■	■	■	■	•	■	•	•	•
Exponents (Benches)	•	■	■	■	•	■	■	■	■	■	■	•	■	•	•	•
Joel	•	■	■	■	•	■	■	■	■	■	■	•	■	•	•	•
Kathryn	☒	■	■	■	■	■	■	■	■	■	■	■	■	■	■	■
Lagunitas	•	■	■	■	•	■	■	■	■	■	■	■	■	■	■	■
Lox	•	■	■	■	■	■	■	■	■	■	■	•	■	•	•	•
Millbrae Contract	☒	■	■	■	•	■	■	■	■	■	■	■	■	■	■	■
Millbrae Lifestyle	☒	■	■	■	■	■	■	■	■	■	■	■	■	■	■	■
Montara650	•	■	■	■	•	■	■	■	■	■	■	•	■	•	■	•
Passerelle	☒	■	■	■	•	■	■	■	■	■	■	■	■	■	■	■
Ripple	☒	■	■	■	•	■	■	■	■	■	■	■	■	■	■	■
SW_1	•	■	■	■	•	■	■	■	■	■	■	•	■	•	•	•
Switch	☒	■	■	■	•	■	■	■	■	■	■	■	■	■	■	■
Together	•	▣	▣	▣	•	▣	▣	■	▣	▣	▣	•	▣	•	•	•
Visalia	☒	■	■	■	•	■	■	■	■	■	■	■	■	■	■	■
Wrapp	•	■	■	■	•	■	■	■	■	■	■	■	■	■	■	■

Disclaimer: Coalesse is pleased to provide this information. However, even after preliminary approval, Coalesse reserves the right to reject fabrics/leathers when necessary if the quality or construction is not satisfactory for the item it is intended for use on. Coalesse reserves the right to evaluate data daily and make any necessary changes or improvements to the information provided. Textile recommendations do not imply a warranty for the textiles. The textile manufacturer provides all warranties for textiles. All trademarks and trade names are the property of the different manufacturers. All pricing quotes for product should be obtained from your local Sales Representative or a Coalesse Customer Service Representative. Recommendations such as latex backing, Gore SP and CAL 133 will require additional cost and may require additional lead-time. All specifications are subject to change without notice.

Surface Materials - Wood

Wood

Standard Wood Finishes

Coalesse's primary wood finish, Clarity, is a water-borne UV topcoat, which protects the environment while providing exceptional durability and resistance to water and chemical stains. Contoured products, such as wood guest chairs and occasional tables, are finished with post-catalyzed vinyl, which provides similar properties and matches the sheen and color of Clarity. Due to natural variations in wood, finished products may vary from samples in color, texture, and grain.

Wood will develop a deep, rich patina over time as the wood ages. Mineral streaks, gum pockets, and pin knots are some of the unique characteristics that are visible in veneers and solids.

All wood products will darken with age and exposure to ultraviolet light. This is especially apparent with cherry and maple veneer.

When storing your wood furniture, please follow the following guidelines:

- Do not store products in trailers
- Store products in areas that simulate office temperatures (60°F to 90°F)
- Store products in areas that maintain constant, office-like humidity levels
- Keep product away from light. Cover products to make sure they are not exposed to light.

Samples contact Customer Service at 1.800.627.6770

Steelcase Wood Finishes

Coalesse will match current Steelcase wood finishes at no upcharge. Finish matches are for color only and do not match the Steelcase finish in sheen.

Natural veneers celebrate the natural beauty of wood with neutral tones.

Plank veneers were intentionally designed to enhance the unique characteristics of wood with natural variations that include grain pattern, color, and texture that are meant to be celebrated.

Stain-To-Match Wood Finish

Coalesse will stain-to-match any wood finish with a one-time \$500 net charge per customer per finish. Customers must work with Concierge team to advise species, cut, and sheen and submit a sample with a surface dimension of at least 3" x 3" for matching. Coalesse requires written approval of a strike-off sample before starting production. When ordering, customers must select the applicable finish code, specifying cut and species, and reference the Customiz stain finish number attached to the match. The one-time charge and strike-off sample is not required for standard Steelcase or Coalesse finishes. Contact Concierge team for additional program details.

Phone: 1.866.645.6952

Email: concierge@steelcase.com

Steelcase Select Surfaces

In addition to the standard Steelcase veneer palette, Coalesse offers Steelcase Select Surfaces.

Composite veneers are engineered veneer intended to create consistent grain patterns and characteristics with minimal inconsistency within an order. Please note that because these finishes are part of Steelcase Select Surfaces, they may have additional lead times.

Painted MDF

The **Painted medium density fiberboard (MDF)** is utilizing molding grade MDF, therefore, the 45 lb density is consistent throughout the entire thickness of the board. This allows for a smooth edge when painted. Three coats of water reducible finish is applied to the board in a milk or black. The painted MDF has durability and care properties like a wood veneer, thus, must be treated as such.

Wood Veneer Specifications

Cherry

- American Black Cherry
- Flat-cut, plain sliced/book matched
- Quarter-cut/book matched
- Narrow cathedrals, mild grain, minimal pitch
- 5-10" wide leaves of 1/42" thick veneer, balanced on panel
- No gaps between leaves
- PB (particle board) core
- Low sheen 15 or high sheen 35

Maple

- Eastern Hard White Maple
- Flat-cut, plain sliced/slip matched
- Quarter-cut/book matched
- Narrow cathedrals, mild grain, minimal pitch
- 5-10" wide leaves of 1/42" thick veneer, balanced on panel
- No gaps between leaves
- PB (particle board) core
- Low sheen 15 or high sheen 35

Oak

- White Oak
- Rift-cut
- Slip match
- Mild grain
- 4-8" wide leaves of 1/42" thick veneer, balanced on panel
- No gaps between leaves
- PB (particle board) core
- Low sheen 15 or high sheen 35

Walnut

- American Black Walnut
- Flat-cut, plain sliced/book matched
- Quarter-cut/book matched
- Narrow cathedrals, mild grain
- 5-10" wide leaves of 1/42" thick veneer, balanced on panel
- No gaps between leaves
- PB (particle board) core
- Low sheen 15 or high sheen 35

Exclusive (by product)

Teak

- Quarter-cut/book match
- 15 sheen

Ash (Grey)

- Quarter-cut/book match
- 15 sheen

Flat-Cut – High Sheen

Group 1

- V10C FC/HS Natural Cherry
- V11C FC/HS Clear Cherry
- V12C FC/HS Medium Amber Cherry
- V13C FC/HS Dark Cherry
- V10M FC/HS Clear Maple
- V11M FC/HS Natural Beech on Maple
- V12M FC/HS Medium Maple
- V10W FC/HS Natural Walnut
- V11W FC/HS Clear Walnut
- V12W FC/HS Medium Walnut
- V13W FC/HS Black Walnut
- V14W FC/HS Dark Walnut

Flat-Cut – Low Sheen

Group 1

- V1AC FC/LS Natural Cherry
- V1BC FC/LS Clear Cherry
- V1CC FC/LS Medium Amber Cherry
- V1DC FC/LS Dark Cherry
- V1AM FC/LS Clear Maple
- V1BM FC/LS Natural Beech on Maple
- V1CM FC/LS Medium Maple
- V1AW FC/LS Natural Walnut
- V1BW FC/LS Clear Walnut
- V1CW FC/LS Medium Walnut
- V1EW FC/LS Dark Walnut

Rift-Cut – High Sheen

Group 1

- V30K RC/HS Natural Oak
- V31K RC/HS Desert Oak
- V32K RC/HS Medium Brown Oak
- V33K RC/HS Medium Gray Oak
- V34K RC/HS Black Brown Oak

Rift-Cut – Low Sheen

Group 1

- V3AK RC/LS Natural Oak
- V3BK RC/LS Desert Oak
- V3CK RC/LS Medium Brown Oak
- V3DK RC/LS Medium Gray Oak
- V3EK RC/LS Black Brown Oak

FC=Flat Cut
 RC=Rift Cut
 QC=Quarter Cut
 HS=High Sheen
 LS=Low Sheen

Surface Materials - Wood

Quarter-Cut – High Sheen

Group 2

- V20C QC/HS Natural Cherry
- V21C QC/HS Clear Cherry
- V22C QC/HS Medium Amber Cherry
- V23C QC/HS Dark Cherry
- V20M QC/HS Clear Maple
- V21M QC/HS Natural Beech on Maple
- V22M QC/HS Medium Maple
- V20W QC/HS Natural Walnut
- V21W QC/HS Clear Walnut
- V22W QC/HS Medium Walnut
- V23W QC/HS Black Walnut
- V24W QC/HS Dark Walnut

Quarter-Cut – Low Sheen

Group 2

- V2AA QC/LS Ash Natural FSC
- V2AC QC/LS Natural Cherry
- V2BC QC/LS Clear Cherry
- V2CC QC/LS Medium Amber Cherry
- V2DC QC/LS Dark Cherry
- V2AM QC/LS Clear Maple
- V2BM QC/LS Natural Beech on Maple
- V2CM QC/LS Medium Maple
- V2AW QC/LS Natural Walnut
- V2BW QC/LS Clear Walnut
- V2CW QC/LS Medium Walnut
- V2EW QC/LS Dark Walnut
- V2AT QC/LS Teak Natural Raw FSC

Steelcase Veneers, Open Pore Only

Group 1

Cherry, Flat-Cut

- 3402 FC/OP Clear Cherry
- 3412 FC/OP Natural Cherry
- 3422 FC/OP Medium Cherry

Maple, Flat-Cut

- 3522 FC/OP Clear Maple
- 3592 FC/OP Blonde on Maple

Maple, Quarter-Cut

- 3222 QC/OP Clear Maple
- 3292 QC/OP Blonde on Maple

Walnut, Flat-Cut

- 3062 FC/OP Graphite Walnut
- 3342 FC/OP Black Walnut
- 3702 FC/OP Clear Walnut
- 3712 FC/OP Natural Walnut
- 3752 FC/OP Medium Walnut
- 3762 FC/OP Dark Walnut
- 3772 FC/OP Medium Mahogany on Walnut

Walnut, Quarter-Cut

- 3302 QC/OP Clear Walnut
- 3312 QC/OP Natural Walnut
- 3352 QC/OP Medium Walnut
- 3362 QC/OP Dark Walnut
- 3372 QC/OP Medium Mahogany on Walnut
- 3382 QC/OP Graphite Walnut
- 3392 QC/OP Black Walnut

Oak, Rift-Cut

- 3602 RC/OP Desert Oak
- 3612 RC/OP Warm Oak

Premium Wood, Quarter-Cut

- 3832 QC/OP Figured Anegre

Planked Veneer

- 3P41 OP Planked Cherry
- 3P51 OP Planked Maple
- 3P61 OP Planked Oak
- 3P71 OP Planked Walnut
- 3VFX OP Unmarked Oak

Natural Veneer, Flat-Cut

- 35A2 FC/OP Blanch Maple
- 37A2 FC/OP Thunder Walnut

Natural Veneer, Rift Cut

- 36A2 RC/OP Volcanic Oak

Group 2

Ash, Quarter-Cut

- 3042 QC/OP Ash

Natural Veneer, Flat-Cut

- 3082 FC/OP Washed Walnut

Natural Veneer, Quarter Cut

- 32A2 QC/OP Blanch Maple
- 33A2 QC/OP Thunder Walnut

Composite Veneer Group 1

Composite Flat-Cut Open-Pore

- 3JDX FC/OP Oak Composite
- 3JJX FC/OP Walnut Composite
- 3LAX FC/OP Graphite on Oak Composite
- 3LCX FC/OP Medium Cherry on Cherry Composite

Composite Quarter-Cut Open-Pore

- 3F8X QC/OP European Walnut Composite
- 3GGX QC/OP Zebrano Composite
- 3HGX QC/OP Oak Composite
- 3HVX QC/OP Walnut Composite
- 3LBX QC/OP Clear Walnut on Walnut Composite
- 3LDX QC/OP Natural Walnut on Walnut Composite
- 3ZNX QC/OP Night Cerused Oak Composite

Composite Veneer Group 2

Composite Flat-Cut Open-Pore

- 3LHX FC/OP Espresso on Walnut Composite

Composite Quarter-Cut Open-Pore

- 3LEX QC/OP Desert Oak on Oak Composite
- 3LGX QC/OP Chai on Walnut Composite
- 3LJX QC/OP Ebony on Walnut Composite

Painted MDF

Applies to: Exponents

- V145 Milk
- V197 Black

FC=Flat Cut
 RC=Rift Cut
 QC=Quarter Cut
 HS=High Sheen
 LS=Low Sheen
 OP=Open Pore

Solid Wood Matrix

For Solid Hardwood Components of Seating and Tables

Legend

- = Not available
- = Available
- = Stain color only on maple
- = Stain color on Beech
- ▶ See specification pages in the Coalesse Specification Guides for details.

Maple Flat-Cut – High Sheen
Maple Flat-Cut – Low Sheen
Maple Quarter-Cut – High Sheen
Maple Quarter-Cut – Low Sheen
Cherry Flat-Cut – High Sheen
Cherry Flat-Cut – Low Sheen
Cherry Quarter-Cut – High Sheen
Cherry Quarter-Cut – Low Sheen
Oak Rift-Cut – High Sheen
Oak Rift-Cut – Low Sheen
Walnut Flat-Cut – High Sheen
Walnut Flat-Cut – Low Sheen
Walnut Quarter-Cut – High Sheen
Walnut Quarter-Cut – Low Sheen
Teak Quarter-Cut – High Sheen
Teak Quarter-Cut – Low Sheen
Grey Ash – High Sheen
Grey Ash – Low Sheen

Seating

Circa Cylinder Legs	•	•	•	•	•	•	•	•	•	■	■	•	•	•	•	•	•	•
Circa Tapered Legs	•	•	■	■	•	•	•	•	•	•	•	•	■	■	•	•	•	•
Coupe Lounge	■	■	•	•	■	■	•	•	■	■	■	■	•	•	•	•	•	•
Enea Altzo943	•	•	•	•	•	•	•	•	•	■	•	•	•	•	•	•	•	•
Enea Café Wood Stool*	•	•	•	•	•	•	•	•	•	■	•	•	•	•	•	•	•	•
Kathryn	■	■	•	•	■	■	•	•	■	■	■	■	•	•	•	•	•	•
Passerelle	■	■	•	•	■	■	•	•	■	■	■	■	•	•	•	•	•	•
Sistema Lounge System**	•	•	•	•	•	•	•	•	•	■	•	•	•	•	•	•	•	•

* V3AK Natural Oak only.

** Select colors only: VP01, VP02, VP03, VP04, and VP05

▶ Matrix, continued on next page

Solid Wood Matrix

For Solid Hardwood Components of Seating and Tables

► Matrix, continued from previous page

Legend

- = Not available
- = Available
- = Stain color only on maple
- See specification pages in the Coalesse Specification Guides for details.

	Maple Flat-Cut – High Sheen	Maple Flat-Cut – Low Sheen	Maple Quarter-Cut – High Sheen	Maple Quarter-Cut – Low Sheen	Cherry Flat-Cut – High Sheen	Cherry Flat-Cut – Low Sheen	Cherry Quarter-Cut – High Sheen	Cherry Quarter-Cut – Low Sheen	Oak Rift-Cut – High Sheen	Oak Rift-Cut – Low Sheen	Walnut Flat-Cut – High Sheen	Walnut Flat-Cut – Low Sheen	Walnut Quarter-Cut – High Sheen	Walnut Quarter-Cut – Low Sheen	Teak Quarter-Cut – Low Sheen	Grey Ash – Low Sheen
Occasional Tables																
Circa Cylinder Legs	•	•	•	•	•	•	•	•	■	■	•	•	•	•	•	•
Circa Tapered Legs	•	•	■	■	•	•	•	•	■	■	•	•	■	■	•	•
Passerelle	■	■	•	•	■	■	•	•	■	■	■	■	•	•	•	•

Surface Materials - Laminate

Laminate

Coalesse's graded laminate program includes our standard laminates, Steelcase High-Pressure Laminates, and standard High-Pressure Laminates from Nevamar, Wilsonart, Formica, and Pionite.

Standard Coalesse Laminate

Group 1

Coalesse High-Pressure Laminates are priced as Group 1.

High-Pressure Laminates listed below are not available on all products, check laminate matrix for availability.

- 2730 Arctic White
- 2746 Black
- 2759 Warm White
- 2826 White Nebula
- 2829 Poppyseed
- 2830 Charcoal
- 2884 Milk
- 2886 Maple
- 2887 Amber Cherry
- 2890 Folkstone BMW
- 2891 Ingot
- 2892 Ash
- 2894 Natural Cork
- 2895 Natural Walnut
- 2896 Dark Cork
- 2897 Desert Oak
- 2898 Satin Stainless

Standard Steelcase Laminate

Group 1

All Steelcase High-Pressure Laminates may be specified on Coalesse products with exception (must be ordered as Special): Await tables and Enea Lottus tables. The use of Steelcase High-Pressure Laminate may be subject to extended lead times.

Tip: For a visual palette, please refer to the Steelcase Finish Library.

Fiber Laminate

- 2850 Vanadium Fiber
- 2852 Tungsten Fiber
- 2854 Vellum Fiber
- 2859 Novell Fiber
- 2860 Granite Fiber
- 2861 Coconut Fiber
- 2862 Stucco Fiber

Micro Laminate

- 2920 Marl Micro
- 2921 Gypsum Micro
- 2922 Clay Micro

Patina Laminate

- 2870 Blonde Bronze Patina
- 2871 Balckened Bronze Patina
- 2873 Instant Iron Patina

Solid Laminate

- 2722 Cream
- 2730 Arctic White
- 2746 Black
- 2759 Warm White
- 2811 Mist
- 2883 Seagull
- 2884 Milk
- 2885 Dune
- 2HAA Persian Salt
- 2HAB Rose
- 2HAC Indigo
- 2HAD Green Citrine
- 2HAE Dark Olivine
- 2HAF Cloudy
- 2HMG Merle
- 2HWU Clay
- 2HWV Chalk

Speckle Laminate

- 2820 Coffee Speckle
- 2823 Driftwood Speckle
- 2824 Smoke Speckle
- 2825 Vanadium Speckle

Textured Laminate

- 2TH2 Fawn Cypress
- 2TH4 Saddle Oak
- 2TH5 Veranda Teak
- 2TH7 Walnut Heights

Woodgrain Laminate

- 2406 Clear Cherry
- 2409 Clear Maple
- 2410 Graphite Walnut
- 2412 Natural Cherry
- 2422 Medium Cherry
- 2511 Winter on Maple
- 2535 Virginia Walnut
- 2536 Blackwood
- 2538 Clear Walnut
- 2539 Warm Oak
- 2592 Blonde on Maple
- 2714 Natural Walnut
- 2HAK Clear Oak
- 2HAN Ash Noce
- 2HAT Acacia
- 2HAW Ash Wenge
- 2HBN Bisque Noce
- 2HBW Bisque Wenge
- 2HCN Clay Noce
- 2HCW Clay Wenge
- 2HSN Storm Noce
- 2HSW Storm Wenge
- 2HWA Grey Kingswood
- 2HWB Planked Walnut
- 2HWD Resolute Walnut
- 2HWE Natural Recon
- 2HWF Smoked Walnut

Group 2

Textured Laminate

- 2UH1 Reclaimed Aggregate
- 2UH2 Reclaimed Gravel
- 2UH4 Cement*
- 2UH6 Sheetrock

**2UH4 Cement has limited availability, determined by product sizing and/or options.*

Group 3

Solid Laminate

- 24H1 Satin White
- 24H2 Satin Black
- 24H3 Satin Stone
- 24H4 Satin Mocha

Open Line Laminates

Customers can select laminates that are not offered as standard from select suppliers. Standard grade High-Pressure Laminates can be specified in Group 1 (290A) or Group 2 (290B) as indicated below (subject to availability). Group 2 laminates will have extended lead time. Select from any Coalesse or Steelcase standard edge band finishes.

Contact Customer Service at 1.800.627.6770 to verify that your laminate selection falls within the categories noted below.

Directional patterns and woodgrains may be used on freestanding systems products, but will not be patterned matched.

Some standard High-Pressure Laminates, may not be available in the appropriate size to produce large products.

Wilsonart (Group 1)
Standards (matte finish)
Exceptions: High definition which must be quoted as a special. Marker board which is grade 2.

Nevamar (Group 2)
Solids (textured finish)
Patterns (textured finish)

Formica (Group 2)
Color portfolio (matte finish)
Patterns (matte finish)
Formations (matte finish)

Pionite (Group 2)
Decorative surfaces (suede finish)

Non-Standard Laminates

Coalesse can supply additional laminates for an upcharge. Contact your Coalesse sales consultant for a custom quotation. Custom upcharges will vary based upon the cost of the material specified and additional labor required to manufacture the products. Some non-standard laminates will not be available in the appropriate size to produce large Coalesse products. A sample of the laminate may be requested for approval. Some non-standard laminates may be subject to extended lead times.

High-Pressure Laminate Matrix *continued*

Legend

- = Not available
- = Available
- ▶ See specification pages for details.

	2HAE Dark Olivine	2HAF Cloudy	2HAK Clear Oak	2HAN Ash Noce	2HAT Acacia	2HAW Ash Wenge	2HBN Bisque Noce	2HBW Bisque Wenge	2HCN Clay Noce	2HCW Clay Wenge	2HMG Merle	2HSN Storm Noce	2HSW Storm Wenge	2HWA Grey Kingswood	2HWB Planked Walnut	2HWD Resolute Walnut	2HWE Natural Recon	2HWF Smoked Walnut	2HWU Clay	2HWV Chalk	2TH2 Fawn Cypress	2TH4 Saddle Oak	2TH5 Veranda Teak	2TH7 Walnut Heights	2UH1 Reclaimed Aggregate	2UH2 Reclaimed Gravel	2UH4 Cement	2UH6 Sheetrock
Seating																												
Await	•	•	•	•	•	•	•	•	•	•	•	•	•	•	•	•	•	•	•	•	•	•	•	•	•	•	•	•
Coupe	•	•	•	•	•	•	•	•	•	•	•	•	•	•	•	•	•	•	•	•	•	•	•	•	•	•	•	•
Sidewalk Tablet	•	•	•	•	•	•	•	•	•	•	■	•	•	•	•	•	•	•	•	•	■	■	■	■	■	■	■	■
Occasional Tables																												
Await	•	•	•	•	•	•	•	•	•	•	•	•	•	•	•	•	•	•	•	•	•	•	•	•	•	•	•	•
Bob Tables	■	■	■	■	■	■	■	■	■	■	■	■	■	■	■	■	■	■	■	■	■	■	■	■	■	■	■	■
Circa Tables	■	■	■	■	■	■	■	■	■	■	■	■	■	■	■	■	■	■	■	■	■	■	■	■	■	■	■	■
Enea Lottus	■	■	■	■	■	■	■	■	■	■	■	■	■	■	■	■	■	■	■	■	•	•	•	•	•	•	•	•
Lagunitas Tables	■	■	■	■	■	■	■	■	■	■	■	■	■	■	■	■	■	■	■	■	■	■	■	■	■	■	■	■
Lagunitas Focus Nook	■	■	■	■	■	■	■	■	■	■	■	■	■	■	■	■	■	■	■	■	■	■	■	■	■	■	■	■
Montara650	■	■	■	■	■	■	■	■	■	■	■	■	■	■	■	■	■	■	■	■	■	■	■	■	■	■	■	■
SW_1	■	■	■	■	■	■	■	■	■	■	■	■	■	■	■	■	■	■	■	■	■	■	■	■	■	■	■	■
Tables and Casegoods																												
Ballet	■	■	■	■	■	■	■	■	■	■	■	■	■	■	■	■	■	■	■	■	■	■	■	■	■	■	■	■
Bob	■	■	■	■	■	■	■	■	■	■	■	■	■	■	■	■	■	■	■	■	■	■	■	■	■	■	■	■
E-Table 2 Top	■	■	■	•	•	•	■	■	■	■	■	■	■	■	■	■	■	■	■	■	■	■	■	■	■	■	■	■
E-Table 2 Laminate Base	•	•	■	■	■	■	■	■	•	•	•	•	•	•	•	•	•	•	•	•	•	•	•	•	•	•	•	•
Enea Lottus	■	■	■	■	■	■	■	■	■	■	■	■	■	■	■	■	■	■	■	■	•	•	•	•	•	•	•	•
Host Collection	■	■	■	■	■	■	■	■	■	■	■	■	■	■	■	■	■	■	■	■	■	■	■	■	■	■	■	■
Montara650	■	■	■	■	■	■	■	■	■	■	■	■	■	■	■	■	■	■	■	■	■	■	■	■	■	■	■	■
SW_1	■	■	■	■	■	■	■	■	■	■	■	■	■	■	■	■	■	■	■	■	■	■	■	■	■	■	■	■
Train	■	■	■	■	■	■	■	■	■	■	■	■	■	■	■	■	■	■	■	■	■	■	■	■	■	■	■	■

High-Pressure Laminate Matrix

Surface Materials - Glass

Glass

Not all glass selections are available on every product. Refer to glass matrix for availability by product.

Back-Painted Glass

6720	Sand
6721	Pewter
6722	Mojave
6723	Terra
6724	Jade
6725	Ocean
ACM	Moonlight
ACS	Sage
ACP	Poppy
ACG	Goldenrod
ACB	Black
ACC	Sea Salt/Crystal Spring

Glass

6511	Acid Etched
AC	Absolute Clear
CG	Clear Green

Surface Materials - Metal/Paint

Metal/Paint

Coalesse powder coats all painted metal components for an exceptionally durable, environmentally responsible finish — eliminating VOC's (volatile organic compounds) from being released into the environment. Electrostatically charged powder coat material is applied to an exacting thickness and then temperature baked, resulting in a smooth, flawless finish that is abrasion and impact resistant. The following Coalesse metal finishes are available:

Paint

Coalesse Standard Paint—Neutrals

Group 1

Standard Coat Paint

- 4138 Graphite Gloss
- 4140 Arctic White Gloss
- 4141 Platinum Matte
- 4142 Platinum Gloss
- 4144 Black Gloss (formerly anthracite gloss)
- 4145 Milk Gloss
- 4146 Champagne Matte
- 4147 Champagne Gloss
- 4148 Midnight Brown Gloss
- 4180 Graphite Matte
- 4193 Midnight Brown Matte
- 4242 Milk Matte
- 4710 Low Gloss Black
- 7196 Midnight Brown Textured
- 7197 Anthracite Textured

Coalesse Standard Paint—Colors

Group 1

- 4065 Blue Ink Textured
- 4066 Ocean Textured
- 4067 Ice Textured
- 4068 Olive Textured
- 4069 Honey Textured
- 4070 Currant Textured
- 4071 Saffron Textured

Steelcase Standard Paint

Accent Paints

Group 3

Allow customers to add trend-driven color to painted surfaces. We evolve this collection often, to ensure that fresh new colors are always available.

- 1ATG Rose Quartz
- 4AQB Wasabi
- 4AV3 Blue Jay
- 4AV4 Baltic
- 4AX1 Citron
- 4AY2 Chili
- 4AZ5 Marlin
- 4BH7 Canary
- 4CL1 Dark Olivine
- 4CL2 Ice Blue
- 4CL3 Aura
- 4CL4 Sea Glass
- 4CL5 Light Matcha
- 4CL6 Terra
- 4CL7 Sandstone
- 4CL8 Smokey Plum
- 4CZ5 Honey
- 4CZ6 Lagoon

Coatings

Group 3

- 1ATT Cast Shadow

Lux Coatings

Group 3

Introduces a softer, more human-centered aesthetic to the workplace. These powder coat paints provide tasteful accent for your spaces.

- 4B20 Obsidian
- 4B22 Matte Brass
- 4B23 Burnished Bronze
- 4B24 Night Bronze
- 4B25 Matte Copper
- 4B26 Smoked Mica
- 4B29 Cast Iron

Applies to: Enea

- 4018 Silver Metallic
- 4016 White Gloss
- 4017 Black Gloss

Applies to: Enea Lottus

- 4062 Anthracite Grey Textured
 - 4063 Cool Grey Textured
 - 4064 Sand Textured
 - 4216 Red*
 - 4217 Brown
 - 4218 Platinum Silver
 - 7207 Black Textured
 - 7241 Arctic White Textured
- *Not available on Enea Lottus tables.

Applies to: Exponents (Base, Accent Ribbon, Handle, and Grommet)

- 4135 Black Matte
- 4141 Platinum Matte

Applies to: Exponents mobile displays (Base, Handle, and Inner Frame)

- 4135 Black Matte
- 4145 Milk Gloss

Metal

Anodized Aluminum

Applies to: Rod or disc pulls
5200 Satin Aluminum

Polished Aluminum

Applies to: Lox chair, Potrero415, and Bindu conference bases
8046 Polished Aluminum

Applies to: Bob and SW_1

8040 Aluminum Matte Polished

Chrome

- 9201 Chrome
- 9207 Polished trivalent chrome
- 9208 Etched trivalent chrome

Brushed Nickel

Applies to: Millbrae seating and tables

- 9238 Brushed Nickel

Surface Materials - Metal/Paint

Metal/Paint Matrix

Legend

- = Not available
- = Available
- ▶ See specification pages for details.

Seating

Bindu Conference
Bindu Guest
Bix
Bob
Chord
Circa
Coupe
Enea
Enea Lottus
Lagunitas
Millbrae
Montara650
SW_1
Switch
Visalia
Wrapp

Occasional Tables

Bob
Circa
Enea Lottus
Lagunitas
Lagunitas Focus Nook
Millbrae
Montara650
Switch
SW_1

Coalesse Standard Paint—Neutrals																	Coalesse Standard Paint—Colors																	Product Line Exclusives				
4135 Black Matte	4138 Graphite Gloss	4140 Arctic White Gloss	4141 Platinum Matte	4142 Platinum Gloss	4144 Black Gloss	4145 Milk Gloss	4146 Champagne Matte	4147 Champagne Gloss	4148 Midnight Brown Gloss	4180 Graphite Matte	4193 Midnight Brown Matte	4242 Milk Matte	4710 Low Gloss Black	7196 Midnight Brown Textured	7197 Anthracite Textured	4065 Blue Ink Textured	4066 Ocean Textured	4067 Ice Textured	4068 Olive Textured	4069 Honey Textured	4070 Currant Textured	4071 Saffron Textured	LessThanFive	LessThanFive Essential	Enea Exclusive Finishes	Enea Café Wood Exclusive Finishes	Enea Lottus Exclusive Finishes											
Bindu Conference	•	•	•	•	•	•	•	•	•	•	•	•	•	•	•	•	•	•	•	•	•	•	•	•	•	•	•	•										
Bindu Guest	•	•	•	•	•	•	•	•	•	•	•	•	•	•	•	•	•	•	•	•	•	•	•	•	•	•	•	•										
Bix	•	■	■	•	■	■	■	■	■	■	■	■	■	■	■	■	■	■	■	■	■	■	■	■	■	■	■	■										
Bob	•	■	•	■	■	■	■	■	■	■	■	■	■	■	■	■	■	■	■	■	■	■	■	■	■	■	■	■										
Chord	•	•	•	•	•	■	•	•	•	•	•	•	•	•	•	•	•	•	•	•	•	•	•	•	•	•	•	•										
Circa	•	■	■	■	■	■	■	■	■	■	■	■	■	■	■	■	■	■	■	■	■	■	■	■	■	■	■	■										
Coupe	•	■	■	•	■	■	•	•	■	•	•	•	•	•	•	•	•	•	•	•	•	•	•	•	•	•	•	•										
Enea	•	•	•	•	•	•	•	•	•	•	•	•	•	•	•	•	•	•	•	•	•	•	•	•	■	•	•	•										
Enea Lottus	•	•	■	•	■	■	■	■	■	•	•	•	•	•	•	■	■	■	■	■	■	■	■	■	■	■	■	■										
Lagunitas	•	•	•	■	•	•	•	•	•	•	•	•	•	■	•	•	•	•	•	•	•	•	•	•	•	•	•	•										
Millbrae	•	■	•	■	•	■	■	•	■	■	■	■	■	■	■	■	■	■	■	■	■	■	■	■	■	■	■	■										
Montara650	•	■	•	■	•	■	■	■	■	■	■	■	■	■	■	■	■	■	■	■	■	■	■	■	■	■	■	■										
SW_1	•	•	•	•	•	•	•	•	•	•	•	•	•	•	•	•	•	•	•	•	•	•	•	•	•	•	•	•										
Switch	•	•	•	•	•	•	•	•	•	•	•	•	•	•	•	•	•	•	•	•	•	•	•	•	•	•	•	•										
Visalia	•	■	•	■	•	■	■	•	■	■	■	■	■	■	■	■	■	■	■	■	■	■	■	■	■	■	■	■										
Wrapp	•	•	•	•	•	•	•	•	•	•	•	•	•	•	•	•	•	•	•	•	•	•	•	•	•	•	•	•										
Bob	•	■	•	■	■	■	■	■	■	■	■	■	■	■	■	■	■	■	■	■	■	■	■	■	■	■	■	■										
Circa	•	■	■	■	■	■	■	■	■	■	■	■	■	■	■	■	■	■	■	■	■	■	■	■	■	■	■	■										
Enea Lottus	•	•	■	•	■	■	■	■	■	•	•	•	•	•	•	■	■	■	■	■	■	■	■	■	■	■	■	■										
Lagunitas	•	■	■	■	■	■	■	■	■	■	■	■	■	■	■	■	■	■	■	■	■	■	■	■	■	■	■	■										
Lagunitas Focus Nook	•	■	■	■	■	■	■	■	■	■	■	■	■	■	■	■	■	■	■	■	■	■	■	■	■	■	■	■										
Millbrae	•	■	•	■	•	■	■	•	■	■	■	■	■	■	■	■	■	■	■	■	■	■	■	■	■	■	■	■										
Montara650	•	■	•	■	•	■	■	■	■	■	■	■	■	■	■	■	■	■	■	■	■	■	■	■	■	■	■	■										
Switch	•	•	•	•	•	•	•	•	•	•	•	•	•	•	•	•	•	•	•	•	•	•	•	•	•	•	•	•										
SW_1	•	•	•	•	•	•	•	•	•	•	•	•	•	•	•	•	•	•	•	•	•	•	•	•	•	•	•	•										

Surface Materials - Miscellaneous

Convex Vinyl Edge Band

Applies to:

- E-Table 2:
- 6000 Black
- 6607 Woodrose
- 6609 Smoke
- 6655 Warm White

Plastic

Applies to:

- Enea
- 003 White
- 0013 Sunset Orange
- 0014 Clover Green
- 0015 Sand
- 0016 Walnut Brown
- 0017 Cool Grey
- 0400 Black
- 0405 Periwinkle
- 0406 Alabaster
- 0409 Red
- 0414 Anthracite Grey
- 0421 Blue

Applies to:

- Enea Lottus
- 003 White
- 0015 Sand
- 0017 Cool Grey
- 0400 Black
- 0414 Anthracite Grey
- 0422 Blue Ink
- 0423 Ocean
- 0424 Ice
- 0425 Olive
- 0426 Honey
- 0427 Currant
- 0428 Saffron

Tip: Not all colors available on all products. Consult the Enea plastic matrix for product line availability.

Applies to:

- Exponents and mobile display casters
- 6000 Black
- 6009 Arctic White

Applies to:

- Lox stools
- 6347 Black Gloss
- 6348 White Gloss

Applies to:

- SW_1 tablets, grommet, barrier, wire manager, sub-structure, lounge tablet, Sebastopol grommet
- 6000 Black
- 6052 Milk

Applies to:

- Grommet, spheres, flex-gangers, Mini-Port, Interport, casters, horizontal wire manager, and vertical wire manager
- Black plastic

Applies to:

- Lagunitas focus nook
- 6000 Black
- 6052 Milk
- 6D03 Graphite

TAP Power Module Door Finishes

Brushed Anodized Aluminum

Applies to:

- Host
- 8043 Silver
- 8044 Black

Utility Bay

Applies to:

- E-Table 2
- 4137 Matte Black
- 4745 Nickel Mica
- 4746 Silver Mica
- 4747 Charcoal Mica

Locks

Applies to:

- Exponents
- 9211 Nickel
- 9250 Ember Chrome

Solid

Applies to:

- Exponents and SW_1 tables
- 2801 Glacier White

Grommet

Applies to:

- Exponents
- 4135 Black Matte
- 4141 Platinum Black

Power, Voice Data Modules

Applies to:

- Exponents
- 4140 Arctic White Gloss
- 4141 Black Gloss

Glossy Laminate

Applies to:

- Sebastopol
- 2001 Smoky White Glossy
- 2002 Studio Grey Glossy
- 2003 Wrought Iron Glossy
- 2004 Black Pearl Glossy
- 2005 Liberty Red Glossy

Surface Materials - Miscellaneous

Ordering

How to Order

Coalesse furniture is available through authorized dealers and retailers. Select products are available for order from our web site. The authorized dealer can help you with everything from surface material selection and order placement, to specialized services, such as space planning and design, delivery and installation. Best of all, they are part of your local community, providing expert advice with a thorough understanding of local needs. For more information and a listing of dealers and retailers, visit www.coalesse.com or call 1.800.627.6770.

Coalesse reserves the right to limit distribution of any or all models.

Credit, Prices, and Terms

Credit may be established upon acceptance of satisfactory references. For payment terms, contact Coalesse's Credit Department. Coalesse may cancel or change credit terms at its discretion and may request advance payment at any time.

The order confirmation will be deemed by the customer and by Coalesse, as the final expression of agreement and will be deemed the exclusive statement of terms. The order confirmation supersedes all prior writings and may not be modified or rescinded, except by a revised Coalesse order confirmation signed by the customer. No changes are binding on Coalesse until delivery of the order confirmation.

Any storage charges and applicable sales taxes are in addition to the prices shown for merchandise. Inside delivery, uncartoning and installation are customer's responsibility unless separately quoted. All list pricing shown includes freight prepaid to one destination for delivery in the 48 contiguous United States. Hawaii and Alaska are not included. We reserve the right to increase prices without notice due to increases in labor and material costs. If timely payment is not made, customer is liable for reasonable collection costs, including attorney's fees.

Shipping and Storage

Coalesse reserves the right to select carrier and packaging method. Partial shipments may be delivered. Coalesse is not liable for delays or delivery failure due to strikes, lockouts, labor, or transportation difficulties, failure or delay of supply sources, accidents, fire, acts of God, or any other cause of like or unlike nature beyond Coalesse's control. Coalesse may transfer merchandise to storage if not accepted when shipment scheduled. Transfer and storage charges will be the customer's expense. Coalesse's invoice is payable upon transfer. If transfer is made prior to confirmed shipping date, storage expenses will be borne by customer.

Shipping charges MAY be calculated per order. Lead-times vary by product. Coalesse reserves the right to select carrier. Partial shipments may be delivered. Coalesse will make every effort to provide current and accurate lead-time information, however, Coalesse is not liable for delays or delivery failure due to strikes, lockouts, labor, or transportation difficulties, failure or delay of supply sources, accidents, fire, acts of God, or any other cause of like or unlike nature beyond Coalesse's control.

Freight is included on domestically manufactured products within the 48 contiguous states of the United States.

Claims

Merchandise shipped from Coalesse is thoroughly inspected and properly packed before leaving the factory. Responsibility of its safe delivery is assumed by the carrier at the time of shipment. Customer must match the freight delivered with the bill of lading. Customer must examine packaging material upon delivery and note any damage on the carrier bill of lading. If there is damage to the packaging material, inspect the furniture immediately. If concealed damage is found, contact the carrier within 10 days of delivery date. Save all packaging materials until after inspection.

Freight damage and claims must be reported by the purchaser to the carrier. Coalesse is not responsible for freight claims. Claims for loss or damage must not be deducted from our invoice, nor payment withheld awaiting adjustment of such claims. Do not return any merchandise to Coalesse without a Return Authorization number. By following these procedures carefully, Coalesse guarantees our full support of your claims to protect you against loss or damages. All claims against Coalesse for defects, errors or shortages must be made by customer in writing within ten (10) days after delivery. Failure to make claims within ten (10) days constitutes acceptance of merchandise and waives claims. Cutting of textiles deems acceptance of yardage and waives all defects, errors, and shortages. Coalesse is not liable for subsequent damages.

Special/Custom Products

Coalesse prides itself on being responsive to our customer's needs. Contact our Customer Service team at 1.800.627.6770 to discuss a special opportunity. Due to product modifications and engineering time, special orders may not be cancelled. Charges will apply.

FOR MORE INFORMATION (on ordering our products) Please contact Coalesse Customer Service at: 1.800.627.6770.

Order Cancellations/Changes

All order change/cancellation requests must be submitted using the Coalesse order change/cancellation request form. Late changes could jeopardize the committed delivery of an order.

Rapid10 program, no change or cancellations allowed.

Coalesse Products:

- No charges will be assessed for change or cancellation 14 or more calendar days prior to the manufacturing completion date (excludes holidays and/or large quantity project size orders). For import products, charges may apply.

- No manufacturing changes are allowed 0-13 calendar days prior to the manufacturing completion date. Simple changes including shipping address changes are subject to approval but will be accommodated when possible.

- No cancellations or product changes will be accepted for quick ship or special/custom product orders including special laminates. A cancellation fee will be applicable for any custom product and/or change may jeopardize lead time.

- If COM/COL has been received at time of change or cancellation, it is the dealer's responsibility to advise disposition or return of materials. Coalesse will not store materials after 30 days.

Additional Charges

- Changes or cancellations that involve any of the following may be subject to a charge earlier and/or greater than shown above: Special engineering product, CSM, pre-ordered components, materials with extended lead times (e.g., veneers, special paint, etc.) or large quantities of standard materials.

- Use our Order Change/Cancellation Request Form for all order changes. It is Coalesse responsibility to accurately process change order requests. It is the dealer's responsibility to verify that we have accurately interpreted your change requests by checking the acknowledgment after the change has been made. If you do not use the web-based change order form process and an error occurs during our translation which cannot be corrected prior to ship, all costs will be shared on a 50/50 basis. Changing ship dates or adding product to your order is subject to the availability of manufacturing capacity.

- Cartoning changes and shipping address changes are subject to approval and to a change charge. Please consult your Customer Service for specific information pertaining to your order.

Reserved Fabric Policy

Prior to order receipt, reserving textiles (COM/COL, Maharam, Designtex, and select Luna Select Surfaces) is the responsibility of the dealer. Coalesse cannot reserve textiles based on projected orders. Coalesse cannot guarantee Maharam or Designtex fabric availability. If dealer reserves Maharam or Designtex textiles, Coalesse will require the reserve number and zip code for locating purposes when ordering.

Schedule Enhancements

Coalesse will entertain schedule enhancements on a case-by-case basis; however, please understand that we must receive complete information such as installation date, opening date, etc., to make informed scheduling decisions.

No order move-ups or move-outs are allowed on any order that falls within the 15-working day period of its manufacturing completion date. If it is within the 15-working day period, Coalesse will invoice at shipment but may offer storage options at a charge for manufactured product.

Ordering

Surface Materials

ELMOSOFT, ELMORUSTICAL LEATHER CARE

Only the finest hides are used for Elmo leather. Expect some color variations from hide to hide due to the aniline state of the product. Color fading may occur if leather is exposed to direct or intense light. Care is required to allow this product to achieve the rich natural patina that beautiful natural leather develops. The hallmarks of this leather include some naturally occurring markings, such as healed scars, insect bites, stretch marks, and fat wrinkles. Elmorustical's leather treatment is very natural with little protection from spills or body oils. This rich leather will exhibit stains and oils through normal use. Coalesse is not responsible for discoloration, spotting, or staining on this leather.

Special Color Match Leather

Coalesse can provide a special color match in its leather to any supplier's leather color, paint color, carpet color, wall-paper color, etc. Sample to match must be submitted to Coalesse with purchase order. Sample for approval can be supplied if requested.

Note: Minimum order 2,500 sq. ft.

Special Fabric Applications

Backing*

• Backing information is found on each product page in the Coalesse Specification Guides. Select this option when ordering your product to have backing applied. Price varies by product according to yardage it requires.

*Prices subject to change without notice and an additional two week lead time will apply for 54" wide fabrics. Wider fabrics will require four week additional lead time. *Check fabric database to determine if backing is required at www.Coalesse.com.

Upholstery

All Coalesse textiles are priced by groups. Some Coalesse fabrics can be treated for flame retardancy, contact Customer Service. All Coalesse products are handcrafted making each unique. Certain fabrics and leathers will appear loose and may differ from like products due to comfort wrinkles when upholstered.

A contrasting welt is available on some products. Consult Customer Service for yardage or square feet requirements and prices. All stripes will be applied vertically unless customer specifies otherwise. Loose cushions on Coalesse products are not fully upholstered (not reversible).

Designtex, Maharam, and select Luna fabrics are graded in our pricing. Simply order Coalesse products with Designtex, Maharam, and select Luna specified. Designtex and Maharam fabrics are graded in on Coalesse products; however, Coalesse does not stock fabrics and can only respond based on Designtex and Maharam lead times. For current groups, refer to Coalesse website: www.Coalesse.com.

Pre-approved CAL 133 Textiles Designtex and Maharam textiles have been graded into our pricing; however, not all textiles are recommended on all seating. For current group and approval information, please visit our website and click on FABRICEVALUATIONS to obtain group pricing for a specific pattern.

Wood and Finish Specifications

Solid hardwood is a renewable natural resource, and each section of a tree is unique. The color and grain pattern will vary emphasizing the natural beauty of each product built. Wood is a natural material and will accept stain differently. Coalesse cannot guarantee finished products to be an exact match to finish samples due to the natural characteristics of wood. Light finishes will exhibit some mineral streaks and dark graining due to the natural wood.

The finish used by Coalesse on hardwood frames and occasional tables is pre-catalyzed lacquer which can be easily repaired in the field if damage occurs. Veneer is sanded prior to finish application, and sanded between coats. The lacquer top coat is then polished after final application with wool wax. 4 to 6 layers of finish are applied during the process. The CH process varies from our internal processes.

Coalesse Tables and Casegoods

Coalesse's primary wood finish, Clarity, is a water-borne UV topcoat, which protects the environment while providing exceptional durability and resistance to water and chemical stains. contoured products, such as wood guest chairs & occasional tables, are finished with post-catalyzed vinyl, which provides similar properties and matches the sheen and color of Clarity. due to natural variations in wood, finished products may vary from samples in color, texture, and grain.

Stain-To-Match Program

Coalesse will offer a stain to match program at no additional upcharge for all products with wood finish options.

Customer must supply Coalesse Customer Service with sample to be matched. (internal note - CSR's will have samples of bare wood to compare and define species when applicable that will be used to accomplish the closest stain to match).

Coalesse high sheen will be standard unless specified by customer.

Sheen to match is available as part of the stain/sheen to match program at no upcharge.

Species to match is considered a special and requires to special request to Coalesse Customer Service. Species to match may require an upcharge.

Care and Maintenance

Chrome

Use commercial cleanser and polish, according to manufacturer's directions.

Fabric

Under normal use, clean with soft cloth dampened with water. For spots and spills, we recommend professional cleaning. For COM, refer to the specific cleaning instructions recommended by the fabric supplier.

SW_1 Knit:

Clean with warm water and soap. Wet sponge and wipe fabric. Household cleaners such as Windex™ may be used. Do NOT use cleaners containing bleach.

Laminate and solid phenolic should be cleaned with soap and water. For stubborn stains, use a non-abrasive household cleaner.

SW_1 Tablet surfaces clean with soft cloth dampened with water and soap, if needed. The use of general purpose cleaners are acceptable but must be void of citric content that has z-butoxyethanol in the formulation listing.

Cleaning Laminate

Markerboard Surface

Use dry erase markers only. Remove dry-erase markings with a markerboard eraser or soft cloth as often as possible. Change erasers, as they become dirty. Dirty erasers will leave ink residue on the surface.

For daily cleaning, or as needed, use a dry erase cleaner, or a non-abrasive household cleaner, such as glass cleaner. This may be done with a soft cloth or sponge. Dry the surface with a soft cloth prior to writing. All markings should be removed weekly.

Caution:

- Do not use permanent markers on markerboard surfaces. In the event a permanent marker is used, removal of markings may be attempted by using dry erase cleaner, or by writing over the marking with a dry erase marker and erasing with a markerboard eraser or soft cloth.
- Do not use abrasive cleaners or solvent type cleaning solutions, such as Ketones (Acetone, MEK, etc.) lacquer thinner, nail polish remover, etc. because they may remove the finish from the markerboard surface.

Cleaning CeramicSteel

Markerboard Surface

- Care and maintenance applies to both a³ CeramicSteel and e³ CeramicSteel.
- Wipe board with a clean cloth moistened by a liquid markerboard cleaner or a solution of 50% water and 50% isopropyl alcohol.
- Rinse with clear water.
- Wipe dry with a clean cloth. If your board is used daily, the cleaning should be performed at least 2-3 times a week.

More thorough cleaning may be required if writing is left on the board for more than two days.

Markers

Use any high-quality dry erase marker.

CAUTION! The use of Low Odor markers may cause ghosting to occur. If Low Odor markers have been used, the surface can be completely cleaned by following the cleaning instructions above. Remember to discard eraser if used with Low Odor markers.

Removing Permanent Marker

Option 1:

- Write over the top of the permanent marker ink with a dry-erase marker
- Simply erase

Option 2:

- Moisten a clean, dry cloth with isopropyl alcohol
- Wipe the board in a circular motion to loosen marker residue
- Rinse with clear water
- Dry the board with a clean cloth
- Repeat these steps as necessary

Installer's Instructions for Initial Cleaning at Time of Installation

NOTE: These initial cleaning instructions are shipped with every board.

- For initial cleaning, wipe your board with a clean cloth moistened by a mild, alcohol-based cleaner.
- Rinse with clear water. This step is simple, but very important.
- Wipe dry with a clean cloth.

Leather

Under normal use, regular dusting and vacuum cleaning are all that is necessary. For spots and spills, wipe excess liquid immediately. If necessary, use lukewarm water cleaning the entire area where spot occurred and air dry. For stubborn spots or stains, use a solution of mild non-detergent soap and air dry. For butter, oil, or grease, wipe excess with dry cloth and then leave alone. The spot will dissipate into the leather. Do not apply water.

Faux Leather

Under normal use, clean with soft cloth dampened with water. For spots and stains, use the recommended mixture of Woolite and water. Rinse with clean water and air dry.

Granite/Glass

Under normal use, clean with Windex and soft cotton cloth.

Powder coat finishes on chairs and table bases

should be cleaned with a liquid detergent and water. Remove stubborn stains with liquid cleanser, such as Formula 409.

Polished Aluminum finishes on table bases

should be cleaned with a commercial powder, liquid, or paste metal cleaner and polish. Follow the manufacturer's directions.

Veneers and painted MDF

should be cleaned regularly with mild soap and water and dried with a soft cloth.

Tip: Never use ammonia-based cleaners or wax on wood surfaces.

Veneers should be cleaned regularly with mild soap and water and dried with a soft cloth.

Tip: Never use ammonia-based cleaners or wax on wood surfaces.

Protecting Wood Surfaces

Use desk pads and coasters to help protect the finish against dents, scratches, moisture and hot and cold liquids. Do not use desk pads that have plastic backing. Use felt or leather pads on the bottoms of office equipments and accessories.

Periodically move desk accessories and other objects kept on the worksurface to ensure even aging.

Lift objects when you move them, instead of pulling or pushing them across the surface, to avoid scratching the surface. Avoid leaving vinyl binders on worksurface for long periods.

If you use a protective glass top, insert felt pads between the glass and the worksurface to create an air space and allow the wood to breathe.

Keep your furniture away from direct sunlight. Avoid extreme temperatures and humidity. Maintain temperatures between 60 and 80 degrees Fahrenheit and humidity levels between 30 and 50 percent.

Cleaning Wood Surfaces

Keep a supply of soft, clean, absorbent cloths handy for wiping up spills and regular dusting.

To dust, wipe with a slightly damp, soft cloth, using another soft cloth to dry. Always wipe the surface in the direction of the woodgrain.

Use a quality cleaner or flax soap formulated especially for use on wood surfaces. Do not use oils or ammonia. Dilute the cleaner as directed by the manufacturer. Dampen but do not saturate a soft cloth with the diluted cleaning solution. Wipe the surface in the direction of the woodgrain to remove dirt and fingerprints. Wipe the surface clean with a soft, dry cloth.

Care and Maintenance

Vinyl

Under normal use, clean with soft cloth dampened with mild soap solution. For stubborn stains and spills, a sponge or soft brush may be used with mild non-abrasive cleaner.

Transolid/Corian:

Clean regularly with mild soap and water. Dry with a soft cloth.

Tables should be inspected and maintained regularly by tightening screws and bolts, inspecting casters and glides for damage, and inspecting all moving parts for damage and wear.

Resources



Lock and Keying	216
Style Number Index	218

Lock and Keying

All locking products are standard with factory-installed, keyed-random locks. Consecutive, specific, and random keying are available as field-installed options. *Exceptions: Individual locking drawers are only available with field-installed locks. Overfiles are only available with factory-installed locks.*

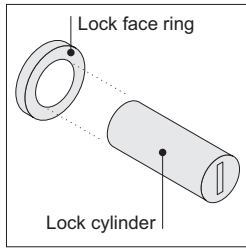

Locks consist of a factory- or field-installed lock cylinder and a factory-installed lock face ring.

Two types of locks are available—the standard keying system (FR series) and the master keying system (XF series). All the locks in the XF series can be opened with a single master key.

Factory-Installed Keying

Factory-installed locks are always key random (standard) or master key random (option). Key random means that the locks will be assigned arbitrarily at the factory with key numbers ranging from FR305 to FR999 (Master keying numbers: XF1001 to XF3000). All locks within a unit will be keyed alike.

Tip: Random keying can mean that different furniture units will have the same key number. If you must have all locks keyed differently, you should specify field-installed, key specific or key consecutive lock cylinders.

▶ See example at right

Key Random

FR305

FR421

FR305

or

XF1011

XF1042

XF1011

XF
Master
Key

Required to Specify

Master key random	+ \$37	Specify with master key random.
--------------------------	--------	---------------------------------

Field-Installed Keying

Field-installed locks are only available on products that include factory-installed lock mechanisms.

Specify "plug" when specifying furniture, and the product will ship without the lock cylinder.

Tip: Lock tools are reusable. You do not need to order additional lock tools with every furniture order.

Lock cylinders will be shipped separately so that you can install the locks when you are ready.

Front-removable lock cylinders must be specified separately. You must also order a special lock tool to install or remove lock cylinders in the field.

Three keying choices are available for field installation—random (standard), specific, and consecutive. All three are also available with master keying, which means that all locks can be opened with a single master key.

Key random means that the locks will be assigned arbitrarily at the factory with key numbers ranging from FR305 to FR999 (Master keying numbers: XF1001 to XF3000).

Tip: Random keying can mean that different furniture units will have the same key number. If you must have all locks keyed differently, you should specify key specific or key consecutive lock cylinders.

Key specific means that you can specify any key number from FR305 to FR999 (Master keying numbers: XF1001 to XF3000). This option can be used to key all the furniture units in a workstation or department the same.

Tip: Designate the quantity per key number in your specification.

▶ See below.

Key consecutive means that you can specify lock numbers in a consecutive order to ensure that no two locks have the same key number until the key sequence repeats. You must select a beginning key number from FR305 to FR999 (Master keying numbers: XF1001 to XF3000).

Example of a typical lock cylinder specification is shown below:

10	LOCKFR FR320
5	LOCKFR FR350
15	LOCKXF XF1100

30	Total
1	877102003SR standard lock tool
1	877102002SR master lock tool

Key Random

FR305

FR421

FR305

or

XF1011

XF1042

XF1011

XF
Master
Key

Key Specific

FR350

FR350

FR350

or

XF1020

XF1020

XF1020

XF
Master
Key

Key Consecutive

FR350

FR351

FR352

or

XF1020

XF1021

XF1022

XF
Master
Key

Lock and Keying

Field-Installed Lock Cylinders

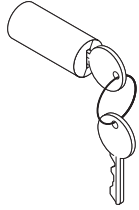

Tip: Lock price is included in price of furniture with locks.

Standard Includes	Required to Specify
<ul style="list-style-type: none"> • Lock cylinder • Two keys 	1 Style number 2 Lock finish 9201 Polished Chrome 9250 Ember Chrome 3 Options, if selected (see below)

Options	Price	Required to Specify
Key specific	No cost	Select key number from FR305–FR999.
Key consecutive	No cost	Specify <i>key consecutive</i> and must select beginning key number from FR305–FR999.
Master key random	+\$37 each	Specify master key random.
Master key specific	+\$37 each	Specify key number from XF1001–XF3000.
Master key consecutive	+\$37 each	Specify <i>master key consecutive</i> and must select beginning key number from XF1001–XF3000.

Specification Information

Style Number	Base Price
--------------	------------

FR Series (Standard Keying System)—Lock Cylinder

LOCKFR	No cost
--------	---------

Standard Lock Tool

877102003SR	\$37
-------------	------

XF Series (Master Keying System)—Lock Cylinder

LOCKXF	No additional cost. Price included in price of furniture with master-keyed locks.
--------	---

Master Lock Tool

877102002SR	\$37
-------------	------

Tip: For replacement lock cylinders, refer to Service Parts.

Tip: You can change lock cylinders in the field by using the appropriate lock tool.

Style Number Index

Style Number	Page	Description	Style Number	Page	Description
1404M	148	Switch Counter-Height Stool	451-7460FI	51	Circa 60° Inside Wedge Loveseat
1404PC	148	Switch Counter-Height Stool	451-7460FO	51	Circa 60° Outside Wedge Loveseat
1405M	148	Switch Bar-Height Stool	451-A1800ER	54	Circa Straight Armrest
1405PC	148	Switch Bar-Height Stool	451-A1800G	54	Circa Straight Armrest
216	48	Bob Lounge Swivel Chair	451-A1815FIER	54	Circa 15° Inside Armrest
221	48	Bob Lounge Chair w/Headrest	451-A1815FIG	54	Circa 15° Inside Armrest
221-H	49, 135	Bob Ottoman	451-A1815FOER	55	Circa 15° Outside Armrest
231	135	Bob Guest Chair	451-A1815FOG	55	Circa 15° Outside Armrest
2540-1	146	Kathryn Wood with Open Back	451-A3730FIER	55	Circa 30° Inside Armrest
2542-1	146	Kathryn Wood/Uph with Panel Back	451-A3730FIG	55	Circa 30° Inside Armrest
2547-1	146	Kathryn Fully Uphol Back	451-A3730FOER	55	Circa 30° Outside Armrest
2547-1RIBD	147	Kathryn Fully Uphol Back w/Ribbed uph	451-A3730FOG	55	Circa 30° Outside Armrest
391	118	Switch Chair	451-B42RD	55	Circa Round Ottoman
391-2	118	Switch Two-Seat	451-B5000	52	Circa Straight Bench
391-3	119	Switch Three-Seat	451-B7460FI	51	Circa 60° Inside Wedge Bench
391-4	119	Switch Two-Seat w/Extensions	451-B7460FO	51	Circa 60° Outside Wedge Bench
391-B	119	Switch Arm Bolster	451-GANGPKG	52, 55	Circa Ganging Kit
430-B1724	72	Sidewalk Bench	46-T1	168	Await Freestanding Table
430-B1736	72	Sidewalk Bench	46-T2	168	Await Freestanding Table
430-B1748	72	Sidewalk Bench	460-3	33	Await Modular Three-Seat Lounge
430-H1717	71	Sidewalk Collaborative Ottoman	460-4	33	Await Modular Four-Seat Lounge
430-H1720	71	Sidewalk Collaborative Ottoman	460-4B	33	Await Modular Four-Seat Bench
430-H2026	71	Sidewalk Collaborative Ottoman	460-GANGPKG	34	Ganging Kit
430-H3636	72	Sidewalk Ottoman	460-H	33	Await Modular Ottoman
440-2WB	114	Passerelle Two-Seat Lounge	460-SE22	35	Await Lounge Table
440-3WB	115	Passerelle Three-Seat Lounge	460-SE22PD	35	Await Lounge Table
440-B	69, 115	Passerelle Arm Bolster	460-SE30	35	Await Lounge Table
440-B2060WB	116	Passerelle Bench	460-SE30PD	35	Await Lounge Table
440-B3060WB	116	Passerelle Bench	460-SE44	35	Await Lounge Table
440-WB	114	Passerelle Chair	460-SE44PD	35	Await Lounge Table
444	68	Sidewalk Lowback Chair	461-1B	34	Await Connector Bench
444-2	69	Sidewalk Two-Seat	461-2B	34	Await Connector Bench
444M	69	Sidewalk Lowback Chair w/Tablet	461-3B	34	Await Connector Bench
446	69	Sidewalk Highback Chair	470	61	Coupe Lounge Chair
446M	69	Sidewalk Mobile Highback Chair w/Tablet	476	62	Coupe Grande Chair
45-T1300H	58	Circa Freestanding Table	476M	62	Coupe Grande Chair
45-T1300HER	57	Circa Ganging Table	490-B35HRZ	67	Ripple Bench
45-T1300HG	57	Circa Ganging Table	490-B35VRT	66	Little Ripple Wave Bench
45-T1300LER	57	Circa Ganging Table	490-B96HRZ	66	Ripple Flat Seat Bench
45-T1300LG	57	Circa Ganging Table	490-B96VRT	66	Ripple Wave Bench
45-T1815H	56	Circa Freestanding Table	70-C-TPM	175	Tree Bevel High-Embossed Wood
45-T1815HER	56	Circa Ganging Table	70-D-TPM	175	Tree Bevel Medium-Embossed Wood
45-T1815HG	56	Circa Ganging Table	795	162	Chord Conference Chair
45-T1815LER	56	Circa Ganging Table	795AU	162	Chord Conference Chair
45-T1815LG	56	Circa Ganging Table	796	163	Chord Midback Chair
45-T28HER	58	Circa Ganging Table	796-P	163	Chord Midback Chair
45-T3730HER	57	Circa Ganging Table	796-PAU	163	Chord Midback Chair
45-T3730HG	57	Circa Ganging Table	796AU	163	Chord Midback Chair
45-T3730LER	57	Circa Ganging Table	797	163	Chord High Back Chair
45-T3730LG	57	Circa Ganging Table	797AU	163	Chord Midback Chair
45-T42RD	59	Circa Freestanding Table	798	163	Chord High-Back Chair
451-2500	52	Circa Straight Seat Chair	798-P	163	Chord High-Back Chair
451-3730FI	51	Circa 30° Inside Wedge Armless Seat	798-PAU	163	Chord Midback Chair
451-3730FO	50	Circa 30° Outside Wedge Seat	798AU	163	Chord Midback Chair
451-5000	52	Circa Straight Loveseat	877102002SR	217	Master Lock Tool

Style Number Index

Style Number	Page	Description	Style Number	Page	Description
877102003SR	217	Standard Lock Tool	COEL4236	172	Enea Lottus Café Bar-Height Table
BB48	43	Bix Bench	COEL4242	172	Enea Lottus Café Bar-Height Table
BB72	43	Bix Bench	COEL500	142	Enea Lottus Sled-Base Stool
BL26AA	38	Bix Lounge Chair with Arms	COEL500INSERT	142	Enea Lottus Sled-Base Stool
BL26XX	38	Bix Lounge Chair	COEL500UPH	142	Enea Lottus Sled-Base Stool
BLB26XX	38	Bix Lounge Chair with Screen	COEL600	145	Enea Lottus Post-Base Stool
BLD26AA	39	Bix Sled Lounge with Arms	COEL600INSERT	145	Enea Lottus Post-Base Stool
BLD26TX	39	Bix Sled Lounge Tablet Arm	COEL600UPH	145	Enea Lottus Post-Base Stool
BLD26XT	39	Bix Sled Lounge Tablet Arm	COEL700	144	Enea Lottus Post-Base Stool
BLD26XX	39	Bix Sled Lounge	COEL700INSERT	144	Enea Lottus Post-Base Stool
BSE54LX	40	Bix Sectional Seating	COEL700UPH	144	Enea Lottus Post-Base Stool
BSE54RX	40	Bix Sectional Seating	COELDOLLY	139	Enea Lottus Stacking Dolly
BSS48XX	40	Bix Sectional Seating	COH350W27	137	Enea Wood Café Stool, Counter-Height
BSS72XX	41	Bix Sectional seating	COH350W31	137	Enea Wood Café Stool, Bar-Height
BSSB48XX	40	Bix Sectional Seating	COH352W27	136	Enea Wood Café Stool, Counter-Height Upholstered
BSSB72XX	41	Bix Sectional Seating	COH352W31	136	Enea Wood Café Stool, Bar-Height Upholstered
CO200G	134	Bindu-Low Back Guest/Side Chair	COH353W27	137	Enea Wood Café Stool, Counter-Height
CO300	160	Bindu-Mid Back Executive Chair	COH353W31	137	Enea Wood Café Stool, Bar-Height
CO300G	134	Bindu-Mid Back Guest/Side Chair	COJHB100	132	Visalia Lounge
CO400	160	Bindu Mid-Back High Back Executive Chair	COJHB200	132	Visalia Lounge
CODAV	73	Davos Chair	COJHBC100	132	Visalia Lounge
CODAV16	73	Davos Small Bench	COJHBC200	132	Visalia Lounge
CODAV38	73	Davos Medium Bench	COJHL100	131	Visalia Lounge
CODAV60	73	Davos Large Bench	COJHL200	131	Visalia Lounge
COEB2723H	174	Sebastopol 22" High Table	COJHL300	131	Visalia Lounge
COEB2723L	174	Sebastopol 16" High Table	COJHLC100	131	Visalia Lounge
COEB4118H	174	Sebastopol 22" High Table	COJHLC200	131	Visalia Lounge
COEB4118L	174	Sebastopol 16" High Table	COJHLC300	131	Visalia Lounge
COEL100	138	Enea Lottus Armless Chair	COLAGB1	109	Lagunitas 1-Seat Bench
COEL100INSERT	138	Enea Lottus Armless Chair	COLAGB2	109	Lagunitas 2-Seat Bench
COEL100UPH	138	Enea Lottus Armless Chair	COLAGB3	109	Lagunitas 3-Seat Bench
COEL1830	169	Enea Lottus Occasional Table	COLAGCH2	102	Lagunitas 2-Seat Chaise
COEL1836	169	Enea Lottus Occasional Table	COLAGCH3	106	Lagunitas 3-Seat Chaise
COEL1842	169	Enea Lottus Occasional Table	COLAGCI	111	Alignment Connector
COEL200	140	Enea Lottus Cantilever Arm Chair	COLAGCL2	101	Lagunitas 2-Seat Chaise
COEL200INSERT	140	Enea Lottus Cantilever Arm Chair	COLAGCL3	105	Lagunitas 3-Seat Chaise
COEL200UPH	140	Enea Lottus Cantilever Arm Chair	COLAGFN	113	Lagunitas Focus Nook
COEL300	141	Enea Lottus Aluminum Loop Arm Chair	COLAGLBS	110	Lounge Booth Screen
COEL300INSERT	141	Enea Lottus Aluminum Loop Arm Chair	COLAGLH11	85	Lagunitas 1-Seat Lnge w/ High-Bk Scrn
COEL300UPH	141	Enea Lottus Aluminum Loop Arm Chair	COLAGLH13	85	Lagunitas 1-Seat Lnge w/ HB Scrn, 2 Side Scrns
COEL3030	170	Enea Lottus Conference Table	COLAGLH21	89	Lagunitas 2-Seat Lnge w/ High-Bk Scrn
COEL303072	173	Enea Lottus Rectangular Table	COLAGLH22	90	Lagunitas 2-Seat Lnge w/ HB Scrn, 1 Side Scrn
COEL3036	170	Enea Lottus Conference Table	COLAGLH23	91	Lagunitas 2-Seat Lnge w/ HB Scrn, 2 Side Scrns
COEL3042	170	Enea Lottus Conference Table	COLAGLH31	97	Lagunitas 3-Seat Lnge w/ High-Bk Scrn
COEL3624	171	Enea Lottus Café Counter-Height Table	COLAGLH32	98	Lagunitas 3-Seat Lnge w/ HB Scrn, 1 Side Scrn
COEL3630	171	Enea Lottus Café Counter-Height Table	COLAGLH33	99	Lagunitas 3-Seat Lnge w/ HB Scrn, 2 Side Scrns
COEL363072	173	Enea Lottus Rectangular Table	COLAGLL11	84	Lagunitas 1-Seat Lnge w/ Low-Bk Scrn
COEL3636	171	Enea Lottus Café Counter-Height Table	COLAGLL13	84	Lagunitas 1-Seat Lnge w/ LB Scrn, 2 Side Scrns
COEL3642	171	Enea Lottus Café Counter-Height Table	COLAGLL21	88	Lagunitas 2-Seat Lnge w/ Low-Bk Scrn
COEL400	143	Enea Lottus Sled-Base Stool	COLAGLL22	88	Lagunitas 2-Seat Lnge w/ LB Scrn, 1 Side Scrn
COEL400INSERT	143	Enea Lottus Sled-Base Stool	COLAGLL23	89	Lagunitas 2-Seat Lnge w/ LB Scrn, 2 Side Scrns
COEL400UPH	143	Enea Lottus Sled-Base Stool	COLAGLL31	94	Lagunitas 3-Seat Lnge w/ Low-Bk Scrn
COEL4224	172	Enea Lottus Café Bar-Height Table	COLAGLL32	95	Lagunitas 3-Seat Lnge w/ LB Scrn, 1 Side Scrn
COEL4230	172	Enea Lottus Café Bar-Height Table	COLAGLL33	96	Lagunitas 3-Seat Lnge w/ LB Scrn, 2 Side Scrns
COEL423072	173	Enea Lottus Rectangular Table	COMF1	81	Millbrae Ganging Kit

Style Number Index *continued*

Style Number	Page	Description	Style Number	Page	Description
COMFL1	77	Millbrae Lounge	COW413	164	SW_1 Conference Chair
COMFL2	78	Millbrae Lounge	COW415	164	SW_1 Conference Chair
COMFL3	79	Millbrae 3-Seat Lounge	COW613	121	SW_1 Low-Back Collaborative Lounge Chair
COMFL4	80	Millbrae 4-Seat Lounge	COW713	121	SW_1 High-Back Collaborative Lounge Chair
COMFLA1	77	Millbrae Lounge	COWK100	64	Joel Lounge
COMFLA2	78	Millbrae 2-Seat Lounge	COWRP4LEG	158	Wrapp Chair, 4 Leg
COMFLA3	79	Millbrae 3-Seat Lounge	COWRPSLD	158	Wrapp Chair, Sled-Base
COMFLA4	80	Millbrae 4-Seat Lounge	LOCKFR	217	Lock Cylinder
COMFLB1	81	Millbrae 1-Seat Bench	LOCKXF	217	Lock Cylinder
COMFLB2	81	Millbrae 2-Seat Bench			
COMFLB3	81	Millbrae 3-Seat Bench			
COMFLB4	81	Millbrae 4-Seat Bench			
COMFLLA1	77	Millbrae Lounge			
COMFLLA2	78	Millbrae 2-Seat Lounge			
COMFLLA3	79	Millbrae 3-Seat Lounge			
COMFLLA4	80	Millbrae 4-Seat Lounge			
COMFLRA1	77	Millbrae Lounge			
COMFLRA2	78	Millbrae 2-Seat Lounge			
COMFLRA3	79	Millbrae 3-Seat Lounge			
COMFLRA4	80	Millbrae 4-Seat Lounge			
COMLPRND	81	Millbrae Round Arm Bolster			
COMLPSQR	81	Millbrae Square Arm Bolster			
COMSL1	77	Millbrae Lounge			
COMSL2	77	Millbrae 2-Seat			
COMSL3	77	Millbrae 3-Seat			
COSFZCH	151	Montara650 Chair			
COSFZLC	153	Montara650 Lounge			
COSFZRC	157	Montara650 Rocker			
COSFZST	154-155	Montara650 Stools			
COTO12369L15	125	Together Bench			
COTO12369L8	125	Together Bench			
COTO12369R15	127	Together Bench			
COTO12369R8	126	Together Bench			
COTO12396L15	125	Together Bench			
COTO12396L8	125	Together Bench			
COTO12396R15	127	Together Bench			
COTO12396R8	126	Together Bench			
COTO69	129	Together Bench			
COTO69WB15	128	Together Bench			
COTO69WB8	128	Together Bench			
COTO96	129	Together Bench			
COTO9669L15	125	Together Bench			
COTO9669L8	124	Together Bench			
COTO9669R15	127	Together Bench			
COTO9669R8	126	Together Bench			
COTO9696L15	125	Together Bench			
COTO9696L8	124	Together Bench			
COTO9696R15	127	Together Bench			
COTO9696R8	126	Together Bench			
COTO96WB15	128	Together Bench			
COTO96WB8	128	Together Bench			
COURQL	75	Hosu Lounge w/Attached Lumbar			
COURQLO	75	Hosu Lounge w/Otto and Attached Lumbar			
COURQS	75	Hosu 2-Seat Lounge			
COW210	121	SW_1 Ottoman			

Style Number Index

Trademark List

™/® The following is a non-exhaustive list of trademarks and registered trademarks for products of Steelcase Inc. or one of its related corporate entities: Agree, Airtouch, Alight, Amia, Answer, Apprise, Aspekt, Avenir, Await, B-Free, Ballet, Bassline, Bindu, Bivi, Bix, Bottomline, Brody, Buoy, Cachet, Campfire, Capa, CF Series, CG_1, Chord, Circa, Clipper, Cobi, Collaboration, Convene, Coupe, Cura, Currency, dash, Divisio, Duo, E-Table 2, Edge Series, Elbrook, Elective Elements, Embold, Empath, Everwall, Exponents, Folio, FrameOne, Gesture, Groupwork, Host, Hosu, i2i, Jenny, Kart, Kathryn, Kick, Lagunitas, Leap, Leela, LessThanFive, LiveBack, LiveSeat, Mackinac, Marien152, Max-Stacker, media:scape, Migration, Millbrae, Mineral, Mitra, Montage, Montara650, MoreThanFive, Move, Node, Ocular, Ology, Opus, Paperflo, Passerelle, Player, Pocket, Potrero415, QiVi, Radia, Regard, Relay, Reply, Ripple, Roam, Sarto, Scoop, Sebastopol, Senti Series, Senza, Shortcut, Sidewalk, Siento, Sieste, SILQ, Soffio, Sorrel, SOTO, Steelcase Eclipse, Steelcase Flex, Steelcase Karman, Steelcase Relay, Steelcase Rise, Steelcase Series, Surround, SW_1, Switch, Sync, Tava, Tenor, Think, Thoughtful, Thread, Together, Train, Trees, Turnstone, Umami, Underscore, V.I.A., Verb, Verge, Verlay, Victor2, Visalia, WorkValet, and X-tenz.

™/® The following are trademarks or registered trademarks of AMQ Solutions, LLC: 3F, Activ, Amobi, Bixby, Bodi, Cluvo, Concur, Embank, FL-X, Iline, Jaku, Kinex, Personality Plus, Revi, S-Series, Siya, Tektis, Tizu, Uptake, and Zilo.

™/® The following are trademarks or registered trademarks of Orangebox Ltd., Cardiff, UK: Air3, Aspect, Avi, Away from the Desk, Border, Campers & Dens, Coppice, Cubb, Kirm, On the QT, Ramsey, Skomer, Sully, Track-B, and Vale.

™/® The following are trademarks or registered trademarks of Viccarbe Habitat, S.L.: Aleta, Cambio, Designed in The Sun, Foro, Funda, Holy Day, Kelly, Last Minute, Noha, Savina, Sistema, Sistema, Viable, and Wrapp.

® The following are registered brands of Steelcase Inc. and its family of companies: Steelcase, AMQ, Coalesse, Designtex, Halcon, Orangebox, Smith System, and Viccarbe.

® The following registered trademarks are under license from AWI Licensing Company, Dover, DE: SoundScapes, DuraBrite, BioBlock, and Armstrong.

® The following registered trademarks are under license from Byrne Electrical, Rockford, MI: Interport, Mini-Port, Axil Z, and Ellora.

® The following is a registered trademark of DuPont, Wilmington, DE: Corian.

® The following is a registered trademark of Genlyte Thomas Company, Louisville, KY: Lightolier.

® The following is a registered trademark of Hilti Corporation, FL-9494 Schaan, Principality of Liechtenstein: Hilti.

® The following is a registered trademark of Leviton Manufacturing Company, Little Neck, NY: Decora.

® The following is a registered trademark of Mechanical Plastics Corp, Elmsford, NY: Toggler.

® The following is a registered trademark of Microsoft Corporation, Redmond, WA: Microsoft.

® The following are registered trademarks of Orangebox Ltd., Cardiff, UK: Orangebox.

® The following is a registered trademark of Panduit Corporation, Lockport, IL: Panduit.

® The following is a registered trademark of Trav (Press), Cuneo, Italy: Assisa.

® The following is a registered trademark of Virtual Ink, Boston, MA: mimioActive.

® The following registered trademarks are under license from Wilkhahn Furniture Products: Avera, Senzo, Versal, and Wilkhahn FS.

® The following are registered trademarks of Polyvision Corp: Flow, Motif, Polyvision, Sans, and Serif.

® The following is a registered trademark of Wilsonart International, Temple, TX: Chemsurf.

® The following is a registered trademark of Wiremold, West Hartford, CT: Wiremold.

® The following is a registered trademark of EMU Group S.P.A., Perugia, Italy: EMU.

® The following is a registered trademark of Security People, Inc.: Digilock.

® The following are registered trademarks of Natural Capital Partners Europe Limited: CarbonNeutral and the CarbonNeutral Certified logo.

™ The following is a trademark of Microsoft Corporation, Redmond, WA: Windows.

™ The following is a trademark of Rodman Industries, Inc., Oconomowoc, WI: ResinCore1.

™ The following is a trademark of Ultrafabrics, LLC, Elmsford, NY: Ultraleather.

™ The following trademarks are under license from Wilkhahn Furniture products: Cana, Linus, Logon, Picto, Range, Stitz, Thema, Timetable, and Tubis.

™ The following trademarks are under license from Walter Knoll: Andoo, Bob, Lazlo, Lox, Ribbon, and Together.

™ The following trademarks are under license from PP Mobler: Bar and Flag Halyard.

™ The following trademarks are under license from Carl Hansen: Elbow, Paddle, Shell, Wing, and Wishbone.

™ The following trademarks are under license from Cambridge Sound Management, LLC Cambridge, MA: QtPro Soundmasking, Qt Quiet Technology, and Sonet Qt.

™ The following is a trademark of Electri-Cable Assemblies, Shelton, CT: Interact.

™ The following is a trademark of Clestra Hauserman: IRYS.

™ The following is a trademark of Wiesner-Hager Möbel GmbH: Nooi.

™ The following are trademarks of Polyvision: Accord, a3, e3, Boundri, and Nota.

™ The following is a trademark of Bostock Company, Inc: SnapCab.

™ The following is a trademark of Williams-Sonoma, Inc: West Elm.

™ The following is a trademark of Elena Marquina Testor: nanimarquina.

™ The following is a trademark of Forbo International SA: Forbo.

Trademarks used herein are the property of Steelcase Inc. or their respective owners.