



# Orangebox Specification Guide

## Availability

**Electronic price list updated** with release 200.G (U.S.) and 156.G (Canada), dated June 19, 2023.

All specifications subject to change without notice. Reference the electronic catalog/Hedberg for current pricing.

Transitional products in this specification guide are **maintained for existing customers only** and are likely to be phased out over time. These products are indicated with a . Products that are scheduled to be culled are indicated with an , followed by the last order entry date.

## Surface Materials

**The surface materials team** has announced the launch of the Finish Library, found at <https://finishlibrary.steelcase.com/>.

► For a list of all trademarks, refer to the last page of this specification guide. © 2023 Steelcase Inc.

## Working with This Specification Guide

Ten Tips: How to Get The Most Out of This Book	2
Additional Resources	4

## Statement of Line

6

## Product Details

Air <sup>3</sup>	16
On the QT	22
Aspect	26
Avi	28
Sully, Ramsey, and Skomer	29
Border	30
Away from the Desk	32
Cubb Seating and Tables	36

## Specifying

41

## Style Number Index

188



### For Canadian Pricing

Canadian factor can be found at [www.steelcase.com/CADpricing](http://www.steelcase.com/CADpricing).

Calculate in the following order to avoid rounding errors:

- Multiply the base price and each option by the Canadian factor.
- Round each to the nearest dollar.
- Add base and options for total list price.

# Ten Tips: How to Get the Most Out of This Book

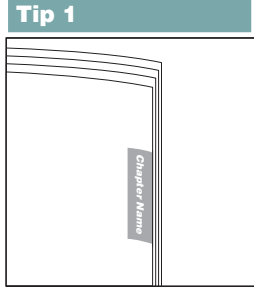

**Watch** the tabs on the right-hand edges of the pages. They'll always indicate which chapter you are in.

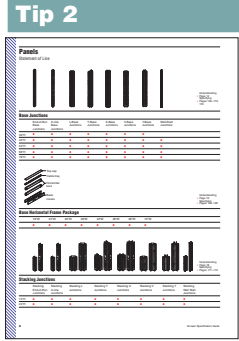

**Use the Statement of Line pages** for an overview of the available components, their sizes, and page references for additional information. Each *Understanding* chapter includes a statement of line after the table of contents.

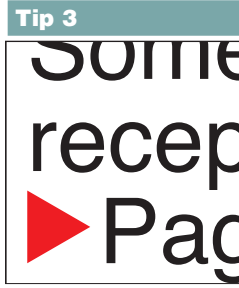

**Find cross references** by looking for page numbers flagged with an arrow.

**Tip 4**  
**Study the product detail pages** in the *Understanding* section to learn everything an expert knows about specific products. Each product detail page in this section contains the following features, where applicable:

- Product Drawing
- Actual Dimensions
- Product Details
- Connections
- Wiring and Cabling
- Surface Materials
- Application Topics

**Product Drawing** shows you what the product looks like and points out important features.

**Product Details** gives specific information on the product and how it is used.

**Connections** describes how the product is assembled or how it attaches to another product.

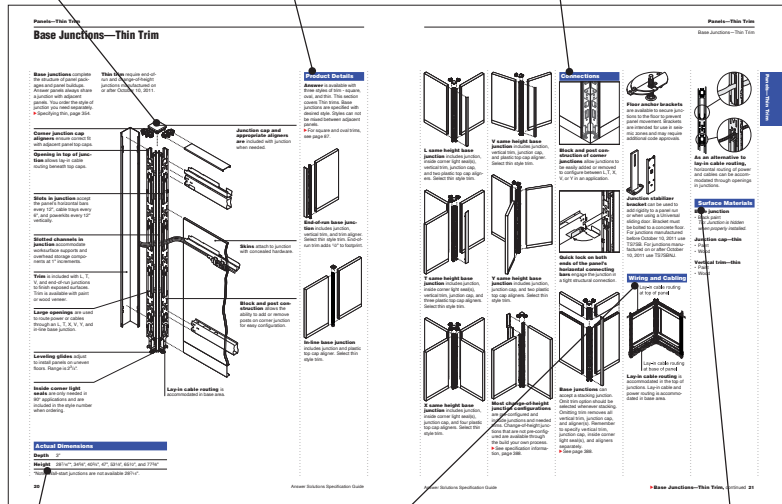

**Actual Dimensions** table lists the dimensions of the product.

**Wiring and Cabling** details the power and cable-management and cable routing capabilities of the product.

**Surface Materials** lists what material is used for each part of the product.

**Tip 5**

**Refer to the specifying pages** for all the information needed to order a product. Each product specifying page contains a variety of elements to help you complete a specification:

- Product Drawing
- Standard Includes
- Options
- Specification Information
- Dimensions
- Style Number
- Price

**Product Drawing** shows you what the product looks like.

**Standard Includes** (under the red or dark grey band) provides a list of what comes standard with the product.

**Specification Information** (under the teal or light grey band) provides product dimensions, style numbers, and prices for the standard product and any surface material choices that are available.

**Base Horizontal Frame Packages—Thin Trim**  
Full Panel Buildups

Standard Includes		Standard Includes	
Item #	Description	Item #	Description
...	...	...	...

Options		U.S. Price	Required to Specify
...	...	...	Specify with [option name]

**Panel—Thin Trim**  
Base Horizontal Frame Packages—Thin Trim

Specification Information			
Width	Style	U.S. Price	Option
#	Number	Price	
...	...	...	Specify with [option name]

**Options** (under the black band) lists all the options that apply to the product, their price, and what is required to specify.

**Tip 6**

**Required to Specify**

Specify with Customiz Stain

**Italic typeface** on specifying pages usually identifies wording that you should use in your order.

i

**Tip 7**

**To determine** how many skins are needed to complete a panel, consult the table at the right.

*Tip: Remember to order skins for both sides of the panel buildup.*

**Watch for tips** throughout the text that give you explanations and helpful instructions.

**Tip 8**

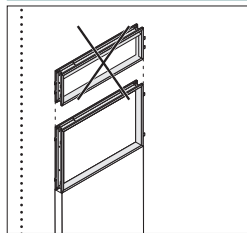

**Learn what you cannot do** by looking for drawings crossed out with an "X".

**Tip 9**

Style Number	Page
TS7042BL	131
TS7042S	130
TS7048BL	131
TS7048S	130
TS7060BL	131
TS7060S	130
TS7072BL	131

**Refer to the style number index** when you know a style number and you need to find the page that has more details about the product.

# Additional Resources

**Orangebox products** are supported with informational materials, tools, and software to help you plan, specify, and order an installation efficiently.

## Printed Materials

### Other Specification Guides

Steelcase offers a comprehensive portfolio of furniture and solutions. For the full offering of products, refer to the individual product specification guides. These can be accessed at the [www.steelcase.com](http://www.steelcase.com) web site or at [village.steelcase.com](http://village.steelcase.com)

## Computer Tools

### Electronic Catalog

Accurate sales quotations and purchase orders for Steelcase products are created with specification software that uses Steelcase Electronic Catalog data. Use the data to specify and price style numbers and options for every Steelcase product. The data is updated bimonthly by Steelcase and provided to software programs including: the Hedberg Business System, SmartTools—Steelcase's design and specification software (for more information on SmartTools, please email [SmartTools@steelcase.com](mailto:SmartTools@steelcase.com)), the ProjectMatrix Project Symbols libraries, as well as 20-20 CAP Studio.

### Furniture Symbol Graphic Data

Steelcase creates 2D and 3D furniture symbols (with attributes) for planning and initially specifying Steelcase products. This data is incorporated into several add-on software packages that work in either a Microstation or an AutoCAD drafting environment.

### Digital Publications

You can access these digital publications at [www.steelcase.com](http://www.steelcase.com) or [village.steelcase.com](http://village.steelcase.com).

## Support

### Steelcase Capabilities

Steelcase products are distributed, installed, and serviced through a network of more than 600 dealers worldwide. Steelcase is also represented with offices and corporate showrooms in 26 U.S. cities, 4 Canadian cities, and in France, Germany, Great Britain, and Japan. Every Steelcase product meets our exceptionally high standards of quality and durability and comes with the Steelcase assurance of excellence in service.

### For ordering or product assistance,

please call your local dealer, the Steelcase Solutions Resource Team, or the Steelcase Solutions Fulfillment Team at 1.888.STEELCASE (1.888.783.3522) or send an e-mail to [lineone@steelcase.com](mailto:lineone@steelcase.com).

Call the Steelcase Solutions Resource Team prior to placing an order, when working on a bid, or when you need information about product applications and specifications.

Call the Steelcase Solutions Fulfillment Team if you have submitted an order to Steelcase and you need to speak to your Solutions Fulfillment Team Representative about the order. Also call if you have any post-shipment quality concerns or service parts questions.

For warranty information, please go to: <http://www.steelcase.com/warranty/>.

Outside the U.S.A., Canada, Mexico, Puerto Rico, and the U.S. Virgin Islands, call 1.616.247.2500.

For information about Steelcase, the name of your nearest Steelcase dealer, or for product literature, call 1.800.333.9939 or visit our Web site: [www.steelcase.com](http://www.steelcase.com).



# Statement of Line

## Air<sup>3</sup>

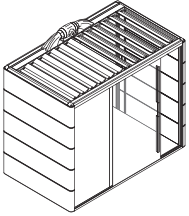

**Half Square with Opening Roof**  
Understanding  
▶ Page 16  
Specifying  
▶ Page 42

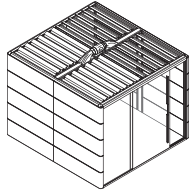

**Square with Opening Roof**  
Understanding  
▶ Page 16  
Specifying  
▶ Page 43

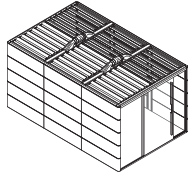

**Rectangle with Opening Roof**  
Understanding  
▶ Page 16  
Specifying  
▶ Page 45

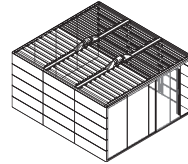

**Square 3X3 with Opening Roof**  
Understanding  
▶ Page 16  
Specifying  
▶ Page 47

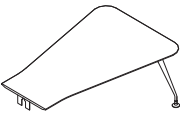

**Small Pod Table**  
Understanding  
▶ Page 16  
Specifying  
▶ Page 49

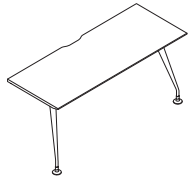

**Short, Straight Pod Table**  
Understanding  
▶ Page 16  
Specifying  
▶ Page 49

## On the QT

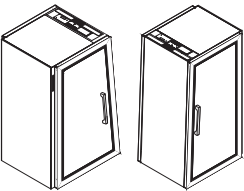

**Short Angled Phone Booth, LH or RH Hinge**  
Understanding  
▶ Page 22  
Specifying  
▶ Page 52

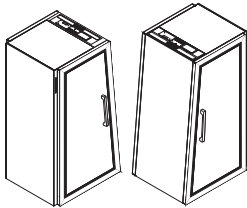

**Tall Angled Phone Booth, LH or RH Hinge**  
Understanding  
▶ Page 22  
Specifying  
▶ Page 55

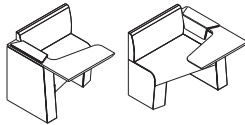

**Furniture Seat, LH or RH Application**  
Understanding  
▶ Page 22  
Specifying  
▶ Page 58

**Aspect**



**One Seat Work Unit with Curved Arm**

Understanding  
 ▶ Page 26  
 Specifying  
 ▶ Page 60

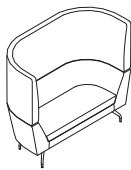

**Two Seat Work Unit with Curved Arm**

Understanding  
 ▶ Page 26  
 Specifying  
 ▶ Page 62

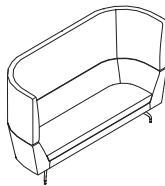

**Three Seat Work Unit with Curved Arm**

Understanding  
 ▶ Page 26  
 Specifying  
 ▶ Page 64

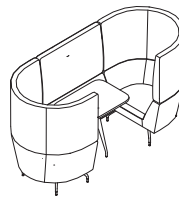

**Two Seat Work Screened Unit with Fixed Table**

Understanding  
 ▶ Page 26  
 Specifying  
 ▶ Page 66

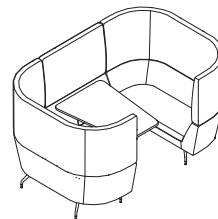

**Four Seat Work Screened Unit with Fixed Table**

Understanding  
 ▶ Page 26  
 Specifying  
 ▶ Page 70

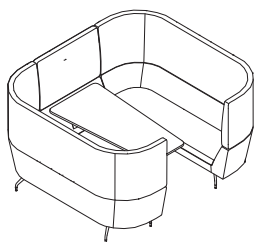

**Six Seat Work Screened Unit with Fixed Table**

Understanding  
 ▶ Page 26  
 Specifying  
 ▶ Page 74

**Avi**



**Upholstered Chair with Swivel Base**

Understanding  
 ▶ Page 28  
 Specifying  
 ▶ Page 78



**Hooded Upholstered Chair with Swivel Base**

Understanding  
 ▶ Page 28  
 Specifying  
 ▶ Page 78



**Upholstered Chair with Wire Frame Base**

Understanding  
 ▶ Page 28  
 Specifying  
 ▶ Page 79



**Hooded Upholstered Chair with Wire Frame Base**

Understanding  
 ▶ Page 28  
 Specifying  
 ▶ Page 79

**Sully, Skomer, and Ramsey**

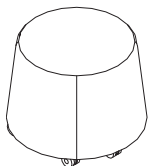

**Upholstered Stool**

Understanding

▶ Page 29

Specifying

▶ Page 81

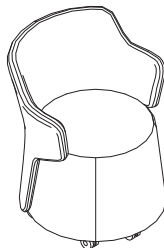

**Upholstered Arm Chair**

Understanding

▶ Page 29

Specifying

▶ Page 82

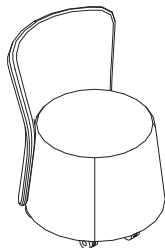

**Upholstered Work Chair**

Understanding

▶ Page 29

Specifying

▶ Page 84

**Border**

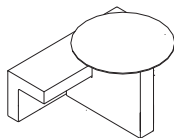

**One Seat, Low, with 32" Dia. Table**

Understanding

▶ Page 30

Specifying

▶ Page 86

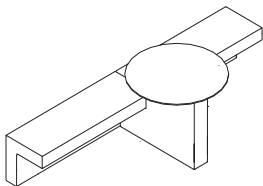

**Two Seat Low, with 32" Dia. Table**

Understanding

▶ Page 30

Specifying

▶ Page 87

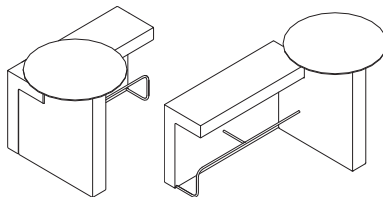

**One Seat High, with Left or Right Hand 32" Dia. Table**

Understanding

▶ Page 30

Specifying

▶ Page 88

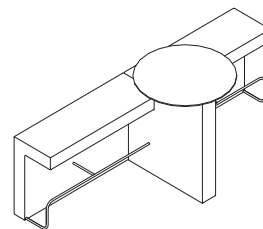

**Two Seat, High, with 32" Dia. Table**

Understanding

▶ Page 30

Specifying

▶ Page 90



## Away from the Desk Seating

Understanding  
▶ Page 32  
Specifying  
▶ Pages 92–133

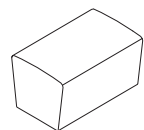

**31 1/2" W Modular Straight Seat**

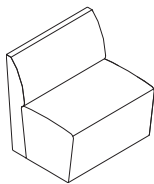

**31 1/2" W Modular Straight Seat with Back**

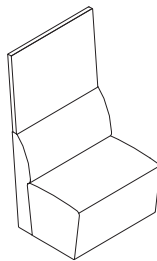

**31 1/2" W Modular Straight Seat with Back and Screen**

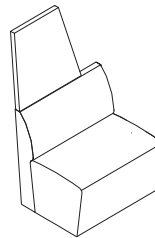

**31 1/2" W Modular Straight Seat with Back and Left or Right Hand Tapered Screen**

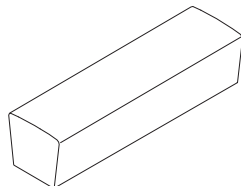
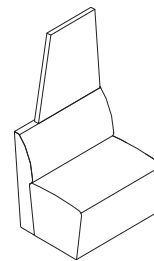

**70 7/8" W Modular Straight Seat**

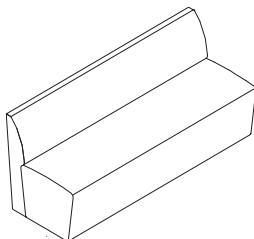

**70 7/8" W Modular Straight Seat with Back**

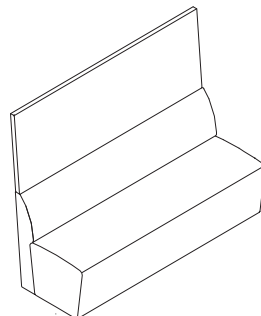

**70 7/8" W Modular Straight Seat with Back and Screen**

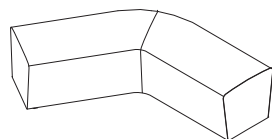

**120° Modular Seat**

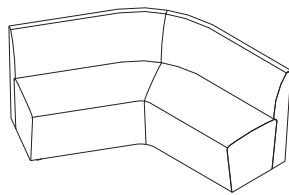

**120° Modular Seat with External Back**

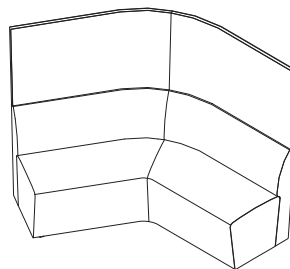

**120° Modular Seat with External Back and Screen**

**Away from the Desk, continued**

Seating

Understanding  
▶ Page 32  
Specifying  
▶ Pages 92–133

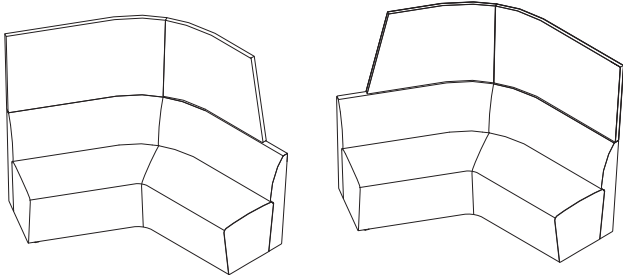

**120° Modular Seat with External Back and Left or Right Hand Tapered Screen**

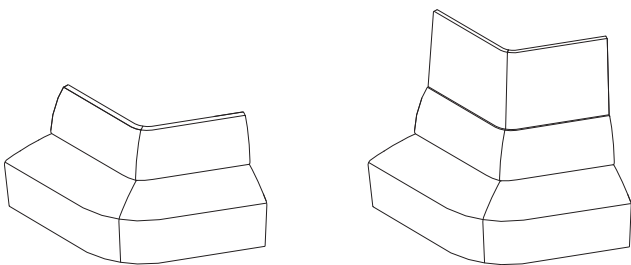

**120° Modular Seat with Internal Back**

**120° Modular Seat with Internal Back and Screen**

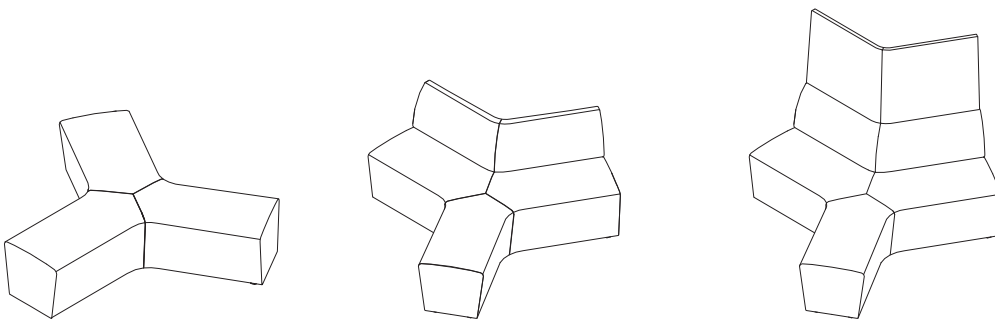

**120° Modular Tri-Seat**

**120° Modular Tri-Seat with Internal Back**

**120° Modular Tri-Seat with Internal Back and Screen**

### Away from the Desk, continued

#### Seating

Understanding  
▶ Page 32  
Specifying  
▶ Pages 92–133

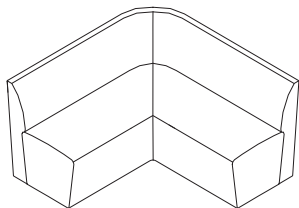

**90° Modular Seat with Back**

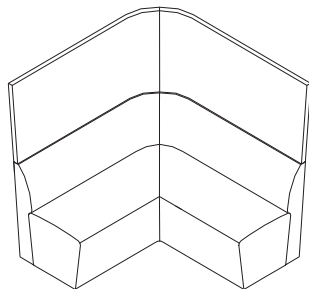

**90° Modular Seat with Back and Screen**

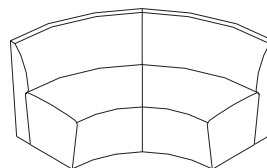

**90° Modular Curved Seat with Back**

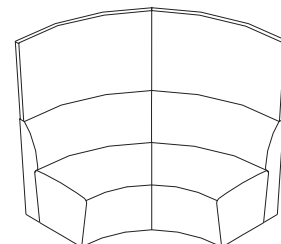

**90° Modular Curved Seat with Back and Screen**

### Away from the Desk

#### Tables

Understanding  
▶ Page 32  
Specifying  
▶ Pages 136–140

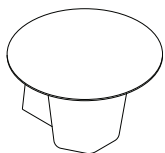

**Modular Small Round Top with Large Upholstered Tapered Base**

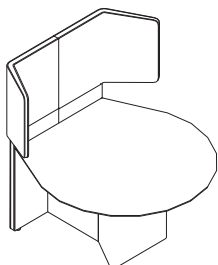

**Media Unit with Low, D Shaped Top**

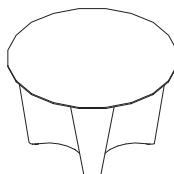

**47<sup>1</sup>/<sub>4</sub> Dia. Huddle Buddle Group Working Table**

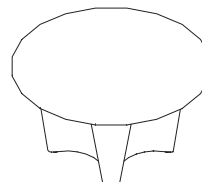

**55<sup>1</sup>/<sub>8</sub> Dia. Huddle Buddle Group Working Table**



**23<sup>5</sup>/<sub>8</sub> Dia. Low Table**

**Away from the Desk**

Detached Seating

Understanding  
▶ Page 32  
Specifying  
▶ Pages 141–148

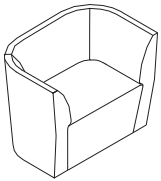

**Single Seat Detached Unit**

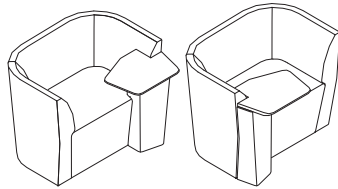

**Single Seat Detached Unit with Left or Right Hand Integrated Tablet**

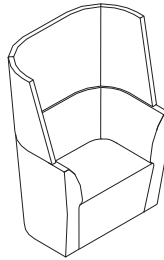

**Single Seat Detached Unit with Screen**

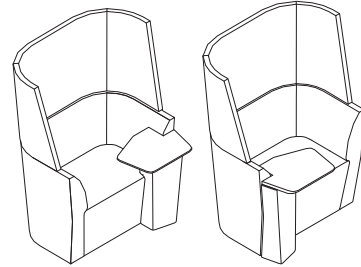

**Single Seat Detached Unit with Screen and Left or Right Hand Integrated Tablet**

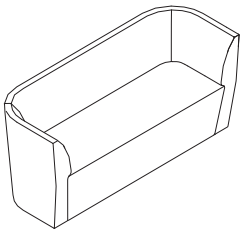

**Three Seat Detached Unit**

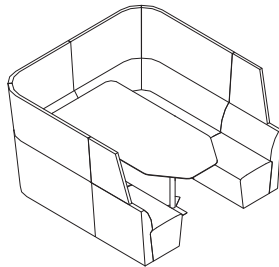

**Enclosed Media Den**

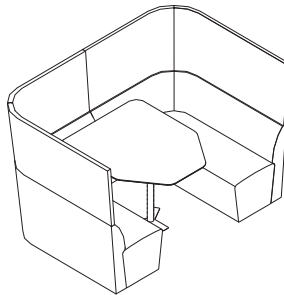

**Enclosed Media Den for Four to Six People**

### Cubb Seating

Understanding  
▶ Page 36  
Specifying  
▶ Pages 150–165



**Armless Chair with Wood Legs**

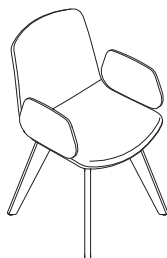

**Upholstered Arm Chair with Wood Legs**

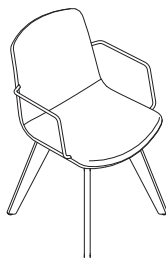

**Wire Arm Chair with Wood Legs**



**Armless Chair on 4-Star Trestle Base**

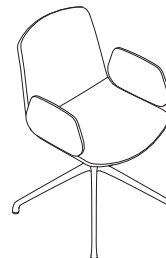

**Upholstered Arm Chair on 4-Star Trestle Base**



**Wire Arm Chair on 4-Star Trestle Base**

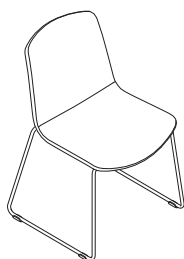

**Armless Chair with Wire Frame Base**

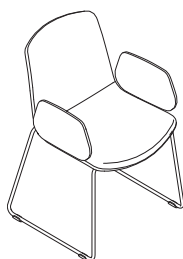

**Upholstered Arm Chair with Wire Frame Base**

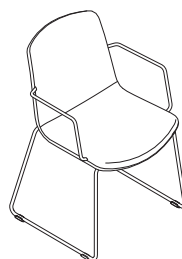

**Wire Arm Chair with Wire Frame Base**



**Armless Chair on 5-Star Base**



**Upholstered Arm Chair on 5-Star Base**

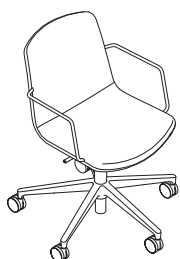

**Wire Arm Chair on 5-Star Base**

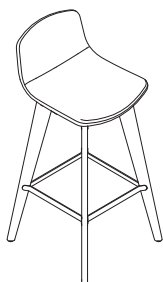

**Barstool with Oak Base**

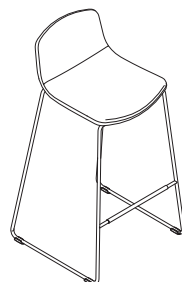

**Barstool with Wire Frame Base**



**Occasional Stool with Oak Base**

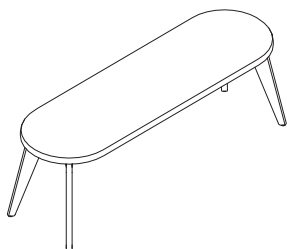

**Two Seat Bench**

**Cubb Tables**

Understanding  
▶ Page 38  
Specifying  
▶ Pages 166–186



**Four Person Round Meeting Table**



**Six Person Round Meeting Table**

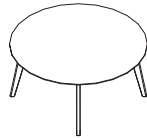

**Seven Person Round Meeting Table**

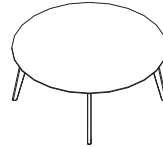

**Eight Person Round Meeting Table**

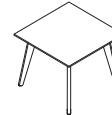

**Four Person Square Meeting Table**



**Four Person Square Meeting Table with Softened Corners**

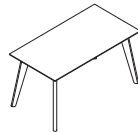

**Four Person Rectangle Meeting Table**

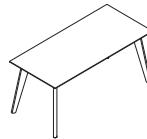

**Four to Six Person Rectangle Meeting Table**

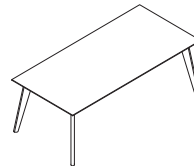

**Six to Eight Person Rectangle Meeting Table**

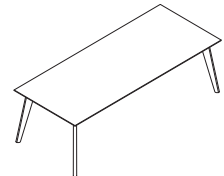

**Eight Person Rectangle Meeting Table**

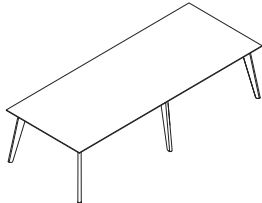

**47\"/>**

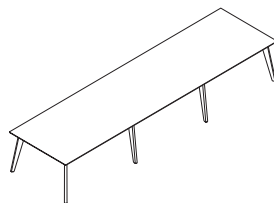

**47\"/>**

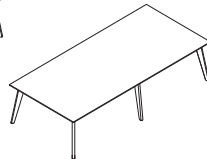

**55\"/>**

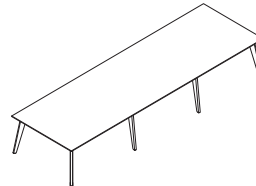

**55\"/>**

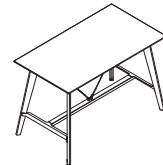

**Four to Six Person Standing Height Project Table**



**Six to Eight Person Standing Height Project Table**

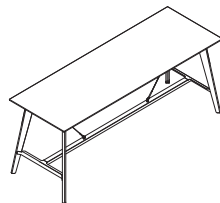

**Eight to Ten Person Standing Height Project Table**



**23 5/8\"/>**



**31\"/>**

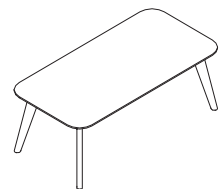

**Rectangle Occasional Table**



**Square Occasional Table**



# Air<sup>3</sup>

**Air<sup>3</sup>** is a modular freestanding meeting room. Its internationally patented opening roof system features an advanced fire safety system developed specifically for sprinklered office environments.

► Specifying, pages 42–51

**Louved roof** controlled by motion sensor as well as user control buttons.

**Air circulation fan.**

**Exterior and interior side panels** are upholstered acoustic panels.

**Front and back panel glass** are tempered glass.

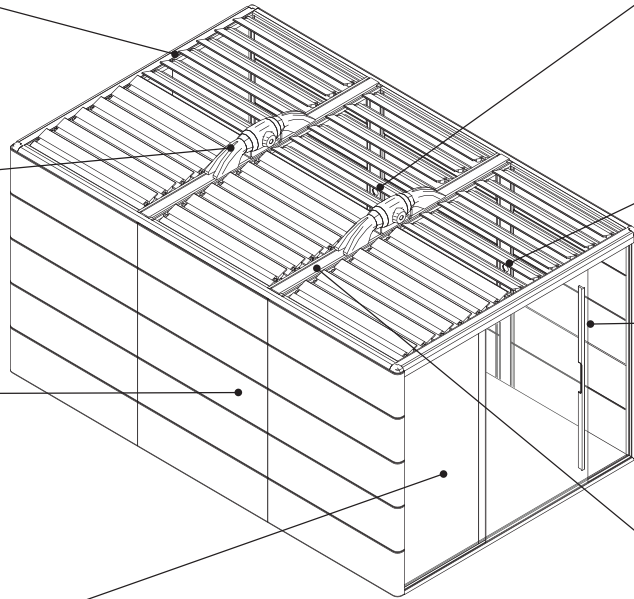

**Service hoop control panel side** includes touch button controls for lighting, air circulation, and roof.

**Service hoop power side** includes three NEMA 5-15 3-prong power outlets and two data connection cutouts.

**Sliding glass door** can be fitted to open right to left, or left to right, at time of installation.

**Service hoop horizontal bar** includes three LED lights, two heat detectors, monitor sensor, and fan.



**Pod Dimensions**

	External Dimensions			Internal Dimensions			
	Depth	Width	Height	Depth	Width	Height*	Weight
<b>OB1AIR23</b>	5' 6"	9' 2"	8' 4"	5' 1"	8' 7"	7'	1017 lb
<b>OB1AIR25</b>	9' 9"	9' 2"	8' 4"	9' 5"	8' 7"	7'	1313 lb
<b>OB1AIR27</b>	14' 5"	9' 2"	8' 4"	14' 1"	8' 7"	7'	1313 lb
<b>OB1AIR29</b>	14' 4"	13' 4"	8' 4"	14' 1"	13'	7'	2085 lb

*Tip: Minimum height recommended for a non-sprinkler covered space is 8'5". Minimum height recommended for a sprinkler covered space is 9'3" to allow for 18" clearance between the top of the open roof blade and a sprinkler head above it. These are recommendations as it is still up to the local authority having jurisdiction to identify their building requirements.*

*\*Internal height when roof blades open is 6'9".*

**Table Dimensions**

	Depth	Width	Height	Weight
<b>OB1AIR30</b>	69"	45"	29"	56 lb
<b>OB1AIR35</b>	24"	61"	29"	47 lb

**Product Details**

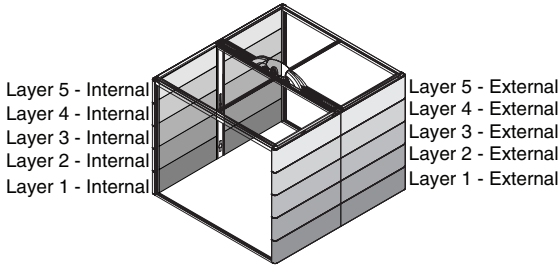

**Fabric panel layer numbering** begins from the bottom position.

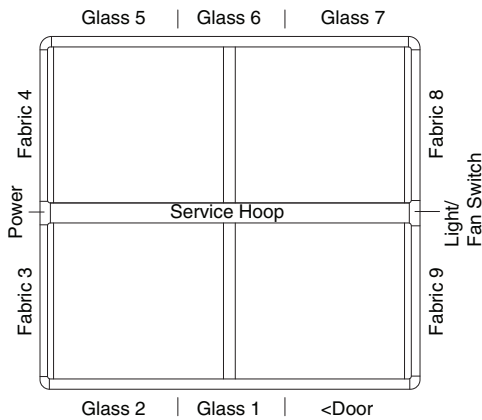

**Panel positions** account for both glass and fabric panels and are determined when standing outside of the pod with a right to left opening door.

**Optional whiteboards** can be installed in place of internal fabric panels on layers 3 and 4 (all panels will still be included). Dimensions are 50<sup>3</sup>/<sub>4</sub>" x 34<sup>3</sup>/<sub>4</sub>".

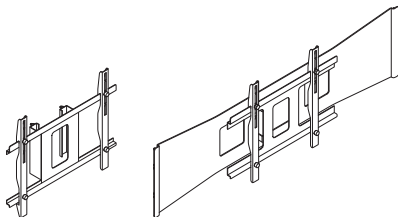

**Monitor brackets** are available in two different styles and both support a monitor up to a maximum weight of 55 pounds:

- Over upholstery monitor brackets—mounted directly to the fabric panels on layers 3 and 4.
- Hoop mounted monitor brackets—attached to the power side of the service hoop.

**Space Layout Constraints**

**Do not obstruct** exit corridor. Ensure visibility to on site alarm strobes is not blocked. If sprinklers are not required interior to the unit, be advised that local codes typically prohibit obstructions within 18" (457.2 mm) of the existing building sprinklers. Ensure final placement of the unit does not block airflow inlets or outlets of the building or unit ventilation systems.

**Electrical Connections**

**Hardwired units:** Electric power is delivered through a hardwired connection which must be routed to a junction box in the floor, wall, or ceiling via a conduit whip. Orangebox does not provide the conduit whip to make the power connection to the building. It is the responsibility of the qualified site electrician to supply and install a suitable power connection to the building in accordance with local codes.

**The assembly directions and user guide** describe the enclosures which contain the electrical services such as power, lighting, and airflow. Lighting, fan, outlets, and sensors share one circuit within the unit. The enclosure may accommodate a single 15 or 20 Amp connection. The maximum loading of the components within the enclosure is 1.2 Kilowatts.

**Power usage when occupied** is 100W (not including any plugged-in external equipment) per hoop.

**Electrical Components**

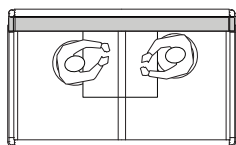
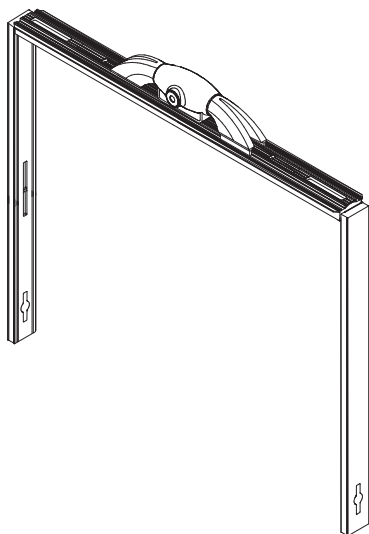

**The service hoop** contains all the electrical services, including power, lighting, and airflow.

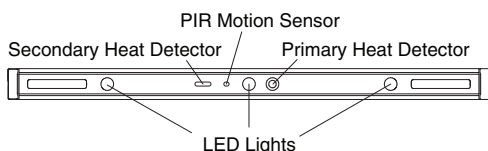

**Service hoop horizontal bar** includes three LED lights, two heat detectors, motion sensor, and fan.

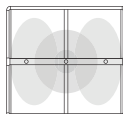

**Work**  
Lux level at table height: 450-850  
Center light: 100%  
Outer light: 100%

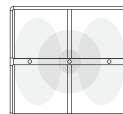

**Think**  
Lux level at table height: 120-400  
Center light: 50%  
Outer light: 20%

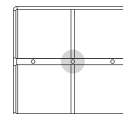

**Present**  
Lux level at table height: 50-60  
Center light: 20%  
Outer light: OFF

**Three LED lights** are used for illumination. The lights are 4000K with a max brightness of 1300 lumens.

**Passive inferred (PIR) motion sensor** turns on the power to the pod when activated. Power is shut off within the pod after five minutes of inactivity.

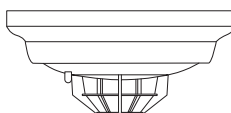

**Primary heat detector** will cut all power in the pod and open the roof fully if heat at 135°F (57°C) is detected.

**Secondary heat detector** acts as a failsafe fusible link and will cut all power in the pod and open the roof fully if heat at 150.8°F (66°C) is detected.

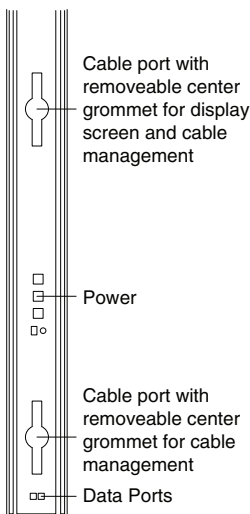

**Service hoop power side** comes standard with three NEMA 5-15 3-prong power outlets, two data connection cutouts, and two cable ports with removable center grommet for cable management.

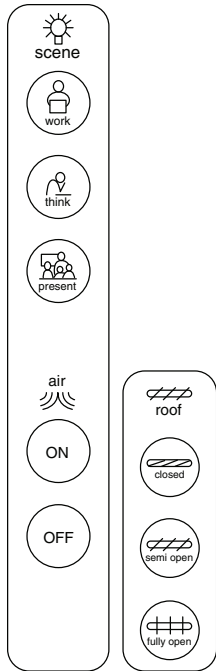

**Service hoop control panel side** includes touch button controls for lighting, air circulation, and roof.

**The patented louvred roof** has three settings: fully open, semi open, and closed. When the pod is unoccupied, the roof is always open. When entering the pod, the passive inferred sensor (PIR) senses movement and closes the roof to create acoustic privacy. When the pod is occupied, it is possible to select either 10° (semi) or 90° (fully) open position manually for enhanced airflow. The PIR turns the power off after five minutes and the roof automatically opens.

**Occupancy sensor** activates the lights and fan. The sensor operates at low voltage and utilizes both ultrasonic and infrared sensing to avoid false triggering.

**Airflow and Handling**

**Ventilation fans** are rated at 94 cubic feet of air per minute (CFM) and 56 dBA.

*Tip: Fan CFM ratings alone cannot be used to determine the actual system ventilation rate.*

**Building and Fire Code Compliance**

**Seismic considerations:** For seismic considerations, the building’s Structural Engineer of Record (SEOR) must be consulted. Seismic structural analysis report prepared by a licensed professional engineer may be required for specific locations.

**Fire suppression:** Sprinkler requirements are an important consideration for product assembly. Local codes may impact the number and location of mandated sprinklers. It is important to check with the local authorities to ensure product installation meets local requirements. If required, sprinkler location options within the unit are identified in product-specific assembly directions.

**Fire alarms:** National Fire Protection Agency (NFPA) 72 requires a fire alarm to be at least 15 dB above ambient to ensure occupants can hear the alarm. This is an on-site requirement. This may require a visible and/or audible notifier within the unit. If the unit is equipped with a fire detection system, some jurisdictions may require it be connected to the building’s fire detection system.

**Energy efficiency:** ASHRAE 90.1 and California Energy Commission (CEC) Title 24 identify lighting controls and power density requirements. This is an on-site requirement. Ensure this unit in its final environment adheres to these standards by confirming with local authorities.

**Surface Materials**

**External and Internal Air<sup>3</sup> Panels**

- Designtex Billiard Panel
- Designtex Billiard Select Surfaces
- Designtex Brushed Flannel
- Camira Synergy
- Designtex Everywhere Texture
- Kvadrat Divina MD\*
- Kvadrat Divina Mélange 3\*
- Gabriel Europost 2
- Guilford of Maine Anchorage\*
- Kvadrat Divina 3\*
- Maharam Mode\*

*\*Tip: Only fabrics permitted for use in Canada.*

*Tip: Fabrics are Graded-In. Please reference the COM database to identify appropriate price grade.*

**Table Top Finish**

- Fiber HPL
- Micro HPL
- Patina HPL
- Solid HPL
- Speckle HPL
- Woodgrain HPL
- Textured Industrial HPL
- Textured Woodgrain HPL

**Table Edge Finish**

- Plastic

**Table Leg Finish**

- Black
- Polished
- Silver

*Tip: For comparable finish, please reference Steelcase standard finishes 7207 Textured Black, 4799 Platinum Metallic, 9201/9207 Polished Trivalent Chrome.*

**Frame**

- RAL9003 Signal White

**Roof Blades**

- RAL7035 Light Grey



# On the QT

**On the QT phone booths** were designed to provide compact enclosed space in open plan workspaces to allow work to be carried out more effectively with reduced distractions.

► Specifying, pages 52–58

**Frame** constructed of aluminum.

**Cover caps** frame the glass door and glass wall. Available in a range of paint finishes.

**Front and back panel glass** are clear laminated glass.

**Seat** designed with ergonomic focus to promote comfortable longer term use.

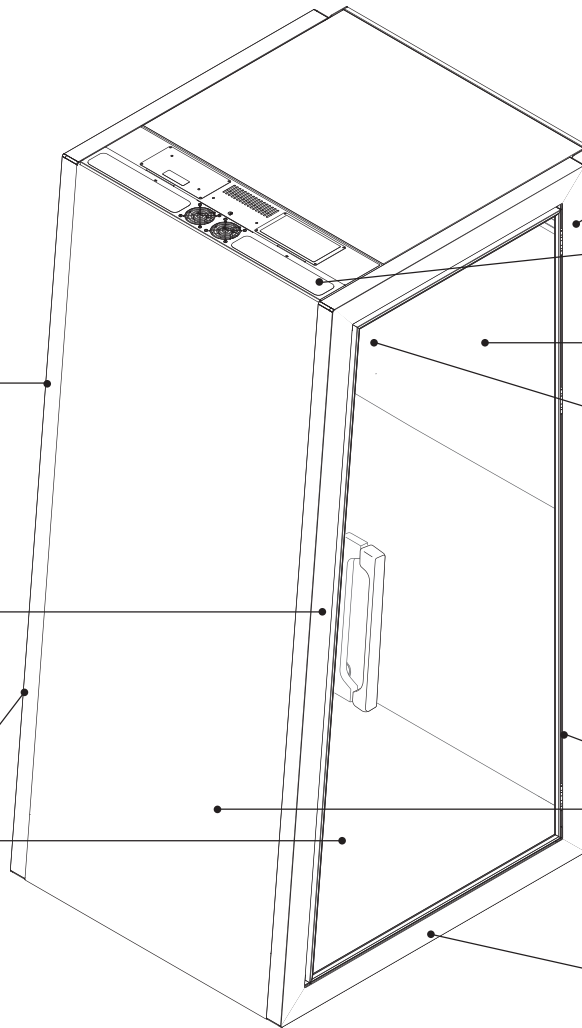

**Occupancy light** illuminates red when booth is in use.

**Fan** built discretely into the roof panel.

**Interior cladding** is polyester felt.

**Lighting** positioned near the front of the booth for optimal work lighting.

**Front and rear cladding** is laminate as standard, with option of fabric, painted steel, plywood, or whiteboard.

**Threshold height** is 5" min to 7" max.

**Tablet** included as standard.

**Angled seat face** creates a comfortable pivot space to enter the booth and sit.

Phone Booths								
	External Dimensions					Internal Dimensions		
	Depth	Width	Height	Weight*	Shelf Height	Depth	Width	Height
<b>OB1QT01/OB1QT02</b>	39 <sup>3</sup> / <sub>8</sub> "	47 <sup>1</sup> / <sub>4</sub> "	74 <sup>4</sup> / <sub>5</sub> "	535 lb	28 <sup>3</sup> / <sub>4</sub> "	36"	39"	69 <sup>7</sup> / <sub>8</sub> "
<b>OB1QT03/OB1QT04</b>	39 <sup>3</sup> / <sub>8</sub> "	47 <sup>1</sup> / <sub>4</sub> "	86 <sup>3</sup> / <sub>5</sub> "	661 lb	41 <sup>3</sup> / <sub>4</sub> "	36"	39"	78 <sup>3</sup> / <sub>4</sub> "

Furniture Units						
	Depth	Width	Height	Weight	Seat Height	Tablet Height
<b>OB1QTF01/OB1QTF02</b>	25"	35"	32"	101 lb	18 <sup>8</sup> / <sub>9</sub> "	28 <sup>3</sup> / <sub>4</sub> "

\*includes plywood cladding

On the QT, continued

**Product Details**

**Left hand (LH) and right hand (RH)** are determined by the location of the door hinge when entering the booth.

**Front and rear** are determined based on the user seated position. "Front" will indicate the wall the user faces, while "rear" will indicate the wall behind the user.

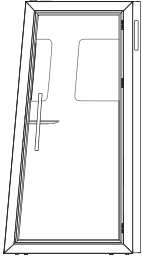

**Baffles** can be optioned to add an additional layer of visual and acoustic privacy. These fully upholstered baffles are available as a privacy screen or lean pad.

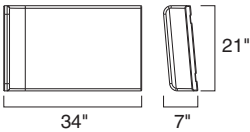
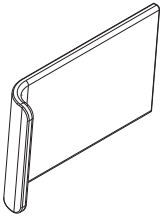

**Privacy screens** install to the front of the phone booth and sit above worksurface height.

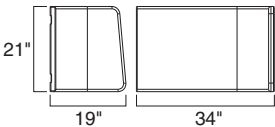
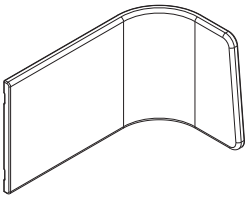

**Lean pads** install to the rear of the phone booth and sit at shoulder/head height.

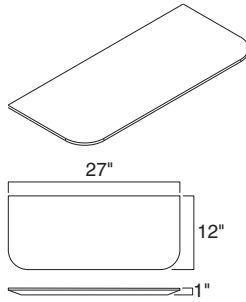

**Shelf** can be specified in both the short and tall phone booths. When specified, the shelf height is 28<sup>3</sup>/<sub>4</sub>" in the short booth and 41<sup>3</sup>/<sub>4</sub>" in the tall booth.  
*Tip: Shelf should not be optioned if an On the QT furniture unit (OB1QTF01 or OB1QTF02) is specified.*

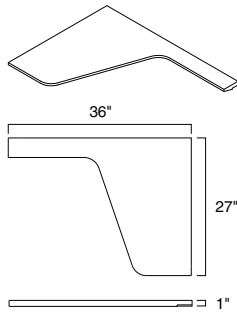

**L-shelf** can be specified in the tall phone booths only. When specified, the shelf height is 41<sup>3</sup>/<sub>4</sub>".  
**All worksurfaces** come standard in High-Pressure Laminate.

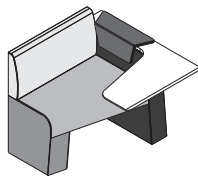

**Contrasting upholstery** option available on lounge furniture units with four specifiable upholstery surfaces.

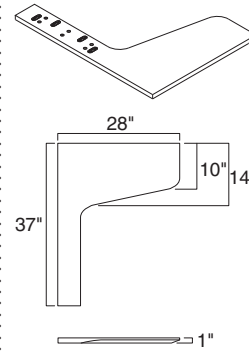

**Each furniture unit** comes standard with an integrated worksurface in laminate.

**Occupancy light** is available as an option. When the phone booth is in use, the occupancy light will illuminate red. When not specified, illumination will not occur.

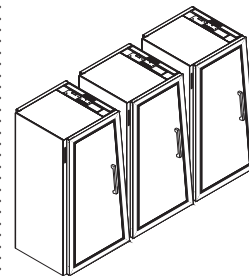

**Do not obstruct exit corridor.** Ensure visibility to on site alarm strobes is not blocked. If sprinklers are not required interior to the unit, be advised that local codes typically prohibit obstructions within 18" of the existing building sprinklers. Ensure final placement of the unit does not block airflow inlets or outlets of the building or unit ventilation systems.

**Electrical Connections**

**Hardwired units:** Electric power is delivered through a hardwired connection which must be routed to a junction box in the floor, wall, or ceiling via a conduit whip. Orangebox does not provide the conduit whip to make the power connection to the building. It is the responsibility of the qualified site electrician to supply and install a suitable power connection to the building in accordance with local codes.

**The assembly directions and user guide** describe the enclosures which contain the electrical services such as power, lighting, and airflow. Lighting, fan, outlets, and sensors share one circuit within the unit. The enclosure may accommodate a single 15 Amp connection. The maximum loading of the components within the enclosure is 1.8 Kilowatts at 120 VAC.



**Cord and plug units:** The unit is provided with a flexible power cord which is to be plugged directly into a building's hardwired electrical receptacle. A minimum spacing of 4" between the receptacle and the assembled unit is needed to protect the plug from damage.

**Total cord length** is 12" from the point of connection at the power distribution unit (PDU). Exposed length will be dependent on exit location.

- 108" when exiting from front
- 64" when exiting from rear

**Power usage:** when occupied is 30W (not including any plugged-in external equipment).

**Power usage:** the unit draws 30W when nothing is plugged into internal receptacles.

### Electrical Components

**Occupancy sensor** activates the lights and fan. The sensor operates at low voltage and utilizes both ultrasonic and infrared sensing to avoid false triggering. Three minutes after the booth is vacated, all features will power down.

**One LED light panel** is used for illumination. The light is 3000K and 450 lux at worksurface height.

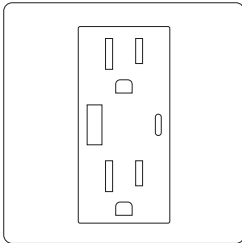

**When selected,** unit includes two power outlets, one USB A, and one USB C port. Each outlet will supply 3 Amps max with a total of 4.5 Amp max draw collectively.

**An isolator switch** is located directly below the power outlets and can be used to turn off all power to the booth.

### Airflow and Handling

**The air handling ventilation system** is designed to provide a minimum of 10 air changes per hour when the unit is occupied, per Business & Institutional Furniture Manufacturer's Association (BIFMA) Guidance for Pods (2020) and American Society of Heating Refrigerating and Air Conditioning Engineers (ASHRAE) 111 Testing, Adjusting, and Balancing of Building HVAC Systems.

**On the QT** has been designed to perform 35 (short booth) and 30 (tall booth) air changes per hour (ACH).

**Ventilation fans** are rated at 21.9 CFM and 21.5 dBA.  
*Tip: Fan CFM ratings alone cannot be used to determine the actual system ventilation rate.*

### Building and Fire Code Compliance

**Seismic considerations:** For seismic considerations, the building's Structural Engineer of Record (SEOR) must be consulted. Seismic structural analysis report prepared by a licensed professional engineer may be required for specific locations.

**Fire suppression:** Sprinkler requirements are an important consideration for product assembly. Local codes may impact the number and location of mandated sprinklers. It is important to check with the local authorities to ensure product installation meets local requirements. If required, sprinkler location options within the unit are identified in product-specific assembly directions.

**Fire alarms:** National Fire Protection Agency (NFPA) 72 requires a fire alarm to be at least 15 dB above ambient to ensure occupants can hear the alarm. This is an on-site requirement. This may require a visible and/or audible notifier within the unit. If the unit is equipped with a fire detection system, some jurisdictions may require it be connected to the building's fire detection system.

**Energy efficiency:** ASHRAE 90.1 and California Energy Commission (CEC) Title 24 identify lighting controls and power density requirements. This is an on-site requirement. Ensure this unit in its final environment adheres to these standards by confirming with local authorities.

#### Frame

- 7207 Textured Black

#### Door handle

- V3AK Natural Oak
- VP03 Black Oak

#### Cover caps

- Accent paint
- Accessory paint
- Smooth metallic
- Smooth paint
- Textured paint
- Textured metallic

#### Front and rear cladding

##### Laminate

- Fiber HPL
- Micro HPL
- Patina HPL
- Solid HPL
- Speckle HPL
- Textured Woodgrain HPL
- Woodgrain HPL
- Textured Industrial HPL
- Open Line laminate

##### Whiteboard

- 2977 White Markerboard

##### Painted Metal

- Accent paint
- Accessory paint
- Smooth metallic
- Smooth paint
- Textured paint
- Textured metallic

#### Fabric

- Graded-In Price Group 1-10
- Customer's Own Material (COM)

#### Plywood

- 3862 Baltic Birch

#### Internal cladding

- PT19 Charcoal
- PT36 Silver

#### Privacy screen

- Fabric
- Customer's Own Material (COM)

#### Lean pad

- Fabric
- Customer's Own Material (COM)

#### Furniture upholstery

- Fabric
- Customer's Own Material (COM)

*Tip: This product does not use glue due to the environmental impact. Because of this, occasional dressing of the upholstery may be required.*

#### Shelf and tablet

- Fiber HPL
- Micro HPL
- Patina HPL
- Solid HPL
- Speckle HPL
- Textured Woodgrain HPL
- Woodgrain HPL
- Textured Industrial HPL
- Open Line laminate

#### Custom Surfaces

Applies to:

- Cover caps
- Front and rear cladding

#### PerfectMatch

PerfectMatch is a service that allows you to create your own paint color. Refer to the *Surface Materials Reference Guide* for more information about this program.

# Aspect

**Aspect** is a high back, semi-enclosed sofa line. Aspect sofas can be connected via a screen to create semi-private working booths with power and media capabilities.

► Specifying, pages 70–87

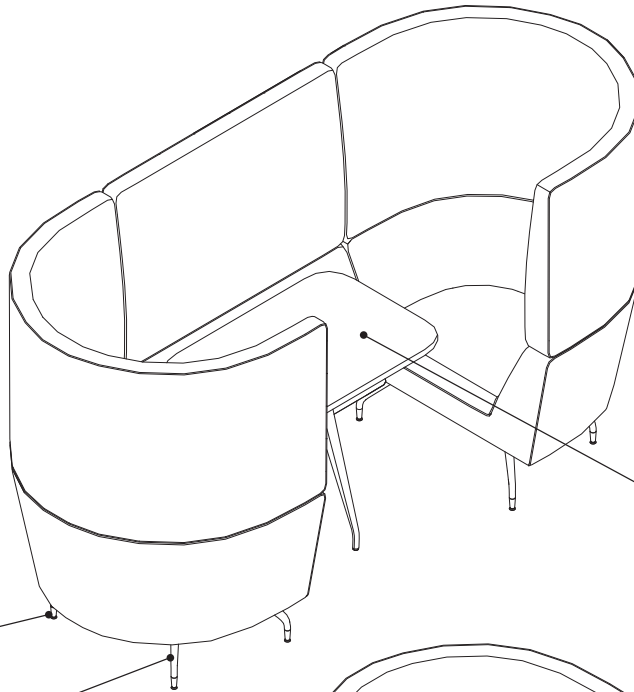

**Feet adjustable** up to 1/2".

**Legs** 8" high.

**Table top** available in laminate with tapered edge detail.

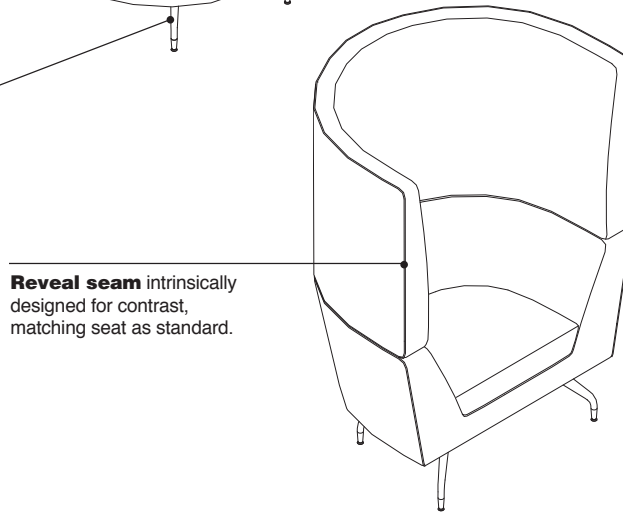

**Reveal seam** intrinsically designed for contrast, matching seat as standard.

## Actual Dimensions

	Depth	Width	Height	Weight	Seat Depth	Seat Height	Worksurface Depth	Worksurface Width	Worksurface Height
<b>OBASPECT07HB</b>	29"	41"	54"	100 lb	19"	17"	N.A.	N.A.	N.A.
<b>OBASPECT08HB</b>	29"	64"	54"	131 lb	19"	17"	N.A.	N.A.	N.A.
<b>OBASPECT09HB</b>	29"	87"	54"	166 lb	19"	17"	N.A.	N.A.	N.A.
<b>OBASPECT57HB</b>	87"	30"	54"	277 lb	19"	17"	21 1/2"	21 1/2"	28 3/4"
<b>OBASPECT58HB</b>	97"	64"	54"	371 lb	19"	17"	43 1/3"	31 1/4"	28 3/4"
<b>OBASPECT59HB</b>	97"	87"	54"	457 lb	19"	17"	63"	32"	28 3/4"

## Product Details

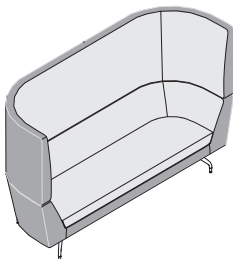

**Two-tone contrasting upholstery option** is available through specifying inner and outer contrasting colorways.

*Tip: Inner/outer selection must stay in the same fabric family.*

**Patterned fabric** works best when specified on the seat only. Patterns should be avoided on the upper and lower body due to predominant double stitch seams making pattern matching unachievable.

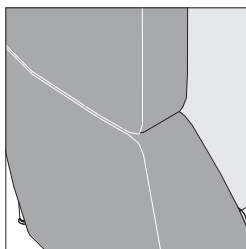

**Reveal seam** matches seat as standard but can match body finish or "other." Other allows specification to be independent of the seat and body finish selection.

*Tip: Reveal seam not allowed to match seat when patterned.*

*Tip: Reveal seam may only be vinyl if body is also vinyl.*

## Power and Media

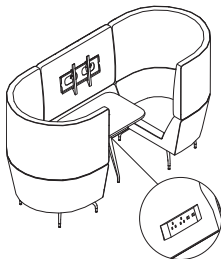

**Power** integrated in lower screen when optioned on media den units.

- 4 power outlets
- 2 power, 1 CAT6 data, 1 dual USB-A outlets
- 2 power, 1 CAT6 data, 1 HDMI outlets
- 2 power, 2 CAT6 data outlets

**72" cord length** exits through bottom of lower screen and comes fitted with a standard NEMA 5–15 plug.

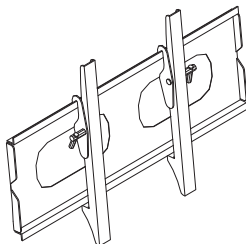

**Tilting monitor brackets** available as an option on media den units. Monitor bracket supports a single screen up to 32" and 44 pounds.

**Wire channel and grommet** are located in the upper screen for cable management.

## Surface Materials

### Upholstery

- Fabric
- Customer's Own Material (COM)

*Tip: This product does not use glue due to the environmental impact. Because of this, occasional dressing of the upholstery may be required.*

### Table tops

- Fiber HPL
- Micro HPL
- Patina HPL
- Solid HPL
- Speckle HPL
- Textured Woodgrain HPL
- Woodgrain HPL
- Textured Industrail HPL
- Open Line laminate

### Legs/feet

- Black
- Silver
- Chrome

*Tip: For comparable finish, please reference Steelcase standard finishes 7207 Textured Black, 4799 Platinum Metallic, 9201/9207 Polished Trivalent Chrome.*

### Power

- 4118 Warm Platinum
- 7015 Silk Textured
- 7207 Black

# Avi

**Avi** is a classic low- or high-back upholstered lounge chair.  
 ▶ Specifying, pages 88–90

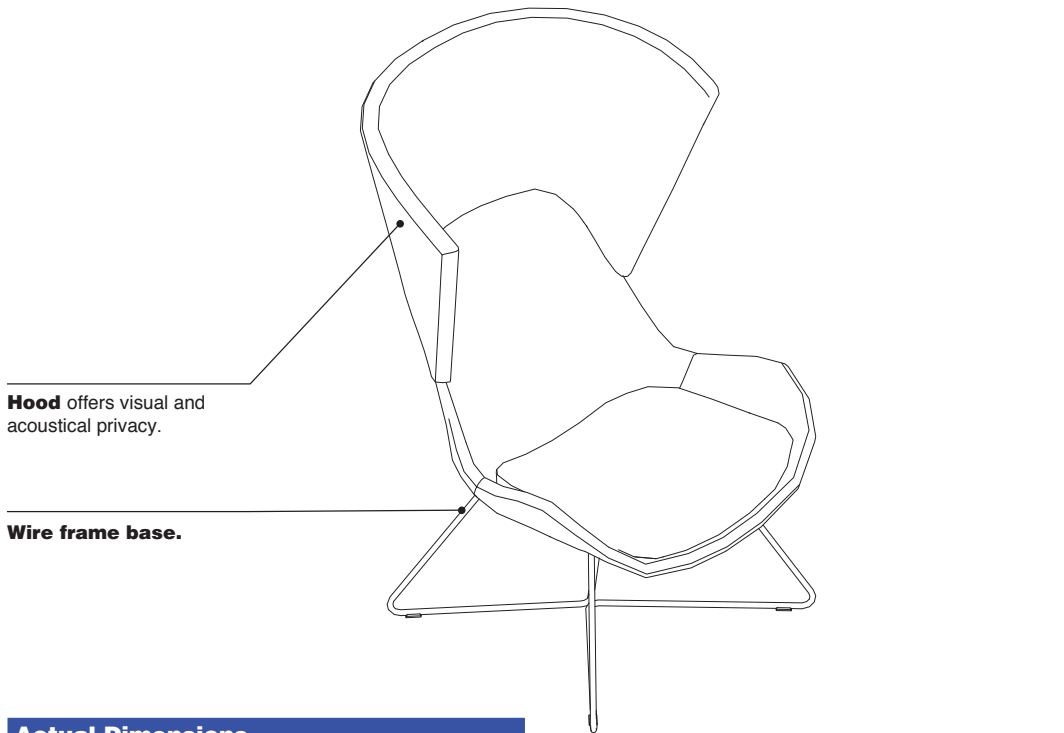
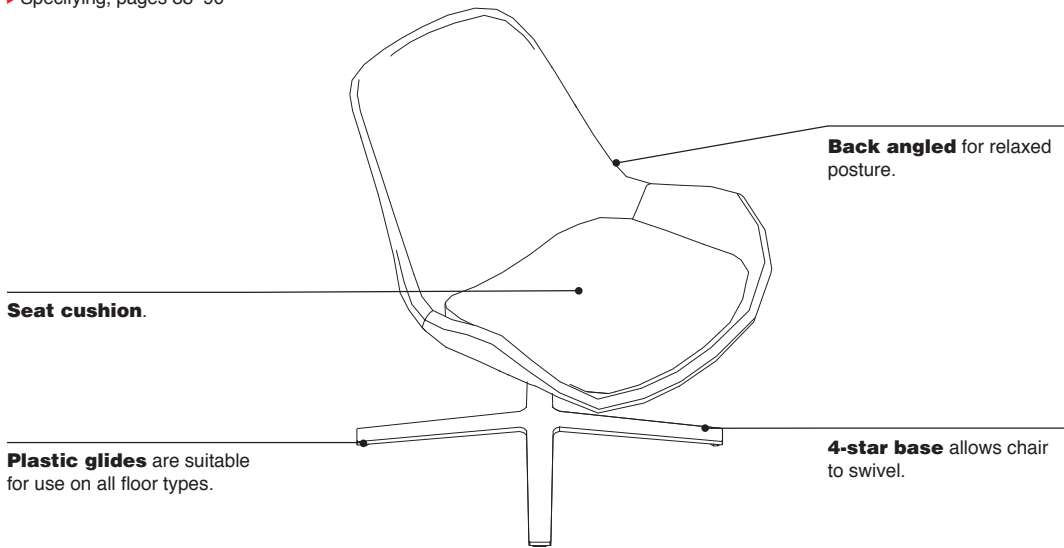

## Product Details



**Contrasting upholstery** is available by specifying each surface independently.

**Avi low- and high-back chairs** are both available on 4-star swivel or wire frame bases.

## Surface Materials

### Upholstery

- Fabric
- Customer's Own Material (COM)
- Customer's Own Leather (COL)

### Base

- Black
- Silver
- Chrome

*Tip: For comparable finish, please reference Steelcase standard finishes 7207 Textured Black, 4799 Platinum Metallic, 9201/9207 Polished Trivalent Chrome.*

## Actual Dimensions

<b>Depth</b>	31"
<b>Width</b>	27"
<b>Height</b>	32" and 46"
<b>Weight</b>	34 lb and 42 lb
<b>Seat Depth</b>	19"
<b>Seat Height</b>	17"

# Sully, Ramsey, and Skomer

Sully, Ramsey, and Skomer

**Sully, Ramsey, and Skomer** are fully upholstered chairs designed to work together in small clusters or as part of larger configurations.  
 ▶ Specifying, pages 92–90

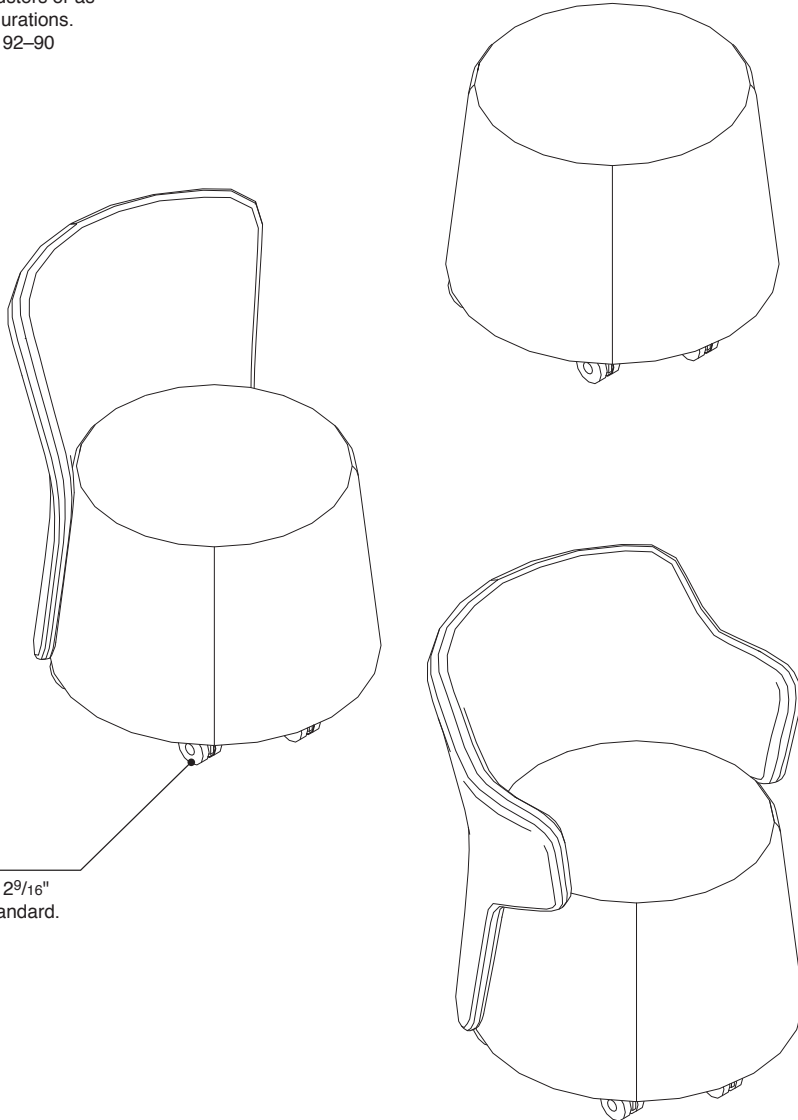

**Soft casters** are 2<sup>9</sup>/<sub>16</sub>" with no brake as standard.

## Product Details

**Two-tone contrasting upholstery** is available as an option.

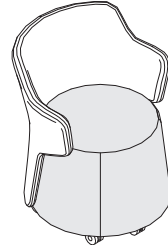

**Option 1**—seat and back.  
*Tip: If two-tone upholstered option one is selected, contrasting price groups are available. Total seat finish and back finish price is driven by highest price group selection.*

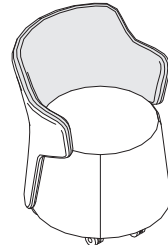

**Option 2**—seat and outer back with contrasting inner back.  
*Tip: If two-tone upholstered option two is selected, contrasting price groups are not available. Total seat and outer back finish and inner back finish must come from the same finish family.*

## Surface Materials

### Upholstery

- Fabric
- Customer's Own Material (COM)
- Customer's Own Leather (COL)

### Casters

- Black
- Grey

Sully, Ramsey, and Skomer

## Actual Dimensions

	Depth	Width	Height	Weight	Seat Depth	Seat Height
<b>OBSSULLY01</b>	21"	21"	19"	18 lb	16"	19"
<b>OBSRAMSEY01</b>	26"	23"	32"	29 lb	19"	19"
<b>OBSSKOMER01</b>	26"	26"	32"	34 lb	19"	19"

# Border

**Border** provides a simple and precise way of dividing up space.  
 ▶ Specifying, pages 114–125

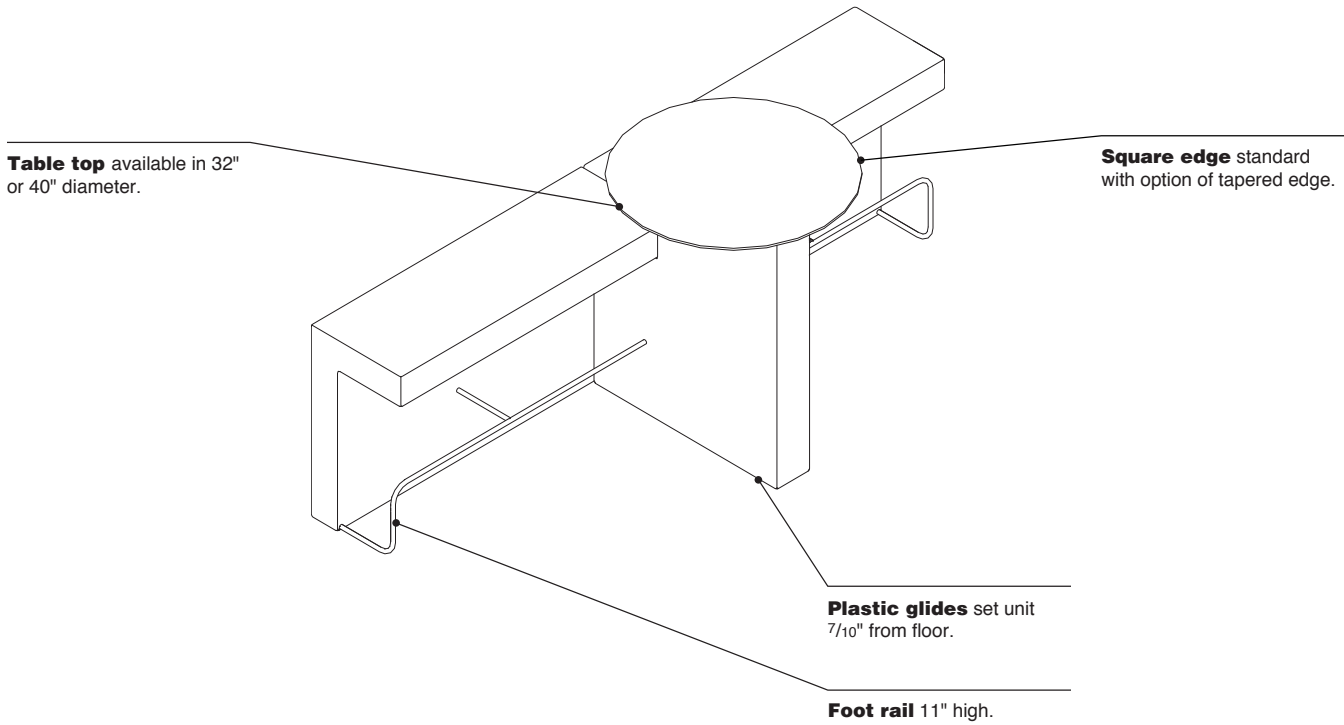

### Actual Dimensions

	Depth	Width	Height	Weight	Seat Depth	Seat Height	Table Height
<b>OBBORDER01</b>	42"	47"	30"	80 lb	16"	18"	30"
<b>OBBORDER02</b>	42"	94"	30"	111 lb	16"	18"	30"
<b>OBBORDER03/ OBBORDER04</b>	42"	47"	42"	106 lb	16"	30"	42"
<b>OBBORDER05</b>	42"	94"	42"	146 lb	16"	30"	42"

## Product Details

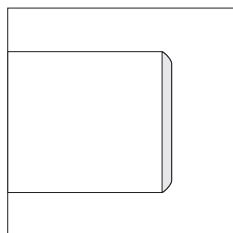
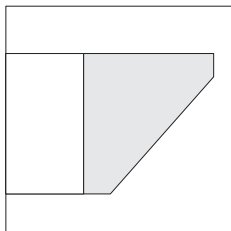

**Edge profile** available tapered or squared.

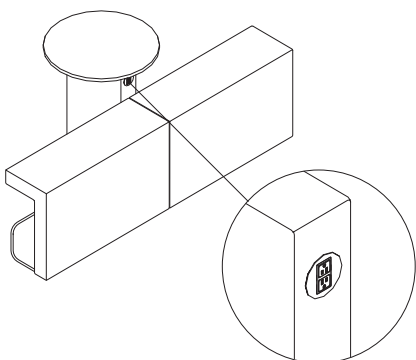

**Round power module** is available as an option and located in table base.

- 2 power outlets
- 1 power, 1 dual USB-A outlets
- 1 power, 1 HDMI outlets
- 1 power, 1 CAT6 data outlets

*Tip: Power is not available in the table top due to the presence of a mounting plate.*

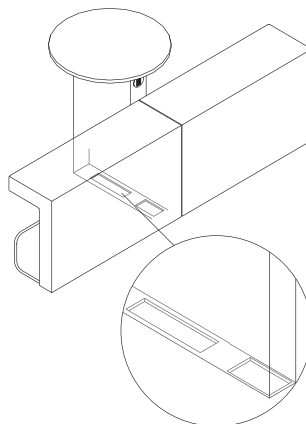

**72" cord length** exits through bottom of table base and comes fitted with a standard NEMA 5-15 plug.

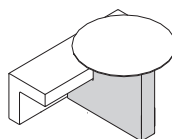

**Two-tone contrasting upholstery** is available as an option.

*Tip: If two-tone upholstered option is selected, contrasting price groups are available. Total seat finish and table base finish price is driven by highest price group selection.*

## Surface Materials

### Table tops

- Fiber HPL
- Micro HPL
- Patina HPL
- Solid HPL
- Speckle HPL
- Textured Woodgrain HPL
- Woodgrain HPL
- Textured Industrial HPL
- Open Line laminate

### Upholstery

- Fabric
- Customer's Own Material (COM)
- Customer's Own Leather (COL)

### Foot rail

- Chrome

### Power

- 4118 Warm Platinum
- 7015 Silk Textured
- 7207 Black

# Away from the Desk

**Away from the Desk** is a dynamic and extensive upholstery modular sofa system.  
▶ Specifying, pages 128–140

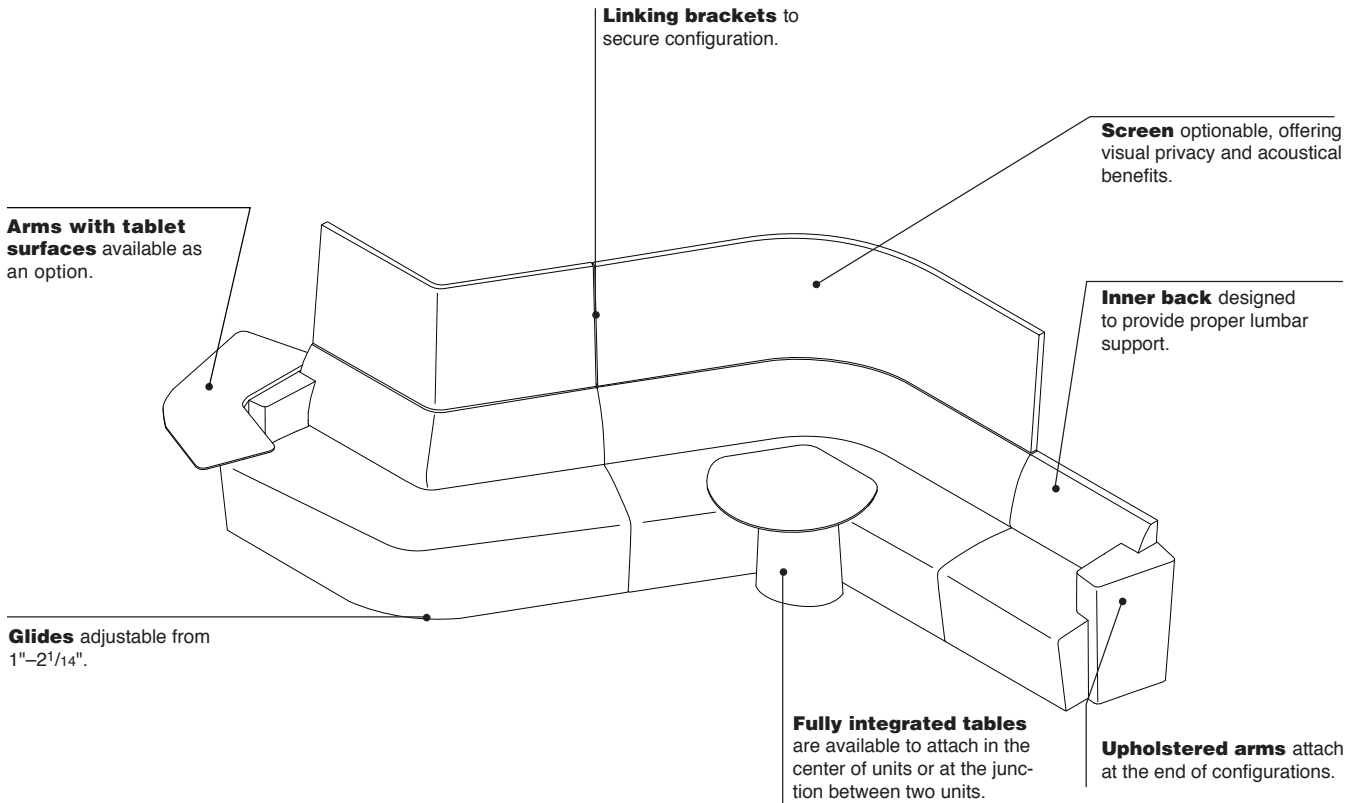



<b>Actual Dimensions</b>						
	<b>Depth</b>	<b>Width</b>	<b>Height</b>	<b>Weight</b>	<b>Seat Depth</b>	<b>Seat Height</b>
<b>OBAD01</b>	20"	31"	19"	32 lb	20"	19"
<b>OBAD02</b>	26"	31"	32"	39 lb	20"	19"
<b>OBAD03</b>	28"	31"	58"	62 lb	20"	19"
<b>OBAD03LC</b>	28"	31"	58"	59 lb	20"	19"
<b>OBAD03RC</b>	28"	31"	58"	59 lb	20"	19"
<b>OBAD11</b>	28"	71"	19"	55 lb	20"	19"
<b>OBAD12</b>	24"	71"	32"	98 lb	20"	19"
<b>OBAD13</b>	28"	71"	58"	115 lb	20"	19"
<b>OBAD21</b>	36"	78"	19"	71 lb	20"	19"
<b>OBAD22</b>	42"	84"	32"	135 lb	20"	19"
<b>OBAD23</b>	44"	86"	58"	160 lb	20"	19"
<b>OBAD23LC</b>	44"	85"	58"	154 lb	20"	19"
<b>OBAD23RC</b>	44"	85"	58"	154 lb	20"	19"
<b>OBAD24</b>	41"	78"	32"	135 lb	20"	19"
<b>OBAD25</b>	43"	78"	58"	160 lb	20"	19"
<b>OBAD31</b>	68"	78"	19"	111 lb	20"	19"
<b>OBAD32</b>	73"	78"	32"	159 lb	20"	19"
<b>OBAD33</b>	74"	78"	58"	181 lb	20"	19"
<b>OBAD42</b>	57"	57"	32"	135 lb	20"	19"
<b>OBAD43</b>	59"	59"	58"	161 lb	20"	19"
<b>OBAD52</b>	33"	72"	32"	120 lb	20"	19"
<b>OBAD53</b>	35"	75"	58"	142 lb	20"	19"
<b>OBAD64SRO</b>	43"	43"	29"	78 lb	N.A.	N.A.
<b>OBAD81DS</b>	53"	51"	57"	100 lb	N.A.	N.A.
<b>OBAD91SRO</b>	47"	47"	29"	100 lb	N.A.	N.A.
<b>OBAD91LRO</b>	55"	55"	29"	111 lb	N.A.	N.A.
<b>OBAD92</b>	24"	24"	20"	20 lb	N.A.	N.A.
<b>OBAD101</b>	26"	41"	32"	58 lb	20"	19"
<b>OBAD102</b>	28"	45"	58"	86 lb	20"	19"
<b>OBAD101LT</b>	36"	41"	32"	71 lb	20"	19"
<b>OBAD101RT</b>	36"	41"	32"	71 lb	20"	19"
<b>OBAD102LT</b>	38"	45"	58"	100 lb	20"	19"
<b>OBAD102RT</b>	38"	45"	58"	100 lb	20"	19"

► **Actual Dimensions, continued on next page**

Away from the Desk, continued

► Actual Dimensions, continued from previous page

Actual Dimensions, continued						
	Depth	Width	Height	Weight	Seat Depth	Seat Height
<b>OBAD103</b>	26"	72"	32"	128 lb	20"	19"
<b>OBAD85</b>	90"	93"	58"	474 lb	20"	19"
<b>OBAD85A</b>	59"	93"	58"	358 lb	20"	19"
<b>AD-61LA*</b>	18"	11"	28"	16 lb	N.A.	N.A.
<b>AD-61RA*</b>	18"	11"	28"	16 lb	N.A.	N.A.
<b>AD-62LC*</b>	41"	31"	29"	25 lb	N.A.	N.A.
<b>AD-62RC*</b>	41"	31"	29"	25 lb	N.A.	N.A.
<b>AD-71*</b>	31"	24"	29"	23 lb	N.A.	N.A.
<b>AD-72*</b>	28"	31"	29"	23 lb	N.A.	N.A.

\* AD-61LA, AD-61RA, AD-62LC, AD-62RC, AD-71, and AD-72 tables are not available as standalone styles. Please refer to Away from the Desk specifying pages for styles that have AD-71 and AD-72 tables available as an option.

Product Details

**Patterned fabric** works best when specified on the seat or inner back only. Patterns should be avoided on the outer back and screen due to predominant double stitch seams making pattern matching unachievable.

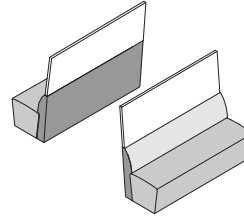

**Contrasting upholstery option** possible through specifying each surface independently.

**Power and Media**

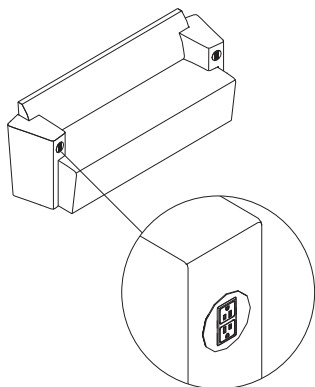
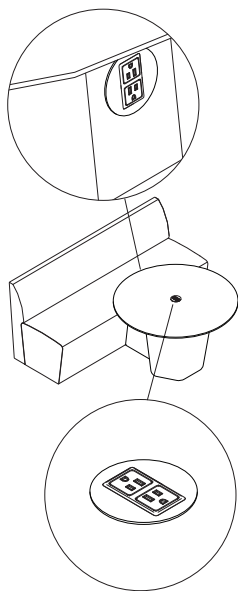

**Round power modules** are available as an option on table tops, table bases, and arm:

- 2 power outlets
- 1 power, 1 dual USB-A outlets
- 1 power, 1 HDMI outlets
- 1 power, 1 CAT6 data outlets

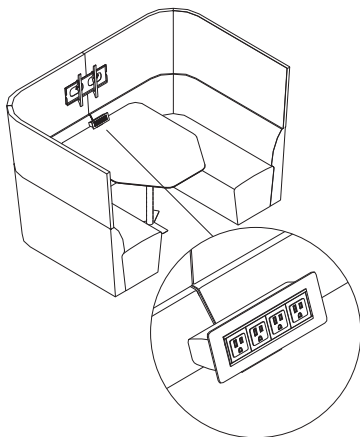

**Table mounted power** is available as an option for booth style numbers:

- 4 power outlets
- 2 power, 1 CAT6 data, 1 dual USB-A outlets
- 2 power, 1 CAT6 data, 1 HDMI outlets
- 2 power, 2 CAT6 data outlets

**72" cord length** exits through base of the tables and arms and comes fitted with a standard NEMA 5-15 plug.

**Tilting monitor brackets** available as an option on media den units. Monitor bracket supports a single screen up to 32" and 44 pounds.

**Application Topics**

**Handedness of units and connection points** are determined based on the user sitting position.

**Arms** can only connect the outer most ends of a configuration.

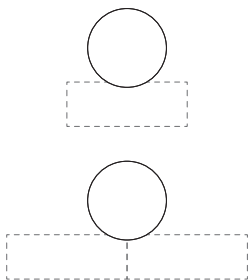

**Tables** can connect to the center of a single unit or at the junction between units.

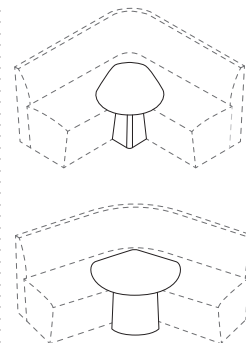

**Dedicated tables AD-71 and AD-72** can only be specified for use with 90° and 120° units respectively.

**Surface Materials**

**Table tops**

- Fiber HPL
- Micro HPL
- Patina HPL
- Solid HPL
- Speckle HPL
- Textured Woodgrain HPL
- Woodgrain HPL
- Textured Industrial HPL
- Open Line laminate

**Upholstery**

- Fabric
- Customer's Own Material (COM)

*Tip: This product does not use glue due to the environmental impact. Because of this, occasional dressing of the upholstery may be required.*

**Power**

- 4118 Warm Platinum
- 7015 Silk Textured
- 7207 Black

# Cubb Seating

**Cubb seating** is a succinct range of chairs and stools with a clear personality, delivering robust functionality for any environment.   
 ▶ Specifying, pages 150–165

**Upholstered arms.**

**Wood legs** made of solid white oak with glides.

**Metal chassis** secure legs to each other as well as seat shell.

**Wire arms** designed to complement wire frame base.

**Wire frame base.**

**Plastic glides** suitable for all surfaces.

**Seat shell** is gently curved, offering integrated lumbar support.

**Trestle base** allows 360° of swivel and is available in polished chrome or black.

**Hard glides** are standard. Soft glides available as an option.

**Gas lift** allows for travel up to 5" of seat height adjustment.

**Five-star base** available in polished chrome or black.

**Casters** are 2½" in diameter. Hard casters for use on carpet as standard.

## Actual Dimensions

	Depth	Width	Height	Weight	Seat Depth	Seat Height
<b>OBCUBB01</b>	18"	19"	33"	20 lb	16"	19"
<b>OBCUBB02</b>	18"	21"	33"	26 lb	16"	19"
<b>OBCUBB03</b>	18"	21"	33"	22 lb	16"	19"
<b>OBCUBB04</b>	19"	22"	33"	19 lb	16"	19"
<b>OBCUBB05</b>	19"	22"	33"	27 lb	16"	19"
<b>OBCUBB06</b>	19"	22"	33"	20 lb	16"	19"
<b>OBCUBB07</b>	19"	22"	33"	19 lb	16"	19"
<b>OBCUBB08</b>	19"	22"	33"	25 lb	16"	19"
<b>OBCUBB09</b>	19"	22"	33"	20 lb	16"	19"
<b>OBCUBB10</b>	26"	26"	33"	25 lb	16"	19"
<b>OBCUBB11</b>	26"	26"	33"	31 lb	16"	19"
<b>OBCUBB12</b>	26"	26"	33"	26 lb	16"	19"
<b>OBCUBB13</b>	19"	18"	39"	21 lb	15"	30"
<b>OBCUBB14</b>	20"	20"	39"	21 lb	15"	30"
<b>OBCUBB15</b>	17"	18"	19"	10 lb	N.A.	N.A.
<b>OBCUBB19</b>	16"	51"	19"	27 lb	N.A.	N.A.

**Product Details**

**Cubb seating** utilizes the same core seat with a combination of two arm options and four base styles.

**Both the trestle and five-star base options** swivel 360°.

**A foot rail cover** is available as an option on wire base stool.

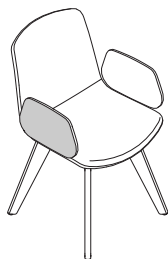

**Two-tone contrasting upholstery option** is available.

*Tip: If two-tone upholstered option is selected, contrasting price groups are available. Total seat finish and outer seat finish price is driven by highest price group selection.*

**Cubb seating** does not stack.

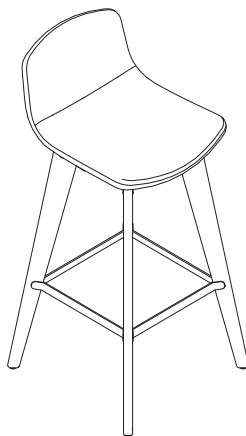

**Armless seat on wood base** available as bar height stool.

*Tip: Foot rail finish will match that of chassis.*

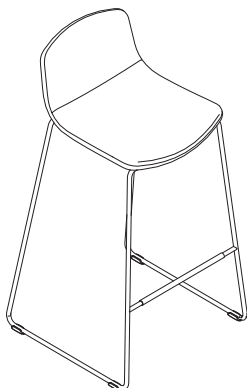

**Armless seat on wire frame base** available as bar height stool.

**Surface Materials****Upholstery**

- Fabric
- Customer's Own Material (COM)
- Customer's Own Leather (COL)

**Wood leg base**

- 31WK Medium Walnut on Oak
- 3652 Dark Distressed Oak Stain
- V3AK Natural Oak
- VP03 Black Oak

**Metal chassis**

- Accent paint
- Accessory paint
- Smooth metallic
- Smooth paint
- Textured paint
- Textured metallic

**Wire frame base**

- Accent paint
- Accessory paint
- Polished chrome
- Smooth metallic
- Smooth paint
- Textured paint
- Textured metallic
- Lux coatings

**Trestle base**

- Black
- Polished chrome

**5-Star base**

- Black
- Polished chrome

**Wire arms**

- Accent paint
- Accessory paint
- Smooth metallic
- Smooth paint
- Textured paint
- Textured metallic

*Tip: Wire arms will always match finish of base when base is trestle or five-star.*

**Custom Surfaces****Perfect Match**

**PerfectMatch** is a service that allows you to create your own paint color Refer to the *Surface Materials Reference Guide* for more information about this program.

Applies to:

- Metal chassis
- Wire frame base
- Wire arms

# Cubb Tables

**Cubb tables** are a distinctive range of meeting and project tables with a laid-back, informal feel— great for any environment.

► Specifying, pages 166–186

**Meeting tables** sit 29"H and are available in widths ranging from 35" to 177".

**Worksurface** available with tapered edge detail as standard.

**Metal chassis** secure legs to each other as well as worksurface.

**Project tables** stand 41<sup>3</sup>/<sub>8</sub>"H and are available at 63", 82<sup>1</sup>/<sub>16</sub>", or 102<sup>3</sup>/<sub>8</sub>"W.

**Footrail** designed to match the finish of the metal chassis.

**Leg channel** allows for cables to be managed seamlessly through any leg.

**Cables** provide additional stability and support.

**Actual Dimensions**

	Depth	Width	Height	Weight
<b>OBCUBBRCM01</b>	29 1/2"	55 1/8"	29 1/3"	70 lb
<b>OBCUBBRCM02</b>	29 1/2"	63"	29 1/3"	78 lb
<b>OBCUBBRCM03</b>	39 3/8"	82 11/16"	29 1/3"	121 lb
<b>OBCUBBRCM04</b>	39 3/8"	94 1/2"	29 1/3"	138 lb
<b>OBCUBBRCM05</b>	47 1/4"	118 1/8"	29 1/3"	198 lb
<b>OBCUBBRCM07</b>	47 1/4"	177 3/16"	29 1/3"	289 lb
<b>OBCUBBRCM09</b>	55 1/8"	118 1/8"	29 1/3"	222 lb
<b>OBCUBBRCM11</b>	55 1/8"	177 3/16"	29 1/3"	325 lb
<b>OBCUBBRCP01</b>	47 1/4"	23 2/3"	17 3/4"	43 lb
<b>OBCUBBRCP02</b>	35 7/16"	63"	41 3/5"	113 lb
<b>OBCUBBRCP03</b>	35 7/16"	82 11/16"	41 3/5"	139 lb
<b>OBCUBBRCP03</b>	35 7/16"	102 3/8"	41 3/5"	166 lb
<b>OBCUBBRDM01</b>	47 1/4"	47 1/4"	29 1/3"	70 lb
<b>OBCUBBRDM02</b>	55 1/8"	55 1/8"	29 1/3"	88 lb
<b>OBCUBBRDM03</b>	63"	63"	29 1/3"	109 lb
<b>OBCUBBRDM04</b>	70 7/8"	70 7/8"	29 1/3"	137 lb
<b>OBCUBBRDO01</b>	26 5/8"	26 5/8"	17 23/32"	19 lb
<b>OBCUBBRDO02</b>	31 1/2"	31 1/2"	17 23/32"	37 lb
<b>OBCUBBSQM01</b>	35 7/16"	35 7/16"	29 1/3"	57 lb
<b>OBCUBBSQO01</b>	23 2/3"	23 2/3"	17 3/4"	24 lb
<b>OBCUBBSSM01</b>	35 7/16"	35 7/16"	29 1/3"	57 lb

**Product Details**

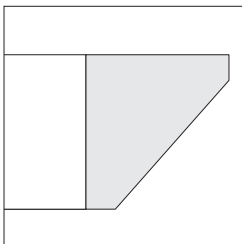

Edge profile is tapered as standard.

**Integrated power** available in all meeting and project table worksurfaces. All power cords are 10' long and available with either a standard three prong NEMA plug or hardwire.

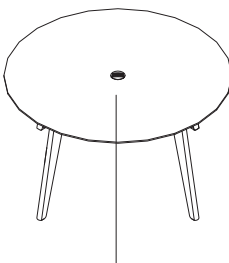

**Round meeting tables**

can accept a single centrally located round face power unit in the following configurations:

- 2 power outlets
- 1 power, 1 dual USB-A outlets

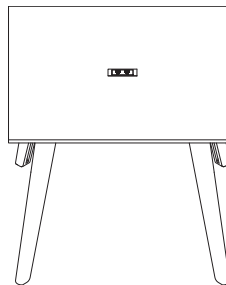
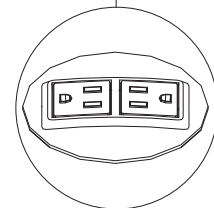

**Square meeting tables**

can accept a centrally located rectangular face power unit in the following configurations:

- 2 power outlets
- 1 power, 1 dual USB-A outlets

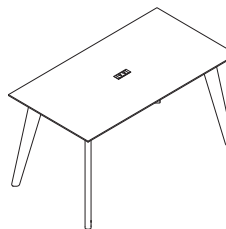

**Small, rectangular meeting tables**

can accept a centrally located rectangular face power unit in the following configurations:

- 2 power outlets
- 1 power, 1 dual USB-A outlets
- 3 power, 1 dual USB-A outlets
- 2 power, 2 dual USB-A outlets
- 3 power, 1 dual USB-A, and 1 USB-C outlets

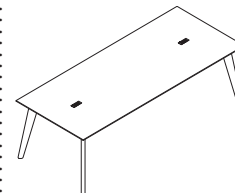

**Medium and large rectangular meeting tables**

can accept multiple rectangular face power units in the following configurations:

- 2 power outlets
- 1 power, 1 dual USB-A outlets
- 3 power, 1 dual USB-A outlets
- 2 power, 2 dual USB-A outlets
- 3 power, 1 dual USB-A, and 1 USB-C outlets

Cubb Tables, continued



Center only



Left and center



Left and right



Left only

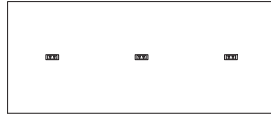

Left, right and center



Center and right



Right only

When multiple power units are specified, power location can be left, right, or center of the table.

Tip: Location and quantity allowed is dependent on the style number.

**Wiring and Cabling**

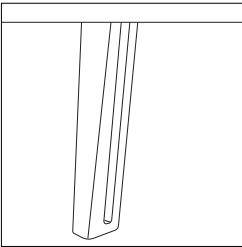

**Wood legs** designed with a channel for seamless cable management. Each leg come standard with a channel and rubber riser insert (black).

When multiple power units per table are specified, Interlink daisy chaining will come standard with a single plug located at the end of the configuration.

Multiple hardwire power units per table do not daisy chain and require independent connections.

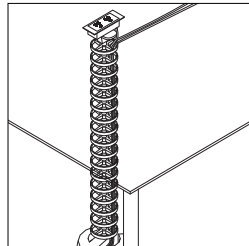
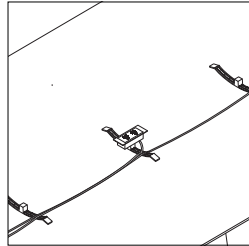

Additional cable management options are available through specification of a set of cable clips or an umbilical riser.

**Surface Materials**

**Worksurface**

- Fiber LPL
- Solid LPL
- Woodgrain LPL
- Fiber HPL
- Micro HPL
- Patina HPL
- Solid HPL
- Speckle HPL
- Textured Woodgrain HPL
- Woodgrain HPL
- Textured Industrial HPL
- Open Line laminate



Woodgrain laminate on single-piece tables will always be oriented at 0° with the grain direction running parallel with the length of the table top.

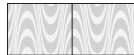

Woodgrain laminate on multi-piece tables will always be oriented at 90° with the grain direction running perpendicular with the length of the table top.

Woodgrain laminates cannot be grain matched.

**Wood leg base**

- 31WK Medium Walnut on Oak
- 3652 Dark Distressed Oak Stain
- V3AK Natural Oak
- VP03 Black Oak

**Metal chassis**

- Accent paint
- Accessory paint
- Smooth metallic
- Smooth paint
- Textured paint
- Textured metallic

Tip: Project table foot rail will always match finish of the chassis finish.

**Power**

- 0835 Black
- 4242 Milk
- 4799 Platinum
- 7360 Merle

Applies to:  
• Metal chassis

**Custom Surfaces**

**Perfect Match**

PerfectMatch is a service that allows you to create your own paint color Refer to the Surface Materials Reference Guide for more information about this program.



---

# Specifying

<b>Acoustic Pods</b>	
<b>Air<sup>3</sup></b>	<b>42</b>
<b>Air<sup>3</sup> Tables</b>	<b>49</b>
<b>Accessories</b>	<b>50</b>
<b>On the QT</b>	
Phone Booths	<b>52</b>
Seating	<b>58</b>
<b>Seating</b>	
<b>Aspect</b>	
Work Unit with Curved Arm	<b>60</b>
Work Screened Units with Fixed Table	<b>66</b>
<b>Avi</b>	<b>78</b>
<b>Sully, Skomer, and Ramsey</b>	<b>81</b>
<b>Border</b>	<b>86</b>
<b>Away from the Desk</b>	
Seating	<b>92</b>
Tables	<b>136</b>
Detached Seating	<b>141</b>
Media Dens	<b>146</b>
<b>Cubb Seating and Tables</b>	
Seating	<b>150</b>
Tables	<b>165</b>

# Acoustic Pods

## Pods

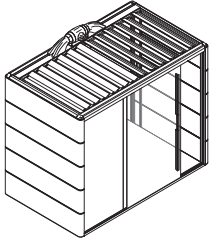

*Tip: All Air3 models must be installed by Orangebox certified installers or warranty is void.*

### Standard Includes

- One service hoop:
  - three NEMA 5-15 3-prong power outlets
  - three LED lights
  - heat detector
  - occupancy sensor
  - user control panel
- 10 exterior fabric panels: one grommet
- 10 interior fabric panels
- Five glass panels (clear):
  - one 85 7/16" x 26 3/4"
  - four 85 7/16" x 34 3/8"
- One 86 3/16" x 45 11/16" glass sliding door: clear
- One air circulation fan
- Two louvered roof ceiling squares: aluminum roof blades (grey)

### Options

Over Upholstery Fixed Monitor Bracket	No Over Upholstery Monitor Bracket	No cost
	Over Upholstery Fixed Monitor Bracket	+\$1268
	2 Over Upholstery Fixed Monitor Brackets	+\$2536
Whiteboard	No Whiteboard	No cost
	Straight Glass Magnetic Whiteboard	+\$3159
	2 Straight Glass Magnetic Whiteboards	+\$6318
Door Size	Standard Door Size	No cost
	Ontario AODA Compliant Door	+\$5328
Door Lock	No Lock	No cost
	Locking Door	+\$1965

### Specification Information

Style Number	Base Price	
<b>Air<sup>3</sup> Half-Square with Opening Roof</b>		
<b>OB1AIR23</b>	\$47,216	
<b>Single Grade Prices (for all five layers)</b>	<b>Internal Fabric</b>	<b>External Fabric</b>
Grade 3	+\$1080	+\$1435
Grade 4	+\$1370	+\$1810
Grade 5	+\$1825	+\$2430
Grade 6	+\$2400	+\$3185
Grade 8	+\$3410	+\$4540
<b>Layered Grade Prices (per layer)</b>		
Grade 3 Layer	+\$216	+\$287
Grade 4 Layer	+\$274	+\$362
Grade 5 Layer	+\$365	+\$486
Grade 6 Layer	+\$480	+\$637
Grade 8 Layer	+\$682	+\$908

# Acoustic Pods

## Pods

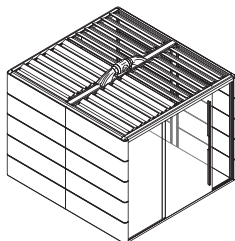

*Tip: All Air3 models must be installed by Orangebox certified installers or warranty is void.*

### Standard Includes

- One service hoop:
  - three NEMA 5-15 3-prong power outlets
  - three LED lights
  - heat detector
  - occupancy sensor
  - user control panel
- 20 exterior fabric panels: one grommet
- 20 interior fabric panels
- Five glass panels (clear):
  - one 85 7/16" x 26 3/4"
  - four 85 7/16" x 34 3/8"
- One 86 3/16" x 45 11/16" glass sliding door: clear
- One air circulation fan
- Four louvered roof ceiling squares: aluminum roof blades (grey)

### Options

Hoop Mounted Monitor Bracket	No Hoop Mounted Monitor Bracket	No cost
	Hoop Mounted Fixed Monitor Bracket	+\$820
Over Upholstery Fixed Monitor Bracket	No Over Upholstery Monitor Bracket	No cost
	Over Upholstery Fixed Monitor Bracket	+\$1268
	2 Over Upholstery Fixed Monitor Brackets	+\$2536
	3 Over Upholstery Fixed Monitor Brackets	+\$3804
	4 Over Upholstery Fixed Monitor Brackets	+\$5072
Whiteboard	No Whiteboard	No cost
	Straight Glass Magnetic Whiteboard	+\$3159
	2 Straight Glass Magnetic Whiteboards	+\$6318
	3 Straight Glass Magnetic Whiteboards	+\$9477
	4 Straight Glass Magnetic Whiteboards	+\$12,636
Door Size	Standard Door Size	No cost
	Ontario AODA Compliant Door	+\$5328
Door Lock	No Lock	No cost
	Locking Door	+\$1965

► **Product Information continued on next page**

# Acoustic Pods

## Pods

► **Product Information continued from previous page**

### Specification Information

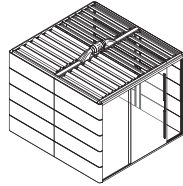

Style Number	Base Price
--------------	------------

### Air<sup>3</sup> Square with Opening Roof

<b>OB1AIR25</b>	\$57,974
-----------------	----------

Single Grade Prices (for all five layers)	Internal Fabric	External Fabric
Grade 3	+\$2125	+\$2745
Grade 4	+\$2675	+\$3425
Grade 5	+\$3565	+\$4500
Grade 6	+\$4620	+\$5780
Grade 8	+\$6620	+\$8200

#### Layered Grade Prices (per layer)

Grade 3 Layer	+\$425	+\$549
Grade 4 Layer	+\$535	+\$685
Grade 5 Layer	+\$713	+\$900
Grade 6 Layer	+\$924	+\$1156
Grade 8 Layer	+\$1324	+\$1640

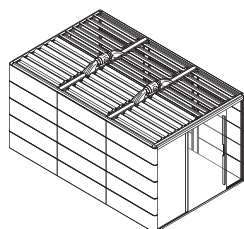
**Acoustic Pods****Pods**

*Tip: All Air3 models must be installed by Orangebox certified installers or warranty is void.*

**Standard Includes**

- Two service hoops:
  - three NEMA 5-15 3-prong power outlets
  - three LED lights
  - heat detector
  - user control panel
  - occupancy sensor
- 30 exterior panels: two grommets
- 30 interior panels
- Five glass panels (clear):
  - one 85 7/16" x 26 3/4"
  - four 85 7/16" x 34 3/8"
- One 86 3/16" x 45 11/16" glass sliding door: clear
- Two air circulation fans
- Six louvered roof ceiling squares: aluminum roof blades (grey)

**Options**

Hoop Mounted Monitor Bracket	No Hoop Mounted Monitor Bracket	No cost
	Hoop Mounted Fixed Monitor Bracket	+\$820
	2 Hoop Mounted Fixed Monitor Brackets	+\$1640
Over Upholstery Fixed Monitor Bracket	No Over Upholstery Monitor Bracket	No cost
	Over Upholstery Fixed Monitor Bracket	+\$1268
	2 Over Upholstery Fixed Monitor Brackets	+\$2536
	3 Over Upholstery Fixed Monitor Brackets	+\$3804
	4 Over Upholstery Fixed Monitor Brackets	+\$5072
	5 Over Upholstery Fixed Monitor Brackets	+\$6340
Whiteboard	6 Over Upholstery Fixed Monitor Brackets	+\$7608
	No Whiteboard	No cost
	Straight Glass Magnetic Whiteboard	+\$3159
	2 Straight Glass Magnetic Whiteboards	+\$6318
	3 Straight Glass Magnetic Whiteboards	+\$9477
	4 Straight Glass Magnetic Whiteboards	+\$12,636
Door Size	5 Straight Glass Magnetic Whiteboards	+\$15,795
	6 Straight Glass Magnetic Whiteboards	+\$18,954
	Standard Door Size	No cost
Door Lock	Ontario AODA Compliant Door	+\$5328
	No Lock	No cost
	Locking Door	+\$1965

► **Product Information continued on next page**

# Acoustic Pods

## Pods

► **Product Information continued from previous page**

### Specification Information

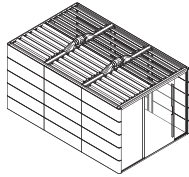

Style Number	Base Price	
<b>Air<sup>3</sup> Rectangle with Opening Roof</b>		
<b>OB1AIR27</b>	\$91,019	
<b>Single Grade Prices (for all five layers)</b>	<b>Internal Fabric</b>	<b>External Fabric</b>
Grade 3	+\$3175	+\$3775
Grade 4	+\$3995	+\$4740
Grade 5	+\$5310	+\$6315
Grade 6	+\$6965	+\$8195
Grade 8	+\$9860	+\$11,705
<b>Layered Grade Prices (per layer)</b>		
Grade 3 Layer	+\$635	+\$755
Grade 4 Layer	+\$799	+\$948
Grade 5 Layer	+\$1062	+\$1263
Grade 6 Layer	+\$1393	+\$1639
Grade 8 Layer	+\$1972	+\$2341

# Acoustic Pods

## Pods

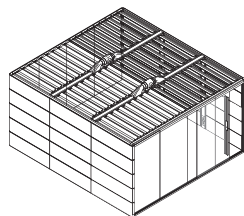

*Tip: All Air3 models must be installed by Orangebox certified installers or warranty is void.*

### Standard Includes

- Two service hoops:
  - three NEMA 5-15 3-prong power outlets
  - three LED lights
  - heat detector
  - user control panel
  - occupancy sensor
- 30 exterior panels: two grommets
- 30 interior panels
- Seven glass panels (clear):
  - two 85 5/16" x 40 3/4"
  - five 85 7/16" x 26 3/4"
- One 86 3/16" x 45 11/16" glass sliding door: clear
- Two air circulation fans
- Six louvered roof ceiling squares: aluminum roof blades (grey)

### Options

Hoop Mounted Monitor Bracket	No Hoop Mounted Monitor Bracket	No cost
	Hoop Mounted Fixed Monitor Bracket	+\$820
	2 Hoop Mounted Fixed Monitor Brackets	+\$1640
Over Upholstery Fixed Monitor Bracket	No Over Upholstery Monitor Bracket	No cost
	Over Upholstery Fixed Monitor Bracket	+\$1268
	2 Over Upholstery Fixed Monitor Brackets	+\$2536
	3 Over Upholstery Fixed Monitor Brackets	+\$3804
	4 Over Upholstery Fixed Monitor Brackets	+\$5072
	5 Over Upholstery Fixed Monitor Brackets	+\$6340
Whiteboard	6 Over Upholstery Fixed Monitor Brackets	+\$7608
	No Whiteboard	No cost
	Straight Glass Magnetic Whiteboard	+\$3159
	2 Straight Glass Magnetic Whiteboards	+\$6318
	3 Straight Glass Magnetic Whiteboards	+\$9477
	4 Straight Glass Magnetic Whiteboards	+\$12,636
Door Size	5 Straight Glass Magnetic Whiteboards	+\$15,795
	6 Straight Glass Magnetic Whiteboards	+\$18,954
	Standard Door Size	No cost
Door Lock	Ontario AODA Compliant Door	+\$5328
	No Lock	No cost
	Locking Door	+\$1965

► **Product Information continued on next page**

Acoustic Pods

# Acoustic Pods

## Pods

► **Product Information continued from previous page**

### Specification Information

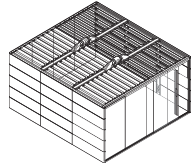

Style Number	Base Price	
<b>Air<sup>3</sup> Square 3x3 with Opening Roof</b>		
<b>OB1AIR29</b>	\$127,651	
<b>Single Grade Prices (for all five layers)</b>	<b>Internal Fabric</b>	<b>External Fabric</b>
Grade 3	+\$3175	+\$3775
Grade 4	+\$3995	+\$4740
Grade 5	+\$5310	+\$6315
Grade 6	+\$6965	+\$8195
Grade 8	+\$9860	+\$11,705
<b>Layered Grade Prices (per layer)</b>		
Grade 3 Layer	+\$635	+\$755
Grade 4 Layer	+\$799	+\$948
Grade 5 Layer	+\$1062	+\$1263
Grade 6 Layer	+\$1393	+\$1639
Grade 8 Layer	+\$1972	+\$2341



# Acoustic Pods

## Pod Tables

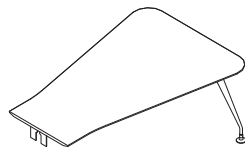

Tip: Recommended for use in OB1AIR25.

### Standard Includes

- 1" thick table top: High-Pressure Laminate price group 01
- 3 mm edgeband: plastic price group 01
- Two legs with feet
- Attachment bracket with hardware

### Options

Top Finish	Laminate HPL Price Group 01	No cost
	Laminate HPL Price Group 02	+\$187
	Laminate HPL Price Group 03	+\$388
	OLL Price Group 1	+\$102
Edge Finish	Plastic Group 1	No cost
Leg Finish	Orangebox Paint Price Group 01	No cost
	Orangebox Paint Price Group 02	+\$74

### Specification Information

Style Number	Base Price
<b>Air3 Small Pod Table</b>	
<b>OB1AIR30</b>	\$2818

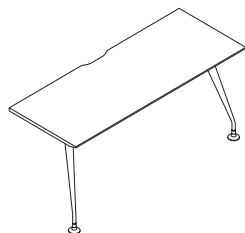

Tip: Recommended for use in OB1AIR23.

### Standard Includes

- 1" thick table top: High-Pressure Laminate price group 01
- 3 mm edgeband: plastic price group 01
- Two legs with feet
- Attachment bracket with hardware

### Options

Top Finish	Laminate HPL Price Group 01	No cost
	Laminate HPL Price Group 02	+\$87
	Laminate HPL Price Group 03	+\$183
	OLL Price Group 1	+\$102
Edge Finish	Plastic Group 1	No cost
Leg Finish	Orangebox Paint Price Group 01	No cost
	Orangebox Paint Price Group 02	+\$74

### Specification Information

Style Number	Base Price
<b>Air3 Short, Straight Pod Table</b>	
<b>OB1AIR35</b>	\$2584

# Acoustic Pods

## Accessories

### Standard Includes

- Style Number

### Specification Information

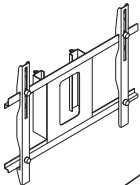
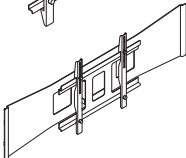
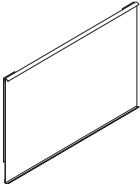
	Style Number	Price
	<b>Hoop Mounted Monitor Bracket</b>	
	<b>OB1AIRGA153US</b>	\$820
	<b>Over Upholstery Monitor Bracket</b>	
	<b>OB1AIRGA174US</b>	\$1268
	<b>Straight Glass Magnetic Whiteboard</b>	
	<b>OB1AIRGA151</b>	\$3159

*Tip: Use of the installation template is highly recommended. The installation template can be ordered from the CS3 catalog under style number 1379688001SR.*

### Standard Includes

- Installation training

### Specification Information

	Style Number	Price
	<b>Air3 Installation Training, One to Five Units</b>	
	<b>OB1AIRINSTALL1</b>	\$1309
	<b>Air3 Installation Training, Six to 10 Units</b>	
	<b>OB1AIRINSTALL2</b>	\$2619
	<b>Air3 Installation Training, 11+ Units</b>	
	<b>OB1AIRINSTALL3</b>	\$6549

# Acoustic Pods

## Accessories

*Tip: Seismic kits do not include hardware to anchor brackets to the building.*

### Standard Includes

- Seismic bracket

### Specification Information

Style Number	Price
<b>Air23 Pod Seismic Kit</b>	
<b>OB1AIRGA180</b>	\$692
<b>Air25 Pod Seismic Kit</b>	
<b>OB1AIRGA176</b>	\$692
<b>Air27 Pod Seismic Kit</b>	
<b>OB1AIRGA181</b>	\$1069
<b>Air29 Pod Seismic Kit</b>	
<b>OB1AIRGA204</b>	\$1448

Acoustic Pods

# On the QT

## Phone Booths

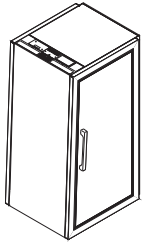

### Standard Includes

- Frame assembly:
  - aluminum framework
  - acoustic wall cassettes
  - roof and floor panels (black)
- Carpet
- One set of framed laminated glass, door, and wall
- One solid oak door handle
- Two laminate cladding exterior walls: High-Pressure Laminate price group 01
- Two pressed felt interior cladding walls
- Integrated lighting and air ventilation, with motion sensor

### Options

Front Exterior Cladding Type	Laminate	No cost
	Painted Metal	+\$193
	Whiteboard	+\$651
	Fabric	+\$1026
	Plywood	+\$1332
Front Exterior Cladding Finish	Fabric Customer's Own Material	No cost
	Fabric Price Group 01	No cost
	Laminate HPL Price Group 01	No cost
	Markerboard Price Group 01	No cost
	Paint Price Group 01	No cost
	Plywood Price Group 01	No cost
	Fabric Price Group 02	+\$39
	Fabric Price Group 03	+\$72
	Paint Price Group 02	+\$72
	Laminate HPL Price Group 02	+\$88
	Fabric Price Group 04	+\$112
	Paint Price Group 03	+\$117
	Fabric Price Group 05	+\$174
	Laminate HPL Price Group 03	+\$186
	Fabric Price Group 06	+\$240
Fabric Price Group 07	+\$304	
Fabric Price Group 08	+\$368	
Fabric Price Group 09	+\$441	
Fabric Price Group 10	+\$509	
OLL Price Group 1	+\$102	
Rear Exterior Cladding Type	Laminate	No cost
	Painted Metal	+\$193
	Whiteboard	+\$651
	Fabric	+\$1026
	Plywood	+\$1332
Rear Exterior Cladding Finish	Fabric Customer's Own Material	No cost
	Fabric Price Group 01	No cost
	Laminate HPL Price Group 01	No cost
	Markerboard Price Group 01	No cost
	Paint Price Group 01	No cost
	Plywood Price Group 01	No cost
	Fabric Price Group 02	+\$39
	Fabric Price Group 03	+\$72

► **Product Information continued on next page**

► **Product Information continued from previous page**

<b>Options</b>		
Rear Exterior Cladding Finish	Paint Price Group 02	+\$72
	Laminate HPL Price Group 02	+\$88
	Fabric Price Group 04	+\$112
	Paint Price Group 03	+\$117
	Fabric Price Group 05	+\$174
	Laminate HPL Price Group 03	+\$186
	Fabric Price Group 06	+\$240
	Fabric Price Group 07	+\$304
	Fabric Price Group 08	+\$368
	Fabric Price Group 09	+\$441
	Fabric Price Group 10	+\$509
	OLL Price Group 1	+\$102
Cover Cap Finish	Paint Price Group 01	No cost
	Paint Price Group 02	+\$55
	Paint Price Group 03	+\$111
Lean Pad Option	No Lean Pad	No cost
	Lean Pad	+\$895
Lean Pad Finish	Fabric Customer's Own Material	No cost
	Fabric Price Group 01	No cost
	Fabric Price Group 02	+\$24
	Fabric Price Group 03	+\$47
	Fabric Price Group 04	+\$81
	Fabric Price Group 05	+\$134
	Fabric Price Group 06	+\$186
	Fabric Price Group 07	+\$254
	Fabric Price Group 08	+\$316
	Fabric Price Group 09	+\$368
	Fabric Price Group 10	+\$438
Screen Type	No Screen	No cost
	Privacy Screen	+\$686
Screen Finish	Fabric Customer's Own Material	No cost
	Fabric Price Group 01	No cost
	Fabric Price Group 02	+\$24
	Fabric Price Group 03	+\$47
	Fabric Price Group 04	+\$81
	Fabric Price Group 05	+\$134
	Fabric Price Group 06	+\$186
	Fabric Price Group 07	+\$254
	Fabric Price Group 08	+\$316
	Fabric Price Group 09	+\$368
	Fabric Price Group 10	+\$438
Power Plug Type	Hardware	No cost
	Type B	No cost
Power Outlet Type	No Power Outlet	No cost
	Type B	No cost
Power Configuration	2 Power	+\$258
Light	No Light	No cost
	Occupancy Light	+\$375

Tip: "Type B" is the standard North American NEMA 5-15 plug.

► **Product Information continued on next page**

# On the QT

## Phone Booths

► **Product Information continued from previous page**

Options		
Seismic Kit Option	No Kit	No cost
	Seismic Kit	+\$729
Shelf Option	No Shelf	No cost
	With Shelf	+\$364
Shelf Finish	Laminate HPL Price Group 01	No cost
	Laminate HPL Price Group 02	+\$76
	Laminate HPL Price Group 03	+\$154
	OLL Price Group 1	+\$102

### Specification Information

Style Number    Base Price

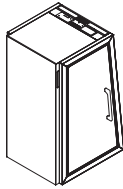

#### Short Angled Phone Booth, LH Hinge

**OB1QT01**    \$20,903

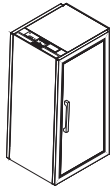

#### Short Angled Phone Booth, RH Hinge

**OB1QT02**    \$20,903

# On the QT

## Phone Booths

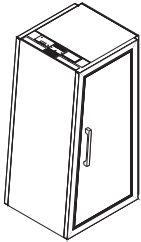

### Standard Includes

- Frame assembly:
  - aluminum framework
  - acoustic wall cassettes
  - roof and floor panels (black)
- Carpet
- One set of framed laminated glass, door, and wall
- One solid oak door handle
- Two laminate cladding exterior walls: High-Pressure Laminate price group 01
- Two pressed felt interior cladding walls
- Integrated lighting and air ventilation, with motion sensor

### Options

Front Exterior Cladding Type	Laminate	No cost
	Painted Metal	+\$251
	Whiteboard	+\$741
	Fabric	+\$1114
	Plywood	+\$1446
Front Exterior Cladding Finish	Fabric Customer's Own Material	No cost
	Fabric Price Group 01	No cost
	Laminate HPL Price Group 01	No cost
	Markerboard Price Group 01	No cost
	Paint Price Group 01	No cost
	Plywood Price Group 01	No cost
	Fabric Price Group 02	+\$44
	Fabric Price Group 03	+\$72
	Paint Price Group 02	+\$85
	Laminate HPL Price Group 02	+\$107
	Fabric Price Group 04	+\$119
	Paint Price Group 03	+\$144
	Fabric Price Group 05	+\$186
	Laminate HPL Price Group 03	+\$223
	Fabric Price Group 06	+\$254
Fabric Price Group 07	+\$320	
Fabric Price Group 08	+\$389	
Fabric Price Group 09	+\$465	
Fabric Price Group 10	+\$541	
OLL Price Group 1	+\$102	
Rear Exterior Cladding Type	Laminate	No cost
	Painted Metal	+\$251
	Whiteboard	+\$741
	Fabric	+\$1114
	Plywood	+\$1446
Rear Exterior Cladding Finish	Fabric Customer's Own Material	No cost
	Fabric Price Group 01	No cost
	Laminate HPL Price Group 01	No cost
	Markerboard Price Group 01	No cost
	Paint Price Group 01	No cost
	Plywood Price Group 01	No cost
	Fabric Price Group 02	+\$44
	Fabric Price Group 03	+\$75

► **Product Information continued on next page**

**On the QT****Phone Booths****► Product Information continued from previous page**

<b>Options</b>		
Rear Exterior Cladding Finish	Paint Price Group 02	+\$85
	Laminate HPL Price Group 02	+\$107
	Fabric Price Group 04	+\$119
	Paint Price Group 03	+\$144
	Fabric Price Group 05	+\$186
	Laminate HPL Price Group 03	+\$223
	Fabric Price Group 06	+\$254
	Fabric Price Group 07	+\$320
	Fabric Price Group 08	+\$389
	Fabric Price Group 09	+\$465
	Fabric Price Group 10	+\$541
	OLL Price Group 1	+\$102
Cover Cap Finish	Paint Price Group 01	No cost
	Paint Price Group 02	+\$74
	Paint Price Group 03	+\$140
Lean Pad Option	No Lean Pad	No cost
	Lean Pad	+\$895
Lean Pad Finish	Fabric Customer's Own Material	No cost
	Fabric Price Group 01	No cost
	Fabric Price Group 02	+\$24
	Fabric Price Group 03	+\$47
	Fabric Price Group 04	+\$81
	Fabric Price Group 05	+\$134
	Fabric Price Group 06	+\$186
	Fabric Price Group 07	+\$254
	Fabric Price Group 08	+\$316
	Fabric Price Group 09	+\$368
	Fabric Price Group 10	+\$438
Screen Type	No Screen	No cost
	Privacy Screen	+\$686
Screen Finish	Fabric Customer's Own Material	No cost
	Fabric Price Group 01	No cost
	Fabric Price Group 02	+\$24
	Fabric Price Group 03	+\$47
	Fabric Price Group 04	+\$81
	Fabric Price Group 05	+\$134
	Fabric Price Group 06	+\$186
	Fabric Price Group 07	+\$254
	Fabric Price Group 08	+\$316
	Fabric Price Group 09	+\$368
	Fabric Price Group 10	+\$438
Power Plug Type	Hardwire	No cost
	Type B	No cost
Power Outlet Type	No Power Outlet	No cost
	Type B	No cost
Power Configuration	2 Power	+\$258
Light	No Light	No cost
	Occupancy Light	+\$375

*Tip: "Type B" is the standard North American NEMA 5-15 plug.*

**► Product Information continued on next page**



# On the QT

## Phone Booths

► **Product Information continued from previous page**

Options		
Seismic Kit Option	No Kit	No cost
	Seismic Kit	+\$729
Shelf Option	No Shelf	No cost
	With Shelf	+\$364
	With L-Shelf	+\$414
Shelf Finish	Laminate HPL Price Group 01	No cost
	Laminate HPL Price Group 02	+\$76
	Laminate HPL Price Group 03	+\$154
	OLL Price Group 1	+\$102

### Specification Information

Style Number    Base Price

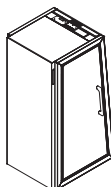

#### Tall Angled Phone Booth, LH Hinge

**OB1QT03**    \$21,020

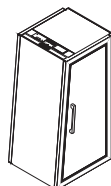

#### Tall Angled Phone Booth, RH Hinge

**OB1QT04**    \$21,020

On the QT

# On the QT

## Seating

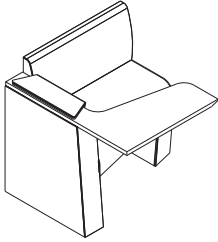

Tip: (OB1QTF01) and (OB1QTF02) are not standalone units and are only for use in On the Q.T. phone booths.

### Standard Includes

- Fully upholstered seating unit: fabric price group 01
- 1" thick integrated tablet: High-Pressure Laminate price group 01 with 3 mm plastic edge

### Options

Color Scheme	Non Contrasting	No cost
	Contrasting	+\$102
Upholstery Finish	Fabric Customer's Own Material	No cost
	Fabric Price Group 01	No cost
	Fabric Price Group 02	+\$84
	Fabric Price Group 03	+\$222
	Fabric Price Group 04	+\$301
	Fabric Price Group 05	+\$352
	Fabric Price Group 06	+\$428
	Fabric Price Group 07	+\$529
	Fabric Price Group 08	+\$642
	Fabric Price Group 09	+\$797
Fabric Price Group 10	+\$918	
Seat Finish	Fabric Customer's Own Material	No cost
	Fabric Price Group 01	No cost
	Fabric Price Group 02	+\$24
	Fabric Price Group 03	+\$61
	Fabric Price Group 04	+\$82
	Fabric Price Group 05	+\$97
	Fabric Price Group 06	+\$117
	Fabric Price Group 07	+\$144
	Fabric Price Group 08	+\$174
	Fabric Price Group 09	+\$217
Fabric Price Group 10	+\$250	
Back Finish	Fabric Customer's Own Material	No cost
	Fabric Price Group 01	No cost
	Fabric Price Group 02	+\$16
	Fabric Price Group 03	+\$39
	Fabric Price Group 04	+\$55
	Fabric Price Group 05	+\$63
	Fabric Price Group 06	+\$78
	Fabric Price Group 07	+\$97
	Fabric Price Group 08	+\$117
	Fabric Price Group 09	+\$144
Fabric Price Group 10	+\$166	
Arm Finish	Fabric Customer's Own Material	No cost
	Fabric Price Group 01	No cost
	Fabric Price Group 02	+\$31
	Fabric Price Group 03	+\$81
	Fabric Price Group 04	+\$108
	Fabric Price Group 05	+\$129
	Fabric Price Group 06	+\$155
	Fabric Price Group 07	+\$193
	Fabric Price Group 08	+\$234
	Fabric Price Group 09	+\$288
Fabric Price Group 10	+\$335	

► Product Information continued on next page

► **Product Information continued from previous page**

Options		
Arm Pad Finish	Fabric Customer's Own Material	No cost
	Fabric Price Group 01	No cost
	Fabric Price Group 02	+\$16
	Fabric Price Group 03	+\$39
	Fabric Price Group 04	+\$55
	Fabric Price Group 05	+\$63
	Fabric Price Group 06	+\$78
	Fabric Price Group 07	+\$97
	Fabric Price Group 08	+\$117
	Fabric Price Group 09	+\$144
	Fabric Price Group 10	+\$166
Tablet Finish	Laminate HPL Price Group 01	No cost
	Laminate HPL Price Group 02	+\$76
	Laminate HPL Price Group 03	+\$154
	OLL Price Group 1	+\$102
Edge Finish	Plastic - PG1	No cost

### Specification Information

Style Number    Base Price

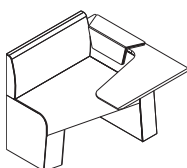

#### Furniture Seat Left Hand Application

**OB1QTF01**    \$3099

**OB1QTF01** *only compatible in phone booths OB1QT01 and OB1QT03.*

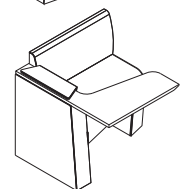

#### Furniture Seat Right Hand Application

**OB1QTF02**    \$3099

**OB1QTF02** *only compatible in phone booths OB1QT02 and OB1QT04.*

On the QT

# Aspect

## Work Unit with Curved Arm

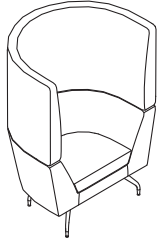

*Tip: Body lower and body upper finishes are only selectable if upholstered body configuration is selected.*

*Tip: Body inner and body outer finishes are only selectable if body inner/outer configuration is selected. Inner/outer selection must stay in the same fabric family.*

### Standard Includes

- Fully upholstered seating unit: fabric price group 01
- Contrasting reveal seam matching seat or body finish
- Adjustable feet

### Options

Body Configuration	Upholstered	No cost
	Body Inner/Outer Configuration	+\$261
Body Lower Finish	Fabric Customer's Own Material	No cost
	Fabric Price Group 01	No cost
	Fabric Price Group 02	+\$69
	Fabric Price Group 03	+\$138
	Fabric Price Group 04	+\$234
	Fabric Price Group 05	+\$387
	Fabric Price Group 06	+\$542
	Fabric Price Group 07	+\$739
	Fabric Price Group 08	+\$917
	Fabric Price Group 09	+\$1070
	Fabric Price Group 10	+\$1273
Body Upper Finish	Fabric Customer's Own Material	No cost
	Fabric Price Group 01	No cost
	Fabric Price Group 02	+\$114
	Fabric Price Group 03	+\$233
	Fabric Price Group 04	+\$393
	Fabric Price Group 05	+\$652
	Fabric Price Group 06	+\$909
	Fabric Price Group 07	+\$1243
	Fabric Price Group 08	+\$1539
	Fabric Price Group 09	+\$1799
	Fabric Price Group 10	+\$2141
Body Inner Finish	Fabric Customer's Own Material	No cost
	Fabric Price Group 01	No cost
	Fabric Price Group 02	+\$183
	Fabric Price Group 03	+\$372
	Fabric Price Group 04	+\$626
	Fabric Price Group 05	+\$1040
	Fabric Price Group 06	+\$1451
	Fabric Price Group 07	+\$1982
	Fabric Price Group 08	+\$2456
	Fabric Price Group 09	+\$2867
	Fabric Price Group 10	+\$3416
Body Outer Finish	Fabric Customer's Own Material	No cost
	Fabric Price Group 01	No cost
	Fabric Price Group 02	No cost
	Fabric Price Group 03	No cost
	Fabric Price Group 04	No cost
	Fabric Price Group 05	No cost
	Fabric Price Group 06	No cost
	Fabric Price Group 07	No cost
	Fabric Price Group 08	No cost
	Fabric Price Group 09	No cost

► **Product Information continued on next page**

# Aspect

## Work Unit with Curved Arm

► **Product Information continued from previous page**

Options		
Body Outer Finish	Fabric Price Group 10	No cost
Seat Finish	Customer's Own Leather	No cost
	Fabric Customer's Own Material	No cost
	Fabric Price Group 01	No cost
	Fabric Price Group 02	+\$28
	Fabric Price Group 03	+\$59
	Fabric Price Group 04	+\$100
	Fabric Price Group 05	+\$165
	Fabric Price Group 06	+\$232
	Fabric Price Group 07	+\$316
	Fabric Price Group 08	+\$389
Fabric Price Group 09	+\$457	
Fabric Price Group 10	+\$543	
Reveal Seam	Does Not Match Seat or Body	No cost
	Matches Body	No cost
	Matches Body - Inner	No cost
	Matches Body - Outer	No cost
	Matches Seat	No cost
Reveal Seam Finish	Fabric Price Group 03	+\$164
	Fabric Price Group 04	+\$164
	Fabric Price Group 08	+\$195
Leg Finish	Orangebox Paint Price Group 01	No cost
	Orangebox Paint Price Group 02	+\$125
Foot Finish	Orangebox Paint Price Group 01	No cost
	Orangebox Paint Price Group 02	+\$49

*Tip: Reveal seam finish is only selectable if "Does Not Match Seat or Body" option is chosen.*

### Specification Information

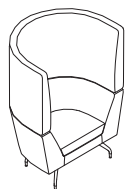

Style Number	Base Price
<b>Aspect One Seat Work Unit with Curved Arm</b>	
<b>OBASPECT07HB</b>	\$8209



# Aspect

## Work Unit with Curved Arm

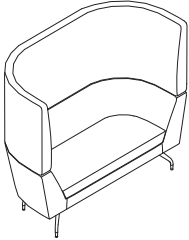

*Tip: Body lower and body upper finishes are only selectable if upholstered body configuration is selected.*

*Tip: Body inner and body outer finishes are only selectable if body inner/outer configuration is selected. Inner/outer selection must stay in the same fabric family.*

### Standard Includes

- Fully upholstered seating unit: fabric price group 01
- Contrasting reveal seam matching seat or body finish
- Adjustable feet

### Options

Body Configuration	Upholstered	No cost
	Body Inner/Outer Configuration	+\$396
Body Lower Finish	Fabric Customer's Own Material	No cost
	Fabric Price Group 01	No cost
	Fabric Price Group 02	+\$93
	Fabric Price Group 03	+\$189
	Fabric Price Group 04	+\$317
	Fabric Price Group 05	+\$529
	Fabric Price Group 06	+\$737
	Fabric Price Group 07	+\$1005
	Fabric Price Group 08	+\$1245
	Fabric Price Group 09	+\$1456
	Fabric Price Group 10	+\$1731
Body Upper Finish	Fabric Customer's Own Material	No cost
	Fabric Price Group 01	No cost
	Fabric Price Group 02	+\$145
	Fabric Price Group 03	+\$293
	Fabric Price Group 04	+\$495
	Fabric Price Group 05	+\$822
	Fabric Price Group 06	+\$1150
	Fabric Price Group 07	+\$1567
	Fabric Price Group 08	+\$1943
	Fabric Price Group 09	+\$2268
	Fabric Price Group 10	+\$2700
Body Inner Finish	Fabric Customer's Own Material	No cost
	Fabric Price Group 01	No cost
	Fabric Price Group 02	+\$238
	Fabric Price Group 03	+\$483
	Fabric Price Group 04	+\$814
	Fabric Price Group 05	+\$1349
	Fabric Price Group 06	+\$1886
	Fabric Price Group 07	+\$2575
	Fabric Price Group 08	+\$3187
	Fabric Price Group 09	+\$3725
	Fabric Price Group 10	+\$4431
Body Outer Finish	Fabric Customer's Own Material	No cost
	Fabric Price Group 01	No cost
	Fabric Price Group 02	No cost
	Fabric Price Group 03	No cost
	Fabric Price Group 04	No cost
	Fabric Price Group 05	No cost
	Fabric Price Group 06	No cost
	Fabric Price Group 07	No cost
	Fabric Price Group 08	No cost
	Fabric Price Group 09	No cost

► **Product Information continued on next page**

# Aspect

## Work Unit with Curved Arm

► **Product Information continued from previous page**

Options		
Body Outer Finish	Fabric Price Group 10	No cost
Seat Finish	Customer's Own Leather	No cost
	Fabric Customer's Own Material	No cost
	Fabric Price Group 01	No cost
	Fabric Price Group 02	+\$52
	Fabric Price Group 03	+\$104
	Fabric Price Group 04	+\$174
	Fabric Price Group 05	+\$289
	Fabric Price Group 06	+\$404
	Fabric Price Group 07	+\$552
	Fabric Price Group 08	+\$683
Reveal Seam	Fabric Price Group 09	+\$799
	Fabric Price Group 10	+\$950
	Does Not Match Seat or Body	No cost
	Matches Body	No cost
	Matches Body - Inner	No cost
Reveal Seam Finish	Matches Body - Outer	No cost
	Matches Seat	No cost
	Fabric Price Group 03	+\$164
	Fabric Price Group 04	+\$164
Leg Finish	Fabric Price Group 08	+\$195
	Orangebox Paint Price Group 01	No cost
Foot Finish	Orangebox Paint Price Group 02	+\$125
	Orangebox Paint Price Group 01	No cost
	Orangebox Paint Price Group 02	+\$49

*Tip: Reveal seam finish is only selectable if "Does Not Match Seat or Body" option is chosen.*

### Specification Information

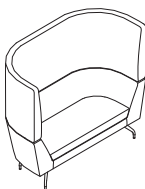

Style Number	Base Price
<b>OBASPECT08HB</b>	\$10,323

## Aspect Two Seat Work Unit with Curved Arm

**OBASPECT08HB** \$10,323

# Aspect

## Work Unit with Curved Arm

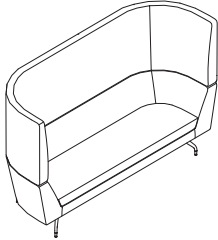

*Tip: Body lower and body upper finishes are only selectable if upholstered body configuration is selected.*

*Tip: Body inner and body outer finishes are only selectable if body inner/outer configuration is selected. Inner/outer selection must stay in the same fabric family.*

### Standard Includes

- Fully upholstered seating unit: fabric price group 01
- Contrasting reveal seam matching seat or body finish
- Adjustable feet

### Options

Body Configuration	Upholstered	No cost
	Body Inner/Outer Configuration	+\$525
Body Lower Finish	Fabric Customer's Own Material	No cost
	Fabric Price Group 01	No cost
	Fabric Price Group 02	+\$107
	Fabric Price Group 03	+\$217
	Fabric Price Group 04	+\$365
	Fabric Price Group 05	+\$603
	Fabric Price Group 06	+\$845
	Fabric Price Group 07	+\$1155
	Fabric Price Group 08	+\$1429
	Fabric Price Group 09	+\$1670
	Fabric Price Group 10	+\$1987
Body Upper Finish	Fabric Customer's Own Material	No cost
	Fabric Price Group 01	No cost
	Fabric Price Group 02	+\$179
	Fabric Price Group 03	+\$361
	Fabric Price Group 04	+\$606
	Fabric Price Group 05	+\$1007
	Fabric Price Group 06	+\$1408
	Fabric Price Group 07	+\$1924
	Fabric Price Group 08	+\$2382
	Fabric Price Group 09	+\$2782
	Fabric Price Group 10	+\$3313
Body Inner Finish	Fabric Customer's Own Material	No cost
	Fabric Price Group 01	No cost
	Fabric Price Group 02	+\$286
	Fabric Price Group 03	+\$577
	Fabric Price Group 04	+\$972
	Fabric Price Group 05	+\$1613
	Fabric Price Group 06	+\$2255
	Fabric Price Group 07	+\$3079
	Fabric Price Group 08	+\$3810
	Fabric Price Group 09	+\$4452
	Fabric Price Group 10	+\$5300
Body Outer Finish	Fabric Customer's Own Material	No cost
	Fabric Price Group 01	No cost
	Fabric Price Group 02	No cost
	Fabric Price Group 03	No cost
	Fabric Price Group 04	No cost
	Fabric Price Group 05	No cost
	Fabric Price Group 06	No cost
	Fabric Price Group 07	No cost
	Fabric Price Group 08	No cost
	Fabric Price Group 09	No cost

► **Product Information continued on next page**



# Aspect

## Work Unit with Curved Arm

► **Product Information continued from previous page**

Options		
Body Outer Finish	Fabric Price Group 10	No cost
Seat Finish	Customer's Own Leather	No cost
	Fabric Customer's Own Material	No cost
	Fabric Price Group 01	No cost
	Fabric Price Group 02	+\$52
	Fabric Price Group 03	+\$106
	Fabric Price Group 04	+\$178
	Fabric Price Group 05	+\$294
	Fabric Price Group 06	+\$412
	Fabric Price Group 07	+\$562
	Fabric Price Group 08	+\$697
Fabric Price Group 09	+\$814	
Fabric Price Group 10	+\$968	
Reveal Seam	Does Not Match Seat or Body	No cost
	Matches Body	No cost
	Matches Body - Inner	No cost
	Matches Body - Outer	No cost
	Matches Seat	No cost
Reveal Seam Finish	Fabric Price Group 03	+\$164
	Fabric Price Group 04	+\$164
	Fabric Price Group 08	+\$195
Leg Finish	Orangebox Paint Price Group 01	No cost
	Orangebox Paint Price Group 02	+\$125
Foot Finish	Orangebox Paint Price Group 01	No cost
	Orangebox Paint Price Group 02	+\$49

*Tip: Reveal seam finish is only selectable if "Does Not Match Seat or Body" option is chosen.*

### Specification Information

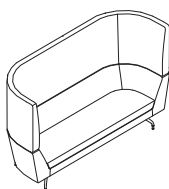

Style Number	Base Price
<b>Aspect Three Seat Work Unit with Curved Arm</b>	
<b>OBASPECT09HB</b>	\$11,489



# Aspect

## Work Screened Units with Fixed Table

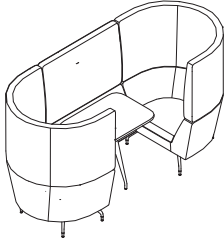

*Tip: Body lower and body upper finishes are only selectable if upholstered body configuration is selected.*

*Tip: Body inner and body outer finishes are only selectable if body inner/outer configuration is selected. Inner/outer selection must stay in the same fabric family.*

### Standard Includes

- Fully upholstered booth: fabric price group 01
- Contrasting reveal seam matching seat or body finish
- 1" thick tabletop with tapered edge:
  - High-Pressure Laminate price group 01
  - Fixed
- 3 mm edgeband: plastic price group 01
- Single table leg with foot
- Adjustable feet

### Options

Body Configuration	Upholstered	No cost
	Body Inner/Outer Configuration	+\$398
Body Lower Finish	Fabric Customer's Own Material	No cost
	Fabric Price Group 01	No cost
	Fabric Price Group 02	+\$137
	Fabric Price Group 03	+\$278
	Fabric Price Group 04	+\$467
	Fabric Price Group 05	+\$776
	Fabric Price Group 06	+\$1083
	Fabric Price Group 07	+\$1480
	Fabric Price Group 08	+\$1831
	Fabric Price Group 09	+\$2141
	Fabric Price Group 10	+\$2547
Body Upper Finish	Fabric Customer's Own Material	No cost
	Fabric Price Group 01	No cost
	Fabric Price Group 02	+\$227
	Fabric Price Group 03	+\$460
	Fabric Price Group 04	+\$776
	Fabric Price Group 05	+\$1287
	Fabric Price Group 06	+\$1799
	Fabric Price Group 07	+\$2458
	Fabric Price Group 08	+\$3041
	Fabric Price Group 09	+\$3552
	Fabric Price Group 10	+\$4229
Body Inner Finish	Fabric Customer's Own Material	No cost
	Fabric Price Group 01	No cost
	Fabric Price Group 02	+\$365
	Fabric Price Group 03	+\$738
	Fabric Price Group 04	+\$1244
	Fabric Price Group 05	+\$2063
	Fabric Price Group 06	+\$2883
	Fabric Price Group 07	+\$3937
	Fabric Price Group 08	+\$4872
	Fabric Price Group 09	+\$5693
	Fabric Price Group 10	+\$6777
Body Outer Finish	Fabric Customer's Own Material	No cost
	Fabric Price Group 01	No cost
	Fabric Price Group 02	No cost
	Fabric Price Group 03	No cost
	Fabric Price Group 04	No cost

► **Product Information continued on next page**

# Aspect

## Work Screened Units with Fixed Table

### ► Product Information continued from previous page

Options		
Body Outer Finish	Fabric Price Group 05	No cost
	Fabric Price Group 06	No cost
	Fabric Price Group 07	No cost
	Fabric Price Group 08	No cost
	Fabric Price Group 09	No cost
	Fabric Price Group 10	No cost
Seat Finish	Customer's Own Leather	No cost
	Fabric Customer's Own Material	No cost
	Fabric Price Group 01	No cost
	Fabric Price Group 02	+\$41
	Fabric Price Group 03	+\$83
	Fabric Price Group 04	+\$140
	Fabric Price Group 05	+\$233
	Fabric Price Group 06	+\$325
	Fabric Price Group 07	+\$444
	Fabric Price Group 08	+\$548
	Fabric Price Group 09	+\$643
Reveal Seam	Does Not Match Seat or Body	No cost
	Matches Body	No cost
	Matches Body - Inner	No cost
	Matches Body - Outer	No cost
	Matches Seat	No cost
Reveal Seam Finish	Fabric Price Group 03	+\$483
	Fabric Price Group 04	+\$483
	Fabric Price Group 08	+\$584
Screen Configuration	Upholstered	No cost
	Screen Inner/Outer Configuration	+\$143
Screen Upper Finish	Customer's Own Leather	No cost
	Fabric Customer's Own Material	No cost
	Fabric Price Group 01	No cost
	Fabric Price Group 02	+\$73
	Fabric Price Group 03	+\$144
	Fabric Price Group 04	+\$243
	Fabric Price Group 05	+\$403
	Fabric Price Group 06	+\$564
	Fabric Price Group 07	+\$770
	Fabric Price Group 08	+\$953
Screen Lower Finish	Customer's Own Leather	No cost
	Fabric Customer's Own Material	No cost
	Fabric Price Group 01	No cost
	Fabric Price Group 02	+\$60
	Fabric Price Group 03	+\$122
	Fabric Price Group 04	+\$206
	Fabric Price Group 05	+\$341
	Fabric Price Group 06	+\$479
	Fabric Price Group 07	+\$650

*Tip: Reveal seam finish is only selectable if "Does Not Match Seat or Body" option is chosen.*

*Tip: Screen upper and screen lower finishes are only selectable if upholstered screen configuration is selected.*

### ► Product Information continued on next page

# Aspect

## Work Screened Units with Fixed Table

► **Product Information continued from previous page**

<b>Options</b>		
Screen Lower Finish	Fabric Price Group 08	+\$806
	Fabric Price Group 09	+\$942
	Fabric Price Group 10	+\$1123
Screen Inner Finish	Customer's Own Leather	No cost
	Fabric Customer's Own Material	No cost
	Fabric Price Group 01	No cost
	Fabric Price Group 02	+\$133
	Fabric Price Group 03	+\$265
	Fabric Price Group 04	+\$449
	Fabric Price Group 05	+\$744
	Fabric Price Group 06	+\$1041
	Fabric Price Group 07	+\$1420
	Fabric Price Group 08	+\$1758
Screen Outer Finish	Customer's Own Leather	No cost
	Fabric Customer's Own Material	No cost
	Fabric Price Group 01	No cost
	Fabric Price Group 02	No cost
	Fabric Price Group 03	No cost
	Fabric Price Group 04	No cost
	Fabric Price Group 05	No cost
	Fabric Price Group 06	No cost
	Fabric Price Group 07	No cost
	Fabric Price Group 08	No cost
Leg Finish	Orangebox Paint Price Group 01	No cost
	Orangebox Paint Price Group 02	+\$280
Foot Finish	Orangebox Paint Price Group 01	No cost
	Orangebox Paint Price Group 02	+\$101
Top Finish	Laminate HPL Price Group 01	No cost
	Laminate HPL Price Group 02	+\$94
	Laminate HPL Price Group 03	+\$195
	OLL Price Group 1	+\$102
Edge Finish	Plastic Group 1	No cost
Monitor Bracket	No Monitor Bracket Required	No cost
	Tilting Monitor Bracket	+\$311
Lower Screen Power/Data Axil	No Power/Data Required	No cost
	4 Duplex Outlets	+\$507
	2 Outlets with CAT6 & HDMI Ports	+\$579
	2 Outlets with Two CAT6 Data Ports	+\$585
	2 Outlets with CAT6 and USB Data Ports	+\$602
Power Finish	Paint Price Group 01	No cost
	Paint Price Group 02	No cost

► **Product Information continued on next page**

*Tip: Screen inner and screen outer finishes are only selectable if screen inner/outer configuration is selected. Inner/outer selection must stay in the same fabric family.*

# Aspect

## Work Screened Units with Fixed Table

▶ **Product Information continued from previous page**

### Specification Information

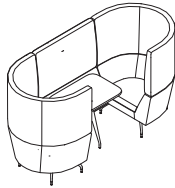

Style Number	Base Price
--------------	------------

### Aspect Two Seat Work Screened Unit with Fixed Table

<b>OBASPECT57HB</b>	\$20,976
---------------------	----------



# Aspect

## Work Screened Units with Fixed Table

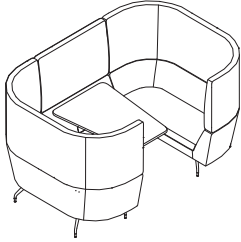

### Standard Includes

- Fully upholstered booth: fabric price group 01
- Contrasting reveal seam matching seat or body finish
- 1" thick tabletop with tapered edge:
  - High-Pressure Laminate price group 01
  - Fixed
- 3 mm edgeband: plastic price group 01
- Single table leg with foot
- Adjustable feet

### Options

Body Configuration	Upholstered	No cost
	Body Inner/Outer Configuration	+\$593
Body Lower Finish	Fabric Customer's Own Material	No cost
	Fabric Price Group 01	No cost
	Fabric Price Group 02	+\$186
	Fabric Price Group 03	+\$377
	Fabric Price Group 04	+\$637
	Fabric Price Group 05	+\$1055
	Fabric Price Group 06	+\$1474
	Fabric Price Group 07	+\$2013
	Fabric Price Group 08	+\$2491
	Fabric Price Group 09	+\$2910
	Fabric Price Group 10	+\$3465
Body Upper Finish	Fabric Customer's Own Material	No cost
	Fabric Price Group 01	No cost
	Fabric Price Group 02	+\$291
	Fabric Price Group 03	+\$589
	Fabric Price Group 04	+\$992
	Fabric Price Group 05	+\$1644
	Fabric Price Group 06	+\$2297
	Fabric Price Group 07	+\$3137
	Fabric Price Group 08	+\$3884
	Fabric Price Group 09	+\$4538
	Fabric Price Group 10	+\$5402
Body Inner Finish	Fabric Customer's Own Material	No cost
	Fabric Price Group 01	No cost
	Fabric Price Group 02	+\$479
	Fabric Price Group 03	+\$966
	Fabric Price Group 04	+\$1625
	Fabric Price Group 05	+\$2699
	Fabric Price Group 06	+\$3770
	Fabric Price Group 07	+\$5149
	Fabric Price Group 08	+\$6374
	Fabric Price Group 09	+\$7449
	Fabric Price Group 10	+\$8868
Body Outer Finish	Fabric Customer's Own Material	No cost
	Fabric Price Group 01	No cost
	Fabric Price Group 02	No cost
	Fabric Price Group 03	No cost
	Fabric Price Group 04	No cost

*Tip: Body lower and body upper finishes are only selectable if upholstered body configuration is selected.*

*Tip: Body inner and body outer finishes are only selectable if body inner/outer configuration is selected. Inner/outer selection must stay in the same fabric family.*

► **Product Information continued on next page**

# Aspect

## Work Screened Units with Fixed Table

### ► Product Information continued from previous page

Options		
Body Outer Finish	Fabric Price Group 05	No cost
	Fabric Price Group 06	No cost
	Fabric Price Group 07	No cost
	Fabric Price Group 08	No cost
	Fabric Price Group 09	No cost
	Fabric Price Group 10	No cost
Seat Finish	Customer's Own Leather	No cost
	Fabric Customer's Own Material	No cost
	Fabric Price Group 01	No cost
	Fabric Price Group 02	+\$75
	Fabric Price Group 03	+\$150
	Fabric Price Group 04	+\$253
	Fabric Price Group 05	+\$420
	Fabric Price Group 06	+\$585
	Fabric Price Group 07	+\$799
	Fabric Price Group 08	+\$989
	Fabric Price Group 09	+\$1156
Reveal Seam	Does Not Match Seat or Body	No cost
	Matches Body	No cost
	Matches Body - Inner	No cost
	Matches Body - Outer	No cost
	Matches Seat	No cost
Reveal Seam Finish	Fabric Price Group 03	+\$483
	Fabric Price Group 04	+\$483
	Fabric Price Group 08	+\$584
Screen Configuration	Upholstered	No cost
	Screen Inner/Outer Configuration	+\$143
Screen Upper Finish	Customer's Own Leather	No cost
	Fabric Customer's Own Material	No cost
	Fabric Price Group 01	No cost
	Fabric Price Group 02	+\$73
	Fabric Price Group 03	+\$144
	Fabric Price Group 04	+\$243
	Fabric Price Group 05	+\$403
	Fabric Price Group 06	+\$564
	Fabric Price Group 07	+\$770
	Fabric Price Group 08	+\$953
Fabric Price Group 09	+\$1113	
Screen Lower Finish	Fabric Price Group 10	+\$1324
	Customer's Own Leather	No cost
	Fabric Customer's Own Material	No cost
	Fabric Price Group 01	No cost
	Fabric Price Group 02	+\$60
	Fabric Price Group 03	+\$122
	Fabric Price Group 04	+\$206
	Fabric Price Group 05	+\$341
Fabric Price Group 06	+\$479	
Fabric Price Group 07	+\$650	

*Tip: Reveal seam finish is only selectable if "Does Not Match Seat or Body" option is chosen.*

*Tip: Screen upper and screen lower finishes are only selectable if upholstered screen configuration is selected.*

### ► Product Information continued on next page

# Aspect

## Work Screened Units with Fixed Table

► **Product Information continued from previous page**

<b>Options</b>			
Screen Lower Finish	Fabric Price Group 08	+\$806	
	Fabric Price Group 09	+\$942	
	Fabric Price Group 10	+\$1123	
Screen Inner Finish	Customer's Own Leather	No cost	
	Fabric Customer's Own Material	No cost	
	Fabric Price Group 01	No cost	
	Fabric Price Group 02	+\$133	
	Fabric Price Group 03	+\$265	
	Fabric Price Group 04	+\$449	
	Fabric Price Group 05	+\$744	
	Fabric Price Group 06	+\$1041	
	Fabric Price Group 07	+\$1420	
	Fabric Price Group 08	+\$1758	
Screen Outer Finish	Customer's Own Leather	No cost	
	Fabric Customer's Own Material	No cost	
	Fabric Price Group 01	No cost	
	Fabric Price Group 02	No cost	
	Fabric Price Group 03	No cost	
	Fabric Price Group 04	No cost	
	Fabric Price Group 05	No cost	
	Fabric Price Group 06	No cost	
	Fabric Price Group 07	No cost	
	Fabric Price Group 08	No cost	
Leg Finish	Orangebox Paint Price Group 01	No cost	
	Orangebox Paint Price Group 02	+\$280	
	Foot Finish	Orangebox Paint Price Group 01	No cost
		Orangebox Paint Price Group 02	+\$101
	Top Finish	Laminate HPL Price Group 01	No cost
		Laminate HPL Price Group 02	+\$169
		Laminate HPL Price Group 03	+\$355
		OLL Price Group 1	+\$102
	Edge Finish	Plastic Group 1	No cost
	Monitor Bracket	No Monitor Bracket Required	No cost
Tilting Monitor Bracket		+\$311	
Lower Screen Power/Data Axil	No Power/Data Required	No cost	
	4 Duplex Outlets	+\$507	
	2 Outlets with CAT6 & HDMI Ports	+\$579	
	2 Outlets with Two CAT6 Data Ports	+\$585	
	2 Outlets with CAT6 and USB Data Ports	+\$602	
Power Finish	Paint Price Group 01	No cost	
	Paint Price Group 02	No cost	

► **Product Information continued on next page**

*Tip: Screen inner and screen outer finishes are only selectable if screen inner/outer configuration is selected. Inner/outer selection must stay in the same fabric family.*



# Aspect

## Work Screened Units with Fixed Table

▶ **Product Information continued from previous page**

### Specification Information

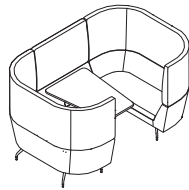

Style Number	Base Price
--------------	------------

### Aspect Four Seat Work Screened Unit with Fixed Table

<b>OBASPECT58HB</b>	\$25,721
---------------------	----------

# Aspect

## Work Screened Units with Fixed Table

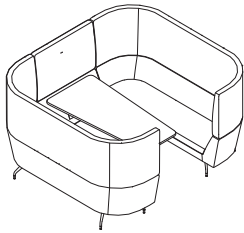

### Standard Includes

- Fully upholstered booth: fabric price group 01
- Contrasting reveal seam matching seat or body finish
- 1" thick tabletop with tapered edge:
  - High-Pressure Laminate price group 01
  - Fixed
- 3 mm edgeband: plastic price group 01
- Single table leg with foot
- Adjustable feet

### Options

Body Configuration	Upholstered	No cost
	Body Inner/Outer Configuration	+\$786
Body Lower Finish	Fabric Customer's Own Material	No cost
	Fabric Price Group 01	No cost
	Fabric Price Group 02	+\$211
	Fabric Price Group 03	+\$427
	Fabric Price Group 04	+\$719
	Fabric Price Group 05	+\$1194
	Fabric Price Group 06	+\$1669
	Fabric Price Group 07	+\$2278
	Fabric Price Group 08	+\$2822
	Fabric Price Group 09	+\$3296
	Fabric Price Group 10	+\$3922
Body Upper Finish	Fabric Customer's Own Material	No cost
	Fabric Price Group 01	No cost
	Fabric Price Group 02	+\$353
	Fabric Price Group 03	+\$716
	Fabric Price Group 04	+\$1207
	Fabric Price Group 05	+\$2001
	Fabric Price Group 06	+\$2797
	Fabric Price Group 07	+\$3817
	Fabric Price Group 08	+\$4726
	Fabric Price Group 09	+\$5523
	Fabric Price Group 10	+\$6574
Body Inner Finish	Fabric Customer's Own Material	No cost
	Fabric Price Group 01	No cost
	Fabric Price Group 02	+\$565
	Fabric Price Group 03	+\$1141
	Fabric Price Group 04	+\$1925
	Fabric Price Group 05	+\$3194
	Fabric Price Group 06	+\$4465
	Fabric Price Group 07	+\$6095
	Fabric Price Group 08	+\$7546
	Fabric Price Group 09	+\$8818
	Fabric Price Group 10	+\$10496
Body Outer Finish	Fabric Customer's Own Material	No cost
	Fabric Price Group 01	No cost
	Fabric Price Group 02	No cost
	Fabric Price Group 03	No cost
	Fabric Price Group 04	No cost

*Tip: Body lower and body upper finishes are only selectable if upholstered body configuration is selected.*

*Tip: Body inner and body outer finishes are only selectable if body inner/outer configuration is selected. Inner/outer selection must stay in the same fabric family.*

► **Product Information continued on next page**

# Aspect

## Work Screened Units with Fixed Table

### ► Product Information continued from previous page

Options		
Body Outer Finish	Fabric Price Group 05	No cost
	Fabric Price Group 06	No cost
	Fabric Price Group 07	No cost
	Fabric Price Group 08	No cost
	Fabric Price Group 09	No cost
	Fabric Price Group 10	No cost
Seat Finish	Customer's Own Leather	No cost
	Fabric Customer's Own Material	No cost
	Fabric Price Group 01	No cost
	Fabric Price Group 02	+\$105
	Fabric Price Group 03	+\$211
	Fabric Price Group 04	+\$356
	Fabric Price Group 05	+\$590
	Fabric Price Group 06	+\$824
	Fabric Price Group 07	+\$1126
	Fabric Price Group 08	+\$1393
	Fabric Price Group 09	+\$1625
Reveal Seam	Does Not Match Seat or Body	No cost
	Matches Body	No cost
	Matches Body - Inner	No cost
	Matches Body - Outer	No cost
	Matches Seat	No cost
Reveal Seam Finish	Fabric Price Group 03	+\$483
	Fabric Price Group 04	+\$483
	Fabric Price Group 08	+\$584
Screen Configuration	Upholstered	No cost
	Screen Inner/Outer Configuration	+\$143
Screen Upper Finish	Customer's Own Leather	No cost
	Fabric Customer's Own Material	No cost
	Fabric Price Group 01	No cost
	Fabric Price Group 02	+\$73
	Fabric Price Group 03	+\$144
	Fabric Price Group 04	+\$243
	Fabric Price Group 05	+\$403
	Fabric Price Group 06	+\$564
	Fabric Price Group 07	+\$770
	Fabric Price Group 08	+\$953
Screen Lower Finish	Fabric Price Group 09	+\$1113
	Fabric Price Group 10	+\$1324
	Customer's Own Leather	No cost
	Fabric Customer's Own Material	No cost
	Fabric Price Group 01	No cost
	Fabric Price Group 02	+\$60
	Fabric Price Group 03	+\$122
	Fabric Price Group 04	+\$206
Fabric Price Group 05	+\$341	
Fabric Price Group 06	+\$479	
Fabric Price Group 07	+\$650	

*Tip: Reveal seam finish is only selectable if "Does Not Match Seat or Body" option is chosen.*

*Tip: Screen upper and screen lower finishes are only selectable if upholstered screen configuration is selected.*

### ► Product Information continued on next page

# Aspect

## Work Screened Units with Fixed Table

### ► Product Information continued from previous page

Options		
Screen Lower Finish	Fabric Price Group 08	+\$806
	Fabric Price Group 09	+\$942
	Fabric Price Group 10	+\$1123
Screen Inner Finish	Customer's Own Leather	No cost
	Fabric Customer's Own Material	No cost
	Fabric Price Group 01	No cost
	Fabric Price Group 02	+\$133
	Fabric Price Group 03	+\$265
	Fabric Price Group 04	+\$449
	Fabric Price Group 05	+\$744
	Fabric Price Group 06	+\$1041
	Fabric Price Group 07	+\$1420
	Fabric Price Group 08	+\$1758
Screen Outer Finish	Customer's Own Leather	No cost
	Fabric Customer's Own Material	No cost
	Fabric Price Group 01	No cost
	Fabric Price Group 02	No cost
	Fabric Price Group 03	No cost
	Fabric Price Group 04	No cost
	Fabric Price Group 05	No cost
	Fabric Price Group 06	No cost
	Fabric Price Group 07	No cost
	Fabric Price Group 08	No cost
Leg Finish	Orangebox Paint Price Group 01	No cost
	Orangebox Paint Price Group 02	+\$280
Foot Finish	Orangebox Paint Price Group 01	No cost
	Orangebox Paint Price Group 02	+\$101
Top Finish	Laminate HPL Price Group 01	No cost
	Laminate HPL Price Group 02	+\$243
	Laminate HPL Price Group 03	+\$508
	OLL Price Group 1	+\$102
Edge Finish	Plastic Group 1	No cost
Monitor Bracket	No Monitor Bracket Required	No cost
	Tilting Monitor Bracket	+\$311
Lower Screen Power/Data Axil	No Power/Data Required	No cost
	4 Duplex Outlets	+\$507
	2 Outlets with CAT6 & HDMI Ports	+\$579
	2 Outlets with Two CAT6 Data Ports	+\$585
	2 Outlets with CAT6 and USB Data Ports	+\$602
Power Finish	Paint Price Group 01	No cost
	Paint Price Group 02	No cost

### ► Product Information continued on next page

*Tip: Screen inner and screen outer finishes are only selectable if screen inner/outer configuration is selected. Inner/outer selection must stay in the same fabric family.*

# Aspect

## Work Screened Units with Fixed Table

▶ **Product Information continued from previous page**

### Specification Information

Style Number      Base Price

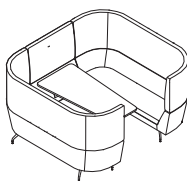

### Aspect Six Seat Work Screened Unit with Fixed Table

**OBASPECT59HB**      \$28,484

# Seating

## Avi



### Standard Includes

- Fully upholstered lounge chair: fabric price group 01
- 4-star swivel base
- Glides
- Shipped fully assembled

### Options

Body Finish	Customer's Own Leather	No cost
	Fabric Customer's Own Material	No cost
	Fabric Price Group 01	No cost
	Fabric Price Group 02	+\$47
	Fabric Price Group 03	+\$94
	Fabric Price Group 04	+\$159
	Fabric Price Group 05	+\$263
	Fabric Price Group 06	+\$368
	Fabric Price Group 07	+\$504
	Fabric Price Group 08	+\$622
	Fabric Price Group 09	+\$727
Fabric Price Group 10	+\$867	
Seat Finish	Customer's Own Leather	No cost
	Fabric Customer's Own Material	No cost
	Fabric Price Group 01	No cost
	Fabric Price Group 02	+\$25
	Fabric Price Group 03	+\$52
	Fabric Price Group 04	+\$86
	Fabric Price Group 05	+\$145
	Fabric Price Group 06	+\$203
	Fabric Price Group 07	+\$277
	Fabric Price Group 08	+\$342
	Fabric Price Group 09	+\$400
Fabric Price Group 10	+\$477	
4-Star Base Finish	Black	No cost
	Silver	No cost
	Polished Base & Black Column	+\$78
	Polished Chrome	+\$95
Hood Finish	Customer's Own Leather	No cost
	Fabric Customer's Own Material	No cost
	Fabric Price Group 01	No cost
	Fabric Price Group 02	+\$48
	Fabric Price Group 03	+\$97
	Fabric Price Group 04	+\$162
	Fabric Price Group 05	+\$267
	Fabric Price Group 06	+\$376
	Fabric Price Group 07	+\$513
	Fabric Price Group 08	+\$635
	Fabric Price Group 09	+\$741
Fabric Price Group 10	+\$883	

► **Product Information continued on next page**

► **Product Information continued from previous page**

**Specification Information**

Style Number    Base Price



**Avi Upholstered Chair with Swivel Base**

**OBAVI01**    \$2458



**Avi Hooded Upholstered Chair with Swivel Base**

**OBAVI02**    \$3156



**Standard Includes**

- Fully upholstered lounge chair: fabric price group 01
- Wire frame base
- Glides
- Shipped fully assembled

**Options**

Body Finish	Customer's Own Leather	No cost
	Fabric Customer's Own Material	No cost
	Fabric Price Group 01	No cost
	Fabric Price Group 02	+\$47
	Fabric Price Group 03	+\$94
	Fabric Price Group 04	+\$159
	Fabric Price Group 05	+\$263
	Fabric Price Group 06	+\$368
	Fabric Price Group 07	+\$504
	Fabric Price Group 08	+\$622
Seat Finish	Fabric Price Group 09	+\$727
	Fabric Price Group 10	+\$867
	Customer's Own Leather	No cost
	Fabric Customer's Own Material	No cost
	Fabric Price Group 01	No cost
	Fabric Price Group 02	+\$25
	Fabric Price Group 03	+\$52
	Fabric Price Group 04	+\$86
	Fabric Price Group 05	+\$145
	Fabric Price Group 06	+\$203
Fabric Price Group 07	+\$277	
Fabric Price Group 08	+\$342	

► **Product Information continued on next page**

Seating

# Seating

## Avi

► **Product Information continued from previous page**

<b>Options</b>		
Seat Finish	Fabric Price Group 09	+\$400
	Fabric Price Group 10	+\$477
Wire Frame Base Finish	Orangebox Paint Price Group 01	No cost
	Orangebox Paint Price Group 02	+\$96
Hood Finish	Customer's Own Leather	No cost
	Fabric Customer's Own Material	No cost
	Fabric Price Group 01	No cost
	Fabric Price Group 02	+\$48
	Fabric Price Group 03	+\$97
	Fabric Price Group 04	+\$162
	Fabric Price Group 05	+\$267
	Fabric Price Group 06	+\$376
	Fabric Price Group 07	+\$513
	Fabric Price Group 08	+\$635
Fabric Price Group 09	+\$741	
Fabric Price Group 10	+\$883	

**Specification Information**

Style Number    Base Price



**Avi Upholstered Chair with Wire Frame Base**

**OBAVI03**    \$2458



**Avi Hooded Upholstered Chair with Wire Frame Base**

**OBAVI04**    \$3156



# Seating

## Sully, Skomer, and Ramsey

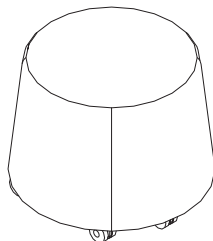

### Standard Includes

- Fully upholstered ottoman: fabric price group 01
- Soft casters: black
- Shipped fully assembled

### Options

Seat Finish	Customer's Own Leather	No cost
	Fabric Customer's Own Material	No cost
	Fabric Price Group 01	No cost
	Fabric Price Group 02	+\$45
	Fabric Price Group 03	+\$87
	Fabric Price Group 04	+\$150
	Fabric Price Group 05	+\$249
	Fabric Price Group 06	+\$346
	Fabric Price Group 07	+\$474
	Fabric Price Group 08	+\$586
Fabric Price Group 09	+\$685	
Fabric Price Group 10	+\$816	
Caster Type	Black Soft Casters	No cost
	Grey Soft Casters	No cost
	Black Soft Casters W/ Brakes	+\$81
	Grey Soft Casters W/ Brakes	+\$81

### Specification Information

Style Number	Base Price
--------------	------------

### Sully Upholstered Stool

**OBSSULLY01** \$1136

# Seating

## Sully, Skomer, and Ramsey

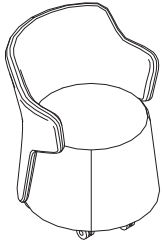

*Tip: If two tone upholstered option one is selected, contrasting price groups are available. Total seat finish and back finish price is driven by highest price group selection.*

*Tip: If two tone upholstered option two is selected, contrasting price groups are not available. Total seat and outer back finish and inner back finish price is driven by highest price group selection.*

### Standard Includes

- Fully upholstered armchair: fabric price group 01
- Soft casters: black
- Shipped fully assembled

### Options

Configuration	Upholstered	No cost
	Two Tone Upholstered-Option 1	+\$101
	Two Tone Upholstered-Option 2	+\$101
Seat Finish	Customer's Own Leather	No cost
	Fabric Customer's Own Material	No cost
	Fabric Price Group 01	No cost
	Fabric Price Group 02	+\$65
	Fabric Price Group 03	+\$134
	Fabric Price Group 04	+\$225
	Fabric Price Group 05	+\$372
	Fabric Price Group 06	+\$519
	Fabric Price Group 07	+\$710
	Fabric Price Group 08	+\$880
Back Finish	Fabric Price Group 09	+\$1027
	Fabric Price Group 10	+\$1223
	Customer's Own Leather	No cost
	Fabric Customer's Own Material	No cost
	Fabric Price Group 01	No cost
	Fabric Price Group 02	No cost
	Fabric Price Group 03	No cost
	Fabric Price Group 04	No cost
	Fabric Price Group 05	No cost
	Fabric Price Group 06	No cost
Seat & Outer Back Finish	Fabric Price Group 07	No cost
	Fabric Price Group 08	No cost
	Fabric Price Group 09	No cost
	Fabric Price Group 10	No cost
	Customer's Own Leather	No cost
	Fabric Customer's Own Material	No cost
	Fabric Price Group 01	No cost
	Fabric Price Group 02	+\$65
	Fabric Price Group 03	+\$134
	Fabric Price Group 04	+\$225
Inner Back Finish	Fabric Price Group 05	+\$372
	Fabric Price Group 06	+\$519
	Fabric Price Group 07	+\$710
	Fabric Price Group 08	+\$880
	Fabric Price Group 09	+\$1027
	Fabric Price Group 10	+\$1223
	Customer's Own Leather	No cost
	Fabric Customer's Own Material	No cost
Fabric Price Group 01	No cost	
Fabric Price Group 02	No cost	
Fabric Price Group 03	No cost	
Fabric Price Group 04	No cost	

► **Product Information continued on next page**

# Seating

Sully, Skomer, and Ramsey

► **Product Information continued from previous page**

Options		
Inner Back Finish	Fabric Price Group 05	No cost
	Fabric Price Group 06	No cost
	Fabric Price Group 07	No cost
	Fabric Price Group 08	No cost
	Fabric Price Group 09	No cost
	Fabric Price Group 10	No cost
Caster Type	Black Soft Casters	No cost
	Grey Soft Casters	No cost
	Black Soft Casters W/ Brakes	+\$81
	Grey Soft Casters W/ Brakes	+\$81

## Specification Information



Style Number      Base Price

### Skomer Upholstered Arm Chair

**OBSSKOMER01**    \$2377

# Seating

## Sully, Skomer, and Ramsey

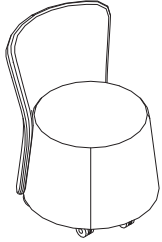

*Tip: If two tone upholstered option one is selected, contrasting price groups are available. Total seat finish and back finish price is driven by highest price group selection.*

*Tip: If two tone upholstered option one is selected, contrasting price groups are available. Total seat finish and back finish price is driven by highest price group selection.*

### Standard Includes

- Fully upholstered armless chair: fabric price group 01
- Soft casters: black
- Shipped fully assembled

### Options

Configuration	Upholstered	No cost
	Two Tone Upholstered-Option 1	+\$101
	Two Tone Upholstered-Option 2	+\$101
Seat Finish	Customer's Own Leather	No cost
	Fabric Customer's Own Material	No cost
	Fabric Price Group 01	No cost
	Fabric Price Group 02	+\$60
	Fabric Price Group 03	+\$122
	Fabric Price Group 04	+\$206
	Fabric Price Group 05	+\$341
	Fabric Price Group 06	+\$479
	Fabric Price Group 07	+\$650
	Fabric Price Group 08	+\$806
Back Finish	Fabric Price Group 09	+\$942
	Fabric Price Group 10	+\$1123
	Customer's Own Leather	No cost
	Fabric Customer's Own Material	No cost
	Fabric Price Group 01	No cost
	Fabric Price Group 02	No cost
	Fabric Price Group 03	No cost
	Fabric Price Group 04	No cost
	Fabric Price Group 05	No cost
	Fabric Price Group 06	No cost
Seat & Outer Back Finish	Fabric Price Group 07	No cost
	Fabric Price Group 08	No cost
	Fabric Price Group 09	No cost
	Fabric Price Group 10	No cost
	Customer's Own Leather	No cost
	Fabric Customer's Own Material	No cost
	Fabric Price Group 01	No cost
	Fabric Price Group 02	+\$60
	Fabric Price Group 03	+\$122
	Fabric Price Group 04	+\$206
Inner Back Finish	Fabric Price Group 05	+\$341
	Fabric Price Group 06	+\$479
	Fabric Price Group 07	+\$650
	Fabric Price Group 08	+\$806
	Fabric Price Group 09	+\$942
	Fabric Price Group 10	+\$1123
	Customer's Own Leather	No cost
	Fabric Customer's Own Material	No cost
Fabric Price Group 01	No cost	
Fabric Price Group 02	No cost	
Fabric Price Group 03	No cost	
Fabric Price Group 04	No cost	

► **Product Information continued on next page**

► **Product Information continued from previous page**

<b>Options</b>		
Inner Back Finish	Fabric Price Group 05	No cost
	Fabric Price Group 06	No cost
	Fabric Price Group 07	No cost
	Fabric Price Group 08	No cost
	Fabric Price Group 09	No cost
	Fabric Price Group 10	No cost
Caster Type	Black Soft Casters	No cost
	Grey Soft Casters	No cost
	Black Soft Casters W/ Brakes	+\$81
	Grey Soft Casters W/ Brakes	+\$81

**Specification Information**

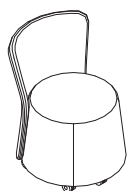

Style Number	Base Price
<b>Ramsey Upholstered Work Chair</b>	
<b>OBSRAMSEY01</b>	\$2121

# Seating

## Border

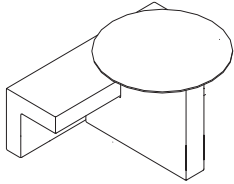

*Tip: If two tone upholstered option is selected, contrasting price groups are available. Total seat finish and table base finish price is driven by highest price group selection.*

### Standard Includes

- Fully upholstered bench with attached table: fabric price group 01
- 31" dia., 1" thick tabletop with square edge: High-Pressure Laminate price group 01
- 3 mm edgeband: plastic price group 01
- Two foot rails: polished chrome
- Plastic feet: black

### Options

Configuration	Upholstered	No cost
	Two Tone Upholstered	+\$198
Seat Finish	Customer's Own Leather	No cost
	Fabric Customer's Own Material	No cost
	Fabric Price Group 01	No cost
	Fabric Price Group 02	+\$109
	Fabric Price Group 03	+\$222
	Fabric Price Group 04	+\$375
	Fabric Price Group 05	+\$620
	Fabric Price Group 06	+\$868
	Fabric Price Group 07	+\$1184
	Fabric Price Group 08	+\$1465
Table Base Finish	Fabric Price Group 09	+\$1712
	Fabric Price Group 10	+\$2039
	Customer's Own Leather	No cost
	Fabric Customer's Own Material	No cost
	Fabric Price Group 01	No cost
	Fabric Price Group 02	No cost
	Fabric Price Group 03	No cost
	Fabric Price Group 04	No cost
	Fabric Price Group 05	No cost
	Fabric Price Group 06	No cost
Top Finish	Fabric Price Group 07	No cost
	Fabric Price Group 08	No cost
	Fabric Price Group 09	No cost
	Fabric Price Group 10	No cost
Top Finish	Laminate HPL Price Group 01	No cost
	Laminate HPL Price Group 02	+\$80
	Laminate HPL Price Group 03	+\$164
	OLL Price Group 1	+\$102
Edge Finish	Plastic Group 1	No cost
Top Size and Edge	31 1/2" Top with Square Edge	No cost
	39 3/8" Top with Square Edge	+\$82
	31 1/2" Top with Tapered Edge	+\$258
	39 3/8" Top with Tapered Edge	+\$337
Base Power/Data Node	No Power/Data Required	No cost
	2 Duplex Outlets	+\$287
	Duplex Outlet with HDMI Video Port	+\$376
	Duplex Outlet with CAT6 Data Port	+\$382
	Duplex Outlet with USB Data Port	+\$395
Power Finish	Paint Price Group 01	No cost
	Paint Price Group 02	No cost

► **Product Information continued on next page**

► **Product Information continued from previous page**

**Specification Information**

Style Number    Base Price

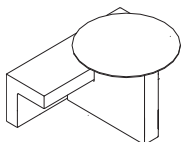

**Border One Seat- Low, with 32" Dia Table**

**OBBORDER01**    \$5006

**Standard Includes**

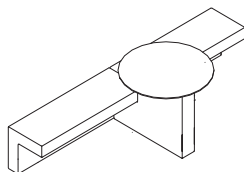

- Fully upholstered bench with attached table: fabric price group 01
- 31" dia., 1" thick tabletop with square edge: High-Pressure Laminate price group 01
- 3 mm edgeband: plastic price group 01
- Two foot rails: polished chrome
- Plastic feet: black

**Options**

*Tip: If two tone upholstered option is selected, contrasting price groups are available. Total seat finish and table base finish price is driven by highest price group selection.*

Configuration	Upholstered	No cost
	Two Tone Upholstered	+\$198
Seat Finish	Customer's Own Leather	No cost
	Fabric Customer's Own Material	No cost
	Fabric Price Group 01	No cost
	Fabric Price Group 02	+\$164
	Fabric Price Group 03	+\$334
	Fabric Price Group 04	+\$561
	Fabric Price Group 05	+\$932
	Fabric Price Group 06	+\$1300
	Fabric Price Group 07	+\$1777
	Fabric Price Group 08	+\$2197
Table Base Finish	Fabric Price Group 09	+\$2568
	Fabric Price Group 10	+\$3057
	Customer's Own Leather	No cost
	Fabric Customer's Own Material	No cost
	Fabric Price Group 01	No cost
	Fabric Price Group 02	No cost
	Fabric Price Group 03	No cost
	Fabric Price Group 04	No cost
	Fabric Price Group 05	No cost
	Fabric Price Group 06	No cost
Top Finish	Fabric Price Group 07	No cost
	Fabric Price Group 08	No cost
	Fabric Price Group 09	No cost
	Fabric Price Group 10	No cost
Top Finish	Laminate HPL Price Group 01	No cost
	Laminate HPL Price Group 02	+\$80
	Laminate HPL Price Group 03	+\$164

► **Product Information continued on next page**

# Seating

## Border

► **Product Information continued from previous page**

Options		
Top Finish	OLL Price Group 1	+\$102
Edge Finish	Plastic Group 1	No cost
Top Size and Edge	31 1/2" Top with Square Edge	No cost
	39 3/8" Top with Square Edge	+\$82
	31 1/2" Top with Tapered Edge	+\$258
	39 3/8" Top with Tapered Edge	+\$337
Base Power/Data Node	No Power/Data Required	No cost
	2 Duplex Outlets	+\$287
	Duplex Outlet with HDMI Video Port	+\$376
	Duplex Outlet with CAT6 Data Port	+\$382
	Duplex Outlet with USB Data Port	+\$395
Power Finish	Paint Price Group 01	No cost
	Paint Price Group 02	No cost

### Specification Information

Style Number    Base Price

#### Border Two Seat- Low, with 32" Dia Table

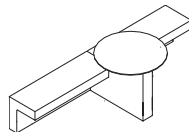

**OBBORDER02** \$6750

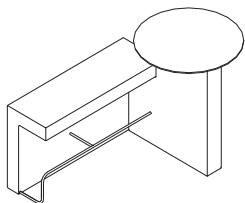

*Tip: If two tone upholstered option is selected, contrasting price groups are available. Total seat finish and table base finish price is driven by highest price group selection.*

### Standard Includes

- Fully upholstered bench with attached table: fabric price group 01
- 31" dia., 1" thick tabletop with square edge: High-Pressure Laminate price group 01
- 3 mm edgeband on user's side: plastic price group 01
- Foot rail: polished chrome
- Plastic feet: black

### Options

Configuration	Upholstered	No cost
	Two Tone Upholstered	+\$198
Seat Finish	Customer's Own Leather	No cost
	Fabric Customer's Own Material	No cost
	Fabric Price Group 01	No cost
	Fabric Price Group 02	+\$152
	Fabric Price Group 03	+\$305
	Fabric Price Group 04	+\$514
	Fabric Price Group 05	+\$853
	Fabric Price Group 06	+\$1190
	Fabric Price Group 07	+\$1626
	Fabric Price Group 08	+\$2015
Fabric Price Group 09	+\$2352	

► **Product Information continued on next page**



► **Product Information continued from previous page**

Options		
Seat Finish	Fabric Price Group 10	+\$2802
Table Base Finish	Customer's Own Leather	No cost
	Fabric Customer's Own Material	No cost
	Fabric Price Group 01	No cost
	Fabric Price Group 02	No cost
	Fabric Price Group 03	No cost
	Fabric Price Group 04	No cost
	Fabric Price Group 05	No cost
	Fabric Price Group 06	No cost
	Fabric Price Group 07	No cost
	Fabric Price Group 08	No cost
Fabric Price Group 09	No cost	
Fabric Price Group 10	No cost	
Top Finish	Laminate HPL Price Group 01	No cost
	Laminate HPL Price Group 02	+\$80
	Laminate HPL Price Group 03	+\$164
	OLL Price Group 1	+\$102
Edge Finish	Plastic Group 1	No cost
Top Size and Edge	31 1/2" Top with Square Edge	No cost
	39 3/8" Top with Square Edge	+\$82
	31 1/2" Top with Tapered Edge	+\$258
	39 3/8" Top with Tapered Edge	+\$337
Base Power/Data Node	No Power/Data Required	No cost
	2 Duplex Outlets	+\$287
	Duplex Outlet with HDMI Video Port	+\$376
	Duplex Outlet with CAT6 Data Port	+\$382
	Duplex Outlet with USB Data Port	+\$395
Power Finish	Paint Price Group 01	No cost
	Paint Price Group 02	No cost

### Specification Information

Style Number    Base Price

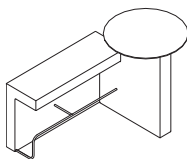

#### **Border One Seat- High, with Left Hand 32" Dia Table**

**OBBORDER03** \$5878

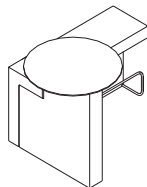

#### **Border One Seat- High, with Right Hand 32" Dia Table**

**OBBORDER04** \$5878



# Seating

## Border

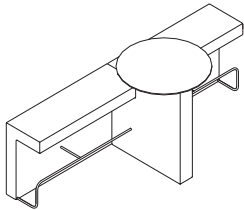

*Tip: If two tone upholstered option is selected, contrasting price groups are available. Total seat finish and table base finish price is driven by highest price group selection.*

### Standard Includes

- Fully upholstered bench with attached table: fabric price group 01
- 31" dia., 1" thick tabletop with square edge: High-Pressure Laminate price group 01
- 3 mm edgeband: plastic price group 01
- Two foot rails: polished chrome
- Plastic feet: black

### Options

Configuration	Upholstered	No cost
	Two Tone Upholstered	+\$198
Seat Finish	Customer's Own Leather	No cost
	Fabric Customer's Own Material	No cost
	Fabric Price Group 01	No cost
	Fabric Price Group 02	+\$222
	Fabric Price Group 03	+\$449
	Fabric Price Group 04	+\$758
	Fabric Price Group 05	+\$1257
	Fabric Price Group 06	+\$1755
	Fabric Price Group 07	+\$2398
	Fabric Price Group 08	+\$2967
Table Base Finish	Fabric Price Group 09	+\$3466
	Fabric Price Group 10	+\$4128
	Customer's Own Leather	No cost
	Fabric Customer's Own Material	No cost
	Fabric Price Group 01	No cost
	Fabric Price Group 02	No cost
	Fabric Price Group 03	No cost
	Fabric Price Group 04	No cost
	Fabric Price Group 05	No cost
	Fabric Price Group 06	No cost
Top Finish	Fabric Price Group 07	No cost
	Fabric Price Group 08	No cost
	Fabric Price Group 09	No cost
	Fabric Price Group 10	No cost
Top Finish	Laminate HPL Price Group 01	No cost
	Laminate HPL Price Group 02	+\$80
	Laminate HPL Price Group 03	+\$164
	OLL Price Group 1	+\$102
Edge Finish	Plastic Group 1	No cost
Top Size and Edge	31 1/2" Top with Square Edge	No cost
	39 3/8" Top with Square Edge	+\$82
	31 1/2" Top with Tapered Edge	+\$258
	39 3/8" Top with Tapered Edge	+\$337
Base Power/Data Node	No Power/Data Required	No cost
	2 Duplex Outlets	+\$287
	Duplex Outlet with HDMI Video Port	+\$376
	Duplex Outlet with CAT6 Data Port	+\$382
	Duplex Outlet with USB Data Port	+\$395
Power Finish	Paint Price Group 01	No cost
	Paint Price Group 02	No cost

► **Product Information continued on next page**

▶ **Product Information continued from previous page**

**Specification Information**

Style Number    Base Price

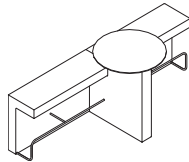

**Border Two Seat- High, with 32" Dia Table**

**OBBORDER05**    \$8752

# Away from the Desk

## Seating

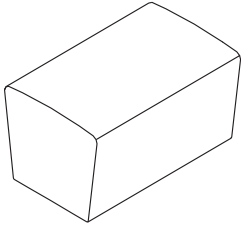

*Tip: Customer's Own Material (COM) is available at a price group 1.*

### Standard Includes

- Fully upholstered seat: fabric price group 01
- Adjustable glides: black
- Linking brackets

### Options

Seat Finish	Fabric Price Group 01	No cost
	Fabric Price Group 02	+\$41
	Fabric Price Group 03	+\$83
	Fabric Price Group 04	+\$140
	Fabric Price Group 05	+\$233
	Fabric Price Group 06	+\$325
	Fabric Price Group 07	+\$444
	Fabric Price Group 08	+\$548
	Fabric Price Group 09	+\$643
	Fabric Price Group 10	+\$764
Left End Configuration	Connecting Unit	No cost
	Open	No cost
Right End Configuration	Connecting Unit	No cost
	Open	No cost

### Specification Information

Style Number    Base Price

## 31 1/2" W Modular Straight Seat

**OBAD01**      \$1994

# Away from the Desk

## Seating

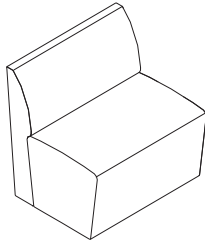

Tip: Customer's Own Material (COM) is available at a price group 1.

### Standard Includes

- Fully upholstered seat with back: fabric price group 01
- Adjustable glides: black
- Linking brackets

### Options

Seat Finish	Fabric Price Group 01	No cost
	Fabric Price Group 02	+\$41
	Fabric Price Group 03	+\$83
	Fabric Price Group 04	+\$140
	Fabric Price Group 05	+\$233
	Fabric Price Group 06	+\$325
	Fabric Price Group 07	+\$444
	Fabric Price Group 08	+\$548
	Fabric Price Group 09	+\$643
	Fabric Price Group 10	+\$764
Backrest Outer Finish	Fabric Price Group 01	No cost
	Fabric Price Group 02	+\$48
	Fabric Price Group 03	+\$97
	Fabric Price Group 04	+\$162
	Fabric Price Group 05	+\$267
	Fabric Price Group 06	+\$376
	Fabric Price Group 07	+\$513
	Fabric Price Group 08	+\$635
	Fabric Price Group 09	+\$741
	Fabric Price Group 10	+\$883
Backrest Inner Finish	Fabric Price Group 01	No cost
	Fabric Price Group 02	+\$36
	Fabric Price Group 03	+\$75
	Fabric Price Group 04	+\$124
	Fabric Price Group 05	+\$206
	Fabric Price Group 06	+\$288
	Fabric Price Group 07	+\$395
	Fabric Price Group 08	+\$487
	Fabric Price Group 09	+\$571
	Fabric Price Group 10	+\$679
Left End Configuration	Connecting Unit	No cost
	Open	No cost
	AD-61 LA Uph LH Arm	+\$1226
	AD-62 LC Uph LH Arm with Tablet	+\$2623
Left Arm Finish	Fabric Price Group 01	No cost
	Fabric Price Group 02	+\$48
	Fabric Price Group 03	+\$97
	Fabric Price Group 04	+\$162
	Fabric Price Group 05	+\$267
	Fabric Price Group 06	+\$376
	Fabric Price Group 07	+\$513
	Fabric Price Group 08	+\$635
	Fabric Price Group 09	+\$741
	Fabric Price Group 10	+\$883

Tip: Tablet is selectable on one end only.

► Product Information continued on next page

# Away from the Desk

## Seating

### ► Product Information continued from previous page

Options		
Left Tablet Top Finish	Laminate HPL Price Group 01	No cost
	Laminate HPL Price Group 02	+\$76
	Laminate HPL Price Group 03	+\$154
	OLL Price Group 1	+\$102
Left Tablet Edge Finish	Plastic Group 1	No cost
Left Arm Power/Data Node	No Power/Data Required	No cost
	2 Duplex Outlets	+\$287
	Duplex Outlet with HDMI Video Port	+\$376
	Duplex Outlet with CAT6 Data	+\$382
	Duplex Outlet with USB Data Ports	+\$395
Left Arm Power Finish	Paint Price Group 01	No cost
	Paint Price Group 02	No cost
Right End Configuration	Connecting Unit	No cost
	Open	No cost
	AD-61 RA Uph RH Arm	+\$1226
	AD-62 RC Uph RH Arm with Tablet	+\$2623
Right Arm Finish	Fabric Price Group 01	No cost
	Fabric Price Group 02	+\$48
	Fabric Price Group 03	+\$97
	Fabric Price Group 04	+\$162
	Fabric Price Group 05	+\$267
	Fabric Price Group 06	+\$376
	Fabric Price Group 07	+\$513
	Fabric Price Group 08	+\$635
	Fabric Price Group 09	+\$741
	Fabric Price Group 10	+\$883
Right Tablet Top Finish	Laminate HPL Price Group 01	No cost
	Laminate HPL Price Group 02	+\$76
	Laminate HPL Price Group 03	+\$154
	OLL Price Group 1	+\$102
Right Tablet Edge Finish	Plastic Group 1	No cost
Right Arm Power/Data Node	No Power/Data Required	No cost
	2 Duplex Outlets	+\$287
	Duplex Outlet with HDMI Video Port	+\$376
	Duplex Outlet with CAT6 Data	+\$382
	Duplex Outlet with USB Data Ports	+\$395
Right Arm Power Finish	Paint Price Group 01	No cost
	Paint Price Group 02	No cost

### Specification Information

Style Number Base Price

## 31 1/2" W Modular Straight Seat with Back

**OBAD02** \$3552

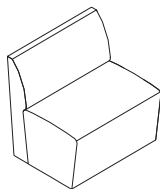

# Away from the Desk

## Seating

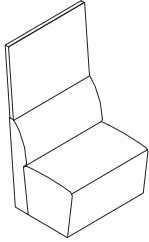

Tip: Customer's Own Material (COM) is available at a price group 1.

### Standard Includes

- Fully upholstered seat, back, and screen: fabric price group 01
- Adjustable glides: black
- Linking brackets

### Options

Seat Finish	Fabric Price Group 01	No cost
	Fabric Price Group 02	+\$41
	Fabric Price Group 03	+\$83
	Fabric Price Group 04	+\$140
	Fabric Price Group 05	+\$233
	Fabric Price Group 06	+\$325
	Fabric Price Group 07	+\$444
	Fabric Price Group 08	+\$548
	Fabric Price Group 09	+\$643
	Fabric Price Group 10	+\$764
Backrest Outer Finish	Fabric Price Group 01	No cost
	Fabric Price Group 02	+\$48
	Fabric Price Group 03	+\$97
	Fabric Price Group 04	+\$162
	Fabric Price Group 05	+\$267
	Fabric Price Group 06	+\$376
	Fabric Price Group 07	+\$513
	Fabric Price Group 08	+\$635
	Fabric Price Group 09	+\$741
	Fabric Price Group 10	+\$883
Backrest Inner Finish	Fabric Price Group 01	No cost
	Fabric Price Group 02	+\$36
	Fabric Price Group 03	+\$75
	Fabric Price Group 04	+\$124
	Fabric Price Group 05	+\$206
	Fabric Price Group 06	+\$288
	Fabric Price Group 07	+\$395
	Fabric Price Group 08	+\$487
	Fabric Price Group 09	+\$571
	Fabric Price Group 10	+\$679
Screen Connection	No Screen Connections	No cost
	Screen Connection-Left	No cost
	Screen Connection-Left & Right	No cost
	Screen Connection-Right	No cost
Left End Configuration	Connecting Unit	No cost
	Open	No cost
	AD-61 LA Uph LH Arm	+\$1226
	AD-62 LC Uph LH Arm with Tablet	+\$2623
Left Arm Finish	Fabric Price Group 01	No cost
	Fabric Price Group 02	+\$48
	Fabric Price Group 03	+\$97
	Fabric Price Group 04	+\$162
	Fabric Price Group 05	+\$267
	Fabric Price Group 06	+\$376
	Fabric Price Group 07	+\$513

Tip: Tablet is selectable on one end only.

► **Product Information continued on next page**

# Away from the Desk

## Seating

### ► Product Information continued from previous page

Options		
Left Arm Finish	Fabric Price Group 08	+\$635
	Fabric Price Group 09	+\$741
	Fabric Price Group 10	+\$883
Left Tablet Top Finish	Laminate HPL Price Group 01	No cost
	Laminate HPL Price Group 02	+\$76
	Laminate HPL Price Group 03	+\$154
	OLL Price Group 1	+\$102
Left Tablet Edge Finish	Plastic Group 1	No cost
Left Arm Power/Data Node	No Power/Data Required	No cost
	2 Duplex Outlets	+\$287
	Duplex Outlet with HDMI Video Port	+\$376
	Duplex Outlet with CAT6 Data	+\$382
	Duplex Outlet with USB Data Ports	+\$395
Left Arm Power Finish	Paint Price Group 01	No cost
	Paint Price Group 02	No cost
Right End Configuration	Connecting Unit	No cost
	Open	No cost
	AD-61 RA Uph RH Arm	+\$1226
	AD-62 RC Uph RH Arm with Tablet	+\$2623
Right Arm Finish	Fabric Price Group 01	No cost
	Fabric Price Group 02	+\$48
	Fabric Price Group 03	+\$97
	Fabric Price Group 04	+\$162
	Fabric Price Group 05	+\$267
	Fabric Price Group 06	+\$376
	Fabric Price Group 07	+\$513
	Fabric Price Group 08	+\$635
	Fabric Price Group 09	+\$741
	Fabric Price Group 10	+\$883
Right Tablet Top Finish	Laminate HPL Price Group 01	No cost
	Laminate HPL Price Group 02	+\$76
	Laminate HPL Price Group 03	+\$154
	OLL Price Group 1	+\$102
Right Tablet Edge Finish	Plastic Group 1	No cost
Right Arm Power/Data Node	No Power/Data Required	No cost
	2 Duplex Outlets	+\$287
	Duplex Outlet with HDMI Video Port	+\$376
	Duplex Outlet with CAT6 Data	+\$382
	Duplex Outlet with USB Data Ports	+\$395
Right Arm Power Finish	Paint Price Group 01	No cost
	Paint Price Group 02	No cost

### ► Product Information continued on next page



# Away from the Desk

## Seating

► Product Information continued from previous page

### Specification Information

Style Number	Base Price									
	Screen Grades:									
	1	2	3	4	5	6	7	8	9	10

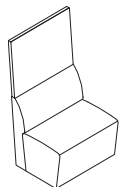

#### 31 1/2" W Modular Straight Seat with Back and Screen

<b>OBAD03</b>	\$4780	\$4829	\$4880	\$4948	\$5059	\$5169	\$5314	\$5439	\$5552	\$5698
---------------	--------	--------	--------	--------	--------	--------	--------	--------	--------	--------

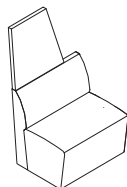

#### 31 1/2" W Modular Straight Seat with Back and Left Hand Tapered Screen

<b>OBAD03LC</b>	\$4726	\$4762	\$4801	\$4850	\$4932	\$5014	\$5121	\$5213	\$5297	\$5405
-----------------	--------	--------	--------	--------	--------	--------	--------	--------	--------	--------

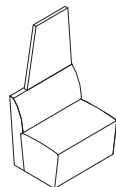

#### 31 1/2" W Modular Straight Seat with Back and Right Hand Tapered Screen

<b>OBAD03RC</b>	\$4726	\$4762	\$4801	\$4850	\$4932	\$5014	\$5121	\$5213	\$5297	\$5405
-----------------	--------	--------	--------	--------	--------	--------	--------	--------	--------	--------



# Away from the Desk

## Seating

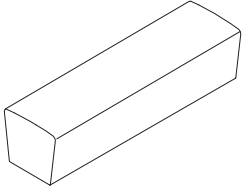

*Tip: Customer's Own Material (COM) is available at a price group 1.*

### Standard Includes

- Fully upholstered seat: fabric price group 01
- Adjustable glides: black
- Linking brackets

### Options

Seat Finish	Fabric Price Group 01	No cost
	Fabric Price Group 02	+\$69
	Fabric Price Group 03	+\$138
	Fabric Price Group 04	+\$234
	Fabric Price Group 05	+\$387
	Fabric Price Group 06	+\$542
	Fabric Price Group 07	+\$739
	Fabric Price Group 08	+\$917
	Fabric Price Group 09	+\$1070
	Fabric Price Group 10	+\$1273
Left End Configuration	Connecting Unit	No cost
	Open	No cost
Right End Configuration	Connecting Unit	No cost
	Open	No cost

### Specification Information

Style Number    Base Price

## 70 7/8" W Modular Straight Seat

**OBAD11**      \$2860

# Away from the Desk

## Seating

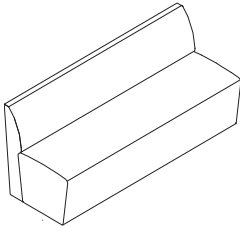

Tip: Customer's Own Material (COM) is available at a price group 1.

### Standard Includes

- Fully upholstered seat with back: fabric price group 01
- Adjustable glides: black
- Linking brackets

### Options

Seat Finish	Fabric Price Group 01	No cost
	Fabric Price Group 02	+\$69
	Fabric Price Group 03	+\$138
	Fabric Price Group 04	+\$234
	Fabric Price Group 05	+\$387
	Fabric Price Group 06	+\$542
	Fabric Price Group 07	+\$739
	Fabric Price Group 08	+\$917
	Fabric Price Group 09	+\$1070
	Fabric Price Group 10	+\$1273
Backrest Outer Finish	Fabric Price Group 01	No cost
	Fabric Price Group 02	+\$65
	Fabric Price Group 03	+\$134
	Fabric Price Group 04	+\$225
	Fabric Price Group 05	+\$372
	Fabric Price Group 06	+\$519
	Fabric Price Group 07	+\$710
	Fabric Price Group 08	+\$880
	Fabric Price Group 09	+\$1027
	Fabric Price Group 10	+\$1223
Backrest Inner Finish	Fabric Price Group 01	No cost
	Fabric Price Group 02	+\$39
	Fabric Price Group 03	+\$82
	Fabric Price Group 04	+\$137
	Fabric Price Group 05	+\$227
	Fabric Price Group 06	+\$317
	Fabric Price Group 07	+\$434
	Fabric Price Group 08	+\$537
	Fabric Price Group 09	+\$627
	Fabric Price Group 10	+\$747
Left End Configuration	Connecting Unit	No cost
	Open	No cost
	AD-61 LA Uph LH Arm	+\$1226
	AD-62 LC Uph LH Arm with Tablet	+\$2623
Left Arm Finish	Fabric Price Group 01	No cost
	Fabric Price Group 02	+\$48
	Fabric Price Group 03	+\$97
	Fabric Price Group 04	+\$162
	Fabric Price Group 05	+\$267
	Fabric Price Group 06	+\$376
	Fabric Price Group 07	+\$513
	Fabric Price Group 08	+\$635
	Fabric Price Group 09	+\$741
	Fabric Price Group 10	+\$883

► Product Information continued on next page

# Away from the Desk

## Seating

► **Product Information continued from previous page**

<b>Options</b>		
Left Tablet Top Finish	Laminate HPL Price Group 01	No cost
	Laminate HPL Price Group 02	+\$76
	Laminate HPL Price Group 03	+\$154
	OLL Price Group 1	+\$102
Left Tablet Edge Finish	Plastic Group 1	No cost
Left Arm Power/Data Node	No Power/Data Required	No cost
	2 Duplex Outlets	+\$287
	Duplex Outlet with HDMI Video Port	+\$376
	Duplex Outlet with CAT6 Data	+\$382
	Duplex Outlet with USB Data Ports	+\$395
Left Arm Power Finish	Paint Price Group 01	No cost
	Paint Price Group 02	No cost
Right End Configuration	Connecting Unit	No cost
	Open	No cost
	AD-61 RA Uph RH Arm	+\$1226
	AD-62 RC Uph RH Arm with Tablet	+\$2623
Right Arm Finish	Fabric Price Group 01	No cost
	Fabric Price Group 02	+\$48
	Fabric Price Group 03	+\$97
	Fabric Price Group 04	+\$162
	Fabric Price Group 05	+\$267
	Fabric Price Group 06	+\$376
	Fabric Price Group 07	+\$513
	Fabric Price Group 08	+\$635
	Fabric Price Group 09	+\$741
	Fabric Price Group 10	+\$883
Right Tablet Top Finish	Laminate HPL Price Group 01	No cost
	Laminate HPL Price Group 02	+\$76
	Laminate HPL Price Group 03	+\$154
	OLL Price Group 1	+\$102
Right Tablet Edge Finish	Plastic Group 1	No cost
Right Arm Power/Data Node	No Power/Data Required	No cost
	2 Duplex Outlets	+\$287
	Duplex Outlet with HDMI Video Port	+\$376
	Duplex Outlet with CAT6 Data	+\$382
	Duplex Outlet with USB Data Ports	+\$395
Right Arm Power Finish	Paint Price Group 01	No cost
	Paint Price Group 02	No cost

**Specification Information**

Style Number    Base Price

**70 7/8" W Modular Straight Seat with Back**

**OBAD12**    \$5201

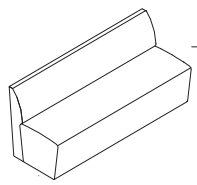

# Away from the Desk

## Seating

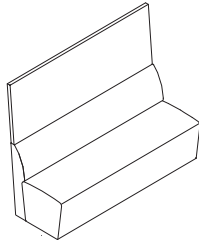

Tip: Customer's Own Material (COM) is available at a price group 1.

### Standard Includes

- Fully upholstered seat, back, and screen: fabric price group 01
- Adjustable glides: black
- Linking brackets

### Options

Seat Finish	Fabric Price Group 01	No cost
	Fabric Price Group 02	+\$69
	Fabric Price Group 03	+\$138
	Fabric Price Group 04	+\$234
	Fabric Price Group 05	+\$387
	Fabric Price Group 06	+\$542
	Fabric Price Group 07	+\$739
	Fabric Price Group 08	+\$917
	Fabric Price Group 09	+\$1070
	Fabric Price Group 10	+\$1273
Backrest Outer Finish	Fabric Price Group 01	No cost
	Fabric Price Group 02	+\$65
	Fabric Price Group 03	+\$134
	Fabric Price Group 04	+\$225
	Fabric Price Group 05	+\$372
	Fabric Price Group 06	+\$519
	Fabric Price Group 07	+\$710
	Fabric Price Group 08	+\$880
	Fabric Price Group 09	+\$1027
	Fabric Price Group 10	+\$1223
Backrest Inner Finish	Fabric Price Group 01	No cost
	Fabric Price Group 02	+\$39
	Fabric Price Group 03	+\$82
	Fabric Price Group 04	+\$137
	Fabric Price Group 05	+\$227
	Fabric Price Group 06	+\$317
	Fabric Price Group 07	+\$434
	Fabric Price Group 08	+\$537
	Fabric Price Group 09	+\$627
	Fabric Price Group 10	+\$747
Screen Connection	No Screen Connections	No cost
	Screen Connection-Left	No cost
	Screen Connection-Left & Right	No cost
	Screen Connection-Right	No cost
Left End Configuration	Connecting Unit	No cost
	Open	No cost
	AD-61 LA Uph LH Arm	+\$1226
	AD-62 LC Uph LH Arm with Tablet	+\$2623
Left Arm Finish	Fabric Price Group 01	No cost
	Fabric Price Group 02	+\$48
	Fabric Price Group 03	+\$97
	Fabric Price Group 04	+\$162
	Fabric Price Group 05	+\$267
	Fabric Price Group 06	+\$376
	Fabric Price Group 07	+\$513

► **Product Information continued on next page**

# Away from the Desk

## Seating

### ► Product Information continued from previous page

Options		
Left Arm Finish	Fabric Price Group 08	+\$635
	Fabric Price Group 09	+\$741
	Fabric Price Group 10	+\$883
Left Tablet Top Finish	Laminate HPL Price Group 01	No cost
	Laminate HPL Price Group 02	+\$76
	Laminate HPL Price Group 03	+\$154
	OLL Price Group 1	+\$102
Left Tablet Edge Finish	Plastic Group 1	No cost
Left Arm Power/Data Node	No Power/Data Required	No cost
	2 Duplex Outlets	+\$287
	Duplex Outlet with HDMI Video Port	+\$376
	Duplex Outlet with CAT6 Data	+\$382
	Duplex Outlet with USB Data Ports	+\$395
Left Arm Power Finish	Paint Price Group 01	No cost
	Paint Price Group 02	No cost
Right End Configuration	Connecting Unit	No cost
	Open	No cost
	AD-61 RA Uph RH Arm	+\$1226
	AD-62 RC Uph RH Arm with Tablet	+\$2623
Right Arm Finish	Fabric Price Group 01	No cost
	Fabric Price Group 02	+\$48
	Fabric Price Group 03	+\$97
	Fabric Price Group 04	+\$162
	Fabric Price Group 05	+\$267
	Fabric Price Group 06	+\$376
	Fabric Price Group 07	+\$513
	Fabric Price Group 08	+\$635
	Fabric Price Group 09	+\$741
	Fabric Price Group 10	+\$883
Right Tablet Top Finish	Laminate HPL Price Group 01	No cost
	Laminate HPL Price Group 02	+\$76
	Laminate HPL Price Group 03	+\$154
	OLL Price Group 1	+\$102
Right Tablet Edge Finish	Plastic Group 1	No cost
Right Arm Power/Data Node	No Power/Data Required	No cost
	2 Duplex Outlets	+\$287
	Duplex Outlet with HDMI Video Port	+\$376
	Duplex Outlet with CAT6 Data	+\$382
	Duplex Outlet with USB Data Ports	+\$395
Right Arm Power Finish	Paint Price Group 01	No cost
	Paint Price Group 02	No cost

### ► Product Information continued on next page

# Away from the Desk

## Seating

► Product Information continued from previous page

### Specification Information

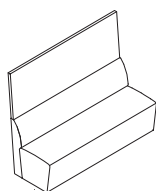

Style Number	Base Price									
	Screen Grades:									
	1	2	3	4	5	6	7	8	9	10
<b>70 7/8" W Modular Straight Seat with Back and Screen</b>										
<b>OBAD13</b>	\$7020	\$7100	\$7181	\$7293	\$7469	\$7647	\$7878	\$8081	\$8262	\$8498

# Away from the Desk

## Seating

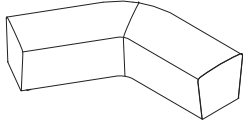

Tip: Customer's Own Material (COM) is available at a price group 1.

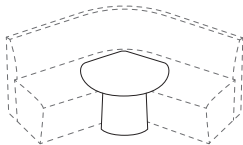

### Standard Includes

- Fully upholstered seat: fabric price group 01
- Adjustable glides: black
- Linking brackets

### Options

Seat Finish	Fabric Price Group 01	No cost
	Fabric Price Group 02	+\$77
	Fabric Price Group 03	+\$155
	Fabric Price Group 04	+\$262
	Fabric Price Group 05	+\$434
	Fabric Price Group 06	+\$606
	Fabric Price Group 07	+\$828
	Fabric Price Group 08	+\$1026
	Fabric Price Group 09	+\$1198
	Fabric Price Group 10	+\$1426
Left End Configuration	Connecting Unit	No cost
	Open	No cost
Right End Configuration	Connecting Unit	No cost
	Open	No cost
Table	No Table	No cost
	AD-72 120 Corner Table	+\$3142
Table Top Finish	Laminate HPL Price Group 01	No cost
	Laminate HPL Price Group 02	+\$76
	Laminate HPL Price Group 03	+\$154
	OLL Price Group 1	+\$102
Table Edge Finish	Plastic Group 1	No cost
Base Power/Data Node	No Power/Data Required	No cost
	2 Duplex Outlets	+\$287
	Duplex Outlet with HDMI Video Port	+\$376
	Duplex Outlet with CAT6 Data	+\$382
Base Power Finish	Duplex Outlet with USB Data Ports	+\$395
	Paint Price Group 01	No cost
Table Base Finish	Paint Price Group 02	No cost
	Fabric Price Group 01	No cost
Table Base Finish	Fabric Price Group 02	+\$36
	Fabric Price Group 03	+\$75
	Fabric Price Group 04	+\$124
	Fabric Price Group 05	+\$206
	Fabric Price Group 06	+\$288
	Fabric Price Group 07	+\$395
	Fabric Price Group 08	+\$487
	Fabric Price Group 09	+\$571
	Fabric Price Group 10	+\$679

► Product Information continued on next page



# Away from the Desk

## Seating

▶ **Product Information continued from previous page**

### Specification Information

Style Number    Base Price

#### **120° Modular Seat**

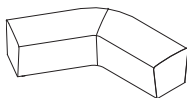

**OBAD21**      \$3600

# Away from the Desk

## Seating

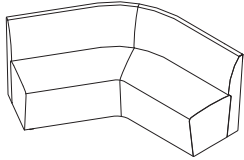

*Tip: Customer's Own Material (COM) is available at a price group 1.*

### Standard Includes

- Fully upholstered seat with back: fabric price group 01
- Adjustable glides: black
- Linking brackets

### Options

Seat Finish	Fabric Price Group 01	No cost
	Fabric Price Group 02	+\$77
	Fabric Price Group 03	+\$155
	Fabric Price Group 04	+\$262
	Fabric Price Group 05	+\$434
	Fabric Price Group 06	+\$606
	Fabric Price Group 07	+\$828
	Fabric Price Group 08	+\$1026
	Fabric Price Group 09	+\$1198
	Fabric Price Group 10	+\$1426
Backrest Outer Finish	Fabric Price Group 01	No cost
	Fabric Price Group 02	+\$80
	Fabric Price Group 03	+\$161
	Fabric Price Group 04	+\$273
	Fabric Price Group 05	+\$449
	Fabric Price Group 06	+\$627
	Fabric Price Group 07	+\$858
	Fabric Price Group 08	+\$1061
	Fabric Price Group 09	+\$1242
	Fabric Price Group 10	+\$1478
Backrest Inner Finish	Fabric Price Group 01	No cost
	Fabric Price Group 02	+\$52
	Fabric Price Group 03	+\$104
	Fabric Price Group 04	+\$174
	Fabric Price Group 05	+\$289
	Fabric Price Group 06	+\$404
	Fabric Price Group 07	+\$552
	Fabric Price Group 08	+\$683
	Fabric Price Group 09	+\$799
	Fabric Price Group 10	+\$950
Left End Configuration	Connecting Unit	No cost
	Open	No cost
	AD-61 LA Uph LH Arm	+\$1226
	AD-62 LC Uph LH Arm with Tablet	+\$2623
Left Arm Finish	Fabric Price Group 01	No cost
	Fabric Price Group 02	+\$48
	Fabric Price Group 03	+\$97
	Fabric Price Group 04	+\$162
	Fabric Price Group 05	+\$267
	Fabric Price Group 06	+\$376
	Fabric Price Group 07	+\$513
	Fabric Price Group 08	+\$635
	Fabric Price Group 09	+\$741
	Fabric Price Group 10	+\$883

► **Product Information continued on next page**

# Away from the Desk

## Seating

### ► Product Information continued from previous page

Options		
Left Tablet Top Finish	Laminate HPL Price Group 01	No cost
	Laminate HPL Price Group 02	+\$76
	Laminate HPL Price Group 03	+\$154
	OLL Price Group 1	+\$102
Left Tablet Edge Finish	Plastic Group 1	No cost
Left Arm Power/Data Node	No Power/Data Required	No cost
	2 Duplex Outlets	+\$287
	Duplex Outlet with HDMI Video Port	+\$376
	Duplex Outlet with CAT6 Data	+\$382
Left Arm Power Finish	Duplex Outlet with USB Data Ports	+\$395
	Paint Price Group 01	No cost
	Paint Price Group 02	No cost
Right End Configuration	Connecting Unit	No cost
	Open	No cost
	AD-61 RA Uph RH Arm	+\$1226
	AD-62 RC Uph RH Arm with Tablet	+\$2623
Right Arm Finish	Fabric Price Group 01	No cost
	Fabric Price Group 02	+\$48
	Fabric Price Group 03	+\$97
	Fabric Price Group 04	+\$162
	Fabric Price Group 05	+\$267
	Fabric Price Group 06	+\$376
	Fabric Price Group 07	+\$513
	Fabric Price Group 08	+\$635
	Fabric Price Group 09	+\$741
	Fabric Price Group 10	+\$883
Right Tablet Top Finish	Laminate HPL Price Group 01	No cost
	Laminate HPL Price Group 02	+\$76
	Laminate HPL Price Group 03	+\$154
	OLL Price Group 1	+\$102
Right Tablet Edge Finish	Plastic Group 1	No cost
Right Arm Power/Data Node	No Power/Data Required	No cost
	2 Duplex Outlets	+\$287
	Duplex Outlet with HDMI Video Port	+\$376
	Duplex Outlet with CAT6 Data	+\$382
Right Arm Power Finish	Duplex Outlet with USB Data Ports	+\$395
	Paint Price Group 01	No cost
	Paint Price Group 02	No cost
Table	No Table	No cost
	AD-72 120 Corner Table	+\$3142
Table Top Finish	Laminate HPL Price Group 01	No cost
	Laminate HPL Price Group 02	+\$76
	Laminate HPL Price Group 03	+\$154
	OLL Price Group 1	+\$102
Table Edge Finish	Plastic Group 1	No cost
Table Base Finish	Fabric Price Group 01	No cost
	Fabric Price Group 02	+\$36

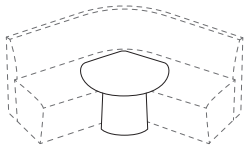

### ► Product Information continued on next page

# Away from the Desk

## Seating

► **Product Information continued from previous page**

<b>Options</b>			
Table Base Finish	Fabric Price Group 03	+\$75	
	Fabric Price Group 04	+\$124	
	Fabric Price Group 05	+\$206	
	Fabric Price Group 06	+\$288	
	Fabric Price Group 07	+\$395	
	Fabric Price Group 08	+\$487	
	Fabric Price Group 09	+\$571	
	Fabric Price Group 10	+\$679	
	Base Power/Data Node	No Power/Data Required	No cost
		2 Duplex Outlets	+\$287
Duplex Outlet with HDMI Video Port		+\$376	
Duplex Outlet with CAT6 Data		+\$382	
Duplex Outlet with USB Data Ports		+\$395	
Base Power Finish	Paint Price Group 01	No cost	
	Paint Price Group 02	No cost	

### Specification Information

Style Number    Base Price

## **120° Modular Seat with External Back**

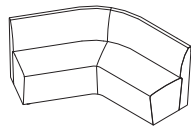

**OBAD22**      \$6991

# Away from the Desk

## Seating

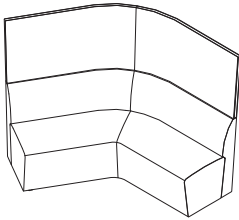

Tip: Customer's Own Material (COM) is available at a price group 1.

### Standard Includes

- Fully upholstered seat, back, and screen: fabric price group 01
- Adjustable glides: black
- Linking brackets

### Options

Seat Finish	Fabric Price Group 01	No cost
	Fabric Price Group 02	+\$77
	Fabric Price Group 03	+\$155
	Fabric Price Group 04	+\$262
	Fabric Price Group 05	+\$434
	Fabric Price Group 06	+\$606
	Fabric Price Group 07	+\$828
	Fabric Price Group 08	+\$1026
	Fabric Price Group 09	+\$1198
	Fabric Price Group 10	+\$1426
Backrest Outer Finish	Fabric Price Group 01	No cost
	Fabric Price Group 02	+\$80
	Fabric Price Group 03	+\$161
	Fabric Price Group 04	+\$273
	Fabric Price Group 05	+\$449
	Fabric Price Group 06	+\$627
	Fabric Price Group 07	+\$858
	Fabric Price Group 08	+\$1061
	Fabric Price Group 09	+\$1242
	Fabric Price Group 10	+\$1478
Backrest Inner Finish	Fabric Price Group 01	No cost
	Fabric Price Group 02	+\$52
	Fabric Price Group 03	+\$104
	Fabric Price Group 04	+\$174
	Fabric Price Group 05	+\$289
	Fabric Price Group 06	+\$404
	Fabric Price Group 07	+\$552
	Fabric Price Group 08	+\$683
	Fabric Price Group 09	+\$799
	Fabric Price Group 10	+\$950
Screen Connection	No Screen Connections	No cost
	Screen Connection-Left	No cost
	Screen Connection-Left & Right	No cost
	Screen Connection-Right	No cost
Left End Configuration	Connecting Unit	No cost
	Open	No cost
	AD-61 LA Uph LH Arm	+\$1226
	AD-62 LC Uph LH Arm with Tablet	+\$2623
Left Arm Finish	Fabric Price Group 01	No cost
	Fabric Price Group 02	+\$48
	Fabric Price Group 03	+\$97
	Fabric Price Group 04	+\$162
	Fabric Price Group 05	+\$267
	Fabric Price Group 06	+\$376
	Fabric Price Group 07	+\$513

► **Product Information continued on next page**

# Away from the Desk

## Seating

► **Product Information continued from previous page**

<b>Options</b>		
Left Arm Finish	Fabric Price Group 08	+\$635
	Fabric Price Group 09	+\$741
	Fabric Price Group 10	+\$883
Left Tablet Top Finish	Laminate HPL Price Group 01	No cost
	Laminate HPL Price Group 02	+\$76
	Laminate HPL Price Group 03	+\$154
	OLL Price Group 1	+\$102
Left Tablet Edge Finish	Plastic Group 1	No cost
Left Arm Power/Data Node	No Power/Data Required	No cost
	2 Duplex Outlets	+\$287
	Duplex Outlet with HDMI Video Port	+\$376
	Duplex Outlet with CAT6 Data	+\$382
	Duplex Outlet with USB Data Ports	+\$395
Left Arm Power Finish	Paint Price Group 01	No cost
	Paint Price Group 02	No cost
Right End Configuration	Connecting Unit	No cost
	Open	No cost
	AD-61 RA Uph RH Arm	+\$1226
	AD-62 RC Uph RH Arm with Tablet	+\$2623
Right Arm Finish	Fabric Price Group 01	No cost
	Fabric Price Group 02	+\$48
	Fabric Price Group 03	+\$97
	Fabric Price Group 04	+\$162
	Fabric Price Group 05	+\$267
	Fabric Price Group 06	+\$376
	Fabric Price Group 07	+\$513
	Fabric Price Group 08	+\$635
	Fabric Price Group 09	+\$741
	Fabric Price Group 10	+\$883
Right Tablet Top Finish	Laminate HPL Price Group 01	No cost
	Laminate HPL Price Group 02	+\$76
	Laminate HPL Price Group 03	+\$154
	OLL Price Group 1	+\$102
Right Tablet Edge Finish	Plastic Group 1	No cost
Right Arm Power/Data Node	No Power/Data Required	No cost
	2 Duplex Outlets	+\$287
	Duplex Outlet with HDMI Video Port	+\$376
	Duplex Outlet with CAT6 Data	+\$382
	Duplex Outlet with USB Data Ports	+\$395
Right Arm Power Finish	Paint Price Group 01	No cost
	Paint Price Group 02	No cost
Table	No Table	No cost
	AD-72 120 Corner Table	+\$3142
Table Top Finish	Laminate HPL Price Group 01	No cost
	Laminate HPL Price Group 02	+\$76
	Laminate HPL Price Group 03	+\$154
	OLL Price Group 1	+\$102

► **Product Information continued on next page**

# Away from the Desk

## Seating

► **Product Information continued from previous page**

<b>Options</b>		
Table Edge Finish	Plastic Group 1	No cost
Table Base Finish	Fabric Price Group 01	No cost
	Fabric Price Group 02	+\$36
	Fabric Price Group 03	+\$75
	Fabric Price Group 04	+\$124
	Fabric Price Group 05	+\$206
	Fabric Price Group 06	+\$288
	Fabric Price Group 07	+\$395
	Fabric Price Group 08	+\$487
	Fabric Price Group 09	+\$571
	Fabric Price Group 10	+\$679
Base Power/Data Node	No Power/Data Required	No cost
	2 Duplex Outlets	+\$287
	Duplex Outlet with HDMI Video Port	+\$376
	Duplex Outlet with CAT6 Data	+\$382
Base Power Finish	Paint Price Group 01	No cost
	Paint Price Group 02	No cost

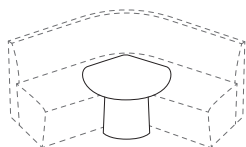

### Specification Information

Style Number	Base Price									
	Screen Grades:									
	1	2	3	4	5	6	7	8	9	10

#### 120° Modular Seat with External Back and Screen

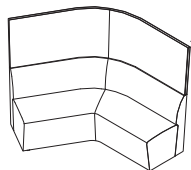

OBAD23	\$8892	\$8994	\$9097	\$9238	\$9465	\$9693	\$9989	\$10,248	\$10,477	\$10,778
--------	--------	--------	--------	--------	--------	--------	--------	----------	----------	----------

#### 120° Modular Seat with External Back and Left Hand Tapered Screen

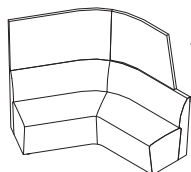

OBAD23LC	\$8844	\$8928	\$9016	\$9133	\$9326	\$9517	\$9762	\$9980	\$10,172	\$10,425
----------	--------	--------	--------	--------	--------	--------	--------	--------	----------	----------

#### 120° Modular Seat with External Back and Right Hand Tapered Screen

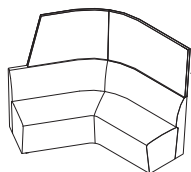

OBAD23RC	\$8844	\$8928	\$9016	\$9133	\$9326	\$9517	\$9762	\$9980	\$10,172	\$10,425
----------	--------	--------	--------	--------	--------	--------	--------	--------	----------	----------

# Away from the Desk

## Seating

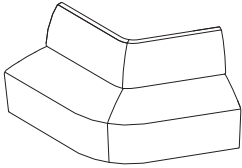

Tip: Customer's Own Material (COM) is available at a price group 1.

### Standard Includes

- Fully upholstered seat with back: fabric price group 01
- Adjustable glides: black
- Linking brackets

### Options

Seat Finish	Fabric Price Group 01	No cost
	Fabric Price Group 02	+\$77
	Fabric Price Group 03	+\$155
	Fabric Price Group 04	+\$262
	Fabric Price Group 05	+\$434
	Fabric Price Group 06	+\$606
	Fabric Price Group 07	+\$828
	Fabric Price Group 08	+\$1026
	Fabric Price Group 09	+\$1198
	Fabric Price Group 10	+\$1426
Backrest Outer Finish	Fabric Price Group 01	No cost
	Fabric Price Group 02	+\$58
	Fabric Price Group 03	+\$117
	Fabric Price Group 04	+\$197
	Fabric Price Group 05	+\$325
	Fabric Price Group 06	+\$456
	Fabric Price Group 07	+\$621
	Fabric Price Group 08	+\$770
	Fabric Price Group 09	+\$899
	Fabric Price Group 10	+\$1070
Backrest Inner Finish	Fabric Price Group 01	No cost
	Fabric Price Group 02	+\$36
	Fabric Price Group 03	+\$75
	Fabric Price Group 04	+\$124
	Fabric Price Group 05	+\$206
	Fabric Price Group 06	+\$288
	Fabric Price Group 07	+\$395
	Fabric Price Group 08	+\$487
	Fabric Price Group 09	+\$571
	Fabric Price Group 10	+\$679
Left End Configuration	Connecting Unit	No cost
	Open	No cost
	AD-61 LA Uph LH Arm	+\$1226
	AD-62 LC Uph LH Arm with Tablet	+\$2623
Left Arm Finish	Fabric Price Group 01	No cost
	Fabric Price Group 02	+\$48
	Fabric Price Group 03	+\$97
	Fabric Price Group 04	+\$162
	Fabric Price Group 05	+\$267
	Fabric Price Group 06	+\$376
	Fabric Price Group 07	+\$513
	Fabric Price Group 08	+\$635
	Fabric Price Group 09	+\$741
	Fabric Price Group 10	+\$883

► Product Information continued on next page



# Away from the Desk

## Seating

### ► Product Information continued from previous page

Options		
Left Tablet Top Finish	Laminate HPL Price Group 01	No cost
	Laminate HPL Price Group 02	+\$76
	Laminate HPL Price Group 03	+\$154
	OLL Price Group 1	+\$102
Left Tablet Edge Finish	Plastic Group 1	No cost
Left Arm Power/Data Node	No Power/Data Required	No cost
	2 Duplex Outlets	+\$287
	Duplex Outlet with HDMI Video Port	+\$376
	Duplex Outlet with CAT6 Data	+\$382
Left Arm Power Finish	Duplex Outlet with USB Data Ports	+\$395
	Paint Price Group 01	No cost
Right End Configuration	Paint Price Group 02	No cost
	Connecting Unit	No cost
Right Arm Finish	Open	No cost
	AD-61 RA Uph RH Arm	+\$1226
	AD-62 RC Uph RH Arm with Tablet	+\$2623
	Fabric Price Group 01	No cost
Right Tablet Top Finish	Fabric Price Group 02	+\$48
	Fabric Price Group 03	+\$97
	Fabric Price Group 04	+\$162
	Fabric Price Group 05	+\$267
	Fabric Price Group 06	+\$376
	Fabric Price Group 07	+\$513
	Fabric Price Group 08	+\$635
	Fabric Price Group 09	+\$741
	Fabric Price Group 10	+\$883
	Right Tablet Edge Finish	Laminate HPL Price Group 01
Laminate HPL Price Group 02		+\$76
Laminate HPL Price Group 03		+\$154
OLL Price Group 1		+\$102
Right Tablet Edge Finish	Plastic Group 1	No cost
Right Arm Power/Data Node	No Power/Data Required	No cost
	2 Duplex Outlets	+\$287
	Duplex Outlet with HDMI Video Port	+\$376
	Duplex Outlet with CAT6 Data	+\$382
Right Arm Power Finish	Duplex Outlet with USB Data Ports	+\$395
	Paint Price Group 01	No cost
Right Arm Power Finish	Paint Price Group 02	No cost

### Specification Information

Style Number Base Price

#### 120° Modular Seat with Internal Back

**OBAD24** \$6515

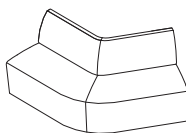

# Away from the Desk

## Seating

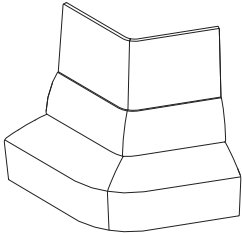

Tip: Customer's Own Material (COM) is available at a price group 1.

### Standard Includes

- Fully upholstered seat, back, and screen: fabric price group 01
- Adjustable glides: black
- Linking brackets

### Options

Seat Finish	Fabric Price Group 01	No cost
	Fabric Price Group 02	+\$77
	Fabric Price Group 03	+\$155
	Fabric Price Group 04	+\$262
	Fabric Price Group 05	+\$434
	Fabric Price Group 06	+\$606
	Fabric Price Group 07	+\$828
	Fabric Price Group 08	+\$1026
	Fabric Price Group 09	+\$1198
	Fabric Price Group 10	+\$1426
Backrest Outer Finish	Fabric Price Group 01	No cost
	Fabric Price Group 02	+\$58
	Fabric Price Group 03	+\$117
	Fabric Price Group 04	+\$197
	Fabric Price Group 05	+\$325
	Fabric Price Group 06	+\$456
	Fabric Price Group 07	+\$621
	Fabric Price Group 08	+\$770
	Fabric Price Group 09	+\$899
	Fabric Price Group 10	+\$1070
Backrest Inner Finish	Fabric Price Group 01	No cost
	Fabric Price Group 02	+\$36
	Fabric Price Group 03	+\$75
	Fabric Price Group 04	+\$124
	Fabric Price Group 05	+\$206
	Fabric Price Group 06	+\$288
	Fabric Price Group 07	+\$395
	Fabric Price Group 08	+\$487
	Fabric Price Group 09	+\$571
	Fabric Price Group 10	+\$679
Screen Connection	No Screen Connections	No cost
	Screen Connection-Left	No cost
	Screen Connection-Left & Right	No cost
	Screen Connection-Right	No cost
Left End Configuration	Connecting Unit	No cost
	Open	No cost
	AD-61 LA Uph LH Arm	+\$1226
	AD-62 LC Uph LH Arm with Tablet	+\$2623
Left Arm Finish	Fabric Price Group 01	No cost
	Fabric Price Group 02	+\$48
	Fabric Price Group 03	+\$97
	Fabric Price Group 04	+\$162
	Fabric Price Group 05	+\$267
	Fabric Price Group 06	+\$376
	Fabric Price Group 07	+\$513

► **Product Information continued on next page**

# Away from the Desk

## Seating

► **Product Information continued from previous page**

<b>Options</b>		
Left Arm Finish	Fabric Price Group 08	+\$635
	Fabric Price Group 09	+\$741
	Fabric Price Group 10	+\$883
Left Tablet Top Finish	Laminate HPL Price Group 01	No cost
	Laminate HPL Price Group 02	+\$76
	Laminate HPL Price Group 03	+\$154
	OLL Price Group 1	+\$102
Left Tablet Edge Finish	Plastic Group 1	No cost
Left Arm Power/Data Node	No Power/Data Required	No cost
	2 Duplex Outlets	+\$287
	Duplex Outlet with HDMI Video Port	+\$376
	Duplex Outlet with CAT6 Data	+\$382
	Duplex Outlet with USB Data Ports	+\$395
Left Arm Power Finish	Paint Price Group 01	No cost
	Paint Price Group 02	No cost
Right End Configuration	Connecting Unit	No cost
	Open	No cost
	AD-61 RA Uph RH Arm	+\$1226
	AD-62 RC Uph RH Arm with Tablet	+\$2623
Right Arm Finish	Fabric Price Group 01	No cost
	Fabric Price Group 02	+\$48
	Fabric Price Group 03	+\$97
	Fabric Price Group 04	+\$162
	Fabric Price Group 05	+\$267
	Fabric Price Group 06	+\$376
	Fabric Price Group 07	+\$513
	Fabric Price Group 08	+\$635
	Fabric Price Group 09	+\$741
	Fabric Price Group 10	+\$883
Right Tablet Top Finish	Laminate HPL Price Group 01	No cost
	Laminate HPL Price Group 02	+\$76
	Laminate HPL Price Group 03	+\$154
	OLL Price Group 1	+\$102
Right Tablet Edge Finish	Plastic Group 1	No cost
Right Arm Power/Data Node	No Power/Data Required	No cost
	2 Duplex Outlets	+\$287
	Duplex Outlet with HDMI Video Port	+\$376
	Duplex Outlet with CAT6 Data	+\$382
	Duplex Outlet with USB Data Ports	+\$395
Right Arm Power Finish	Paint Price Group 01	No cost
	Paint Price Group 02	No cost

► **Product Information continued on next page**

# Away from the Desk

## Seating

► Product Information continued from previous page

### Specification Information

Style Number	Base Price									
	Screen Grades:									
	1	2	3	4	5	6	7	8	9	10

### 120° Modular Seat with Internal Back and Screen

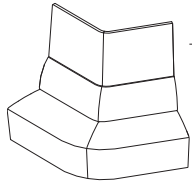

<b>OBAD25</b>	\$8047	\$8116	\$8185	\$8281	\$8434	\$8589	\$8786	\$8964	\$9117	\$9320
---------------	--------	--------	--------	--------	--------	--------	--------	--------	--------	--------

# Away from the Desk

## Seating

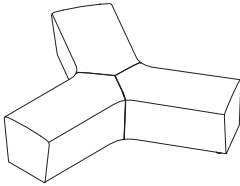

Tip: Customer's Own Material (COM) is available at a price group 1.

### Standard Includes

- Fully upholstered seat: fabric price group 01
- Adjustable glides: black
- Linking brackets

### Options

Seat Finish	Fabric Price Group 01	No cost
	Fabric Price Group 02	+\$109
	Fabric Price Group 03	+\$222
	Fabric Price Group 04	+\$375
	Fabric Price Group 05	+\$620
	Fabric Price Group 06	+\$868
	Fabric Price Group 07	+\$1184
	Fabric Price Group 08	+\$1465
	Fabric Price Group 09	+\$1712
	Fabric Price Group 10	+\$2039
Left End Configuration	Connecting Unit	No cost
	Open	No cost
Center End Configuration	Connecting Unit	No cost
	Open	No cost
Right End Configuration	Connecting Unit	No cost
	Open	No cost
Table	No Table	No cost
	AD-72 120 Corner Table	+\$3142
Table Top Finish	Laminate HPL Price Group 01	No cost
	Laminate HPL Price Group 02	+\$76
	Laminate HPL Price Group 03	+\$154
	OLL Price Group 1	+\$102
Table Edge Finish	Plastic Group 1	No cost
Table Base Finish	Fabric Price Group 01	No cost
	Fabric Price Group 02	+\$36
	Fabric Price Group 03	+\$75
	Fabric Price Group 04	+\$124
	Fabric Price Group 05	+\$206
	Fabric Price Group 06	+\$288
	Fabric Price Group 07	+\$395
	Fabric Price Group 08	+\$487
	Fabric Price Group 09	+\$571
	Fabric Price Group 10	+\$679
Base Power/Data Node	No Power/Data Required	No cost
	2 Duplex Outlets	+\$287
	Duplex Outlet with HDMI Video Port	+\$376
	Duplex Outlet with CAT6 Data	+\$382
	Duplex Outlet with USB Data Ports	+\$395
Base Power Finish	Paint Price Group 01	No cost
	Paint Price Group 02	No cost

► **Product Information continued on next page**

# Away from the Desk

## Seating

▶ **Product Information continued from previous page**

### Specification Information

Style Number    Base Price

---

#### **120° Modular Tri Seat**

---

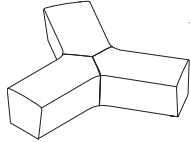

**OBAD31**      \$5142

# Away from the Desk

## Seating

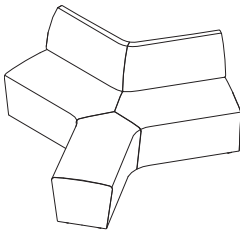

Tip: Customer's Own Material (COM) is available at a price group 1.

### Standard Includes

- Fully upholstered seat with back: fabric price group 01
- Adjustable glides: black
- Linking brackets

### Options

Seat Finish	Fabric Price Group 01	No cost
	Fabric Price Group 02	+\$109
	Fabric Price Group 03	+\$222
	Fabric Price Group 04	+\$375
	Fabric Price Group 05	+\$620
	Fabric Price Group 06	+\$868
	Fabric Price Group 07	+\$1184
	Fabric Price Group 08	+\$1465
	Fabric Price Group 09	+\$1712
	Fabric Price Group 10	+\$2039
Backrest Outer Finish	Fabric Price Group 01	No cost
	Fabric Price Group 02	+\$58
	Fabric Price Group 03	+\$117
	Fabric Price Group 04	+\$197
	Fabric Price Group 05	+\$325
	Fabric Price Group 06	+\$456
	Fabric Price Group 07	+\$621
	Fabric Price Group 08	+\$770
	Fabric Price Group 09	+\$899
	Fabric Price Group 10	+\$1070
Backrest Inner Finish	Fabric Price Group 01	No cost
	Fabric Price Group 02	+\$36
	Fabric Price Group 03	+\$75
	Fabric Price Group 04	+\$124
	Fabric Price Group 05	+\$206
	Fabric Price Group 06	+\$288
	Fabric Price Group 07	+\$395
	Fabric Price Group 08	+\$487
	Fabric Price Group 09	+\$571
	Fabric Price Group 10	+\$679
Left End Configuration	Connecting Unit	No cost
	Open	No cost
	AD-61 LA Uph LH Arm	+\$1226
	AD-62 LC Uph LH Arm with Tablet	+\$2623
Left Arm Finish	Fabric Price Group 01	No cost
	Fabric Price Group 02	+\$48
	Fabric Price Group 03	+\$97
	Fabric Price Group 04	+\$162
	Fabric Price Group 05	+\$267
	Fabric Price Group 06	+\$376
	Fabric Price Group 07	+\$513
	Fabric Price Group 08	+\$635
	Fabric Price Group 09	+\$741
	Fabric Price Group 10	+\$883

► Product Information continued on next page

# Away from the Desk

## Seating

### ► Product Information continued from previous page

Options		
Left Tablet Top Finish	Laminate HPL Price Group 01	No cost
	Laminate HPL Price Group 02	+\$76
	Laminate HPL Price Group 03	+\$154
	OLL Price Group 1	+\$102
Left Tablet Edge Finish	Plastic Group 1	No cost
Left Arm Power/Data Node	No Power/Data Required	No cost
	2 Duplex Outlets	+\$287
	Duplex Outlet with HDMI Video Port	+\$376
	Duplex Outlet with CAT6 Data	+\$382
	Duplex Outlet with USB Data Ports	+\$395
Left Arm Power Finish	Paint Price Group 01	No cost
	Paint Price Group 02	No cost
Center End Configuration	Connecting Unit	No cost
	Open	No cost
Right End Configuration	Connecting Unit	No cost
	Open	No cost
	AD-61 RA Uph RH Arm	+\$1226
	AD-62 RC Uph RH Arm with Tablet	+\$2623
Right Arm Finish	Fabric Price Group 01	No cost
	Fabric Price Group 02	+\$48
	Fabric Price Group 03	+\$97
	Fabric Price Group 04	+\$162
	Fabric Price Group 05	+\$267
	Fabric Price Group 06	+\$376
	Fabric Price Group 07	+\$513
	Fabric Price Group 08	+\$635
	Fabric Price Group 09	+\$741
	Fabric Price Group 10	+\$883
Right Tablet Top Finish	Laminate HPL Price Group 01	No cost
	Laminate HPL Price Group 02	+\$76
	Laminate HPL Price Group 03	+\$154
	OLL Price Group 1	+\$102
Right Tablet Edge Finish	Plastic Group 1	No cost
Right Arm Power/Data Node	No Power/Data Required	No cost
	2 Duplex Outlets	+\$287
	Duplex Outlet with HDMI Video Port	+\$376
	Duplex Outlet with CAT6 Data	+\$382
	Duplex Outlet with USB Data Ports	+\$395
Right Arm Power Finish	Paint Price Group 01	No cost
	Paint Price Group 02	No cost
Table	No Table	No cost
	AD-72 120 Corner Table	+\$3142
Table Location	Table - Left	No cost
	Table - Right	No cost
Table Top Finish	Laminate HPL Price Group 01	No cost
	Laminate HPL Price Group 02	+\$76
	Laminate HPL Price Group 03	+\$154

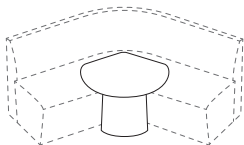

### ► Product Information continued on next page



# Away from the Desk

## Seating

► **Product Information continued from previous page**

<b>Options</b>		
Table Top Finish	OLL Price Group 1	+\$102
Table Edge Finish	Plastic Group 1	No cost
Table Base Finish	Fabric Price Group 01	No cost
	Fabric Price Group 02	+\$36
	Fabric Price Group 03	+\$75
	Fabric Price Group 04	+\$124
	Fabric Price Group 05	+\$206
	Fabric Price Group 06	+\$288
	Fabric Price Group 07	+\$395
	Fabric Price Group 08	+\$487
	Fabric Price Group 09	+\$571
	Fabric Price Group 10	+\$679
Base Power/Data Node	No Power/Data Required	No cost
	2 Duplex Outlets	+\$287
	Duplex Outlet with HDMI Video Port	+\$376
	Duplex Outlet with CAT6 Data	+\$382
	Duplex Outlet with USB Data Ports	+\$395
Base Power Finish	Paint Price Group 01	No cost
	Paint Price Group 02	No cost

### Specification Information

Style Number    Base Price

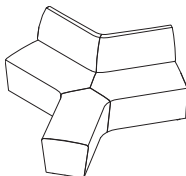

## **120° Modular Tri Seat with Internal Back**

**OBAD32**      \$8053

# Away from the Desk

## Seating

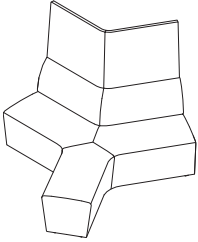

Tip: Customer's Own Material (COM) is available at a price group 1.

### Standard Includes

- Fully upholstered seat, back, and screen: fabric price group 01
- Adjustable glides: black
- Linking brackets

### Options

Seat Finish	Fabric Price Group 01	No cost
	Fabric Price Group 02	+\$109
	Fabric Price Group 03	+\$222
	Fabric Price Group 04	+\$375
	Fabric Price Group 05	+\$620
	Fabric Price Group 06	+\$868
	Fabric Price Group 07	+\$1184
	Fabric Price Group 08	+\$1465
	Fabric Price Group 09	+\$1712
	Fabric Price Group 10	+\$2039
Backrest Outer Finish	Fabric Price Group 01	No cost
	Fabric Price Group 02	+\$58
	Fabric Price Group 03	+\$117
	Fabric Price Group 04	+\$197
	Fabric Price Group 05	+\$325
	Fabric Price Group 06	+\$456
	Fabric Price Group 07	+\$621
	Fabric Price Group 08	+\$770
	Fabric Price Group 09	+\$899
	Fabric Price Group 10	+\$1070
Backrest Inner Finish	Fabric Price Group 01	No cost
	Fabric Price Group 02	+\$36
	Fabric Price Group 03	+\$75
	Fabric Price Group 04	+\$124
	Fabric Price Group 05	+\$206
	Fabric Price Group 06	+\$288
	Fabric Price Group 07	+\$395
	Fabric Price Group 08	+\$487
	Fabric Price Group 09	+\$571
	Fabric Price Group 10	+\$679
Screen Connection	No Screen Connections	No cost
	Screen Connection-Left	No cost
	Screen Connection-Left & Right	No cost
	Screen Connection-Right	No cost
Left End Configuration	Connecting Unit	No cost
	Open	No cost
	AD-61 LA Uph LH Arm	+\$1226
	AD-62 LC Uph LH Arm with Tablet	+\$2623
Left Arm Finish	Fabric Price Group 01	No cost
	Fabric Price Group 02	+\$48
	Fabric Price Group 03	+\$97
	Fabric Price Group 04	+\$162
	Fabric Price Group 05	+\$267
	Fabric Price Group 06	+\$376
	Fabric Price Group 07	+\$513

► **Product Information continued on next page**

# Away from the Desk

## Seating

### ► Product Information continued from previous page

Options		
Left Arm Finish	Fabric Price Group 08	+\$635
	Fabric Price Group 09	+\$741
	Fabric Price Group 10	+\$883
Left Tablet Top Finish	Laminate HPL Price Group 01	No cost
	Laminate HPL Price Group 02	+\$76
	Laminate HPL Price Group 03	+\$154
	OLL Price Group 1	+\$102
Left Tablet Edge Finish	Plastic Group 1	No cost
Left Arm Power/Data Node	No Power/Data Required	No cost
	2 Duplex Outlets	+\$287
	Duplex Outlet with HDMI Video Port	+\$376
	Duplex Outlet with CAT6 Data	+\$382
	Duplex Outlet with USB Data Ports	+\$395
Left Arm Power Finish	Paint Price Group 01	No cost
	Paint Price Group 02	No cost
Center End Configuration	Connecting Unit	No cost
	Open	No cost
Right End Configuration	Connecting Unit	No cost
	Open	No cost
	AD-61 RA Uph RH Arm	+\$1226
	AD-62 RC Uph RH Arm with Tablet	+\$2623
Right Arm Finish	Fabric Price Group 01	No cost
	Fabric Price Group 02	+\$48
	Fabric Price Group 03	+\$97
	Fabric Price Group 04	+\$162
	Fabric Price Group 05	+\$267
	Fabric Price Group 06	+\$376
	Fabric Price Group 07	+\$513
	Fabric Price Group 08	+\$635
	Fabric Price Group 09	+\$741
	Fabric Price Group 10	+\$883
Right Tablet Top Finish	Laminate HPL Price Group 01	No cost
	Laminate HPL Price Group 02	+\$76
	Laminate HPL Price Group 03	+\$154
	OLL Price Group 1	+\$102
Right Tablet Edge Finish	Plastic Group 1	No cost
Right Arm Power/Data Node	No Power/Data Required	No cost
	2 Duplex Outlets	+\$287
	Duplex Outlet with HDMI Video Port	+\$376
	Duplex Outlet with CAT6 Data	+\$382
	Duplex Outlet with USB Data Ports	+\$395
Right Arm Power Finish	Paint Price Group 01	No cost
	Paint Price Group 02	No cost
Table	No Table	No cost
	AD-72 120 Corner Table	+\$3142
Table Location	Table - Left	No cost
	Table - Right	No cost

### ► Product Information continued on next page

# Away from the Desk

## Seating

► **Product Information continued from previous page**

Options		
Table Top Finish	Laminate HPL Price Group 01	No cost
	Laminate HPL Price Group 02	+\$76
	Laminate HPL Price Group 03	+\$154
	OLL Price Group 1	+\$102
Table Edge Finish	Plastic Group 1	No cost
Table Base Finish	Fabric Price Group 01	No cost
	Fabric Price Group 02	+\$36
	Fabric Price Group 03	+\$75
	Fabric Price Group 04	+\$124
	Fabric Price Group 05	+\$206
	Fabric Price Group 06	+\$288
	Fabric Price Group 07	+\$395
	Fabric Price Group 08	+\$487
	Fabric Price Group 09	+\$571
	Fabric Price Group 10	+\$679
Base Power/Data Node	No Power/Data Required	No cost
	2 Duplex Outlets	+\$287
	Duplex Outlet with HDMI Video Port	+\$376
	Duplex Outlet with CAT6 Data	+\$382
Base Power Finish	Duplex Outlet with USB Data Ports	+\$395
	Paint Price Group 01	No cost
	Paint Price Group 02	No cost

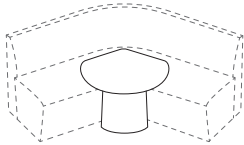

### Specification Information

Style Number	Base Price									
	Screen Grades:									
	1	2	3	4	5	6	7	8	9	10
<b>120° Modular Tri Seat with Internal Back and Screen</b>										
<b>OBAD33</b>	\$9589	\$9658	\$9727	\$9823	\$9976	\$10,131	\$10,328	\$10,506	\$10,659	\$10,862

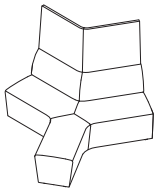

# Away from the Desk

## Seating

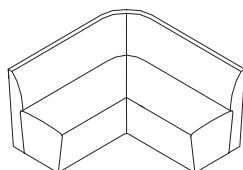

Tip: Customer's Own Material (COM) is available at a price group 1.

### Standard Includes

- Fully upholstered seat with back: fabric price group 01
- Adjustable glides: black
- Linking brackets

### Options

Seat Finish	Fabric Price Group 01	No cost
	Fabric Price Group 02	+\$80
	Fabric Price Group 03	+\$161
	Fabric Price Group 04	+\$273
	Fabric Price Group 05	+\$449
	Fabric Price Group 06	+\$627
	Fabric Price Group 07	+\$858
	Fabric Price Group 08	+\$1061
	Fabric Price Group 09	+\$1242
	Fabric Price Group 10	+\$1478
Backrest Outer Finish	Fabric Price Group 01	No cost
	Fabric Price Group 02	+\$88
	Fabric Price Group 03	+\$183
	Fabric Price Group 04	+\$307
	Fabric Price Group 05	+\$512
	Fabric Price Group 06	+\$716
	Fabric Price Group 07	+\$977
	Fabric Price Group 08	+\$1209
	Fabric Price Group 09	+\$1413
	Fabric Price Group 10	+\$1681
Backrest Inner Finish	Fabric Price Group 01	No cost
	Fabric Price Group 02	+\$45
	Fabric Price Group 03	+\$87
	Fabric Price Group 04	+\$150
	Fabric Price Group 05	+\$249
	Fabric Price Group 06	+\$346
	Fabric Price Group 07	+\$474
	Fabric Price Group 08	+\$586
	Fabric Price Group 09	+\$685
	Fabric Price Group 10	+\$816
Left End Configuration	Connecting Unit	No cost
	Open	No cost
	AD-61 LA Uph LH Arm	+\$1226
	AD-62 LC Uph LH Arm with Tablet	+\$2623
Left Arm Finish	Fabric Price Group 01	No cost
	Fabric Price Group 02	+\$48
	Fabric Price Group 03	+\$97
	Fabric Price Group 04	+\$162
	Fabric Price Group 05	+\$267
	Fabric Price Group 06	+\$376
	Fabric Price Group 07	+\$513
	Fabric Price Group 08	+\$635
	Fabric Price Group 09	+\$741
	Fabric Price Group 10	+\$883

Tip: Tablet is selectable on one end only.

► Product Information continued on next page

# Away from the Desk

## Seating

► **Product Information continued from previous page**

<b>Options</b>		
Left Tablet Top Finish	Laminate HPL Price Group 01	No cost
	Laminate HPL Price Group 02	+\$76
	Laminate HPL Price Group 03	+\$154
	OLL Price Group 1	+\$102
Left Tablet Edge Finish	Plastic Group 1	No cost
Left Arm Power/Data Node	No Power/Data Required	No cost
	2 Duplex Outlets	+\$287
	Duplex Outlet with HDMI Video Port	+\$376
	Duplex Outlet with CAT6 Data	+\$382
	Duplex Outlet with USB Data Ports	+\$395
Left Arm Power Finish	Paint Price Group 01	No cost
	Paint Price Group 02	No cost
Right End Configuration	Connecting Unit	No cost
	Open	No cost
	AD-61 RA Uph RH Arm	+\$1226
	AD-62 RC Uph RH Arm with Tablet	+\$2623
Right Arm Finish	Fabric Price Group 01	No cost
	Fabric Price Group 02	+\$48
	Fabric Price Group 03	+\$97
	Fabric Price Group 04	+\$162
	Fabric Price Group 05	+\$267
	Fabric Price Group 06	+\$376
	Fabric Price Group 07	+\$513
	Fabric Price Group 08	+\$635
	Fabric Price Group 09	+\$741
	Fabric Price Group 10	+\$883
Right Tablet Top Finish	Laminate HPL Price Group 01	No cost
	Laminate HPL Price Group 02	+\$76
	Laminate HPL Price Group 03	+\$154
	OLL Price Group 1	+\$102
Right Tablet Edge Finish	Plastic Group 1	No cost
Right Arm Power/Data Node	No Power/Data Required	No cost
	2 Duplex Outlets	+\$287
	Duplex Outlet with HDMI Video Port	+\$376
	Duplex Outlet with CAT6 Data	+\$382
	Duplex Outlet with USB Data Ports	+\$395
Right Arm Power Finish	Paint Price Group 01	No cost
	Paint Price Group 02	No cost
Table	No Table	No cost
	AD-71 90 Corner Table	+\$2703
Table Top Finish	Laminate HPL Price Group 01	No cost
	Laminate HPL Price Group 02	No cost
	Laminate HPL Price Group 02	+\$76
	Laminate HPL Price Group 03	+\$154
	OLL Price Group 1	+\$102
Table Edge Finish	Plastic Group 1	No cost

► **Product Information continued on next page**

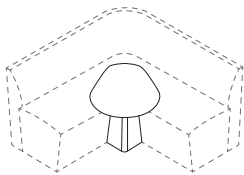

# Away from the Desk

## Seating

► **Product Information continued from previous page**

Options		
Table Base Finish	Fabric Price Group 01	No cost
	Fabric Price Group 02	+\$36
	Fabric Price Group 03	+\$75
	Fabric Price Group 04	+\$124
	Fabric Price Group 05	+\$206
	Fabric Price Group 06	+\$288
	Fabric Price Group 07	+\$395
	Fabric Price Group 08	+\$487
	Fabric Price Group 09	+\$571
	Fabric Price Group 10	+\$679
Base Power/Data Node	No Power/Data Required	No cost
	2 Duplex Outlets	+\$287
	Duplex Outlet with HDMI Video Port	+\$376
	Duplex Outlet with CAT6 Data	+\$382
Base Power Finish	Duplex Outlet with USB Data Ports	+\$395
	Paint Price Group 01	No cost
	Paint Price Group 02	No cost

### Specification Information

Style Number    Base Price

#### 90° Modular Seat with Back

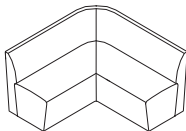

**OBAD42**    \$7763

# Away from the Desk

## Seating

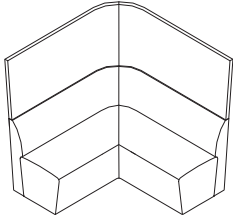

Tip: Customer's Own Material (COM) is available at a price group 1.

### Standard Includes

- Fully upholstered seat, back, and screen: fabric price group 01
- Adjustable glides: black
- Linking brackets

### Options

Seat Finish	Fabric Price Group 01	No cost
	Fabric Price Group 02	+\$80
	Fabric Price Group 03	+\$161
	Fabric Price Group 04	+\$273
	Fabric Price Group 05	+\$449
	Fabric Price Group 06	+\$627
	Fabric Price Group 07	+\$858
	Fabric Price Group 08	+\$1061
	Fabric Price Group 09	+\$1242
	Fabric Price Group 10	+\$1478
Backrest Outer Finish	Fabric Price Group 01	No cost
	Fabric Price Group 02	+\$88
	Fabric Price Group 03	+\$183
	Fabric Price Group 04	+\$307
	Fabric Price Group 05	+\$512
	Fabric Price Group 06	+\$716
	Fabric Price Group 07	+\$977
	Fabric Price Group 08	+\$1209
	Fabric Price Group 09	+\$1413
	Fabric Price Group 10	+\$1681
Backrest Inner Finish	Fabric Price Group 01	No cost
	Fabric Price Group 02	+\$45
	Fabric Price Group 03	+\$87
	Fabric Price Group 04	+\$150
	Fabric Price Group 05	+\$249
	Fabric Price Group 06	+\$346
	Fabric Price Group 07	+\$474
	Fabric Price Group 08	+\$586
	Fabric Price Group 09	+\$685
	Fabric Price Group 10	+\$816
Screen Connection	No Screen Connections	No cost
	Screen Connection-Left	No cost
	Screen Connection-Left & Right	No cost
	Screen Connection-Right	No cost
Left End Configuration	Connecting Unit	No cost
	Open	No cost
	AD-61 LA Uph LH Arm	+\$1226
	AD-62 LC Uph LH Arm with Tablet	+\$2623
Left Arm Finish	Fabric Price Group 01	No cost
	Fabric Price Group 02	+\$48
	Fabric Price Group 03	+\$97
	Fabric Price Group 04	+\$162
	Fabric Price Group 05	+\$267
	Fabric Price Group 06	+\$376
	Fabric Price Group 07	+\$513

Tip: Tablet is selectable on one end only.

► **Product Information continued on next page**



# Away from the Desk

## Seating

### ► Product Information continued from previous page

Options		
Left Arm Finish	Fabric Price Group 08	+\$635
	Fabric Price Group 09	+\$741
	Fabric Price Group 10	+\$883
Left Tablet Top Finish	Laminate HPL Price Group 01	No cost
	Laminate HPL Price Group 02	+\$76
	Laminate HPL Price Group 03	+\$154
	OLL Price Group 1	+\$102
Left Tablet Edge Finish	Plastic Group 1	No cost
Left Arm Power/Data Node	No Power/Data Required	No cost
	2 Duplex Outlets	+\$287
	Duplex Outlet with HDMI Video Port	+\$376
	Duplex Outlet with CAT6 Data	+\$382
	Duplex Outlet with USB Data Ports	+\$395
Left Arm Power Finish	Paint Price Group 01	No cost
	Paint Price Group 02	No cost
Right End Configuration	Connecting Unit	No cost
	Open	No cost
	AD-61 RA Uph RH Arm	+\$1226
	AD-62 RC Uph RH Arm with Tablet	+\$2623
Right Arm Finish	Fabric Price Group 01	No cost
	Fabric Price Group 02	+\$48
	Fabric Price Group 03	+\$97
	Fabric Price Group 04	+\$162
	Fabric Price Group 05	+\$267
	Fabric Price Group 06	+\$376
	Fabric Price Group 07	+\$513
	Fabric Price Group 08	+\$635
	Fabric Price Group 09	+\$741
	Fabric Price Group 10	+\$883
Right Tablet Top Finish	Laminate HPL Price Group 01	No cost
	Laminate HPL Price Group 02	+\$76
	Laminate HPL Price Group 03	+\$154
	OLL Price Group 1	+\$102
Right Tablet Edge Finish	Plastic Group 1	No cost
Right Arm Power/Data Node	No Power/Data Required	No cost
	2 Duplex Outlets	+\$287
	Duplex Outlet with HDMI Video Port	+\$376
	Duplex Outlet with CAT6 Data	+\$382
	Duplex Outlet with USB Data Ports	+\$395
Right Arm Power Finish	Paint Price Group 01	No cost
	Paint Price Group 02	No cost
Table	No Table	No cost
	AD-71 90 Corner Table	+\$2703
Table Top Finish	Laminate HPL Price Group 01	No cost
	Laminate HPL Price Group 02	+\$76
	Laminate HPL Price Group 03	+\$154
	OLL Price Group 1	+\$102

### ► Product Information continued on next page

# Away from the Desk

## Seating

► **Product Information continued from previous page**

Options		
Table Edge Finish	Plastic Group 1	No cost
Table Base Finish	Fabric Price Group 01	No cost
	Fabric Price Group 02	+\$36
	Fabric Price Group 03	+\$75
	Fabric Price Group 04	+\$124
	Fabric Price Group 05	+\$206
	Fabric Price Group 06	+\$288
	Fabric Price Group 07	+\$395
	Fabric Price Group 08	+\$487
	Fabric Price Group 09	+\$571
	Fabric Price Group 10	+\$679
Base Power/Data Node	No Power/Data Required	No cost
	2 Duplex Outlets	+\$287
	Duplex Outlet with HDMI Video Port	+\$376
	Duplex Outlet with CAT6 Data	+\$382
Base Power Finish	Paint Price Group 01	No cost
	Paint Price Group 02	No cost

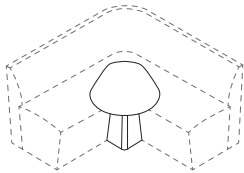

### Specification Information

Style Number	Base Price									
	Screen Grades:									
	1	2	3	4	5	6	7	8	9	10
<b>90° Modular Seat with Back and Screen</b>										
<b>OBAD43</b>	\$9433	\$9553	\$9678	\$9845	\$10,115	\$10,387	\$10,736	\$11,046	\$11,317	\$11,675

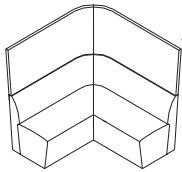

# Away from the Desk

## Seating

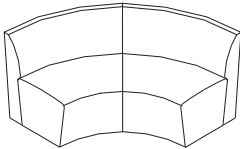

Tip: Customer's Own Material (COM) is available at a price group 1.

### Standard Includes

- Fully upholstered seat with back: fabric price group 01
- Adjustable glides: black
- Linking brackets

### Options

Seat Finish	Fabric Price Group 01	No cost
	Fabric Price Group 02	+\$69
	Fabric Price Group 03	+\$138
	Fabric Price Group 04	+\$234
	Fabric Price Group 05	+\$387
	Fabric Price Group 06	+\$542
	Fabric Price Group 07	+\$739
	Fabric Price Group 08	+\$917
	Fabric Price Group 09	+\$1070
	Fabric Price Group 10	+\$1273
Backrest Outer Finish	Fabric Price Group 01	No cost
	Fabric Price Group 02	+\$69
	Fabric Price Group 03	+\$138
	Fabric Price Group 04	+\$234
	Fabric Price Group 05	+\$387
	Fabric Price Group 06	+\$542
	Fabric Price Group 07	+\$739
	Fabric Price Group 08	+\$917
	Fabric Price Group 09	+\$1070
	Fabric Price Group 10	+\$1273
Backrest Inner Finish	Fabric Price Group 01	No cost
	Fabric Price Group 02	+\$52
	Fabric Price Group 03	+\$104
	Fabric Price Group 04	+\$174
	Fabric Price Group 05	+\$289
	Fabric Price Group 06	+\$404
	Fabric Price Group 07	+\$552
	Fabric Price Group 08	+\$683
	Fabric Price Group 09	+\$799
	Fabric Price Group 10	+\$950
Left End Configuration	Connecting Unit	No cost
	Open	No cost
	AD-61 LA Uph LH Arm	+\$1226
	AD-62 LC Uph LH Arm with Tablet	+\$2623
Left Arm Finish	Fabric Price Group 01	No cost
	Fabric Price Group 02	+\$48
	Fabric Price Group 03	+\$97
	Fabric Price Group 04	+\$162
	Fabric Price Group 05	+\$267
	Fabric Price Group 06	+\$376
	Fabric Price Group 07	+\$513
	Fabric Price Group 08	+\$635
	Fabric Price Group 09	+\$741
	Fabric Price Group 10	+\$883

Tip: Tablet is selectable on one end only.

► Product Information continued on next page

# Away from the Desk

## Seating

► **Product Information continued from previous page**

<b>Options</b>		
Left Tablet Top Finish	Laminate HPL Price Group 01	No cost
	Laminate HPL Price Group 02	+\$76
	Laminate HPL Price Group 03	+\$154
	OLL Price Group 1	+\$102
Left Tablet Edge Finish	Plastic Group 1	No cost
Left Arm Power/Data Node	No Power/Data Required	No cost
	2 Duplex Outlets	+\$287
	Duplex Outlet with HDMI Video Port	+\$376
	Duplex Outlet with CAT6 Data	+\$382
	Duplex Outlet with USB Data Ports	+\$395
Left Arm Power Finish	Paint Price Group 01	No cost
	Paint Price Group 02	No cost
Right End Configuration	Connecting Unit	No cost
	Open	No cost
	AD-61 RA Uph RH Arm	+\$1226
	AD-62 RC Uph RH Arm with Tablet	+\$2623
Right Arm Finish	Fabric Price Group 01	No cost
	Fabric Price Group 02	+\$48
	Fabric Price Group 03	+\$97
	Fabric Price Group 04	+\$162
	Fabric Price Group 05	+\$267
	Fabric Price Group 06	+\$376
	Fabric Price Group 07	+\$513
	Fabric Price Group 08	+\$635
	Fabric Price Group 09	+\$741
	Fabric Price Group 10	+\$883
Right Tablet Top Finish	Laminate HPL Price Group 01	No cost
	Laminate HPL Price Group 02	+\$76
	Laminate HPL Price Group 03	+\$154
	OLL Price Group 1	+\$102
Right Tablet Edge Finish	Plastic Group 1	No cost
Right Arm Power/Data Node	No Power/Data Required	No cost
	2 Duplex Outlets	+\$287
	Duplex Outlet with HDMI Video Port	+\$376
	Duplex Outlet with CAT6 Data	+\$382
	Duplex Outlet with USB Data Ports	+\$395
Right Arm Power Finish	Paint Price Group 01	No cost
	Paint Price Group 02	No cost

### Specification Information

Style Number    Base Price

## 90° Modular Curved Seat with Back

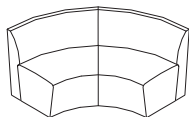

**OBAD52**    \$7044

# Away from the Desk

## Seating

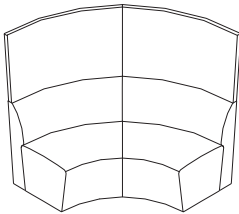

Tip: Customer's Own Material (COM) is available at a price group 1.

### Standard Includes

- Fully upholstered seat, back, and screen: fabric price group 01
- Adjustable glides: black
- Linking brackets

### Options

Seat Finish	Fabric Price Group 01	No cost
	Fabric Price Group 02	+\$69
	Fabric Price Group 03	+\$138
	Fabric Price Group 04	+\$234
	Fabric Price Group 05	+\$387
	Fabric Price Group 06	+\$542
	Fabric Price Group 07	+\$739
	Fabric Price Group 08	+\$917
	Fabric Price Group 09	+\$1070
	Fabric Price Group 10	+\$1273
Backrest Outer Finish	Fabric Price Group 01	No cost
	Fabric Price Group 02	+\$69
	Fabric Price Group 03	+\$138
	Fabric Price Group 04	+\$234
	Fabric Price Group 05	+\$387
	Fabric Price Group 06	+\$542
	Fabric Price Group 07	+\$739
	Fabric Price Group 08	+\$917
	Fabric Price Group 09	+\$1070
	Fabric Price Group 10	+\$1273
Backrest Inner Finish	Fabric Price Group 01	No cost
	Fabric Price Group 02	+\$52
	Fabric Price Group 03	+\$104
	Fabric Price Group 04	+\$174
	Fabric Price Group 05	+\$289
	Fabric Price Group 06	+\$404
	Fabric Price Group 07	+\$552
	Fabric Price Group 08	+\$683
	Fabric Price Group 09	+\$799
	Fabric Price Group 10	+\$950
Screen Connection	No Screen Connections	No cost
	Screen Connection-Left	No cost
	Screen Connection-Left & Right	No cost
	Screen Connection-Right	No cost
Left End Configuration	Connecting Unit	No cost
	Open	No cost
	AD-61 LA Uph LH Arm	+\$1226
	AD-62 LC Uph LH Arm with Tablet	+\$2623
Left Arm Finish	Fabric Price Group 01	No cost
	Fabric Price Group 02	+\$48
	Fabric Price Group 03	+\$97
	Fabric Price Group 04	+\$162
	Fabric Price Group 05	+\$267
	Fabric Price Group 06	+\$376
	Fabric Price Group 07	+\$513

Tip: Tablet is selectable on one end only.

► **Product Information continued on next page**

# Away from the Desk

## Seating

### ► Product Information continued from previous page

Options		
Left Arm Finish	Fabric Price Group 08	+\$635
	Fabric Price Group 09	+\$741
	Fabric Price Group 10	+\$883
Left Tablet Top Finish	Laminate HPL Price Group 01	No cost
	Laminate HPL Price Group 02	+\$76
	Laminate HPL Price Group 03	+\$154
	OLL Price Group 1	+\$102
Left Tablet Edge Finish	Plastic Group 1	No cost
Left Arm Power/Data Node	No Power/Data Required	No cost
	2 Duplex Outlets	+\$287
	Duplex Outlet with HDMI Video Port	+\$376
	Duplex Outlet with CAT6 Data	+\$382
	Duplex Outlet with USB Data Ports	+\$395
Left Arm Power Finish	Paint Price Group 01	No cost
	Paint Price Group 02	No cost
Right End Configuration	Connecting Unit	No cost
	Open	No cost
	AD-61 RA Uph RH Arm	+\$1226
	AD-62 RC Uph RH Arm with Tablet	+\$2623
Right Arm Finish	Fabric Price Group 01	No cost
	Fabric Price Group 02	+\$48
	Fabric Price Group 03	+\$97
	Fabric Price Group 04	+\$162
	Fabric Price Group 05	+\$267
	Fabric Price Group 06	+\$376
	Fabric Price Group 07	+\$513
	Fabric Price Group 08	+\$635
	Fabric Price Group 09	+\$741
	Fabric Price Group 10	+\$883
Right Tablet Top Finish	Laminate HPL Price Group 01	No cost
	Laminate HPL Price Group 02	+\$76
	Laminate HPL Price Group 03	+\$154
	OLL Price Group 1	+\$102
Right Tablet Edge Finish	Plastic Group 1	No cost
Right Arm Power/Data Node	No Power/Data Required	No cost
	2 Duplex Outlets	+\$287
	Duplex Outlet with HDMI Video Port	+\$376
	Duplex Outlet with CAT6 Data	+\$382
	Duplex Outlet with USB Data Ports	+\$395
Right Arm Power Finish	Paint Price Group 01	No cost
	Paint Price Group 02	No cost

### ► Product Information continued on next page

# Away from the Desk

## Seating

► Product Information continued from previous page

### Specification Information

Style Number	Base Price									
	Screen Grades:									
	1	2	3	4	5	6	7	8	9	10

### 90° Modular Curved Seat with Back and Screen

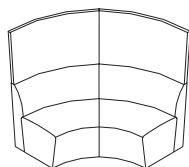

<b>OBAD53</b>	\$8974	\$9062	\$9157	\$9281	\$9486	\$9690	\$9951	\$10,183	\$10,387	\$10,655
---------------	--------	--------	--------	--------	--------	--------	--------	----------	----------	----------

# Away from the Desk

## Tables

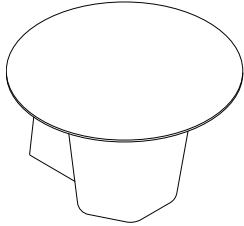

Tip: Customer's Own Material (COM) is available at a price group 1.

### Standard Includes

- 1" thick tabletop with tapered edge: High-Pressure Laminate price group 01
- 3 mm edgeband: plastic price group 01
- Fully upholstered base: fabric price group 01
- Linking brackets

### Options

Table Top Finish	Laminate HPL Price Group 01	No cost
	Laminate HPL Price Group 02	+\$80
	Laminate HPL Price Group 03	+\$164
	OLL Price Group 1	+\$102
Table Edge Finish	Plastic Group 1	No cost
Table Base Finish	Fabric Price Group 01	No cost
	Fabric Price Group 02	+\$75
	Fabric Price Group 03	+\$150
	Fabric Price Group 04	+\$253
	Fabric Price Group 05	+\$420
	Fabric Price Group 06	+\$585
	Fabric Price Group 07	+\$799
	Fabric Price Group 08	+\$989
	Fabric Price Group 09	+\$1156
	Fabric Price Group 10	+\$1378
Top Power / Data Node	No Power/Data Required	No cost
	2 Duplex Outlets	+\$287
	Duplex Outlet with HDMI Video Port	+\$376
	Duplex Outlet with CAT6 Data	+\$382
Top Power Finish	Paint Price Group 01	No cost
	Paint Price Group 02	No cost
Base Power/Data Node	No Power/Data Required	No cost
	2 Duplex Outlets	+\$287
	Duplex Outlet with HDMI Video Port	+\$376
	Duplex Outlet with CAT6 Data	+\$382
Base Power Finish	Paint Price Group 01	No cost
	Paint Price Group 02	No cost

### Specification Information

Style Number      Base Price

#### Modular Small Round Top with Large Upholstered Tapered Base

**OBAD64SRO**      \$4796



# Away from the Desk

## Tables

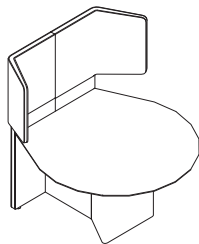

Tip: Customer's Own Material (COM) is available at a price group 1.

### Standard Includes

- Upholstered media unit: fabric price group 01
- 1" thick table top: High-Pressure Laminate price group 01
- 3 mm edgeband: plastic price group 01
- Fixed monitor bracket
- Adjustable glides: black

### Options

Table Top Finish	Laminate HPL Price Group 01	No cost
	Laminate HPL Price Group 02	+\$86
	Laminate HPL Price Group 03	+\$181
	OLL Price Group 1	+\$102
Table Edge Finish	Plastic Group 1	No cost
Table Base Finish	Fabric Price Group 01	No cost
	Fabric Price Group 02	+\$69
	Fabric Price Group 03	+\$138
	Fabric Price Group 04	+\$234
	Fabric Price Group 05	+\$387
	Fabric Price Group 06	+\$542
	Fabric Price Group 07	+\$739
	Fabric Price Group 08	+\$917
	Fabric Price Group 09	+\$1070
	Fabric Price Group 10	+\$1273
Screen Finish	Fabric Price Group 01	No cost
	Fabric Price Group 02	+\$109
	Fabric Price Group 03	+\$222
	Fabric Price Group 04	+\$375
	Fabric Price Group 05	+\$620
	Fabric Price Group 06	+\$868
	Fabric Price Group 07	+\$1184
	Fabric Price Group 08	+\$1465
	Fabric Price Group 09	+\$1712
	Fabric Price Group 10	+\$2039
Top Power / Data Node	No Power/Data Required	No cost
	2 Duplex Outlets	+\$287
	Duplex Outlet with HDMI Video Port	+\$376
	Duplex Outlet with CAT6 Data	+\$382
Top Power Finish	Duplex Outlet with USB Data Ports	+\$395
	Paint Price Group 01	No cost
	Paint Price Group 02	No cost

### Specification Information

Style Number    Base Price

#### Media Unit with Low, D Shaped Top

**OBAD81DS**    \$5681



# Away from the Desk

## Tables

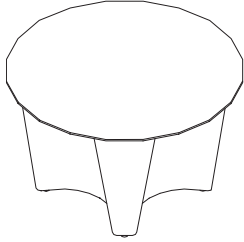

Tip: Customer's Own Material (COM) is available at a price group 1.

### Standard Includes

- 1" thick tabletop with tapered edge: High-Pressure Laminate price group 01
- 3 mm edgeband: plastic price group 01
- Fully upholstered base: fabric price group 01
- Adjustable glides: black

### Options

Table Top Finish	Laminate HPL Price Group 01	No cost
	Laminate HPL Price Group 02	+\$86
	Laminate HPL Price Group 03	+\$181
	OLL Price Group 1	+\$102
Table Edge Finish	Plastic Group 1	No cost
Table Base Finish	Fabric Price Group 01	No cost
	Fabric Price Group 02	+\$112
	Fabric Price Group 03	+\$227
	Fabric Price Group 04	+\$384
	Fabric Price Group 05	+\$637
	Fabric Price Group 06	+\$888
	Fabric Price Group 07	+\$1214
	Fabric Price Group 08	+\$1502
	Fabric Price Group 09	+\$1755
	Fabric Price Group 10	+\$2088
Top Power / Data Node	No Power/Data Required	No cost
	2 Duplex Outlets	+\$287
	Duplex Outlet with HDMI Video Port	+\$376
	Duplex Outlet with CAT6 Data	+\$382
Top Power Finish	Duplex Outlet with USB Data Ports	+\$395
	Paint Price Group 01	No cost
	Paint Price Group 02	No cost

### Specification Information

Style Number      Base Price

## 47 1/4" Dia Huddle Buddle Group Working Table

**OBAD91SRO**      \$4411

# Away from the Desk

## Tables

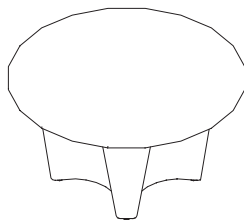

Tip: Customer's Own Material (COM) is available at a price group 1.

### Standard Includes

- 1" thick tabletop with tapered edge: High-Pressure Laminate price group 01
- 3 mm edgeband: plastic price group 01
- Fully upholstered base: fabric price group 01
- Adjustable glides: black

### Options

Table Top Finish	Laminate HPL Price Group 01	No cost
	Laminate HPL Price Group 02	+\$96
	Laminate HPL Price Group 03	+\$198
	OLL Price Group 1	+\$102
Table Edge Finish	Plastic Group 1	No cost
Table Base Finish	Fabric Price Group 01	No cost
	Fabric Price Group 02	+\$112
	Fabric Price Group 03	+\$227
	Fabric Price Group 04	+\$384
	Fabric Price Group 05	+\$637
	Fabric Price Group 06	+\$888
	Fabric Price Group 07	+\$1214
	Fabric Price Group 08	+\$1502
	Fabric Price Group 09	+\$1755
	Fabric Price Group 10	+\$2088
Top Power / Data Node	No Power/Data Required	No cost
	2 Duplex Outlets	+\$287
	Duplex Outlet with HDMI Video Port	+\$376
	Duplex Outlet with CAT6 Data	+\$382
Top Power Finish	Duplex Outlet with USB Data Ports	+\$395
	Paint Price Group 01	No cost
	Paint Price Group 02	No cost

### Specification Information

Style Number      Base Price

## 55 1/8" Dia Huddle Buddle Group Working Table

**OBAD91LRO**      \$4594

Away from the Desk

# Away from the Desk

## Tables

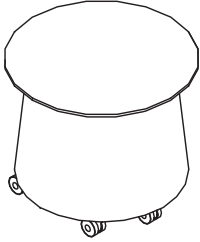

Tip: Customer's Own Material (COM) is available at a price group 1.

### Standard Includes

- 1" thick tabletop with tapered edge: High-Pressure Laminate price group 01
- 3 mm edgeband: plastic price group 01
- Fully upholstered base: fabric price group 01
- Locking, hard casters: black

### Options

Table Top Finish	Laminate HPL Price Group 01	No cost
	Laminate HPL Price Group 02	+\$73
	Laminate HPL Price Group 03	+\$145
	OLL Price Group 1	+\$102
Table Edge Finish	Plastic Group 1	No cost
Table Base Finish	Fabric Price Group 01	No cost
	Fabric Price Group 02	+\$36
	Fabric Price Group 03	+\$75
	Fabric Price Group 04	+\$124
	Fabric Price Group 05	+\$206
	Fabric Price Group 06	+\$288
	Fabric Price Group 07	+\$395
	Fabric Price Group 08	+\$487
	Fabric Price Group 09	+\$571
	Fabric Price Group 10	+\$679

### Specification Information

Style Number    Base Price

#### 23 5/8" Dia Low Table

**OBAD92**      \$2333

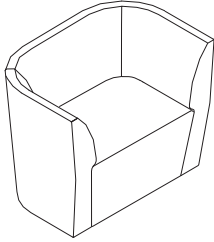
**Away from the Desk****Detached Seating**

Tip: Customer's Own Material (COM) is available at a price group 1.

**Standard Includes**

- Fully upholstered seating unit: fabric price group 01
- 1" thick integrated tablet with tapered edge, if selected:
  - High-Pressure Laminate price group 01
  - 3 mm edgeband: plastic price group 1
- Adjustable glides: black

**Options**

Seat Finish	Fabric Price Group 01	No cost
	Fabric Price Group 02	+\$45
	Fabric Price Group 03	+\$87
	Fabric Price Group 04	+\$150
	Fabric Price Group 05	+\$249
	Fabric Price Group 06	+\$346
	Fabric Price Group 07	+\$474
	Fabric Price Group 08	+\$586
	Fabric Price Group 09	+\$685
	Fabric Price Group 10	+\$816
Backrest Outer Finish	Fabric Price Group 01	No cost
	Fabric Price Group 02	+\$73
	Fabric Price Group 03	+\$144
	Fabric Price Group 04	+\$243
	Fabric Price Group 05	+\$403
	Fabric Price Group 06	+\$564
	Fabric Price Group 07	+\$770
	Fabric Price Group 08	+\$953
	Fabric Price Group 09	+\$1113
	Fabric Price Group 10	+\$1324
Backrest Inner Finish	Fabric Price Group 01	No cost
	Fabric Price Group 02	+\$52
	Fabric Price Group 03	+\$104
	Fabric Price Group 04	+\$174
	Fabric Price Group 05	+\$289
	Fabric Price Group 06	+\$404
	Fabric Price Group 07	+\$552
	Fabric Price Group 08	+\$683
	Fabric Price Group 09	+\$799
	Fabric Price Group 10	+\$950
Arm Finish	Fabric Price Group 01	No cost
	Fabric Price Group 02	+\$36
	Fabric Price Group 03	+\$75
	Fabric Price Group 04	+\$124
	Fabric Price Group 05	+\$206
	Fabric Price Group 06	+\$288
	Fabric Price Group 07	+\$395
	Fabric Price Group 08	+\$487
	Fabric Price Group 09	+\$571
	Fabric Price Group 10	+\$679
Tablet Top Finish	Laminate HPL Price Group 01	No cost
	Laminate HPL Price Group 02	+\$65
	Laminate HPL Price Group 03	+\$137

► **Product Information continued on next page**

# Away from the Desk

## Detached Seating

► **Product Information continued from previous page**

Options		
Tablet Top Finish	OLL Price Group 1	+\$102
Tablet Edge Finish	Plastic Group 1	No cost
Arm Power / Data Node	No Power/Data Required	No cost
	2 Duplex Outlets	+\$287
	Duplex Outlet with HDMI Video Port	+\$376
	Duplex Outlet with CAT6 Data	+\$382
Power Finish	Duplex Outlet with USB Data Ports	+\$395
	Paint Price Group 01	No cost
	Paint Price Group 02	No cost

### Specification Information

Style Number      Base Price

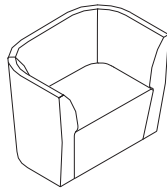

#### Single Seat Detached Unit

**OBAD101**      \$4119

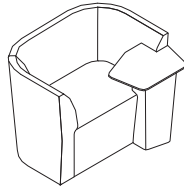

#### Single Seat Detached Unit with Left Hand Integrated Tablet

**OBAD101LT**      \$6381

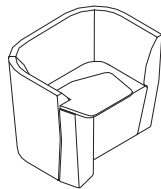

#### Single Seat Detached Unit with Right Hand Integrated Tablet

**OBAD101RT**      \$6381

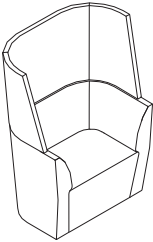
**Away from the Desk****Detached Seating**

Tip: Customer's Own Material (COM) is available at a price group 1.

**Standard Includes**

- Fully upholstered seating unit with screen: fabric price group 01
- 1" thick integrated tablet with tapered edge, if selected:
  - High-Pressure Laminate price group 01
  - 3 mm edgeband: plastic price group 1
- Adjustable glides: black

**Options**

Seat Finish	Fabric Price Group 01	No cost
	Fabric Price Group 02	+\$45
	Fabric Price Group 03	+\$87
	Fabric Price Group 04	+\$150
	Fabric Price Group 05	+\$249
	Fabric Price Group 06	+\$346
	Fabric Price Group 07	+\$474
	Fabric Price Group 08	+\$586
	Fabric Price Group 09	+\$685
	Fabric Price Group 10	+\$816
Backrest Outer Finish	Fabric Price Group 01	No cost
	Fabric Price Group 02	+\$73
	Fabric Price Group 03	+\$144
	Fabric Price Group 04	+\$243
	Fabric Price Group 05	+\$403
	Fabric Price Group 06	+\$564
	Fabric Price Group 07	+\$770
	Fabric Price Group 08	+\$953
	Fabric Price Group 09	+\$1113
	Fabric Price Group 10	+\$1324
Backrest Inner Finish	Fabric Price Group 01	No cost
	Fabric Price Group 02	+\$52
	Fabric Price Group 03	+\$104
	Fabric Price Group 04	+\$174
	Fabric Price Group 05	+\$289
	Fabric Price Group 06	+\$404
	Fabric Price Group 07	+\$552
	Fabric Price Group 08	+\$683
	Fabric Price Group 09	+\$799
	Fabric Price Group 10	+\$950
Arm Finish	Fabric Price Group 01	No cost
	Fabric Price Group 02	+\$36
	Fabric Price Group 03	+\$75
	Fabric Price Group 04	+\$124
	Fabric Price Group 05	+\$206
	Fabric Price Group 06	+\$288
	Fabric Price Group 07	+\$395
	Fabric Price Group 08	+\$487
	Fabric Price Group 09	+\$571
	Fabric Price Group 10	+\$679
Tablet Top Finish	Laminate HPL Price Group 01	No cost
	Laminate HPL Price Group 02	+\$65
	Laminate HPL Price Group 03	+\$137

► **Product Information continued on next page**

# Away from the Desk

## Detached Seating

► **Product Information continued from previous page**

Options		
Tablet Top Finish	OLL Price Group 1	+\$102
Tablet Edge Finish	Plastic Group 1	No cost
Arm Power / Data Node	No Power/Data Required	No cost
	2 Duplex Outlets	+\$287
	Duplex Outlet with HDMI Video Port	+\$376
	Duplex Outlet with CAT6 Data	+\$382
Power Finish	Duplex Outlet with USB Data Ports	+\$395
	Paint Price Group 01	No cost
	Paint Price Group 02	No cost

### Specification Information

Style Number	Base Price									
	Screen Grades:									
	1	2	3	4	5	6	7	8	9	10

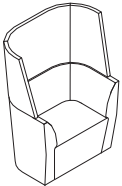

#### Single Seat Detached Unit with Screen

<b>OBAD102</b>	\$5564	\$5666	\$5769	\$5910	\$6137	\$6365	\$6661	\$6920	\$7149	\$7450
----------------	--------	--------	--------	--------	--------	--------	--------	--------	--------	--------

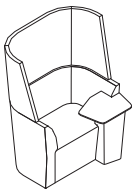

#### Single Seat Detached Unit with Left Hand Integrated Tablet and Screen

<b>OBAD102LT</b>	\$7828	\$7930	\$8033	\$8174	\$8401	\$8629	\$8925	\$9184	\$9413	\$9714
------------------	--------	--------	--------	--------	--------	--------	--------	--------	--------	--------

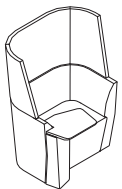

#### Single Seat Detached Unit with Right Hand Integrated Tablet and Screen

<b>OBAD102RT</b>	\$7828	\$7930	\$8033	\$8174	\$8401	\$8629	\$8925	\$9184	\$9413	\$9714
------------------	--------	--------	--------	--------	--------	--------	--------	--------	--------	--------



# Away from the Desk

## Detached Seating

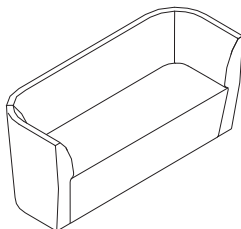

Tip: Customer's Own Material (COM) is available at a price group 1.

### Standard Includes

- Fully upholstered seating unit: fabric price group 01
- 1" thick integrated tablet with tapered edge, if selected:
  - High-Pressure Laminate price group 01
  - 3 mm edgeband: plastic price group 1
- Adjustable glides: black

### Options

Seat Finish	Fabric Price Group 01	No cost
	Fabric Price Group 02	+\$55
	Fabric Price Group 03	+\$111
	Fabric Price Group 04	+\$186
	Fabric Price Group 05	+\$312
	Fabric Price Group 06	+\$434
	Fabric Price Group 07	+\$593
	Fabric Price Group 08	+\$732
	Fabric Price Group 09	+\$856
	Fabric Price Group 10	+\$1020
Backrest Outer Finish	Fabric Price Group 01	No cost
	Fabric Price Group 02	+\$93
	Fabric Price Group 03	+\$189
	Fabric Price Group 04	+\$317
	Fabric Price Group 05	+\$529
	Fabric Price Group 06	+\$737
	Fabric Price Group 07	+\$1005
	Fabric Price Group 08	+\$1245
	Fabric Price Group 09	+\$1456
	Fabric Price Group 10	+\$1731
Backrest Inner Finish	Fabric Price Group 01	No cost
	Fabric Price Group 02	+\$47
	Fabric Price Group 03	+\$94
	Fabric Price Group 04	+\$159
	Fabric Price Group 05	+\$263
	Fabric Price Group 06	+\$368
	Fabric Price Group 07	+\$504
	Fabric Price Group 08	+\$622
	Fabric Price Group 09	+\$727
	Fabric Price Group 10	+\$867

### Specification Information

Style Number	Base Price
<b>Three Seat Detached Unit</b>	
<b>OBAD103</b>	\$6218



# Away from the Desk

## Media Dens

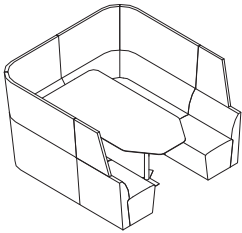

Tip: Customer's Own Material (COM) is available at a price group 1.

### Standard Includes

- Fully upholstered booth: fabric price group 01
- 1" thick tabletop with tapered edge:
  - High-Pressure Laminate price group 01
  - Fixed
- 3 mm edgeband: plastic price group 01
- Single table leg with foot
- Adjustable glides: black
- Linking brackets

### Options

Seat Finish	Fabric Price Group 01	No cost
	Fabric Price Group 02	+\$179
	Fabric Price Group 03	+\$361
	Fabric Price Group 04	+\$606
	Fabric Price Group 05	+\$1007
	Fabric Price Group 06	+\$1408
	Fabric Price Group 07	+\$1924
	Fabric Price Group 08	+\$2382
	Fabric Price Group 09	+\$2782
	Fabric Price Group 10	+\$3313
Backrest Outer Finish	Fabric Price Group 01	No cost
	Fabric Price Group 02	+\$222
	Fabric Price Group 03	+\$449
	Fabric Price Group 04	+\$758
	Fabric Price Group 05	+\$1257
	Fabric Price Group 06	+\$1755
	Fabric Price Group 07	+\$2398
	Fabric Price Group 08	+\$2967
	Fabric Price Group 09	+\$3466
	Fabric Price Group 10	+\$4128
Backrest Inner Finish	Fabric Price Group 01	No cost
	Fabric Price Group 02	+\$120
	Fabric Price Group 03	+\$245
	Fabric Price Group 04	+\$412
	Fabric Price Group 05	+\$682
	Fabric Price Group 06	+\$954
	Fabric Price Group 07	+\$1303
	Fabric Price Group 08	+\$1613
	Fabric Price Group 09	+\$1884
	Fabric Price Group 10	+\$2242
Table Top Finish	Laminate HPL Price Group 01	No cost
	Laminate HPL Price Group 02	+\$412
	Laminate HPL Price Group 03	+\$857
	OLL Price Group 1	+\$102
Table Edge Finish	Plastic Group 1	No cost
Top Power / Data Axil	No Power/Data Required	No cost
	4 Duplex Outlets	+\$547
	2 Outlets with CAT6 & HDMI Ports	+\$626
	2 Outlets with Two CAT6 Data Ports	+\$631
	2 Outlets with CAT6 and USB Data Port	+\$650

► **Product Information continued on next page**

# Away from the Desk

## Media Dens

► **Product Information continued from previous page**

Options		
Power Finish	Paint Price Group 01	No cost
	Paint Price Group 02	No cost
Monitor Bracket	No Monitor Bracket Required	No cost
	Tilting Monitor Bracket	+\$311
Leg/Foot Scheme	Black Foot & Column	No cost
	Silver Foot & Column	No cost
	Black Foot Chrome Column	+\$173

### Specification Information

Style Number	Base Prices									
	Screen Grades:									
	1	2	3	4	5	6	7	8	9	10

#### Enclosed Media Den

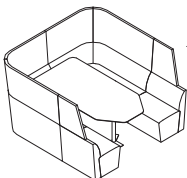

<b>OBAD85</b>	\$31,064	\$31,263	\$31,468	\$31,746	\$32,197	\$32,646	\$33,224	\$33,739	\$34,188	\$34,784
---------------	----------	----------	----------	----------	----------	----------	----------	----------	----------	----------

# Away from the Desk

## Media Dens

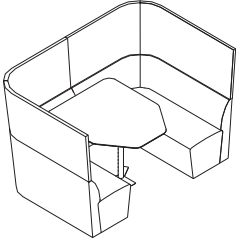

Tip: Customer's Own Material (COM) is available at a price group 1.

### Standard Includes

- Fully upholstered booth: fabric price group 01
- 1" thick tabletop with tapered edge:
  - High-Pressure Laminate price group 01
  - Fixed
- 3 mm edgeband: plastic price group 01
- Single table leg with foot
- Adjustable glides: black
- Linking brackets

### Options

Seat Finish	Fabric Price Group 01	No cost
	Fabric Price Group 02	+\$105
	Fabric Price Group 03	+\$211
	Fabric Price Group 04	+\$356
	Fabric Price Group 05	+\$590
	Fabric Price Group 06	+\$824
	Fabric Price Group 07	+\$1126
	Fabric Price Group 08	+\$1393
	Fabric Price Group 09	+\$1625
	Fabric Price Group 10	+\$1936
Backrest Outer Finish	Fabric Price Group 01	No cost
	Fabric Price Group 02	+\$159
	Fabric Price Group 03	+\$323
	Fabric Price Group 04	+\$542
	Fabric Price Group 05	+\$899
	Fabric Price Group 06	+\$1257
	Fabric Price Group 07	+\$1718
	Fabric Price Group 08	+\$2126
	Fabric Price Group 09	+\$2484
	Fabric Price Group 10	+\$2956
Backrest Inner Finish	Fabric Price Group 01	No cost
	Fabric Price Group 02	+\$97
	Fabric Price Group 03	+\$195
	Fabric Price Group 04	+\$328
	Fabric Price Group 05	+\$543
	Fabric Price Group 06	+\$759
	Fabric Price Group 07	+\$1036
	Fabric Price Group 08	+\$1283
	Fabric Price Group 09	+\$1499
	Fabric Price Group 10	+\$1783
Table Top Finish	Laminate HPL Price Group 01	No cost
	Laminate HPL Price Group 02	+\$245
	Laminate HPL Price Group 03	+\$508
	OLL Price Group 1	+\$102
Table Edge Finish	Plastic Group 1	No cost
Top Power / Data Axil	No Power/Data Required	No cost
	4 Duplex Outlets	+\$547
	2 Outlets with CAT6 & HDMI Ports	+\$626
	2 Outlets with Two CAT6 Data Ports	+\$631
	2 Outlets with CAT6 and USB Data Port	+\$650

► **Product Information continued on next page**

# Away from the Desk

## Media Dens

► **Product Information continued from previous page**

Options		
Power Finish	Paint Price Group 01	No cost
	Paint Price Group 02	No cost
Monitor Bracket	No Monitor Bracket Required	No cost
	Tilting Monitor Bracket	+\$311
Leg/Foot Scheme	Black Foot & Column	No cost
	Silver Foot & Column	No cost
	Black Foot Chrome Column	+\$173

### Specification Information

Style Number	Base Price									
	Screen Grades:									
	1	2	3	4	5	6	7	8	9	10

#### Enclosed Media Den, Four to Six People

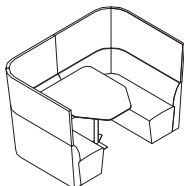

<b>OBAD85A</b>	\$18,829	\$18,998	\$19,172	\$19,407	\$19,790	\$20,172	\$20,665	\$21,099	\$21,482	\$21,988
----------------	----------	----------	----------	----------	----------	----------	----------	----------	----------	----------

# Cubb Seating and Tables

## Seating



### Standard Includes

- Fully upholstered armless chair: fabric price group 01
- Metal chassis: paint price group 01
- Solid oak legs: wood group 01
- Glides
- Shipped fully assembled

### Options

Configuration	Upholstered	No cost
	Two Toned Upholstered	+\$41
Seat Finish	Customer's Own Leather	No cost
	Fabric Customer's Own Material	No cost
	Fabric Price Group 01	No cost
	Fabric Price Group 02	+\$28
	Fabric Price Group 03	+\$59
	Fabric Price Group 04	+\$100
	Fabric Price Group 05	+\$162
	Fabric Price Group 06	+\$228
	Fabric Price Group 07	+\$313
	Fabric Price Group 08	+\$385
Outer Seat Finish	Customer's Own Leather	No cost
	Fabric Customer's Own Material	No cost
	Fabric Price Group 01	No cost
	Fabric Price Group 02	+\$28
	Fabric Price Group 03	+\$59
	Fabric Price Group 04	+\$100
	Fabric Price Group 05	+\$162
	Fabric Price Group 06	+\$228
	Fabric Price Group 07	+\$313
	Fabric Price Group 08	+\$385
Frame Finish	Paint Price Group 01	No cost
	Paint Price Group 02	+\$27
	Paint Price Group 03	+\$44
Leg Finish	Wood	No cost

*Tip: When two toned upholstered (contrasting) is selected, both seat finish and outer seat finish will need to be specified. Only a single price grade upcharge will be applied. The highest price group upcharge will be applied if multiple price groups are selected.*

### Specification Information

Style Number    Base Price

## Cubb Armless Chair with Wood Legs

**OBCUBB01**    \$941

# Cubb Seating and Tables

## Seating

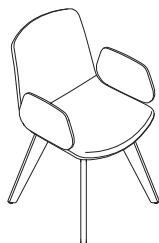

### Standard Includes

- Fully upholstered armchair: fabric price group 01
- Metal chassis: paint price group 01
- Solid oak legs: wood group 01
- Glides
- Shipped fully assembled

### Options

Configuration	Upholstered	No cost
	Two Toned Upholstered	+\$41
Seat Finish	Customer's Own Leather	No cost
	Fabric Customer's Own Material	No cost
	Fabric Price Group 01	No cost
	Fabric Price Group 02	+\$28
	Fabric Price Group 03	+\$60
	Fabric Price Group 04	+\$101
	Fabric Price Group 05	+\$166
	Fabric Price Group 06	+\$234
	Fabric Price Group 07	+\$318
	Fabric Price Group 08	+\$393
Outer Seat Finish	Fabric Price Group 09	+\$460
	Fabric Price Group 10	+\$547
	Customer's Own Leather	No cost
	Fabric Customer's Own Material	No cost
	Fabric Price Group 01	No cost
	Fabric Price Group 02	+\$28
	Fabric Price Group 03	+\$60
	Fabric Price Group 04	+\$101
	Fabric Price Group 05	+\$166
	Fabric Price Group 06	+\$234
Frame Finish	Fabric Price Group 07	+\$318
	Fabric Price Group 08	+\$393
	Fabric Price Group 09	+\$460
Leg Finish	Fabric Price Group 10	+\$547
	Paint Price Group 01	No cost
	Paint Price Group 02	+\$27
Leg Finish	Paint Price Group 03	+\$44
	Wood	No cost

*Tip: When two toned upholstered (contrasting) is selected, both seat finish and outer seat finish will need to be specified. Only a single price grade upcharge will be applied. The highest price group upcharge will be applied if multiple price groups are selected.*

### Specification Information

Style Number    Base Price

## Cubb Upholstered Arm Chair with Wood Legs

**OBCUBB02**    \$1202

# Cubb Seating and Tables

## Seating

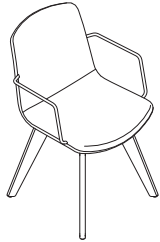

### Standard Includes

- Upholstered armchair with wire arms: fabric price group 01
- Metal chassis: paint price group 01
- Solid oak legs: wood group 01
- Glides
- Shipped fully assembled

### Options

Configuration	Upholstered	No cost
	Two Toned Upholstered	+\$41
Seat Finish	Customer's Own Leather	No cost
	Fabric Customer's Own Material	No cost
	Fabric Price Group 01	No cost
	Fabric Price Group 02	+\$28
	Fabric Price Group 03	+\$59
	Fabric Price Group 04	+\$100
	Fabric Price Group 05	+\$162
	Fabric Price Group 06	+\$228
	Fabric Price Group 07	+\$313
	Fabric Price Group 08	+\$385
Outer Seat Finish	Fabric Price Group 09	+\$452
	Fabric Price Group 10	+\$536
	Customer's Own Leather	No cost
	Fabric Customer's Own Material	No cost
	Fabric Price Group 01	No cost
	Fabric Price Group 02	+\$28
	Fabric Price Group 03	+\$59
	Fabric Price Group 04	+\$100
	Fabric Price Group 05	+\$162
	Fabric Price Group 06	+\$228
Frame Finish	Fabric Price Group 07	+\$313
	Fabric Price Group 08	+\$385
	Fabric Price Group 09	+\$452
Arms	Fabric Price Group 10	+\$536
	Paint Price Group 01	No cost
	Paint Price Group 02	+\$27
Leg Finish	Paint Price Group 03	+\$44
	Match Frame	No cost
	Polished Chrome	+\$50
	Wood	No cost

*Tip: When two toned upholstered (contrasting) is selected, both seat finish and outer seat finish will need to be specified. Only a single price grade upcharge will be applied. The highest price group upcharge will be applied if multiple price groups are selected.*

### Specification Information

Style Number    Base Price

## Cubb Wire Arm Chair with Wood Legs

**OBCUBB03**    \$1053



# Cubb Seating and Tables

## Seating



### Standard Includes

- Fully upholstered armless chair: fabric price group 01
- 4-star trestle base:
  - black
  - polished aluminum
- Glides
- Shipped fully assembled

### Options

Configuration	Upholstered	No cost
	Two Toned Upholstered	+\$41
Seat Finish	Customer's Own Leather	No cost
	Fabric Customer's Own Material	No cost
	Fabric Price Group 01	No cost
	Fabric Price Group 02	+\$28
	Fabric Price Group 03	+\$59
	Fabric Price Group 04	+\$100
	Fabric Price Group 05	+\$162
	Fabric Price Group 06	+\$228
	Fabric Price Group 07	+\$313
	Fabric Price Group 08	+\$385
Outer Seat Finish	Customer's Own Leather	No cost
	Fabric Customer's Own Material	No cost
	Fabric Price Group 01	No cost
	Fabric Price Group 02	+\$28
	Fabric Price Group 03	+\$59
	Fabric Price Group 04	+\$100
	Fabric Price Group 05	+\$162
	Fabric Price Group 06	+\$228
	Fabric Price Group 07	+\$313
	Fabric Price Group 08	+\$385
Base Finish	Paint Price Group 01	No cost
	Polished Aluminum	No cost
Glides	Standard Glides	No cost
	Soft Glides	+\$5

*Tip: When two toned upholstered (contrasting) is selected, both seat finish and outer seat finish will need to be specified. Only a single price grade upcharge will be applied. The highest price group upcharge will be applied if multiple price groups are selected.*

### Specification Information

Style Number    Base Price

#### Cubb Armless Chair on 4-Star Trestle Base

**OBCUBB04**    \$1074

# Cubb Seating and Tables

## Seating



### Standard Includes

- Fully upholstered armchair: fabric price group 01
- 4-star trestle base:
  - black
  - polished aluminum
- Glides
- Shipped fully assembled

### Options

Configuration	Upholstered	No cost
	Two Toned Upholstered	+\$41
Seat Finish	Customer's Own Leather	No cost
	Fabric Customer's Own Material	No cost
	Fabric Price Group 01	No cost
	Fabric Price Group 02	+\$28
	Fabric Price Group 03	+\$60
	Fabric Price Group 04	+\$101
	Fabric Price Group 05	+\$166
	Fabric Price Group 06	+\$234
	Fabric Price Group 07	+\$318
	Fabric Price Group 08	+\$393
	Fabric Price Group 09	+\$460
Outer Seat Finish	Fabric Price Group 10	+\$547
	Customer's Own Leather	No cost
	Fabric Customer's Own Material	No cost
	Fabric Price Group 01	No cost
	Fabric Price Group 02	+\$28
	Fabric Price Group 03	+\$60
	Fabric Price Group 04	+\$101
	Fabric Price Group 05	+\$166
	Fabric Price Group 06	+\$234
	Fabric Price Group 07	+\$318
	Fabric Price Group 08	+\$393
Base Finish	Fabric Price Group 09	+\$460
	Fabric Price Group 10	+\$547
Paint Price Group 01	Paint Price Group 01	No cost
	Polished Aluminum	No cost
Glides	Standard Glides	No cost
	Soft Glides	+\$5

*Tip: When two toned upholstered (contrasting) is selected, both seat finish and outer seat finish will need to be specified. Only a single price grade upcharge will be applied. The highest price group upcharge will be applied if multiple price groups are selected.*

### Specification Information

Style Number    Base Price

## Cubb Upholstered Arm Chair on 4-Star Trestle Base

**OBCUBB05**    \$1252

# Cubb Seating and Tables

## Seating



### Standard Includes

- Upholstered armchair with wire arms: fabric price group 01
- 4-star trestle base:
  - black
  - polished aluminum
- Glides
- Shipped fully assembled

### Options

Configuration	Upholstered	No cost
	Two Toned Upholstered	+\$41
Seat Finish	Customer's Own Leather	No cost
	Fabric Customer's Own Material	No cost
	Fabric Price Group 01	No cost
	Fabric Price Group 02	+\$28
	Fabric Price Group 03	+\$59
	Fabric Price Group 04	+\$100
	Fabric Price Group 05	+\$162
	Fabric Price Group 06	+\$228
	Fabric Price Group 07	+\$313
	Fabric Price Group 08	+\$385
Outer Seat Finish	Fabric Price Group 09	+\$452
	Fabric Price Group 10	+\$536
	Customer's Own Leather	No cost
	Fabric Customer's Own Material	No cost
	Fabric Price Group 01	No cost
	Fabric Price Group 02	+\$28
	Fabric Price Group 03	+\$59
	Fabric Price Group 04	+\$100
	Fabric Price Group 05	+\$162
	Fabric Price Group 06	+\$228
Base Finish	Fabric Price Group 07	+\$313
	Fabric Price Group 08	+\$385
Glides	Fabric Price Group 09	+\$452
	Fabric Price Group 10	+\$536
Base Finish	Paint Price Group 01	No cost
	Polished Aluminum	No cost
Glides	Standard Glides	No cost
	Soft Glides	+\$5

*Tip: When two toned upholstered (contrasting) is selected, both seat finish and outer seat finish will need to be specified. Only a single price grade upcharge will be applied. The highest price group upcharge will be applied if multiple price groups are selected.*

### Specification Information

Style Number    Base Price

### Cubb Wire Arm Chair on 4-Star Trestle Base

**OBCUBB06**    \$1105

# Cubb Seating and Tables

## Seating

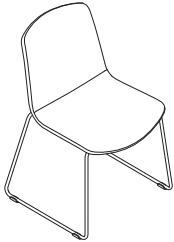

*Tip: When two toned upholstered (contrasting) is selected, both seat finish and outer seat finish will need to be specified. Only a single price grade upcharge will be applied. The highest price group upcharge will be applied if multiple price groups are selected.*

### Standard Includes

- Fully upholstered armless chair: fabric price group 01
- Wire frame base: paint price group 01
- Glides
- Shipped fully assembled

### Options

Configuration	Upholstered	No cost
	Two Toned Upholstered	+\$41
Seat Finish	Customer's Own Leather	No cost
	Fabric Customer's Own Material	No cost
	Fabric Price Group 01	No cost
	Fabric Price Group 02	+\$28
	Fabric Price Group 03	+\$59
	Fabric Price Group 04	+\$100
	Fabric Price Group 05	+\$162
	Fabric Price Group 06	+\$228
	Fabric Price Group 07	+\$313
	Fabric Price Group 08	+\$385
	Fabric Price Group 09	+\$452
	Fabric Price Group 10	+\$536
Outer Seat Finish	Customer's Own Leather	No cost
	Fabric Customer's Own Material	No cost
	Fabric Price Group 01	No cost
	Fabric Price Group 02	+\$28
	Fabric Price Group 03	+\$59
	Fabric Price Group 04	+\$100
	Fabric Price Group 05	+\$162
	Fabric Price Group 06	+\$228
	Fabric Price Group 07	+\$313
	Fabric Price Group 08	+\$385
	Fabric Price Group 09	+\$452
	Fabric Price Group 10	+\$536
Frame Finish	Paint Price Group 01	No cost
	Paint Price Group 02	+\$53
	Paint Price Group 03	+\$83
	Polished Chrome	+\$109

### Specification Information

Style Number    Base Price

## Cubb Armless Chair with Wire Frame Base

**OBCUBB07**    \$825

# Cubb Seating and Tables

## Seating

Cubb Seating and Tables

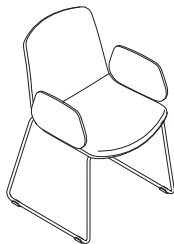

### Standard Includes

- Fully upholstered armchair: fabric price group 01
- Wire frame base: paint price group 01
- Glides
- Shipped fully assembled

### Options

Configuration	Upholstered	No cost
	Two Toned Upholstered	+\$41
Seat Finish	Customer's Own Leather	No cost
	Fabric Customer's Own Material	No cost
	Fabric Price Group 01	No cost
	Fabric Price Group 02	+\$28
	Fabric Price Group 03	+\$60
	Fabric Price Group 04	+\$101
	Fabric Price Group 05	+\$166
	Fabric Price Group 06	+\$234
	Fabric Price Group 07	+\$318
	Fabric Price Group 08	+\$393
	Fabric Price Group 09	+\$460
	Fabric Price Group 10	+\$547
Outer Seat Finish	Customer's Own Leather	No cost
	Fabric Customer's Own Material	No cost
	Fabric Price Group 01	No cost
	Fabric Price Group 02	+\$28
	Fabric Price Group 03	+\$60
	Fabric Price Group 04	+\$101
	Fabric Price Group 05	+\$166
	Fabric Price Group 06	+\$234
	Fabric Price Group 07	+\$318
	Fabric Price Group 08	+\$393
	Fabric Price Group 09	+\$460
	Fabric Price Group 10	+\$547
Frame Finish	Paint Price Group 01	No cost
	Paint Price Group 02	+\$53
	Paint Price Group 03	+\$83
	Polished Chrome	+\$109

*Tip: When two toned upholstered (contrasting) is selected, both seat finish and outer seat finish will need to be specified. Only a single price grade upcharge will be applied. The highest price group upcharge will be applied if multiple price groups are selected.*

### Specification Information

Style Number    Base Price

### Cubb Upholstered Arm Chair with Wire Frame Base

**OBCUBB08**    \$1089

# Cubb Seating and Tables

## Seating

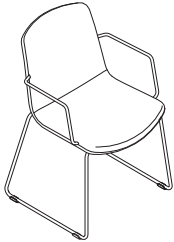

### Standard Includes

- Upholstered armchair with wire arms: fabric price group 01
- Wire frame base: paint price group 01
- Glides
- Shipped fully assembled

### Options

Configuration	Upholstered	No cost
	Two Toned Upholstered	+\$41
Seat Finish	Customer's Own Leather	No cost
	Fabric Customer's Own Material	No cost
	Fabric Price Group 01	No cost
	Fabric Price Group 02	+\$28
	Fabric Price Group 03	+\$59
	Fabric Price Group 04	+\$100
	Fabric Price Group 05	+\$162
	Fabric Price Group 06	+\$228
	Fabric Price Group 07	+\$313
	Fabric Price Group 08	+\$385
Outer Seat Finish	Fabric Price Group 09	+\$452
	Fabric Price Group 10	+\$536
	Customer's Own Leather	No cost
	Fabric Customer's Own Material	No cost
	Fabric Price Group 01	No cost
	Fabric Price Group 02	+\$28
	Fabric Price Group 03	+\$59
	Fabric Price Group 04	+\$100
	Fabric Price Group 05	+\$162
	Fabric Price Group 06	+\$228
Frame Finish	Fabric Price Group 07	+\$313
	Fabric Price Group 08	+\$385
	Fabric Price Group 09	+\$452
	Fabric Price Group 10	+\$536
	Paint Price Group 01	No cost
	Paint Price Group 02	+\$53
	Paint Price Group 03	+\$83
	Polished Chrome	+\$109

*Tip: When two toned upholstered (contrasting) is selected, both seat finish and outer seat finish will need to be specified. Only a single price grade upcharge will be applied. The highest price group upcharge will be applied if multiple price groups are selected.*

### Specification Information

Style Number    Base Price

## Cubb Wire Arm Chair with Wire Frame Base

**OBCUBB09**    \$941

# Cubb Seating and Tables

## Seating

Cubb Seating and Tables



### Standard Includes

- Fully upholstered armless chair: fabric price group 01
- 5-star base:
  - black
  - polished aluminum
- Hard casters: black
- Pneumatic seat height
- Shipped fully assembled

### Options

Configuration	Upholstered	No cost
	Two Toned Upholstered	+\$41
Seat Finish	Customer's Own Leather	No cost
	Fabric Customer's Own Material	No cost
	Fabric Price Group 01	No cost
	Fabric Price Group 02	+\$28
	Fabric Price Group 03	+\$59
	Fabric Price Group 04	+\$100
	Fabric Price Group 05	+\$162
	Fabric Price Group 06	+\$228
	Fabric Price Group 07	+\$313
	Fabric Price Group 08	+\$385
Outer Seat Finish	Customer's Own Leather	No cost
	Fabric Customer's Own Material	No cost
	Fabric Price Group 01	No cost
	Fabric Price Group 02	+\$28
	Fabric Price Group 03	+\$59
	Fabric Price Group 04	+\$100
	Fabric Price Group 05	+\$162
	Fabric Price Group 06	+\$228
	Fabric Price Group 07	+\$313
	Fabric Price Group 08	+\$385
Base Finish	Paint Price Group 01	No cost
	Polished Aluminum	No cost
Caster Type	Hard Black Casters	No cost
	Soft Black Casters	+\$40

*Tip: When two toned upholstered (contrasting) is selected, both seat finish and outer seat finish will need to be specified. Only a single price grade upcharge will be applied. The highest price group upcharge will be applied if multiple price groups are selected.*

### Specification Information

Style Number	Base Price
<b>Cubb Armless Chair on 5-Star Base</b>	
<b>OBCUBB10</b>	\$1017

# Cubb Seating and Tables

## Seating



### Standard Includes

- Fully upholstered armchair: fabric price group 01
- 5-star base:
  - black
  - polished aluminum
- Hard casters: black
- Pneumatic seat height
- Shipped fully assembled

### Options

Configuration	Upholstered	No cost
	Two Toned Upholstered	+\$41
Seat Finish	Customer's Own Leather	No cost
	Fabric Customer's Own Material	No cost
	Fabric Price Group 01	No cost
	Fabric Price Group 02	+\$28
	Fabric Price Group 03	+\$60
	Fabric Price Group 04	+\$101
	Fabric Price Group 05	+\$166
	Fabric Price Group 06	+\$234
	Fabric Price Group 07	+\$318
	Fabric Price Group 08	+\$393
Outer Seat Finish	Customer's Own Leather	No cost
	Fabric Customer's Own Material	No cost
	Fabric Price Group 01	No cost
	Fabric Price Group 02	+\$28
	Fabric Price Group 03	+\$60
	Fabric Price Group 04	+\$101
	Fabric Price Group 05	+\$166
	Fabric Price Group 06	+\$234
	Fabric Price Group 07	+\$318
	Fabric Price Group 08	+\$393
Base Finish	Paint Price Group 01	No cost
	Polished Aluminum	No cost
Caster Type	Hard Black Casters	No cost
	Soft Black Casters	+\$40

*Tip: When two toned upholstered (contrasting) is selected, both seat finish and outer seat finish will need to be specified. Only a single price grade upcharge will be applied. The highest price group upcharge will be applied if multiple price groups are selected.*

### Specification Information

Style Number    Base Price

## Cubb Upholstered Arm Chair on 5-Star Base

**OBCUBB11**    \$1276



# Cubb Seating and Tables

## Seating

Cubb Seating and Tables

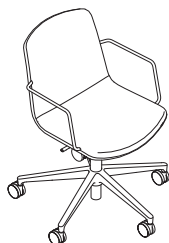

### Standard Includes

- Upholstered armchair with wire arms: fabric price group 01
- 5-star base:
  - black
  - polished aluminum
- Hard casters: black
- Pneumatic seat height
- Shipped fully assembled

### Options

Configuration	Upholstered	No cost
	Two Toned Upholstered	+\$41
Seat Finish	Customer's Own Leather	No cost
	Fabric Customer's Own Material	No cost
	Fabric Price Group 01	No cost
	Fabric Price Group 02	+\$28
	Fabric Price Group 03	+\$59
	Fabric Price Group 04	+\$100
	Fabric Price Group 05	+\$162
	Fabric Price Group 06	+\$228
	Fabric Price Group 07	+\$313
	Fabric Price Group 08	+\$385
Outer Seat Finish	Customer's Own Leather	No cost
	Fabric Customer's Own Material	No cost
	Fabric Price Group 01	No cost
	Fabric Price Group 02	+\$28
	Fabric Price Group 03	+\$59
	Fabric Price Group 04	+\$100
	Fabric Price Group 05	+\$162
	Fabric Price Group 06	+\$228
	Fabric Price Group 07	+\$313
	Fabric Price Group 08	+\$385
Base Finish	Paint Price Group 01	No cost
	Polished Aluminum	No cost
Caster Type	Hard Black Casters	No cost
	Soft Black Casters	+\$40

*Tip: When two toned upholstered (contrasting) is selected, both seat finish and outer seat finish will need to be specified. Only a single price grade upcharge will be applied. The highest price group upcharge will be applied if multiple price groups are selected.*

### Specification Information

Style Number	Base Price
<b>OBCUBB12</b>	\$1131

### Cubb Wire Arm Chair on 5-Star Base

# Cubb Seating and Tables

## Seating

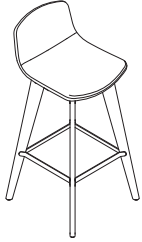

### Standard Includes

- Fully upholstered barstool: fabric price group 01
- Solid oak legs: wood group 01
- Metal chassis: paint price group 01
- Glides
- Shipped fully assembled

### Options

Configuration	Upholstered	No cost
	Two Toned Upholstered	+\$41
Seat Finish	Customer's Own Leather	No cost
	Fabric Customer's Own Material	No cost
	Fabric Price Group 01	No cost
	Fabric Price Group 02	+\$24
	Fabric Price Group 03	+\$47
	Fabric Price Group 04	+\$81
	Fabric Price Group 05	+\$134
	Fabric Price Group 06	+\$186
	Fabric Price Group 07	+\$254
	Fabric Price Group 08	+\$316
Outer Seat Finish	Fabric Price Group 09	+\$368
	Fabric Price Group 10	+\$438
	Customer's Own Leather	No cost
	Fabric Customer's Own Material	No cost
	Fabric Price Group 01	No cost
	Fabric Price Group 02	+\$24
	Fabric Price Group 03	+\$47
	Fabric Price Group 04	+\$81
	Fabric Price Group 05	+\$134
	Fabric Price Group 06	+\$186
Frame Finish	Fabric Price Group 07	+\$254
	Fabric Price Group 08	+\$316
	Fabric Price Group 09	+\$368
Leg Finish	Fabric Price Group 10	+\$438
	Paint Price Group 01	No cost
	Paint Price Group 02	+\$27
Leg Finish	Paint Price Group 03	+\$44
	Wood	No cost

*Tip: When two toned upholstered (contrasting) is selected, both seat finish and outer seat finish will need to be specified. Only a single price grade upcharge will be applied. The highest price group upcharge will be applied if multiple price groups are selected.*

### Specification Information

Style Number    Base Price

### Cubb Barstool with Oak Base

**OBCUBB13**    \$1100

# Cubb Seating and Tables

## Seating

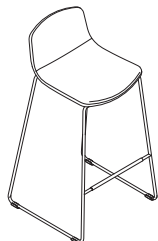

### Standard Includes

- Wire frame base: paint price group 01
- Glides
- Shipped fully assembled

### Options

Configuration	Upholstered	No cost
	Two Toned Upholstered	+\$41
Seat Finish	Customer's Own Leather	No cost
	Fabric Customer's Own Material	No cost
	Fabric Price Group 01	No cost
	Fabric Price Group 02	+\$24
	Fabric Price Group 03	+\$47
	Fabric Price Group 04	+\$81
	Fabric Price Group 05	+\$134
	Fabric Price Group 06	+\$186
	Fabric Price Group 07	+\$254
	Fabric Price Group 08	+\$316
Outer Seat Finish	Customer's Own Leather	No cost
	Fabric Customer's Own Material	No cost
	Fabric Price Group 01	No cost
	Fabric Price Group 02	+\$24
	Fabric Price Group 03	+\$47
	Fabric Price Group 04	+\$81
	Fabric Price Group 05	+\$134
	Fabric Price Group 06	+\$186
	Fabric Price Group 07	+\$254
	Fabric Price Group 08	+\$316
Frame Finish	Paint Price Group 01	No cost
	Paint Price Group 02	+\$53
	Paint Price Group 03	+\$83
	Polished Chrome	+\$109
Footrail Cover	No Footrail Cover	No cost
	With Footrail Cover	+\$5

*Tip: When two toned upholstered (contrasting) is selected, both seat finish and outer seat finish will need to be specified. Only a single price grade upcharge will be applied. The highest price group upcharge will be applied if multiple price groups are selected.*

### Specification Information

Style Number    Base Price

### Cubb Barstool with Wire Frame Base

**OBCUBB14**    \$858

# Cubb Seating and Tables

## Seating

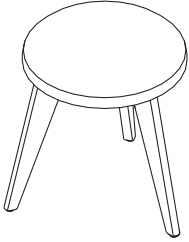

### Standard Includes

- Fully upholstered occasional stool: fabric price group 01
- Solid oak legs: wood group 01
- Metal chassis: paint price group 01
- Glides
- Shipped fully assembled

### Options

Seat Finish	Customer's Own Leather	No cost
	Fabric Customer's Own Material	No cost
	Fabric Price Group 01	No cost
	Fabric Price Group 02	+\$11
	Fabric Price Group 03	+\$26
	Fabric Price Group 04	+\$45
	Fabric Price Group 05	+\$75
	Fabric Price Group 06	+\$105
	Fabric Price Group 07	+\$141
	Fabric Price Group 08	+\$174
Frame Finish	Paint Price Group 01	No cost
	Paint Price Group 02	+\$27
	Paint Price Group 03	+\$44
Leg Finish	Wood	No cost

### Specification Information

Style Number    Base Price

## Cubb Occasional Stool with Oak Base

**OBCUBB15**    \$582

# Cubb Seating and Tables

## Seating

Cubb Seating and Tables

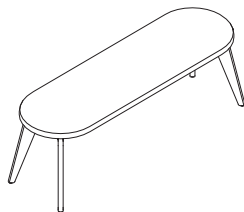

### Standard Includes

- Fully upholstered bench: fabric price group 01
- Solid oak legs: wood group 01
- Metal chassis: paint price group 01
- Glides
- Shipped fully assembled

### Options

Seat Finish	Customer's Own Leather	No cost
	Fabric Customer's Own Material	No cost
	Fabric Price Group 01	No cost
	Fabric Price Group 02	+\$22
	Fabric Price Group 03	+\$44
	Fabric Price Group 04	+\$73
	Fabric Price Group 05	+\$118
	Fabric Price Group 06	+\$165
	Fabric Price Group 07	+\$227
	Fabric Price Group 08	+\$279
Frame Finish	Paint Price Group 01	No cost
	Paint Price Group 02	+\$27
	Paint Price Group 03	+\$44
Leg Finish	Wood	No cost

### Specification Information

Style Number    Base Price

### Cubb Two Seat Bench

**OBCUBB19**    \$1337

# Cubb Seating and Tables

## Tables

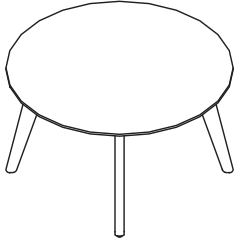

### Standard Includes

- 1" thick table top: Low-Pressure Laminate price group 01
- 3 mm edgeband: plastic price group 01
- Solid oak legs: wood group 01
- Cable management channel with rubber riser inset per leg: black
- Metal chassis: paint price group 01
- Glides

### Options

Top Finish	Laminate LPL Price Group 01	No cost
	Laminate HPL Price Group 01	+\$481
	Laminate HPL Price Group 02	+\$794
	Laminate HPL Price Group 03	+\$1397
	OLL Price Group 1	+\$102
Edge Finish	Plastic Group 1	No cost
Leg Finish	Wood	No cost
Frame Finish	Paint Price Group 01	No cost
	Paint Price Group 02	+\$55
	Paint Price Group 03	+\$111
Power Option	No Power	No cost
	Node 201 - 2 Power	+\$274
	Node 204 - 1 Power, 1 USB	+\$375
Power Location	Center Only	No cost
Plug or Hardwire	Hardwire	No cost
	Plug	No cost
Power Finish	Paint Price Group 01	No cost
	Paint Price Group 02	No cost
Cable Clips	No Cable Clips	No cost
	Cable Clips	+\$49
Umbilical Cable Riser	No Cable Riser	No cost
	Umbilical Cable Riser	+\$209

### Specification Information

Style Number      Base Price

## Cubb Four Person Round Meeting Table

**OBCUBBRDM01**    \$2420

# Cubb Seating and Tables

## Tables

Cubb Seating and Tables

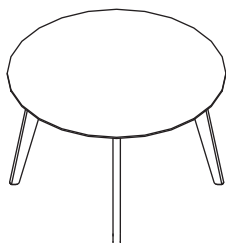

### Standard Includes

- 1" thick table top: Low-Pressure Laminate price group 01
- 3 mm edgeband: plastic price group 01
- Solid oak legs: wood group 01
- Cable management channel with rubber riser inset per leg: black
- Metal chassis: paint price group 01
- Glides

### Options

Top Finish	Laminate LPL Price Group 01	No cost
	Laminate HPL Price Group 01	+\$505
	Laminate HPL Price Group 02	+\$832
	Laminate HPL Price Group 03	+\$1464
	OLL Price Group 1	+\$102
Edge Finish	Plastic Group 1	No cost
Leg Finish	Wood	No cost
Frame Finish	Paint Price Group 01	No cost
	Paint Price Group 02	+\$55
	Paint Price Group 03	+\$111
Power Option	No Power	No cost
	Node 201 - 2 Power	+\$274
	Node 204 - 1 Power, 1 USB	+\$375
Power Location	Center Only	No cost
Plug or Hardwire	Hardwire	No cost
	Plug	No cost
Power Finish	Paint Price Group 01	No cost
	Paint Price Group 02	No cost
Cable Clips	No Cable Clips	No cost
	Cable Clips	+\$49
Umbilical Cable Riser	No Cable Riser	No cost
	Umbilical Cable Riser	+\$209

### Specification Information

Style Number	Base Price
--------------	------------

### Cubb Six Person Round Meeting Table

**OBCUBBRDM02** \$2539

# Cubb Seating and Tables

## Tables

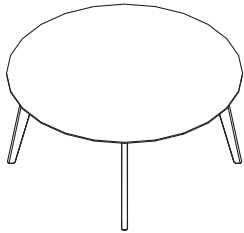

### Standard Includes

- 1" thick table top: Low-Pressure Laminate price group 01
- 3 mm edgeband: plastic price group 01
- Solid oak legs: wood group 01
- Cable management channel with rubber riser inset per leg: black
- Metal chassis: paint price group 01
- Glides

### Options

Top Finish	Laminate LPL Price Group 01	No cost
	Laminate HPL Price Group 01	+\$585
	Laminate HPL Price Group 02	+\$964
	Laminate HPL Price Group 03	+\$1697
	OLL Price Group 1	+\$102
Edge Finish	Plastic Group 1	No cost
Leg Finish	Wood	No cost
Frame Finish	Paint Price Group 01	No cost
	Paint Price Group 02	+\$55
	Paint Price Group 03	+\$111
Power Option	No Power	No cost
	Node 201 - 2 Power	+\$274
	Node 204 - 1 Power, 1 USB	+\$375
Power Location	Center Only	No cost
Plug or Hardwire	Hardwire	No cost
	Plug	No cost
Power Finish	Paint Price Group 01	No cost
	Paint Price Group 02	No cost
Cable Clips	No Cable Clips	No cost
	Cable Clips	+\$49
Umbilical Cable Riser	No Cable Riser	No cost
	Umbilical Cable Riser	+\$209

### Specification Information

Style Number      Base Price

## Cubb Seven Person Round Meeting Table

**OBCUBBRDM03**    \$2938



# Cubb Seating and Tables

## Tables

Cubb Seating and Tables

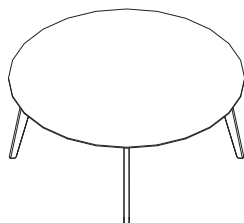

### Standard Includes

- 1" thick table top: Low-Pressure Laminate price group 01
- 3 mm edgeband: plastic price group 01
- Solid oak legs: wood group 01
- Cable management channel with rubber riser inset per leg: black
- Metal chassis: paint price group 01
- Glides

### Options

Top Finish	Laminate LPL Price Group 01	No cost
	Laminate HPL Price Group 01	+\$589
	Laminate HPL Price Group 02	+\$970
	Laminate HPL Price Group 03	+\$1707
	OLL Price Group 1	+\$102
Edge Finish	Plastic Group 1	No cost
Leg Finish	Wood	No cost
Frame Finish	Paint Price Group 01	No cost
	Paint Price Group 02	+\$55
	Paint Price Group 03	+\$111
Power Option	No Power	No cost
	Node 201 - 2 Power	+\$274
	Node 204 - 1 Power, 1 USB	+\$375
Power Location	Center Only	No cost
Plug or Hardwire	Hardwire	No cost
	Plug	No cost
Power Finish	Paint Price Group 01	No cost
	Paint Price Group 02	No cost
Cable Clips	No Cable Clips	No cost
	Cable Clips	+\$49
Umbilical Cable Riser	No Cable Riser	No cost
	Umbilical Cable Riser	+\$209

### Specification Information

Style Number      Base Price

## Cubb Eight Person Round Meeting Table

**OBCUBBRDM04**    \$2963

# Cubb Seating and Tables

## Tables

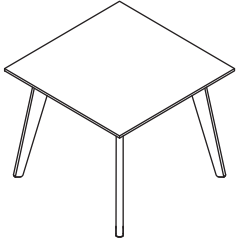

### Standard Includes

- 1" thick table top: Low-Pressure Laminate price group 01
- 3 mm edgeband: plastic price group 01
- Solid oak legs: wood group 01
- Cable management channel with rubber riser inset per leg: black
- Metal chassis: paint price group 01
- Glides

### Options

Top Finish	Laminate LPL Price Group 01	No cost
	Laminate HPL Price Group 01	+\$461
	Laminate HPL Price Group 02	+\$762
	Laminate HPL Price Group 03	+\$1341
	OLL Price Group 1	+\$102
Edge Finish	Plastic Group 1	No cost
Leg Finish	Wood	No cost
Frame Finish	Paint Price Group 01	No cost
	Paint Price Group 02	+\$55
	Paint Price Group 03	+\$111
Power Option	No Power	No cost
	Dean Z 201 - 2 Power	+\$281
	Dean Z 202 - 1 Power, 1 USB	+\$391
Power Location	Center Only	No cost
Plug or Hardwire	Hardwire	No cost
	Plug	No cost
Power Finish	Paint Price Group 01	No cost
	Paint Price Group 02	No cost
Cable Clips	No Cable Clips	No cost
	Cable Clips	+\$49
Umbilical Cable Riser	No Cable Riser	No cost
	Umbilical Cable Riser	+\$209

### Specification Information

Style Number      Base Price

## Cubb Four Person Square Meeting Table

**OBCUBBSQM01**    \$2323

# Cubb Seating and Tables

## Tables

Cubb Seating and Tables

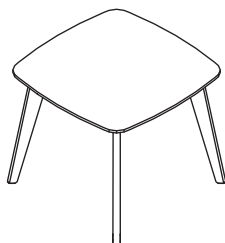

### Standard Includes

- 1" thick table top: Low-Pressure Laminate price group 01
- 3 mm edgeband: plastic price group 01
- Solid oak legs: wood group 01
- Cable management channel with rubber riser inset per leg: black
- Metal chassis: paint price group 01
- Glides

### Options

Top Finish	Laminate LPL Price Group 01	No cost
	Laminate HPL Price Group 01	+\$467
	Laminate HPL Price Group 02	+\$774
	Laminate HPL Price Group 03	+\$1360
	OLL Price Group 1	+\$102
Edge Finish	Plastic Group 1	No cost
Leg Finish	Wood	No cost
Frame Finish	Paint Price Group 01	No cost
	Paint Price Group 02	+\$55
	Paint Price Group 03	+\$111
Power Option	No Power	No cost
	Dean Z 201 - 2 Power	+\$281
	Dean Z 202 - 1 Power, 1 USB	+\$391
Power Location	Center Only	No cost
Plug or Hardwire	Hardwire	No cost
	Plug	No cost
Power Finish	Paint Price Group 01	No cost
	Paint Price Group 02	No cost
Cable Clips	No Cable Clips	No cost
	Cable Clips	+\$49
Umbilical Cable Riser	No Cable Riser	No cost
	Umbilical Cable Riser	+\$209

### Specification Information

Style Number	Base Price
<b>Cubb Four Person Square Meeting Table with Softened Corners</b>	
<b>OBCUBBSSM01</b>	\$2360

# Cubb Seating and Tables

## Tables

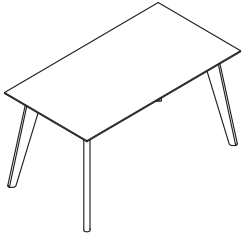

### Standard Includes

- 1" thick table top: Low-Pressure Laminate price group 01
- 3 mm edgeband: plastic price group 01
- Solid oak legs: wood group 01
- Cable management channel with rubber riser inset per leg: black
- Metal chassis: paint price group 01
- Glides

### Options

Top Finish	Laminate LPL Price Group 01	No cost
	Laminate HPL Price Group 01	+\$459
	Laminate HPL Price Group 02	+\$755
	Laminate HPL Price Group 03	+\$1329
	OLL Price Group 1	+\$102
Edge Finish	Plastic Group 1	No cost
Leg Finish	Wood	No cost
Frame Finish	Paint Price Group 01	No cost
	Paint Price Group 02	+\$55
	Paint Price Group 03	+\$111
Power Option	No Power	No cost
	Dean Z 201 - 2 Power	+\$281
	Dean Z 202 - 1 Power, 1 USB	+\$391
	Dean Z 401 - 3 Power, 1 USB	+\$437
	Dean Z 402 - 2 Power, 2 USB	+\$544
Dean Z 501 - 3 Power, 1 USB-C	+\$670	
Power Location	Center Only	No cost
Plug or Hardwire	Hardwire	No cost
	Plug	No cost
Power Finish	Paint Price Group 01	No cost
	Paint Price Group 02	No cost
Cable Clips	No Cable Clips	No cost
	Cable Clips	+\$49
Umbilical Cable Riser	No Cable Riser	No cost
	Umbilical Cable Riser	+\$209

### Specification Information

Style Number	Base Price
--------------	------------

## Cubb Four Person Rectangle Meeting Table

<b>OBCUBBRM01</b>	\$2305
-------------------	--------

# Cubb Seating and Tables

## Tables

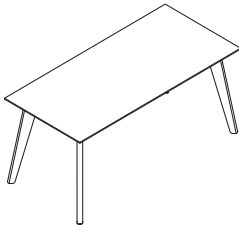

### Standard Includes

- 1" thick table top: Low-Pressure Laminate price group 01
- 3 mm edgeband: plastic price group 01
- Solid oak legs: wood group 01
- Cable management channel with rubber riser inset per leg: black
- Metal chassis: paint price group 01
- Glides

### Options

Top Finish	Laminate LPL Price Group 01	No cost
	Laminate HPL Price Group 01	+\$475
	Laminate HPL Price Group 02	+\$784
	Laminate HPL Price Group 03	+\$1380
	OLL Price Group 1	+\$102
Edge Finish	Plastic Group 1	No cost
Leg Finish	Wood	No cost
Frame Finish	Paint Price Group 01	No cost
	Paint Price Group 02	+\$55
	Paint Price Group 03	+\$111
Power Option	No Power	No cost
	Dean Z 201 - 2 Power	+\$281
	Dean Z 202 - 1 Power, 1 USB	+\$391
	Dean Z 401 - 3 Power, 1 USB	+\$437
	Dean Z 402 - 2 Power, 2 USB	+\$544
	Dean Z 501 - 3 Power, 1 USB-C	+\$670
Power Location	Center Only	No cost
Plug or Hardwire	Hardwire	No cost
	Plug	No cost
Power Finish	Paint Price Group 01	No cost
	Paint Price Group 02	No cost
Cable Clips	No Cable Clips	No cost
	Cable Clips	+\$49
Umbilical Cable Riser	No Cable Riser	No cost
	Umbilical Cable Riser	+\$209

### Specification Information

Style Number      Base Price

## Cubb Four to Six Person Rectangle Meeting Table

**OBCUBBRM02**    \$2387

# Cubb Seating and Tables

## Tables

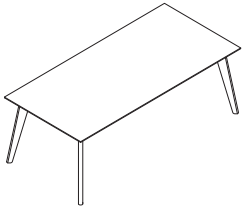

### Standard Includes

- 1" thick table top: Low-Pressure Laminate price group 01
- 3 mm edgeband: plastic price group 01
- Solid oak legs: wood group 01
- Cable management channel with rubber riser inset per leg: black
- Metal chassis: paint price group 01
- Glides

### Options

Top Finish	Laminate LPL Price Group 01	No cost
	Laminate HPL Price Group 01	+\$514
	Laminate HPL Price Group 02	+\$850
	Laminate HPL Price Group 03	+\$1497
	OLL Price Group 1	+\$102
Edge Finish	Plastic Group 1	No cost
Leg Finish	Wood	No cost
Frame Finish	Paint Price Group 01	No cost
	Paint Price Group 02	+\$55
	Paint Price Group 03	+\$111
Power Option	No Power	No cost
	Dean Z 201 - 2 Power	+\$281
	Dean Z 202 - 1 Power, 1 USB	+\$391
	Dean Z 401 - 3 Power, 1 USB	+\$437
	Dean Z 402 - 2 Power, 2 USB	+\$544
	Dean Z 501 - 3 Power, 1 USB-C	+\$670
Power Location	Center Only	No cost
	Left & Right	No cost
	Left Only	No cost
	Left and center	No cost
	Left, Right and center	No cost
	Right Only	No cost
	Right and center	No cost
Plug or Hardwire	Hardwire	No cost
	Plug	No cost
Power Finish	Paint Price Group 01	No cost
	Paint Price Group 02	No cost
Cable Clips	No Cable Clips	No cost
	Cable Clips	+\$49
Umbilical Cable Riser	No Cable Riser	No cost
	Umbilical Cable Riser	+\$209

### Specification Information

Style Number      Base Price

## Cubb Six to Eight Person Rectangle Meeting Table

**OBCUBBRCM03**    \$2592

# Cubb Seating and Tables

## Tables

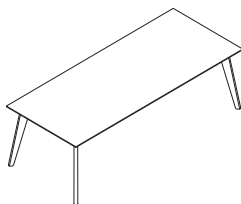

### Standard Includes

- 1" thick table top: Low-Pressure Laminate price group 01
- 3 mm edgeband: plastic price group 01
- Solid oak legs: wood group 01
- Cable management channel with rubber riser inset per leg: black
- Metal chassis: paint price group 01
- Glides

### Options

Top Finish	Laminate LPL Price Group 01	No cost
	Laminate HPL Price Group 01	+\$534
	Laminate HPL Price Group 02	+\$876
	Laminate HPL Price Group 03	+\$1542
	OLL Price Group 1	+\$102
Edge Finish	Plastic Group 1	No cost
Leg Finish	Wood	No cost
Frame Finish	Paint Price Group 01	No cost
	Paint Price Group 02	+\$55
	Paint Price Group 03	+\$111
Power Option	No Power	No cost
	Dean Z 201 - 2 Power	+\$281
	Dean Z 202 - 1 Power, 1 USB	+\$391
	Dean Z 401 - 3 Power, 1 USB	+\$437
	Dean Z 402 - 2 Power, 2 USB	+\$544
	Dean Z 501 - 3 Power, 1 USB-C	+\$670
Power Location	Center Only	No cost
	Left & Right	No cost
	Left Only	No cost
	Left and center	No cost
	Left, Right and center	No cost
	Right Only	No cost
	Right and center	No cost
Plug or Hardwire	Hardwire	No cost
	Plug	No cost
Power Finish	Paint Price Group 01	No cost
	Paint Price Group 02	No cost
Cable Clips	No Cable Clips	No cost
	Cable Clips	+\$49
Umbilical Cable Riser	No Cable Riser	No cost
	Umbilical Cable Riser	+\$209

### Specification Information

Style Number      Base Price

## Cubb Eight Person Rectangle Meeting Table

**OBCUBBRCM04**    \$2672

# Cubb Seating and Tables

## Tables

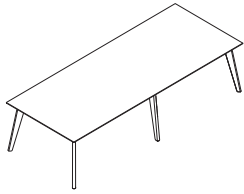

### Standard Includes

- 1" thick table top: Low-Pressure Laminate price group 01
- 3 mm edgeband: plastic price group 01
- Solid oak legs: wood group 01
- Cable management channel with rubber riser inset per leg: black
- Metal chassis: paint price group 01
- Glides

### Options

Top Finish	Laminate LPL Price Group 01	No cost
	Laminate HPL Price Group 01	+\$948
	Laminate HPL Price Group 02	+\$1565
	Laminate HPL Price Group 03	+\$2754
	OLL Price Group 1	+\$102
Edge Finish	Plastic Group 1	No cost
Leg Finish	Wood	No cost
Frame Finish	Paint Price Group 01	No cost
	Paint Price Group 02	+\$55
	Paint Price Group 03	+\$111
Power Option	No Power	No cost
	Dean Z 201 - 2 Power	+\$281
	Dean Z 202 - 1 Power, 1 USB	+\$391
	Dean Z 401 - 3 Power, 1 USB	+\$437
	Dean Z 402 - 2 Power, 2 USB	+\$544
	Dean Z 501 - 3 Power, 1 USB-C	+\$670
Power Location	Left & Right	No cost
	Left Only	No cost
	Right Only	No cost
Plug or Hardwire	Hardwire	No cost
	Plug	No cost
Power Finish	Paint Price Group 01	No cost
	Paint Price Group 02	No cost
Cable Clips	No Cable Clips	No cost
	Cable Clips	+\$49
Umbilical Cable Riser	No Cable Riser	No cost
	Umbilical Cable Riser	+\$209

### Specification Information

Style Number	Base Price
--------------	------------

### Cubb 47" D Eight to Ten Person Rectangle Meeting Table

**OBCUBBRCM05** \$4774



# Cubb Seating and Tables

## Tables

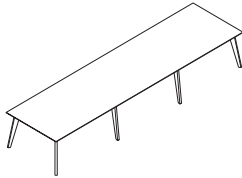

### Standard Includes

- 1" thick table top: Low-Pressure Laminate price group 01
- 3 mm edgeband: plastic price group 01
- Solid oak legs: wood group 01
- Cable management channel with rubber riser inset per leg: black
- Metal chassis: paint price group 01
- Glides

### Options

Top Finish	Laminate LPL Price Group 01	No cost
	Laminate HPL Price Group 01	+\$1366
	Laminate HPL Price Group 02	+\$2251
	Laminate HPL Price Group 03	+\$3965
	OLL Price Group 1	+\$102
Edge Finish	Plastic Group 1	No cost
Leg Finish	Wood	No cost
Frame Finish	Paint Price Group 01	No cost
	Paint Price Group 02	+\$55
	Paint Price Group 03	+\$111
Power Option	No Power	No cost
	Dean Z 201 - 2 Power	+\$281
	Dean Z 202 - 1 Power, 1 USB	+\$391
	Dean Z 401 - 3 Power, 1 USB	+\$437
	Dean Z 402 - 2 Power, 2 USB	+\$544
	Dean Z 501 - 3 Power, 1 USB-C	+\$670
Power Location	Center Only	No cost
	Left & Right	No cost
	Left Only	No cost
	Left and center	No cost
	Left, Right and center	No cost
	Right Only	No cost
	Right and center	No cost
Plug or Hardwire	Hardwire	No cost
	Plug	No cost
Power Finish	Paint Price Group 01	No cost
	Paint Price Group 02	No cost
Cable Clips	No Cable Clips	No cost
	Cable Clips	+\$49
Umbilical Cable Riser	No Cable Riser	No cost
	Umbilical Cable Riser	+\$209

### Specification Information

Style Number      Base Price

## Cubb 47" D 12 to 14 Person Rectangle Meeting Table

**OBCUBBRCM07** \$6870

# Cubb Seating and Tables

## Tables

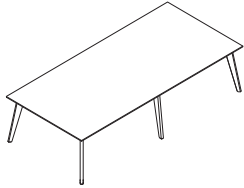

### Standard Includes

- 1" thick table top: Low-Pressure Laminate price group 01
- 3 mm edgeband: plastic price group 01
- Solid oak legs: wood group 01
- Cable management channel with rubber riser inset per leg: black
- Metal chassis: paint price group 01
- Glides

### Options

Top Finish	Laminate LPL Price Group 01	No cost
	Laminate HPL Price Group 01	+\$1030
	Laminate HPL Price Group 02	+\$1701
	Laminate HPL Price Group 03	+\$2993
	OLL Price Group 1	+\$102
Edge Finish	Plastic Group 1	No cost
Leg Finish	Wood	No cost
Frame Finish	Paint Price Group 01	No cost
	Paint Price Group 02	+\$55
	Paint Price Group 03	+\$111
Power Option	No Power	No cost
	Dean Z 201 - 2 Power	+\$281
	Dean Z 202 - 1 Power, 1 USB	+\$391
	Dean Z 401 - 3 Power, 1 USB	+\$437
	Dean Z 402 - 2 Power, 2 USB	+\$544
	Dean Z 501 - 3 Power, 1 USB-C	+\$670
Power Location	Left & Right	No cost
	Left Only	No cost
	Right Only	No cost
Plug or Hardwire	Hardwire	No cost
	Plug	No cost
Power Finish	Paint Price Group 01	No cost
	Paint Price Group 02	No cost
Cable Clips	No Cable Clips	No cost
	Cable Clips	+\$49
Umbilical Cable Riser	No Cable Riser	No cost
	Umbilical Cable Riser	+\$209

### Specification Information

Style Number      Base Price

## Cubb 55" D Eight to Ten Person Rectangle Meeting Table

**OBCUBBRCM09**    \$5189

# Cubb Seating and Tables

## Tables

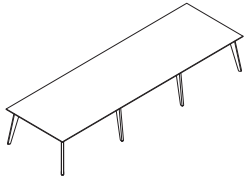

### Standard Includes

- 1" thick table top: Low-Pressure Laminate price group 01
- 3 mm edgeband: plastic price group 01
- Solid oak legs: wood group 01
- Cable management channel with rubber riser inset per leg: black
- Metal chassis: paint price group 01
- Glides

### Options

Top Finish	Laminate LPL Price Group 01	No cost
	Laminate HPL Price Group 01	+\$1450
	Laminate HPL Price Group 02	+\$2391
	Laminate HPL Price Group 03	+\$4207
	OLL Price Group 1	+\$102
Edge Finish	Plastic Group 1	No cost
Leg Finish	Wood	No cost
Frame Finish	Paint Price Group 01	No cost
	Paint Price Group 02	+\$55
	Paint Price Group 03	+\$111
Power Option	No Power	No cost
	Dean Z 201 - 2 Power	+\$281
	Dean Z 202 - 1 Power, 1 USB	+\$391
	Dean Z 401 - 3 Power, 1 USB	+\$437
	Dean Z 402 - 2 Power, 2 USB	+\$544
	Dean Z 501 - 3 Power, 1 USB-C	+\$670
Power Location	Center Only	No cost
	Left & Right	No cost
	Left Only	No cost
	Left and center	No cost
	Left, Right and center	No cost
	Right Only	No cost
	Right and center	No cost
Plug or Hardwire	Hardwire	No cost
	Plug	No cost
Power Finish	Paint Price Group 01	No cost
	Paint Price Group 02	No cost
Cable Clips	No Cable Clips	No cost
	Cable Clips	+\$49
Umbilical Cable Riser	No Cable Riser	No cost
	Umbilical Cable Riser	+\$209

### Specification Information

Style Number      Base Price

## Cubb 55" D 12 to 14 Person Rectangle Meeting Table

**OBCUBBRCM11**    \$7301

# Cubb Seating and Tables

## Tables

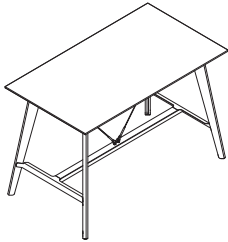

### Standard Includes

- 1" thick table top: Low-Pressure Laminate price group 01
- 3 mm edgeband: plastic price group 01
- Solid oak legs: wood group 01
- Cable management channel with rubber riser inset per leg: black
- Metal chassis and beam: paint price group 01
- Two structural cable attachments with hardware
- Glides

### Options

Top Finish	Laminate LPL Price Group 01	No cost
	Laminate HPL Price Group 01	+\$822
	Laminate HPL Price Group 02	+\$1357
	Laminate HPL Price Group 03	+\$2394
	OLL Price Group 1	+\$102
Edge Finish	Plastic Group 1	No cost
Leg Finish	Wood	No cost
Frame Finish	Paint Price Group 01	No cost
	Paint Price Group 02	+\$111
	Paint Price Group 03	+\$222
Power Option	No Power	No cost
	Dean Z 201 - 2 Power	+\$281
	Dean Z 202 - 1 Power, 1 USB	+\$391
	Dean Z 401 - 3 Power, 1 USB	+\$437
	Dean Z 402 - 2 Power, 2 USB	+\$544
	Dean Z 501 - 3 Power, 1 USB-C	+\$670
Power Location	Center Only	No cost
Plug or Hardwire	Hardwire	No cost
	Plug	No cost
Power Finish	Paint Price Group 01	No cost
	Paint Price Group 02	No cost
Cable Clips	No Cable Clips	No cost
	Cable Clips	+\$49

### Specification Information

Style Number      Base Price

## Cubb Four to Six Person Standing Height Project Table

**OBCUBBRCP01**    \$4140

# Cubb Seating and Tables

## Tables

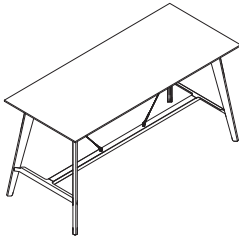

### Standard Includes

- 1" thick table top: Low-Pressure Laminate price group 01
- 3 mm edgeband: plastic price group 01
- Solid oak legs: wood group 01
- Cable management channel with rubber riser inset per leg: black
- Metal chassis and beam: paint price group 01
- Two structural cable attachments with hardware
- Glides

### Options

Top Finish	Laminate LPL Price Group 01	No cost
	Laminate HPL Price Group 01	+\$857
	Laminate HPL Price Group 02	+\$1414
	Laminate HPL Price Group 03	+\$2488
	OLL Price Group 1	+\$102
Edge Finish	Plastic Group 1	No cost
Leg Finish	Wood	No cost
Frame Finish	Paint Price Group 01	No cost
	Paint Price Group 02	+\$111
	Paint Price Group 03	+\$222
Power Option	No Power	No cost
	Dean Z 201 - 2 Power	+\$281
	Dean Z 202 - 1 Power, 1 USB	+\$391
	Dean Z 401 - 3 Power, 1 USB	+\$437
	Dean Z 402 - 2 Power, 2 USB	+\$544
	Dean Z 501 - 3 Power, 1 USB-C	+\$670
Power Location	Center Only	No cost
	Left & Right	No cost
	Left Only	No cost
	Left and center	No cost
	Left, Right and center	No cost
	Right Only	No cost
	Right and center	No cost
Plug or Hardwire	Hardwire	No cost
	Plug	No cost
Power Finish	Paint Price Group 01	No cost
	Paint Price Group 02	No cost
Cable Clips	No Cable Clips	No cost
	Cable Clips	+\$49

### Specification Information

Style Number      Base Price

### Cubb Six to Eight Person Standing Height Project Table

**OBCUBBRCP02**    \$4310

# Cubb Seating and Tables

## Tables

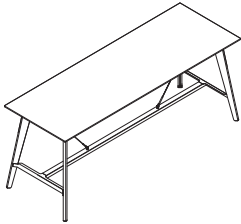

*Tip: OBCUBBRCP03 is unavailable in LPL due to manufacturing restrictions related to the single-piece worksurface size.*

### Standard Includes

- 1" thick table top: Low-Pressure Laminate price group 01
- 3 mm edgeband: plastic price group 01
- Solid oak legs: wood group 01
- Cable management channel with rubber riser inset per leg: black
- Metal chassis and beam: paint price group 01
- Two structural cable attachments with hardware
- Glides

### Options

Top Finish	Laminate HPL Price Group 01	+\$882
	Laminate HPL Price Group 02	+\$1457
	Laminate HPL Price Group 03	+\$2566
	OLL Price Group 1	+\$102
Edge Finish	Plastic Group 1	No cost
Leg Finish	Wood	No cost
Frame Finish	Paint Price Group 01	No cost
	Paint Price Group 02	+\$111
	Paint Price Group 03	+\$222
Power Option	No Power	No cost
	Dean Z 201 - 2 Power	+\$281
	Dean Z 202 - 1 Power, 1 USB	+\$391
	Dean Z 401 - 3 Power, 1 USB	+\$437
	Dean Z 402 - 2 Power, 2 USB	+\$544
	Dean Z 501 - 3 Power, 1 USB-C	+\$670
Power Location	Center Only	No cost
	Left & Right	No cost
	Left Only	No cost
	Left and center	No cost
	Left, Right and center	No cost
	Right Only	No cost
	Right and center	No cost
Plug or Hardwire	Hardwire	No cost
	Plug	No cost
Power Finish	Paint Price Group 01	No cost
	Paint Price Group 02	No cost
Cable Clips	No Cable Clips	No cost
	Cable Clips	+\$49

### Specification Information

Style Number      Base Price

#### Cubb Eight to Ten Person Standing Height Project Table

**OBCUBBRCP03**    \$4442

# Cubb Seating and Tables

## Tables

Cubb Seating and Tables

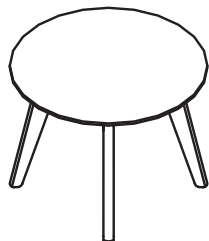

### Standard Includes

- 1" thick table top: Low-Pressure Laminate price group 01
- 3 mm edgeband: plastic price group 01
- Solid oak legs: wood group 01
- Metal chassis: paint price group 01
- Glides

### Options

Top Finish	Laminate LPL Price Group 01	No cost
	Laminate HPL Price Group 01	+\$313
	Laminate HPL Price Group 02	+\$513
	Laminate HPL Price Group 03	+\$901
	OLL Price Group 1	+\$102
Edge Finish	Plastic Group 1	No cost
Leg Finish	Wood	No cost
Frame Finish	Paint Price Group 01	No cost
	Paint Price Group 02	+\$55
	Paint Price Group 03	+\$111

### Specification Information

Style Number	Base Price
<b>Cubb 23 5/8" W Round Occasional Table</b>	
<b>OBCUBBRD001</b>	\$1569

# Cubb Seating and Tables

## Tables

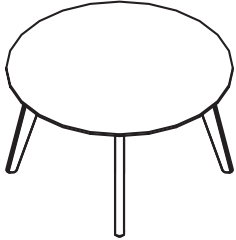

### Standard Includes

- 1" thick table top: Low-Pressure Laminate price group 01
- 3 mm edgeband: plastic price group 01
- Solid oak legs: wood group 01
- Metal chassis: paint price group 01
- Glides

### Options

Top Finish	Laminate LPL Price Group 01	No cost
	Laminate HPL Price Group 01	+\$359
	Laminate HPL Price Group 02	+\$592
	Laminate HPL Price Group 03	+\$1041
	OLL Price Group 1	+\$102
Edge Finish	Plastic Group 1	No cost
Leg Finish	Wood	No cost
Frame Finish	Paint Price Group 01	No cost
	Paint Price Group 02	+\$55
	Paint Price Group 03	+\$111

### Specification Information

Style Number      Base Price

### Cubb 31" W Round Occasional Table

**OBCUBBRD002**    \$1804



# Cubb Seating and Tables

## Tables

Cubb Seating and Tables

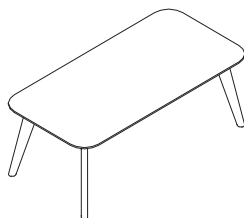

### Standard Includes

- 1" thick table top: Low-Pressure Laminate price group 01
- 3 mm edgeband: plastic price group 01
- Solid oak legs: wood group 01
- Metal chassis: paint price group 01
- Glides

### Options

Top Finish	Laminate LPL Price Group 01	No cost
	Laminate HPL Price Group 01	+\$380
	Laminate HPL Price Group 02	+\$628
	Laminate HPL Price Group 03	+\$1107
	OLL Price Group 1	+\$102
Edge Finish	Plastic Group 1	No cost
Leg Finish	Wood	No cost
Frame Finish	Paint Price Group 01	No cost
	Paint Price Group 02	+\$55
	Paint Price Group 03	+\$111

### Specification Information

Style Number	Base Price
--------------	------------

### Cubb Rectangle Occasional Table

**OBCUBBRC001** \$1923

# Cubb Seating and Tables

## Tables

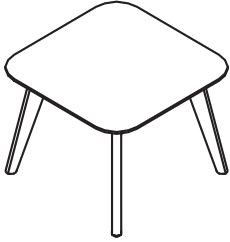

### Standard Includes

- 1" thick table top: Low-Pressure Laminate price group 01
- 3 mm edgeband: plastic price group 01
- Solid oak legs: wood group 01
- Metal chassis: paint price group 01
- Glides

### Options

Top Finish	Laminate LPL Price Group 01	No cost
	Laminate HPL Price Group 01	+\$320
	Laminate HPL Price Group 02	+\$530
	Laminate HPL Price Group 03	+\$930
	OLL Price Group 1	+\$102
Edge Finish	Plastic Group 1	No cost
Leg Finish	Wood	No cost
Frame Finish	Paint Price Group 01	No cost
	Paint Price Group 02	+\$55
	Paint Price Group 03	+\$111

### Specification Information

Style Number      Base Price

### Cubb Square Occasional Table

**OBCUBBSQ001**    \$1615



# Style Number Index

Style Number	Page	Description
<b>OB1AIR23</b>	42	Air <sup>3</sup> ; Half-Sq, Opening roof
<b>OB1AIR25</b>	44	Air <sup>3</sup> ; Sq, Opening roof
<b>OB1AIR27</b>	46	Air <sup>3</sup> ; Rect, Opening roof
<b>OB1AIR29</b>	48	Air <sup>3</sup> ; Sq-3x3, Opening roof
<b>OB1AIR30</b>	49	Air <sup>3</sup> ; Pod table-Small
<b>OB1AIR35</b>	49	Air <sup>3</sup> ; Pod table-Short, Str
<b>OB1AIRGA151</b>	50	Magnetic-Whiteboard, Glass, Str
<b>OB1AIRGA153US</b>	50	Monitor bracket-Hoop mounted
<b>OB1AIRGA174US</b>	50	Monitor bracket-Over upholster
<b>OB1AIRGA176</b>	51	Air25 Pod Seismic Kit
<b>OB1AIRGA180</b>	51	Air23 Pod Seismic Kit
<b>OB1AIRGA181</b>	51	Air27 Pod Seismic Kit
<b>OB1AIRGA204</b>	51	Air29 Pod Seismic Kit
<b>OB1AIRINSTALL1</b>	50	Air <sup>3</sup> Installation Training-1 to 5 units
<b>OB1AIRINSTALL2</b>	50	Air <sup>3</sup> Installation Training-6 to 10 units
<b>OB1AIRINSTALL3</b>	50	Air <sup>3</sup> Installation Training-11+ units
<b>OB1QT01</b>	54	Short Angled Phone Booth, LH
<b>OB1QT02</b>	54	Short Angled Phone Booth, RH
<b>OB1QT03</b>	57	Tall Angled Phone Booth, LH
<b>OB1QT04</b>	57	Tall Angled Phone Booth, RH
<b>OB1QTF01</b>	59	Furniture Seat, LH
<b>OB1QTF02</b>	59	Furniture Seat, RH
<b>OBAD01</b>	92	Str Seat-Mod, 31½W
<b>OBAD02</b>	94	Str Seat-Mod, Back, 31½W
<b>OBAD03</b>	97	Str Seat-Mod, Back, Scr, 31½W
<b>OBAD03LC</b>	97	Str seat-Back, LH, Tprd Scr, 31½W
<b>OBAD03RC</b>	97	Str seat-Back, RH, Tprd Scr, 31½W
<b>OBAD101</b>	142	Sgl seat-Det, Unit
<b>OBAD101LT</b>	142	Sgl seat-Det, Unit, Int tablet, LH
<b>OBAD101RT</b>	142	Sgl seat-Det, Unit, Int tablet, RH
<b>OBAD102</b>	144	Sgl seat-Det, Unit, Scr
<b>OBAD102LT</b>	144	Sgl seat-Det, Unit, Scr, Int tablet, LH
<b>OBAD102RT</b>	144	Sgl seat-Det, Unit, Scr, Int tablet, RH
<b>OBAD103</b>	145	Three seat-Det, Unit
<b>OBAD11</b>	98	Str Seat-Mod, 707/8W
<b>OBAD12</b>	100	Str Seat-Mod, Back, 707/8W
<b>OBAD13</b>	103	Str Seat-Mod, Back, Scr, 707/8W
<b>OBAD21</b>	105	Seat-Mod, 120°
<b>OBAD22</b>	108	Seat-Ext back, 120°, Mod
<b>OBAD23</b>	111	Seat-Ext back, 120°, Scr, Mod
<b>OBAD23LC</b>	111	Seat-Ext back, 120°, LH, Tprd Scr, Mod
<b>OBAD23RC</b>	111	Seat-Ext back, 120°, RH, Tprd Scr, Mod
<b>OBAD24</b>	113	Seat-Intl back, 120°, Mod
<b>OBAD25</b>	116	Seat-Intl back, 120°, Scr, Mod
<b>OBAD31</b>	118	Tri Seat-Mod, 120°
<b>OBAD32</b>	121	Tri seat-Intl back, 120°, Mod
<b>OBAD33</b>	124	Tri seat-Intl back, 120°, Scr, Mod
<b>OBAD42</b>	127	Seat-Back, 90°, Mod
<b>OBAD43</b>	130	Seat-Back, 90°, Scr, Mod
<b>OBAD52</b>	132	Curved seat-Back, 90°, Mod
<b>OBAD53</b>	135	Curved seat-Back, 90°, Scr, Mod
<b>OBAD64SRO</b>	136	Lrg Uph Trprd base-Round top, Small, Mod
<b>OBAD81DS</b>	137	Media unit-Low, Top, D shaped
<b>OBAD85</b>	147	Media den-Enclosed

Style Number	Page	Description
<b>OBAD85A</b>	149	Media den-Enclosed, 4 to 6 ppl
<b>OBAD91LRO</b>	139	Huddle buddle-Group working table, 55½ dia
<b>OBAD91SRO</b>	138	Huddle buddle-Group working table, 47¼ dia
<b>OBAD92</b>	140	Table-Low, 23½ dia
<b>OBASPECT07HB</b>	61	Aspect; Work unit with curved arm-1 seat
<b>OBASPECT08HB</b>	63	Aspect; Work unit with curved arm-2 seat
<b>OBASPECT09HB</b>	65	Aspect; Work unit with curved arm-3 seat
<b>OBASPECT57HB</b>	69	Aspect; Work Scred unit with fixed table-2 seat
<b>OBASPECT58HB</b>	73	Aspect; Work Scred unit with fixed table-4 seat
<b>OBASPECT59HB</b>	77	Aspect; Work Scred unit with fixed table-6 seat
<b>OBAVI01</b>	79	Avi; Chair-Uph,Swvl base
<b>OBAVI02</b>	79	Avi; Chair-Uph,Swvl base,Hood
<b>OBAVI03</b>	80	Avi; Chair-Uph,Wire frm base
<b>OBAVI04</b>	80	Avi; Chair-Uph,Wire frm base,Hood
<b>OBORDER01</b>	87	Border; 1 seat-Low,Tbl, 32 dia
<b>OBORDER02</b>	88	Border; 2 seat-Low,Tbl, 32 dia
<b>OBORDER03</b>	89	Border; 1 seat-Hi,LH,Tbl, 32 dia
<b>OBORDER04</b>	89	Border; 1 seat-Hi,RH,Tbl, 32 dia
<b>OBORDER05</b>	91	Border; 2 seat-Hi,Tbl, 32 dia
<b>OBCUBB01</b>	150	Cubb; Chair-Armless, Wood legs
<b>OBCUBB02</b>	151	Cubb; Chair-Uph arm, Wood legs
<b>OBCUBB03</b>	152	Cubb; Chair-Wire arm, Wood legs
<b>OBCUBB04</b>	153	Cubb; Chair-Armless, Trestle base, 4 star
<b>OBCUBB05</b>	154	Cubb; Chair-Uph arm, Trestle base, 4 star
<b>OBCUBB06</b>	155	Cubb; Chair-Wire arm, Trestle base, 4 star
<b>OBCUBB07</b>	156	Cubb; Chair-Armless, Wire frame base
<b>OBCUBB08</b>	157	Cubb; Chair-Uph arm, Wire frame base
<b>OBCUBB09</b>	158	Cubb; Chair-Wire arm, Wire frame base
<b>OBCUBB10</b>	159	Cubb; Chair-Armless, Base, 5 star
<b>OBCUBB11</b>	160	Cubb; Chair-Uph arm, Base, 5 star
<b>OBCUBB12</b>	161	Cubb; Chair-Wire arm, Base, 5 star
<b>OBCUBB13</b>	162	Cubb; Barstool-Base, Oak
<b>OBCUBB14</b>	163	Cubb; Barstool-Wire frame base
<b>OBCUBB15</b>	164	Cubb; Stool-Occasional, Base, Oak
<b>OBCUBB19</b>	165	Cubb; Bench-2 seat
<b>OBCUBBRM01</b>	172	Cubb; Table-Mtg, 4 pers, Rect
<b>OBCUBBRM02</b>	173	Cubb; Table-Mtg, 4-6 ppl, Rect
<b>OBCUBBRM03</b>	174	Cubb; Table-Mtg, 6-8 ppl, Rect
<b>OBCUBBRM04</b>	175	Cubb; Table-Mtg, 8 pers, Rect
<b>OBCUBBRM05</b>	176	Cubb; Table-Mtg, Rect, 8-10 ppl, 47 D
<b>OBCUBBRM07</b>	177	Cubb; Table-Mtg, Rect, 12-14 ppl, 47 D
<b>OBCUBBRM09</b>	178	Cubb; Table-Mtg, Rect, 8-10 ppl, 55 D
<b>OBCUBBRM11</b>	179	Cubb; Table-Mtg, Rect, 12-14 ppl, 55 D
<b>OBCUBBRM001</b>	185	Cubb; Table-Rect, Occasional
<b>OBCUBBRCP01</b>	180	Cubb; Table-Project, 4-6 ppl, Standing height
<b>OBCUBBRCP02</b>	181	Cubb; Table-Project, 6-8 ppl, Standing height
<b>OBCUBBRCP03</b>	182	Cubb; Table-Project, 8-10 ppl, Standing height
<b>OBCUBBRDM01</b>	166	Cubb; Table-Mtg, 4 pers, Round
<b>OBCUBBRDM02</b>	167	Cubb; Table-Mtg, 6 pers, Round
<b>OBCUBBRDM03</b>	168	Cubb; Table-Mtg, 7 pers, Round
<b>OBCUBBRDM04</b>	169	Cubb; Table-Mtg, 8 pers, Round
<b>OBCUBBRDO01</b>	183	Cubb; Table-Round, Occasional, 23½ W
<b>OBCUBBRDO02</b>	184	Cubb; Table-Round, Occasional, 31 W
<b>OBCUBBSQM01</b>	170	Cubb; Table-Mtg, 4 pers, Sq

<b>Style Number</b>	<b>Page</b>	<b>Description</b>
<b>OBCUBBSQ001</b>	186	Cubb; Table-Sq, Occasional
<b>OBCUBBSSM01</b>	171	Cubb; Table-Mtg, 4 pers, Sq, Softened corners
<b>OBSRAMSEY01</b>	85	Ramsey; Chair-Work, Uph
<b>OBSSKOMERO1</b>	83	Skomer; Arm chair-Uph
<b>OBSSULLY01</b>	81	Sully; Stool-Uph

# Trademark List

- ® The following are registered trademarks for products of Steelcase Inc. or one of its related corporate entities: 4 o'clock, 900 Series, à la carte, Airtouch, Ally, Amia, Answer, Archipelago, Avenir, Ballet, Bix, Brayton International, Cachet, Canopy, Canto, Chancellor, Coalesse, Confidante, Context, Convene, CopyCam, Criterion, Crushed Can, Currency, dash, Designtex, Details, Detour, Drive, Elective Elements, Ellipse, Ember Chrome, Emerge, E-Table 2, FYI, Garland, Gentry, Ginkgo Biloba, Groupwork, Ideo, Jacket, Jenny, Jersey, Kart, Kick, LaCosta, Leap, LessThanFive, Let's B, LiveBack, Max-Stacker, media:scape, Metro, Migrations, Mitra, Montage, Nurture, Oriana, Parade, Pathways, PCT, Permiso, Player, Portal, Power Pincher, Progeny, Protégé, R2, Rally, Relevant, Reply, Rizzi Arc, Sensor, Series 9000, Siento, Sieste, Sine, Softcare, Springboard, Steelcase, Steelcase Design Partnership, Stella, Stow Davis, Swathmore, Sylvi, TeamWork, Technique, Texpress, Think, Thunder, Topo, Train, turnstone, Underline, Unison, Vecta, Viridian, Walden, Wernld, and X-Stack.
- ® The following registered trademarks are under license from AWI Licensing Company, Dover, DE: SoundScapes, DuraBrite, BioBlock, and Armstrong.
- ® The following registered trademarks are under license from Byrne Electrical, Rockford, MI: Interport, Mini-Port, Axil Z, and Ellora.
- ® The following is a registered trademark of DuPont, Wilmington, DE: Corian.
- ® The following is a registered trademark of Genlyte Thomas Company, Louisville, KY: Lightolier.
- ® The following is a registered trademark of Hilti Corporation, FL-9494 Schaan, Principality of Liechtenstein: Hilti.
- ® The following is a registered trademark of Leviton Manufacturing Company, Little Neck, NY: Decora.
- ® The following is a registered trademark of Mechanical Plastics Corp, Elmsford, NY: Toggler.
- ® The following is a registered trademark of Microsoft Corporation, Redmond, WA: Microsoft.
- ® The following are registered trademarks of Orangebox Ltd., Cardiff, UK: Orangebox.
- ® The following is a registered trademark of Panduit Corporation, Lockport, IL: Panduit.
- ® The following is a registered trademark of Trav (Press), Cuneo, Italy: Assisa.
- ® The following is a registered trademark of Virtual Ink, Boston, MA: mimioActive.
- ® The following registered trademarks are under license from Wilkhahn Furniture Products: Avera, Senzo, Versal, and Wilkhahn FS.
- ® The following are registered trademarks of Polyvision Corp: Flow, Motif, Polyvision, Sans, and Serif.
- ® The following is a registered trademark of Wilsonart International, Temple, TX: Chemsurf.
- ® The following is a registered trademark of Wiremold, West Hartford, CT: Wiremold.
- ® The following is a registered trademark of EMU Group S.P.A., Perugia, Italy: EMU.
- ® The following is a registered trademark of Security People, Inc.: Digilock.
- ® The following are registered trademarks of Natural Capital Partners Europe Limited: CarbonNeutral and the CarbonNeutral Certified logo.
- ™ The following are trademarks for products of Steelcase Inc. or one of its related corporate entities: Access, Active/Passive Shelf, Agree, Ainsley, Akira, Alcove, Alerion, Alight, Amaris, American Elect, American Tradition, ap40, Arbor, Arriva, Asana, Ascot, Aspekt, Astor, Await, Bassline, B-Free, Bira, Bivi, Bixby, Bottomline, Brody, Brook, Buoy, Burton, c:scape, Calla, Calm, Camber, Campfire, Capa, Cappuccino, Cesar, Chester, Chord, Circa, Clarendon, Classic Rectangular, Clipper, cobl, Collaboration, Community, Company, Convey, Cortex, Coupe, Crea, Crew, Cura, Cypress, Davenport, Dearborn, Deck, Déjà, Denizen, Denska, Derby, DeskWizard, Divisio, Donovan, Dune, Duo, Echo, Edge, Elbrook, Elsa, Empath, Empress, Enea, ño, EnSync, Enviro, Escapade, Everwall, Exchange, Exponents, Field, Flat Top, FlexFrame, Flip Top, Flute, Folio, FrameOne, FreeFlow, Frontier, Galilei, Gesture, Ginger, Ginkgo, Go Wall, Grip, Groove, Hatchback, Hawthorne, Hitch, Host Collection, Hosu, Huddleboard, i2i, Impact, Indy, InfoLink, IOS, I-Solve, Jack, Jarrah, Jetty, Juice, Kami, Kast, Kathryn, Lagunitas, Lark, L'Attitude, LearnLab, Leela, Lincoln, Linden, LiveSeat, Loria, Lyric, Malibu, Malibu Too, Mansfield, Marathon, Marien152, Martini, Mason, Masque, Migration, Millbrae, Mineral, Mingle, Mystic, Mystic Metal, Mystic Wood, Montara650, Montreal, MoreThanFive, Move, Nadia, Neighbor, nesso, Nickel, Nikko, Nod, Node, Norfolk, Ocular, Ology, Ontrak, Oom, Opus, Orchid, Outlook Collection, Ovation, Paloma, Paperflo, Parliament, Pasio, Passerelle, Patriarch, Payback, Peek, Pile File, Pisa, Pool, Potrero415, PUCK, QiVi, Quba, Rave, Reed, Regard, Relay, Reunion, Ripple, Riser, Roam, Rocco, Rocky, RoomWizard, Runner, Satellite, Sawyer, ScapeSeries, Senti, Sentinel, Senza, Sequoia, Session, ShareLink, Shield, Shortcut, Sidewalk, SILQ, Skylar, Slumber, Smoke, Snug, Soft Leaf, Sonata, Sorrel, SOTO, Southside, Stationkits, Steelcase Karman, Steelcase Series, Stiletto, Surprise!, Surround, Switch, Symphony, Sync, TagWizard, Tava, TeamStudio, TeamTheater, Tenaro, Tenor, Terrazzo, Theorem, Thread, Topaz, Touchdown, Tour, Tower Too, Trees, Trillium, Trolly, tX2, U-Free, Umami, Underscore, Uno, V.I.A., Verb, Verge, Verlay, Victor2, Visalia, Waldorf, Woodruff, Workspring, WorkValet and X-tenz.
- ™ The following is a trademark of Microsoft Corporation, Redmond, WA: Windows.
- ™ The following is a trademark of Rodman Industries, Inc., Oconomowoc, WI: ResinCore1.
- ™ The following is a trademark of Ultrafabrics, LLC, Elmsford, NY: Ultraleather.
- ™ The following trademarks are under license from Wilkhahn Furniture products: Cana, Linus, Logon, Picto, Range, Stitz, Thema, Timetable, and Tubis.
- ™ The following is a trademark of Cradle to Cradle Products Innovation Institute, Oakland, CA: Cradle to Cradle Certified.
- ™ The following trademarks are under license from Walter Knoll: Andoo, Bob, Lazlo, Lox, Ribbon, and Together.
- ™ The following trademarks are under license from PP Møbler: Bar and Flag Halyard.
- ™ The following trademarks are under license from Carl Hansen: Elbow, Paddle, Shell, Wing, and Wishbone.
- ™ The following trademarks are under license from Cambridge Sound Management, LLC, Cambridge, MA: QtPro Soundmasking, Qt Quiet Technology, and Sonet Qt.
- ™ The following is a trademark of Electri-Cable Assemblies, Shelton, CT: Interact.
- ™ The following is a trademark of Clestra Hauserman: IRYS.
- ™ The following is a trademark of Wiesner-Hager Möbel GmbH: Nooi.
- ™ The following are trademarks of Polyvision: Accord, a<sup>3</sup>, e<sup>3</sup>, Boundri, and Nota.
- ™ The following is a trademark of Bostock Company, Inc: SnapCab.
- ™ The following is a trademark of Williams-Sonoma, Inc: West Elm.
- ™ The following is a trademark of Elena Marquina Testor: nanimarquina.
- ™ The following is a trademark of Forbo International SA: Forbo.
- ™ The following are trademarks of Orangebox Ltd., Cardiff, UK: Air<sup>3</sup>, Aspect, Avi, Away from the Desk, Border, Campers & Dens, Coppice, Cubb, Kim, On the QT, Ramsey, Skomer, Sully, Track-B, and Vale.
- ™/® The following are trademarks or registered trademarks of AMQ Solutions, LLC: AMQ, AMQ logo, KINEX, iLINE, ACTIV, AMOBI, CONCUR, 3F, REVI, S-SERIES, JAKU, SIYA, ZILO, BODI, FL-X, TIZU, EMBANK, TEKTIS and BIXBY.
- ™/® The following are trademarks or registered trademarks of Viccarbe Habitat, S.L.: Holy Day, Last Minute, Wrapp, Foro, Kelly, Noha, Viable, Solar, Sistema, Savina, Designed In The Sun, Cambio, Aleta, Viccarbe (logo), Viccarbe.

*Trademarks used here in are the property of Steelcase Inc. or of their respective owners.*