

## **NOTICE TO AUTHORIZED USERS OF AWARD #23295 - Furniture, All Types (Except Hospital Room and Patient Handling)**

This pricelist/catalog **may** contain items that are not within the Scope of the Contract Award and/or not within this Contractors approved furniture Categories. All Authorized Users are strongly encouraged to review the Scope of the Award and the Contractors Category Matrix prior to selecting items for purchase under the Contract. Per Solicitation Section 4.5 (D) - Procurement Instructions for Authorized Users: When placing orders under this Award, the Authorized User should follow and be familiar with the terms and conditions governing the Contract and are responsible for determining that the product(s) they intend to purchase fit within the scope of the Award.

References to other government contracts that may be included in a Contractor's pricelist/catalog, including any additional terms or conditions, are void under the OGS Award and should be disregarded. Only OGS' Terms and Conditions, including those within a Contractor's posted Contractor Information and Supplemental Information sheet, are valid under the Contract.

Additionally, Authorized Users are reminded that where discrepancies exist between Price List documents, the lowest price shall prevail (see Section 5.3 Price).

All orders must be placed with the Contractor, or the Contractor's OGS approved Authorized Reseller listed on the OGS website under the Award. Orders placed with a reseller not approved by OGS are not considered contract orders and therefore are not subject to the same terms and conditions of the OGS Award.

Authorized Users should contact the OGS Contract Manager listed on the Award with any questions pertaining to this pricelist/catalog.

# **NYS Price List Effective 3/4/24**



# **Steelcase Pricing and Specification Guides**

# Everwall Specification Guide

## Availability

**Electronic price list updated** with release 200.G (U.S.) and 156.G (Canada), dated June 19, 2023.

All specifications subject to change without notice. Reference the electronic catalog/Hedberg for current pricing.

Transitional products in this specification guide are **maintained for existing customers only** and are likely to be phased out over time. These products are indicated with a . Products that are scheduled to be culled are indicated with an , followed by the last order entry date.

## Surface Materials

**The surface materials team** has announced the launch of the Finish Library, found at <https://finishlibrary.steelcase.com/>.

► For a list of all trademarks, refer to the last page of this specification guide. © 2023 Steelcase Inc.

## Working With This Specification Guide

|                                                |   |
|------------------------------------------------|---|
| Ten Tips: How to Get the Most Out of This Book | 4 |
| Additional Resources                           | 6 |

## Statement of Line

8

## Understanding

|                                   |    |
|-----------------------------------|----|
| Structural Frame Components       | 22 |
| Hang-on Components                | 25 |
| Ceiling Clip Application          | 26 |
| Skins                             | 28 |
| Unitized Glass                    | 32 |
| Glass Frame Kits                  | 36 |
| Swing Doors                       | 38 |
| Slider Doors                      | 42 |
| Door Pulls                        | 46 |
| Posts                             | 50 |
| Adapters                          | 52 |
| Vertical Transition to Lite Scale | 54 |
| Bypass                            | 56 |
| Cutable Ends                      | 58 |
| Mini End and Wall Start           | 60 |
| Electrical Components             | 62 |
| Electrical Location               | 68 |
| Electrical Wiring Schematics      | 71 |
| How to Calculate Power Needs      | 72 |

► **Table of Contents, continued on next page**



### For Canadian Pricing

Canadian factor can be found at [www.steelcase.com/CADpricing](http://www.steelcase.com/CADpricing). Calculate in the following order to avoid rounding errors:

- Multiply the base price and each option by the Canadian factor.
- Round each to the nearest dollar.
- Add base and options for total list price.

► **Table of Contents, continued from previous page**

**Specifying**

|                             |            |
|-----------------------------|------------|
| Structural Frame Components | <b>74</b>  |
| Hang-on Components          | <b>80</b>  |
| Skins                       | <b>82</b>  |
| Unitized Glass              | <b>90</b>  |
| Glass Frame Kits            | <b>94</b>  |
| Swing Doors                 | <b>96</b>  |
| Slider Doors                | <b>107</b> |
| Door Pulls                  | <b>112</b> |
| Posts                       | <b>114</b> |
| Adapters                    | <b>116</b> |
| Bypass                      | <b>119</b> |
| Cutable Ends                | <b>120</b> |
| Mini End and Wall Start     | <b>126</b> |
| Electrical Components       | <b>127</b> |

**Surface Materials** **135**

**Resources** **141**

|                    |            |
|--------------------|------------|
| Style Number Index | <b>142</b> |
|--------------------|------------|



# Ten Tips: How to Get the Most Out of This Book

## Tip 1

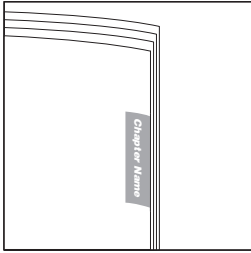

**Watch** the tabs on the right-hand edges of the pages. They'll always indicate which chapter you are in.

## Tip 2

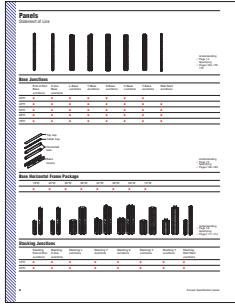

**Use the Statement of Line pages** for an overview of the available components, their sizes, and page references for additional information. Each *Understanding* chapter includes a statement of line after the table of contents.

## Tip 3



**Find cross references** by looking for page numbers flagged with an arrow.

## Tip 4

**Study the product detail pages** in the *Understanding* section to learn everything an expert knows about specific products. Each product detail page in this section contains the following features, where applicable:

- Product Drawing
- Actual Dimensions
- Product Details
- Connections
- Wiring and Cabling
- Surface Materials
- Application Topics

**Product Drawing** shows you what the product looks like and points out important features.

**Product Details** gives specific information on the product and how it is used.

**Connections** describes how the product is assembled or how it attaches to another product.

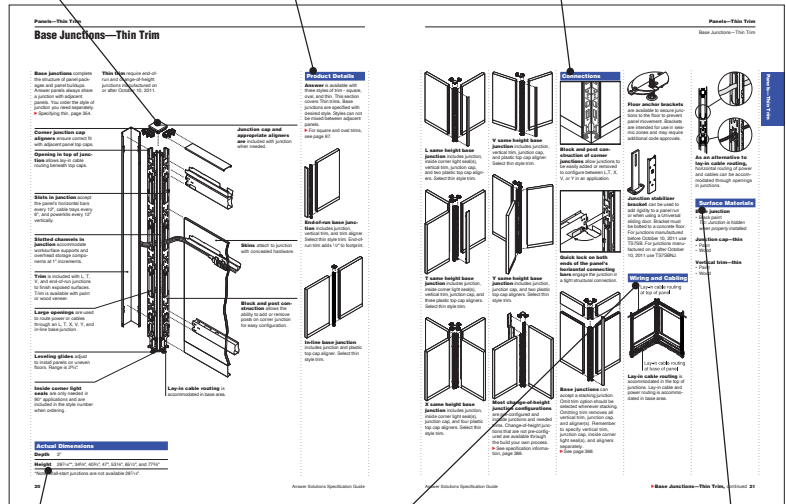

**Actual Dimensions** table lists the dimensions of the product.

**Wiring and Cabling** details the power and cable-management and cable routing capabilities of the product.

**Surface Materials** lists what material is used for each part of the product.

**Tip 5**

**Refer to the specifying pages** for all the information needed to order a product. Each product specifying page contains a variety of elements to help you complete a specification:

- Product Drawing
- Standard Includes
- Required to Specify
- Options
- Related Products
- Specification Information
  - Dimensions
  - Style Number
  - Price

**Product Drawing** shows you what the product looks like.

**Standard Includes** (under the red or dark grey band) provides a list of what comes standard with the product.

**Required to Specify** (under the red or dark grey band) itemizes the information that you must provide to order the standard product and the preferred sequence for specification.

**Specification Information** (under the teal or light grey band) provides product dimensions, style numbers, and prices for the standard product and any surface material choices that are available.

**Standard Includes**

- Standard length (100, 120, 144, 168, 192) (see page 19)
- Base trim with no backcoat (see 197) (see page 19)
- Base trim with backcoat (197) (see page 19)
- See page 19 for information on the backcoat

**Options**

| Option              | Unit  | Price |
|---------------------|-------|-------|
| Paint (see page 19) | sq ft | 1.00  |
| Paint (see page 19) | sq ft | 1.00  |
| Paint (see page 19) | sq ft | 1.00  |

**Required to Specify**

| Option              | Unit  | Price |
|---------------------|-------|-------|
| Paint (see page 19) | sq ft | 1.00  |
| Paint (see page 19) | sq ft | 1.00  |
| Paint (see page 19) | sq ft | 1.00  |

**Specification Information**

| Style Number | Width | Depth | Price | Option |
|--------------|-------|-------|-------|--------|
| 100          | 100   | 100   | 100   | 100    |
| 120          | 120   | 120   | 120   | 120    |
| 144          | 144   | 144   | 144   | 144    |
| 168          | 168   | 168   | 168   | 168    |
| 192          | 192   | 192   | 192   | 192    |

**Options** (under the black band) lists all the options that apply to the product, their price, and what is required to specify.

**Related Products** provide specification information for products that are directly related.

**Tip 6**

**Required to Specify**

Specify with *Customiz Stain*

**Italic typeface** on specifying pages usually identifies wording that you should use in your order.

i

**Tip 7**

**To determine** how many skins are needed to complete a panel, consult the table at the right.  
*Tip: Remember to order skins for both sides of the panel buildup.*

**Watch for tips** throughout the text that give you explanations and helpful instructions.

**Tip 8**

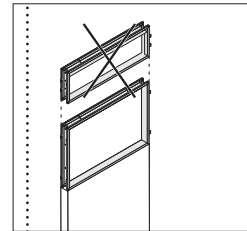

**Learn what you cannot do** by looking for drawings crossed out with an "X."

**Tip 9**

**Use the surface materials listings** in the Surface Materials section of this book to find surface material color numbers.

**Tip 10**

| Style Number    | Page |
|-----------------|------|
| <b>TS7042BL</b> | 131  |
| <b>TS7042S</b>  | 130  |
| <b>TS7048BL</b> | 131  |
| <b>TS7048S</b>  | 130  |
| <b>TS7060BL</b> | 131  |
| <b>TS7060S</b>  | 130  |
| <b>TS7072BL</b> | 131  |

**Refer to the style number index** when you need a style number and you need to find the page that has more details about the product.

# Additional Resources

**Everwall** is supported with informational materials, tools, and software to help you plan, specify, and order an installation efficiently.

**Product brochures and planning tools** can be ordered through your Steelcase area office by calling 1.800.784.0358 or through Marketing Resources web site at [village.steelcase.com](http://village.steelcase.com).

## Printed Materials

### Surface Materials Reference Manual

This publication provides:

- An explanation of the surface materials
- "Available on" matrices
- Vertical surface fabric and seating upholstery selection listing
- Technical data for surface materials
- Surface material care and cleaning instructions

## Computer Tools

### SmartTools

**Everwall** is designed and structured to offer the designer a broad range of dimensional and planning choices. By leveraging the parametric and functional options to best suit a given solution, a **Everwall** application can be as simple or intricate as the design criteria demands.

**To help speed the product application process and ensure that product interfaces have been properly planned,** all **Everwall**

projects will be drawn using **SmartTools** in order to create a bill of material and then link to Hedberg.

**All of the product logic and parametric values that are contained within this specification guide** have been

incorporated into **SmartTools** planning logic. This content is important in understanding overall product capabilities and performance. However, a full understanding is not required for planning with **Everwall**, as **SmartTools** will assist by offering the appropriate feedback and preventing any applications that don't comply with product logic.

### Electronic Catalog

Accurate sales quotations and purchase orders for Steelcase products are created with specification software that uses Steelcase Electronic Catalog data. Use the data to specify and price style numbers and options for every Steelcase product. The data is updated bimonthly by Steelcase and provided to software programs including: the Hedberg Business System, **SmartTools**—Steelcase's design and specification software (for more information on **SmartTools**, please email [SmartTools@steelcase.com](mailto:SmartTools@steelcase.com)), the ProjectMatrix ProjectSymbols libraries.

## Digital Publications

You can access these digital publications at [www.steelcase.com](http://www.steelcase.com) or [village.steelcase.com](http://village.steelcase.com).

### Everwall Product Training

Basic training for the products included in the **Everwall** product portfolio is available on the Steelcase University website at [village.steelcase.com](http://village.steelcase.com).

## Support

### Steelcase Capabilities

Steelcase products are distributed, installed, and serviced through a network of more than 600 dealers worldwide. Steelcase is also represented with offices and corporate showrooms in 26 U.S. cities, 4 Canadian cities, and in France, Germany, Great Britain, and Japan. Every Steelcase product meets our exceptionally high standards of quality and durability and comes with the Steelcase assurance of excellence in service.

### For ordering or product assistance,

please call line one at 1.888.STEELCASE (1.888.783.3522) or send an e-mail to [lineone@steelcase.com](mailto:lineone@steelcase.com) for product application and specification assistance.

Call the Steelcase Solutions Resource Team for assistance prior to placing an order or when working on a bid.

Call the Steelcase Solutions Fulfillment Team if you have submitted an order to Steelcase and you need to speak to your Solutions Fulfillment Team Representative about the order. Also call if you have any post shipment quality concerns or service parts questions.

For warranty information, please go to <http://www.steelcase.com/warranty/>.

Outside the U.S.A., Canada, Mexico, Puerto Rico, and the U.S. Virgin Islands, call 1.616.247.2500.

For information about Steelcase, the name of your nearest Steelcase dealer, or for product literature, call 1.800.333.9939, or visit our Web site: [www.steelcase.com](http://www.steelcase.com).





# Statement of Line

## Structural Frame Components

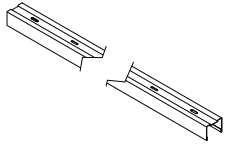

Understanding  
▶ Page 22  
Specifying  
▶ Page 74



Understanding  
▶ Page 22  
Specifying  
▶ Page 75

### Ceiling Track

120" 144"

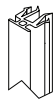

Understanding  
▶ Page 22  
Specifying  
▶ Page 76

### Structural Frame—Solid

84"H–120"H x 8"W–60"W



Understanding  
▶ Page 22  
Specifying  
▶ Page 77

### Frame Coupler

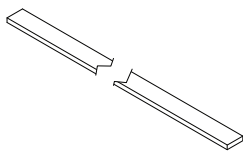

Understanding  
▶ Page 22  
Specifying  
▶ Page 78

### Ceiling Fastener

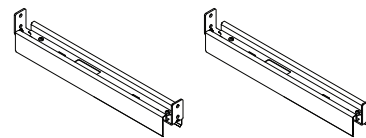

Understanding  
▶ Page 23  
Specifying  
▶ Page 79

### Floor Guide

### Monitor Support Horizontals

24"W–60"W



## Hang-on Components

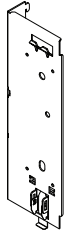

Understanding  
▶ Page 25  
Specifying  
▶ Page 80

### Elective Elements Storage Bracket

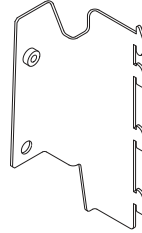

Understanding  
▶ Page 25  
Specifying  
▶ Page 80

### Elective Elements Organizer and Open Shelf Bracket



Understanding  
▶ Page 25  
Specifying  
▶ Page 80

### Universal Vertical Off Module Bracket



Understanding  
▶ Page 25  
Specifying  
▶ Page 80

### Universal Storage Bracket

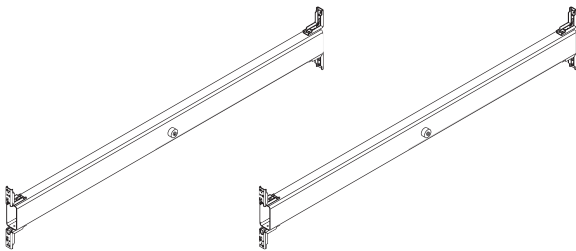

Understanding  
▶ Page 25  
Specifying  
▶ Page 81

### French Cleat Support

12"W-60"W



**Skins**



Understanding  
▶ Page 28  
Specifying  
▶ Page 82

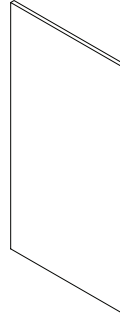

Understanding  
▶ Page 28  
Specifying  
▶ Page 83

**Solid Skin—Laminate**

12"H–120"H x 8"W–120"W

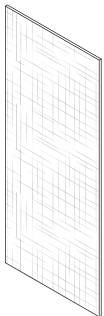

Understanding  
▶ Page 28  
Specifying  
▶ Page 84

**Solid Skin—Laminate Markerboard**

12"H–120"H x 8"W–120"W

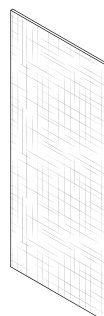

Understanding  
▶ Page 28  
Specifying  
▶ Page 85

**Solid Skin—Fabric**

12"H–120"H x 8"W–120"W

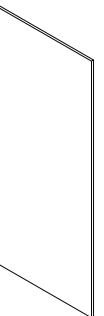

Understanding  
▶ Page 28  
Specifying  
▶ Page 86

**Solid Skin—Steel, Fabric**

12"H–120"H x 8"W–120"W

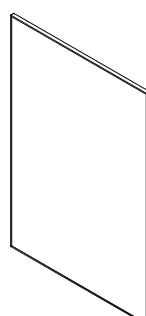

Understanding  
▶ Page 28  
Specifying  
▶ Page 87

**Solid Skin—Steel, Painted**

12"H–120"H x 8"W–120"W



**Solid Skin—Ceramic Markerboard**

24"H–120"H x 24"W–120"W



## Skins, continued

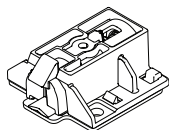

Understanding  
▶ Page 28  
Specifying  
▶ Page 88

### Solid Skin Latches

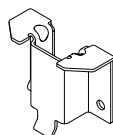

Understanding  
▶ Page 28  
Specifying  
▶ Page 88

### Solid Skin Brackets



Understanding  
▶ Page 28  
Specifying  
▶ Page 88

### Solid Skin Screw

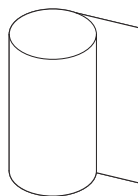

Understanding  
▶ Page 28  
Specifying  
▶ Page 89

### Acoustic Insulation

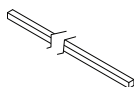

Understanding  
▶ Page 28  
Specifying  
▶ Page 89

### Acoustic Skin Seal—Small

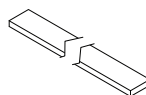

Understanding  
▶ Page 28  
Specifying  
▶ Page 89

### Acoustic Skin Seal—Large

---

## Unitized Glass



Understanding  
▶ Page 32  
Specifying  
▶ Page 90



Understanding  
▶ Page 32  
Specifying  
▶ Page 92

---

### Unitized Glass Panel

84"H–120"H x 12"W–60"W



---

### Structural Frame—Clerestory

84"H–120"H x 12"W–60"W

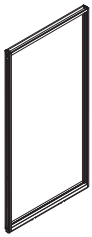

Understanding  
▶ Page 36  
Specifying  
▶ Page 94

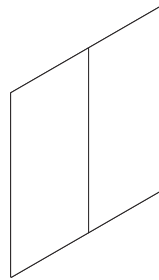

Understanding  
▶ Page 36  
Specifying  
▶ Page 95

---

### Frame Kit

84"H–120"H x 12"W–144"W



---

### Glass Kit

84"H–120"H x 12"W–144"W



---

## Glazing Tape—Clear



Understanding  
▶ Page 32  
Specifying  
▶ Page 95

## Swing Doors



Understanding  
 ▶ Page 38  
 Specifying  
 ▶ Page 96

### Door Frame, Swing, Single

84"H–120"H x 28"W–48"W



Understanding  
 ▶ Page 38  
 Specifying  
 ▶ Page 97

### Door Leaf, Swing, Solid

84"H–120"H x 28"W–48"W



Understanding  
 ▶ Page 38  
 Specifying  
 ▶ Page 98

### Door Leaf, Swing, Polished Edge

84"H–120"H x 28"W–48"W



## Door Hardware



**Dome Style Floor Stop**  
 Specifying  
 ▶ Page 100

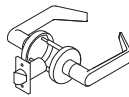

**Cylindrical Latchset**  
 Specifying  
 ▶ Page 100

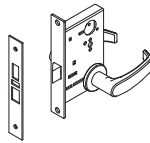

**Mortise Latchset**  
 Specifying  
 ▶ Page 101



**Magnetic Wall Stop**  
 Specifying  
 ▶ Page 101

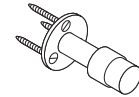

**Screw In Base Stop**  
 Specifying  
 ▶ Page 102

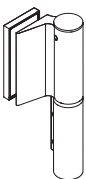

**Slim Line Hinge**  
 Specifying  
 ▶ Page 103

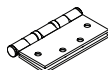

**Butt Hinge**  
 Specifying  
 ▶ Page 103

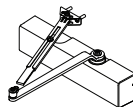

**Closer**  
 Specifying  
 ▶ Page 104

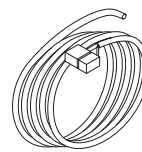

**Electric Hinge**  
 Specifying  
 ▶ Page 104

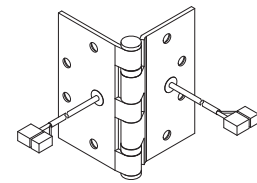

## Door Hardware, continued



**Roller Latch**  
Specifying  
▶ Page 104

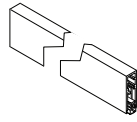

**Drop Seal Assembly, Swing Door**  
Specifying  
▶ Page 105

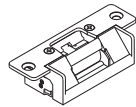

**Electric Strike**  
Specifying  
▶ Page 105

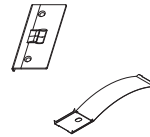

**Assembly Hardware, Swing Door Frame**  
Specifying  
▶ Page 106

## Slider Doors



Understanding  
▶ Page 42  
Specifying  
▶ Page 107

### Door Frame, Slider, Single

84"H-120"H x 40"W-48"W

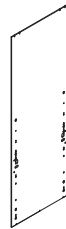

Understanding  
▶ Page 42  
Specifying  
▶ Page 108

### Door Leaf, Slider, Polished Edge

84"H-120"H x 40"W-48"W

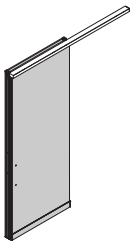

Understanding  
▶ Page 42  
Specifying  
▶ Page 109

### Door Track, Slider, Single

75"W-120"W

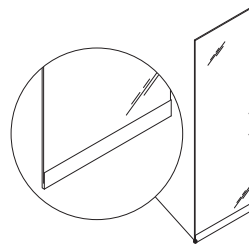

Understanding  
▶ Page 42  
Specifying  
▶ Page 110

### Slider Door-Drop Seal Housing

40"W-48"W





## Slider Doors, continued

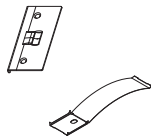

Understanding  
▶ Page 42  
Specifying  
▶ Page 110

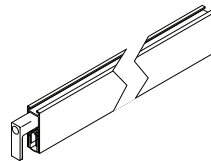

Understanding  
▶ Page 42  
Specifying  
▶ Page 111

### Assembly Hardware, Slider Door Frame

### Slider Door Hardware—Drop Seal

40"W–48"W



Understanding  
▶ Page 42  
Specifying  
▶ Page 111

### Door Hardware—Slider Lever Lock

**Door Pulls**

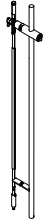

Understanding  
 ▶ Page 46  
 Specifying  
 ▶ Page 112

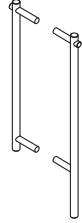

Understanding  
 ▶ Page 46  
 Specifying  
 ▶ Page 113

**Door Hardware—Ladder Pull, Aligned**

**Door Hardware—Ladder Pull, Offset**



Understanding  
 ▶ Page 46  
 Specifying  
 ▶ Page 113

**Door Hardware—Push/Pull Handle**

**Posts**



Understanding  
 ▶ Page 50  
 Specifying  
 ▶ Page 114



Understanding  
 ▶ Page 50  
 Specifying  
 ▶ Page 114

**Post, Two-Way**

**Post, Three-Way**

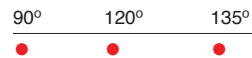

Understanding  
 ▶ Page 50  
 Specifying  
 ▶ Page 115



Understanding  
 ▶ Page 52  
 Specifying  
 ▶ Page 116

**Post, Four-Way**

**90° T/X Adapter**

## Adapters



Understanding  
▶ Page 52  
Specifying  
▶ Page 116



Understanding  
▶ Page 52  
Specifying  
▶ Page 117

## Finished End



Understanding  
▶ Page 52  
Specifying  
▶ Page 118



Understanding  
▶ Page 52

## Utility Panel Cover

84"H-120"H



Understanding  
▶ Page 52  
Specifying  
▶ Page 119

## Utility Panel Frame

84"H-120"H



## Vertical Transition to Lite Scale

## Bypass

## Cutable Ends

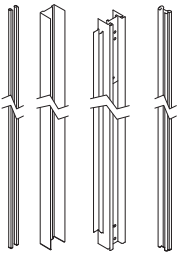

Understanding  
▶ Page 58  
Specifying  
▶ Page 120



Understanding  
▶ Page 58  
Specifying  
▶ Page 121

### 90° Cutable End Assembly

84"H–120"H



### 90° Cutable End Inner Channel

48"L 120"L

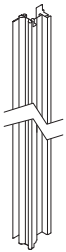

Understanding  
▶ Page 58  
Specifying  
▶ Page 122



Understanding  
▶ Page 58  
Specifying  
▶ Page 123

### 90° Cutable End Outer Channel

48"L 120"L



### Cutable End Capture Trim

12.1"H–120"H



Understanding  
▶ Page 58  
Specifying  
▶ Page 124



Understanding  
▶ Page 58  
Specifying  
▶ Page 125

### Cutable End Corner Angle

### Cutable End Elbow

## Mini End and Wall Start

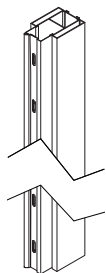

Understanding  
▶ Page 60  
Specifying  
▶ Page 126



Understanding  
▶ Page 60  
Specifying  
▶ Page 126

### 90° Adjustable Mini End

Medium  
(2¼"H–37⁄8"H)

Large  
(4¼"H–57⁄8"H)



### Wall Start

## Electrical Components

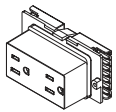

**Receptacle**  
Understanding  
▶ Page 62  
Specifying  
▶ Page 127

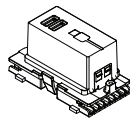

**USB Receptacle**  
Understanding  
▶ Page 62  
Specifying  
▶ Page 128

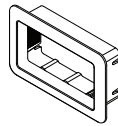

**Power Receptacle Trim**  
Understanding  
▶ Page 62  
Specifying  
▶ Page 128

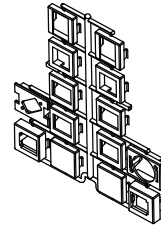
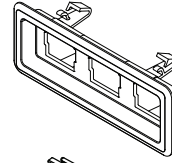

**Modular Communication Faceplate**  
Understanding  
▶ Page 62  
Specifying  
▶ Page 129



Hardwire

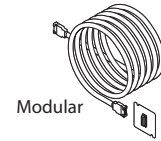

Modular

**Multipurpose Infeed - 8 Wire**  
Understanding  
▶ Page 62  
Specifying  
▶ Page 130

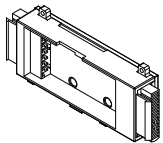

**Power Block**  
Understanding  
▶ Page 62  
Specifying  
▶ Page 130

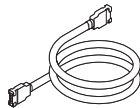

**Modular Harness - 8 Wire**  
Understanding  
▶ Page 62  
Specifying  
▶ Page 131



**Harness-to-Harness Branching Connector**  
Understanding  
▶ Page 62  
Specifying  
▶ Page 132

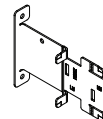

**Electrical Mounting Bracket-Skin Modular**  
Understanding  
▶ Page 62  
Specifying  
▶ Page 133

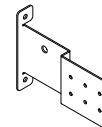

**Electrical Mounting Bracket-Skin Hardwire**  
Understanding  
▶ Page 62  
Specifying  
▶ Page 133

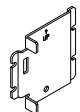

Modular



Hardwire

**Electrical Mounting Bracket-Utility Panel**  
Understanding  
▶ Page 62  
Specifying  
▶ Page 133



# Structural Frame Components

## Everwall's structural frame components

arrive on-site with all verticals, horizontals, and floor track assembled. Once the ceiling track is installed, the frame tilts into place.

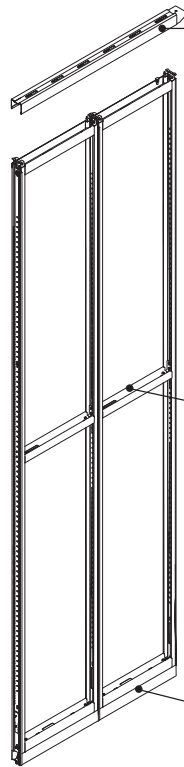

**Ceiling track** secures the top of the Everwall structural frame to the suspended ceiling grid. Allows plus/minus  $\frac{1}{2}$ " of adjustment.

**Intermediate horizontals** are mounted between the floor and ceiling to support skin segmentation and electrical components.

**Floor track** is unitized to the structural frame as part of the manufacturing process.

## Product Details

**Structural frame components** can be specified in sizes ranging from 84"H–120"H (ceiling height) and from 8"W–60"W in  $\frac{1}{16}$ " increments.

**Everwall finished wall thickness** is 4".

**For improved structural frame reconfigurability**, pre-set widths are available: 8", 12", 18", 20", 24", 30", 36", 40", 42", 48", 54", and 60".

**Frame couplers** are used to join structural frame components once the skins are attached. Frame couplers are recessed and fit in between skins. They run to the top of the skin without overlapping the ceiling track and run to the floor, overlapping the floor track.

**Acoustic seals** are applied to the vertical and horizontal pieces of the structural frame components for improved acoustics. These seals are slightly visible when viewed from certain angles.

**Large seals** are for horizontals, small seals are for verticals.

**There is a consistent 0.35 inch reveal** between skins, junctions, and any other structural component.

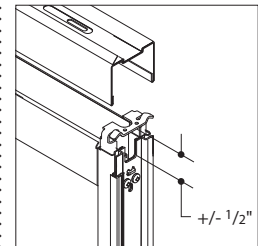

**Ceiling track** comes in 120" and 144" lengths; can be field cut on site. Allows plus/minus  $\frac{1}{2}$ " of vertical adjustments to accommodate ceiling variation.



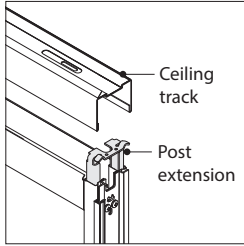

**Structural frames** include an adjustable post extension to ensure connection into the ceiling track.

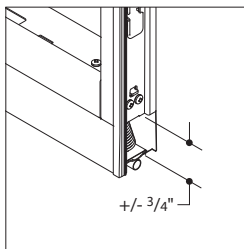

**The floor track** is factory assembled to the structural frame, and serves as the base trim as well. There is plus/minus 3/4" of adjustment to accommodate variations at the floor.

**Springs** are located between the floor track and structural horizontals to ensure continuous contact of the floor track with the floor.

**Floor track sections** that are 18"W or wider include cut-outs for routing cable through the floor.

**Ceiling track seal** can be specified from three color choices.

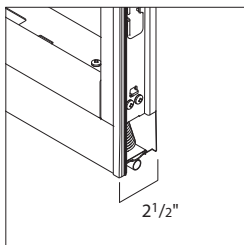

**Structural frames** are approximately 2 1/2" thick to accommodate an overall wall thickness of 4".

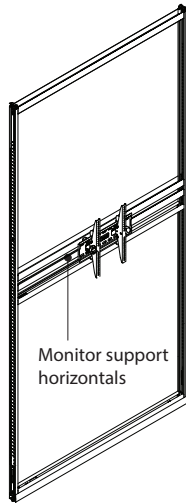

**Monitor support horizontals** come in sets of two and include hardware for anchoring the monitor mount bracket through the skin. Monitor support horizontals are installed on site. Each set has a maximum weight capacity of 200 pounds.

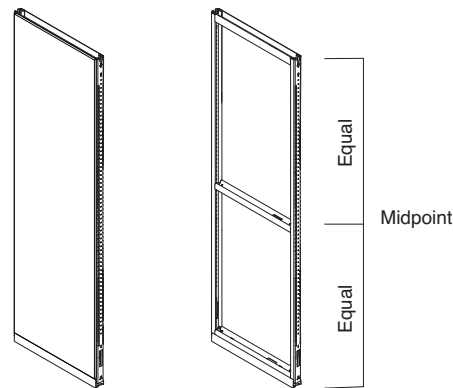

Monolithic Skin

**To improve rigidity in shipping and handling, structural frames** automatically include an intermediate horizontal at the midpoint of the frame.

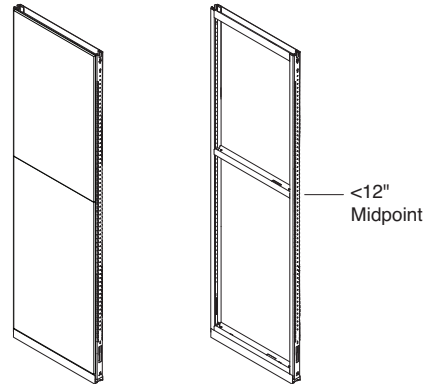

Segmented Skin

**When a horizontal** is added for segmentation or clerestory, and it is less than 12" from the center of the frame, that muntin will take the place of the shipping horizontal.

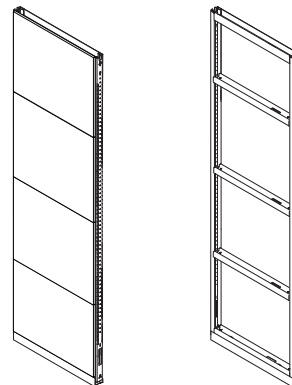

Segmented Skin

**Intermediate horizontals** are positioned according to skin configuration.

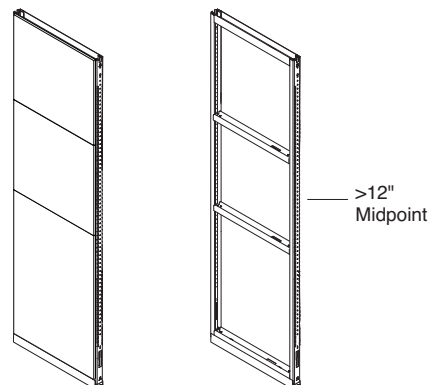

Segmented Skin

**When horizontals** are added for segmentation or clerestory, and the muntin is greater than 12" from the center of the frame, a shipping horizontal is still included.

**Up to two cable access holes per intermediate horizontal** allows for routing of power and communications cabling.

**Power and communication mounting brackets** are attached to verticals and intermediate horizontals for positioning modular and hardwire electrical components.

**If mounted on a horizontal**, brackets will be mounted horizontally. Please see electrical section for more details.

**If mounted on a vertical**, brackets will be mounted vertically.

**Brackets can be mounted** in three positions:

**Low**  
Default height is ADA (17½")  
Other options are: 10½" to 23½" in 1" increments.

**Medium**  
Default height is Desk (34½")  
Other options are: 24½" to 47½" in 1" increments.

**High**  
Default height is Standing Monitor (49½")  
Other options are: 47½" to 102½" in 1" increments.

## Connections

**Ceiling track brackets** connect sections of straight ceiling track at all T and X intersections.

- T = one bracket
- X = two brackets

**Ceiling track fasteners** secure the track to the suspended ceiling grid. Seven standard styles:

- 1"W exposed T
- ¾"W exposed T
- ¼" Donn fineline
- ⅛" Donn fineline
- 1" fluted runner ¼–20
- 1"W T for tegular ceiling tiles
- ¾"W T for tegular ceiling tiles

**Spacers** are included with fasteners for tegular ceiling tiles that allow adjustment for different tile edge depths.

**Fasteners for other types of ceilings** are purchased locally.

**The building's designated design professional (architect or engineer)** must verify that the ceiling grid is adequate to support the lateral loads imposed by ceiling supported walls. Local codes may require independent bracing.

**Floor guides** are positioned under verticals, and are required when installing Everwall on Underscore. They include material for gripping to hard surfaces and carpet.

**Floor guides** can also be specified for use in seismic design applications. Additional mechanical fasteners (not included with the floor guide) may be required as specified by the structural engineer.

*Tip: Floor guides are cut in half when placed adjacent to posts and door frames.*

**When planning with Everwall on Underscore**, do not position the wall directly above the edge trim, as this will create an unstable condition.

## Wiring & Cabling

**Power and data components** are ordered separately. Standard access openings are available in the framing components. There is adequate space within the walls to feed the wires and cable needed for either modular or hardwire power and communication. ADA and desk height are the most common placements for power and communication. However, Everwall allows for power to be mounted on the verticals every 1", as long as it is above 15½" from the floor and more than 13½" from the ceiling. When mounting both modular and hardwired power horizontally, the structural frame must be at least 24" wide and the power must be mounted at center.

## Surface Materials

**Ceiling track**

- 4799 Platinum Metallic
- 7241 Arctic White
- 7360 Merle

**Floor track**

- 7190 Platinum Solid
- 7360 Merle

**Frame coupler**

- 6249 Platinum Solid
- 6527 Merle

**Acoustic seals**

- 6249 Platinum Solid
- 6527 Merle

## Surface Materials

Ceiling Clip Application  
▶ See page 26



French Cleat Support

**French cleat supports** are used in sets of two to provide internal reinforcement in those applications where surface mounted storage is desired.

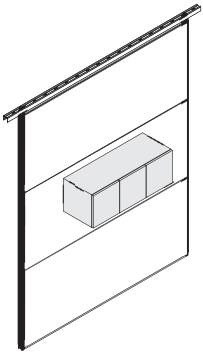

**Storage hang-ons** can be attached to the steel structure with brackets that interface with Elective Elements.

**In certain sizes and applications,** items such as artwork or signage can be surface mounted directly to skins (steel or laminate) without the need for internal reinforcement. Surface mounting in this manner will result in holes in the skin. The following guidelines are based on an overall projection off the face of the wall of 4" or less with a maximum weight of 20 pounds.

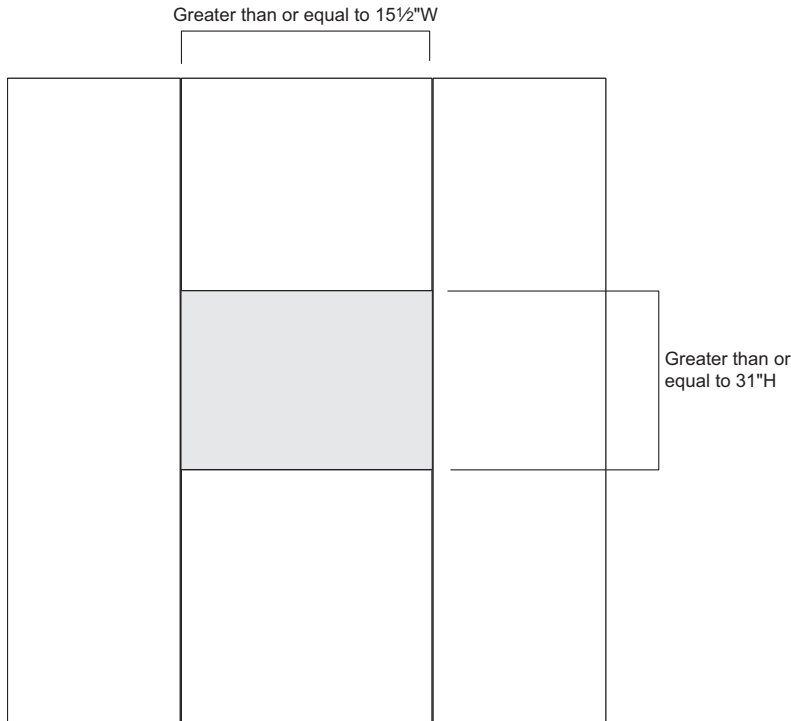

**If skin height** is greater than or equal to 31"H and skin width is greater than or equal to 15 1/2"W, surface mounting of up to 20 pounds is allowed. The item being mounted must project 4" or less from the surface of the skin.

# Ceiling Clip Application

**Tip:** All planning and application guidelines contained in this section of the specification guide are based on the requirement that ceiling track is connected to a ceiling in order to properly install and align the wall components as shown. When any partition is fastened to a suspended ceiling grid, it may be necessary for an architect or engineer to verify that the grid can adequately support the partition. Local codes may require additional bracing.

## T Grid Ceiling Fastener Kits

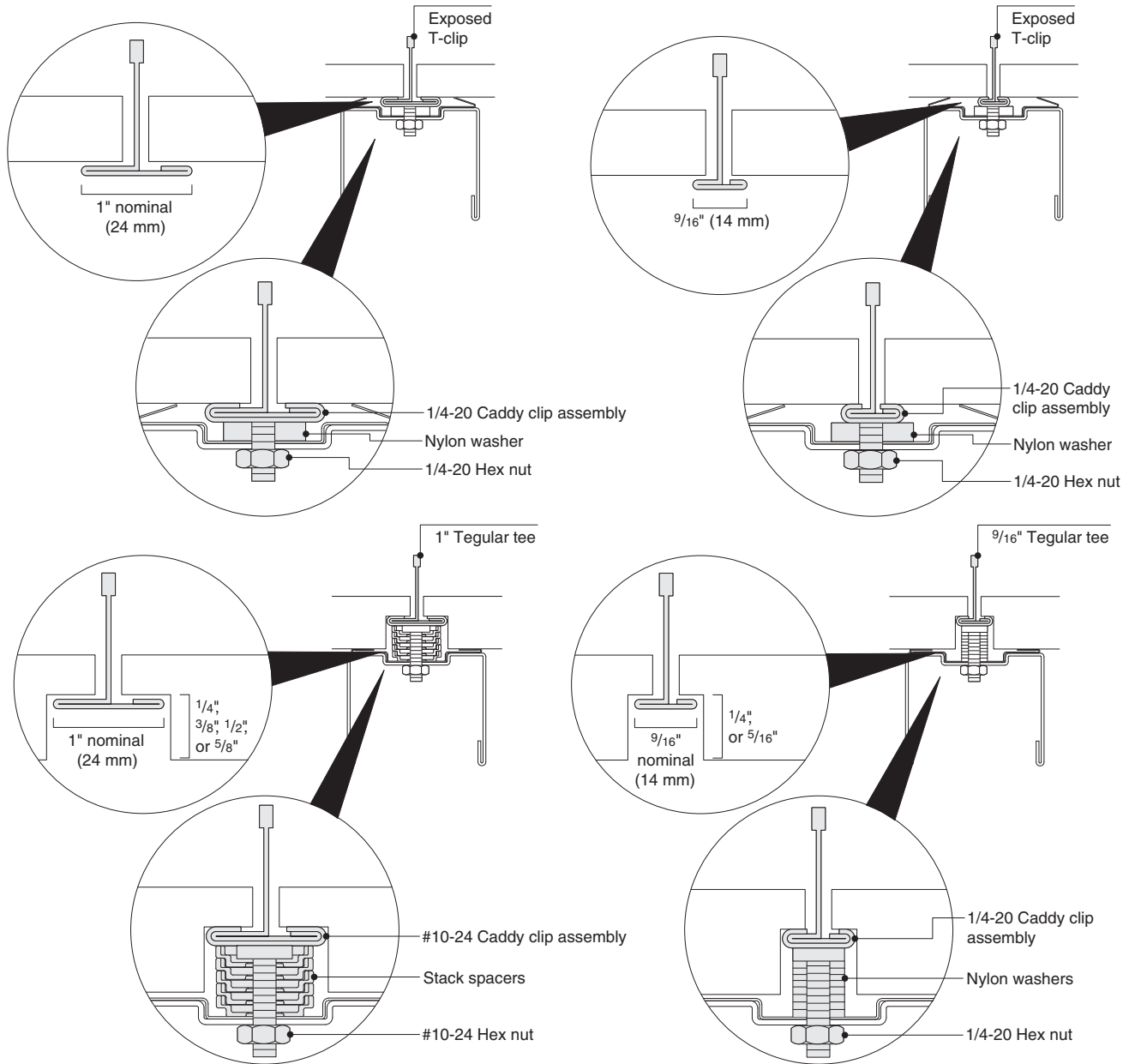

### Bolt Slot Grids Ceiling Fastener Kits

Ceiling clips support the most common types of ceiling systems.

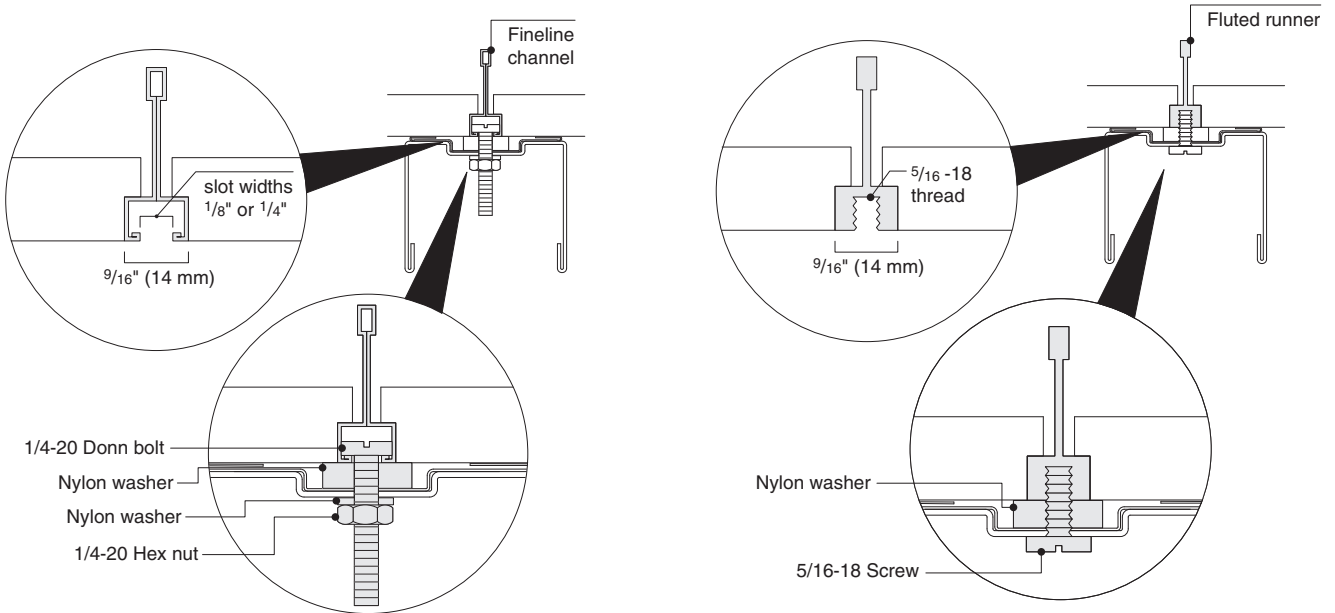

### Concealed Grids – Field-Purchased Generic Fasteners

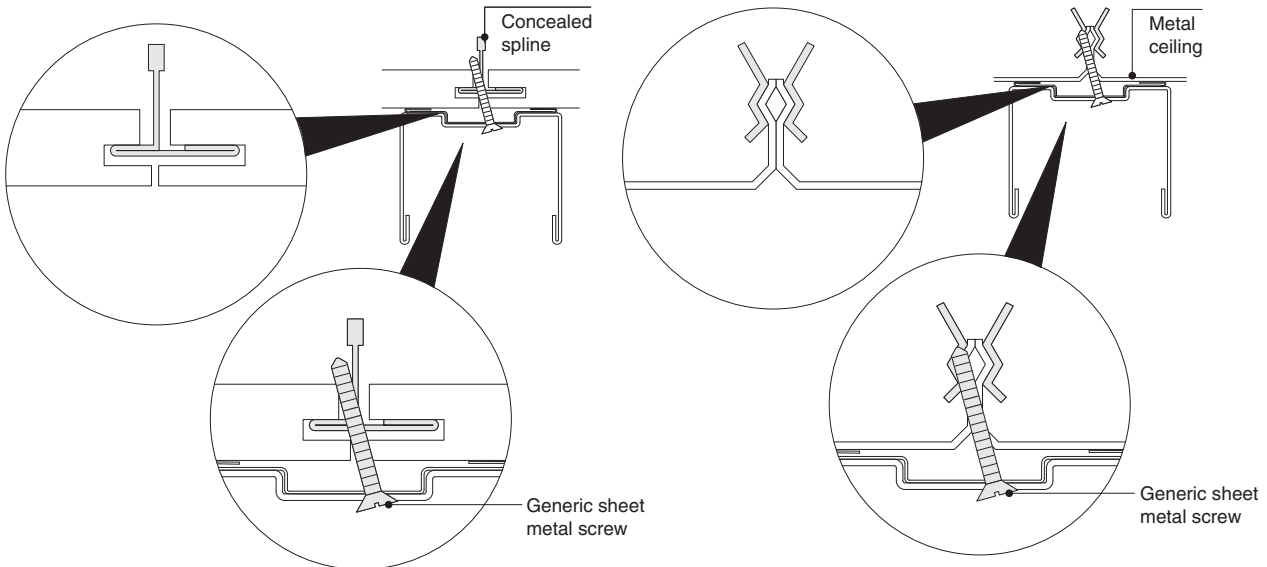

**For these and other types of ceilings, the following fasteners can be sourced locally by the installer:**

|                  |                                                  |
|------------------|--------------------------------------------------|
| Concealed spline | #7 – 17 x 1 5/8" Bugle Head Self-Drilling Screws |
| Drywall          | #14 – 1" Phillips Head SMS with plastic anchor   |
| Plaster          | 1/4 – 20 Toggle Bolt                             |
| Concrete         | Tapcon Anchor x 2"                               |
| Metal Pan        | #7 – 17 x 1" Bugle Head Self-Drilling Screws     |

# Skins

**Everwall's skins** can span up to four frames in either portrait or landscape orientation. A portrait skin is considered to be taller than it is wide and landscape skin is wider than it is tall.

**Painted steel skins** provide a simple and functional finish that is durable and easy to maintain. Surfaces support magnetic accessories. Skins can be combined with different acoustic accessories to achieve high STC levels.

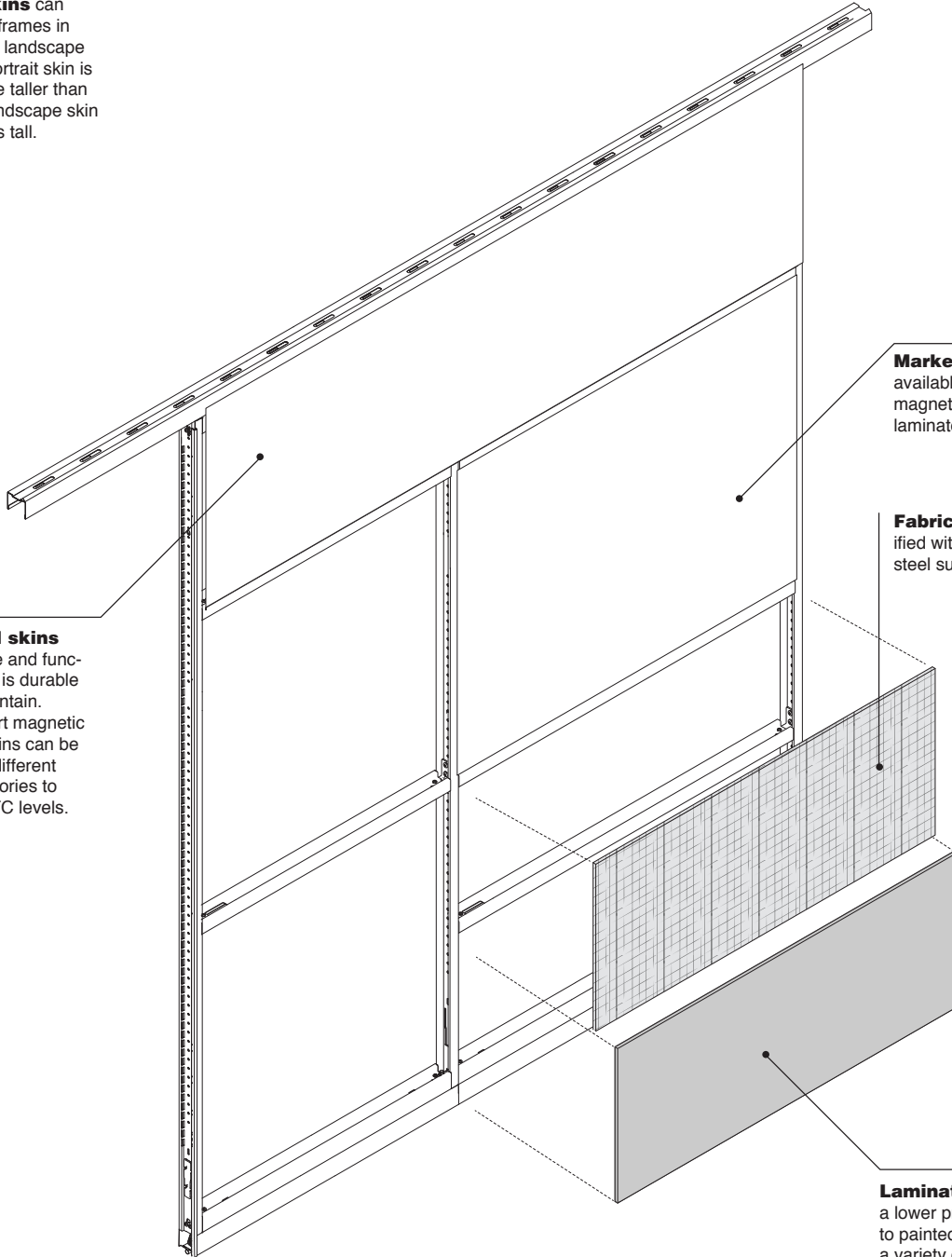

**Markerboards** are available in CeramicSteel magnetic and non-magnetic laminate.

**Fabric skins** can be specified with a particle board or steel substrate.

**Laminate skins** provide a lower priced alternative to painted steel and offer a variety of colors and finishes.

**Product Details**

**Solid skins** can be specified in a range of sizes depending on material.

**While skins can be specified in 1/16" increments, for improved solid skin reconfigurability**, pre-set sized widths are available: 12", 18", 20", 24", 30", 36", 40", 42", 48", 54", and 60".

**Everwall finished wall thickness** is 4".

**If plan height is greater than 60"**, the width cannot be greater than 60".

**If plan width is greater than 60"**, plan height cannot exceed 60".

**Solid skins**, available with steel and laminate surfaces, form the visual and functional surface of the vertical plane that creates the desired environment and facilitates future change.

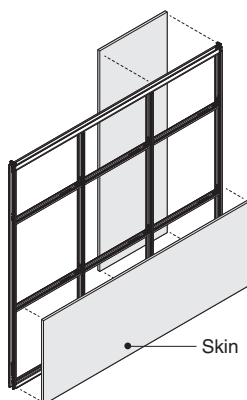

**Skins** can span up to four structural frames, and allow for differing configurations on opposite sides of the wall.

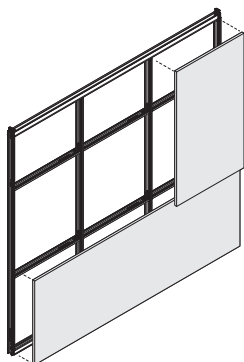

**Skins** can be oriented horizontally or vertically on the wall.

**Solid skins** include brackets for mounting to the structural frame.

**Skin brackets** are positioned for mounting specifically in top, bottom, or intermediate positions.

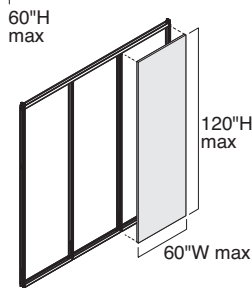
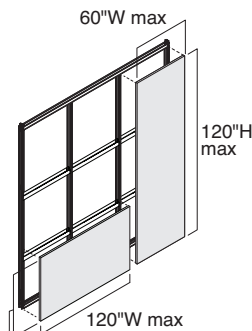

**Steel painted, steel fabric, laminate, laminate markerboard, and fabric skins' maximum planning dimensions** are 120"W by 60"H for landscape planning and 60"W by 120"H for portrait planning. Minimum planning dimensions are 8"W and 12"H.

**CeramicSteel markerboard maximum planning dimensions** are 120"W and 120"H. Minimum planning dimensions are 24"W and 24"H.

**When the width or height of the skin exceeds 60"**, the fabric warp direction will run parallel to the long dimension.

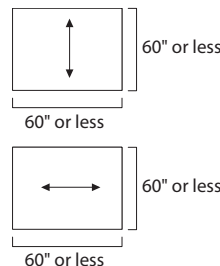

**When the skin size is 60" or less in width and height**, the fabric warp direction can be specified to run vertically or horizontally.

**When the width or height of wood grain laminate skin exceeds 60"**, the grain pattern will run parallel to the long dimension.

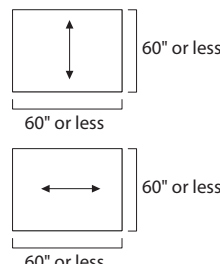

**When the skin size is 60" or less in width and height**, the grain pattern can be specified to run vertically or horizontally.

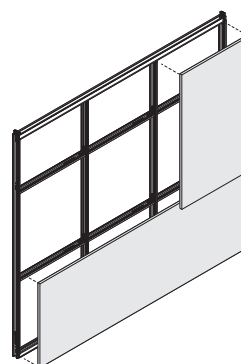

**Skins** can span multiple frames and can span across intermediate horizontals.

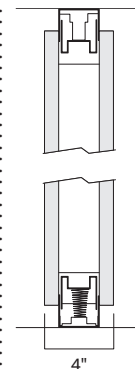

**The overall wall thickness** is 4".

**Ceramic Skins**

**Ceramic skins** can be mounted in top, bottom, and intermediate positions and used in a single floor to ceiling application. There are no restrictions with the opposite side of the wall when using a ceramic skin.

**Everwall ceramic skins** incorporate the e<sup>3</sup> environmental CeramicSteel surface.

**Ceramic skins** do not accommodate electrical cutouts.

**Acoustics**

**The STC performance levels** can be improved by adding insulation to the wall cavity between the skins.

**Insulation** is provided in rolls that are 48"W x 174 feet long x 1" thick.

**Flammability**

**Skins** comply with ASTM E84 Surface Characteristics of Building Materials:

- Painted steel and fabric on steel—Class A (Type 1)
- Ceramic skins—Class A
- Laminate and fabric on laminate—Class C (Type 3)

### Connections

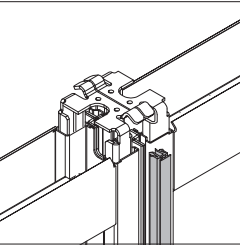

**Frame couplers**, ordered separately, join panels together. They prevent light and sound leaks and run from the top of the glass frame to the floor, overlapping the floor track.

### Wiring & Cabling

**Solid skins** can be specified with electrical cut-outs to accommodate modular power, communications, and hardwire devices.

**Electrical cut-outs** can also be cut on site during installation.

**ADA and desk height** are the most common placements for power and communication. However, power can be placed at various heights. Please see Structural Frame Components for more information  
▶ See page 22

**Receptacles in walls** can be specified in any combination of ADA, desk height, or other positions.

**Hardwired switches and other electrical devices** can also be located in the wall, but are not provided by Steelcase.

**Electrical devices** can be specified on either side or both sides of the wall. Components cannot be positioned back-to-back.

### Surface Materials

#### Steel skins

- Fabric
  - Paint
- Tip: Metallic paint size restrictions = 36"W maximum width and 24 square feet.*

#### Laminate skins

- Low-Pressure Laminate
  - Open Line laminate
- Tip: Edge trim colors are pre-set for standard finishes.*

### Application Topics

Electrical Components  
▶ See page 62





# Unitized Glass

**Note: All planning and application guidelines contained in this section of the specification guide are based on the requirement that ceiling track is connected to a ceiling in order to properly support the wall components as shown.**

**Everwall unitized glass** creates floor-to-ceiling walls, prefabricated to the height and width dimensions you specify. These panels can be easily relocated to respond to changing needs.

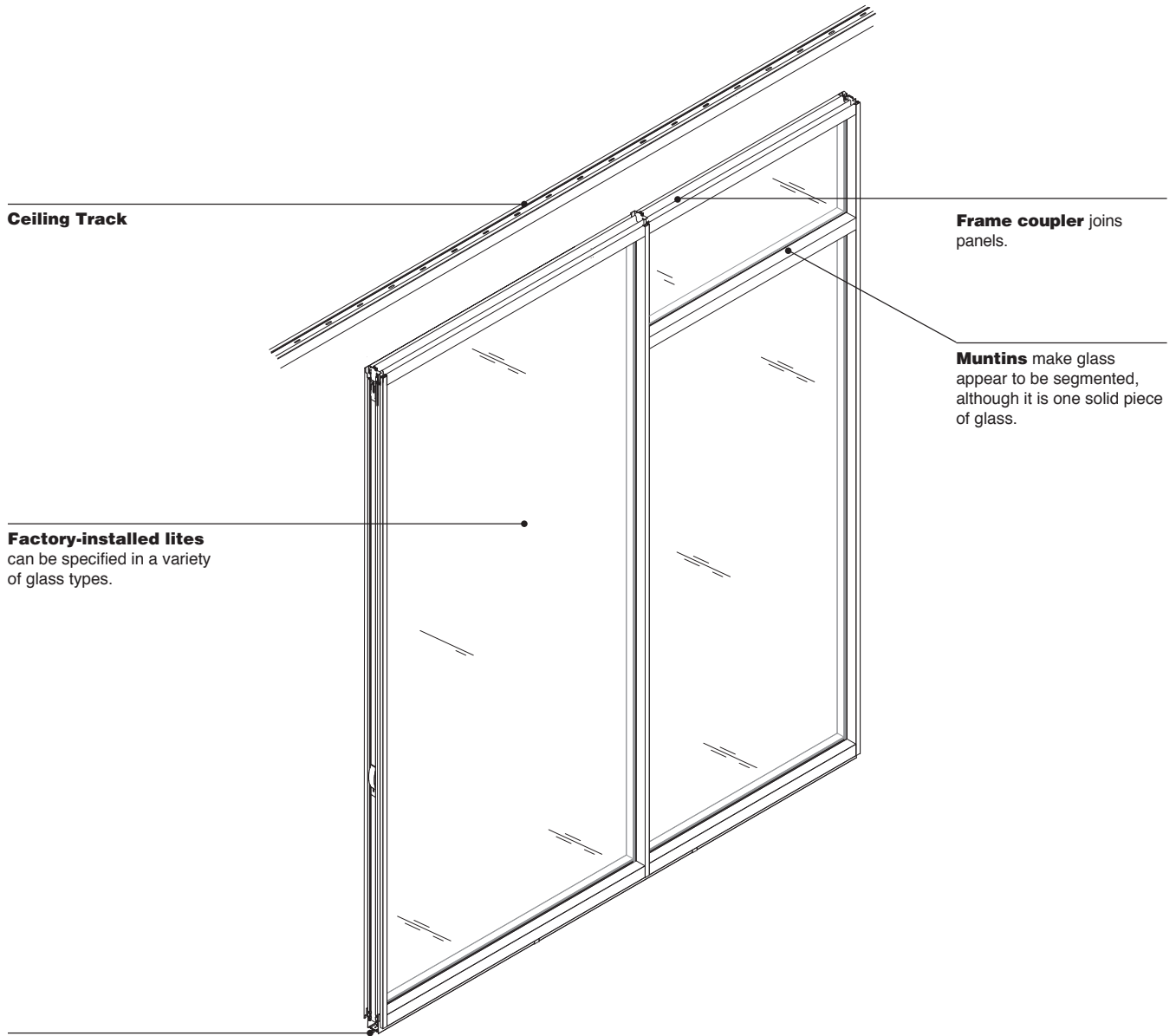

**Factory-installed lites** can be specified in a variety of glass types.

**Adjustable glides** allow panels to be installed on uneven floors.

**Frame coupler** joins panels.

**Muntins** make glass appear to be segmented, although it is one solid piece of glass.

**Product Details**

**Unitized glass panels** arrive on-site with glass, frame, and floor track pre-assembled.

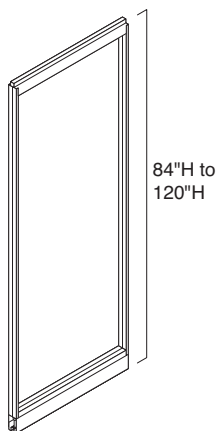

**Panel height** can be specified from 84"H–120"H at 1/16" increments.

**For improved unitized glass reconfigurability, pre-set sized** plan widths are available: 12", 18", 20", 24", 30", 36", 40", 42", 48", 54", and 60".

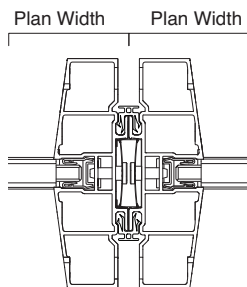

**Plan width of panel** is measured to center of joint between two panels.

**Unitized glass** can accommodate glass thickness of 1/4" or 3/8".

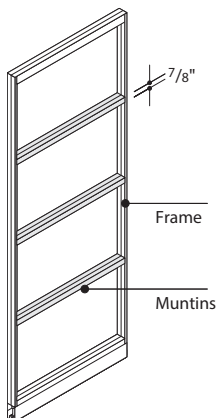

**Muntins** can be used to add visual segmentation to glass panels. Muntin positions can be specified in 1" increments.

**Unitized glass frames maximum height** is 120" and maximum width is 60". Minimum height and width is 84"H by 12"W.

**Different types and thicknesses of glass** may change the overall acoustic performance of a glass wall.

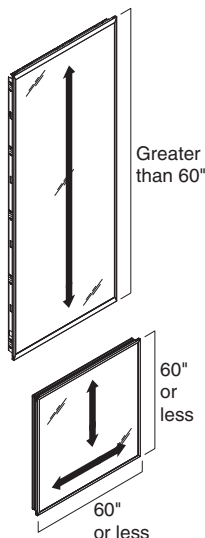

**Certain glass patterns** may have a linear pattern. When one of the glass frame dimensions is greater than 60", the linear direction will run parallel to the long dimension. When both frame dimensions are less than 60", the user can specify if the pattern is to run vertically or horizontally.

**Certain etched or pattern glass types** are polished on one face, and rough (etched or pattern) on the other. When defining the surface orientation of a glass frame, it is also important to consider the surface orientation of these types of glass. When planning with etched glass, the polished face of the glass is most often oriented to the corridor side of the wall to minimize the buildup of dirt on the etched face. Pattern glass is most often positioned with the patterned face oriented to the corridor, as the pattern face of the glass is considered the more attractive surface. Although these are the most common preferences for surface orientation, Everwall will allow for any relative position and orientation.

**Connections**

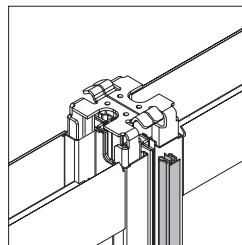

**Frame couplers**, ordered separately, join panels together. They prevent light and sound leaks and run from the top of the glass frame to the floor, overlapping the floor track.

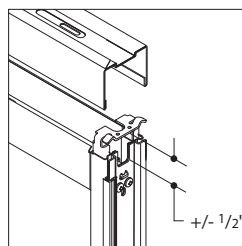

**Ceiling track** comes in 120" and 144" lengths; can be field cut on site. Allows plus/minus 1/2" of floating vertical adjustments to accommodate ceiling variation.

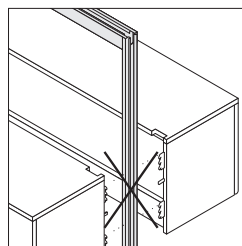

**Panel-supported storage components** cannot be attached to glass wall panels. Use solid wall or Clerestory panels instead.

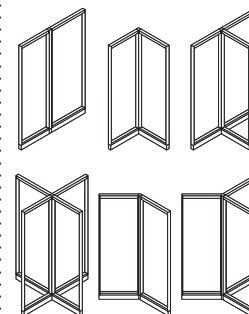

**Posts** join panels in in-line, L-, T-, X-, V-, and Y-configurations without blocking access to integral slotted verticals.

► Page 114

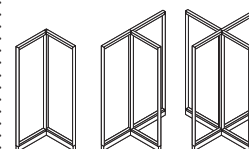

**Adapters** connect panels in L-, T-, and X-configurations without adding extra creep to panel dimension.

► Page 116

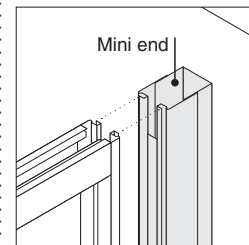

**Mini end** connects a panel or panel run to a perpendicular building wall.

► Page 126

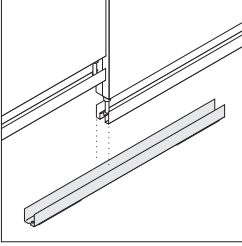

**Floor grippers** can be used to provide additional lateral support at the floor on carpet or hard surfaces. They are required when used in active seismic zones as directed by the structural engineer of record.

**Floor grippers** are required when Everwall is installed on Underscore low profile floor.

### Wiring & Cabling

**Unitized glass** does not accommodate power or communication cabling.

**Utility panels** can be positioned adjacent to glass frames to facilitate cable routing and to introduce outlets, switches, and other electrical devices.

### Surface Materials

#### Panel frame and muntins

- Paint

#### Glass

- 1/4" thick
- 3/8" thick

#### Ceiling track

- 4799 Platinum Metallic
- 7241 Arctic White
- 7360 Merle

#### Frame coupler

- 6249 Platinum Solid
- 6527 Merle



# Glass Frame Kits

**Everwall glass frame kits** allow for spans of uninterrupted glass and are assembled on-site.

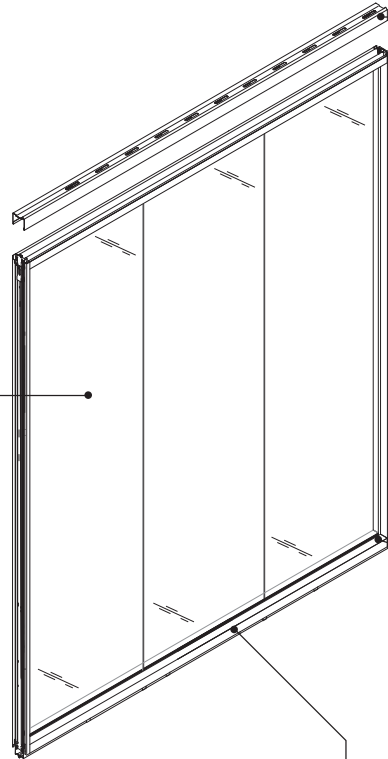

**Frame kit and glass kit** are assembled on site.

**Ceiling track** secures the top of the Everwall to the suspended ceiling grid. Allows plus/minus 1/2" of adjustment.

**Glass frame kits** allow for butt-glazing, creating uninterrupted spans of glass with butt glazing.

**Floor track** allows plus/minus 3/4" of vertical adjustment using floor glides to accommodate variations at the base of the wall.

## Product Details

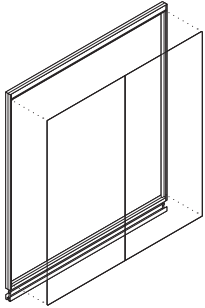

**Everwall frame and glass kits** are assembled in the field. Butt joints must be sealed with glazing tape.  
*Tip: COM glass for frame and glass kits must be  $\frac{3}{8}$ " or  $\frac{1}{2}$ " thick for structural integrity.*

**Glass frame kit** can be specified from 12"W–144"W and 84"H–120"H at  $\frac{1}{16}$ " increments.

**For improved unitized glass reconfigurability**, pre-set sized plan widths are available: 12", 18", 20", 24", 30", 36", 40", 42", 48", 54", 60", 72", 84", 96", 108", 120", 144".

**Glass frame kits** can accommodate glass thicknesses of  $\frac{3}{8}$ " and  $\frac{1}{2}$ ".

**Different types and thicknesses of glass** may change the overall acoustic performance of a glass wall.

## Connections

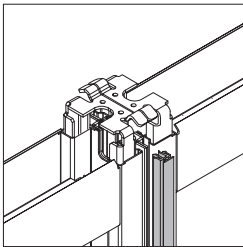

**Frame couplers**, ordered separately, join panels together. They prevent light and sound leaks and run from the top of the glass frame to the floor, overlapping the floor track.

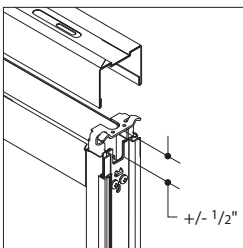

**Ceiling track** comes in 120" and 144" lengths; can be field cut on site. Allows plus/minus  $\frac{1}{2}$ " of floating vertical adjustments to accommodate ceiling variation.

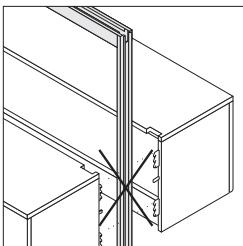

**Panel-supported storage and work surface components** cannot be attached to glass frame kits. Use solid wall or Clerestory panels instead.  
▶ See page 25 for more information about hanging components.

## Wiring and Cabling

**Glass and frame kits** do not accommodate power or communication cabling.

**Utility panels** can be positioned adjacent to glass frames to facilitate cable routing and to introduce outlets, switches, and other electrical devices.

## Surface Materials

### Glass Lite

- Glass
- Customer specified glass

### Glass frames

- Paint
- 8043 Clear Anodized Aluminum

# Swing Doors

**Swing door** units offer controlled access and privacy at door openings, and are available with options to accommodate specific functional requirements.

**Doors and frames** are available in full height applications in specifiable ceiling heights and are configured for single (non-pair) applications.

**Door leaves** are available as solid or polished edge glass and can be equipped with latchsets or door pulls.

**Doors and frames** are factory prepared for hardware as specified.

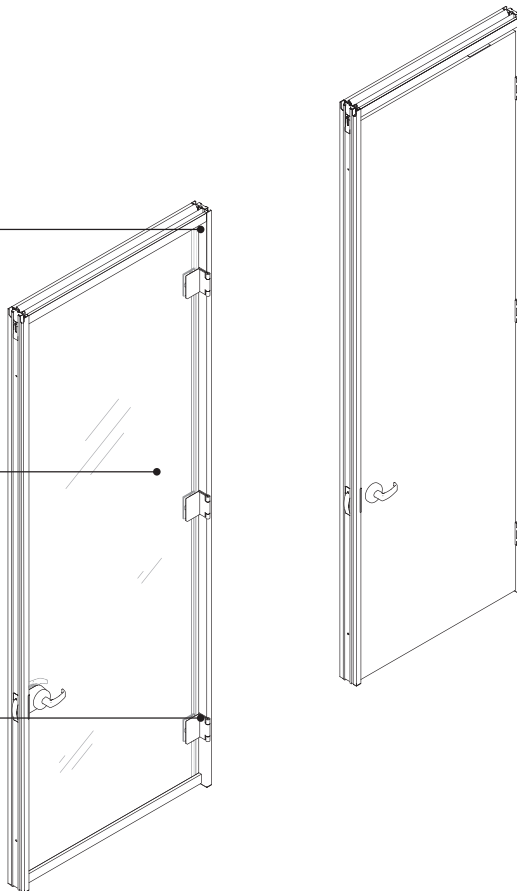

## Product Details



**Door frames** are available in full height configurations. Height range: 84"–120" ceiling height. Heights are specifiable in  $\frac{1}{8}$ " increments. Clear opening height = ceiling height minus  $5\frac{3}{16}$ ".  
*Tip: Door unit ceiling heights less than  $85\frac{1}{8}$ " will not meet criteria for an 80" clear opening height, which is a minimum requirement by code in most areas.*

**Door leaf planning widths** range from 28"–48" and are specifiable in  $\frac{1}{16}$ " increments. Overall door size cannot exceed 5,127 square inches based on planning width x ceiling height.

**Pre-set planning widths for door frames and leaves** are available at 36", 40", 42", 44", and 48" at a reduced price.

**Industry standard tolerances for flatness for  $\frac{3}{8}$ " thick glass** may allow for gaps between the door surface and door frame seals. To minimize the potential for gaps, Steelcase recommends that door sizes for  $\frac{3}{8}$ " thick doors do not exceed 108" ceiling height or 40" planning width.



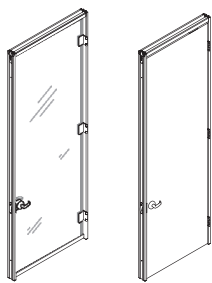

**Door leaves** can be specified as tempered glass with polished edges, or as solid core wood with veneer or painted MDO surfaces.

**Polished edge door leaves** are available in thicknesses of 1/2" or 3/8".

**3/8" thick doors** are available as a lower price alternative to 1/2" thick.

**1/2" thick doors** should be specified when acoustic performance is a priority.

**Industry standard tolerances for flatness for 3/8" thick glass** may allow for gaps between the door surface and door frame seals. To minimize the potential for gaps, Steelcase recommends that door sizes for 3/8" thick doors do not exceed 108" ceiling height or 40" planning width.

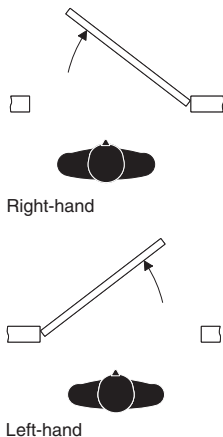

**To determine door swing orientation:** facing the door, so that the door swings away from you, the side that the hinges are on defines the handing of the door. Door units are manufactured to specified swing orientation and cannot be altered.

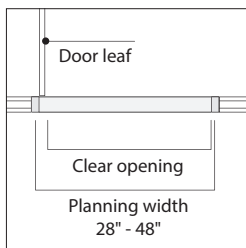

**The handing of a door frame** isn't set until it's installed.

**Single door frame width** is parametric, and can vary from 28" to 48" planning width in 1/16" increments. Planning width is measured to centerline of frame couplers. Steelcase recommends using a 40" wide door frame to maximize accessibility, maintain visual continuity, and simplify the planning process during reconfigurations.

**Door frames and door leaves** can be specified at pre-set planning widths at a lower price than other parametric sizes.

**Pre-set planning widths** for door frames are 36", 40", 42", 44", and 48".

**Clear opening dimension** are as follows:  
 Solid door: PW minus 57/8"  
 Polished glass with slim line hinge: PW minus 67/16"  
 Polished glass with butt hinge: PW minus 61/16"

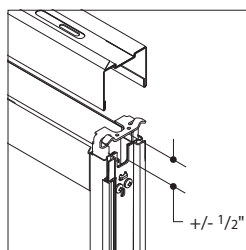

**Ceiling track** allows 1" of vertical adjustment (plus/minus 1/2"), to accommodate ceiling variation.

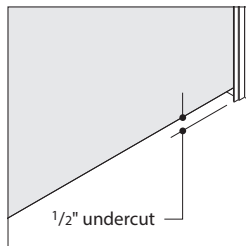

**The door frame assembly** is designed to allow for 1-12" of adjustment at the floor (plus/minus 3/4"), while maintaining a consistent 1/2" undercut.

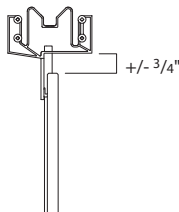

**The visible margin between the top of the door leaf and door frame** can vary by plus/minus 3/4" to accommodate floor variation.

**Door frames** are cut to finished height during installation. New door frames may be required when re-positioning door openings to an area with a taller ceiling height.

**Door frames** are provided with an assembly hardware kit, shipped separately, which includes parts, fittings and strike plate as required to assemble the door frame and hang the door.

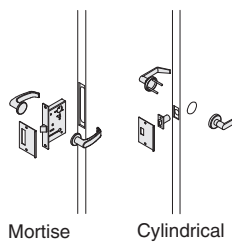

Mortise Cylindrical

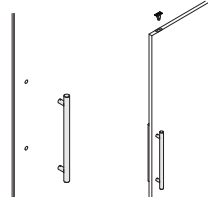

Door Pull (with closer) Door Pull (with roller latch)

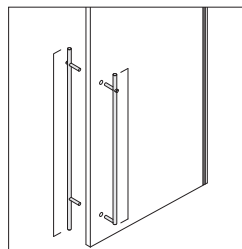

**Latchsets** can be either mortise or cylindrical types.

*Tip: Doors that are specified with hardware prep for mortise locks will not have faces drilled for levers or cylinders, etc. All necessary holes in the face of the door must be drilled by the installer.*

**Mortise lock keying options:**

- Random keyed with interchangeable core (SFIC).
- No cylinder (to allow customer to provide cylinders to specific keying requirements).

**Cylindrical lock keying options:**

- Random key with small format interchangeable core.
- No core (to allow customer to provide cores to specific keying requirements). For customers who require specific keying configurations and/or master key coordination, it is recommended to order locks without cylinders or cores. This will allow the customer to manage their keying requirements locally by securing cylinders or cores through their preferred security hardware provider.

**The cylindrical lock set for swing doors** can be specified in one of two ways:

1. With a random keyed, small format interchangeable core (SFIC).
2. Without a core, configured for a (SFIC).

**Cylindrical lock sets** are compatible with six or seven pin cores (SFIC) as manufactured for Sargent, Best, or Schlage.



**Mortise latchsets** are available with three different lever styles.

**Mortise latchsets** can be specified without lever handles to allow for users to provide locally sourced handles.

**The mortise lockset for swing doors** can be specified in one of two ways:

1. With a random keyed lock cylinder configured for a small format interchangeable core (SFIC).
2. Without a core.

**When ordering cylinders from other suppliers for use with the Everwall mortise locks,** cylinders must be specified with a cam configuration that is compatible with a Sargent 8200 series lock set.

**Locking ladder pull keying options:**

- Random keyed with interchangeable core (SFIC)
- No cylinder (to allow customer to provide cylinders to specific keying)

**Locking ladder pulls** can accommodate SFIC cores (6 pin) as manufactured by Sargent, Schlage, Best, Medeco, Arrow, Yale, and Falcon.

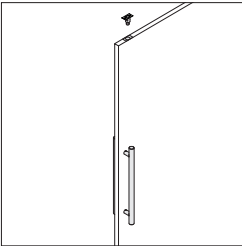

**When specifying a door with push/pull handle or ladder pull,** either a roller latch, closer or slim line hinge with self-close must be selected.

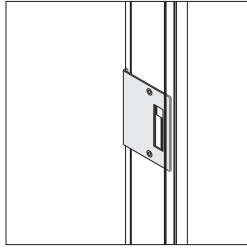

**When specifying single door frames for use with mortise locks,** the strike plate can be specified in either of two configurations. Strike plate type 1 is compatible with the standard Everwall lock, as well as Sargent, Corbin, Russwin, and Yale locks. Strike plate type 2 is compatible with mortise locks manufactured by Schlage and Lawrence. Strike plates are included as part of the assembly hardware kit.

*Tip: If using mortise locks by other manufacturers than those mentioned above, check with the specials team for strike plate compatibility.*

*Tip: Doors that are specified with hardware prep for mortise locks will not have faces drilled for levers, cylinders, etc. All necessary holes in the face of the door must be drilled by the installer.*

*Tip: Swing door frames are not compatible with deadbolt locks.*



**Solid doors** are equipped with butt hinges – 3 hinges per door opening.

**Doors** greater than 44" planning width are equipped with 4 hinges.



Butt Hinge



Slim Line Hinge

**Polished edge doors** can be equipped with slim line hinges or butt hinges. When butt hinges are specified, doors up to 44" planning width will be equipped with 3 hinges.

**Doors** that are greater than 44" wide will be equipped with 4 butt hinges. Slim line hinges will always be used in sets of two per door.

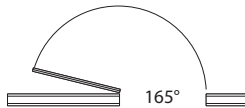
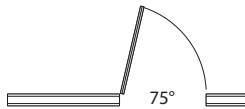

**Slim line hinges** can be specified with a self close feature. This functionality includes a hold-open feature that engages the door at approximately 75° (when 90° hinge is specified) or 165° (when 180° hinge is specified). The hinge includes an adjustable control for regulating the force of the closure and fine-tuning the braking control.

**An electric hinge** is required when equipping a solid door with an electric lock.

**The electric hinge kit** includes two or three additional butt hinges depending on door size.

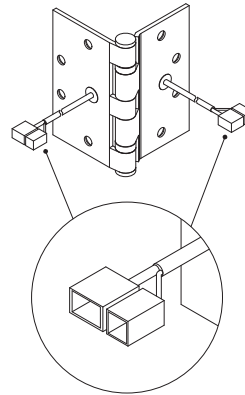

**Electric hinge** is equipped with 8-pin and 4-pin modular Molex connectors for connection to electric lock.

**The electric hinge** includes a 48" lead for connection to electric lock, and a separate 132" long lead for connection to building source.

**When a solid door leaf** is specified for electric hinge, a cableway will be provided from the hinge mortise to the lock mortise cutout.

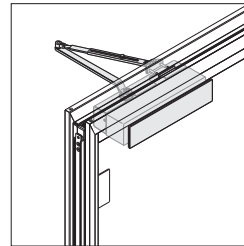

**Door closers** are available for use on solid and glass doors when the door must close automatically for safety and security reasons. *Tip: If self close functionality is required on polished edge doors, specify with slim line hinges.*

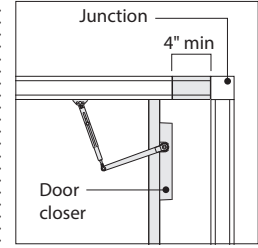

**When mounting a closer on a door, and positioning the door at an inside corner,** the door frame must be spaced at least 4" away from the adjacent surface.

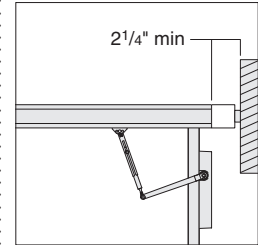

**When mounting a closer on a door and positioning the door at a mini-end,** the door frame must be spaced at least 2 1/4" away from the adjacent surface.

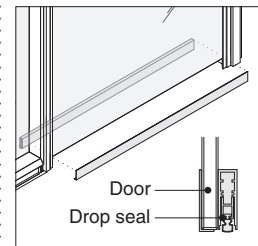

**To enhance acoustical performance,** an optional drop seal can be specified at the bottom of the door. The drop seal automatically deploys to block the gap under the door when the door is closed and retracts when the door is open.

**Drop seals** are not recommended for use on  $\frac{3}{8}$ " polished edge doors that exceed 108" ceiling height or 40" planning width.

*Tip: Polished glass doors with drop seals are compliant with ADA and California Title 24 guidelines.*

*Tip: Dome stops and base stops are not recommended when using polished glass doors with drop seals.*

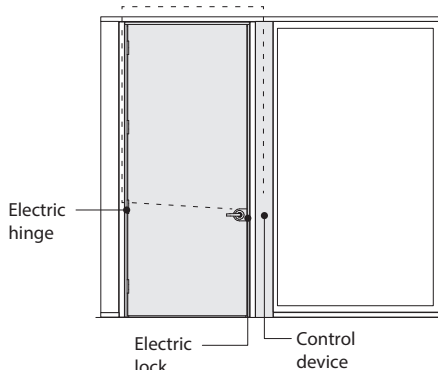

**When door openings** require an electronic security feature, solid doors can be equipped with an electric hinge. The electric hinge includes wire conductors that link an electric lock to the control device (card reader or keypad).

**When specified, the solid door** is constructed with an internal wireway to manage the wires from the hinge to the electric lock. Wires are routed from the hinge to the control device through the vertical door jamb as part of the installation process.

**The wire conductors** are 28 gauge and are suitable for low voltage current only (24 volt maximum). The lengths of the wires is 48" long (through the door) and 120" long (through the door jamb). The electric lock and the control device are not provided by Steelcase.

**Door openings that require electronic security** are typically equipped with closers in order to help maintain a secure opening. When mounting a closer on a door and positioning the door at an inside corner or mini-end, the door frame must be spaced at least 4" away from the adjacent surface.

**Utility panels** can be positioned adjacent to door frames to act as a mounting point for the control device. Electric hinges cannot be used with polished glass doors.

**When electronic security** is desired, as an alternative to electric locks, door frames can be specified for electric strikes. This is especially useful for door openings with polished glass doors.

**When electric keeper strike** is specified, additional parts are included in the door frame assembly kit to allow for the installation of the strike. The door frame is modified by the installer to accept the electric strike. The door frame is compatible with strikes as manufactured by Rutherford Controls International, which are provided by others:  
Cylindrical locks: RCI L6504  
Mortise locks: RCI S6504

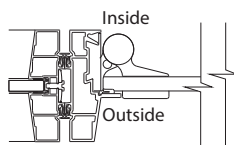

**When specifying doors with etched glass,** the etched surface can be oriented to either face of the door. Specify inside orientation when the polished face is oriented on the same side as the hinge knuckle. Specify outside orientation when polished edge is on the opposing face.

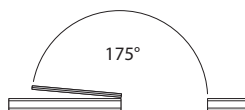

**A swing door with butt hinge** can swing open to a maximum of 175°.

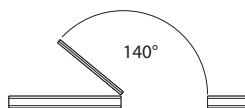

**A swing door with butt hinge and closer** can swing open to a maximum of 140°.

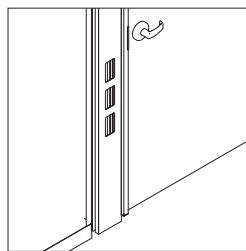

**Utility panels** can be positioned adjacent to door frames to accommodate switches, room schedulers, security control appliances, and other technology devices.



Magnetic wall stop



Dome-style floor stop



Screw-in base stop

**Door stops** can be ordered for use with doors. Magnetic wall stop, dome-style door stop, and screw-in base stop are available.

**Magnetic wall stop** is for use with painted steel skins.

## Surface Materials

### Door frame

- 8043 Clear Anodized Aluminum
- Paint

### Solid door leaf

- Paint
- Wood veneer

### Polished glass door

- Tempered Glass – Clear
- Tempered Glass – Satin

### Latchset

- 9200 Satin Chrome
- 9201 Polished Chrome
- 4710 Black

### Slim line hinges and butt hinges – solid

- 4710 Black
- 9200 Satin Chrome
- 9201 Polished Chrome

### Butt hinges – polished edge

- 4710 Black
- 9200 Satin Chrome

### Door pull (Push/pull handle)

- 4710 Black
- 8031 Brushed Stainless

### Door closer

- 4710 Black
- 4799 Platinum

### Roller latch

- 4710 Black
- 9200 Satin Chrome

# Slider Doors

**Slider door** assemblies offer privacy and security with space savings at door openings, and are available with a variety of hardware options.

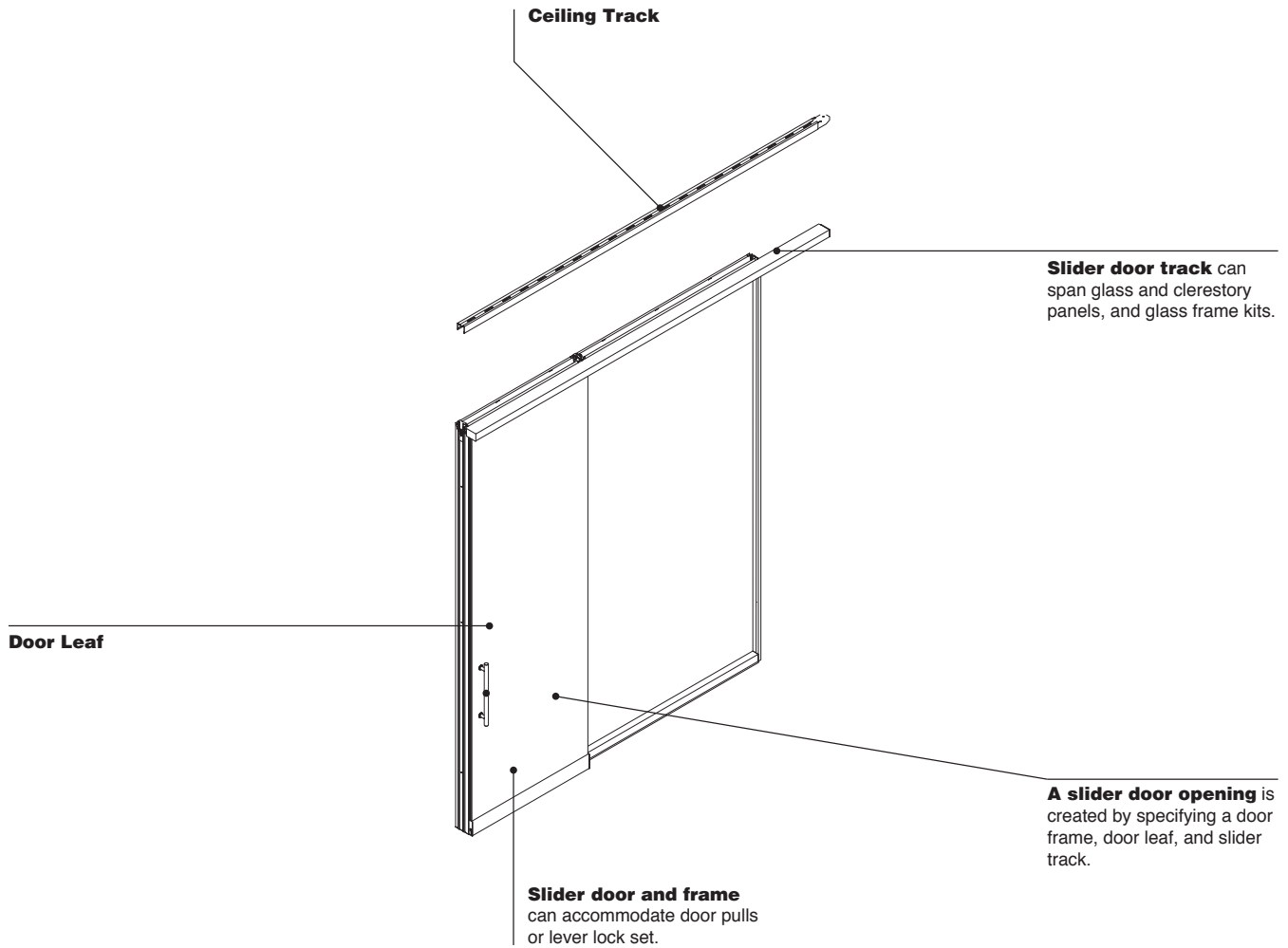

**Product Details**

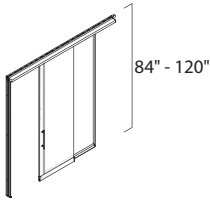

**Door frames** are available in full height configurations. Height range: 84"–120" ceiling height.

**Heights** are specifiable in 1/16" increments. Clear opening height = ceiling height minus 3 1/4".  
*Tip: Door unit ceiling heights less than 83 1/4" will not meet criteria for an 80" clear opening height, which is a minimum requirement by code in most areas.*

**Door units** are manufactured to specified slider orientation and cannot be altered.

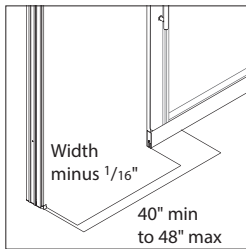

**Door frames** width is parametric and can vary from 40" to 48" planning width in 1/16" increments. Steelcase recommends using a 40" wide door frame to maximize accessibility, maintain visual continuity, and simplify the planning process during reconfigurations.

Clear opening widths:

- With pull: planning width minus 8.
- With lever lock: planning width minus 8 15/16".

*Tip: Door frames that are less than 40" planning width will not meet ADA guidelines for minimum clear opening (32").*

**Single door frame width** is parametric, and can vary from 40" to 48" planning width in 1/16" increments. Planning width is measured to centerline of frame couplers. Steelcase recommends using a 40" wide door frame to maximize accessibility, maintain visual continuity, and simplify the planning process during reconfigurations.

**Door frames and door leaves** can be specified at pre-set planning widths at a lower price than other parametric sizes. Pre-set planning widths for door frames are 40", 42", and 48".

**Ceiling track** allows 1" of vertical adjustment (plus/minus 1/2"), to accommodate ceiling variation.

**The door frame assembly** is designed to allow for 1 1/2" of adjustment at the floor (plus/minus 3/4"), while maintaining a consistent 3/16" undercut between the bottom of the door and the floor.

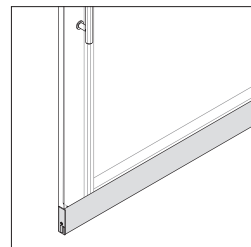

**The polished edge door** includes an adjustable aluminum bottom trim, which can be adjusted during installation to ensure a minimal and consistent clearance at the bottom of the door.

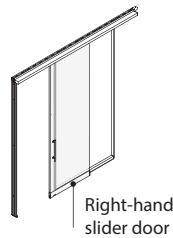

Right-hand slider door

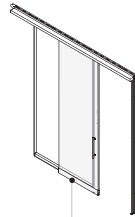

Left-hand slider door

**Door handing** is determined by the direction in which the door travels when opening, as viewed from the face of the wall on which the door is mounted.

**Doors** can be oriented to either face of the wall to position the door on either the interior or exterior of a room.

**Polished edge doors** are available in thicknesses of 3/8" or 1/2".

**Door frames** are cut to finished height during installation. New door frames may be required when repositioning door openings to an area with a greater floor variation.

**Door frames** are provided with an assembly hardware kit, shipped separately, which includes parts and fittings as required to assemble the door frame and hang the door.

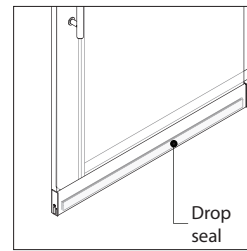

Drop seal

**Slider door frames** include static seals and gaskets to minimize potential sound paths around the door. Acoustic privacy can be enhanced by specifying the optional drop seal. The drop seal automatically deploys to block the gap under the door when the door is closed, and retracts when the door is open.

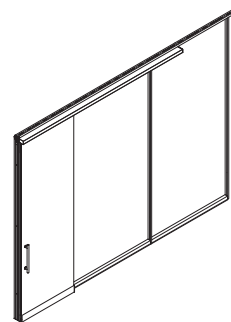

**The slider door track** spans the door frame and adjacent panel. The door track can be mounted to glass panel, clerestory panel, or frame kit.

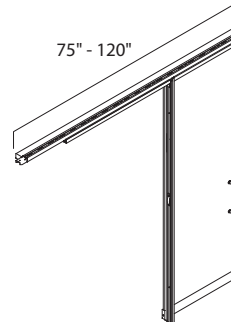

**The slider track** is available in width from 75" to 120", in 1/16" increments.

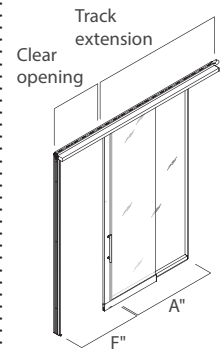

A must be > F-5"

**The modules adjacent to the single door track** on which the track is mounted must be at least as wide as the door frame minus 5" to allow for the door to travel the required distance to meet clear opening requirements.

**The slider track** can span two adjacent side panels or a frame kit, as long as the track length doesn't exceed 120".

**The slider track** cannot span an intersection or mini-end.

**The slider track** can span a utility panel when adjacent to a door frame on the trailing edge of the door.

**Utility panels** can be positioned adjacent to door frames to accommodate switches, room schedulers, security control appliances, and other technology devices.

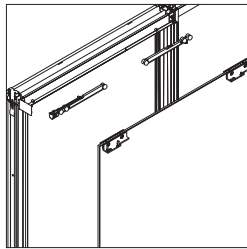

**The slider track** includes the sliding trolley hardware with close-assist functionality.

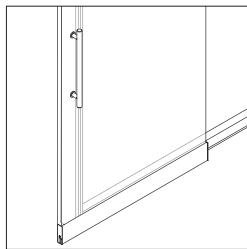

**Slider doors** can be equipped with push/pull handles, ladder pulls, or a lever lock set. See page 46 for a complete list of available pull options.

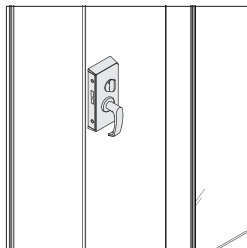

**Lever locksets** are available as an option on slider doors, and are equipped with an ADA compliant single action lock feature, allowing for the door to be unlocked and opened in a single motion.

**Locksets** can be provided in one of two configurations:

- Random key with standard cylinder
- No cylinder (to allow customer to provide cylinders to specific keying requirements)

**Lever locksets** are provided with a standard lever handle. Locksets can be provided without handles to allow for an easy substitution of another locally sourced style of lever.

**Slider locksets** are compatible with levers as manufactured by Schlage, Dorma, and Lawrence.

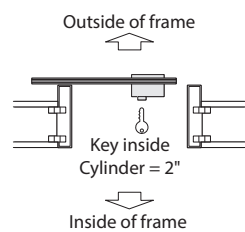
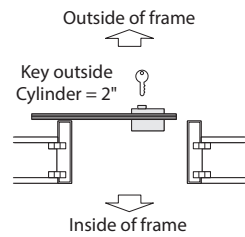

**When ordering cylinders from other suppliers for use with the Everwall slider lever locksets**, cylinders must be specified with a Schlage L cam configuration. When keyway and cylinder are oriented to the outside of the door frame, specify a 2" cylinder with a 7/16" trim ring. When keyway and cylinder are oriented to the inside of the door frame, specify a 1 1/8" cylinder with a 9/16" trim ring.

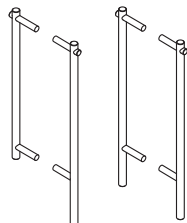

**Locking functionality** can also be addressed by specifying locking ladder pulls. ▶ See page 46 for more information.

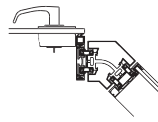
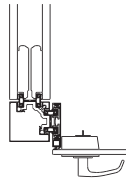

Two-Way 90°

Two-Way 135°

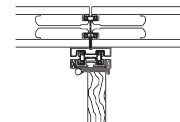
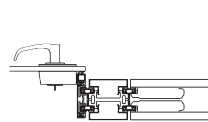

Utility Panel

Adapter T on module

**Door frames** can be positioned adjacent to any post or utility panel or on-module T-adapter.

**Mini ends** connect a door frame to perpendicular building wall.

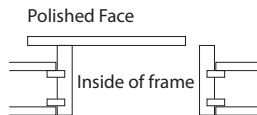

**Polished Outside**

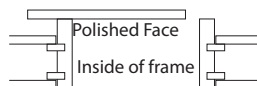

**Polished Inside**

**When specifying doors with etched glass**, the etched surface can be oriented to either side of the wall to accommodate orientation relative to inside/outside of the room. Users often prefer to orient the polished surface of glass to the corridor side for ease of cleaning.

## Surface Materials

### Door frame

- 8043 Clear Anodized Aluminum
- Paint

### Door frame seal

- 6000 Black
- 6249 Platinum Solid

### Polished glass door

- Tempered Glass – Clear
- Tempered Glass – Satin

### Lever lock

- 4710 Black
- 9200 Satin Chrome

### Door bottom trim

- 8043 Clear Anodized
- Paint



# Door Pulls

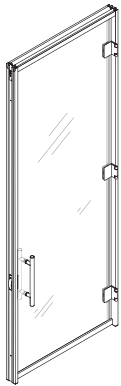

**Push/Pull**

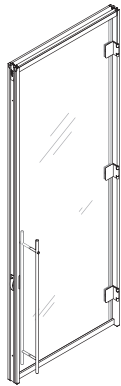

**Locking Ladder Pull**

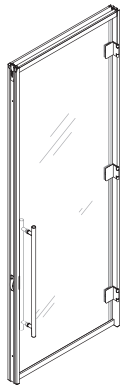

**Ladder Pull**

## Product Details

**Push/pulls and ladder pulls** can be specified for use on both swing and slider doors, either solid or polished edge glass.

**There** are two versions of pulls available. The TCS pulls are a lower price alternative to PBA pulls.

▶ See page 46 for available sizes and functionality.

### Keying options for locking ladder pulls:

- Random key with small format interchangeable core.
- No cylinder (to allow customer to provide housings and core to specific keying requirements). The no cylinder option is configured to receive a rim mounted cylinder. Recommended cylinder length:  
PBA: 1 $\frac{3}{8}$ "  
TCS: 1 $\frac{7}{16}$ "

**Users** can replace existing cores with other SFIC cores (6 pin) as manufactured by Sargent, Schlage, Best, Medeco, Arrow, Yale, and Falcon.

**Locking ladder pulls** are available in heights of 48", 53", or 60".

**When specifying a door with push/pull handle or ladder pull, either a roller latch, closer or slim line hinge with self-close** must be selected to ensure that the door remains in the closed position.

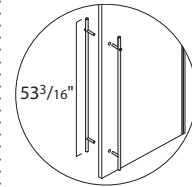

Aligned Pull

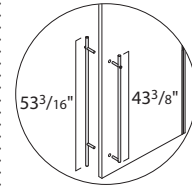

Offset Pull

**When mounted on swing doors**, offset pulls can be specified to provide clearance per ADA guidelines. Offset pulls can also be provided on slider doors when matching pulls are desired.

**72" high ladder pulls** will not be ADA compliant when mounted to swing doors.

**Locking ladder pulls** engage in the floor.



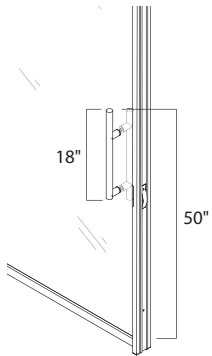

Push/Pull x 18" x 1.0"D

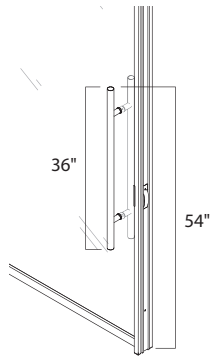

Ladder Pull x 36" x 1.0"D  
Aligned TCS

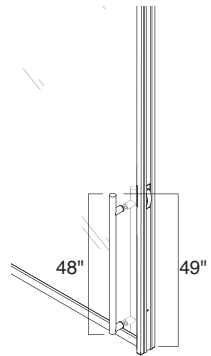

Ladder Pull x 48" x 1.38"D  
Offset TCS  
Locking

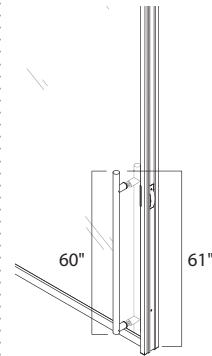

Ladder Pull x 60" x 1.38"D  
Offset TCS  
Locking

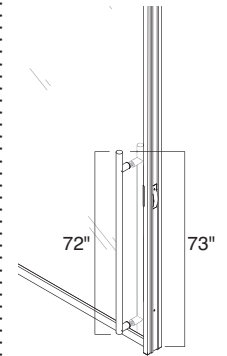

Ladder Pull x 72" x 1.38"D  
Offset TCS  
Locking

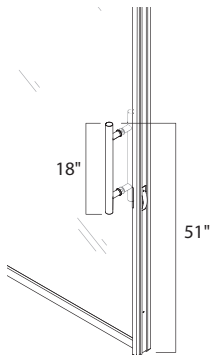

Ladder Pull x 18" x 1.0"D  
Aligned TCS

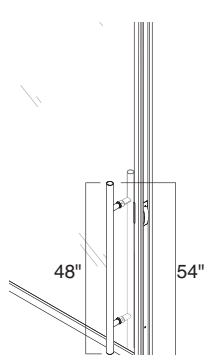

Ladder Pull x 48" x 1.0"D  
Aligned TCS  
Non-locking

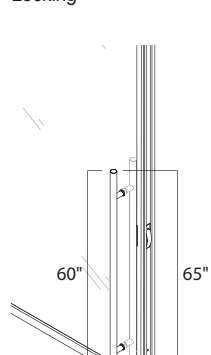

Ladder Pull x 60" x 1.0"D  
Aligned TCS  
Non-locking

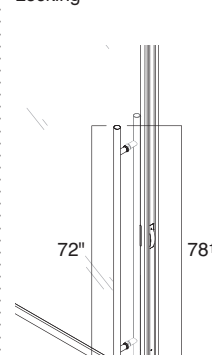

Ladder Pull x 72" x 1.0"D  
Aligned TCS  
Non-locking

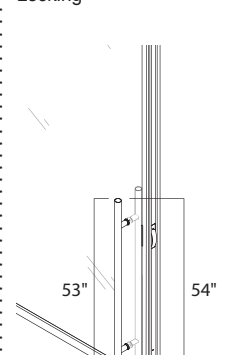

Ladder Pull x 53" x 1.0"D  
Aligned PBA  
Locking

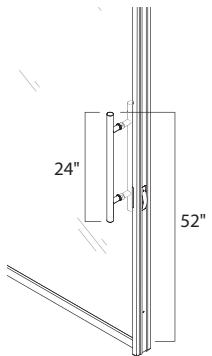

Ladder Pull x 24" x 1.0"D  
Aligned TCS

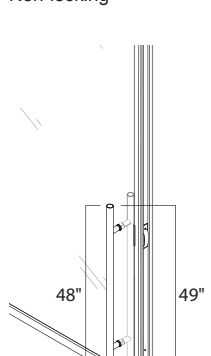

Ladder Pull x 48" x 1.0"D  
Aligned TCS  
Locking

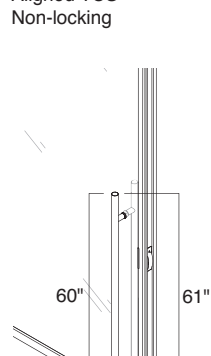

Ladder Pull x 60" x 1.0"D  
Aligned TCS  
Locking

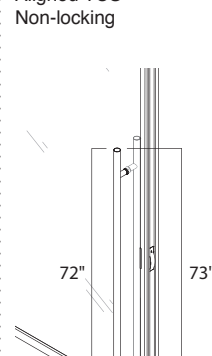

Ladder Pull x 72" x 1.0"D  
Aligned TCS  
Locking

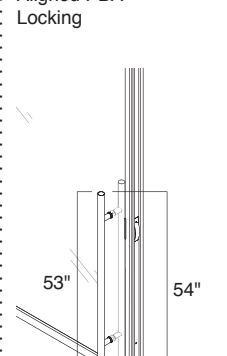

Ladder Pull x 53" x 1.0"D  
Aligned PBA  
Non-locking

**Surface Materials**

- 4710 Black
- 8031 Brushed Stainless

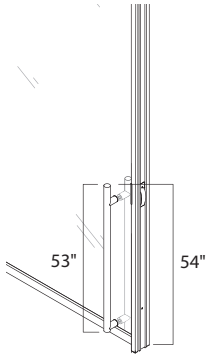

Ladder Pull x 53" x 1.4"D  
Offset PBA  
Locking

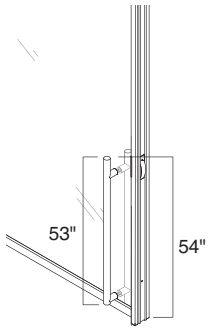

Ladder Pull x 53" x 1.4"D  
Offset PBA  
Non-locking



# Posts

**Note: All planning and application guidelines contained in this section of the specification guide are based on the requirement that ceiling track is connected to a ceiling in order to properly support the wall components as shown.**

**Posts** join panels in a variety of configurations.

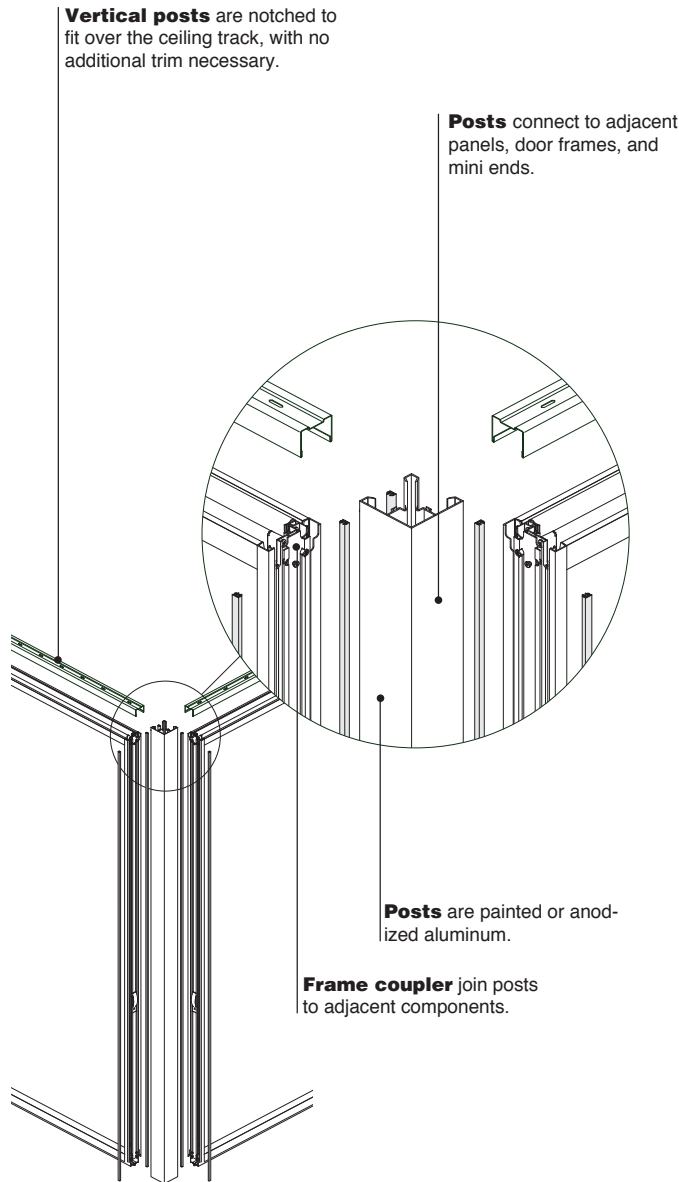

## Product Details

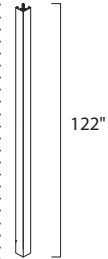

**Posts** are shipped in a standard height of 122" and are cut to fit in the field.

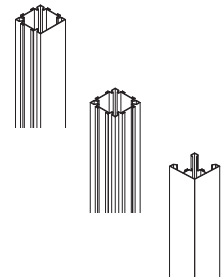

**Posts** span from finished floor to finished ceiling, and are cut to exact length by installer.

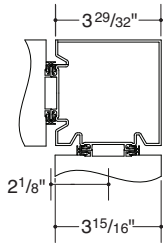

Two-Way 90°

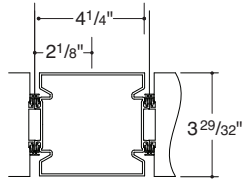

Two-Way 180°

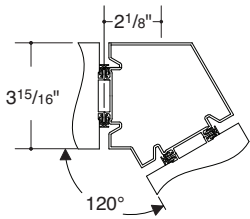

Two-Way 120°

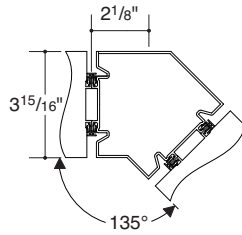

Two-Way 135°

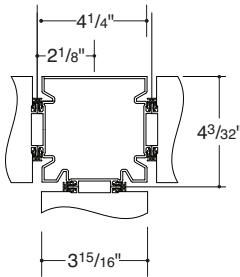

Three-Way 90°

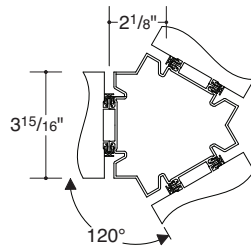

Three-Way 120°

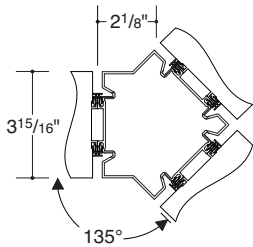

Three-Way 135°

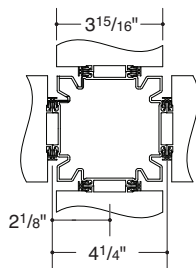

Four-Way°

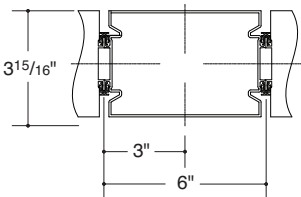

Bypass

Configurations for posts include two-way, three-way, and four-way.

**Connections**

Any panel, door frame, or mini end can be connected to a post.

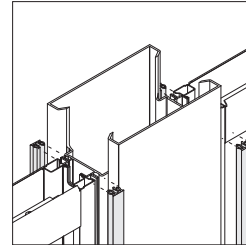

Frame couplers, ordered separately, join posts to panels and door frames. They prevent light and sound leaks and run from the top of the skin or glass frame to the floor, overlapping the floor track.

▶ Page 76

Posts are often more appropriate when planning with interior room dimensions.

*Tip: Remember to allow for post dimensions when calculating the overall length of a wall.*

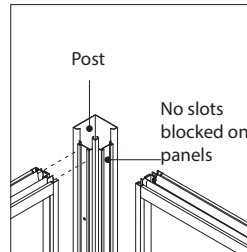

Slotted verticals are accessible when using posts.

**Wiring & Cabling**

Posts can be used to vertically route power and cable infeeds down from the ceiling or up from the floor.

**Surface Materials**

**Post**

- Paint
- Anodized aluminum

**Frame coupler**

- 6249 Platinum Solid
- 6527 Merle

# Adapters

**Note: All planning and application guidelines contained in this section of the specification guide are based on the requirement that ceiling track is connected to a ceiling in order to properly support the wall components as shown.**

**Adapters** engage the verticals on the edge of a panel to allow perpendicular panels to connect at T and X intersections.

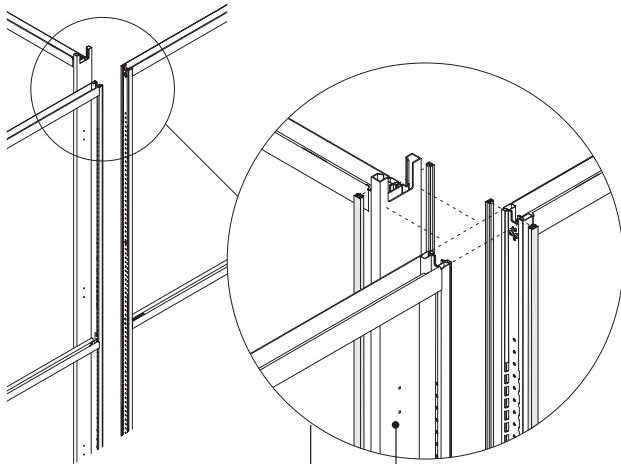

**Surfaces of finished ends and T/X adapters** are painted or anodized aluminum.

**Frame couplers** join adapters to adjacent components.

## Product Details

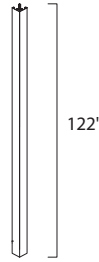

**Adapters** are shipped in a standard height of 122" and are cut to fit in the field.

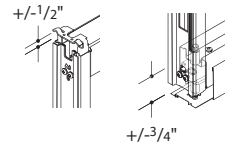

**Ceiling track** allows 1/2" of vertical adjustment to accommodate variations in field conditions. Floor track allows 3/4" of vertical adjustment to accommodate variations at base.

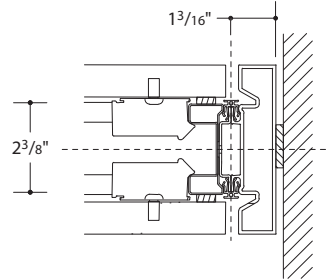

**Finished-end adapter** caps the exposed vertical edge of the last panel in a run. Surface of the adapter is painted or anodized aluminum. Finished-end adapter adds approximately 1 1/16" to the length of the wall.

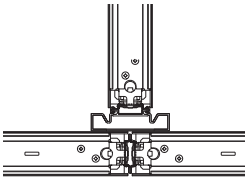

Adapter T on module

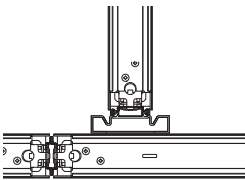

Adapter T off module

**T adapter** allows a perpendicular panel to join to a wall, either off-module or on-module.

**Connections**

**Any panel, door frame, or mini end** can be connected to an adapter.

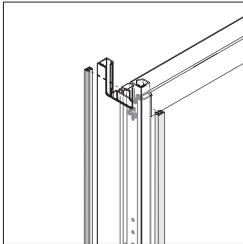

**Frame couplers** ordered separately, join panels and other components to adapters and prevent light and sound leaks. Frame couplers can be cut on site to provide access to the integral slotted verticals so that panel-supported components can be attached. To rearrange panels, frame couplers can be removed and reused.

▶ Page 76

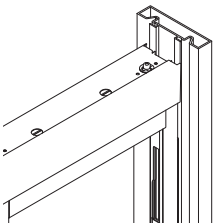

**Finished end** runs from the floor to ceiling, finishing the end of the ceiling track in the same way that the finished end adapter completes the exposed vertical edge of the last panel.

▶ Page 74

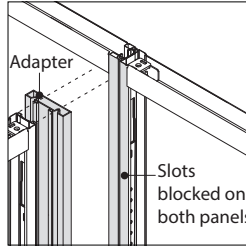

**Blocked slots** occur on the edges of some panels in configurations with adapters. This makes it impractical to attach panel-supported components at these points.

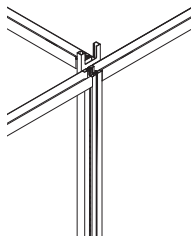
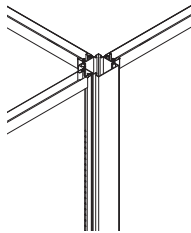

**T-adapters**, can present a cleaner visual than T-posts by presenting a single reveal and ceiling track continuity.

**Wiring & Cabling**

**Adapters** do not accommodate vertical wire and cable routing.

**Surface Materials**

**Finished-end adapter and L-adapter**

- Paint
- Anodized aluminum

# Vertical Transition to Lite Scale

▶ See the *Lite Scale Specification Guide* for information regarding Everwall and Lite Scale.

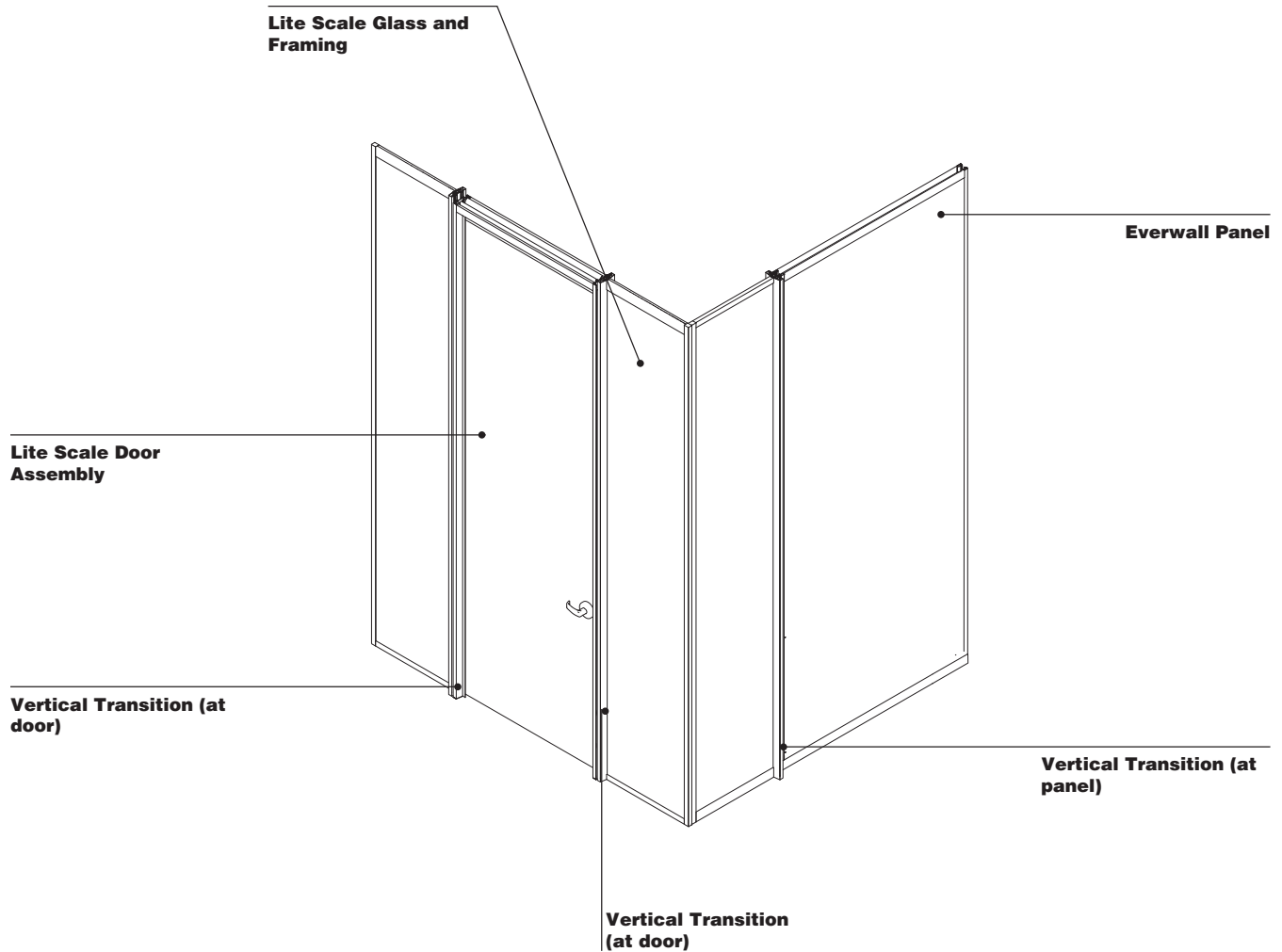





# Bypass

When applying Everwall glass fronts with conventional fixed cross walls, it may be desirable to create an interface condition where the Everwall wall conceals the cross wall. The bypass assembly is designed so that it can be installed as a complete assembly and create an uninterrupted visual along a corridor.

Fixed Conventional Wall

Ceiling Track

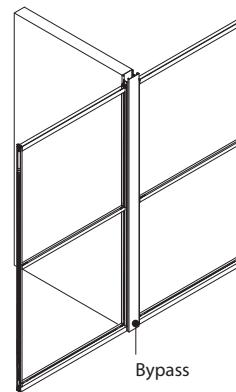
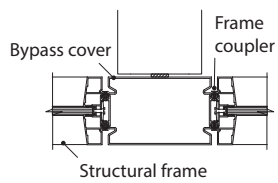
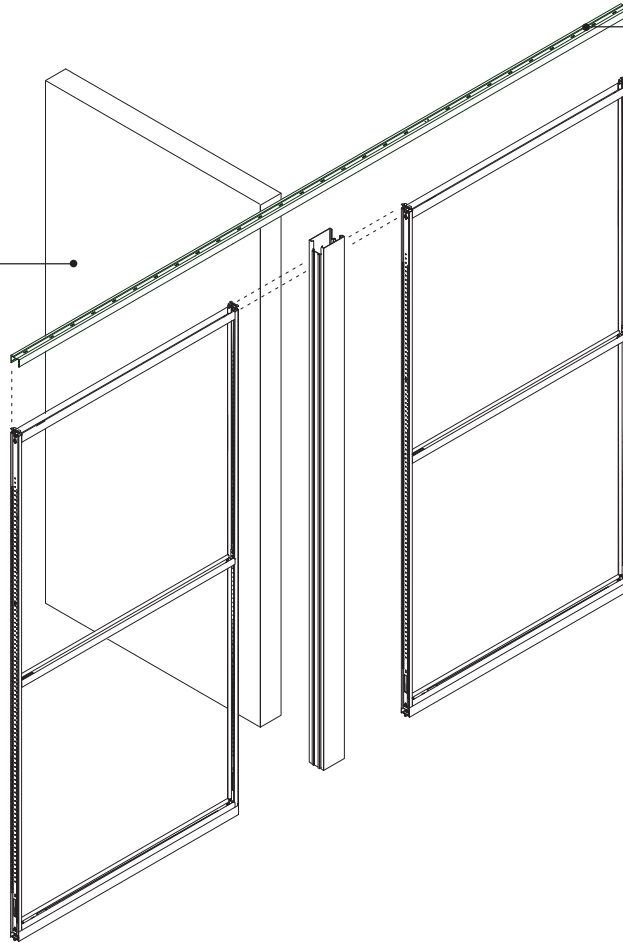

**Product Details**

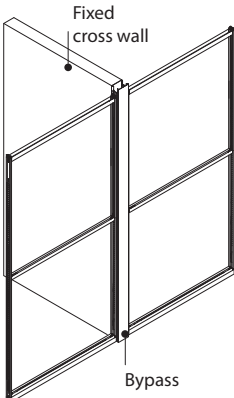

**When applying Everwall glass fronts with conventional fixed cross walls,** it may be desirable to create an interface condition where the Everwall wall conceals the cross wall. The bypass assembly is designed so that it can be installed as a complete assembly and create an uninterrupted visual along a corridor.

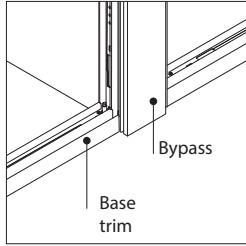

**Bypass assemblies** are designed to be used with base trim along the corridor side of the wall.

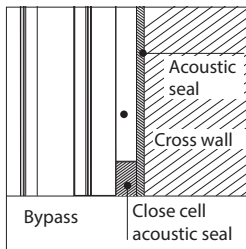

**A close cell acoustic seal** is included to close any gaps between the end of the cross wall and the face of the bypass cover.

**Surface Materials**

- Bypass**
- 8043 Clear Anodized Aluminum
  - Paint

6"

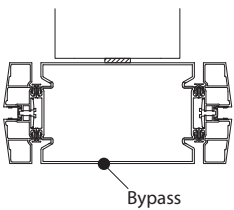

**The planning width for a bypass assembly** is 6".

**Bypass surfaces** can be painted or anodized aluminum.

# Cutable Ends

**Cutable ends** can be field cut around irregular building surfaces.

**Cutable ends** can be used with a cut skin at a single flush cut.

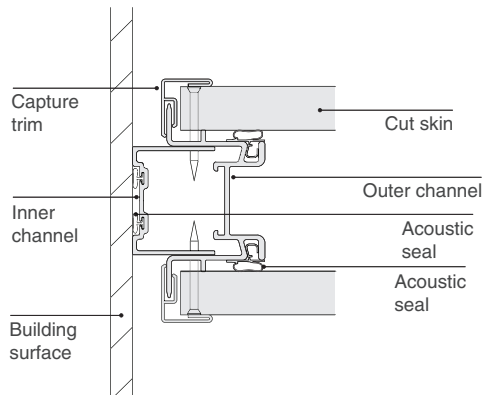
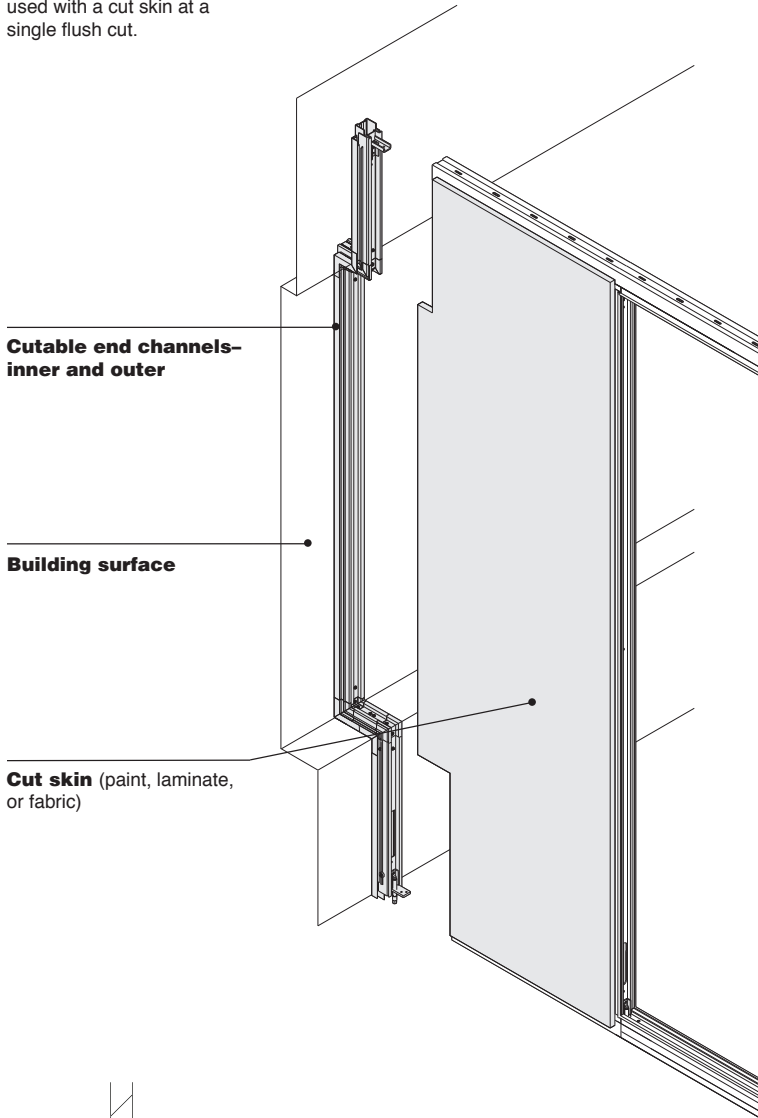

**Cutable ends** can be used at straight cuts to adapt to site conditions or dimensional changes.

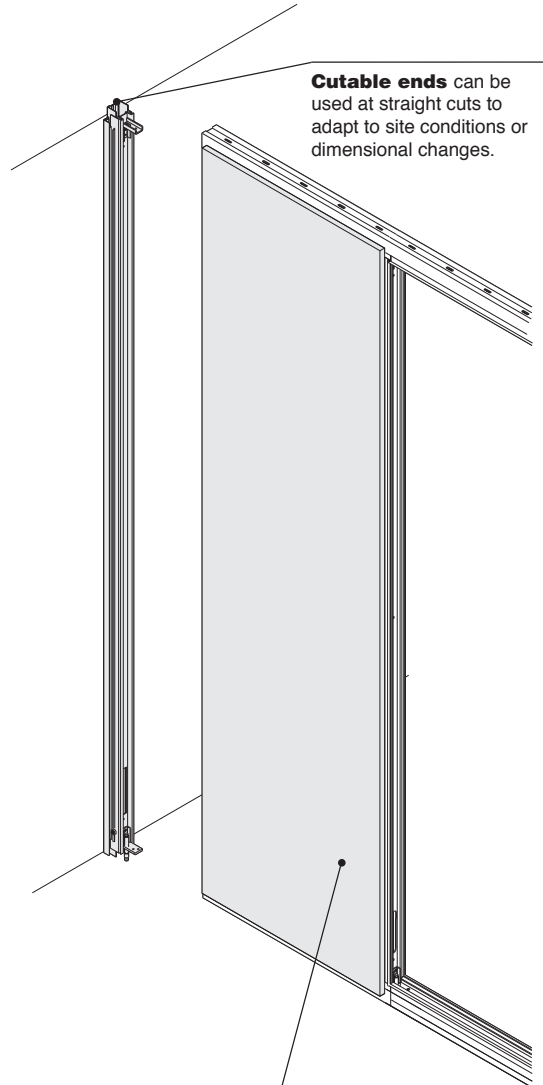

**Cut skin** (paint, laminate, or fabric)

**Product Details**

**Cutable ends** are sometimes necessary for a field cut at a wall termination – either to allow for unknown dimension, or to trim around irregular building conditions.

**Cutable ends** are used with monolithic solid skins – paint, laminate or fabric.

**Special skins** are not required for field cutting.

**Cutable ends** are fastened to the adjacent building surface.

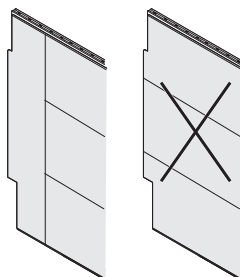

**Cutable end assemblies** do not accommodate intermediate horizontals or segmentation.

**Cutable ends** are not used with slatwall, lighting, ceramic skins, or monitor shrouds.

**Electrical devices** cannot be positioned in a cut skin.

**Infeeds and cables** can be routed behind a cut skin.

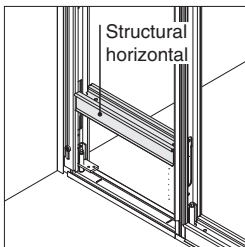

**Structural horizontals that are positioned adjacent to cutable ends** will be modified to ensure that cable cut-outs do not interfere with the bracket connection. These horizontals will receive one cut-out only when 22.61" long or greater. Structural horizontals that are less than 22.61" will not have any cable cut-outs.

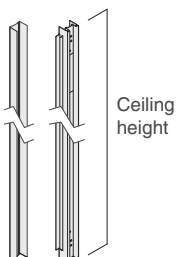

**When intended for use with a single vertical cut**, the inner and outer channel are ordered in lengths that correspond to ceiling height.

**When intended for use with a single vertical cut**, the inner and outer channel are combined into a single assembly.

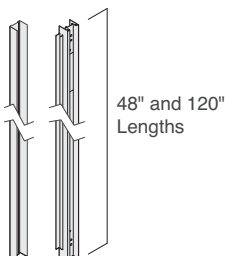

**When intended for use with multiple cuts around sills and soffits**, channel lengths can be specified in different lengths to minimize scrap.

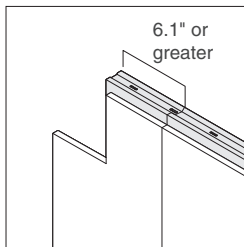

**A skin** cannot be cut to a dimension less than 6.1" (face of skin to centerline of post).

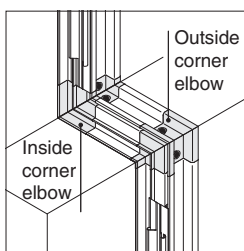

**Cutable end assemblies** can be combined with corner angles and elbows (inside and outside corner) to allow the installer to trim around unique end configurations.

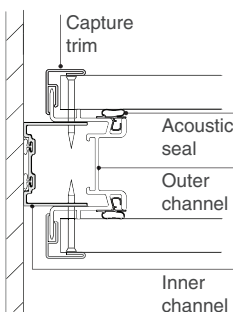

**Inner channel** can be specified in a different color than capture trim.

**In some configurations, the outer channel seal** may be visible and should be specified to be color matched to acoustic seals on adjacent posts and horizontals.

**Capture trim paint color** can differ from one side of wall to the other.

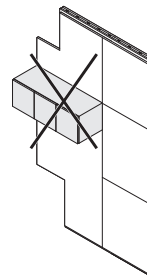

**Cutable ends** do not accommodate hang-on components.

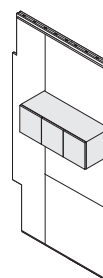

**Hang-on storage components** can be positioned adjacent to a cut condition.

**Surface Materials**

**90° Cutable end assembly**

- Paint (cutable end assembly)
- Plastic (seal)

**90° Cutable end inner channel**

- Paint (cutable end assembly)
- Plastic (seal)

**Cutable end capture trim**

- Paint

# Mini End and Wall Start

**Note: All planning and application guidelines contained in this section of the specification guide are based on the requirement that ceiling track is connected to a ceiling in order to properly support the wall components as shown.**

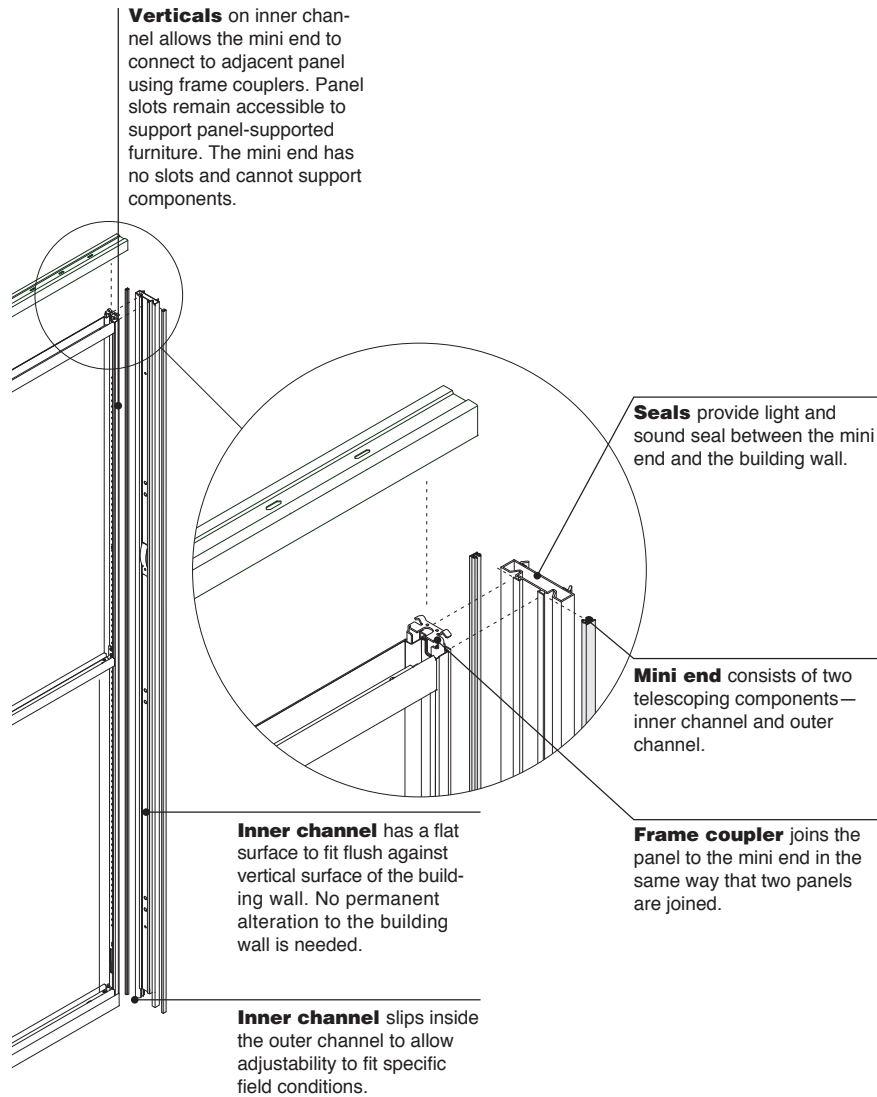

## Product Details

**Mini-ends and wall starts** are shipped in a standard height of 122" and are cut to fit in the field to span from finished floor to finished ceiling.

1 3/16"

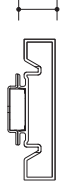

2 1/4" to 3 7/8"

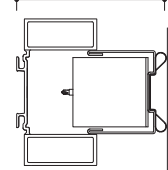

4 1/4" to 5 7/8"

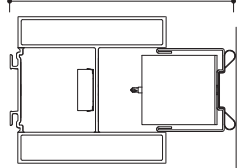

**Two sizes** of mini ends are available. Each telescopes to accommodate a different range of dimensions. For installations that require a dimension smaller than 1 1/2", use a wall start.   
▶ Page 126

**Wall starts** present a more minimal visual than mini-ends. Because they are not adjustable, the interfacing surfaces must be precisely positioned, and be plumb and flat.   
▶ Page 126

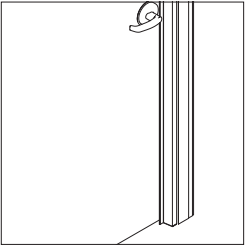
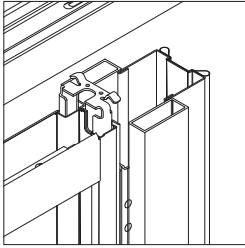

**Mini ends** always go to the floor and ceiling and are field-cut to the proper height.

**Mini-ends and wall starts** span from finished floor to finished ceiling, and are cut to exact length by installer.

**Connections**

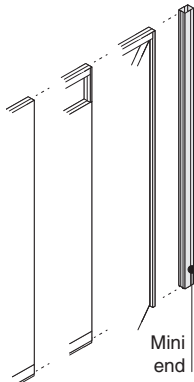

**All panel types and door frames** can connect to a mini end.

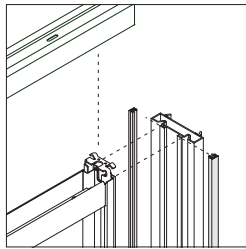

**Adjacent panels** connect to a mini end in the same way all panels connect. Frame couplers on both sides of the panel form a continuous link to the mini end by engaging the verticals of the mini end and the adjacent panel.

**Physical connection to the building** is not always needed. Mini ends are fitted with a continuous seal to prevent light and sound leaks.

**Panel-supported components** cannot be attached to a mini end. Use the adjacent panel to support storage components.

**All wall types and door frames** can connect to a mini end.

**A screw connection to the building** is not typically required. Mini end fits tightly against the building wall, and the contact points are sealed with a continuous polypropylene seal.

**When routing cable through a medium mini-end**, the inner channel will be screwed to the fixed wall.

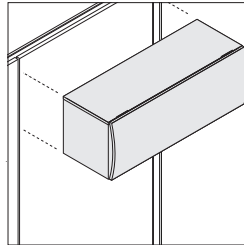

**Solid panel adjacent to mini end** can support hang-on storage.

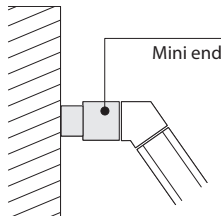

**Mini ends** can be positioned adjacent to an angled post to create an angled wall termination.

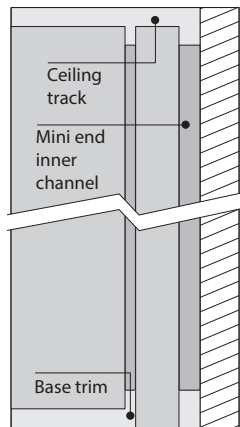

**When making paint color selections**, it is recommended to use the same color for ceiling track and mini end inner channel.

**Wiring & Cabling**

**Wire and cable routing vertically through a mini end** can be used to route power to adjacent clerestory or solid panels. Screws are needed when routing power in medium mini ends.

**Surface Materials**

**Inner finish—mini end**

- Paint

**Outer finish—mini end**

- Paint
- Anodized

**Wall start**

- Paint
- Anodized

**Frame coupler**

- 6249 Platinum Solid
- 6527 Merle

# Electrical Components

**Field-installed electrical components** are available to provide power, data, lighting control, or other types of devices. Power options include modular power or conventional hardwired devices.

**Communication cabling** is field installed.

**Modular power components** utilize modular connections to simplify power distribution and speed installation.

**Electrical mounting brackets** are supported by vertical structure or intermediate horizontals, and allow for either modular or hardwired components.

**Framing components** are pre-punched for cable routing.

**Hardwire (power or communications)**

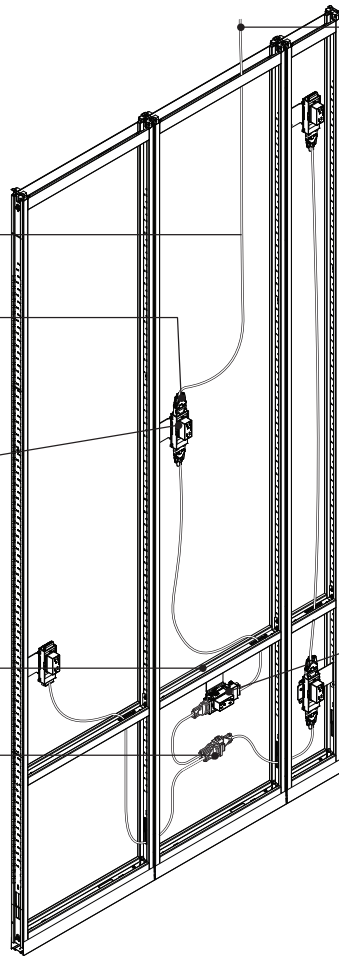

**Infeeds** can be routed through the ceiling or floor.

**Modular harnesses** connect power blocks.

**Modular communications** offer voice and data options consistent with design of modular power faceplate.

**Electrical locations** are parametric.

**Electrical mounting brackets** can be mounted to the underside of intermediate horizontals.

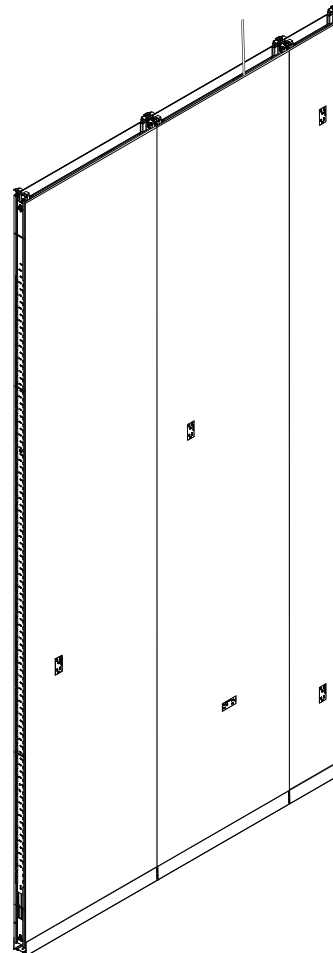



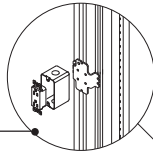

**Electrical mounting brackets** support hard-wired or modular power.

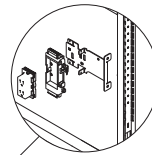
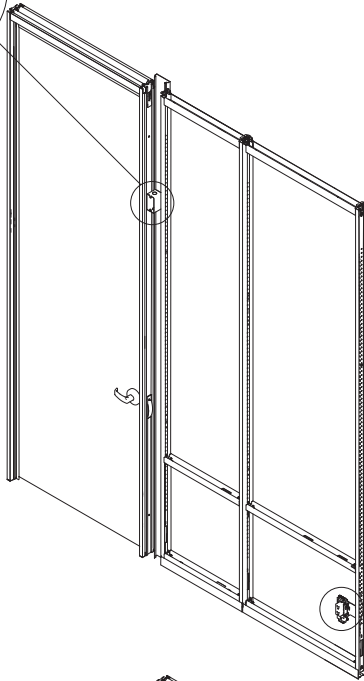

**Electrical mount bracket** at frame vertical.

**Multipurpose infeed** feeds from floor or ceiling.

**Utility panels** are factory cut for modular or hardwired power.

**Utility panel** houses electrical devices when cut-outs in skins are not available or desired.

**Utility panel cover**

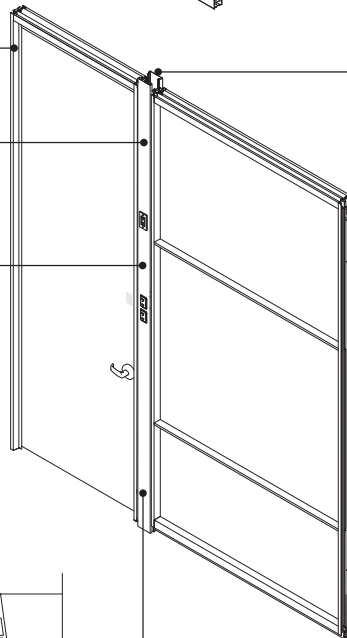

**Utility panel frame**

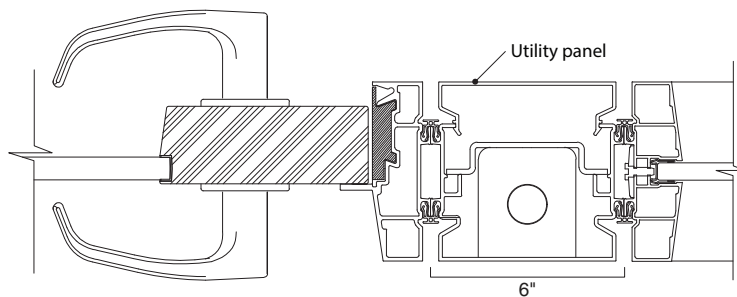

**Product Details**

**Electrical devices** can be positioned in solid skins or in utility panels.  
 ▶ See Utility Panels on page 65

**Modular power or hardwired electrical devices** can be accommodated. Both types can be combined in the same application.

**Receptacles mounted to verticals** are parametric and can be positioned in 1" increments.  
 ▶ See *SmartTools*

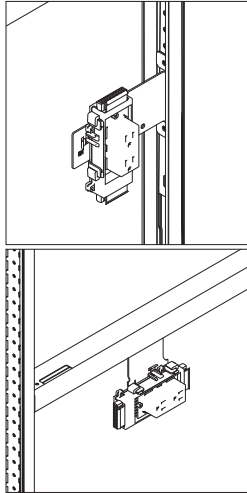

**Electrical devices** are held in place with mounting brackets, which are fastened to vertical structure or intermediate horizontals as part of the installation process.

**Each structural frame vertical, structural horizontal and intermediate horizontal** includes a cut-out for cabling routing. If required, additional cable routing holes can be cut during installation. Horizontals less than 10" wide do not have cutouts.

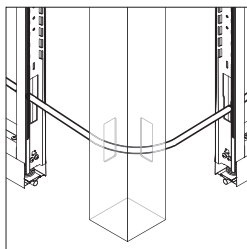

**Infeeds and harnesses** can be fed through posts and utility panels. Horizontal routing holes are field drilled.

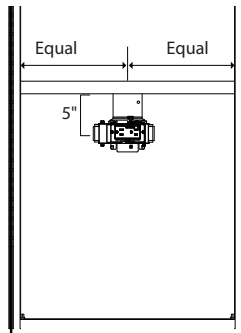

**Receptacles mounted to horizontals** are centered on the horizontal and mounted 5" below the centerline of the horizontal.

**The maximum number of cut-outs per skin** will vary depending on the size of the skin and overall skin geometry. The largest skin will allow for nine cut-outs. Electrical cut-outs can be specified for factory cutting, or can be cut on site.

**A maximum of three devices** can be located in a single utility panel.  
 ▶ See Utility Panels on page 65

**Modular Power in Skins**

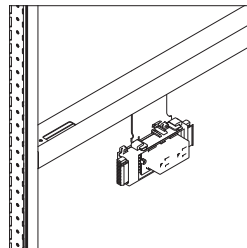

**Modular power blocks** are held in place with mounting brackets, which are fastened to structural frame components.

**A multipurpose infeed** brings power from the ceiling or floor to a power block in the wall.

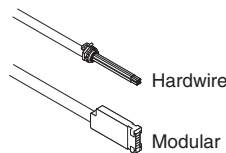

**End of the power infeed** can be hardwire or modular. Hardwire allows the electrician to make a conventional connection to the building's power inside a junction box. Modular allows the infeed to connect to any corresponding modular infeed cover. This is the same modular connector used by Answer, Montage, and Architectural Solutions modular power system.

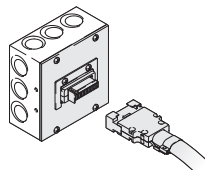

**Modular infeed cover** is included with modular multipurpose infeed to hardwire to a junction box. It allows modular connector on the infeed to snap easily into position. This allows infeeds to be quickly disconnected, moved, and reconnected later.

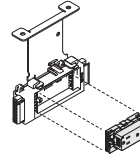

**Receptacles** are ordered separately and field installed in power blocks. Separate duplex receptacles are available to engage each of the different circuits that are possible in the electrical system. Receptacles are coded to indicate which circuit and type of ground they engage.

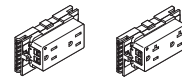

**Receptacles** can be specified as 15 amp or 20 amp rated.

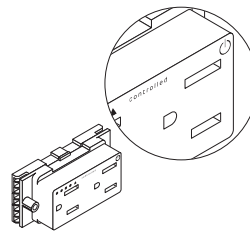

**Modular receptacles** are available with a power icon symbol, including the word "Controlled", when required as part of a controlled power system in compliance with the energy code.

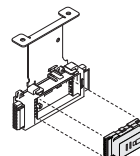

**USB receptacles** are available in three wiring schematics with multiple line options. USB receptacles offer easy access to two changing ports. Each port provides one amperage of output. USB receptacles conveniently charge a wide range of electronic devices. Some devices may not be compatible.

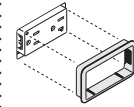

**Receptacle trim** is used with each receptacle to cover the edge of the cut-out and create a precise transition between the cut-out and the receptacle.

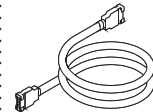

**Modular harnesses** connect power from one power block to another. Harnesses are available in lengths of 36", 72", and 144".

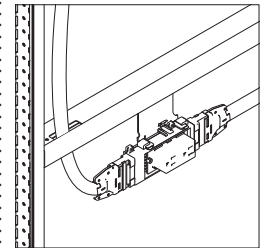

**Each power block** can receive a single harness at either end.

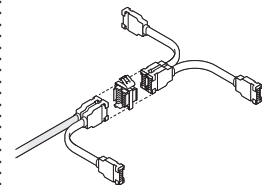

**Harness-to-harness branching connector** link harnesses. This allows multiple harnesses to connect at a single point to allow power networks to branch.

**Harnesses** cannot be routed in the base cavity or door frames.

**Power harnesses** can be routed behind solid skins or within posts, utility panels, and mini ends.

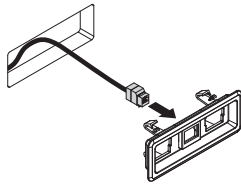

**A modular communication faceplate** can be used to create voice and data terminations using a design that is consistent with modular power receptacles.

**Modular communication faceplates** are not compatible with junction boxes. If junction boxes are desired at communication terminations, a conventional faceplate is required.

**In some cities, like New York and Chicago, local electrical codes** will not allow the use of modular power components in full height walls. When planning for power in these areas, use hardwire power components.

**Hardwire in Skins**

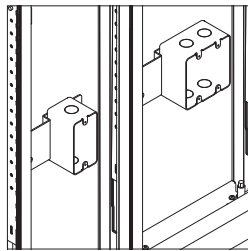

**Junction boxes** are held in place with mounting brackets, which are in turn fastened to structural frame components.

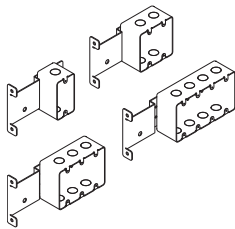

**Mounting brackets** can accommodate single gang, two gang, three gang, or four gang junction boxes. Mounting brackets are designed for use with 2 1/2" deep junction boxes as manufactured by Appleton. Single Gang – M1-250 Two Gang – M2-250 Three Gang – M3-250 Four Gang- M4-250 Partition – LVP250 Skins can be factory cut for any of these four sizes.

**Junction boxes (and associated devices) and cover plates** are purchased locally and are not part of the statement of line.

**Conduit** cannot be routed in the base cavity, or door frames.

**Utility Panel**

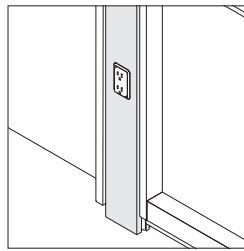

**Utility panels** are used to house electrical devices adjacent to glass panels and door frames, or when skin cut-outs are not desired.

**Utility panels** are made up of utility panel frame and cover.

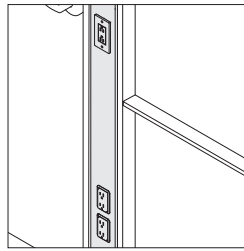

**Utility panels** can include as many as three electrical devices. One of these can be a modular power block. The three cut-outs can be located in one cover, or can be distributed between cover and panel (i.e. two cut-outs in the cover, one cut out in the panel). Utility panel frames and covers can be ordered with factory cut-outs.

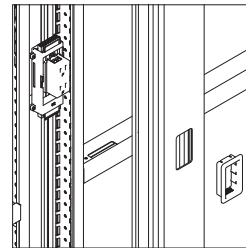
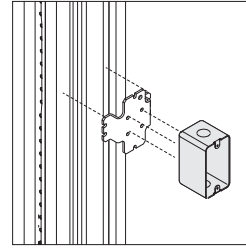

**Electrical devices** are held in place with mounting brackets, which are in turn fastened to utility panel verticals.

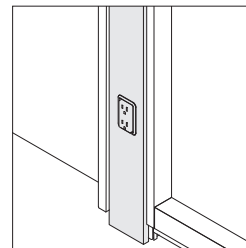

**Modular power blocks** are oriented vertically in the utility panel.

**Utility panels** can accommodate hardwired single gang 2" x 4" electrical boxes – 2 1/2" deep.

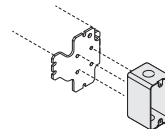

Hardwire box

**Utility panel mounting brackets** are designed for use with hardwired junction boxes as manufactured by Appleton. 2 1/2" deep: 4SSLD-1/2"

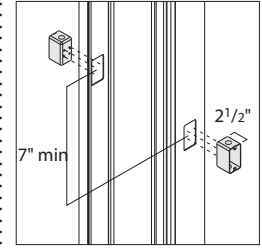

**When hardwired devices using a 2 1/2" deep box** are cut into both sides of the utility panel, they must be offset by a minimum of 7" (center to center).

**There are two types of mounting brackets:**

- hardwired 2 1/2" deep box
- modular power block

**Modular communication covers** cannot be located in a utility panel. Use industry standard communication faceplates.

**Junction boxes (and associated devices) and cover plates** are purchased locally and are not part of the statement of line.

**Communications**

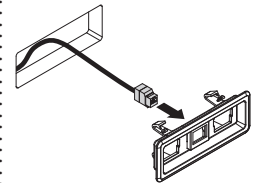

**A modular communication faceplate** can be used to create voice and data terminations using a design that is consistent with modular power receptacles.

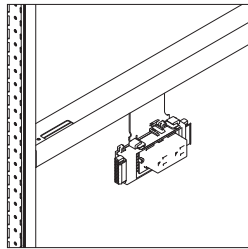

The modular communication faceplate snaps directly into a cutout in the skin.

The modular communication faceplate uses any combination of three adaptors from the provided data tree.

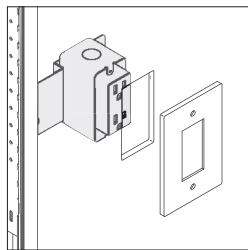

Conventional communication faceplates can be used with an electrical box, which is held in place with electrical mounting brackets.

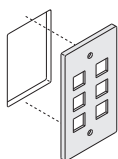

**Cut-Outs**

Cut-out locations are parametric, and are positioned as part of the design/planning process.  
 ▶ Page 68 for more details related to cutout positions.

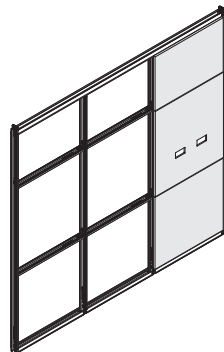

Electrical cut-outs can be specified for factory cutting or can be cut on site.

The maximum number of cut-outs per skin will vary depending on the size of the skin. The largest skin will allow for nine cut-outs.

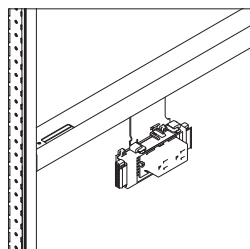

Modular Power (one cut-out for each receptacle)

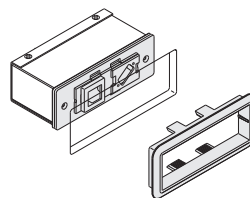

Modular Communications

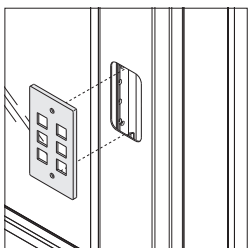

When an electrical box is not desired, communication faceplates can be fastened to the surface of the skin or utility panel.

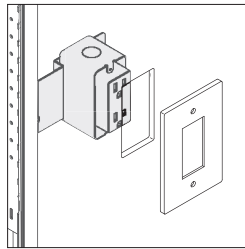

Hardwire Single

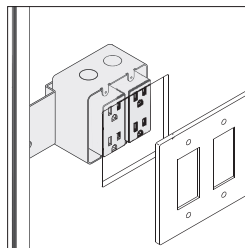

Hardwire Double

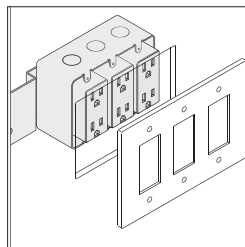

Hardwire Triple

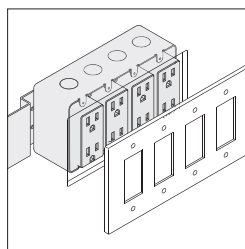

Hardwire Fourplex

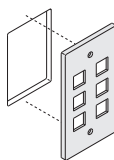

Communications - No Junction Box

Electrical cut-outs in skins are available in eight different configurations.

**Brackets**

Electrical mounting brackets for skins will fasten to intermediate or structural horizontals. They are available in two types:  
 • Modular power  
 • Hardwire

Two types of mounting brackets for utility panels:

- Hardwire 2 1/2" deep box
- Modular power block

All Everwall electrical components are listed by Underwriters Laboratory (UL) and certified by the Canadian Standards Association (CSA).

All Steelcase electrical systems are designed in compliance with the National Electrical Code (NEC) and Canadian Electrical Code (CEC) to function as a multi-wire branch circuit. Installations should be made in accordance with the NEC or CEC provisions for multi-wire branch circuits.

Local electrical codes vary. Consult a qualified electrical contractor or engineer for the proper installation of electrical equipment.

**Surface Materials**

Receptacle  
 • Plastic

Power/communication receptacle trim  
 • Plastic

Modular communication faceplate  
 • Plastic

Utility panel cover  
 • 8043 Clear Anodized Aluminum  
 • Paint



# Electrical Locations

Minimum Dimensions for Outlet Spacing  
Modular Power and Communications with Bracket

All dimensions are to center of receptacle.

All dimensions are to centerline of reveal unless otherwise noted to floor/ceiling.

Electrical brackets do not attach to clerestory horizontals.

## Minimum Skin Size - Mounted to Vertical

|        | Hardwire Single | Hardwire Double | Hardwire Triple | Hardwire Fourplex | Modular |
|--------|-----------------|-----------------|-----------------|-------------------|---------|
| Height | 17"             | 17"             | 17"             | 17"               | 17"     |
| Width  | 10"             | 12"             | 14"             | 16"               | 10"     |

## Minimum Skin Size - Mounted to Horizontal

|        | Hardwire Single | Hardwire Double | Hardwire Triple | Hardwire Fourplex | Modular |
|--------|-----------------|-----------------|-----------------|-------------------|---------|
| Height | 15"             | 15"             | 15"             | 15"               | 12"     |
| Width  | 24"             | 24"             | 24"             | 24"               | 24"     |

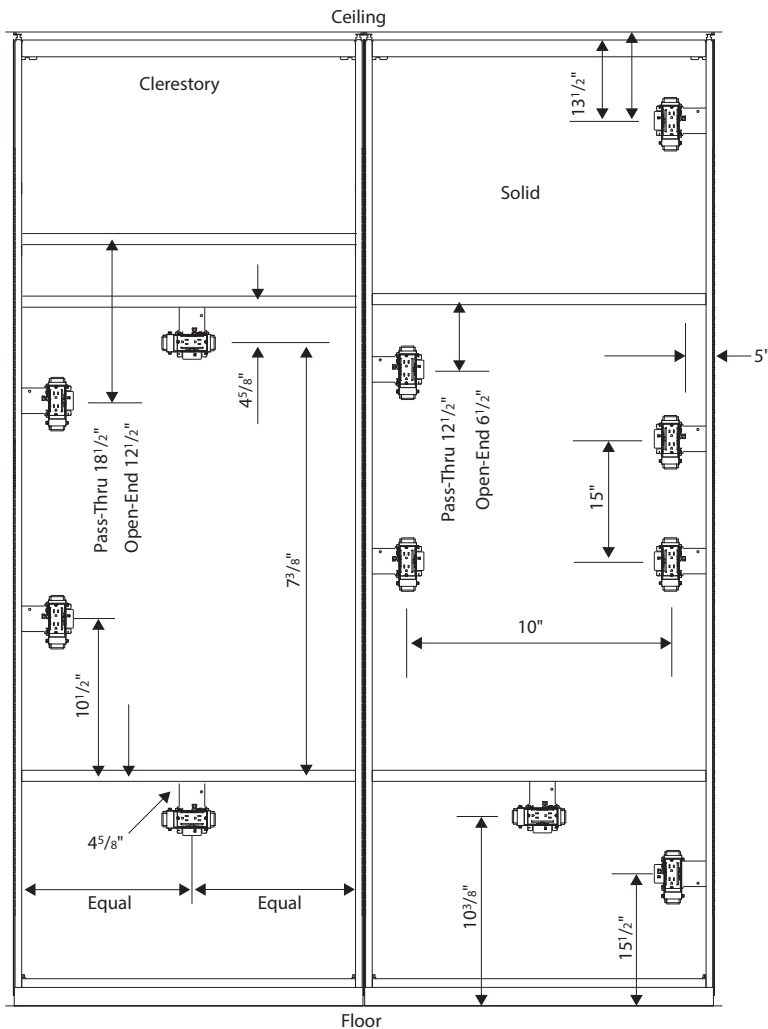

Pass-Thru

Open-End

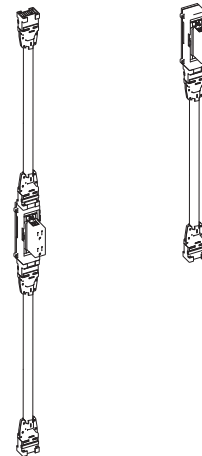

**Minimum Dimensions for Outlet Spacing  
Hardwired Power and Communications  
with Bracket**

|          |              |     |
|----------|--------------|-----|
| <b>A</b> | Single Box   | 5"  |
|          | Double Box   | 6"  |
|          | Triple Box   | 7"  |
|          | Fourplex Box | 8"  |
| <b>B</b> | Single Box   | 10" |
|          | Double Box   | 10" |
|          | Triple Box   | 12" |
|          | Fourplex Box | 12" |

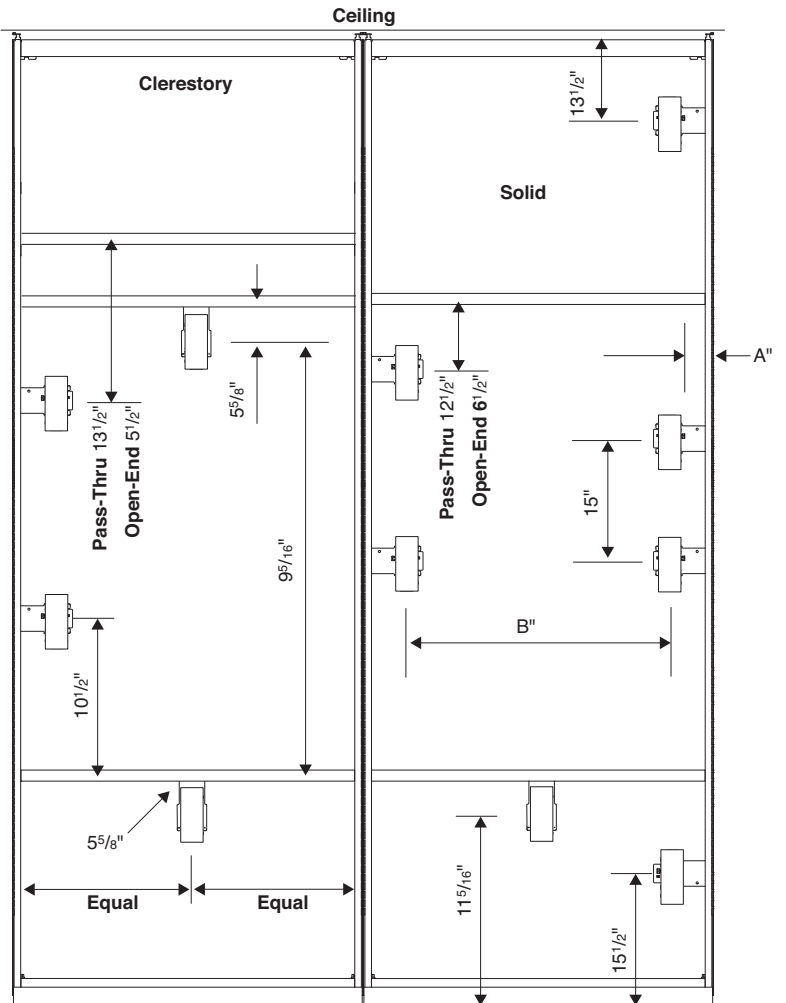

Electrical Locations, Minimum Dimensions for Outlet Spacing,  
Modular Power and Communications with Bracket, continued

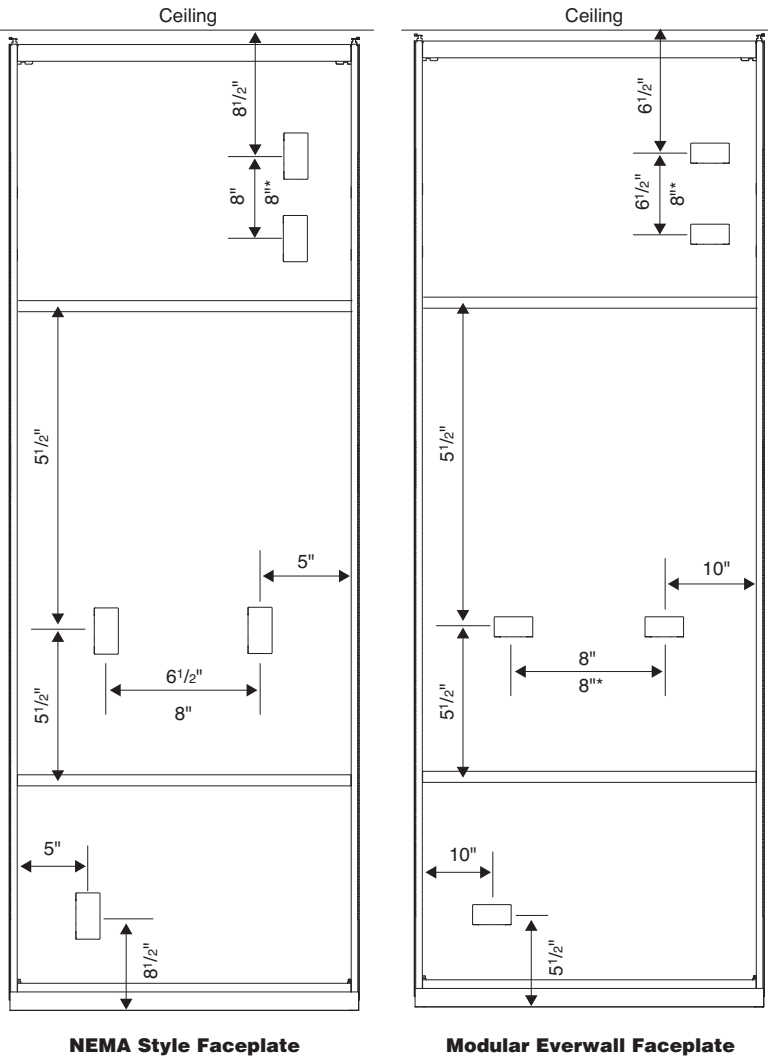

**Communication Cutout Size**

| <b>NEMA Cutouts</b>    | 2 <sup>4</sup> / <sub>5</sub> "H x 1 <sup>3</sup> / <sub>4</sub> "W |         |
|------------------------|---------------------------------------------------------------------|---------|
| <b>Modular Cutouts</b> | 1 <sup>3</sup> / <sub>4</sub> "H x 5"W                              |         |
|                        | Minimum Skin Size                                                   |         |
|                        | NEMA                                                                | Modular |
| <b>Height</b>          | 12"                                                                 | 12"     |
| <b>Width</b>           | 10"                                                                 | 12"     |

\* Indicates minimum distance when combining modular and NEMA style cutouts.



**Everwall modular power components** are offered in three different wiring schematics to allow you to match your specific wiring strategy to any typical building wiring plan.

*Tip: All the components in an electrical system must use the same wiring schematic. The components are color coded and keyed to make it impossible to connect mismatched parts.*

Black = Four-circuit, 3+1

Brown = Four-circuit, 2+2

Rust = Three-circuit, separate neutrals

Shared neutral conductors = 10 gauge

Separate neutral conductors = 12 gauge

Hot conductors = 12 gauge

Grounding conductors = 12 gauge

## Four-Circuit, 3+1

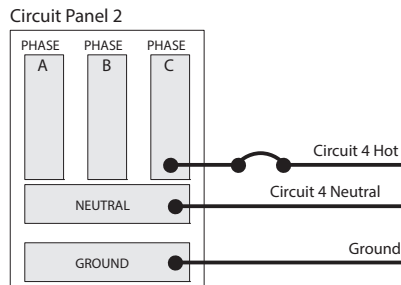
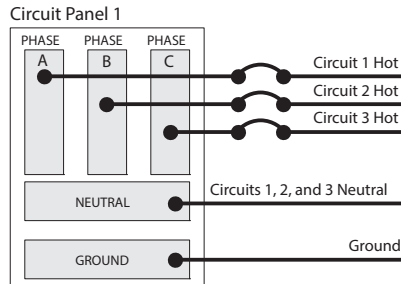

**In the four-circuit 3+1 schematic,** circuits 1, 2, and 3 are distributed from the first circuit panel and are supported with one shared neutral and one shared ground. Circuit 4 is distributed from a second circuit panel and is supported with a separate neutral and ground.

## Single 3-Phase Circuit Panel

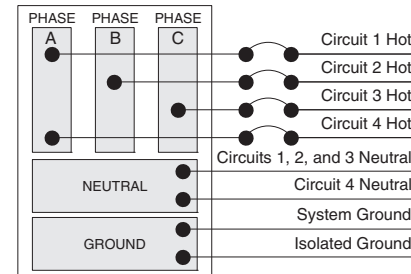

**On a single 3-phase circuit panel,** all four circuits are distributed as shown.

## Four-Circuit, 2+2

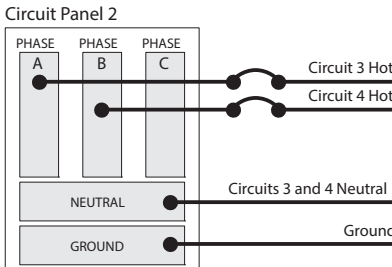
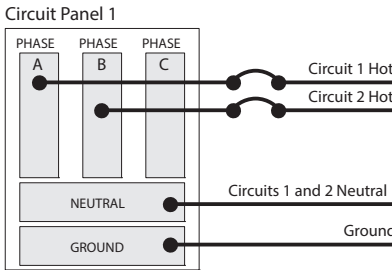

**In the four-circuit 2+2 schematic,** circuits 1 and 2 are distributed from two different phases from the first circuit panel and are supported with one shared neutral and one shared ground. Circuits 3 and 4 are distributed from a second circuit panel and supported by their own shared neutral and ground.

## Single 3-Phase Circuit Panel

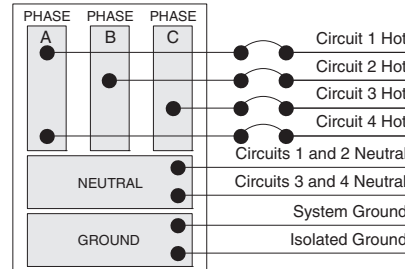

**On a single 3-phase circuit panel,** all four circuits are distributed as shown.

## Split-Phase Circuit Panel

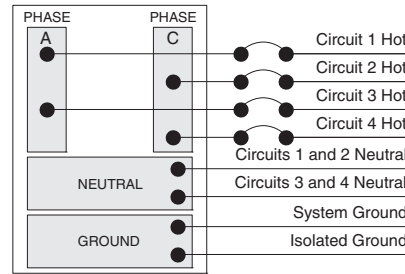

**On a split-phase circuit panel,** all four circuits are distributed as shown.

## Three-Circuit, Separate Neutrals

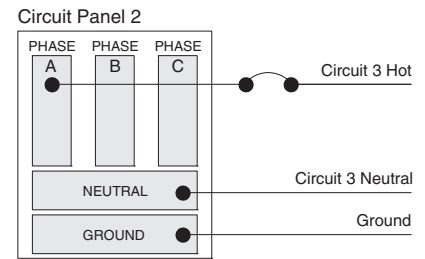
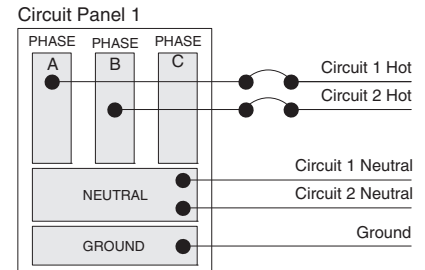

**In the three-circuit, separate neutral schematic,** circuits 1 and 2 are distributed from two different phases from the first circuit panel. Each circuit is supported with its own neutral and a common ground. Circuit 3 is distributed from the second circuit panel and is supported by its own neutral and ground.

## Single 3-Phase Circuit Panel

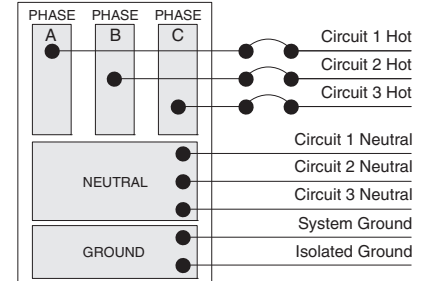

**On a single 3-phase circuit panel,** three circuits are distributed as shown.

## Split-Phase Circuit Panel

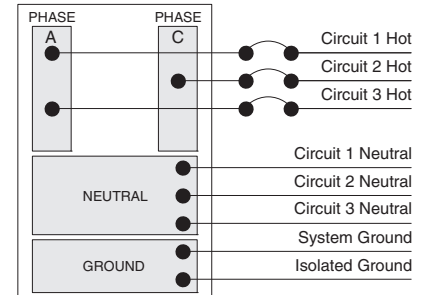

**On a split-phase circuit panel,** three circuits are distributed as shown.

# How to Calculate Power Needs

Use This to Determine How Many Power-Ins You'll Need

**When planning a power network,** you must calculate the amperage requirements of all your electrical components so you can provide sufficient electricity to power them.

**If your usage is not known in advance:**

The National Electrical Code (NEC) allows a maximum of 13 receptacles on each 20-amp circuit. This provides up to 30 receptacles for each 3-circuit power-in.

**If your usage is known in advance:**

Add up the amperage used by each piece of equipment in the workstation. Whenever you reach 60 amps (20 amps times 3 circuits) from items that are likely to be used at the same time, you have reached the limit for a single power-in. Specify another power-in and continue until all equipment is powered.

If the circuits will normally be subject to a continuous load (three or more hours of continuous use, such as lights or computers), the NEC requires that circuit capacity be "de-rated" by 20 percent. Therefore, treat circuits used for continuous loads as if they were rated at 16 amps instead of the regular 20 amps.

Try to anticipate future increases in power requirements and build some excess capacity into your plan.

▶ See table at right for typical and actual amperage usages for components.

To calculate amperage when the wattage of a device is known, divide watts by 120.

Some appliances, such as large copiers, coffee makers, or space heaters require most of the current available on a 20-amp circuit. It is recommended that such devices be supplied with their own receptacle/circuit, directly from the building. This leaves the capacity of the furniture circuits available for the more dynamic requirements of the office equipment.

Local electrical codes vary. Consult a qualified electrical contractor or engineer for the proper planning of electrical circuits in your locale.

**Approximate power consumption for common devices**

| • Device                             | • Wattage | • Amperage | • Voltage | • Number of Devices Supported on Single 20 Amp Circuit* |
|--------------------------------------|-----------|------------|-----------|---------------------------------------------------------|
| Laptop                               | 90        | 0.8        | 110       | 20                                                      |
| CPU/Desktop Computer                 | 120       | 1.1        | 110       | 15                                                      |
| Monitor                              | 60        | 0.5        | 110       | 29                                                      |
| Phone                                | 5         | 0.0        | 110       | 352                                                     |
| High Power Tablet (e.g. Surface Pro) | 40        | 0.4        | 110       | 44                                                      |
| Low Power Tablet (e.g. iPad Air)     | 15        | 0.1        | 110       | 117                                                     |
| Desktop Printer                      | 40        | 0.4        | 110       | 44                                                      |
| 42" LCD Screen                       | 210       | 1.9        | 110       | 8                                                       |
| DVD Player                           | 25        | 0.2        | 110       | 70                                                      |
| Projector                            | 175       | 1.6        | 110       | 10                                                      |
| Desktop Lamp                         | 19        | 0.2        | 110       | 93                                                      |
| Large Printer/Copier (high)          | 1900      | 17.3       | 110       | 1                                                       |
| Large Printer/Copier (low)           | 850       | 7.7        | 110       | 2                                                       |
| Paper Shredder                       | 360       | 3.3        | 110       | 5                                                       |
| Desktop Fan                          | 20        | 0.2        | 110       | 88                                                      |
| Standing Fan                         | 180       | 1.6        | 110       | 10                                                      |
| Coffee Maker (high)                  | 1200      | 10.9       | 110       | 1                                                       |
| Coffee Maker (low)                   | 600       | 5.5        | 110       | 3                                                       |
| Microwave (high)                     | 400       | 3.6        | 110       | 1                                                       |
| Microwave (low)                      | 150       | 1.4        | 110       | 3                                                       |
| Refrigerator (high)                  | 1500      | 13.6       | 110       | 1                                                       |
| Refrigerator (low)                   | 200       | 1.8        | 110       | 12                                                      |
| Vacuum (high)                        | 1500      | 13.6       | 110       | 1                                                       |
| Vacuum (low)                         | 200       | 1.8        | 110       | 9                                                       |
| Space Heater (high)                  | 1500      | 13.6       | 110       | 1                                                       |
| Space Heater (low)                   | 750       | 6.8        | 110       | 2                                                       |

*Tip: These calculations are estimations and are meant solely for informational purposes. It is important to conduct proper power planning for each installation to prevent overloading a circuit.*



# Structural Frame Components

## Ceiling Track

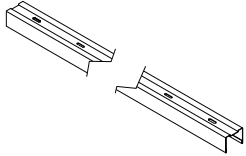

### Standard Includes

- Ceiling track:
  - 4799 Platinum Metallic
  - 7241 Arctic White
  - 7360 Merle
- Seal: plastic

### Options

|              |                      |                |
|--------------|----------------------|----------------|
| Length       | 120"                 | No cost        |
|              | 144"                 | +\$17.44       |
| Track Finish | Paint Price Group 01 | No cost        |
|              | Paint Price Group 02 | 120": +\$33.30 |
|              |                      | 144": +\$39.96 |

### Specification Information

Style Number    Base Price

### Ceiling Track

**NECTS**      \$202.74

# Structural Frame Components

## Structural Frame



*Tip: When the standard pre-set widths are specified the list price will be reduced by 5% from the formula factors as shown above. This discount applies only to the base price per panel and the per square foot of panel add.*

### Standard Includes

- Frame
- Width: 8" - 60"
- Height: 84" - 120"
- Floor track:
  - 7190 Platinum Solid
  - 7360 Merle
- Seal: plastic

### Options

| Option      | Quantity | Price     |
|-------------|----------|-----------|
| Horizontals | 1        | No cost   |
|             | 2        | +\$68.43  |
|             | 3        | +\$136.86 |
|             | 4        | +\$205.29 |
|             | 5        | +\$273.72 |
|             | 6        | +\$342.15 |
|             | 7        | +\$410.58 |
|             | 8        | +\$479.01 |
|             | 9        | +\$547.44 |
|             | 10       | +\$615.87 |

### Specification Information

#### Horizontals

|                                 | (Add \$ to Base Price) |
|---------------------------------|------------------------|
| Horizontal 1 (8"W - 60"W)       | No cost                |
| Horizontals 2 - 10 (8"W - 60"W) | +\$0.38 per inch       |

| Style Number | Base Price |                    |
|--------------|------------|--------------------|
|              | Per Frame  | Per sq ft of Frame |

#### Structural Frame - Solid

|              |          |         |
|--------------|----------|---------|
| <b>NESFS</b> | \$679.70 | +\$2.49 |
|--------------|----------|---------|

*Tip: Per sq. ft. of frame upcharge is based on height and width of the frame and is in addition to the base price.*

Specifying

# Structural Frame Components

## Frame Coupler

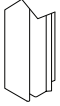
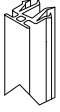

### Standard Includes

- Frame coupler:
  - 6249 Platinum Solid
  - 6527 Merle
- Seal: plastic
- Quantity: 26

### Specification Information

Style Number Price

### Frame Coupler

**NEFC** \$1308.00

# Structural Frame Components

## Ceiling Fastener

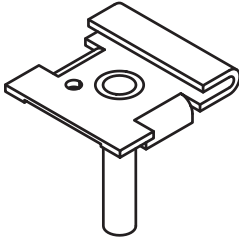

*Tip: Order one ceiling fastener package per 10' of ceiling track.*

*Tip: Spacers are included with fasteners for regular ceiling tiles that allow adjustment for different tile edge depths.*

### Standard Includes

- Fastener package
- Spacers
- Quantity: 5

### Options

|               |                         |         |
|---------------|-------------------------|---------|
| Fastener Type | 1" Fluted Runner 1/4-20 | No cost |
|               | 1" Tegular              | No cost |
|               | 1" Wide Exposed T       | No cost |
|               | 1/4" Donn Finline       | No cost |
|               | 1/8" Donn Finline       | No cost |
|               | 9/16" Tegular           | No cost |
|               | 9/16" Wide Exposed T    | No cost |

### Specification Information

Style Number Price

### Ceiling Fastener

**NECF** \$19.94

# Structural Frame Components

## Floor Guide

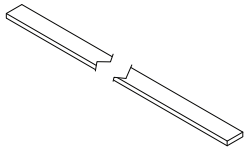

### Standard Includes

- Floor guide

### Options

|              |         |         |
|--------------|---------|---------|
| Gripper Type | Seismic | No cost |
|              | Simple  | No cost |

### Specification Information

Style Number    Price

### Floor Guide

**NEFG**            \$6.54



# Structural Frame Components

## Technology Components

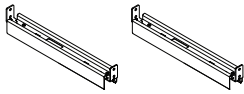

### Standard Includes

- Two monitor supports, horizontal
- Width: 24" - 60"

### Specification Information

| Style Number | Base Price     |                   |
|--------------|----------------|-------------------|
|              | Per Horizontal | Per inch of Width |

### Monitor Support Horizontals

|             |          |         |
|-------------|----------|---------|
| <b>NEMH</b> | \$275.88 | +\$0.76 |
|-------------|----------|---------|

# Hang-on Components

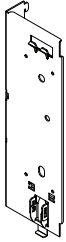

## Standard Includes

- Elective Elements storage bracket

## Specification Information

Style Number Price

### Elective Elements Storage Bracket

**NEEESB** \$31.11

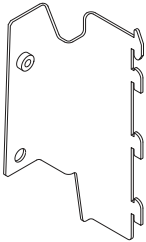

## Standard Includes

- Elective Elements organizer and open shelf bracket

## Specification Information

Style Number Price

### Elective Elements Organizer and Open Shelf Bracket

**NEEESBO** \$148.80



## Standard Includes

- Universal storage bracket

## Specification Information

Style Number Price

### Universal Storage Bracket

**NEUSB** \$31.11



## Standard Includes

- Universal vertical off module bracket

## Specification Information

Style Number Price

### Universal Vertical Off Module Bracket

**NERBKVOFM** \$165.15



## Standard Includes

- French cleat support
- Width: 12" - 60"

## Specification Information

| Style Number | Base Price  |                |
|--------------|-------------|----------------|
|              | Per Support | Per Inch Width |

### French Cleat Support

|              |          |         |
|--------------|----------|---------|
| <b>NEFCS</b> | \$833.11 | +\$2.16 |
|--------------|----------|---------|

# Skins

## Solid Skins



Tip: When the standard pre-set widths are specified the list price will be reduced by 5% from the formula factors as shown above. This discount applies only to the base price per panel and the per square foot of panel add.

### Standard Includes

- Skin: Low-Pressure Laminate price group 01 with 1 mm plastic edge
- Width: 8" - 120"
- Height: 12" - 120"
- Top mount
- Bottom mount

### Options

|                   |                             |                                                    |
|-------------------|-----------------------------|----------------------------------------------------|
| Top Mount Type    | Ceiling Mount               | No cost                                            |
|                   | Clerestory Mount            | No cost                                            |
|                   | Intermediate Mount          | No cost                                            |
| Bottom Mount Type | Floor Mount                 | No cost                                            |
|                   | Intermediate Mount          | No cost                                            |
| Skin Finish       | Laminate LPL Price Group 01 | No cost                                            |
|                   | Laminate HPL Price Group 01 | +\$211.88 per skin<br>+\$5.26 per sq foot of skin  |
|                   | Laminate HPL Price Group 02 | +\$211.88 per skin<br>+\$9.00 per sq foot of skin  |
|                   | Laminate HPL Price Group 03 | +\$211.88 per skin<br>+\$18.05 per sq foot of skin |
|                   | OLL Price Group 1           | +\$102.46                                          |
| Grain Direction   | Horizontal                  | No cost                                            |
|                   | No Grain Direction          | No cost                                            |
|                   | Vertical                    | No cost                                            |
| Cutout Count      | No Holes                    | No cost                                            |
|                   | 1 Hole                      | +\$35.82                                           |
|                   | 2 Holes                     | +\$71.64                                           |
|                   | 3 Holes                     | +\$107.46                                          |
|                   | 4 Holes                     | +\$143.28                                          |
|                   | 5 Holes                     | +\$179.10                                          |
|                   | 6 Holes                     | +\$214.92                                          |
|                   | 7 Holes                     | +\$250.74                                          |
|                   | 8 Holes                     | +\$286.56                                          |
|                   | 9 Holes                     | +\$322.38                                          |
| Cutout Type 1     | Communication Only No Box   | No cost                                            |
|                   | Hardwire Double             | No cost                                            |
|                   | Hardwire Fourplex           | No cost                                            |
|                   | Hardwire Single             | No cost                                            |
|                   | Hardwire Triple             | No cost                                            |
|                   | Modular Data                | No cost                                            |
|                   | Modular Power Horizontal    | No cost                                            |
|                   | Modular Power Vertical      | No cost                                            |

Tip: Each cutout can be a different cutout type.

### Specification Information

| Style Number | Base Price |                   |
|--------------|------------|-------------------|
|              | Per Skin   | Per sq ft of Skin |

### Solid Skin - Laminate

|              |          |          |
|--------------|----------|----------|
| <b>NESSL</b> | \$150.11 | +\$19.70 |
|--------------|----------|----------|

Tip: Per sq. ft. of skin upcharge is based on height and width of the skin and is in addition to the base price.

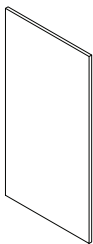

Tip: When the standard pre-set widths are specified the list price will be reduced by 5% from the formula factors as shown above. This discount applies only to the base price per panel and the per square foot of panel add.

Tip: Each cutout can be a different cutout type.

### Standard Includes

- Skin with markerboard surface
- Width: 8" - 120"
- Height: 12" - 120"
- Top mount
- Bottom mount

### Options

|                        |                           |           |
|------------------------|---------------------------|-----------|
| Top Mount Type         | Ceiling Mount             | No cost   |
|                        | Clerestory Mount          | No cost   |
|                        | Intermediate Mount        | No cost   |
| Bottom Mount Type      | Floor Mount               | No cost   |
|                        | Intermediate Mount        | No cost   |
| Cutout Count           | No Holes                  | No cost   |
|                        | 1 Hole                    | +\$35.82  |
|                        | 2 Holes                   | +\$71.64  |
|                        | 3 Holes                   | +\$107.46 |
|                        | 4 Holes                   | +\$143.28 |
|                        | 5 Holes                   | +\$179.10 |
|                        | 6 Holes                   | +\$214.92 |
|                        | 7 Holes                   | +\$250.74 |
|                        | 8 Holes                   | +\$286.56 |
|                        | 9 Holes                   | +\$322.38 |
| Cutout Type 1          | Communication Only No Box | No cost   |
|                        | Hardwire Double           | No cost   |
|                        | Hardwire Fourplex         | No cost   |
|                        | Hardwire Single           | No cost   |
|                        | Hardwire Triple           | No cost   |
|                        | Modular Data              | No cost   |
|                        | Modular Power Horizontal  | No cost   |
| Modular Power Vertical | No cost                   |           |

Specifying

### Specification Information

| Style Number | Base Price |                   |
|--------------|------------|-------------------|
|              | Per Skin   | Per sq ft of Skin |

### Solid Skin - Laminate Markerboard

|               |          |          |
|---------------|----------|----------|
| <b>NESSLM</b> | \$324.06 | +\$17.75 |
|---------------|----------|----------|

Tip: Per sq. ft. of skin upcharge is based on height and width of the skin and is in addition to the base price.

# Skins

## Solid Skins



Tip: When the standard pre-set widths are specified the list price will be reduced by 5% from the formula factors as shown above. This discount applies only to the base price per panel and the per square foot of panel add.

Tip: Each cutout can be a different cutout type.

### Standard Includes

- Skin: fabric price group 01
- Width: 8" - 120"
- Height: 12" - 120"
- Top mount
- Bottom mount

### Options

|                   |                                |                            |
|-------------------|--------------------------------|----------------------------|
| Top Mount Type    | Ceiling Mount                  | No cost                    |
|                   | Clerestory Mount               | No cost                    |
|                   | Intermediate Mount             | No cost                    |
| Bottom Mount Type | Floor Mount                    | No cost                    |
|                   | Intermediate Mount             | No cost                    |
| Skin Finish       | Fabric Customer's Own Material | No cost                    |
|                   | Fabric Price Group 01          | No cost                    |
|                   | Fabric Price Group 02          | +\$8.14 per sq ft of skin  |
|                   | Fabric Price Group 03          | +\$10.32 per sq ft of skin |
| Fabric Direction  | Horizontal                     | No cost                    |
|                   | Vertical                       | No cost                    |
| Cutout Count      | No Holes                       | No cost                    |
|                   | 1 Hole                         | +\$24.05                   |
|                   | 2 Holes                        | +\$48.10                   |
|                   | 3 Holes                        | +\$72.15                   |
|                   | 4 Holes                        | +\$96.20                   |
|                   | 5 Holes                        | +\$120.25                  |
|                   | 6 Holes                        | +\$144.30                  |
|                   | 7 Holes                        | +\$168.35                  |
|                   | 8 Holes                        | +\$192.40                  |
|                   | 9 Holes                        | +\$216.45                  |
| Cutout Type 1     | Communication Only No Box      | No cost                    |
|                   | Hardwire Double                | No cost                    |
|                   | Hardwire Fourplex              | No cost                    |
|                   | Hardwire Single                | No cost                    |
|                   | Hardwire Triple                | No cost                    |
|                   | Modular Data                   | No cost                    |
|                   | Modular Power Horizontal       | No cost                    |
|                   | Modular Power Vertical         | No cost                    |

### Specification Information

| Style Number | Base Price |                   |
|--------------|------------|-------------------|
|              | Per Skin   | Per sq ft of Skin |

### Solid Skin - Fabric

|              |          |          |
|--------------|----------|----------|
| <b>NESSF</b> | \$718.18 | +\$25.91 |
|--------------|----------|----------|

Tip: Per sq. ft. of skin upcharge is based on height and width of the skin and is in addition to the base price.



Tip: When the standard pre-set widths are specified the list price will be reduced by 5% from the formula factors as shown above. This discount applies only to the base price per panel and the per square foot of panel add.

### Standard Includes

- Skin: fabric price group 01
- Width: 8" - 120"
- Height: 12" - 120"
- Top mount
- Bottom mount

### Options

|                   |                                |                            |
|-------------------|--------------------------------|----------------------------|
| Top Mount Type    | Ceiling Mount                  | No cost                    |
|                   | Clerestory Mount               | No cost                    |
|                   | Intermediate Mount             | No cost                    |
| Bottom Mount Type | Floor Mount                    | No cost                    |
|                   | Intermediate Mount             | No cost                    |
| Skin Finish       | Fabric Customer's Own Material | No cost                    |
|                   | Fabric Price Group 01          | No cost                    |
|                   | Fabric Price Group 02          | +\$8.35 per sq ft of skin  |
|                   | Fabric Price Group 03          | +\$10.52 per sq ft of skin |
| Fabric Direction  | Horizontal                     | No cost                    |
|                   | Vertical                       | No cost                    |
| Cutout Count      | No Holes                       | No cost                    |
|                   | 1 Hole                         | +\$60                      |
|                   | 2 Holes                        | +\$120                     |
|                   | 3 Holes                        | +\$180                     |
|                   | 4 Holes                        | +\$240                     |
|                   | 5 Holes                        | +\$300                     |
|                   | 6 Holes                        | +\$360                     |
|                   | 7 Holes                        | +\$420                     |
|                   | 8 Holes                        | +\$480                     |
|                   | 9 Holes                        | +\$540                     |
| Cutout Type 1     | Communication Only No Box      | No cost                    |
|                   | Hardwire Double                | No cost                    |
|                   | Hardwire Fourplex              | No cost                    |
|                   | Hardwire Single                | No cost                    |
|                   | Hardwire Triple                | No cost                    |
|                   | Modular Data                   | No cost                    |
|                   | Modular Power Horizontal       | No cost                    |
|                   | Modular Power Vertical         | No cost                    |

Tip: Each cutout can be a different cutout type.

### Specification Information

| Style Number | Base Price |                   |
|--------------|------------|-------------------|
|              | Per Skin   | Per sq ft of Skin |

### Solid Steel Skin - Fabric

|               |          |          |
|---------------|----------|----------|
| <b>NESSFS</b> | \$833.20 | +\$27.93 |
|---------------|----------|----------|

Tip: Per sq. ft. of skin upcharge is based on height and width of the skin and is in addition to the base price.

# Skins

## Solid Steel Skins



Tip: When the standard pre-set widths are specified the list price will be reduced by 5% from the formula factors as shown above. This discount applies only to the base price per panel and the per square foot of panel add.

Tip: Each cutout can be a different cutout type.

### Standard Includes

- Skin: paint price group 01
- Width: 8" - 120"
- Height: 12" - 120"
- Top mount
- Bottom mount

### Options

|                        |                           |                           |
|------------------------|---------------------------|---------------------------|
| Top Mount Type         | Ceiling Mount             | No cost                   |
|                        | Clerestory Mount          | No cost                   |
|                        | Intermediate Mount        | No cost                   |
| Bottom Mount Type      | Floor Mount               | No cost                   |
|                        | Intermediate Mount        | No cost                   |
| Skin Finish            | Paint Price Group 01      | No cost                   |
|                        | Paint Price Group 02      | +\$1.41 per sq ft of skin |
|                        | Paint Price Group 03      | +\$5.80 per sq ft of skin |
| Cutout Count           | No Holes                  | No cost                   |
|                        | 1 Hole                    | +\$72.01                  |
|                        | 2 Holes                   | +\$144.02                 |
|                        | 3 Holes                   | +\$216.03                 |
|                        | 4 Holes                   | +\$288.04                 |
|                        | 5 Holes                   | +\$360.05                 |
|                        | 6 Holes                   | +\$432.06                 |
|                        | 7 Holes                   | +\$504.07                 |
|                        | 8 Holes                   | +\$576.08                 |
|                        | 9 Holes                   | +\$648.09                 |
| Cutout Type 1          | Communication Only No Box | No cost                   |
|                        | Hardwire Double           | No cost                   |
|                        | Hardwire Fourplex         | No cost                   |
|                        | Hardwire Single           | No cost                   |
|                        | Hardwire Triple           | No cost                   |
|                        | Modular Data              | No cost                   |
|                        | Modular Power Horizontal  | No cost                   |
| Modular Power Vertical | No cost                   |                           |

### Specification Information

| Style Number | Base Price |                   |
|--------------|------------|-------------------|
|              | Per Skin   | Per sq ft of Skin |

### Solid Steel Skin - Painted

|               |          |          |
|---------------|----------|----------|
| <b>NESSPS</b> | \$511.79 | +\$37.69 |
|---------------|----------|----------|



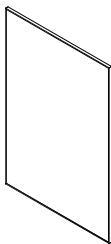

*Tip: When the standard pre-set widths are specified the list price will be reduced by 5% from the formula factors as shown above. This discount applies only to the base price per panel and the per square foot of panel add.*

### Standard Includes

- Skin with ceramic markerboard surface
- Width: 24" - 120"
- Height: 24" - 120"
- Top mount
- Bottom mount

### Options

|                   |                    |         |
|-------------------|--------------------|---------|
| Top Mount Type    | Ceiling Mount      | No cost |
|                   | Clerestory Mount   | No cost |
|                   | Intermediate Mount | No cost |
| Bottom Mount Type | Floor Mount        | No cost |
|                   | Intermediate Mount | No cost |

### Specification Information

| Style Number | Base Price |                   |
|--------------|------------|-------------------|
|              | Per Skin   | Per sq ft of Skin |

### Solid Ceramic Skin - Markerboard

|             |          |          |
|-------------|----------|----------|
| <b>NESC</b> | \$364.86 | +\$23.22 |
|-------------|----------|----------|

*Tip: Per sq. ft. of skin upcharge is based on height and width of the skin and is in addition to the base price.*

Specifying

# Skins

## Skin Hardware

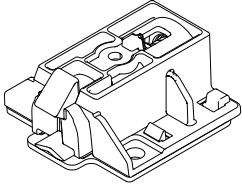

### Standard Includes

- Solid skin latches, qty 200

### Specification Information

Style Number Price

### Solid Skin Latches

**NESSC** \$1615.38

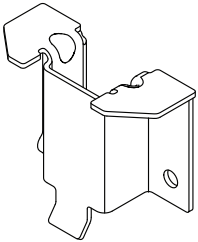

### Standard Includes

- Solid skin brackets, qty 100

### Specification Information

Style Number Price

### Solid Skin Brackets

**NESSB** \$612.80

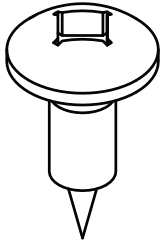

### Standard Includes

- Solid skin screws, qty 1

### Specification Information

Style Number Price

### Solid Skin Screws

**NESSS** \$0.34

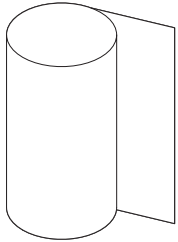

**Standard Includes**

- Acoustic insulation, 48"W x 87"L 2 ply

**Specification Information**

Style Number Price

**Acoustic Insulation**

**NESIA** \$762.57

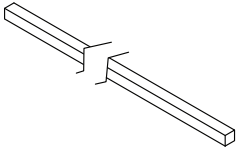

**Standard Includes**

- Seal: 50' roll, quantity of 4:
  - 6249 Platinum Solid
  - 6527 Merle

**Options**

|             |               |         |
|-------------|---------------|---------|
| Seal Finish | Plastic - PG1 | No cost |
|-------------|---------------|---------|

**Specification Information**

Style Number Price

**Acoustic Skin Seal - Small**

**NEASSS** \$203.74

Specifying

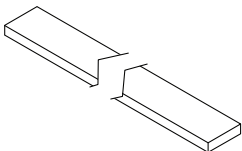

**Standard Includes**

- Seal: 50' roll, quantity of 1:
  - 6249 Platinum Solid
  - 6527 Merle

**Options**

|             |               |         |
|-------------|---------------|---------|
| Seal Finish | Plastic - PG1 | No cost |
|-------------|---------------|---------|

**Specification Information**

Style Number Price

**Acoustic Skin Seal - Large**

**NEASSL** \$105.80

# Unitized Glass

## Unitized Glass Panel



*Tip: When the standard pre-set widths are specified the list price will be reduced by 5% from the formula factors as shown above. This discount applies only to the base price per panel and the per square foot of panel add.*

### Standard Includes

- Frame: paint price group 01 or 8043 Clear Anodized Aluminum
- 1/4" thick glass: glass price group 01
- Width: 12" - 60"
- Height: 84" - 120"
- Floor track:
  - 7190 Platinum Solid
  - 7360 Merle

### Options

|                 |                      |                                                                  |
|-----------------|----------------------|------------------------------------------------------------------|
| Frame Finish    | Anodized Aluminum    | No cost                                                          |
|                 | Paint Price Group 01 | No cost                                                          |
|                 | Paint Price Group 02 | Height: +\$0.22 per inch<br>Width: +\$0.19 per inch              |
|                 | Paint Price Group 03 | Height: +\$0.92 per inch<br>Width: +\$0.76 per inch              |
| Glass A Finish  | Glass Price Group 01 | No cost                                                          |
|                 | Glass Price Group 02 | 1/4" thick: +\$18.88 per sq ft<br>3/8" thick: +\$14.56 per sq ft |
|                 | Glass Price Group 03 | 1/4" thick: +\$8.23 per sq ft<br>3/8" thick: +\$23.15 per sq ft  |
|                 | Glass Price Group 07 | 1/4" thick: +\$28.83 per sq ft<br>3/8" thick: +\$36.19 per sq ft |
| Glass Thickness | 1/4"                 | No cost                                                          |
|                 | 3/8"                 | +\$9.90 per sq ft                                                |
| Seal Finish     | Plastic - PG1        | No cost                                                          |
| Muntin Count    | No Muntin            | No cost                                                          |
|                 | 1 Muntin             | +\$65.36                                                         |
|                 | 2 Muntins            | +\$130.72                                                        |
|                 | 3 Muntins            | +\$196.08                                                        |
|                 | 4 Muntins            | +\$261.44                                                        |

### Specification Information

#### Muntin Width

(Add \$ to Base Price)

Muntin Width +\$2.68 per inch

*Tip: Muntin upcharge is based on the panel width per inch of muntin selected.*

#### Muntin Finish

(Add \$ to Base Price)

Paint Price Group 1 No cost

Paint Price Group 2 +\$0.37

Paint Price Group 3 +\$1.53

*Tip: Muntin paint upcharge is based on the panel width per inch of muntin selected.*

► **Product Information continued on next page**

► Product Information continued from previous page

### Specification Information

| Style Number | Base Price |                    |
|--------------|------------|--------------------|
|              | Per Panel  | Per sq ft of Panel |

---

### Unitized Glass Panel

---

|              |           |          |
|--------------|-----------|----------|
| <b>NEUGP</b> | \$1109.51 | +\$40.26 |
|--------------|-----------|----------|

*Tip: Square feet for frame is clerestory height multiplied by width. Square feet for glass is calculated by height minus clerestory height multiplied by width.*

# Unitized Glass

## Clerestory Frame



Tip: When the standard pre-set widths are specified the list price will be reduced by 5% from the formula factors as shown above. This discount applies only to the base price per panel and the per square foot of panel add.

Tip: Square feet for glass is calculated by height minus clerestory height multiplied by width.

Tip: Square feet for frame finish is clerestory height multiplied by width.

### Standard Includes

- Frame with clerestory: paint price group 01 or 8043 Clear Anodized Aluminum
- 1/4" thick glass: 6500 Clear glass
- Width: 12" - 60"
- Height: 84" - 120"
- Clerestory height: 18" - 108"
- Floor track:
  - 7190 Platinum Solid
  - 7360 Merle

### Options

|                 |                      |                                                                  |
|-----------------|----------------------|------------------------------------------------------------------|
| Glass A Finish  | Glass Price Group 01 | No cost                                                          |
|                 | Glass Price Group 02 | 1/4" thick: +\$18.88 per sq ft<br>3/8" thick: +\$14.56 per sq ft |
|                 | Glass Price Group 03 | 1/4" thick: +\$8.23 per sq ft<br>3/8" thick: +\$23.15 per sq ft  |
|                 | Glass Price Group 07 | 1/4" thick: +\$28.83 per sq ft<br>3/8" thick: +\$36.19 per sq ft |
| Glass Thickness | 1/4"                 | No cost                                                          |
|                 | 3/8"                 | +\$9.90 per sq ft                                                |
| Frame Finish    | Anodized Aluminum    | No cost                                                          |
|                 | Paint Price Group 01 | No cost                                                          |
|                 | Paint Price Group 02 | Height: +\$0.22 per inch<br>Width: +\$0.19 per inch              |
|                 | Paint Price Group 03 | Height: +\$0.92 per inch<br>Width: +\$0.76 per inch              |
| Seal Finish     | Plastic - PG1        | No cost                                                          |
| Muntin Count    | No Muntin            | No cost                                                          |
|                 | 1 Muntin             | +\$65.36                                                         |
|                 | 2 Muntins            | +\$130.72                                                        |
|                 | 3 Muntins            | +\$196.08                                                        |
| Horizontals     | 0                    | No cost                                                          |
|                 | 1                    | No cost                                                          |
|                 | 2                    | +\$68.43                                                         |
|                 | 3                    | +\$136.86                                                        |
|                 | 4                    | +\$205.29                                                        |
|                 | 5                    | +\$273.72                                                        |
|                 | 6                    | +\$342.15                                                        |
|                 | 7                    | +\$410.58                                                        |
|                 | 8                    | +\$479.01                                                        |
| 9               | +\$547.44            |                                                                  |

### Specification Information

#### Horizontals

|                                 | (Add \$ to Base Price) |
|---------------------------------|------------------------|
| Horizontal 1 (8"W - 60"W)       | No cost                |
| Horizontals 2 - 10 (8"W - 60"W) | +\$0.38 per inch       |

► **Product Information continued on next page**

► **Product Information continued from previous page**

**Specification Information**

**Muntin Width**

|                                                                                      |                        |
|--------------------------------------------------------------------------------------|------------------------|
|                                                                                      | (Add \$ to Base Price) |
| Per Muntin                                                                           | +\$2.68 per inch       |
| <i>Tip: Muntin upcharge is based on the panel width per inch of muntin selected.</i> |                        |

**Muntin Finish**

|                                                                                            |                        |
|--------------------------------------------------------------------------------------------|------------------------|
|                                                                                            | (Add \$ to Base Price) |
| Paint Price Group 1                                                                        | No cost                |
| Paint Price Group 2                                                                        | +\$0.37 per inch       |
| Paint Price Group 3                                                                        | +\$1.53 per inch       |
| <i>Tip: Muntin paint upcharge is based on the panel width per inch of muntin selected.</i> |                        |

| Style Number | Base Price |                    |                    |
|--------------|------------|--------------------|--------------------|
|              | Per Frame  | Per sq ft of Frame | Per sq ft of Glass |

**Structural Frame - Clerestory**

|                                                                                                                                     |           |         |          |
|-------------------------------------------------------------------------------------------------------------------------------------|-----------|---------|----------|
| <b>NESFC</b>                                                                                                                        | \$1789.21 | +\$2.49 | +\$40.26 |
| <i>Tip: Per sq. ft. of frame and glass upcharge is based on height and width of the frame and is in addition to the base price.</i> |           |         |          |

Specifying

# Glass Frame Kits

## Glass Accessories

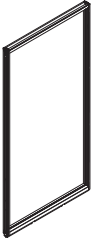

*Tip: When the standard pre-set widths are specified the list price will be reduced by 5% from the formula factors as shown above. This discount applies only to the base price per panel and the per square foot of panel add.*

### Standard Includes

- Frame: paint price group 01 or 8043 Clear Anodized Aluminum
- Width: 12" - 144"
- Height: 84" - 120"
- 3/8" thick glass
- Seal:
  - 6249 Platinum Solid
  - 6527 Merle
- Floor track:
  - 7190 Platinum Solid
  - 7360 Merle

### Options

|                 |                      |                                                     |
|-----------------|----------------------|-----------------------------------------------------|
| Seal Finish     | Plastic - PG1        | No cost                                             |
| Frame Finish    | Anodized Aluminum    | No cost                                             |
|                 | Paint Price Group 01 | No cost                                             |
|                 | Paint Price Group 02 | Height: +\$0.33 per inch<br>Width: +\$0.27 per inch |
|                 | Paint Price Group 03 | Height: +\$1.36 per inch<br>Width: +\$1.14 per inch |
| Glass Thickness | 1/2"                 | No cost                                             |
|                 | 3/8"                 | No cost                                             |

### Specification Information

| Style Number | Base Price |                      |
|--------------|------------|----------------------|
|              | Per Frame  | Per sq ft of Opening |

### Frame Kit

|             |           |          |
|-------------|-----------|----------|
| <b>NEFK</b> | \$1881.67 | +\$15.84 |
|-------------|-----------|----------|



# Glass Frame Kits

## Glass Accessories

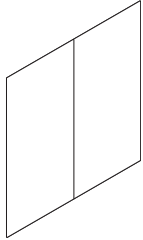

Tip: When the standard pre-set widths are specified the list price will be reduced by 5% from the formula factors as shown above. This discount applies only to the base price per panel and the per square foot of panel add.

### Standard Includes

- 3/8" thick glass: 6500 Clear glass
- Width: 12" - 144"
- Height: 84" - 120"

### Options

|                 |                      |                                     |
|-----------------|----------------------|-------------------------------------|
| Glass A Finish  | Glass Price Group 01 | No cost                             |
|                 | Glass Price Group 02 | 1/2" thick only: +\$1.08 per sq ft  |
|                 | Glass Price Group 03 | 3/8" thick only: +\$20.43 per sq ft |
| Glass Thickness | Glass Price Group 07 | 1/2" thick only: +\$27.17 per sq ft |
|                 | 3/8"                 | No cost                             |
| Division Count  | 1/2"                 | +\$13.00 per sq ft                  |
|                 | 1                    | see below                           |
|                 | 2                    | see below                           |
|                 | 3                    | see below                           |

### Specification Information

#### Division Count

|                  | (Add \$ to Base Price) | (Add \$ to Base Price)     |
|------------------|------------------------|----------------------------|
| Division Count 1 | +\$14.80               | +\$0.74 per inch of height |
| Division Count 2 | +\$29.60               | +\$1.48 per inch of height |
| Division Count 3 | +\$44.40               | +\$2.22 per inch of height |

Tip: Division count upcharge is based on per inch of height.

| Style Number | Base Price |                      |
|--------------|------------|----------------------|
|              | Per Frame  | Per sq ft of Opening |

#### Glass Kit

|             |          |          |
|-------------|----------|----------|
| <b>NEGK</b> | \$322.48 | +\$22.63 |
|-------------|----------|----------|

Specifying

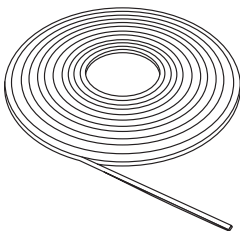

### Standard Includes

- 55' glazing tape, clear

### Specification Information

| Style Number | Price |
|--------------|-------|
|--------------|-------|

#### Glazing Tape - Clear

|              |          |
|--------------|----------|
| <b>NEGTC</b> | \$120.53 |
|--------------|----------|

# Swing Doors

## Single Swing Door Frame



Tip: When the standard pre-set widths are specified the list price will be reduced by 5% from the formula factors as shown above. This discount applies only to the base price per panel and the per square foot of panel add.

Tip: If a pushpull or ladder pull is selected, choose a roller latch or self closing hinge to keep door closed.

### Standard Includes

- Door frame: paint price group 01 or 8043 Clear Anodized Aluminum
- Width: 28" - 48"
- Height: 84" - 120"
- Seal: plastic

### Options

|                                |                                |                                                     |
|--------------------------------|--------------------------------|-----------------------------------------------------|
| Frame Finish                   | Anodized Aluminum              | No cost                                             |
|                                | Paint Price Group 01           | No cost                                             |
|                                | Paint Price Group 02           | Height: +\$0.33 per inch<br>Width: +\$0.14 per inch |
|                                | Paint Price Group 03           | Height: +\$1.36 per inch<br>Width: +\$0.57 per inch |
| Door Type                      | Polished Edge                  | No cost                                             |
|                                | Solid                          | No cost                                             |
| Latch Prep                     | Customiz Pull                  | No cost                                             |
|                                | Cylindrical                    | No cost                                             |
|                                | Mortise                        | No cost                                             |
|                                | PBA Ladder Aligned Locking     | No cost                                             |
|                                | PBA Ladder Aligned Non-Locking | No cost                                             |
|                                | PBA Ladder Offset Locking      | No cost                                             |
|                                | PBA Ladder Offset Non-Locking  | No cost                                             |
|                                | Pushpull                       | No cost                                             |
|                                | TCS Ladder Aligned Locking     | No cost                                             |
| TCS Ladder Aligned Non-Locking | No cost                        |                                                     |
| TCS Ladder Offset Locking      | No cost                        |                                                     |
| Roller Latch                   | No Roller Latch                | No cost                                             |
|                                | Roller Latch                   | No cost                                             |
| Hinge Type                     | Electric                       | No cost                                             |
|                                | Polished Edge Butt             | No cost                                             |
|                                | Slim Line                      | No cost                                             |
|                                | Solid Butt                     | No cost                                             |
| Hinge Quantity                 | 2                              | No cost                                             |
|                                | 3                              | No cost                                             |
|                                | 4                              | No cost                                             |
| Electrification                | Electric Strike                | No cost                                             |
|                                | No Electrification             | No cost                                             |

### Specification Information

Style Number    Base Price

### Door Frame, Swing, Single

**NEDFSWS**    \$2168.24

# Swing Doors

## Single Solid Swing Door Leaf



*Tip: When the standard pre-set widths are specified the list price will be reduced by 5% from the formula factors as shown above. This discount applies only to the base price per panel and the per square foot of panel add.*

*Tip: If a pushpull or ladder pull is selected, choose a roller latch or self closing hinge to keep door closed.*

*Tip: Electrification option is only available when cylindrical or mortise latch prep is selected. Electrification is not available when push/pull handles are selected.*

*Tip: Stanchion upcharges are only applied if latch prep selection is custom pull.*

### Standard Includes

- Door leaf: paint price group 01
- Width: 28" - 48"
- Height: 84" - 120"

### Options

|                                |                                |                    |
|--------------------------------|--------------------------------|--------------------|
| Door Finish                    | Paint Price Group 01           | No cost            |
|                                | Paint Price Group 02           | No cost            |
|                                | Paint Price Group 03           | +\$5.02 per sq ft  |
|                                | Veneer Customiz Stain          | +\$55.08 per sq ft |
|                                | Veneer Price Group 01          | +\$24.71 per sq ft |
|                                | Veneer Price Group 03          | +\$55.08 per sq ft |
| Handedness                     | Left Hand                      | No cost            |
|                                | Right Hand                     | No cost            |
| Latch Prep                     | Customiz Pull                  | No cost            |
|                                | Cylindrical                    | No cost            |
|                                | Mortise                        | No cost            |
|                                | No Latch Prep                  | No cost            |
|                                | PBA Ladder Aligned Locking     | No cost            |
|                                | PBA Ladder Aligned Non-Locking | No cost            |
|                                | PBA Ladder Offset Locking      | No cost            |
|                                | PBA Ladder Offset Non-Locking  | No cost            |
|                                | Pushpull                       | No cost            |
|                                | TCS Ladder Aligned Locking     | No cost            |
| TCS Ladder Aligned Non-Locking | No cost                        |                    |
| TCS Ladder Offset Locking      | No cost                        |                    |
| Pull Size                      | 18"                            | No cost            |
|                                | 24"                            | No cost            |
|                                | 36"                            | No cost            |
|                                | 48"                            | No cost            |
|                                | 60"                            | No cost            |
|                                | 72"                            | No cost            |
| Hinge Type                     | Electric                       | No cost            |
|                                | Solid Butt                     | No cost            |
| Hinge Quantity                 | 3                              | No cost            |
|                                | 4                              | No cost            |
| Number of Stanchions           | 2                              | No cost            |
|                                | 3                              | +\$56.68           |
|                                | 4                              | +\$114.45          |
| Acoustic Seal                  | Drop Seal                      | No cost            |
|                                | No Seal                        | No cost            |
| Roller Latch                   | No Roller Latch                | No cost            |
|                                | Roller Latch                   | No cost            |

### Specification Information

**Style Number**    **Base Price**  
Per sq ft of Leaf

### Door Leaf, Swing, Solid

**NEDLSWS**    \$153.84

# Swing Doors

## Single Polished Edge Swing Door Leaf



*Tip: When the standard pre-set widths are specified the list price will be reduced by 5% from the formula factors as shown above. This discount applies only to the base price per panel and the per square foot of panel add.*

*Tip: For Customer's Own Glass (COG) an engineering quote is required. Upcharges for latch prep, pull size, roller latch, hinge type, hinge quantity, and stanchions will be additional.*

*Tip: If a pushpull or ladder pull is selected, choose a roller latch or self closing hinge to keep door closed.*

*Tip: Stanchion upcharges are only applied if latch prep selection is custom pull.*

### Standard Includes

- 3/8" thick glass: glass price group 01
- Width: 28" - 48"
- Height: 84" - 120"

### Options

|                           |                                |                                                                    |
|---------------------------|--------------------------------|--------------------------------------------------------------------|
| Glass Finish              | Customer's Own Glass           | No cost                                                            |
|                           | Glass Price Group 01           | No cost                                                            |
|                           | Glass Price Group 03           | 3/8": +\$49.99 per sq ft<br>1/2": +\$33.90 per sq ft               |
| Glass Thickness           | 3/8"                           | No cost                                                            |
|                           | 1/2"                           | +\$18.01 per sq ft                                                 |
| Glass Surface Orientation | Polished to inside             | No cost                                                            |
|                           | Polished to outside            | No cost                                                            |
| Handedness                | Left Hand                      | No cost                                                            |
|                           | Right Hand                     | No cost                                                            |
| Latch Prep                | PBA Ladder Aligned Locking     | +\$26.16                                                           |
|                           | PBA Ladder Aligned Non-Locking | +\$26.16                                                           |
|                           | PBA Ladder Offset Locking      | +\$26.16                                                           |
|                           | PBA Ladder Offset Non-Locking  | +\$26.16                                                           |
|                           | Pushpull                       | +\$26.16                                                           |
|                           | TCS Ladder Aligned Locking     | +\$26.16                                                           |
|                           | TCS Ladder Aligned Non-Locking | +\$26.16                                                           |
|                           | TCS Ladder Offset Locking      | +\$26.16                                                           |
|                           | Cylindrical                    | +\$98.10                                                           |
|                           | Mortise                        | +\$98.10                                                           |
| Pull Size                 | 18"                            | No cost                                                            |
|                           | 24"                            | No cost                                                            |
|                           | 36"                            | No cost                                                            |
|                           | 48"                            | No cost                                                            |
|                           | 60"                            | No cost                                                            |
|                           | 72"                            | TCS Aligned Locking: +\$13.08<br>TCS Aligned Non-Locking: +\$13.08 |
| Hinge Type                | Slim Line                      | +\$52.32                                                           |
|                           | Polished Edge Butt             | +\$104.64                                                          |
| Hinge Quantity            | 2                              | No cost                                                            |
|                           | 3                              | +\$52.32                                                           |
|                           | 4                              | +\$104.64                                                          |
| Number of Stanchions      | 2                              | No cost                                                            |
|                           | 3                              | +\$56.68                                                           |
|                           | 4                              | +\$114.45                                                          |
| Roller Latch              | No Roller Latch                | No cost                                                            |
|                           | Roller Latch                   | +\$98.13                                                           |

► **Product Information continued on next page**

---

# Swing Doors

## Single Polished Edge Swing Door Leaf

▶ **Product Information continued from previous page**

### Specification Information

| Style Number | Base Price        |
|--------------|-------------------|
|              | Per sq ft of Leaf |

---

### Door Leaf, Swing, Polished Edge

---

**NEDLSWPE** \$33.81

*Tip: Base price is calculated based on customer selections per square foot.*

# Swing Doors

## Door Hardware

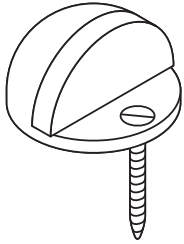

### Standard Includes

- Dome style floor stop: 9200 Satin Chrome

### Options

|                 |                      |          |
|-----------------|----------------------|----------|
| Hardware Finish | Satin Chrome         | No cost  |
|                 | Paint Price Group 01 | +\$23.98 |
|                 | Polished Chrome      | +\$35.97 |

### Specification Information

Style Number    Base Price

### Dome Style Floor Stop

**NEDDFS**    \$26.38

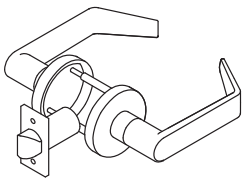

### Standard Includes

- Cylindrical latchset: 9200 Satin Chrome

### Options

|                 |                       |                          |
|-----------------|-----------------------|--------------------------|
| Hardware Finish | Satin Chrome          | No cost                  |
|                 | Paint Price Group 01  | Passage: +\$679.14       |
|                 | Polished Chrome       | Passage: +\$51.03<br>Ran |
| Door Type       | Solid                 | No cost                  |
|                 | Polished Edge         | +\$417.27                |
| Key Option      | Passage               | No cost                  |
|                 | No Core               | +\$158.17                |
|                 | W/ Core, Random Keyed | +\$286.53                |

### Specification Information

Style Number    Base Price

### Cylindrical Latchset

**NEDHCL**    \$781.62

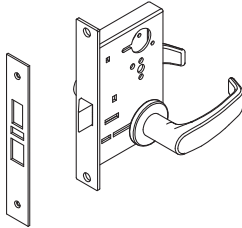

### Standard Includes

- Mortise latchset: 9200 Satin Chrome

### Options

|                 |                       |                                                                         |
|-----------------|-----------------------|-------------------------------------------------------------------------|
| Hardware Finish | Satin Chrome          | No cost                                                                 |
|                 | Paint Price Group 01  | Passage: +\$204.23<br>Random keyed: +\$108.81<br>No cylinder: +\$108.81 |
|                 | Polished Chrome       | Passage: +\$51.03<br>Random keyed: +\$108.81<br>No cylinder: +\$108.81  |
| Door Type       | Solid                 | No cost                                                                 |
|                 | Polished Edge         | +\$590.40                                                               |
| Key Option      | Passage               | No cost                                                                 |
|                 | No Cylinder           | +\$128.36                                                               |
|                 | W/ Core, Random Keyed | +\$256.72                                                               |
| Lever Option    | L Lever               | No cost                                                                 |
|                 | No Lever              | -\$383.34                                                               |
|                 | MB Lever              | No cylinder: +\$414.05<br>Random keyed: +\$680.66                       |
|                 | REM Lever             | No cylinder: +\$763.39<br>Random keyed: +\$940.51                       |

### Specification Information

Style Number    Base Price

#### Mortise Latchset

**NEDHML**    \$1323.45

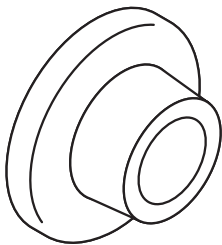

### Standard Includes

- Magnetic wall stop: 9200 Satin Chrome

### Options

|                 |                      |          |
|-----------------|----------------------|----------|
| Hardware Finish | Satin Chrome         | No cost  |
|                 | Paint Price Group 01 | +\$2.73  |
|                 | Polished Chrome      | +\$35.97 |

### Specification Information

Style Number    Base Price

#### Magnetic Wall Stop

**NEDMWS**    \$58.75

# Swing Doors

## Door Hardware

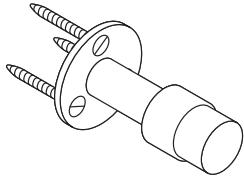

### Standard Includes

- Screw in base stop: 9200 Satin Chrome

### Options

|                 |                      |          |
|-----------------|----------------------|----------|
| Hardware Finish | Satin Chrome         | No cost  |
|                 | Polished Chrome      | +\$35.97 |
|                 | Paint Price Group 01 | +\$70.31 |

### Specification Information

Style Number    Base Price

### Screw In Base Stop

**NEDSBS**    \$99.52



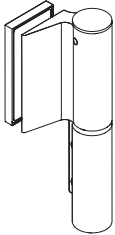

### Standard Includes

- Two free swinging slimline hinges: 9200 Satin Chrome

### Options

|                 |                      |           |
|-----------------|----------------------|-----------|
| Hardware Finish | Satin Chrome         | No cost   |
|                 | Polished Chrome      | +\$85.13  |
|                 | Paint Price Group 01 | +\$116.30 |
| Handedness      | Left Hand            | No cost   |
|                 | Right Hand           | No cost   |
| Hinge Function  | Free-Swinging        | No cost   |
|                 | Self-Closing 180 Deg | +\$280.57 |
|                 | Self-Closing 90 Deg  | +\$280.57 |

### Specification Information

Style Number    Base Price

### Slimline Hinge

**NESWDHSH**    \$1996.34

Specifying

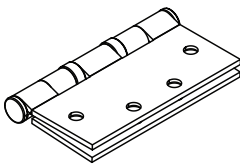

### Standard Includes

- Three butt hinges: 9200 Satin Chrome

### Options

|                 |                      |                                         |
|-----------------|----------------------|-----------------------------------------|
| Hardware Finish | Satin Chrome         | No cost                                 |
|                 | Polished Chrome      | +\$25.54                                |
|                 | Paint Price Group 01 | +\$52.08                                |
| Door Type       | Polished Edge        | No cost                                 |
|                 | Solid                | 3 hinges: -\$331.88 4 hinges: -\$442.51 |
| Handedness      | Left Hand            | No cost                                 |
|                 | Right Hand           | No cost                                 |
| Hinge Quantity  | 3                    | No cost                                 |
|                 | 4                    | +\$179.03                               |

### Specification Information

Style Number    Base Price

### Butt Hinges

**NESWDHBH**    \$537.10

# Swing Doors

## Door Hardware

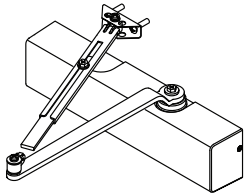

### Standard Includes

- Surface mounted door closer: 4799 Platinum Metallic

### Options

|                 |                      |           |
|-----------------|----------------------|-----------|
| Hardware Finish | Paint Price Group 02 | No cost   |
|                 | Paint Price Group 01 | +\$108.90 |

### Specification Information

Style Number      Base Price

### Door Closer

**NESWDHCLSR**      \$972.39

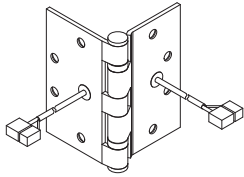

### Standard Includes

- One electric hinge with wire conductors and modular connectors and two standard butt hinges: 9200 Satin Chrome
- Low voltage harness X 132"

### Options

|                 |                      |                    |
|-----------------|----------------------|--------------------|
| Hardware Finish | Satin Chrome         | No cost            |
|                 | Paint Price Group 01 | +\$52.08 per hinge |
|                 | Polished Chrome      | +\$25.54 per hinge |
| Hinge Quantity  | 3                    | No cost            |
|                 | 4                    | No cost            |

### Specification Information

Style Number      Base Price

### Electric Hinge

**NESWDHELECHNG**      \$1393.43

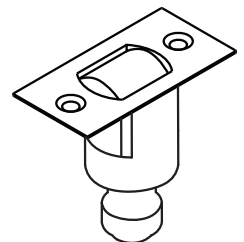
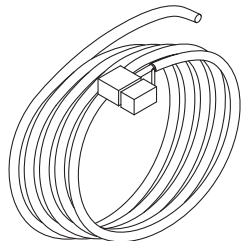

### Standard Includes

- Roller latch: 9200 Satin Chrome

### Options

|                 |                      |           |
|-----------------|----------------------|-----------|
| Door Type       | Solid                | No cost   |
|                 | Polished Edge        | +\$451.34 |
| Hardware Finish | Satin Chrome         | No cost   |
|                 | Paint Price Group 01 | +\$652.92 |

### Specification Information

Style Number      Base Price

### Roller Latch

**NESWDHRL**      \$211.30

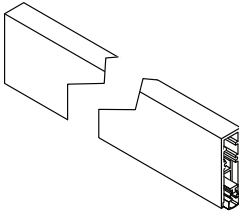

*Tip: When the standard pre-set widths are specified the list price will be reduced by 5% from the formula factors as shown above. This discount applies only to the base price per panel and the per square foot of panel add.*

### Standard Includes

- Drop seal assembly: paint price group 01 or 8043 Clear Anodized Aluminum
- Width: 28" - 48"

### Options

|                    |                      |                        |
|--------------------|----------------------|------------------------|
| Door Type          | Polished Edge        | No cost                |
|                    | Solid                | No cost                |
| Bottom Trim Finish | Anodized Aluminum    | No cost                |
|                    | Paint Price Group 01 | No cost                |
|                    | Paint Price Group 02 | +\$0.14 per inch width |
|                    | Paint Price Group 03 | +\$0.56 per inch width |

### Specification Information

Style Number    Base Price

### Drop Seal Assembly for use with Swing Doors

**NESWDSA**    \$368.26

Specifying

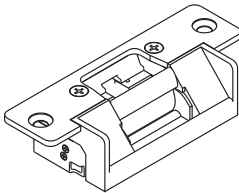

### Standard Includes

- Electric strike
- Multi-voltage single solenoid
- Selectable lock mode
- Horizontal adjustment
- Plug-in wire connectors

### Options

|            |             |         |
|------------|-------------|---------|
| Latch Prep | Cylindrical | No cost |
|            | Mortise     | No cost |

### Specification Information

Style Number    Price

### Electric Strike

**NESESTK**    \$749.50

# Swing Doors

## Door Hardware

Type 2 strikes for field supplied hardware will be available CY23 Q2.

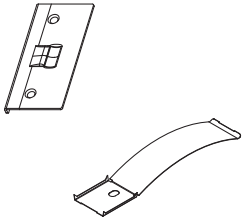

Tip: If a pushpull or ladder pull is selected, choose a roller latch or self closing hinge to keep door closed.

Tip: Electrification is not available for a pushpull or ladder pull.

### Standard Includes

- Two hinges for swing door frame
- Height: 84" - 120"

### Options

|                                |                                |           |
|--------------------------------|--------------------------------|-----------|
| Door Type                      | Polished Edge                  | No cost   |
|                                | Solid                          | No cost   |
| Latch Prep                     | Customiz Pull                  | No cost   |
|                                | Cylindrical                    | No cost   |
|                                | Mortise                        | No cost   |
|                                | PBA Ladder Aligned Locking     | No cost   |
|                                | PBA Ladder Aligned Non-Locking | No cost   |
|                                | PBA Ladder Offset Locking      | No cost   |
|                                | PBA Ladder Offset Non-Locking  | No cost   |
|                                | Pushpull                       | No cost   |
|                                | TCS Ladder Aligned Locking     | No cost   |
| TCS Ladder Aligned Non-Locking | No cost                        |           |
| TCS Ladder Offset Locking      | No cost                        |           |
| Roller Latch                   | No Roller Latch                | No cost   |
|                                | Roller Latch                   | No cost   |
| Hardware Finish                | Satin Chrome                   | No cost   |
|                                | Polished Chrome                | +\$43.22  |
| Hinge Type                     | Electric                       | No cost   |
|                                | Polished Edge Butt             | No cost   |
|                                | Slim Line                      | No cost   |
|                                | Solid Butt                     | No cost   |
| Hinge Quantity                 | 2                              | No cost   |
|                                | 3                              | +\$70.85  |
|                                | 4                              | +\$141.70 |
| Electrification                | Electric Strike                | No cost   |
|                                | No Electrification             | No cost   |
| Strike Plate                   | No Strike Plate                | No cost   |
|                                | Type 1                         | No cost   |
|                                | Type 2                         | No cost   |
| Truck Finish                   | Paint Price Group 01           | No cost   |
|                                | Paint Price Group 02           | No cost   |

### Specification Information

Style Number    Base Price

### Assembly Hardware, Swing Door Frame

**NEAHSW**    \$141.70

# Slider Doors

## Single Slider Door Frame



### Standard Includes

- Door frame: paint price group 01 or 8043 Clear Anodized Aluminum
- Width: 40" - 48"
- Height: 84" - 120"
- Seal: plastic

### Options

|              |                      |                                                     |
|--------------|----------------------|-----------------------------------------------------|
| Frame Finish | Anodized Aluminum    | No cost                                             |
|              | Paint Price Group 01 | No cost                                             |
|              | Paint Price Group 02 | Height: +\$0.33 per inch<br>Width: +\$0.14 per inch |
|              | Paint Price Group 03 | Height: +\$1.36 per inch<br>Width: +\$0.57 per inch |
| Handedness   | Left Hand            | No cost                                             |
|              | Right Hand           | No cost                                             |
| Latch Prep   | Lever Lock           | No cost                                             |
|              | No Latch Prep        | No cost                                             |

### Specification Information

Style Number    Base Price

### Door Frame - Slider, Single

**NEDFSLS**    \$1760.71

Specifying

# Slider Doors

## Single Polished Edge Slider Door Leaf

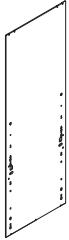

Tip: When the standard pre-set widths are specified the list price will be reduced by 5% from the formula factors as shown above. This discount applies only to the base price per panel and the per square foot of panel add.

Tip: For Customer's Own Glass (COG) an engineering quote is required. Upcharges for latch prep, pull size, and stanchions will be additional.

Tip: Stanchion upcharges are only applied if latch prep selection is custom pull.

### Standard Includes

- 3/8" thick glass door leaf: 6500 Clear glass
- Width: 40" - 48"
- Height: 84" - 120"

### Options

|                           |                                |                                                                    |
|---------------------------|--------------------------------|--------------------------------------------------------------------|
| Glass Finish              | Customer's Own Glass           | No cost                                                            |
|                           | Glass Price Group 01           | No cost                                                            |
|                           | Glass Price Group 03           | 3/8": +\$49.99 per sq ft<br>1/2": +\$33.90 per sq ft               |
| Glass Thickness           | 3/8"                           | No cost                                                            |
|                           | 1/2"                           | +\$18.01 per sq ft                                                 |
| Glass Surface Orientation | Polished to inside             | No cost                                                            |
|                           | Polished to outside            | No cost                                                            |
| Handedness                | Left Hand                      | No cost                                                            |
|                           | Right Hand                     | No cost                                                            |
| Latch Prep                | Customiz Pull                  | No cost                                                            |
|                           | PBA Ladder Aligned Locking     | +\$26.16                                                           |
|                           | PBA Ladder Aligned Non-Locking | +\$26.16                                                           |
|                           | PBA Ladder Offset Locking      | +\$26.16                                                           |
|                           | PBA Ladder Offset Non-Locking  | +\$26.16                                                           |
|                           | Pushpull                       | +\$26.16                                                           |
|                           | TCS Ladder Aligned Locking     | +\$26.16                                                           |
|                           | TCS Ladder Aligned Non-Locking | +\$26.16                                                           |
|                           | TCS Ladder Offset Locking      | +\$26.16                                                           |
|                           | Lever Lock                     | +\$98.10                                                           |
| Pull Size                 | 18"                            | No cost                                                            |
|                           | 24"                            | No cost                                                            |
|                           | 36"                            | No cost                                                            |
|                           | 48"                            | No cost                                                            |
|                           | 60"                            | No cost                                                            |
|                           | 72"                            | TCS Aligned Locking: +\$13.08<br>TCS Aligned Non-Locking: +\$13.08 |
| Number of Stanchions      | 2                              | No cost                                                            |
|                           | 3                              | +\$56.68                                                           |
|                           | 4                              | +\$114.45                                                          |

### Specification Information

| Style Number | Base Price | Per sq ft of Leaf |
|--------------|------------|-------------------|
|              | Per Leaf   |                   |

### Door Leaf - Slider, Polished Edge

|                 |          |          |
|-----------------|----------|----------|
| <b>NEDLSLPE</b> | \$196.20 | +\$33.81 |
|-----------------|----------|----------|

# Slider Doors

## Single Slider Door Track

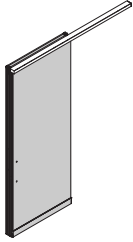

*Tip: When the standard pre-set widths are specified the list price will be reduced by 5% from the formula factors as shown above. This discount applies only to the base price per panel and the per square foot of panel add.*

### Standard Includes

- Door track: paint price group 01 or 8043 Clear Anodized Aluminum
- Width: 75" - 120"

### Options

|                 |                      |                    |
|-----------------|----------------------|--------------------|
| Track Finish    | Anodized Aluminum    | No cost            |
|                 | Paint Price Group 01 | No cost            |
|                 | Paint Price Group 02 | +\$18.20 per sq ft |
|                 | Paint Price Group 03 | +\$75.77 per sq ft |
| Glass Thickness | 1/2"                 | No cost            |
|                 | 3/8"                 | No cost            |

### Specification Information

Style Number    Base Price

### Door Track - Slider, Single

**NEDTSLS**    \$2587.52

Specifying

# Slider Doors

## Slider Door Hardware

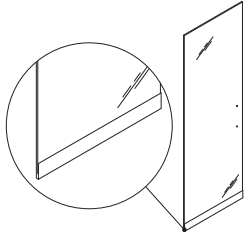

*Tip: When the standard pre-set widths are specified the list price will be reduced by 5% from the formula factors as shown above. This discount applies only to the base price per panel and the per square foot of panel add.*

### Standard Includes

- Drop seal housing: paint price group 01 or 8043 Clear Anodized Aluminum
- Width: 40" - 48"

### Options

|                    |                      |                   |
|--------------------|----------------------|-------------------|
| Bottom Trim Finish | Anodized Aluminum    | No cost           |
|                    | Paint Price Group 01 | No cost           |
|                    | Paint Price Group 02 | +\$0.14 per sq ft |
|                    | Paint Price Group 03 | +\$0.57 per sq ft |
| Glass Thickness    | 1/2"                 | No cost           |
|                    | 3/8"                 | No cost           |
| Handedness         | Left Hand            | No cost           |
|                    | Right Hand           | No cost           |

### Specification Information

Style Number    Base Price

### Drop Seal Housing for use with Slider Doors

**NELSH**      \$718.51

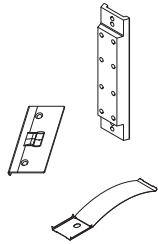

### Standard Includes

- Assembly hardware for slider door frame

### Options

|            |            |         |
|------------|------------|---------|
| Handedness | Left Hand  | No cost |
|            | Right Hand | No cost |

### Specification Information

Style Number    Price

### Assembly Hardware - Slider Door Frame

**NEAHS**      \$88.04



# Slider Doors

## Slider Door Hardware

<sup>3</sup>/<sub>8</sub>" slider door with lever lock will be available CY23 Q2.

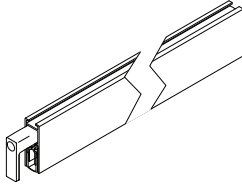

*Tip: When the standard pre-set widths are specified the list price will be reduced by 5% from the formula factors as shown above. This discount applies only to the base price per panel and the per square foot of panel add.*

### Standard Includes

- Drop seal for slider door
- Width: 40" - 48"

### Specification Information

Style Number Price

### Slider Door Hardware-Drop Seal

**NESLDHDS** \$357.43

Specifying



### Standard Includes

- Slider lever lock: 4710 Low Gloss Black or 9200 Satin Chrome

### Options

|                      |                       |           |
|----------------------|-----------------------|-----------|
| Hardware Finish      | Paint Price Group 01  | No cost   |
|                      | Satin Chrome          | No cost   |
| Key Option           | No Cylinder           | No cost   |
|                      | W/ Core, Random Keyed | No cost   |
| Lever Option         | L Lever               | No cost   |
|                      | No Lever              | -\$383.34 |
|                      | MB Lever              | +\$680.66 |
|                      | REM Lever             | +\$940.51 |
| Cylinder Orientation | Key inside            | No cost   |
|                      | Key outside           | No cost   |

### Specification Information

Style Number Base Price

### Slider Lever Lock

**NEDHSSL** \$1391.05

# Door Pulls

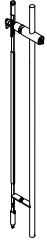

*Tip: Latch prep with lockset includes cylinder with random keyed removable core.*

*Tip: Pull size finish pricing is for TCS ladder aligned non-locking only.*

## Standard Includes

- Ladder pull, aligned: 4710 Low Gloss Black or 9200 Satin Chrome
- Solid door type

## Options

|                                |                                |                                        |
|--------------------------------|--------------------------------|----------------------------------------|
| Hardware Finish                | Paint Price Group 01           | No cost                                |
|                                | Satin Chrome                   | No cost                                |
| Door Type                      | Polished Edge                  | No cost                                |
|                                | Solid                          | No cost                                |
| Latch Prep                     | PBA Ladder Aligned Locking     | 9200: +\$5,025.84                      |
|                                |                                | 4710: +\$5,869.72                      |
|                                | PBA Ladder Aligned Non-Locking | 9200: +\$2,238.17                      |
|                                |                                | 4710: +\$2,850.96                      |
|                                | TCS Ladder Aligned Locking     | 9200-48": +\$3,442.73                  |
|                                |                                | 4710-48": +\$3,730.01                  |
|                                |                                | 9200-60": +\$4,002.68                  |
| 4710-60": +\$4,462.55          |                                |                                        |
| 9200-72": +\$4,327.88          |                                |                                        |
| 4710-72": +\$4,629.20          |                                |                                        |
| TCS Ladder Aligned Non-Locking | See pull sizes below           |                                        |
| Pull Size                      | 18"                            | 9200: +\$602.16<br>4710: +\$878.31     |
|                                | 24"                            | 9200: +\$775.58<br>4710: +\$1,051.59   |
|                                | 36"                            | 9200: +\$909.13<br>4710: +\$1,184.58   |
|                                | 48"                            | 9200: +\$1,068.46<br>4710: +\$1,343    |
|                                | 60"                            | 9200: +\$1,276.80<br>4710: +\$1,540.58 |
|                                | 72"                            | 9200: +\$1,851.98<br>4710: +\$2,129.22 |
| Key Option                     | No Keying Option               | No cost                                |
|                                | W/ Core, Random Keyed          | No cost                                |
|                                | No Cylinder                    | -\$128.36                              |

## Specification Information

Style Number    Base Price

### Door Hardware - Ladder Pull, Aligned

**NEDHLPA**    \$316.09

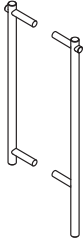

## Standard Includes

- Ladder pull, offset: 4710 Low Gloss Black or 9200 Satin Chrome
- Solid door type

## Options

|                 |                               |                                                                                                  |
|-----------------|-------------------------------|--------------------------------------------------------------------------------------------------|
| Hardware Finish | Paint Price Group 01          | No cost                                                                                          |
|                 | Satin Chrome                  | No cost                                                                                          |
| Door Type       | Polished Edge                 | No cost                                                                                          |
|                 | Solid                         | No cost                                                                                          |
| Latch Prep      | PBA Ladder Offset Locking     | 9200: +\$5,025.84<br>4710: +\$5,869.72                                                           |
|                 | PBA Ladder Offset Non-Locking | 9200: +\$2,748.63<br>4710: +\$3,592.51                                                           |
|                 | TCS Ladder Offset Locking     | 9200-48": +\$3,456.47<br>4710-48": +\$3,730.01<br>9200-60": +\$4,002.68<br>4710-60": +\$4,462.55 |
| Pull Size       | 48"                           | See above                                                                                        |
|                 | 60"                           | See above                                                                                        |
| Key Option      | No Keying Option              | No cost                                                                                          |
|                 | W/ Core, Random Keyed         | No cost                                                                                          |
|                 | No Cylinder                   | -\$128.36                                                                                        |

## Specification Information

Style Number    Base Price

### Door Hardware - Ladder Pull, Offset

**NEDHLPO**    \$316.09

Specifying

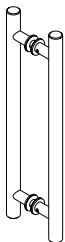

## Standard Includes

- Pushpull handle: 4710 Low Gloss Black or 9200 Satin Chrome

## Options

|                 |                      |          |
|-----------------|----------------------|----------|
| Hardware Finish | Satin Chrome         | No cost  |
|                 | Paint Price Group 01 | +\$43.41 |

## Specification Information

Style Number    Base Price

### Door Hardware-Pushpull Handle

**NEDHPPH**    \$194.30

# Posts



## Standard Includes

- Post: paint price group 01 or 8043 Clear Anodized Aluminum

## Options

|             |                      |           |
|-------------|----------------------|-----------|
| Trim Finish | Anodized Aluminum    | No cost   |
|             | Paint Price Group 01 | No cost   |
|             | Paint Price Group 02 | +\$23.95  |
|             | Paint Price Group 03 | +\$98.65  |
| Angle       | 90 Deg               | No cost   |
|             | 120 Deg              | +\$17.40  |
|             | 180 Deg              | +\$26.40  |
|             | 135 Deg              | +\$241.98 |

## Specification Information

Style Number    Base Price

### Post, Two-Way

**NEP2**            \$849.11



## Standard Includes

- Post: paint price group 01 or 8043 Clear Anodized Aluminum

## Options

|             |                      |          |
|-------------|----------------------|----------|
| Trim Finish | Anodized Aluminum    | No cost  |
|             | Paint Price Group 01 | No cost  |
|             | Paint Price Group 02 | +\$23.95 |
|             | Paint Price Group 03 | +\$98.65 |
| Angle       | 120 Deg              | No cost  |
|             | 135 Deg              | No cost  |
|             | 90 Deg               | No cost  |

## Specification Information

Style Number    Base Price

### Post, 3-way

**NEP3**            \$1219.80



**Standard Includes**

- Post: paint price group 01 or 8043 Clear Anodized Aluminum

**Options**

|             |                      |          |
|-------------|----------------------|----------|
| Trim Finish | Anodized Aluminum    | No cost  |
|             | Paint Price Group 01 | No cost  |
|             | Paint Price Group 02 | +\$23.95 |
|             | Paint Price Group 03 | +\$98.65 |

**Specification Information**

Style Number    Base Price

**Post, 4-way**

|             |           |
|-------------|-----------|
| <b>NEP4</b> | \$1133.96 |
|-------------|-----------|

Specifying

# Adapters



## Standard Includes

- Adapter: paint price group 01 or 8043 Clear Anodized Aluminum

## Options

|             |                      |          |
|-------------|----------------------|----------|
| Trim Finish | Anodized Aluminum    | No cost  |
|             | Paint Price Group 01 | No cost  |
|             | Paint Price Group 02 | +\$10.79 |
|             | Paint Price Group 03 | +\$44.46 |
| Modularity  | Off Mod              | No cost  |
|             | On Mod               | No cost  |

## Specification Information

Style Number    Base Price

### 90° T/X Adapter

**NEIA**            \$752.54



## Standard Includes

- Finished end: paint price group 01 or 8043 Clear Anodized Aluminum

## Options

|             |                      |          |
|-------------|----------------------|----------|
| Trim Finish | Anodized Aluminum    | No cost  |
|             | Paint Price Group 01 | No cost  |
|             | Paint Price Group 02 | +\$9.38  |
|             | Paint Price Group 03 | +\$38.66 |

## Specification Information

Style Number    Base Price

### Finished End

**NEFEA**            \$654.38



**Standard Includes**

- Trim: paint price group 01 or 8043 Clear Anodized Aluminum
- Ceiling height: 84" - 120"

**Options**

|               |                            |          |
|---------------|----------------------------|----------|
| Trim Finish   | Anodized Aluminum          | No cost  |
|               | Paint Price Group 01       | No cost  |
|               | Paint Price Group 02       | +\$23.95 |
|               | Paint Price Group 03       | +\$98.65 |
| Cutout Count  | No Holes                   | No cost  |
|               | 1 Hole                     | +\$60    |
|               | 2 Holes                    | +\$120   |
|               | 3 Holes                    | +\$180   |
| Cutout Type 1 | Hardwire - 2x4 Rectangular | No cost  |
|               | Modular Power              | No cost  |
| Cutout Type 2 | Hardwire - 2x4 Rectangular | No cost  |
|               | Modular Power              | No cost  |
| Cutout Type 3 | Hardwire - 2x4 Rectangular | No cost  |
|               | Modular Power              | No cost  |

**Specification Information**

Style Number    Base Price

**Utility Panel, Frame**

**NEUP**            \$729.28

**Specifying**

# Adapters

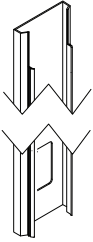

## Standard Includes

- Cover: paint price group 01 or 8043 Clear Anodized Aluminum
- Ceiling height: 84" - 120"

## Options

|               |                            |          |
|---------------|----------------------------|----------|
| Cover Finish  | Anodized Aluminum          | No cost  |
|               | Paint Price Group 01       | No cost  |
|               | Paint Price Group 02       | +\$23.95 |
|               | Paint Price Group 03       | +\$98.65 |
| Cutout Count  | No Holes                   | No cost  |
|               | 1 Hole                     | +\$60    |
|               | 2 Holes                    | +\$120   |
|               | 3 Holes                    | +\$180   |
| Cutout Type 1 | Hardwire - 2x4 Rectangular | No cost  |
|               | Modular Power              | No cost  |
| Cutout Type 2 | Hardwire - 2x4 Rectangular | No cost  |
|               | Modular Power              | No cost  |
| Cutout Type 3 | Hardwire - 2x4 Rectangular | No cost  |
|               | Modular Power              | No cost  |

## Specification Information

Style Number    Base Price

### Utility Panel, Cover

**NEUPC**      \$549.73





**Standard Includes**

- Bypass: paint price group 01 or 8043 Clear Anodized Aluminum

**Options**

|             |                      |          |
|-------------|----------------------|----------|
| Trim Finish | Anodized Aluminum    | No cost  |
|             | Paint Price Group 01 | No cost  |
|             | Paint Price Group 02 | +\$23.95 |
|             | Paint Price Group 03 | +\$98.65 |

**Specification Information**

Style Number    Base Price

**Bypass**

**NEB**            \$846.06

Specifying

# Cutable Ends

## 90° Cutable End Assembly

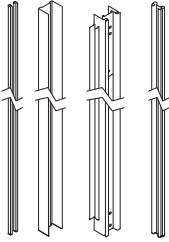

### Standard Includes

- Cutable end assembly: paint price group 01
- Ceiling height: 84" - 120"

### Options

|              |                      |          |
|--------------|----------------------|----------|
| Paint Finish | Paint Price Group 01 | No cost  |
|              | Paint Price Group 02 | +\$23.81 |
|              | Paint Price Group 03 | +\$99.11 |

### Specification Information

Style Number    Base Price

## Cutable End Assembly

**NEECA**    \$1374.97

# Cutable Ends

## 90° Cutable End Inner Channel



### Standard Includes

- Cutable end inner channel: paint price group 01

### Options

|              |                      |          |
|--------------|----------------------|----------|
| Length       | 48"                  | No cost  |
|              | 120"                 | +\$83.19 |
| Paint Finish | Paint Price Group 01 | No cost  |
|              | Paint Price Group 02 | +\$23.79 |
|              | Paint Price Group 03 | +\$99.07 |

### Specification Information

Style Number    Base Price

### 90° Cutable End Part, Inner Channel

**NEECEI**    \$160.50

Specifying

---

# Cutable Ends

## 90° Cutable End Outer Channel

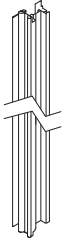

### Standard Includes

- Cutable end outer channel

### Options

|        |      |          |
|--------|------|----------|
| Length | 48"  | No cost  |
|        | 120" | +\$83.18 |

### Specification Information

Style Number    Base Price

---

## 90° Cutable End Outer Channel

---

**NEECEO**    \$178.38

# Cutable Ends

## Cutable End Capture Trim



### Standard Includes

- Cutable end capture trim: paint price group 01
- Ceiling height 12.1" - 120"

### Options

|              |                      |          |
|--------------|----------------------|----------|
| Cover Finish | Paint Price Group 01 | No cost  |
|              | Paint Price Group 02 | +\$11.15 |
|              | Paint Price Group 03 | +\$46.43 |

### Specification Information

| Style Number | Base Price       |                    |
|--------------|------------------|--------------------|
|              | Per Capture Trim | Per inch of Height |

### Cutable End Capture Trim

|                |          |         |
|----------------|----------|---------|
| <b>NEECEPT</b> | \$134.03 | +\$0.15 |
|----------------|----------|---------|

Specifying

---

# Cutable Ends

## Cutable End Corner Angle

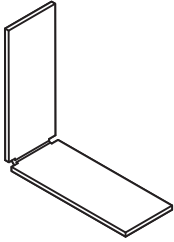

### Standard Includes

- Cutable end corner angle

### Specification Information

Style Number    Price

---

### Cutable End, Corner Angle

---

**NEECEAI**    \$132.81

# Cutable Ends

## Cutable End Elbow

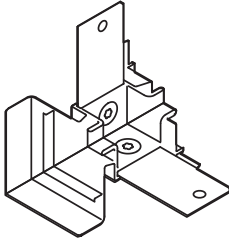

### Standard Includes

- Cutable end elbow

### Options

|                     |                |         |
|---------------------|----------------|---------|
| Miter Configuration | Inside Corner  | No cost |
|                     | Outside Corner | No cost |

### Specification Information

Style Number    Price

### Cutable End, Elbow

**NEECEEO**    \$280.64

Specifying

# Mini End and Wall Start

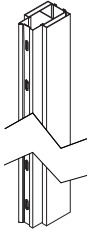

## Standard Includes

- Adjustable mini end
- Seal:
  - 6009 Arctic White
  - 6249 Platinum Solid
  - 6527 Merle

## Options

|              |                      |                                      |
|--------------|----------------------|--------------------------------------|
| Size Option  | Medium               | No cost                              |
|              | Large                | +\$322.69                            |
| Inner Finish | Paint Price Group 01 | No cost                              |
|              | Paint Price Group 02 | Medium: +\$18.64<br>Large: +\$25.82  |
|              | Paint Price Group 03 | Medium: +\$76.71<br>Large: +\$106.32 |
| Outer Finish | Anodized Aluminum    | No cost                              |
|              | Paint Price Group 01 | No cost                              |
|              | Paint Price Group 02 | Medium: +\$18.64<br>Large: +\$25.82  |
|              | Paint Price Group 03 | Medium: +\$76.71<br>Large: +\$106.32 |

## Specification Information

Style Number    Base Price

### 90° Adjustable Mini End

**NEEAM**      \$709.59



## Standard Includes

- Wall start: paint price group 01 or 8043 Clear Anodized Aluminum

## Options

|             |                      |          |
|-------------|----------------------|----------|
| Trim Finish | Anodized Aluminum    | No cost  |
|             | Paint Price Group 01 | No cost  |
|             | Paint Price Group 02 | +\$9.38  |
|             | Paint Price Group 03 | +\$38.66 |

## Specification Information

Style Number    Base Price

### Wall Start

**NEWS**      \$654.38



# Electrical Components

## Receptacles and Power Block

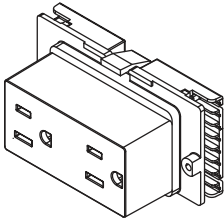

### Standard Includes

- Receptacle:
  - 6009 Arctic White
  - 6249 Platinum Solid
  - 6527 Merle
  - 6B03 Red

### Options

|                  |                       |          |
|------------------|-----------------------|----------|
| Wiring Schematic | 2+2                   | No cost  |
|                  | 3 Separate Neutrals   | No cost  |
|                  | 3+1                   | No cost  |
| Line Number      | Line 1                | No cost  |
|                  | Line 2                | No cost  |
|                  | Line 3                | No cost  |
|                  | Line 4                | No cost  |
| Ground Type      | Isolated              | No cost  |
|                  | System                | No cost  |
| Amp Type         | 15 Amp                | No cost  |
|                  | 20 Amp                | +\$12.25 |
| Controlled Stamp | No Stamp              | No cost  |
|                  | With Controlled Stamp | +\$2.45  |

### Specification Information

Style Number    Base Price

#### Receptacle

**NEPRC**      \$43.60

Specifying

# Electrical Components

## Receptacles and Power Block

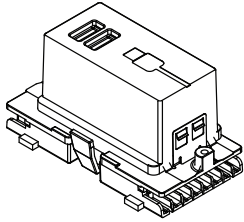

### Standard Includes

- USB receptacle:
  - 6009 Arctic White
  - 6249 Platinum Solid
  - 6527 Merle

### Options

|                   |                     |         |
|-------------------|---------------------|---------|
| Receptacle Finish | Plastic - PG1       | No cost |
| Wiring Schematic  | 2+2                 | No cost |
|                   | 3 Separate Neutrals | No cost |
|                   | 3+1                 | No cost |
| Line Number       | Line 1              | No cost |
|                   | Line 2              | No cost |
|                   | Line 3              | No cost |
|                   | Line 4              | No cost |

### Specification Information

Style Number Price

#### USB Receptacle

**NEPRCUSB** \$264.76

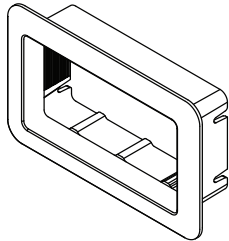

### Standard Includes

- Power receptacle trim:
  - 6009 Arctic White
  - 6249 Platinum Solid
  - 6527 Merle

### Specification Information

Style Number Price

#### Power Receptacle Trim

**NEPRT** \$10.90

# Electrical Components

## Receptacles and Power Block

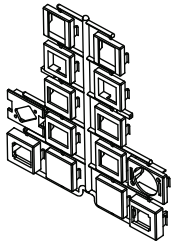
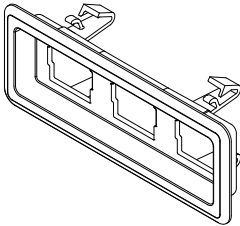

### Standard Includes

- Modular communication faceplate:
  - 6009 Arctic White
  - 6249 Platinum Solid
  - 6527 Merle
- Data adapter trims

### Specification Information

Style Number

Price

### Modular Communication Faceplate

**NEPFPC**

\$43.60

Specifying

# Electrical Components

## Multipurpose Infeed and Power Block Connector



Hardwire

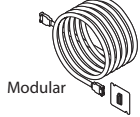

Modular

### Standard Includes

- 24' long infeed
- Junction box fittings
- Conduit: metal

### Options

|                     |                     |           |
|---------------------|---------------------|-----------|
| Wiring Schematic    | 2+2                 | No cost   |
|                     | 3 Separate Neutrals | No cost   |
|                     | 3+1                 | No cost   |
| Building Connection | Hardwire            | No cost   |
|                     | Modular             | +\$150.82 |

### Specification Information

Style Number    Base Price

### Multipurpose Infeed - 8 Wire

**NEPIMP8**    \$726.77

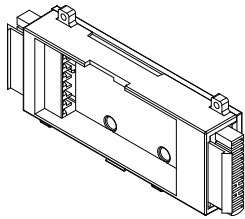

### Standard Includes

- Power block

### Options

|                  |                     |         |
|------------------|---------------------|---------|
| Wiring Schematic | 2+2                 | No cost |
|                  | 3 Separate Neutrals | No cost |
|                  | 3+1                 | No cost |

### Specification Information

Style Number    Price

### Power Block

**NEPB**    \$119.90

# Electrical Components

## Modular Harness

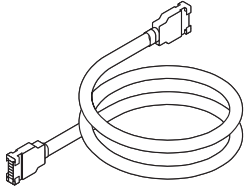

### Standard Includes

- Modular Harness, 8-wire: 36" long

### Options

|                  |                     |           |
|------------------|---------------------|-----------|
| Length           | 36"                 | No cost   |
|                  | 72"                 | +\$84.74  |
|                  | 144"                | +\$244.17 |
| Wiring Schematic | 2+2                 | No cost   |
|                  | 3 Separate Neutrals | No cost   |
|                  | 3+1                 | No cost   |

### Specification Information

Style Number    Base Price

### Modular Harness - 8 Wire

**NEPH8**    \$195.33

Specifying

# Electrical Components

## Harness-to-Harness Branching Connector

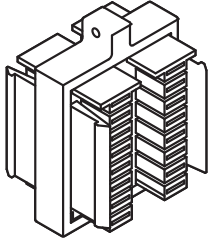

### Standard Includes

- Connector

### Options

|                  |                     |         |
|------------------|---------------------|---------|
| Wiring Schematic | 2+2                 | No cost |
|                  | 3 Separate Neutrals | No cost |
|                  | 3+1                 | No cost |

### Specification Information

Style Number    Price

## Harness-to-Harness Branching Connector

**NEPHNC**    \$44.54

# Electrical Components

## Electrical Mounting Brackets

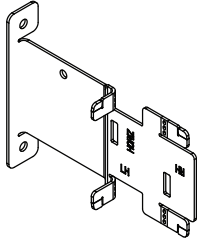

### Standard Includes

- Bracket: Fire Retardant polyurethane foam.

### Specification Information

Style Number Price

## Electrical Mounting Bracket - Skins Modular

**NEPMBESM** \$45.63

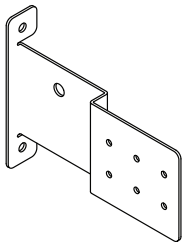

### Standard Includes

- Bracket: Fire Retardant polyurethane foam.

### Specification Information

Style Number Price

## Electrical Mounting Bracket - Skins Hardwire

**NEPMBESH** \$102.50

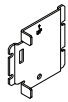

Modular



Hardwire

### Standard Includes

- Bracket: Fire Retardant polyurethane foam.

### Options

| Devices | Modular         | No cost |
|---------|-----------------|---------|
|         | Hardwire Single | +\$1.64 |

### Specification Information

Style Number Base Price

## Electrical Mounting Bracket - Utility Panel

**NEPMBEU** \$96.25

Specifying





---

# Surface Materials

**Surface Materials**

**136**

Surface Materials

# Surface Materials

This listing includes all the surface material choices that are available for the products in this specification guide.

## Resources

For more information about surface materials, refer to the following resources:

**Additional surface material specification tools** are available to assist you in the specification process – the Surface Materials Binders.

**The global surface materials palette** is a core collection of finishes that is available across multiple geographies (Americas/EMEA – Europe, Middle East, and Africa/APAC – Asia Pacific) and on global product lines, where applicable. For a list of finishes included in the offering, see the *Surface Materials Reference Manual*. Additional details, like product approvals by geography and finish number conversions, can also be found in the *Surface Materials Reference Manual* or see [steelcase.com/surface-materials](http://steelcase.com/surface-materials).

## Paint

*Tip: All products may not be available in all colors listed below.*

### Price Group 1

#### Smooth Paint

- 4242 Milk Smooth
- 4710 Low Gloss Black
- 4843 Linen
- 4844 Glacier
- 4849 Vapor
- 4858 Seagull

#### Textured Paint

- 7190 Platinum Solid
- 7207 Black
- 7225 Sand
- 7237 Slate
- 7238 Fieldstone
- 7239 Midnight
- 7241 Arctic White
- 7243 Seagull
- 7278 Dark Bronze
- 7360 Merle

### Price Group 2

#### Smooth Metallic Paint

- 4743 Mineral Metallic
- 4750 Champagne Metallic
- 4798 Sterling Metallic
- 4799 Platinum Metallic
- 4803 Near Black Metallic

#### Textured Metallic

- 7245 Carbon Metallic
- 7246 Midnight Metallic

## Custom Surfaces

### Price Group 3

#### PerfectMatch

PerfectMatch is a service that allows you to create your own paint color. Refer to the *Surface Materials Reference Manual* for more information about this program.

#### Accent Paint

- 1ATG Rose Quartz
- 4AV4 Baltic
- 4CZ6 Lagoon
- 4CZ7 Saffron

## Lux Coatings

- 4B22 Matte Brass
- 4B23 Burnished Bronze
- 4B24 Night Bronze
- 4B25 Matte Copper
- 4B26 Smoked Mica
- 4B29 Cast Iron

## Accent Paint and Lux Coatings

will be added to products that receive the metal and accessories paint finishes.

## Metal and Accessory Paint

### Steelcase Surfaces

Applies to:

- Glass frames
- Bypass
- Adapter
- Finished end
- Utility panel cover and frame
- Door frames
- Slider door track
- Posts
- Vertical transition
- Wall start
- Drop seal assembly and housing

- 8043 Clear Anodized Aluminum

## Laminate

### Steelcase Surfaces

#### Low-Pressure Laminate

### Price Group 1

Applies to:

- Laminate skins

#### Solid Laminate

- 247L Black V2 LPL
- 2L30 Arctic White LPL
- 2L83 Seagull LPL
- 2L84 Milk LPL
- 2L85 Dune LPL
- 2LMG Merle LPL

#### Woodgrain Laminate

- 24L0 Graphite Walnut LPL
- 25L1 Winter on Maple LPL
- 25L5 Virginia Walnut LPL
- 25L6 Blackwood LPL **E**
- 25L8 Clear Walnut LPL
- 265L Marbled Cherry LPL
- 267L Marbled Cherry V2 LPL **E**
- 26L1 Natural Cherry V2 LPL
- 2L09 Clear Maple LPL
- 2LAK Clear Oak LPL
- 2LAN Ash Noce LPL
- 2LAT Acacia LPL
- 2LAW Ash Wenge LPL
- 2LBN Bisque Noce LPL
- 2LBW Bisque Wenge LPL
- 2LCN Clay Noce LPL
- 2LCW Clay Wenge LPL
- 2LSN Storm Noce LPL
- 2LSW Storm Wenge LPL
- 2LWA Grey Kingswood LPL
- 2LWB Planked Walnut LPL
- 2LWD Resolute Walnut LPL
- 2LWF Smoked Walnut LPL
- 2LWG Natural Recon LPL
- 2TL2 Fawn Cypress LPL

## High-Pressure Laminate

### Price Group 1

Applies to:

- Laminate skins

#### Fiber Laminate

- 2850 Vanadium Fiber HPL
- 2852 Tungsten Fiber HPL
- 2854 Vellum Fiber HPL
- 2860 Granite Fiber HPL
- 2862 Stucco Fiber HPL

#### Micro Laminate

- 2920 Marl Micro HPL
- 2921 Gypsum Micro HPL
- 2922 Clay Micro HPL

#### Patina Laminate

- 2870 Blonde Bronze Patina HPL
- 2873 Instant Iron Patina HPL

#### Solid Laminate

- 2722 Cream HPL **E**
- 2730 Arctic White HPL
- 2746 Black HPL
- 2759 Warm White
- 2811 Mist HPL **E**
- 2883 Seagull HPL
- 2884 Milk HPL
- 2885 Dune HPL
- 2HAA Persian Salt HPL
- 2HAB Rose HPL
- 2HAC Indigo HPL
- 2HAD Green Citrine HPL
- 2HAE Dark Olivine HPL
- 2HAF Cloudy HPL
- 2HMG Merle HPL

#### Speckle Laminate

- 2820 Coffee Speckle HPL **E**
- 2823 Driftwood Speckle HPL
- 2824 Smoke Speckle HPL
- 2825 Vanadium Speckle HPL

**E** = Established

**Woodgrain Laminate**

|      |                                |
|------|--------------------------------|
| 2406 | Clear Cherry HPL <b>E</b>      |
| 2409 | Clear Maple HPL                |
| 2410 | Graphite Walnut HPL            |
| 2412 | Natural Cherry HPL             |
| 2422 | Medium Cherry HPL              |
| 2511 | Winter on Maple HPL            |
| 2535 | Virginia Walnut HPL            |
| 2536 | Blackwood HPL <b>E</b>         |
| 2538 | Clear Walnut HPL               |
| 2592 | Blonde on Maple HPL <b>E</b>   |
| 2612 | Marbled Maple HPL <b>E</b>     |
| 2614 | Chocolate Walnut HPL <b>E</b>  |
| 2615 | Marbled Cherry V2 HPL <b>E</b> |
| 2714 | Natural Walnut HPL <b>E</b>    |
| 2HAK | Clear Oak HPL                  |
| 2HAN | Ash Noce HPL                   |
| 2HAT | Acacia HPL                     |
| 2HAW | Ash Wenge HPL                  |
| 2HBN | Bisque Noce HPL                |
| 2HBW | Bisque Wenge HPL               |
| 2HCN | Clay Noce HPL                  |
| 2HCW | Clay Wenge HPL                 |
| 2HSN | Storm Noce HPL                 |
| 2HSW | Storm Wenge HPL                |
| 2HWA | Grey Kingswood HPL             |
| 2HWB | Planked Walnut HPL             |
| 2HWD | Resolute Walnut HPL            |
| 2HWE | Natural Recon HPL              |
| 2HWF | Smoked Walnut HPL              |
| 2HWU | Clay                           |
| 2HWW | Chalk                          |

**Price Group 2****Textured Laminate**

|      |                         |
|------|-------------------------|
| 2TH2 | Fawn Cypress HP         |
| 2TH4 | Saddle Oak HPL          |
| 2TH5 | Veranda Teak HPL        |
| 2TH7 | Walnut Heights HPL      |
| 2UH1 | Reclaimed Aggregate HPL |
| 2UH2 | Reclaimed Gravel HPL    |
| 2UH4 | Cement HPL              |
| 2UH6 | Sheetrock HPL           |

**Price Group 3****Solid Laminate**

|      |                 |
|------|-----------------|
| 24H1 | Satin White HPL |
| 24H2 | Satin Black HPL |
| 24H3 | Satin Stone HPL |
| 24H4 | Satin Mocha HPL |

**Plastic****Steelcase Surfaces**

Applies to:

- Seals
  - Receptacles
  - Receptacle trim
  - Modular communication faceplate
- |      |                        |
|------|------------------------|
| 6009 | Arctic White           |
| 6249 | Platinum Solid         |
| 6527 | Merle                  |
| 6B03 | Red (receptacles only) |

Applies to:

- Laminate skins
- |      |                    |
|------|--------------------|
| 6000 | Black              |
| 6009 | Arctic White       |
| 6034 | Natural Cherry     |
| 6037 | Winter on Maple    |
| 6052 | Milk               |
| 6053 | Seagull            |
| 61AA | Persian Salt       |
| 61AF | Cloudy             |
| 6213 | Acacia             |
| 6219 | Clear Oak          |
| 6231 | Graphite Walnut    |
| 6237 | Clear Maple        |
| 6242 | Virginia Walnut    |
| 6243 | Blackwood <b>E</b> |
| 6245 | Clear Walnut       |
| 6246 | Warm Oak           |
| 6271 | Plywood            |
| 6527 | Merle              |
| 6654 | Sand               |
| 6655 | Warm White         |
| 6697 | Fog                |
| 6698 | Fieldstone         |
| 66WA | Grey Kingswood     |
| 66WB | Planked Walnut     |
| 66WD | Resolute Walnut    |
| 66WE | Natural Recon      |
| 66WF | Smoked Walnut      |
| 66WU | Clay               |
| 66WV | Chalk              |
| 6703 | Ash Wenge          |
| 6704 | Storm Wenge        |
| 6705 | Bisque Wenge       |
| 6706 | Clay Wenge         |
| 6707 | Ash Noce           |
| 6708 | Bisque Noce        |
| 6709 | Clay Noce          |
| 6T02 | Fawn Cypress       |
| 6T04 | Saddle Oak         |
| 6T05 | Veranda Teak       |
| 6T07 | Walnut Heights     |
| 6T08 | Aggregate          |
| 6T09 | Gravel             |
| 6T10 | Cement             |
| 6T12 | Sheetrock          |

**Custom Surfaces****Open Line Laminate (OLL)**

This service allows you to order non-standard laminate OLL at an additional processing fee, plus the cost of the laminate.

High-Pressure Laminate pricing does not include premium or digitally printed patterns from any suppliers. Laminate cost may also vary for basic or standard laminates from other suppliers. Please contact the OLL consultant at 616.475.2426 for pricing. The cost of the laminate will be added to your invoice as a separate line on the acknowledgement.

When processing orders for Open Line laminate on Everwall skins, specify 2900 in the laminate finish field and enter the OLL manufacturer information. Enter the required edge finish as you would a standard laminate.

**Laminate Approval and Material Requirements**

To confirm whether a particular laminate has already been tested for use on a specific Steelcase product or to determine material square requirements: Visit [www.steelcase.com](http://www.steelcase.com)

**For additional information,** refer to the *Steelcase Surface Materials Reference Manual*.

**Glass****Steelcase Surfaces**

Applies to:

- Unitized glass panel
- Glass kit
- Structural frame - clerestory

**Price Group 1**

|      |             |
|------|-------------|
| 6500 | Clear Glass |
|------|-------------|

**Price Group 2**

|      |                 |
|------|-----------------|
| 6540 | Clear Laminated |
| 6541 | White Laminated |

**Price Group 3**

|      |                |
|------|----------------|
| 6501 | Low Iron Clear |
| 6542 | Satin          |

**Price Group 7**

|      |                          |
|------|--------------------------|
| 6504 | Low Iron Clear Laminated |
|------|--------------------------|

**Plated Metal****Steelcase Surfaces**

Applies to:

- Push/pull handle
  - Hinges
  - Roller latch
  - Latchset
  - Wall stops
  - Floor stops
  - Ladder pulls
- |      |                   |
|------|-------------------|
| 4710 | Low Gloss Black   |
| 8031 | Brushed Stainless |
| 9200 | Satin Chrome      |
| 9201 | Polished Chrome   |

**Vertical Surface Fabric****Steelcase Surfaces**

Applies to:

- Solid steel skins

**Price Group 1****Abacus **E****

|      |          |
|------|----------|
| P123 | Portico  |
| P124 | Opus     |
| P125 | Cusp     |
| P126 | Artifact |

**Boccie**

|      |               |
|------|---------------|
| P200 | New Rice      |
| P201 | New Almond    |
| P203 | New Camel     |
| P204 | New Opal      |
| P205 | New Mist      |
| P206 | New Plum      |
| P208 | New Spearmint |
| P209 | New Sky       |

**Buzz2**

|      |              |
|------|--------------|
| 5F03 | Tomato       |
| 5F04 | Red <b>E</b> |
| 5F05 | Burgundy     |
| 5F06 | Sky <b>E</b> |
| 5F07 | Blue         |
| 5F08 | Navy         |
| 5F15 | Stone        |
| 5F16 | Grey         |
| 5F17 | Black        |
| 5G50 | Dunegrass    |
| 5G51 | Sable        |
| 5G55 | Pumpkin      |
| 5G57 | Rouge        |
| 5G59 | Meadow       |
| 5G61 | Cyan         |
| 5G62 | Atlantic     |
| 5G63 | Crocus       |
| 5G64 | Alpine       |
| 5G65 | Tornado      |

**Charm**

|      |          |
|------|----------|
| P505 | Shell    |
| P506 | Mimosa   |
| P507 | Birch    |
| P508 | Sparkle  |
| P510 | Debut    |
| P511 | Clover   |
| P513 | Twilight |

**E** = Established

**Optic**

- P540 Hazel
- P541 Twinkle
- P542 Orion
- P543 Seaglass
- P546 Whiskey
- P547 Bath
- P548 Whisper
- P549 Breezy
- P551 Glimmer

**Rhythm**

- P555 Allegro
- P556 Tempo
- P557 Refrain
- P558 Pitch
- P559 Harmony **E**
- P560 Melody
- P561 Stanza
- P562 Opus

**Tinsel**

- P516 Lit
- P517 Ego
- P518 Fizz
- P519 Muse
- P520 Depth
- P521 Bliss
- P522 Grow
- P523 Dolce

**Price Group 2**

**Bariolage**

- G200 New Etude
- G201 New Andante **E**
- G202 New Cantata **E**
- G203 New Adagio
- G204 New Melody
- G205 New Ballata

**Code**

- 5FA1 Fossil
- 5FA2 Gabbro
- 5FA3 Reed
- 5FA4 Bluff
- 5FA5 Sea Salt
- 5FA6 Cannon
- 5FA7 Tussah
- 5FA8 Mica
- 5FA9 Ecrú
- 5FB1 Bamboo

**Fresco**

- G001 Sandrift
- G002 Mistiblu
- G003 Faon
- G006 Chamoline
- G007 Grapenut **E**
- G017 Flint **E**

**E** = Established

**Intersection**

- P211 Summit
- P212 Chalk
- P213 Lace
- P214 Sea Salt
- P215 Lagoon
- P216 Electric Indigo
- P217 Indigo
- P218 Jungle
- P219 Green Citrine
- P220 Olivine
- P221 Rose Quartz
- P222 Mulberry
- P223 Tango
- P224 Scarlet
- P225 Saffron
- P226 Mousse

**Latch**

- P600 Seashell
- P601 Clam
- P602 Eggshell
- P603 Zen
- P604 Cool Gray
- P605 Armor
- P606 Sentinel
- P607 Rye
- P608 Billow
- P609 Nimbus

**Stencil**

- P455 Midnight
- P456 Mulberry
- P457 Cracked Pepper
- P458 Denim
- P459 Chartreuse
- P460 Bittersweet
- P461 Mauvelous
- P462 Bermuda
- P463 Concrete
- P464 Orchid
- P465 Parchment
- P466 Silk
- P467 Sea Salt
- P468 Honeydew
- P469 Sepia

**Select Surfaces**

**For information on products within Select Surfaces**, including accent paints and fabrics from DesignTex, Gabriel, Kvadrat, and Pollack, please refer to the *Surface Materials Reference Manual* or visit [steelcase.com/surface-materials](http://steelcase.com/surface-materials) under the Select Surfaces section.

**Custom Surfaces**

**Price Group COM (Customer's Own Material)**

**Fabric Approval and Yardage**

To confirm whether a particular COM material has already been tested for use on a specific Steelcase product or to determine actual yardage requirements:

- Visit [www.steelcase.com](http://www.steelcase.com)

**For additional information regarding Customer's Own Material**, call 1.888.STEELCASE (1.888.783.3522) or send an e-mail to [lineone@steelcase.com](mailto:lineone@steelcase.com).

**Wood**

Applies to:

- Door leaf

Steelcase carefully selects veneer and solid wood for consistent color and grain structure. Wood is a natural material and variations will occur in color, grain, and texture. These variations are part of the inherent natural beauty of wood and are not considered defects.

All wood products will darken with age and exposure to ultraviolet light. This is especially apparent with cherry and maple veneer. We recommend that desk accessories be rearranged periodically to ensure even aging of wood surfaces.

When storing your wood furniture, please follow the following guidelines:

- Do not store products in trailers
- Store products in areas that simulate office temperatures (60°F to 90°F)
- Store products in areas that maintain constant, office-like humidity levels
- Keep product away from light. Cover products to make sure they are not exposed to light.

**Steelcase Surfaces**

**Veneers** are matched for proper balance and consistency. Veneers are available flat cut or quarter cut, except for Oak, which is rift cut. Refer to the *Surface Materials Reference Manual* for descriptions of each cut.

**Open-pore finish** is a medium gloss finish that leaves the wood grain texture visible to the eye and distinguishable to the touch.

**Veneer**

**Wood Group 1**

**Flat-Cut Open-Pore**

- 3062 FC/OP Graphite Walnut
- 3402 FC/OP Clear Cherry (Aged)
- 3412 FC/OP Natural Cherry **E**
- 3422 FC/OP Medium Cherry
- 3522 FC/OP Clear Maple
- 3592 FC/OP Blonde on Maple **E**
- 3702 FC/OP Clear Walnut
- 3712 FC/OP Natural Walnut
- 3752 FC/OP Medium Walnut **E**
- 3762 FC/OP Dark Walnut
- 3772 FC/OP Medium Mahogany on Walnut

**Flat-Cut Open-Pore, Natural Veneer**

- 3342 FC/OP Black Walnut
- 35A2 FC/OP Blanch Maple
- 37A2 FC/OP Thunder Walnut

**Quarter-Cut Open-Pore**

- 3042 QC/OP Ash
- 3222 QC/OP Clear Maple
- 3292 QC/OP Blonde on Maple **E**

**Quarter-Cut Open-Pore, Natural Veneer**

- 32A2 QC/OP Blanch Maple
- 33A2 QC/OP Thunder Walnut
- 3392 QC/OP Black Walnut

**Rift-Cut Open-Pore**

- 3602 RC/OP Desert Oak

**Rift-Cut Full-Fill, Natural Veneer**

- 36A2 RC/OP Volcanic Oak

**Wood Group 3**

**Flat-Cut Open-Pore, Natural Veneer**

- 3082 FC/OP Washed Walnut

**Wood Group 1**

**Open-Pore Planked Veneer**

- 3P41 OP Planked Cherry
- 3P51 OP Planked Maple
- 3P61 OP Planked Oak
- 3P71 OP Planked Walnut
- 3VFX OP Unmarked Oak

*Tip: Known for its uniqueness, planked veneer has intentional and natural variations that include, but are not limited to: character marks, grain pattern, color, and natural color aging.*

**Premium Veneers**

A selection of Premium veneers in this collection are available on most Steelcase brand products. The collection will be available as close to standard leadtimes as possible. However, because adequate supplies of veneer and solids must be secured, all orders will be scheduled individually. Leadtimes will vary based on Premium veneer and Premium solids availability at the time the order is placed. The collection is available as Wood Group 3, as part of our Select Surfaces program and supported like standard veneers to make ordering easy. Please see the Steelcase surface materials section on [village.steelcase.com](http://village.steelcase.com) for sample information and product line availability. All premium veneers are in clear-coat.

**Wood Group 3**

**Quarter-Cut Open-Pore**

- 3832 QC/OP Figured Anigre

## Select Surfaces

For information on products within Select Surfaces, including accent paints and fabrics from Designtex, Gabriel, Kvadrat, and Pollack, please refer to the *Surface Materials Reference Manual* or visit [steelcase.com/surface-materials](http://steelcase.com/surface-materials) under the Select Surfaces section.

## Composite Veneer

Composite veneers are an engineered wood intended to create specific grain patterns and characteristics. They are pre-stained and finished with Steelcase's Clarity water-borne UV topcoat, which protects the environment while providing durability and clarity. Only open-pore finishes are available on composite wood. Composite veneer and matching edge bands are available on most Steelcase brand products. Composites, for use as a solid nosing substitute, are not available. Steelcase does not recommend mixing composite veneers with natural solid nosings because composite and natural wood grain and color matching are rarely compatible. Composite veneers are available as Wood Group 1 pricing as part of our Select Surfaces program.

## Wood Group 1

### Flat-Cut Open-Pore

3JDX FC/OP Oak  
Composite  
3JJX FC/OP Walnut  
Composite

### Quarter-Cut Open-Pore

3F8X QC/OP European  
Walnut Composite  
3GGX QC/OP Zebrano  
Composite  
3HGX QC/OP Oak  
Composite  
3HVX QC/OP Walnut  
Composite  
3ZNX QC/OP Night  
Cerused Oak  
Composite

**E** = Established

## Custom Surfaces

**Customiz stain** is a service that allows you to create your own stain colors and finishes on standard veneer. Customiz stain color is available on all product lines that offer wood veneer.

A \$500 stain-matching fee applies on CUSTOMIZ requests (Exception: The \$500 fee does not apply on matches to Coalesse standard finishes or for a low-gloss finish request on a standard color). The \$500 fee covers the cost of formulating the Customiz color finish and applies regardless of whether or not an order for product is placed.

In addition, an approval form must be signed to indicate customer acceptance of Customiz match. A \$1,500 initiation fee will be charged prior to first order entry. This initiation fee activates the finish for unlimited use on any Steelcase product for an 18 month time period. After the 18 month time period has lapsed, the Customiz finish may be reactivated for another 18 months for a \$1,000 fee at any point within five years after the \$1,500 initiation was paid. If the finish is not reactivated within five years after the \$1,500 initiation fee was paid, the finish will be culled and the customer will need to pay the \$1,500 initiation fee again. All style number related Customiz charges products are no cost as of April 2014. The matching and initiation fee are not discountable.

Customiz stain takes 10 days to formulate. Consult the *Surface Materials Reference Manual* for more information. Custom veneers are also available and must be quoted by Steelcase specials group. Customiz stain on custom veneers takes 2 to 4 weeks to formulate.

Requirements and information on ordering a Customiz stain color are found in the *Surface Materials Reference Manual*.



---

# Resources

**Style Number Index**

**142**

# Style Number Index

| Style Number     | Page | Description                                 |
|------------------|------|---------------------------------------------|
| <b>NEAHSL</b>    | 110  | Everwall, Slider Door Hardware              |
| <b>NEAHSW</b>    | 106  | Everwall, Swing Door Hardware               |
| <b>NEASSL</b>    | 89   | Everwall, Skin, Acoustic Product            |
| <b>NEASSS</b>    | 89   | Everwall, Skin, Acoustic Product            |
| <b>NEB</b>       | 119  | Everwall, Bypass                            |
| <b>NECF</b>      | 77   | Everwall, Ceiling Fastener                  |
| <b>NECTS</b>     | 74   | Everwall, Ceiling Track                     |
| <b>NEDDFS</b>    | 100  | Everwall, Swing Door Hardware               |
| <b>NEDFSL</b>    | 107  | Everwall, Slider Door Frame                 |
| <b>NEDFSWS</b>   | 96   | Everwall, Swing Door Frame                  |
| <b>NEDHCL</b>    | 100  | Everwall, Swing Door Hardware               |
| <b>NEDHLPA</b>   | 112  | Everwall, Door Pull                         |
| <b>NEDHLPO</b>   | 113  | Everwall, Door Pull                         |
| <b>NEDHML</b>    | 101  | Everwall, Swing Door Hardware               |
| <b>NEDHPPH</b>   | 113  | Everwall, Door Pull                         |
| <b>NEDHSSL</b>   | 111  | Everwall, Slider Door Hardware              |
| <b>NEDLSLPE</b>  | 108  | Everwall, Slider Door Leaf, Polished Edge   |
| <b>NEDLSLWPE</b> | 99   | Everwall, Slider Door Leaf, Polished Edge   |
| <b>NEDLSWS</b>   | 97   | Everwall, Swing Door Leaf, Solid            |
| <b>NEDMWS</b>    | 101  | Everwall, Swing Door Hardware               |
| <b>NEDSBS</b>    | 102  | Everwall, Swing Door Hardware               |
| <b>NEDTSL</b>    | 109  | Everwall, Slider Door Track                 |
| <b>NEEAM</b>     | 126  | Everwall, Mini End and Wall Start           |
| <b>NEECA</b>     | 120  | Everwall, 90° Cutable End Assembly          |
| <b>NEECAI</b>    | 124  | Everwall, Cutable End Corner Angle          |
| <b>NEEECT</b>    | 123  | Everwall, Cutable End Capture Trim          |
| <b>NEECEEO</b>   | 125  | Everwall, Cutable End Elbow                 |
| <b>NEECEI</b>    | 121  | Everwall, 90° Cutable End Inner Channel     |
| <b>NEECEO</b>    | 122  | Everwall, 90° Cutable End Outer Channel     |
| <b>NEESB</b>     | 80   | Everwall, EE Strg Brckt                     |
| <b>NEESBO</b>    | 80   | Everwall, EE Org and Open Shelf Brkt        |
| <b>NEFC</b>      | 76   | Everwall, Frame Coupler                     |
| <b>NEFCS</b>     | 81   | Everwall, French Cleat Support              |
| <b>NEFEA</b>     | 116  | Everwall, Finished End                      |
| <b>NEFG</b>      | 78   | Everwall, Floor Guide                       |
| <b>NEFK</b>      | 94   | Everwall, Frame Kit                         |
| <b>NEGK</b>      | 95   | Everwall, Glass Kit                         |
| <b>NEGTC</b>     | 95   | Everwall, Glazing Tape – Clear              |
| <b>NEIA</b>      | 116  | Everwall, 90° T/X Adapter                   |
| <b>NEMH</b>      | 79   | Everwall, Monitor Support Horizontal        |
| <b>NEP2</b>      | 114  | Everwall, Post                              |
| <b>NEP3</b>      | 114  | Everwall, Post                              |
| <b>NEP4</b>      | 115  | Everwall, Post                              |
| <b>NEPB</b>      | 130  | Everwall, Power Block                       |
| <b>NEPFC</b>     | 129  | Everwall, Modular Communication Faceplate   |
| <b>NEPHN8</b>    | 131  | Everwall, Modular Harness                   |
| <b>NEPHNC</b>    | 132  | Everwall, Harness-to-Harness Branching Conn |
| <b>NEPIMP8</b>   | 130  | Everwall, Multipurpose Infeed               |
| <b>NEPBESH</b>   | 133  | Everwall, Electrical Mounting Bracket       |
| <b>NEPBESM</b>   | 133  | Everwall, Electrical Mounting Bracket       |
| <b>NEPBEBU</b>   | 133  | Everwall, Electrical Mounting Bracket       |
| <b>NEPRC</b>     | 127  | Everwall, Receptacle                        |
| <b>NEPRCUSB</b>  | 128  | Everwall, USB Receptacle                    |
| <b>NEPRT</b>     | 128  | Everwall, Power Receptacle Trim             |
| <b>NERBKVOFM</b> | 80   | Everwall, Univ Vertical Off Mod Brkt        |

| Style Number         | Page | Description                                 |
|----------------------|------|---------------------------------------------|
| <b>NESC</b>          | 87   | Everwall, Solid Ceramic Skin - Markerboard  |
| <b>NESESTK</b>       | 105  | Everwall, Electric Strike                   |
| <b>NESEFC</b>        | 93   | Everwall, Structural Frame - Clerestory     |
| <b>NESEFS</b>        | 75   | Everwall, Structural Frame                  |
| <b>NESEA</b>         | 89   | Everwall, Acoustic Insulation               |
| <b>NESLDHDS</b>      | 111  | Everwall, Slider Door Hardware-Drop Seal    |
| <b>NESLSH</b>        | 110  | Everwall, Drop Seal Housing                 |
| <b>NESSB</b>         | 88   | Everwall, Solid Skin Bracket                |
| <b>NESSC</b>         | 88   | Everwall, Solid Skin Latch                  |
| <b>NESSF</b>         | 84   | Everwall, Solid Skin                        |
| <b>NESSFS</b>        | 85   | Everwall, Solid Steel Skin                  |
| <b>NESSL</b>         | 82   | Everwall, Solid Skin                        |
| <b>NESSLM</b>        | 83   | Everwall, Solid Skin - Laminate Markerboard |
| <b>NESSPS</b>        | 86   | Everwall, Solid Steel Skin                  |
| <b>NESSS</b>         | 88   | Everwall, Solid Skin Screw                  |
| <b>NESWDHBH</b>      | 103  | Everwall, Butt Hinge                        |
| <b>NESWDHCLSR</b>    | 104  | Everwall, Door Closer                       |
| <b>NESWDHELECHNG</b> | 104  | Everwall, Electric Hinge                    |
| <b>NESWDHRL</b>      | 104  | Everwall, Roller Latch                      |
| <b>NESWDHSH</b>      | 103  | Everwall, Slimline Hinge                    |
| <b>NESWDSA</b>       | 105  | Everwall, Drop Seal Assembly                |
| <b>NEUGP</b>         | 91   | Everwall, Unitized Glass Panel              |
| <b>NEUP</b>          | 117  | Everwall, Utility Panel, Frame              |
| <b>NEUPC</b>         | 118  | Everwall, Utility Panel, Cover              |
| <b>NEUSB</b>         | 80   | Everwall, Universal Storage Bracket         |
| <b>NEWS</b>          | 126  | Everwall, Wall Start                        |





# Trademark List

® The following are registered trademarks for products of Steelcase Inc. or one of its related corporate entities: 4 o'clock, 900 Series, à la carte, Airtouch, Ally, Amia, Answer, Archipelago, Avenir, Ballet, Bix, Brayton International, Cachet, Canopy, Canto, Chancellor, Coalesse, Confidante, Context, Convene, CopyCam, Criterion, Crushed Can, Currency, dash, Designtex, Details, Detour, Drive, Elective Elements, Ellipse, Ember Chrome, Emerge, E-Table 2, FYI, Garland, Gentry, Ginkgo Biloba, Groupwork, Ideo, Jacket, Jenny, Jersey, Kart, Kick, LaCosta, Leap, LessThanFive, Let's B, LiveBack, Max-Stacker, media:scape, Metro, Migrations, Mitra, Montage, Nurture, Oriana, Parade, Pathways, PCT, Permiso, Player, Portal, Power Pincher, Progeny, Protégé, R2, Rally, Relevant, Reply, Rizzi Arc, Sensor, Series 9000, Siento, Sieste, Sine, Softcare, Springboard, Steelcase, Steelcase Design Partnership, Stella, Stow Davis, Swathmore, Sylvi, TeamWork, Technique, Texpress, Think, Thunder, Topo, Train, turnstone, Underline, Unison, Vecta, Viridian, Walden, Werndl, and X-Stack.

® The following registered trademarks are under license from AWI Licensing Company, Dover, DE: SoundScapes, DuraBrite, BioBlock, and Armstrong.

® The following registered trademarks are under license from Byrne Electrical, Rockford, MI: Interport, Mini-Port, Axil Z, and Ellora.

® The following is a registered trademark of DuPont, Wilmington, DE: Corian.

® The following is a registered trademark of Genlyte Thomas Company, Louisville, KY: Lightolier.

® The following is a registered trademark of Hilti Corporation, FL-9494 Schaan, Principality of Liechtenstein: Hilti.

® The following is a registered trademark of Leviton Manufacturing Company, Little Neck, NY: Decora.

® The following is a registered trademark of Mechanical Plastics Corp, Elmsford, NY: Toggler.

® The following is a registered trademark of Microsoft Corporation, Redmond, WA: Microsoft.

® The following are registered trademarks of Orangebox Ltd., Cardiff, UK: Orangebox.

® The following is a registered trademark of Panduit Corporation, Lockport, IL: Panduit.

® The following is a registered trademark of Trav (Press), Cuneo, Italy: Assisa.

® The following is a registered trademark of Virtual Ink, Boston, MA: mimioActive.

® The following registered trademarks are under license from Wilkhahn Furniture Products: Avera, Senzo, Versal, and Wilkhahn FS.

® The following are registered trademarks of Polyvision Corp: Flow, Motif, Polyvision, Sans, and Serif.

® The following is a registered trademark of Wilsonart International, Temple, TX: Chemsurf.

® The following is a registered trademark of Wiremold, West Hartford, CT: Wiremold.

® The following is a registered trademark of EMU Group S.P.A., Perugia, Italy: EMU.

® The following is a registered trademark of Security People, Inc.: Digilock.

® The following are registered trademarks of Natural Capital Partners Europe Limited: CarbonNeutral and the CarbonNeutral Certified logo.

™ The following are trademarks for products of Steelcase Inc. or one of its related corporate entities: Access, Active/Passive Shelf, Agree, Ainsley, Akira, Alcove, Alerion, Alight, Amaris, American Elect, American Tradition, ap40, Arbor, Arriva, Asana, Ascot, Aspekt, Astor, Await, Bassline, B-Free, Bira, Bivi, Bixby, Bottomline, Brody, Brook, Buoy, Burton, c:scape, Calla, Calm, Camber, Campfire, Capa, Cappuccino, Cesar, Chester, Chord, Circa, Clarendon, Classic Rectangular, Clipper, cobl, Collaboration, Community, Company, Convey, Cortex, Coupe, Crea, Crew, Cura, Cypress, Davenport, Dearborn, Deck, Déjà, Denizen, Denska, Derby, DeskWizard, Divisio, Donovan, Dune, Duo, Echo, Edge, Elbrook, Elsa, Empath, Empress, Enea, ño, EnSync, Enviro, Escapade, Everwall, Exchange, Exponents, Field, Flat Top, FlexFrame, Flip Top, Flute, Folio, FrameOne, FreeFlow, Frontier, Galilei, Gesture, Ginger, Ginkgo, Go Wall, Grip, Groove, Hatchback, Hawthorne, Hitch, Host Collection, Hosu, Huddleboard, i2i, Impact, Indy, InfoLink, IOS, I-Solve, Jack, Jarrah, Jetty, Juice, Kami, Kast, Kathryn, Lagunitas, Lark, L'Attitude, LearnLab, Leela, Lincoln, Linden, LiveSeat, Loria, Lyric, Malibu, Malibu Too, Mansfield, Marathon, Marien152, Martini, Mason, Masque, Migration, Millbrae, Mineral, Mingle, Mystic, Mystic Metal, Mystic Wood, Montara650, Montreal, MoreThanFive, Move, Nadia, Neighbor, nesso, Nickel, Nikko, Nod, Node, Norfolk, Ocular, Ology, Ontrak, Oom, Opus, Orchid, Outlook Collection, Ovation, Paloma, Paperflo, Parliament, Pasio, Passerelle, Patriarch, Payback, Peek, Pile File, Pisa, Pool, Potrero415, PUCK, QiVi, Quba, Rave, Reed, Regard, Relay, Reunion, Ripple, Riser, Roam, Rocco, Rocky, RoomWizard, Runner, Satellite, Sawyer, ScapeSeries, Senti, Sentinel, Senza, Sequoia, Session, ShareLink, Shield, Shortcut, Sidewalk, SILQ, Skylar, Slumber, Smoke, Snug, Soft Leaf, Sonata, Sorrel, SOTO, Southside, Stationkits, Steelcase Karman, Steelcase Series, Stiletto, Surprise!, Surround, Switch, Symphony, Sync, TagWizard, Tava, TeamStudio, TeamTheater, Tenaro, Tenor, Terrazzo, Theorem, Thread, Topaz, Touchdown, Tour, Tower Too, Trees, Trillium, Trolley, tX2, U-Free, Umami, Underscore, Uno, V.I.A., Verb, Verge, Verlay, Victor2, Visalia, Waldorf, Woodruff, Workspring, WorkValet and X-tenz.

™ The following is a trademark of Microsoft Corporation, Redmond, WA: Windows.

™ The following is a trademark of Rodman Industries, Inc., Oconomowoc, WI: ResinCore1.

™ The following is a trademark of Ultrafabrics, LLC, Elmsford, NY: Ultraleather.

™ The following trademarks are under license from Wilkhahn Furniture products: Cana, Linus, Logon, Picto, Range, Stitz, Thema, Timetable, and Tubis.

™ The following is a trademark of Cradle to Cradle Products Innovation Institute, Oakland, CA: Cradle to Cradle Certified.

™ The following trademarks are under license from Walter Knoll: Andoo, Bob, Lazlo, Lox, Ribbon, and Together.

™ The following trademarks are under license from PP Møbler: Bar and Flag Halyard.

™ The following trademarks are under license from Carl Hansen: Elbow, Paddle, Shell, Wing, and Wishbone.

™ The following trademarks are under license from Cambridge Sound Management, LLC, Cambridge, MA: QtPro Soundmasking, Qt Quiet Technology, and Sonet Qt.

™ The following is a trademark of Electri-Cable Assemblies, Shelton, CT: Interact.

™ The following is a trademark of Clestra Hauserman: IRYS.

™ The following is a trademark of Wiesner-Hager Möbel GmbH: Nooi.

™ The following are trademarks of Polyvision: Accord, a<sup>3</sup>, e<sup>3</sup>, Boundri, and Nota.

™ The following is a trademark of Bostock Company, Inc: SnapCab.

™ The following is a trademark of Williams-Sonoma, Inc: West Elm.

™ The following is a trademark of Elena Marquina Testor: nanimarquina.

™ The following is a trademark of Forbo International SA: Forbo.

™ The following are trademarks of Orangebox Ltd., Cardiff, UK: Air<sup>3</sup>, Aspect, Avi, Away from the Desk, Border, Campers & Dens, Coppice, Cubb, Kim, On the QT, Ramsey, Skomer, Sully, Track-B, and Vale.

™/® The following are trademarks or registered trademarks of AMQ Solutions, LLC: AMQ, AMQ logo, KINEX, ILINE, ACTIV, AMOBI, CONCUR, 3F, REVI, S-SERIES, JAKU, SIYA, ZILO, BODI, FL-X, TIZU, EMBANK, TEKTIS and BIXBY.

™/® The following are trademarks or registered trademarks of Viccarbe Habitat, S.L.: Holy Day, Last Minute, Wrapp, Foro, Kelly, Noha, Viable, Solar, Sistema, Savina, Designed In The Sun, Cambio, Aleta, Viccarbe (logo), Viccarbe.

*Trademarks used here in are the property of Steelcase Inc. or of their respective owners.*