

Understanding and Specifying Leap 462 Series Work Chairs

Work Chairs

Highly adjustable task seating offers maximum personalization for fit and comfort for a range of duration and use. By making a series of simple adjustments, you can customize the chair to your body, preferences, and tasks. These chairs provide continuous, stable, comfort, and can be quickly adjusted to support you in upright, and reclining work postures.

- Gesture 442 Series
- Leap 462 Series
- Think 465 Series
- Amia 482 Series
- Reply 466 Series
- Jersey Series
- Leap 464 Series WorkLounge
- Criterion 453 Series

Adjustability Features

► See page 30 for a comparison to other chairs.

	Leap 462 Series	Leap Plus
Mechanisms		
Natural glide	●	●
Seat Adjustments		
Pneumatic height	●	●
Passive seat edge angle	●	
Seat depth	●	●
Back Adjustments		
Lumbar height	●	●
Lower back firmness	●	●
Upper back tension	●	●
Variable back stop	●	●
Arm Adjustments		
Arm height	●	●
Arm width	●	●
Arm pivot	●	●
Arm depth	●	●
Other Features		
Foot ring height (stool)	●	

Product Details

Leap 462 Series	52
Leap Upholstery	55
Dimensions	56

Specifying

Work Chairs

Upholstery on Back and Seat	58
3D Knit on Back with Upholstery on Seat	62

Stools

Upholstery on Back and Seat	64
3D Knit on Back with Upholstery on Seat	68

Plus Work Chairs

Upholstery on Back and Seat	70
3D Knit on Back and Upholstery on Seat	74

Leap Coat Hanger

76

Leap 462 Series

Leap is a high-performance chair for customers who place the highest value on ergonomics, health, and productivity.

Outer back and outer seat are plastic.

LiveBack moves with the shape of the user's spine as sitting positions change.

Lumbar height adjusts 5" to provide additional lower back support. It is standard on all chairs, but may be omitted.

Arm height can adjust independently within a 4" range to help relieve upper back and shoulder fatigue.

Seat depth adjusts within a 3" range to accommodate users of varying leg lengths. Seat depth is standard on all models.

Five-arm base is available in plastic or polished aluminum.

Casters have hard, dual-wheels that roll smoothly on carpets. They are 2½" for increased mobility. Soft, dark grey treaded, dual-wheel roll-control casters are available for use on hard floors or mats. Stools are standard with 2" hard casters. Soft casters are available as an option.

Tip: Do not roll the chair across asphalt during installation as this may damage the casters.

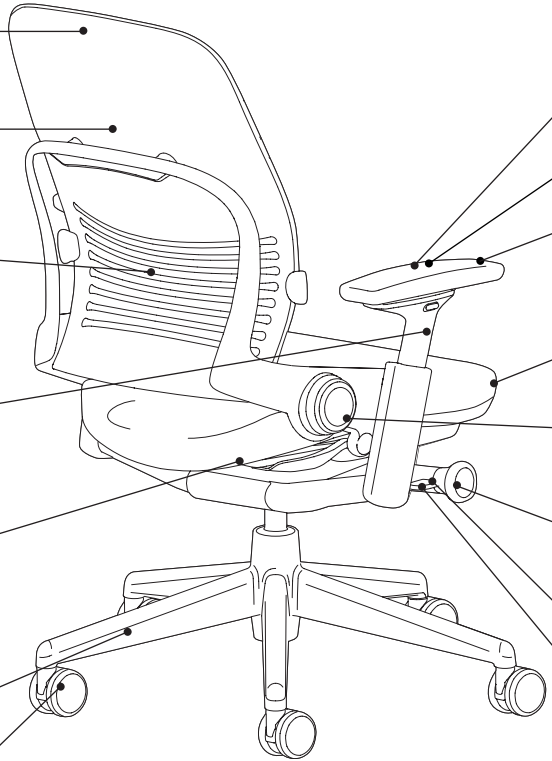

Arm depth can retract 3" to allow user to get closer to worksurface and into tight corners.

Arm width can adjust 4½" overall to provide forearm support.

Arm caps can pivot 30° in and out to accommodate individual user preferences.

Passive seat edge angle allows the front edge of the seat to flex 1½" to relieve pressure under the user's thighs.

Lower back firmness changes the amount of firmness user feels in lower back. Requires only two complete turns.

Upper back force requires only five complete turns and accommodates a broader range of users by allowing user to change the rate of increase in force as the user reclines.

Variable back stop with five positions is standard.

Seat height adjusts within a 5" range with a pneumatic adjustment mechanism. A 7" range is available as an option. Stools have an 8" range.

Product Details

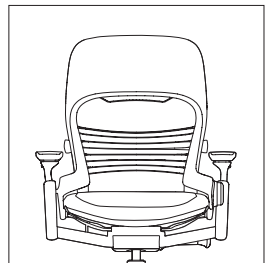

Parallel slats in the Live-Back shell provide extensive flexibility to allow back to conform to individual users.

Leap Plus offers the benefits and functionality of the standard Leap chair, including LiveBack Technology, to users weighing up to 500 pounds.

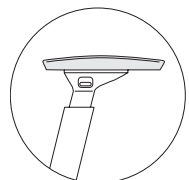

Rectilinear arms with soft caps are standard.

Models are standard with adjustable seats that include seat depth and passive seat edge angle.

Adjustability instructions are included with every chair. Fully adjustable arm models include instructions under the arm cap. Instructions can also be found at www.steelcase.com

Controls under the seat include tactile braille designers.

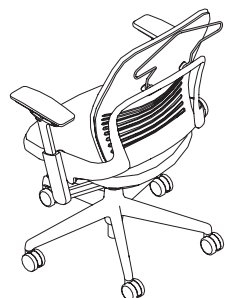

Coat hanger is field installed. It is offered in one finish, 0835 Black. The coat hanger supports up to 10 pounds and is not intended to hold bags or backpacks. The coat hanger cannot be used on stool models.

Cartoned request on your dealer purchase order means Leap chairs will ship knocked down with the chair base separated from the rest of the chair. This allows for shipment in a smaller carton. Assembly instructions are included. This does not apply to Leap stools, Leap Plus, or Leap WorkLounge.

Uncartoned request on your dealer purchase order means Leap chairs will ship fully assembled.

Product Weight

- Leap chair: 46.7 pounds
- Leap Plus chair: 60.2 pounds

Adjustment Features

Seat Adjustments

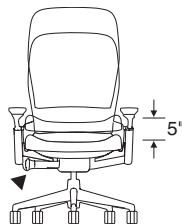

Seat height adjusts pneumatically. To lower, hold handle up while seated. To raise, hold handle up and keep your weight off the chair. Range of adjustability is 5", from 15½"H to 20½"H, and is standard on work chairs. A 7" range of adjustability (17"H to 24"H) is available as an option. Stools are standard with an 8" range of adjustability (22"H to 30"H). Leap Plus is standard with a 4" range of adjustability (15½"H to 19½"H). A 5" range (17½"H to 22½"H) is available as an option.

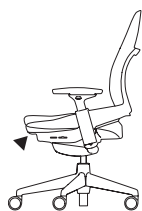

Passive seat edge angle flexes 1½", relieving pressure under the user's thighs. This feature is standard on all work chairs and stools.

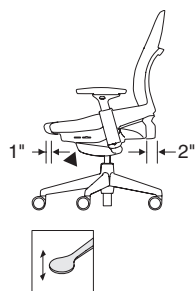

Seat depth adjusts 3" (15¾"-18¾") by pulling handle up. Slide seat forward or back to accommodate various leg lengths. Release handle to lock. This feature is standard on work chairs and stools. Seat depth adjustment range for Leap Plus is 2" (16¾"-18¾").

Back Adjustments

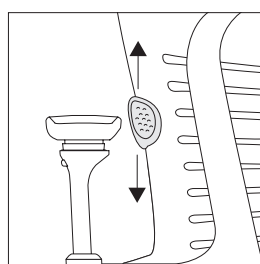

Lumbar height adjusts 5" (5¼" to 10¼" from seat, 6½" to 11½" on Plus chairs) by grabbing exposed tabs and sliding the lumbar support up or down. This feature is standard on work chairs and stools, but may be omitted.

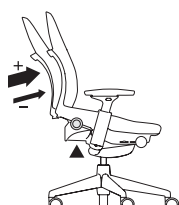

Lower back firmness adjusts by turning knob two complete turns. Forward increases firmness. Backward decreases firmness. This feature is standard on work chairs and stools.

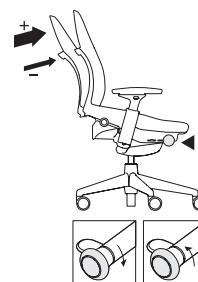

Upper back force adjusts by turning knob five complete turns. Turn knob forward to increase rate of tension; backward to decrease. This feature is standard on work chairs and stools.

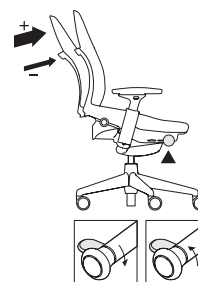

Variable back stop. Rotate handle up or down to set recline angle. Lean back to desired back angle. Five stops are available. This feature is standard on work chairs and stools. *Tip: To stop in upright position, remove weight from back and rotate lever up.*

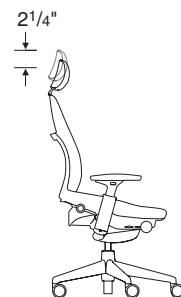

Headrest (option) adjusts 2¼" vertically and adds 6¾" to 9" to the overall height. Plastic shell on the headrest is available in black only. Upholstery is available to match the seat material or black vinyl only. Headrest is not available on stools, Plus models, or when the fire code option (FCS) is selected.

Arm Adjustments

Rectilinear height-, width-, pivot-, and depth-adjustable arms come standard on all arm models of chairs and stools.

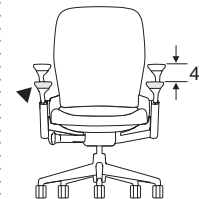

Arm height adjusts independently within a range of 4" (7"-11" from the seat, 7¼"-11¼" on Plus models). Push button on outside and under arm cap in while moving arms up or down. Releasing buttons locks arms in position.

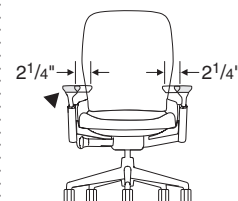

Arm width adjusts 2¼" each independently on chairs with this option. Grasp arm and move in or out.

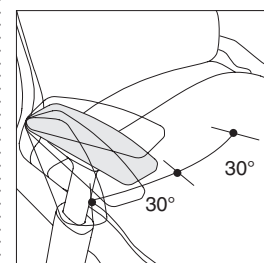

Arms pivot independently 30° inward and outward. Grasp arm and push front to left or right.

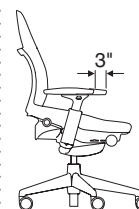

Arm depth adjusts approximately 3" to enable user to get closer to worksurface.

Leap 462 Series

Leap 462 Series, continued

Other Features

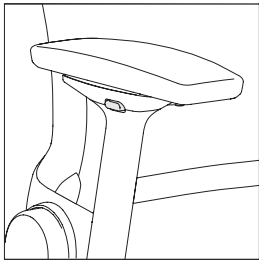

Height-only adjustable arm is also available and adjusts 4".



Armless models are also available.

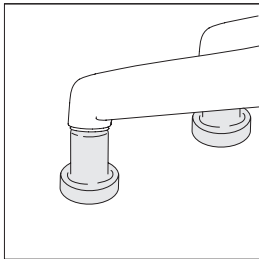

Glides are available as an option, except on chairs with polished aluminum package. Glides ship with chair or stool for field installation and maintain same height as casters.

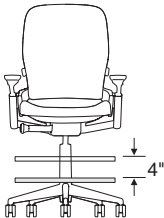

Foot ring height on stools adjusts by first lifting ring and rotating it counter-clockwise to unlock. Then raise or lower ring up to 4" to desired position before rotating it clockwise to lock.

Soft-wheel casters for hard floors are available for specific applications.

▶ See surface materials on page 780 for specific availability or refer to the *Surface Materials Reference Manual* for further information.

Upholstery

- Fabric
- Fabric with soil-retardant treatment (option)
- 3D Knit (back only)
- Leather
- Elmosoft leather
- Select Surfaces leather
- Vinyl
- COM
- COL

Hard components

- (ribbon back frame, outer back, arm retainer, and base)
- 6205 Black
 - 6249 Platinum
 - 6259 Midnight

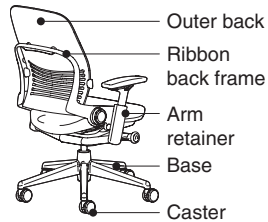

Polished aluminum package is available on black chairs only. Polished aluminum is applied to ribbon back frame, base, and casters. Stools and Plus models are not available with this package.

Arms

- Black only

Column and foot ring on stools

- 7207 Black only

Coat hanger

- 0835 Black

All Steelcase seating with standard upholstery fabrics complies with requirements of the State of California Technical Bulletin 117-2013. All standard seating is labeled to be in compliance with California 117-2013.

Programs & Services

▶ See the *Surface Materials Reference Manual* for further detail about programs and services offered for seating.

The Customer's Own Material (COM) Program

offers the opportunity for customers to select fabrics that are not offered through the standard Steelcase surface materials program for use on Steelcase products. Through the COM program, Steelcase will test your materials for application on Steelcase products. Once approved, you can place your order. Steelcase will facilitate the entire ordering process and give you a production schedule.

Steelcase will order the COM fabric directly from the textile manufacturer. For up-to-date information regarding fabric test results for all COM fabrics and details regarding yardage requirements for most Seating lines, visit the COM website. To locate the COM website:

- Visit www.steelcase.com

Soil retardants are treatments that provide long-term soil and stain resistance to a fabric without affecting the shade or the integrity of the fabric. The following Steelcase Textiles are available pre-treated with soil retardant. (You do not need to select the soil-retardant option for these fabrics and incur the upcharge.)

- Jacks
- Link

For information on soil retardant fabrics on Select Surfaces, please refer to the *Surface Materials Reference Manual*.

Soil-retardant treatment is available on all other seating fabrics at an additional upcharge per seating unit. To order this option, please select "Soil-Retardant Treatment" under "Optional Accessories."

For soil-retardant treatment on COMs, please select "Soil-Retardant Treatment" under "Optional Accessories." Minimums or additional yardage may be required. Please contact the vendor directly for specific information.

Extended lead times may be necessary for this service.

Contact your Steelcase Solutions Fulfillment Team Representative at 1.888.STEELCASE (1.888.783.3522) or send an email to lineone@steelcase.com.

Fire Codes

▶ See page 804 for upholstery fabrics available for use with FCS modification.

Steelcase offers Fire Code Seating modification (FCS) on some seating models. The most rigorous fire codes in the nation have been developed in California, and the Steelcase FCS modification is designed to meet those codes. Fire Code Seating (FCS) indicates that a product is constructed to meet the strict fire code requirements of high public occupancy areas such as theaters, meeting rooms, and lobbies. The FCS standards will meet the State of California Bureau of Electronic and Appliance Repair, Home Furnishings, and Thermal Insulation Technical Bulletin 133 (Cal TB 133). Boston adopted the California Bureau of Electronic and Appliance Repair, Home Furnishings, and Thermal Insulation Technical Bulletin TB 133 test standard in 1992.

Local codes may have special requirements for upholstery.

Dimensions

▶ Page 56

Resources

Printed Materials

- ▶ Leap Brochure (11-0002334)
- ▶ Humantech Case Study (03-0003715)
- ▶ Leap Productivity and Health Impact Study (03-0003716)

Online Resources

- ▶ Interactive User Guide available on www.steelcase.com
- ▶ Leap mini-site (download) available on village.steelcase.com or viewable on www.steelcase.com.
- ▶ Model sales conversation available on village.steelcase.com
- ▶ Leap User Guide available on www.steelcase.com
- ▶ Adjustability video available on www.steelcase.com
- ▶ Leap White Paper Packet available on village.steelcase.com
- ▶ Product Environmental Profiles, which provide key environmental attributes and product certifications can be found by searching for Steelcase at *Origin.build*.

Leap Upholstery

What Is It?

Fabric, leather, or vinyl-covered back and seat, 3D Knit back.

Fabric

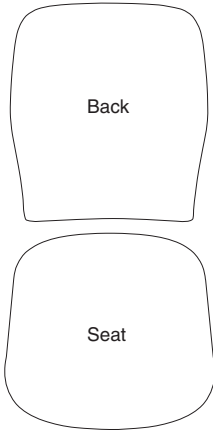

Leather, Vinyl, and Select Fabrics

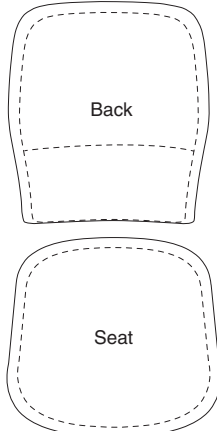

3D Knit Back

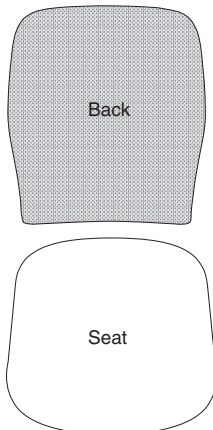

3D Knit back is made up of three layers: the 3D Knit, a solid fabric that matches the 3D Knit color, and the polyester cushion that provides exceptional comfort. The seat on these models can be specified with Cogent: Connect fabric colors to match the 3D Knit color, or in any other material.

Stitched seams are included on the back cushion and seat cushion of the following:

- Leather
- Customer's Own Leather (COL)
- Vinyl
- Select Customer's Own Material/Vinyl (COM)

Pattern alignment at the lumbar seam cannot be guaranteed.

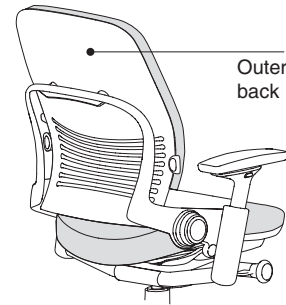

Plastic outer back is fully exposed.

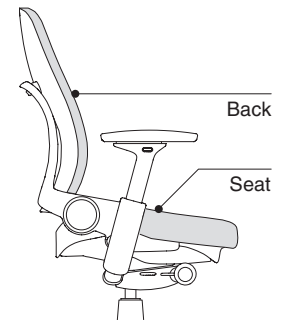

Seat and back cushions can be removed and replaced if damaged.

Dimensions

Leap 462 Series

Features	Overall Depth	Width	Height	Seat Depth	Functional Seat Depth	Seat Width	Seat Height from Floor	Ring Height from Floor	Back Width	Back Height from Seat
Leap 462 Series										
Work Chairs										
Adjustable Seat Depth	21 ³ / ₄ " to 24 ³ / ₄ "	27"	38 ¹ / ₂ " to 43 ¹ / ₂ "	19"	15 ³ / ₄ " to 18 ³ / ₄ "	19 ¹ / ₄ "	15 ¹ / ₂ " to 20 ¹ / ₂ "	N.A.	18"	25"
Stools										
Adjustable Seat Depth	21 ³ / ₄ " to 24 ³ / ₄ "	27"	46" to 54"	19"	15 ³ / ₄ " to 18 ³ / ₄ "	19 ¹ / ₄ "	22" to 30"	6" to 18"	18"	25"
Plus Work Chairs										
Adjustable Seat Depth	21 ³ / ₄ " to 24 ³ / ₄ "	31 ³ / ₄ "	38 ³ / ₄ " to 42 ¹ / ₂ "	20 ¹ / ₂ "	16 ³ / ₄ " to 18 ³ / ₄ "	22 ³ / ₄ "	15 ¹ / ₂ " to 19 ¹ / ₂ "	N.A.	20"	24 ¹ / ₂ "

Dimensions were measured with BIFMA CMD (chair-measuring device).

****Arm width adjustment for Leap** is 15"–20". Arm pivot adjustment adds 2¹/₄" to the minimum width providing a total of 12³/₄"–20" of width between the arms.

****Arm width adjustment for Leap Plus** is 19³/₄"–24³/₄". Arm pivot adjustment adds 2¹/₄" to the minimum width providing a total of 17¹/₂"–24³/₄" of width between the arms.

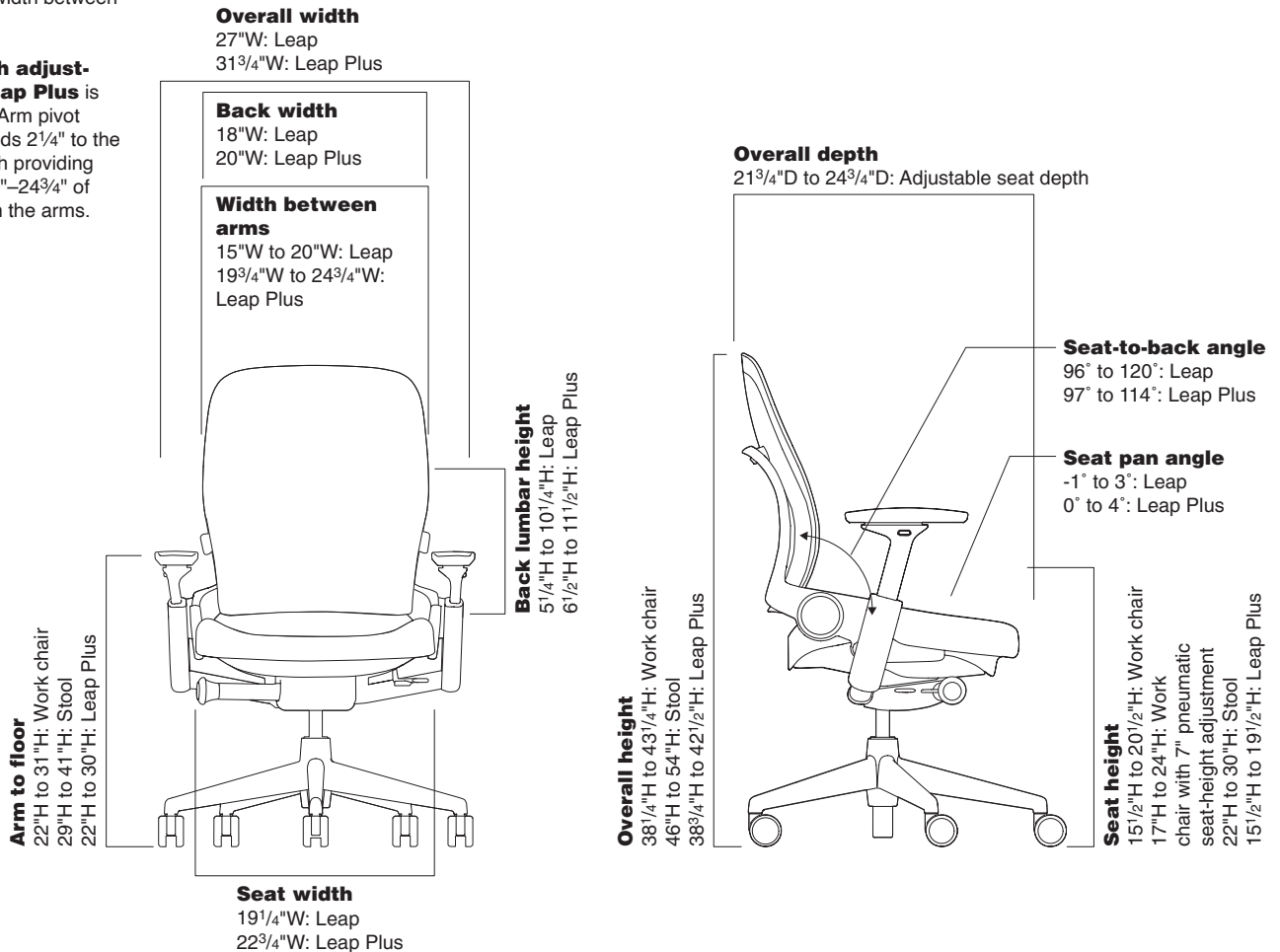

• Back Lumbar Height	• Lumbar Flex Zone	• Width Between Arms	• Arm to Floor	• Arm Height from Seat	• Arm Cap Pivot Range	• Seat Pan Angle	• Angle Between Seat and Back	• Headrest Height Adjustment Range
Work Chairs								
5¼" to 10¼"	5¼" to 10¼"	15" to 20"***	22" to 31"	7" to 11"	30°	-1° to 3°	96° to 120°	2¼"
Stools								
5¼" to 10¼"	5¼" to 10¼"	12¾" to 20"***	29" to 41"	7" to 11"	30°	-1° to 3°	96° to 120°	N.A.
Plus Work Chairs								
6½" to 11½"	11¼" to 16¼"	17½" to 24¾"***	22" to 30"	7¼" to 11¼"	30"	0° to 4°	97° to 114°	N.A.
:	:	:	:	:	:	:	:	:

Leap 462 Series

Leap 462 Series Work Chair

Upholstery on Back and Seat



Standard Includes	Required to Specify
-------------------	---------------------

- | | | |
|---|---|---|
| <ul style="list-style-type: none"> ▶ Need help? Product details, page 52 | <ul style="list-style-type: none"> • Upper back force • 5" pneumatic seat-height adjustment • Variable back stop • Lower back firmness • Rectilinear independent height-, width-, pivot-, and depth- adjustable arms and soft arm caps, if selected: black plastic • Frame, seat shell, outer back, and five-arm base: plastic • 3" seat depth adjustment • Passive seat edge angle • Adjustable lumbar • Standard upholstery design: fabric price group 1 • 2½"-diameter, hard-composition, dual-wheel casters: black | <ol style="list-style-type: none"> 1 Style number 2 Plastic color for frame, seat shell, outer back, and base 3 Fabric color number for upholstery on seat and back 4 Options, if selected (see below) <ul style="list-style-type: none"> ▶ See <i>Surface Materials</i>, page 780. |
|---|---|---|

Options	U.S. Price	Required to Specify
---------	------------	---------------------

Surface Materials	Upholstery on seat and back	
	<ul style="list-style-type: none"> • Fabric price group 1 No cost • Fabric price group 2 +\$ 37 • Fabric price group 3 +\$ 72 • Fabric price group 4 +\$ 100 • Fabric price group 5 +\$ 125 • Fabric price group 6 +\$ 154 • Fabric price group 7 +\$ 179 • Fabric price group 8 +\$ 223 • Fabric price group 9 +\$ 276 • Fabric price group 10 +\$ 312 • Steelcase leather upholstery +\$ 920 	Specify fabric color number. Specify fabric color number. Specify fabric color number. Specify fabric color number. Specify fabric color number. Specify fabric color number. Specify fabric color number. Specify fabric color number. Specify fabric color number. Add suffix S to the style number and specify leather color number. Add suffix S to the style number and specify Select Surfaces leather price group 1. ▶ See <i>Surface Materials Reference Manual</i> . Add suffix S to the style number and specify Elmosoft leather color number. Add suffix S to the style number and specify Select Surfaces leather price group 2. ▶ See <i>Surface Materials Reference Manual</i> . Add suffix S to the style number and specify vinyl color number. ▶ See <i>Surface Materials Reference Manual</i> to specify. Add suffix S to the style number and specify leather color number.
	<ul style="list-style-type: none"> • Select Surfaces leather price group 1 +\$ 920 • Elmosoft leather upholstery +\$1082 • Select Surfaces leather price group 2 +\$1082 • Steelcase vinyl +\$ 37 • Customer's Own Material (COM) No cost • Customer's Own Leather (COL) +\$ 404 	
	Sewn upholstery	
	<ul style="list-style-type: none"> • Sewn upholstery on chair +\$ 113 	Add suffix S to the style number.
	Contrasting upholstery on seat and back	
	<ul style="list-style-type: none"> • Contrasting fabrics +\$ 46 	Add suffix K to the style number and specify fabric color numbers.
	Contrasting upholstery on seat	
	<ul style="list-style-type: none"> • Fabric price group 1 No cost • Fabric price group 2 +\$ 21 • Fabric price group 3 +\$ 34 • Fabric price group 4 +\$ 48 • Fabric price group 5 +\$ 62 • Fabric price group 6 +\$ 77 • Fabric price group 7 +\$ 88 • Fabric price group 8 +\$ 111 • Fabric price group 9 +\$ 137 • Fabric price group 10 +\$ 154 	Specify fabric color number. Specify fabric color number. Specify fabric color number. Specify fabric color number. Specify fabric color number. Specify fabric color number. Specify fabric color number. Specify fabric color number. Specify fabric color number. Specify fabric color number.

Tip: Leather and vinyl upcharges are in addition to sewn upholstery upcharge.

Tip: Select COMs require sewn application with an additional upcharge. Specify with an **S** suffix.

Tip: Suffixes other than **K** for contrasting fabric, will be added in alphabetical order when specifying options. The contrasting fabric suffix, **K**, will always be at the end of the style number.

▶ Detailed dimensions, page 56



For Canadian Pricing
 Multiply U.S. Price by the Canadian price factor.
 ▶ See page 1 for details.

▶ Options, continued on next page

► Options, continued from previous page

	Options	U.S. Price	Required to Specify
Surface Materials, continued	Contrasting upholstery on seat, continued		
	• Steelcase leather upholstery	+\$460	Add suffix S to the style number and specify leather color number.
	• Select Surfaces leather price group 1	+\$460	Add suffix S to the style number and specify leather color number.
	• Elmosoft leather upholstery	+\$542	Add suffix S to the style number and specify leather color number.
	• Select Surfaces leather price group 2	+\$542	Add suffix S to the style number and specify leather color number.
	• Steelcase vinyl	+\$ 21	Add suffix S to the style number and specify vinyl color number.
	• Customer's Own Material (COM)	No cost	► See <i>Surface Materials Reference Manual</i> .
	• Customer's Own Leather (COL)	+\$202	Add suffix S to the style number and specify leather color number.
	Contrasting upholstery on back		
	• Fabric price group 1	No cost	Specify fabric color number.
• Fabric price group 2	+\$ 21	Specify fabric color number.	
• Fabric price group 3	+\$ 34	Specify fabric color number.	
• Fabric price group 4	+\$ 48	Specify fabric color number.	
• Fabric price group 5	+\$ 62	Specify fabric color number.	
• Fabric price group 6	+\$ 78	Specify fabric color number.	
• Fabric price group 7	+\$ 88	Specify fabric color number.	
• Fabric price group 8	+\$112	Specify fabric color number.	
• Fabric price group 9	+\$137	Specify fabric color number.	
• Fabric price group 10	+\$155	Specify fabric color number.	
• Steelcase leather upholstery	+\$460	Add suffix S to the style number and specify leather color number.	
• Select Surfaces leather price group 1	+\$460	Add suffix S to the style number and specify leather color number.	
• Elmosoft leather upholstery	+\$543	Add suffix S to the style number and specify leather color number.	
• Select Surfaces leather price group 2	+\$543	Add suffix S to the style number and specify leather color number.	
• Steelcase vinyl	+\$ 21	Add suffix S to the style number and specify vinyl color number.	
• Customer's Own Material (COM)	No cost	► See <i>Surface Materials Reference Manual</i> .	
• Customer's Own Leather (COL)	+\$204	Add suffix S to the style number and specify leather color number.	
Soil-retardant treatment		+\$ 36	Specify <i>with soil-retardant treatment</i> .
Fire Code Seating (FCS)		+\$113	Add suffix F to the style number.
Polished aluminum package		+\$691	Add suffix C to the style number.
• Polished aluminum package on chairs with arms and 6205 Black frame finish			
Platinum/Midnight		+\$ 65	Specify <i>with 6249 Platinum</i> or <i>with 6259 Midnight</i> .
• On frame, base, arm retainer, and outer back			
Arms	• Height-adjustable arms, soft arm caps	-\$132	Specify <i>with height-adjustable arms</i> .
	• Armless	-\$415	Specify <i>without arms</i> .
Seat Height	• 7" pneumatic seat-height adjustment	+\$ 85	Specify <i>with 7" pneumatic seat-height adjustment</i> .
Headrest	• Headrest	+\$340	Specify <i>with headrest</i> .
Lumbar	• Without lumbar	-\$ 84	Specify <i>without lumbar</i> .

► Options, continued on next page

Tip: Leather and vinyl upcharges are in addition to sewn upholstery upcharge.

Tip: Select COMs require sewn application with an additional upcharge. Specify with an **S** suffix.

Tip: Fire Code Seating (FCS) option is available with certain upholstery fabric choices only.
► Page 804

Tip: Fire Code Seating (FCS) option is available on Leap chairs with fully adjustable arms or armless models only.

Tip: Plastic shell on headrest is available in black only.

**For Canadian Pricing**

Multiply U.S. Price by the Canadian price factor.

► See page 1 for details.

Leap 462 Series Work Chair, Upholstery on Back and Seat, continued

► **Options, continued from previous page**

	Options	U.S. Price	Required to Specify
Casters	• Soft, dark grey treaded, dual-wheel roll-control casters for use on hard floors	+\$36	Specify <i>with soft roll-control casters</i> .
Glides	• Glides: plastic	+\$36	Specify <i>with glides</i> .

Tip: Glides are not available on chairs with polished aluminum package.

Specification Information



Style Number	U.S. Base Price
46216179	\$2222



For Canadian Pricing
 Multiply U.S. Price by the Canadian price factor.
 ► See page 1 for details.

Leap 462 Series Work Chair

3D Knit on Back with Upholstery on Seat



Standard Includes	Required to Specify
<p>▶ Need help? Product details, page 52</p> <ul style="list-style-type: none"> • Upper back force • 5" pneumatic seat-height adjustment • Variable back stop • Lower back firmness • Rectilinear independent height-, width-, pivot-, and depth- adjustable arms and soft arm caps, if selected: black plastic • Frame, seat shell, outer back, and five-arm base: plastic • 3" seat depth adjustment • Passive seat edge angle • Adjustable lumbar • 3D Knit on back only • Standard upholstery design on seat: Fabric price group 1 • 2½"-diameter, hard-composition, dual-wheel casters: black 	<ol style="list-style-type: none"> 1 Style number 2 Plastic color for frame, seat shell, outer back, and base 3 3D Knit color for back 4 Fabric color number for upholstery on seat 5 Options, if selected (see below) <ul style="list-style-type: none"> ▶ See <i>Surface Materials</i>, page 780.

Surface Materials	Options	U.S. Price	Required to Specify
	Upholstery		
	• Fabric price group 1	No cost	Specify fabric color number.
	• Fabric price group 2	+\$ 21	Specify fabric color number.
	• Fabric price group 3	+\$ 34	Specify fabric color number.
	• Fabric price group 4	+\$ 48	Specify fabric color number.
	• Fabric price group 5	+\$ 62	Specify fabric color number.
	• Fabric price group 6	+\$ 77	Specify fabric color number.
	• Fabric price group 7	+\$ 88	Specify fabric color number.
	• Fabric price group 8	+\$111	Specify fabric color number.
	• Fabric price group 9	+\$137	Specify fabric color number.
	• Fabric price group 10	+\$154	Specify fabric color number.
	• Steelcase leather upholstery	+\$460	Add suffix S to the style number and specify leather color number.
	• Select Surfaces leather price group 1	+\$460	Add suffix S to the style number and specify Select Surfaces leather price group 1. ▶ See <i>Surface Materials Reference Manual</i> .
	• Elmosoft leather upholstery	+\$542	Add suffix S to the style number and specify Elmosoft leather color number.
	• Select Surfaces leather price group 2	+\$542	Add suffix S to the style number and specify Select Surfaces leather price group 2. ▶ See <i>Surface Materials Reference Manual</i> .
	• Steelcase vinyl	+\$ 21	Add suffix S to the style number and specify vinyl color number. ▶ See <i>Surface Materials Reference Manual</i> to specify.
	• Customer's Own Material (COM)	No cost	Add suffix S to the style number and specify leather color number.
	• Customer's Own Leather (COL)	+\$202	Add suffix S to the style number and specify leather color number.
	Fire Code Seating (FCS)	+\$113	Add suffix F to the style number.
	Soil-retardant treatment	+\$ 36	Specify <i>with soil-retardant treatment</i> .
	Sewn upholstery		
	• Sewn upholstery on chair	+\$ 58	Add suffix S to the style number.
	Polished aluminum package		
	• Polished aluminum package on chairs with arms and 6205 Black frame finish	+\$691	Add suffix C to the style number.
	Platinum/Midnight		
	• On frame, base, arm retainer, and outer back	+\$ 65	Specify <i>with 6249 Platinum or with 6259 Midnight</i> .

Tip: Always add suffixes in alphabetical order when specifying options to Leap seating.

Tip: Leather and vinyl upcharges are in addition to sewn upholstery upcharge.

Tip: Select COMs require sewn application with an additional upcharge. Specify with an **S** suffix.

Tip: Fire Code Seating (FCS) option is available with certain upholstery fabric choices only.

▶ Page 804

Tip: Fire Code Seating (FCS) option is available on Leap chairs with fully adjustable arms or armless models only.

Tip: Glides are not available on chairs with polished aluminum package.

▶ Detailed dimensions, page 56

▶ Options, continued on next page

► Options, continued from previous page

Options	U.S. Price	Required to Specify
Arms		
• Height-adjustable arms, soft arm caps	-\$132	Specify <i>with height-adjustable arms</i> .
• Armless	-\$415	Specify <i>without arms</i> .
Seat Height		
• 7" pneumatic seat-height adjustment	+\$ 85	Specify <i>with 7" pneumatic seat-height adjustment</i> .
Headrest		
• Headrest	+\$340	Specify <i>with headrest</i> .
Lumbar		
• Without lumbar	-\$ 84	Specify <i>without lumbar</i> .
Casters		
• Soft, dark grey treaded, dual-wheel roll-control casters for use on hard floors	+\$ 36	Specify <i>with soft roll-control casters</i> .
Glides		
• Glides: plastic	+\$ 36	Specify <i>with glides</i> .

Tip: Plastic shell on headrest is available in black only.

Specification Information



Style Number	U.S. Base Price
46216189	\$2307

Leap 462 Series



For Canadian Pricing
Multiply U.S. Price by the Canadian price factor.
► See page 1 for details.

Leap 462 Series Stool

Upholstery on Back and Seat

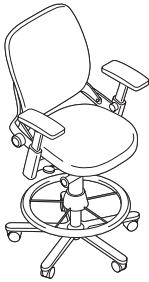

Standard Includes	Required to Specify
-------------------	---------------------

- | | | |
|---|---|---|
| <ul style="list-style-type: none"> ▶ Need help? Product details, page 52 | <ul style="list-style-type: none"> • Upper back force • 8" pneumatic seat-height adjustment • Variable back stop • Lower back firmness • Passive seat edge angle • Rectilinear independent height-, width-, pivot-, and depth-adjustable arms and soft arm caps, if selected: black plastic • Frame, seat shell, outer back, and five-arm base: plastic • 3" seat depth adjustment • Column and 4" adjustable foot ring: black • Standard upholstery design: fabric price group 1 • 2"-diameter, hard-composition, dual-wheel casters: black | <ul style="list-style-type: none"> 1 Style number 2 Plastic color for frame, seat shell, outer back, and base 3 Fabric color number for upholstery on seat and back 4 Options, if selected (see below) <ul style="list-style-type: none"> ▶ See <i>Surface Materials</i>, page 780. |
|---|---|---|

Surface Materials	Options	U.S. Price	Required to Specify
-------------------	---------	------------	---------------------

Surface Materials	Upholstery on seat and back		
	• Fabric price group 1	No cost	Specify fabric color number.
	• Fabric price group 2	+\$ 37	Specify fabric color number.
	• Fabric price group 3	+\$ 72	Specify fabric color number.
	• Fabric price group 4	+\$ 100	Specify fabric color number.
	• Fabric price group 5	+\$ 125	Specify fabric color number.
	• Fabric price group 6	+\$ 154	Specify fabric color number.
	• Fabric price group 7	+\$ 179	Specify fabric color number.
	• Fabric price group 8	+\$ 223	Specify fabric color number.
	• Fabric price group 9	+\$ 276	Specify fabric color number.
• Fabric price group 10	+\$ 312	Specify fabric color number.	
• Steelcase leather upholstery	+\$ 920	Specify fabric color number. Add suffix S to the style number and specify leather color number.	
• Select Surfaces leather price group 1	+\$ 920	Add suffix S to the style number and specify Select Surfaces leather price group 1. ▶ See <i>Surface Materials Reference Manual</i> .	
• Elmosoft leather upholstery	+\$1082	Add suffix S to the style number and specify Elmosoft leather color number.	
• Select Surfaces leather price group 2	+\$1082	Add suffix S to the style number and specify Select Surfaces leather price group 2. ▶ See <i>Surface Materials Reference Manual</i> .	
• Steelcase vinyl	+\$ 37	Add suffix S to the style number and specify vinyl color number. ▶ See <i>Surface Materials Reference Manual</i> to specify.	
• Customer's Own Material (COM)	No cost	Add suffix S to the style number and specify leather color number.	
• Customer's Own Leather (COL)	+\$ 404		
	Platinum/Midnight		
	• On frame, base, arm retainer, and outer back	+\$ 65	Specify with 6249 <i>Platinum</i> or with 6259 <i>Midnight</i> .
	Sewn upholstery		
	• Sewn upholstery on chair	+\$ 113	Add suffix S to the style number.
	Contrasting upholstery on seat and back		
	• Contrasting fabrics	+\$ 46	Add suffix K to the style number and specify fabric color numbers.

▶ Options, continued on next page

Tip: Leather and vinyl upcharges are in addition to sewn upholstery upcharge.

Tip: Select COMs require sewn application with an additional upcharge. Specify with an **S** suffix.

Tip: Suffixes other than **K** for contrasting fabric, will be added in alphabetical order when specifying options. The contrasting fabric suffix, **K**, will always be at the end of the style number.

▶ Detailed dimensions, page 56

► Options, continued from previous page

	Options	U.S. Price	Required to Specify	
Surface Materials, continued	Contrasting upholstery on seat			
	• Fabric price group 1	No cost	Specify fabric color number.	
	• Fabric price group 2	+\$ 21	Specify fabric color number.	
	• Fabric price group 3	+\$ 34	Specify fabric color number.	
	• Fabric price group 4	+\$ 48	Specify fabric color number.	
	• Fabric price group 5	+\$ 62	Specify fabric color number.	
	• Fabric price group 6	+\$ 77	Specify fabric color number.	
	• Fabric price group 7	+\$ 88	Specify fabric color number.	
	• Fabric price group 8	+\$111	Specify fabric color number.	
	• Fabric price group 9	+\$137	Specify fabric color number.	
	• Fabric price group 10	+\$154	Specify fabric color number.	
	• Steelcase leather upholstery	+\$460	Add suffix S to the style number and specify leather color number.	
	• Select Surfaces leather price group 1	+\$460	Add suffix S to the style number and specify leather color number.	
	• Elmosoft leather upholstery	+\$542	Add suffix S to the style number and specify leather color number.	
	• Select Surfaces leather price group 2	+\$542	Add suffix S to the style number and specify leather color number.	
	• Steelcase vinyl	+\$ 21	Add suffix S to the style number and specify vinyl color number.	
	• Customer's Own Material (COM)	No cost	► See <i>Surface Materials Reference Manual</i> .	
	• Customer's Own Leather (COL)	+\$202	Add suffix S to the style number and specify leather color number.	
		Contrasting upholstery on back		
		• Fabric price group 1	No cost	Specify fabric color number.
	• Fabric price group 2	+\$ 21	Specify fabric color number.	
	• Fabric price group 3	+\$ 34	Specify fabric color number.	
	• Fabric price group 4	+\$ 49	Specify fabric color number.	
	• Fabric price group 5	+\$ 62	Specify fabric color number.	
	• Fabric price group 6	+\$ 78	Specify fabric color number.	
	• Fabric price group 7	+\$ 88	Specify fabric color number.	
	• Fabric price group 8	+\$112	Specify fabric color number.	
	• Fabric price group 9	+\$137	Specify fabric color number.	
	• Fabric price group 10	+\$155	Specify fabric color number.	
	• Steelcase leather upholstery	+\$460	Add suffix S to the style number and specify leather color number.	
	• Select Surfaces leather price group 1	+\$460	Add suffix S to the style number and specify leather color number.	
	• Elmosoft leather upholstery	+\$543	Add suffix S to the style number and specify leather color number.	
	• Select Surfaces leather price group 2	+\$543	Add suffix S to the style number and specify leather color number.	
	• Steelcase vinyl	+\$ 21	Add suffix S to the style number and specify vinyl color number.	
	• Customer's Own Material (COM)	No cost	► See <i>Surface Materials Reference Manual</i> .	
	• Customer's Own Leather (COL)	+\$204	Add suffix S to the style number and specify leather color number.	
	Soil-retardant treatment	+\$ 36	Specify <i>with soil-retardant treatment</i> .	
	Fire Code Seating (FCS)	+\$113	Add suffix F to the style number.	
	Arms	• Height-adjustable arms, soft arm caps	-\$132	Specify <i>with height-adjustable arms</i> .
	• Armless	-\$415	Specify <i>without arms</i> .	
	Lumbar	• Without lumbar	-\$ 84	Specify <i>without lumbar</i> .
	Casters	• Soft, dark grey treaded, dual-wheel roll-control casters for use on hard floors	+\$ 36	Specify <i>with soft roll-control casters</i> .

Tip: Leather and vinyl upcharges are in addition to sewn upholstery upcharge.

Tip: Select COMs require sewn application with an additional upcharge. Specify with an **S** suffix.

Tip: Fire Code Seating (FCS) option is available with certain upholstery fabric choices only.

► Page 804

Tip: Fire Code Seating (FCS) option is available on Leap chairs with fully adjustable arms or armless models only.



For Canadian Pricing

Multiply U.S. Price by the Canadian price factor.

► See page 1 for details.

► Options, continued on next page

Leap 462 Series Stool, Upholstery on Back and Seat, continued

► Options, continued from previous page

Options	U.S. Price	Required to Specify
Glides • Glides: plastic	+\$36	Specify <i>with glides</i> .

Specification Information

Tip: Coat hanger cannot be used on Leap stools.



• Style Number	• U.S. Base Price
46267179	\$2561



For Canadian Pricing

Multiply U.S. Price by the Canadian price factor.

► See page 1 for details.

Leap 462 Series Stool

3D Knit on Back with Upholstery on Seat



Standard Includes		Required to Specify
<ul style="list-style-type: none"> ▶ Need help? Product details, page 52 	<ul style="list-style-type: none"> • Upper back force • 8" pneumatic seat-height adjustment • Variable back stop • Lower back firmness • Passive seat edge angle • Rectilinear independent height-, width-, pivot-, and depth-adjustable arms and soft arm caps, if selected: black plastic • Frame, seat shell, outer back, and five-arm base: plastic • Column and 4" adjustable foot ring: black • 3D Knit on back only • 3" seat depth adjustment • Adjustable lumbar • Standard upholstery design on seat: fabric price group 1 • 2"-diameter, hard-composition, dual-wheel casters: black 	<ol style="list-style-type: none"> 1 Style number 2 Plastic color for frame, seat shell, outer back, and base 3 3D Knit color for back 4 Fabric color number for upholstery on seat 5 Options, if selected (see below) <ul style="list-style-type: none"> ▶ See <i>Surface Materials</i>, page 780.

Options	U.S. Price	Required to Specify
Surface Materials	Upholstery	
	<ul style="list-style-type: none"> • Fabric price group 1 No cost • Fabric price group 2 +\$ 21 • Fabric price group 3 +\$ 34 • Fabric price group 4 +\$ 48 • Fabric price group 5 +\$ 62 • Fabric price group 6 +\$ 77 • Fabric price group 7 +\$ 88 • Fabric price group 8 +\$111 • Fabric price group 9 +\$137 • Fabric price group 10 +\$154 • Steelcase leather upholstery +\$460 • Select Surfaces leather price group 1 +\$460 • Elmosoft leather upholstery +\$542 • Select Surfaces leather price group 2 +\$542 • Steelcase vinyl +\$ 21 • Customer's Own Material (COM) No cost • Customer's Own Leather (COL) +\$202 	<ul style="list-style-type: none"> Specify fabric color number. Specify fabric color number. Specify fabric color number. Specify fabric color number. Specify fabric color number. Specify fabric color number. Specify fabric color number. Specify fabric color number. Specify fabric color number. Specify fabric color number. Add suffix S to the style number and specify leather color number. Add suffix S to the style number and specify Select Surfaces leather price group 1. ▶ See <i>Surface Materials Reference Manual</i>. Add suffix S to the style number and specify Elmosoft leather color number. Add suffix S to the style number and specify Select Surfaces leather price group 2. ▶ See <i>Surface Materials Reference Manual</i>. Add suffix S to the style number and specify vinyl color number. ▶ See <i>Surface Materials Reference Manual</i> to specify. Add suffix S to the style number and specify leather color number.
	Fire Code Seating (FCS) +\$113	Add suffix F to the style number.
	Soil-retardant treatment +\$ 36	Specify <i>with soil-retardant treatment</i> .
	Sewn upholstery	
	<ul style="list-style-type: none"> • Sewn upholstery on chair +\$ 58 	Add suffix S to the style number.
	Platinum/Midnight	
	<ul style="list-style-type: none"> • On frame, base, arm retainer, and and outer back +\$ 65 	Specify <i>with 6249 Platinum</i> or <i>with 6259 Midnight</i> .
Arms	<ul style="list-style-type: none"> • Height-adjustable arms, soft arm caps -\$132 • Armless -\$415 	Specify <i>with height-adjustable arms</i> Specify <i>without arms</i> .
Lumbar	<ul style="list-style-type: none"> • Without lumbar -\$ 84 	Specify <i>without lumbar</i> .

▶ Options, continued on next page

Tip: Always add suffixes in alphabetical order when specifying options to Leap seating.

Tip: Leather and vinyl upcharges are in addition to sewn upholstery upcharge.

*Tip: Select COMs require sewn application with an additional upcharge. Specify with an **S** suffix.*

Tip: Fire Code Seating (FCS) option is available on Leap chairs with fully adjustable arms or armless models only.

▶ Detailed dimensions, page 56



For Canadian Pricing

Multiply U.S. Price by the Canadian price factor.

▶ See page 1 for details.

► Options, continued from previous page

Options	U.S. Price	Required to Specify
Casters • Soft, dark grey treaded, dual-wheel roll-control casters for use on hard floors	+\$36	Specify <i>with soft roll-control casters</i> .
Glides • Glides: plastic	+\$36	Specify <i>with glides</i> .

Specification Information

Tip: Coat hanger cannot be used on Leap stools.



• Style Number	• U.S. Base Price
46267189	\$2646

 **For Canadian Pricing**
 Multiply U.S. Price by the Canadian price factor.
 ► See page 1 for details.

Leap Plus 462 Series Work Chair

Upholstery on Back and Seat

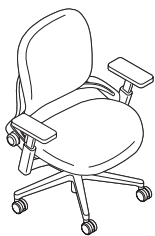

Standard Includes	Required to Specify
-------------------	---------------------

- | | | |
|---|--|---|
| <ul style="list-style-type: none"> ▶ Need help? Product details, page 52 | <ul style="list-style-type: none"> • Upper back force • 4" pneumatic seat-height adjustment • Variable back stop • Lower back firmness • Rectilinear independent height-, width-, pivot-, and depth- adjustable arms and soft arm caps, if selected: black plastic • Frame, seat shell, outer back, and five-arm base: plastic • 2" seat depth adjustment • Adjustable lumbar • Standard upholstery design: fabric price group 1 • 2½"-diameter, hard-composition, dual-wheel casters: black | <ol style="list-style-type: none"> 1 Style number 2 Plastic color for frame, seat shell, outer back, and base 3 Fabric color number for upholstery on seat and back 4 Options, if selected (see below) <ul style="list-style-type: none"> ▶ See <i>Surface Materials</i>, page 780. |
|---|--|---|

Options	U.S. Price	Required to Specify
---------	------------	---------------------

Surface Materials	Upholstery on seat and back	U.S. Price	Required to Specify
	<ul style="list-style-type: none"> • Fabric price group 1 • Fabric price group 2 • Fabric price group 3 • Fabric price group 4 • Fabric price group 5 • Fabric price group 6 • Fabric price group 7 • Fabric price group 8 • Fabric price group 9 • Fabric price group 10 • Steelcase leather upholstery 	<p>No cost</p> <p>+\$ 37</p> <p>+\$ 72</p> <p>+\$ 100</p> <p>+\$ 125</p> <p>+\$ 154</p> <p>+\$ 179</p> <p>+\$ 223</p> <p>+\$ 276</p> <p>+\$ 312</p> <p>+\$ 920</p>	<p>Specify fabric color number.</p> <p>Specify fabric color number.</p> <p>Specify fabric color number.</p> <p>Specify fabric color number.</p> <p>Specify fabric color number.</p> <p>Specify fabric color number.</p> <p>Specify fabric color number.</p> <p>Specify fabric color number.</p> <p>Specify fabric color number.</p> <p>Specify fabric color number.</p> <p>Add suffix S to the style number and specify leather color number.</p> <p>Add suffix S to the style number and specify Select Surfaces leather price group 1.</p> <p>▶ See <i>Surface Materials Reference Manual</i>. Add suffix S to the style number and specify Elmosoft leather color number.</p> <p>Add suffix S to the style number and specify Select Surfaces leather price group 2.</p> <p>▶ See <i>Surface Materials Reference Manual</i>. Add suffix S to the style number and specify vinyl color number.</p> <p>▶ See <i>Surface Materials Reference Manual</i> to specify.</p> <p>Add suffix S to the style number and specify leather color number.</p>
	<ul style="list-style-type: none"> • Select Surfaces leather price group 1 	<p>+\$ 920</p>	<p>Add suffix S to the style number and specify leather color number.</p>
	<ul style="list-style-type: none"> • Elmosoft leather upholstery 	<p>+\$1082</p>	<p>Add suffix S to the style number and specify Elmosoft leather color number.</p>
	<ul style="list-style-type: none"> • Select Surfaces leather price group 2 	<p>+\$1082</p>	<p>Add suffix S to the style number and specify Select Surfaces leather price group 2.</p>
	<ul style="list-style-type: none"> • Steelcase vinyl 	<p>+\$ 37</p>	<p>Add suffix S to the style number and specify vinyl color number.</p>
	<ul style="list-style-type: none"> • Customer's Own Material (COM) 	<p>No cost</p>	<p>▶ See <i>Surface Materials Reference Manual</i> to specify.</p>
	<ul style="list-style-type: none"> • Customer's Own Leather (COL) 	<p>+\$ 404</p>	<p>Add suffix S to the style number and specify leather color number.</p>

Tip: Leather and vinyl upcharges are in addition to sewn upholstery upcharge.

Tip: Select COMs require sewn application with an additional upcharge. Specify with an **S** suffix.

Tip: Suffixes other than **K** for contrasting fabric, will be added in alphabetical order when specifying options. The contrasting fabric suffix, **K**, will always be at the end of the style number.

▶ Detailed dimensions, page 56



For Canadian Pricing

Multiply U.S. Price by the Canadian price factor.

▶ See page 1 for details.

Sewn upholstery		
• Sewn upholstery on chair	+\$ 113	Add suffix S to the style number.

Contrasting upholstery on seat and back		
• Contrasting fabrics	+\$ 46	Add suffix K to the style number and specify fabric color numbers.

Contrasting upholstery on seat		
• Fabric price group 1	No cost	Specify fabric color number.
• Fabric price group 2	+\$ 21	Specify fabric color number.
• Fabric price group 3	+\$ 34	Specify fabric color number.
• Fabric price group 4	+\$ 48	Specify fabric color number.
• Fabric price group 5	+\$ 62	Specify fabric color number.
• Fabric price group 6	+\$ 77	Specify fabric color number.
• Fabric price group 7	+\$ 88	Specify fabric color number.
• Fabric price group 8	+\$ 111	Specify fabric color number.
• Fabric price group 9	+\$ 137	Specify fabric color number.
• Fabric price group 10	+\$ 154	Specify fabric color number.

▶ Options, continued on next page

► Options, continued from previous page

	Options	U.S. Price	Required to Specify
Surface Materials, continued	Contrasting upholstery on seat, continued		
	• Steelcase leather upholstery	+\$460	Add suffix S to the style number and specify leather color number.
	• Select Surfaces leather price group 1	+\$460	Add suffix S to the style number and specify leather color number.
	• Elmosoft leather upholstery	+\$542	Add suffix S to the style number and specify leather color number.
	• Select Surfaces leather price group 2	+\$542	Add suffix S to the style number and specify leather color number.
	• Steelcase vinyl	+\$ 21	Add suffix S to the style number and specify vinyl color number.
	• Customer's Own Material (COM)	No cost	► See <i>Surface Materials Reference Manual</i> .
	• Customer's Own Leather (COL)	+\$ 202	Add suffix S to the style number and specify leather color number.
	Contrasting upholstery on back		
	• Fabric price group 1	No cost	Specify fabric color number.
• Fabric price group 2	+\$ 21	Specify fabric color number.	
• Fabric price group 3	+\$ 34	Specify fabric color number.	
• Fabric price group 4	+\$ 49	Specify fabric color number.	
• Fabric price group 5	+\$ 62	Specify fabric color number.	
• Fabric price group 6	+\$ 78	Specify fabric color number.	
• Fabric price group 7	+\$ 88	Specify fabric color number.	
• Fabric price group 8	+\$112	Specify fabric color number.	
• Fabric price group 9	+\$137	Specify fabric color number.	
• Fabric price group 10	+\$155	Specify fabric color number.	
• Steelcase leather upholstery	+\$460	Add suffix S to the style number and specify leather color number.	
• Select Surfaces leather price group 1	+\$460	Add suffix S to the style number and specify leather color number.	
• Elmosoft leather upholstery	+\$543	Add suffix S to the style number and specify leather color number.	
• Select Surfaces leather price group 2	+\$543	Add suffix S to the style number and specify leather color number.	
• Steelcase vinyl	+\$ 21	Add suffix S to the style number and specify vinyl color number.	
• Customer's Own Material (COM)	No cost	► See <i>Surface Materials Reference Manual</i> .	
• Customer's Own Leather (COL)	+\$204	Add suffix S to the style number and specify leather color number.	
Soil-retardant treatment		+\$ 36	Specify <i>with soil-retardant treatment</i> .
Fire Code Seating (FCS)		+\$113	Add suffix F to the style number.
Platinum/Midnight			
	• On frame, base, arm retainer, and outer back	+\$ 65	Specify <i>with 6249 Platinum</i> or <i>with 6259 Midnight</i> .
Arms	• Height-adjustable arms, soft arm caps	-\$132	Specify <i>with height-adjustable arms</i> .
	• Armless	-\$415	Specify <i>without arms</i> .
Seat Height	• 5" pneumatic seat-height adjustment	+\$ 85	Specify <i>with 5" pneumatic seat-height adjustment</i> .
Lumbar	• Without lumbar	-\$ 84	Specify <i>without lumbar</i> .
Casters	• Soft, dark grey treaded, dual-wheel roll-control casters for use on hard floors	+\$ 36	Specify <i>with soft roll-control casters</i> .
Glides	• Glides: plastic	+\$ 36	Specify <i>with glides</i> .

► Specification Information, on next page

Tip: Leather and vinyl upcharges are in addition to sewn upholstery upcharge.

Tip: Select COMs require sewn application with an additional upcharge. Specify with an **S** suffix.

Tip: Fire Code Seating (FCS) option is available with certain upholstery fabric choices only.

► Page 804

Tip: Fire Code Seating (FCS) option is available on Leap chairs with fully adjustable arms or armless models only.

**For Canadian Pricing**

Multiply U.S. Price by the Canadian price factor.

► See page 1 for details.

► Options, on previous page

Specification Information



• Style • Number	• U.S. • Base • Price
46296179	\$3335



For Canadian Pricing
Multiply U.S. Price by the
Canadian price factor.
► See page 1 for details.

Leap Plus 462 Series Work Chair

3D Knit on Back with Upholstery on Seat



Standard Includes	Required to Specify
-------------------	---------------------

- | | | |
|---|--|--|
| <ul style="list-style-type: none"> ▶ Need help? Product details, page 52 | <ul style="list-style-type: none"> • Upper back force • 4" pneumatic seat-height adjustment • Variable back stop • Lower back firmness • Rectilinear independent height-, width-, pivot-, and depth- adjustable arms and soft arm caps, if selected: black plastic • Frame, seat shell, outer back, and five-arm base: plastic • 2" seat depth adjustment • Adjustable lumbar • 3D Knit on back only • Standard upholstery design on seat: Fabric price group 1 • 2½"-diameter, hard-composition, dual-wheel casters: black | <ol style="list-style-type: none"> 1 Style number 2 Plastic color for frame, seat shell, outer back, and base 3 3D Knit color for back 4 Fabric color number for upholstery on seat 5 Options, if selected (see below) <ul style="list-style-type: none"> ▶ See <i>Surface Materials</i>, page 780. |
|---|--|--|

Options	U.S. Price	Required to Specify
---------	------------	---------------------

Surface Materials	Upholstery		
	<ul style="list-style-type: none"> • Fabric price group 1 • Fabric price group 2 • Fabric price group 3 • Fabric price group 4 • Fabric price group 5 • Fabric price group 6 • Fabric price group 7 • Fabric price group 8 • Fabric price group 9 • Fabric price group 10 • Steelcase leather upholstery 	<ul style="list-style-type: none"> • Select Surfaces leather price group 1 	<ul style="list-style-type: none"> • Elmosoft leather upholstery • Select Surfaces leather price group 2
	<ul style="list-style-type: none"> • Steelcase vinyl • Customer's Own Material (COM) • Customer's Own Leather (COL) 	<ul style="list-style-type: none"> • Steelcase vinyl • Customer's Own Material (COM) • Customer's Own Leather (COL) 	<ul style="list-style-type: none"> • Steelcase vinyl • Customer's Own Material (COM) • Customer's Own Leather (COL)
	Fire Code Seating (FCS)		
	Soil-retardant treatment		
	Sewn upholstery		
	Platinum/Midnight		
Arms	<ul style="list-style-type: none"> • Height-adjustable arms, soft arm caps • Armless 	<ul style="list-style-type: none"> • Height-adjustable arms, soft arm caps • Armless 	<ul style="list-style-type: none"> • Height-adjustable arms, soft arm caps • Armless

▶ Options, continued on next page

Tip: Always add suffixes in alphabetical order when specifying options to Leap seating.

Tip: Leather and vinyl upcharges are in addition to sewn upholstery upcharge.

Tip: Select COMs require sewn application with an additional upcharge. Specify with an **S** suffix.

Tip: Fire Code Seating (FCS) option is available with certain upholstery fabric choices only.

▶ Page 804

Tip: Fire Code Seating (FCS) option is available on Leap chairs with fully adjustable arms or armless models only.

▶ Detailed dimensions, page 56

► Options, continued from previous page

Options	U.S. Price	Required to Specify
Seat Height • 5" pneumatic seat-height adjustment	+\$85	Specify with 5" pneumatic seat-height adjustment.
Lumbar • Without lumbar	-\$84	Specify without lumbar.
Casters • Soft, dark grey treaded, dual-wheel roll-control casters for use on hard floors	+\$36	Specify with soft roll-control casters.
Glides • Glides: plastic	+\$36	Specify with glides.

Specification Information



Style Number	U.S. Base Price
46296189	\$3420

Leap 462 Series



For Canadian Pricing

Multiply U.S. Price by the Canadian price factor.

► See page 1 for details.

Leap Coat Hanger



Tip: The coat hanger cannot be used on Leap stools.

Standard Includes	Required to Specify
-------------------	---------------------

- | | |
|---|---|
| ▶ Need help?
Product details,
page 36 | • Coat hanger: 0835 Black paint

Style number |
|---|---|

Specification Information	
---------------------------	--

• Style • Number	• U.S. • Price
462COATHANGER	\$104

▶ Detailed dimensions,
page 42



For Canadian Pricing

Multiply U.S. Price by the
Canadian price factor.

▶ See page 1 for details.