Understanding and Specifying Surround Lounge Seating

Thought Starters and Applications	546
Configuration Charts	550
Height Diagram	555
Surround Lounge	556
Surround Storage End Tables	560
Surround Mobile Tablet	562

Surround Lounge	
44" Frame Width	564
55" Frame Width	566
60½" Frame Width	570
66" Frame Width	574
71½" Frame Width	578
77" Frame Width	582
82½" Frame Width	586
88" Frame Width	590
93½" Frame Width	594
99" Frame Width	598
104½" Frame Width	602
Surround Storage	
One-Tier End Table	605
Two-Tier End Table	606
Surround Mobile Tablet	607

Surround Thought Starters and Applications

Lounge, 104½" Frame Width

Fully Optioned

104½"W frame offers a generous sleep surface, multiple seated reclining postures, and connectivity options. An integrated coat hanger and two-tier storage provide organization options. User-adjustable light with integrated touch-control buttons enhances the care partner experience.

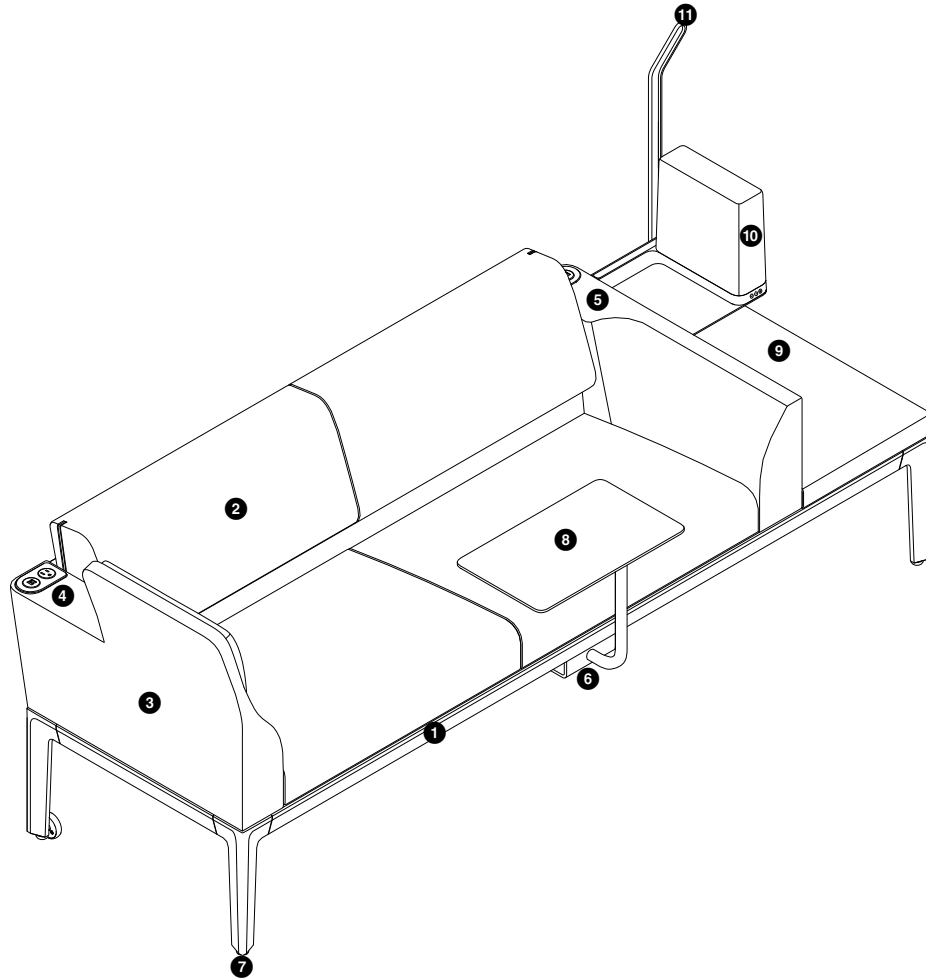

Lounge, 104½" Frame Width

Recommended Components

	Quantity	Style Number	Description	Options	Page for Ordering
1	1	HLS105	104½"W Frame		602
2				77"W Seat, Back, and Outer Back	
3				Left Arm, High	
4				Left Arm, One Power/Two USB	
5				Right Arm, Two Power with Light Capability	
6				Tablet Rail	
7				Two Glides and Two Casters	
8	1	HLSMT	Mobile Tablet		607
9	1	HLS TTT	Two-Tier Storage End Table – 16½"W		606
10				Light	
11				Coat Hanger	

Lounge, 82½" Frame Width

High-Recline Arm, Mobile Tablet, and Power

82½"W frame accommodates multiple individuals and provides a sleep surface, connectivity, and a personal worksurface option for care partners.

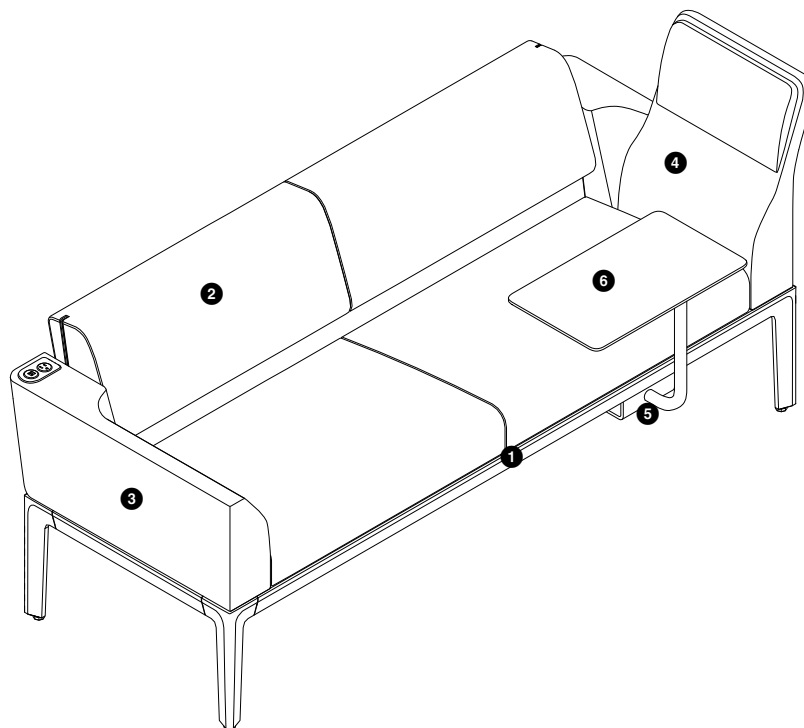

Lounge, 82½" Frame Width

Recommended Components

	Quantity	Style Number	Description	Options	Page for Ordering
1	1	HLS83	82½"W Frame		586
2				71½"W Seat, Back, and Outer Back	
3				Left Arm, One Power/Two USB	
4				Right Arm, High	
5				Tablet Rail	
6	1	HLSMT	Mobile Tablet		607

Surround

Lounge, 71½" Frame Width

Single Arm, Storage, Mobile Tablet, and Power

71½"W frame accommodates spacious lounge postures. Mobile tablet provides a personal worksurface, and storage is easily accessible for care partners.

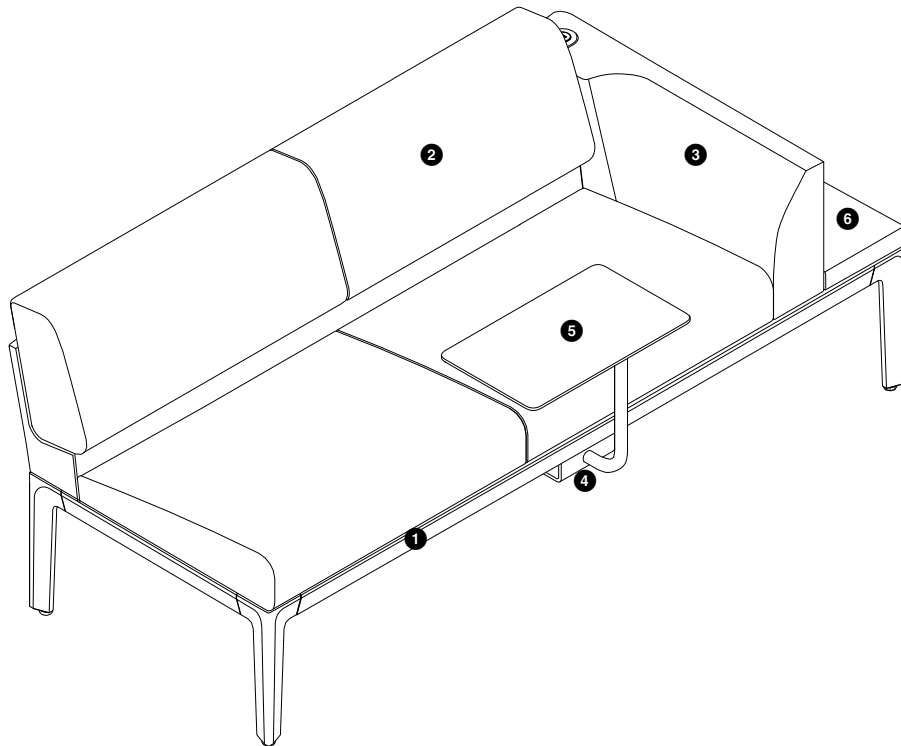

Lounge, 71½" Frame Width

Recommended Components

	Quantity	Style Number	Description	Options	Page for Ordering
1	1	HLS72	71½"W Frame		578
2				55"W Seat, Back, and Outer Back	
3				Right Arm, Two Power	
4				Tablet Rail	
5	1	HLSMT	Mobile Tablet		607
6	1	HLSSET	One-Tier Storage End Table – 11"W		605

Lounge, 44" Frame Width

Two Low Arms, Mobile Tablet, and Power

44"W frame provides a comfortable lounge posture, connectivity, and personal worksurface options for users.

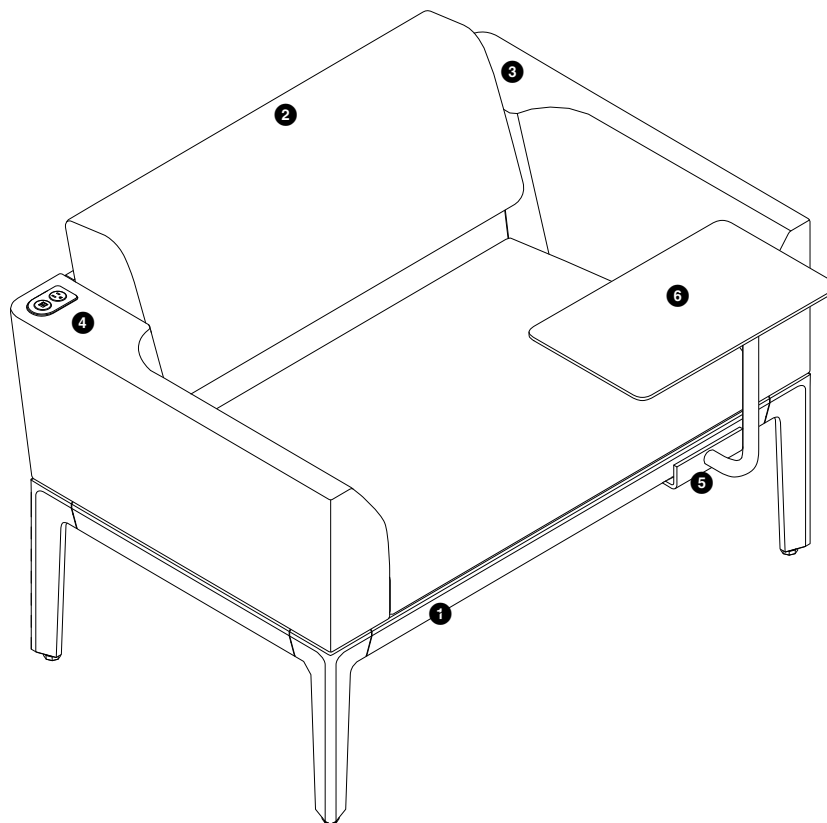

Lounge, 44" Frame Width

Recommended Components

	Quantity	Style Number	Description	Options	Page for Ordering
1	1	HLS44	44"W Frame		564
2				33"W Seat, Back, and Outer Back	
3				Right Arm	
4				Left Arm, One Power/Two USB	
5				Tablet Rail	
6	1	HLSMT	Mobile Tablet		607

Surround

Surround Configuration Charts

Surround is a frame-based modular collection of components designed to maximize the user experience. Each Surround frame can support various combinations of components to accommodate patient room and other various architecture. Product configuration is determined during specification.

Tip: Understand the dimensions of the architectural space to determine the frame.

Tip: Unit weights include one-tier storage where applicable.

Tip: Specify the maximum frame dimension to maximize experience and options.

Tip: All components must fit within the frame dimension (seat, back, arms, and storage).

Tip: Left and right is determined when facing the unit.

Tip: Understand the dimensions of the architectural space to accommodate components that may extend outside frame dimensions.

Tip: Seat and back must be the same width.

Tip: Low arm and high-recline arm are available in left- or right-facing positions.

Tip: High-recline arm placed on end of unit extends 3³/₄" from the frame at the outermost point.

Tip: Storage end table can be specified in one- or two-tier option.

Tip: Storage end table mounts only to the right or left side of the frame unit.

Tip: Two-tier storage requires the specification of an adjacent arm on frame.

Tip: Storage cannot be specified adjacent to other storage.

Tip: Storage width must match storage size specified on frame.

Tip: Power, two front glides and two directional back wheel casters, and mobile tablet can be specified on all units.

Tip: Unit weights are approximations and may vary between units.

44"W Frame				
Seat/Back/Outer Back	Fixed or Sleeper Back	Number of Arms (Positioned on Left and/or Right)	Storage (Positioned on Left or Right)	Weight
33"W	Fixed	N.A.	11"W	130 lb
33"W	Fixed	Two 5½"W	N.A.	145 lb
38½"W	Fixed	One 5½"W	N.A.	139 lb
44"W	Fixed	N.A.	N.A.	130 lb

55"W Frame				
Seat/Back/Outer Back	Fixed or Sleeper Back	Number of Arms (Positioned on Left and/or Right)	Storage (Positioned on Left or Right)	Weight
33"W	Fixed	N.A.	Two 11"W	150 lb
33"W	Fixed	One 5½"W	16½"W	140 lb
38½"W	Fixed	N.A.	16½"W	155 lb
38½"W	Fixed	One 5½"W	11"W	145 lb
44"W	Fixed	N.A.	11"W	155 lb
44"W	Fixed	Two 5½"W	N.A.	166 lb
49½"W	Fixed	One 5½"W	N.A.	151 lb
55"W	Fixed	N.A.	N.A.	150 lb

60½"W Frame				
Seat/Back/Outer Back	Fixed or Sleeper Back	Number of Arms (Positioned on Left and/or Right)	Storage (Positioned on Left or Right)	Weight
33"W	Fixed	N.A.	11"W and 16½"W	160 lb
33"W	Fixed	One 5½"W	Two 11"W	165 lb
33"W	Fixed	Two 5½"W	16½"W	153 lb
38½"W	Fixed	N.A.	Two 11"W	155 lb
38½"W	Fixed	Two 5½"W	11"W	168 lb
38½"W	Fixed	One 5½"W	16½"W	148 lb
44"W	Fixed	N.A.	16½"W	155 lb
44"W	Fixed	One 5½"W	11"W	147 lb
49½"W	Fixed	N.A.	11"W	160 lb
49½"W	Fixed	Two 5½"W	N.A.	174 lb
55"W	Fixed	One 5½"W	N.A.	157 lb
60½"W	Fixed	N.A.	N.A.	160 lb

Tip: Understand the dimensions of the architectural space to determine the frame.

Tip: Specify the maximum frame dimension to maximize experience and options.

Tip: All components must fit within the frame dimension (seat, back, arms, and storage).

Tip: Left and right is determined when facing the unit.

Tip: Understand the dimensions of the architectural space to accommodate components that may extend outside frame dimensions.

Tip: Seat and back must be the same width.

Tip: Low arm and high-recline arm are available in left- or right-facing positions.

Tip: High-recline arm placed on end of unit extends 3³/₄" from the frame at the outermost point.

Tip: Storage end table can be specified in one- or two-tier option.

Tip: Storage end table mounts only to the right or left side of the frame unit.

Tip: Two-tier storage requires the specification of an adjacent arm on frame.

Tip: Storage cannot be specified adjacent to other storage.

Tip: 71¹/₂"W and 77"W seats are standard with a fold-down sleep surface and require two arms.

Tip: 60¹/₂"W and 66"W seats can be specified with or without a fold-down sleep surface.

Tip: If a sleep surface is required, an 71¹/₂"W frame is the smallest frame that can be specified.

Tip: Sleep surface requires the specification of two arms.

Tip: Storage width must match storage size specified on frame.

Tip: Power, two front glides and two directional back wheel casters, and mobile tablet can be specified on all units.

Tip: Unit weights are approximations and may vary between units.

Tip: Unit weights include one-tier storage where applicable.

66" W Frame				
Seat/Back/Outer Back	Fixed or Sleeper Back	Number of Arms (Positioned on Left and/or Right)	Storage (Positioned on Left and/or Right)	Weight
33"W	Fixed	N.A.	Two 16 ¹ / ₂ "W	170 lb
33"W	Fixed	One 5 ¹ / ₂ "W	11"W and 16 ¹ / ₂ "W	175 lb
33"W	Fixed	Two 5 ¹ / ₂ "W	Two 11"W	156 lb
38 ¹ / ₂ "W	Fixed	N.A.	11"W and 16 ¹ / ₂ "W	160 lb
38 ¹ / ₂ "W	Fixed	One 5 ¹ / ₂ "W	Two 11"W	165 lb
38 ¹ / ₂ "W	Fixed	Two 5 ¹ / ₂ "W	16 ¹ / ₂ "W	170 lb
44"W	Fixed	N.A.	Two 11"W	160 lb
44"W	Fixed	Two 5 ¹ / ₂ "W	11"W	171 lb
44"W	Fixed	One 5 ¹ / ₂ "W	16 ¹ / ₂ "W	150 lb
49 ¹ / ₂ "W	Fixed	N.A.	16 ¹ / ₂ "W	160 lb
49 ¹ / ₂ "W	Fixed	One 5 ¹ / ₂ "W	11"W	156 lb
55"W	Fixed	N.A.	11"W	165 lb
55"W	Fixed	Two 5 ¹ / ₂ "W	N.A.	180 lb
60 ¹ / ₂ "W	Fixed	One 5 ¹ / ₂ "W	N.A.	164 lb
66"W	Fixed	N.A.	N.A.	170 lb

71 ¹ / ₂ " W Frame				
Seat/Back/Outer Back	Fixed or Sleeper Back	Number of Arms (Positioned on Left and/or Right)	Storage (Positioned on Left and/or Right)	Weight
33"W	Fixed	One 5 ¹ / ₂ "W	Two 16 ¹ / ₂ "W	180 lb
33"W	Fixed	Two 5 ¹ / ₂ "W	11"W and 16 ¹ / ₂ "W	158 lb
38 ¹ / ₂ "W	Fixed	N.A.	Two 16 ¹ / ₂ "W	165 lb
38 ¹ / ₂ "W	Fixed	One 5 ¹ / ₂ "W	11"W and 16 ¹ / ₂ "W	165 lb
38 ¹ / ₂ "W	Fixed	Two 5 ¹ / ₂ "W	Two 11"W	156 lb
44"W	Fixed	N.A.	11"W and 16 ¹ / ₂ "W	160 lb
44"W	Fixed	One 5 ¹ / ₂ "W	Two 11"W	167 lb
44"W	Fixed	Two 5 ¹ / ₂ "W	16 ¹ / ₂ "W	173 lb
49 ¹ / ₂ "W	Fixed	N.A.	Two 11"W	170 lb
49 ¹ / ₂ "W	Fixed	Two 5 ¹ / ₂ "W	11"W	179 lb
49 ¹ / ₂ "W	Fixed	One 5 ¹ / ₂ "W	16 ¹ / ₂ "W	156 lb
55"W	Fixed	N.A.	16 ¹ / ₂ "W	160 lb
55"W	Fixed	One 5 ¹ / ₂ "W	11"W	160 lb
60 ¹ / ₂ "W	Fixed	N.A.	11"W	165 lb
60 ¹ / ₂ "W	Specify fixed or sleeper	Two 5 ¹ / ₂ "W	N.A.	188 lb
66"W	Fixed	One 5 ¹ / ₂ "W	N.A.	177 lb

Surround Configuration Charts, continued

Tip: Understand the dimensions of the architectural space to determine the frame.

Tip: Specify the maximum frame dimension to maximize experience and options.

Tip: All components must fit within the frame dimension (seat, back, arms, and storage).

Tip: Left and right is determined when facing the unit.

Tip: Understand the dimensions of the architectural space to accommodate components that may extend outside frame dimensions.

Tip: Seat and back must be the same width.

Tip: Low arm and high-recline arm are available in left- or right-facing positions.

Tip: High-recline arm placed on end of unit extends 3¾" from the frame at the outermost point.

Tip: Storage end table can be specified in one- or two-tier option.

Tip: Storage end table mounts only to the right or left side of the frame unit.

Tip: Two-tier storage requires the specification of an adjacent arm on frame.

Tip: Storage cannot be specified adjacent to other storage.

Tip: 71½"W and 77"W seats are standard with a fold-down sleep surface and require two arms.

Tip: 60½"W and 66"W seats can be specified with or without a fold-down sleep surface.

Tip: If a sleep surface is required, a 71½"W frame is the smallest frame that can be specified.

Tip: Sleep surface requires the specification of two arms.

Tip: Power, two front glides and two directional back wheel casters, and mobile tablet can be specified on all units.

Tip: Unit weights are approximations and may vary between units.

Tip: Unit weights include one-tier storage where applicable.

77"W Frame				
Seat/Back/Outer Back	Fixed or Sleeper Back	Number of Arms (Positioned on Left and/or Right)	Storage (Positioned on Left and/or Right)	Weight
33"W	Fixed	Two 5½"W	Two 16½"W	160 lb
38½"W	Fixed	One 5½"W	Two 16½"W	155 lb
38½"W	Fixed	Two 5½"W	11"W and 16½"W	175 lb
44"W	Fixed	N.A.	Two 16½"W	170 lb
44"W	Fixed	One 5½"W	11"W and 16½"W	175 lb
44"W	Fixed	Two 5½"W	Two 11"W	176 lb
49½"W	Fixed	N.A.	11"W and 16½"W	170 lb
49½"W	Fixed	One 5½"W	Two 11"W	175 lb
49½"W	Fixed	Two 5½"W	16½"W	156 lb
55"W	Fixed	N.A.	Two 11"W	160 lb
55"W	Fixed	Two 5½"W	11"W	162 lb
55"W	Fixed	One 5½"W	16½"W	164 lb
60½"W	Fixed	N.A.	16½"W	170 lb
60½"W	Fixed	One 5½"W	11"W	169 lb
66"W	Fixed	N.A.	11"W	175 lb
66"W	Specify fixed or sleeper	Two 5½"W	N.A.	201 lb

82½"W Frame				
Seat/Back/Outer Back	Fixed or Sleeper Back	Number of Arms (Positioned on Left and/or Right)	Storage (Positioned on Left and/or Right)	Weight
38½"W	Fixed	Two 5½"W	Two 16½"W	177 lb
44"W	Fixed	One 5½"W	Two 16½"W	180 lb
44"W	Fixed	Two 5½"W	11"W and 16½"W	178 lb
49½"W	Fixed	N.A.	Two 16½"W	185 lb
49½"W	Fixed	One 5½"W	11"W and 16½"W	185 lb
49½"W	Fixed	Two 5½"W	Two 11"W	184 lb
55"W	Fixed	N.A.	11"W and 16½"W	190 lb
55"W	Fixed	One 5½"W	Two 11"W	185 lb
55"W	Fixed	Two 5½"W	16½"W	187 lb
60½"W	Fixed	N.A.	Two 11"W	190 lb
60½"W	Specify fixed or sleeper	Two 5½"W	11"W	192 lb
60½"W	Fixed	One 5½"W	16½"W	171 lb
66"W	Fixed	N.A.	16½"W	180 lb
66"W	Fixed	One 5½"W	11"W	183 lb
71½"W	Sleeper	Two 5½"W	N.A.	214 lb

***Configurations with asterisk come in fixed back and sleeper back options.**

Tip: Understand the dimensions of the architectural space to determine the frame.

Tip: Specify the maximum frame dimension to maximize experience and options.

Tip: All components must fit within the frame dimension (seat, back, arms, and storage).

Tip: Left and right is determined when facing the unit.

Tip: Understand the dimensions of the architectural space to accommodate components that may extend outside frame dimensions.

Tip: Seat and back must be the same width.

Tip: Low arm and high-recline arm are available in left- or right-facing positions.

Tip: High-recline arm placed on end of unit extends 3¾" from the frame at the outermost point.

Tip: Storage end table can be specified in one- or two-tier option.

Tip: Storage end table mounts only to the right or left side of the frame unit.

Tip: Two-tier storage requires the specification of an adjacent arm on frame.

Tip: Storage cannot be specified adjacent to other storage.

Tip: 71½"W and 77"W seats are standard with a fold-down sleep surface and require two arms.

Tip: 60½"W and 66"W seats can be specified with or without a fold-down sleep surface.

Tip: If a sleep surface is required, an 71½"W frame is the smallest frame that can be specified.

Tip: Sleep surface requires the specification of two arms.

Tip: Storage width must match storage size specified on frame.

Tip: Power, two front glides and two directional back wheel casters, and mobile tablet can be specified on all units.

Tip: Unit weights are approximations and may vary between units.

Tip: Unit weights include one-tier storage where applicable.

88" W Frame				
Seat/Back/Outer Back	Fixed or Sleeper Back	Number of Arms (Positioned on Left and/or Right)	Storage (Positioned on Left and/or Right)	Weight
44"W	Fixed	Two 5½"W	Two 16½"W	181 lb
49½"W	Fixed	One 5½"W	Two 16½"W	180 lb
49½"W	Fixed	Two 5½"W	11"W and 16½"W	186 lb
55"W	Fixed	N.A.	Two 16½"W	190 lb
55"W	Fixed	One 5½"W	11"W and 16½"W	185 lb
55"W	Fixed	Two 5½"W	Two 11"W	191 lb
60½"W	Fixed	N.A.	11"W and 16½"W	193 lb
60½"W	Fixed	One 5½"W	Two 11"W	193 lb
60½"W	Specify fixed or sleeper	Two 5½"W	16½"W	195 lb
66"W	Fixed	N.A.	Two 11"W	200 lb
66"W	Fixed	One 5½"W	16½"W	200 lb
66"W	Specify fixed or sleeper	Two 5½"W	11"W	207 lb
77"W	Sleeper	Two 5½"W	N.A.	235 lb

93½" W Frame				
Seat/Back/Outer Back	Fixed or Sleeper Back	Number of Arms (Positioned on Left and/or Right)	Storage (Positioned on Left and/or Right)	Weight
49½"W	Fixed	Two 5½"W	Two 16½"W	216 lb
55"W	Fixed	One 5½"W	Two 16½"W	218 lb
55"W	Fixed	Two 5½"W	11"W and 16½"W	221 lb
60½"W	Fixed	N.A.	Two 16½"W	223 lb
60½"W	Fixed	One 5½"W	11"W and 16½"W	223 lb
60½"W	Specify fixed or sleeper	Two 5½"W	Two 11"W	226 lb
66"W	Fixed	N.A.	11"W and 16½"W	230 lb
66"W	Fixed	One 5½"W	Two 11"W	230 lb
66"W	Specify fixed or sleeper	Two 5½"W	16½"W	237 lb
71½"W	Sleeper	Two 5½"W	11"W	248 lb

99" W Frame				
Seat/Back/Outer Back	Fixed or Sleeper Back	Number of Arms (Positioned on Left and/or Right)	Storage (Positioned on Left and/or Right)	Weight
55"W	Fixed	Two 5½"W	Two 16½"W	225 lb
60½"W	Fixed	One 5½"W	Two 16½"W	228 lb
60½"W	Specify fixed or sleeper	Two 5½"W	11"W and 16½"W	231 lb
66"W	Fixed	N.A.	Two 16½"W	235 lb
66"W	Fixed	One 5½"W	11"W and 16½"W	240 lb
66"W	Specify fixed or sleeper	Two 5½"W	Two 11"W	242 lb
71½"W	Sleeper	Two 5½"W	16½"W	252 lb
77"W	Sleeper	Two 5½"W	11"W	270 lb

Surround Configuration Charts, continued

Tip: Understand the dimensions of the architectural space to determine the frame.

Tip: Specify the maximum frame dimension to maximize experience and options.

Tip: All components must fit within the frame dimension (seat, back, arms, and storage).

Tip: Left and right is determined when facing the unit.

Tip: Understand the dimensions of the architectural space to accommodate components that may extend outside frame dimensions.

Tip: Seat and back must be the same width.

Tip: Low arm and high-recline arm are available in left- or right-facing positions.

Tip: High-recline arm placed on end of unit extends 3³/₄" from the frame at the outermost point.

Tip: Storage end table can be specified in one- or two-tier option.

Tip: Storage end table mounts only to the right or left side of the frame unit.

Tip: Two-tier storage requires the specification of an adjacent arm on frame.

Tip: Storage cannot be specified adjacent to other storage.

Tip: 71¹/₂"W and 77"W seats are standard with a fold-down sleep surface and require two arms.

Tip: 60¹/₂"W and 66"W seats can be specified with or without a fold-down sleep surface.

Tip: If a sleep surface is required, a 71¹/₂"W frame is the smallest frame that can be specified.

Tip: Sleep surface requires the specification of two arms.

Tip: Power, two front glides and two directional back wheel casters, and mobile tablet can be specified on all units.

Tip: Unit weights are approximations and may vary between units.

Tip: Unit weights include one-tier storage where applicable.

104 ¹ / ₂ " W Frame				
Seat/Back/Outer Back	Fixed or Sleeper Back	Number of Arms (Positioned on Left and/or Right)	Storage (Positioned on Left and/or Right)	Weight
60 ¹ / ₂ "W	Specify fixed or sleeper	Two 5 ¹ / ₂ "W	Two 16 ¹ / ₂ "W	339 lb
66"W	Fixed	One 5 ¹ / ₂ "W	Two 16 ¹ / ₂ "W	345 lb
66"W	Specify fixed or sleeper	Two 5 ¹ / ₂ "W	11"W and 16 ¹ / ₂ "W	351 lb
71 ¹ / ₂ "W	Sleeper	Two 5 ¹ / ₂ "W	Two 11"W	362 lb
77"W	Sleeper	Two 5 ¹ / ₂ "W	16 ¹ / ₂ "W	379 lb

*Configurations with asterisk come in fixed back and sleeper back options.

Surround Height Diagram

Front View

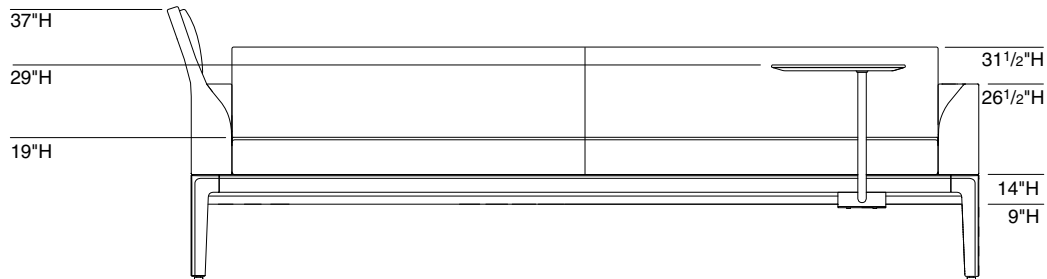

Front View with Sleep Surface Deployed

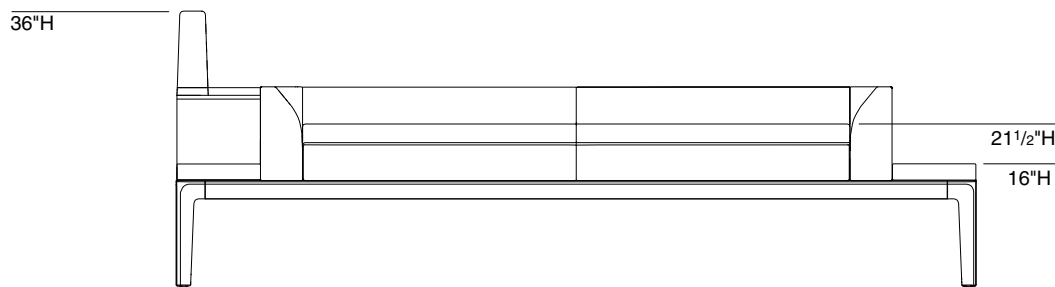

Rear View

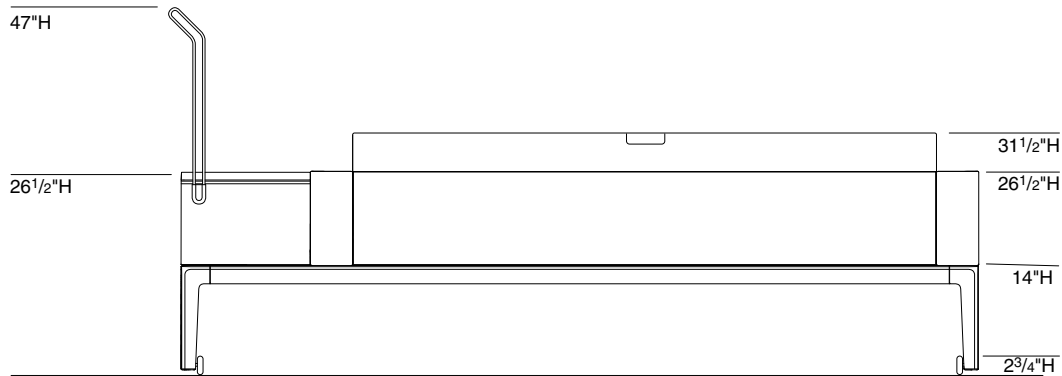

Surround Lounge

Units have a modular design that comes assembled (seat, back, outer back, frame, and arms). Mobile tablet and storage are available and must be specified separately.

Upholstery for seat, back, outer back, and arms must be specified separately. They can have different fabrics.

Low arm and high-recline arm are available in right- or left-facing positions. Specify each arm individually.

Glides are standard with frame and have a 1½" adjustment range.

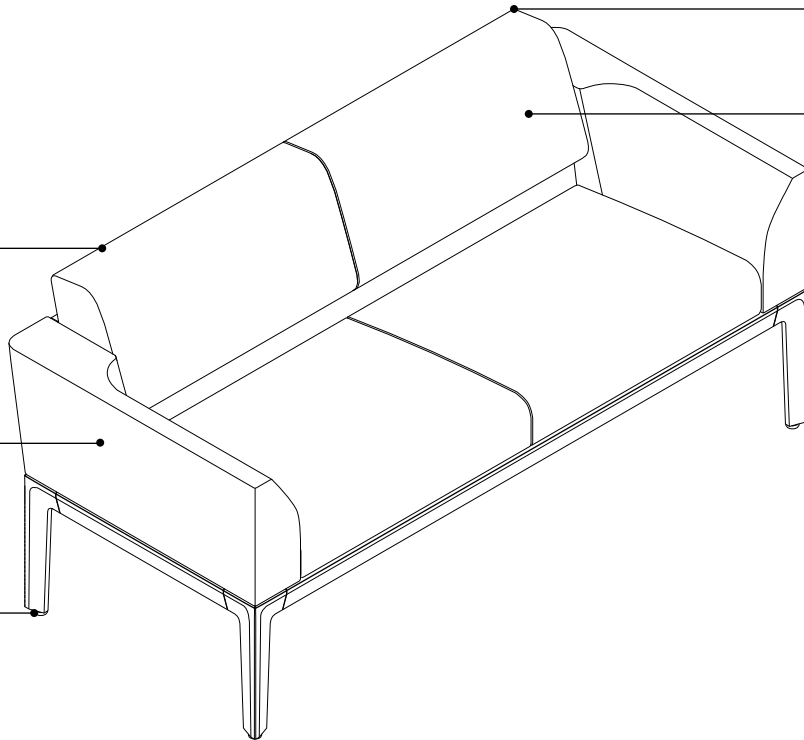

Structural outer back extends 3½" behind the frame at its outermost point.

Back includes an upholstered structural outer back and upholstered back.

Actual Dimensions

	Depth	Width	Height
Base Frames	27½"	44"	14"
	27½"	55"	14"
	27½"	60½"	14"
	27½"	66"	14"
	27½"	71½"	14"
	27½"	77"	14"
	27½"	82½"	14"
	27½"	88"	14"
	27½"	93½"	14"
	27½"	99"	14"
	27½"	104½"	14"
Seat, Back, and Outer Back	N.A.	33"	N.A.
	N.A.	38½"	N.A.
	N.A.	44"	N.A.
	N.A.	49½"	N.A.
	N.A.	55"	N.A.
	N.A.	60½"	N.A.
	N.A.	66½"	N.A.
	N.A.	71½"	N.A.
	N.A.	77"	N.A.

Product Details

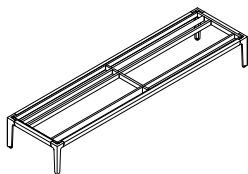

Frame understructure is welded, tubular steel.

Frames are dynamically tested to 550 pounds and statically tested to 750 pounds in all seating positions.

Aluminum extrusion trims span between each corner leg.

Cast aluminum legs are attached to steel understructure to provide support and add visual continuity.

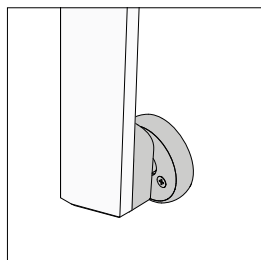

Mobile option includes two directional back wheel casters mounted on the frame leg.

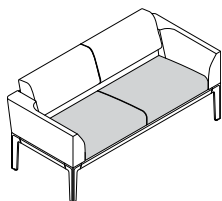

Seat cushions offer a contoured design to maximize overall comfort.

Seat cushions are available in various widths (see actual dimensions).

Crumb sweeps are on all three sides of seat cushions.

Seat cushions in widths of 55", 60½", 66", 71½", and 77" come with a single center seam.

Seat cushions have a depth of 18½".

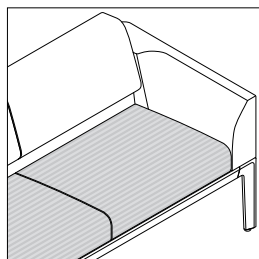

Fabric is applied to the seats in the railroad or horizontal direction to remain consistent with the backs.

Patterned fabrics will not match between seats, arms, and backs.

Large, patterned fabrics should be used selectively and are not recommended for use on all components.

Contrasting fabrics are available on seat and back cushions.

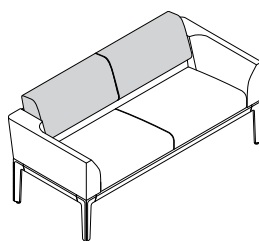

Back cushions are available in various widths (see actual dimensions).

Back cushions in widths of 55", 60½", 66", 71½", and 77" come with a single center seam.

Sleeper surface is standard with back widths of 71½" and 77".

Sleep surface is an option with back widths of 60½"W and 66"W.

Sleep surface requires the specification of two arms.

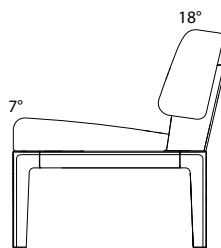

Seat cushions have a 7° recline and back cushions have an 18° recline.

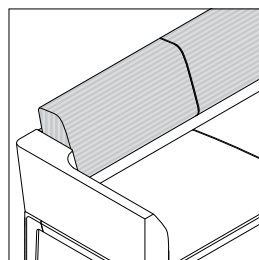

Fabric is applied to the backs in the railroad or horizontal direction to remain consistent with the seat cushions.

Fabric on the top of the back will match patterns on the front of the back but is applied to waterfall over the ends. Ends will not match top and front of back.

Contrasting fabrics are available on back cushions and the structural outer back.

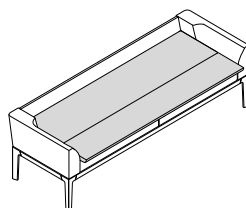

Sleep surface folds down in three easy steps and is designed for maximum comfort.

Sleep surface has a depth of 28".

Sleep surface standard material is an oxford nylon with urethane coating.

Sleep surface extends 2" past seat when deployed.

Sleep surface material comes standard with moisture barrier.

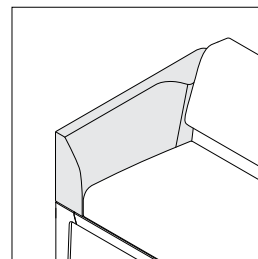

Low arm offers wrap-around contour support that supports a lounge posture.

Low arm dimensions are 31"D x 5½"W x 12½"H.

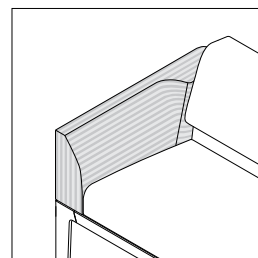

Contrasting fabrics are available on low arms and high-recline arms.
Tip: Thread color that is associated with the more dominant fabric color or surface area will be applied throughout the upholstery.

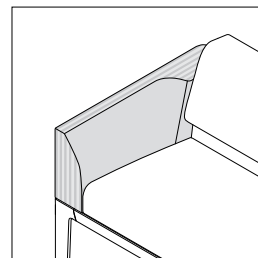

Fabric on the top of the arm will not match patterns on inner arm but is applied to waterfall over the ends. Ends will not match top and sides of arm.

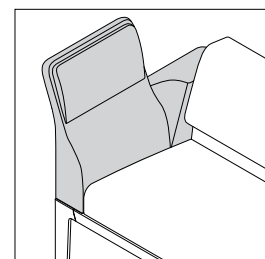

High-recline arm dimensions are 31"D x 5½"W x 23"H.

High-recline arm supports a natural reclining posture.

High-recline arm is standard with an integrated pillow to provide added comfort.

Contrasting fabrics are available on high-recline arm and high-recline pillow.

Patterned fabrics will not match between high-recline arm and high-recline pillow.

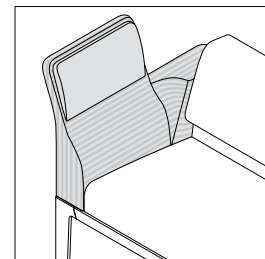

Fabric on the top of the high-recline arm will match patterns on inner arm but is applied to waterfall over the ends. Ends will not match top and sides of arm.

Surround Lounge, continued

Wiring and Cabling

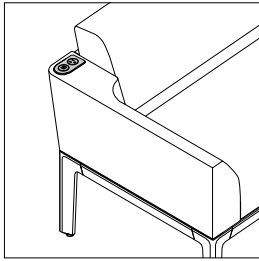

Power can be integrated in low arms or high-recline arms and offers options for up to four devices.

Power options are tamper and spill resistant.

Power options include two standard outlets, two standard outlets with light capability, one standard outlet and two USBs, one standard outlet and two USBs with light capability, four USBs, and four USBs with light capability.

Power outlets are standard 110V outlets and are not hospital grade. If hospital grade is required, please specify the four USB port power option.

The USB ports are USB type A with two amps per port.

Only four USB ports total may be specified in a unit.

Power options without light capability can be integrated within each arm specified.

Power with light capability can only be specified if adjacent two-tier storage and light are specified.

One-arm units specified with two standard outlets without light capability power option will have a 8' power cord that exits the lower center back of the arm specified with power.

Two-arm units specified with two standard outlet without light capability power option in one arm and no power in the other will have a 8' power cord that exits the lower center back of the arm specified with power.

Two-arm units specified with two standard outlets without light capability in both arms will have one 8' power cord exiting the back of each arm.

One or two arm units specified with any other power option except two standard outlets without light capability will have a 8' power cord exiting the lower center back of the unit.

Application Topics

The dimension of the architectural space accommodates components that may extend outside frame dimensions.

All components must fit within the frame dimension (seat, back, outer back, arms, and storage).

Seat cushion width specification determines back cushion and structural outer back widths.

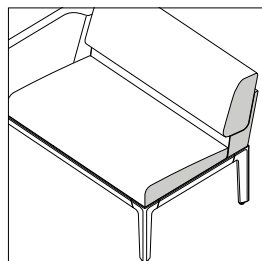

When only one arm is specified, the opposite sides of back, outer back, and seat will be upholstered in their respective upholstery.

If a sleep surface is required, specify 71½"W or 77"W seat.

Sleep surface is standard with integrated instructions for use.

Sleep surface extends 2" past the seat.

Mobile tablet can easily be positioned to not interfere with sleep surface during deployment.

Adding two-tier storage requires the specification of an adjacent arm.

Low arm specified adjacent to storage allows for easier access than high-recline arm.

Power location and power type in the arm must be specified.

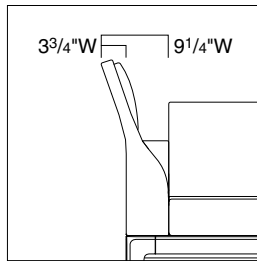

High-recline arm placed on end of unit extends 3¾" from the frame at the outermost point.

High-recline arm is recommended to be specified to allow reclining posture to face wall containing media, such as a monitor or television.

Connections

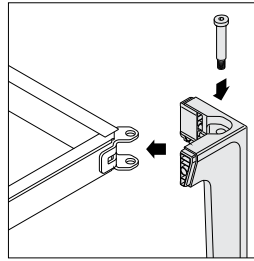

Cast legs come assembled to steel frame with bolts at each corner of the frame.

Surface Materials

All Steelcase Health seating with standard upholstery fabrics comply with the State of California Technical Bulletin 117-2013.

Frame

- Paint

Glides

- Platinum solid plastic

Rail (option)

- Grey paint

Casters (option)

- 7360 Merle

Seat/back/outer back

- Fabric

Sleep surface

- 5031 Light Merle

Low arm

- Fabric

High-recline arm

- Fabric

Power (option)

- 6527 Merle

Surround Storage End Tables

Storage end tables are available in a one- or two-tier option, in two widths: 11"W and 16½"W.

Storage tray with picture rail is standard on two-tier end table.

Adding two-tier storage requires the specification of an adjacent arm.

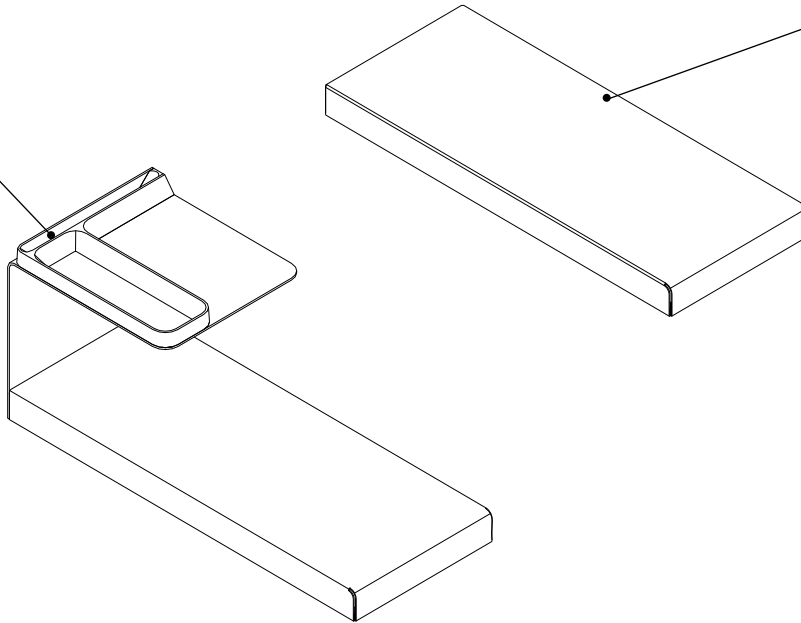

Storage is offered in a variety of Steelcase paint finishes.

Actual Dimensions

	Depth	Width	Height
One-Tier End Table	27½"	11"	2"
	27½"	16½"	2"
Two-Tier End Table	27½"	11"	12½"
	27½"	16½"	12½"

Product Details

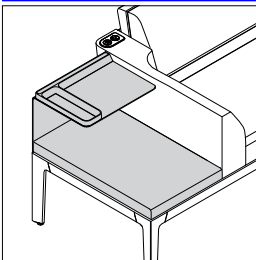

Two-tier end table offers coat hanger and light option.

Top tier of two-tier end table has a depth of 12¾".

Storage tray with picture rail is standard on two-tier end table.

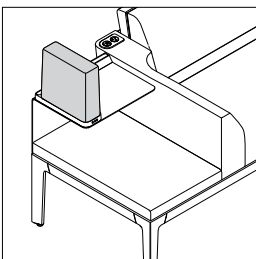

Light is integrated in the two-tier end table and is protected by a durable acrylic shade.

Light is user-adjustable and provides integrated touch control buttons to enhance the care partner experience.

Light source includes an LED fixture that connects to specified power option in adjacent arm.

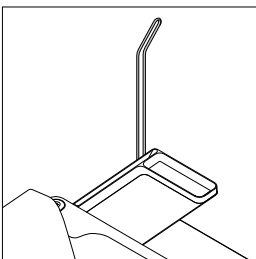

Coat hanger is available on the two-tier end table. It provides vertical organization and supports multiple coats.

Coat hanger is easily accessible and points away from unit.

Coat hanger is a formed continuous loop of 5/16" steel rod.

Application Topics

Storage mounts only to the right or left end of the frame.

Two-tier storage requires the specification of an adjacent arm. One-tier storage does not.

If a low arm is specified adjacent to storage, it allows for easier access.

Storage cannot be specified adjacent to other storage.

Storage width and location must be specified individually. Storage location is determined when frame is specified.

Two-tier end table is available in contrasting finishes.

Lighting requires specification of the two-tier end table.

Lighting requires the specification of power with light in arm adjacent to storage.

Storage tray with picture rail is not available when light is specified.

When power with light capability is specified on the frame, a cutout is made for the light, which is specified separately on two-tier storage.

Only one power with light may be specified in a unit.

Coat hanger attaches to the back of the two-tier end table on site.

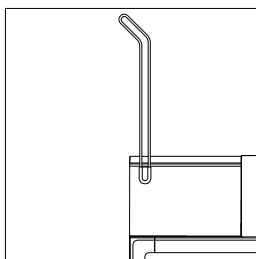

Coat hanger extends 2" from the frame at its outermost point.

Surface Materials

Storage
• Paint

Storage tray with picture rail
• 6527 Merle

Light base (option)
• 6527 Merle

Shade (option)
• White opaque acrylic

Coat hanger (option)
• Paint

Surround Mobile Tablet

Mobile tablet surface is designed to accommodate eating, working, entertaining, and writing.

Mobile tablet surface is offered in a variety of Steelcase plastic finishes.

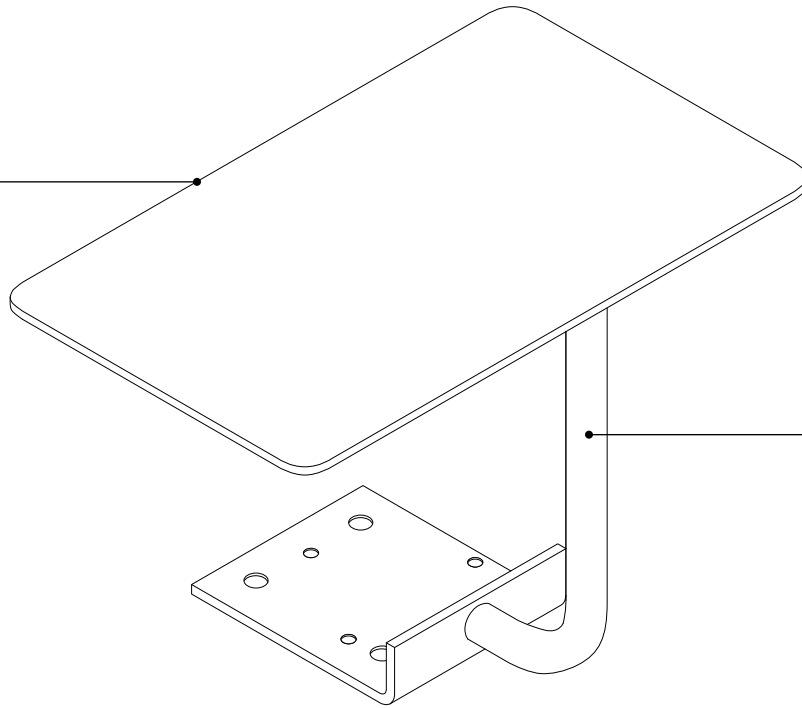

Tablet arm is offered in a variety of Steelcase paint finishes.

Actual Dimensions

	Depth	Width	Height
Mobile Tablet Surface	12"	19½"	7/8"

Product Details

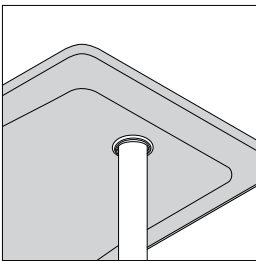

Tablet surface pivots 360°.

Mobile tablet is injection-molded and vibration-welded to create a barrier against moisture.

Mobile tablet is positioned 10" above the seat cushion.

Tablet surface load capacity is 100 pounds.

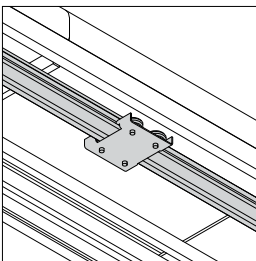

Tablet rail is specified on frame. Tablet rail can be added to existing Surround frame in the field.

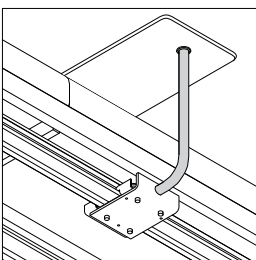

Tablet arm slides along the rail the length of the frame.

Tablet surface has a safe, yielding failure mode.

Application Topics

Mobile tablet is ordered separately and attaches to frame on site.

One tablet rail and mobile tablet can be specified per unit.

Tablet rails have stops to ensure no interference with an adjacent object.

Additional stops can be inserted to prevent interference with other objects.

Tablet rail rollers are protected, preventing pinch points.

Surface Materials

Surface

- Plastic

Tablet arm

- Paint

Surround Lounge

44" Frame Width

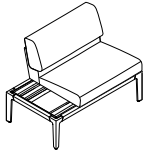

Tip: Left and right determined when facing the unit.

Tip: Understand that standard requires further specification to complete unit.

Tip: For additional specification information, refer to Surround Configuration Charts.

▶ See page 550.

Tip: Fabric upcharges are applied separately for seat, back, and outer back.

Tip: Only four USB ports total may be specified in a unit.



Surround components are not designed for use with international power.



For Canadian Pricing

Multiply U.S. Price by the Canadian price factor.

▶ See page 1 for details.

Standard Includes		Required to Specify
▶ Need help? Product details, page 556	<ul style="list-style-type: none"> • Frame: paint price group 1 • Seat, back, and outer back: fabric price group 1 • Adjustable glides: platinum solid plastic 	<ol style="list-style-type: none"> 1 Style number 2 Seat, back, and outer back width (see below under Required Selections) 3 Paint color number for frame 4 Fabric color number for seat, back, and outer back 5 Arm position (see below under Required Selections) 6 Options, if selected (see below) <p>▶ See <i>Surface Materials</i>, page 677.</p>

Required Selections	U.S. Price	Required to Specify
Seat, Back, and Outer Back Width		
• 33"W seat, back, and outer back	Price at right	Specify with 33"W seat, back, and outer back.
• 38 ¹ / ₂ "W seat, back, and outer back	Price at right	Specify with 38 ¹ / ₂ "W seat, back, and outer back.
• 44"W seat, back, and outer back	Price at right	Specify with 44"W seat, back, and outer back.
Arms		
• No arms	Prices at right	Specify with no arms.
• One arm	Prices at right	Specify with arm right- or left-facing.
• Two arms	Prices at right	Specify with two arms right- and left-facing.

Options	U.S. Price	Required to Specify
Surface Materials		
Frame		
• Paint price group 1	No cost	Specify paint color number.
• Paint price group 2	+\$ 29	Specify paint color number.
• Paint price group 3	+\$103	Specify paint color number.
		▶ See <i>Surface Materials</i> , page 677.
Seat, back, and outer back		
• Fabric	Prices at right	Specify fabric color number.
Arm(s)		
• Fabric	Prices at right	Specify fabric color number.
High arm pillow (if high arm(s) selected)		
• Fabric	Prices at right	Specify fabric color number.
Arm Height(s)		
Right		
• Right arm low	No cost	Specify with right arm low.
• Right arm high	+\$153	Specify with right arm high.
Left		
• Left arm low	No cost	Specify with left arm low.
• Left arm high	+\$153	Specify with left arm high.
Power		
Right		
• Right arm no power	No cost	Specify with right arm no power.
• Right arm two power	+\$383	Specify with right arm two power.
• Right arm one power, two USB	+\$454	Specify with right arm one power, two USB.
• Right arm, four USB	+\$454	Specify with right arm, four USB.
Left		
• Left arm no power	No cost	Specify with left arm no power.
• Left arm two power	+\$383	Specify with left arm two power.
• Left arm one power, two USB	+\$454	Specify with left arm one power, two USB.
• Left arm, four USB	+\$454	Specify with left arm, four USB.

▶ Options, continued on next page

► Options, continued from previous page

Options	U.S. Price	Required to Specify
Mobility • Two glides and two casters	+\$520	Specify with two glides and two casters.
Tablet Rail • Tablet rail	+\$444	Specify with tablet rail.
Related Products • Mobile tablet		► Page 607

Tip: Mobile tablet is specified separately.

► See page 607.

Fabric Upcharges

Style Number	Width	Fabric Price	Fabric Price Group 1	Fabric Price Group 2	Fabric Price Group 3	Fabric Price Group 4	Fabric Price Group 5	Fabric Price Group 6	Fabric Price Group 7	Fabric Price Group 8	Fabric Price Group 9	Fabric Price Group 10	COM

Tip: Seat, back, and outer back fabrics may be specified in different choices.

► See Understanding Lounge on page 556.

HLS44	Seat	33"	38 1/2"	44"
	Seat	No cost	No cost	No cost
		+\$38	+\$38	+\$48
		+\$70	+\$70	+\$88
		+\$114	+\$114	+\$145
		+\$167	+\$167	+\$211
		+\$233	+\$233	+\$296
		+\$570	+\$570	+\$628
		+\$722	+\$722	+\$809
		+\$859	+\$859	+\$973
		+\$1010	+\$1010	+\$1152
		+\$12	+\$12	+\$15
	Back	No cost	No cost	No cost
		+\$38	+\$38	+\$48
		+\$70	+\$70	+\$88
		+\$114	+\$114	+\$145
		+\$167	+\$167	+\$211
		+\$233	+\$233	+\$296
		+\$570	+\$570	+\$628
		+\$722	+\$722	+\$809
		+\$859	+\$859	+\$973
		+\$1010	+\$1010	+\$1152
		+\$12	+\$12	+\$15
	Outer Back	No cost	No cost	No cost
		+\$38	+\$38	+\$48
		+\$70	+\$70	+\$88
		+\$114	+\$114	+\$145
		+\$167	+\$167	+\$211
		+\$233	+\$233	+\$296
		+\$570	+\$570	+\$628
		+\$722	+\$722	+\$809
		+\$859	+\$859	+\$973
		+\$1010	+\$1010	+\$1152
		+\$12	+\$12	+\$15
	Arm	No cost	No cost	No cost
		+\$36	+\$36	+\$56
		+\$49	+\$49	+\$76
		+\$96	+\$96	+\$149
		+\$125	+\$125	+\$193
		+\$145	+\$145	+\$268
		+\$189	+\$189	+\$363
		+\$253	+\$253	+\$436
		+\$317	+\$317	+\$534
		+\$388	+\$388	+\$644
		+\$15	+\$15	+\$23
	High Arm Pillow	No cost	No cost	No cost
		+\$36	+\$36	+\$56
		+\$49	+\$49	+\$76
		+\$96	+\$96	+\$149
		+\$125	+\$125	+\$193
		+\$145	+\$145	+\$268
		+\$189	+\$189	+\$363
		+\$253	+\$253	+\$436
		+\$317	+\$317	+\$534
		+\$388	+\$388	+\$644
		+\$15	+\$15	+\$23

Tip: Arm fabric and high arm pillow fabric is per arm selected.

Tip: High arm and pillow fabrics may be specified in different choices.

► See Understanding Lounge on page 556.

Specification Information

Style Number	Frame Dimensions		Seat, Back, and Outer Back Width	U.S. Base Prices Low Arms		
	W	D		No arm(s)	One arm	Two arms

44" Frame Width

HLS44	44"	27 1/2"	33"	\$2082	N.A.	\$2760
			38 1/2"	N.A.	\$2559	N.A.
			44"	\$2459	N.A.	N.A.

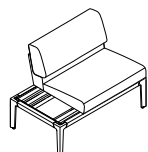

For Canadian Pricing
 Multiply U.S. Price by the Canadian price factor.
 ► See page 1 for details.

Surround Lounge

55" Frame Width

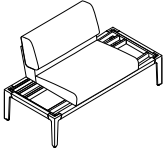

Tip: Left and right determined when facing the unit.

Tip: Understand that standard requires further specification to complete unit.

Tip: For additional specification information, refer to Surround Configuration Charts.

▶ See page 550.

Tip: Fabric upcharges are applied separately for seat, back, and outer back.

Tip: Storage is specified separately.

▶ See pages 605–606.

Tip: Storage not available if 49 1/2"W seat, back, and outer back is specified.

Tip: Storage type is only specified when storage size and location is chosen.



For Canadian Pricing

Multiply U.S. Price by the Canadian price factor.

▶ See page 1 for details.

Standard Includes	Required to Specify
<p>▶ Need help? Product details, page 556</p> <ul style="list-style-type: none"> • Frame: paint price group 1 • Seat, back, and outer back: fabric price group 1 • One low arm (if 33"W, 38 1/2"W, or 49 1/2"W seat, back, and outer back selected): fabric price group 1 • Two low arms (if 44"W seat, back, and outer back selected): fabric price group 1 • Adjustable glides: platinum solid plastic 	<ol style="list-style-type: none"> 1 Style number 2 Seat, back, and outer back width (see below under Required Selections) 3 Paint color number for frame 4 Fabric color number for seat, back, and outer back 5 Fabric color number for arm(s) 6 Arm position (see below under Required Selections) 7 Options, if selected (see below) <p>▶ See <i>Surface Materials</i>, page 677.</p>

Required Selections	U.S. Price	Required to Specify
<p>Seat, Back, and Outer Back Width</p> <ul style="list-style-type: none"> • 33"W seat, back, and outer back • 38 1/2"W seat, back, and outer back • 44"W seat, back, and outer back • 49 1/2"W seat, back, and outer back • 55"W seat, back, and outer back 	<p>Price at right</p> <p>Price at right</p> <p>Price at right</p> <p>Price at right</p> <p>Price at right</p>	<p>Specify with 33"W seat, back, and outer back.</p> <p>Specify with 38 1/2"W seat, back, and outer back.</p> <p>Specify with 44"W seat, back, and outer back.</p> <p>Specify with 49 1/2" seat, back, and outer back.</p> <p>Specify with 55" W seat, back, and outer back.</p>
<p>Arm Position</p> <ul style="list-style-type: none"> • No arms • One arm • Two arms 	<p>Prices at right</p> <p>Prices at right</p> <p>Prices at right</p>	<p>Specify with no arms.</p> <p>Specify with arm right- or left-facing.</p> <p>Specify with two arms right- and left-facing.</p>

Options	U.S. Price	Required to Specify
<p>Surface Materials</p> <p>Frame</p> <ul style="list-style-type: none"> • Paint price group 1 • Paint price group 2 • Paint price group 3 	<p>No cost</p> <p>+\$ 29</p> <p>+\$103</p>	<p>Specify paint color number.</p> <p>Specify paint color number.</p> <p>Specify paint color number.</p> <p>▶ See <i>Surface Materials</i>, page 677.</p>
<p>Seat, back, and outer back</p> <ul style="list-style-type: none"> • Fabric 	<p>Prices at right</p>	<p>Specify fabric color number.</p>
<p>Arm(s)</p> <ul style="list-style-type: none"> • Fabric 	<p>Prices at right</p>	<p>Specify fabric color number.</p>
<p>High arm pillow (if high arm(s) selected)</p> <ul style="list-style-type: none"> • Fabric 	<p>Prices at right</p>	<p>Specify fabric color number.</p>
<p>Storage Size(s) and Location(s)</p> <ul style="list-style-type: none"> • No storage • 11"W right-facing storage • 16 1/2"W right-facing storage • 11"W left-facing storage • 16 1/2"W left-facing storage 	<p>No cost</p> <p>No cost</p> <p>No cost</p> <p>No cost</p> <p>No cost</p>	<p>Specify with no storage.</p> <p>Specify with 11"W right-facing storage.</p> <p>Specify with 16 1/2"W right-facing storage.</p> <p>Specify with 11"W left-facing storage.</p> <p>Specify with 16 1/2"W left-facing storage.</p>
<p>Storage Type</p> <p>Right</p> <ul style="list-style-type: none"> • Right one-tier end table • Right two-tier end table <p>Left</p> <ul style="list-style-type: none"> • Left one-tier end table • Left two-tier end table 	<p>No cost</p> <p>No cost</p> <p>No cost</p> <p>No cost</p>	<p>Specify with right one-tier end table.</p> <p>Specify with right two-tier end table.</p> <p>Specify with left one-tier end table.</p> <p>Specify with left two-tier end table.</p>

▶ Options, continued on next page

► Options, continued from previous page

	Options	U.S. Price	Required to Specify
Arm Height(s)	Right		
	• Right arm low	No cost	Specify <i>with right arm low</i> .
	• Right arm high	+\$153	Specify <i>with right arm high</i> .
	Left		
	• Left arm low	No cost	Specify <i>with left arm low</i> .
	• Left arm high	+\$153	Specify <i>with left arm high</i> .
Power and Light	Right		
	• Right arm no power	No cost	Specify <i>with right arm no power</i> .
	• Right arm two power	+\$383	Specify <i>with right arm two power</i> .
	• Right arm one power, two USB	+\$454	Specify <i>with right arm one power, two USB</i> .
	• Right arm, four USB	+\$454	Specify <i>with right arm, four USB</i> .
	• Right arm two power, with light capability	+\$383	Specify <i>with right arm two power, with light capability</i> .
	• Right arm one power, two USB, with light capability	+\$454	Specify <i>with right arm one power, two USB, with light capability</i> .
	• Right arm, four USB, with light capability	+\$454	Specify <i>with right arm, four USB, with light capability</i> .
	Left		
	• Left arm no power	No cost	Specify <i>with left arm no power</i> .
	• Left arm two power	+\$383	Specify <i>with left arm two power</i> .
	• Left arm one power, two USB	+\$454	Specify <i>with left arm one power, two USB</i> .
	• Left arm, four USB	+\$454	Specify <i>with left arm, four USB</i> .
• Left arm two power, with light capability	+\$383	Specify <i>with left arm two power, with light capability</i> .	
• Left arm one power, two USB, with light capability	+\$454	Specify <i>with left arm one power, two USB, with light capability</i> .	
• Left arm, four USB, with light capability	+\$454	Specify <i>with left arm, four USB, with light capability</i> .	
Mobility	• Two glides and two casters	+\$520	Specify <i>with two glides and two casters</i> .
Tablet Rail	• Tablet rail	+\$444	Specify <i>with tablet rail</i> .
Related Products	• Storage, one-tier end table		► Page 605
	• Storage, two-tier end table		► Page 606
	• Mobile tablet		► Page 607

► Options, continued on next page

Tip: Power with light can only be specified if adjacent two-tier storage and light are specified. There is an upcharge for the light option on two-tier storage.

► See page 606.



Surround components are not designed for use with international power.

Tip: Only one power with light may be specified in a unit.

Tip: Only four USB ports total may be specified in a unit.

Tip: Mobile tablet is specified separately.

► See page 607.

**For Canadian Pricing**

Multiply U.S. Price by the Canadian price factor.

► See page 1 for details.

Surround Lounge, 55" Frame Width, continued

► Options, continued from previous page

Fabric Upcharges

Style Number	Width	Fabric Price	Fabric Price Group 1	Fabric Price Group 2	Fabric Price Group 3	Fabric Price Group 4	Fabric Price Group 5	Fabric Price Group 6	Fabric Price Group 7	Fabric Price Group 8	Fabric Price Group 9	Fabric Price Group 10	COM
HLS55 Seat													
33"	No cost	+\$38	+\$ 70	+\$114	+\$167	+\$233	+\$570	+\$722	+\$ 859	+\$1010	+\$12		
38½"	No cost	+\$38	+\$ 70	+\$114	+\$167	+\$233	+\$570	+\$722	+\$ 859	+\$1010	+\$12		
44"	No cost	+\$48	+\$ 88	+\$145	+\$211	+\$296	+\$628	+\$809	+\$ 973	+\$1152	+\$15		
49½"	No cost	+\$56	+\$103	+\$170	+\$249	+\$348	+\$647	+\$848	+\$1029	+\$1228	+\$17		
55"	No cost	+\$58	+\$107	+\$175	+\$257	+\$360	+\$653	+\$869	+\$1079	+\$1295	+\$18		
Back													
33"	No cost	+\$38	+\$ 70	+\$114	+\$167	+\$233	+\$570	+\$722	+\$ 859	+\$1010	+\$12		
38½"	No cost	+\$38	+\$ 70	+\$114	+\$167	+\$233	+\$570	+\$722	+\$ 859	+\$1010	+\$12		
44"	No cost	+\$48	+\$ 88	+\$145	+\$211	+\$296	+\$628	+\$809	+\$ 973	+\$1152	+\$15		
49½"	No cost	+\$56	+\$103	+\$170	+\$249	+\$348	+\$647	+\$848	+\$1029	+\$1228	+\$17		
55"	No cost	+\$58	+\$107	+\$175	+\$257	+\$360	+\$653	+\$869	+\$1079	+\$1295	+\$18		
Outer Back													
33"	No cost	+\$38	+\$ 70	+\$114	+\$167	+\$233	+\$570	+\$722	+\$ 859	+\$1010	+\$12		
38½"	No cost	+\$38	+\$ 70	+\$114	+\$167	+\$233	+\$570	+\$722	+\$ 859	+\$1010	+\$12		
44"	No cost	+\$48	+\$ 88	+\$145	+\$211	+\$296	+\$628	+\$809	+\$ 973	+\$1152	+\$15		
49½"	No cost	+\$56	+\$103	+\$170	+\$249	+\$348	+\$647	+\$848	+\$1029	+\$1228	+\$17		
55"	No cost	+\$58	+\$107	+\$175	+\$257	+\$360	+\$653	+\$869	+\$1079	+\$1295	+\$18		
Arm													
Low	No cost	+\$36	+\$ 49	+\$ 96	+\$125	+\$145	+\$189	+\$253	+\$ 317	+\$ 388	+\$15		
High	No cost	+\$56	+\$ 76	+\$149	+\$193	+\$268	+\$363	+\$436	+\$ 534	+\$ 644	+\$23		
High Arm Pillow													
Pillow	No cost	+\$36	+\$ 49	+\$ 96	+\$125	+\$145	+\$189	+\$253	+\$ 317	+\$ 388	+\$15		

Tip: Seat, back, and outer back fabrics may be specified in different choices. ► See Understanding Lounge on page 556.

Tip: Arm fabric and high arm pillow fabric is per arm selected.

Tip: High arm and pillow fabrics may be specified in different choices. ► See Understanding Lounge on page 556.

Specification Information

Style Number	Frame Dimensions		Seat, Back, and Outer Back Width	U.S. Base Prices Low Arms		
	W	D		No arm(s)	One arm	Two arms

55" Frame Width

HLS55	55"	27½"	33"	\$2302	\$2641	N.A.
			38½"	\$2440	\$2779	N.A.
			44"	\$2679	N.A.	\$3357
			49½"	N.A.	\$3239	N.A.
			55"	\$3057	N.A.	N.A.

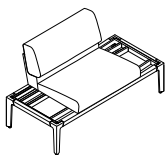

For Canadian Pricing
 Multiply U.S. Price by the Canadian price factor.
 ► See page 1 for details.

Surround Lounge

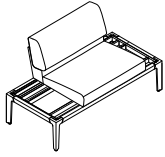
60¹/₂" Frame Width

Standard Includes	Required to Specify
-------------------	---------------------

<ul style="list-style-type: none"> ▶ Need help? Product details, page 556 	<ul style="list-style-type: none"> • Frame: paint price group 1 • Seat, back, and outer back: fabric price group 1 • Adjustable glides: platinum solid plastic 	<ol style="list-style-type: none"> 1 Style number 2 Seat, back, and outer back width (see below under Required Selections) 3 Paint color number for frame 4 Fabric color number for seat, back, and outer back 5 Arm position (see below under Required Selections) 6 Options, if selected (see below) <p>▶ See <i>Surface Materials</i>, page 677.</p>
--	---	---

Required Selections	U.S. Price	Required to Specify
---------------------	------------	---------------------

Seat, Back, and Outer Back Width	<ul style="list-style-type: none"> • 33"W seat, back, and outer back • 38¹/₂"W seat, back, and outer back • 44"W seat, back, and outer back • 49¹/₂"W seat, back, and outer back • 55"W seat, back, and outer back • 60¹/₂"W seat, back, and outer back 	<ul style="list-style-type: none"> Price at right Price at right Price at right Price at right Price at right Price at right 	<p>Specify with 33"W seat, back, and outer back.</p> <p>Specify with 38¹/₂"W seat, back, and outer back.</p> <p>Specify with 44"W seat, back, and outer back.</p> <p>Specify with 49¹/₂"W seat, back, and outer back.</p> <p>Specify with 55"W seat, back, and outer back.</p> <p>Specify with 60¹/₂"W seat, back, and outer back.</p>
---	---	--	--

Arm Position	U.S. Price	Required to Specify
--------------	------------	---------------------

<ul style="list-style-type: none"> • No arms • One arm • Two arms 	<ul style="list-style-type: none"> Prices at right Prices at right Prices at right 	<p>Specify with no arms.</p> <p>Specify with arm right- or left-facing.</p> <p>Specify with two arms right- and left-facing.</p>
--	---	--

Tip: Left and right determined when facing the unit.

Tip: Understand that standard requires further specification to complete unit.

Tip: For additional specification information, refer to Surround Configuration Charts.

▶ See page 550.

Tip: Fabric upcharges are applied separately for seat, back, and outer back.

Tip: Storage is specified separately.

▶ See pages 605–606.

Tip: Storage not available if 55"W seat, back, and outer back is specified.

Options	U.S. Price	Required to Specify
---------	------------	---------------------

Surface Materials	Frame	<ul style="list-style-type: none"> • Paint price group 1 • Paint price group 2 • Paint price group 3 	<ul style="list-style-type: none"> No cost +\$ 29 +\$103 	<ul style="list-style-type: none"> Specify paint color number. Specify paint color number. Specify paint color number. <p>▶ See <i>Surface Materials</i>, page 677.</p>
	Seat, back, and outer back	<ul style="list-style-type: none"> • Fabric 	<ul style="list-style-type: none"> Prices at right 	<ul style="list-style-type: none"> Specify fabric color number.
	Arm(s)	<ul style="list-style-type: none"> • Fabric 	<ul style="list-style-type: none"> Prices at right 	<ul style="list-style-type: none"> Specify fabric color number.
	High arm pillow (if high arm(s) selected)	<ul style="list-style-type: none"> • Fabric 	<ul style="list-style-type: none"> Prices at right 	<ul style="list-style-type: none"> Specify fabric color number.
Storage Size(s) and Location(s)	<ul style="list-style-type: none"> • No storage • 11"W right-facing storage • 16¹/₂"W right-facing storage • 11"W left-facing storage • 16¹/₂"W left-facing storage 	<ul style="list-style-type: none"> No cost No cost No cost No cost No cost 	<ul style="list-style-type: none"> Specify with no storage. Specify with 11"W right-facing storage. Specify with 16¹/₂"W right-facing storage. Specify with 11"W left-facing storage. Specify with 16¹/₂"W left-facing storage. 	

▶ Options, continued on next page



For Canadian Pricing

Multiply U.S. Price by the Canadian price factor.

▶ See page 1 for details.

► Options, continued from previous page

	Options	U.S. Price	Required to Specify
Storage Type	Right		
	<ul style="list-style-type: none"> • Right one-tier end table • Right two-tier end table 	No cost No cost	Specify <i>with right one-tier end table.</i> Specify <i>with right two-tier end table.</i>
	Left		
	<ul style="list-style-type: none"> • Left one-tier end table • Left two-tier end table 	No cost No cost	Specify <i>with left one-tier end table.</i> Specify <i>with left two-tier end table.</i>
Arm Height(s)	Right		
	<ul style="list-style-type: none"> • Right arm low • Right arm high 	No cost +\$153	Specify <i>with right arm low.</i> Specify <i>with right arm high.</i>
	Left		
	<ul style="list-style-type: none"> • Left arm low • Left arm high 	No cost +\$153	Specify <i>with left arm low.</i> Specify <i>with left arm high.</i>
Power and Light	Right		
	<ul style="list-style-type: none"> • Right arm no power • Right arm two power • Right arm one power, two USB 	No cost +\$383 +\$454	Specify <i>with right arm no power.</i> Specify <i>with right arm two power.</i> Specify <i>with right arm one power, two USB.</i>
	<ul style="list-style-type: none"> • Right arm, four USB • Right arm two power, with light capability • Right arm one power, two USB, with light capability • Right arm, four USB, with light capability 	+ \$454 +\$383 +\$454 +\$454	Specify <i>with right arm, four USB.</i> Specify <i>with right arm two power, with light capability.</i> Specify <i>with right arm one power, two USB, with light capability.</i> Specify <i>with right arm, four USB, with light capability.</i>
	Left		
	<ul style="list-style-type: none"> • Left arm no power • Left arm two power • Left arm one power, two USB 	No cost +\$383 +\$454	Specify <i>with left arm no power.</i> Specify <i>with left arm two power.</i> Specify <i>with left arm one power, two USB.</i>
	<ul style="list-style-type: none"> • Left arm, four USB • Left arm two power, with light capability • Left arm one power, two USB, with light capability • Left arm, four USB, with light capability 	+ \$454 +\$383 +\$454 +\$454	Specify <i>with left arm, four USB.</i> Specify <i>with left arm two power, with light capability.</i> Specify <i>with left arm one power, two USB, with light capability.</i> Specify <i>with left arm, four USB, with light capability.</i>
Mobility	<ul style="list-style-type: none"> • Two glides and two casters 	+\$520	Specify <i>with two glides and two casters.</i>
Tablet Rail	<ul style="list-style-type: none"> • Tablet rail 	+\$444	Specify <i>with tablet rail.</i>
Related Products	<ul style="list-style-type: none"> • Storage, one-tier end table • Storage, two-tier end table • Mobile tablet 		► Page 605 ► Page 606 ► Page 607

► Options, continued on next page

Tip: Storage type is only specified when storage size and location is chosen.

Tip: Power with light can only be specified if adjacent two-tier storage and light are specified. There is an upcharge for the light option on two-tier storage.
► See page 606.

Tip: Only one power with light may be specified in a unit.

Tip: Only four USB ports total may be specified in a unit.



Surround components are not designed for use with international power.

Tip: Mobile tablet is specified separately.

► See page 607.

**For Canadian Pricing**

Multiply U.S. Price by the Canadian price factor.

► See page 1 for details.

► Options, continued from previous page

Fabric Upcharges

Style Number	Width	Fabric Price	Fabric Price Group 1	Fabric Price Group 2	Fabric Price Group 3	Fabric Price Group 4	Fabric Price Group 5	Fabric Price Group 6	Fabric Price Group 7	Fabric Price Group 8	Fabric Price Group 9	Fabric Price Group 10	COM
HLS61													
Seat													
33"	No cost	+\$38	+\$ 70	+\$114	+\$167	+\$233	+\$570	+\$722	+\$ 859	+\$1010	+\$12		
38 ¹ / ₂ "	No cost	+\$38	+\$ 70	+\$114	+\$167	+\$233	+\$570	+\$722	+\$ 859	+\$1010	+\$12		
44"	No cost	+\$48	+\$ 88	+\$145	+\$211	+\$296	+\$628	+\$809	+\$ 973	+\$1152	+\$15		
49 ¹ / ₂ "	No cost	+\$56	+\$103	+\$170	+\$249	+\$348	+\$647	+\$848	+\$1029	+\$1228	+\$17		
55"	No cost	+\$58	+\$107	+\$175	+\$257	+\$360	+\$653	+\$869	+\$1079	+\$1295	+\$18		
60 ¹ / ₂ "	No cost	+\$65	+\$119	+\$196	+\$286	+\$400	+\$665	+\$886	+\$1086	+\$1305	+\$20		
Back													
33"	No cost	+\$38	+\$ 70	+\$114	+\$167	+\$233	+\$570	+\$722	+\$ 859	+\$1010	+\$12		
38 ¹ / ₂ "	No cost	+\$38	+\$ 70	+\$114	+\$167	+\$233	+\$570	+\$722	+\$ 859	+\$1010	+\$12		
44"	No cost	+\$48	+\$ 88	+\$145	+\$211	+\$296	+\$628	+\$809	+\$ 973	+\$1152	+\$15		
49 ¹ / ₂ "	No cost	+\$56	+\$103	+\$170	+\$249	+\$348	+\$647	+\$848	+\$1029	+\$1228	+\$17		
55"	No cost	+\$58	+\$107	+\$175	+\$257	+\$360	+\$653	+\$869	+\$1079	+\$1295	+\$18		
60 ¹ / ₂ "	No cost	+\$65	+\$119	+\$196	+\$286	+\$400	+\$665	+\$886	+\$1086	+\$1305	+\$20		
Outer Back													
33"	No cost	+\$38	+\$ 70	+\$114	+\$167	+\$233	+\$570	+\$722	+\$ 859	+\$1010	+\$12		
38 ¹ / ₂ "	No cost	+\$38	+\$ 70	+\$114	+\$167	+\$233	+\$570	+\$722	+\$ 859	+\$1010	+\$12		
44"	No cost	+\$48	+\$ 88	+\$145	+\$211	+\$296	+\$628	+\$809	+\$ 973	+\$1152	+\$15		
49 ¹ / ₂ "	No cost	+\$56	+\$103	+\$170	+\$249	+\$348	+\$647	+\$848	+\$1029	+\$1228	+\$17		
55"	No cost	+\$58	+\$107	+\$175	+\$257	+\$360	+\$653	+\$869	+\$1079	+\$1295	+\$18		
60 ¹ / ₂ "	No cost	+\$65	+\$119	+\$196	+\$286	+\$400	+\$665	+\$886	+\$1086	+\$1305	+\$20		
Arm													
Low	No cost	+\$36	+\$ 49	+\$ 96	+\$125	+\$145	+\$189	+\$253	+\$ 317	+\$ 388	+\$15		
High	No cost	+\$56	+\$ 76	+\$149	+\$193	+\$268	+\$363	+\$436	+\$ 534	+\$ 644	+\$23		
High Arm Pillow													
Pillow	No cost	+\$36	+\$ 49	+\$ 96	+\$125	+\$145	+\$189	+\$253	+\$ 317	+\$ 388	+\$15		

Tip: Seat, back, and outer back fabrics may be specified in different choices. ► See Understanding Lounge on page 556.

Tip: Arm fabric and high arm pillow fabric is per arm selected.

Tip: High arm and pillow fabrics may be specified in different choices. ► See Understanding Lounge on page 556.

 **For Canadian Pricing**
 Multiply U.S. Price by the Canadian price factor.
 ► See page 1 for details.

Specification Information

Style Number	Frame Dimensions		Seat, Back, and Outer Back Width	U.S. Base Prices Low Arms		
	W	D		No arm(s)	One arm	Two arms

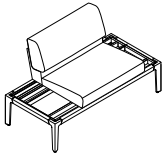

60 1/2" Frame Width

Style Number	W	D	Seat, Back, and Outer Back Width	U.S. Base Price (No arm(s))	U.S. Base Price (One arm)	U.S. Base Price (Two arms)
HLS61	60 1/2"	27 1/2"	33"	\$2412	\$2751	\$3090
			38 1/2"	\$2550	\$2889	\$3228
			44"	\$2789	\$3128	N.A.
			49 1/2"	\$3010	N.A.	\$3688
			55"	N.A.	\$3506	N.A.
			60 1/2"	\$3369	N.A.	N.A.



For Canadian Pricing
 Multiply U.S. Price by the Canadian price factor.
 ▶ See page 1 for details.

Surround Lounge

66" Frame Width

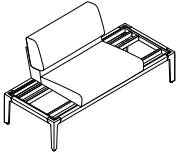

Standard Includes	Required to Specify
-------------------	---------------------

<ul style="list-style-type: none"> ▶ Need help? Product details, page 556 	<ul style="list-style-type: none"> • Frame: paint price group 1 • Seat, back, and outer back: fabric price group 1 • Adjustable glides: platinum solid plastic 	<ol style="list-style-type: none"> 1 Style number 2 Seat, back, and outer back width (see below under Required Selections) 3 Paint color number for frame 4 Fabric color number for seat, back, and outer back 5 Arm position (see below under Required Selections) 6 Options, if selected (see below) <p>▶ See <i>Surface Materials</i>, page 677.</p>
--	---	---

Required Selections	U.S. Price	Required to Specify
---------------------	------------	---------------------

Seat, Back, and Outer Back Width	<ul style="list-style-type: none"> • 33"W seat, back, and outer back • 38½"W seat, back, and outer back • 44"W seat, back, and outer back • 49½"W seat, back, and outer back • 55"W seat, back, and outer back • 60½"W seat, back, and outer back • 66"W seat, back, and outer back 	<p>Price at right</p> <p>Price at right</p> <p>Price at right</p> <p>Price at right</p> <p>Price at right</p> <p>Price at right</p> <p>Price at right</p>	<p>Specify with 33"W seat, back, and outer back.</p> <p>Specify with 38½"W seat, back, and outer back.</p> <p>Specify with 44"W seat, back, and outer back.</p> <p>Specify with 49½"W seat, back, and outer back.</p> <p>Specify with 55"W seat, back, and outer back.</p> <p>Specify with 60½"W seat, back, and outer back.</p> <p>Specify with 66"W seat, back, and outer back.</p>
---	--	---	---

Arm Position	<ul style="list-style-type: none"> • No arms • One arm • Two arms 	<p>Prices at right</p> <p>Prices at right</p> <p>Prices at right</p>	<p>Specify with no arms.</p> <p>Specify with arm right- or left-facing.</p> <p>Specify with two arms right- and left-facing.</p>
---------------------	--	--	--

Tip: Left and right determined when facing the unit.

Tip: Understand that standard requires further specification to complete unit.

Tip: For additional specification information, refer to Surround Configuration Charts.

▶ See page 550.

Tip: Fabric upcharges are applied separately for seat, back, and outer back.

Options	U.S. Price	Required to Specify
---------	------------	---------------------

Surface Materials	Frame	<ul style="list-style-type: none"> • Paint price group 1 • Paint price group 2 • Paint price group 3 	<p>No cost</p> <p>+\$ 29</p> <p>+\$103</p>	<p>Specify paint color number.</p> <p>Specify paint color number.</p> <p>Specify paint color number.</p> <p>▶ See <i>Surface Materials</i>, page 677.</p>
	Seat, back, and outer back	<ul style="list-style-type: none"> • Fabric 	<p>Prices at right</p>	<p>Specify fabric color number.</p>
	Arm(s)	<ul style="list-style-type: none"> • Fabric 	<p>Prices at right</p>	<p>Specify fabric color number.</p>
	High arm pillow (if high arm(s) selected)	<ul style="list-style-type: none"> • Fabric 	<p>Prices at right</p>	<p>Specify fabric color number.</p>

▶ Options, continued on next page



For Canadian Pricing

Multiply U.S. Price by the Canadian price factor.

▶ See page 1 for details.

► Options, continued from previous page

	Options	U.S. Price	Required to Specify
Storage Size(s) and Location(s)	• No storage	No cost	Specify <i>with no storage</i> .
	• 11"W right-facing storage	No cost	Specify <i>with 11"W right-facing storage</i> .
Storage Type	• 16 1/2"W right-facing storage	No cost	Specify <i>with 16 1/2"W right-facing storage</i> .
	• 11"W left-facing storage	No cost	Specify <i>with 11"W left-facing storage</i> .
	• 16 1/2"W left-facing storage	No cost	Specify <i>with 16 1/2"W left-facing storage</i> .
	• 11"W left- and 11"W right-facing storage	No cost	Specify <i>with 11"W left- and 11"W right-facing storage</i> .
	Right		
	• Right one-tier end table	No cost	Specify <i>with right one-tier end table</i> .
• Right two-tier end table	No cost	Specify <i>with right two-tier end table</i> .	
Arm Height(s)	Left		
	• Left one-tier end table	No cost	Specify <i>with left one-tier end table</i> .
	• Left two-tier end table	No cost	Specify <i>with left two-tier end table</i> .
	Right		
• Right arm low	No cost	Specify <i>with right arm low</i> .	
• Right arm high	+\$153	Specify <i>with right arm high</i> .	
Power and Light	Left		
	• Left arm low	No cost	Specify <i>with left arm low</i> .
	• Left arm high	+\$153	Specify <i>with left arm high</i> .
	Right		
	• Right arm no power	No cost	Specify <i>with right arm no power</i> .
	• Right arm two power	+\$383	Specify <i>with right arm two power</i> .
	• Right arm one power, two USB	+\$454	Specify <i>with right arm one power, two USB</i> .
	• Right arm, four USB	+\$454	Specify <i>with right arm, four USB</i> .
	• Right arm two power, with light capability	+\$383	Specify <i>with right arm two power, with light capability</i> .
	• Right arm one power, two USB, with light capability	+\$454	Specify <i>with right arm one power, two USB, with light capability</i> .
	• Right arm, four USB, with light capability	+\$454	Specify <i>with right arm, four USB, with light capability</i> .
	Left		
	• Left arm no power	No cost	Specify <i>with left arm no power</i> .
	• Left arm two power	+\$383	Specify <i>with left arm two power</i> .
• Left arm one power, two USB	+\$454	Specify <i>with left arm one power, two USB</i> .	
• Left arm, four USB	+\$454	Specify <i>with left arm, four USB</i> .	
• Left arm two power, with light capability	+\$383	Specify <i>with left arm two power, with light capability</i> .	
• Left arm one power, two USB, with light capability	+\$454	Specify <i>with left arm one power, two USB, with light capability</i> .	
• Left arm, four USB, with light capability	+\$454	Specify <i>with left arm, four USB, with light capability</i> .	
Mobility	• Two glides and two casters	+\$520	Specify <i>with two glides and two casters</i> .
Tablet Rail	• Tablet rail	+\$444	Specify <i>with tablet rail</i> .
Related Products	• Storage, one-tier end table		► Page 605
	• Storage, two-tier end table		► Page 606
	• Mobile tablet		► Page 607

► Options, continued on next page

Tip: Storage is specified separately.

► See pages 605–606.

Tip: Storage not available if 60 1/2"W seat, back, and outer back is specified.

Tip: Storage type is only specified when storage size and location is chosen.

Tip: Power with light can only be specified if adjacent two-tier storage and light are specified. There is an upcharge for the light option on two-tier storage.

► See page 606.

Tip: Only one power with light may be specified in a unit.

Tip: Only four USB ports total may be specified in a unit.



Surround components are not designed for use with international power.

Tip: Mobile tablet is specified separately.

► See page 607.

**For Canadian Pricing**

Multiply U.S. Price by the Canadian price factor.

► See page 1 for details.

Surround Lounge, 66" Frame Width, continued

► Options, continued from previous page

Fabric Upcharges

Style Number	Width	Fabric Price	Fabric Price Group 1	Fabric Price Group 2	Fabric Price Group 3	Fabric Price Group 4	Fabric Price Group 5	Fabric Price Group 6	Fabric Price Group 7	Fabric Price Group 8	Fabric Price Group 9	Fabric Price Group 10	COM
HLS66													
Seat													
33"	No cost	+\$38	+\$ 70	+\$114	+\$167	+\$233	+\$570	+\$722	+\$ 859	+\$1010	+\$12		
38½"	No cost	+\$38	+\$ 70	+\$114	+\$167	+\$233	+\$570	+\$722	+\$ 859	+\$1010	+\$12		
44"	No cost	+\$48	+\$ 88	+\$145	+\$211	+\$296	+\$628	+\$809	+\$ 973	+\$1152	+\$15		
49½"	No cost	+\$56	+\$103	+\$170	+\$249	+\$348	+\$647	+\$848	+\$1029	+\$1228	+\$17		
55"	No cost	+\$58	+\$107	+\$175	+\$257	+\$360	+\$653	+\$869	+\$1079	+\$1295	+\$18		
60½"	No cost	+\$65	+\$119	+\$196	+\$286	+\$400	+\$665	+\$886	+\$1086	+\$1305	+\$20		
66"	No cost	+\$72	+\$132	+\$217	+\$318	+\$444	+\$680	+\$897	+\$1097	+\$1309	+\$22		
Back													
33"	No cost	+\$38	+\$ 70	+\$114	+\$167	+\$233	+\$570	+\$722	+\$ 859	+\$1010	+\$12		
38½"	No cost	+\$38	+\$ 70	+\$114	+\$167	+\$233	+\$570	+\$722	+\$ 859	+\$1010	+\$12		
44"	No cost	+\$48	+\$ 88	+\$145	+\$211	+\$296	+\$628	+\$809	+\$ 973	+\$1152	+\$15		
49½"	No cost	+\$56	+\$103	+\$170	+\$249	+\$348	+\$647	+\$848	+\$1029	+\$1228	+\$17		
55"	No cost	+\$58	+\$107	+\$175	+\$257	+\$360	+\$653	+\$869	+\$1079	+\$1295	+\$18		
60½"	No cost	+\$65	+\$119	+\$196	+\$286	+\$400	+\$665	+\$886	+\$1086	+\$1305	+\$20		
66"	No cost	+\$72	+\$132	+\$217	+\$318	+\$444	+\$680	+\$897	+\$1097	+\$1309	+\$22		
Outer Back													
33"	No cost	+\$38	+\$ 70	+\$114	+\$167	+\$233	+\$570	+\$722	+\$ 859	+\$1010	+\$12		
38½"	No cost	+\$38	+\$ 70	+\$114	+\$167	+\$233	+\$570	+\$722	+\$ 859	+\$1010	+\$12		
44"	No cost	+\$48	+\$ 88	+\$145	+\$211	+\$296	+\$628	+\$809	+\$ 973	+\$1152	+\$15		
49½"	No cost	+\$56	+\$103	+\$170	+\$249	+\$348	+\$647	+\$848	+\$1029	+\$1228	+\$17		
55"	No cost	+\$58	+\$107	+\$175	+\$257	+\$360	+\$653	+\$869	+\$1079	+\$1295	+\$18		
60½"	No cost	+\$65	+\$119	+\$196	+\$286	+\$400	+\$665	+\$886	+\$1086	+\$1305	+\$20		
66"	No cost	+\$72	+\$132	+\$217	+\$318	+\$444	+\$680	+\$897	+\$1097	+\$1309	+\$22		
Arm													
Low	No cost	+\$36	+\$ 49	+\$ 96	+\$125	+\$145	+\$189	+\$253	+\$ 317	+\$ 388	+\$15		
High	No cost	+\$56	+\$ 76	+\$149	+\$193	+\$268	+\$363	+\$436	+\$ 534	+\$ 644	+\$23		
High Arm Pillow													
Pillow	No cost	+\$36	+\$ 49	+\$ 96	+\$125	+\$145	+\$189	+\$253	+\$ 317	+\$ 388	+\$15		

Tip: Seat, back, and outer back fabrics may be specified in different choices.

► See Understanding Lounge on page 556.

Tip: Arm fabric and high arm pillow fabric is per arm selected.

Tip: High arm and pillow fabrics may be specified in different choices.

► See Understanding Lounge on page 556.



For Canadian Pricing

Multiply U.S. Price by the Canadian price factor.

► See page 1 for details.

Specification Information

• Style • Number	• Frame • Dimensions		• Seat, Back, and Outer Back Width	• U.S. Base Prices • Low Arms		
	W	D		No arm(s)	One arm	Two arms

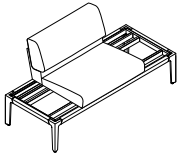

66" Frame Width

Style Number	W	D	Seat, Back, and Outer Back Width	No arm(s)	One arm	Two arms
HLS66	66"	27½"	33"	\$2522	\$2861	\$3200
			38½"	\$2660	\$2999	\$3338
			44"	\$2899	\$3238	\$3577
			49½"	\$3120	\$3459	N.A.
			55"	\$3277	N.A.	\$3955
			60½"	N.A.	\$3818	N.A.
			66"	\$3688	N.A.	N.A.



For Canadian Pricing
 Multiply U.S. Price by the
 Canadian price factor.
 ▶ See page 1 for details.

Surround Lounge

71¹/₂" Frame Width

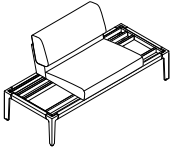

Standard Includes	Required to Specify
-------------------	---------------------

<ul style="list-style-type: none"> ▶ Need help? Product details, page 556 	<ul style="list-style-type: none"> • Frame: paint price group 1 • Seat, back, and outer back: fabric price group 1 • Adjustable glides: platinum solid plasticA 	<ol style="list-style-type: none"> 1 Style number 2 Seat, back, and outer back width (see below under Required Selections) 3 Sleep surface (see below under Required Selections) 4 Paint color number for frame 5 Fabric color number for seat, back, and outer back 6 Arm position (see below under Required Selections) 7 Options, if selected (see below) <p>▶ See <i>Surface Materials</i>, page 677.</p>
--	--	--

Required Selections	U.S. Price	Required to Specify
---------------------	------------	---------------------

<p>Seat, Back, and Outer Back Width</p> <ul style="list-style-type: none"> • 33"W seat, back, and outer back • 38¹/₂"W seat, back, and outer back • 44"W seat, back, and outer back • 49¹/₂"W seat, back, and outer back • 55"W seat, back, and outer back • 60¹/₂"W seat, back, and outer back • 66"W seat, back, and outer back 	<p>Price at right</p> <p>Price at right</p> <p>Price at right</p> <p>Price at right</p> <p>Price at right</p> <p>Price at right</p> <p>Price at right</p>	<p>Specify with 33"W seat, back, and outer back.</p> <p>Specify with 38¹/₂"W seat, back, and outer back.</p> <p>Specify with 44"W seat, back, and outer back.</p> <p>Specify with 49¹/₂"W seat, back, and outer back.</p> <p>Specify with 55"W seat, back, and outer back.</p> <p>Specify with 60¹/₂"W seat, back, and outer back.</p> <p>Specify with 66"W seat, back, and outer back.</p>
---	---	---

<p>Sleep Surface</p> <ul style="list-style-type: none"> • No sleep surface • Sleep surface with 60¹/₂"W seat, back, and outer back 	<p>No cost</p> <p>+\$600</p>	<p>Specify with no sleep surface.</p> <p>Specify with sleep surface.</p>
---	------------------------------	--

<p>Arm Position</p> <ul style="list-style-type: none"> • No arms • One arm • Two arms 	<p>Prices at right</p> <p>Prices at right</p> <p>Prices at right</p>	<p>Specify with no arms.</p> <p>Specify with arm right- or left-facing.</p> <p>Specify with two arms right- and left-facing.</p>
---	--	--

Options	U.S. Price	Required to Specify
---------	------------	---------------------

<p>Surface Materials</p> <p>Frame</p> <ul style="list-style-type: none"> • Paint price group 1 • Paint price group 2 • Paint price group 3 	<p>No cost</p> <p>+\$ 29</p> <p>+\$103</p>	<p>Specify paint color number.</p> <p>Specify paint color number.</p> <p>Specify paint color number.</p> <p>▶ See <i>Surface Materials</i>, page 677.</p>
---	--	---

<p>Seat, back, and outer back</p> <ul style="list-style-type: none"> • Fabric 	<p>Prices at right</p>	<p>Specify fabric color number.</p>
---	------------------------	-------------------------------------

<p>Arm(s)</p> <ul style="list-style-type: none"> • Fabric 	<p>Prices at right</p>	<p>Specify fabric color number.</p>
---	------------------------	-------------------------------------

<p>High arm pillow (if high arm(s) selected)</p> <ul style="list-style-type: none"> • Fabric 	<p>Prices at right</p>	<p>Specify fabric color number.</p>
--	------------------------	-------------------------------------

▶ Options, continued on next page

Tip: When specifying no sleep surface, a fixed back will be received.

Tip: Left and right determined when facing the unit.

Tip: Understand that standard requires further specification to complete unit.

Tip: For additional specification information, refer to Surround Configuration Charts.

▶ See page 550.

Tip: Sleep surface requires the specification of two arms.

Tip: Fabric upcharges are applied separately for seat, back, and outer back.



For Canadian Pricing

Multiply U.S. Price by the Canadian price factor.

▶ See page 1 for details.

► Options, continued from previous page

Options	U.S. Price	Required to Specify
Storage Size(s) and Location(s)		
• No storage	No cost	Specify <i>with no storage</i> .
• 11"W right-facing storage	No cost	Specify <i>with 11"W right-facing storage</i> .
• 16 ¹ / ₂ "W right-facing storage	No cost	Specify <i>with 16¹/₂"W right-facing storage</i> .
• 11"W left-facing storage	No cost	Specify <i>with 11"W left-facing storage</i> .
• 16 ¹ / ₂ "W left-facing storage	No cost	Specify <i>with 16¹/₂"W left-facing storage</i> .
• 11"W left- and 11"W right-facing storage	No cost	Specify <i>with 11"W left- and 11"W right-facing storage</i> .
• 11"W left- and 16 ¹ / ₂ "W right-facing storage	No cost	Specify <i>with 11"W left- and 16¹/₂"W right-facing storage</i> .
• 16 ¹ / ₂ "W left- and 11"W right-facing storage	No cost	Specify <i>with 16¹/₂"W left- and 11"W right-facing storage</i> .
Storage Type		
Right		
• Right one-tier end table	No cost	Specify <i>with right one-tier end table</i> .
• Right two-tier end table	No cost	Specify <i>with right two-tier end table</i> .
Left		
• Left one-tier end table	No cost	Specify <i>with left one-tier end table</i> .
• Left two-tier end table	No cost	Specify <i>with left two-tier end table</i> .
Arm Height(s)		
Right		
• Right arm low	No cost	Specify <i>with right arm low</i> .
• Right arm high	+\$153	Specify <i>with right arm high</i> .
Left		
• Left arm low	No cost	Specify <i>with left arm low</i> .
• Left arm high	+\$153	Specify <i>with left arm high</i> .
Power and Light		
Right		
• Right arm no power	No cost	Specify <i>with right arm no power</i> .
• Right arm two power	+\$383	Specify <i>with right arm two power</i> .
• Right arm one power, two USB	+\$454	Specify <i>with right arm one power, two USB</i> .
• Right arm, four USB	+\$454	Specify <i>with right arm, four USB</i> .
• Right arm two power, with light capability	+\$383	Specify <i>with right arm two power, with light capability</i> .
• Right arm one power, two USB, with light capability	+\$454	Specify <i>with right arm one power, two USB, with light capability</i> .
• Right arm, four USB, with light capability	+\$454	Specify <i>with right arm, four USB, with light capability</i> .
Left		
• Left arm no power	No cost	Specify <i>with left arm no power</i> .
• Left arm two power	+\$383	Specify <i>with left arm two power</i> .
• Left arm one power, two USB	+\$454	Specify <i>with left arm one power, two USB</i> .
• Left arm, four USB	+\$454	Specify <i>with left arm, four USB</i> .
• Left arm two power, with light capability	+\$383	Specify <i>with left arm two power, with light capability</i> .
• Left arm one power, two USB, with light capability	+\$454	Specify <i>with left arm one power, two USB, with light capability</i> .
• Left arm, four USB, with light capability	+\$454	Specify <i>with left arm, four USB, with light capability</i> .
Mobility		
• Two glides and two casters	+\$520	Specify <i>with two glides and two casters</i> .
Tablet Rail		
• Tablet rail	+\$444	Specify <i>with tablet rail</i> .
Related Products		
• Storage, one-tier end table		► Page 605
• Storage, two-tier end table		► Page 606
• Mobile tablet		► Page 607

Tip: Storage is specified separately.

► See pages 605–606.

Tip: Storage not available if 66"W seat, back, and outer back is specified.

Tip: Storage type is only specified when storage size and location is chosen.

Tip: Power with light can only be specified if adjacent two-tier storage and light are specified. There is an upcharge for the light option on two-tier storage.

► See page 606.

Tip: Only one power with light may be specified in a unit.

Tip: Only four USB ports total may be specified in a unit.



Surround components are not designed for use with international power.

Tip: Mobile tablet is specified separately.

► See page 607.

► Options, continued on next page

**For Canadian Pricing**

Multiply U.S. Price by the Canadian price factor.

► See page 1 for details.

Surround Lounge, 71 1/2" Frame Width, continued

► Options, continued from previous page

Fabric Upcharges

Style Number	Width	Fabric Price	Fabric Price Group 1	Fabric Price Group 2	Fabric Price Group 3	Fabric Price Group 4	Fabric Price Group 5	Fabric Price Group 6	Fabric Price Group 7	Fabric Price Group 8	Fabric Price Group 9	Fabric Price Group 10	COM
HLS72													
Seat													
33"	No cost	+\$38	+\$ 70	+\$114	+\$167	+\$233	+\$570	+\$722	+\$ 859	+\$1010	+\$12		
38 1/2"	No cost	+\$38	+\$ 70	+\$114	+\$167	+\$233	+\$570	+\$722	+\$ 859	+\$1010	+\$12		
44"	No cost	+\$48	+\$ 88	+\$145	+\$211	+\$296	+\$628	+\$809	+\$ 973	+\$1152	+\$15		
49 1/2"	No cost	+\$56	+\$103	+\$170	+\$249	+\$348	+\$647	+\$848	+\$1029	+\$1228	+\$17		
55"	No cost	+\$58	+\$107	+\$175	+\$257	+\$360	+\$653	+\$869	+\$1079	+\$1295	+\$18		
60 1/2"	No cost	+\$65	+\$119	+\$196	+\$286	+\$400	+\$665	+\$886	+\$1086	+\$1305	+\$20		
66"	No cost	+\$72	+\$132	+\$217	+\$318	+\$444	+\$680	+\$897	+\$1097	+\$1309	+\$22		
Back													
33"	No cost	+\$38	+\$ 70	+\$114	+\$167	+\$233	+\$570	+\$722	+\$ 859	+\$1010	+\$12		
38 1/2"	No cost	+\$38	+\$ 70	+\$114	+\$167	+\$233	+\$570	+\$722	+\$ 859	+\$1010	+\$12		
44"	No cost	+\$48	+\$ 88	+\$145	+\$211	+\$296	+\$628	+\$809	+\$ 973	+\$1152	+\$15		
49 1/2"	No cost	+\$56	+\$103	+\$170	+\$249	+\$348	+\$647	+\$848	+\$1029	+\$1228	+\$17		
55"	No cost	+\$58	+\$107	+\$175	+\$257	+\$360	+\$653	+\$869	+\$1079	+\$1295	+\$18		
60 1/2"	No cost	+\$65	+\$119	+\$196	+\$286	+\$400	+\$665	+\$886	+\$1086	+\$1305	+\$20		
66"	No cost	+\$72	+\$132	+\$217	+\$318	+\$444	+\$680	+\$897	+\$1097	+\$1309	+\$22		
Outer Back													
33"	No cost	+\$38	+\$ 70	+\$114	+\$167	+\$233	+\$570	+\$722	+\$ 859	+\$1010	+\$12		
38 1/2"	No cost	+\$38	+\$ 70	+\$114	+\$167	+\$233	+\$570	+\$722	+\$ 859	+\$1010	+\$12		
44"	No cost	+\$48	+\$ 88	+\$145	+\$211	+\$296	+\$628	+\$809	+\$ 973	+\$1152	+\$15		
49 1/2"	No cost	+\$56	+\$103	+\$170	+\$249	+\$348	+\$647	+\$848	+\$1029	+\$1228	+\$17		
55"	No cost	+\$58	+\$107	+\$175	+\$257	+\$360	+\$653	+\$869	+\$1079	+\$1295	+\$18		
60 1/2"	No cost	+\$65	+\$119	+\$196	+\$286	+\$400	+\$665	+\$886	+\$1086	+\$1305	+\$20		
66"	No cost	+\$72	+\$132	+\$217	+\$318	+\$444	+\$680	+\$897	+\$1097	+\$1309	+\$22		
Arm													
Low	No cost	+\$36	+\$ 49	+\$ 96	+\$125	+\$145	+\$189	+\$253	+\$ 317	+\$ 388	+\$15		
High	No cost	+\$56	+\$ 76	+\$149	+\$193	+\$268	+\$363	+\$436	+\$ 534	+\$ 644	+\$23		
High Arm Pillow													
Pillow	No cost	+\$36	+\$ 49	+\$ 96	+\$125	+\$145	+\$189	+\$253	+\$ 317	+\$ 388	+\$15		

Tip: Seat, back, and outer back fabrics may be specified in different choices.
► See Understanding Lounge on page 556.

Tip: Arm fabric and high arm pillow fabric is per arm selected.

Tip: High arm and pillow fabrics may be specified in different choices.
► See Understanding Lounge on page 556.

For Canadian Pricing
Multiply U.S. Price by the Canadian price factor.
► See page 1 for details.

Specification Information

• Style • Number	• Frame • Dimensions		• Seat, Back, and Outer Back Width	• U.S. Base Prices • Low Arms		
	W	D		No arm(s)	One arm	Two arms

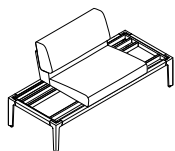

71½" Frame Width

Style Number	W	D	Seat, Back, and Outer Back Width	No arm(s)	One arm	Two arms
HLS72	71½"	27½"	33"	N.A.	\$2971	\$3310
			38½"	\$2770	\$3109	\$3448
			44"	\$3009	\$3348	\$3687
			49½"	\$3230	\$3569	\$3908
			55"	\$3387	\$3726	N.A.
			60½"	\$3589	N.A.	\$4267
			66"	N.A.	\$4137	N.A.



For Canadian Pricing
 Multiply U.S. Price by the
 Canadian price factor.
 ▶ See page 1 for details.

Surround Lounge

77" Frame Width

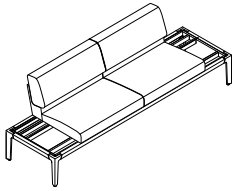

Standard Includes	Required to Specify
-------------------	---------------------

- | | | |
|--|---|--|
| <ul style="list-style-type: none"> ▶ Need help? Product details, page 556 | <ul style="list-style-type: none"> • Frame: paint price group 1 • Seat, back, and outer back: fabric price group 1 • Adjustable glides: platinum solid plastic | <ol style="list-style-type: none"> 1 Style number 2 Seat, back, and outer back width (see below under Required Selections) 3 Sleep surface (see below under Required Selections) 4 Paint color number for frame 5 Fabric color number for seat, back, and outer back 6 Arm position (see below under Required Selections) 7 Options, if selected (see below) <p>▶ See <i>Surface Materials</i>, page 677.</p> |
|--|---|--|

Required Selections	U.S. Price	Required to Specify
---------------------	------------	---------------------

Seat, Back, and Outer Back Width	• 33"W seat, back, and outer back	Price at right	Specify with 33"W seat, back, and outer back.
	• 38 ¹ / ₂ "W seat, back, and outer back	Price at right	Specify with 38 ¹ / ₂ "W seat, back, and outer back.
	• 44"W seat, back, and outer back	Price at right	Specify with 44"W seat, back, and outer back.
	• 49 ¹ / ₂ "W seat, back, and outer back	Price at right	Specify with 49 ¹ / ₂ "W seat, back, and outer back.
	• 55"W seat, back, and outer back	Price at right	Specify with 55"W seat, back, and outer back.
	• 60 ¹ / ₂ "W seat, back, and outer back	Price at right	Specify with 60 ¹ / ₂ "W seat, back, and outer back.
	• 66"W seat, back, and outer back	Price at right	Specify with 66"W seat, back, and outer back.

Tip: Lounge will have a fixed back when no sleep surface is specified.

Sleep Surface	• No sleep surface	No cost	Specify with no sleep surface.
	• Sleep surface with 66"W seat, back, and outer back	+\$625	Specify with sleep surface.

Tip: Sleep surface requires the specification of two arms.

Arm Position	• No arms	Prices at right	Specify with no arms.
	• One arm	Prices at right	Specify with arm right- or left-facing.
	• Two arms	Prices at right	Specify with two arms right- and left-facing.

Tip: Left and right determined when facing the unit.

Options	U.S. Price	Required to Specify
---------	------------	---------------------

Surface Materials	Frame		
	• Paint price group 1	No cost	Specify paint color number.
	• Paint price group 2	+\$ 29	Specify paint color number.
	• Paint price group 3	+\$103	Specify paint color number.
	Seat, back, and outer back		
	• Fabric	Prices at right	Specify fabric color number.
	Arm(s)		
	• Fabric	Prices at right	Specify fabric color number.
	High arm pillow (if high arm(s) selected)		
	• Fabric	Prices at right	Specify fabric color number.

Tip: Understand that standard requires further specification to complete unit.

Tip: For additional specification information, refer to Surround Configuration Charts.

▶ See page 550.

Tip: Fabric upcharges are applied separately for seat, back, and outer back.

▶ Options, continued on next page



For Canadian Pricing

Multiply U.S. Price by the Canadian price factor.

▶ See page 1 for details.

► Options, continued from previous page

	Options	U.S. Price	Required to Specify
Storage Size(s) and Location(s)	• No storage	No cost	Specify <i>with no storage</i> .
	• 11"W right-facing storage	No cost	Specify <i>with 11"W right-facing storage</i> .
	• 16 1/2"W right-facing storage	No cost	Specify <i>with 16 1/2"W right-facing storage</i> .
	• 11"W left-facing storage	No cost	Specify <i>with 11"W left-facing storage</i> .
	• 16 1/2"W left-facing storage	No cost	Specify <i>with 16 1/2"W left-facing storage</i> .
	• 11"W left- and 11"W right-facing storage	No cost	Specify <i>with 11"W left- and 11"W right-facing storage</i> .
	• 11"W left- and 16 1/2"W right-facing storage	No cost	Specify <i>with 11"W left- and 16 1/2"W right-facing storage</i> .
	• 16 1/2"W left- and 11"W right-facing storage	No cost	Specify <i>with 16 1/2"W left- and 11"W right-facing storage</i> .
	• 16 1/2"W left- and 16 1/2"W right-facing storage	No cost	Specify <i>with 16 1/2"W left- and 16 1/2"W right-facing storage</i> .
Storage Type	Right		
	• Right one-tier end table	No cost	Specify <i>with right one-tier end table</i> .
	• Right two-tier end table	No cost	Specify <i>with right two-tier end table</i> .
	Left		
• Left one-tier end table	No cost	Specify <i>with left one-tier end table</i> .	
• Left two-tier end table	No cost	Specify <i>with left two-tier end table</i> .	
Arm Height(s)	Right		
	• Right arm low	No cost	Specify <i>with right arm low</i> .
	• Right arm high	+\$153	Specify <i>with right arm high</i> .
	Left		
• Left arm low	No cost	Specify <i>with left arm low</i> .	
• Left arm high	+\$153	Specify <i>with left arm high</i> .	
Power and Light	Right		
	• Right arm no power	No cost	Specify <i>with right arm no power</i> .
	• Right arm two power	+\$383	Specify <i>with right arm two power</i> .
	• Right arm one power, two USB	+\$454	Specify <i>with right arm one power, two USB</i> .
	• Right arm, four USB	+\$454	Specify <i>with right arm, four USB</i> .
	• Right arm two power, with light capability	+\$383	Specify <i>with right arm two power, with light capability</i> .
	• Right arm one power, two USB, with light capability	+\$454	Specify <i>with right arm one power, two USB, with light capability</i> .
	• Right arm, four USB, with light capability	+\$454	Specify <i>with right arm, four USB, with light capability</i> .
	Left		
	• Left arm no power	No cost	Specify <i>with left arm no power</i> .
	• Left arm two power	+\$383	Specify <i>with left arm two power</i> .
	• Left arm one power, two USB	+\$454	Specify <i>with left arm one power, two USB</i> .
• Left arm, four USB	+\$454	Specify <i>with left arm, four USB</i> .	
• Left arm two power, with light capability	+\$383	Specify <i>with left arm two power, with light capability</i> .	
• Left arm one power, two USB, with light capability	+\$454	Specify <i>with left arm one power, two USB, with light capability</i> .	
• Left arm, four USB, with light capability	+\$454	Specify <i>with left arm, four USB, with light capability</i> .	
Mobility	• Two glides and two casters	+\$520	Specify <i>with two glides and two casters</i> .
Tablet Rail	• Tablet rail	+\$444	Specify <i>with tablet rail</i> .
Related Products	• Storage, one-tier end table		► Page 605
	• Storage, two-tier end table		► Page 606
	• Mobile tablet		► Page 607

Tip: Storage is specified separately.

► See pages 605–606.

Tip: Storage type is only specified when storage size and location is chosen.

Tip: Power with light can only be specified if adjacent two-tier storage and light are specified. There is an upcharge for the light option on two-tier storage.

► See page 606.

Tip: Only one power with light may be specified in a unit.

Tip: Only four USB ports total may be specified in a unit.



Surround components are not designed for use with international power.

Tip: Mobile tablet is specified separately.

► See page 607.

**For Canadian Pricing**

Multiply U.S. Price by the Canadian price factor.

► See page 1 for details.

► Options, continued on next page

Surround Lounge, 77" Frame Width, continued

► Options, continued from previous page

Fabric Upcharges

Style Number	Width	Fabric Price Group 1	Fabric Price Group 2	Fabric Price Group 3	Fabric Price Group 4	Fabric Price Group 5	Fabric Price Group 6	Fabric Price Group 7	Fabric Price Group 8	Fabric Price Group 9	Fabric Price Group 10	COM
--------------	-------	----------------------	----------------------	----------------------	----------------------	----------------------	----------------------	----------------------	----------------------	----------------------	-----------------------	-----

Tip: Seat, back, and outer back fabrics may be specified in different choices.

► See Understanding Lounge on page 556.

HLS77		Seat										
33"	No cost	+\$38	+\$ 70	+\$114	+\$167	+\$233	+\$570	+\$722	+\$ 859	+\$1010	+\$12	
38½"	No cost	+\$38	+\$ 70	+\$114	+\$167	+\$233	+\$570	+\$722	+\$ 859	+\$1010	+\$12	
44"	No cost	+\$48	+\$ 88	+\$145	+\$211	+\$296	+\$628	+\$809	+\$ 973	+\$1152	+\$15	
49½"	No cost	+\$56	+\$103	+\$170	+\$249	+\$348	+\$647	+\$848	+\$1029	+\$1228	+\$17	
55"	No cost	+\$58	+\$107	+\$175	+\$257	+\$360	+\$653	+\$869	+\$1079	+\$1295	+\$18	
60½"	No cost	+\$65	+\$119	+\$196	+\$286	+\$400	+\$665	+\$886	+\$1086	+\$1305	+\$20	
66"	No cost	+\$72	+\$132	+\$217	+\$318	+\$444	+\$680	+\$897	+\$1097	+\$1309	+\$22	

Back												
33"	No cost	+\$38	+\$ 70	+\$114	+\$167	+\$233	+\$570	+\$722	+\$ 859	+\$1010	+\$12	
38½"	No cost	+\$38	+\$ 70	+\$114	+\$167	+\$233	+\$570	+\$722	+\$ 859	+\$1010	+\$12	
44"	No cost	+\$48	+\$ 88	+\$145	+\$211	+\$296	+\$628	+\$809	+\$ 973	+\$1152	+\$15	
49½"	No cost	+\$56	+\$103	+\$170	+\$249	+\$348	+\$647	+\$848	+\$1029	+\$1228	+\$17	
55"	No cost	+\$58	+\$107	+\$175	+\$257	+\$360	+\$653	+\$869	+\$1079	+\$1295	+\$18	
60½"	No cost	+\$65	+\$119	+\$196	+\$286	+\$400	+\$665	+\$886	+\$1086	+\$1305	+\$20	
66"	No cost	+\$72	+\$132	+\$217	+\$318	+\$444	+\$680	+\$897	+\$1097	+\$1309	+\$22	

Outer Back												
33"	No cost	+\$38	+\$ 70	+\$114	+\$167	+\$233	+\$570	+\$722	+\$ 859	+\$1010	+\$12	
38½"	No cost	+\$38	+\$ 70	+\$114	+\$167	+\$233	+\$570	+\$722	+\$ 859	+\$1010	+\$12	
44"	No cost	+\$48	+\$ 88	+\$145	+\$211	+\$296	+\$628	+\$809	+\$ 973	+\$1152	+\$15	
49½"	No cost	+\$56	+\$103	+\$170	+\$249	+\$348	+\$647	+\$848	+\$1029	+\$1228	+\$17	
55"	No cost	+\$58	+\$107	+\$175	+\$257	+\$360	+\$653	+\$869	+\$1079	+\$1295	+\$18	
60½"	No cost	+\$65	+\$119	+\$196	+\$286	+\$400	+\$665	+\$886	+\$1086	+\$1305	+\$20	
66"	No cost	+\$72	+\$132	+\$217	+\$318	+\$444	+\$680	+\$897	+\$1097	+\$1309	+\$22	

Arm												
Low	No cost	+\$36	+\$ 49	+\$ 96	+\$125	+\$145	+\$189	+\$253	+\$ 317	+\$ 388	+\$15	
High	No cost	+\$56	+\$ 76	+\$149	+\$193	+\$268	+\$363	+\$436	+\$ 534	+\$ 644	+\$23	

High Arm Pillow												
Pillow	No cost	+\$36	+\$ 49	+\$ 96	+\$125	+\$145	+\$189	+\$253	+\$ 317	+\$ 388	+\$15	

Tip: Arm fabric and high arm pillow fabric is per arm selected.

Tip: High arm and pillow fabrics may be specified in different choices.

► See Understanding Lounge on page 556.

 **For Canadian Pricing**
 Multiply U.S. Price by the Canadian price factor.
 ► See page 1 for details.

Specification Information

Style Number	Frame Dimensions		Seat, Back, and Outer Back Width	U.S. Base Prices Low Arms		
	W	D		No arm(s)	One arm	Two arms

77" Frame Width

Style Number	W	D	Seat, Back, and Outer Back Width	No arm(s)	One arm	Two arms
HLS77	77"	27 ¹ / ₂ "	33"	N.A.	N.A.	\$3420
			38 ¹ / ₂ "	N.A.	\$3219	\$3558
			44"	\$3119	\$3458	\$3797
			49 ¹ / ₂ "	\$3340	\$3679	\$4018
			55"	\$3497	\$3836	\$4175
			60 ¹ / ₂ "	\$3699	\$4038	N.A.
			66"	\$3908	N.A.	\$4586

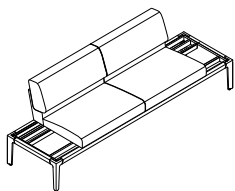
**For Canadian Pricing**

Multiply U.S. Price by the Canadian price factor.

► See page 1 for details.

Surround Lounge

82½" Frame Width

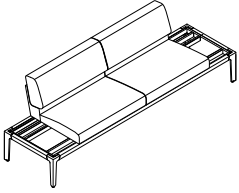

Standard Includes	Required to Specify
<ul style="list-style-type: none"> ▶ Need help? Product details, page 556 • Frame: paint price group 1 • Seat, back, and outer back: fabric price group 1 • Sleep surface (if 71½"W seat, back, and outer back selected): 5031 Light Merle • Adjustable glides: platinum solid plastic 	<ol style="list-style-type: none"> 1 Style number 2 Seat, back, and outer back width (see below under Required Selections) 3 Sleep surface (see below under Required Selections) 4 Paint color number for frame 5 Fabric color number for seat, back, and outer back 6 Arm position (see below under Required Selections) 7 Options, if selected (see below) <ul style="list-style-type: none"> ▶ See <i>Surface Materials</i>, page 677.

Required Selections	U.S. Price	Required to Specify
Seat, Back, and Outer Back Width		
• 38½"W seat, back, and outer back	Price at right	Specify with 38½"W seat, back, and outer back.
• 44"W seat, back, and outer back	Price at right	Specify with 44"W seat, back, and outer back.
• 49½"W seat, back, and outer back	Price at right	Specify with 49½"W seat, back, and outer back.
• 55"W seat, back, and outer back	Price at right	Specify with 55"W seat, back, and outer back.
• 60½"W seat, back, and outer back	Price at right	Specify with 60½"W seat, back, and outer back.
• 66"W seat, back, and outer back	Price at right	Specify with 66"W seat, back, and outer back.
• 71½"W seat, back, and outer back	Price at right	Specify with 71½"W seat, back, and outer back.
Sleep Surface		
• No sleep surface	No cost	Specify with no sleep surface.
• Sleep surface with 60½"W seat, back, and outer back	+\$600	Specify with sleep surface.
• Sleep surface with 71½"W seat, back, and outer back	\$ 650 Included in U.S. Base Price	Specify with sleep surface.
Arm Position		
• No arms	Prices at right	Specify with no arms.
• One arm	Prices at right	Specify with arm right- or left-facing.
• Two arms	Prices at right	Specify with two arms right- and left-facing.

Tip: When specifying no sleep surface, a fixed back will be received.

Tip: Sleep surface is included and the only back available with 71½"W seat, back, and outer back selection.

Tip: Sleep surface requires the specification of two arms.

Tip: Left and right determined when facing the unit.

Tip: Understand that standard requires further specification to complete unit.

Tip: For additional specification information, refer to Surround Configuration Charts.

▶ See page 550.

Tip: Fabric upcharges are applied separately for seat, back, and outer back.

Options	U.S. Price	Required to Specify
Surface Materials		
Frame		
• Paint price group 1	No cost	Specify paint color number.
• Paint price group 2	+\$ 29	Specify paint color number.
• Paint price group 3	+\$103	Specify paint color number.
		▶ See <i>Surface Materials</i> , page 677.
Seat, back, and outer back		
• Fabric	Prices at right	Specify fabric color number.
Arm(s)		
• Fabric	Prices at right	Specify fabric color number.
High arm pillow (if high arm(s) selected)		
• Fabric	Prices at right	Specify fabric color number.

▶ Options, continued on next page



For Canadian Pricing

Multiply U.S. Price by the Canadian price factor.

▶ See page 1 for details.

► Options, continued from previous page

	Options	U.S. Price	Required to Specify
Storage Size(s) and Location(s)	• No storage	No cost	Specify with no storage.
	• 11"W right-facing storage	No cost	Specify with 11"W right-facing storage.
	• 16 1/2"W right-facing storage	No cost	Specify with 16 1/2"W right-facing storage.
	• 11"W left-facing storage	No cost	Specify with 11"W left-facing storage.
	• 16 1/2"W left-facing storage	No cost	Specify with 16 1/2"W left-facing storage.
	• 11"W left- and 11"W right-facing storage	No cost	Specify with 11"W left- and 11"W right-facing storage.
	• 11"W left- and 16 1/2"W right-facing storage	No cost	Specify with 11"W left- and 16 1/2"W right-facing storage.
	• 16 1/2"W left- and 11"W right-facing storage	No cost	Specify with 16 1/2"W left- and 11"W right-facing storage.
Storage Type	Right		
	• Right one-tier end table	No cost	Specify with right one-tier end table.
	• Right two-tier end table	No cost	Specify with right two-tier end table.
Storage Type	Left		
	• Left one-tier end table	No cost	Specify with left one-tier end table.
	• Left two-tier end table	No cost	Specify with left two-tier end table.
Arm Height(s)	Right		
	• Right arm low	No cost	Specify with right arm low.
	• Right arm high	+\$153	Specify with right arm high.
Arm Height(s)	Left		
	• Left arm low	No cost	Specify with left arm low.
	• Left arm high	+\$153	Specify with left arm high.
Power and Light	Right		
	• Right arm no power	No cost	Specify with right arm no power.
	• Right arm two power	+\$383	Specify with right arm two power.
	• Right arm one power, two USB	+\$454	Specify with right arm one power, two USB.
	• Right arm, four USB	+\$454	Specify with right arm, four USB.
	• Right arm two power, with light capability	+\$383	Specify with right arm two power, with light capability.
	• Right arm one power, two USB, with light capability	+\$454	Specify with right arm one power, two USB, with light capability.
	• Right arm, four USB, with light capability	+\$454	Specify with right arm, four USB, with light capability.
	Left		
	• Left arm no power	No cost	Specify with left arm no power.
• Left arm two power	+\$383	Specify with left arm two power.	
• Left arm one power, two USB	+\$454	Specify with left arm one power, two USB.	
• Left arm, four USB	+\$454	Specify with left arm, four USB.	
• Left arm two power, with light capability	+\$383	Specify with left arm two power, with light capability.	
• Left arm one power, two USB, with light capability	+\$454	Specify with left arm one power, two USB, with light capability.	
• Left arm, four USB, with light capability	+\$454	Specify with left arm, four USB, with light capability.	
Mobility	• Two glides and two casters	+\$520	Specify with two glides and two casters.
Tablet Rail	• Tablet rail	+\$444	Specify with tablet rail.
Related Products	• Storage, one-tier end table		► Page 605
	• Storage, two-tier end table		► Page 606
	• Mobile tablet		► Page 607

Tip: Storage not available if 71 1/2"W seat, back, and outer back is specified.

Tip: Storage is specified separately.

► See pages 605–606.

Tip: Storage type is only specified when storage size and location is chosen.

Tip: Power with light can only be specified if adjacent two-tier storage and light are specified. There is an upcharge for the light option on two-tier storage.

► See page 606.

Tip: Only one power with light may be specified in a unit.

Tip: Only four USB ports total may be specified in a unit.



Surround components are not designed for use with international power.

Tip: Mobile tablet is specified separately.

► See page 607.

**For Canadian Pricing**

Multiply U.S. Price by the Canadian price factor.

► See page 1 for details.

► Options, continued on next page

► Options, continued from previous page

Fabric Upcharges

Style Number	Width	Fabric Price	Fabric Price Group 1	Fabric Price Group 2	Fabric Price Group 3	Fabric Price Group 4	Fabric Price Group 5	Fabric Price Group 6	Fabric Price Group 7	Fabric Price Group 8	Fabric Price Group 9	Fabric Price Group 10	COM
HLS83													
Seat													
	38 ¹ / ₂ "	No cost	+\$38	+\$ 70	+\$114	+\$167	+\$233	+\$570	+\$ 722	+\$ 859	+\$1010	+\$12	
	44"	No cost	+\$48	+\$ 88	+\$145	+\$211	+\$296	+\$628	+\$ 809	+\$ 973	+\$1152	+\$15	
	49 ¹ / ₂ "	No cost	+\$56	+\$103	+\$170	+\$249	+\$348	+\$647	+\$ 848	+\$1029	+\$1228	+\$17	
	55"	No cost	+\$58	+\$107	+\$175	+\$257	+\$360	+\$653	+\$ 869	+\$1079	+\$1295	+\$18	
	60 ¹ / ₂ "	No cost	+\$65	+\$119	+\$196	+\$286	+\$400	+\$665	+\$ 886	+\$1086	+\$1305	+\$20	
	66"	No cost	+\$72	+\$132	+\$217	+\$318	+\$444	+\$680	+\$ 897	+\$1097	+\$1309	+\$22	
	71 ¹ / ₂ "	No cost	+\$84	+\$155	+\$255	+\$373	+\$523	+\$746	+\$1021	+\$1269	+\$1540	+\$26	
Back													
	38 ¹ / ₂ "	No cost	+\$38	+\$ 70	+\$114	+\$167	+\$233	+\$570	+\$ 722	+\$ 859	+\$1010	+\$12	
	44"	No cost	+\$48	+\$ 88	+\$145	+\$211	+\$296	+\$628	+\$ 809	+\$ 973	+\$1152	+\$15	
	49 ¹ / ₂ "	No cost	+\$56	+\$103	+\$170	+\$249	+\$348	+\$647	+\$ 848	+\$1029	+\$1228	+\$17	
	55"	No cost	+\$58	+\$107	+\$175	+\$257	+\$360	+\$653	+\$ 869	+\$1079	+\$1295	+\$18	
	60 ¹ / ₂ "	No cost	+\$65	+\$119	+\$196	+\$286	+\$400	+\$665	+\$ 886	+\$1086	+\$1305	+\$20	
	66"	No cost	+\$72	+\$132	+\$217	+\$318	+\$444	+\$680	+\$ 897	+\$1097	+\$1309	+\$22	
	71 ¹ / ₂ "	No cost	+\$84	+\$155	+\$255	+\$373	+\$523	+\$746	+\$1021	+\$1269	+\$1540	+\$26	
Outer Back													
	38 ¹ / ₂ "	No cost	+\$38	+\$ 70	+\$114	+\$167	+\$233	+\$570	+\$ 722	+\$ 859	+\$1010	+\$12	
	44"	No cost	+\$48	+\$ 88	+\$145	+\$211	+\$296	+\$628	+\$ 809	+\$ 973	+\$1152	+\$15	
	49 ¹ / ₂ "	No cost	+\$56	+\$103	+\$170	+\$249	+\$348	+\$647	+\$ 848	+\$1029	+\$1228	+\$17	
	55"	No cost	+\$58	+\$107	+\$175	+\$257	+\$360	+\$653	+\$ 869	+\$1079	+\$1295	+\$18	
	60 ¹ / ₂ "	No cost	+\$65	+\$119	+\$196	+\$286	+\$400	+\$665	+\$ 886	+\$1086	+\$1305	+\$20	
	66"	No cost	+\$72	+\$132	+\$217	+\$318	+\$444	+\$680	+\$ 897	+\$1097	+\$1309	+\$22	
	71 ¹ / ₂ "	No cost	+\$84	+\$155	+\$255	+\$373	+\$523	+\$746	+\$1021	+\$1269	+\$1540	+\$26	
Arm													
	Low	No cost	+\$36	+\$ 49	+\$ 96	+\$125	+\$145	+\$189	+\$ 253	+\$ 317	+\$ 388	+\$15	
	High	No cost	+\$56	+\$ 76	+\$149	+\$193	+\$268	+\$363	+\$ 436	+\$ 534	+\$ 644	+\$23	
High Arm Pillow													
	Pillow	No cost	+\$36	+\$ 49	+\$ 96	+\$125	+\$145	+\$189	+\$ 253	+\$ 317	+\$ 388	+\$15	

Tip: Seat, back, and outer back fabrics may be specified in different choices.
 ► See Understanding Lounge on page 556.

Tip: Arm fabric and high arm pillow fabric is per arm selected.

Tip: High arm and pillow fabrics may be specified in different choices.
 ► See Understanding Lounge on page 556.



For Canadian Pricing
 Multiply U.S. Price by the Canadian price factor.
 ► See page 1 for details.

Specification Information

• Style Number	• Frame Dimensions		• Seat, Back, and Outer Back Width	• U.S. Base Prices Low Arms		
	W	D		No arm(s)	One arm	Two arms

82½" Frame Width

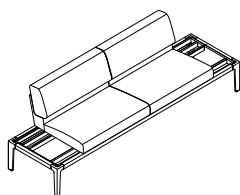
Style Number	W	D	Seat, Back, and Outer Back Width	No arm(s)	One arm	Two arms
HLS83	82½"	27½"	38½"	N.A.	N.A.	\$3668
			44"	N.A.	\$3568	\$3907
			49½"	\$3450	\$3789	\$4128
			55"	\$3607	\$3946	\$4285
			60½"	\$3809	\$4148	\$4487
			66"	\$4018	\$4357	N.A.
			71½"	N.A.	N.A.	\$4961



Tip: Sleep surface upcharge is included in base price for 71½"W seat, back, and outer back.



For Canadian Pricing

Multiply U.S. Price by the Canadian price factor.

▶ See page 1 for details.

Surround Lounge

88" Frame Width

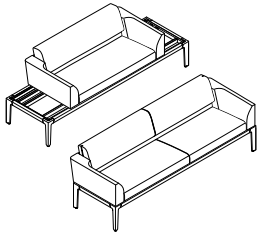

	Standard Includes	Required to Specify
<p>► Need help? Product details, page 556</p>	<ul style="list-style-type: none"> • Frame: paint price group 1 • Seat, back, and outer back: fabric price group 1 • Sleep surface (if 77"W seat, back, and outer back selected): 5031 Light Merle • Adjustable glides: platinum solid plastic 	<ol style="list-style-type: none"> 1 Style number 2 Seat, back, and outer back width (see below under Required Selections) 3 Sleep surface (see below under Required Selections) 4 Paint color number for frame 5 Fabric color number for seat, back, and outer back 6 Arm position (see below under Required Selections) 7 Options, if selected (see below) <p>► See <i>Surface Materials</i>, page 677.</p>

	Required Selections	U.S. Price	Required to Specify
Seat, Back, and Outer Back Width	• 44"W seat, back, and outer back	Price at right	Specify with 44"W seat, back, and outer back.
	• 49 ¹ / ₂ "W seat, back, and outer back	Price at right	Specify with 49 ¹ / ₂ "W seat, back, and outer back.
	• 55"W seat, back, and outer back	Price at right	Specify with 55"W seat, back, and outer back.
	• 60 ¹ / ₂ "W seat, back, and outer back	Price at right	Specify with 60 ¹ / ₂ "W seat, back, and outer back.
	• 66"W seat, back, and outer back	Price at right	Specify with 66"W seat, back, and outer back.
	• 77"W seat, back, and outer back	Price at right	Specify with 77"W seat, back, and outer back.
Sleep Surface	• No sleep surface	No cost	Specify with no sleep surface.
	• Sleep surface with 60 ¹ / ₂ "W seat, back, and outer back	+\$600	Specify with sleep surface.
	• Sleep surface with 66"W seat, back, and outer back	+\$625	Specify with sleep surface.
	• Sleep surface with 77"W seat, back, and outer back	\$ 675 Included in U.S. Base Price	Specify with sleep surface.
Arm Position	• No arms	Prices at right	Specify with no arms.
	• One arm	Prices at right	Specify with arm right- or left-facing.
	• Two arms	Prices at right	Specify with two arms right- and left-facing.

Tip: When specifying no sleep surface, a fixed back will be received.

Tip: Sleep surface is included and the only back available with 77"W seat, back, and outer back selection.

Tip: Sleep surface requires the specification of two arms.

Tip: Left and right determined when facing the unit.

Tip: Understand that standard requires further specification to complete unit.

Tip: For additional specification information, refer to Surround Configuration Charts.

► See page 550.

Tip: Fabric upcharges are applied separately for seat, back, and outer back.

	Options	U.S. Price	Required to Specify
Surface Materials	Frame		
	• Paint price group 1	No cost	Specify paint color number.
	• Paint price group 2	+\$ 29	Specify paint color number.
	• Paint price group 3	+\$103	Specify paint color number. ► See <i>Surface Materials</i> , page 677.
	Seat, back, and outer back		
	• Fabric	Prices at right	Specify fabric color number.
	Arms		
	• Fabric	Prices at right	Specify fabric color number.
	High arm pillow (if high arm(s) selected)		
	• Fabric	Prices at right	Specify fabric color number.

► Options, continued on next page



For Canadian Pricing

Multiply U.S. Price by the Canadian price factor.

► See page 1 for details.

► Options, continued from previous page

	Options	U.S. Price	Required to Specify
Storage Size(s) and Location(s)	• No storage	No cost	Specify with no storage.
	• 11"W right-facing storage	No cost	Specify with 11"W right-facing storage.
	• 16 1/2"W right-facing storage	No cost	Specify with 16 1/2"W right-facing storage.
	• 11"W left-facing storage	No cost	Specify with 11"W left-facing storage.
	• 16 1/2"W left-facing storage	No cost	Specify with 16 1/2"W left-facing storage.
	• 11"W left- and 11"W right-facing storage	No cost	Specify with 11"W left- and 11"W right-facing storage.
	• 11"W left- and 16 1/2"W right-facing storage	No cost	Specify with 11"W left- and 16 1/2"W right-facing storage.
	• 16 1/2"W left- and 11"W right-facing storage	No cost	Specify with 16 1/2"W left- and 11"W right-facing storage.
	• 16 1/2"W left- and 16 1/2"W right-facing storage	No cost	Specify with 16 1/2"W left- and 16 1/2"W right-facing storage.
Storage Type	Right		
	• Right one-tier end table	No cost	Specify with right one-tier end table.
	• Right two-tier end table	No cost	Specify with right two-tier end table.
	Left		
	• Left one-tier end table	No cost	Specify with left one-tier end table.
	• Left two-tier end table	No cost	Specify with left two-tier end table.
Arm Height(s)	Right		
	• Right arm low	No cost	Specify with right arm low.
	• Right arm high	+\$153	Specify with right arm high.
	Left		
	• Left arm low	No cost	Specify with left arm low.
	• Left arm high	+\$153	Specify with left arm high.
Power and Light	Right		
	• Right arm no power	No cost	Specify with right arm no power.
	• Right arm two power	+\$383	Specify with right arm two power.
	• Right arm one power, two USB	+\$454	Specify with right arm one power, two USB.
	• Right arm, four USB	+\$454	Specify with right arm, four USB.
	• Right arm two power, with light capability	+\$383	Specify with right arm two power, with light capability.
	• Right arm one power, two USB, with light capability	+\$454	Specify with right arm one power, two USB, with light capability.
	• Right arm, four USB, with light capability	+\$454	Specify with right arm, four USB, with light capability.
	Left		
	• Left arm no power	No cost	Specify with left arm no power.
	• Left arm two power	+\$383	Specify with left arm two power.
	• Left arm one power, two USB	+\$454	Specify with left arm one power, two USB.
	• Left arm, four USB	+\$454	Specify with left arm, four USB.
	• Left arm two power, with light capability	+\$383	Specify with left arm two power, with light capability.
	• Left arm one power, two USB, with light capability	+\$454	Specify with left arm one power, two USB, with light capability.
• Left arm, four USB, with light capability	+\$454	Specify with left arm, four USB, with light capability.	
Mobility	• Two glides and two casters	+\$520	Specify with two glides and two casters.
Tablet Rail	• Tablet rail	+\$444	Specify with tablet rail.
Related Products	• Storage, one-tier end table		► Page 605
	• Storage, two-tier end table		► Page 606
	• Mobile tablet		► Page 607

Tip: Storage is specified separately.

► See pages 605–606.

Tip: Storage not available if 77"W seat, back, and outer back is specified.

Tip: Sleep surface requires the specification of two arms.

Tip: Storage type is only specified when storage size and location is chosen.

Tip: Power with light can only be specified if adjacent two-tier storage and light are specified. There is an upcharge for the light option on two-tier storage.

► See page 606.

Tip: Only one power with light may be specified in a unit.

Tip: Only four USB ports total may be specified in a unit.



Surround components are not designed for use with international power.

Tip: Mobile tablet is specified separately.

► See page 606.



For Canadian Pricing

Multiply U.S. Price by the Canadian price factor.

► See page 1 for details.

► Options, continued on next page

Surround Lounge, 88" Frame Width, continued

► Options, continued from previous page

Fabric Upcharges

Style Number	Width	Fabric Price	Fabric Price Group 1	Fabric Price Group 2	Fabric Price Group 3	Fabric Price Group 4	Fabric Price Group 5	Fabric Price Group 6	Fabric Price Group 7	Fabric Price Group 8	Fabric Price Group 9	Fabric Price Group 10	COM
HLS88													
Seat													
44"	No cost	+\$48	+\$ 88	+\$145	+\$211	+\$296	+\$628	+\$ 809	+\$ 973	+\$1152	+\$15		
49½"	No cost	+\$56	+\$103	+\$170	+\$249	+\$348	+\$647	+\$ 848	+\$1029	+\$1228	+\$17		
55"	No cost	+\$58	+\$107	+\$175	+\$257	+\$360	+\$653	+\$ 869	+\$1079	+\$1295	+\$18		
60½"	No cost	+\$65	+\$119	+\$196	+\$286	+\$400	+\$665	+\$ 886	+\$1086	+\$1305	+\$20		
66"	No cost	+\$72	+\$132	+\$217	+\$318	+\$444	+\$680	+\$ 897	+\$1097	+\$1309	+\$22		
77"	No cost	+\$93	+\$170	+\$280	+\$410	+\$575	+\$822	+\$1124	+\$1395	+\$1694	+\$29		
Back													
44"	No cost	+\$48	+\$ 88	+\$145	+\$211	+\$296	+\$628	+\$ 809	+\$ 973	+\$1152	+\$15		
49½"	No cost	+\$56	+\$103	+\$170	+\$249	+\$348	+\$647	+\$ 848	+\$1029	+\$1228	+\$17		
55"	No cost	+\$58	+\$107	+\$175	+\$257	+\$360	+\$653	+\$ 869	+\$1079	+\$1295	+\$18		
60½"	No cost	+\$65	+\$119	+\$196	+\$286	+\$400	+\$665	+\$ 886	+\$1086	+\$1305	+\$20		
66"	No cost	+\$72	+\$132	+\$217	+\$318	+\$444	+\$680	+\$ 897	+\$1097	+\$1309	+\$22		
77"	No cost	+\$93	+\$170	+\$280	+\$410	+\$575	+\$822	+\$1124	+\$1395	+\$1694	+\$29		
Outer Back													
44"	No cost	+\$48	+\$ 88	+\$145	+\$211	+\$296	+\$628	+\$ 809	+\$ 973	+\$1152	+\$15		
49½"	No cost	+\$56	+\$103	+\$170	+\$249	+\$348	+\$647	+\$ 848	+\$1029	+\$1228	+\$17		
55"	No cost	+\$58	+\$107	+\$175	+\$257	+\$360	+\$653	+\$ 869	+\$1079	+\$1295	+\$18		
60½"	No cost	+\$65	+\$119	+\$196	+\$286	+\$400	+\$665	+\$ 886	+\$1086	+\$1305	+\$20		
66"	No cost	+\$72	+\$132	+\$217	+\$318	+\$444	+\$680	+\$ 897	+\$1097	+\$1309	+\$22		
77"	No cost	+\$93	+\$170	+\$280	+\$410	+\$575	+\$822	+\$1124	+\$1395	+\$1694	+\$29		
Arm													
Low	No cost	+\$36	+\$49	+\$ 96	+\$125	+\$145	+\$189	+\$ 253	+\$ 317	+\$ 388	+\$15		
High	No cost	+\$56	+\$76	+\$149	+\$193	+\$268	+\$363	+\$ 436	+\$ 534	+\$ 644	+\$23		
High Arm Pillow													
Pillow	No cost	+\$36	+\$49	+\$ 96	+\$125	+\$145	+\$189	+\$ 253	+\$ 317	+\$ 388	+\$15		

Tip: Seat, back, and outer back fabrics may be specified in different choices.

► See Understanding Lounge on page 556.

Tip: Arm fabric and high arm pillow fabric is per arm selected.

Tip: High arm and pillow fabrics may be specified in different choices.

► See Understanding Lounge on page 556.



For Canadian Pricing

Multiply U.S. Price by the Canadian price factor.

► See page 1 for details.

Specification Information

• Style Number	• Frame Dimensions		• Seat, Back, and Outer Back Width	• U.S. Base Prices Low Arms		
	W	D		No arm(s)	One arm	Two arms

88" Frame Width

Style Number	W	D	Seat, Back, and Outer Back Width	No arm(s)	One arm	Two arms
HLS88	88"	27½"	44"	N.A.	N.A.	\$4017
			49½"	N.A.	\$3899	\$4238
			55"	\$3717	\$4056	\$4395
			60½"	\$3919	\$4258	\$4597
			66"	\$4128	\$4467	\$4806
			77"	N.A.	N.A.	\$5292

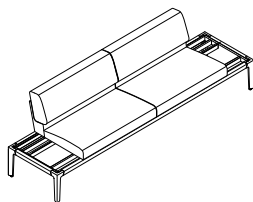

Tip: Sleep surface upcharge is included in base price for 77"W seat, back, and outer back.



For Canadian Pricing

Multiply U.S. Price by the Canadian price factor.

▶ See page 1 for details.

Surround Lounge

93½" Frame Width

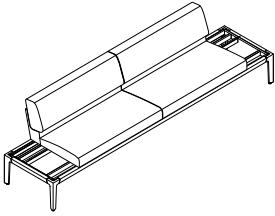

▶ Need help? Product details, page 556

Standard Includes

- Frame: paint price group 1
- Seat, back, and outer back: fabric price group 1
- Sleep surface (if 71½"W seat, back and outer back selected): 5031 Light Merle
- Adjustable glides: platinum solid plastic

Required to Specify

- 1 Style number
 - 2 Seat, back, and outer back width (see below under Required Selections)
 - 3 Sleep surface (see below under Required Selections)
 - 4 Paint color number for frame
 - 5 Fabric color number for seat, back, and outer back
 - 6 Arm position (see below under Required Selections)
 - 7 Options, if selected (see below)
- ▶ See *Surface Materials*, page 677.

	Required Selections	U.S. Price	Required to Specify
Seat, Back, and Outer Back Width	• 49½"W seat, back, and outer back	Prices at right	Specify with 49½"W seat, back, and outer back.
	• 55"W seat, back, and outer back	Prices at right	Specify with 55"W seat, back, and outer back.
	• 60½"W seat, back, and outer back	Prices at right	Specify with 60½"W seat, back, and outer back.
	• 66"W seat, back, and outer back	Prices at right	Specify with 66"W seat, back, and outer back.
	• 71½"W seat, back, and outer back	Prices at right	Specify with 71½"W seat, back, and outer back.

Tip: When specifying no sleep surface, a fixed back will be received.

Tip: Sleep surface is included and the only back available with 71½"W seat, back, and outer back selection.

Tip: Sleep surface requires the specification of two arms.

Tip: Left and right determined when facing the unit.

Tip: Understand that standard requires further specification to complete unit.

Tip: For additional specification information, refer to Surround Configuration Charts.

▶ See page 550.

Tip: Fabric upcharges are applied separately for seat, back, and outer back.

Tip: Sleep surface requires the specification of two arms.

Sleep Surface	• No sleep surface	No cost	Specify with no sleep surface.
	• Sleep surface with 60½"W seat, back, and outer back	+\$600	Specify with sleep surface.
	• Sleep surface with 66"W seat, back, and outer back	+\$625	Specify with sleep surface.
	• Sleep surface with 71½"W seat, back, and outer back	\$ 650 Included in U.S. Base Price	Specify with sleep surface.

Arm Position	• No arms	Prices at right	Specify with no arms.
	• One arm	Prices at right	Specify with arm right- or left-facing.
	• Two arms	Prices at right	Specify with two arms right- and left-facing.

	Options	U.S. Price	Required to Specify
Surface Materials	Frame		
	• Paint price group 1	No cost	Specify paint color number.
	• Paint price group 2	+\$ 29	Specify paint color number.
	• Paint price group 3	+\$103	Specify paint color number. ▶ See <i>Surface Materials</i> , page 677.
	Seat, back, and outer back		
	• Fabric	Prices at right	Specify fabric color number.
	Arms		
	• Fabric	Prices at right	Specify fabric color number.
	High arm pillow (if high arm(s) selected)		
	• Fabric	Prices at right	Specify fabric color number.

▶ Options, continued on next page



For Canadian Pricing

Multiply U.S. Price by the Canadian price factor.

▶ See page 1 for details.

► Options, continued from previous page

	Options	U.S. Price	Required to Specify
Storage Size(s) and Location(s)	• 11"W right-facing storage	No cost	Specify with 11"W right-facing storage.
	• 16 1/2"W right-facing storage	No cost	Specify with 16 1/2"W right-facing storage.
	• 11"W left-facing storage	No cost	Specify with 11"W left-facing storage.
	• 16 1/2"W left-facing storage	No cost	Specify with 16 1/2"W left-facing storage.
	• 11"W left- and 11"W right-facing storage	No cost	Specify with 11"W left- and 11"W right-facing storage.
	• 16 1/2"W left- and 11"W right-facing storage	No cost	Specify with 16 1/2"W left- and 11"W right-facing storage.
	• 11"W left- and 16 1/2"W right-facing storage	No cost	Specify with 11"W left- and 16 1/2"W right-facing storage.
Storage Type	Right		
	• Right one-tier end table	No cost	Specify with right one-tier end table.
	• Right two-tier end table	No cost	Specify with right two-tier end table.
Arm Height(s)	Left		
	• Left one-tier end table	No cost	Specify with left one-tier end table.
	• Left two-tier end table	No cost	Specify with left two-tier end table.
Power and Light	Right		
	• Right arm low	No cost	Specify with right arm low.
	• Right arm high	+\$153	Specify with right arm high.
	Left		
	• Left arm low	No cost	Specify with left arm low.
	• Left arm high	+\$153	Specify with left arm high.
Mobility	Right		
	• Right arm no power	No cost	Specify with right arm no power.
	• Right arm two power	+\$383	Specify with right arm two power.
	• Right arm one power, two USB	+\$454	Specify with right arm one power, two USB.
	• Right arm, four USB	+\$454	Specify with right arm, four USB.
	• Right arm two power, with light capability	+\$383	Specify with right arm two power, with light capability.
	• Right arm one power, two USB, with light capability	+\$454	Specify with right arm one power, two USB, with light capability.
	• Right arm, four USB, with light capability	+\$454	Specify with right arm, four USB, with light capability.
	Left		
	• Left arm no power	No cost	Specify with left arm no power.
	• Left arm two power	+\$383	Specify with left arm two power.
	• Left arm one power, two USB	+\$454	Specify with left arm one power, two USB.
	• Left arm, four USB	+\$454	Specify with left arm, four USB.
	• Left arm two power, with light capability	+\$383	Specify with left arm two power, with light capability.
• Left arm one power, two USB, with light capability	+\$454	Specify with left arm one power, two USB, with light capability.	
• Left arm, four USB, with light capability	+\$454	Specify with left arm, four USB, with light capability.	
Tablet Rail	• Tablet rail	+\$444	Specify with tablet rail.
Related Products	• Storage, one-tier end table		► Page 605
	• Storage, two-tier end table		► Page 606
	• Mobile tablet		► Page 607

Tip: Storage is specified separately.

► See pages 605–606.

Tip: Storage type is only specified when storage size and location is chosen.

Tip: Power with light can only be specified if adjacent two-tier storage and light are specified. There is an upcharge for the light option on two-tier storage.

► See page 606.

Tip: Only one power with light may be specified in a unit.

Tip: Only four USB ports total may be specified in a unit.



Surround components are not designed for use with international power.

Tip: Mobile tablet is specified separately.

► See page 606.

► Options, continued on next page

**For Canadian Pricing**

Multiply U.S. Price by the Canadian price factor.

► See page 1 for details.

Surround Lounge, 93½" Frame Width, continued

► Options, continued from previous page

Fabric Upcharges

Style Number	Width	Fabric Price	Fabric Price Group 1	Fabric Price Group 2	Fabric Price Group 3	Fabric Price Group 4	Fabric Price Group 5	Fabric Price Group 6	Fabric Price Group 7	Fabric Price Group 8	Fabric Price Group 9	Fabric Price Group 10	COM
HLS94													
Seat													
	49½"	No cost	+\$56	+\$103	+\$170	+\$249	+\$348	+\$647	+\$ 848	+\$1029	+\$1228	+\$17	
	55"	No cost	+\$58	+\$107	+\$175	+\$257	+\$360	+\$653	+\$ 869	+\$1079	+\$1295	+\$18	
	60½"	No cost	+\$65	+\$119	+\$196	+\$286	+\$400	+\$665	+\$ 886	+\$1086	+\$1305	+\$20	
	66"	No cost	+\$72	+\$132	+\$217	+\$318	+\$444	+\$680	+\$ 897	+\$1097	+\$1309	+\$22	
	71½"	No cost	+\$84	+\$155	+\$255	+\$373	+\$523	+\$746	+\$1021	+\$1269	+\$1540	+\$26	
Back													
	49½"	No cost	+\$56	+\$103	+\$170	+\$249	+\$348	+\$647	+\$ 848	+\$1029	+\$1228	+\$17	
	55"	No cost	+\$58	+\$107	+\$175	+\$257	+\$360	+\$653	+\$ 869	+\$1079	+\$1295	+\$18	
	60½"	No cost	+\$65	+\$119	+\$196	+\$286	+\$400	+\$665	+\$ 886	+\$1086	+\$1305	+\$20	
	66"	No cost	+\$72	+\$132	+\$217	+\$318	+\$444	+\$680	+\$ 897	+\$1097	+\$1309	+\$22	
	71½"	No cost	+\$84	+\$155	+\$255	+\$373	+\$523	+\$746	+\$1021	+\$1269	+\$1540	+\$26	
Outer Back													
	49½"	No cost	+\$56	+\$103	+\$170	+\$249	+\$348	+\$647	+\$ 848	+\$1029	+\$1228	+\$17	
	55"	No cost	+\$58	+\$107	+\$175	+\$257	+\$360	+\$653	+\$ 869	+\$1079	+\$1295	+\$18	
	60½"	No cost	+\$65	+\$119	+\$196	+\$286	+\$400	+\$665	+\$ 886	+\$1086	+\$1305	+\$20	
	66"	No cost	+\$72	+\$132	+\$217	+\$318	+\$444	+\$680	+\$ 897	+\$1097	+\$1309	+\$22	
	71½"	No cost	+\$84	+\$155	+\$255	+\$373	+\$523	+\$746	+\$1021	+\$1269	+\$1540	+\$26	
Arm													
	Low	No cost	+\$36	+\$ 49	+\$ 96	+\$125	+\$145	+\$189	+\$ 253	+\$ 317	+\$ 388	+\$15	
	High	No cost	+\$56	+\$ 76	+\$149	+\$193	+\$268	+\$363	+\$ 436	+\$ 534	+\$ 644	+\$23	
High Arm Pillow													
	Pillow	No cost	+\$36	+\$ 49	+\$ 96	+\$125	+\$145	+\$189	+\$ 253	+\$ 317	+\$ 388	+\$15	

Tip: Seat, back, and outer back fabrics may be specified in different choices.

► See Understanding Lounge on page 556.

Tip: Arm fabric and high arm pillow fabric is per arm selected.

Tip: High arm and pillow fabrics may be specified in different choices.

► See Understanding Lounge on page 556.

Specification Information

Style Number	Frame Dimensions		Seat, Back, and Outer Back Width	U.S. Base Price Low Arms		
	W	D		No arm(s)	One arm	Two arms

93½" Frame Width

HLS94	93½"	27½"	49½"	N.A.	N.A.	\$4348
			55"	N.A.	\$4166	\$4505
			60½"	\$4029	\$4368	\$4707
			66"	\$4238	\$4577	\$4916
			71½"	N.A.	N.A.	\$5181

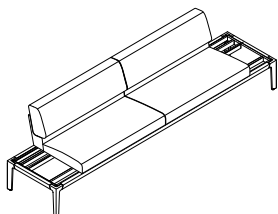

Tip: Sleep surface upcharge is included in base price for 71½"W seat, back, and outer back.

Surround Lounge

99" Frame Width

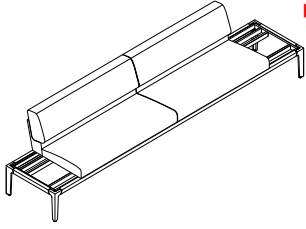

▶ Need help? Product details, page 556

Standard Includes

- Frame: paint price group 1
- Seat, back, and outer back: fabric price group 1
- Sleep surface (if 71¹/₂"W or 77"W seat, back and outer back selected): 5031 Light Merle
- Adjustable glides: platinum solid plastic

Required to Specify

- 1 Style number
 - 2 Seat, back, and outer back width (see below under Required Selections)
 - 3 Sleep surface (see below under Required Selections)
 - 4 Paint color number for frame
 - 5 Fabric color number for seat, back, and outer back
 - 6 Arm position (see below under Required Selections)
 - 7 Options, if selected (see below)
- ▶ See *Surface Materials*, page 677.

	Required Selections	U.S. Price	Required to Specify
Seat, Back, and Outer Back Width	• 55"W seat, back, and outer back	Price at right	Specify with 55"W seat, back, and outer back.
	• 60 ¹ / ₂ "W seat, back, and outer back	Price at right	Specify with 60 ¹ / ₂ "W seat, back, and outer back.
	• 66"W seat, back, and outer back	Price at right	Specify with 66"W seat, back, and outer back.
	• 71 ¹ / ₂ "W seat, back, and outer back	Price at right	Specify with 71 ¹ / ₂ "W seat, back, and outer back.
	• 77"W seat, back, and outer back	Price at right	Specify with 77"W seat, back, and outer back.
Sleep Surface	• No sleep surface	No cost	Specify with no sleep surface.
	• Sleep surface with 60 ¹ / ₂ "W seat, back, and outer back	+\$600	Specify with sleep surface.
	• Sleep surface with 66"W seat, back, and outer back	+\$625	Specify with sleep surface.
	• Sleep surface with 71 ¹ / ₂ "W seat, back, and outer back	\$ 650 Included in U.S. Base Price	Specify with sleep surface.
Arm Position	• Sleep surface with 77"W seat, back, and outer back	\$ 675 Included in U.S. Base Price	Specify with sleep surface.
	• No arms	Prices at right	Specify with no arms.
	• One arm	Prices at right	Specify with arm right- or left-facing.
	• Two arms	Prices at right	Specify with two arms right- and left-facing.

Tip: When specifying no sleep surface, a fixed back will be received.

Tip: Sleep surface is included and the only back available with 71¹/₂"W or 77"W seat, back, and outer back selection.

Tip: Sleep surface requires the specification of two arms.

Tip: Left and right determined when facing the unit.

Tip: Understand that standard requires further specification to complete unit.

Tip: For additional specification information, refer to Surround Configuration Charts.

▶ See page 550.

Tip: Fabric upcharges are applied separately for seat, back, and outer back.

Tip: Sleep surface requires the specification of two arms.

	Options	U.S. Price	Required to Specify
Surface Materials	Frame		
	• Paint price group 1	No cost	Specify paint color number.
	• Paint price group 2	+\$ 29	Specify paint color number.
	• Paint price group 3	+\$103	Specify paint color number.
	Seat, back, and outer back		
	• Fabric	Prices at right	Specify fabric color number.
	Arms		
	• Fabric	Prices at right	Specify fabric color number.
	High arm pillow (if high arm(s) selected)		
	• Fabric	Prices at right	Specify fabric color number.

▶ See *Surface Materials*, page 677.

▶ Options, continued on next page



For Canadian Pricing

Multiply U.S. Price by the Canadian price factor.

▶ See page 1 for details.

► Options, continued from previous page

	Options	U.S. Price	Required to Specify
Storage Size(s) and Location(s)	• 11"W right-facing storage	No cost	Specify with 11"W right-facing storage.
	• 16 1/2"W right-facing storage	No cost	Specify with 16 1/2"W right-facing storage.
	• 11"W left-facing storage	No cost	Specify with 11"W left-facing storage.
	• 16 1/2"W left-facing storage	No cost	Specify with 16 1/2"W left-facing storage.
	• 11"W left- and 11"W right-facing storage	No cost	Specify with 11"W left- and 11"W right-facing storage.
	• 16 1/2"W left- and 11"W right-facing storage	No cost	Specify with 16 1/2"W left- and 11"W right-facing storage.
	• 11"W left- and 16 1/2"W right-facing storage	No cost	Specify with 11"W left- and 16 1/2"W right-facing storage.
Storage Type	Right		
	• Right one-tier end table	No cost	Specify with right one-tier end table.
	• Right two-tier end table	No cost	Specify with right two-tier end table.
	Left		
	• Left one-tier end table	No cost	Specify with left one-tier end table.
	• Left two-tier end table	No cost	Specify with left two-tier end table.
Arm Height(s)	Right		
	• Right arm low	No cost	Specify with right arm low.
	• Right arm high	+\$153	Specify with right arm high.
	Left		
	• Left arm low	No cost	Specify with left arm low.
	• Left arm high	+\$153	Specify with left arm high.
Power and Light	Right		
	• Right arm no power	No cost	Specify with right arm no power.
	• Right arm two power	+\$383	Specify with right arm two power.
	• Right arm one power, two USB	+\$454	Specify with right arm one power, two USB.
	• Right arm, four USB	+\$454	Specify with right arm, four USB.
	• Right arm two power, with light capability	+\$383	Specify with right arm two power, with light capability.
	• Right arm one power, two USB, with light capability	+\$454	Specify with right arm one power, two USB, with light capability.
	• Right arm, four USB, with light capability	+\$454	Specify with right arm, four USB, with light capability.
	Left		
	• Left arm no power	No cost	Specify with left arm no power.
	• Left arm two power	+\$383	Specify with left arm two power.
	• Left arm one power, two USB	+\$454	Specify with left arm one power, two USB.
	• Left arm, four USB	+\$454	Specify with left arm, four USB.
	• Left arm two power, with light capability	+\$383	Specify with left arm two power, with light capability.
• Left arm one power, two USB, with light capability	+\$454	Specify with left arm one power, two USB, with light capability.	
• Left arm, four USB, with light capability	+\$454	Specify with left arm, four USB, with light capability.	
Mobility	• Two glides and two casters	+\$520	Specify with two glides and two casters.
Tablet Rail	• Tablet rail	+\$444	Specify with tablet rail.
Related Products	• Storage, one-tier end table		► Page 605
	• Storage, two-tier end table		► Page 606
	• Mobile tablet		► Page 607

Tip: Storage is specified separately.

► See pages 605–606.

Tip: Storage type is only specified when storage size and location is chosen.

Tip: Power with light can only be specified if adjacent two-tier storage and light are specified. There is an upcharge for the light option on two-tier storage.

► See page 606.

Tip: Only one power with light may be specified in a unit.

Tip: Only four USB ports total may be specified in a unit.



Surround components are not designed for use with international power.

Tip: Mobile tablet is specified separately.

► See page 606.

► Options, continued on next page

**For Canadian Pricing**

Multiply U.S. Price by the Canadian price factor.

► See page 1 for details.

Surround Lounge, 99" Frame Width, continued

► Options, continued from previous page

Fabric Upcharges

Style Number	Width	Fabric Price	Fabric Price Group 1	Fabric Price Group 2	Fabric Price Group 3	Fabric Price Group 4	Fabric Price Group 5	Fabric Price Group 6	Fabric Price Group 7	Fabric Price Group 8	Fabric Price Group 9	Fabric Price Group 10	COM
HLS99													
Seat													
55"	No cost	+\$58	+\$107	+\$175	+\$257	+\$360	+\$653	+\$ 869	+\$1079	+\$1295	+\$18		
60½"	No cost	+\$65	+\$119	+\$196	+\$286	+\$400	+\$665	+\$ 886	+\$1086	+\$1305	+\$20		
66"	No cost	+\$72	+\$132	+\$217	+\$318	+\$444	+\$680	+\$ 897	+\$1097	+\$1309	+\$22		
71½"	No cost	+\$84	+\$155	+\$255	+\$373	+\$523	+\$746	+\$1021	+\$1269	+\$1540	+\$26		
77"	No cost	+\$93	+\$170	+\$280	+\$410	+\$575	+\$822	+\$1124	+\$1395	+\$1694	+\$29		
Back													
55"	No cost	+\$58	+\$107	+\$175	+\$257	+\$360	+\$653	+\$ 869	+\$1079	+\$1295	+\$18		
60½"	No cost	+\$65	+\$119	+\$196	+\$286	+\$400	+\$665	+\$ 886	+\$1086	+\$1305	+\$20		
66"	No cost	+\$72	+\$132	+\$217	+\$318	+\$444	+\$680	+\$ 897	+\$1097	+\$1309	+\$22		
71½"	No cost	+\$84	+\$155	+\$255	+\$373	+\$523	+\$746	+\$1021	+\$1269	+\$1540	+\$26		
77"	No cost	+\$93	+\$170	+\$280	+\$410	+\$575	+\$822	+\$1124	+\$1395	+\$1694	+\$29		
Outer Back													
55"	No cost	+\$58	+\$107	+\$175	+\$257	+\$360	+\$653	+\$ 869	+\$1079	+\$1295	+\$18		
60½"	No cost	+\$65	+\$119	+\$196	+\$286	+\$400	+\$665	+\$ 886	+\$1086	+\$1305	+\$20		
66"	No cost	+\$72	+\$132	+\$217	+\$318	+\$444	+\$680	+\$ 897	+\$1097	+\$1309	+\$22		
71½"	No cost	+\$84	+\$155	+\$255	+\$373	+\$523	+\$746	+\$1021	+\$1269	+\$1540	+\$26		
77"	No cost	+\$93	+\$170	+\$280	+\$410	+\$575	+\$822	+\$1124	+\$1395	+\$1694	+\$29		
Arm													
Low	No cost	+\$36	+\$ 49	+\$ 96	+\$125	+\$145	+\$189	+\$ 253	+\$ 317	+\$ 388	+\$15		
High	No cost	+\$56	+\$ 76	+\$149	+\$193	+\$268	+\$363	+\$ 436	+\$ 534	+\$ 644	+\$23		
High Arm Pillow													
Pillow	No cost	+\$36	+\$ 49	+\$ 96	+\$125	+\$145	+\$189	+\$ 253	+\$ 317	+\$ 388	+\$15		

Tip: Seat, back, and outer back fabrics may be specified in different choices.

► See Understanding Lounge on page 556.

Tip: Arm fabric and high arm pillow fabric is per arm selected.

Tip: High arm and pillow fabrics may be specified in different choices.

► See Understanding Lounge on page 556.

Specification Information

Style Number	Frame Dimensions		Seat, Back, and Outer Back Width	U.S. Base Prices Low Arms		
	W	D		No arm(s)	One arm	Two arms

99" Frame Width

HLS99	99"	27½"	55"	N.A.	N.A.	\$4615
			60½"	N.A.	\$4478	\$4817
			66"	\$4348	\$4687	\$5026
			71½"	N.A.	N.A.	\$5291
			77"	N.A.	N.A.	\$5512

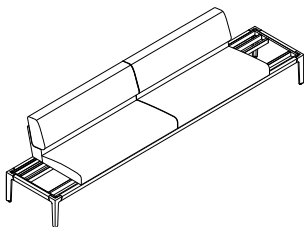

Tip: Sleep surface upcharge is included in base price for 71½"W and 77"W seat, back, and outer back.

Surround Lounge

104½" Frame Width

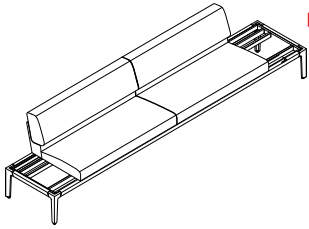

► Need help?
Product details,
page 556

Standard Includes

- Frame: paint price group 1
- Seat, back, and outer back: fabric price group 1
- Sleep surface (if 71½"W or 77"W seat, back and outer back selected): 5031 Light Merle
- Adjustable glides: platinum solid plastic

Required to Specify

- 1 Style number
 - 2 Seat, back, and outer back width (see below under Required Selections)
 - 3 Sleep surface (see below under Required Selections)
 - 4 Paint color number for frame
 - 5 Fabric color number for seat, back, and outer back
 - 6 Arm position (see below under Required Selections)
 - 7 Options, if selected (see below)
- See *Surface Materials*, page 677.

Tip: When specifying no sleep surface, a fixed back will be received.

Tip: Sleep surface is included and the only back available with 71½"W or 77"W seat, back, and outer back selection.

Tip: Sleep surface requires the specification of two arms.

Tip: Left and right determined when facing the unit.

Tip: Understand that standard requires further specification to complete unit.

Tip: For additional specification information, refer to Surround Configuration Charts.

► See page 550.

Tip: Fabric upcharges are applied separately for seat, back, and outer back.

Tip: Sleep surface requires the specification of two arms.

	Required Selections	U.S. Price	Required to Specify
Seat, Back, and Outer Back Width	• 60½"W seat, back, and outer back	Price at right	Specify with 60½"W seat, back, and outer back.
	• 66"W seat, back, and outer back	Price at right	Specify with 66"W seat, back, and outer back.
	• 71½"W seat, back, and outer back	Price at right	Specify with 71½"W seat, back, and outer back.
	• 77"W seat, back, and outer back	Price at right	Specify with 77"W seat, back, and outer back.
Sleep Surface	• No sleep surface	No cost	Specify with no sleep surface.
	• Sleep surface with 60½"W seat, back, and outer back	+\$600	Specify with sleep surface.
	• Sleep surface with 66"W seat, back, and outer back	+\$625	Specify with sleep surface.
	• Sleep surface with 71½"W seat, back, and outer back	\$ 650 Included in U.S. Base Price	Specify with sleep surface.
	• Sleep surface with 77"W seat, back, and outer back	\$ 675 Included in U.S. Base Price	Specify with sleep surface.
Arm Position	• No arms	Prices at right	Specify with no arms.
	• One arm	Prices at right	Specify with arm right- or left-facing.
	• Two arms	Prices at right	Specify with two arms right- and left-facing.

	Options	U.S. Price	Required to Specify
Surface Materials	Frame		
	• Paint price group 1	No cost	Specify paint color number.
	• Paint price group 2	+\$ 29	Specify paint color number.
	• Paint price group 3	+\$103	Specify paint color number. ► See <i>Surface Materials</i> , page 677.
	Seat, back, and outer back		
	• Fabric	Prices at right	Specify fabric color number.
	Arms		
	• Fabric	Prices at right	Specify fabric color number.
	High arm pillow (if high arm(s) selected)		
	• Fabric	Prices at right	Specify fabric color number.

► Options, continued on next page



For Canadian Pricing

Multiply U.S. Price by the Canadian price factor.

► See page 1 for details.

► Options, continued from previous page

	Options	U.S. Price	Required to Specify
Storage Size(s) and Location(s)	• 16 ¹ / ₂ "W right-facing storage	No cost	Specify with 16 ¹ / ₂ "W right-facing storage.
	• 11"W left-facing storage	No cost	Specify with 11"W left-facing storage.
	• 16 ¹ / ₂ "W left-facing storage	No cost	Specify with 16 ¹ / ₂ "W left-facing storage.
	• 11"W left- and 11"W right-facing storage	No cost	Specify with 11"W left- and 11"W right-facing storage.
	• 16 ¹ / ₂ "W left- and 11"W right-facing storage	No cost	Specify with 16 ¹ / ₂ "W left- and 11"W right-facing storage.
	• 11"W left- and 16 ¹ / ₂ "W right-facing storage	No cost	Specify with 11"W left- and 16 ¹ / ₂ "W right-facing storage.
	• 16 ¹ / ₂ "W left- and 16 ¹ / ₂ "W right-facing storage	No cost	Specify with 16 ¹ / ₂ "W left- and 16 ¹ / ₂ "W right-facing storage.
Storage Type	Right		
	• Right one-tier end table	No cost	Specify with right one-tier end table.
	• Right two-tier end table	No cost	Specify with right two-tier end table.
	Left		
	• Left one-tier end table	No cost	Specify with left one-tier end table.
	• Left two-tier end table	No cost	Specify with left two-tier end table.
Arm Height(s)	Right		
	• Right arm low	No cost	Specify with right arm low.
	• Right arm high	+\$153	Specify with right arm high.
	Left		
	• Left arm low	No cost	Specify with left arm low.
	• Left arm high	+\$153	Specify with left arm high.
Power and Light	Right		
	• Right arm no power	No cost	Specify with right arm no power.
	• Right arm two power	+\$383	Specify with right arm two power.
	• Right arm one power, two USB	+\$454	Specify with right arm one power, two USB.
	• Right arm, four USB	+\$454	Specify with right arm, four USB.
	• Right arm two power, with light capability	+\$383	Specify with right arm two power, with light capability.
	• Right arm one power, two USB, with light capability	+\$454	Specify with right arm one power, two USB, with light capability.
	• Right arm, four USB, with light capability	+\$454	Specify with right arm, four USB, with light capability.
	Left		
	• Left arm no power	No cost	Specify with left arm no power.
	• Left arm two power	+\$383	Specify with left arm two power.
	• Left arm one power, two USB	+\$454	Specify with left arm one power, two USB.
	• Left arm, four USB	+\$454	Specify with left arm, four USB.
	• Left arm two power, with light capability	+\$383	Specify with left arm two power, with light capability.
• Left arm one power, two USB, with light capability	+\$454	Specify with left arm one power, two USB, with light capability.	
• Left arm, four USB, with light capability	+\$454	Specify with left arm, four USB, with light capability.	
Mobility	• Two glides and two casters	+\$520	Specify with two glides and two casters.
Tablet Rail	• Tablet rail	+\$444	Specify with tablet rail.
Related Products	• Storage, one-tier end table • Storage, two-tier end table • Mobile tablet		► Page 605 ► Page 606 ► Page 607

Tip: Storage is specified separately.

► See pages 605–606.

Tip: Storage type is only specified when storage size and location is chosen.

Tip: Power with light can only be specified if adjacent two-tier storage and light are specified. There is an upcharge for the light option on two-tier storage.

► See page 606.

Tip: Only one power with light may be specified in a unit.

Tip: Only four USB ports total may be specified in a unit.



Surround components are not designed for use with international power.

Tip: Mobile tablet is specified separately.

► See page 606.



For Canadian Pricing

Multiply U.S. Price by the Canadian price factor.

► See page 1 for details.

► Options, continued on next page

Surround Lounge, 104½" Frame Width, continued

► Options, continued from previous page

Fabric Upcharges

Style Number	Width	Fabric Price	Fabric Price Group 1	Fabric Price Group 2	Fabric Price Group 3	Fabric Price Group 4	Fabric Price Group 5	Fabric Price Group 6	Fabric Price Group 7	Fabric Price Group 8	Fabric Price Group 9	Fabric Price Group 10	COM
HLS105 Seat													
60½"	No cost	+\$65	+\$119	+\$196	+\$286	+\$400	+\$665	+\$ 886	+\$1086	+\$1305	+\$20		
66"	No cost	+\$72	+\$132	+\$217	+\$318	+\$444	+\$680	+\$ 897	+\$1097	+\$1309	+\$22		
71½"	No cost	+\$84	+\$155	+\$255	+\$373	+\$523	+\$746	+\$1021	+\$1269	+\$1540	+\$26		
77"	No cost	+\$93	+\$170	+\$280	+\$410	+\$575	+\$822	+\$1124	+\$1395	+\$1694	+\$29		
Back													
60½"	No cost	+\$65	+\$119	+\$196	+\$286	+\$400	+\$665	+\$ 886	+\$1086	+\$1305	+\$20		
66"	No cost	+\$72	+\$132	+\$217	+\$318	+\$444	+\$680	+\$ 897	+\$1097	+\$1309	+\$22		
71½"	No cost	+\$84	+\$155	+\$255	+\$373	+\$523	+\$746	+\$1021	+\$1269	+\$1540	+\$26		
77"	No cost	+\$93	+\$170	+\$280	+\$410	+\$575	+\$822	+\$1124	+\$1395	+\$1694	+\$29		
Outer Back													
60½"	No cost	+\$65	+\$119	+\$196	+\$286	+\$400	+\$665	+\$ 886	+\$1086	+\$1305	+\$20		
66"	No cost	+\$72	+\$132	+\$217	+\$318	+\$444	+\$680	+\$ 897	+\$1097	+\$1309	+\$22		
71½"	No cost	+\$84	+\$155	+\$255	+\$373	+\$523	+\$746	+\$1021	+\$1269	+\$1540	+\$26		
77"	No cost	+\$93	+\$170	+\$280	+\$410	+\$575	+\$822	+\$1124	+\$1395	+\$1694	+\$29		
Arm													
Low	No cost	+\$36	+\$ 49	+\$ 96	+\$125	+\$145	+\$189	+\$ 253	+\$ 317	+\$ 388	+\$15		
High	No cost	+\$56	+\$ 76	+\$149	+\$193	+\$268	+\$363	+\$ 436	+\$ 534	+\$ 644	+\$23		
High Arm Pillow													
Pillow	No cost	+\$36	+\$ 49	+\$ 96	+\$125	+\$145	+\$189	+\$ 253	+\$ 317	+\$ 388	+\$15		

Tip: Seat, back, and outer back fabrics may be specified in different choices.

► See Understanding Lounge on page 556.

Tip: Arm fabric and high arm pillow fabric is per arm selected.

Tip: High arm and pillow fabrics may be specified in different choices.

► See Understanding Lounge on page 556.

Specification Information

Style Number	Frame Dimensions		Seat, Back, and Outer Back Width	U.S. Base Prices Low Arms		
	W	D		No arm(s)	One arm	Two arms

104½" Frame Width

HLS105	104½"	27½"	60½"	N.A.	N.A.	\$4927
			66"	N.A.	\$4797	\$5136
			71½"	N.A.	N.A.	\$5401
			77"	N.A.	N.A.	\$5622

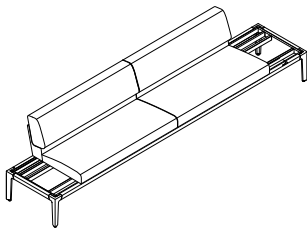

Tip: Sleep surface upcharge is included in base price for 71½"W and 77"W seat, back, and outer back.



For Canadian Pricing

Multiply U.S. Price by the Canadian price factor.

► See page 1 for details.

Surround Storage

One-Tier End Table

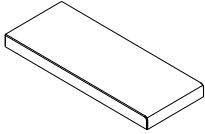

Tip: Storage width must match storage size specified on frame.

Tip: Storage cannot be specified adjacent to other storage.

Standard Includes	Required to Specify
-------------------	---------------------

<ul style="list-style-type: none"> ▶ Need help? Product details, page 560 	<ul style="list-style-type: none"> • Table: paint 	<ol style="list-style-type: none"> 1 Style number 2 Table width (see below under Required Selections) 3 Storage location (see below under Required Selections) 4 Paint color number for table <p>▶ See <i>Surface Materials</i>, page 677.</p>
--	--	--

Required Selections	U.S. Price	Required to Specify
---------------------	------------	---------------------

Table Width	<ul style="list-style-type: none"> • 11"W • 16¹/₂"W 	<p>Price below Price below</p>	<p>Specify <i>with 11"W</i>. Specify <i>with 16¹/₂"W</i>.</p>
Storage Location	<ul style="list-style-type: none"> • Left-facing storage • Right-facing storage 	<p>No cost No cost</p>	<p>Specify <i>with left-facing storage</i>. Specify <i>with right-facing storage</i>.</p>

Specification Information

• Style Number	U.S. Prices	
	• 11"W	• 16 ¹ / ₂ "W
HLSET	\$510	\$612
:	:	:



For Canadian Pricing

Multiply U.S. Price by the Canadian price factor.

▶ See page 1 for details.

Surround Storage

Two-Tier End Table

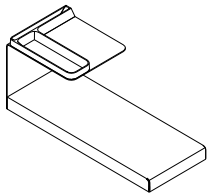

Tip: Two-tier storage requires the specification of an adjacent arm.

Tip: Storage tray with picture rail is not available when light is specified.

Tip: Storage width must match storage size specified on frame.

Tip: Storage location is determined when frame is specified.

Tip: Light requires the specification of power with light in arm adjacent to storage.

Tip: Upper storage refers to the entire second tier, and lower storage refers to the bottom tier.

Tip: Storage cannot be specified adjacent to other storage.

Standard Includes	Required to Specify
-------------------	---------------------

<ul style="list-style-type: none"> ▶ Need help? Product details, page 560 • Table: paint • Storage tray with picture rail: 6527 Merle 	<ol style="list-style-type: none"> 1 Style number 2 Table width (see below under Required Selections) 3 Paint color number for table 4 Coat hanger (see below under Required Selections) 5 Light (see below under Required Selections) 6 Storage location (see below under Required Selections) 7 Color scheme (see below under Required Selections) <p>▶ See <i>Surface Materials</i>, page 677.</p>
--	--

Table Width	Required Selections	U.S. Price	Required to Specify
-------------	---------------------	------------	---------------------

Table Width	<ul style="list-style-type: none"> • 11"W • 16¹/₂"W 	Price below Price below	Specify with 11"W. Specify with 16 ¹ / ₂ "W.
Coat Hanger	<ul style="list-style-type: none"> • Coat hanger 	+\$102	Specify with coat hanger and select paint color number. ▶ See <i>Surface Materials</i> , page 677.
Light	<ul style="list-style-type: none"> • Light 	+\$459	Specify with light (power in arm).
Storage Location	<ul style="list-style-type: none"> • Left-facing storage • Right-facing storage 	No cost No cost	Specify with left-facing storage. Specify with right-facing storage.
Color Scheme	<ul style="list-style-type: none"> • Contrasting finish 	+\$ 26	Specify with contrasting and select paint color number for upper and lower storage. ▶ See <i>Surface Materials</i> , page 677.

Specification Information

Style Number	U.S. Base Prices	
	11"W	16 ¹ / ₂ "W
HLSTTT	\$1428	\$1530

For Canadian Pricing
 Multiply U.S. Price by the Canadian price factor.
 ▶ See page 1 for details.

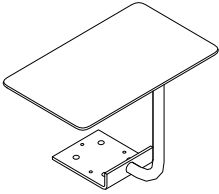

Tip: Tablet arm and tablet attach to the unit on site.

Tip: Tablet rail is specified on the frame.

Tip: Only one tablet rail and mobile tablet can be specified per unit.

Standard Includes		Required to Specify
-------------------	--	---------------------

▶ Need help? Product details, page 562	<ul style="list-style-type: none"> • Tablet surface: plastic • Tablet arm: paint 	1 Style number 2 Plastic color number for tablet surface 3 Paint color number for tablet arm ▶ See <i>Surface Materials</i> , page 677.
--	--	--

Specification Information	
Style Number	U.S. Price

HLSMT	\$1341
-------	--------



For Canadian Pricing
 Multiply U.S. Price by the Canadian price factor.
 ▶ See page 1 for details.

