Steelcase Worktools and Height-Adjustable Worksurfaces and Benching Volume 9

Terms and Conditions	2
Sample Order Form	10
Participating Steelcase Dealers	12
Steelcase Showrooms and Manufacturing Locations	17

Product Information	
Organizational Worktools (SIN 711.2)	19
Lighting (SIN 711.2/711.1)	57
Computer Support Tools (SIN 711.2)	85
Height-Adjustable Worksurfaces (SIN 711.2)	209
Height-Adjustable Benching (SIN 711.2)	305

Surface Materials	345
Resources	356

► For a list of all trademarks, refer to the last page of this specification guide.

Terms and Conditions

Customer Information

For more information, please contact your participating Steelcase GSA dealer.

For more information, please contact your participating Steelcase GSA dealer.

For more information, please contact your participating Steelcase GSA dealer.

For more information, please contact your participating Steelcase GSA dealer.

For more information, please contact your participating Steelcase GSA dealer.

For more information, please contact your participating Steelcase GSA dealer.

For more information, please contact your participating Steelcase GSA dealer.

For more information, please contact your participating Steelcase GSA dealer.

Sample Order Form

Sample Order Form

ORDER FOR SUPPLIES OR SERVICES			PAGE	OF	PAGES
IMPORTANT: Mark all packages and papers with contract and/or order numbers.					
DATE OF ORDER 1 6-1-04	CONTRACT NO. (If any) 2 GS-27F-0014V	ORDER NO. 3 10 - 000	REQUISITION/REFERENCE NO.		
ISSUING OFFICE (Address correspondence to) 4 GSA 1 Town Street City, State, Zip Name and Telephone Number		SHIP TO: (Consignee and address, ZIP Code) 5 GSA 2 Town Street City, State, Zip Name and Telephone Number			
TO: CONTRACTOR (Name, address and ZIP Code) 6 Steelcase Inc. c/o Participating Dealer 901 44th Street, SE Grand Rapids, MI 49508 Attn: Solutions Fullfillment Team CH-2W-SS (GSA)		Cage Code: 39880		TYPE OF ORDER <input type="checkbox"/> A. PURCHASE — Reference your _____ Please furnish the following on the terms and conditions specified on both sides of this order and on the attached sheets, if any, including delivery as indicated. This purchase is negotiated under authority of: <input type="checkbox"/> B. DELIVERY — Except for billing instructions on the reverse, this delivery order is subject to instructions contained on this side only of this form and is issued subject to the terms and conditions of the above-numbered contract.	
ACCOUNTING AND APPROPRIATION DATA			REQUISITIONING OFFICE		
			BUSINESS CLASSIFICATION (Check appropriate box(es)) 20 <input type="checkbox"/> SMALL <input checked="" type="checkbox"/> OTHER THAN SMALL <input type="checkbox"/> DIS-ADVANTAGED <input type="checkbox"/> WOMEN-OWNED		
FCA DESTINATION 7		GOVERNMENT NO.	DELIVER TO FCA DESTINATION ON OR BEFORE (Date) 8 ARO date	DISCOUNT TERMS 9 Net 30 days	
PLACE OF INSPECTION AND ACCEPTANCE					

(See reverse for Rejections)

ITEM NO. (A)	SUPPLIES OR SERVICES (B)	QUANTITY ORDERED (C)	UNIT (D)	UNIT PRICE (E)	AMOUNT (F)	QUANTITY ACCEPTED (G)	
1	10 One lot of Steelcase Office Furniture: See attached specifications	13 1		14 \$000	15 \$000		
2	11 Design: \$55.41/hour	2 hrs		\$000	\$000		
3	12 Installation	1		\$000	\$000		
SEE BILLING INSTRUCTIONS ON REVERSE		SHIPPING POINT		GROSS SHIPPING WEIGHT		INVOICE NO.	
		MAIL INVOICE TO: (Include ZIP Code) 17 GSA, 3 Town Street, City, State, Zip				16 \$000	(H) TOT. (Cont. pages) ◀ (I) GRAND TOTAL ◀
UNITED STATES OF AMERICA BY (Signature) 18 Contracting Officer signature and telephone no.				NAME (Typed) 19 John Doe, Department Manager TITLE: CONTRACTING/ORDERING OFFICER			

NSN 7540_01_152_8083

50347-101

OPTIONAL FORM 347 (10-83)
Prescribed by GSA
FAR (48 CFR) 53.213 (e)

- 1 Order date
- 2 Contract number
- 3 Order number
- 4 Issuing office: Requester name and telephone number
- 5 Shipping address: Contact name and telephone number
- 6 Contractor:
Steelcase Inc.
c/o Participating Dealer
901 - 44th Street, S.E.
Grand Rapids, MI 49508
Attn: Solutions Fulfillment Team
- 7 FCA destination
- 8 ARO date (After Receipt of Order)
- 9 Terms: Net 30 days
- 10 Complete product description, including SIN number, style number, all applicable surface materials.
- 11 Separate line for design
- 12 Separate line for installation
- 13 Quantity ordered
- 14 Individual unit price
- 15 Amount (quantity x unit price)
- 16 Total cost
- 17 Invoice address
- 18 Authorized contracting officer signature and telephone number
- 19 Authorized contracting officer name and title (typed)
- 20 Steelcase is the seller of record and is not registered as "small," "disadvantaged," or "woman-owned." If one of these boxes is checked in error, a modification will be required.

Please note on order that all invoice payments must be sent to:

Steelcase Inc.
62087 Collection Center Dr.
Chicago, IL 60693-0620

Storage and Delays

(Open Market) In the event that the site is not accessible, or safe and adequate storage space is not available during installation, the furnishings will be stored until delivery or installation can be accomplished. Pricing for storage will be negotiated on a project-by-project basis. Invoices will be sent to the local government purchasing facility upon delivery of the furniture to a designated storage facility. Steelcase shall provide notice to the Government purchasing facility that the furnishings are available for inspection by the Government at the Storage facility. Upon this notice, the Government, or representative for the Government, must inspect and accept the furniture prior to payment of any invoice. The inspection and acceptance must be completed within reasonable time frame agreed upon by both parties. Payment will be made by the Government 30 days after acceptance of the furniture.

Participating Steelcase Dealers

Alabama

Dekalb Office of Alabama
2901 Second Ave South
Birmingham, AL 35233
Phone: (205) 933-9100

Kyser OfficeWorks Inc.
2400 Spruce Street
Montgomery, AL 36107-3150
Phone: (334) 834-9400
Fax: (334) 262-0701

OEC Business Interiors
104 East I-65 Service Road North
Mobile, AL 36607-2501
Phone: (251) 471-3368
Fax: (251) 471-0019

Office Interiors by OSCO
1300 Meridian Street
Suite 203
Huntsville, AL 35801
Phone: (256) 604-5696
Fax: (256) 604-5699

OSCO Inc.
229 Grant Street SE
Decatur, AL 35601-2511
Phone: (256) 340-5100
Fax: (256) 340-5108

Alaska

Capital Office Systems
1120 East 35th Avenue
Anchorage, AK 99508-4257
Phone: (907) 777-1500
Fax: (907) 777-1515

Capital Office Systems
3201 Industrial Avenue
Fairbanks, AK 99701-7370
Phone: (907) 456-3946
Fax: (907) 452-6257

Capital Office Systems
3143 Channel Drive
Juneau, AK 99801-7214
Phone: (907) 780-3636
Fax: (907) 780-2290

Arizona

Atmosphere Commercial Interiors
815 North Central Avenue
Phoenix, AZ 85004
Phone: (602) 252-6971

Atmosphere Commercial Interiors
Suite 100
88 East Broadway Boulevard
Tucson, Arizona 85701-1720
Phone: (520) 792-4200

Atmosphere Commercial Interiors
Suite 100
88 East Broadway Boulevard
Tucson, Arizona 85701-1720
Phone: (520) 792-4200
Fax: (540) 791-9568

Arkansas

ImageWorks
Suite B
1424 North Shackelford
Little Rock, AR 72211
Phone: (501) 944-7501

Today's Office Inc.
717 West 7th Street
Little Rock, AR 72201-4044
Phone: (501) 375-5050
Fax: (501) 375-1350

Today's Office Inc.
3157 West Sunset Avenue
Springdale, AR 72762-4945
Phone: (479) 751-5861
Fax: (479) 756-2233

California

BKM Office Environments
816 Via Alondra
Camarillo, CA 93012
Phone: (877) 256-1256
Fax: (805) 339-9032

BKM San Diego
Suite 100
9201 Spectrum Center Blvd.
San Diego, CA 92123-1407
Phone: (858) 569-4700
Fax: (858) 277-8931

One Workplace L. Ferrari
2500 De La Cruz Blvd.
Santa Clara, CA 95050
Phone: (669) 800-2500
Fax: (669) 800-2501

One Workplace L. Ferrari
7220 Edgewater Drive
Oakland, CA 94621
Phone: (510) 729-7800
Fax: (510) 729-7801

One Workplace L. Ferrari
475 Brannan Street
San Francisco, CA 94107-1731
Phone: (415) 357-2200
Fax: (415) 357-2201

Peninsula Business Interiors
325 Main Street
Salinas, CA 93901-2705
Phone: (831) 757-4107
Fax: (831) 757-1339

Tangram Interiors
Suite 102
4057 W Shaw Ave
Fresno, CA 93722-6212
Phone: (559) 275-7070
Fax: (559) 275-7080

Tangram Interiors
Suite 100
2850 South Red Hill Avenue
Santa Ana, CA 92705-5532
Phone: (949) 955-6700
Fax: (949) 955-6799

Tangram Interiors
9200 Sorensen Avenue
Santa Fe Springs, CA 90670-2645
Phone: (562) 365-5000
Fax: (562) 365-5399

United Corporate Furnishings
1780 North Market Blvd.
Sacramento, CA 95834-1997
Phone: (916) 553-5900
Fax: (916) 553-5800

Colorado

Office Outfitters & Planners Inc.
749 Main Street
Grand Junction, CO 81501-3535
Phone: (970) 245-6300
Fax: (970) 245-6301

OfficeScapes
2506 Zeppelin Rd
Colorado Springs, CO 80916
Phone: (719) 574-1113
Fax: (719) 574-1133

OfficeScapes
9900 East 51st Avenue
Denver, CO 80238-2430
Phone: (303) 574-1115
Fax: (303) 574-1116

OfficeScapes
Suite 180
4812 McMurry Avenue
Fort Collins, CO 80525-6222
Phone: (970) 223-5959
Fax: (970) 223-5858

Connecticut

Red Thread
300 East River Drive
East Hartford, CT 06108-4205
Phone: (860) 528-9981
Fax: (860) 528-1843

Red Thread
488 Wheelers Farm Rd.
Milford, CT 06461
Phone: (203) 874-7754
Fax: (203) 876-7915

Red Thread
700 Canal St 3rd Fl
Stamford, CT 06902
Phone: (860) 528-9981

Red Thread
40 Main Street
Torrington, CT 06790
Phone: (860) 482-2679
Fax: (860) 482-3590

Delaware

Corporate Interiors Inc.
223 Lisa Drive
New Castle, DE 19720-4193
Phone: (302) 323-9100
Fax: (302) 323-9251

Florida

American Business Interiors
215 Waverly Place
Melbourne, FL 32901-5444
Phone: (321) 723-5003
Fax: (321) 984-4221

Empire Office
Suite 140
2 Oakwood Boulevard
Hollywood, FL 33020
Phone: (954) 707-6200

Empire Office
South Florida
3201 Commerce Parkway
Miramar, FL 33025-3908
Phone: (954) 435-7300
Fax: (954) 435-7212

Empire Office
Suite 17
2315 Lynx Lane
Orlando, FL 32804
Phone: (407) 628-2400

Empire Office
5112 West Linebaugh Avenue
Tampa, FL 33624
Phone: (813) 418-3300

Empire Office
Suite 2
7830 Byron Drive
West Palm Beach, FL 33404-3332
Phone: (561) 840-8600
Fax: (561) 840-1873

Leitz & Reed Office Products
1119 Florida Avenue
Lynn Haven, FL 32444-4622
Phone: (850) 271-2600
Fax: (850) 271-0076

OEC Business Interiors
1601 NW 80th Boulevard
Gainesville, FL 32606-9140
Phone: (352) 332-1192
Fax: (352) 333-8002

OEC Business Interiors
2393 SW College Road
Ocala, FL 34474-1661
Phone: (352) 620-2888
Fax: (352) 620-2891

OEC Business Interiors
6254 North W Street
Pensacola, FL 32503-2746
Phone: (850) 438-1100
Fax: (850) 432-0003

Office Furniture & Design Concepts
11866 Metro Parkway
Ft. Myers, FL 33966-1307
Phone: (239) 337-1212
Fax: (239) 337-4910

Perdue Office Interiors
Suite 100
5 W Forsyth
Jacksonville, FL 32256-7440
Phone: (904) 737-5858
Fax: (904) 737-6088

Perdue Office Interiors
Suite C7
1516 Capital Circle SE
Tallahassee, FL 32301
Phone: (850) 383-4225

Georgia

Advent Business Interiors
1318 U.S. HWY 82 West
Leesburg, GA 31721
Phone: (229) 439-7418
Fax: (229) 435-1279

Advent Business Interiors
110 West Macon Park Dr.
Macon, GA 31210
Phone: (478) 471-0600

DeKalb Office Environments
1320 Ridgeland Parkway
Alpharetta, GA 30004-8442
Phone: (770) 360-0200
Fax: (770) 360-0305

McWaters Inc.
3708 Benchmark Drive
Augusta, GA 30907
Phone: (706) 396-5400
Fax: (706) 396-5401

McWaters Inc.
117 Prosperity Drive
Savannah, GA 31408-9551
Phone: (912) 352-9000
Fax: (912) 352-2034

Hawaii

Interior Showplace Ltd.
956 Queen Street
Honolulu, HI 96814-4118
Phone: (808) 593-8420
Fax: (808) 591-8324

Idaho

Porter's Office Products
435 West Center Street
Pocatello, ID 83204-3241
Phone: (208) 232-1233
Fax: (208) 232-8759

Porter's Office Products
1050 North 2nd East
Rexburg, ID 83440-5127
Phone: (208) 356-4616
Fax: (208) 356-8901

Office Environment Company
623 South Americana Blvd.
Boise, ID 83702-5120
Phone: (208) 385-0507
Fax: (208) 385-9392

Illinois

A. Pomerantz
Suite 940
222 Merchandise Mart Plaza
Chicago, IL 60654-1223
Phone: (312) 929-3335
Fax: (312) 929-3311

Atmosphere Commercial Interiors
801 North Perryville Road
Rockford, IL 61107
Phone: (815) 398-3300

Egyptian Business Furniture
129 West Main Street
Belleville, IL 62220-1501
Phone: (618) 234-2323
Fax: (618) 236-3295

Interiors for Business Inc.
409 N River Street
Batavia, IL 60510-2359
Phone: (630) 761-1070
Fax: (630) 761-1065

Lincoln Office
205 Eastgate Drive
Washington, IL 61571-9238
Phone: (309) 427-2500
Fax: (309) 427-2625

Forward Space
Suite 614
222 Merchandise Mart Plaza
Chicago, IL 60654-1223
Phone: (312) 563-5206

Forward Space
1142 N North Branch Street
Chicago, IL 60642
Phone: (312) 942-1100
Fax: (312) 942-9840

Forward Space
13820 West Business Center Drive
Lake Forest, IL 60045-1181
Phone: (847) 573-8890
Fax: (847) 573-8891

Forward Space
Suite 150
1111 West 22nd Street
Oak Brook, IL 60523
Phone: (312) 563-5206

Indiana

Business Furnishings LLC
4102 Meghan Beeler Court
South Bend, IN 46628
Phone: (574) 243-3255
Fax: (574) 243-3266

Business Furniture LLC
6102 Victory Way
Indianapolis, IN 46278-2934
Phone: (317) 216-1600
Fax: (317) 216-1601

Corporate Design Inc.
Suite 400
1419 West Lloyd Expressway
Evansville, IN 47710-1002
Phone: (812) 422-3000
Fax: (812) 422-3413

Lincoln Office
1200 Arrowhead Court
Crown Point, IN 46307-8222
Phone: (219) 662-2777
Fax: (219) 662-7770

Iowa

Lincoln Office
1026 Mound St
Davenport, IA 52803
Phone: (563) 322-5660

Tallgrass Business Resources
Highway 6 West
218 Second Street
Coralville, IA 52241-2608
Phone: (319) 338-3135
Fax: (319) 338-7484

Workspace Inc.
309 Locust Street
Des Moines, IA 50309-1788
Phone: (515) 288-7090
Fax: (515) 288-0250

Kansas

Design Central Inc.
152 South 5th Street
Salina, KS 67401
Phone: (785) 825-4131
Fax: (785) 825-4778

Scott Rice Office Interiors
224 East Douglas
Wichita, KS 67211-1640
Phone: (316) 269-2700
Fax: (316) 269-3527

Scott Rice Office Works
14720 West 105th Street
Lenexa, KS 66215-4414
Phone: (913) 888-7600
Fax: (913) 227-7793

Kentucky

Office Resources Inc.
530 Corvette Drive
Bowling Green, KY 42101-7132
Phone: (270) 781-5858
Fax: (270) 781-5884

Office Resources Inc.
101 Bradley Drive
Nicholasville, KY 40356-9121
Phone: (859) 885-6161
Fax: (859) 885-9610

Office Resources Inc.
816 East Broadway
Louisville, KY 40204-1053
Phone: (502) 589-8400
Fax: (502) 589-8408

Louisiana

Frost-Barber Inc.
9322 Interline Avenue
Baton Rouge, LA 70809-1966
Phone: (225) 926-5000
Fax: (225) 926-5011

Workplace Solutions
401 St. Joseph Street.
New Orleans, LA 70130
Phone: (504) 522-9558
Fax: (504) 522-7070

Maine

Red Thread
One City Center
Portland, ME 04101
Phone: (207) 774-4900
Fax: (207) 774-8155

Maryland

Arbee Associates
6311 Ammendale Road
Beltsville, MD 20705-1249
Phone: (410) 385-5180
Fax: (410) 385-5199

Arbee Associates
9300 Gaither Road
Gaithersburg, MD 20877
Phone: (301) 963-3900
Fax: (301) 977-1734

Dancker, Sellow & Douglas Inc.
Suite 309
509 Exeter Street
Baltimore, MD 21202
Phone: (301) 671-2541
Fax: (301) 797-1504

Participating Steelcase Dealers, continued

Dancker, Sellaw & Douglas Inc.
9200 Alaking Court
Suite 100
Capitol Heights, MD 20743
Phone: (301) 350-8700
Fax: (301) 350-9393

Massachusetts

Red Thread
Suite 600
101 Seaport Blvd.
Boston, MA 02210-1838
Phone: (617) 439-4900
Fax: (617) 439-4131

Red Thread
Suite 150
293 Boston Post Road West
Marlborough, MA 01752-4615
Phone: (508) 449-6550
Fax: (508) 449-6570

Red Thread
Suite 1108
1350 Main Street
Springfield, MA 01103
Phone: (413) 736-1802

Red Thread
100 Fordham Road
Wilmington, MA 01887
Phone: (978) 658-3900
Fax: (978) 694-4107

Michigan

Custer Office Environments Inc.
2435 Plaza Drive
Benton Harbor, MI 49022-2229
Phone: (616) 926-8719
Fax: (616) 926-9482

Custer Office Environments Inc.
217 Grandville Ave SW
Grand Rapids, MI 49503-4013
Phone: (616) 458-6322
Fax: (616) 458-1117

Custer Office Environments Inc.
5737 East Cork Street
Kalamazoo, MI 49048-9668
Phone: (269) 342-3919
Fax: (269) 342-3923

Custer Office Environments
442 East Michigan
Marquette, MI 49885
Phone: (906) 226-1161
Fax: (906) 226-1164

Custer Office Environments
120 East Front Street
Traverse City, MI 49684
Phone: (616) 402-8489

NBS
701 Salzburg Avenue
Bay City, MI 48706-5390
Phone: (989) 895-8574
Fax: (989) 895-8545

NBS
5133 West Grand River Avenue
Lansing, MI 48906-9117
Phone: (517) 886-0072
Fax: (517) 886-0014

NBS
2595 Bellingham Drive
Troy, MI 48083-2036
Phone: (248) 823-5400
Fax: (248) 823-5401

Minnesota

Atmosphere Commercial Interiors
Suite 350
81 South 9th Street
Minneapolis, MN 55402-3226
Phone: (612) 343-0868
Fax: (612) 332-5733

Burgher Office Equipment Company
101 East Chestnut Street
Virginia, MN 55792-2512
Phone: (218) 749-2661
Fax: (218) 749-2662

Duluth Typewriter & Business Furniture
30 N 3rd. Ave W
Duluth, MN 55802-1607
Phone: (218) 722-5811
Fax: (218) 722-4876

General Office Products Company
4521 Highway 7
Minneapolis, MN 55416-4098
Phone: (952) 925-7500
Fax: (952) 925-7531

Mississippi

Workplace Solutions
251 West South Street
Jackson, MS 39203-3636
Phone: (601) 354-4960
Fax: (601) 353-6231

Workplace Solutions
2207 5th Street
Meridian, MS 38652
Phone: (601) 484-7279

Workplace Solutions
520 Main Street
Natchez, MS 39120
Phone: (601) 442-1494
Fax: (601) 442-0457

Workplace Solutions
718 West Bankhead St.
New Albany, MS 38652
Phone: (662) 534-0882
Fax: (662) 534-5753

OEC Business Interiors
12199 Highway 49 N.
Suite 300
Gulfport, MS 39503-3167
Phone: (228) 539-9575
Fax: (228) 539-9566

Missouri

Color-Art Integrated Interiors
1325 North Warson Road
Saint Louis, MO 63132-1807
Phone: (314) 432-3000
Fax: (314) 993-2752

Marathon Office Interiors
1715 Paris Road
Columbia, MO 65201-5571
Phone: (573) 875-7115
Fax: (573) 875-7116

Montana

KR Office Interiors
119 North 7th Avenue
Bozeman, MT 59715
Phone: (406) 587-3775
Fax: (406) 587-4636

KR Office Interiors
1710 North Montana Avenue
Helena, MT 59601
Phone: (406) 513-1004
Fax: (406) 513-1006

Missoula's Office City
115 West Broadway Street
Missoula, MT 59802-4217
Phone: (406) 543-7171
Fax: (406) 543-4254

Peterson's Quality Office Equipment
502 North 32nd Street
Billings, MT 59101-6003
Phone: (406) 245-5151
Fax: (406) 245-7516

Western Office Equipment
317 2nd Street South
Great Falls, MT 59405-1802
Phone: (406) 761-7473
Fax: (406) 761-0245

Nebraska

Eakes Office Plus
2911 13th Street
Columbus, NE 68601-4829
Phone: (402) 564-2679
Fax: (402) 564-0295

Eakes Office Plus
Suite 201
2630 North Yager Road
Fremont, NE 68025-7800
Phone: (402) 941-5001
Fax: (402) 941-5002

Eakes Office Plus
617 West Third Street
Grand Island, NE 68801-5946
Phone: (308) 382-8026
Fax: (308) 382-7401

Eakes Office Plus
839 West Second Street
Hastings, NE 68901-5099
Phone: (402) 463-2537
Fax: (402) 463-6802

Eakes Office Plus
2401 Avenue A
Kearney, NE 68847-5498
Phone: (308) 234-2538
Fax: (308) 234-2540

Eakes Office Plus
110 N 35th Street
Lincoln, NE 68503
Phone: (402) 438-6700
Fax: (402) 438-6701

Eakes Office Plus
1803 North 6th Street
Beatrice, NE 68310
Phone: (402) 228-7202
Fax: (402) 228-0262

Eakes Office Plus
120 Norris Avenue
McCook, NE 69001
Phone: (308) 345-5447
Fax: (308) 345-5237

Eakes Office Plus
510 W. 13th Street
Souix City, NE 68776
Phone: (402) 412-2334

Eakes Office Plus
201 South 1st Street
Norfolk, NE 68701-5303
Phone: (402) 371-4181
Fax: (402) 371-5139

Eakes Office Plus
520 North Vine Street
North Platte, NE 69101-3954
Phone: (308) 534-7800
Fax: (308) 534-3936

Eakes Office Plus
710 North Lincoln Ave.
York, NE 68467
Phone: (402) 362-5442
Fax: (402) 362-7530

Sheppard's Business Interiors Inc.
725 South 72nd Street
Omaha, NE 68114-4665
Phone: (402) 393-8888
Fax: (402) 393-0113

Nevada

Machabee Office Environments
6435 Sunset Corporate Drive
Las Vegas, NV 89120-2798
Phone: (702) 263-8800
Fax: (702) 263-8801

Machabee Office Environments
1335 Greg Parkway #101
Sparks, NV 89431
Phone: (775) 329-3145
Fax: (775) 786-5710

New Hampshire

Red Thread
Suite 103
650 Elm Street
Manchester, NH 03101-1160
Phone: (603) 668-5511
Fax: (603) 668-6851

New Jersey

Arbee Associates
1531 South Washington Avenue
Piscataway, NJ 08854-3815
Phone: (732) 424-3900
Fax: (732) 752-6034

Concepts Office Furnishings
280 North Midland Avenue
Building J
Saddle Brook, NJ 07663-5708
Phone: (201) 727-9110
Fax: (201) 727-9112

Dancker, Sellow, and Douglas
291 Evans Way
Somerville, NJ 08876-3766
Phone: (908) 231-1600
Fax: (908) 231-6469

W.S. Goff Company Inc.
5104 Oakland Blvd.
Mays Landing, NJ 08330-2016
Phone: (609) 625-5600
Fax: (609) 625-5633

New Mexico

Business Environments
5351 Wilshire Avenue, N.E.
Albuquerque, NM 87113-1834
Phone: (505) 888-4400
Fax: (505) 889-9146

New York

AFD Contract Furniture Inc
810 7th Avenue
New York, NY 10019
Phone: (212) 721-7100
Fax: (212) 721-7175

Merkel-Donohue
1 Interstate Avenue
Albany, NY 12205
Phone: (518) 273-9359
Fax: (518) 272-1552

Empire Office Inc.
105 Madison Avenue
New York, NY 10016-8810
Phone: (212) 607-5500
Fax: (212) 607-5654

Merkel-Donohue
1349 University Avenue Suite 2
Rochester, NY 14607
Phone: (585) 325-7696
Fax: (585) 325-3065

Prentice Office Environments
472 Franklin Street
Buffalo, NY 14202-1302
Phone: (716) 884-8452
Fax: (716) 884-0894

Stevens Office Interiors
6804 Manlius Center Road
East Syracuse, NY 13057-3902
Phone: (315) 479-5595
Fax: (315) 428-1688

Waldner's Business Environments
125 Route 110
Farmingdale, NY 11735-4864
Phone: (631) 844-9300
Fax: (631) 694-3503

Waldner's Business Environments
215 Lexington Avenue, 9th Floor
New York, NY 10016-6023
Phone: (212) 696-7500
Fax: (212) 696-7699

Waldner's Business Environments
411 Theodore Fremd Avenue
3rd Floor, South Building
Rye, NY 10580-1410
Phone: (914) 921-8500
Fax: (914) 921-0991

North Carolina

Office Environments Inc.
11407 Granite Street
Charlotte, NC 28273-6429
Phone: (704) 714-7200
Fax: (704) 714-7400

Young Office Environments
of Asheville Inc.
71 Thompson St
Asheville, NC 28803-2328
Phone: (888) 202-0508
Fax: (828) 505-1974

Storr Office Environments Inc.
496 Gallimore Dairy Road
Greensboro, NC 27409-9202
Phone: (336) 217-4500
Fax: (336) 217-4501

Storr Office Environments Inc.
10800 World Trade Blvd.
Raleigh, NC 27617-4200
Phone: (919) 313-3700
Fax: (919) 313-3701

Williams Office Environments Inc.
407 Ray Avenue
Fayetteville, NC 28301-4915
Phone: (910) 483-0354
Fax: (910) 486-4077

North Dakota

Fireside Office Products Inc.
1713 East Bismarck Expressway
Bismarck, ND 58504-6706
Phone: (701) 258-8586
Fax: (701) 223-9598

Hannaher's
1809 13th Avenue North
Grand Forks, ND 58203-2323
Phone: (701) 746-6466
Fax: (701) 746-0737

Hannaher's Inc.
4324 20th Avenue SW
Fargo, ND 58103-4434
Phone: (701) 277-7222
Fax: (701) 277-7097

Ohio

Business Furniture
8 North Main Street
Dayton, OH 45439
Phone: (937) 293-1010
Fax: (937) 293-7501

Loth Inc.
3574 East Kemper Road
Cincinnati, OH 45241-2009
Phone: (513) 554-4900
Fax: (513) 554-8737

Loth Company
855 Grandview Avenue
Columbus, OH 43215-1123
Phone: (614) 487-4000
Fax: (614) 487-4306

NBS
4 North St. Clair Street
Toledo, OH 43604
Phone: (419) 662-2040
Fax: (419) 662-2041

Ohio Desk
34 Swartz Road
Akron, OH 44319
Phone: (330) 499-1030

Ohio Desk
1122 Prospect Avenue
Cleveland, OH 44115-1292
Phone: (216) 623-0600
Fax: (216) 623-0611

Ohio Desk
5100 Market Street
Youngstown, OH 44512
Phone: (330) 782-3331

Oklahoma

Scott Rice
2900 North Hemlock Circle
Broken Arrow, OK 74012-1185
Phone: (918) 362-4300
Fax: (918) 362-4303

Scott Rice
7501 Broadway Ext
Oklahoma City, OK 73116-9015
Phone: (405) 848-2224
Fax: (405) 848-3999

Oregon

Hypfn
Suite 103/104
150 SW Scalehouse Loop
Bend, OR 97702
Phone: (541) 317-8777
Fax: (541) 317-2833

Hypfn
620 NE 19th Avenue
Portland, OR 97232-2832
Phone: (503) 226-4151
Fax: (503) 226-9233

Pennsylvania

A. Pomerantz & Company
Suite 7000
701 Market Street
Philadelphia, PA 19106-1597
Phone: (215) 408-2100
Fax: (215) 408-2110

Corporate Interiors
Suite 200
161 Washington Street
Conshohocken, PA 19428-2083
Phone: (610) 631-5400
Fax: (610) 631-2720

Interior Workplace Solutions LLC.
145 Stewart Road
Wilkes-Barre, PA 18706
Phone: (570) 288-7211
Fax: (570) 970-5817

Franklin Interiors
Suite 600
2740 Smallman Street
Pittsburgh, PA 15222-4720
Phone: (412) 261-2525
Fax: (412) 255-4089

Participating Steelcase Dealers, continued

Pennsylvania

Interior Workplace Solutions LLC.
6765 Ambassador Drive
Allentown, PA 18106-9510
Phone: (610) 391-0733
Fax: (610) 391-1155

Interior Workplace Solutions LLC.
Suite B-25
2209 Quarry Drive
Reading, PA 19609-1155
Phone: (610) 670-1800
Fax: (610) 670-8181

McCartney's Inc.
819 Howard Avenue
Altoona, PA 16601-4727
Phone: (814) 505-1111
Fax: (814) 949-6197

Phillips Workplace Interiors
6345 Flank Drive
Harrisburg, PA 17112
Phone: (844) 228-2600

South Carolina

Aiken Office Supply Inc.
2560 Whiskey Road
Aiken, SC 29803-9664
Phone: (803) 648-8339
Fax: (803) 649-4470

McWaters Inc.
1104 Shop Road
Columbia, SC 29201-4743
Phone: (803) 256-8303
Fax: (803) 252-5567

McWaters Inc.
3841 Commercial Center Drive
Ladson, SC 29456-4146
Phone: (843) 486-1823

Wulbern-Koval Company Inc.
1111 Morrison Drive
Charleston, SC 29403-3119
Phone: (843) 577-7666
Fax: (843) 577-7299

Young Office Environments
1280 Ridge Road
Greenville, SC 29607-4626
Phone: (864) 281-9500
Fax: (864) 281-9555

South Dakota

Interstate Office Products Inc.
228 South Main Avenue
Sioux Falls, SD 57104-6310
Phone: (605) 339-0300
Fax: (605) 339-1989

Western Stationers
714 Saint Joseph Street
Rapid City, SD 57701-2721
Phone: (605) 342-3310
Fax: (605) 342-4746

Tennessee

Bentco Office Solutions
1501 Stuart Street
Chattanooga, TN 37406
Phone: (423) 756-4437
Fax: (423) 756-6198

Memphis Business Interiors
4539 West Distriplex Drive
Memphis, TN 38118-7280
Phone: (901) 360-8899
Fax: (901) 360-8370

Office Resources Inc.
4020 Armory Oaks Drive
Nashville, TN 37204
Phone: (615) 376-1200
Fax: (615) 376-1245

Workspace Interiors
Suite 300
200 E. Main Street
Kingsport, TN 37660-4354
Phone: (423) 392-2600
Fax: (423) 392-2601

Workspace Interiors
2820 Middlebrook Pike
Knoxville, TN 39721
Phone: (865) 223-5404
Fax: (865) 223-5405

Texas

Abilene Printing & Stationery
218 Cedar Street
Abilene, TX 79601-5720
Phone: (915) 677-2673
Fax: (915) 675-6963

BKM Total Office of Texas
9755 Clifford Drive
Dallas, TX 75220
Phone: (214) 902-7200
Fax: (214) 902-7201

Business Interiors
1111 Valley View Lane
Irving, TX 75061-6008
Phone: (817) 858-2000
Fax: (817) 858-2020

McCoys Inc.
6869 Old Katy Road
Houston, TX 77024-2105
Phone: (713) 862-4600
Fax: (713) 862-7676

Rockford Business Interiors
211 East Riverside Drive
Austin, TX 78704-1203
Phone: (512) 442-0703
Fax: (512) 442-6555

Texas Wilson Office Furniture &
Services
5801 George McVay Drive
McAllen, Texas 78503
Phone: (210) 647-8800
Fax: (210) 647-3110

Texas Wilson Office Furniture &
Services

6812 Fairgrounds Pkwy
San Antonio, TX 78238-4536
Phone: (210) 647-8800
Fax: (210) 647-3110

West Supply Company
1601 Scurry
Big Spring, TX 79720
Phone: (432) 264-1788
Fax: (432) 264-1789

West Supply Company
2 South Chadbourne Street
San Angelo, TX 76903-5875
Phone: (325) 655-8181
Fax: (325) 655-5480

Utah

MidWest Office Furniture
987 South West Temple
Salt Lake City, UT 84101-2988
Phone: (801) 359-7681
Fax: (801) 355-2713

Vermont

Red Thread
180 Battery St Ste 210
Burlington, VT 05401-5212
Phone: (802) 862-0434
Fax: (802) 862-0729

Virginia

Barrows
1302 Rockland Avenue
Roanoke, VA 24012-3838
Phone: (540) 362-5700
Fax: (540) 362-4826

Creative Office Environments
11798 North Lakeridge Boulevard
Ashland, VA 23005-8152
Phone: (804) 329-0400
Fax: (804) 321-3134

Creative Office Environments LLC
650 Peter Jefferson Parkway #140
Charlottesville, VA 22911
Phone: (434) 327-1898
Fax: (434) 327-1896

Creative Office Environments LLC
Suite C
500 Woodlake Circle
Chesapeake, VA 23320-2807
Phone: (757) 549-4801
Fax: (757) 549-2795

reDistrict
Suite 30
66 Canal Center Plaza
Arlington, VA 22314
Phone: (703) 276-8901
Fax: (703) 276-8908

Washington

OpenSquare
6th Floor
5601 Sixth Avenue South
Seattle, WA 98108-2522
Phone: (206) 768-8000
Fax: (206) 768-0236

OpenSquare
126 South Sheridan Street
Spokane, WA 99202-1527
Phone: (509) 483-1000
Fax: (509) 483-1011

Wisconsin

Atmosphere Commercial Interiors
999 Fourier Drive Suite 200
Madison, WI 53717
Phone: (608) 257-0521
Fax: (608) 257-1859

Puerto Rico

AFD Contract Furnishings
Suite 250
350 Chardon Avenue
Torre Chardon
San Juan, Puerto Rico 00918-2123
Phone: (787) 754-2938
Fax: (787) 754-8076

Showrooms

Atlanta

Steelcase Inc.
Suite AL-175
303 Peachtree Center
Atlanta, GA 30303
Phone: (404) 523-2201

Chicago

Steelcase Worklife Chicago
Suite 300
222 Merchandise Mart
Chicago, IL 60654-1174
Phone: (312) 321-3720

Chicago

Coalesse
Suite 1032
222 Merchandise Mart
Chicago, IL 60654
Phone: (312) 467-1783

Dallas

Steelcase Inc.
1616 Hi Line Drive
Dallas, TX 75207
Phone: (214) 871-3044

Grand Rapids

Steelcase Inc.
901 44th Street, SE
Grand Rapids, MI 49508-7594
Phone: (616) 247-2710

New York

Steelcase Worklife New York
4 Columbus Circle
New York, NY 10019-1100
Phone: (212) 445-8800

Philadelphia

Steelcase Inc.
One Liberty Place
1650 Market Street, 3rd Floor
Philadelphia, PA 19103-7307
Phone: (215) 561-5331

San Francisco

Steelcase Inc.
Suite 110
475 Brannan Street
San Francisco, CA 94107
Phone: (415) 344-6700

Santa Monica

Steelcase Inc.
1217 2nd Street
Santa Monica, CA 90401-1180
Phone: (310) 633-2200

Washington D.C.

Steelcase Inc.
1121 14th Street NW
4th Floor
Washington, DC 20005

Manufacturing Sites

Amex de Mexico

Calle 5 Sur No.160
Ciudad Industrial
Tijuana, Mexico B.C. 22500
Phone: 52-662-342-6234

Athens

214 Durham Drive
Athens, AL 35611
Phone: (256) 232-8112

Grand Rapids Wood Furniture

4100 68th Street SE
Caledonia, MI 49316
Phone: (616) 698-5735

Kentwood Distribution Center

4384 52nd Street SE
Kentwood, MI 49512-9673

Kentwood West

4360 52nd Street SE
Kentwood, MI 49512

Details

901 44th Street SE
Grand Rapids, MI 49508
Phone: (616) 247-2710

Reynosa Plant

Ave. Prologis S/N Ed. 8 Suite
801 Prologis Park Pharr Bridge
Reynosa,
Tamaulipas, Mx CP. 88780
Phone: 52-899-263-9000



Organizational Worktools

► For more detailed product information, see the *Steelcase Worktools Specification Guide* or consult your Steelcase dealer.

Statement of Line	20
--------------------------	-----------

Specifying	
Slatwall (SIN 711.2)	26
SlatRail (SIN 711.2)	30
Slatwall, SlatRail, and Freestanding Worktools (SIN 711.2)	33
SOTO Worktools (SIN 711.2)	45
Screens (SIN 711.2)	56

Statement of Line

Slatwall

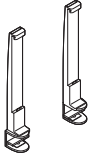

Specifying
▶ Page 26

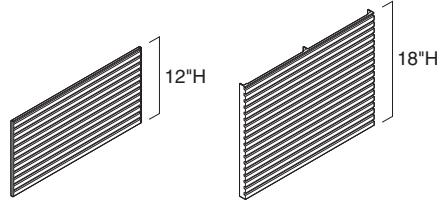

Specifying
▶ Page 27

Freestanding Slatwall Stanchions

Slatwall Tiles

	24"W	30"W	36"W	42"W	45"W	48"W	60"W
12"H	●	●	●	●	●	●	●
18"H	●	●	●	●	●	●	●

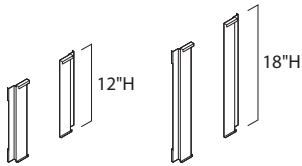

Specifying
▶ Page 28

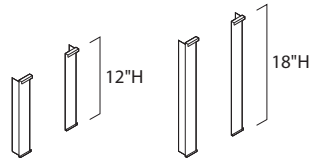

Specifying
▶ Page 28

Slatwall Panel-Mount Brackets

Slatwall Wall-Mount Brackets

12"H 18"H



12"H 18"H

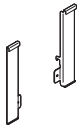

Specifying
▶ Page 28

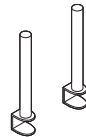

Specifying
▶ Page 30

Slatwall Post and Beam Brackets

Freestanding SlatRail Stanchions

12"H



SlatRail

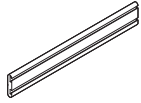

Specifying
▶ Page 31



Specifying
▶ Page 32

SlatRail

24"W	30"W	36"W	42"W	45"W	48"W	60"W
●	●	●	●	●	●	●

SlatRail Panel-Mount Brackets



Specifying
▶ Page 32

SlatRail Wall-Mount Brackets

Slatwall, SlatRail, and Freestanding Worktools

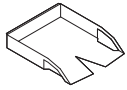

10" Portrait Letter Tray
Specifying
▶ Page 33

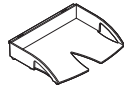

12" Landscape Letter Tray
Specifying
▶ Page 33

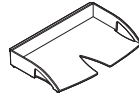

15" Landscape Legal Tray
Specifying
▶ Page 33



Binder Holder
Specifying
▶ Page 34

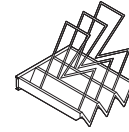

PaperFlo Manager
Specifying
▶ Page 34

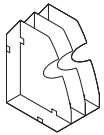

Universal Shelves
Specifying
▶ Page 35

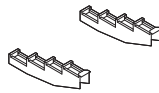

Hanging Brackets
Specifying
▶ Page 35



Pen/Pencil Cup
Specifying
▶ Page 36



Double Square Dish
Specifying
▶ Page 36



Office in a File
Specifying
▶ Page 37

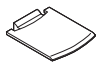

Mini Shelf
Specifying
▶ Page 37

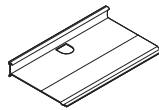

Portrait Slatshelves
Specifying
▶ Page 38

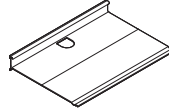

Landscape Slatshelves
Specifying
▶ Page 38



Slatshelf Labels
Specifying
▶ Page 38



Slatshelf Dividers
Specifying
▶ Page 39

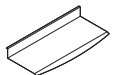

Personal Shelf
Specifying
▶ Page 39

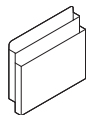

Chart/File Holder
Specifying
▶ Page 39



Glove Box
Specifying
▶ Page 40

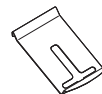

Telephone Caddy
Specifying
▶ Page 40



Tackstrip
Specifying
▶ Page 40



Utility Hook
Specifying
▶ Page 41



Work Tags
Specifying
▶ Page 41

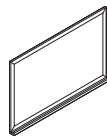

Markerboard
Specifying
▶ Page 41



Cable Rings
Specifying
▶ Page 42

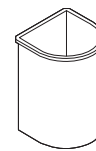

Wastebasket
Specifying
▶ Page 42



Coat Hook
Specifying
▶ Page 42

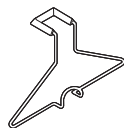

Flat Top Hanger
Specifying
▶ Page 43

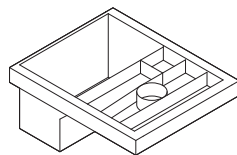

Pelican Pencil Drawers and Security Lid
Specifying
▶ Page 43

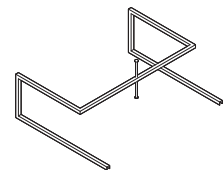
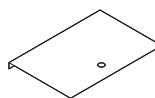

Pelican Installation Bar
Specifying
▶ Page 44

SOTO Worktools

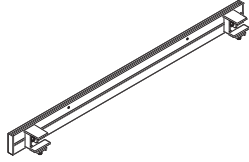

Specifying
▶ Page 45

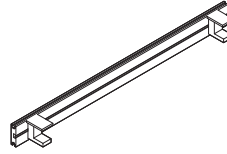

Specifying
▶ Page 46

SOTO Rails

28"W	34"W	40"W	46"W	52"W	58"W	64"W
●	●	●	●	●	●	●

SOTO Rails For Use with Tour

52"W	58"W	64"W
●	●	●

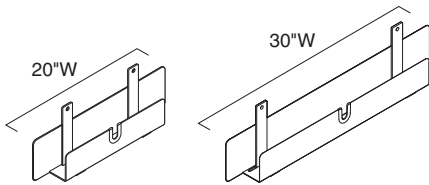

Specifying
▶ Page 46

SOTO Cableways

20"W	30"W
●	●

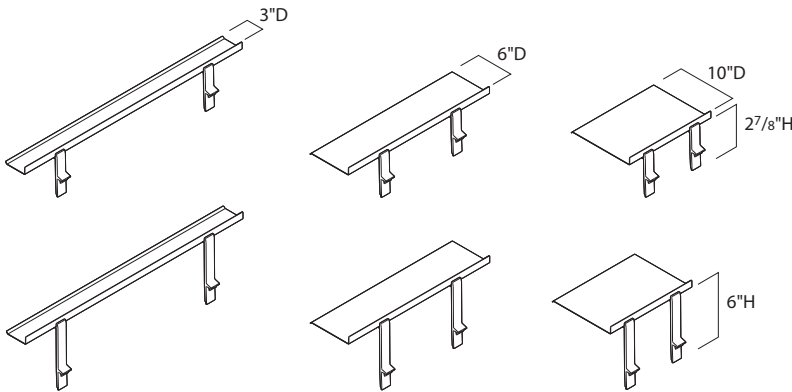

Specifying
▶ Page 47

SOTO Shelves

	14"W	24"W	36"W
3"D	●		●
6"D	●	●	
10"D	●	●	

SOTO Worktools, continued

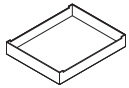

SOTO Pile Box
Specifying
▶ Page 48

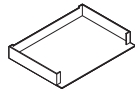

SOTO Landscape Letter Box
Specifying
▶ Page 48



SOTO Tool Box
Specifying
▶ Page 48

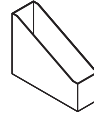

SOTO Diagonal File Box
Specifying
▶ Page 49



SOTO Utility Box
Specifying
▶ Page 49

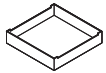

SOTO Personal Box
Specifying
▶ Page 49

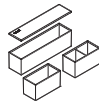

SOTO Storage Boxes Set of Three
Specifying
▶ Page 50

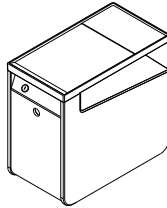

SOTO Personal Console
Specifying
▶ Page 50

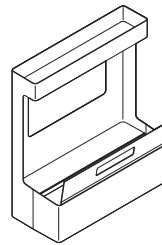

SOTO Mobile Caddy
Specifying
▶ Page 51

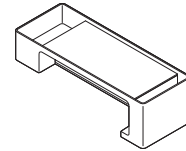

SOTO Launch Pad
Specifying
▶ Page 51

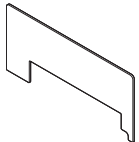

SOTO Launch Pad Divider Screen
Specifying
▶ Page 52

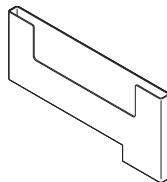

SOTO Functional Screen
Specifying
▶ Page 52



SOTO Personal Pocket
Specifying
▶ Page 52



SOTO Cable Clip
Specifying
▶ Page 53



SOTO Personal Hook
Specifying
▶ Page 53

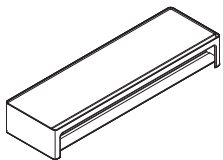

SOTO Monitor Bridge
Specifying
▶ Page 53

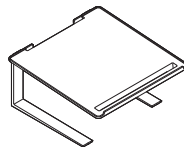

SOTO Laptop Shelf
Specifying
▶ Page 54

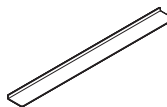

SOTO Ergo Edge
Specifying
▶ Page 54

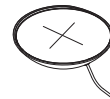

SOTO Wireless Charger
Specifying
▶ Page 55

Steelcase Screens

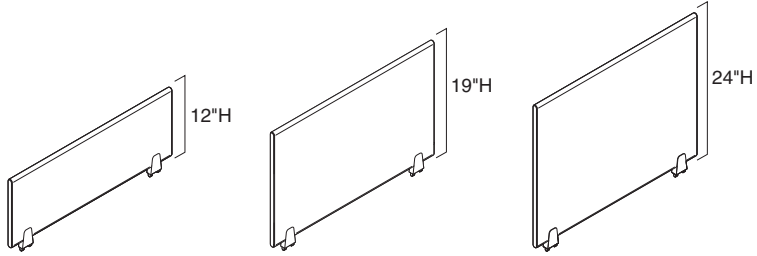

Specifying
▶ Page 56

Fixed Personal/Modesty Screens

	30\"W	36\"W	42\"W	48\"W
12\"H	●	●	●	●
19\"H	●	●	●	●
24\"H	●	●	●	●

Slatwall

SIN 711.2

Freestanding Slatwall Stanchions

For Use on Worksurfaces ¾" to 2" thick

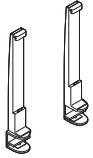

Tip: Positions top of Slatwall a fixed height of 15½" above mounting surface.

Tip: Slatwall can overhang stanchions up to 12".

Tip: Worksurface/table must be able to support 60 lb.

Tip: Stanchion cannot be used in a corner application or on a glass surface.

Tip: Requires 18"D work-surface and uses 2" surface footprint.

Tip: Freestanding Slatwall stanchion is for use with 12"H tiles only.

Standard Includes	Required to Specify
<ul style="list-style-type: none"> • Pair of Slatwall; paint • Non-marring rubber feet 	<ul style="list-style-type: none"> 1 Style number 2 Paint color number for slatwall brackets: <ul style="list-style-type: none"> 0835 Black 4750 Champagne 4799 Platinum

Related Products
<ul style="list-style-type: none"> • Slatwall tiles

▶ Page 27

Specification Information

• Dimensions			• Weight	• Style	• Price
D	W	H		Number	
3"	3½"	16"	3.5 lb	WFCS	\$149

Slatwall Tiles

Tip: Total dimensions of Worktools specified should not exceed Slatwall dimensions.

Tip: Slatwall is not dedicated to the exact panel width; a 12" overhang is acceptable.

Tip: Two Slatwall tiles cannot be used in a corner application.

Tip: Tiles require a minimum worksurface depth of 18" for stability.

Tip: A clearance of 2" is required under worksurface to accommodate C-clamp.

Tip: Tiles cannot be used on glass, bullnose, knife edge, or other non-standard work-surface edges.

Tip: Supports up to 140 lb.

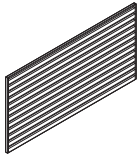

Tip: Slatwall is 1/8" shorter than stated without end caps installed.

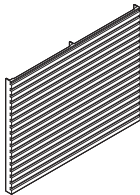

Standard Includes	Required to Specify
-------------------	---------------------

- Slatwall tile: paint

- 1 Style number
- 2 Paint color number for slatwall tile:
 - 0835 Black
 - 4799 Platinum
 - 4750 Champagne

Related Products

- Slatwall brackets
- Freestanding Slatwall stanchions
- Slatwall and SlatRail worktools

- ▶ Page 28
- ▶ Page 26
- ▶ Page 33

Specification Information					
• Dimensions			• Weight	• Style	• Price
D	W	H		Number	

12"H Tiles

1/2"	24"	12"	4.5 lb	WS24	\$119
1/2"	30"	12"	5.7 lb	WS30	\$133
1/2"	36"	12"	6.8 lb	WS36	\$149
1/2"	42"	12"	8 lb	WS42	\$173
1/2"	45"	12"	8.5 lb	WS45	\$185
1/2"	48"	12"	9.1 lb	WS48	\$198
1/2"	60"	12"	11.4 lb	WS60	\$247
:	:	:	:	:	:

18"H Tiles

1 1/8"	24"	18"	4.04 lb	WS2418H	\$250
1 1/8"	30"	18"	11.5 lb	WS3018H	\$285
1 1/8"	36"	18"	13.16 lb	WS3618H	\$320
1 1/8"	42"	18"	15.62 lb	WS4218H	\$353
1 1/8"	45"	18"	16.5 lb	WS4518H	\$387
1 1/8"	48"	18"	17.28 lb	WS4818H	\$424
1 1/8"	60"	18"	19 lb	WS6018H	\$458
:	:	:	:	:	:

Slatwall, continued

SIN 711.2

Slatwall Brackets

Tip: Wall-mount brackets must be mounted to a wall stud.

Tip: Brackets for use with 42"H panels cannot be used with transaction top worksurfaces.

Standard Includes	Required to Specify
-------------------	---------------------

- Pair of slatwall brackets: paint

- 1 Style number
- 2 Paint color number for slatwall brackets:
 - 0835 Black
 - 4750 Champagne
 - 4799 Platinum

Related Products

- Slatwall tiles

▶ Page 27

Specification Information			
Dimensions	Weight	Style Number	Price
W H			

12"H Panel-Mount Brackets

For Use with Answer, Kick, and Privacy Wall

2"	12 1/3"	2 lb	WSWANS	\$ 38
----	---------	------	---------------	-------

For Use with Avenir

2"	12 1/3"	2 lb	WSWUSA	\$ 38
----	---------	------	---------------	-------

For Use with Answer and Kick 42"H Panels

2"	12 1/3"	2 lb	WSW42AN	\$ 74
----	---------	------	----------------	-------

For Use with Avenir 42"H Panels

2"	12 1/3"	2 lb	WSW42AV	\$ 74
----	---------	------	----------------	-------

18"H Panel-Mount Brackets

Standard

2"	18"	3.5 lb	WSWUSA18	\$107
----	-----	--------	-----------------	-------

For Use with Answer, Kick, and Privacy Wall

2"	18"	3.5 lb	WSWANS18	\$107
----	-----	--------	-----------------	-------

▶ **Specification Information, continued on next page**

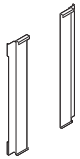
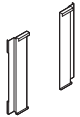

► Specification Information, continued from previous page

Specification Information

• Dimensions		• Weight	• Style Number	• Price
W	H			

Wall-Mount Brackets

12"H Standard

2"	12 ¹ / ₃ "	2 lb	WSWM	\$ 38
----	----------------------------------	------	-------------	-------

18"H Standard

2"	18"	3.5 lb	WSWM18	\$107
----	-----	--------	---------------	-------

12"H Brackets For Use with Post and Beam

2"	12 ¹ / ₃ "	2.5 lb	WSWPBOF12	\$107
----	----------------------------------	--------	------------------	-------

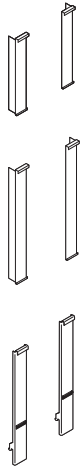

SlatRail

SIN 711.2

Freestanding SlatRail Stanchions

For Use on Worksurfaces and Materials 1/2" to 1 3/4" thick

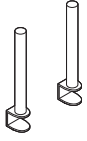

Tip: Positions top of SlatRail a fixed height of 12 3/4" above mounting surface.

Tip: Worksurface/table must be able to support 100 lb.

Tip: Stanchion cannot be used in a corner application or on a glass surface.

Tip: Requires 18"D worksurface and uses 2 1/2" surface footprint.

Tip: A clearance of 2" is required under worksurface to accommodate C-clamp.

Tip: Actual width of usable SlatRail is 3 1/8" less than stated when installed using freestanding stanchions.

Standard Includes	Required to Specify
-------------------	---------------------

- Pair of SlatRail stanchions: paint

- 1 Style number
- 2 Paint color number for SlatRail stanchions:
 - 0835 Black
 - 4750 Champagne
 - 4799 Platinum

Related Products

- SlatRail

▶ Page 31

Specification Information						
• Dimensions			• Weight	• Style	• Price	
D	W	H	:	Number	:	:

1 1/2"	1 1/2"	13 1/2"	4 lb	WSRFS	\$130	
:	:	:	:	:	:	:

SlatRail

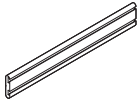

Tip: When mounting SlatRail with stanchions in combination with a cableway, see Worktools Compatibility Charts, page 224.

Tip: To determine appropriate SlatRail with stanchions width when mounting to height-adjustable work-surfaces, see Worktools Compatibility Charts, page 224.

Tip: SlatRail requires a minimum worksurface depth of 18" for stability.

Tip: Total dimensions of worktools specified should not exceed SlatRail dimensions.

Tip: Two SlatRails cannot be used in a corner application.

Tip: Not applicable on glass surfaces.

Tip: Actual width of usable SlatRail is 3/8" less than stated when installed using freestanding stanchions.

Tip: Supports up to 100 lb.

Standard Includes	Required to Specify
<ul style="list-style-type: none"> SlatRail: paint 	<ul style="list-style-type: none"> 1 Style number 2 Paint color number for SlatRail: <ul style="list-style-type: none"> 0835 Black 4750 Champagne 4799 Platinum

Related Products	
<ul style="list-style-type: none"> Freestanding SlatRail stanchions SlatRail panel-mount brackets SlatRail wall-mount brackets Slatwall and SlatRail worktools 	<ul style="list-style-type: none"> ▶ Page 30 ▶ Page 32 ▶ Page 32 ▶ Page 33

Specification Information					
• Dimensions			• Weight	• Style Number	• Price
D	W	H			
3/4"	24"	4"	2 lb	WSR24	\$ 70
3/4"	30"	4"	3 lb	WSR30	\$ 83
3/4"	36"	4"	3 lb	WSR36	\$ 95
3/4"	42"	4"	3.5 lb	WSR42	\$109
3/4"	48"	4"	4 lb	WSR48	\$121
3/4"	60"	4"	4.5 lb	WSR60	\$148
.

SlatRail, continued

SIN 711.2

SlatRail Panel-Mount Brackets



Tip: Answer, Avenir, Kick, and Privacy Wall furniture systems accommodate the SlatRail panel-mount brackets.

Standard Includes **Required to Specify**

- Pair of SlatRail panel-mount brackets: paint

- 1 Style number
- 2 Paint color number for SlatRail panel-mount brackets:
 - 0835 Black
 - 4750 Champagne
 - 4799 Platinum

Related Products

- SlatRail

▶ Page 31

Specification Information

• Dimensions		• Weight	• Style Number	• Price
W	H			
2½"	4½"	1.5 lb	WSRU1	\$40
:	:	:	:	:

SlatRail Wall-Mount Brackets



Tip: Wall-mount brackets must be installed in a wall stud.

Standard Includes **Required to Specify**

- Pair of SlatRail wall-mount brackets: paint

- 1 Style number
- 2 Paint color number for SlatRail panel-mount brackets:
 - 0835 Black
 - 4750 Champagne
 - 4799 Platinum

Related Products

- SlatRail

▶ Page 31

Specification Information

• Dimensions			• Weight	• Style Number	• Price
D	W	H			
2¾"	¾"	4¾"	1.5 lb	WSRW	\$40
:	:	:	:	:	:

Slatwall, SlatRail, and Freestanding Worktools

SIN 711.2

Trays

Tip: Trays do not interlock when installed on slatwall.

Standard Includes

- Tray: plastic

Required to Specify

- 1 Style number
- 2 Plastic color number for letter tray:
 - 6000 Black
 - 6009 Arctic White
 - 6544 Frost
 - 6546 Rain

Related Products

- Slatwall tiles
- SlatRail

- ▶ Page 27
- ▶ Page 31

Specification Information

• Dimensions			• Weight	• Style	• Price
D	W	H		Number	

Portrait Letter Tray

12½"	10 ³ / ₁₆ "	2½"	1.5 lb	WLTS	\$38
------	-----------------------------------	-----	--------	-------------	------

Landscape Letter Tray

10"	12½"	2½"	1.5 lb	WLT12L	\$38
-----	------	-----	--------	---------------	------

Landscape Legal Tray

10"	15½"	2½"	1.75 lb	WLG15L	\$38
-----	------	-----	---------	---------------	------

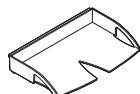
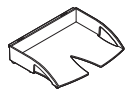
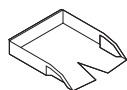

Slatwall, SlatRail, and Freestanding Worktools, continued

SIN 711.2

Binder Holder



Tip: Binder holder requires 9 1/2" H clearance under bins or shelves.

Standard Includes **Required to Specify**

- Binder holder: plastic
- 1 Style number
 - 2 Plastic color number for binder holder:
 - 6000 Black
 - 6009 Arctic White
 - 6544 Frost
 - 6546 Rain

Related Products

- Slatwall tiles ▶ Page 27
- SlatRail ▶ Page 31

Specification Information

• Dimensions			• Weight	• Style	• Price
D	W	H		Number	
9 1/8"	4 3/4"	11 3/8"	1.2 lb	WBHS	\$38

PaperFlo Manager

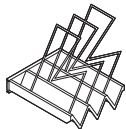

Tip: PaperFlo manager requires 11" clearance under bins.

Standard Includes **Required to Specify**

- PaperFlo manager: plastic
- 1 Style number
 - 2 Plastic color number for PaperFlo manager:
 - 6000 Black
 - 6009 Arctic White
 - 6544 Frost
 - 6546 Rain

Specification Information

• Dimensions			• Weight	• Style	• Price
D	W	H		Number	
12"	9 3/4"	9 3/4"	2 lb	WPFS	\$92

Universal Shelves

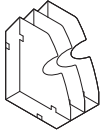

Tip: Universal shelves are not recommended for use on SlatRail.

Tip: Shelves do not interlock when installed on Slatwall.

Standard Includes	Required to Specify
<ul style="list-style-type: none"> Shelf: plastic 	1 Style number 2 Plastic color number for shelf: 6000 Black 6009 Arctic White 6544 Frost 6546 Rain

Specification Information

Dimensions			Weight	Style Number	Price
D	W	H			
Single Pack					
9½"	2¾"	12"	0.5 lb	WUS	\$23
Three Pack					
9½"	2¾"	12"	1.5 lb	WUS3	\$66

Hanging Brackets

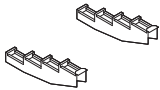

Tip: Hanging brackets require 6" clearance from top step of bracket to access files under bin and a 9" clearance from the bottom step to the top of worksurface to allow files to hang freely.

Tip: Hanging brackets are recommended using in pairs only. Brackets should not be shared when mounting multiple brackets side by side.

Standard Includes	Required to Specify
<ul style="list-style-type: none"> Hanging brackets: plastic 	1 Style number 2 Plastic color number for hanging brackets: 6000 Black 6009 Arctic White 6544 Frost 6546 Rain

Related Products

<ul style="list-style-type: none"> Slatwall tiles SlatRail 	<ul style="list-style-type: none"> ▶ Page 27 ▶ Page 31
--	--

Specification Information

Dimensions			Weight	Style Number	Price
D	W	H			
9¾"	1½"	1¼"	1 lb	WHB	\$38

Slatwall, SlatRail, and Freestanding Worktools, continued

SIN 711.2

Pen/Pencil Cup



Standard Includes	Required to Specify
<ul style="list-style-type: none"> • Pen/pencil cup: plastic 	<ul style="list-style-type: none"> 1 Style number 2 Plastic color number for pen/pencil cup: <ul style="list-style-type: none"> 6000 Black 6009 Arctic White 6544 Frost 6546 Rain

Related Products
<ul style="list-style-type: none"> • Slatwall tiles ▶ Page 27 • SlatRail ▶ Page 31

Specification Information					
• Dimensions			• Weight	• Style	• Price
D	W	H		Number	
4"	3¼"	3⅝"	0.5 lb	WPCS	\$38

Double Square Dish



Standard Includes	Required to Specify
<ul style="list-style-type: none"> • Double square dish: plastic • Attachment bracket 	<ul style="list-style-type: none"> 1 Style number 2 Plastic color number for square dish: <ul style="list-style-type: none"> 6000 Black 6009 Arctic White 6544 Frost 6546 Rain

Related Products
<ul style="list-style-type: none"> • Slatwall tiles ▶ Page 27 • SlatRail ▶ Page 31

Specification Information					
• Dimensions			• Weight	• Style	• Price
D	W	H		Number	
4"	9¾"	1½"	0.5 lb	WSQS	\$38

Office in a File

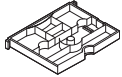

Standard Includes	Required to Specify
<ul style="list-style-type: none"> Storage file: plastic Built-in tape dispenser Translucent cover 	1 Style number 2 Plastic color number for storage file: 6000 Black 6009 Arctic White 6544 Frost 6546 Rain

Specification Information

Dimensions			Weight	Style Number	Price
D	W	H			
9 ⁵ / ₈ "	12 ¹ / ₄ "	1 ³ / ₈ "	1.5 lb	WOFS	\$38

Mini Shelf



Standard Includes	Required to Specify
<ul style="list-style-type: none"> Shelf: plastic 	1 Style number 2 Plastic color number for shelf: 6000 Black 6009 Arctic White 6544 Frost 6546 Rain

Related Products

- Slatwall tiles ▶ Page 27
- SlatRail ▶ Page 31

Specification Information

Dimensions			Weight	Style Number	Price
D	W	H			
10"	8"	1 ⁷ / ₈ "	0.5 lb	KMINI	\$27

Slatwall, SlatRail, and Freestanding Worktools, continued

SIN 711.2

Slatshelves

Tip: 12"W and 18"W shelves mount on Slatwall tiles or SlatRails.

Tip: 24"W shelves do not mount on 24"W Slatwall tile or 24"W SlatRail.

Tip: For Cisco phones specify 12"W shelf.

Standard Includes **Required to Specify**

- Slatshelf: paint
- 1 Style number
 - 2 Paint color number for slatshelf:
0835 Black
4750 Champagne
7018 Pewter

Related Products

- Slatwall tiles
 - SlatRail
- ▶ Page 27
 - ▶ Page 31

Specification Information

• Dimensions			• Weight	• Style	• Price
D	W	H		Number	

Landscape

10 ⁵ / ₈ "	12"	2 ³ / ₈ "	3.5 lb	WSS12L	\$129
10 ⁵ / ₈ "	18"	2 ³ / ₈ "	3.75 lb	WSS18L	\$133
10 ⁵ / ₈ "	24"	2 ³ / ₈ "	4.75 lb	WSS24L	\$149

Portrait

12 ⁵ / ₈ "	18"	2 ³ / ₈ "	4.5 lb	WSS18P	\$139
12 ⁵ / ₈ "	24"	2 ³ / ₈ "	5.5 lb	WSS24P	\$154

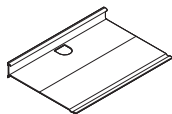
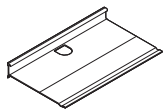

Slatshelf Labels



Standard Includes **Required to Specify**

- Labels, package of three wet-erase: 6544 Frost
- Style number

Specification Information

• Dimensions			• Weight	• Style	• Price
D	W	H		Number	

5/8"	2"	3/8"	0.1 lb	WSSL	\$7
------	----	------	--------	-------------	-----

Slatshelf Dividers



Standard Includes	Required to Specify
<ul style="list-style-type: none"> • Pair of dividers: polar gray 	Style number

Specification Information

• Dimensions		• Weight	• Style Number	• Price
D	H			
8 ³ / ₈ "	3"	0.4 lb	WSSD	\$18
•	•	•	•	•

Personal Shelf

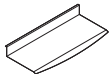

Standard Includes	Required to Specify
<ul style="list-style-type: none"> • Personal shelf: paint 	1 Style number 2 Paint color number for personal shelf: 0835 Black 4750 Champagne 7018 Pewter

Related Products

- | | |
|--|--|
| <ul style="list-style-type: none"> • Slatwall tiles • SlatRail | <ul style="list-style-type: none"> ▶ Page 27 ▶ Page 31 |
|--|--|

Specification Information

• Dimensions		• Weight	• Style Number	• Price
D	W			
7 ¹ / ₈ "	13 ¹ / ₂ "	3 lb	WSPS	\$43
•	•	•	•	•

Chart/File Holder

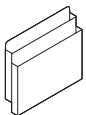

Standard Includes	Required to Specify
<ul style="list-style-type: none"> • Two-tier holder: 7018 Pewter 	Style number

Specification Information

• Dimensions			• Weight	• Style Number	• Price
D	W	H			
2 ¹ / ₂ "	12"	10 ¹ / ₂ "	4.5 lb	HCCHT	\$186
•	•	•	•	•	•

Slatwall, SlatRail, and Freestanding Worktools, continued

SIN 711.2

Glove Box



Tip: Glove box accommodates standard size tissue box.

Standard Includes	Required to Specify
<ul style="list-style-type: none"> Glove box: 7018 Pewter 	Style number

Specification Information

• Dimensions			• Weight	• Style Number	• Price
D	W	H			
3¼"	10"	3"	1 lb	HCGB	\$62

Telephone Caddy



Tip: Telephone caddy is not compatible with Cisco phones.

Tip: 4¾" clearance required to install on Slatwall or SlatRail.

Standard Includes	Required to Specify
<ul style="list-style-type: none"> Telephone caddy: paint 	1 Style number 2 Paint color number for telephone caddy: 0835 Black 4750 Champagne 7018 Pewter

Related Products

- Slatwall tiles ▶ Page 27
- SlatRail ▶ Page 31

Specification Information

• Dimensions			• Weight	• Style Number	• Price
D	W	H			
2"	8"	11"	6 lb	WTCS	\$93

Tackstrip



Standard Includes	Required to Specify
<ul style="list-style-type: none"> Tackstrip: 6000 Black 	Style number

Specification Information

• Dimensions			• Weight	• Style Number	• Price
D	W	H			
5/16"	15"	3 1/8"	0.5 lb	WTBS	\$44

Utility Hook



Standard Includes	Required to Specify
<ul style="list-style-type: none"> Utility hook: paint 	1 Style number 2 Paint color number for utility hook: 0835 Black 4750 Champagne 7018 Pewter

Specification Information					
Dimensions			Weight	Style Number	Price
D	W	H			
1¾"	3½"	2"	0.25 lb	WHOOK	\$38

Work Tags



Tip: Tags are wet-erase and reusable.

Standard Includes	Required to Specify
<ul style="list-style-type: none"> Tags, package of 10: 6544 Frost 	Style number

Specification Information					
Dimensions			Weight	Style Number	Price
D	W	H			
1½"	2¾"	5/16"	1 lb	WWT	\$38

Markerboard

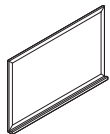

Tip: Not recommended for use on SlatRail.

Standard Includes	Required to Specify
<ul style="list-style-type: none"> Dry-erase markerboard Frame: aluminum Integrated holder for dry-erase markers 	Style number

Specification Information					
Dimensions			Weight	Style Number	Price
D	W	H			
1"	17¾"	11¾"	1.75 lb	WMB	\$106

Slatwall, SlatRail, and Freestanding Worktools, continued

SIN 711.2

Cable Rings



Standard Includes	Required to Specify
<ul style="list-style-type: none"> Cable ring, package of 4: plastic 	1 Style number 2 Plastic color for cable ring: 6000 Black 6009 Arctic White 6544 Frost

Specification Information					
• Dimensions			• Weight	• Style	• Price
D	W	H		Number	
1"	1½"	1"	0.25 lb	KCR	\$31

Wastebasket

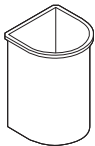

Standard Includes	Required to Specify
<ul style="list-style-type: none"> Wastebasket: 6000 Black Labels, if selected 	Style number

Specification Information					
• Dimensions			• Weight	• Style	• Price
D	W	H		Number	
10"	10"	15"	5 lb	DWBE	\$43

Wastebasket

10"	10"	15"	5 lb	DWBE	\$43
-----	-----	-----	------	-------------	------

Recycling Labels

				DRCY	No cost
--	--	--	--	-------------	---------

Coat Hook



Tip: Coat hook not recommended for use at end of panel run configurations.

Tip: Maximum weight for coat hook is 10 lb.

Standard Includes	Required to Specify
<ul style="list-style-type: none"> Coat hook: paint 	1 Style number 2 Paint color number for coat hook: 0835 Black 7018 Pewter

Specification Information					
• Dimensions			• Weight	• Style	• Price
D	W	H		Number	
7/8"	2½"	2¼"	0.15 lb	WCH	\$17

Flat Top Hanger

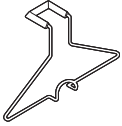

Tip: Maximum weight for hanger is 10 lb.

Standard Includes	Required to Specify
<ul style="list-style-type: none"> • Hanger: paint • Rubber sleeve 	1 Style number 2 Paint color number for hanger: 0835 Black 4750 Champagne

Specification Information					
• Dimensions			• Weight	• Style	• Price
D	W	H		Number	
3"	15½"	7¾"	1 lb	FTH	\$23
:	:	:	:	:	:

Pelican Pencil Drawers

Tip: Drawer requires a 24" unobstructed worksurface depth and 20"W clearance.

Tip: For locks to be keyed alike to other Steelcase locks, specify a non-locking drawer and order locking plugs separately (service part number 877209201SR). Field installation will be required.

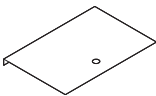
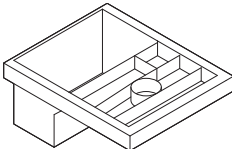

Standard Includes	Required to Specify
<ul style="list-style-type: none"> • Pencil drawer: 6000 Black • File bars • Lock, if selected • Security lid, if selected 	Style number

Specification Information					
• Dimensions			• Weight	• Style	• Price
D	W	H		Number	

Non-Locking Pencil Drawer

23"	19"	2"	22 lb	WDPDNL	\$352
:	:	:	:	:	:

Locking Pencil Drawer

23"	19"	2"	22 lb	WDPDL	\$356
:	:	:	:	:	:

Security Lid

:	:	:	:	WDPL	\$ 99
:	:	:	:	:	:

Slatwall, SlatRail, and Freestanding Worktools, continued

SIN 711.2

Pelican Installation Bar

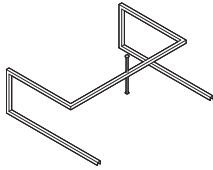

Standard Includes	Required to Specify
• Installation bar	Style number

Specification Information

• Dimensions			• Weight	• Style Number	• Price
D	W	H			
17"	21½"	7"	5 lb	WIB	\$169
:	:	:	:	:	:

SOTO Worktools

SIN 711.2

SOTO Rails

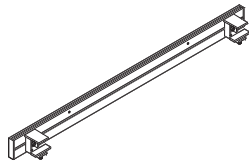

Tip: The colors for plastic end caps are defaulted by bracket color.

▶ See *Worktools Specification Guide* for default finish matrix.

Tip: Rails clamp to free-standing worksurfaces or material up to 2" thick. Rails are not applicable for glass surfaces.

Tip: Not applicable on glass surfaces.

Tip: Allow 1" clearance between worksurface and rail for cable management. Allow 2" for rail mount installed behind a worksurface, and 3¾" overall to install the rail.

Tip: Maximum weight load for rails is 2 lb per lineal inch.

Tip: Each clamp requires a 2" footprint above the worksurface, and a 3¼" clearance below the worksurface.

Tip: Rails require a minimum worksurface depth of 18" for stability.

Standard Includes	Required to Specify
<ul style="list-style-type: none"> • Rail: 4799 Platinum Metallic • Brackets and stanchions: 4799 Platinum Metallic 	1 Style number 2 Options, if selected (see below)

Options	Price	Required to Specify
Surface Materials • Rail	• Paint price group 3 +\$25	Specify paint color number. ▶ See <i>Surface Materials Reference Manual</i> for accent paint options.
Related Products	• SOTO worktools • SOTO shelves	▶ Pages 45–55 ▶ Page 47

Specification Information					
• Dimensions			• Weight	• Style Number	• Base Price
D	W	H			
1"	28"	3¼"	4.6 lb	DSR28	\$202
1"	34"	3¼"	5.2 lb	DSR34	\$213
1"	40"	3¼"	5.75 lb	DSR40	\$226
1"	46"	3¼"	6.3 lb	DSR46	\$239
1"	52"	3¼"	6.9 lb	DSR52	\$251
1"	58"	3¼"	7.5 lb	DSR58	\$263
1"	64"	3¼"	8 lb	DSR64	\$277
:	:	:	:	:	:

SOTO Worktools, continued

SIN 711.2

SOTO Rails for Use with Tour

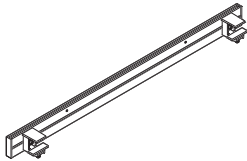

Tip: Allow 1" clearance between worksurface and rail for cable management. Allow 2" for rail mount installed behind a worksurface, and 3/4" overall to install the rail.

Tip: The colors for plastic end caps are defaulted by bracket color.
 ▶ See Worktools Specification Guide for default finishes.

Tip: Maximum weight load for rails is 2 lb per lineal inch.
 Tip: Each clamp requires a 2" footprint above the worksurface, and a 3/4" clearance below the worksurface.

Tip: Tour rails clamp to Tour bench troughs. Rails are not applicable for glass surfaces.

Standard Includes		Required to Specify	
<ul style="list-style-type: none"> • Rail: 4799 Platinum Metallic • Brackets and stanchions: 4799 Platinum Metallic 		1 Style number 2 Options, if selected (see below)	

Options	Price	Required to Specify
Surface Materials Rail <ul style="list-style-type: none"> • Paint price group 3 	+\$25	Specify paint color number. ▶ See <i>Surface Materials Reference Manual</i> for accent paint options.
Related Products <ul style="list-style-type: none"> • SOTO worktools • SOTO shelves 		▶ Page 45 ▶ Page 47

Specification Information						
Corresponding Table Top Width	Dimensions			Weight	Style Number	Base Price
	D	W	H			
60"	1"	52"	3/4"	6.9 lb	DSRT52	\$251
66"	1"	58"	3/4"	7.5 lb	DSRT58	\$263
72"	1"	64"	3/4"	8 lb	DSRT64	\$277

Tip: Rails require a minimum worksurface depth of 18" for stability.

SOTO Cableways

Tip: Cableway hangs fixed at 8" below the worksurface.

Tip: The colors for plastic components are defaulted by bracket color.
 ▶ See Worktools Specification Guide for default paint matrix.

Standard Includes		Required to Specify	
<ul style="list-style-type: none"> • Cableway: 4799 Platinum Metallic • Brackets: 4799 Platinum Metallic 		1 Style number 2 Options, if selected (see below)	

Options	Price	Required to Specify
Surface Materials Rail <ul style="list-style-type: none"> • Paint price group 3 	+\$20	Specify paint color number. ▶ See <i>Surface Materials Reference Manual</i> for accent paint options.
Related Products <ul style="list-style-type: none"> • SOTO worktools • SOTO shelves 		▶ Page 45 ▶ Page 47

Specification Information						
Dimensions	Dimensions			Weight	Style Number	Base Price
	D	W	H			
2 1/2"	20"	8"		2 lb	DSCW20	\$149
2 1/2"	30"	8"		2.5 lb	DSCW30	\$167

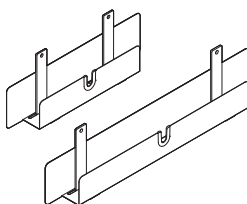

SOTO Shelves

Tip: All SOTO shelves allow for 2⁷/₈" or 6" between work-surface and bottom of shelf.

Tip: The colors for plastic spacers are defaulted by stanchion color.

► See *Worktools Specification Guide* for default finish matrix.

Tip: SOTO shelves are compatible to connect to Answer beam top cap rail.

Standard Includes	Required to Specify
<ul style="list-style-type: none"> Shelf: paint Stanchions: <ul style="list-style-type: none"> – 4799 Platinum Metallic, if 4799 Platinum Metallic selected on shelf – Paint price group 1, if 4231 Arctic White selected on shelf 	<ol style="list-style-type: none"> Style number Paint color number for shelf: <ul style="list-style-type: none"> 4231 Arctic White 4799 Platinum Metallic Paint color number for stanchions, if 4231 Arctic White is selected on shelf: <ul style="list-style-type: none"> 4799 Platinum Metallic 7360 Merle Options, if selected (see below)

Options	Price	Required to Specify
Surface Materials Shelf <ul style="list-style-type: none"> Paint price group 3 	+\$20	Specify paint color number. ► See <i>Surface Materials Reference Manual</i> for accent paint options.

Specification Information

Dimensions	Weight	Style Number	Base Price
D	W	H	Price

36"W Standard Shelf						
3 ¹ / ₂ "	36"	6 ⁹ / ₁₀ "	3.9 lb	DSSA363	\$148	

36"W High Shelf						
3 ¹ / ₂ "	36"	10"	4.2 lb	DSSA363H	\$153	

24"W Standard Shelves						
6 ³ / ₄ "	24"	6 ⁹ / ₁₀ "	4.9 lb	DSSA246	\$153	
10 ¹ / ₄ "	24"	6 ⁹ / ₁₀ "	6.4 lb	DSSA2410	\$163	

24"W High Shelves						
6 ³ / ₄ "	24"	10"	5.3 lb	DSSA246H	\$158	
10 ¹ / ₄ "	24"	10"	6.7 lb	DSSA2410H	\$168	

14"W Standard Shelves						
3 ¹ / ₂ "	14"	6 ⁹ / ₁₀ "	2.2 lb	DSSA143	\$141	
6 ³ / ₄ "	14"	6 ⁹ / ₁₀ "	3.6 lb	DSSA146	\$148	
10 ¹ / ₄ "	14"	6 ⁹ / ₁₀ "	4.4 lb	DSSA1410	\$158	

14"W High Shelves						
3 ¹ / ₂ "	14"	10"	2.5 lb	DSSA143H	\$148	
6 ³ / ₄ "	14"	10"	3.9 lb	DSSA146H	\$153	
10 ¹ / ₄ "	14"	10"	4.7 lb	DSSA1410H	\$163	

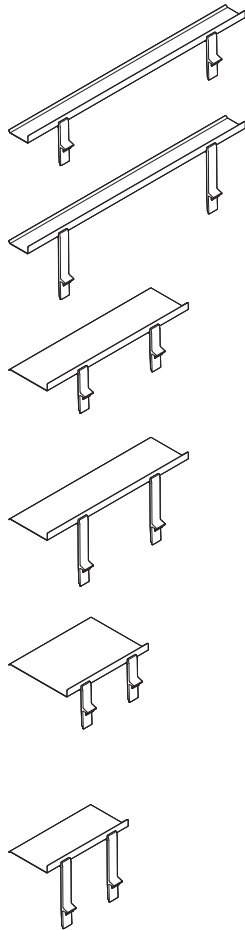

SOTO Worktools, continued

SIN 711.2

SOTO Pile Box

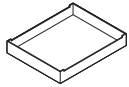

Standard Includes	Required to Specify
-------------------	---------------------

- | | |
|---------------------|--|
| • Pile box: plastic | 1 Style number
2 Plastic color number for box:
6009 Arctic White
6302 Baltic
6338 Chili
6527 Merle
6BE2 Light Peacock
6BE3 Cotton Candy |
|---------------------|--|

Specification Information					
• Dimensions			• Weight	• Style Number	• Price
D	W	H	:	:	:

9 7/8"	12 1/4"	2"	:	0.7 lb	DSSPB	\$39
:	:	:	:	:	:	:

SOTO Landscape Letter Box

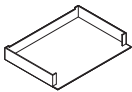

Standard Includes	Required to Specify
-------------------	---------------------

- | | |
|---------------------------------|--|
| • Landscape letter box: plastic | 1 Style number
2 Plastic color number for box:
6009 Arctic White
6302 Baltic
6338 Chili
6527 Merle
6BE2 Light Peacock
6BE3 Cotton Candy |
|---------------------------------|--|

Specification Information					
• Dimensions			• Weight	• Style Number	• Price
D	W	H	:	:	:

9 7/8"	13 3/4"	2"	:	0.8 lb	DSSLB	\$39
:	:	:	:	:	:	:

SOTO Tool Box



Tip: Tool box contains removable semi-opaque insert to separate pens from sticky notes.

Standard Includes	Required to Specify
-------------------	---------------------

- | | |
|---------------------|--|
| • Tool box: plastic | 1 Style number
2 Plastic color number for box:
6009 Arctic White
6302 Baltic
6338 Chili
6527 Merle
6BE2 Light Peacock
6BE3 Cotton Candy |
|---------------------|--|

Specification Information					
• Dimensions			• Weight	• Style Number	• Price
D	W	H	:	:	:

3 1/2"	3 1/4"	3 1/2"	:	0.3 lb	DSTB	\$34
:	:	:	:	:	:	:

SOTO Diagonal File Box

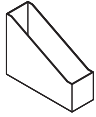

Standard Includes	Required to Specify
<ul style="list-style-type: none"> Diagonal file box: plastic 	<ul style="list-style-type: none"> 1 Style number 2 Plastic color number for box: <ul style="list-style-type: none"> 6009 Arctic White 6302 Baltic 6338 Chili 6527 Merle 6BE2 Light Peacock 6BE3 Cotton Candy

Specification Information					
Dimensions			Weight	Style Number	Price
D	W	H			
12 1/4"	4"	9 7/8"	0.5 lb	DSDFB	\$39
:	:	:	:	:	:

SOTO Utility Box



Standard Includes	Required to Specify
<ul style="list-style-type: none"> Utility box: plastic 	<ul style="list-style-type: none"> 1 Style number 2 Plastic color number for box: <ul style="list-style-type: none"> 6009 Arctic White 6302 Baltic 6338 Chili 6527 Merle 6BE2 Light Peacock 6BE3 Cotton Candy

Specification Information					
Dimensions			Weight	Style Number	Price
D	W	H			
3 7/8"	9"	1 1/4"	0.3 lb	DSUB	\$34
:	:	:	:	:	:

SOTO Personal Box



Standard Includes	Required to Specify
<ul style="list-style-type: none"> Personal box: plastic 	<ul style="list-style-type: none"> 1 Style number 2 Plastic color number for box: <ul style="list-style-type: none"> 6009 Arctic White 6302 Baltic 6338 Chili 6527 Merle 6BE2 Light Peacock 6BE3 Cotton Candy

Specification Information					
Dimensions			Weight	Style Number	Price
D	W	H			
9"	9"	2"	0.3 lb	DSPB	\$34
:	:	:	:	:	:

SOTO Worktools, continued

SIN 711.2

SOTO Storage Boxes, Set of Three

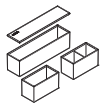

Tip: The storage box set fits inside the personal box.

Tip: The box dimensions are:

- Open rectangle box with or without divider 2¹/₈"D x 4¹/₄"W x 2³/₈"H
- Long rectangle box with lid 2¹/₈"D x 8⁵/₈"W x 2³/₈"H

Standard Includes	Required to Specify
<ul style="list-style-type: none"> • Set of three storage boxes: semi-opaque boxes with white cover 	Style number

Specification Information

Style Number	Weight	Price
DSSB	0.4 lb	\$39

SOTO Personal Console

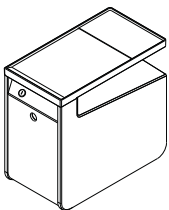

Tip: SOTO personal console charging options include USB ports (two ports, 2.1A each) and Qi wireless charging (5W).

Tip: Height-adjustable work-surface controllers and sliding top release mechanisms should be placed on the opposite side of the work-surface from the personal console.

Tip: SOTO personal console should be placed inboard of legs by a 1/2" and is not to be placed on an overhang.

Tip: SOTO personal console can only be mounted on square worksurface edge profiles between 1/2" and 1 1/2" thick.

Standard Includes	Required to Specify
<ul style="list-style-type: none"> • Personal console: 6009 Arctic White • Tambour door: 6527 Merle • Fabric colored pad: dark grey felt • 12V power supply with 72" black cord (charging versions) • Lock, keyed random: 6205 Black 	1 Style number 2 Options, if selected (see below)

Options	Price	Required to Specify
Surface Materials <ul style="list-style-type: none"> • Grey felt • Fabric finish set 1 • Fabric finish set 2 	No cost +\$ 38 +\$ 81	Specify grey felt. Specify fabric color number. Specify fabric color number. ▶ See <i>Surface Materials</i> , page 346.
Charging Options <ul style="list-style-type: none"> • None • USB charging • USB with Qi wireless charging 	No cost +\$ 75 +\$245	Specify <i>with no USB</i> . Specify <i>with USB</i> . Specify <i>with USB and Qi wireless</i> .

Specification Information

Dimensions D W	Style Number	Base Price
16 ³ / ₄ " 9"	DSPC	\$475

SOTO Mobile Caddy

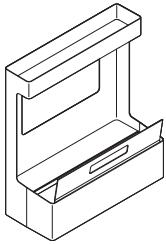

Standard Includes	Required to Specify
<ul style="list-style-type: none"> Mobile caddy: 6009 Arctic White Fabric covered pad: dark grey felt 	1 Style number 2 Options, if selected (see below) ▶ See <i>Surface Materials</i> , page 346.

Options	Price	Required to Specify
Surface Materials Fabric covered pad <ul style="list-style-type: none"> Grey felt Fabric finish set 1 Fabric finish set 2 	No cost +\$38 +\$81	Specify grey felt. Specify fabric color number. Specify fabric color number.

Specification Information

Dimensions			Weight	Style Number	Base Price
D	W	H			
21"	9½"	23¾"	16.8 lb	DSMC	\$436

SOTO Launch Pad

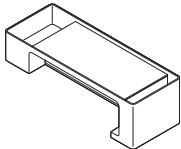

Standard Includes	Required to Specify
<ul style="list-style-type: none"> Launch pad: plastic Fabric pad: grey felt Powered, if selected: 3 outlets on each side, 9' power cord, cable management clips 	1 Style number 2 Plastic color number for launch pad: 6009 Arctic White 6527 Merle 3 Options, if selected (see below)

Options	Price	Required to Specify
Surface Materials Fabric covered pad <ul style="list-style-type: none"> Grey felt Fabric finish set 1 Fabric finish set 2 	No cost +\$38 +\$81	Specify grey felt. Specify fabric color number. Specify fabric color number. ▶ See <i>Surface Materials</i> , page 346.

Specification Information

Dimensions			Weight	Style Number	Base Price
D	W	H			
Non-Powered Launch Pad					
24"	9"	5"	7.75 lb	DSLPLNP	\$287
Powered Launch Pad					
24"	9"	5"	10.1 lb	DSLPLP	\$436

Tip: SOTO powered launch pad contains a 15 amp circuit breaker.

SOTO Worktools, continued

SIN 711.2

SOTO Launch Pad Divider Screen

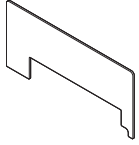

Tip: Screen is 14"H off work-surface when installed.

Standard Includes	Required to Specify
• Screen: 6544 Frost	Style number

Specification Information

• Dimensions			• Weight	• Style	• Price
D	W	H		Number	
23 ⁵ / ₈ "	3 ¹ / ₁₆ "	9 ¹ / ₂ "	2.1 lb	DSLPS	\$111
·	·	·	·	·	·

SOTO Functional Screen

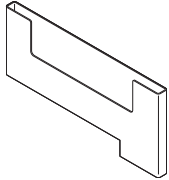

Tip: Screens cannot be used on glass, bullnose, knife edge, or other non-standard worksurface edges.

Tip: All height-adjustable worksurface controllers must be mounted clear of installed screen.

Standard Includes	Required to Specify
• Functional screen: plastic	1 Style number 2 Plastic color number for launch pad: 6009 Arctic White 6527 Merle

Specification Information

• Dimensions			• Weight	• Style	• Price
D	W	H		Number	
28 ¹ / ₂ "	1 ³ / ₄ "	14"	5.1 lb	DSFS	\$263
·	·	·	·	·	·

SOTO Personal Pocket



Tip: Personal pocket fits on mobile caddy and functional screen, or can be ganged together while freestanding.

Standard Includes	Required to Specify
• Personal pocket: 6000 Black	Style number

Specification Information

• Dimensions			• Weight	• Style	• Price
D	W	H		Number	
11 ³ / ₄ "	2"	5 ¹ / ₂ "	1.1 lb	DSPP	\$39
·	·	·	·	·	·

SOTO Cable Clip



Tip: Clips cannot be used with glass, bullnose, knife edge, or other non-standard worksurface edges.

Standard Includes	Required to Specify
<ul style="list-style-type: none"> Cable clip: plastic 	1 Style number 2 Plastic color number for cable clip: 6009 Arctic White 6059 Sterling Dark Solid

Specification Information					
• Dimensions			• Weight	• Style Number	• Price
D	W	H			
2"	1"	2"	0.5 lb	DCCLIP	\$24

SOTO Personal Hook



Tip: Hooks cannot be used with glass, bullnose, knife edge, or other non-standard worksurface edges.

Standard Includes	Required to Specify
<ul style="list-style-type: none"> Personal hook: plastic 	1 Style number 2 Plastic color number for personal hook: 6009 Arctic White 6059 Sterling Dark Solid

Specification Information					
• Dimensions			• Weight	• Style Number	• Price
D	W	H			
2"	¾"	2"	0.5 lb	DPHOOK	\$24

SOTO Monitor Bridge

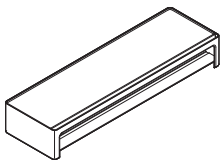

Standard Includes	Required to Specify
<ul style="list-style-type: none"> Monitor bridge: plastic Fabric covered pad: dark grey felt 	1 Style number 2 Plastic color number for monitor bridge: 6009 Arctic White 6527 Merle 3 Options, if selected (see below)

Options	Price	Required to Specify
Surface Materials <ul style="list-style-type: none"> Merle shelf 	+\$69	Specify with 6527 Merle.
Fabric covered pad <ul style="list-style-type: none"> Grey felt Fabric finish set 1 Fabric finish set 2 	No cost +\$38 +\$81	Specify grey felt. Specify fabric color number. Specify fabric color number. ▶ See <i>Surface Materials</i> , page 346.

Specification Information					
• Dimensions			• Weight	• Style Number	• Base Price
D	W	H			
9"	29 ² / ₁₆ "	4½"	4.1 lb	DSMB	\$210

SOTO Worktools, continued

SIN 711.2

SOTO Laptop Shelf

Standard Includes	Required to Specify
<ul style="list-style-type: none"> Laptop shelf: 6009 Arctic White Stanchion: 4799 Platinum 	Style number

Specification Information

• Dimensions	• Weight	• Style	• Price
D W H	:	Number	:

Rail-Mounted

14 ³ / ₄ "	14"	9 ⁵ / ₈ "	2.7 lb	DSL SRM	\$153

Freestanding

14 ³ / ₄ "	14"	7"	3 lb	DSL S	\$168

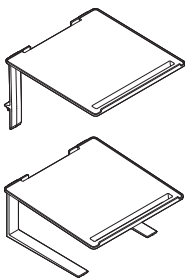

Tip: To prevent tipping with freestanding unit, press only on middle to rear of product.

Tip: Laptop shelf is able to accommodate side or rear mounted docking stations.

SOTO Ergo Edge

Standard Includes	Required to Specify
<ul style="list-style-type: none"> Ergo edge: 6527 Merle Antimicrobial edge 	1 Style number 2 Options (see below)

Edge Type	Options	Price	Required to Specify
	• Non-antimicrobial	No cost	Specify with non-antimicrobial.

Specification Information

• Dimensions	• Weight	• Style	• Price
D W H	:	Number	:

2 ¹ / ₂ "	27"	7 ¹ / ₁₀ "	0.21 lb	DSEE	\$99

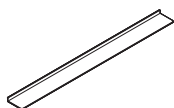

Tip: Ergo edge not applicable for use with bull-nose, knife-edge, or other non-standard worksurface edge.

Tip: Ergo edge must be stored flat.

Tip: Antimicrobial version is treated with Bactiblock.

Tip: Ergo edge front lip extends 1/2" down front edge of worksurface.

SOTO Wireless Charger



Standard Includes	Required to Specify
<ul style="list-style-type: none"> SOTO wireless charger: plastic 	1 Style number 2 Plastic color number: 6009 Arctic White 6302 Baltic 6338 Chili 6527 Merle 3 Options, if selected (see below)

Options	Price	Required to Specify
Cork Pedestal • Cork pedestal	+\$25	Specify with cork pedestal.

Tip: Optional cork pedestal allows for articulation of the charger.

Specification Information			
• Dimensions	• Weight	• Style	• Base
• Dia. H	•	• Number	• Price
7" 2 ³ / ₁₀ "	1.10 lb	DSWIRELESS	\$239
•	•	•	•

Screens

SIN 711.2

Fixed Personal/Modesty Screens

Standard Includes	Required to Specify
<ul style="list-style-type: none"> Personal/modesty screens: fabric price group 1 Brackets: 4799 Platinum 	<ul style="list-style-type: none"> 1 Style number 2 Fabric color number for screen 3 Options, if selected (see below) ▶ See <i>Surface Materials</i>, page 346.

Surface Materials	Options	Price			Required to Specify
	Fabric	12"H	19 1/2"H	24"H	
	• Fabric price group 1	No cost	No cost	No cost	Specify fabric color number.
	• Fabric price group 2	+\$25	+\$ 34	+\$ 40	Specify fabric color number.
	• Fabric price group 3	+\$66	+\$ 89	+\$114	Specify fabric color number.
	• Fabric price group 4	+\$85	+\$114	+\$139	Specify fabric color number.
	• Customer's Own Material (COM)	+\$16	+\$ 16	+\$ 16	▶ See <i>Surface Materials Reference Manual</i> .

Tip: When using COM fabric, it is recommended that non-patterned fabric be used to provide a consistent visual between adjacent screens, and from one side to the other.

Specification Information		
Width	Style Number	Base Price

12"H Screens		
30"	CQSF3012	\$166
36"	CQSF3612	\$194
42"	CQSF4212	\$219
48"	CQSF4812	\$247
:	:	:

19 1/2"H Screens		
30"	CQSF3019	\$256
36"	CQSF3619	\$284
42"	CQSF4219	\$311
48"	CQSF4819	\$337
:	:	:

24"H Screens		
30"	CQSF3024	\$345
36"	CQSF3624	\$374
42"	CQSF4224	\$400
48"	CQSF4824	\$427
:	:	:

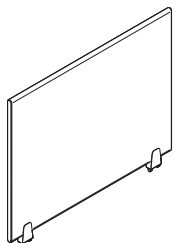
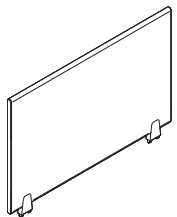
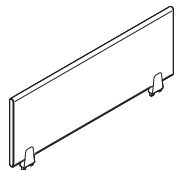

Tip: 24"H screens are not intended for use in the modesty position.

Lighting

► For more detailed product information, see the *Steelcase Worktools Specification Guide* or consult your Steelcase dealer.



Statement of Line and Comparison **58**



Specifying

dash LED Lights (SIN 711.2)	64
dash mini LED Lights (SIN 711.2)	66
SOTO LED Lights (SIN 711.2)	68
SOTO Extended LED Lights (SIN 711.2)	69
Mini SOTO LED Light (SIN 711.2)	70
Mini SOTO Extended LED Light (SIN 711.2)	71
LED Radial Desktop Lights (SIN 711.2)	72
LED Linear Desktop Lights (SIN 711.2)	73
LED Linear Shelf Lights (SIN 711.1)	74
LED Shelf Lights (SIN 711.1)	76
LED Personal Task Lights (SIN 711.1)	77
Standard Shelf Lights (SIN 711.1)	78
Utility2 Shelf Lights (SIN 711.1)	80
Bottomline Shelf Lights (SIN 711.1)	82
Accessories (SIN 711.1)	83

Statement of Line and Comparison

Task lights offer end users added control and adjustability to place the proper amount of task lighting to create a holistic work setting.

LED Lights

dash and dash mini LED Lights

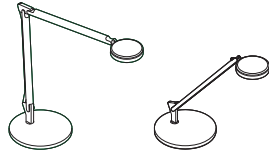

SOTO and SOTO Extended LED Lights

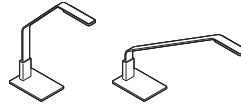

Mini SOTO and Mini SOTO Extended LED Lights

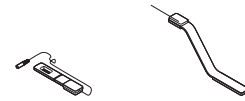

Mounting Options

- Freestanding
- Freestanding with USB
- C-clamp
- Slatwall
- Panel
- Rails—SOTO, c:scape, EE, FrameOne, Campfire, Answer beam, and Tour

- Freestanding
- Rails—SOTO, c:scape, EE, FrameOne, Campfire, and Tour

- Magnetic or screw mount

Specifying
▶ Pages 64–67

Specifying
▶ Pages 68 and 69

Specifying
▶ Pages 70 and 71

Watts/Lumens/Efficacy	9.3 Watts/570 Lumens/61.3 Efficacy	4.8 Watts/ 258 Lumens/53.8 Efficacy	4.8 Watts/ 258 Lumens/53.8 Efficacy
Color Rendering Index	94	83	83
Color Temperature	3500K	3500K	3500K
Automatic Turn Off	10 hours	N.A.	N.A.
Horizontal Arm Range	Standard 0"–37" Mini 0"–24"	Standard 12 ¹ / ₄ " Extended 21 ³ / ₄ "	N.A.
Vertical Height Adjustment	Standard 2"–25" Mini 0"–20 ³ / ₈ "	Standard 14 ³ / ₄ " Extended 13"	N.A.
Tilt/Swivel	360° at light head, 160° at freestanding base, and 360° at mounting bracket	• Not available	• Not available
Replacement Lamp/Bulb	• Not available	• Not available	• Not available
Average Rated Lamp Life	• 50,000 hrs.	• 50,000 hrs.	• 50,000 hrs.
Finish Options	• Paint: Arctic White (4231), Low Gloss Black (4710), Platinum Metallic (4799), or accent paint*	• Paint: Arctic White (4231), Low Gloss Black (4710), or Platinum Metallic (4799)	• Platinum Metallic (4799)
Electronic Dimmer	• 100%–15%	• Not available	• Not available
Occupancy Sensor	• Available	• Not available	• Not available
USB Ports	• One type-A (2.4A max) • One type-C (60-watt max)	• Not available	• Not available

* For complete listing of accent paints, see *Surface Materials Reference Manual*.

Task lights offer end users added control and adjustability to place the proper amount of task lighting to create a holistic work setting.

LED Lights

LED Radial and Linear Desktop Lights

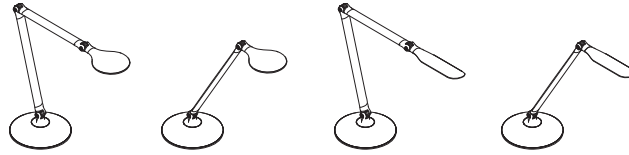

Mounting Options	<ul style="list-style-type: none"> • Freestanding • Freestanding with USB • C-clamp • Slatwall • Panel • Rails-SOTO, Ology, c:scape, Elective Elements, FrameOne, Campfire, and Tour • Through mount • Theft deterrent through-mount 	
	Specifying ▶ Pages 72 and 73	
Watts/Lumens/Efficacy	7.5 Watts/ 337 Lumens/ 44.9 Efficacy	
Color Rendering Index	85	
Color Temperature	3500K	
Horizontal Arm Range	Radial Double 8"–20½" Single 0"–13"	Linear Double 10"–22½" Single 2"–15"
Vertical Height Adjustment	Radial Double 6"–21½" Single 13"–16½"	Linear Double 6"–21½" Single 13"–16½"
Tilt/Swivel	90° vertical tilt at head and 320° at base	
Replacement Lamp/Bulb	• Not available	
Average Rated Lamp Life	• 50,000 hrs.	
Finish Options	• Paint: Arctic White (4231), Low Gloss Black (4710), Platinum Metallic (4799), or accent paint*	
Electronic Dimmer	• 100%–15%	
Occupancy Sensor	• Available	
USB Ports	• One type-A (1.2A max)	

* For complete listing of accent paints, see *Surface Materials Reference Manual*.

Statement of Line and Comparison, continued

Shelf lights offer end users added control and adjustability to place the proper amount of shelf lighting to create a holistic work setting. Ideally suited for recessed mount applications to bottom of bin or shelf.

Shelf Lights

LED Linear Shelf Lights

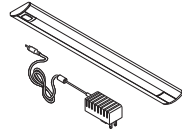

LED Shelf Light

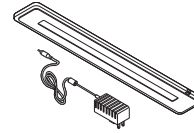

Mounting	<ul style="list-style-type: none"> Standard includes magnetic mount for steel bins and shelves. Each light length comes with set quantity of mounting brackets for both steel and wood applications. 	<ul style="list-style-type: none"> Standard includes magnetic mount for steel bins and shelves. Optional fastener kit for wood shelves are available. 																				
	Specifying ▶ Page 74	Specifying ▶ Page 76																				
Depth	2"	2½"																				
Width	17", 31", 44", or 58"	18"																				
Number of LEDs	17"W 31"W 44"W 58"W 24 48 72 96 47 94 141 188 Standard Output LEDs High Output LEDs	<ul style="list-style-type: none"> 102 LEDs 																				
Watts/Lumens/Efficacy	<table border="1"> <tr> <td>17"W</td> <td>31"W</td> <td>44"W</td> <td>58"W</td> <td>Standard Output</td> </tr> <tr> <td>7.8</td> <td>17.6</td> <td>25.9</td> <td>33.6</td> <td>Watts</td> </tr> <tr> <td>444</td> <td>980</td> <td>1412</td> <td>1791</td> <td>Lumens</td> </tr> <tr> <td>57</td> <td>55.6</td> <td>54.5</td> <td>53.3</td> <td>Efficacy</td> </tr> </table>	17"W	31"W	44"W	58"W	Standard Output	7.8	17.6	25.9	33.6	Watts	444	980	1412	1791	Lumens	57	55.6	54.5	53.3	Efficacy	9.6 Watts /522 Lumens/54 Efficacy
17"W	31"W	44"W	58"W	Standard Output																		
7.8	17.6	25.9	33.6	Watts																		
444	980	1412	1791	Lumens																		
57	55.6	54.5	53.3	Efficacy																		
	<table border="1"> <tr> <td>17"W</td> <td>31"W</td> <td>44"W</td> <td>58"W</td> <td>High Output</td> </tr> <tr> <td>10.9</td> <td>23.4</td> <td>34.3</td> <td>43.5</td> <td>Watts</td> </tr> <tr> <td>44</td> <td>1590</td> <td>2290</td> <td>2807</td> <td>Lumens</td> </tr> <tr> <td>68</td> <td>68</td> <td>67</td> <td>64.5</td> <td>Efficacy</td> </tr> </table>	17"W	31"W	44"W	58"W	High Output	10.9	23.4	34.3	43.5	Watts	44	1590	2290	2807	Lumens	68	68	67	64.5	Efficacy	
17"W	31"W	44"W	58"W	High Output																		
10.9	23.4	34.3	43.5	Watts																		
44	1590	2290	2807	Lumens																		
68	68	67	64.5	Efficacy																		
Color Rendering Index	84	87																				
Color Temperature	3500K	3500K																				
Description	With its low profile and available four widths, the LED linear light will fit in a variety of shelving and overhead storage applications. Beneficial features of this fixture include: energy efficient LEDs, continuous dimming, automatic turn off after 10 hours, and optional occupancy sensor.	An environmentally-friendly light that consumes only 11 watts of power, contains no harmful metals (mercury), and has a useful life of over 50,000 hours. Ideally suited for recessed mount applications to bottom of bin or shelf.																				
Finish Options	<ul style="list-style-type: none"> 4231 Arctic White body with Arctic White (6009) end caps or 0835 Black body with Black (6000) end caps. 	<ul style="list-style-type: none"> Bottom surface clear anodized aluminum only. Plastic cover Arctic White (6009) or Black (6000). 																				
Optics	<ul style="list-style-type: none"> Polycarbonate matte film 	<ul style="list-style-type: none"> Polycarbonate matte film 																				
Ballasts	<ul style="list-style-type: none"> Energy saving low-voltage power supply 	<ul style="list-style-type: none"> Energy saving low-voltage power supply 																				
Electronic Dimmer	<ul style="list-style-type: none"> Standard on all lights 	<ul style="list-style-type: none"> Standard on all lights 																				
Average Rated Lamp Life	<ul style="list-style-type: none"> 50,000 hrs. 	<ul style="list-style-type: none"> 50,000 hrs. 																				
Warranty	<ul style="list-style-type: none"> Power supply - 5 years Fixture - 12 years 	<ul style="list-style-type: none"> Power supply – 5 years Fixture – 12 years 																				

Personal task lights

offer end users added control and adjustability to place the proper amount of personal lighting to create a holistic worksetting. Ideally suited for rail-mount, desk, or freestanding applications.

LED Lights

Rail-Mounted and Non Rail-Mounted

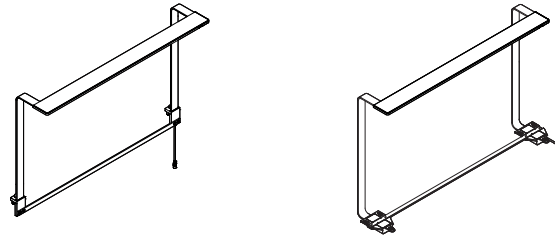
LED Personal Task Lights

Mounting	<ul style="list-style-type: none"> Rail-mounted attaches directly to rail systems in Ology, c:scape, FrameOne, Elective Elements, turnstone Campfire big table, and SOTO Rail. The non rail-mounted version attaches to most freestanding desks and tables. <i>Tip: Non rail-mounted LED personal task lights will not work on worksurfaces with knife edge that is longer than 1¼", or with modesty panels or modesty screens closer than 6" from the back edge.</i>
	<p>Specifying ▶ Page 77</p>
Depth	6"
Width	30"
Number of LEDs	• 120 LEDs
Watts/Lumens/Efficacy	12.6 Watts/414 Lumens/44.1 Efficacy
Color Rendering Index	86
Color Temperature	3500K
Description	<p>Intended to be a primary light source, LED personal task light covers the user's active work zone with a smartly-designed array of light. The light is specifically designed to direct light where it is needed. Energy efficient at only 12.6 watts, LED personal task light is engineered to have a useful life of over 50,000 hours. It attaches directly to the rail systems of Ology, c:scape, FrameOne, Elective Elements, turnstone Campfire big table, and SOTO Rail. A non-rail mounted version attaches to freestanding desks and tables.</p>
Finish Options	<ul style="list-style-type: none"> Fixture and stanchions, paint: 4799 Platinum Metallic, 4231 Arctic White, 4710 Low Gloss Black. Plastic cover Arctic White (6009) only.
Optics	• Polycarbonate matte film
Ballasts	• Energy saving low-voltage power supply
Electronic Dimmer	• Standard on all lights
Average Rated Lamp Life	• 50,000 hrs.
Warranty	<ul style="list-style-type: none"> Power supply - 5 years Fixture - 12 years

Statement of Line and Comparison, continued

Shelf lights mount into the recessed bottom of storage shelves and bins to illuminate the worksurface. Five types of shelf lights are available to control the quality of light for specific applications. Each type is compatible with Steelcase systems furniture.

Shelf Lights

Storage-Mounted Lights

Standard Shelf Light

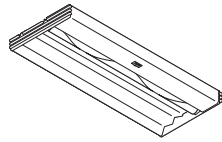

Utility2 Shelf Light

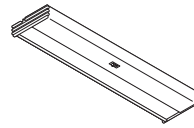

Mounting Options	<ul style="list-style-type: none"> • Universal mounting package (standard) • Flush mount • Competitive mounting package 	<ul style="list-style-type: none"> • Universal and flush mounting package (standard)
	Specifying ▶ Page 78	Specifying ▶ Page 80
Depth	9¼"	6⅞"
Width	25", 37", or 49"	25", 37", or 49"
Lamp	<ul style="list-style-type: none"> • T8 Fluorescent 	<ul style="list-style-type: none"> • T8 Fluorescent
Watts/Lumens/Efficacy	25"W – 17 Watts/1343 Lumens/79 Efficacy 37"W – 25 Watts/2150 Lumens/86 Efficacy 49"W – 32 Watts/2899 Lumens/90.6 Efficacy	25"W – 17 Watts/1343 Lumens/79 Efficacy 37"W – 25 Watts/2150 Lumens/86 Efficacy 49"W – 32 Watts/2899 Lumens/90.6 Efficacy
Color Temperature	3500K	3500K
Description	The right choice for the majority of people in today's workplace who switch frequently from task to task throughout the day.	Designed for use in display areas, service centers, under transaction tops, and other applications where glare control is not a primary consideration.
Optics	<ul style="list-style-type: none"> • Faceted, white reflector • Contrast sleeve that can be manually rotated to vary light 	Silver reflector Prismatic lens— flat acrylic diffuser intensity
Ballasts	<ul style="list-style-type: none"> • Electronic ballast • High power factor ballast 	<ul style="list-style-type: none"> • Electronic ballast • High power factor ballast • Normal-power-factor ballast
Electronic Dimmer	<ul style="list-style-type: none"> • Not available 	<ul style="list-style-type: none"> • Not available
Lens Options	<ul style="list-style-type: none"> • None 	<ul style="list-style-type: none"> • Batwing lens option
Average Rated Lamp Life	<ul style="list-style-type: none"> • 20,000 hours 	<ul style="list-style-type: none"> • 20,000 hours
Warranty	<ul style="list-style-type: none"> • Ballast - 5 years • Fixture - 12 years 	<ul style="list-style-type: none"> • Ballast - 5 years • Fixture - 12 years

Shelf lights offer end users added control and adjustability to place the proper amount of shelf lighting to create a holistic work setting. Ideally suited for recessed mount applications to bottom of bin or shelf.

Shelf Lights

Bottomline Light

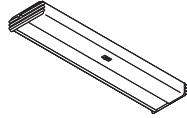

Mounting	<ul style="list-style-type: none"> Standard includes universal spring bracket for recessed mount or screw-in for flush mount (tool free clips for New York applications). <p>Specifying ▶ Page 82</p>
Depth	4½"
Width	23¼", 35", or 46¾"
Height	1¼"
Weight	4.02 lb, 4.95 lb, or 6.9 lb
Lamp	<ul style="list-style-type: none"> T5 Fluorescent
Watts/Lumens/Efficacy	23¼"W – 14 Watts/1275 Lumens/91 Efficacy 35"W – 21 Watts/2000 Lumens/95 Efficacy 46¾"W – 28 Watts/2697 Lumens/96 Efficacy
Color Temperature	3500K
Description	Designed to be environmentally friendly providing 15% more light with an even distribution of light on the worksurface. Ideally suited for recessed mount applications to bottom of bin or shelf.
Finish Options	<ul style="list-style-type: none"> Paint: Black (0835), Pewter (7018), or Dark Champagne (7021)
Optics	<ul style="list-style-type: none"> Mylar reflector with batwing lens
Ballasts	<ul style="list-style-type: none"> Energy saving electronic ballast
Electronic Dimmer	<ul style="list-style-type: none"> Not available
Average Rated Lamp Life	<ul style="list-style-type: none"> 20,000 hrs.
Warranty	<ul style="list-style-type: none"> Ballast - 5 years Fixture - 12 years

dash LED Lights

SIN 711.2

Tip: For applications that include an integrated SOTO rail; Ology, FrameOne, c:scape, Campfire, Tour, or SOTO rail; specify dash rail mount with integrated SOTO bracket. dash can be mounted in front of privacy screens, Slatwall, or FrameOne center screen.

Tip: 90° mini extension cord can be used with Ology bench, FrameOne, or where power receptacles are located in confined spaces.

► See Worktools Specification Guide.

Tip: For a complete listing of accent paints, see Surface Materials Reference Manual.

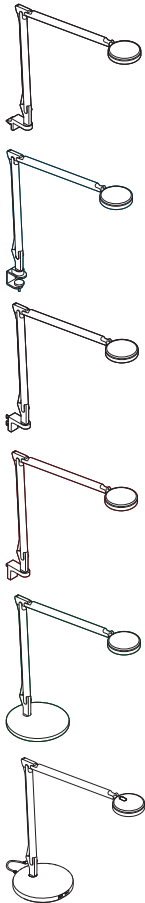

Standard Includes	Required to Specify
<ul style="list-style-type: none"> • Task light and mounting bracket: paint price group 1 • 9.3-watt LED 3500K • Continuous range dimmer • 15-watt, 9' black power supply • 60-watt, 11' black modular power supply, if USB base is selected • Two integrated USB charging ports (type-A and type-C), if freestanding USB is selected • Integrated SOTO rail bracket, if selected 	<ol style="list-style-type: none"> 1 Style number 2 Paint color number for light: <ul style="list-style-type: none"> 4231 Arctic White 4710 Low Gloss Black 4799 Platinum Metallic 3 Options, if selected (see below) <ul style="list-style-type: none"> ► See <i>Surface Materials</i>, page 346.

Options	Price	Required to Specify
Surface Materials <ul style="list-style-type: none"> • Paint price group 3 	+\$29	Specify paint color number. ► See <i>Surface Materials Reference Manual</i> for accent paint options.
Rail Bracket <ul style="list-style-type: none"> • Elective Elements Tech Zone bracket 	No cost	Specify with <i>EE Tech Zone</i> bracket.

Specification Information

• Dimensions			• Weight	• Style	• Base
D	W	H		Number	Price

Rail-Mounted

37"	¾"	24¼"	1.7 lb	LDASHR	\$524
-----	----	------	--------	---------------	-------

C-Clamp Mount

37"	¾"	24¼"	2.2 lb	LDASHC	\$524
-----	----	------	--------	---------------	-------

Panel-Mounted For Use with Answer, Avenir, and Kick

37"	¾"	24¼"	2 lb	LDASHP	\$524
-----	----	------	------	---------------	-------

Slatwall- and SlatRail-Mounted

37"	¾"	24¼"	2 lb	LDASHS	\$524
-----	----	------	------	---------------	-------

Freestanding

37"	8¼"	25"	9.65 lb	LDASHF	\$524
-----	-----	-----	---------	---------------	-------

Freestanding USB

37"	8¼"	25¼"	9.65 lb	LDASHU	\$664
-----	-----	------	---------	---------------	-------

Tip: Applications that include a rail mounted dash to Elective Elements Tech Zone will need to choose the optional Elective Elements Tech Zone rail mount bracket. Elective Elements Tech Zone rail mount bracket cannot be used with privacy screens, Slatwall, or FrameOne center screens. The light must be mounted adjacent to the screens or Slatwall.

dash LED Lights

With Occupancy Sensor

SIN 711.2

Tip: For applications that include an integrated SOTO rail; Ology, FrameOne, c:scape, Campfire, Tour, or SOTO rail; specify dash rail mount with integrated SOTO bracket. dash can be mounted in front of privacy screens, Slatwall, or FrameOne center screen.

Tip: 90° mini extension cord can be used with Ology bench, FrameOne, or where power receptacles are located in confined spaces.

▶ See *Worktools Specification Guide*.

Tip: For a complete listing of accent paints, see Surface Materials Reference Manual.

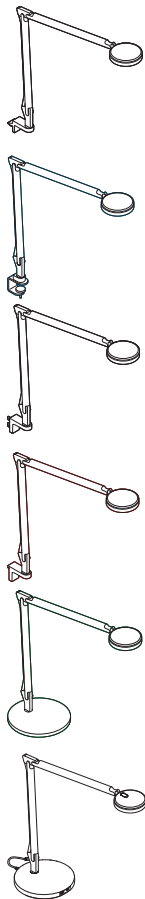

Standard Includes	Required to Specify
<ul style="list-style-type: none"> • Task light and mounting bracket: paint price group 1 • Occupancy sensor • 9.3-watt LED 3500K • Continuous range dimmer • 15-watt, 9' black power supply • 60-watt, 11' black modular power supply, if USB base is selected • Two integrated USB charging ports (type-A and type-C), if freestanding USB is selected • Integrated SOTO rail bracket, if selected 	<ol style="list-style-type: none"> 1 Style number 2 Paint color number for light: <ul style="list-style-type: none"> 4231 Arctic White 4710 Low Gloss Black 4799 Platinum Metallic 3 Options, if selected (see below) <ul style="list-style-type: none"> ▶ See <i>Surface Materials</i>, page 346.

Options	Price	Required to Specify
Surface Materials <ul style="list-style-type: none"> • Paint price group 3 	+\$29	Specify paint color number. ▶ See <i>Surface Materials Reference Manual</i> for accent paint options.
Rail Bracket <ul style="list-style-type: none"> • Elective Elements Tech Zone bracket 	No cost	Specify with <i>EE Tech Zone</i> bracket.

Specification Information

Dimensions	Weight	Style	Base
D W H	:	Number	Price

Rail-Mounted

37"	3/4"	24 1/4"	1.7 lb	LDASHOR	\$576

C-Clamp Mount

37"	3/4"	24 1/4"	2.2 lb	LDASHOC	\$576

Panel-Mounted For Use with Answer, Avenir, and Kick

37"	3/4"	24 1/4"	2 lb	LDASHOP	\$576

Slatwall- and SlatRail-Mounted

37"	3/4"	24 1/4"	2 lb	LDASHOS	\$576

Freestanding

37"	8 1/4"	25"	9.65 lb	LDASHOF	\$576

Freestanding USB

37"	8 1/4"	25 1/4"	9.65 lb	LDASHOU	\$716

Tip: Applications that include a rail mounted dash to Elective Elements Tech Zone will need to choose the optional Elective Elements Tech Zone rail mount bracket. Elective Elements Tech Zone rail mount bracket cannot be used with privacy screens, Slatwall, or FrameOne center screens. The light must be mounted adjacent to the screens or Slatwall.



dash mini LED Lights

SIN 711.2

Tip: For applications that include an integrated SOTO rail; Ology, FrameOne, c:scape, Campfire, Tour, or SOTO rail; specify dash rail mount with integrated SOTO bracket. dash can be mounted in front of privacy screens, Slatwall, or FrameOne center screen.

Tip: 90° mini extension cord can be used with Ology bench, FrameOne, or where power receptacles are located in confined spaces.

▶ See Worktools Specification Guide.

Tip: For a complete listing of accent paints, see Surface Materials Reference Manual.

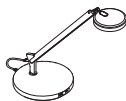
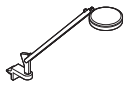

Tip: Applications that include a rail mounted dash to Elective Elements Tech Zone will need to choose the optional Elective Elements Tech Zone rail mount bracket. Elective Elements Tech Zone rail mount bracket cannot be used with privacy screens, Slatwall, or FrameOne center screens. The light must be mounted adjacent to the screens or Slatwall.

Standard Includes	Required to Specify
<ul style="list-style-type: none"> • Task light and mounting bracket: paint price group 1 • 9.3-watt LED 3500K • Continuous range dimmer • 15-watt, 9' black power supply • 60-watt, 11' black modular power supply, if USB base is selected • Two integrated USB charging ports (type-A and type-C), if freestanding USB is selected • Integrated SOTO rail bracket, if selected 	1 Style number 2 Paint color number for light: 4231 Arctic White 4710 Low Gloss Black 4799 Platinum Metallic 3 Options, if selected (see below) ▶ See <i>Surface Materials</i> , page 346.

Options	Price	Required to Specify
Surface Materials <ul style="list-style-type: none"> • Paint price group 3 	+\$29	Specify paint color number. ▶ See <i>Surface Materials Reference Manual</i> for accent paint options.
Rail Bracket <ul style="list-style-type: none"> • Elective Elements Tech Zone bracket 	No cost	Specify with <i>EE Tech Zone</i> bracket.

Specification Information

Dimensions	Weight	Style Number	Base Price
D W H			

Rail-Mounted

24"	3/4"	20 3/8"	1.3 lb	LDASHMINIR	\$431
-----	------	---------	--------	-------------------	-------

C-Clamp Mount

24"	3/4"	20 3/8"	1.8 lb	LDASHMINIC	\$431
-----	------	---------	--------	-------------------	-------

Panel-Mounted For Use with Answer, Avenir, and Kick

24"	3/4"	20 3/8"	1.6 lb	LDASHMINIP	\$431
-----	------	---------	--------	-------------------	-------

Slatwall- and SlatRail-Mounted

24"	3/4"	20 3/8"	1.6 lb	LDASHMINIS	\$431
-----	------	---------	--------	-------------------	-------

Freestanding

24"	8 1/4"	21 1/10"	9.25 lb	LDASHMINIF	\$431
-----	--------	----------	---------	-------------------	-------

Freestanding USB

24"	8 1/4"	21 7/10"	9.25 lb	LDASHMINIU	\$571
-----	--------	----------	---------	-------------------	-------

dash mini LED Lights

With Occupancy Sensor

SIN 711.2

Tip: For applications that include an integrated SOTO rail; Ology, FrameOne, c:scape, Campfire, Tour, or SOTO rail; specify dash rail mount with integrated SOTO bracket. dash can be mounted in front of privacy screens, Slatwall, or FrameOne center screen.

Tip: 90° mini extension cord can be used with Ology bench, FrameOne, or where power receptacles are located in confined spaces. ▶ See Worktools Specification Guide.

Standard Includes	Required to Specify
-------------------	---------------------

<ul style="list-style-type: none"> • Task light and mounting bracket: paint price group 1 • 9.3-watt LED 3500K • Continuous range dimmer • 15-watt, 9' black power supply • Occupancy sensor • 60-watt, 11' black modular power supply, if USB base is selected • Two integrated USB charging ports (type-A and type-C), if freestanding USB is selected • Integrated SOTO rail bracket, if selected 	<ol style="list-style-type: none"> 1 Style number 2 Paint color number for light: <ul style="list-style-type: none"> 4231 Arctic White 4710 Low Gloss Black 4799 Platinum Metallic 3 Options, if selected (see below) <ul style="list-style-type: none"> ▶ See <i>Surface Materials</i>, page 346.
--	---

Options	Price	Required to Specify
---------	-------	---------------------

Surface Materials <ul style="list-style-type: none"> • Paint price group 3 	+\$29	Specify paint color number. ▶ See <i>Surface Materials Reference Manual</i> for accent paint options.
Rail Bracket <ul style="list-style-type: none"> • Elective Elements Tech Zone bracket 	No cost	Specify with <i>EE Tech Zone</i> bracket.

Specification Information					
Dimensions			Weight	Style Number	Base Price
D	W	H			

Rail-Mounted

24"	¾"	20 ³ / ₈ "	1.3 lb	LDASHMINIOR	\$483
-----	----	----------------------------------	--------	--------------------	-------

C-Clamp Mount

24"	¾"	20 ³ / ₈ "	1.8 lb	LDASHMINIOC	\$483
-----	----	----------------------------------	--------	--------------------	-------

Panel-Mounted For Use with Answer, Avenir, and Kick

24"	¾"	20 ³ / ₈ "	1.6 lb	LDASHMINIOP	\$483
-----	----	----------------------------------	--------	--------------------	-------

Slatwall- and SlatRail-Mounted

24"	¾"	20 ³ / ₈ "	1.6 lb	LDASHMINIOS	\$483
-----	----	----------------------------------	--------	--------------------	-------

Freestanding

24"	8 ¹ / ₄ "	21 ¹ / ₁₀ "	9.25 lb	LDASHMINIOF	\$483
-----	---------------------------------	-----------------------------------	---------	--------------------	-------

Freestanding USB

24"	8 ¹ / ₄ "	21 ⁷ / ₁₀ "	9.25 lb	LDASHMINIOU	\$623
-----	---------------------------------	-----------------------------------	---------	--------------------	-------



Tip: Applications that include a rail mounted dash to Elective Elements Tech Zone will need to choose the optional Elective Elements Tech Zone rail mount bracket. Elective Elements Tech Zone rail mount bracket cannot be used with privacy screens, Slatwall, or FrameOne center screens. The light must be mounted adjacent to the screens or Slatwall.

SOTO LED Lights

SIN 711.2

Tip: SOTO LED may not occupy the same space as a SOTO 3½"W, 6¾"W, or 10¼"W shelf. The angle of the extended arm will not extend over the shelf. Mount next to shelf or slatwall.

Tip: 90° mini extension cord can be used with Ology bench, FrameOne, or where power receptacles are located in confined spaces. ▶ See Worktools Specification Guide.

Tip: Rail mounted SOTO LEDs will fit in front of c:scape privacy screens.

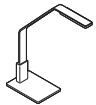

Standard Includes	Required to Specify
-------------------	---------------------

- Task light and mounting bracket: paint
- 4.8-watt LED 3500K
- 9' low voltage modular cord: black plastic only

- 1 Style number
- 2 Paint color number for light:
 - 4231 Arctic White
 - 4710 Low Gloss Black
 - 4799 Platinum

Specification Information					
• Dimensions			• Weight	• Style	• Price
D	W	H		Number	

D	W	H	Weight	Style Number	Price
---	---	---	--------	--------------	-------

Rail-Mounted

12¾"	1½"	14¼"	0.6 lb	DSLEDR	\$302
------	-----	------	--------	---------------	-------

Freestanding

12¾"	4¼"	14¾"	2.2 lb	DSLEDF	\$329
------	-----	------	--------	---------------	-------

SOTO Extended LED Lights

SIN 711.2

Tip: SOTO Extended LED may not occupy the same space as a SOTO 3"W, 6"W or 10"W shelf. The angle of the extended arm will not extend over the shelf. Mount next to shelf or slatwall.

Tip: 90° mini extension cord can be used with Ology bench, FrameOne, or where power receptacles are located in confined spaces. ▶ See Worktools Specification Guide.



Tip: Rail mounted SOTO LEDs will fit in front of c:scape privacy screens.

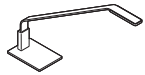

Standard Includes	Required to Specify
-------------------	---------------------

- Task light and mounting bracket: paint
- 4.8-watt LED 3500K
- 9' low voltage modular cord: black plastic only

- 1 Style number
- 2 Paint color number for light:
 - 4231 Arctic White
 - 4710 Low Gloss Black
 - 4799 Platinum

Specification Information					
• Dimensions			• Weight	• Style	• Price
D	W	H		Number	

Rail-Mounted

21¼"	1½"	14¼"	0.7 lb	DSLEDER	\$356
:	:	:	:	:	:

Freestanding

21¾"	4¼"	14¾"	2.3 lb	DSLEDEF	\$383
:	:	:	:	:	:

Lighting

Mini SOTO LED Light

SIN 711.2



Tip: 90° mini extension cord can be used with Ology bench, FrameOne, or where power receptacles are located in confined spaces.

▶ See *Worktools Specification Guide*.

Standard Includes	Required to Specify
<ul style="list-style-type: none"> • Task light and mounting bracket: 4799 Platinum Metallic • 4.8-watt LED 3500K • 9' low voltage modular cord: black plastic only 	<ul style="list-style-type: none"> • Style number

Specification Information					
• Dimensions			• Weight	• Style	• Price
D	W	H		Number	
1 3/8"	7"	5/8"	0.3 lb	LMINILED	\$242
:	:	:	:	:	:

Mini SOTO Extended LED Light

Mini SOTO Extended
LED Light

SIN 711.2



Tip: 90° mini extension cord can be used with Ology bench, FrameOne, or where power receptacles are located in confined spaces. ▶ See Worktools Specification Guide.

Standard Includes	Required to Specify
<ul style="list-style-type: none"> • Task light and mounting bracket: 4799 Platinum Metallic • 4.8-watt LED 3500K • 9' low voltage modular cord: black plastic only 	<ul style="list-style-type: none"> • Style number

Specification Information					
• Dimensions			• Weight	• Style	• Price
D	W	H		Number	
1 ³ / ₈ "	11 ⁷ / ₈ "	5 ⁵ / ₈ "	0.5 lb	LMINILEDE	\$267
:	:	:	:	:	:

Lighting

LED Radial Desktop Lights

SIN 711.2

Standard Includes	Required to Specify
<ul style="list-style-type: none"> • Task light and mounting bracket: paint price group 1 • 18-watt power supply with 9' black cord with 3' silver cord with quick connector • Continuous range dimmer • Automatic turn off program • 7.5-watt LED 3500K 	<ol style="list-style-type: none"> 1 Style number 2 Paint color number for light: 4231 Arctic White 4710 Low Gloss Black 4799 Platinum Metallic 3 Options, if selected (see below) ▶ See <i>Surface Materials</i>, page 346.

Tip: For a complete listing of accent paints, see Surface Materials Reference Manual.

Tip: Must be registered in PerfectMatch program when ordering accent finishes. Registration is available at no charge.

Tip: Through-mount and theft deterrent through-mount brackets can only be used with worksurfaces that are 1" to 1¾" thick. They are not for use with turnstone Bivi, FrameOne, or c:scape worksurfaces under 1"D.

Options	Price	Required to Specify
Surface Materials	• Paint price group 3 +\$ 29	Specify paint color number. ▶ See <i>Surface Materials Reference Manual</i> for accent paint options.
Occupancy Sensor	• With occupancy sensor +\$114	Specify <i>with occupancy sensor</i> .
Base/Mounting Brackets	<ul style="list-style-type: none"> • Freestanding base No cost • C-clamp mount bracket No cost • Slatwall mount bracket No cost • Integrated rail-mount bracket No cost • Panel-mount bracket No cost • Through-mount bracket No cost • Theft deterrent through-mount bracket No cost • Freestanding base with USB +\$ 50 	Specify <i>with freestanding base</i> . Specify <i>with C-clamp mount bracket</i> . Specify <i>with Slatwall mount bracket</i> . Specify <i>with integrated rail-mount bracket</i> . Specify <i>with panel-mount bracket</i> . Specify <i>with through-mount bracket</i> . Specify <i>with theft deterrent through-mount bracket</i> . Specify <i>with freestanding base with USB</i> .

Specification Information				
• Dimensions			• Style	• Base
D	W	H	Number	Price

LED Radial Single Arm Light

13"	6"	16½"	LLRDS	\$338
•	•	•	•	•

LED Radial Double Arm Light

20½"	6"	21½"	LLRDD	\$385
•	•	•	•	•



LED Linear Desktop Lights

SIN 711.2

Tip: For a complete listing of accent paints, see Surface Materials Reference Manual.

Tip: Must be registered in PerfectMatch program when ordering accent finishes. Registration is available at no charge.

Tip: Through-mount and theft deterrent through-mount brackets can only be used with worksurfaces that are 1" to 1¼" thick. They are not for use with turnstone Bivi, FrameOne, or c:scape worksurfaces under 1"D.



Standard Includes	Required to Specify
<ul style="list-style-type: none"> • Task light and mounting bracket: paint price group 1 • 18-watt power supply with 9' black cord with 3' silver cord with quick connector • Continuous range dimmer • Automatic turn off program • 7.5-watt LED 3500K 	<ol style="list-style-type: none"> 1 Style number 2 Paint color number for light: <ul style="list-style-type: none"> 4231 Arctic White 4710 Low Gloss Black 4799 Platinum Metallic 3 Options, if selected (see below) <ul style="list-style-type: none"> ▶ See <i>Surface Materials</i>, page 346.

Options	Price	Required to Specify
Surface Materials <ul style="list-style-type: none"> • Paint price group 3 	+\$ 29	Specify paint color number. ▶ See <i>Surface Materials Reference Manual</i> for accent paint options.
Occupancy Sensor <ul style="list-style-type: none"> • With occupancy sensor 	+\$114	Specify with occupancy sensor.
Base/Mounting Brackets <ul style="list-style-type: none"> • Freestanding base • C-clamp mount bracket • Slatwall-mount bracket • Integrated rail-mount bracket 	No cost	Specify with freestanding base. Specify with C-clamp mount bracket. Specify with Slatwall-mount bracket. Specify with integrated rail-mount bracket.
<ul style="list-style-type: none"> • Panel-mount bracket • Through-mount bracket • Theft deterrent through-mount bracket • Freestanding base with USB 	No cost No cost No cost +\$ 50	Specify with panel-mount bracket. Specify with through-mount bracket. Specify with theft deterrent through-mount bracket. Specify with freestanding base with USB.

Specification Information				
Dimensions			Style	Base
D	W	H	Number	Price

LED Linear Single Arm Light				
15"	6"	16½"	LLLDS	\$338

LED Linear Double Arm Light				
22½"	6"	21½"	LLLDD	\$385

Lighting

LED Linear Shelf Lights

SIN 711.1

Tip: The power supply for the 17" stand alone only uses a straight plug with a 9' 18 watt 24 volt wall transformer. The power supply for the 31", 44", 58", or 17" starter light uses a 11' 60 watt compact in-line brick with straight plug.

Standard Includes	Required to Specify
<ul style="list-style-type: none"> • Task light and mounting bracket: 4231 Arctic White • Power supply with cord: black • Soft touch switch • Magnetic and wood mounting brackets • Continuous range dimmer • Automatic turn off program • Color temperature 3500K 	<ul style="list-style-type: none"> 1 Style number 2 Options, if selected (see below)

Options	Price	Required to Specify
Surface Materials • Painted light housing in 0835 Black	+\$ 12	Specify with 0835 Black.
Occupancy Sensor • 17"W, 31"W, 44"W, and 58"W with stand alone or daisy chain starter	+\$126	Specify with occupancy sensor.
High Output • 17"W with stand alone, starter, or secondary • 31"W, 44"W, and 58"W with stand alone or daisy chain starter, or secondary	+\$ 79 +\$136	Specify with high output. Specify with high output.

Specification Information					
Dimensions			Style	Base	
D	W	H	Number	Price	

17" Stand Alone Light

2"	17"	7/10"	LLL17	\$259
:	:	:	:	:

17" Daisy Chain Starter Light

2"	17"	7/10"	LLL17YA	\$303
:	:	:	:	:

17" Daisy Chain Secondary Light

2"	17"	7/10"	LLL17YB	\$227
:	:	:	:	:

31" Stand Alone or Daisy Chain Starter Light

2"	31"	7/10"	LLL31	\$421
:	:	:	:	:

31" Daisy Chain Secondary Light

2"	31"	7/10"	LLL31YB	\$350
:	:	:	:	:

► Specification Information, continued on next page

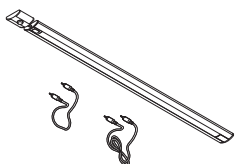
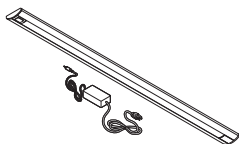
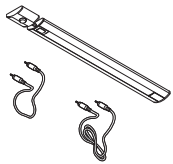
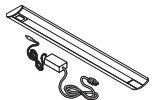
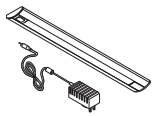

SIN 711.1

► Specification Information, continued from previous page

Specification Information

• Dimensions			• Style	• Base
D	W	H	Number	Price

44" Stand Alone or Daisy Chain Starter Light

2"	44"	7/10"	LLL44	\$559
:	:	:	:	:

44" Daisy Chain Secondary Light

2"	44"	7/10"	LLL44YB	\$469
:	:	:	:	:

58" Stand Alone or Daisy Chain Starter Light

2"	58"	7/10"	LLL58	\$717
:	:	:	:	:

58" Daisy Chain Secondary Light

2"	58"	7/10"	LLL58YB	\$506
:	:	:	:	:

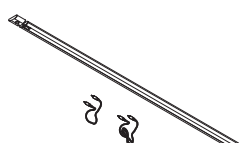
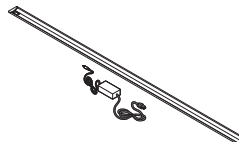
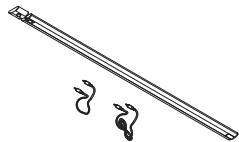
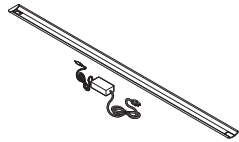

Lighting

LED Shelf Lights

SIN 711.1

Tip: Maximum number of lights that can be daisy chained is three lights.

Standard Includes	Required to Specify
<ul style="list-style-type: none"> Aluminum extrusion with plastic cover Power supply with cord Soft touch switch Thin profile accommodates recessed and low profile flush mounting Ultra energy efficient LED light source Universal magnetic mounting Polycarbonate matte film diffuser Continuous dimming 	<ul style="list-style-type: none"> 1 Style number 2 Plastic color number for cover: <ul style="list-style-type: none"> 6000 Black 6009 Arctic White 3 Options, if selected (see below)

Options	Price	Required to Specify
Mounting <ul style="list-style-type: none"> Fastener kit for use with wood shelf 	+\$8	Specify with fastener kit.

Specification Information

Dimensions	Lamp	Style	Base
D W H	Wattage	Number	Price

LED Standard Light

2 1/2"	18"	1/2"	9.6 watts	LSL18	\$344
--------	-----	------	-----------	--------------	-------

LED Daisy Chain Starter Light

2 1/2"	18"	1/2"	9.6 watts	LSL18YA	\$369
--------	-----	------	-----------	----------------	-------

LED Daisy Chain Secondary Light

2 1/2"	18"	1/2"	9.6 watts	LSL18YB	\$338
--------	-----	------	-----------	----------------	-------

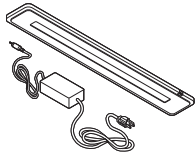
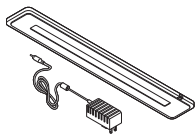

Tip: Daisy chain starter light comes with a 60 watt power supply that will support up to three lights in series (11' cord; 6' from power supply to power outlet, 5' from power supply to fixture). Does not include daisy chain jumper cords.

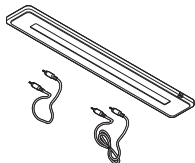

Tip: Daisy chain secondary light does not come with a power supply. Daisy chain cord package (9" and 36") comes standard with each secondary light.

LED Personal Task Lights

SIN 711.1

Standard Includes	Required to Specify
<ul style="list-style-type: none"> • Housing: 6009 Arctic White plastic only • Fixture and stanchions: paint • Power supply (9') • Soft touch switch • Ultra energy efficient LED light source • Polycarbonate matte film diffuser • Continuous dimming 	<ul style="list-style-type: none"> 1 Style number 2 Paint color number for fixture and stanchions: <ul style="list-style-type: none"> 4231 Arctic White 4710 Low Gloss Black 4799 Platinum Metallic

Specification Information

Dimensions			Lamp	Style	Price
D	W	H	Wattage	Number	
:	:	:	:	:	:

Rail-Mounted LED Personal Task Light

6"	30"	17"	12.6 watts	LPTL30	\$605
:	:	:	:	:	:

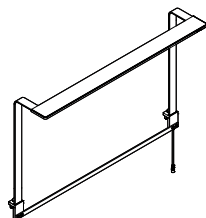

Non Rail-Mounted LED Personal Task Light

6"	30"	17"	12.6 watts	LPTL30NR	\$605
:	:	:	:	:	:

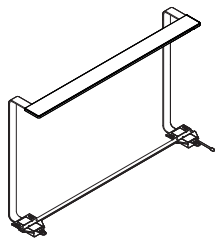

Tip: Non rail-mounted LED personal task lights will not work on worksurfaces with knife edge that is longer than 1¼", or with modesty panels or modesty screens closer than 6" from the back edge.

Lighting

Standard Shelf Lights

SIN 711.1

Tip: Daisy chaining shelf lights together extends power from one fixture to another within workstations to help keep receptacles clear for other uses.

Tip: Daisy chaining is not allowed in Chicago. Local electrical codes vary, so you should consult a qualified electrical contractor or engineer for proper installation of all electrical equipment.

Tip: Because shelf lights are usually recessed, black is the standard paint color. Paint colors other than black have an upcharge.

Tip: If an optional paint color is selected for the housing, the electrical switches and end caps will remain black plastic.

Tip: Flush mounting package contains a pair of clips that allow shelf lights to be installed and removed without tools.

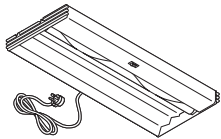

Tip: When ordering with standard power cord or Chicago cord, daisy chaining is not possible.

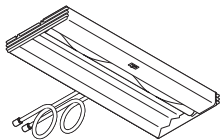

Tip: Remember to order a daisy chain starter cord.
▶ Page 83

Standard Includes	Required to Specify
<ul style="list-style-type: none"> Light housing with centered on-off switch: black paint End cap cord managers: black plastic only Cords: <ul style="list-style-type: none"> Standard and Chicago (including circuit breaker), 9' cord with three-prong plug at 45° angle: black plastic only Daisy chain, one 78" cord with modular connectors for daisy chaining: black plastic only Contrast sleeve around lamp Faceted reflector: white only T8 3500K lamp Ballast Universal mounting hardware package Daisy chain starter cord, if selected: black plastic only (order separately) 	<ol style="list-style-type: none"> Style number Paint color number, if other than black (see options below) Options, if selected (see below) ▶ See <i>Surface Materials</i> , page 346.

Options	Price	Required to Specify
Surface Materials <ul style="list-style-type: none"> Painted light housing other than black 	+\$25	Specify paint color number for housing. ▶ See <i>Surface Materials</i> , page 346.
Bracket Options <ul style="list-style-type: none"> Competitive mounting package Flush mounting package 	No cost No cost	Specify <i>with competitive mounting package</i> . Specify <i>with flush mounting package</i> and paint color number for end cap covers.

Specification Information					
Dimensions	Lamp	Style	Base		
D W H	Wattage	Number	Price		

Electronic High-Power-Factor Ballast

With Standard Power Cord

9¼"	25"	1¾"	17 watts	LSM24K	\$417
9¼"	37"	1¾"	25 watts	LSM36K	\$443
9¼"	49"	1¾"	32 watts	LSM48K	\$479

With Chicago Cord Including Circuit Breaker

9¼"	25"	1¾"	17 watts	LSM24KC	\$482
9¼"	37"	1¾"	25 watts	LSM36KC	\$508
9¼"	49"	1¾"	32 watts	LSM48KC	\$544

With Daisy Chain Cords

9¼"	25"	1¾"	17 watts	LSM24KD	\$453
9¼"	37"	1¾"	25 watts	LSM36KD	\$479
9¼"	49"	1¾"	32 watts	LSM48KD	\$515

SIN 711.1

Utility2 Shelf Lights

SIN 711.1

Tip: Daisy chaining is not allowed in Chicago. Local electrical codes vary, so you should consult a qualified electrical contractor or engineer for proper installation of all electrical equipment.

Tip: Specification guidelines can be found on the next page.

Tip: Cord on stand alone light has right-hand exit. Cord on daisy chain light has off center exit.

Tip: Because shelf lights are usually recessed, black is the standard paint color. Paint colors other than black have an upcharge.

Tip: If an optional paint color is selected for the housing, the electrical switches and end caps will remain black plastic.

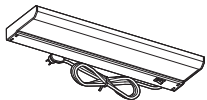

Tip: When ordering with standard power cord or Chicago cord, daisy chaining is not possible.

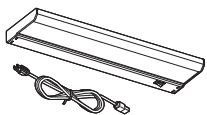
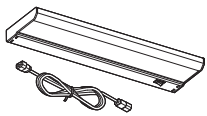

Tip: Minimum of two fixtures for daisy chaining and maximum of 10.

Tip: When ordering starter light do not order a daisy chain starter cord.

Standard Includes	Required to Specify
<ul style="list-style-type: none"> Light housing with right-hand on-off switch: black paint End cap cord managers: black plastic only Cords: <ul style="list-style-type: none"> Standard and Chicago (including circuit breaker), 9' cord with three-prong plug at 45° angle: black plastic only Daisy chain, one 78" cord with modular connectors for daisy chaining: black plastic only Prismatic lens Angled reflector: silver only T8 3500K lamp Ballast Universal and flush mounting hardware package 	<ol style="list-style-type: none"> Style number Paint color number, if other than black (see options below) Options, if selected (see below) <ul style="list-style-type: none"> ▶ See <i>Surface Materials</i>, page 346.

Options	Price	Required to Specify
Surface Materials <ul style="list-style-type: none"> Painted light housing other than black 	+ \$25	Specify paint color number for housing. ▶ See <i>Surface Materials</i> , page 346.
Lens <ul style="list-style-type: none"> Batwing lens 	+ \$33	Specify with batwing lens.

Specification Information					
Dimensions			Lamp	Style	Base
D	W	H	Wattage	Number	Price

Electronic High-Power-Factor Ballast

With Standard Power Cord

6 ⁷ / ₈ "	25"	1 ⁵ / ₈ "	17 watts	LSB24K2	\$276
6 ⁷ / ₈ "	37"	1 ⁵ / ₈ "	25 watts	LSB36K2	\$326
6 ⁷ / ₈ "	49"	1 ⁵ / ₈ "	32 watts	LSB48K2	\$362

With Chicago Cord Including Circuit Breaker

6 ⁷ / ₈ "	25"	1 ⁵ / ₈ "	17 watts	LSB24KC2	\$341
6 ⁷ / ₈ "	37"	1 ⁵ / ₈ "	25 watts	LSB36KC2	\$391
6 ⁷ / ₈ "	49"	1 ⁵ / ₈ "	32 watts	LSB48KC2	\$427

Daisy Chain Light with 78" Jumper Cord

6 ⁷ / ₈ "	25"	1 ⁵ / ₈ "	17 watts	LSB24KD2	\$312
6 ⁷ / ₈ "	37"	1 ⁵ / ₈ "	25 watts	LSB36KD2	\$362
6 ⁷ / ₈ "	49"	1 ⁵ / ₈ "	32 watts	LSB48KD2	\$398

Daisy Chain Starter Light with 9' Starter Cord

6 ⁷ / ₈ "	25"	1 ⁵ / ₈ "	17 watts	LSB24KS2	\$312
6 ⁷ / ₈ "	37"	1 ⁵ / ₈ "	25 watts	LSB36KS2	\$362
6 ⁷ / ₈ "	49"	1 ⁵ / ₈ "	32 watts	LSB48KS2	\$398

▶ **Specification Information, continued on next page**

SIN 711.1

► Specification Information, continued from previous page

Specification Information

Dimensions			Lamp	Style	Base
D	W	H	Wattage	Number	Price

Electronic Normal-Power-Factor Ballast

With Standard Power Cord

6 ⁷ / ₈ "	25"	1 ⁵ / ₈ "	17 watts	LSB24M2	\$197
6 ⁷ / ₈ "	37"	1 ⁵ / ₈ "	25 watts	LSB36M2	\$247
6 ⁷ / ₈ "	49"	1 ⁵ / ₈ "	32 watts	LSB48M2	\$283

With Chicago Cord Including Circuit Breaker

6 ⁷ / ₈ "	25"	1 ⁵ / ₈ "	17 watts	LSB24MC2	\$262
6 ⁷ / ₈ "	37"	1 ⁵ / ₈ "	25 watts	LSB36MC2	\$312
6 ⁷ / ₈ "	49"	1 ⁵ / ₈ "	32 watts	LSB48MC2	\$348

Daisy Chain Light with 78" Jumper Cord

6 ⁷ / ₈ "	25"	1 ⁵ / ₈ "	17 watts	LSB24MD2	\$233
6 ⁷ / ₈ "	37"	1 ⁵ / ₈ "	25 watts	LSB36MD2	\$283
6 ⁷ / ₈ "	49"	1 ⁵ / ₈ "	32 watts	LSB48MD2	\$319

Daisy Chain Starter Light with 9' Starter Cord

6 ⁷ / ₈ "	25"	1 ⁵ / ₈ "	17 watts	LSB24MS2	\$233
6 ⁷ / ₈ "	37"	1 ⁵ / ₈ "	25 watts	LSB36MS2	\$283
6 ⁷ / ₈ "	49"	1 ⁵ / ₈ "	32 watts	LSB48MS2	\$319

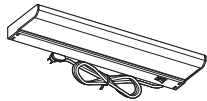

Tip: When ordering with standard power cord or Chicago cord, daisy chaining is not possible.

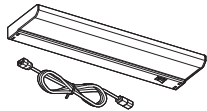

Tip: When ordering daisy chain with jumper cord there is no power supply.

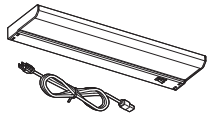

Tip: Minimum of two fixtures for daisy chaining and maximum of 10.

Tip: When ordering starter light do not order a daisy chain starter cord.

Specification Guidelines

Application	Requirement
2 lights	1 starter light fixture and 1 daisy chain light with jumper cord fixtures
3 lights	1 starter light fixture and 2 daisy chain light with jumper cord fixtures
4 lights	1 starter light fixture and 3 daisy chain light with jumper cord fixtures
5 lights	1 starter light fixture and 4 daisy chain light with jumper cord fixtures
6 lights	1 starter light fixture and 5 daisy chain light with jumper cord fixtures
7 lights	1 starter light fixture and 6 daisy chain light with jumper cord fixtures
8 lights	1 starter light fixture and 7 daisy chain light with jumper cord fixtures
9 lights	1 starter light fixture and 8 daisy chain light with jumper cord fixtures
10 lights	1 starter light fixture and 9 daisy chain light with jumper cord fixtures

Lighting

Bottomline Shelf Lights

SIN 711.1

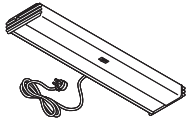

Tip: Daisy chaining shelf lights together extends power from one fixture to another within workstations to help keep receptacles clear for other uses.

Tip: Daisy chaining is not allowed in New York City or Chicago. Local electrical codes vary, so you should consult a qualified electrical contractor or engineer for proper installation of all electrical equipment.

Tip: When ordering with standard power cord or Chicago cord, daisy chaining is not possible

Tip: When ordering the Bottomline shelf lights with daisy chain starter cord you do NOT need to order a starter cord or jumper cord.

Standard Includes	Required to Specify
<ul style="list-style-type: none"> Steel light housing: paint Mylar reflector Batwing lens Polycarbonate end caps: molded to match housing Cords: <ul style="list-style-type: none"> — Standard and Chicago (including circuit breaker), 9' cord with three-prong plug at 45° angle: black plastic only — Daisy chain, one 56" cord with modular connectors for daisy chaining: black plastic only Energy efficient electronic ballast Energy efficient 3500K T5 fluorescent light Universal spring brackets for recessed mount and screw-in for flush mount Tool free clips for New York application 	<ul style="list-style-type: none"> 1 Style number 2 Paint color number for housing and end caps: <ul style="list-style-type: none"> 0835 Black 7018 Pewter 7021 Dark Champagne

Specification Information					
Dimensions			Lamp	Style	Price
D	W	H	Wattage	Number	
With Standard Power Cord					
4½"	23¼"	1¼"	14 watts	L52FT	\$251
4½"	35"	1¼"	21 watts	L53FT	\$268
4½"	46¾"	1¼"	28 watts	L54FT	\$288
With Chicago Cord Including Circuit Breaker					
4½"	23¼"	1¼"	14 watts	L52FTCHI	\$293
4½"	35"	1¼"	21 watts	L53FTCHI	\$318
4½"	46¾"	1¼"	28 watts	L54FTCHI	\$341
With Daisy Chain Cord					
4½"	23¼"	1¼"	14 watts	L52FTY	\$276
4½"	35"	1¼"	21 watts	L53FTY	\$293
4½"	46¾"	1¼"	28 watts	L54FTY	\$312
With Daisy Chain Starter Cord					
4½"	23¼"	1¼"	14 watts	L52FTS	\$276
4½"	35"	1¼"	21 watts	L53FTS	\$293
4½"	46¾"	1¼"	28 watts	L54FTS	\$312

Specification Guidelines

Application	Requirement
2 lights	1 starter fixture and 1 daisy chain fixture
3 lights	1 starter fixture and 2 daisy chain fixtures
4 lights	1 starter fixture and 3 daisy chain fixtures
5 lights	1 starter fixture and 4 daisy chain fixtures
6 lights	1 starter fixture and 5 daisy chain fixtures

Note: Daisy chaining minimum of two fixtures; maximum of six fixtures.

Accessories

SIN 711.1

Vertical Wire Manager

For Use on Answer and Kick Panels



Tip: Wire manager can be cut in the field to the specific length needed.

Standard Includes	Required to Specify
-------------------	---------------------

- Vertical wire manager: plastic

- 1 Style number
- 2 Plastic color number:
 - 6000 Black
 - 6009 Arctic White
 - 6249 Platinum Solid
 - 6654 Sand
 - 6697 Fog

Specification Information		
Height	Style Number	Price

Height	Style Number	Price
48"	TS7PVWM	\$29
:	:	:

Daisy Chain Starter Cord

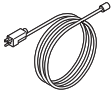

Standard Includes	Required to Specify
-------------------	---------------------

- Cord: black plastic only

Style number

Specification Information			
Quantity in Package	Length	Style Number	Price

Quantity in Package	Length	Style Number	Price
:	:	:	:

Daisy Chain Starter Cord			
--------------------------	--	--	--

1	78"	LS1FSC	\$ 57
6	78"	LS6FSC	\$342
:	:	:	:

Computer Support Tools

► For more detailed product information, see the *Steelcase Worktools Specification Guide* or consult your Steelcase dealer.

Statement of Line	86
--------------------------	-----------

Specifying

Mechanisms and Tracks (SIN 711.2)	96
Keyboard Platforms (SIN 711.2)	101
Palm Rests (SIN 711.2)	110
Keyboard Assemblies (SIN 711.2)	114
Technology Worktools and Cable Management (SIN 711.2)	142
Eyesite Flat Panel Monitor Arm Support Assemblies (SIN 711.2)	148
Eyesite Modular Components (SIN 711.2)	168
Eyesite Extended Static Column with VESA Bracket/Hook (SIN 711.2)	171
Eyesite Mounting Brackets (SIN 711.2)	172
CF Series Flat Panel Monitor Arms and Supports (SIN 711.2)	174
FYI Single Flat Panel Monitor Arms and Supports with Mounting Brackets (SIN 711.2)	203
FYI Flat Panel Monitor Arms and Supports without Mounting Brackets (SIN 711.2)	204

Statement of Line

Mechanisms with Tracks

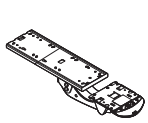

Stella Standard Mechanism with 20" Track
Specifying
▶ Page 96

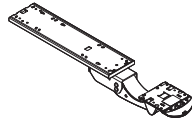

Stella Extended Mechanism with 23" Track
Specifying
▶ Page 96

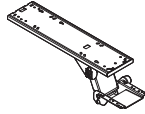

5" Lift and Lock Mechanism with 18" Track
Specifying
▶ Page 96

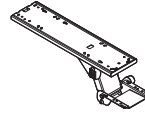

5" Lift and Lock Mechanism with 22" Track
Specifying
▶ Page 97

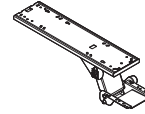

5" Lift and Lock Mechanism with 23" Track
Specifying
▶ Page 97

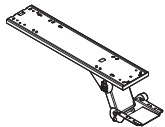

7" Lift and Lock Mechanism with 18" Track
Specifying
▶ Page 97

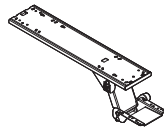

7" Lift and Lock Mechanism with 26" Track
Specifying
▶ Page 98

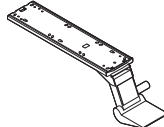

Dial Indicator6 Mechanism with 23" Track
Specifying
▶ Page 98

Mechanisms without Tracks



Stella Standard Mechanism
Specifying
▶ Page 98



Stella Extended Mechanism
Specifying
▶ Page 99



5" Lift and Lock Mechanism
Specifying
▶ Page 99



7" Lift and Lock Mechanism
Specifying
▶ Page 99



Dial Indicator6 Mechanism
Specifying
▶ Page 100



Specifying
▶ Page 100

Tracks

11"L 12"L 17"L 18"L 20"L 22"L 23"L 26"L



Keyboard Platforms



Slider Keyboard Platforms
Specifying
▶ Page 101



Jules Keyboard Platforms
Specifying
▶ Page 102



17" and 21" Diagonal Keyboard Platforms
Specifying
▶ Page 103



18" Radius Keyboard Platform
Specifying
▶ Page 103

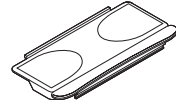

Classic Rectangular Platform
Specifying
▶ Page 104

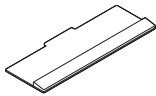

26" Keyboard Platform
Specifying
▶ Page 105

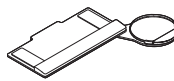

19" Keyboard Platform
Specifying
▶ Page 106

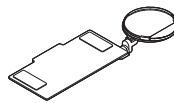

19" Keyboard Platform with Articulating Mouse
Specifying
▶ Page 107

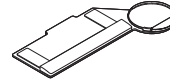

Enviro Platform
Specifying
▶ Page 108

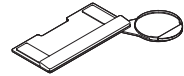

FrameOne/c:scape Platform
Specifying
▶ Page 109

Freestanding and Slider Palm Rests



Standard Adjustable Foam Palm Rest
Specifying
▶ Page 110

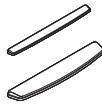

Cushioned Replacement Pad
Specifying
▶ Page 110



Slider Platform Mousing Surface Palm Rest
Specifying
▶ Page 111

19" and 26" Green-Gel Palm Rests



19" Green-Gel Palm Rest
Specifying
▶ Page 111



26" Green-Gel Palm Rest
Specifying
▶ Page 111

Tip: 19" palm rest is for use with 19", 26", and Enviro keyboard platforms. 26" palm rest is for use with 26" keyboard platform only.

Statement of Line, continued

Classic Rectangular Platform Palm Rests



Full-Width, Fixed-Height Palm Rest
Specifying
▶ Page 112



Full-Width, Height-Adjustable Palm Rest
Specifying
▶ Page 112



Positionable Palm Rest
Specifying
▶ Page 112

Jules Platform Palm Rest



Standard Foam Palm Rest
Specifying
▶ Page 113



Extended Foam Palm Rest
Specifying
▶ Page 113

Radius and Diagonal Platform Palm Rest

Stella Standard Keyboard Assemblies

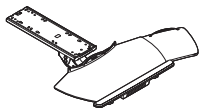

Slider Keyboard Platform with Stella Standard Mechanism
Specifying
▶ Page 114

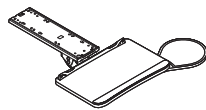

Jules Keyboard Platform with Stella Standard Mechanism
Specifying
▶ Page 114

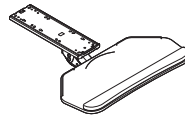

Diagonal Keyboard Platform with Stella Standard Mechanism
Specifying
▶ Page 114

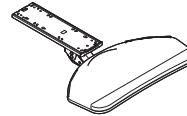

Radius Keyboard Platform with Stella Standard Mechanism
Specifying
▶ Page 114

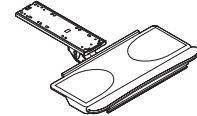

Classic Rectangular Keyboard Platform with Stella Standard Mechanism
Specifying
▶ Page 114

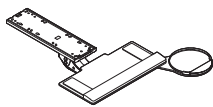

19" Keyboard Platform with Stella Standard Mechanism
Specifying
▶ Page 114

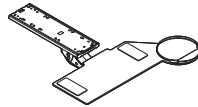

Enviro Keyboard Platform with Stella Standard Mechanism
Specifying
▶ Page 114

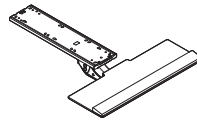

26" Keyboard Platform with Stella Standard Mechanism
Specifying
▶ Page 114

Stella Extended Keyboard Assemblies

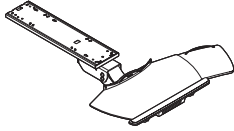

Slider Keyboard Platform with Stella Extended Mechanism
Specifying
▶ Page 118

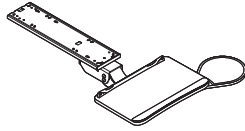

Jules Keyboard Platform with Stella Extended Mechanism
Specifying
▶ Page 118

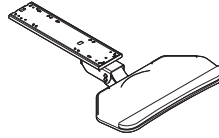

Diagonal Keyboard Platform with Stella Extended Mechanism
Specifying
▶ Page 118

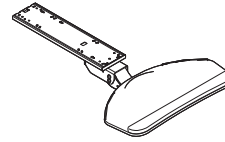

Radius Keyboard Platform with Stella Extended Mechanism
Specifying
▶ Page 118

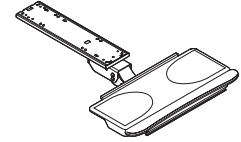

Classic Rectangular Keyboard Platform with Stella Extended Mechanism
Specifying
▶ Page 118

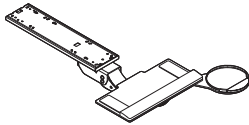

19" Keyboard Platform with Stella Extended Mechanism
Specifying
▶ Page 118

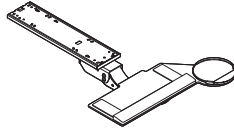

Enviro Keyboard Platform with Stella Extended Mechanism
Specifying
▶ Page 118

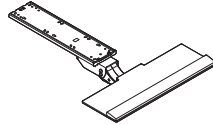

26" Keyboard Platform with Stella Extended Mechanism
Specifying
▶ Page 118

5" Lift and Lock Keyboard Assemblies

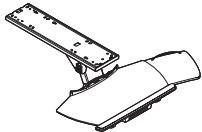

Slider Keyboard Platform with 5" Lift and Lock Mechanism
Specifying
▶ Page 124

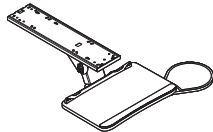

Jules Keyboard Platform with 5" Lift and Lock Mechanism
Specifying
▶ Page 124

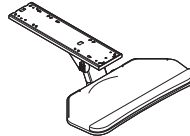

Diagonal Keyboard Platform with 5" Lift and Lock Mechanism
Specifying
▶ Page 124

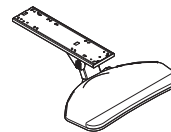

Radius Keyboard Platform with 5" Lift and Lock Mechanism
Specifying
▶ Page 124

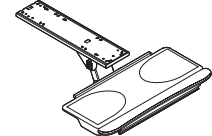

Classic Rectangular Keyboard Platform with 5" Lift and Lock Mechanism
Specifying
▶ Page 124

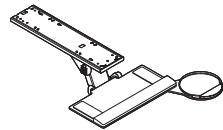

19" Keyboard Platform with 5" Lift and Lock Mechanism
Specifying
▶ Page 124
Tip: 18"L and 22"L tracks are not for use with all platforms. See specification pages for platform and track compatibility.

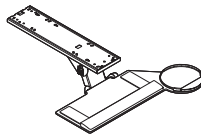

Enviro Keyboard Platform with 5" Lift and Lock Mechanism
Specifying
▶ Page 124

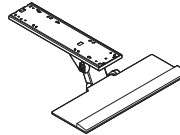

26" Keyboard Platform with 5" Lift and Lock Mechanism
Specifying
▶ Pages 128

Statement of Line, continued

7" Lift and Lock Keyboard Assemblies

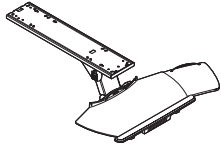

Slider Keyboard Platform with 7" Lift and Lock Mechanism
 Specifying
 ▶ Pages 134

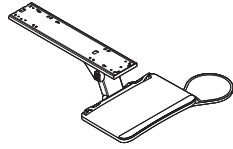

Jules Keyboard Platform with 7" Lift and Lock Mechanism
 Specifying
 ▶ Pages 134

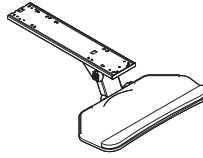

Diagonal Keyboard Platform with 7" Lift and Lock Mechanism
 Specifying
 ▶ Pages 134

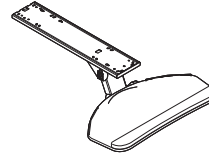

Radius Keyboard Platform with 7" Lift and Lock Mechanism
 Specifying
 ▶ Pages 134

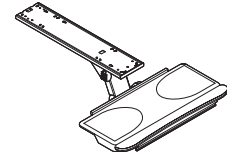

Classic Rectangular Keyboard Platform with 7" Lift and Lock Mechanism
 Specifying
 ▶ Pages 134

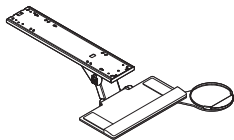

19" Keyboard Platform with 7" Lift and Lock Mechanism
 Specifying
 ▶ Pages 134

Tip: 18"L tracks are not for use with all platforms. See specification pages for platform and track compatibility.

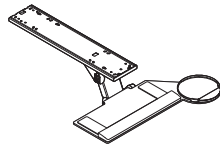

Enviro Keyboard Platform with 7" Lift and Lock Mechanism
 Specifying
 ▶ Pages 134

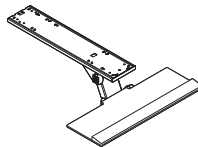

26" Keyboard Platform with 7" Lift and Lock Mechanism
 Specifying
 ▶ Pages 134

Dial Indicator6 Keyboard Assemblies

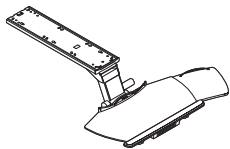

Slider Keyboard Platform with Dial Indicator6 Mechanism
 Specifying
 ▶ Page 138

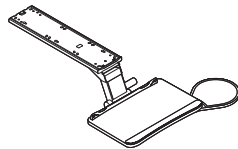

Jules Keyboard Platform with Dial Indicator6 Mechanism
 Specifying
 ▶ Page 138

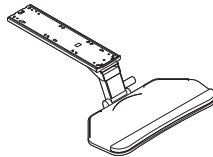

Diagonal Keyboard Platform with Dial Indicator6 Mechanism
 Specifying
 ▶ Page 138

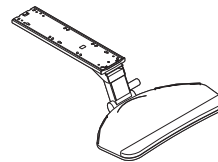

Radius Keyboard Platform with Dial Indicator6 Mechanism
 Specifying
 ▶ Page 138

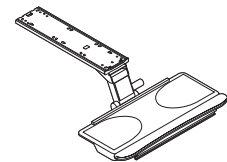

Classic Rectangular Keyboard Platform with Dial Indicator6 Mechanism
 Specifying
 ▶ Page 138

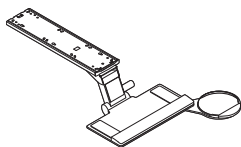

19" Keyboard Platform with Dial Indicator6 Mechanism
 Specifying
 ▶ Page 138

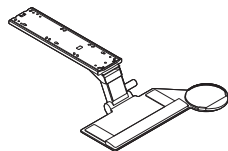

Enviro Keyboard Platform with Dial Indicator6 Mechanism
 Specifying
 ▶ Page 138

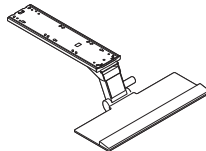

26" Keyboard Platform with Dial Indicator6 Mechanism
 Specifying
 ▶ Page 138

Technology Worktools and Cable Management

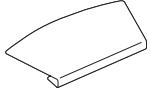

Corner Filler
Specifying
▶ Page 142

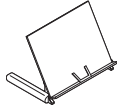

Freestanding In-Line Document Support
Specifying
▶ Page 142

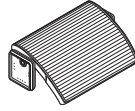

Adjustable Foot Rest
Specifying
▶ Page 143



Mobile Collapsible Laptop Support
Specifying
▶ Page 143

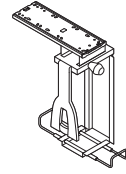

Vertical Locking CPU Cradle
Specifying
▶ Page 143

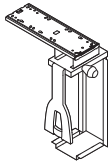

Vertical Non-Locking CPU Cradle
Specifying
▶ Page 144



Vertical Cable Carrier
Specifying
▶ Page 144

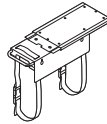

Vertical Processor Standard Sling
Specifying
▶ Page 145

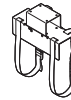

Vertical Processor Fixed Sling
Specifying
▶ Page 145

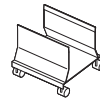

CPU Trolley
Specifying
▶ Page 145



Slatwall/SlatRail Mounted CPU Cradle
Specifying
▶ Page 145

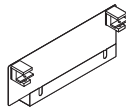

Cableways
Specifying
▶ Page 146

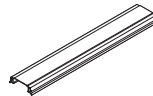

6\"/>

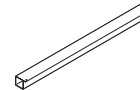

1 3/4\"/>

Eyesite Flat Panel Monitor Arm Support Assemblies



Eyesite Single Display Support
Specifying
▶ Page 148

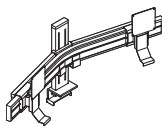

Eyesite Adjustable Dual Display Support
Specifying
▶ Page 150

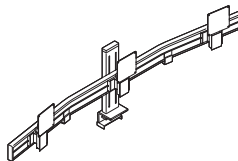

Eyesite Static Triple Display Support
Specifying
▶ Page 154



Eyesite Static One-Over-One Display Support
Specifying
▶ Page 156

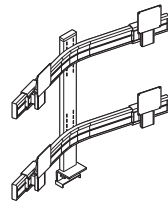

Eyesite Static Two-Over-Two Display Support
Specifying
▶ Page 158

Eyesite Flat Panel Monitor Arm Support Assemblies, continued

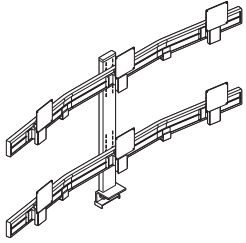

Eyesite Static Three-Over-Three Display Support
Specifying
▶ Page 161

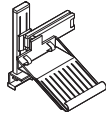

Eyesite Single Laptop Support
Specifying
▶ Page 162

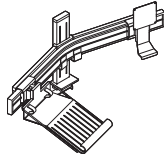

Eyesite Dual Laptop Support
Specifying
▶ Page 164



Single Arm
Specifying
▶ Page 168

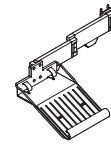

Single Arm with Laptop Support
Specifying
▶ Page 168

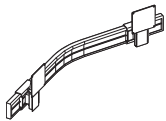

Dual Static Yoke
Specifying
▶ Page 168

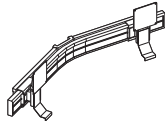

Dual Adjustable Yoke
Specifying
▶ Page 168

Eyesite Modular Components



Single Arm
Specifying
▶ Page 168

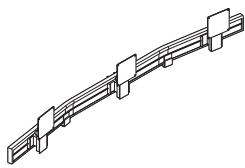

Triple Static Yoke
Specifying
▶ Page 168



12\"/>



18\"/>



26\"/>

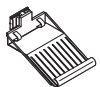

Laptop Component
Specifying
▶ Page 170



VESA Bracket/Hook
Specifying
▶ Page 170



VESA Bracket Assembly—Slide
Specifying
▶ Page 170

Eyesite Mounting Brackets



C-clamp Bracket
Specifying
▶ Page 172



Through-Mount Bracket
Specifying
▶ Page 172



FrameOne Bracket
Specifying
▶ Page 172



c:scape Bracket—Desk Only
Specifying
▶ Page 172

CF Series Flat Panel Monitor Arms and Supports

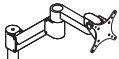

CF Series Light-Duty Arms
Specifying
▶ Page 174

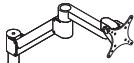

CF Series Standard Arms
Specifying
▶ Page 174

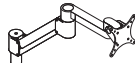

CF Series Heavy-Duty Arm
Specifying
▶ Page 174



CF Series Maximum-Duty Arm
Specifying
▶ Page 176

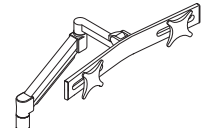

CF Series Standard-Duty Monitor Arm with Dual-Bar Arm and Standard Tilt Head
Specifying
▶ Page 177

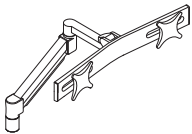

CF Series Heavy-Duty Monitor Arm with Dual-Bar Arm and Standard Tilt Head
Specifying
▶ Page 177

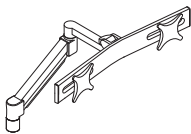

CF Series Maximum-Duty Monitor Arm with Dual-Bar Arm, Heavy-Duty Spring Tilt Head
Specifying
▶ Page 178



CF Series Single Flat Panel Monitor Pole Mount with Arm
Specifying
▶ Page 180

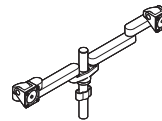

CF Series Dual Flat Panel Monitor Pole Mount with Arm
Specifying
▶ Page 180



CF Series Flat Panel Pole Mount without Arm
Specifying
▶ Page 182



CF Series Single Static Modular Monitor Arm Assembly with Pole
Specifying
▶ Page 183



CF Series Single Static One-Over-One Monitor Arm Assembly with Pole
Specifying
▶ Page 184

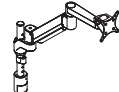

CF Series Single Dynamic Modular Monitor Arm Assembly with Pole
Specifying
▶ Page 185

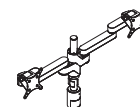

CF Series Dual Static Modular Monitor Arm Assembly with Pole
Specifying
▶ Page 186

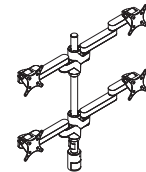

CF Series Dual Static Modular Monitor Arm Assembly with Pole
Specifying
▶ Page 187

CF Series Flat Panel Monitor Arms and Supports, continued

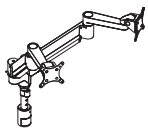

CF Series Dual Dynamic Modular Monitor Arm Assembly with Pole
Specifying
▶ Page 188

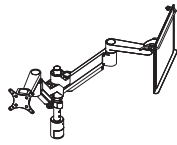

CF Series Dual Dynamic Modular Monitor Arm Assembly with Laptop Holder and with Pole
Specifying
▶ Page 189

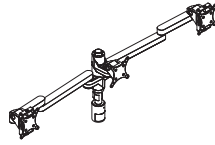

CF Series Triple Static Modular Monitor Arm Assembly with Pole
Specifying
▶ Page 192

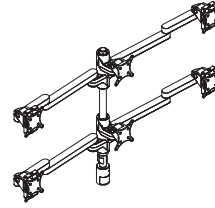

CF Series Static Modular Three-Over-Three Monitor Arm Assembly with Pole
Specifying
▶ Page 193

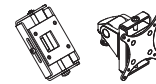

CF Series Adjustable Tilt Head Monitor Arm Adapters
Specifying
▶ Page 194

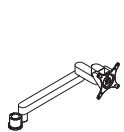

CF Series Single Flat Panel Pole Arm
Specifying
▶ Page 195

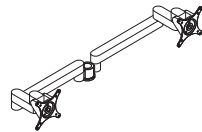

CF Series Dual Flat Panel Pole Arm
Specifying
▶ Page 195

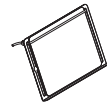

CF Series Laptop Holder Platform
Specifying
▶ Page 196



CF Series Desk-Clamp/Grommet Bracket
Specifying
▶ Page 198



CF Series Through-Mount Bracket
Specifying
▶ Page 198



CF Series Desk-Clamp/Grommet/Through-Mount Bracket
Specifying
▶ Page 198



CF Series Wall/Reverse Wall Mount Bracket
Specifying
▶ Page 198



CF Series Slatwall Bracket
Specifying
▶ Page 198



CF Series Maximum-Duty Arm Bracket
Specifying
▶ Page 199



CF Series Modular Pole Mount C-Clamp Bracket
Specifying
▶ Page 199



FrameOne Bracket
Specifying
▶ Page 199



c:scape Bracket
Specifying
▶ Page 199



CF Series T-Shape Dual Base Bracket
Specifying
▶ Page 199

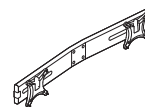

CF Series Dual-Bar Bracket
Specifying
▶ Page 199



CF Series 6" Flat Panel Arm Extender
Specifying
▶ Page 200



CF Series Modular Articulating Arm Extensions for Pole Mount Assemblies
Specifying
▶ Page 200



CF Series Wall-Mount Monitor Support
Specifying
▶ Page 201



CF Series Modular Arm Bracket Connector
Specifying
▶ Page 201

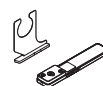

LED Monitor Lights with Bracket
Specifying
▶ Page 202



CF Series Technology Cradle
Specifying
▶ Page 202

FYI Flat Panel Monitor Arms and Supports

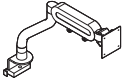

FYI Single Flat Panel Monitor Arm with Mounting Brackets

Specifying
▶ Page 203

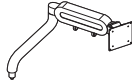

FYI Flat Panel Monitor Arm without Mounting Bracket

Specifying
▶ Page 204



FYI Upper Arm

Specifying
▶ Page 204



FYI Tilt/Pan Only

Specifying
▶ Page 205



Wall Mount Bracket

Specifying
▶ Page 205



Slatwall/SlatRail Bracket

Specifying
▶ Page 205

FYI Sync Flat Panel Monitor Arms and Supports

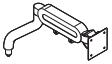

FYI Sync Upper Monitor Arm

Specifying
▶ Page 206

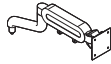

FYI Sync Lower Monitor Arm

Specifying
▶ Page 206

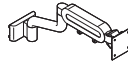

FYI Sync Lower Monitor Arm with Slatwall/SlatRail Mount

Specifying
▶ Page 206

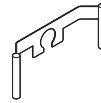

FYI Monitor Handle For Use with Sync

Specifying
▶ Page 206



FYI Sync Hardware Pack

Specifying
▶ Page 206

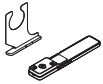

LED Monitor Light with Bracket

Specifying
▶ Page 207

Mechanisms and Tracks

SIN 711.2

Stella Standard Mechanism with 20" Track

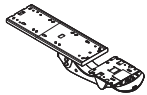

Tip: Mechanism requires 20"D worksurface clearance.

Standard Includes				Required to Specify	
<ul style="list-style-type: none"> Standard Stella mechanism and track: 0835 Black 				Style number	
Specification Information					
Dimensions			Weight	Style Number	Price
D	W	H			
16"	6 1/2"	6"	15.5 lb	SS20	\$304

Stella Extended Mechanism with 23" Track

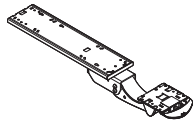

Tip: Mechanism requires 23"D worksurface clearance.

Tip: Extended mechanism recommended for less than 18" radius or 17" diagonal applications.

Standard Includes				Required to Specify	
<ul style="list-style-type: none"> Extended Stella mechanism and track: 0835 Black 				Style number	
Specification Information					
Dimensions			Weight	Style Number	Price
D	W	H			
20"	6 1/2"	6"	18.5 lb	SE23	\$322

5" Lift and Lock Mechanism with 18" Track

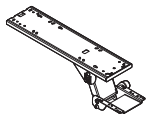

Standard Includes				Required to Specify	
<ul style="list-style-type: none"> 5" Lift and Lock mechanism and track: 0835 Black 				Style number	
Specification Information					
Dimensions			Weight	Style Number	Price
D	W	H			
15 1/2"	4"	2 1/4"	11.5 lb	L518	\$164

5" Lift and Lock Mechanism with 22" Track

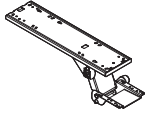

Standard Includes

- 5" Lift and Lock mechanism and track: 0835 Black

Required to Specify

Style number

Specification Information

• Dimensions			• Weight	• Style Number	• Price
D	W	H			
15½"	4"	2¼"	11.5 lb	L522	\$164

5" Lift and Lock Mechanism with 23" Track

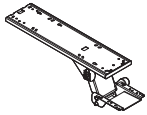

Tip: Mechanism requires 23"D worksurface clearance.

Standard Includes

- 5" Lift and Lock mechanism and track: 0835 Black

Required to Specify

Style number

Specification Information

• Dimensions			• Weight	• Style Number	• Price
D	W	H			
15½"	4"	2¼"	11.5 lb	L523	\$164

7" Lift and Lock Mechanism with 18" Track

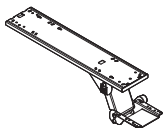

Tip: Extended mechanism recommended for less than 18" radius or 17" diagonal applications.

Standard Includes

- 7" Lift and Lock mechanism and track: 0835 Black

Required to Specify

Style number

Specification Information

• Dimensions			• Weight	• Style Number	• Price
D	W	H			
17½"	4"	2¼"	12.5 lb	L718	\$164

Mechanisms and Tracks, continued

SIN 711.2

7" Lift and Lock Mechanism with 26" Track

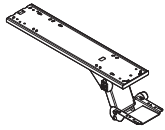

Tip: Mechanism requires 26"D worksurface clearance.

Tip: Extended mechanism recommended for less than 18" radius or 17" diagonal applications.

Standard Includes	Required to Specify
-------------------	---------------------

- | | |
|--|--------------|
| <ul style="list-style-type: none"> 7" Lift and Lock mechanism and track: 0835 Black | Style number |
|--|--------------|

Specification Information					
• Dimensions			• Weight	• Style Number	• Price
D	W	H			

17½"	4"	2¼"	12.5 lb	L726	\$164
:	:	:	:	:	:

Dial Indicator6 Mechanism with 23" Track

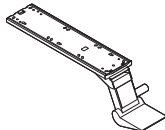

Tip: Mechanism requires 23"D worksurface clearance.

Standard Includes	Required to Specify
-------------------	---------------------

- | | |
|---|--------------|
| <ul style="list-style-type: none"> Dial Indicator6 mechanism and track: 0835 Black | Style number |
|---|--------------|

Specification Information					
• Dimensions			• Weight	• Style Number	• Price
D	W	H			

17½"	4"	2¼"	8.5 lb	D623	\$239
:	:	:	:	:	:

Stella Standard Mechanism Only



Tip: Mechanism requires a 20"L track to completely store platform under the worksurface.

Standard Includes	Required to Specify
-------------------	---------------------

- | | |
|--|--------------|
| <ul style="list-style-type: none"> Stella Standard mechanism: 0835 Black Attachment hardware | Style number |
|--|--------------|

Specification Information		
• Weight	• Style Number	• Price

12 lb	SS	\$288
:	:	:

Stella Extended Mechanism Only



Tip: Mechanism requires a 23"L track to completely store platform under the worksurface.

Tip: Extended mechanism recommended for less than 18" radius or 17" diagonal applications.

Standard Includes	Required to Specify
<ul style="list-style-type: none"> Stella Extended mechanism: 0835 Black Attachment hardware 	Style number

Specification Information

Weight	Style Number	Price
15 lb	SE	\$304
:	:	:

5" Lift and Lock Mechanism Only



Tip: Mechanism requires a 23"L track to completely store platform under the worksurface.

Standard Includes	Required to Specify
<ul style="list-style-type: none"> 5" Lift and Lock mechanism: 0835 Black Attachment hardware 	Style number

Specification Information

Weight	Style Number	Price
8 lb	L5	\$148
:	:	:

7" Lift and Lock Mechanism Only



Tip: Mechanism requires a 26"L track to completely store platform under the worksurface.

Tip: Extended mechanism recommended for less than 18" radius or 17" diagonal applications.

Standard Includes	Required to Specify
<ul style="list-style-type: none"> 7" Lift and Lock mechanism: 0835 Black Attachment hardware 	Style number

Specification Information

Weight	Style Number	Price
9 lb	L7	\$148
:	:	:

Mechanisms and Tracks, continued

SIN 711.2

Dial Indicator6 Mechanism Only



Tip: Mechanism requires a 23"L track to completely store platform under the worksurface.

Standard Includes		Required to Specify
<ul style="list-style-type: none"> Dial Indicator6 mechanism: 0835 Black Attachment hardware 		Style number

Specification Information		
Weight	Style Number	Price
5 lb	D6	\$221

Tracks

For Use with Stella Standard, Stella Extended, 5", and 7" Lift and Lock, and Dial Indicator6 Mechanisms



Tip: Attachment hardware and end cap not included. Order service part 18711701SR, if required.

Tip: 11"L and 17"L tracks are recommended for use with c:scape and FrameOne 24"D and 30"D worksurfaces.

Standard Includes		Required to Specify
<ul style="list-style-type: none"> Track: 0835 Black 		Style number

Specification Information			
Dimensions Length	Weight	Style Number	Price
11"	3.5 lb	Q11T	\$17
12"	3.5 lb	Q12T	\$17
17"	3.5 lb	Q17T	\$17
18"	3.5 lb	Q18T	\$17
20"	3.5 lb	Q20T	\$17
22"	3.5 lb	Q22T	\$17
23"	3.5 lb	Q23T	\$17
26"	3.5 lb	Q26T	\$17

Dual Pivot Plate

Tip: Dual pivot plate mounts between keyboard platform and mechanism to allow additional rotation.

Standard Includes		Required to Specify
<ul style="list-style-type: none"> Dual pivot plate: 0835 Black 		Style number

Specification Information				
Dimensions			Style Number	Price
D	W	H	Number	
1"	6"	6"	X04815	\$40

Keyboard Platforms

SIN 711.2

Slider Keyboard Platforms

Tip: Slider keyboard platforms are for use in straight, 21" diagonal, and 22" radius applications.

Tip: Extended mechanism required for less than 18" radius or 17" diagonal applications.

Tip: Slider keyboard platform required 20"W of knee-space clearance below worksurface.

Tip: When using MS Natural Keyboard, specify platform without palm rest.



Standard Includes	Required to Specify
<ul style="list-style-type: none"> • Keyboard platform: 7027 Charcoal paint • Foam palm rest, if selected • 8"D x 8"W ambidextrous sliding mouse surface 	Style number

Specification Information					
• Dimensions			• Weight	• Style	• Price
D	W	H		Number	
Without Palm Rest					
9 1/2"	20"	2"	7 lb	SL1000	\$183
With 1 1/2" Standard Adjustable Palm Rest					
9 1/2"	20"	2"	8 lb	SL10SA	\$224
With 3" Deeper Adjustable Palm Rest					
9 1/2"	20"	2"	8 lb	SL10DA	\$245

Computer Support Tools

Keyboard Platforms, continued

SIN 711.2

Jules Keyboard Platforms

Tip: Jules keyboard platforms are for use in straight, 17" diagonal, and 18" radius applications.

Tip: Extended mechanism required for 12" radius corner applications.

Tip: Jules keyboard platform requires 20"W of kneespace clearance below worksurface.

Tip: For use with MS Natural Keyboard, specify platform without palm rest.

Tip: Jules keyboard platform is 19" wide without the ambidextrous, sliding mouse surface.



Standard Includes	Required to Specify
<ul style="list-style-type: none"> • Keyboard platform: 6288 Charcoal plastic • 8 1/2"D x 8 1/2"W ambidextrous, sliding mouse surface • Foam palm rest, if selected 	Style number

Specification Information

• Dimensions			• Weight	• Style	• Price
D	W	H		Number	
:	:	:	:	:	:

Without Palm Rest

12"	19"	2 1/2"	3 lb	JP1000	\$ 89
:	:	:	:	:	:

With Standard Foam Palm Rest

12"	19"	2 1/2"	3.08 lb	JP10SF	\$118
:	:	:	:	:	:

17" and 21" Diagonal Keyboard Platforms with Extended Foam Palm Rest

Tip: Diagonal platforms are for use in 17" and 21" diagonal applications.

Tip: Diagonal keyboard platform require 28"W of kneespace clearance below worksurface.

Tip: Diagonal keyboard platform not recommended for use with MS Natural Keyboard.

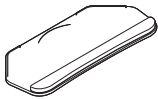

Standard Includes	Required to Specify
<ul style="list-style-type: none"> Keyboard platform: 6288 Charcoal plastic Ambidextrous, integrated mouse surface Foam palm rest 	Style number

Specification Information					
Dimensions			Weight	Style Number	Price
D	W	H			
17" Diagonal Platform					
12 ¹ / ₂ "	27 ¹ / ₂ "	³ / ₄ "	7 lb	1710EF	\$165
21" Diagonal Platform					
12 ¹ / ₂ "	27 ¹ / ₂ "	³ / ₄ "	7 lb	2110EF	\$165

18" Radius Keyboard Platform with Extended Foam Palm Rest



Tip: Radius keyboard platform is for use in 18" radius application only.

Tip: Radius keyboard platform require 28"W of kneespace clearance below worksurface.

Tip: Radius keyboard platform not recommended for use with MS Natural Keyboard.

Standard Includes	Required to Specify
<ul style="list-style-type: none"> Keyboard platform: 6288 Charcoal plastic Ambidextrous, integrated mouse surface Foam palm rest 	Style number

Specification Information					
Dimensions			Weight	Style Number	Price
D	W	H			
14"	27 ¹ / ₂ "	³ / ₄ "	7 lb	1810EF	\$165

Keyboard Platforms, continued

SIN 711.2

Classic Rectangular Keyboard Platforms

Tip: Classic Rectangular keyboard platforms are for straight applications only.

Tip: Classic Rectangular with positionable palm rest is available in 4750 Champagne and 7027 Charcoal only.

Tip: Classic Rectangular with full-width, fixed height palm rest is available in 7018 Pewter and 7027 Charcoal only.

Tip: Classic Rectangular keyboard platforms require 28"W of kneespace clearance below worksurface.

Tip: When using MS Natural Keyboard, specify platform without palm rest.

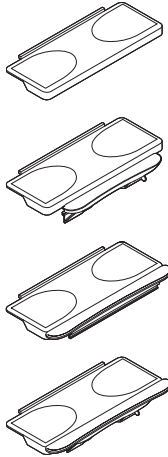

Standard Includes	Required to Specify
<ul style="list-style-type: none"> • Keyboard platform: 7027 Charcoal paint • Ambidextrous, integrated mouse surface • Foam palm rest, if selected 	Style number

Specification Information

• Dimensions			• Weight	• Style Number	• Price
D	W	H			
Without Palm Rest					
10 ¹ / ₄ "	27 ¹ / ₂ "	2 ¹ / ₂ "	8.5 lb	CR1000	\$113
With Positionable Palm Rest					
10 ¹ / ₄ "	27 ¹ / ₂ "	2 ¹ / ₂ "	10.5 lb	CR10PP	\$204
With Full-Width, Fixed-Height Palm Rest					
10 ¹ / ₄ "	27 ¹ / ₂ "	2 ¹ / ₂ "	9.5 lb	CR10FF	\$195
With Full-Width, Adjustable Palm Rest					
10 ¹ / ₄ "	27 ¹ / ₂ "	2 ¹ / ₂ "	10.5 lb	CR10FA	\$222

26" Keyboard Platforms

Tip: 26" keyboard platform is for use in straight application only.

Tip: 26" keyboard platforms require 26" of kneespace clearance below worksurface.

Tip: When using MS Natural Keyboard, specify platform without palm rest.

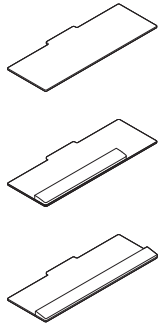

Standard Includes	Required to Specify
<ul style="list-style-type: none"> Keyboard platform: 7027 Charcoal paint Ambidextrous, integrated mouse surface Green-Gel palm rest, if selected 	1 Style number 2 Palm rest type (see below under Required Selections)

Required Selections	Price	Required to Specify
Palm Rest		
<ul style="list-style-type: none"> Non-antimicrobial Antimicrobial 	No cost No cost	Specify with <i>non-antimicrobial</i> . Specify with <i>antimicrobial</i> .

Specification Information

Dimensions			Weight	Style Number	Price
D	W	H			

Without Palm Rest

9 ³ / ₄ "	26"	1/4"	4 lb	261000	\$134
---------------------------------	-----	------	------	---------------	-------

With 19" Green-Gel Palm Rest

9 ³ / ₄ "	26"	1/4"	4.9 lb	2610GG	\$157
---------------------------------	-----	------	--------	---------------	-------

With 26" Green-Gel Palm Rest

9 ³ / ₄ "	26"	1/4"	5 lb	261026GG	\$163
---------------------------------	-----	------	------	-----------------	-------

Keyboard Platforms, continued

SIN 711.2

19" Keyboard Platforms

Tip: 19" keyboard platforms are for use in straight, 17" diagonal, and 18" radius applications.

Tip: Extended mechanism required for 12" radius corner applications.

Tip: 19" keyboard platforms require 28"W of kneespace clearance.

Tip: When using MS Natural Keyboard, specify platform without palm rest.

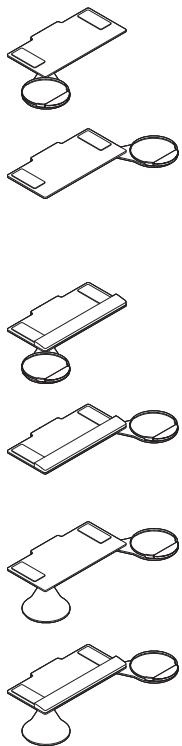

Standard Includes	Required to Specify
<ul style="list-style-type: none"> • Keyboard platform: 7027 Charcoal paint • 9" diameter same-plane swivel mouse surface • Mouse pad with mouse retention fence/wire management • Green-Gel palm rest, if selected 	<ul style="list-style-type: none"> 1 Style number 2 Palm rest type (see below under Required Selections)

Palm Rest	Required Selections	Price	Required to Specify
	<ul style="list-style-type: none"> • Non-antimicrobial • Antimicrobial 	<ul style="list-style-type: none"> No cost No cost 	<ul style="list-style-type: none"> Specify with <i>non-antimicrobial</i>. Specify with <i>antimicrobial</i>.

Specification Information					
Dimensions			Weight	Style Number	Price
D	W	H			
:	:	:	:	:	:
:	:	:	:	:	:

Without Palm Rest

Left-Handed

9 ³ / ₄ "	19"	1/4"	3.5 lb	19ML00	\$123
---------------------------------	-----	------	--------	---------------	-------

Right-Handed

9 ³ / ₄ "	19"	1/4"	3.5 lb	19MR00	\$123
:	:	:	:	:	:

With Green-Gel Palm Rest

Left-Handed

9 ³ / ₄ "	19"	1/4"	4.4 lb	19MLGG	\$146
---------------------------------	-----	------	--------	---------------	-------

Right-Handed

9 ³ / ₄ "	19"	1/4"	4.4 lb	19MRGG	\$146
:	:	:	:	:	:

19" Dual-Mouse Platform without Palm Rest

9 ³ / ₄ "	19"	1/4"	4 lb	19MD00	\$169
:	:	:	:	:	:

19" Dual-Mouse Platform with Green-Gel Palm Rest

9 ³ / ₄ "	19"	1/4"	4.9 lb	19MDGG	\$192
:	:	:	:	:	:

19" Keyboard Platforms with Articulating Mouse

Tip: 19" keyboard platforms are for use in straight, 17" diagonal, and 12" radius applications.

Tip: Extended mechanism required for 12" radius corner applications.

Tip: 19" platform with articulating mouse, requires 21½"W of kneespace clearance below worksurface.

Tip: Mouse surface allows six different height positions and can be positioned over 10 key or used on the same horizontal plane as the platform.

Tip: When using MS Natural Keyboard, specify platform without palm rest.

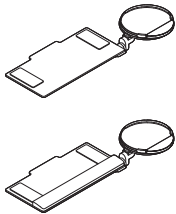

Standard Includes	Required to Specify
<ul style="list-style-type: none"> Keyboard platform: 7027 Charcoal paint 9" diameter height-adjustable swivel mouse surface Mouse pad with mouse retention fence/wire management Green-Gel palm rest, if selected 	<ul style="list-style-type: none"> 1 Style number 2 Palm rest type (see below under Required Selections)

Required Selections	Price	Required to Specify
Palm Rest <ul style="list-style-type: none"> Non-antimicrobial Antimicrobial 	No cost No cost	Specify with <i>non-antimicrobial</i> . Specify with <i>antimicrobial</i> .

Specification Information

• Dimensions			• Weight	• Style	• Price
D	W	H	:	Number	:
:	:	:	:	:	:

Without Palm Rest

9¾"	19"	¼"	4 lb	19AM00	\$208
:	:	:	:	:	:

With Green-Gel Palm Rest

9¾"	19"	¼"	4.9 lb	19AMGG	\$230
:	:	:	:	:	:

Keyboard Platforms, continued

SIN 711.2

Enviro Keyboard Platforms

Tip: Enviro keyboard platforms are for use in straight, 17" diagonal, and 18" radius applications.

Tip: Enviro keyboard platform requires 28"W of kneespace clearance below worksurface.

Tip: When using MS Natural Keyboard, specify platform without palm rest.

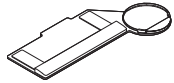
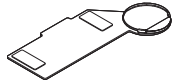

Standard Includes	Required to Specify
<ul style="list-style-type: none"> • Keyboard platform: 7027 Charcoal paint • Reversible platform for left- or right-hand use • Mouse pad with mouse retention fence/wire management • Green-Gel palm rest, if selected 	<ul style="list-style-type: none"> 1 Style number 2 Palm rest type (see below under Required Selections)

Palm Rest	Required Selections	Price	Required to Specify
	<ul style="list-style-type: none"> • Non-antimicrobial • Antimicrobial 	<ul style="list-style-type: none"> No cost No cost 	<ul style="list-style-type: none"> Specify with non-antimicrobial. Specify with antimicrobial.

Specification Information

• Dimensions			• Weight	• Style	• Price
D	W	H		Number	
:	:	:	:	:	:
:	:	:	:	:	:

Without Palm Rest

14 ¹ / ₂ "	28"	³ / ₄ "	3.5 lb	EN1000	\$123
:	:	:	:	:	:

With Green-Gel Palm Rest

14 ¹ / ₂ "	28"	³ / ₄ "	4.4 lb	EN10GG	\$146
:	:	:	:	:	:

FrameOne/c:scape Keyboard Platforms

Tip: FrameOne/c:scape keyboard platform is for use with FrameOne, c:scape, and shallow depth worksurface applications only.

Tip: FrameOne/c:scape keyboard platform is for use with Stella Standard mechanisms only.

Tip: FrameOne/c:scape keyboard platform requires 28"W of kneespace clearance below worksurface.

Tip: FrameOne/c:scape keyboard platform will stow under 30"D FrameOne and c:scape worksurfaces when used with a 17"L track and Stella Standard mechanism.

Tip: FrameOne/c:scape platform will not stow under 24"D FrameOne or c:scape worksurfaces.

Tip: When using MS Natural Keyboard, specify platform without palm rest.

Standard Includes	Required to Specify
<ul style="list-style-type: none"> Keyboard platform: 7027 Charcoal paint 9" diameter swiveling mouse surface Mouse pad with mouse retention fence/wire management Green-Gel palm rest, if selected 	<ul style="list-style-type: none"> 1 Style number 2 Palm rest type (see below under Required Selections)

Required Selections	Price	Required to Specify
Palm Rest <ul style="list-style-type: none"> Non-antimicrobial Antimicrobial 	No cost No cost	Specify with <i>non-antimicrobial</i> . Specify with <i>antimicrobial</i> .

Specification Information

Dimensions	Weight	Style Number	Price
D W H			
:	:	:	:
:	:	:	:

Without Palm Rest

Left-Handed

9"	19"	1/4"	3.5 lb	FOCSML00	\$123
----	-----	------	--------	-----------------	-------

Right-Handed

9"	19"	1/4"	3.5 lb	FOCSMR00	\$123
----	-----	------	--------	-----------------	-------

With Green-Gel Palm Rest

Left-Handed

9"	19"	1/4"	4.4 lb	FOCSMLGG	\$146
----	-----	------	--------	-----------------	-------

Right-Handed

9"	19"	1/4"	4.4 lb	FOCSMRGG	\$146
----	-----	------	--------	-----------------	-------

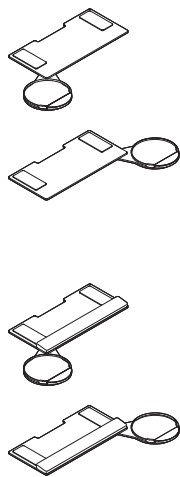

Palm Rests

SIN 711.2

Standard Adjustable Foam Palm Rest

For Use with Freestanding Palm Rest or Slider Keyboard Platforms



Standard Includes	Required to Specify
• Foam palm rest: 7027 Charcoal paint	Style number

Specification Information

• Dimensions			• Weight	• Style	• Price
D	W	H		Number	
3"	18"	2"	1 lb	SA	\$41
:	:	:	:	:	:

Cushioned Replacement Pads

For Use with Freestanding Palm Rest or Slider Keyboard Platforms

Tip: Replacement pad snaps down into existing palm rest.



Standard Includes	Required to Specify
• Pad: 7027 Charcoal paint	Style number

Specification Information

• Dimensions			• Weight	• Style	• Price
D	W	H		Number	
1 1/2"			1 lb	CSWP	\$37
3"			1 lb	CSWPD	\$57
:	:	:	:	:	:

Slider Platform Mousing Surface Palm Rest



Tip: Slider platform mousing surface palm rest is for use with Slider keyboard platforms only.

Tip: Palm rest must be removed to slide mouse surface.

Standard Includes				Required to Specify	
• Foam palm rest: 7027 Charcoal paint				Style number	
Specification Information					
• Dimensions			• Weight	• Style Number	• Price
D	W	H			
1 1/2"	6 5/8"	1"	1 lb	SMPRS	\$54

19" Green-Gel Palm Rest

For Use with 19", 26", Enviro, or FrameOne/c:scape Keyboard Platforms



Tip: 19" palm rest is for use with 19", 26", Enviro, and FrameOne/c:scape platforms.

Standard Includes				Required to Specify	
• Palm rest: 0835 Black				Style number	
Specification Information					
• Dimensions			• Weight	• Style Number	• Price
D	W	H			
3/4"	19"	2 1/2"	0.9 lb	GG	\$24

26" Green-Gel Palm Rest

For Use with 26" Keyboard Platforms

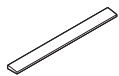

Tip: 26" palm rest is for use with 26" keyboard platform only.

Standard Includes				Required to Specify	
• Palm rest: 0835 Black				Style number	
Specification Information					
• Dimensions			• Weight	• Style Number	• Price
D	W	H			
3/4"	26"	2 1/2"	1 lb	26GG	\$29

Palm Rests, continued

SIN 711.2

Full-Width, Fixed-Height Palm Rest

For Use with Classic Rectangular Platforms



Standard Includes	Required to Specify
• Palm rest: 7027 Charcoal paint	Style number

Specification Information

• Dimensions			• Weight	• Style	• Price
D	W	H		Number	
2 1/2"	27 1/2"	2 1/2"	1 lb	FF	\$84
:	:	:	:	:	:

Full-Width, Height-Adjustable Palm Rest

For Use with Classic Rectangular Platforms



Standard Includes	Required to Specify
• Palm rest: 7027 Charcoal paint	Style number

Specification Information

• Dimensions			• Weight	• Style	• Price
D	W	H		Number	
2 1/2"	27 1/2"	2 1/2"	2 lb	FA	\$117
:	:	:	:	:	:

Positionable Palm Rest

For Use with Classic Rectangular Platforms



Tip: Palm rest can be positioned on the left- or right-hand side.

Standard Includes	Required to Specify
• Palm rest: 7027 Charcoal paint	Style number

Specification Information

• Dimensions			• Weight	• Style	• Price
D	W	H		Number	
2"	19 1/2"	2 1/2"	2 lb	PP	\$94
:	:	:	:	:	:

Standard Foam Palm Rest

For Use with Jules Platforms

**Standard Includes**

- Palm rest: 6288 Charcoal plastic

Required to Specify

Style number

Specification Information

• Dimensions			• Weight	• Style Number	• Price
D	W	H			
3/4"	18 1/2"	2 1/2"	0.08 lb	SF	\$29

Extended Foam Palm Rest

For Use with Diagonal and Radius Platforms

**Standard Includes**

- Palm rest: 6288 Charcoal plastic

Required to Specify

Style number

Specification Information

• Dimensions			• Weight	• Style Number	• Price
D	W	H			
3/4"	26"	2 1/2"	0.1 lb	EF	\$34

Keyboard Assemblies

SIN 711.2

Stella Standard Keyboard Assemblies

Tip: Jules platform can be used in 12" radius corners when used with an extended mechanism.

Tip: Be sure to consider the mechanism track length in relationship to the work surface depth.

Standard Includes	Required to Specify
<ul style="list-style-type: none"> Mechanism and 20"L track: 0835 Black Keyboard platform: <ul style="list-style-type: none"> Slider and Classic Rectangular: 7027 Charcoal paint Jules, Diagonal, and Radius: 6288 Charcoal plastic 19", 26", and Enviro: 7027 Charcoal paint Mouse surface: <ul style="list-style-type: none"> Slider and Jules: ambidextrous, sliding mouse surface Diagonal, Radius, Classic Rectangular, and 26": ambidextrous, integrated mouse surface 19" and Enviro: 9" diameter same-plane, swivel mouse surface Palm rest, if selected 	<ul style="list-style-type: none"> 1 Style number 2 Palm rest type, if green-gel palm rest is selected (see below under Required Selections)

Required Selections	Price	Required to Specify
Palm Rest <ul style="list-style-type: none"> Non-antimicrobial Antimicrobial 	No cost No cost	Specify with <i>non-antimicrobial</i> . Specify with <i>antimicrobial</i> .

Specification Information

Dimensions	Style	Price
D W H	Number	
:	:	:
:	:	:

Slider Platforms

Without Palm Rest

9 1/2"	20"	3"	SS20SL1000	\$488
--------	-----	----	-------------------	-------

With Standard Palm Rest

9 1/2"	20"	3"	SS20SL10SA	\$529
--------	-----	----	-------------------	-------

With Deep Palm Rest

9 1/2"	20"	3"	SS20SL10DA	\$549
--------	-----	----	-------------------	-------

Jules Platforms

Without Palm Rest

12"	18 3/4"	5 5/8"	SS20JP1000	\$394
-----	---------	--------	-------------------	-------

With Standard Foam Palm Rest

12"	18 3/4"	5 5/8"	SS20JP10SF	\$422
-----	---------	--------	-------------------	-------

► **Specification Information, continued on next page**

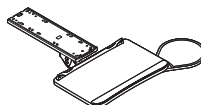
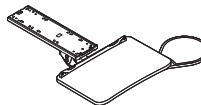
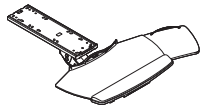
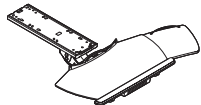
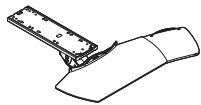

► Specification Information, continued from previous page

Specification Information

Dimensions			Style	Price
D	W	H	Number	

Diagonal Platforms

17" with Extended Foam Palm Rest

12"	27½"	3"	SS201710EF	\$469
-----	------	----	-------------------	-------

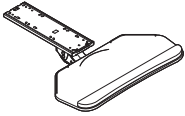

21" with Extended Foam Palm Rest

12"	27½"	3"	SS202110EF	\$469
-----	------	----	-------------------	-------

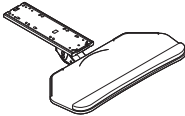

Radius Platform

18" with Extended Foam Palm Rest

14"	27½"	3"	SS201810EF	\$469
-----	------	----	-------------------	-------

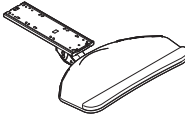

Classic Rectangular Platforms

Without Palm Rest

10¼"	27½"	5⅝"	SS20CR1000	\$417
------	------	-----	-------------------	-------

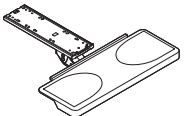

With Positionable Palm Rest

10¼"	27½"	5⅝"	SS20CR10PP	\$508
------	------	-----	-------------------	-------

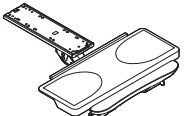

With Full-Width, Fixed-Height Palm Rest

10¼"	27½"	5⅝"	SS20CR10FF	\$499
------	------	-----	-------------------	-------

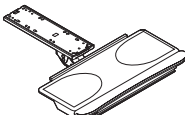

With Full-Width, Height-Adjustable Palm Rest

10¼"	27½"	5⅝"	SS20CR10FA	\$527
------	------	-----	-------------------	-------

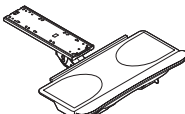

► Specification Information, continued on next page

Computer Support Tools

Keyboard Assemblies, continued

SIN 711.2

► Specification Information, continued from previous page

Specification Information

Dimensions			Style Number	Price
D	W	H		

19" Platforms without Palm Rest

Left-Handed

9 ³ / ₄ "	19"	3"	SS2019ML00	\$427
---------------------------------	-----	----	-------------------	-------

Right-Handed

9 ³ / ₄ "	19"	3"	SS2019MR00	\$427
---------------------------------	-----	----	-------------------	-------

Dual Mouse

9 ³ / ₄ "	19"	3"	SS2019MD00	\$474
---------------------------------	-----	----	-------------------	-------

With Articulating Mouse Surface

9 ³ / ₄ "	19"	3"	SS2019AM00	\$513
---------------------------------	-----	----	-------------------	-------

19" Platforms with Green-Gel Palm Rest

Left-Handed

9 ³ / ₄ "	19"	3"	SS2019MLGG	\$450
---------------------------------	-----	----	-------------------	-------

Right-Handed

9 ³ / ₄ "	19"	3"	SS2019MRGG	\$450
---------------------------------	-----	----	-------------------	-------

Dual Mouse

9 ³ / ₄ "	19"	3"	SS2019MDGG	\$496
---------------------------------	-----	----	-------------------	-------

With Articulating Mouse Surface

9 ³ / ₄ "	19"	3"	SS2019AMGG	\$534
---------------------------------	-----	----	-------------------	-------

► Specification Information, continued on next page

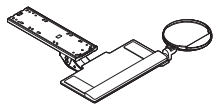
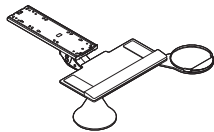
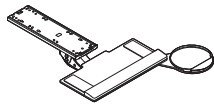
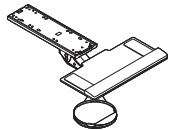
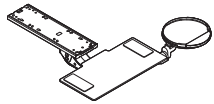
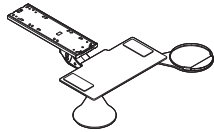
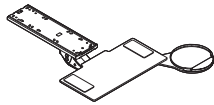
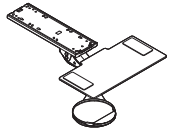

► Specification Information, continued from previous page

Specification Information

Dimensions			Style	Price
D	W	H	Number	

Enviro Platforms

Without Palm Rest

14 ¹ / ₂ "	28"	3"	SS20EN1000	\$427
----------------------------------	-----	----	-------------------	-------

With Green Gel Palm Rest

14 ¹ / ₂ "	28"	3"	SS20EN10GG	\$450
----------------------------------	-----	----	-------------------	-------

26" Platforms

Without Palm Rest

9 ³ / ₄ "	26"	3"	SS20261000	\$439
---------------------------------	-----	----	-------------------	-------

With 19" Green Gel Palm Rest

9 ³ / ₄ "	26"	3"	SS202610GG	\$461
---------------------------------	-----	----	-------------------	-------

With 26" Green Gel Palm Rest

9 ³ / ₄ "	26"	3"	SS20261026GG	\$467
---------------------------------	-----	----	---------------------	-------

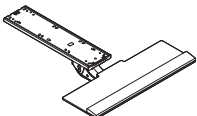
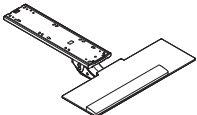
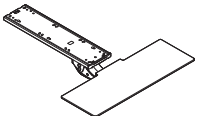
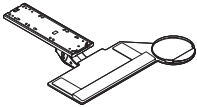
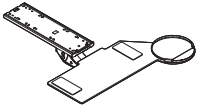

Keyboard Assemblies, continued

SIN 711.2

Stella Extended Keyboard Assemblies

Tip: Be sure to consider the mechanism track length in relationship to the work surface depth.

Standard Includes	Required to Specify
<ul style="list-style-type: none"> • Mechanism and 23"L track: 0835 Black • Keyboard platform: <ul style="list-style-type: none"> – Slider and Classic Rectangular: 7027 Charcoal paint – Jules, Diagonal, and Radius: 6288 Charcoal plastic – 19", 26" and Enviro: 7027 Charcoal paint • Mouse surface: <ul style="list-style-type: none"> – Slider and Jules: ambidextrous, sliding mouse surface – Diagonal, Radius, Classic Rectangular, and 26": ambidextrous, integrated mouse surface – 19" and Enviro: 9" diameter same-plane, swivel mouse surface • Palm rest, if selected 	<ul style="list-style-type: none"> 1 Style number 2 Palm rest type, if green-gel palm rest is selected (see below under Required Selections)

Required Selections	Price	Required to Specify
Palm Rest <ul style="list-style-type: none"> • Non-antimicrobial • Antimicrobial 	No cost No cost	Specify <i>with non-antimicrobial</i> . Specify <i>with antimicrobial</i> .

Specification Information

Dimensions	Style	Price
D W H	Number	
:	:	:

Slider Platforms

With Standard Palm Rest					
9 ¹ / ₂ "	20"	3"	SE23SL10SA		\$546

With Deep Palm Rest					
9 ¹ / ₂ "	20"	3"	SE23SL10DA		\$567

Jules Platforms

Without Palm Rest					
12"	18 ³ / ₄ "	5 ⁵ / ₈ "	SE23JP1000		\$411

With Standard Foam Palm Rest					
12"	18 ³ / ₄ "	5 ⁵ / ₈ "	SE23JP10SF		\$440

► **Specification Information, continued on next page**

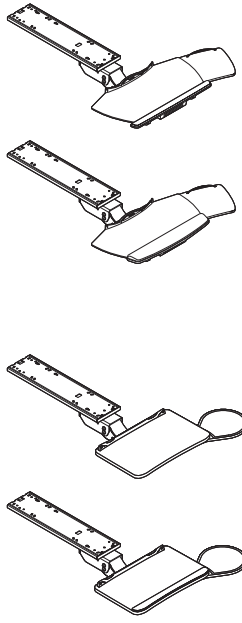

► Specification Information, continued from previous page

Specification Information

Dimensions			Style	Price
D	W	H	Number	
:	:	:	:	:

Diagonal Platforms

17" with Extended Foam Palm Rest

12 ¹ / ₂ "	27 ¹ / ₂ "	3"	SE231710EF	\$487
----------------------------------	----------------------------------	----	-------------------	-------

21" with Extended Foam Palm Rest

12 ¹ / ₂ "	27 ¹ / ₂ "	3"	SE232110EF	\$487
----------------------------------	----------------------------------	----	-------------------	-------

Radius Platform

18" with Extended Foam Palm Rest

14"	27 ¹ / ₂ "	3"	SE231810EF	\$487
-----	----------------------------------	----	-------------------	-------

Classic Rectangular Platforms

Without Palm Rest

10 ¹ / ₄ "	27 ¹ / ₂ "	5 ⁵ / ₈ "	SE23CR1000	\$435
----------------------------------	----------------------------------	---------------------------------	-------------------	-------

With Positionable Palm Rest

10 ¹ / ₄ "	27 ¹ / ₂ "	5 ⁵ / ₈ "	SE23CR10PP	\$526
----------------------------------	----------------------------------	---------------------------------	-------------------	-------

With Full-Width, Fixed-Height Palm Rest

10 ¹ / ₄ "	27 ¹ / ₂ "	5 ⁵ / ₈ "	SE23CR10FF	\$517
----------------------------------	----------------------------------	---------------------------------	-------------------	-------

With Full-Width, Height-Adjustable Palm Rest

10 ¹ / ₄ "	27 ¹ / ₂ "	5 ⁵ / ₈ "	SE23CR10FA	\$544
----------------------------------	----------------------------------	---------------------------------	-------------------	-------

► Specification Information, continued on next page

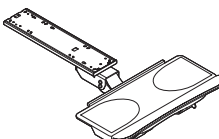
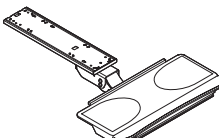
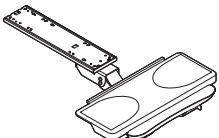
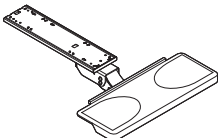
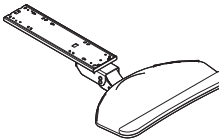
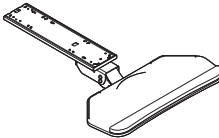
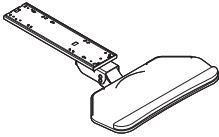

Keyboard Assemblies, continued

SIN 711.2

► Specification Information, continued from previous page

Specification Information

Dimensions			Style Number	Price
D	W	H		

19" Platforms without Palm Rest

Left-Handed

9 ³ / ₄ "	19"	3"	SE2319ML00	\$445
---------------------------------	-----	----	-------------------	-------

Right-Handed

9 ³ / ₄ "	19"	3"	SE2319MR00	\$445
---------------------------------	-----	----	-------------------	-------

Dual Mouse

9 ³ / ₄ "	19"	3"	SE2319MD00	\$491
---------------------------------	-----	----	-------------------	-------

With Articulating Mouse Surface

9 ³ / ₄ "	19"	3"	SE2319AM00	\$530
---------------------------------	-----	----	-------------------	-------

19" Platforms with Green-Gel Palm Rest

Left-Handed

9 ³ / ₄ "	19"	3"	SE2319MLGG	\$467
---------------------------------	-----	----	-------------------	-------

Right-Handed

9 ³ / ₄ "	19"	3"	SE2319MRGG	\$467
---------------------------------	-----	----	-------------------	-------

Dual Mouse

9 ³ / ₄ "	19"	3"	SE2319MDGG	\$514
---------------------------------	-----	----	-------------------	-------

With Articulating Mouse Surface

9 ³ / ₄ "	19"	3"	SE2319AMGG	\$551
---------------------------------	-----	----	-------------------	-------

► Specification Information, continued on next page

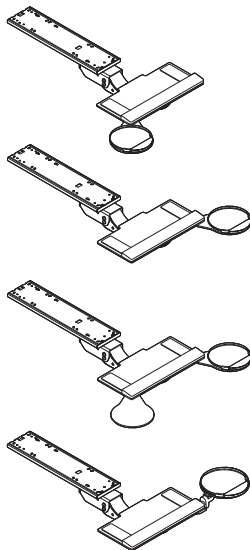
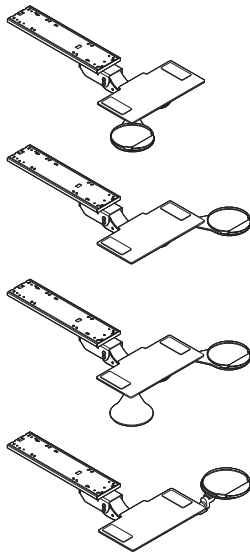

► Specification Information, continued from previous page

Specification Information

Dimensions			Style Number	Price
D	W	H		

Enviro Platforms

Without Palm Rest

14 ¹ / ₂ "	28"	3"	SE23EN1000	\$445
----------------------------------	-----	----	-------------------	-------

With Green Gel Palm Rest

14 ¹ / ₂ "	28"	3"	SE23EN10GG	\$467
----------------------------------	-----	----	-------------------	-------

26" Platforms

Without Palm Rest

9 ³ / ₄ "	26"	5 ⁵ / ₈ "	SE23261000	\$456
---------------------------------	-----	---------------------------------	-------------------	-------

With 19" Green Gel Palm Rest

9 ³ / ₄ "	26"	3"	SE232610GG	\$479
---------------------------------	-----	----	-------------------	-------

With 26" Green Gel Palm Rest

9 ³ / ₄ "	26"	3"	SE23261026GG	\$485
---------------------------------	-----	----	---------------------	-------

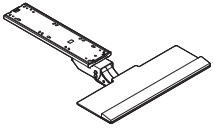
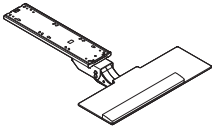
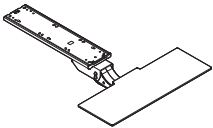
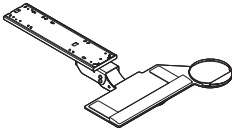
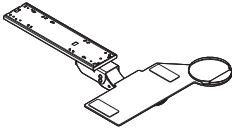

Computer Support Tools

Keyboard Assemblies, continued

SIN 711.2

5" Lift and Lock Keyboard Assemblies

with 18"L Track

Tip: Be sure to consider the mechanism track length in relationship to the work surface depth.

Standard Includes **Required to Specify**

- Mechanism and 18"L track: 0835 Black
- Keyboard platform:
 - 19" and Enviro: 7027 Charcoal paint
- Mouse surface:
 - 19" and Enviro: 9" diameter same-plane, swivel mouse surface
- Palm rest, if selected

- 1 Style number
- 2 Palm rest type, if green-gel palm rest is selected (see below under Required Selections)

Required Selections **Price** **Required to Specify**

Palm Rest	<ul style="list-style-type: none"> • Non-antimicrobial • Antimicrobial 	No cost No cost	Specify <i>with non-antimicrobial.</i> Specify <i>with antimicrobial.</i>
------------------	--	--------------------	--

Specification Information

• Dimensions	• Style	• Price
D W H	Number	:
:	:	:
:	:	:

19" Platforms without Palm Rest

Left-Handed

9 ³ / ₄ "	19"	3"	L51819ML00	\$287
---------------------------------	-----	----	-------------------	-------

Right-Handed

9 ³ / ₄ "	19"	3"	L51819MR00	\$287
---------------------------------	-----	----	-------------------	-------

Dual Mouse

9 ³ / ₄ "	19"	3"	L51819MD00	\$333
---------------------------------	-----	----	-------------------	-------

With Articulating Mouse Surface

9 ³ / ₄ "	19"	3"	L51819AM00	\$372
---------------------------------	-----	----	-------------------	-------

► **Specification Information, continued on next page**

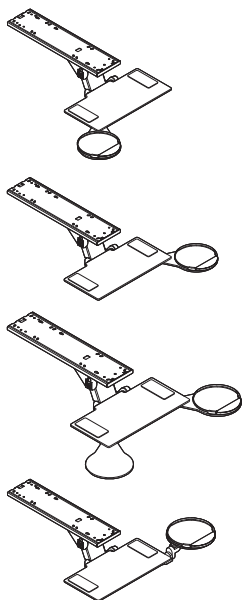

► Specification Information, continued from previous page

Specification Information

• Dimensions			• Style	• Price
D	W	H	Number	

19" Platforms with Green-Gel Palm Rest

Left-Handed

9 ³ / ₄ "	19"	3"	L51819MLGG	\$310
---------------------------------	-----	----	-------------------	-------

Right-Handed

9 ³ / ₄ "	19"	3"	L51819MRGG	\$310
---------------------------------	-----	----	-------------------	-------

Dual Mouse

9 ³ / ₄ "	19"	3"	L51819MDGG	\$356
---------------------------------	-----	----	-------------------	-------

With Articulating Mouse Surface

9 ³ / ₄ "	19"	3"	L51819AMGG	\$394
---------------------------------	-----	----	-------------------	-------

Enviro Platforms

Without Palm Rest

14 ¹ / ₂ "	28"	3"	L518EN1000	\$287
----------------------------------	-----	----	-------------------	-------

With Green Gel Palm Rest

14 ¹ / ₂ "	28"	3"	L518EN10GG	\$310
----------------------------------	-----	----	-------------------	-------

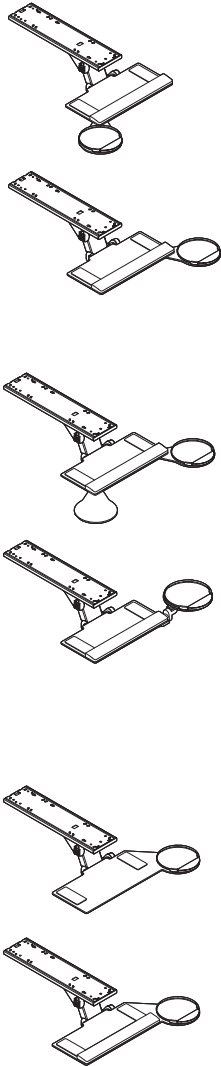

Keyboard Assemblies, continued

SIN 711.2

5" Lift and Lock Keyboard Assemblies

with 22"L Track

Tip: Be sure to consider the mechanism track length in relationship to the worksurface depth.

Standard Includes	Required to Specify
<ul style="list-style-type: none"> Mechanism and 22"L track: 0835 Black Keyboard platform: <ul style="list-style-type: none"> Slider and Classic Rectangular: 7027 Charcoal paint Jules, Diagonal, and Radius: 6288 Charcoal plastic 19", 26", and Enviro: 7027 Charcoal paint Mouse surface: <ul style="list-style-type: none"> Slider and Jules: ambidextrous, sliding mouse surface Diagonal, Radius, Classic Rectangular, and 26" ambidextrous, integrated mouse surface 19" and Enviro: 9" diameter same-plane, swivel mouse surface Palm rest, if selected 	<ul style="list-style-type: none"> 1 Style number 2 Palm rest type, if green-gel palm rest is selected (see below under Required Selections)

Required Selections	Price	Required to Specify
Palm Rest <ul style="list-style-type: none"> Non-antimicrobial Antimicrobial 	No cost No cost	Specify <i>with non-antimicrobial</i> . Specify <i>with antimicrobial</i> .

Specification Information

Dimensions	Style Number	Price
D W H	:	:

Slider Platforms

Without Palm Rest

9½"	20"	3"	L522SL1000	\$347
-----	-----	----	-------------------	-------

With Standard Palm Rest

9½"	20"	3"	L522SL10SA	\$388
-----	-----	----	-------------------	-------

With Deep Palm Rest

9½"	20"	3"	L522SL10DA	\$409
-----	-----	----	-------------------	-------

Jules Platforms

Without Palm Rest

12"	18¾"	5⅝"	L522JP1000	\$253
-----	------	-----	-------------------	-------

With Standard Foam Palm Rest

12"	18¾"	5⅝"	L522JP10SF	\$282
-----	------	-----	-------------------	-------

► **Specification Information, continued on next page**

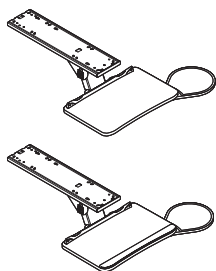
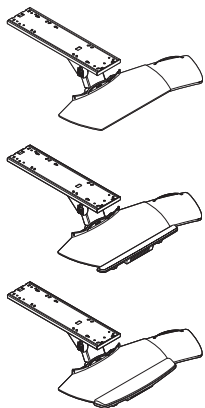

► Specification Information, continued from previous page

Specification Information

• Dimensions			• Style	• Price
D	W	H	Number	

Diagonal Platforms

17" with Extended Foam Palm Rest

12 ¹ / ₂ "	27 ¹ / ₂ "	3"	L5221710EF	\$329
----------------------------------	----------------------------------	----	-------------------	-------

21" with Extended Foam Palm Rest

12 ¹ / ₂ "	27 ¹ / ₂ "	3"	L5222110EF	\$329
----------------------------------	----------------------------------	----	-------------------	-------

Radius Platform

18" with Extended Foam Palm Rest

14 ¹ / ₂ "	27 ¹ / ₂ "	3"	L5221810EF	\$329
----------------------------------	----------------------------------	----	-------------------	-------

Classic Rectangular Platforms

Without Palm Rest

10 ¹ / ₄ "	27 ¹ / ₂ "	5 ⁵ / ₈ "	L522CR1000	\$277
----------------------------------	----------------------------------	---------------------------------	-------------------	-------

With Positionable Palm Rest

10 ¹ / ₄ "	27 ¹ / ₂ "	5 ⁵ / ₈ "	L522CR10PP	\$368
----------------------------------	----------------------------------	---------------------------------	-------------------	-------

With Full-Width, Fixed-Height Palm Rest

10 ¹ / ₄ "	27 ¹ / ₂ "	5 ⁵ / ₈ "	L522CR10FF	\$359
----------------------------------	----------------------------------	---------------------------------	-------------------	-------

With Full-Width, Height-Adjustable Palm Rest

10 ¹ / ₄ "	27 ¹ / ₂ "	5 ⁵ / ₈ "	L522CR10FA	\$386
----------------------------------	----------------------------------	---------------------------------	-------------------	-------

► Specification Information, continued on next page

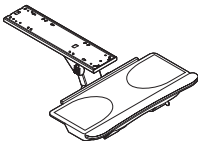
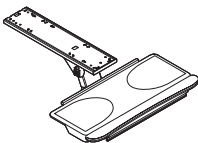
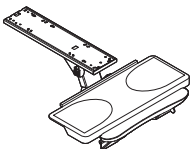
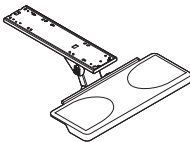
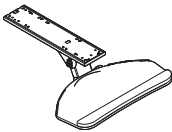
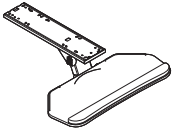
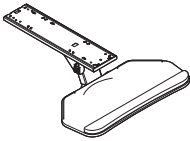

Keyboard Assemblies, continued

SIN 711.2

► Specification Information, continued from previous page

Specification Information

Dimensions			Style	Price
D	W	H	Number	

19" Platforms without Palm Rest

Left-Handed

9 ³ / ₄ "	19"	3"	L52219ML00	\$287
---------------------------------	-----	----	-------------------	-------

Right-Handed

9 ³ / ₄ "	19"	3"	L52219MR00	\$287
---------------------------------	-----	----	-------------------	-------

Dual Mouse

9 ³ / ₄ "	19"	3"	L52219MD00	\$333
---------------------------------	-----	----	-------------------	-------

With Articulating Mouse Surface

9 ³ / ₄ "	19"	3"	L52219AM00	\$372
---------------------------------	-----	----	-------------------	-------

19" Platforms with Green-Gel Palm Rest

Left-Handed

9 ³ / ₄ "	19"	3"	L52219MLGG	\$310
---------------------------------	-----	----	-------------------	-------

Right-Handed

9 ³ / ₄ "	19"	3"	L52219MRGG	\$310
---------------------------------	-----	----	-------------------	-------

Dual Mouse

9 ³ / ₄ "	19"	3"	L52219MDGG	\$356
---------------------------------	-----	----	-------------------	-------

With Articulating Mouse Surface

9 ³ / ₄ "	19"	3"	L52219AMGG	\$394
---------------------------------	-----	----	-------------------	-------

► Specification Information, continued on next page

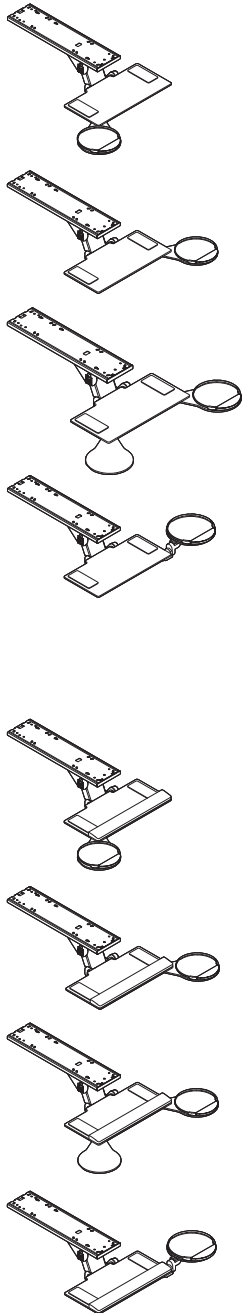

SIN 711.2

► Specification Information, continued from previous page

Specification Information

• Dimensions			• Style	• Price
D	W	H	Number	

Enviro Platforms

Without Palm Rest

14 ¹ / ₂ "	28"	3"	L522EN1000	\$287
----------------------------------	-----	----	-------------------	-------

With Green Gel Palm Rest

14 ¹ / ₂ "	28"	3"	L522EN10GG	\$310
----------------------------------	-----	----	-------------------	-------

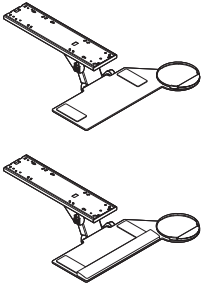

Keyboard Assemblies, continued

SIN 711.2

5" Lift and Lock Keyboard Assemblies

with 23"L Track

Tip: Be sure to consider the mechanism track length in relationship to the worksurface depth.

Standard Includes	Required to Specify
<ul style="list-style-type: none"> • Mechanism and 23"L track: 0835 Black • Keyboard platform: <ul style="list-style-type: none"> – Slider and Classic Rectangular: 7027 Charcoal paint – Jules, Diagonal, and Radius: 6288 Charcoal plastic – 19", 26", and Enviro: 7027 Charcoal paint • Mouse surface: <ul style="list-style-type: none"> – Slider and Jules: ambidextrous, sliding mouse surface – Diagonal, Radius, Classic Rectangular, and 26": ambidextrous, integrated mouse surface – 19" and Enviro: 9" diameter same-plane, swivel mouse surface • Palm rest, if selected 	<ul style="list-style-type: none"> 1 Style number 2 Palm rest type, if green-gel palm rest is selected (see below under Required Selections)

Required Selections	Price	Required to Specify
Palm Rest <ul style="list-style-type: none"> • Non-antimicrobial • Antimicrobial 	No cost No cost	Specify <i>with non-antimicrobial</i> . Specify <i>with antimicrobial</i> .

Specification Information

Dimensions	Style	Price
D W H	Number	

Slider Platforms

With Standard Palm Rest

9½"	20"	3"	L523SL10SA	\$388
-----	-----	----	-------------------	-------

With Deep Palm Rest

9½"	20"	3"	L523SL10DA	\$409
-----	-----	----	-------------------	-------

Jules Platforms

Without Palm Rest

12"	18¾"	5⅝"	L523JP1000	\$253
-----	------	-----	-------------------	-------

With Standard Foam Palm Rest

12"	18¾"	5⅝"	L523JP10SF	\$282
-----	------	-----	-------------------	-------

► **Specification Information, continued on next page**

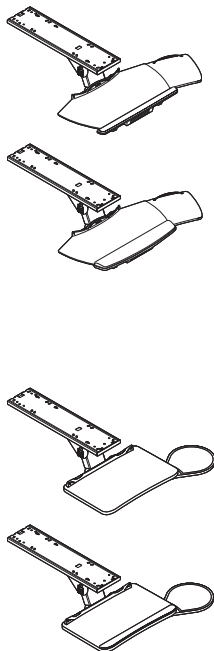

► Specification Information, continued from previous page

Specification Information

Dimensions			Style	Price
D	W	H	Number	
:	:	:	:	:

Diagonal Platforms

17" with Extended Foam Palm Rest

12 ¹ / ₂ "	27 ¹ / ₂ "	3"	L5231710EF	\$329
----------------------------------	----------------------------------	----	-------------------	-------

21" with Extended Foam Palm Rest

12 ¹ / ₂ "	27 ¹ / ₂ "	3"	L5232110EF	\$329
----------------------------------	----------------------------------	----	-------------------	-------

Radius Platform

18" with Extended Foam Palm Rest

14 ¹ / ₂ "	27 ¹ / ₂ "	3"	L5231810EF	\$329
----------------------------------	----------------------------------	----	-------------------	-------

Classic Rectangular Platforms

Without Palm Rest

10 ¹ / ₄ "	27 ¹ / ₂ "	5 ⁵ / ₈ "	L523CR1000	\$277
----------------------------------	----------------------------------	---------------------------------	-------------------	-------

With Positionable Palm Rest

10 ¹ / ₄ "	27 ¹ / ₂ "	5 ⁵ / ₈ "	L523CR10PP	\$368
----------------------------------	----------------------------------	---------------------------------	-------------------	-------

With Full-Width, Fixed-Height Palm Rest

10 ¹ / ₄ "	27 ¹ / ₂ "	5 ⁵ / ₈ "	L523CR10FF	\$359
----------------------------------	----------------------------------	---------------------------------	-------------------	-------

With Full-Width, Height-Adjustable Palm Rest

10 ¹ / ₄ "	27 ¹ / ₂ "	5 ⁵ / ₈ "	L523CR10FA	\$386
----------------------------------	----------------------------------	---------------------------------	-------------------	-------

► Specification Information, continued on next page

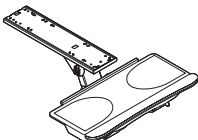
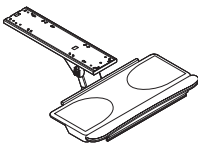
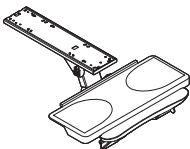
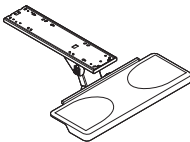
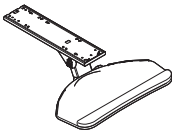
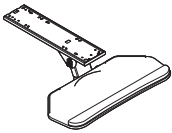
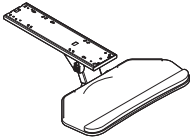

Keyboard Assemblies, continued

SIN 711.2

► Specification Information, continued from previous page

Specification Information

Dimensions			Style	Price
D	W	H	Number	

19" Platforms without Palm Rest

Left-Handed

9 ³ / ₄ "	19"	3"	L52319ML00	\$287
---------------------------------	-----	----	-------------------	-------

Right-Handed

9 ³ / ₄ "	19"	3"	L52319MR00	\$287
---------------------------------	-----	----	-------------------	-------

Dual Mouse

9 ³ / ₄ "	19"	3"	L52319MD00	\$333
---------------------------------	-----	----	-------------------	-------

With Articulating Mouse Surface

9 ³ / ₄ "	19"	3"	L52319AM00	\$372
---------------------------------	-----	----	-------------------	-------

19" Platforms with Green-Gel Palm Rest

Left-Handed

9 ³ / ₄ "	19"	3"	L52319MLGG	\$310
---------------------------------	-----	----	-------------------	-------

Right-Handed

9 ³ / ₄ "	19"	3"	L52319MRGG	\$310
---------------------------------	-----	----	-------------------	-------

Dual Mouse

9 ³ / ₄ "	19"	3"	L52319MDGG	\$356
---------------------------------	-----	----	-------------------	-------

With Articulating Mouse Surface

9 ³ / ₄ "	19"	3"	L52319AMGG	\$394
---------------------------------	-----	----	-------------------	-------

► Specification Information, continued on next page

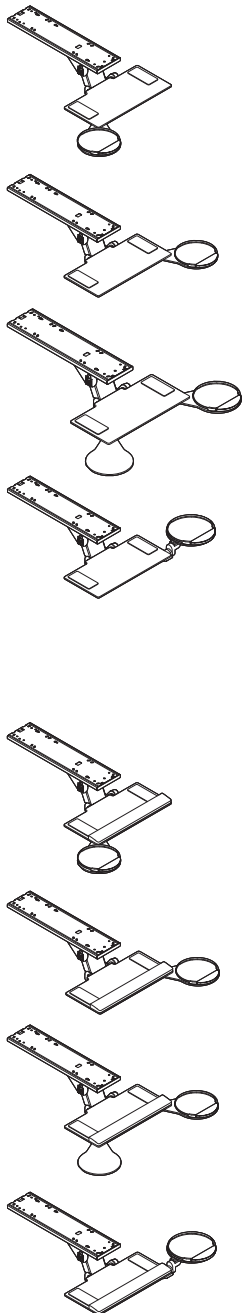

► Specification Information, continued from previous page

Specification Information

• Dimensions			• Style	• Price
D	W	H	Number	

Enviro Platforms

Without Palm Rest

14 ¹ / ₂ "	28"	3"	L523EN1000	\$287
----------------------------------	-----	----	-------------------	-------

With Green Gel Palm Rest

14 ¹ / ₂ "	28"	3"	L523EN10GG	\$310
----------------------------------	-----	----	-------------------	-------

26" Platforms

Without Palm Rest

9 ³ / ₄ "	26"	3"	L523261000	\$298
---------------------------------	-----	----	-------------------	-------

With 19" Green Gel Palm Rest

9 ³ / ₄ "	26"	3"	L5232610GG	\$321
---------------------------------	-----	----	-------------------	-------

With 26" Green Gel Palm Rest

9 ³ / ₄ "	26"	3"	L523261026GG	\$327
---------------------------------	-----	----	---------------------	-------

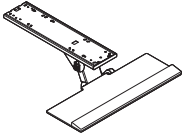
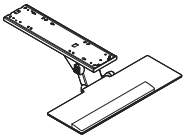
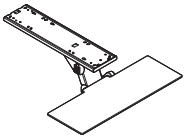
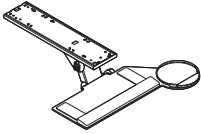
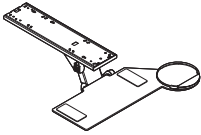

Keyboard Assemblies, continued

SIN 711.2

7" Lift and Lock Keyboard Assemblies

with 18"L Track

Tip: Be sure to consider the mechanism track length in relationship to the worksurface depth.

Standard Includes	Required to Specify
<ul style="list-style-type: none"> • Mechanism and 18"L track: 0835 Black • Keyboard platform: <ul style="list-style-type: none"> – 19", 26" and Enviro: 7027 Charcoal paint • Mouse surface: <ul style="list-style-type: none"> – 19" and Enviro: 9" diameter same-plane, swivel mouse surface • Palm rest, if selected 	<ul style="list-style-type: none"> 1 Style number 2 Palm rest type, if green-gel palm rest is selected (see below under Required Selections)

Required Selections	Price	Required to Specify
Palm Rest <ul style="list-style-type: none"> • Non-antimicrobial • Antimicrobial 	No cost No cost	Specify <i>with non-antimicrobial</i> . Specify <i>with antimicrobial</i> .

Specification Information

• Dimensions	• Style	• Price
D W H	Number	

19" Platforms without Palm Rest

With Articulating Mouse Surface

9 ³ / ₄ "	19"	3"	L71819AM00	\$372
---------------------------------	-----	----	-------------------	-------

19" Platforms with Green-Gel Palm Rest

Left-Handed

9 ³ / ₄ "	19"	3"	L71819MLGG	\$310
---------------------------------	-----	----	-------------------	-------

Right-Handed

9 ³ / ₄ "	19"	3"	L71819MRGG	\$310
---------------------------------	-----	----	-------------------	-------

Dual Mouse

9 ³ / ₄ "	19"	3"	L71819MDGG	\$356
---------------------------------	-----	----	-------------------	-------

With Articulating Mouse Surface

9 ³ / ₄ "	19"	3"	L71819AMGG	\$394
---------------------------------	-----	----	-------------------	-------

► **Specification Information, continued on next page**

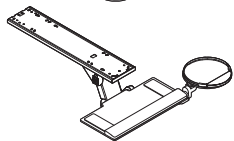
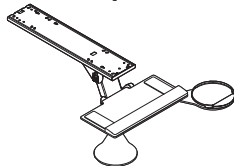
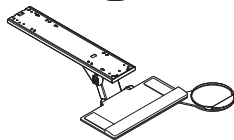
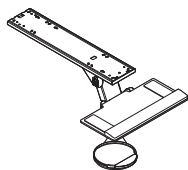
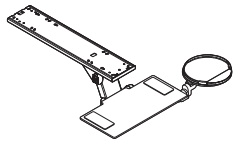

SIN 711.2

► Specification Information, continued from previous page

Specification Information

• Dimensions			• Style	• Price
D	W	H	Number	

Enviro Platforms

With Green Gel Palm Rest

14 ¹ / ₂ "	28"	3"	L718EN10GG	\$310
----------------------------------	-----	----	-------------------	-------

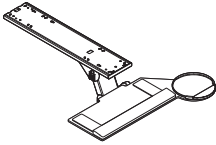

Computer Support Tools

Keyboard Assemblies, continued

SIN 711.2

7" Lift and Lock Keyboard Assemblies
with 26"L Track

Tip: Be sure to consider the mechanism track length in relationship to the work surface depth.

Standard Includes	Required to Specify
<ul style="list-style-type: none"> • Mechanism and 26"L track: 0835 Black • Keyboard platform: <ul style="list-style-type: none"> – Slider and Classic Rectangular: 7027 Charcoal paint – Jules, Diagonal, and Radius: 6288 Charcoal plastic – 19", 26" and Enviro: 7027 Charcoal paint • Mouse surface: <ul style="list-style-type: none"> – Slider and Jules: ambidextrous, sliding mouse surface – Diagonal, Radius, Classic Rectangular, and 26": ambidextrous, integrated mouse surface – 19" and Enviro: 9" diameter same-plane, swivel mouse surface • Palm rest, if selected 	<ul style="list-style-type: none"> 1 Style number 2 Palm rest type, if green-gel palm rest is selected (see below under Required Selections)

Required Selections	Price	Required to Specify
Palm Rest <ul style="list-style-type: none"> • Non-antimicrobial • Antimicrobial 	No cost No cost	Specify <i>with non-antimicrobial</i> . Specify <i>with antimicrobial</i> .

Specification Information

Dimensions	Style	Price
D W H	Number	

Slider Platforms

With Standard Palm Rest

9½"	20"	3"	L726SL10SA	\$388
-----	-----	----	-------------------	-------

With Deep Palm Rest

9½"	20"	3"	L726SL10DA	\$409
-----	-----	----	-------------------	-------

Jules Platforms

Without Palm Rest

12"	18¾"	5⅝"	L726JP1000	\$253
-----	------	-----	-------------------	-------

With Standard Foam Palm Rest

12"	18¾"	5⅝"	L726JP10SF	\$282
-----	------	-----	-------------------	-------

► **Specification Information, continued on next page**

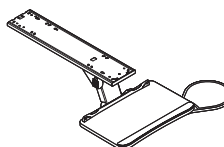
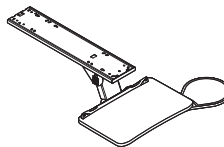
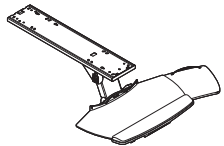
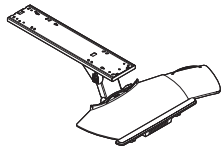

► Specification Information, continued from previous page

Specification Information

Dimensions			Style	Price
D	W	H	Number	

Diagonal Platforms

17" with Extended Foam Palm Rest

12 ¹ / ₂ "	27 ¹ / ₂ "	3"	L7261710EF	\$329
----------------------------------	----------------------------------	----	-------------------	-------

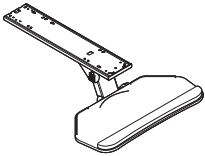

21" with Extended Foam Palm Rest

12 ¹ / ₂ "	27 ¹ / ₂ "	3"	L7262110EF	\$329
----------------------------------	----------------------------------	----	-------------------	-------

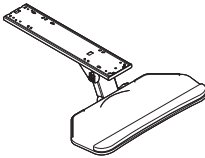

Radius Platform

18" with Extended Foam Palm Rest

14 ¹ / ₂ "	27 ¹ / ₂ "	3"	L7261810EF	\$329
----------------------------------	----------------------------------	----	-------------------	-------

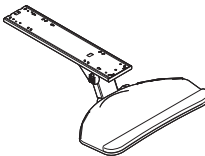

Classic Rectangular Platforms

Without Palm Rest

10 ¹ / ₄ "	27 ¹ / ₂ "	5 ⁵ / ₈ "	L726CR1000	\$277
----------------------------------	----------------------------------	---------------------------------	-------------------	-------

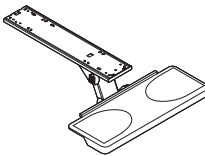

With Positionable Palm Rest

10 ¹ / ₄ "	27 ¹ / ₂ "	5 ⁵ / ₈ "	L726CR10PP	\$368
----------------------------------	----------------------------------	---------------------------------	-------------------	-------

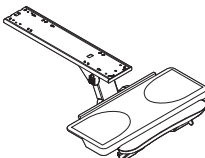

With Full-Width, Fixed-Height Palm Rest

10 ¹ / ₄ "	27 ¹ / ₂ "	5 ⁵ / ₈ "	L726CR10FF	\$359
----------------------------------	----------------------------------	---------------------------------	-------------------	-------

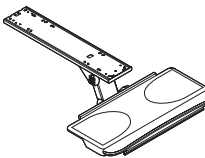

With Full-Width, Height-Adjustable Palm Rest

10 ¹ / ₄ "	27 ¹ / ₂ "	5 ⁵ / ₈ "	L726CR10FA	\$386
----------------------------------	----------------------------------	---------------------------------	-------------------	-------

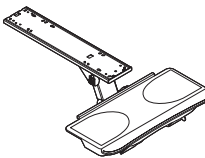

► Specification Information, continued on next page

Computer Support Tools

Keyboard Assemblies, continued

SIN 711.2

► Specification Information, continued from previous page

Specification Information

Dimensions			Style	Price
D	W	H	Number	

19" Platforms without Palm Rest

Left-Handed

9 ³ / ₄ "	19"	3"	L72619ML00	\$287
---------------------------------	-----	----	-------------------	-------

Right-Handed

9 ³ / ₄ "	19"	3"	L72619MR00	\$287
---------------------------------	-----	----	-------------------	-------

Dual Mouse

9 ³ / ₄ "	19"	3"	L72619MD00	\$333
---------------------------------	-----	----	-------------------	-------

With Articulating Mouse Surface

9 ³ / ₄ "	19"	3"	L72619AM00	\$372
---------------------------------	-----	----	-------------------	-------

19" Platforms with Green-Gel Palm Rest

Left-Handed

9 ³ / ₄ "	19"	3"	L72619MLGG	\$310
---------------------------------	-----	----	-------------------	-------

Right-Handed

9 ³ / ₄ "	19"	3"	L72619MRGG	\$310
---------------------------------	-----	----	-------------------	-------

Dual Mouse

9 ³ / ₄ "	19"	3"	L72619MDGG	\$356
---------------------------------	-----	----	-------------------	-------

With Articulating Mouse Surface

9 ³ / ₄ "	19"	3"	L72619AMGG	\$394
---------------------------------	-----	----	-------------------	-------

► Specification Information, continued on next page

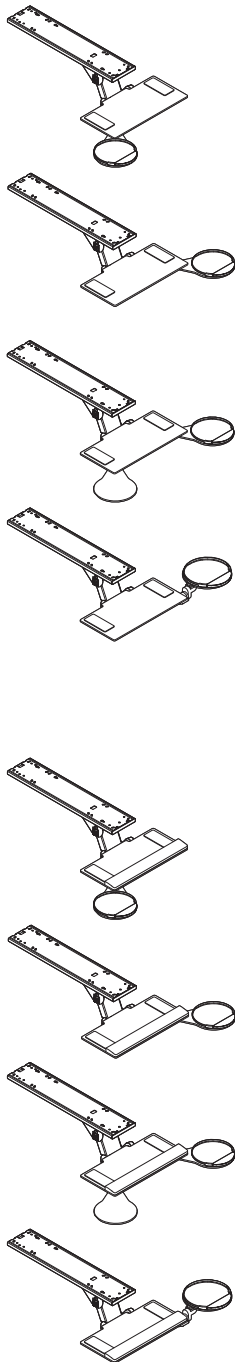

► Specification Information, continued from previous page

Specification Information

• Dimensions			• Style	• Price
D	W	H	Number	

Enviro Platforms

Without Palm Rest

14 ¹ / ₂ "	28"	3"	L726EN1000	\$287
----------------------------------	-----	----	-------------------	-------

With Green Gel Palm Rest

14 ¹ / ₂ "	28"	3"	L726EN10GG	\$310
----------------------------------	-----	----	-------------------	-------

26" Platforms

Without Palm Rest

9 ³ / ₄ "	26"	5 ⁵ / ₈ "	L726261000	\$298
---------------------------------	-----	---------------------------------	-------------------	-------

With 19" Green Gel Palm Rest

9 ³ / ₄ "	26"	3"	L7262610GG	\$321
---------------------------------	-----	----	-------------------	-------

With 26" Green Gel Palm Rest

9 ³ / ₄ "	26"	3"	L726261026GG	\$327
---------------------------------	-----	----	---------------------	-------

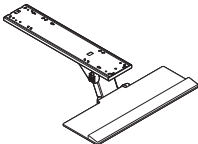
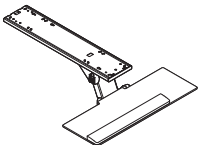
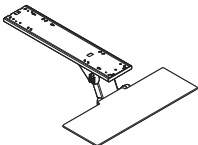
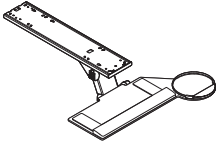
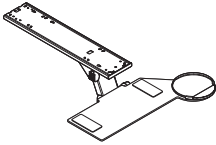

Keyboard Assemblies, continued

SIN 711.2

Dial Indicator6 Keyboard Assemblies

Tip: Be sure to consider the mechanism track length in relationship to the work surface depth.

Standard Includes	Required to Specify
<ul style="list-style-type: none"> • Mechanism and 23"L track: 0835 Black • Keyboard platform: <ul style="list-style-type: none"> – Slider and Classic Rectangular: 7027 Charcoal paint – Jules, Diagonal, and Radius: 6288 Charcoal plastic – 19", 26", and Enviro: 7027 Charcoal paint • Mouse surface: <ul style="list-style-type: none"> – Slider and Jules: ambidextrous, sliding mouse surface – Diagonal, Radius, Classic Rectangular, and 26": ambidextrous, integrated mouse surface – 19" and Enviro: 9" diameter same-plane, swivel mouse surface • Palm rest, if selected 	<ul style="list-style-type: none"> 1 Style number 2 Palm rest type, if green-gel palm rest is selected (see below under Required Selections)

Required Selections	Price	Required to Specify
Palm Rest <ul style="list-style-type: none"> • Non-antimicrobial • Antimicrobial 	No cost No cost	Specify with non-antimicrobial. Specify with antimicrobial.

Specification Information

Dimensions	Style Number	Price
D W H	:	:

Slider Platforms

Without Palm Rest

9 1/2"	20"	3"	D623SL1000	\$422
--------	-----	----	-------------------	-------

With Standard Palm Rest

9 1/2"	20"	3"	D623SL10SA	\$463
--------	-----	----	-------------------	-------

With Deep Palm Rest

9 1/2"	20"	3"	D623SL10DA	\$484
--------	-----	----	-------------------	-------

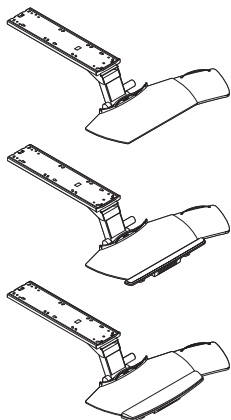

Jules Platforms

Without Palm Rest

12"	18 3/4"	5 5/8"	D623JP1000	\$328
-----	---------	--------	-------------------	-------

With Standard Foam Palm Rest

12"	18 3/4"	5 5/8"	D623JP10SF	\$357
-----	---------	--------	-------------------	-------

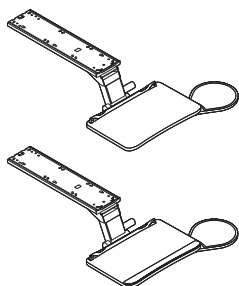

► Specification Information, continued on next page

► Specification Information, continued from previous page

Specification Information

Dimensions			Style	Price
D	W	H	Number	

Diagonal Platforms

17" with Extended Foam Palm Rest

12 ¹ / ₂ "	27 ¹ / ₂ "	3"	D6231710EF	\$404
----------------------------------	----------------------------------	----	-------------------	-------

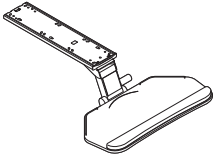

21" with Extended Foam Palm Rest

12 ¹ / ₂ "	27 ¹ / ₂ "	3"	D6232110EF	\$404
----------------------------------	----------------------------------	----	-------------------	-------

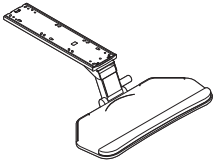

Radius Platform

18" with Extended Foam Palm Rest

14"	27 ¹ / ₂ "	3"	D6231810EF	\$404
-----	----------------------------------	----	-------------------	-------

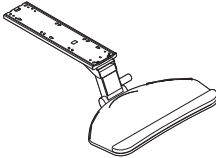

Classic Rectangular Platforms

Without Palm Rest

10 ¹ / ₄ "	27 ¹ / ₂ "	5 ⁵ / ₈ "	D623CR1000	\$352
----------------------------------	----------------------------------	---------------------------------	-------------------	-------

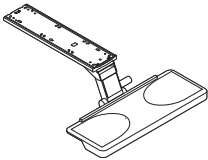

With Positionable Palm Rest

10 ¹ / ₄ "	27 ¹ / ₂ "	5 ⁵ / ₈ "	D623CR10PP	\$443
----------------------------------	----------------------------------	---------------------------------	-------------------	-------

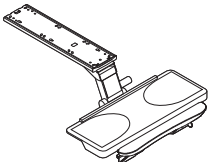

With Full-Width, Fixed-Height Palm Rest

10 ¹ / ₄ "	27 ¹ / ₂ "	5 ⁵ / ₈ "	D623CR10FF	\$434
----------------------------------	----------------------------------	---------------------------------	-------------------	-------

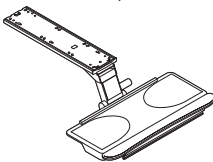

With Full-Width, Height-Adjustable Palm Rest

10 ¹ / ₄ "	27 ¹ / ₂ "	5 ⁵ / ₈ "	D623CR10FA	\$461
----------------------------------	----------------------------------	---------------------------------	-------------------	-------

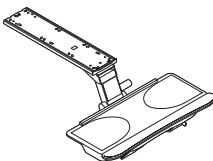

► Specification Information, continued on next page

Computer Support Tools

Keyboard Assemblies, continued

SIN 711.2

► Specification Information, continued from previous page

Specification Information

Dimensions			Style	Price
D	W	H	Number	

19" Platforms without Palm Rest

Left-Handed

9 ³ / ₄ "	19"	3"	D62319ML00	\$362
---------------------------------	-----	----	-------------------	-------

Right-Handed

9 ³ / ₄ "	19"	3"	D62319MR00	\$362
---------------------------------	-----	----	-------------------	-------

Dual Mouse

9 ³ / ₄ "	19"	3"	D62319MD00	\$408
---------------------------------	-----	----	-------------------	-------

With Articulating Mouse Surface

9 ³ / ₄ "	19"	3"	D62319AM00	\$447
---------------------------------	-----	----	-------------------	-------

19" Platforms with Green-Gel Palm Rest

Left-Handed

9 ³ / ₄ "	19"	3"	D62319MLGG	\$384
---------------------------------	-----	----	-------------------	-------

Right-Handed

9 ³ / ₄ "	19"	3"	D62319MRGG	\$384
---------------------------------	-----	----	-------------------	-------

Dual Mouse

9 ³ / ₄ "	19"	3"	D62319MDGG	\$431
---------------------------------	-----	----	-------------------	-------

With Articulating Mouse Surface

9 ³ / ₄ "	19"	3"	D62319AMGG	\$468
---------------------------------	-----	----	-------------------	-------

► Specification Information, continued on next page

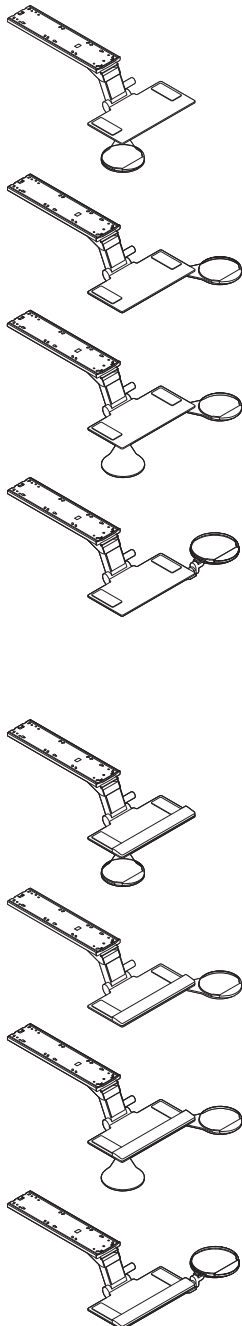

SIN 711.2

► Specification Information, continued from previous page

Specification Information

Dimensions			Style	Price
D	W	H	Number	

Enviro Platforms

Without Palm Rest

14 ¹ / ₂ "	28"	3"	D623EN1000	\$362
----------------------------------	-----	----	-------------------	-------

With Green Gel Palm Rest

14 ¹ / ₂ "	28"	3"	D623EN10GG	\$384
----------------------------------	-----	----	-------------------	-------

26" Platforms

Without Palm Rest

9 ³ / ₄ "	26"	3"	D623261000	\$373
---------------------------------	-----	----	-------------------	-------

With 19" Green Gel Palm Rest

9 ³ / ₄ "	26"	3"	D6232610GG	\$396
---------------------------------	-----	----	-------------------	-------

With 26" Green Gel Palm Rest

9 ³ / ₄ "	26"	3"	D623261026GG	\$402
---------------------------------	-----	----	---------------------	-------

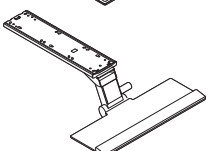
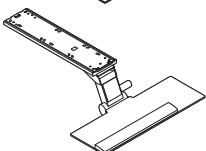
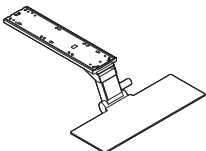
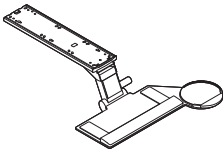
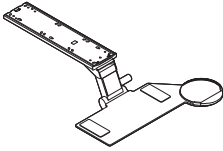

Computer Support Tools

Technology Worktools and Cable Management

SIN 711.2

Corner Fillers

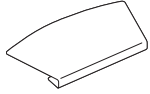

Tip: 18"W corner filler creates a 17" diagonal application. 22"W corner filler creates a 21" diagonal application.

Standard Includes	Required to Specify
-------------------	---------------------

- | | |
|--------------------------------------|--------------|
| • Corner filler: 7027 Charcoal paint | Style number |
|--------------------------------------|--------------|

Specification Information			
---------------------------	--	--	--

• Dimensions		• Style	• Price
D	W	Number	
•	•	•	•

18" Corner Fillers

For Use with 1 1/4" Thick Worksurfaces

13"	24"	CCWS18125	\$132
-----	-----	------------------	-------

For Use with 1 1/2" Thick Worksurfaces

13"	24"	CCWS18150	\$132
-----	-----	------------------	-------

22" Corner Fillers

For Use with 1 1/4" Thick Worksurfaces

13"	28"	CCWS22125	\$132
-----	-----	------------------	-------

For Use with 1 1/2" Thick Worksurfaces

13"	28"	CCWS22150	\$132
-----	-----	------------------	-------

Freestanding In-Line Document Support

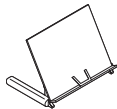

Standard Includes	Required to Specify
-------------------	---------------------

- | | |
|---|--------------|
| • Freestanding in-line document support: 6000 Black | Style number |
|---|--------------|

Specification Information				
---------------------------	--	--	--	--

• Dimensions			• Style	• Price
D	W	H	Number	
•	•	•	•	•

18"	14"	12"	CDFIS14	\$120
-----	-----	-----	----------------	-------

Adjustable Foot Rest

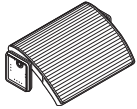

Standard Includes

- Adjustable foot rest: 6000 Black

Required to Specify

Style number

Specification Information

Dimensions			Style	Price
D	W	H	Number	
12"	18"	2"-6"	CFTR	\$132

Mobile Collapsible Laptop Support



Tip: Mobile collapsible laptop support is for use with laptops that open past 90° only.

Standard Includes

- Laptop support: brushed aluminum

Required to Specify

Style number

Specification Information

Dimensions			Style	Price
D	W	H	Number	
9½"	12¼"	½"-7"	CMLSA	\$115

Vertical Locking CPU Cradle

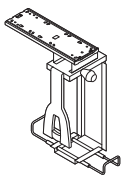

Tip: Vertical CPU cradle supports CPUs 3½"W to 9"W, 15"D to 22"D, 12½"H to 22½"H and up to 85 lb.

Tip: CPU cradle requires 18" clearance under the work surface.

Standard Includes

- CPU cradle: 0835 Black
- Soft touch knob with locking system for side clamp adjustment
- 17" track
- Lock mechanism

Required to Specify

Style number

Specification Information

Dimensions			Style	Price
D	W	H	Number	
15"	4"	18¼"	CPRCCL	\$212

SIN 711.2

Vertical Non-Locking CPU Cradle

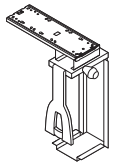

Tip: Vertical CPU cradle supports CPUs 3½"W to 9"W, 15"D to 22"D, 12½"H to 22½"H and up to 85 lb.

Tip: CPU cradle requires 18" clearance under the worksurface.

Standard Includes	Required to Specify
-------------------	---------------------

- CPU cradle: 0835 Black
- Soft touch knob for side clamp adjustment
- 17"L track

Style number

Specification Information				
• Dimensions			• Style	• Price
D	W	H	Number	

17"	3½"	18¼"	CPRCCN	\$182
-----	-----	------	---------------	-------

Vertical Cable Carrier



Tip: Vertical cable carrier is recommended for use with height-adjustable worksurfaces.

Tip: Vertical cable carrier affixes under the worksurface and has a weighted base to hold it in place.

Standard Includes	Required to Specify
-------------------	---------------------

- Cable carrier: 6688 Steel
- Attachment hardware

Style number

Specification Information				
• Dimensions		• Style	• Price	
W	H	Number		

2½"	52"	AHCC	\$158	
-----	-----	-------------	-------	--

Vertical Processor Slings

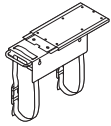

Tip: CPU must be at least 10"D and 3½"W for both standard and fixed vertical processor slings.

Tip: Standard vertical processor sling supports CPUs with perimeters of 53" and 75 lb.

Tip: Standard vertical processor requires 18" clearance under the worksurface.

Standard Includes	Required to Specify
-------------------	---------------------

- Vertical processor sling: 7207 Textured Black
- 17"L track for standard vertical processor sling, if selected

Style number

Specification Information				
• Dimensions			• Style	• Price
D	W	H	Number	

Standard				
----------	--	--	--	--

18"	5½"	2½"	CPRSL	\$150
-----	-----	-----	--------------	-------

Fixed (For Use with c:scape, FrameOne, and Ology)				
---	--	--	--	--

10¾"	3¾"	6"	CPRSLFO	\$125
------	-----	----	----------------	-------

Tip: Fixed vertical processor sling supports CPUs with perimeters of 53" and 50 lb.

Tip: Fixed vertical processor sling requires 12" clearance under the worksurface.

Tip: Fixed vertical processor sling is mounted in a fixed position.

CPU Trolley

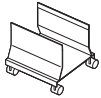

Tip: Trolley supports CPUs from 5¼"W to 8½"W and up to 85 lb.

Tip: CPU trolley requires a maximum 10"W floor clearance when fully expanded.

Standard Includes	Required to Specify
-------------------	---------------------

- CPU trolley that supports CPU vertically: 6029 Chalk
- Two locking and two non-locking casters

Style number

Specification Information				
• Dimensions			• Style	• Price
D	W	H	Number	

11"	10"	10"	QACPUT	\$112
-----	-----	-----	---------------	-------

Slatwall/SlatRail Mounted CPU Cradle



Tip: Small CPU cradle accommodates CPUs with perimeters up to 44" and 20 lb.

Standard Includes	Required to Specify
-------------------	---------------------

- Cradle: 7018 Pewter

Style number

Specification Information				
• Dimensions			• Style	• Price
D	W	H	Number	

Small CPU Cradle				
------------------	--	--	--	--

3¾"	7"	9¾"	HCCPUS	\$97
-----	----	-----	---------------	------

Technology Worktools and Cable Management, continued

SIN 711.2

Cableways

Tip: Cableway with universal clamp can be used in combination with privacy and modesty screens.

▶ See page 300

Tip: Cableways may need to be shorter than worksurface width. To determine screen/cableway and height-adjustable worksurface compatibility, see Worktools Compatibility Charts, page 224.

Tip: Cableways are not recommended for use with 22¹/₄"D rectangular Airtouch worksurfaces.

Tip: Cableways with universal clamp are 3" shorter than privacy and modesty screen widths.

Tip: 55"W and 61"W cableways ship with three universal clamps or horizontal brackets. All other cableway widths ship with two universal clamps or horizontal brackets.

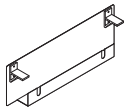

Tip: To determine SlatRail compatibility and mounting requirements, see Height-Adjustable Desks Specification Guide.

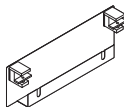

Standard Includes	Required to Specify
<ul style="list-style-type: none"> • Cableway: paint • Universal clamp, if selected: paint to match cableway • Horizontal mounting bracket, if selected: paint to match cableway 	1 Style number 2 Paint color number for cableway: 0835 Black 4799 Platinum Metallic

Specification Information

• Dimensions			• Weight	• Style	• Price
D	W	H		Number	

With Horizontal Mounting Bracket

2 ¹ / ₂ "	25"	8"	7.45 lb	AHORZ25	\$ 74
2 ¹ / ₂ "	31"	8"	8.40 lb	AHORZ31	\$ 94
2 ¹ / ₂ "	37"	8"	9.35 lb	AHORZ37	\$114
2 ¹ / ₂ "	43"	8"	10.30 lb	AHORZ43	\$130
2 ¹ / ₂ "	49"	8"	11.25 lb	AHORZ49	\$152
2 ¹ / ₂ "	55"	8"	14.20 lb	AHORZ55	\$181
2 ¹ / ₂ "	61"	8"	15.15 lb	AHORZ61	\$199

With Universal Clamp

2 ¹ / ₂ "	25"	8"	4.70 lb	AC25	\$158
2 ¹ / ₂ "	31"	8"	5.65 lb	AC31	\$175
2 ¹ / ₂ "	37"	8"	6.60 lb	AC37	\$194
2 ¹ / ₂ "	43"	8"	7.55 lb	AC43	\$211
2 ¹ / ₂ "	49"	8"	8.50 lb	AC49	\$228
2 ¹ / ₂ "	55"	8"	9.95 lb	AC55	\$276
2 ¹ / ₂ "	61"	8"	10.91 lb	AC61	\$292

6"D Wire Managers

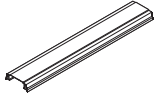

Tip: Wire manager attaches to a clip that is affixed to the underside of a worksurface.

Standard Includes	Required to Specify
<ul style="list-style-type: none"> Wire manager: 6000 Black or 6249 Platinum Attachment hardware 	<ul style="list-style-type: none"> 1 Style number 2 Plastic color number for wire manager

Specification Information						
Dimensions			Weight	Style Number	Price	
D	W	H				
6"	30 ¹ / ₂ "	2"	0.13 lb	AWMXL30	\$ 69	
6"	36 ¹ / ₂ "	2"	0.24 lb	AWMXL36	\$ 79	
6"	42 ¹ / ₂ "	2"	0.34 lb	AWMXL42	\$ 89	
6"	48 ¹ / ₂ "	2"	0.44 lb	AWMXL48	\$ 99	
6"	54 ¹ / ₂ "	2"	0.56 lb	AWMXL54	\$111	
6"	60 ¹ / ₂ "	2"	0.65 lb	AWMXL60	\$121	
:	:	:	:	:	:	:

1³/₄"D Wire Managers

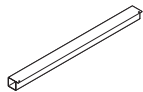

Tip: Actual width of AWM23 is 23¹/₄".

Standard Includes	Required to Specify
<ul style="list-style-type: none"> Wire manager: 6000 Black Attachment hardware 	<ul style="list-style-type: none"> Style number

Specification Information						
Dimensions			Weight	Style Number	Price	
D	W	H				
1 ³ / ₄ "	6"	1 ³ / ₄ "	0.13 lb	AWM06	\$24	
1 ³ / ₄ "	12"	1 ³ / ₄ "	0.24 lb	AWM12	\$31	
1 ³ / ₄ "	18"	1 ³ / ₄ "	0.34 lb	AWM18	\$36	
1 ³ / ₄ "	23"	1 ³ / ₄ "	0.44 lb	AWM23	\$41	
1 ³ / ₄ "	30"	1 ³ / ₄ "	0.56 lb	AWM30	\$47	
1 ³ / ₄ "	35"	1 ³ / ₄ "	0.65 lb	AWM35	\$52	
1 ³ / ₄ "	42"	1 ³ / ₄ "	0.77 lb	AWM42	\$58	
1 ³ / ₄ "	48"	1 ³ / ₄ "	0.88 lb	AWM48	\$65	
:	:	:	:	:	:	:

Eyesite Flat Panel Monitor Arm Support Assemblies

SIN 711.2

Eyesite Single Display Supports

Tip: Eyesite single display support is for use with monitors up to 20 lb.

Tip: For large monitor screens (20"+), order standard columns. For small monitor screens (17"-19"), order extended columns.
 ▶ Page 169



Tip: Ology bracket mount is available with optional brackets. See options above.

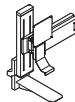

Tip: Eyesite arms should only be mounted to c:scape desks that are tethered to either the beam, another desk, or 1 1/2-High low storage with a connect zone.

Tip: Monitor cables that connect to the rear of the monitor near the VESA plate will not fit properly on the Eyesite monitor arm.

Tip: Eyesite is not recommended with 22 1/4"D Airtouch worksurfaces due to C-clamp interference with the lifting column.

Standard Includes	Required to Specify
<ul style="list-style-type: none"> • Monitor arm: 4799 Platinum Metallic • Mounting bracket: 4799 Platinum Metallic 	1 Style number 2 Options, if selected (see below)

Options	Price	Required to Specify
Ology Brackets		
• C-clamp mount for use without power data access door	No cost	Specify with C-clamp mount for use without power data access door.
• C-clamp mount for use with power data access door	+\$75	Specify with C-clamp mount for use with power data access door.
• Rail mount bracket	+\$80	Specify with rail mount bracket.

Specification Information			
Dimensions	Weight	Style	Base
D W H		Number	Price

12"H Standard Crank Adjustment Column

C-Clamp Mount

6 ⁵ / ₈ "	11 ⁵ / ₈ "	15 ¹ / ₂ "	11 lb	FPAC1CC	\$372
---------------------------------	----------------------------------	----------------------------------	-------	----------------	-------

Ology Bracket Mount

6 ⁵ / ₈ "	11 ⁵ / ₈ "	15 ¹ / ₂ "	11 lb	FPAC1OL	\$372
---------------------------------	----------------------------------	----------------------------------	-------	----------------	-------

c:scape Bvbracket Mount

6 ⁵ / ₈ "	11 ⁵ / ₈ "	15 ¹ / ₂ "	11 lb	FPAC1CS	\$426
---------------------------------	----------------------------------	----------------------------------	-------	----------------	-------

▶ **Specification Information, continued on next page**

Tip: Eyesite display supports will not fit in front of station mounted Slatwall and SlatRail when using a C-clamp bracket. A through-mount bracket is recommended.

Tip: Monitor arms and lap-top supports with C-clamp brackets are not recommended on Universal Tables with P-edge as the user's edge wraps all the way around table. Universal Systems Worksurfaces with P-edge will work as the user's edge is applied to the front only.

► Specification Information, continued from previous page

Specification Information

• Dimensions			• Weight	• Style	• Price
D	W	H		Number	

12"H Standard Crank Adjustment Column, continued

Through-Mount

6 ⁵ / ₈ "	11 ⁵ / ₈ "	15 ¹ / ₂ "	10 lb	FPAC1TM	\$372
---------------------------------	----------------------------------	----------------------------------	-------	----------------	-------

FrameOne Mount

6 ⁵ / ₈ "	11 ⁵ / ₈ "	15 ¹ / ₂ "	10 lb	FPAC1FO	\$420
---------------------------------	----------------------------------	----------------------------------	-------	----------------	-------



Tip: When mounting dual or triple Eyesite on stand-alone, single-sided FrameOne base units, the worksurface must be 66"W or greater and must be used with Eyesite standard crank adjustable column only.

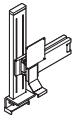
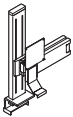

Tip: Ology bracket mount is available with optional brackets. See options on previous page.

18"H Extended Crank Adjustment Column

C-Clamp Mount

6 ⁵ / ₈ "	11 ⁵ / ₈ "	20"	12 lb	FPAEC1CC	\$426
---------------------------------	----------------------------------	-----	-------	-----------------	-------

Ology Bracket Mount

6 ⁵ / ₈ "	11 ⁵ / ₈ "	20"	12 lb	FPAEC1OL	\$426
---------------------------------	----------------------------------	-----	-------	-----------------	-------

c:scape Bracket Mount

6 ⁵ / ₈ "	11 ⁵ / ₈ "	20"	12 lb	FPAEC1CS	\$481
---------------------------------	----------------------------------	-----	-------	-----------------	-------

Through-Mount

6 ⁵ / ₈ "	11 ⁵ / ₈ "	20"	11 lb	FPAEC1TM	\$426
---------------------------------	----------------------------------	-----	-------	-----------------	-------

FrameOne Mount

6 ⁵ / ₈ "	11 ⁵ / ₈ "	20"	11 lb	FPAEC1FO	\$475
---------------------------------	----------------------------------	-----	-------	-----------------	-------

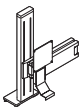
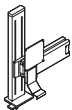
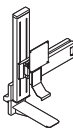

Tip: Eyesite columns may be mounted back to back on double-sided FrameOne worksurfaces when using FrameOne brackets.

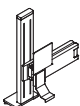

Tip: Bivi bracket to be used with Eyesite single support, dual display support, and dual laptop support with extended crank adjust columns only.

Eyesite Flat Panel Monitor Arm Support Assemblies, continued

SIN 711.2

Eyesite Dual Display Supports

Tip: Eyesite dual display support is for use with two monitors up to 27" or less screens and up to 20 lb each. 27" monitors should be use with extended 18" column assemblies or taller.

Standard Includes	Required to Specify
<ul style="list-style-type: none"> • Monitor arm: 4799 Platinum Metallic • Mounting bracket: 4799 Platinum Metallic 	1 Style number 2 Options, if selected (see below)

Bracket	Options	Price	Required to Specify
Bracket	• Without pivot	No cost	Specify <i>without pivot</i> .
	• With pivot	+\$18	Specify <i>with pivot</i> .
Ology Brackets	• C-clamp mount for use without power data access door	No cost	Specify <i>with C-clamp mount for use without power data access door</i> .
	• C-clamp mount for use with power data access door	+\$75	Specify <i>with C-clamp mount for use with power data access door</i> .
	• Rail mount bracket	+\$80	Specify <i>with rail mount bracket</i> .

Specification Information					
• Dimensions			• Weight	• Style	• Base
D	W	H		Number	Price
:	:	:	:	:	:
:	:	:	:	:	:

12"H Standard Crank Adjustment Column with Dual Yoke and Focal Adjustment

C-Clamp Mount

8½"	31"	15½"	16 lb	FPAC2CC	\$656
-----	-----	------	-------	----------------	-------

Ology Bracket Mount

8½"	31"	15½"	16 lb	FPAC2OL	\$656
-----	-----	------	-------	----------------	-------

c:scape Bracket Mount

8½"	31"	15½"	16 lb	FPAC2CS	\$710
-----	-----	------	-------	----------------	-------

► **Specification Information, continued on next page**

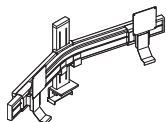
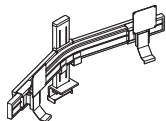

Tip: Ology bracket mount is available with optional brackets. See options above.

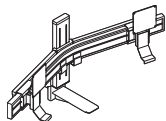

Tip: Eyesite arms should only be mounted to c:scape desks that are tethered to either the beam, another desk, or 1½"-High low storage with a connect zone.

Tip: Monitor cables that connect to the rear of the monitor near the VESA plate will not fit properly on the Eyesite monitor arm.

Tip: Eyesite is not recommended with 22¼"D Airtouch worksurfaces due to C-clamp interference with the lifting column.

Tip: Eyesite display supports will not fit in front of stationion mounted Slatwall and SlatRail when using a C-clamp bracket. A through-mount bracket is recommended.

Tip: Monitor arms and lap-top supports with C-clamp brackets are not recommended on Universal Tables with P-edge as the user's edge wraps all the way around table. Universal Systems Worksurfaces with P-edge will work as the user's edge is applied to the front only.

► Specification Information, continued from previous page

Specification Information

Dimensions			Weight	Style	Base
D	W	H		Number	Price

12"H Standard Crank Adjustment Column with Dual Yoke and Focal Adjustment, continued

Through-Mount

8½"	31"	15½"	15 lb	FPAC2TM	\$656
-----	-----	------	-------	----------------	-------

FrameOne Mount

8½"	31"	15½"	15 lb	FPAC2FO	\$710
-----	-----	------	-------	----------------	-------

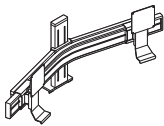
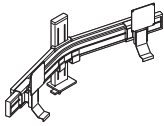

Tip: When mounting dual or triple Eyesite on stand-alone, single-sided FrameOne base units, the worksurface must be 66"W or greater and must be used with Eyesite standard crank adjustable column only.

18"H Extended Crank Adjustment Column with Dual Yoke and Focal Adjustment

C-Clamp Mount

8½"	31"	20"	17 lb	FPAEC2CC	\$710
-----	-----	-----	-------	-----------------	-------

Ology Bracket Mount

8½"	31"	20"	17 lb	FPAEC2OL	\$710
-----	-----	-----	-------	-----------------	-------

c:scape Bracket Mount

8½"	31"	20"	17 lb	FPAEC2CS	\$765
-----	-----	-----	-------	-----------------	-------

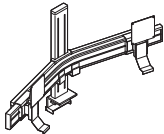
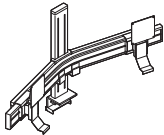

Tip: Ology bracket mount is available with optional brackets. See options above.

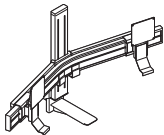

► Specification Information, continued on next page

Eyesite Flat Panel Monitor Arm Support Assemblies, continued

SIN 711.2

► Specification Information, continued from previous page

Specification Information

Dimensions			Weight	Style	Base
D	W	H		Number	Price

18"H Extended Crank Adjustment Column with Dual Yoke and Focal Adjustment continued

Through-Mount

8½"	31"	20"	16 lb	FPAEC2TM	\$710
-----	-----	-----	-------	-----------------	-------

FrameOne Mount

8½"	31"	20"	16 lb	FPAEC2FO	\$765
-----	-----	-----	-------	-----------------	-------

Bivi Mount

8½"	31"	20"	16 lb	FPAEC2BIVI	\$782
-----	-----	-----	-------	-------------------	-------

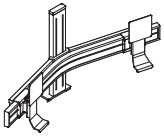
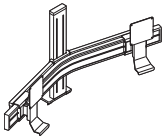
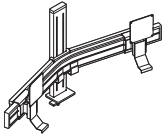

Tip: Bivi bracket to be used with Eyesite single support, dual display support, and dual laptop support with extended crank adjust columns only.

Eyesite Flat Panel Monitor Arm Support Assemblies, continued

SIN 711.2

Eyesite Triple Display Supports

Tip: Eyesite triple display support is for use with three monitors up to 24" screens and 15 lb each.

Standard Includes	Required to Specify
<ul style="list-style-type: none"> • Monitor arm: 4799 Platinum Metallic • Mounting bracket: 4799 Platinum Metallic 	1 Style number 2 Options, if selected (see below)

Options	Price	Required to Specify
Bracket <ul style="list-style-type: none"> • Without pivot • With pivot 	No cost +\$27	Specify <i>without pivot</i> . Specify <i>with pivot</i> .
Ology Brackets <ul style="list-style-type: none"> • C-clamp mount for use without power data access door • C-clamp mount for use with power data access door • Rail mount bracket 	No cost +\$75 +\$80	Specify <i>with C-clamp mount for use without power data access door</i> . Specify <i>with C-clamp mount for use with power data access door</i> . Specify <i>with rail mount bracket</i> .

Specification Information				
Dimensions	Weight	Style Number	Base Price	
D	W	H		

12"H Standard Crank Adjustment Column with Triple Yoke and without Focal Adjustment

C-Clamp Mount				
77/8"	541/2"	151/2"	14 lb	FPAFC3CC \$710

Ology Bracket Mount				
77/8"	541/2"	151/2"	14 lb	FPAFC3OL \$710

c:scape Bracket Mount				
77/8"	541/2"	151/2"	14 lb	FPAFC3CS \$765

► **Specification Information, continued on next page**

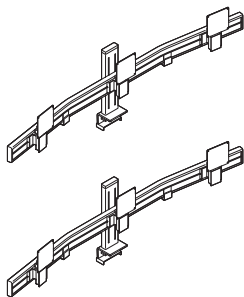

Tip: Ology bracket mount is available with optional brackets. See options above.

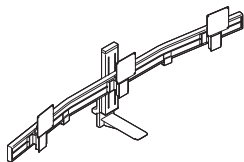

Tip: Eyesite arms should only be mounted to c:scape desks that are tethered to either the beam, another desk, or 1 1/2"-High low storage with a connect zone.

Tip: Monitor cables that connect to the rear of the monitor near the VESA plate will not fit properly on the Eyesite monitor arm.

Tip: Eyesite is not recommended with 22 1/4"D Airtouch worksurfaces due to C-clamp interference with the lifting column.

Tip: Eyesite display supports will not fit in front of stanchion mounted Slatwall and SlatRail when using a C-clamp bracket. A through-mount bracket is recommended.

Tip: Monitor arms and laptop supports with C-clamp brackets are not recommended on Universal Tables with P-edge as the user's edge wraps all the way around table. Universal Systems Worksurfaces with P-edge will work as the user's edge is applied to the front only.

► Specification Information, continued from previous page

Specification Information

Dimensions			Weight	Style Number	Base Price
D	W	H			

12"H Standard Crank Adjustment Column with Triple Yoke and without Focal Adjustment, continued

Through-Mount

7 ⁷ / ₈ "	54 ¹ / ₂ "	15 ¹ / ₂ "	13 lb	FPAFC3TM	\$710
---------------------------------	----------------------------------	----------------------------------	-------	-----------------	-------

18"H Extended Crank Adjustment Column

C-Clamp Mount

7 ⁷ / ₈ "	54 ¹ / ₂ "	20"	15 lb	FPAFEC3CC	\$765
---------------------------------	----------------------------------	-----	-------	------------------	-------

Ology Bracket Mount

7 ⁷ / ₈ "	54 ¹ / ₂ "	20"	20 lb	FPAFEC3OL	\$765
---------------------------------	----------------------------------	-----	-------	------------------	-------

c:scape Bracket Mount

7 ⁷ / ₈ "	54 ¹ / ₂ "	20"	15 lb	FPAFEC3CS	\$820
---------------------------------	----------------------------------	-----	-------	------------------	-------

Through-Mount

7 ⁷ / ₈ "	54 ¹ / ₂ "	20"	14 lb	FPAFEC3TM	\$765
---------------------------------	----------------------------------	-----	-------	------------------	-------

FrameOne Mount

7 ⁷ / ₈ "	54 ¹ / ₂ "	20"	14 lb	FPAFEC3FO	\$820
---------------------------------	----------------------------------	-----	-------	------------------	-------

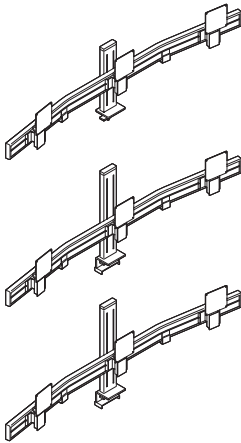

Tip: Ology bracket mount is available with optional brackets. See options on previous page.

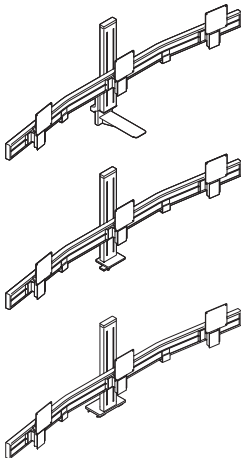

Tip: Eyesite arms should only be mounted to c:scape desks that are tethered to either the beam, another desk, or 1¹/₂-High low storage with a connect zone.

Tip: Monitor cables that connect to the rear of the monitor near the VESA plate will not fit properly on the Eyesite monitor arm.

Tip: Eyesite is not recommended with 22¹/₄"D Airtouch worksurfaces due to C-clamp interference with the lifting column.

Tip: Eyesite display supports will not fit in front of station mounted Slatwall and SlatRail when using a C-clamp bracket. A through-mount bracket is recommended.

Eyesite Flat Panel Monitor Arm Support Assemblies, continued

SIN 711.2

Eyesite Static One-Over-One Display Supports

Tip: Eyesite static one-over-one display support is for use with two monitors up to 30" and 25 lb each.

Tip: Monitor cables that connect to the rear of the monitor near the VESA plate will not fit properly on the Eyesite monitor arm.

Standard Includes	Required to Specify
<ul style="list-style-type: none"> Extended static column: 4799 Platinum Metallic Mounting bracket: 4799 Platinum Metallic 	1 Style number 2 Options, if selected (see below)

Options	Price	Required to Specify
Ology Brackets		
• C-clamp mount for use without power data access door	No cost	Specify with C-clamp mount for use without power data access door.
• C-clamp mount for use with power data access door	+\$75	Specify with C-clamp mount for use with power data access door.
• Rail mount bracket	+\$80	Specify with rail mount bracket.

Specification Information

Dimensions	Weight	Style Number	Base Price
D W H			

26"H Extended Static Column

C-Clamp Mount

5 ³ / ₄ "	4 ¹ / ₈ "	31 ³ / ₄ "	11 lb	FPAS101CC	\$420
---------------------------------	---------------------------------	----------------------------------	-------	------------------	-------

Ology Bracket Mount

5 ³ / ₄ "	4 ¹ / ₈ "	31 ³ / ₄ "	11 lb	FPAS101OL	\$420
---------------------------------	---------------------------------	----------------------------------	-------	------------------	-------

c:scape Bracket Mount

5 ³ / ₄ "	4 ¹ / ₈ "	31 ³ / ₄ "	11 lb	FPAS101CS	\$475
---------------------------------	---------------------------------	----------------------------------	-------	------------------	-------

► Specification Information, continued on next page



Tip: Ology bracket mount is available with optional brackets. See options above.

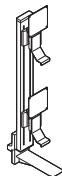

Tip: Eyesite arms should only be mounted to c:scape desks that are tethered to either the beam, another desk, or 1¹/₂-High low storage with a connect zone.

Tip: Eyesite is not recommended with 22¹/₄"D Airtouch worksurfaces due to C-clamp interference with the lifting column.

Tip: Eyesite display supports will not fit in front of stanchion mounted Slatwall and SlatRail when using a C-clamp bracket. A through-mount bracket is recommended.

Tip: Monitor arms and laptop supports with C-clamp brackets are not recommended on Universal Tables with P-edge as the user's edge wraps all the way around table. Universal Systems Worksurfaces with P-edge will work as the user's edge is applied to the front only.

► Specification Information, continued from previous page

Specification Information

• Dimensions			• Weight	• Style	• Price
D	W	H		Number	

26"H Extended Static Column, continued

Through-Mount

5 ³ / ₄ "	4 ¹ / ₈ "	31 ³ / ₄ "	10 lb	FPAS1O1TM	\$420
---------------------------------	---------------------------------	----------------------------------	-------	------------------	-------

FrameOne Mount

5 ³ / ₄ "	4 ¹ / ₈ "	31 ³ / ₄ "	10 lb	FPAS1O1FO	\$469
---------------------------------	---------------------------------	----------------------------------	-------	------------------	-------

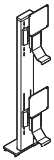

Tip: When mounting dual or triple Eyesite on stand-alone, single-sided FrameOne base units, the worksurface must be 66"W or greater and must be used with Eyesite standard crank adjustable column only.

Eyesite Flat Panel Monitor Arm Support Assemblies, continued

SIN 711.2

Eyesite Two-Over-Two Display Supports

Tip: Eyesite dual display support is for use with two monitors up to 24" screens and 15 lb each.

Tip: Bar-over-bar applications utilize the 26" extended static column only. Bar-over-bar is not permitted on c:scape, Bivi, or big table. Bar-over-bar may be used with FrameOne utilizing the static, non-focal adjusting dual and triple static yokes.

Tip: Bar-over-bar applications may be used with Series 5 and 7 worksurfaces with three column base configurations. Bar-over-bar applications are not permitted for use with Airtouch, any Series 5 and 7 worksurfaces with two column-base configurations, or any freestanding table with casters.

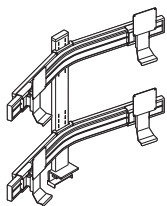
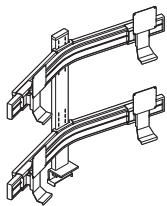

Standard Includes	Required to Specify
<ul style="list-style-type: none"> • Monitor arm: 4799 Platinum Metallic • Mounting bracket: 4799 Platinum Metallic 	1 Style number 2 Options, if selected (see below)

Options	Price	Required to Specify
Bracket <ul style="list-style-type: none"> • Without pivot • With pivot 	No cost +\$36	Specify <i>without pivot</i> . Specify <i>with pivot</i> .
Ology Brackets <ul style="list-style-type: none"> • C-clamp mount for use without power data access door • C-clamp mount for use with power data access door • Rail mount bracket 	No cost +\$75 +\$80	Specify <i>with C-clamp mount for use without power data access door</i> . Specify <i>with C-clamp mount for use with power data access door</i> . Specify <i>with rail mount bracket</i> .

Specification Information					
• Dimensions			• Weight	• Style	• Base
D	W	H		Number	Price
.....

26"H Extended Static Column with Dual Yoke and Focal Adjustment

C-Clamp Mount					
D	W	H	Weight	Style Number	Price
8 1/2"	31"	26"	27 lb	FPAC2BBDCC	\$1213

Ology Bracket Mount					
D	W	H	Weight	Style Number	Price
8 1/2"	31"	26"	27 lb	FPAC2BBDOL	\$1213

► **Specification Information, continued on next page**

► Specification Information, continued from previous page

Specification Information

Dimensions			Weight	Style	Base
D	W	H		Number	Price

26"H Extended Static Column with Dual Yoke and Focal Adjustment, continued

Through-Mount

8½"	31"	26"	27 lb	FPAC2BBDTM	\$1213
-----	-----	-----	-------	-------------------	--------

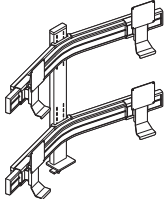

Tip: Monitor cables that connect to the rear of the monitor near the VESA plate will not fit properly on the Eyesite monitor arm.

26"H Extended Static Column with Dual Yoke and without Focal Adjustment

C-Clamp Mount

8½"	31"	26"	17 lb	FPAC2BBSCC	\$1114
-----	-----	-----	-------	-------------------	--------

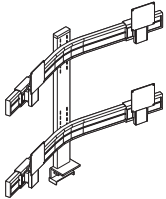

Ology Bracket Mount

8½"	31"	26"	17 lb	FPAC2BBSOL	\$1114
-----	-----	-----	-------	-------------------	--------

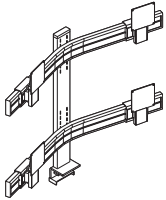

Through-Mount

8½"	31"	26"	17 lb	FPAC2BBSTM	\$1114
-----	-----	-----	-------	-------------------	--------

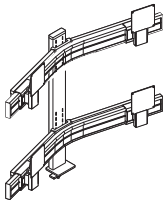

► Specification Information, continued on next page

Eyesite Flat Panel Monitor Arm Support Assemblies, continued

SIN 711.2

► Specification Information, continued from previous page

Specification Information

• Dimensions			• Weight	• Style	• Base
D	W	H		Number	Price

26"H Extended Static Column with Dual Yoke and without Focal Adjustment, continued

FrameOne Mount

8½"	31"	26"	17 lb	FPAC2BBSFO	\$1166
-----	-----	-----	-------	-------------------	--------

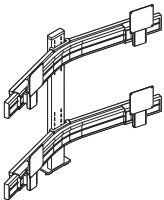

Tip: When mounting dual or triple Eyesite on stand-alone, single-sided FrameOne base units, the worksurface must be 66"W or greater.

Tip: Bar-over-bar applications for use with FrameOne must be used with static columns without focal adjustment yokes only.

Tip: Bar-over-bar applications are not permitted for use with c:scape worksurfaces.

Tip: Eyesite display supports will not fit in front of station mounted Slatwall and SlatRail when using a C-clamp bracket. A through-mount bracket is recommended.

Tip: Monitor arms and laptop supports with C-clamp brackets are not recommended on Universal Tables with P-edge as the user's edge wraps all the way around table. Universal Systems Worksurfaces with P-edge will work as the user's edge is applied to the front only.

Eyesite Three-Over-Three Display Supports

Tip: Eyesite triple display support is for use with three monitors up to 24" screens and 15 lb each.

Tip: Static yoke must be used when mounting a bar-over-bar application to FrameOne.

Tip: Bar-over-bar applications utilize the 26" extended static column only. Bar-over-bar is not permitted on c:scape, Bivi, or big table. Bar-over-bar may be used with FrameOne utilizing the static, non-focal adjusting dual and triple static yokes.

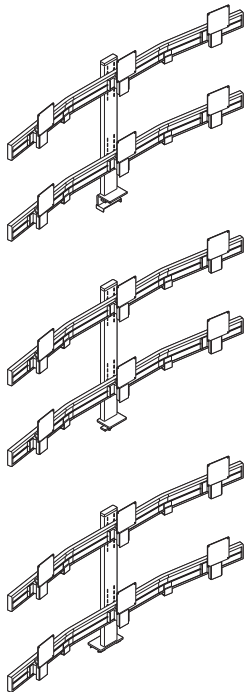

Tip: Bar-over-bar applications may be used with Series 5 and 7 worksurfaces with three column base configurations. Bar-over-bar applications are not permitted for use with Airtouch, any Series 5 and 7 worksurfaces with two column-base configurations, or any free-standing table with casters.

Standard Includes	Required to Specify
<ul style="list-style-type: none"> • Monitor arm: 4799 Platinum Metallic • Mounting bracket: 4799 Platinum Metallic 	1 Style number 2 Options, if selected (see below)

Options	Price	Required to Specify
Bracket <ul style="list-style-type: none"> • Without pivot • With pivot 	No cost +\$54	Specify <i>without pivot</i> . Specify <i>with pivot</i> .

Specification Information					
• Dimensions			• Weight	• Style	• Base
D	W	H		Number	Price

26"H Extended Static Column with Triple Yoke and without Focal Adjustment

C-Clamp Mount					
7 ⁷ / ₈ "	54 ¹ / ₂ "	26"	23 lb	FPAC3BBSCC	\$1321

Through-Mount					
7 ⁷ / ₈ "	54 ¹ / ₂ "	26"	23 lb	FPAC3BBSTM	\$1321

FrameOne Mount					
7 ⁷ / ₈ "	54 ¹ / ₂ "	26"	23 lb	FPAC3BBSFO	\$1377

Tip: Monitor cables that connect to the rear of the monitor near the VESA plate will not fit properly on the Eyesite monitor arm.

Tip: Eyesite display supports will not fit in front of station mounted Slatwall and SlatRail when using a C-clamp bracket. A through-mount bracket is recommended.

Tip: Monitor arms and laptop supports with C-clamp brackets are not recommended on Universal Tables with P-edge as the user's edge wraps all the way around table. Universal Systems Worksurfaces with P-edge will work as the user's edge is applied to the front only.

Eyesite Flat Panel Monitor Arm Support Assemblies, continued

SIN 711.2

Eyesite Single Laptop Supports

Tip: Eyesite flat panel monitor arms with laptop supports are not recommended for use with docking stations.

Tip: Supports laptops up to 20 lb.

Tip: Eyesite is not recommended with 22 1/4" D Airtouch worksurfaces due to C-clamp interference with the lifting column.

Tip: Eyesite display supports will not fit in front of Slatwall and SlatRail when using a C-clamp bracket a through-mount bracket is recommended.

Tip: Monitor arms and laptop supports with C-clamp brackets are not recommended on Universal Tables with P-edge as the user's edge wraps all the way around table. Universal Systems Worksurfaces with P-edge will work as the user's edge is applied to the front only.

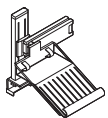
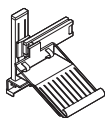

Tip: Ology bracket mount is available with optional brackets. See options above.

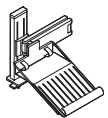
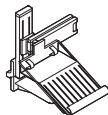

Standard Includes	Required to Specify
-------------------	---------------------

- | | |
|---|--|
| <ul style="list-style-type: none"> • Monitor arm: 4799 Platinum Metallic • Laptop support and adjustment column: 4799 Platinum Metallic • Mounting bracket: 4799 Platinum Metallic | <ul style="list-style-type: none"> 1 Style number 2 Options, if selected (see below) |
|---|--|

Options	Price	Required to Specify
---------	-------	---------------------

Ology Brackets <ul style="list-style-type: none"> • C-clamp mount for use without power data access door • C-clamp mount for use with power data access door • Rail mount bracket 	<ul style="list-style-type: none"> No cost +\$75 +\$80 	<ul style="list-style-type: none"> Specify with C-clamp mount for use without power data access door. Specify with C-clamp mount for use with power data access door. Specify with rail mount bracket.
---	---	---

Specification Information			
Dimensions	Weight	Style	Price
D W H	:	Number	:

12"H Standard Crank Adjustment Column

C-Clamp Mount

16"	11 5/8"	15 1/2"	15 lb	FPALC1CC	\$400
-----	---------	---------	-------	-----------------	-------

Ology Bracket Mount

16"	11 5/8"	15 1/2"	14 lb	FPALC1OL	\$400
-----	---------	---------	-------	-----------------	-------

C-clamp Mount

16"	11 5/8"	15 1/2"	15 lb	FPALC1CS	\$454
-----	---------	---------	-------	-----------------	-------

Through-Mount

16"	11 5/8"	15 1/2"	14 lb	FPALC1TM	\$400
-----	---------	---------	-------	-----------------	-------

► Specification Information, continued on next page

► Specification Information, continued from previous page

Specification Information

• Dimensions			• Weight	• Style Number	• Price
D	W	H			

12"H Standard Crank Adjustment Column, continued

FrameOne Mount

16"	11 ⁵ / ₈ "	15 ¹ / ₂ "	14 lb	FPALC1FO	\$514
-----	----------------------------------	----------------------------------	-------	-----------------	-------

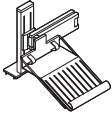

Tip: When mounting dual or triple Eyesite on stand-alone, single-sided FrameOne base units, the worksurface must be 66"W or greater and must be used with Eyesite standard crank adjustable column only.

18"H Extended Crank Adjustment Column

C-Clamp Mount

16"	11 ⁵ / ₈ "	19 ⁷ / ₈ "	16 lb	FPAELC1CC	\$454
-----	----------------------------------	----------------------------------	-------	------------------	-------

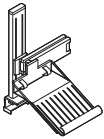

Ology Bracket Mount

16"	11 ⁵ / ₈ "	19 ⁷ / ₈ "	15 lb	FPAELC1OL	\$454
-----	----------------------------------	----------------------------------	-------	------------------	-------

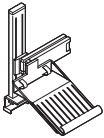

Tip: Ology bracket mount is available with optional brackets. See options on previous page.

c:scape Mount

16"	11 ⁵ / ₈ "	19 ⁷ / ₈ "	16 lb	FPAELC1CS	\$508
-----	----------------------------------	----------------------------------	-------	------------------	-------

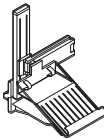

Through-Mount

16"	11 ⁵ / ₈ "	19 ⁷ / ₈ "	15 lb	FPAELC1TM	\$454
-----	----------------------------------	----------------------------------	-------	------------------	-------

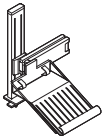

FrameOne Mount

16"	11 ⁵ / ₈ "	19 ⁷ / ₈ "	15 lb	FPAELC1FO	\$569
-----	----------------------------------	----------------------------------	-------	------------------	-------

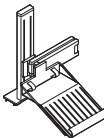

Bivi Mount

16"	11 ⁵ / ₈ "	19 ⁷ / ₈ "	15 lb	FPAELC1BIVI	\$526
-----	----------------------------------	----------------------------------	-------	--------------------	-------

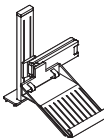

Tip: Bivi bracket to be used with Eyesite single support, dual display support, and dual laptop support with extended crank adjust columns only.

Eyesite Flat Panel Monitor Arm Support Assemblies, continued

SIN 711.2

Eyesite Dual Laptop Supports

Tip: Eyesite dual display support is for use with two monitors up to 27" or less screens and up to 20 lb each. 27" monitors should be used with extended 18" column assemblies or taller.

Tip: Eyesite flat panel monitor arms with laptop supports are not recommended for use with docking stations.

Standard Includes **Required to Specify**

- Monitor arm: 4799 Platinum Metallic Metallic
 - Laptop support and adjustment column: 4799 Platinum Metallic
 - Mounting bracket: 4799 Platinum Metallic
- 1 Style number
2 Options, if selected (see below)

Options **Price** **Required to Specify**

Bracket	• Without pivot	No cost	Specify <i>without pivot</i> .
	• With pivot	+\$18	Specify <i>with pivot</i> .
Ology Brackets	• C-clamp mount for use without power data access door	No cost	Specify <i>with C-clamp mount for use without power data access door</i> .
	• C-clamp mount for use with power data access door	+\$75	Specify <i>with C-clamp mount for use with power data access door</i> .
	• Rail mount bracket	+\$80	Specify <i>with rail mount bracket</i> .

Specification Information

• Dimensions			• Weight	• Style	• Base
D	W	H		Number	Price

12"H Standard Crank Adjustment Column

C-Clamp Mount

17"	31"	15½"	20 lb	FPALC2CC	\$704
-----	-----	------	-------	-----------------	-------

Ology Bracket Mount

17"	31"	15½"	20 lb	FPALC2OL	\$704
-----	-----	------	-------	-----------------	-------

c:scape Mount

17"	31"	15½"	20 lb	FPALC2CS	\$760
-----	-----	------	-------	-----------------	-------

Through-Mount

17"	31"	15½"	19 lb	FPALC2TM	\$704
-----	-----	------	-------	-----------------	-------

► **Specification Information, continued on next page**

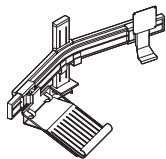
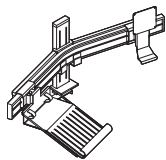

Tip: Ology bracket mount is available with optional brackets. See options above.

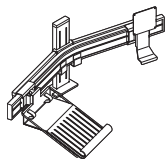
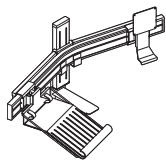

► **Specification Information, continued from previous page****Specification Information**

• Dimensions			• Weight	• Style	• Base
D	W	H		Number	Price

12"H Standard Crank Adjustment Column, continued**FrameOne Mount**

17"	31"	15½"	19 lb	FPALC2FO	\$760
-----	-----	------	-------	-----------------	-------

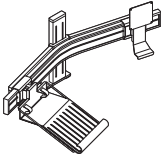
► **Specification Information, continued on next page**

Tip: When mounting dual or triple Eyesite on stand-alone, single-sided FrameOne base units, the worksurface must be 66"W or greater and must be used with Eyesite standard crank adjustable column only.

Tip: When planning with stand-alone, single-sided FrameOne base units, and dual or triple monitor arms, the worksurface must be 66"W or greater and monitor arm must be 15½"H maximum.

Tip: Monitor arms and lap-top supports with C-clamp brackets are not recommended on Universal Tables with P-edge as the user's edge wraps all the way around table. Universal Systems Worksurfaces with P-edge will work as the user's edge is applied to the front only.

Tip: Monitor cables that connect to the rear of the monitor near the VESA plate will not fit properly on the Eyesite monitor arm.

Tip: Eyesite is not recommended with 22¼"D Airtouch worksurfaces due to C-clamp interference with the lifting column.

Tip: Eyesite display supports will not fit in front of stanchion mounted Slatwall and SlatRail when using a C-clamp bracket. A through-mount bracket is recommended.

Tip: Eyesite arms should only be mounted to c:scape desks that are tethered to either the beam, another desk, or 1½-High low storage with a connect zone.

Eyesite Flat Panel Monitor Arm Support Assemblies, continued

SIN 711.2

► Specification Information, continued from previous page

Specification Information

Dimensions			Weight	Style	Base
D	W	H		Number	Price

18"H Extended Crank Adjustment Column

C-Clamp Mount

17"	31"	19 ⁷ / ₈ "	21 lb	FPAELC2CC	\$760
-----	-----	----------------------------------	-------	------------------	-------

Ology Bracket Mount

17"	31"	19 ⁷ / ₈ "	21 lb	FPAELC2OL	\$760
-----	-----	----------------------------------	-------	------------------	-------

scape Mount

17"	31"	19 ⁷ / ₈ "	21 lb	FPAELC2CS	\$816
-----	-----	----------------------------------	-------	------------------	-------

Through-Mount

17"	31"	19 ⁷ / ₈ "	20 lb	FPAELC2TM	\$760
-----	-----	----------------------------------	-------	------------------	-------

FrameOne Mount

17"	31"	19 ⁷ / ₈ "	20 lb	FPAELC2FO	\$816
-----	-----	----------------------------------	-------	------------------	-------

Bivi Mount

17"	31"	19 ⁷ / ₈ "	20 lb	FPAELC2BIVI	\$833
-----	-----	----------------------------------	-------	--------------------	-------

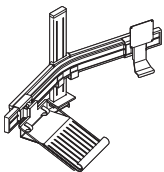
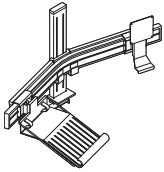

Tip: Ology bracket mount is available with optional brackets. See options on previous page.

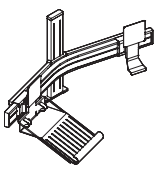
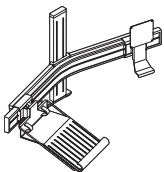
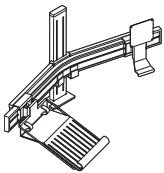
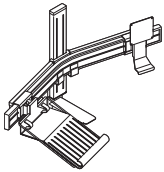

Tip: Bivi bracket to be used with Eyesite single support, dual display support, and dual laptop support with extended crank adjust columns only.

Eyesite Flat Panel Monitor
Arm Support Assemblies

SIN 711.2

Eyesite Modular Components

SIN 711.2

Modular Arm Components

Tip: Column and mounting bracket must be ordered separately.

Standard Includes	Required to Specify
<ul style="list-style-type: none"> Modular arm components: 4799 Platinum Metallic 	1 Style number 2 Options, if selected (see below)

Options	Price	Required to Specify
Bracket		
<ul style="list-style-type: none"> Without pivot 	No cost	Specify <i>without pivot</i> .
<ul style="list-style-type: none"> Dual adjustable yoke or dual static yoke with pivot 	+\$18	Specify <i>with pivot</i> .
<ul style="list-style-type: none"> Triple static yoke with pivot 	+\$27	Specify <i>with pivot</i> .

Specification Information

Dimensions	Weight	Style Number	Base Price
D W H			
:	:	:	:
:	:	:	:

Single Flex Mount Arm

4 ⁵ / ₈ "	11 ⁵ / ₈ "	9 ¹ / ₂ "	5 lb	FPC1	\$167
:	:	:	:	:	:



Tip: Eyesite single flex mount, when used with monitors with weight concentration at bottom of monitors or all-in-one monitors with CPUs, may be prone to drift.

Single Direct Mount Arm with Laptop Support

4 ⁵ / ₈ "	11 ⁵ / ₈ "	9 ¹ / ₂ "	6 lb	FPCL1	\$290
:	:	:	:	:	:

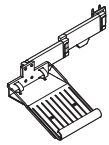

Dual Static Yoke

5"	31"	3"	5 lb	FPC2SB	\$452
:	:	:	:	:	:

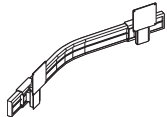

Dual Adjustable Yoke

5"	31"	3"	10 lb	FPC2	\$511
:	:	:	:	:	:

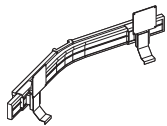

Triple Static Yoke

3"	54 ¹ / ₄ "	3"	8 lb	FPC3	\$551
:	:	:	:	:	:

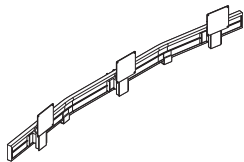

Columns

Tip: For large monitor screens (20"+), order standard columns. For small monitor screens (17"-19"), order extended columns.

Tip: Modular component and mount option must be ordered separately.



Tip: 26"H extended static column must be used for two-over-two and three-over-three applications.

Standard Includes	Required to Specify
• Column: 4799 Platinum Metallic	Style number

Specification Information

• Dimensions			• Weight	• Style Number	• Price
D	W	H			
12" Standard Crank					
1"	3"	12 ¹ / ₂ "	3.35 lb	FPCSCC	\$169
18" Extended Crank					
1"	3"	17 ³ / ₈ "	4.5 lb	FPCECC	\$224
26" Extended Static					
1"	3"	26 ¹ / ₂ "	5 lb	FPCESC	\$205

Computer Support Tools

Eyesite Modular Components, continued

SIN 711.2

Laptop Component



Standard Includes				Required to Specify	
• Laptop component: 4799 Platinum Metallic				Style number	
Specification Information					
• Dimensions			• Weight	• Style Number	• Price
D	W	H			
14"	10"	7"	3.4 lb	FPCL	\$135

VESA Bracket/Hook



Tip: VESA bracket/hook is for use with static column.

Standard Includes				Required to Specify	
• Bracket/hook: 4799 Platinum Metallic				Style number	
Specification Information					
• Dimensions			• Weight	• Style Number	• Price
D	W	H			
2 ¹ / ₂ "	4 ¹ / ₂ "	10"	1.7 lb	FPCHTV	\$115

VESA Bracket Assembly—Slide



Tip: VESA/bracket assembly-slide is for use with dual yoke or triple yoke modular components.

Standard Includes				Required to Specify	
• Bracket assembly: 4799 Platinum Metallic				1 Style number 2 Options, if selected (see below)	
Bracket		Options	Price	Required to Specify	
		• Without pivot	No cost	Specify <i>without pivot</i> .	
		• With pivot	+\$9	Specify <i>with pivot</i> .	
Specification Information					
• Dimensions			• Weight	• Style Number	• Base Price
D	W	H			
2 ⁵ / ₁₆ "	4 ⁵ / ₁₆ "	9 ¹ / ₂ "	1.25 lb	FPCFTV	\$115

Eyesite Extended Static Column with VESA Bracket/Hook

Eyesite Extended
Static Column with
VESA Bracket/Hook

SIN 711.2

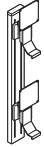

Tip: For large monitor screens (20"+), order standard columns. For small monitor screens (17"-19"), order extended columns.

▶ Page 169

Tip: Mounting brackets must be ordered separately.

Standard Includes	Required to Specify
• Modular assembly: 4799 Platinum Metallic	Style number

Specification Information					
• Dimensions			• Weight	• Style Number	• Price
D	W	H			
5 ³ / ₄ "	4 ¹ / ₈ "	29 ³ / ₄ "	9 lb	FPAS101	\$372
:	:	:	:	:	:

Computer Support Tools

Eyesite Mounting Brackets

SIN 711.2

Tip: Eyesite is not recommended with 22 1/4" D Airtouch worksurfaces due to C-clamp interference with the lifting column.

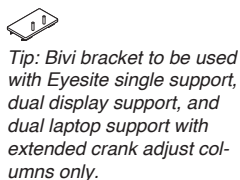
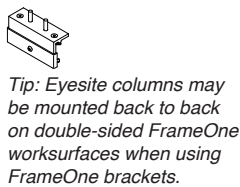
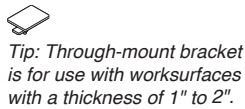
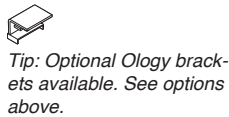
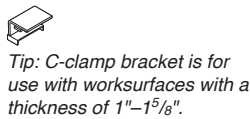
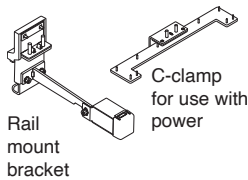

Standard Includes	Required to Specify
-------------------	---------------------

- | | |
|---|--|
| <ul style="list-style-type: none"> Bracket: 4799 Platinum Metallic | <ul style="list-style-type: none"> 1 Style number 2 Options, if selected (see below) |
|---|--|

Options	Price	Required to Specify
---------	-------	---------------------

- | | | |
|---|---|---|
| Ology Brackets <ul style="list-style-type: none"> C-clamp mount for use without power data access door C-clamp mount for use with power data access door Rail mount bracket | <ul style="list-style-type: none"> No cost +\$75 +\$80 | <ul style="list-style-type: none"> Specify with C-clamp mount for use without power data access door. Specify with C-clamp mount for use with power data access door. Specify with rail mount bracket. |
|---|---|---|

Specification Information					
Dimensions			Weight	Style Number	Base Price
D	W	H			

C-Clamp Bracket					
-----------------	--	--	--	--	--

3"	4"	2 1/2"	2 lb	FPCCC	\$ 51
:	:	:	:	:	:

Ology Bracket					
---------------	--	--	--	--	--

3"	4"	2 1/2"	2 lb	FPCOL	\$ 51
:	:	:	:	:	:

Through-Mount Bracket					
-----------------------	--	--	--	--	--

3"	4"	1/4"	1.3 lb	FPCTM	\$ 51
:	:	:	:	:	:

FrameOne Bracket					
------------------	--	--	--	--	--

3"	4"	1/4"	1.5 lb	FPCFO	\$ 90
:	:	:	:	:	:

c:scape Bracket					
-----------------	--	--	--	--	--

4"	10"	6 1/2"	2.5 lb	FPCCS	\$110
:	:	:	:	:	:

Bivi Bracket					
--------------	--	--	--	--	--

3"	4"	1/4"	1.5 lb	FPCBIVI	\$127
:	:	:	:	:	:

SIN 711.2

CF Series Flat Panel Monitor Arms and Supports

SIN 711.2

CF Series Flat Panel Light-Duty, Standard, and Heavy Duty Monitor Arms



Tip: When using CF Series slider bar, reduce monitor weight capacity by 2 lb per monitor supported by the slider bar tilt head.

Tip: Bracket color will match selected monitor arm color.

Standard Includes	Required to Specify
-------------------	---------------------

- Monitor arm: paint
- Standard tilt head
- No mounting bracket

- 1 Style number
- 2 Paint color number for monitor arm:
0835 Black
7018 Pewter
ZW01 Pearl Snow
- 3 Tilt head mechanism (see Required Selections below)
- 4 Options, if selected (see below)

Required Selections	Price	Required to Specify
---------------------	-------	---------------------

Tilt Head Mechanism

- Standard tilt head
No cost
- Standard tilt head with quick release
+\$ 20
- Heavy-duty spring tilt head
+\$ 27
- Heavy-duty spring tilt head with quick release
+\$ 38
- Standard tilt head slider bar with quick release
+\$110
- Heavy-duty spring tilt head slider bar with quick release
+\$130

- Specify with *standard tilt head*.
Specify with *standard tilt head with quick release*.
Specify with *heavy-duty spring tilt head*.
Specify with *heavy-duty spring tilt head with quick release*.
Specify with *standard tilt head slider bar with quick release*.
Specify with *heavy-duty spring tilt head slider bar with quick release*.

Options	Price	Required to Specify
---------	-------	---------------------

Brackets

- No bracket
No cost
- Desk C-clamp/grommet bracket
+\$ 51
- Through-mount
+\$ 51
- Desk C-clamp/through-mount grommet
+\$ 51
- Wall/reverse wall mount bracket
+\$ 51
- Slatwall
+\$ 51
- FrameOne
+\$ 90
- c:scape
+\$106

- Specify with *no bracket*.
Specify with *desk C-clamp/grommet bracket*.
Specify with *through-mount bracket*.
Specify with *desk C-clamp/through-mount grommet bracket*.
Specify with *wall/reverse wall mount bracket*.
Specify with *Slatwall bracket*.
Specify with *FrameOne bracket*.
Specify with *c:scape bracket*.

Specification Information

Weight	Style Number	Base Price
--------	--------------	------------

Light-Duty Monitor Arms

5 lb	CF450	\$365
6 lb	CF500	\$390

Standard Monitor Arms

10.5 lb	CF600	\$389
10.5 lb	CF800	\$407

Heavy-Duty Monitor Arm

10.5 lb	CF1000	\$442
---------	---------------	-------



Tip: CF450 arm supports monitors 6–19 lb. CF500 arm supports monitors 2–12.5 lb.



Tip: CF600 arm supports monitors 5–17 lb. CF800 arm supports monitors 9–25 lb.

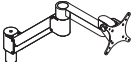

Tip: Heavy-duty arm, CF1000 supports 11-28 lb.

Tip: CF450, CF500, CF600, CF800, and CF1000 cannot be used with maximum-duty arm bracket CFSPSGLBASE.

Tip: Slatwall skin brace package is required when mounting a flat panel monitor arm on an Answer slatwall skin.

Tip: When mounting CF Series arm brackets to Slatwall, bracket must be mounted no further than 10" away from Slatwall mounting bracket. If application does not allow bracket to be installed within the 10" range, an additional bracket or brackets should be installed within 10" of desired arm location.

Tip: Two single arms can be mounted on 18"H or 24"H Answer slatwall skin that has an installed brace package. For optimal stability, the monitor arm should be mounted as shown at right:

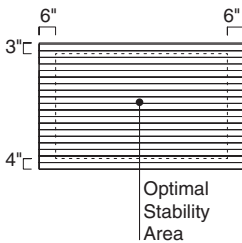

CF Series Flat Panel Monitor Arms and Supports, continued

SIN 711.2

CF Series Flat Panel Maximum-Duty Monitor Arm and Support

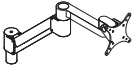

Tip: Maximum-duty arm supports monitors 13–40 lb.

Tip: Maximum-duty monitor arm is standard with a heavy-duty spring tilt head mechanism only.

Tip: When using CF Series slider bar, reduce monitor weight capacity by 2 lb per monitor supported by the slider bar tilt head.

Tip: CF2500 can only be used with the maximum-duty arm bracket (CFSPSGLBASE).

Tip: Bracket color will match selected monitor arm color.

Standard Includes	Required to Specify
-------------------	---------------------

- Monitor arm: paint
- Heavy-duty spring tilt head mechanism
- No mounting bracket

- 1 Style number
- 2 Paint color number for monitor arm:
0835 Black
7018 Pewter
ZW01 Pearl Snow
- 3 Tilt head mechanism (see Required Selections below)
- 4 Options, if selected (see below)

Required Selections	Price	Required to Specify
---------------------	-------	---------------------

Tilt Head Mechanism	• Heavy-duty spring tilt head	No cost	Specify with heavy-duty spring tilt head. Specify with heavy-duty spring tilt head with quick release. Specify with heavy-duty spring tilt head slider bar with quick release.
	• Heavy-duty spring tilt head with quick release	+\$ 38	
	• Heavy-duty spring tilt head slider bar with quick release	+\$130	

Options	Price	Required to Specify
---------	-------	---------------------

Brackets	• No bracket	No cost	Specify with no bracket. Specify with maximum-duty arm bracket.
	• Maximum-duty arm	+\$ 62	

Specification Information		
•Weight	•Style Number	•Base Price

12 lb	CF2500	\$509
.	.	.
.	.	.

CF Series Flat Panel Monitor Arm Assemblies with Dual-Bar Arm

Standard Includes	Required to Specify
-------------------	---------------------

- Monitor arm: paint
- Heavy-duty tilt head
- Dual-bar arm: 7018 Pewter
- No mounting bracket

- 1 Style number
- 2 Paint color number for monitor arm:
0835 Black
7018 Pewter
ZW01 Pearl Snow
- 3 Options, if selected (see below)

Tip: Bracket color will match selected monitor arm color.

Tip: Bivi mounting bracket requires additional Bivi brace (TS8TMBRAC).
▶ See turnstone Specification Guide.

Tip: Grommet mount requires 2" or larger hole.

Options	Price	Required to Specify
---------	-------	---------------------

Brackets

- No bracket: No cost
- Desk C-clamp/grommet: +\$ 51
- Through-mount: +\$ 51
- Desk C-clamp/through-mount grommet: +\$ 51
- Wall/reverse wall mount: +\$ 51
- Slatwall: +\$ 51
- FrameOne: +\$ 90
- c:scape: +\$106

- Specify with *no bracket*.
Specify with *desk C-clamp/grommet bracket*.
Specify with *through-mount bracket*.
Specify with *desk C-clamp/through-mount grommet bracket*.
Specify with *wall/reverse wall mount grommet bracket*.
Specify with *Slatwall bracket*.
Specify with *FrameOne bracket*.
Specify with *c:scape bracket*.

Specification Information		
Weight	Style Number	Base Price

Weight	Style Number	Base Price
--------	--------------	------------

Standard Monitor Arm with Dual-Bar Arm, Heavy-Duty Tilt Head

18 lb	CF800DUALBAR	\$641
-------	---------------------	-------

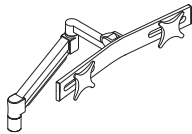

Tip: When using dual-bar arm the standard arm supports monitors 4–20 lb total weight.

Heavy-Duty Monitor Arm with Dual-Bar Arm, Heavy-Duty Tilt Head

13 lb	CF1000DUALBAR	\$676
-------	----------------------	-------

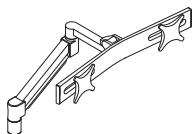

Tip: When using dual-bar arm the heavy-duty arm supports monitors 6–26 lb total weight.

Tip: 5 lb must be subtracted from the standard CF Series maximum arm load rating when determining the load for CF Series dual-bar arms.

CF Series Flat Panel Monitor Arms and Supports, continued

SIN 711.2

CF Series Flat Panel Maximum-Duty Monitor Arm Assembly with Dual-Bar Arm

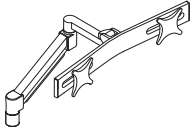

Tip: When using dual-bar arm the maximum-duty arm supports monitors 8–39 lb total weight.

Tip: Bracket color will match selected monitor arm color.

Standard Includes	Required to Specify
<ul style="list-style-type: none"> • Monitor arm: paint • Heavy-duty spring tilt head • Dual-bar arm: 7018 Pewter • No mounting bracket 	<ul style="list-style-type: none"> 1 Style number 2 Paint color number for monitor arm: <ul style="list-style-type: none"> 0835 Black 7018 Pewter ZW01 Pearl Snow 3 Options, if selected (see below)

Options	Price	Required to Specify
Brackets <ul style="list-style-type: none"> • No bracket • Maximum-duty arm 	<ul style="list-style-type: none"> No cost +\$62 	<ul style="list-style-type: none"> Specify <i>with no bracket</i>. Specify <i>with maximum-duty arm bracket</i>.

Specification Information		
Weight	Style Number	Base Price
21 lb	CF2500DUALBAR	\$716
.	.	.

CF Series Flat Panel Monitor Arms and Supports, continued

SIN 711.2

CF Series Flat Panel Monitor Pole Mounts with Arms



Standard Includes	Required to Specify
<ul style="list-style-type: none"> • Monitor arm pole mount: paint • 14"H pole • Tilt head mechanism • Standard tilt head • No mounting bracket 	<ol style="list-style-type: none"> 1 Style number 2 Paint color number for pole mount: 0835 Black 7018 Pewter ZW01 Pearl Snow 3 Tilt head mechanism (see Required Selections below) 4 Pole height (see Required Selections below) 5 Options, if selected (see below)

Tip: When using CF Series slider bar, reduce monitor weight capacity by 2 lb per monitor supported by the slider bar tilt head.

	Required Selections	Price	Required to Specify
Tilt Head Mechanism	Single		
	• Standard tilt head	No cost	Specify with standard tilt head.
	• Standard tilt head with quick release	+\$ 20	Specify with standard tilt head with quick release.
	• Heavy-duty spring tilt head	+\$ 27	Specify with heavy-duty spring tilt head.
	• Heavy-duty spring tilt head with quick release	+\$ 38	Specify with heavy-duty spring tilt head with quick release.
	• Standard tilt head slider bar with quick release	+\$110	Specify with standard tilt head slider bar with quick release.
	• Heavy-duty spring tilt head slider bar with quick release	+\$130	Specify with heavy-duty spring tilt head slider bar with quick release.
	Double		
	• Standard tilt head	No cost	Specify with standard tilt head.
	• Standard tilt head with quick release	+\$ 40	Specify with standard tilt head with quick release.
	• Heavy-duty spring tilt head	+\$ 54	Specify with heavy-duty spring tilt head.
	• Heavy-duty spring tilt head with quick release	+\$ 76	Specify with heavy-duty spring tilt head with quick release.
	• Standard tilt head slider bar with quick release	+\$220	Specify with standard tilt head slider bar with quick release.
	• Heavy-duty spring tilt head slider bar with quick release	+\$260	Specify with heavy-duty spring tilt head slider bar with quick release.
Pole Height	• 14"H pole	No cost	Specify with 14"H pole.
	• 20"H pole	+\$ 55	Specify with 20"H pole.

Tip: Bracket color will match selected monitor arm color.

	Options	Price	Required to Specify
Brackets	• No bracket	No cost	Specify with no bracket.
	• Desk C-clamp/grommet	+\$ 51	Specify with desk C-clamp/grommet bracket.
	• Through-mount	+\$ 51	Specify with through-mount bracket.
	• Desk C-clamp/through-mount grommet	+\$ 51	Specify with desk C-clamp/through-mount grommet bracket.
	• Wall/reverse wall mount	+\$ 51	Specify with wall/reverse wall mount bracket.
	• Slatwall (single-arm only)	+\$ 51	Specify with Slatwall bracket.
	• Bivi	+\$ 51	Specify with Bivi bracket.
	• FrameOne	+\$ 90	Specify with FrameOne bracket.
	• c:scape	+\$106	Specify with c:scape bracket.

Tip: Bivi mounting bracket requires additional Bivi brace (TS8TMBRAC).
▶ See turnstone Specification Guide.

Tip: Grommet mount requires 2" or larger hole.

Specification Information

• Height	• Weight	• Style Number	• Base Price
----------	----------	----------------	--------------

Single-Arm Pole Mount

12"	6 lb	CFSHA	\$333
-----	------	--------------	-------



Tip: Lower arm is 8" in length and upper arm is 4" in length. Tilt head included.

Tip: Single-arm pole mount supports monitors up to 25 pounds.

Double-Arm Pole Mount

12"	11.5 lb	CFDHA	\$569
-----	---------	--------------	-------

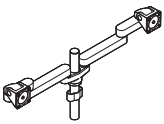

Tip: Double-arm pole mount supports two 24" monitors (16:9 aspect ratio, 22"W side to side) up to 25 pounds per monitor. Use of 24" monitors will reduce available focal depth adjustment.

Tip: Double-arm pole is not recommended for use with Slatwall mounting bracket.

Tip: Slatwall skin brace package is required when mounting a flat panel monitor arm on an Answer slatwall skin.

Tip: Two single arms can be mounted on 18"H or 24"H Answer slatwall skin that has an installed brace package. For optimal stability, the monitor arm should be mounted as shown at right:

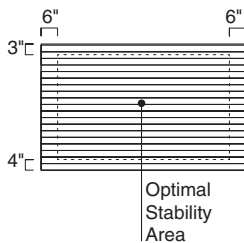

Computer Support Tools

CF Series Flat Panel Monitor Arms and Supports, continued

SIN 711.2

CF Series Flat Panel Pole Without Arms



Tip: Assemblies using CFP28 may not exceed 15 lb per monitor.

Standard Includes	Required to Specify
<ul style="list-style-type: none"> • Monitor pole mount: paint 	1 Style number 2 Paint color number for pole mount: 0835 Black 7018 Pewter ZW01 Pearl Snow

Related Products
<ul style="list-style-type: none"> • Flat panel monitor arm • Flat panel monitor brackets

▶ Page 174
▶ Page 198

Specification Information			
• Dimensions	• Weight	• Style	• Price
H		Number	
14"	2 lb	CFP14	\$124
20"	2.3 lb	CFP20	\$146
28"	3 lb	CFP28	\$163
:	:	:	:

CF Series Single Static Modular Monitor Arm Assembly



Tip: CFMSP supports monitors up to 30 lb and up to 50".

Tip: CF Series modular c:scape, FrameOne, Bivi mounting brackets are not approved for use on one over one, two over two and three over three applications.

Tip: When using CF Series slider bar, reduce monitor weight capacity by 2 lb per monitor supported by the slider bar tilt head.

Tip: CF modular pole mount C-clamp can be C-clamped/through-mounted/grommet mounted.

Tip: CF Series modular monitor arm assemblies are standard with standard tilt head, and VESA plate.

Tip: Bracket color will match selected monitor arm color.

Standard Includes	Required to Specify
<ul style="list-style-type: none"> • Monitor arm: paint • Standard tilt head • 14"H pole 	<ol style="list-style-type: none"> 1 Style number 2 Paint color number for monitor arm: 0835 Black 7018 Pewter ZW01 Pearl Snow 3 Tilt head mechanism (see Required Selections below) 4 Pole height (see Required Selections below) 5 Options, if selected (see below)

Required Selections	Price	Required to Specify
Tilt Head Mechanism <ul style="list-style-type: none"> • Standard tilt head • Standard tilt head with quick release • Heavy-duty spring tilt head • Heavy-duty spring tilt head with quick release • Standard tilt head slider bar with quick release • Heavy-duty spring tilt head slider bar with quick release 	No cost +\$ 20 +\$ 27 +\$ 38 +\$110 +\$130	Specify with <i>standard tilt head</i> . Specify with <i>standard tilt head with quick release</i> . Specify with <i>heavy-duty spring tilt head</i> . Specify with <i>heavy-duty spring tilt head with quick release</i> . Specify with <i>standard tilt head slider bar with quick release</i> . Specify with <i>heavy-duty spring tilt head slider bar with quick release</i> .
Pole Height <ul style="list-style-type: none"> • 14"H pole • 20"H pole 	No cost +\$ 55	Specify with <i>14"H pole</i> . Specify with <i>20"H pole</i> .

Options	Price	Required to Specify
Brackets <ul style="list-style-type: none"> • No bracket • Modular pole mount C-clamp single tier 	No cost +\$ 60	Specify with <i>no bracket</i> . Specify with <i>modular pole mount C-clamp single tier bracket</i> .

Specification Information

Style Number	Base Price
CFMSP	\$176

CF Series Flat Panel Monitor Arms and Supports, continued

SIN 711.2

CF Series Single Static One-Over-One Monitor Arm Assembly



Tip: CFMSSP supports monitors up to 20 lb per monitor and up to 24" per monitor.

Tip: CF modular pole mount C-clamp can be C-clamped/through-mounted/grommet mounted.

Tip: CF Series modular monitor arm assemblies are standard with standard tilt head, and VESA plate.

Tip: When using CF Series slider bar, reduce monitor weight capacity by 2 lb per monitor supported by the slider bar tilt head.

Tip: Bracket color will match selected monitor arm color.

Standard Includes	Required to Specify
-------------------	---------------------

- Monitor arm: paint
- Standard tilt head

- 1 Style number
- 2 Paint color number for monitor arm:
0835 Black
7018 Pewter
ZW01 Pearl Snow
- 3 Tilt head mechanism (see Required Selections below)
- 4 Options, if selected (see below)

Tilt Head Mechanism	Required Selections	Price	Required to Specify
---------------------	---------------------	-------	---------------------

- | | | | |
|----------------------------|---|---------|---|
| Tilt Head Mechanism | • Standard tilt head | No cost | Specify with <i>standard tilt head</i> .
Specify with <i>standard tilt head with quick release</i> .
Specify with <i>heavy-duty spring tilt head</i> .
Specify with <i>heavy-duty spring tilt head with quick release</i> .
Specify with <i>standard tilt head slider bar with quick release</i> .
Specify with <i>heavy-duty spring tilt head slider bar with quick release</i> . |
| | • Standard tilt head with quick release | +\$ 40 | |
| | • Heavy-duty spring tilt head | +\$ 54 | |
| | • Heavy-duty spring tilt head with quick release | +\$ 76 | |
| | • Standard tilt head slider bar with quick release | +\$220 | |
| | • Heavy-duty spring tilt head slider bar with quick release | +\$260 | |

Brackets	Options	Price	Required to Specify
----------	---------	-------	---------------------

- | | | | |
|-----------------|------------------------------|---------|--|
| Brackets | • No bracket | No cost | Specify with <i>no bracket</i> .
Specify with <i>modular pole mount C-clamp bracket</i> . |
| | • Modular pole mount C-clamp | +\$60 | |

Specification Information

Style Number	Base Price
CFMSSP	\$510

CF Series Single Dynamic Modular Monitor Arm Assemblies

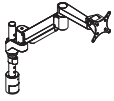

Tip: CF Series modular monitor arm assemblies are standard with standard tilt head, and VESA plate.

Standard Includes	Required to Specify
<ul style="list-style-type: none"> • Monitor arm with pole: paint • Standard tilt head • 14"H pole 	<ol style="list-style-type: none"> 1 Style number 2 Paint color number for monitor arm: <ul style="list-style-type: none"> 0835 Black 7018 Pewter ZW01 Pearl Snow 3 Tilt head mechanism (see Required Selections below) 4 Pole height (see Required Selections below) 5 Options, if selected (see below)

	Required Selections	Price	Required to Specify
Tilt Head Mechanism	• Standard tilt head	No cost	Specify with <i>standard tilt head</i> .
	• Standard tilt head with quick release	+\$ 20	Specify with <i>standard tilt head with quick release</i> .
	• Heavy-duty spring tilt head	+\$ 27	Specify with <i>heavy-duty spring tilt head</i> .
	• Heavy-duty spring tilt head with quick release	+\$ 38	Specify with <i>heavy-duty spring tilt head with quick release</i> .
	• Standard tilt head slider bar with quick release	+\$110	Specify with <i>standard tilt head slider bar with quick release</i> .
	• Heavy-duty spring tilt head slider bar with quick release	+\$130	Specify with <i>heavy-duty spring tilt head slider bar with quick release</i> .
Pole Height	• 14"H pole	No cost	Specify with <i>14"H pole</i> .
	• 20"H pole	+\$ 55	Specify with <i>20"H pole</i> .

Tip: When using CF Series slider bar, reduce monitor weight capacity by 2 lb per monitor supported by the slider bar tilt head.

	Options	Price	Required to Specify
Brackets	• No bracket	No cost	Specify with <i>no bracket</i> .
	• Modular pole mount C-clamp single tier	+\$ 60	Specify with <i>modular pole mount C-clamp single tier modular</i> .

Tip: Bracket color will match selected monitor arm color.

Tip: Bivi mounting bracket requires additional Bivi brace (TS8TMBRAC).
 ▶ See turnstone Specification Guide.

Tip: CF Series single dynamic modular monitor arm assemblies support monitors for various weights and sizes.
 ▶ See Worktools Specification Guide.

Tip: CF Series modular C-clamp can be grommet mounted and also comes with the flex mount package which allows through-mount.

Specification Information	
Style Number	Base Price
CF450MSP	\$333
CF500MSP	\$337
CF600MSP	\$342
CF800MSP	\$345
CF1000MSP	\$366

Computer Support Tools

CF Series Flat Panel Monitor Arms and Supports, continued

SIN 711.2

CF Series Dual Static Modular Monitor Arm Assemblies

Tip: CF Series modular monitor arm assemblies are standard with standard tilt head, and VESA plate.

Tip: CF Series modular C-clamp can be grommet mounted and also comes with the flex mount package which allows through-mount.

Tip: When using CF Series slider bar, reduce monitor weight capacity by 2 lb per monitor supported by the slider bar tilt head.

Tip: Bracket color will match selected monitor arm color.

Standard Includes	Required to Specify
<ul style="list-style-type: none"> • Monitor arm: paint • Standard tilt head • 14"H pole 	<ol style="list-style-type: none"> 1 Style number 2 Paint color number for monitor arm: <ul style="list-style-type: none"> 0835 Black 7018 Pewter ZW01 Pearl Snow 3 Tilt head mechanism (see Required Selections below) 4 Pole height (see Required Selections below) 5 Options, if selected (see below)

Required Selections	Price	Required to Specify
Tilt Head Mechanism <ul style="list-style-type: none"> • Standard tilt head • Standard tilt head with quick release • Heavy-duty spring tilt head • Heavy-duty spring tilt head with quick release • Standard tilt head slider bar with quick release • Heavy-duty spring tilt head slider bar with quick release 	No cost +\$ 40 +\$ 54 +\$ 76 +\$220 +\$260	Specify with <i>standard tilt head</i> . Specify with <i>standard tilt head with quick release</i> . Specify with <i>heavy-duty spring tilt head</i> . Specify with <i>heavy-duty spring tilt head with quick release</i> . Specify with <i>standard tilt head slider bar with quick release</i> . Specify with <i>heavy-duty spring tilt head slider bar with quick release</i> .
Pole Height <ul style="list-style-type: none"> • 14"H pole • 20"H pole 	No cost +\$ 55	Specify with <i>14"H pole</i> . Specify with <i>20"H pole</i> .

Options	Price	Required to Specify
Brackets <ul style="list-style-type: none"> • No bracket • Modular pole mount C-clamp single tier 	No cost +\$ 60	Specify with <i>no bracket</i> . Specify with <i>modular pole mount C-clamp single tier bracket</i> .

Specification Information	
Style Number	Base Price

Dual Static Monitor Arm Assembly with Pole

CFMDSP \$443

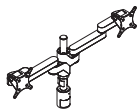

Tip: CFMDSP supports monitors up to 20 lb and up to 24" per monitor.

Wide Dual Static Monitor Arm Assembly with Pole

CFMDSWP \$481

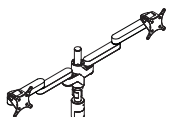

Tip: CFMDSWP supports monitors up to 20 lb and 24" to 30" per monitor.

CF Series Dual Static Modular Monitor Arm Assemblies

Tip: CF Series modular monitor arm assemblies are standard with standard tilt head, and VESA plate.

Tip: CF Series modular C-clamp can be grommet mounted and also comes with the flex mount package which allows through-mount.

Tip: When using CF Series slider bar, reduce monitor weight capacity by 2 lb per monitor supported by the slider bar tilt head.

Tip: Bracket color will match selected monitor arm color.

Standard Includes	Required to Specify
-------------------	---------------------

- Monitor arm: paint
- Standard tilt head

- 1 Style number
- 2 Paint color number for monitor arm:
0835 Black
7018 Pewter
ZW01 Pearl Snow
- 3 Tilt head mechanism (see Required Selections below)
- 4 Options, if selected (see below)

Required Selections	Price	Required to Specify
---------------------	-------	---------------------

Tilt Head Mechanism

- Standard tilt head: No cost
- Standard tilt head with quick release: +\$ 80
- Heavy-duty spring tilt head: +\$108
- Heavy-duty spring tilt head with quick release: +\$152
- Standard tilt head slider bar with quick release: +\$440
- Heavy-duty spring tilt head slider bar with quick release: +\$520

Specify with *standard tilt head*.
Specify with *standard tilt head with quick release*.
Specify with *heavy-duty spring tilt head with quick release*.
Specify with *standard tilt head slider bar with quick release*.
Specify with *heavy-duty spring tilt head slider bar with quick release*.

Options	Price	Required to Specify
---------	-------	---------------------

Brackets

- No bracket: No cost
- Modular pole mount C-clamp two tier: +\$ 60

Specify with *no bracket*.
Specify with *modular pole mount C-clamp two tier bracket*.

Specification Information

Style Number	Base Price
--------------	------------

Static Two-Over-Two Monitor Arm Assembly with Pole

CFMDSDSP	\$ 890
----------	--------

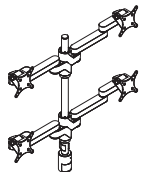

Tip: CFMDSDSP supports monitors up to 12 lb and up to 24" per monitor.

Wide Static Two-Over-Two Monitor Arm Assembly with Pole

CFMDSWDP	\$1045
----------	--------

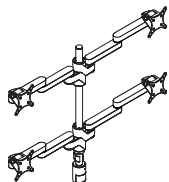

Tip: CFMDSWDP supports monitors up to 12 lb and 30" per monitor.

Computer Support Tools

CF Series Flat Panel Monitor Arms and Supports, continued

SIN 711.2

CF Series Dual Dynamic Modular Monitor Arm Assemblies

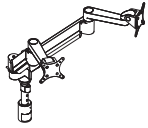

Tip: CF Series dual dynamic modular monitor arm assemblies support monitors for various weights and sizes. ▶ See Worktools Specification Guide.

The C-clamp can be grommet and through mounted.

Tip: CF Series modular monitor arm assemblies are standard with standard tilt head, and VESA plate.

Tip: When using CF Series slider bar, reduce monitor weight capacity by 2 lb per monitor supported by the slider bar tilt head.

Tip: CF Series modular C-clamp can be grommet mounted and also comes with the flex mount package which allows through-mount.

Tip: Bracket color will match selected monitor arm color.

Tip: CF1000MDDP is limited to 25 lbs per monitor when using FrameOne and c:scape brackets.

Standard Includes	Required to Specify
-------------------	---------------------

- Monitor arm with pole: paint
- Standard tilt head
- 14"H pole

- 1 Style number
- 2 Paint color number for monitor arm:
0835 Black
7018 Pewter
ZW01 Pearl Snow
- 3 Tilt head mechanism (see Required Selections below)
- 4 Pole height (see Required Selections below)
- 5 Options, if selected (see below)

Required Selections	Price	Required to Specify
---------------------	-------	---------------------

Tilt Head Mechanism	• Standard tilt head	No cost	Specify with <i>standard tilt head</i> .
	• Standard tilt head with quick release	+\$ 40	Specify with <i>standard tilt head with quick release</i> .
	• Heavy-duty spring tilt head	+\$ 54	Specify with <i>heavy-duty spring tilt head</i> .
	• Heavy-duty spring tilt head with quick release	+\$ 76	Specify with <i>heavy-duty spring tilt head with quick release</i> .
	• Standard tilt head slider bar with quick release	+\$220	Specify with <i>standard tilt head slider bar with quick release</i> .
	• Heavy-duty spring tilt head slider bar with quick release	+\$260	Specify with <i>heavy-duty spring tilt head slider bar with quick release</i> .

Pole Height	• 14"H pole	No cost	Specify with <i>14"H pole</i> .
	• 20"H pole	+\$ 55	Specify with <i>20"H pole</i> .

Options	Price	Required to Specify
---------	-------	---------------------

Brackets	• No bracket	No cost	Specify with <i>no bracket</i> .
	• Modular pole mount C-clamp single tier	+\$ 60	Specify with <i>modular pole mount C-clamp single tier bracket</i> .

Specification Information	
Style Number	Base Price

CF450MDDP	\$599
CF500MDDP	\$603
CF600MDDP	\$611
CF800MDDP	\$626
CF1000MDDP	\$635

CF Series Dual Dynamic Modular Monitor Arm Assemblies

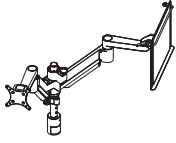

Tip: Supports laptops weighing up to 11 lb.

Tip: For dual dynamic monitor arm assembly with laptop holder, CF500 monitor arm will be designated for laptop holder use. If CF800MDDL is specified, one CF800 arm for the monitor and one CF500 arm for the laptop holder will be ordered.

Tip: When using CF Series slider bar, reduce monitor weight capacity by 2 lb per monitor supported by the slider bar tilt head.

Tip: CF Series modular monitor arm assemblies are standard with standard tilt head, and VESA plate.

Tip: CF Series modular C-clamp can be grommet mounted and also comes with the flex mount package which allows through-mount.

Tip: Bracket color will match selected monitor arm color.

Standard Includes	Required to Specify
<ul style="list-style-type: none"> • Monitor arm with laptop holder and pole: paint • Standard tilt head • 14"H pole 	<ol style="list-style-type: none"> 1 Style number 2 Paint color number for monitor arm: 0835 Black, 7018 Pewter, ZW01 Pearl Snow 3 Tilt head mechanism (see Required Selections below) 4 Pole height (see Required Selections below) 5 Options, if selected (see below)

Required Selections	Price	Required to Specify
Tilt Head Mechanism		Specify with standard tilt head. Specify with standard tilt head with quick release. Specify with heavy-duty spring tilt head. Specify with heavy-duty spring tilt head with quick release. Specify with standard tilt head slider bar with quick release. Specify with heavy-duty spring tilt head slider bar with quick release.
<ul style="list-style-type: none"> • Standard tilt head • Standard tilt head with quick release • Heavy-duty spring tilt head • Heavy-duty spring tilt head with quick release • Standard tilt head slider bar with quick release • Heavy-duty spring tilt head slider bar with quick release 	<ul style="list-style-type: none"> No cost +\$ 20 +\$ 27 +\$ 38 +\$110 +\$130 	

Required Selections	Price	Required to Specify
Pole Height		Specify with 14"H pole. Specify with 20"H pole.
<ul style="list-style-type: none"> • 14"H pole • 20"H pole 	<ul style="list-style-type: none"> No cost +\$ 55 	

Options	Price	Required to Specify
Brackets		Specify with no bracket. Specify with modular pole mount C-clamp single tier bracket.
<ul style="list-style-type: none"> • No bracket • Modular pole mount C-clamp single tier 	<ul style="list-style-type: none"> No cost +\$ 60 	

Specification Information	
Style Number	Base Price
CF450MDDL	\$701
CF500MDDL	\$703
CF600MDDL	\$713
CF800MDDL	\$728
CF1000MDDL	\$737
:	:

Computer Support Tools

CF Series Flat Panel Monitor Arms and Supports, continued

SIN 711.2

CF Series Evolution Single Monitor Arm

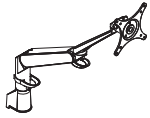

Tip: Single C-clamp mounting bracket is for use on worksurfaces with a thickness of 1/2" to 1 5/8".

Tip: The C-clamp can be grommet mounted.

Tip: Single monitor arm with C-clamp bracket installs from the top of the bracket, not below the worksurface.

Tip: Single monitor arm supports monitors up to 15 lb each and up to 27".

Tip: Bracket color will match selected monitor arm color.

Tip: Bivi mounting bracket requires additional Bivi brace (TS8TMBRAC).
▶ See turnstone Specification Guide.

Tip: CF Series evolution single monitor arms are standard with quick connect tilt head.

Tip: The universal laptop/tablet holder, CFTULT, and the laptop holder platform, CFHLS, can be used with CF Series evolution single. The CFLHS supports up to 9 lb. The CFTULT can support up to 10 lb.

Standard Includes	Required to Specify
-------------------	---------------------

- Monitor arm: paint
- No mounting bracket

- 1 Style number
- 2 Paint color number for monitor arm:
0835 Black
7018 Pewter
ZW01 Pearl Snow
- 3 Options, if selected (see below)

Bracket	Options	Price	Required to Specify
---------	---------	-------	---------------------

- No bracket No cost
- C-clamp CF Series evolution single +\$ 50
- Through-mount CF Series evolution single +\$ 50
- Bivi CF Series evolution single +\$ 50
- FrameOne CF Series evolution single +\$ 90
- c:scape CF Series evolution single +\$106

Specify with no bracket.
Specify with C-clamp CF Series evolution single bracket.
Specify with through-mount CF Series evolution single bracket.
Specify with Bivi CF Series evolution single bracket.
Specify with FrameOne CF Series evolution single bracket.
Specify c:scape CF Series evolution single bracket.

Specification Information				
• Dimensions			• Style	• Base
D	W	H	Number	Price

3 1/8"	10 1/8"	9 1/5"	CFESARMG	\$238
--------	---------	--------	-----------------	-------

CF Series Evolution Dual Monitor Arms

Tip: Bracket color will match selected monitor arm color.

Tip: Bivi mounting bracket requires additional Bivi brace (TS8TMBRAC).

▶ See turnstone Specification Guide.

Tip: CF Series evolution dual monitor arms are standard with quick connect tilt head.

Tip: The universal laptop/tablet holder, CFTULT, and the laptop holder platform, CFHLS, can be used with CF Series evolution dual. The CFLHS supports up to 9 lb. The CFTULT can support up to 10 lb.

Tip: Dual C-clamp mounting bracket is for use on work-surfaces with a thickness of 1/2" to 2".

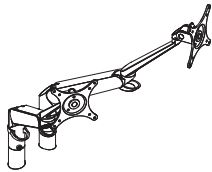

Tip: Dual monitor arm with C-clamp bracket installs from below the worksurface, without tools.

Tip: Dual monitor arm supports monitors up to 15 lb each and up to 27" per monitor.

Tip: To through mount dual CF Series evolution, two CF Series evolution single through-mount brackets (CFSPESTM) must be ordered.

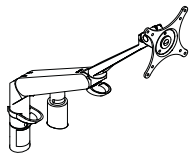

Standard Includes	Required to Specify
-------------------	---------------------

- Monitor arm: paint
- No mounting bracket

- 1 Style number
- 2 Paint color number for monitor arm:
 - 0835 Black
 - 7018 Pewter
 - ZW01 Pearl Snow
- 3 Options, if selected (see below)

Bracket	Options	Price	Required to Specify
---------	---------	-------	---------------------

- No bracket: No cost
- C-clamp CF Series evolution dual: +\$119
- Bivi CF Series evolution dual: +\$119
- FrameOne CF Series evolution dual: +\$125
- c:scape CF Series evolution dual: +\$135

- Specify with no bracket.
- Specify with C-clamp CF Series evolution dual bracket.
- Specify with Bivi CF Series evolution dual bracket.
- Specify with FrameOne CF Series evolution dual bracket.
- Specify c:scape CF Series evolution dual bracket.

Specification Information				
• Dimensions			• Style	• Base
D	W	H	Number	Price

Dual Monitor Arm				
3 1/5"	20 3/5"	9 1/5"	CFEDARMG	\$476

Dual Monitor Arm Conversion Kit				
3 1/5"	20 3/5"	9 1/5"	CFEDARMCKG	\$238

Computer Support Tools

CF Series Flat Panel Monitor Arms and Supports, continued

SIN 711.2

CF Series Triple Static Modular Monitor Arm Assemblies

Tip: CF Series modular monitor arm assemblies are standard with standard tilt head, and VESA plate.

Standard Includes	Required to Specify
<ul style="list-style-type: none"> • Monitor arm: paint • Standard tilt head • 14"H pole 	<ol style="list-style-type: none"> 1 Style number 2 Paint color number for monitor arm: 0835 Black 7018 Pewter ZW01 Pearl Snow 3 Tilt head mechanism (see Required Selections below) 4 Pole height (see Required Selections below) 5 Options, if selected (see below)

Required Selections	Price	Required to Specify
Tilt Head Mechanism <ul style="list-style-type: none"> • Standard tilt head • Heavy-duty spring tilt head 	No cost +\$81	Specify with standard tilt head. Specify with heavy-duty spring tilt head.
Pole Height <ul style="list-style-type: none"> • 14"H pole • 20"H pole 	No cost +\$55	Specify with 14"H pole. Specify with 20"H pole.

Options	Price	Required to Specify
Brackets <ul style="list-style-type: none"> • No bracket • Modular pole mount C-clamp single tier 	No cost +\$60	Specify with no bracket. Specify with modular pole mount C-clamp single tier bracket.

Specification Information	
Style Number	Base Price

Triple Static Monitor Arm Assembly with Pole

CFMTSP	\$580
---------------	-------

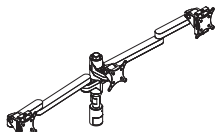

Tip: CFMTSP supports monitors up to 20 lb and up to 24" per monitor and 15 lb when using FrameOne and c:scape brackets.

Wide Triple Static Monitor Arm Assembly with Pole

CFMTSWP	\$640
----------------	-------

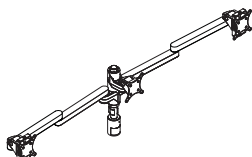

Tip: The C-clamp can be grommet and through-mounted.

Tip: CFMTSWP supports monitors up to 20 lb and 24" to 30" per monitor and 15 lb when using FrameOne and c:scape brackets.

Tip: CF Series modular C-clamp can be grommet mounted and also comes with the flex mount package which allows through-mount.

CF Series Triple Static Modular Monitor Arm Assemblies

Tip: CF Series modular monitor arm assemblies are standard with standard tilt head, and VESA plate.

Standard Includes	Required to Specify
<ul style="list-style-type: none"> • Monitor arm: paint • Standard tilt head 	<ol style="list-style-type: none"> 1 Style number 2 Paint color number for monitor arm: <ul style="list-style-type: none"> 0835 Black 7018 Pewter ZW01 Pearl Snow 3 Tilt head mechanism (see Required Selections below) 4 Options, if selected (see below)

Required Selections	Price	Required to Specify
Tilt Head Mechanism <ul style="list-style-type: none"> • Standard tilt head • Heavy-duty spring tilt head 	No cost +\$162	Specify with <i>standard tilt head</i> . Specify with <i>heavy-duty spring tilt head</i> .

Options	Price	Required to Specify
Brackets <ul style="list-style-type: none"> • No bracket • Modular pole mount C-clamp two tier 	No cost +\$ 60	Specify with <i>no bracket</i> . Specify with <i>modular pole mount C-clamp two tier bracket</i> .

Tip: Bracket color will match selected monitor arm color.

Tip: Three-over-three monitor arm assembly includes four fine height adjustable adapter tilt heads and two standard tilt heads.

Specification Information

Style Number	Base Price

Static Three-Over-Three Monitor Arm Assembly with Pole

CFMTSTSP	\$1112
----------	--------

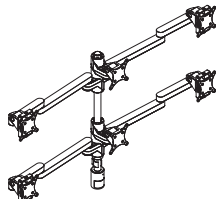

Tip: CFMTSTSP supports monitors up to 10 lb and up to 24" per monitor.

Wide Static Three-Over-Three Monitor Arm Assembly with Pole

CFMTSTWP	\$1240
----------	--------

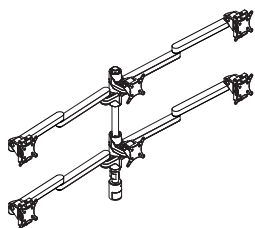

Tip: CFMTSTWP supports monitors up to 10 lb and up to 30" per monitor.

CF Series Flat Panel Monitor Arms and Supports, continued

SIN 711.2

CF Series Monitor Arm Adapters and Tilt Heads

Tip: Use the adjustable monitor adapter with standard tilt head mechanism to add more vertical movement on the CF modular pole system triple assemblies.

Standard Includes	Required to Specify
<ul style="list-style-type: none"> • Tilt head: paint • CTHSLIDEWO adapter: black paint only • Tilt head mechanism with VESA plate, if selected 	<ul style="list-style-type: none"> 1 Style number 2 Paint color number for tilt head: <ul style="list-style-type: none"> 0835 Black 7018 Pewter ZW01 Pearl Snow

Specification Information

Style Number	Price

Adjustable Monitor Adapter without Tilt Head Mechanism

CFTHSLIDEWO	\$ 50



Tip: To adjust the monitor height up and down using a static pole, specify the adjustable monitor arm adapter.

Adjustable Monitor Adapter with Standard Tilt Head Mechanism

CFTHSLIDE	\$112



Adjustable Monitor Adapter with Heavy-Duty Tilt Head Mechanism

CFTHSLIDEHD	\$135



Standard Tilt Head Mechanism with Quick Release

CFQRTH2	\$128



Heavy-Duty Tilt Head Mechanism with Quick Release

CFHDQRTH2	\$147



CF Series Flat Panel Pole Arms

Tip: See CF Series Monitor Arm Application Guide on www.steelcase.com for all possible arm configurations.

Standard Includes	Required to Specify
<ul style="list-style-type: none"> • Monitor arm: paint • Standard tilt head 	<ol style="list-style-type: none"> 1 Style number 2 Paint color number for arm: <ul style="list-style-type: none"> 0835 Black 7018 Pewter ZW01 Pearl Snow 3 Tilt head mechanism (see Required Selections below)

Tilt Head Mechanism	Required Selections	Price	Required to Specify
	• Standard tilt head	No cost	Specify with <i>standard tilt head</i> .
	• Standard tilt head with quick release	+\$ 20 each	Specify with <i>standard tilt head with quick release</i> .
	• Heavy-duty spring tilt head	+\$ 27 each	Specify with <i>heavy-duty spring tilt head</i> .
	• Heavy-duty spring tilt head with quick release	+\$ 38 each	Specify with <i>heavy-duty spring tilt head with quick release</i> .
	• Standard tilt head slider bar with quick release	+\$110 each	Specify with <i>standard tilt head slider bar with quick release</i> .
	• Heavy-duty spring tilt head slider bar with quick release	+\$130 each	Specify with <i>heavy-duty spring tilt head slider bar with quick release</i> .

Tip: When using CF Series slider bar, reduce monitor weight capacity by 2 lb per monitor supported by the slider bar tilt head.

Related Products	Required to Specify
<ul style="list-style-type: none"> • Flat panel monitor arm • Flat panel monitor brackets 	<ul style="list-style-type: none"> ▶ Page 174 ▶ Page 198

Specification Information		
Weight	Style Number	Base Price

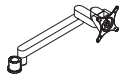

Tip: Lower arm is 8" in length and upper arm is 4" in length. Tilt head included.

Single Pole Arm		
2 lb	CFSARM	\$126

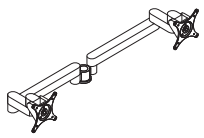

Dual Pole Arm		
4 lb	CFDARM	\$262

Computer Support Tools

CF Series Flat Panel Monitor Arms and Supports, continued

SIN 711.2

CF Series Tablet and Laptop Holders



Tip: Laptop holder and universal laptop/tablet holder attach to tilt head mechanism (not included).

Tip: The laptop holder platform (CFLHS) and the Universal tablet and laptop support (CFTULT) can be used on CF Series, as well as most monitor arms with a VESA plate and tilt head that has tilt functionality.

Tip: Laptop holder includes black pad to stop laptop slippage. Security cord secures laptop in place.

Standard Includes	Required to Specify
-------------------	---------------------

- Laptop holder, if selected: paint
- Universal laptop/tablet holder, if selected: black/pewter combination

- 1 Style number
- 2 Paint color number for laptop holder, if selected:
0835 Black
7018 Pewter
ZW01 Pearl Snow

Specification Information			
• Dimensions		• Style	• Price
D	W	Number	

D	W	Style Number	Price
---	---	--------------	-------

Laptop Holder Platform

10"	13½"	CFLHS	\$174
-----	------	--------------	-------

CF Series Flat Panel Monitor Arms and Supports, continued

SIN 711.2

CF Series Flat Panel Monitor Brackets

Tip: Flat panel monitor arm must be used with flat panel monitor brackets, ordered separately.

Tip: When mounting CF Series arm brackets to Slatwall, bracket must be mounted no further than 10" away from Slatwall mounting bracket. If application does not allow bracket to be installed within the 10" range, an additional bracket or brackets should be installed within 10" of desired arm location.

Tip: See CF Series Monitor Arm Application Guide on www.steelcase.com for all possible arm configurations.



Tip: C-clamp bracket is for use with worksurfaces with a thickness of 1" to 1 5/8".



Tip: Requires 3/8" diameter through hole. For use with maximum worksurface thickness of 1" with throughmount bracket base plate and 1 5/8" without throughmount bracket base plate.



Tip: CFSPWM is not recommended for drywall, sheet rock, or plaster surfaces.



Tip: When using CFSPSW, limit the CF arm load to 25 lb.

Standard Includes

- Bracket: paint

Required to Specify

- 1 Style number
- 2 Paint color number for bracket:
 - 0835 Black
 - 7018 Pewter
 - ZW01 Pearl Snow

Related Products

- CF Series flat panel monitor arm ▶ Page 174
- CF Series flat panel monitor pole mounts ▶ Page 178

Specification Information

•Weight	•Style Number	•Price
:	:	:
:	:	:

Desk-Clamp/Grommet Bracket

3.5 lb	CFSPC	\$51
:	:	:

Through-Mount Bracket

2.5 lb	CFSPTM	\$51
:	:	:

Desk-Clamp/Grommet/Through-Mount Bracket

3.5 lb	CFSPCTM	\$51
:	:	:

Wall/Reverse Wall Mount Bracket

2.5 lb	CFSPWM	\$51
:	:	:

Slatwall Bracket

3 lb	CFSPSW	\$51
:	:	:

▶ **Specification Information, continued on next page**

► Specification Information, continued from previous page

Specification Information

•Weight	•Style •Number	•Price
---------	-------------------	--------

Maximum-Duty Arm Bracket

4 lb	CFSPSGLBASE	\$ 62
------	--------------------	-------



Tip: Maximum-duty monitor arms CF2500 and flat panel pole CFP28 can be used only with maximum-duty arm bracket CFSPSGLBASE.

Modular Pole Mount C-Clamp Bracket

4 lb	CFSPMOD	\$ 60
------	----------------	-------



Tip: CFSPMODST is used with CFP14 and CFSPMOD is used with CFP28.

Tip: CFSPMOD is recommended for use with CF Series modular assemblies one over one, two over two, and three over three.

Tip: CF Series modular C-clamp also comes with the flex mount package which allows thru-mount.

FrameOne Bracket

3 lb	CFSPFO	\$ 90
------	---------------	-------



c:scape Bracket

3 lb	CFSPCS	\$106
------	---------------	-------



T-Shape Dual-Base Bracket

5 lb	CFSPSHAPEBASE	\$107
------	----------------------	-------



Tip: T-shape dual-base bracket is for use with CF450, CF500, CF600, CF800, and CF1000 Series monitor arms.

Tip: CFSPSGLBASE is recommended for use with CFP28 and monitor over monitor configurations.

Dual-Bar Bracket

5 lb	CFDUALBAR	\$207
------	------------------	-------

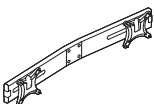

Tip: When using dual-bar bracket, the maximum weight of monitor is 5 lb less than arm support allows with other brackets.

Tip: Heavy-duty spring tilt head option must be specified on monitor arm (ordered separately) when using dual-bar bracket.

Tip: CFDUALBAR is available in 7018 Pewter only.

CF Series Flat Panel Monitor Arms and Supports, continued

SIN 711.2

CF Series 6"H Flat Panel Arm Extender



Standard Includes	Required to Specify
<ul style="list-style-type: none"> • 11" Extender: paint 	<ul style="list-style-type: none"> 1 Style number 2 Paint color number for extender: <ul style="list-style-type: none"> 0835 Black 7018 Pewter ZW01 Pearl Snow

Related Products
<ul style="list-style-type: none"> • CF450, CF500, CF800, and CF1000 monitor arms

▶ Page 174

Specification Information

Weight	Style Number	Price
•	•	•
:	:	:
:	:	:

For use with CF450, CF500, CF800, and CF1000

1 lb	CFXT6H	\$188
:	:	:

CF Series Modular Articulating Arm Extensions for Pole Mount Assemblies



Tip: CF Series modular arm extensions are interchangeable and retrofitable. Arm extensions support larger monitors.

Tip: Tilt head is not included with the extension arm. Order tilt heads through Service Parts.

Standard Includes	Required to Specify
<ul style="list-style-type: none"> • Articulating extension arm: paint 	<ul style="list-style-type: none"> 1 Style number 2 Paint color number for extender: <ul style="list-style-type: none"> 0835 Black 7018 Pewter ZW01 Pearl Snow

Specification Information

Weight	Style Number	Price
•	•	•
:	:	:
:	:	:

0.5 lb	CFXP4H	\$24
0.8 lb	CFXP8H	\$39
1.1 lb	CFXP12H	\$60
:	:	:

CF Series Wall-Mount Support



Standard Includes	Required to Specify
<ul style="list-style-type: none"> • Wall-mount bracket: paint • Tilt head 	1 Style number 2 Paint color number for bracket: 0835 Black 7018 Pewter ZW01 Pearl Snow

Specification Information		
Weight	Style Number	Price
3.5 lb	CFWM	\$122

Tip: CFWM is not recommended for drywall, sheet rock, or plaster surfaces.

Computer Support Tools

CF Series Modular Arm Brackets

Standard Includes	Required to Specify
<ul style="list-style-type: none"> • Bracket: paint • Inserts to attach arm extensions and hardware 	1 Style number 2 Paint color number for bracket: 0835 Black 7018 Pewter ZW01 Pearl Snow

Specification Information	
Style Number	Price
One Connector	
CFMSC	\$25



Tip: CFMSC connectors are included with CF Series modular assemblies.

Two Connectors	
CFMDC	\$50



Tip: CF Series dynamic arms can be used with the connectors with the connector inserts removed.

CF Series Flat Panel Monitor Arms and Supports, continued

SIN 711.2

LED Monitor Light with Bracket

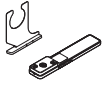

Standard Includes	Required to Specify
<ul style="list-style-type: none"> • Light housing: 4799 Platinum Metallic • Bracket: 0835 Black • 4-watt LED • 9' cord: black plastic only • Attachment hardware 	Style number

Specification Information

Weight	Style Number	Price
0.75 lb	FPALED	\$287

For Use with CF Series and FYI Monitor Arms

0.75 lb	FPALED	\$287
---------	---------------	-------

For Use with Sync

0.75 lb	FPASYNLED	\$287
---------	------------------	-------

CF Series Technology Cradle



Standard Includes	Required to Specify
<ul style="list-style-type: none"> • Cradle: 0835 Black • Technology support strap 	Style number

Specification Information

Dimensions			Style Number	Price
D	W	H		
7/8"–2 1/4"	7"–9"	9 3/4"	CFTECHCRD	\$80

Tip: Technology cradle will work with 75 mm/ 100 mm VESA plate of other monitor arms.

Tip: Technology cradle can be mounted to a monitor arm, pole, wall mount, or under the worksurface.

Tip: When mounted between a monitor and tilt head, maximum monitor weight is 15 lb or the rated load of the monitor arm, whichever is lower.

Tip: Technology cradle maximum load capacity is 6 lb when mounted to a VESA plate and 11 lb when attached to a CF Series modular pole, mounted underneath a worksurface or to a wall.

FYI Single Flat Panel Monitor Arms and Supports with Mounting Brackets

FYI Single Flat Panel Monitor Arms and Supports with Mounting Brackets

SIN 711.2

Tip: FYI flat panel arm support is for use with monitors 5 to 20 lb.

Tip: When planning with stand-alone, single-sided FrameOne base units, the worksurface must be 66"W or greater and utilize no more than one single FYI flat panel monitor arm.

Tip: FYI flat panel monitor arm is not for use in front of stanchion mounted Slatwall.

Tip: The colors for upper arm and cable cover are defaulted by monitor arm.
 ▶ See Worktools Specification Guide for default finishes.

Tip: Monitor arms with C-clamp brackets are not recommended on Universal tables with P-edge as the user's edge wraps all the way around. Universal Systems Worksurfaces with P-edge will work as the user's edge is applied to the front only.

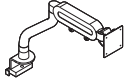

Tip: C-clamp bracket is for use with worksurfaces with a thickness of 3/4" to 1 3/8".

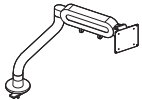

Tip: Through-mount bracket is for use with worksurfaces with a thickness of 1" to 2".

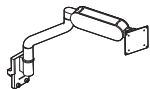
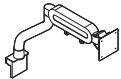

Tip: FYI flat panel monitor arms should only be mounted to c:scape desks that are tethered to either the beam, another desk, or 1 1/2"-High low storage with a connect zone.

Standard Includes	Required to Specify
<ul style="list-style-type: none"> • Monitor arm: paint • 75 mm/100 mm VESA plate • Mounting bracket • Upper arm and cable cover: color defaulted by monitor arm color 	<ul style="list-style-type: none"> 1 Style number 2 Paint color number for monitor arm: <ul style="list-style-type: none"> 4231 Arctic White 4710 Low Gloss Black 4799 Platinum Metallic

Specification Information

• Dimensions			• Weight	• Style	• Price
D	W	H		Number	

C-Clamp Mounting Bracket					
4"	14"	15"	13.5 lb	FPASINGLECC	\$394

Through-Mount Mounting Bracket					
4"	14"	15"	12.5 lb	FPASINGLETM	\$394

FrameOne Mounting Bracket					
4"	14"	15"	13.5 lb	FPASINGLEFO	\$394

c:scape Mounting Bracket					
9"	14"	15"	15 lb	DFPASINGLECS	\$436

Tip: Slatwall skin brace package is required when mounting a flat panel monitor arm on an Answer slatwall skin.

Tip: Single monitor arm can be mounted on 12"H slatwall skin that has an installed brace package.

Tip: Two single or one dual monitor arm can be mounted on 18"H or 24"H Answer slatwall skin that has an installed brace package. For optimal stability, the monitor arm should be mounted as shown at right:

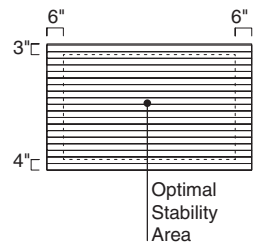

Computer Support Tools

FYI Flat Panel Monitor Arms and Supports without Mounting Brackets

SIN 711.2

FYI Flat Panel Monitor Arm without Mounting Bracket

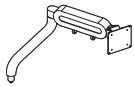

Tip: FYI flat panel arm support is for use with monitors 5 to 20 lb.

Tip: Mounting brackets must be ordered separately. ▶ See page 205

Tip: The colors for upper arm and cable cover are defaulted by monitor arm. ▶ See Worktools Specification Guide for default finishes.

Tip: Except for FPASINGLECC, FPASINGLETM, DFPASINGLECS, and FPASINGLEFO please order modular options and mounting bracket separately.

Standard Includes	Required to Specify
-------------------	---------------------

- | | |
|--|---|
| <ul style="list-style-type: none"> • Monitor arm: paint • 75 mm/100 mm VESA plate • Upper arm and cable cover: color defaulted by monitor arm color | <ul style="list-style-type: none"> 1 Style number 2 Paint color number for flat panel monitor arm: <ul style="list-style-type: none"> 4231 Arctic White 4710 Low Gloss Black 4799 Platinum Metallic |
|--|---|

Related Products

- | | |
|--|--|
| <ul style="list-style-type: none"> • Wall-mount bracket • Slatwall/SlatRail mounting bracket | <ul style="list-style-type: none"> ▶ Page 205 ▶ Page 205 |
|--|--|

Specification Information					
• Dimensions			• Weight	• Style Number	• Price
D	W	H			

4"	14"	15"	10 lb	FPASINGLE	\$343
•	•	•	•	•	•

FYI Upper Arm



Tip: FYI flat panel arm support is for use with monitors 5 to 20 lb.

Tip: Mounting brackets must be ordered separately. ▶ See page 205

Tip: The colors for cable cover are defaulted by monitor arm. ▶ See Worktools Specification Guide.

Tip: When mounting FYI single flat panel arms to Slatwall, bracket must be mounted no further than 10" away from Slatwall mounting bracket. If application does not allow bracket to be installed within the 10" range, an additional bracket or brackets should be installed within 10" of desired arm location.

Standard Includes	Required to Specify
-------------------	---------------------

- | | |
|---|--|
| <ul style="list-style-type: none"> • Monitor arm: paint • Cable cover: <ul style="list-style-type: none"> – 6000 Black, if 4710 Black selected on monitor arm – Plastic price group 1, if 9212 Silver selected on monitor arm • 75 mm/100 mm VESA plate | <ul style="list-style-type: none"> 1 Style number 2 Paint color number for monitor arm: <ul style="list-style-type: none"> 4710 Black 9212 Silver 3 Plastic color number for cable covers, if 9212 Silver is selected on monitor arm: <ul style="list-style-type: none"> 6000 Black 6009 Arctic White 6544 Frost |
|---|--|

Related Products

- | | |
|--|--|
| <ul style="list-style-type: none"> • Wall-mount bracket • Slatwall/SlatRail mounting bracket | <ul style="list-style-type: none"> ▶ Page 205 ▶ Page 205 |
|--|--|

Specification Information					
• Dimensions			• Weight	• Style Number	• Price
D	W	H			

4"	4 ¹ / ₂ "	10"	3.5 lb	FPAUPPER	\$302
•	•	•	•	•	•

FYI Tilt/Pan



Tip: Mounting bracket must be ordered separately.
▶ See below

Standard Includes	Required to Specify
<ul style="list-style-type: none"> Tilt/pan knuckle: bright metal 75 mm/100 mm VESA plate 	Style number

Related Products
<ul style="list-style-type: none"> Wall-mount bracket ▶ See below Slatwall/SlatRail mounting bracket ▶ See below

Specification Information					
Dimensions			Weight	Style Number	Price
D	W	H			
5"	4 1/2"	4 1/2"	2 lb	FPATILTPAN	\$133

FYI Flat Panel Monitor Arm Mounting Brackets

Standard Includes	Required to Specify
<ul style="list-style-type: none"> Bracket: paint 	1 Style number 2 Paint color number for bracket: 4231 Arctic White 4710 Low Gloss Black 4799 Platinum Metallic

Specification Information		
Weight	Style Number	Price

Wall-Mount Bracket		
3 lb	FPAWALL	\$50

Slatwall/SlatRail Mounting Bracket		
2 lb	FPASWR	\$50

C-Clamp Mounting Bracket		
3 lb	14474101SR	\$60

Through-Mount Bracket		
3 lb	14474501SR	\$60



Tip: When mounting FYI single flat panel arms to Slatwall, bracket must be mounted no further than 10" away from Slatwall mounting bracket. If application does not allow bracket to be installed within the 10" range, an additional bracket or brackets should be installed within 10" of desired arm location.

Tip: C-clamp and through-mount brackets are available in Steelcase Service Parts Catalog only.

FYI Flat Panel Monitor Arms and Supports without Mounting Brackets, continued

SIN 711.2

FYI Sync Monitor Arms, Handle, and Mounting Brackets

Tip: FYI flat panel arm support is for use with monitors 5 to 20 lb.

Tip: To use upper or lower monitor arms, specify for use with monitor arm option on the base unit.

Tip: For upper and lower monitor arms, FYI Sync hardware pack must be ordered separately.

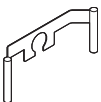
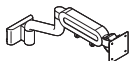
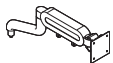
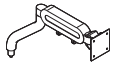

Tip: FPAHANDLE can accept monitors up to 18" of actual horizontal monitor width in a 4:3 format.



Standard Includes	Required to Specify
<ul style="list-style-type: none"> • Monitor arm and handle: 4799 Platinum Metallic • Hardware pack, if selected: 7018 Pewter, if selected 	Style number

Specification Information

Weight	Style Number	Price
:	:	:

Upper Monitor Arm

10 lb	FPASYNCU	\$346
:	:	:

Lower Monitor Arm

4.5 lb	FPASYNCL	\$346
:	:	:

Lower Monitor Arm with Slatwall/SlatRail Mount

6.5 lb	FPASYNCWR	\$394
:	:	:

Handle

1.5 lb	FPAHANDLE	\$232
:	:	:

FYI Sync Hardware Pack

0.75 lb	FPASYNCMT	\$ 49
:	:	:

LED Monitor Light with Bracket

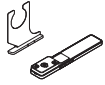

Standard Includes	Required to Specify
<ul style="list-style-type: none"> • Light housing: 4799 Platinum Metallic • Bracket: 0835 Black • 4-watt LED • 9' cord: black plastic only • Attachment hardware 	Style number

Specification Information

• Weight	• Style • Number	• Price
•	•	•

For Use with CF Series and FYI Monitor Arms

0.75 lb	FPALED	\$287
•	•	•

For Use with Sync

0.75 lb	FPASYNLED	\$287
•	•	•

Computer Support Tools

Height-Adjustable Worksurfaces

► For more detailed product information, see the *Height-Adjustable Desks Specification Guide* or consult your Steelcase dealer.

	
Statement of Line	210
	
Workstation Design Guidelines and Requirements	219
Height-Adjustable Desks Comparison Chart	220
Worksurface Shape Overview	222
Worksurface Edge Options	223
Worktools Compatibility Charts	224
Worksurface Weights	
Ology Height-Adjustable Worksurface Weights	228
Airtouch Height-Adjustable Worksurface Weights	240
Series 5 Height-Adjustable Worksurface Weights	242
Ology Corner Desks and Bases Size Restrictions	244
	
Specifying	
Ology Height-Adjustable Desks (SIN 711.2)	250
Universal Steel One-High Open Laterals (SIN 711.2)	284
Universal Common Tops (SIN 711.2)	286
Universal Shrouds (SIN 711.2)	288
Universal Filler (SIN 711.2)	289
Airtouch Height-Adjustable Worksurfaces (SIN 711.1)	290
Series 5 Height-Adjustable Worksurfaces (SIN 711.2)	296
Series 5 Bases (SIN 711.2)	298
FitWork: Walkstation and Sit-to-Walkstation (SIN 711.99)	299
Acrylic Screens (SIN 711.2)	300
Cableways (SIN 711.2)	302
Cable and Power Management (SIN 711.2)	303

Statement of Line

Ology Height-Adjustable Desks

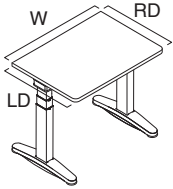

Specifying
▶ Page 250

Rectangular Desks

	34"	40"	46"	52"	58"	64"	70"	76"
23" or 24"D								
29" or 30"D								
35" or 36"D								

Tip: Widths are parametric to 1/16" from 34"W—78"W.

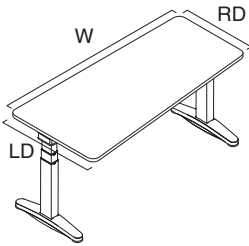

Specifying
▶ Page 254

Tapered Desks*

29" or 30"		23" or 24"	29" or 30"		23" or 24"
29" or 30"		23" or 24"	29" or 30"		23" or 24"

*Left-hand units shown. Right-hand units available.
Tip: Widths are parametric to 1/16" from 58"W—78"W.

Ology Height-Adjustable Desks, continued

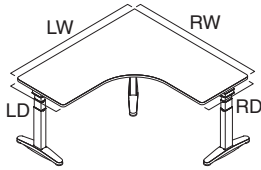

Specifying
▶ Page 258

90° Equal Corner Desks

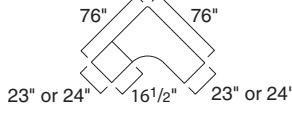
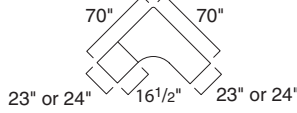
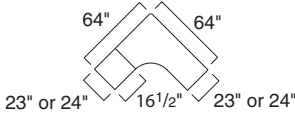
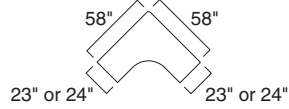
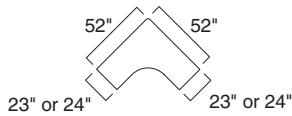

Tip: Widths are parametric to 1/16" from 52"W – 78"W.
Tip: 64"W, 70"W, and 76"W 90° equal worksurfaces ship in two pieces.

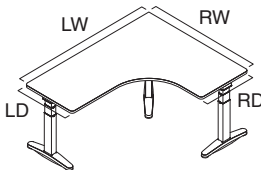

Specifying
▶ Page 258

90° Extended Corner Desks*

	40"W	46"W	52"W	58"W	64"W	70"W	76"W
23"D or 24"D	●	●	●	●	●	●	●
29"D or 30"D	●	●	●	●	●	●	●

*Left-hand units shown. Right-hand units available.
Tip: Widths are parametric to 1/16" from 40"W–78"W.

Statement of Line, continued

Ology Height-Adjustable Desks, continued

120° Equal Corner Desks

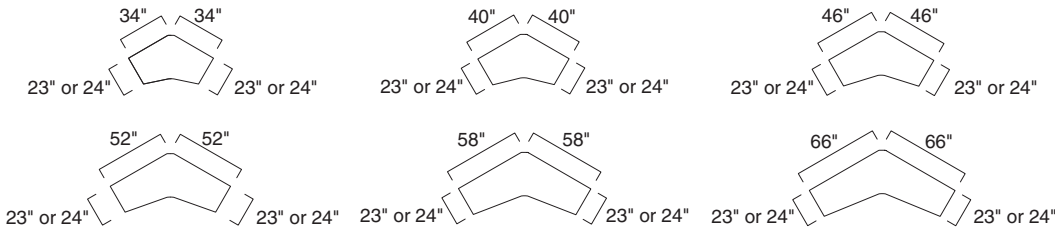

Tip: Widths are parametric to 1/16" from 34"W—64"W.

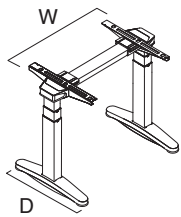

Specifying
▶ Page 272

Rectangular Bases

	34"W	40"W	46"W	52"W	58"W	64"W	70"W	76"W
23"D or 24"D	●	●	●	●	●	●	●	●
29"D or 30"D	●	●	●	●	●	●	●	●
35"D or 36"D	●	●	●	●	●	●	●	●

Tip: Widths are parametric to 1/16" from 34"W—78"W.

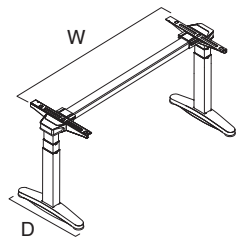

Specifying
▶ Page 272

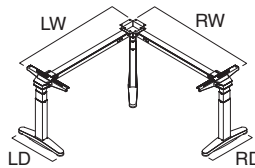

Specifying
▶ Page 272

Tapered Bases*

	58"W	64"W	70"W	76"W
23"D/29"D or 24"D/30"D	●	●	●	●

*Left-hand units shown. Right-hand units available.
Tip: Widths are parametric to 1/16" from 58"W—78"W.

90° Equal Corner Bases

	52"W	58"W	64"W	70"W	76"W
23"D or 24"D	●	●	●	●	●

Tip: Widths are parametric to 1/16" from 52"W—78"W.

Ology Height-Adjustable Desks, continued

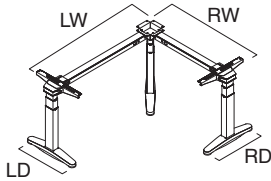

Specifying
▶ Page 272

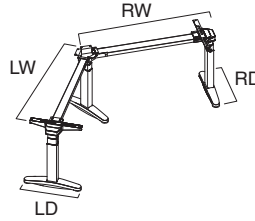

Specifying
▶ Page 272

90° Extended Corner Bases*

	40"W	46"W	52"W	58"W	64"W	70"W	76"W
23"D or 24"D	●	●	●	●	●	●	●
29"D or 30"D	●	●	●	●	●	●	●

*Left-hand units shown. Right-hand units available.
Tip: Widths are parametric to 1/16" from 40"W—78"W.

120° Equal Corner Bases

	34"W	40"W	46"W	52"W	58"W	64"W
23"D or 24"D	●	●	●	●	●	●

Tip: Widths are parametric to 1/16" from 34"W—64"W.

Modesty Panels and Fixed Personal/Modesty Screens

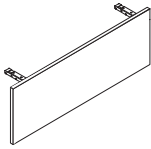

Specifying
▶ Page 281

Modesty Panels

	34"W	40"W	46"W	58"W	64"W	70"W	76"W
14 3/8"H	●	●	●	●	●	●	●

Tip: Widths are parametric to 1/16" from 34"W—78"W.

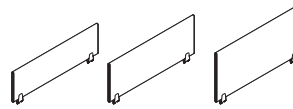

Specifying
▶ Page 282

Fixed Personal/Modesty Screens

	30"W	36"W	42"W	48"W
12"H	●	●	●	●
19 1/2"H	●	●	●	●
24"H	●	●	●	●

Tip: 19 1/2"H and 24"H are for privacy use only.

Cable and Power Management

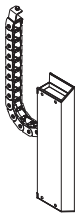

Cable Riser
Specifying
▶ Page 283

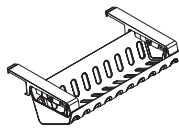

Cable Basket
Specifying
▶ Page 283

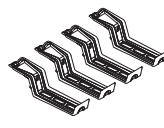

Cable Brackets
Specifying
▶ Page 283

Statement of Line, continued

Storage

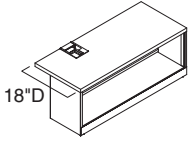

18"D

Flush steel
open front

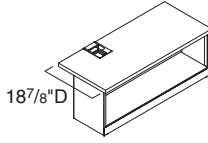

18 7/8"D

Proud steel
open front

Specifying
▶ Page 284

Universal Steel One-High Open Laterals

30"W 36"W 42"W

16"H ● ● ●

Drawings show Ology right application.
Units are also available with Ology left application.

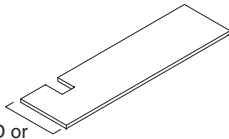

18"D or
18 7/8"D

Specifying
▶ Page 286

Universal Common Tops

60"W 66"W 72"W 78"W 84"W 90"W 96"W 108"W

● ● ● ● ● ● ● ●

Drawings show Ology right application.
Units are also available with Ology left application.

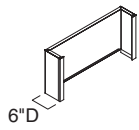

6"D
For Ology

Specifying
▶ Page 288



6"D
For Ology

Specifying
▶ Page 289

Universal Shrouds

Universal Filler

Airtouch Height-Adjustable Worksurfaces

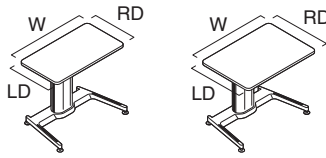

Specifying
▶ Page 290

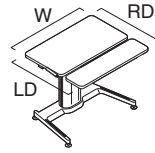

Specifying
▶ Page 290

Rectangular Worksurfaces

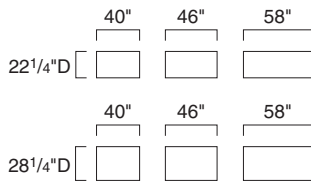

Rectangular Bi-Level Worksurfaces

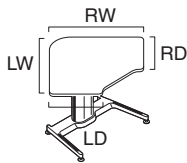
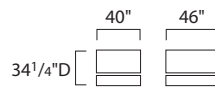

Specifying
▶ Page 290

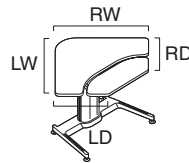

Specifying
▶ Page 290

90° Corner Worksurfaces

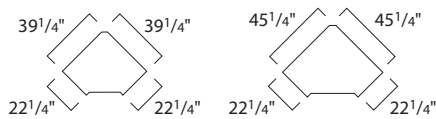

90° Corner Bi-Level Worksurfaces

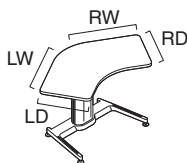
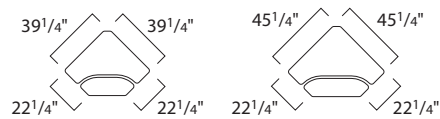

Specifying
▶ Page 290

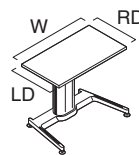

Specifying
▶ Page 292

120° Equal Worksurfaces

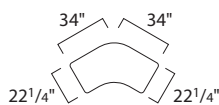

Rectangular Worksurfaces

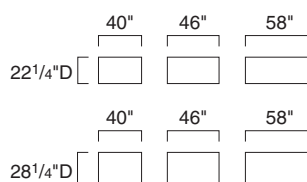

Statement of Line, continued

Airtouch Height-Adjustable Worksurfaces, continued

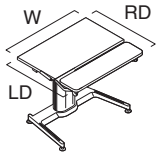

Specifying
▶ Page 292

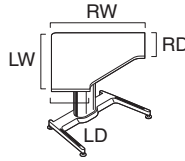

Specifying
▶ Page 292

Rectangular Bi-Level Worksurfaces

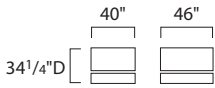

90° Corner Worksurfaces

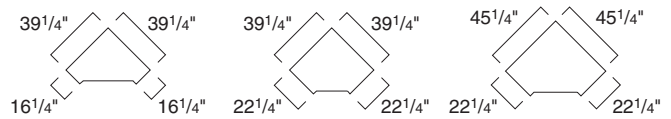

Airtouch Height-Adjustable Worksurfaces

For Use with Universal Systems

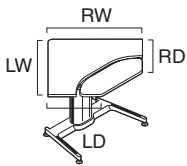

Specifying
▶ Page 292

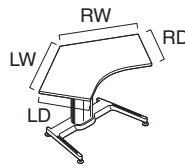

Specifying
▶ Page 292

90° Corner Bi-Level Worksurfaces

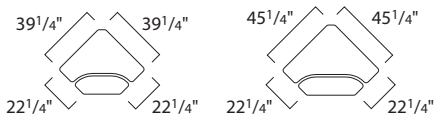

120° Equal Worksurfaces

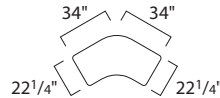

Series 5 Height-Adjustable Worksurfaces

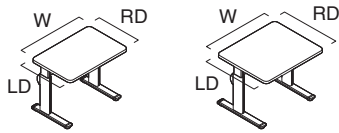

Specifying
▶ Page 296

Rectangular Worksurfaces

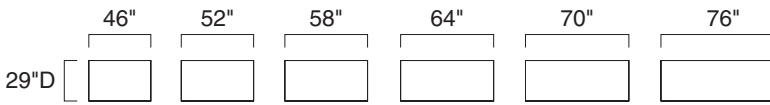

Series 5 Bases

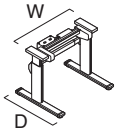

Specifying
▶ Page 298

Rectangular Bases

	46"W-52"W	58"W	64"W-76"W
29"D	●	●	●

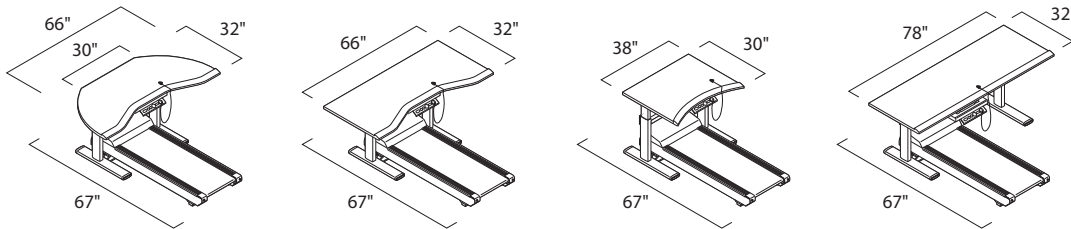

Specifying
▶ Page 299

FitWork: Walkstation and Sit-to-Walkstation

	38"W	66"W	78"W
30"D	●		
32"D	●	●	●

*Left-hand units shown. Right-hand units available.



Statement of Line, continued

Privacy Screens, Modesty Screens, and Cableways



Specifying
▶ Page 300

Privacy Screens

	22"W	28"W	34"W	40"W	46"W	52"W	58"W	64"W
22"H	•	•	•	•	•	•	•	•



Specifying
▶ Page 300

Modesty Screens

	22"W	28"W	34"W	40"W	46"W	52"W	58"W	64"W
14"H	•	•	•	•	•	•	•	•



Specifying
▶ Page 302

Cableways

	25"W	31"W	37"W	43"W	49"W	55"W	61"W
8"H	•	•	•	•	•	•	•

Cable and Power Management

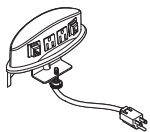

Power/Data with C-clamp
Specifying
▶ Page 303

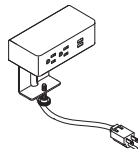

USB Two-Outlet Powerstrip with Clamp Mount
Specifying
▶ Page 303

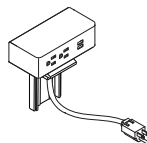

USB Two-Outlet Powerstrip with Rail Mount
Specifying
▶ Page 303

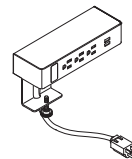

USB Three-Outlet Powerstrip with Clamp Mount
Specifying
▶ Page 304

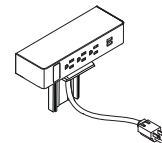

USB Three-Outlet Powerstrip with Rail Mount
Specifying
▶ Page 304

Workstation Design Guidelines and Requirements

Overview

Designed for movement with dynamic seating, adjustable worktools and height-adjustable desks are important for today's office workers.

To determine the best height-adjustable solution, consider these four criteria:

1. **Adjustability Needed:**
What is the height range requirement? (seated or sit-to-stand)
2. **Worksurface Size Needed:**
What does the physical space look like? (worksurface configuration)
3. **Equipment/Tools Used:**
What type of computer equipment and other worktools are being used on the worksurface? (load capacity)
4. **Use:**
What is the height-adjustable desk being used for (individual or shared, touchdown space or full workstation, sit-to-stand or seated)?

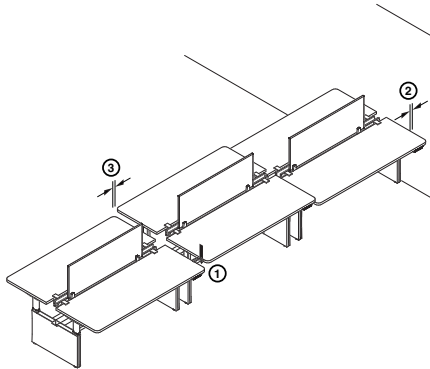

WARNING

Risk of Serious Injury. If not used as intended, moving work-surfaces can pinch or injure people, or damage property. Always follow these Instructions:

1. Keep height-adjustment range free from obstructions above and below the worksurface.
2. Plan for a minimum 1" gap against a panel or wall.
3. Plan for a minimum 1" gap to adjacent furniture.

Tips

Obstructions

Moving worksurfaces can collide with other objects. Do not install overhead storage, stationary pedestals or components in the path of height-adjustable desks.

Weight

The maximum allowable load (varies by height-adjustable bench) should be evenly distributed and must not be exceeded.

Width

Specify a minimum 1" gap to adjacent furniture. This eliminates any pinch points between a height-adjustable desk and a fixed object.

Managing Technology

Design workstations with computer equipment in mind so that the height-adjustment range of the height-adjustable desk is not impeded because of cables.

Power

Plan easy and unobstructed access to power for users at worksurface height through the use of the power access door or power strip.

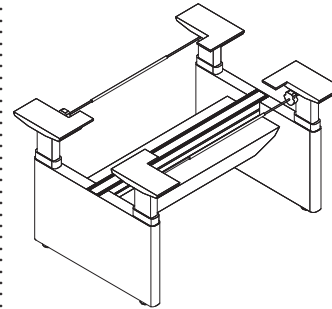

WARNING

Risk of serious injury.

Bases-only warranty limitations and potential for injury: The use of worksurfaces that do not comply with the Steelcase defined criteria and limitations could cause personal injury or property damage due to pinch points, instability, or other problems, and voids all Steelcase Warranties, expressed or implied.

The use of worksurfaces that do not comply with Steelcase criteria voids any Steelcase claims of compliance with ANSI/ BIFMA, UL, LEED, or other applicable requirements. The use of non-Steelcase worksurfaces on Steelcase adjustable-height bases may not be accepted as compliant to municipal electrical codes or OSHA federal workplace standards, because this use does not create an NRTL (UL, ETL, etc.) listed product. Steelcase is not responsible for the ultimate determinations of compliance for height-adjustable bases with non-Steelcase worksurface, and assumes no liability for their compliance with standards when height adjustable bases are used without a Steelcase worksurface as intended.

Worksurface Criteria and Limitations

The use of non-Steelcase worksurfaces is not recommended. Any use of a non-Steelcase worksurface requires additional investigation by the customer regarding the appropriateness for use. It is the sole responsibility of the customer to determine the suitability and safety of the selected worksurface construction and attachment means. The following information is provided as a guideline, but does not address all potential issues. Customers should seek professional guidance as to the appropriateness of their chosen worksurface.

Tips

Height-adjustable bases include fasteners intended for use with Steelcase worksurfaces. These fasteners may be suitable for worksurfaces meeting the following criteria:

- Medium-density or higher particleboard or fiberboard cores, with High- or Low-Pressure Laminates and backers.
- Thickness of 1" or greater (Ology)
- Thickness of 1 $\frac{3}{8}$ " or greater (Series 5 and 8 bases)
- Fasteners located a minimum distance of 1" from any edge

Height-Adjustable Desks Comparison Chart

Height-adjustable desks transform to meet the needs of someone 5' to 6'4" tall. Adjustables offer three selections; Ology, Airtouch, and Series 5.

The chart below will help you determine which product line best meets your needs.

Ology

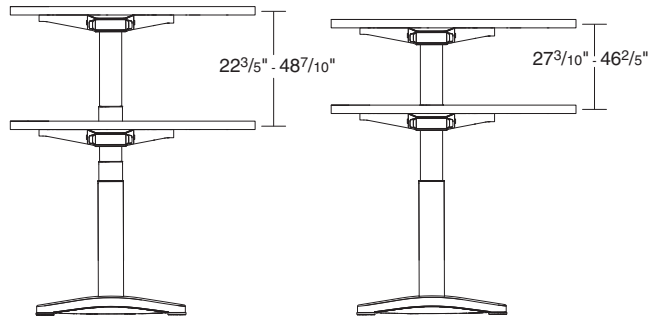

Enhanced sit-to-stand height-adjustability

A push button delivers electric adjustability at 1½" per second. Includes three controller options:

- Simple touch
- Active touch
- 4 Pre-sets

Weight capacity of 314 pounds (2-leg) or 471 pounds (3-leg).

Tip: When calculating lifting capacity, subtract the weight of the worksurface, understructure, and options selected.

▶ See page 228 for worksurface weights.

*Small configurations only.

** 29"D knee depth requirement for worksurface

Adjustables Comparison Chart

	Ology Sit-to-Stand
Range of Adjustment	22 ³ / ₅ " – 48 ⁷ / ₁₀ "
With Bi-Level Worksurfaces	N.A.
Type of Adjustment	Electric
Distributed Weight Capacity	314 lb (2-leg) 471 lb (3-leg)
Worksurface Weight	See page 228 for worksurface weights
Worksurface Thickness	1"
Controller	Simple touch, Active touch, 4 Pre-sets
Integrated Rail	Yes
Integrated Soft Edge	Yes
Integrated Power Access Door	Yes
Motor	Enclosed
Decibel Rating	< 55 dBA
Volts	120v AC
Amps	2-leg: 2.5A/ 3-leg: 3.75A
Watts	2-leg: 300W/ 3-leg: 450W
Standby Power	0.1W
Frequency and Phase	60 Hz Single Phase
Adjustability Speed	1½" per second
Stretcher or Understructure Design	Fixed
Base Only Availability	Yes
ANSI/BIFMA**	Meet or Exceed

Airtouch

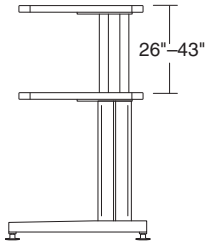

Collaborative height-adjustability

Weight capacity of 150 pounds.

Tip: When calculating lifting capacity, subtract the weight of the worksurface.

▶ See page 240 for worksurface weights.

Series 5

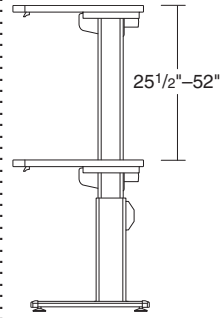

Sit-to-stand height-adjustability

A simple push button delivers electric adjustability at 1⁷/₁₀" per second. Weight capacity of 195 pounds.

Tip: When calculating lifting capacity, subtract the weight of the worksurface.

▶ See page 242 for worksurface weights.

** 29"D knee depth requirement for worksurface

Height-Adjustable
Worksurfaces

Adjustables Comparison Chart

	Airtouch Sit-to-Stand	Series 5 Sit-to-Stand
Range of Adjustment	26" – 43"	25 ¹ / ₂ " – 52"
With Bi-Level Worksurfaces	21" – 49"	21" – 58"
Type of Adjustment	Counterforce Mechanism	Electric
Distributed Weight Capacity	150 lb	195 lb
Worksurface Weight	See page 240 for worksurface weights	See page 242 for worksurface weights
Worksurface Thickness	1 ³ / ₁₆ "	1 ³ / ₁₆ "
Controller	Paddle	Up/down
Integrated Rail	No	No
Integrated Soft Edge	No	No
Integrated Power Access Door	No	No
Motor	N.A.	Exposed
Decibel Rating	N.A.	<50 dBa
Volts	N.A.	120v AC
Amps	N.A.	4.0A
Watts	N.A.	480W
Standby Power	N.A.	4.5W
Frequency and Phase	N.A.	60 Hz, Single Phase
Adjustability Speed	User speed (1 sec.)	1 ⁷ / ₁₀ "/sec.
Stretcher or Understructure Design	N.A.	Telescoping
Base Only Availability	No	Yes
ANSI/BIFMA**	Meet or Exceed	Meet or Exceed

Worksurface Shape Overview

Extensive worksurface shape and size offering allows designers to meet a variety of planning applications and footprints.



Rectangular
Ology
Series 5
Airtouch

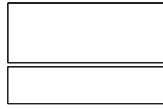

Rectangular Bi-Level
Airtouch

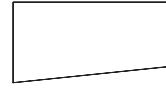

Tapered
Ology

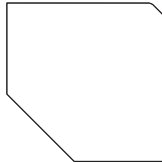

90° Corner
Airtouch

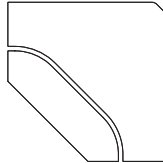

90° Corner Bi-Level
Airtouch

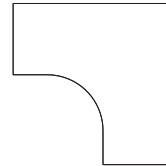

90° Equal
Ology

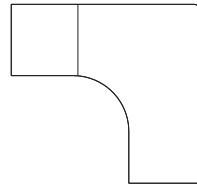

90° Equal *
Ology

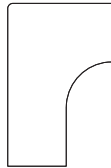

90° Extended
Ology

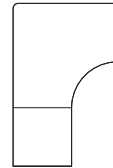

90° Extended *
Ology

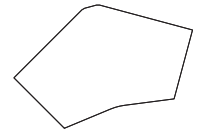

120° Equal
Ology
Airtouch

* Worksurfaces equal to and wider than 60¹/₁₆" x 60¹/₁₆" ship in two pieces.

Worksurface Edge Options

High-Pressure Laminate Worksurfaces

Front (user's) edge profile is available in two shapes. Universal tables have a continuous edge profile available in four shapes.

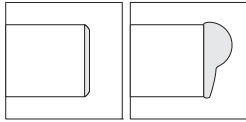

3 mm edge profile P-edge edge profile

PVC-free, 3 mm edge profiles are proprietary polyolefin blend for all solid colors and seven woodgrain finishes. Matching 1 mm side and back edges are also PVC-free. See surface material listing in this book for specific PVC-free availability.

Tip: Universal Tables have a continuous 3 mm edge.

Edge profile finishes are specified separately from laminate color.

P-edge profile rises slightly above the laminate surface and curves into a $\frac{3}{8}$ " radius. Back and side edges are flat.

Tip: P-edge profile available on Airtouch height-adjustable worksurfaces only.

Tip: Universal tables have a continuous P-edge profile.

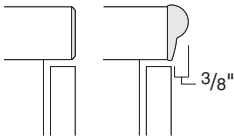

P-edge profile work surface depths are $\frac{3}{8}$ " deeper than 3 mm edge profile worksurfaces. Both edge profiles provide a flush interface with universal pedestals.

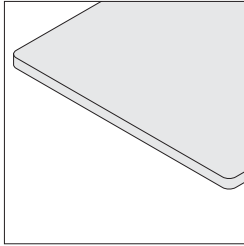

Universal tables have rounded corners on all four sides with a continuous user edge. Radius corners eliminate sharp edges and are appropriate for freestanding furniture.

Tip: Ology, when optioned with rounded corners and with integrated rail, will have $\frac{1}{4}$ " radius corners on the two front (user's) corners and 90° corners on the rear two corners.

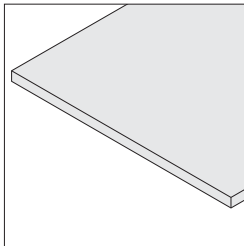

Universal systems and wood veneer worksurfaces have 90° corner on all four sides with a front user's edge.

Wood Veneer Worksurfaces

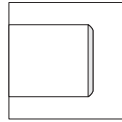

Front (user's) edge profile is wood veneer with a square (3 mm) radius. Back edge and edge that joins to adjacent worksurfaces are flat. Wood edge color matches finish specified for worksurface.

Tip: Wood veneer worksurfaces are available on Ology height-adjustable desks and Series 5 height-adjustable worksurfaces only.

Universal Tables Edge Profiles



Rectangular



Rectangular Bi-Level



Tapered

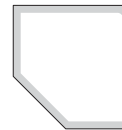

90° Corner

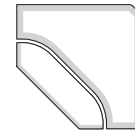

90° Corner Bi-Level

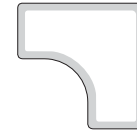

90° Equal



90° Extended

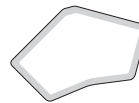

120° Equal

Universal Systems and Wood Edge Profiles



Rectangular



Rectangular Bi-Level



Tapered

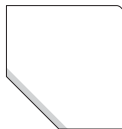

90° Corner

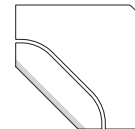

90° Corner Bi-Level

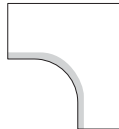

90° Equal



90° Extended



120° Equal

Worktools Compatibility Charts

To determine worksurface compatibility with privacy/modesty screens, cableway, SOTO rail, and SlatRail worktools for each configuration and shape, see compatibility chart below.

Tip: The Ology integrated rail option does not apply to these rules because the rail matches the worksurface width.

Tip: Slatwall stanchions are not applicable because they allow Slatwall to overhang mounting area.

Tip: SlatRail stanchions do not work with the same size screen, SOTO rail, or cableway combination (e.g. 48"W SlatRail will not work with 49"W cableway and 52"W screens) because of clamp location. Specify the SlatRail one size smaller or larger when using in combination (if applicable).

Ology Desks

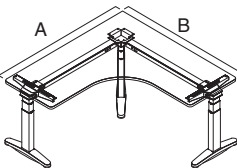
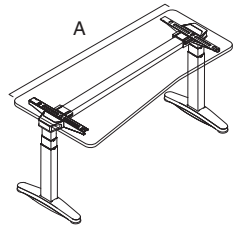
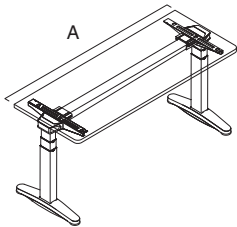

Rectangular and Tapered

Side **A** width

Acrylic Privacy/Modesty/SOTO Rail

Worksurfaces	28"W	34"W	40"W	46"W	52"W	58"W	64"W
34"W	■						
40"W	■	■					
46"W	■	■	■				
52"W	■	■	■	■			
58"W	■	■	■	■	■		
64"W	■	■	■	■	■	■	
70"W	■	■	■	■	■	■	■
76"W	■	■	■	■	■	■	■

25"W 31"W 37"W 43"W 49"W 55"W 61"W

Cableway

Side **A** width

SlatRail

Worksurfaces	24"W	30"W	36"W	42"W	48"W	60"W
34"W	■	■				
40"W	■	■	■			
46"W	■	■	■	■		
52"W	■	■	■	■	■	
58"W	■	■	■	■	■	■
64"W	■	■	■	■	■	■
70"W	■	■	■	■	■	■
76"W	■	■	■	■	■	■

90° Equal

Side **A** width

Acrylic Privacy/Modesty/SOTO Rail

Worksurfaces	28"W	34"W	40"W	46"W	52"W	58"W	64"W
52"W	■	■	■	■			
58"W	■	■	■	■	■		
64"W	■	■	■	■	■	■	
70"W	■	■	■	■	■	■	■
76"W	■	■	■	■	■	■	■

25"W 31"W 37"W 43"W 49"W 55"W 61"W

Cableway

Side **B** width

Acrylic Privacy/Modesty/SOTO Rail

Worksurfaces	28"W	34"W	40"W	46"W	52"W	58"W	64"W
52"W	■	■	■	■			
58"W	■	■	■	■	■		
64"W	■	■	■	■	■	■	
70"W	■	■	■	■	■	■	■
76"W	■	■	■	■	■	■	■

Side **A** width

SlatRail

Worksurfaces	24"W	30"W	36"W	42"W	48"W	60"W
52"W	■	■	■	■	■	
58"W	■	■	■	■	■	
64"W	■	■	■	■	■	■
70"W	■	■	■	■	■	■
76"W	■	■	■	■	■	■

Side **B** width

SlatRail

Worksurfaces	24"W	30"W	36"W	42"W	48"W	60"W
52"W	■	■	■	■	■	
58"W	■	■	■	■	■	
64"W	■	■	■	■	■	■
70"W	■	■	■	■	■	■
76"W	■	■	■	■	■	■

Ology Desks, continued

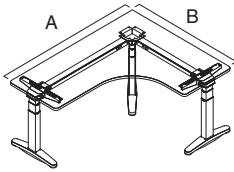

90° Extended

Side A width

Acrylic Privacy/Modesty/SOTO Rail

28"W 34"W 40"W 46"W 52"W 58"W 64"W

Worksurfaces	28"W	34"W	40"W	46"W	52"W	58"W	64"W
40"W							
46"W							
58"W	■	■	■	■	■	■	
64"W	■	■	■	■	■	■	
70"W	■	■	■	■	■	■	■
76"W	■	■	■	■	■	■	■

25"W 31"W 37"W 43"W 49"W 55"W 61"W

Cableway

Side B width

Acrylic Privacy/Modesty/SOTO Rail

28"W 34"W 40"W 46"W 52"W 58"W 64"W

Worksurfaces	28"W	34"W	40"W	46"W	52"W	58"W	64"W
40"W	■	■					
46"W	■	■	■				
58"W	■	■	■	■	■		
70"W							
76"W							

Side A width

SlatRail

24"W 30"W 36"W 42"W 48"W 60"W

Worksurfaces	24"W	30"W	36"W	42"W	48"W	60"W
40"W						
46"W						
58"W	■	■	■	■	■	
64"W	■	■	■	■	■	
70"W	■	■	■	■	■	■
76"W	■	■	■	■	■	■

Side B width

SlatRail

24"W 30"W 36"W 42"W 48"W 60"W

Worksurfaces	24"W	30"W	36"W	42"W	48"W	60"W
40"W	■	■	■			
46"W	■	■	■	■		
58"W	■	■	■	■	■	
70"W						
76"W						

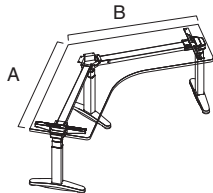

120° Equal

Side A width

Acrylic Privacy/Modesty/SOTO Rail

28"W 34"W 40"W 46"W 52"W 58"W 64"W

Worksurfaces	28"W	34"W	40"W	46"W	52"W	58"W	64"W
34"W	■						
40"W	■	■					
46"W	■	■	■				
52"W	■	■	■	■			
58"W	■	■	■	■	■		
64"W	■	■	■	■	■	■	

25"W 31"W 37"W 43"W 49"W 55"W

Cableway

Side B width

Acrylic Privacy/Modesty/SOTO Rail

28"W 34"W 40"W 46"W 52"W 58"W 64"W

Worksurfaces	28"W	34"W	40"W	46"W	52"W	58"W	64"W
34"W	■						
40"W	■	■					
46"W	■	■	■				
52"W	■	■	■	■			
58"W	■	■	■	■	■		
64"W	■	■	■	■	■	■	

Side A width

SlatRail

24"W 30"W 36"W 42"W 48"W 60"W

Worksurfaces	24"W	30"W	36"W	42"W	48"W	60"W
34"W	■	■				
40"W	■	■	■			
46"W	■	■	■	■		
52"W	■	■	■	■	■	
58"W	■	■	■	■	■	
64"W	■	■	■	■	■	■

Side B width

SlatRail

24"W 30"W 36"W 42"W 48"W 60"W

Worksurfaces	24"W	30"W	36"W	42"W	48"W	60"W
34"W	■	■				
40"W	■	■	■			
46"W	■	■	■	■		
52"W	■	■	■	■	■	
58"W	■	■	■	■	■	
64"W	■	■	■	■	■	■

Height-Adjustable Worksurfaces

Worktools Compatibility Charts, continued

Series 5 Worksurfaces

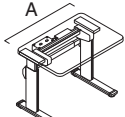

Series 5

Rectangular

Side **A** width

Acrylic Privacy/Modesty/SOTO Rail

Worksurfaces	Side A width						
	28"W	34"W	40"W	46"W	52"W	58"W	64"W
46"W	▲	▲	▲				
52"W	▲	▲	▲	▲			
58"W	▲	▲	▲	▲	▲		
64"W	▲	▲	▲	▲	▲	▲	
70"W	▲	▲	▲	▲	▲	▲	▲
76"W	▲	▲	▲	▲	▲	▲	▲

Side **A** width

SlatRail

Worksurfaces	Side A width					
	24"W	30"W	36"W	42"W	48"W	60"W
46"W	▲	▲	▲			
52"W	▲	▲	▲	▲		
58"W	▲	▲	▲	▲	▲	
64"W	▲	▲	▲	▲	▲	
70"W	▲	▲	▲	▲	▲	▲
76"W	▲	▲	▲	▲	▲	▲

Cableway

Worksurfaces

Airtouch Worksurfaces

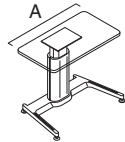

Tip: Cableways are not recommended for use with Airtouch 22 1/4"D rectangular worksurfaces.

Rectangular and Rectangular Bi-level

Side **A** width

Acrylic Privacy/Modesty/SOTO Rail

Worksurfaces	Side A width						
	28"W	34"W	40"W	46"W	52"W	58"W	64"W
40"W	●	●					
46"W	●	●	●				
58"W	●	●	●	●	●		

Side **A** width

SlatRail

Worksurfaces	Side A width					
	24"W	30"W	36"W	42"W	48"W	60"W
40"W	●	●	●			
46"W	●	●	●	●		
58"W	●	●	●	●	●	

Cableway

Worksurfaces

Airtouch Worksurfaces, continued

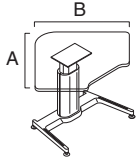

90° Corner and 90° Corner Bi-Level

Side **A** width

Side **B** width

Acrylic Privacy/Modesty/SOTO Rail

Worksurfaces	28"W	34"W	40"W	46"W	52"W	58"W	64"W
39 1/4"W	•	•					
45 1/4"W	•	•	•				

Cableway

Worksurfaces	25"W	31"W	37"W	43"W	49"W	55"W	61"W

Acrylic Privacy/Modesty/SOTO Rail

Worksurfaces	28"W	34"W	40"W	46"W	52"W	58"W	64"W
	•	•					
	•	•	•				

Side **A** width

Side **B** width

SlatRail

Worksurfaces	24"W	30"W	36"W	42"W	48"W	60"W
39 1/4"W	•	•	•			
45 1/4"W	•	•	•	•		

SlatRail

Worksurfaces	24"W	30"W	36"W	42"W	48"W	60"W
	•	•	•			
	•	•	•	•		

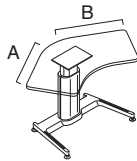

120° Equal

Side **A** width

Side **B** width

Acrylic Privacy/Modesty/SOTO Rail

Worksurfaces	28"W	34"W	40"W	46"W	52"W	58"W	64"W
34"W	•						

Cableway

Worksurfaces	25"W	31"W	37"W	43"W	49"W	55"W	61"W

Acrylic Privacy/Modesty/SOTO Rail

Worksurfaces	28"W	34"W	40"W	46"W	52"W	58"W	64"W
	•						

Side **A** width

Side **B** width

SlatRail

Worksurfaces	24"W	30"W	36"W	42"W	48"W	60"W
34"W	•	•				

SlatRail

Worksurfaces	24"W	30"W	36"W	42"W	48"W	60"W
	•	•				

Height-Adjustable Worksurfaces

Ology Height-Adjustable Worksurface Weights

Worksurface Weight

Worksurface Shape	W	LD	RD	Base only Weight (OLELRQB)	Worksurface Weight	
-------------------	---	----	----	----------------------------	--------------------	--

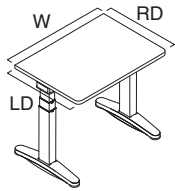

					23"D	24"D
Rectangular	34"	23" or 24"	23" or 24"	59 lb	20 lb	21 lb
	40"	23" or 24"	23" or 24"	61 lb	24 lb	25 lb
	46"	23" or 24"	23" or 24"	62 lb	27 lb	29 lb
	52"	23" or 24"	23" or 24"	64 lb	31 lb	32 lb
	58"	23" or 24"	23" or 24"	66 lb	35 lb	36 lb
	64"	23" or 24"	23" or 24"	67 lb	39 lb	40 lb
	70"	23" or 24"	23" or 24"	69 lb	42 lb	43 lb
	76"	23" or 24"	23" or 24"	71 lb	46 lb	47 lb
					29"D	30"D
	34"	29" or 30"	29" or 30"	61 lb	26 lb	27 lb
	40"	29" or 30"	29" or 30"	63 lb	30 lb	31 lb
	46"	29" or 30"	29" or 30"	65 lb	34 lb	36 lb
	52"	29" or 30"	29" or 30"	67 lb	39 lb	41 lb
	58"	29" or 30"	29" or 30"	69 lb	43 lb	45 lb
	64"	29" or 30"	29" or 30"	71 lb	48 lb	50 lb
	70"	29" or 30"	29" or 30"	73 lb	52 lb	54 lb
	76"	29" or 30"	29" or 30"	75 lb	56 lb	59 lb
					35"D	36"D
	34"	35" or 36"	35" or 36"	64 lb	31 lb	32 lb
	40"	35" or 36"	35" or 36"	66 lb	36 lb	37 lb
	46"	35" or 36"	35" or 36"	68 lb	42 lb	43 lb
	52"	35" or 36"	35" or 36"	70 lb	47 lb	48 lb
	58"	35" or 36"	35" or 36"	72 lb	52 lb	54 lb
	64"	35" or 36"	35" or 36"	74 lb	58 lb	60 lb
	70"	35" or 36"	35" or 36"	76 lb	63 lb	65 lb
	76"	35" or 36"	35" or 36"	78 lb	69 lb	71 lb

Understructure Weight	Options		Soft Edge Weight	Accessory	
	Integrated Rail Weight	Power and Data Access Door Weight		Modesty Panel Weight	
16.9 lb	5.1 lb	N.A.	N.A.	15.2 lb	
18.6 lb	5.8 lb	6.9 lb	N.A.	17.6 lb	
20.3 lb	6.6 lb	6.9 lb	N.A.	20.0 lb	
22.0 lb	7.3 lb	6.9 lb	N.A.	22.4 lb	
23.7 lb	8.0 lb	6.9 lb	N.A.	24.8 lb	
25.4 lb	8.8 lb	6.9 lb	2.6 lb	27.3 lb	
27.1 lb	9.5 lb	6.9 lb	2.6 lb	29.7 lb	
28.9 lb	10.2 lb	6.9 lb	2.6 lb	32.1 lb	
17.9 lb	5.1 lb	N.A.	N.A.	15.2 lb	
19.6 lb	5.8 lb	6.9 lb	N.A.	17.6 lb	
21.3 lb	6.6 lb	6.9 lb	N.A.	20.0 lb	
23.0 lb	7.3 lb	6.9 lb	N.A.	22.4 lb	
24.7 lb	8.0 lb	6.9 lb	N.A.	24.8 lb	
26.4 lb	8.8 lb	6.9 lb	2.6 lb	27.3 lb	
28.1 lb	9.5 lb	6.9 lb	2.6 lb	29.7 lb	
29.9 lb	10.2 lb	6.9 lb	2.6 lb	32.1 lb	
18.9 lb	5.1 lb	N.A.	N.A.	15.2 lb	
20.6 lb	5.8 lb	6.9 lb	N.A.	17.6 lb	
22.3 lb	6.6 lb	6.9 lb	N.A.	20.0 lb	
24.0 lb	7.3 lb	6.9 lb	N.A.	22.4 lb	
25.7 lb	8.0 lb	6.9 lb	N.A.	24.8 lb	
27.4 lb	8.8 lb	6.9 lb	2.6 lb	27.3 lb	
29.1 lb	9.5 lb	6.9 lb	2.6 lb	29.7 lb	
30.9 lb	10.2 lb	6.9 lb	2.6 lb	32.1 lb	

Height-Adjustable Worksurfaces

Ology Height-Adjustable Worksurface Weights, continued

Worksurface Weight, continued

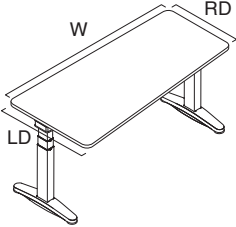
Worksurface Shape	W	LD	RD	• Base only Weight (OLELRTB)	• Worksurface Weight	
					23"D/29"D	24"D/30"D
	58"	29" or 30"	23" or 24"	67 lb	39 lb	40 lb
	64"	29" or 30"	23" or 24"	69 lb	43 lb	45 lb
	70"	29" or 30"	23" or 24"	71 lb	47 lb	49 lb
	76"	29" or 30"	23" or 24"	73 lb	51 lb	53 lb
	58"	23" or 24"	29" or 30"	67 lb	39 lb	40 lb
	64"	23" or 24"	29" or 30"	69 lb	43 lb	45 lb
	70"	23" or 24"	29" or 30"	71 lb	47 lb	49 lb
	76"	23" or 24"	29" or 30"	73 lb	51 lb	53 lb

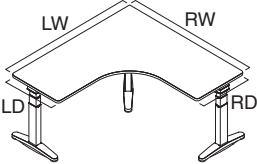
Worksurface Shape	LW	LD	RW	RD	• Base only Weight (OLELLCB)	• Worksurface Weight	
						23"D	24"D
	52"	23" or 24"	52"	23" or 24"	86 lb	58.2 lb	59.2 lb
	58"	23" or 24"	58"	23" or 24"	88 lb	66.6 lb	67.6 lb
	64"	23" or 24"	64"	23" or 24"	90 lb	75.0 lb	77.0 lb
	70"	23" or 24"	70"	23" or 24"	93 lb	83.4 lb	85.4 lb
	76"	23" or 24"	76"	23" or 24"	95 lb	91.8 lb	94.8 lb

Understructure Weight	Options		Soft Edge Weight	Accessory Modesty Panel Weight
	Integrated Rail Weight	Power and Data Access Door Weight		
24.2 lb	8.0 lb	6.9 lb	N.A.	24.8 lb
25.9 lb	8.8 lb	6.9 lb	2.6 lb	27.3 lb
27.6 lb	9.5 lb	6.9 lb	2.6 lb	29.7 lb
29.4 lb	10.2 lb	6.9 lb	2.6 lb	32.1 lb
24.2 lb	8.0 lb	6.9 lb	N.A.	24.8 lb
25.9 lb	8.8 lb	6.9 lb	2.6 lb	27.3 lb
27.6 lb	9.5 lb	6.9 lb	2.6 lb	29.7 lb
29.4 lb	10.2 lb	6.9 lb	2.6 lb	32.1 lb

Understructure Weight	Options		Soft Edge Weight
	Integrated Rail Weight	Power and Data Access Door Weight	
29.2 lb	15.8 lb	N.A.	N.A.
31.5 lb	17.3 lb	6.9 lb each	N.A.
33.9 lb	18.7 lb	6.9 lb each	N.A.
36.2 lb	20.2 lb	6.9 lb each	N.A.
38.5 lb	21.7 lb	6.9 lb each	N.A.

Height-Adjustable
Worksurfaces

Ology Height-Adjustable Worksurface Weights, continued

Worksurface Weight, continued

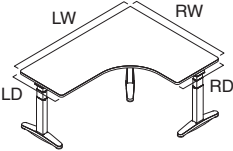
Worksurface Shape	LW	LD	RW	RD	Base only Weight (OLELLCB)	Worksurface Weight	
						23" D	24" D
	40"	23" or 24"	52"	23" or 24"	32.7 lb	49.8 lb	50.8 lb
	40"	23" or 24"	58"	23" or 24"	33.9 lb	54.1 lb	55.1 lb
	40"	23" or 24"	64"	23" or 24"	35.0 lb	58.2 lb	59.2 lb
	40"	23" or 24"	70"	23" or 24"	36.2 lb	62.4 lb	63.4 lb
	40"	23" or 24"	76"	23" or 24"	37.4 lb	66.6 lb	67.6 lb
	46"	23" or 24"	52"	23" or 24"	33.9 lb	54.0 lb	55.0 lb
	46"	23" or 24"	58"	23" or 24"	35.0 lb	58.2 lb	59.2 lb
	46"	23" or 24"	64"	23" or 24"	36.2 lb	62.4 lb	64.4 lb
	46"	23" or 24"	70"	23" or 24"	37.4 lb	66.6 lb	68.6 lb
	46"	23" or 24"	76"	23" or 24"	38.5 lb	70.8 lb	72.8 lb
	52"	23" or 24"	40"	23" or 24"	32.7 lb	49.8 lb	50.8 lb
	52"	23" or 24"	46"	23" or 24"	35.0 lb	54.0 lb	55.0 lb
	52"	23" or 24"	58"	23" or 24"	36.2 lb	62.4 lb	63.4 lb
	52"	23" or 24"	64"	23" or 24"	37.4 lb	66.6 lb	67.6 lb
	52"	23" or 24"	70"	23" or 24"	38.5 lb	70.8 lb	72.8 lb
	52"	23" or 24"	76"	23" or 24"	39.7 lb	75.0 lb	77.0 lb
	58"	23" or 24"	40"	23" or 24"	33.9 lb	54.1 lb	55.1 lb
	58"	23" or 24"	46"	23" or 24"	35.0 lb	58.2 lb	59.2 lb
	58"	23" or 24"	52"	23" or 24"	36.2 lb	62.4 lb	63.4 lb
	58"	23" or 24"	64"	23" or 24"	38.5 lb	70.8 lb	72.8 lb
	58"	23" or 24"	70"	23" or 24"	39.7 lb	75.0 lb	77.0 lb
	58"	23" or 24"	76"	23" or 24"	40.9 lb	79.2 lb	81.2 lb
	64"	23" or 24"	40"	23" or 24"	35.0 lb	58.2 lb	59.2 lb
	64"	23" or 24"	46"	23" or 24"	36.2 lb	62.4 lb	64.4 lb
	64"	23" or 24"	52"	23" or 24"	37.4 lb	66.6 lb	67.6 lb
	64"	23" or 24"	58"	23" or 24"	38.5 lb	70.8 lb	72.8 lb
	64"	23" or 24"	70"	23" or 24"	40.9 lb	79.2 lb	82.2 lb
	64"	23" or 24"	76"	23" or 24"	42.0 lb	83.4 lb	86.4 lb
	70"	23" or 24"	40"	23" or 24"	36.2 lb	62.4 lb	63.4 lb
	70"	23" or 24"	46"	23" or 24"	37.4 lb	66.6 lb	68.6 lb
	70"	23" or 24"	52"	23" or 24"	38.5 lb	70.8 lb	72.8 lb
	70"	23" or 24"	58"	23" or 24"	39.7 lb	75.0 lb	77.0 lb
70"	23" or 24"	64"	23" or 24"	40.9 lb	79.2 lb	82.2 lb	
70"	23" or 24"	76"	23" or 24"	42.0 lb	87.6 lb	90.6 lb	
76"	23" or 24"	40"	23" or 24"	43.2 lb	66.6 lb	67.6 lb	
76"	23" or 24"	46"	23" or 24"	37.4 lb	70.8 lb	72.8 lb	
76"	23" or 24"	52"	23" or 24"	39.7 lb	75.0 lb	77.0 lb	
76"	23" or 24"	58"	23" or 24"	40.9 lb	79.2 lb	81.2 lb	
76"	23" or 24"	64"	23" or 24"	42.0 lb	83.4 lb	86.4 lb	
76"	23" or 24"	70"	23" or 24"	42.0 lb	87.6 lb	90.6 lb	

Options				
Understructure Weight	Integrated Rail Weight	Power and Data Access Door Weight	Soft Edge Weight	
29.8 lb	18.8 lb	6.9 lb	N.A.	
31.0 lb	19.9 lb	6.9 lb	N.A.	
32.2 lb	20.9 lb	6.9 lb	N.A.	
33.3 lb	21.9 lb	6.9 lb	N.A.	
34.5 lb	23.0 lb	6.9 lb	N.A.	
31.0 lb	19.9 lb	6.9 lb	N.A.	
32.2 lb	20.9 lb	6.9 lb	N.A.	
33.3 lb	21.9 lb	6.9 lb	N.A.	
34.5 lb	23.0 lb	6.9 lb	N.A.	
35.7 lb	24.0 lb	6.9 lb	N.A.	
29.8 lb	18.8 lb	6.9 lb	N.A.	
31.0 lb	19.9 lb	6.9 lb	N.A.	
33.3 lb	21.9 lb	6.9 lb	N.A.	
34.5 lb	23.0 lb	6.9 lb	N.A.	
35.7 lb	24.0 lb	6.9 lb	N.A.	
36.9 lb	25.1 lb	6.9 lb	N.A.	
31.0 lb	19.9 lb	6.9 lb	N.A.	
32.2 lb	20.9 lb	6.9 lb	N.A.	
33.3 lb	21.9 lb	6.9 lb	N.A.	
35.7 lb	24.0 lb	6.9 lb	N.A.	
36.9 lb	25.1 lb	6.9 lb	N.A.	
38.1 lb	26.1 lb	6.9 lb	N.A.	
32.2 lb	20.9 lb	6.9 lb	N.A.	
33.3 lb	21.9 lb	6.9 lb	N.A.	
34.5 lb	23.0 lb	6.9 lb	N.A.	
35.7 lb	24.0 lb	6.9 lb	N.A.	
38.0 lb	26.1 lb	6.9 lb	N.A.	
39.2 lb	27.1 lb	6.9 lb	N.A.	
33.3 lb	21.9 lb	6.9 lb	N.A.	
34.5 lb	23.0 lb	6.9 lb	N.A.	
35.7 lb	24.0 lb	6.9 lb	N.A.	
36.9 lb	25.1 lb	6.9 lb	N.A.	
38.0 lb	26.1 lb	6.9 lb	N.A.	
40.4 lb	28.2 lb	6.9 lb	N.A.	
34.5 lb	23.0 lb	6.9 lb	N.A.	
35.7 lb	24.0 lb	6.9 lb	N.A.	
36.9 lb	25.1 lb	6.9 lb	N.A.	
38.1 lb	26.1 lb	6.9 lb	N.A.	
39.2 lb	27.1 lb	6.9 lb	N.A.	
40.4 lb	28.2 lb	6.9 lb	N.A.	

Height-Adjustable Worksurfaces

Ology Height-Adjustable Worksurface Weights, continued

Base supports a maximum distributed weight capacity of 314 pounds (2-leg) and 471 pounds (3-leg).

Tip: When calculating lifting capacity, subtract the weight of the worksurface, under-structure and options (i.e. integrated rail, power and data access door or soft edge).

Tip: A label applied to the underside of the worksurface will include the load-capacity for each desk.

Worksurface Weight, continued

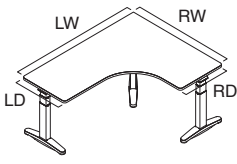
Worksurface Shape	LW	RW	Worksurface Weight	Worksurface Weight	Worksurface Weight	
			LD and RD	LD and RD	LD and RD	
			23"D/29"D	23"D/30"D	24"D/29"D	
	90° Extended	46"	40"	48.8 lb	49.3 lb	49.3 lb
		46"	52"	59.3 lb	60.2 lb	59.9 lb
		46"	58"	64.6 lb	65.7 lb	65.2 lb
		46"	64"	69.9 lb	71.2 lb	70.4 lb
		46"	70"	75.2 lb	76.6 lb	75.7 lb
		46"	76"	80.5 lb	82.1 lb	81.0 lb
		46"	78"	82.3 lb	83.9 lb	82.8 lb
		52"	40"	53.0 lb	53.5 lb	53.7 lb
		52"	46"	58.3 lb	59.0 lb	59.0 lb
		52"	58"	68.8 lb	69.9 lb	69.5 lb
		52"	64"	74.1 lb	75.4 lb	74.8 lb
		52"	70"	79.4 lb	80.8 lb	80.1 lb
		52"	76"	84.7 lb	86.3 lb	85.4 lb
		52"	78"	86.5 lb	88.1 lb	87.2 lb
		58"	40"	57.2 lb	57.7 lb	58.0 lb
		58"	46"	62.4 lb	63.1 lb	63.3 lb
		58"	52"	67.7 lb	68.6 lb	68.6 lb
		58"	64"	78.3 lb	79.6 lb	79.2 lb
		58"	70"	83.6 lb	85.0 lb	84.5 lb
		58"	76"	88.9 lb	90.5 lb	89.8 lb
	58"	78"	90.7 lb	92.3 lb	91.5 lb	
	64"	40"	61.4 lb	61.9 lb	62.4 lb	
	64"	46"	66.6 lb	67.3 lb	67.7 lb	
	64"	52"	71.9 lb	72.8 lb	73.0 lb	
	64"	58"	77.2 lb	78.3 lb	78.3 lb	
	64"	70"	87.8 lb	89.2 lb	88.9 lb	
	64"	76"	93.1 lb	94.7 lb	94.2 lb	
	64"	78"	94.9 lb	96.5 lb	95.9 lb	

• Worksurface Weight LD and RD 24"D/30"D	• Worksurface Weight LD and RD 29"D/29"D	• Worksurface Weight LD and RD 29"D/30"D	• Worksurface Weight LD and RD 30"D/30"D
49.8 lb	N.A.	N.A.	N.A.
60.7 lb	62.4 lb	63.1 lb	63.6 lb
66.2 lb	67.7 lb	68.6 lb	69.1 lb
71.7 lb	73.0 lb	74.1 lb	74.6 lb
77.1 lb	78.3 lb	79.6 lb	80.0 lb
82.6 lb	83.6 lb	85.0 lb	85.5 lb
84.4 lb	85.4 lb	86.9 lb	87.3 lb
54.1 lb	N.A.	N.A.	N.A.
59.6 lb	62.4 lb	63.0 lb	63.6 lb
70.6 lb	73.0 lb	73.9 lb	74.6 lb
76.0 lb	78.3 lb	79.4 lb	80.0 lb
81.5 lb	83.6 lb	84.9 lb	85.5 lb
87.0 lb	88.9 lb	90.3 lb	91.0 lb
88.8 lb	90.7 lb	92.1 lb	92.8 lb
58.5 lb	N.A.	N.A.	N.A.
64.0 lb	67.7 lb	68.3 lb	69.1 lb
69.5 lb	73.0 lb	73.7 lb	74.6 lb
80.4 lb	83.6 lb	84.7 lb	85.5 lb
85.9 lb	88.9 lb	90.1 lb	91.0 lb
91.4 lb	94.2 lb	95.6 lb	96.5 lb
93.2 lb	95.9 lb	97.4 lb	98.3 lb
62.9 lb	N.A.	N.A.	N.A.
68.4 lb	73.0 lb	73.5 lb	74.6 lb
73.8 lb	78.3 lb	79.0 lb	80.0 lb
79.3 lb	83.6 lb	84.5 lb	85.5 lb
90.3 lb	94.2 lb	95.4 lb	96.5 lb
95.7 lb	99.5 lb	100.9 lb	101.9 lb
97.6 lb	101.2 lb	102.7 lb	103.8 lb

Height-Adjustable
Worksurfaces

Ology Height-Adjustable Worksurface Weights, continued

Base supports a maximum distributed weight capacity of 314 pounds (2-leg) and 471 pounds (3-leg).

Tip: When calculating lifting capacity, subtract the weight of the worksurface, under-structure and options (i.e. integrated rail, power and data access door or soft edge).

Tip: A label applied to the underside of the worksurface will include the load-capacity for each desk.

Worksurface Weight, continued

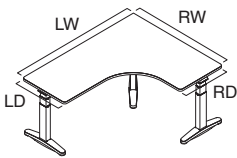
Worksurface Shape	LW	RW	Worksurface Weight	Worksurface Weight	Worksurface Weight	
			LD and RD	LD and RD	LD and RD	
			23"D/29"D	23"D/30"D	24"D/29"D	
	90° Extended	70"	40"	65.5 lb	66.1 lb	66.8 lb
		70"	46"	70.8 lb	71.5 lb	72.1 lb
		70"	52"	76.1 lb	77.0 lb	77.4 lb
		70"	58"	81.4 lb	82.5 lb	82.7 lb
		70"	64"	86.7 lb	88.0 lb	88.0 lb
		70"	76"	97.3 lb	98.9 lb	98.5 lb
		70"	78"	99.0 lb	100.7 lb	100.3 lb
		76"	40"	69.7 lb	70.3 lb	71.2 lb
		76"	46"	75.0 lb	75.7 lb	76.5 lb
		76"	52"	80.3 lb	81.2 lb	81.8 lb
		76"	58"	85.6 lb	86.7 lb	87.0 lb
		76"	64"	90.9 lb	92.1 lb	92.3 lb
		76"	70"	96.2 lb	97.6 lb	97.6 lb
		76"	78"	103.2 lb	104.9 lb	104.7 lb
		78"	40"	71.1 lb	71.7 lb	72.6 lb
		78"	46"	76.4 lb	77.1 lb	77.9 lb
		78"	52"	81.7 lb	82.6 lb	83.2 lb
		78"	58"	87.0 lb	88.1 lb	88.5 lb
		78"	64"	92.3 lb	93.5 lb	93.8 lb
		78"	70"	97.6 lb	99.0 lb	99.1 lb
	78"	76"	102.9 lb	104.5 lb	104.4 lb	

• Worksurface Weight LD and RD 24"D/30"D	• Worksurface Weight LD and RD 29"D/29"D	• Worksurface Weight LD and RD 29"D/30"D	• Worksurface Weight LD and RD 30"D/30"D
--	--	--	--

67.3 lb	N.A.	N.A.	N.A.
72.8 lb	78.3 lb	78.8 lb	80.0 lb
78.2 lb	83.6 lb	84.3 lb	85.5 lb
83.7 lb	88.9 lb	89.8 lb	91.0 lb
89.2 lb	94.2 lb	95.2 lb	96.5 lb
100.1 lb	104.8 lb	106.2 lb	107.4 lb
101.9 lb	106.5 lb	108.0 lb	109.2 lb
71.7 lb	N.A.	N.A.	N.A.
77.1 lb	83.6 lb	84.1 lb	85.5 lb
82.6 lb	88.9 lb	89.6 lb	91.0 lb
88.1 lb	94.2 lb	95.1 lb	96.5 lb
93.5 lb	99.5 lb	100.5 lb	101.9 lb
99.0 lb	104.8 lb	106.0 lb	107.4 lb
106.3 lb	111.8 lb	113.3 lb	114.7 lb
73.1 lb	N.A.	N.A.	N.A.
78.6 lb	85.4 lb	85.9 lb	87.3 lb
84.1 lb	90.7 lb	91.4 lb	92.8 lb
89.5 lb	95.9 lb	96.8 lb	98.3 lb
95.0 lb	101.2 lb	102.3 lb	103.8 lb
100.5 lb	106.5 lb	107.8 lb	109.2 lb
106.0 lb	111.8 lb	113.2 lb	114.7 lb

Height-Adjustable
Worksurfaces

Ology Height-Adjustable Worksurface Weights, continued

Worksurface Weight, continued

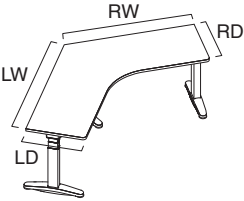
Worksurface Shape	LW	LD	RW	RD	• Base only Weight (OLELWCB)	• Worksurface Weight	
						23" D	24" D
	34"	23" or 24"	34"	23" or 24"	81 lb	38.7 lb	39.7 lb
	40"	23" or 24"	40"	23" or 24"	83 lb	47.1 lb	48.1 lb
	46"	23" or 24"	46"	23" or 24"	85 lb	55.5 lb	56.5 lb
	52"	23" or 24"	52"	23" or 24"	88 lb	63.9 lb	65.9 lb
	58"	23" or 24"	58"	23" or 24"	90 lb	72.3 lb	74.3 lb
	64"	23" or 24"	64"	23" or 24"	92 lb	80.7 lb	82.7 lb

Options			
Understructure Weight	Integrated Rail Weight	Power and Data Access Door Weight	Soft Edge Weight
20.1 lb	11.5 lb	N.A.	N.A.
22.5 lb	13.0 lb	N.A.	N.A.
24.8 lb	14.5 lb	N.A.	N.A.
27.2 lb	15.9 lb	6.9 lb	N.A.
29.5 lb	17.4 lb	6.9 lb	N.A.
31.8 lb	18.9 lb	6.9 lb	N.A.

Airtouch Height-Adjustable Worksurface Weights

Base supports a maximum distributed weight capacity of 150 pounds.
 Tip: When calculating lifting capacity, subtract the weight of the worksurface.

Worksurface Weight

Worksurface Shape	W	LD	RD	Style Number	Worksurface Weight
Universal Tables					
Rectangular – 22¼"D	40"	22¼"	22¼"	BAPSS2424	30.6 lb
	46"	22¼"	22¼"	BAPSS2448	35.0 lb
	58"	22¼"	22¼"	BAPSS2460	44.8 lb

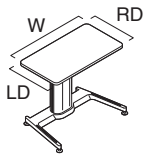

Rectangular – 28¼"D	40"	28¼"	28¼"	BAPSS3042	38.3 lb
	46"	28¼"	28¼"	BAPSS3048	44.8 lb
	58"	28¼"	28¼"	BAPSS3060	55.8 lb

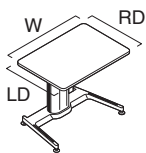

Rectangular Bi-level	40"	34¼"	34¼"	BAPDS3642	62.3 lb
	46"	34¼"	34¼"	BAPDS3648	70.0 lb

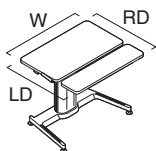

Worksurface Shape	LW	LD	RW	RD	Style Number	Worksurface Weight
90° Corner	39¼"	22¼"	39¼"	22¼"	BAPSC2442	45.9 lb
	45¼"	22¼"	45¼"	22¼"	BAPSC2448	59.0 lb

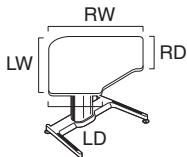

90° Corner Bi-Level	39¼"	22¼"	39¼"	22¼"	BAPDC2442	59.0 lb
	45¼"	22¼"	45¼"	22¼"	BAPDC2448	72.2 lb

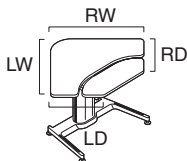

120° Equal	34"	22¼"	34"	22¼"	BAPB2436	55.8 lb
------------	-----	------	-----	------	----------	---------

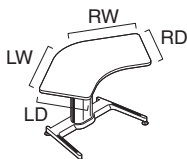

Worksurface Weight, continued

Worksurface Shape	W	LD	RD	Style Number	Worksurface Weight
For use with Universal Systems					
Rectangular – 22¼"D	40"	22¼"	22¼"	UAPSS2424	30.6 lb
	46"	22¼"	22¼"	UAPSS2448	35.0 lb
	58"	22¼"	22¼"	UAPSS2460	44.8 lb

Rectangular – 28¼"D	40"	28¼"	28¼"	UAPSS3042	38.3 lb
	46"	28¼"	28¼"	UAPSS3048	44.8 lb
	58"	28¼"	28¼"	UAPSS3060	55.8 lb

Rectangular Bi-level	40"	34¼"	34¼"	UAPDS3642	62.3 lb
	46"	34¼"	34¼"	UAPDS3648	70.0 lb

Worksurface Shape	LW	LD	RW	RD	Style Number	Worksurface Weight
90° Corner	39¼"	16¼"	39¼"	16¼"	UAPSC1842	30.6 lb
	39¼"	22¼"	39¼"	22¼"	UAPSC2442	45.9 lb
	45¼"	22¼"	45¼"	22¼"	UAPSC2448	59.0 lb

90° Corner Bi-Level	39¼"	22¼"	39¼"	22¼"	UAPDC2442	59.0 lb
	45¼"	22¼"	45¼"	22¼"	UAPDC2448	72.2 lb

120° Equal	34"	22¼"	34"	22¼"	UAPB2436	55.8 lb
------------	-----	------	-----	------	----------	---------

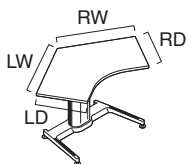
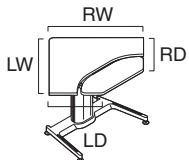
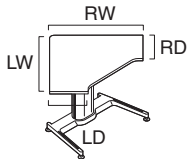
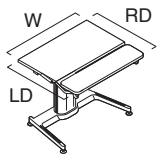
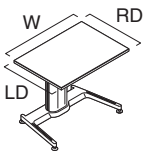
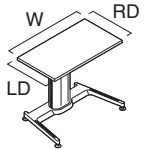

Height-Adjustable
Worksurfaces

Series 5 Height-Adjustable Worksurface Weights

Base supports a maximum distributed weight capacity of 195 pounds.
 Tip: When calculating lifting capacity, subtract the weight of the worksurface.

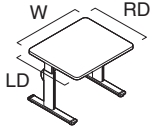

Worksurface Weight					
Worksurface Shape	W	LD	RD	Style Number	Worksurface Weight
Rectangular – 29"D	46"	29"	29"	A5RQ462929	45.9 lb
	52"	29"	29"	A5RQ522929	51.4 lb
	58"	29"	29"	A5RQ582929	56.9 lb
	64"	29"	29"	A5RQ642929	63.4 lb
	70"	29"	29"	A5RQ702929	68.9 lb
	76"	29"	29"	A5RQ762929	74.4 lb

Ology Corner Desks and Bases Size Restrictions

Style Number	Desks Specified as	Base Price	Desks Specified as	Base Price
90° Corner Desks — Extended Height (Different Depth Opposite Ends 23"/24" Right/Left and 29"/30" Left/Right)				
High-Pressure Laminate Desks				
OLELLC	40WL x 23DL x 52WR x 29DR	N.A.	40WL x 29DL x 52WR x 23DR	\$2718
	40WL x 24DL x 52WR x 29DR	N.A.	40WL x 29DL x 52WR x 24DR	\$2718
	40WL x 23DL x 58WR x 29DR	N.A.	40WL x 29DL x 58WR x 23DR	\$2809
	40WL x 24DL x 58WR x 29DR	N.A.	40WL x 29DL x 58WR x 24DR	\$2809
	40WL x 23DL x 64WR x 29DR	N.A.	40WL x 29DL x 64WR x 23DR	\$2900
	40WL x 24DL x 64WR x 29DR	N.A.	40WL x 29DL x 64WR x 24DR	\$2900
	40WL x 23DL x 70WR x 29DR	N.A.	40WL x 29DL x 70WR x 23DR	\$2990
	40WL x 24DL x 70WR x 29DR	N.A.	40WL x 29DL x 70WR x 24DR	\$2990
	40WL x 23DL x 76WR x 29DR	N.A.	40WL x 29DL x 76WR x 23DR	\$3080
	40WL x 24DL x 76WR x 29DR	N.A.	40WL x 29DL x 76WR x 24DR	\$3080
	40WL x 23DL x 52WR x 30DR	N.A.	40WL x 30DL x 52WR x 23DR	\$2718
	40WL x 24DL x 52WR x 30DR	N.A.	40WL x 30DL x 52WR x 24DR	\$2718
	40WL x 23DL x 58WR x 30DR	N.A.	40WL x 30DL x 58WR x 23DR	\$2809
	40WL x 24DL x 58WR x 30DR	N.A.	40WL x 30DL x 58WR x 24DR	\$2809
	40WL x 23DL x 64WR x 30DR	N.A.	40WL x 30DL x 64WR x 23DR	\$2900
	40WL x 24DL x 64WR x 30DR	N.A.	40WL x 30DL x 64WR x 24DR	\$2900
	40WL x 23DL x 70WR x 30DR	N.A.	40WL x 30DL x 70WR x 23DR	\$2990
	40WL x 24DL x 70WR x 30DR	N.A.	40WL x 30DL x 70WR x 24DR	\$2990
	40WL x 23DL x 76WR x 30DR	N.A.	40WL x 30DL x 76WR x 23DR	\$3080
	40WL x 24DL x 76WR x 30DR	N.A.	40WL x 30DL x 76WR x 24DR	\$3080
	52WL x 29DL x 40WR x 23DR	N.A.	52WL x 23DL x 40WR x 29DR	\$2718
	52WL x 29DL x 40WR x 24DR	N.A.	52WL x 24DL x 40WR x 29DR	\$2718
	52WL x 30DL x 40WR x 23DR	N.A.	52WL x 23DL x 40WR x 30DR	\$2718
	52WL x 30DL x 40WR x 24DR	N.A.	52WL x 24DL x 40WR x 30DR	\$2718

Tip: Desks that are 23"D or 24"D right and 29"D or 30"D left cannot be specified between 40"W–42"W left width and 48¹/₁₆"W–52"W right.

Tip: Desks that are 23"D or 24"D left and 29"D or 30"D right cannot be specified between 48¹/₁₆"W–52"W left width and 40"W–42"W right.

Style Number	Desks Specified as	Base Price	Desks Specified as	Base Price
90° Corner Desks — Extended Height (Different Depth Opposite Ends 23"/24" Right/Left and 29"/30" Left/Right)				
Wood Veneer Desks				
OLELLC	40WL x 23DL x 52WR x 29DR	N.A.	40WL x 29DL x 52WR x 23DR	\$3630
	40WL x 24DL x 52WR x 29DR	N.A.	40WL x 29DL x 52WR x 24DR	\$3630
	40WL x 23DL x 58WR x 29DR	N.A.	40WL x 29DL x 58WR x 23DR	\$3734
	40WL x 24DL x 58WR x 29DR	N.A.	40WL x 29DL x 58WR x 24DR	\$3734
	40WL x 23DL x 64WR x 29DR	N.A.	40WL x 29DL x 64WR x 23DR	\$3838
	40WL x 24DL x 64WR x 29DR	N.A.	40WL x 29DL x 64WR x 24DR	\$3838
	40WL x 23DL x 70WR x 29DR	N.A.	40WL x 29DL x 70WR x 23DR	\$3941
	40WL x 24DL x 70WR x 29DR	N.A.	40WL x 29DL x 70WR x 24DR	\$3941
	40WL x 23DL x 76WR x 29DR	N.A.	40WL x 29DL x 76WR x 23DR	\$4048
	40WL x 24DL x 76WR x 29DR	N.A.	40WL x 29DL x 76WR x 24DR	\$4048
	40WL x 23DL x 52WR x 30DR	N.A.	40WL x 30DL x 52WR x 23DR	\$3630
	40WL x 24DL x 52WR x 30DR	N.A.	40WL x 30DL x 52WR x 24DR	\$3630
	40WL x 23DL x 58WR x 30DR	N.A.	40WL x 30DL x 58WR x 23DR	\$3734
	40WL x 24DL x 58WR x 30DR	N.A.	40WL x 30DL x 58WR x 24DR	\$3734
	40WL x 23DL x 64WR x 30DR	N.A.	40WL x 30DL x 64WR x 23DR	\$3838
	40WL x 24DL x 64WR x 30DR	N.A.	40WL x 30DL x 64WR x 24DR	\$3838
	40WL x 23DL x 70WR x 30DR	N.A.	40WL x 30DL x 70WR x 23DR	\$3941
	40WL x 24DL x 70WR x 30DR	N.A.	40WL x 30DL x 70WR x 24DR	\$3941
	40WL x 23DL x 76WR x 30DR	N.A.	40WL x 30DL x 76WR x 23DR	\$4048
	40WL x 24DL x 76WR x 30DR	N.A.	40WL x 30DL x 76WR x 24DR	\$4048
	52WL x 29DL x 40WR x 23DR	N.A.	52WL x 23DL x 40WR x 29DR	\$3630
	52WL x 29DL x 40WR x 24DR	N.A.	52WL x 24DL x 40WR x 29DR	\$3630
	52WL x 30DL x 40WR x 23DR	N.A.	52WL x 23DL x 40WR x 30DR	\$3630
	52WL x 30DL x 40WR x 24DR	N.A.	52WL x 24DL x 40WR x 30DR	\$3630

Tip: Desks that are 23"D or 24"D right and 29"D or 30"D left cannot be specified between 40"W-42"W left width and 48¹/₁₆"W-52"W right.

Tip: Desks that are 23"D or 24"D left and 29"D or 30"D right cannot be specified between 48¹/₁₆"W-52"W left width and 40"W-42"W right.

Ology Corner Desks and Bases Size Restrictions, continued

Style Number	Desks Specified as	Base Price	Desks Specified as	Base Price
90° Corner Desks — Basic Height (Different Depth Opposite Ends 23"/24" Right/Left and 29"/30" Left/Right)				
High-Pressure Laminate Desks				
OLSLLC	40WL x 23DL x 52WR x 29DR	N.A.	40WL x 29DL x 52WR x 23DR	\$2506
	40WL x 24DL x 52WR x 29DR	N.A.	40WL x 29DL x 52WR x 24DR	\$2506
	40WL x 23DL x 58WR x 29DR	N.A.	40WL x 29DL x 58WR x 23DR	\$2588
	40WL x 24DL x 58WR x 29DR	N.A.	40WL x 29DL x 58WR x 24DR	\$2588
	40WL x 23DL x 64WR x 29DR	N.A.	40WL x 29DL x 64WR x 23DR	\$2672
	40WL x 24DL x 64WR x 29DR	N.A.	40WL x 29DL x 64WR x 24DR	\$2672
	40WL x 23DL x 70WR x 29DR	N.A.	40WL x 29DL x 70WR x 23DR	\$2755
	40WL x 24DL x 70WR x 29DR	N.A.	40WL x 29DL x 70WR x 24DR	\$2755
	40WL x 23DL x 76WR x 29DR	N.A.	40WL x 29DL x 76WR x 23DR	\$2838
	40WL x 24DL x 76WR x 29DR	N.A.	40WL x 29DL x 76WR x 24DR	\$2838
	40WL x 23DL x 52WR x 30DR	N.A.	40WL x 30DL x 52WR x 23DR	\$2506
	40WL x 24DL x 52WR x 30DR	N.A.	40WL x 30DL x 52WR x 24DR	\$2506
	40WL x 23DL x 58WR x 30DR	N.A.	40WL x 30DL x 58WR x 23DR	\$2588
	40WL x 24DL x 58WR x 30DR	N.A.	40WL x 30DL x 58WR x 24DR	\$2588
	40WL x 23DL x 64WR x 30DR	N.A.	40WL x 30DL x 64WR x 23DR	\$2672
	40WL x 24DL x 64WR x 30DR	N.A.	40WL x 30DL x 64WR x 24DR	\$2672
	40WL x 23DL x 70WR x 30DR	N.A.	40WL x 30DL x 70WR x 23DR	\$2755
	40WL x 24DL x 70WR x 30DR	N.A.	40WL x 30DL x 70WR x 24DR	\$2755
	40WL x 23DL x 76WR x 30DR	N.A.	40WL x 30DL x 76WR x 23DR	\$2838
	40WL x 24DL x 76WR x 30DR	N.A.	40WL x 30DL x 76WR x 24DR	\$2838
	52WL x 29DL x 40WR x 23DR	N.A.	52WL x 23DL x 40WR x 29DR	\$2506
	52WL x 29DL x 40WR x 24DR	N.A.	52WL x 24DL x 40WR x 29DR	\$2506
	52WL x 30DL x 40WR x 23DR	N.A.	52WL x 23DL x 40WR x 30DR	\$2506
	52WL x 30DL x 40WR x 24DR	N.A.	52WL x 24DL x 40WR x 30DR	\$2506

Tip: Desks that are 23"D or 24"D right and 29"D or 30"D left cannot be specified between 40"W–42"W left width and 48¹/₁₆"W–52"W right.

Tip: Desks that are 23"D or 24"D left and 29"D or 30"D right cannot be specified between 48¹/₁₆"W–52"W left width and 40"W–42"W right.

Style Number	Desks Specified as	Base Price	Desks Specified as	Base Price
90° Corner Desks — Basic Height (Different Depth Opposite Ends 23"/24" Right/Left and 29"/30" Left/Right)				
Wood Veneer Desks				
OLSLLC	40WL x 23DL x 52WR x 29DR	N.A.	40WL x 29DL x 52WR x 23DR	\$3420
	40WL x 24DL x 52WR x 29DR	N.A.	40WL x 29DL x 52WR x 24DR	\$3420
	40WL x 23DL x 58WR x 29DR	N.A.	40WL x 29DL x 58WR x 23DR	\$3514
	40WL x 24DL x 58WR x 29DR	N.A.	40WL x 29DL x 58WR x 24DR	\$3514
	40WL x 23DL x 64WR x 29DR	N.A.	40WL x 29DL x 64WR x 23DR	\$3610
	40WL x 24DL x 64WR x 29DR	N.A.	40WL x 29DL x 64WR x 24DR	\$3610
	40WL x 23DL x 70WR x 29DR	N.A.	40WL x 29DL x 70WR x 23DR	\$3706
	40WL x 24DL x 70WR x 29DR	N.A.	40WL x 29DL x 70WR x 24DR	\$3706
	40WL x 23DL x 76WR x 29DR	N.A.	40WL x 29DL x 76WR x 23DR	\$3806
	40WL x 24DL x 76WR x 29DR	N.A.	40WL x 29DL x 76WR x 24DR	\$3806
	40WL x 23DL x 52WR x 30DR	N.A.	40WL x 30DL x 52WR x 23DR	\$3420
	40WL x 24DL x 52WR x 30DR	N.A.	40WL x 30DL x 52WR x 24DR	\$3420
	40WL x 23DL x 58WR x 30DR	N.A.	40WL x 30DL x 58WR x 23DR	\$3514
	40WL x 24DL x 58WR x 30DR	N.A.	40WL x 30DL x 58WR x 24DR	\$3514
	40WL x 23DL x 64WR x 30DR	N.A.	40WL x 30DL x 64WR x 23DR	\$3610
	40WL x 24DL x 64WR x 30DR	N.A.	40WL x 30DL x 64WR x 24DR	\$3610
	40WL x 23DL x 70WR x 30DR	N.A.	40WL x 30DL x 70WR x 23DR	\$3706
	40WL x 24DL x 70WR x 30DR	N.A.	40WL x 30DL x 70WR x 24DR	\$3706
	40WL x 23DL x 76WR x 30DR	N.A.	40WL x 30DL x 76WR x 23DR	\$3806
	40WL x 24DL x 76WR x 30DR	N.A.	40WL x 30DL x 76WR x 24DR	\$3806
	52WL x 29DL x 40WR x 23DR	N.A.	52WL x 23DL x 40WR x 29DR	\$3420
	52WL x 29DL x 40WR x 24DR	N.A.	52WL x 24DL x 40WR x 29DR	\$3420
	52WL x 30DL x 40WR x 23DR	N.A.	52WL x 23DL x 40WR x 30DR	\$3420
	52WL x 30DL x 40WR x 24DR	N.A.	52WL x 24DL x 40WR x 30DR	\$3420

Tip: Desks that are 23"D or 24"D right and 29"D or 30"D left cannot be specified between 40"W–42"W left width and 48¹/₁₆"W–52"W right.

Tip: Desks that are 23"D or 24"D left and 29"D or 30"D right cannot be specified between 48¹/₁₆"W–52"W left width and 40"W–42"W right.

Ology Corner Desks and Bases Size Restrictions, continued

Style Number	Desks Specified as	Base Price	Desks Specified as	Base Price
90° Corner Base — Extended Height (Different Depth Opposite Ends 23"/24" Right/Left and 29"/30" Left/Right)				
OLELLCB	40WL x 23DL x 52WR x 29DR	N.A.	40WL x 29DL x 52WR x 23DR	\$2613
	40WL x 24DL x 52WR x 29DR	N.A.	40WL x 29DL x 52WR x 24DR	\$2613
	40WL x 23DL x 58WR x 29DR	N.A.	40WL x 29DL x 58WR x 23DR	\$2653
	40WL x 24DL x 58WR x 29DR	N.A.	40WL x 29DL x 58WR x 24DR	\$2653
	40WL x 23DL x 64WR x 29DR	N.A.	40WL x 29DL x 64WR x 23DR	\$2693
	40WL x 24DL x 64WR x 29DR	N.A.	40WL x 29DL x 64WR x 24DR	\$2693
	40WL x 23DL x 70WR x 29DR	N.A.	40WL x 29DL x 70WR x 23DR	\$2733
	40WL x 24DL x 70WR x 29DR	N.A.	40WL x 29DL x 70WR x 24DR	\$2733
	40WL x 23DL x 76WR x 29DR	N.A.	40WL x 29DL x 76WR x 23DR	\$2773
	40WL x 24DL x 76WR x 29DR	N.A.	40WL x 29DL x 76WR x 24DR	\$2773
	40WL x 23DL x 52WR x 30DR	N.A.	40WL x 30DL x 52WR x 23DR	\$2613
	40WL x 24DL x 52WR x 30DR	N.A.	40WL x 30DL x 52WR x 24DR	\$2613
	40WL x 23DL x 58WR x 30DR	N.A.	40WL x 30DL x 58WR x 23DR	\$2653
	40WL x 24DL x 58WR x 30DR	N.A.	40WL x 30DL x 58WR x 24DR	\$2653
	40WL x 23DL x 64WR x 30DR	N.A.	40WL x 30DL x 64WR x 23DR	\$2693
	40WL x 24DL x 64WR x 30DR	N.A.	40WL x 30DL x 64WR x 24DR	\$2693
	40WL x 23DL x 70WR x 30DR	N.A.	40WL x 30DL x 70WR x 23DR	\$2733
	40WL x 24DL x 70WR x 30DR	N.A.	40WL x 30DL x 70WR x 24DR	\$2733
	40WL x 23DL x 76WR x 30DR	N.A.	40WL x 30DL x 76WR x 23DR	\$2773
	40WL x 24DL x 76WR x 30DR	N.A.	40WL x 30DL x 76WR x 24DR	\$2773
	52WL x 29DL x 40WR x 23DR	N.A.	52WL x 23DL x 40WR x 29DR	\$2613
	52WL x 29DL x 40WR x 24DR	N.A.	52WL x 24DL x 40WR x 29DR	\$2613
	52WL x 30DL x 40WR x 23DR	N.A.	52WL x 23DL x 40WR x 30DR	\$2613
	52WL x 30DL x 40WR x 24DR	N.A.	52WL x 24DL x 40WR x 30DR	\$2613

Tip: Desks that are 23"D or 24"D right and 29"D or 30"D left cannot be specified between 40"W–42"W left width and 48¹/₁₆"W–52"W right.

Tip: Desks that are 23"D or 24"D left and 29"D or 30"D right cannot be specified between 48¹/₁₆"W–52"W left width and 40"W–42"W right.

Style Number	Desks Specified as	Base Price	Desks Specified as	Base Price
90° Corner Base — Basic Height (Different Depth Opposite Ends 23"/24" Right/Left and 29"/30" Left/Right)				
OLSLLCB	40WL x 23DL x 52WR x 29DR	N.A.	40WL x 29DL x 52WR x 23DR	\$2408
	40WL x 24DL x 52WR x 29DR	N.A.	40WL x 29DL x 52WR x 24DR	\$2408
	40WL x 23DL x 58WR x 29DR	N.A.	40WL x 29DL x 58WR x 23DR	\$2445
	40WL x 24DL x 58WR x 29DR	N.A.	40WL x 29DL x 58WR x 24DR	\$2445
	40WL x 23DL x 64WR x 29DR	N.A.	40WL x 29DL x 64WR x 23DR	\$2481
	40WL x 24DL x 64WR x 29DR	N.A.	40WL x 29DL x 64WR x 24DR	\$2481
	40WL x 23DL x 70WR x 29DR	N.A.	40WL x 29DL x 70WR x 23DR	\$2518
	40WL x 24DL x 70WR x 29DR	N.A.	40WL x 29DL x 70WR x 24DR	\$2518
	40WL x 23DL x 76WR x 29DR	N.A.	40WL x 29DL x 76WR x 23DR	\$2555
	40WL x 24DL x 76WR x 29DR	N.A.	40WL x 29DL x 76WR x 24DR	\$2555
	40WL x 23DL x 52WR x 30DR	N.A.	40WL x 30DL x 52WR x 23DR	\$2408
	40WL x 24DL x 52WR x 30DR	N.A.	40WL x 30DL x 52WR x 24DR	\$2408
	40WL x 23DL x 58WR x 30DR	N.A.	40WL x 30DL x 58WR x 23DR	\$2445
	40WL x 24DL x 58WR x 30DR	N.A.	40WL x 30DL x 58WR x 24DR	\$2445
	40WL x 23DL x 64WR x 30DR	N.A.	40WL x 30DL x 64WR x 23DR	\$2481
	40WL x 24DL x 64WR x 30DR	N.A.	40WL x 30DL x 64WR x 24DR	\$2481
	40WL x 23DL x 70WR x 30DR	N.A.	40WL x 30DL x 70WR x 23DR	\$2518
	40WL x 24DL x 70WR x 30DR	N.A.	40WL x 30DL x 70WR x 24DR	\$2518
	40WL x 23DL x 76WR x 30DR	N.A.	40WL x 30DL x 76WR x 23DR	\$2555
	40WL x 24DL x 76WR x 30DR	N.A.	40WL x 30DL x 76WR x 24DR	\$2555
	52WL x 29DL x 40WR x 23DR	N.A.	52WL x 23DL x 40WR x 29DR	\$2408
	52WL x 29DL x 40WR x 24DR	N.A.	52WL x 24DL x 40WR x 29DR	\$2408
	52WL x 30DL x 40WR x 23DR	N.A.	52WL x 23DL x 40WR x 30DR	\$2408
	52WL x 30DL x 40WR x 24DR	N.A.	52WL x 24DL x 40WR x 30DR	\$2408

Tip: Desks that are 23"D or 24"D right and 29"D or 30"D left cannot be specified between 40"W-42"W left width and 48¹/₁₆"W-52"W right.

Tip: Desks that are 23"D or 24"D left and 29"D or 30"D right cannot be specified between 48¹/₁₆"W-52"W left width and 40"W-42"W right.

Ology Height-Adjustable Rectangular Desks

High-Pressure Laminate or Wood Veneer

SIN 711.2

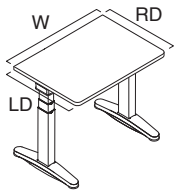

Tip: Any storage higher than 19" or 16 1/2" if the power access door is optioned, will impede lowest height range of worksurface. Do not place storage underneath controller.

Tip: Only single and dual flat panel monitor arm applications are permitted for use with 2-leg height-adjustable desks.

▶ See Steelcase Worktools Specification Guide.

Tip: Base supports a maximum distributed weight capacity of 314 pounds (2-leg) and 471 pounds (3-leg). When calculating lifting capacity, subtract the weight of the worksurface, understructure, and options selected.

▶ See page 228 for worksurface weights.

Tip: Antimicrobial can be specified only when specifying up/down controller and/or soft edge.

For laminate price group 2 pricing, please refer to the electronic catalog or SmartTools.

Tip: 9" overhang is available on desks 64"W and larger. Overhang on both sides is available on 70"W and larger.

Standard Includes	Required to Specify
-------------------	---------------------

- | | |
|---|---|
| <ul style="list-style-type: none"> • Worksurface: High-Pressure Laminate price group 1 with 3 mm plastic edge or wood group 1 veneer • Electric height-adjustable sit-to-stand base: paint • Active touch controller • Modular widths: 34"-76" • 1/2" adjustable glides • Power cord: 9' • Attachment hardware | <ol style="list-style-type: none"> 1 Style number 2 Desk depth 3 Desk width 4 High-Pressure Laminate or wood color for worksurface 5 Plastic color number for profile edge on laminate worksurface, if selected 6 Desk corner style, if laminate desk selected (see below under Required Selections) 7 Paint color number for base
4799 Platinum Metallic
7207 Black
7241 Arctic White
7360 Merle 8 Integrated rail (see below under Required Selections) 9 Antimicrobial or non-antimicrobial surface, if up/down controller selected (see below under Required Selections) 10 Options, if selected (see below) <p>▶ See <i>Surface Materials</i>, page 346.</p> |
|---|---|

Required Selections	Price	Required to Specify
---------------------	-------	---------------------

Desk Corner Style (Laminate Desks Only) <ul style="list-style-type: none"> • Square corners • Radius corners 	No cost +\$ 62	Specify <i>with square corners</i> . Specify <i>with radius corners</i> .
Integrated Rail <ul style="list-style-type: none"> • Without integrated rail • With integrated rail 	No cost +\$299	Specify <i>without integrated rail</i> . Specify <i>with integrated rail</i> .
Antimicrobial Surface <ul style="list-style-type: none"> • Non-antimicrobial surface • Antimicrobial surface 	No cost No cost	Specify <i>with non-antimicrobial surface</i> . Specify <i>with antimicrobial surface</i> .

Options	Price	Required to Specify
---------	-------	---------------------

Surface Materials	High-Pressure Laminate desks <ul style="list-style-type: none"> • Laminate price group 2 • Open Line laminate 	See information at left +\$ 69 plus cost of laminate	Specify laminate color number. ▶ See <i>Surface Materials Reference Manual</i> .
	Wood veneer desks <ul style="list-style-type: none"> • Wood group 2 • Wood group 3 • Customiz stain 	+\$ 69 +\$242 No cost	Specify wood color number. Specify wood color number. Specify <i>with customiz stain</i> . ▶ See <i>Surface Materials Reference Manual</i> . Specify full-fill finish number.
	Base <ul style="list-style-type: none"> • Paint price group 1 • Paint price group 2 	No cost +\$ 28	Specify paint color number. Specify paint color number. ▶ See <i>Surface Materials</i> , page 346.
Desk Type	<ul style="list-style-type: none"> • Parametric width desk 	No cost	Specify <i>with parametric desk type</i> .
Overhang	<ul style="list-style-type: none"> • Desk overhang on left • Desk overhang on right • Desk overhang left and right 	+\$ 56 +\$ 56 +\$112	Specify <i>with desk overhang left</i> . Specify <i>with desk overhang right</i> . Specify <i>with desk overhang left and right</i> .
Controller	<ul style="list-style-type: none"> • Up/down controller • 4 Pre-set controller 	-\$ 52 +\$ 63	Specify <i>with up/down controller</i> . Specify <i>with 4 pre-set controller</i> .

▶ Options, continued on next page

SIN 711.2

► Options, continued from previous page

Tip: Soft edge is available on desks 58"W and larger. If overhang left or overhang right is selected, soft edge is available on desks 70"W or 76"W. Soft edge cannot be specified on desks that have overhang on both sides.

Tip: Power and data access door is available on desks 40"W or greater.

Tip: Power access door and soft edge can be positioned left or right on desks that are 64"W or wider for use with One-High universal storage.

Tip: Rectangular desks accommodate either power and data access door or grommet, but not both.

Options	Price	Required to Specify
Soft Edge • With soft edge	+\$206	Specify with soft edge.
Power and Data Access Door, Tray and USB	• Power and data access door, tray and USB: paint group 1 or 2	+\$793
	• Power and data access door, tray and USB: anodized aluminum	+\$803
Power and Data Access Door and Soft Edge Position	• Centered	No cost
	• Left	No cost
	• Right	No cost
Grommet • Grommet	+\$ 40	Specify with grommet and select left- or right-hand side.
Glides • 1" adjustable glides	+\$ 28	Specify with 1" glides.
Related Products	• Modesty panels	► Page 281
	• Fixed personal/modesty screens	► Page 282
	• Cable and power management	► Page 283

Specification Information

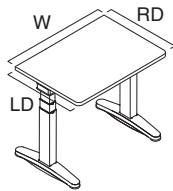

Style Number	Dimensions D	Desk Type	Base Prices							
			34"W	40"W	46"W	52"W	58"W	64"W	70"W	76"W
Modular			34"W	40"W	46"W	52"W	58"W	64"W	70"W	76"W
		Parametric	34"W	36 ¹ / ₁₆ "W	42 ¹ / ₁₆ "W	48 ¹ / ₁₆ "W	54 ¹ / ₁₆ "W	60 ¹ / ₁₆ "W	66 ¹ / ₁₆ "W	72 ¹ / ₁₆ "W
			36"W	42"W	48"W	54"W	60"W	66"W	72"W	78"W

High-Pressure Laminate Desks—Extended Height

OLELRQ	Height	34"W	40"W	46"W	52"W	58"W	64"W	70"W	76"W
	23" or 24"	\$1672	\$1723	\$1774	\$1829	\$1884	\$1943	\$2001	\$2061
	29" or 30"	\$1875	\$1932	\$1990	\$2052	\$2114	\$2178	\$2244	\$2313
	35" or 36"	\$2079	\$2141	\$2207	\$2274	\$2345	\$2413	\$2488	\$2565

Wood Group 1 Veneer Desks—Extended Height

OLELRQ	Height	34"W	40"W	46"W	52"W	58"W	64"W	70"W	76"W
	23" or 24"	\$2206	\$2265	\$2323	\$2388	\$2451	\$2520	\$2586	\$2657
	29" or 30"	\$2431	\$2497	\$2563	\$2634	\$2703	\$2779	\$2852	\$2930
	35" or 36"	\$2656	\$2728	\$2804	\$2880	\$2957	\$3037	\$3118	\$3204

► Specification Information, continued on next page

Height-Adjustable Worksurfaces

Ology Height-Adjustable Rectangular Desks, High-Pressure Laminate or Wood Veneer, continued

SIN 711.2

► Specification Information, continued from previous page

Specification Information

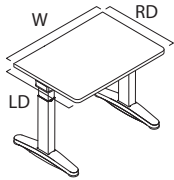

• Style Number	• Dimensions D	• Desk Type	• Base Prices										
			34"W	40"W	46"W	52"W	58"W	64"W	70"W	76"W			
		Modular											
		Parametric	34"W	36 ¹ / ₁₆ "W	42 ¹ / ₁₆ "W	48 ¹ / ₁₆ "W	54 ¹ / ₁₆ "W	60 ¹ / ₁₆ "W	66 ¹ / ₁₆ "W	72 ¹ / ₁₆ "W			
			-36"W	-42"W	-48"W	-54"W	-60"W	-66"W	-72"W	-78"W			

High-Pressure Laminate Desks — Basic Height

OLSLRQ	23" or 24"	29" or 30"	35" or 36"						
	\$1542	\$1729	\$1917	\$1589	\$1835	\$2035	\$1636	\$1892	\$2096
	\$1792	\$2008	\$2224	\$1845	\$2069	\$2293	\$1737	\$1949	\$2162
	\$1900	\$2132	\$2364	\$1900	\$2132	\$2364	\$1900	\$2132	\$2364

Wood Group 1 Veneer Desks — Basic Height

OLSLRQ	23" or 24"	29" or 30"	35" or 36"						
	\$2076	\$2285	\$2494	\$2131	\$2408	\$2632	\$2185	\$2474	\$2702
	\$2304	\$2609	\$2848	\$2369	\$2677	\$2923	\$2304	\$2609	\$2774
	\$2496	\$2749	\$3003	\$2496	\$2749	\$3003	\$2496	\$2749	\$3003

Ology
Height-Adjustable
Rectangular Desks

SIN 711.2

Ology Height-Adjustable Tapered Desks

High-Pressure Laminate or Wood Veneer

SIN 711.2

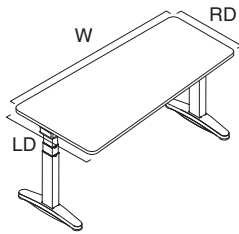

Tip: Any storage higher than 19" or 16 1/2" if the power access door is optioned, will impede lowest height range of worksurface. Do not place storage underneath controller.

Tip: Only single and dual flat panel monitor arm applications are permitted for use with 2-leg height-adjustable desks.

▶ See Steelcase Worktools Specification Guide.

Tip: Base supports a maximum distributed weight capacity of 314 pounds (2-leg) and 471 pounds (3-leg). When calculating lifting capacity, subtract the weight of the worksurface, understructure, and options selected.

▶ See page 228 for worksurface weights.

Tip: Antimicrobial can be specified only when specifying up/down controller and/or soft edge.

For laminate price group 2 pricing, please refer to the electronic catalog or SmartTools.

Tip: Soft edge is available on desks 58"W and larger.

Tip: Power access door and soft edge can be positioned left or right on desks that are 64"W or wider for use with One-High universal storage.

Standard Includes	Required to Specify
-------------------	---------------------

- Worksurface: High-Pressure Laminate price group 1 with 3 mm plastic edge or wood group 1 veneer
- Electric height-adjustable sit-to-stand base: paint
- Active touch controller
- Modular widths: 58"-76"
- 1/2" adjustable glides
- Power cord: 9'
- Attachment hardware

- 1 Style number
 - 2 Desk depth
 - 3 Desk width
 - 4 High-Pressure Laminate or wood color for worksurface
 - 5 Plastic color number for profile edge on laminate worksurface, if selected
 - 6 Desk corner style, if laminate desk selected (see below under Required Selections)
 - 7 Paint color number for base
4799 Platinum Metallic
7207 Black
7241 Arctic White
7360 Merle
 - 8 Integrated rail (see below under Required Selections)
 - 9 Antimicrobial or non-antimicrobial surface, if up/down controller selected (see below under Required Selections)
 - 10 Options, if selected (see below)
- ▶ See *Surface Materials*, page 346.

Required Selections	Price	Required to Specify
---------------------	-------	---------------------

Desk Corner Style (Laminate Desks Only)	<ul style="list-style-type: none"> • Square corners • Radius corners 	No cost +\$ 62	Specify <i>with square corners</i> . Specify <i>with radius corners</i> .
Integrated Rail	<ul style="list-style-type: none"> • Without integrated rail • With integrated rail 	No cost +\$299	Specify <i>without integrated rail</i> . Specify <i>with integrated rail</i> .
Antimicrobial Surface	<ul style="list-style-type: none"> • Non-antimicrobial surface • Antimicrobial surface 	No cost No cost	Specify <i>with non-antimicrobial surface</i> . Specify <i>with antimicrobial surface</i> .

Options	Price	Required to Specify
---------	-------	---------------------

Surface Materials	High-Pressure Laminate desks <ul style="list-style-type: none"> • Laminate price group 2 • Open Line laminate 	See information at left +\$ 69 plus cost of laminate	Specify laminate color number. ▶ See <i>Surface Materials Reference Manual</i> .
	Wood veneer desks <ul style="list-style-type: none"> • Wood group 2 • Wood group 3 • Customiz stain 	+\$ 69 +\$242 No cost	Specify wood color number. Specify wood color number. Specify <i>with customiz stain</i> . ▶ See <i>Surface Materials Reference Manual</i> . Specify full-fill finish number.
	Base <ul style="list-style-type: none"> • Paint price group 1 • Paint price group 2 	No cost +\$ 28	Specify paint color number. Specify paint color number. ▶ See <i>Surface Materials</i> , page 346.
Desk Type	<ul style="list-style-type: none"> • Parametric width desk 	No cost	Specify <i>with parametric desk type</i> .
Soft Edge	<ul style="list-style-type: none"> • With soft edge 	+\$206	Specify <i>with soft edge</i> .
Power and Data Access Door, Tray and USB	<ul style="list-style-type: none"> • Power and data access door, tray and USB: paint group 1 or 2 • Power and data access door, tray and USB: anodized aluminum 	+\$793 +\$803	Specify <i>with power and data access door</i> and select paint color number. Specify <i>with power and data access door</i> and select anodized aluminum.

▶ Options, continued on next page

► Options, continued from previous page

	Options	Price	Required to Specify
Controller	• Up/down controller	-\$52	Specify with up/down controller.
	• 4 Pre-set controller	+\$63	Specify with 4 pre-set controller.
Power and Data Access Door and Soft Edge Position	• Centered	No cost	Specify with centered position.
	• Left	No cost	Specify with left position.
	• Right	No cost	Specify with right position.
Grommet	• Grommet	+\$40	Specify with grommet and select left- or right-hand side.
Glides	• 1" adjustable glides	+\$28	Specify with 1" glides.
Related Products	• Modesty panels		► Page 281
	• Fixed personal/modesty screens		► Page 282
	• Cable and power management		► Page 283

Tip: Tapered desks accommodate either power and data access door or grommet, but not both.

Specification Information

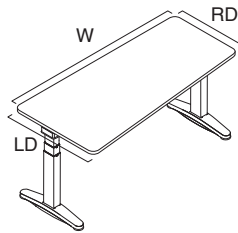

• Style Number	• Dimensions		• Desk Type	• Base Prices			
	LD	RD		58"W	64"W	70"W	76"W
			Modular	58"W	64"W	70"W	76"W
			Parametric	58 ¹ / ₁₆ "W-60"W	60 ¹ / ₁₆ "W-66"W	66 ¹ / ₁₆ "W-72"W	72 ¹ / ₁₆ "W-78"W

High-Pressure Laminate Desks—Extended Height

OLELRT	23" or 24"	29" or 30"	\$2114	\$2178	\$2244	\$2313
	29" or 30"	23" or 24"	\$2114	\$2178	\$2244	\$2313

Wood Group 1 Veneer Desks—Extended Height

OLELRT	23" or 24"	29" or 30"	\$2703	\$2779	\$2852	\$2930
	29" or 30"	23" or 24"	\$2703	\$2779	\$2852	\$2930

► Specification Information, continued on next page

Ology Height-Adjustable Tapered Desks, High-Pressure Laminate or Wood Veneer, continued

SIN 711.2

► Specification Information, continued from previous page

Specification Information

• Style Number	• Dimensions		• Desk Type	• Base Prices			
	LD	RD		58"W	64"W	70"W	76"W
			Modular				
			Parametric	58 ¹ / ₁₆ "W-60"W	60 ¹ / ₁₆ "W-66"W	66 ¹ / ₁₆ "W-72"W	72 ¹ / ₁₆ "W-78"W

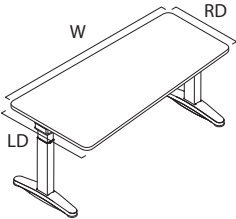

High-Pressure Laminate Desks — Basic Height

OLSLRT	23" or 24"	29" or 30"	\$1949	\$2008	\$2069	\$2132
	29" or 30"	23" or 24"	\$1949	\$2008	\$2069	\$2132

Wood Group 1 Veneer Desks — Basic Height

OLSLRT	23" or 24"	29" or 30"	\$2538	\$2609	\$2677	\$2749
	29" or 30"	23" or 24"	\$2538	\$2609	\$2677	\$2749

Ology
Height-Adjustable
Tapered Desks

SIN 711.2

Ology Height-Adjustable Corner Desks

High-Pressure Laminate or Wood Veneer

SIN 711.2

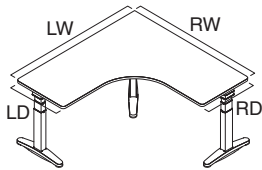

Tip: Any storage higher than 19" or 16 1/2" if the power access door is optioned, will impede lowest height range of worksurface. Do not place storage underneath controller.

Tip: Base supports a maximum distributed weight capacity of 314 pounds (2-leg) and 471 pounds (3-leg). When calculating lifting capacity, subtract the weight of the worksurface, understructure and options selected.

▶ See page 228 for worksurface weights.

Tip: Antimicrobial can be specified only when specifying up/down controller.

For laminate price group 2 pricing, please refer to the electronic catalog or SmartTools.

Standard Includes	Required to Specify
-------------------	---------------------

- Worksurface: High-Pressure Laminate price group 1 with 3 mm plastic edge or wood group 1 veneer
- Electric height-adjustable sit-to-stand base: paint
- Active touch controller
- Modular widths:
 - 90° equal corner: 52"–76"
 - 90° extended corner: 40"–76"
 - 120° equal corner: 34"–64"
- 1/2" adjustable glides
- Power cord: 9'
- Attachment hardware

- 1 Style number
 - 2 Desk depth
 - 3 Desk width
 - 4 High-Pressure Laminate or wood color for worksurface
 - 5 Plastic color number for profile edge on laminate worksurface, if selected
 - 6 Desk corner style, if laminate desk selected (see below under Required Selections)
 - 7 Paint color number for base
 - 4799 Platinum Metallic
 - 7207 Black
 - 7241 Arctic White
 - 7360 Merle
 - 8 Integrated rail (see below under Required Selections)
 - 9 Antimicrobial or non-antimicrobial surface, if up/down controller selected (see below under Required Selections)
 - 10 Options, if selected (see below)
- ▶ See *Surface Materials*, page 346.

	Required Selections	Price	Required to Specify
--	---------------------	-------	---------------------

Desk Corner Style (Laminate Desks Only)	• Square corners	No cost	Specify with square corners.
	• Radius corners	+\$ 62	Specify with radius corners.
Integrated Rail	• Without integrated rail	No cost	Specify without integrated rail.
	• With integrated rail	+\$598	Specify with integrated rail.
Antimicrobial Surface	• Non-antimicrobial surface	No cost	Specify with non-antimicrobial surface.
	• Antimicrobial surface	No cost	Specify with antimicrobial surface.

	Options	Price	Required to Specify
--	---------	-------	---------------------

Surface Materials	High-Pressure Laminate desks		Specify laminate color number. ▶ See <i>Surface Materials Reference Manual</i> .
	• Laminate price group 2	See information at left	
	• Open Line laminate	+\$ 69 plus cost of laminate	
	Wood veneer desks		Specify wood color number. Specify wood color number. Specify with customiz stain. ▶ See <i>Surface Materials Reference Manual</i> . Specify full-fill finish number.
• Wood group 2	+\$ 69		
• Wood group 3	+\$242		
	• Customiz stain	No cost	
	• Full-fill finish on wood group 1	+\$ 69	
	Base		Specify paint color number. Specify paint color number. ▶ See <i>Surface Materials</i> , page 346.
	• Paint price group 1	No cost	
	• Paint price group 2	+\$ 42	
Desk Type	• Modular width desk	No cost	Specify with modular desk type.
	• Parametric width desk	No cost	Specify with parametric desk type.
Controller	• Up/down controller	–\$ 52	Specify with up/down controller.
	• 4 Pre-set controller	+\$ 63	Specify with 4 pre-set controller.

▶ Options, continued on next page

► Options, continued from previous page

Tip: Power and data access door and grommet cannot be located on the same side of the desk.

Tip: Power and data access door is available on desks 58"W or greater.

Tip: When selecting power and data access door or grommet on one side, a cord drop will be standard on opposite side if integrated rail is present.

Options	Price	Required to Specify
Power and Data Access Door, Tray and USB		
• Power and data access door on left or right: paint group 1 or 2	+\$ 793	Specify with power and data access door on left or right and select paint color number.
• Power and data access door on left or right: anodized aluminum	+\$ 803	Specify with power and data access door on left or right and select anodized aluminum.
• Power and data access door on left and right: paint group 1 or 2	+\$1586	Specify with power and data access door on left and right and select paint color number.
• Power and data access door on left and right: anodized aluminum	+\$1606	Specify with power and data access door on left and right and select anodized aluminum.
Grommet		
• Grommet on left- or right-hand side.	+\$ 40	Specify with grommet and select left- or right-hand sides.
• Grommet on left- and right-hand side.	+\$ 80	Specify with grommet and select left- and right-hand sides.
Glides		
• 1" adjustable glides	+\$ 42	Specify with 1" glides.
Related Products		
• Modesty panels		► Page 281
• Fixed personal/modesty screens		► Page 282
• Cable and power management		► Page 283

Style Number		Dimensions D		Base Prices							
Modular	Right Width	Modular	Parametric	Right Width	40"W	46"W	52"W	58"W	64"W	70"W	76"W
				Parametric	40"W	42 ¹ / ₁₆ "W	48 ¹ / ₁₆ "W	52 ¹ / ₁₆ "W	60 ¹ / ₁₆ "W	66 ¹ / ₁₆ "W	72 ¹ / ₁₆ "W
Left Width	Right Width	Left Width	Left Width	Right Width	42"W	48"W	52"W	60"W	66"W	72"W	78"W
				Right Width	42"W	48"W	52"W	60"W	66"W	72"W	78"W

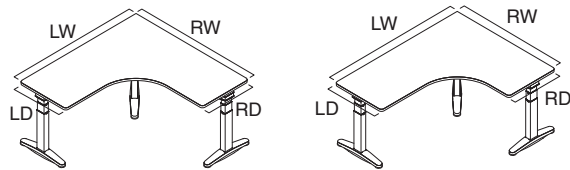

90° Corner Desks—Extended Height (Same Depth Both Ends 23"/24")

High-Pressure Laminate Desks										
OLELLC	23" or 24"	40"W	40"W-42"W	N.A.	N.A.	\$2626	\$2626	\$2707	\$2789	\$2873
	23" or 24"	46"W	42 ¹ / ₁₆ "W-48"W	N.A.	N.A.	\$2707	\$2707	\$2789	\$2873	\$2963
	23" or 24"	52"W	48 ¹ / ₁₆ "W-52"W	\$2626	\$2707	\$2707	\$2707	\$2963	\$3054	\$3148
	23" or 24"	58"W	52 ¹ / ₁₆ "W-60"W	\$2626	\$2707	\$2707	\$2873	\$2963	\$3054	\$3148
	23" or 24"	64"W	60 ¹ / ₁₆ "W-66"W	\$2707	\$2789	\$2963	\$2963	\$3054	\$3246	\$3246
	23" or 24"	70"W	66 ¹ / ₁₆ "W-72"W	\$2789	\$2873	\$3054	\$3054	\$3246	\$3246	\$3447
	23" or 24"	76"W	72 ¹ / ₁₆ "W-78"W	\$2873	\$2963	\$3148	\$3148	\$3246	\$3447	\$3447

Tip: At least one side must be 52"W or greater.

Tip: Equal corner widths are parametric to 1/16" from 52"W-78"W.

Tip: 90° desks, 60¹/₁₆"W x 60¹/₁₆"W and wider, are manufactured in two pieces. The worksurface split is located on the left side of an equal corner and on the longest side of an extended corner.

► Specification Information, continued on next page

Olgy Height-Adjustable Corner Desks, High-Pressure Laminate or Wood Veneer, continued

SIN 711.2

► Specification Information, continued from previous page

Specification Information													
Style Number	Dimensions				Base Prices								
	D		Modular Left Width	Parametric Left Width	Modular Right Width	Parametric Right Width	40"W	46"W	52"W	58"W	64"W	70"W	76"W
							40"W—42"W	42 ¹ / ₁₆ "W—48"W	48 ¹ / ₁₆ "W—52"W	52 ¹ / ₁₆ "W—60"W	60 ¹ / ₁₆ "W—66"W	66 ¹ / ₁₆ "W—72"W	72 ¹ / ₁₆ "W—78"W

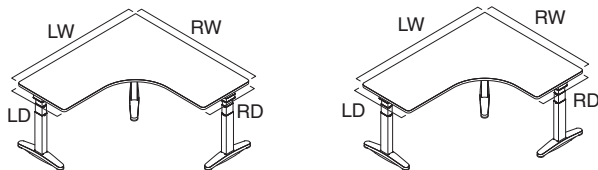

90° Corner Desks — Extended Height (Different Depth Opposite Ends 23"/24" Right/Left and 29"/30" Left/Right)

High-Pressure Laminate Desks

OLELLC	23" or 24" R/L	29" or 30" L/R	40"W	40"W—42"W	N.A.	N.A.	► See page 244	► See page 244	► See page 244	► See page 244	► See page 244
	23" or 24" R/L	29" or 30" L/R	46"W	42 ¹ / ₁₆ "W—48"W	N.A.	N.A.	\$2809	\$2900	\$2990	\$3080	\$3176
	23" or 24" R/L	29" or 30" L/R	52"W	48 ¹ / ₁₆ "W—52"W	► See page 244	\$2809	\$2900	\$2990	\$3080	\$3176	\$3274
	23" or 24" R/L	29" or 30" L/R	58"W	52 ¹ / ₁₆ "W—60"W	\$2809	\$2900	\$2990	\$3080	\$3176	\$3274	\$3373
	23" or 24" R/L	29" or 30" L/R	64"W	60 ¹ / ₁₆ "W—66"W	\$2900	\$2990	\$3080	\$3176	\$3274	\$3373	\$3476
	23" or 24" R/L	29" or 30" L/R	70"W	66 ¹ / ₁₆ "W—72"W	\$2990	\$3080	\$3176	\$3274	\$3373	\$3476	\$3584
	23" or 24" R/L	29" or 30" L/R	76"W	72 ¹ / ₁₆ "W—78"W	\$3080	\$3176	\$3274	\$3373	\$3476	\$3584	\$3687

Tip: At least one side must be 52"W or greater.

Tip: Equal corner widths are parametric to 1/16" from 52"W—78"W.

Tip: 90° desks, 60¹/₁₆"W x 60¹/₁₆"W and wider, are manufactured in two pieces. The worksurface split is located on the left side of an equal corner and on the longest side of an extended corner.

► Specification Information, continued on next page

► Specification Information, continued from previous page

Specification Information											
Style Number	Dimensions			Modular Right Width	Base Prices						
	D	Modular Left Width	Parametric Left Width		Parametric Right Width	40"W	46"W	52"W	58"W	64"W	70"W
					40"W	42 ¹ / ₁₆ "W	48 ¹ / ₁₆ "W	52 ¹ / ₁₆ "W	60 ¹ / ₁₆ "W	66 ¹ / ₁₆ "W	72 ¹ / ₁₆ "W
					42"W	48"W	52"W	60"W	66"W	72"W	78"W

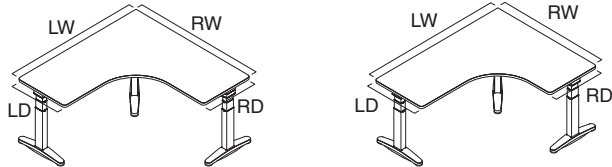

90° Corner Desks — Extended Height (Same Depth Both Ends 29"/30")

High-Pressure Laminate Desks

OLELLC	29" or 30"	40"W	40"W-42"W	N.A.	N.A.	N.A.	N.A.	N.A.	N.A.	N.A.
	29" or 30"	46"W	42 ¹ / ₁₆ "W-48"W	N.A.	N.A.	\$2889	\$2986	\$3082	\$3174	\$3272
	29" or 30"	52"W	48 ¹ / ₁₆ "W-52"W	N.A.	\$2889	\$2986	\$3082	\$3174	\$3272	\$3374
	29" or 30"	58"W	52 ¹ / ₁₆ "W-60"W	N.A.	\$2986	\$3082	\$3174	\$3272	\$3374	\$3475
	29" or 30"	64"W	60 ¹ / ₁₆ "W-66"W	N.A.	\$3082	\$3174	\$3272	\$3374	\$3475	\$3579
	29" or 30"	70"W	66 ¹ / ₁₆ "W-72"W	N.A.	\$3174	\$3272	\$3374	\$3475	\$3579	\$3688
	29" or 30"	76"W	72 ¹ / ₁₆ "W-78"W	N.A.	\$3272	\$3374	\$3475	\$3579	\$3688	\$3791

Tip: At least one side must be 52"W or greater.

Tip: Equal corner widths are parametric to 1/16" from 52"W-78"W.

Tip: 90° desks, 60¹/₁₆"W x 60¹/₁₆"W and wider, are manufactured in two pieces. The worksurface split is located on the left side of an equal corner and on the longest side of an extended corner.

► Specification Information, continued on next page

Height-Adjustable
Worksurfaces

Office Height-Adjustable Corner Desks, High-Pressure Laminate or Wood Veneer, continued

SIN 711.2

► Specification Information, continued from previous page

Specification Information											
Style Number	Dimensions			Modular Right Width	Base Prices						
	D	Modular Left Width	Parametric Left Width		Parametric Right Width	40"W	46"W	52"W	58"W	64"W	70"W
					40"W	42 ¹ / ₁₆ "W	48 ¹ / ₁₆ "W	52 ¹ / ₁₆ "W	60 ¹ / ₁₆ "W	66 ¹ / ₁₆ "W	72 ¹ / ₁₆ "W
					42"W	48"W	52"W	60"W	66"W	72"W	78"W

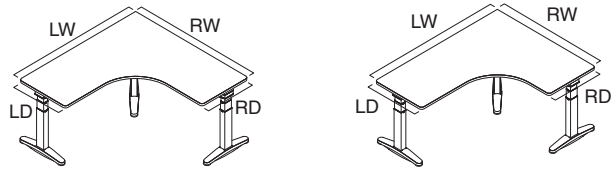

90° Corner Desks—Extended Height (Same Depth Both Ends 23"/24")

Wood Group 1 Veneer

OLELLC	23" or 24"	40"W	40"W-42"W	N.A.	N.A.	\$3515	\$3515	\$3609	\$3703	\$3804
	23" or 24"	46"W	42 ¹ / ₁₆ "W-48"W	N.A.	N.A.	\$3609	\$3609	\$3703	\$3804	\$3907
	23" or 24"	52"W	48 ¹ / ₁₆ "W-52"W	\$3515	\$3609	\$3609	\$3609	\$3907	\$4011	\$4120
	23" or 24"	58"W	52 ¹ / ₁₆ "W-60"W	\$3515	\$3609	\$3609	\$3804	\$3907	\$4011	\$4120
	23" or 24"	64"W	60 ¹ / ₁₆ "W-66"W	\$3609	\$3703	\$3907	\$3907	\$4011	\$4231	\$4231
	23" or 24"	70"W	66 ¹ / ₁₆ "W-72"W	\$3703	\$3804	\$4011	\$4011	\$4231	\$4231	\$4465
	23" or 24"	76"W	72 ¹ / ₁₆ "W-78"W	\$3804	\$3907	\$4120	\$4120	\$4231	\$4465	\$4465

Tip: At least one side must be 52"W or greater.

Tip: Equal corner widths are parametric to 1/16" from 52"W-78"W.

Tip: 90° desks, 60¹/₁₆"W x 60¹/₁₆"W and wider, are manufactured in two pieces. The worksurface split is located on the left side of an equal corner and on the longest side of an extended corner.

► Specification Information, continued on next page

► Specification Information, continued from previous page

Specification Information											
Style Number	Dimensions			Base Prices							
	D	Modular Left Width	Parametric Left Width	Modular Right Width	40"W	46"W	52"W	58"W	64"W	70"W	76"W
				Parametric Right Width	40"W—42"W	42 ¹ / ₁₆ "W—48"W	48 ¹ / ₁₆ "W—52"W	52 ¹ / ₁₆ "W—60"W	60 ¹ / ₁₆ "W—66"W	66 ¹ / ₁₆ "W—72"W	72 ¹ / ₁₆ "W—78"W

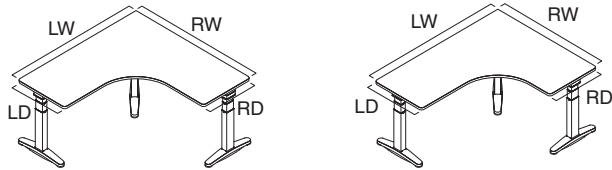

90° Corner Desks — Extended Height (Different Depth Opposite Ends 23"/24" Right/Left and 29"/30" Left/Right)

Wood Group 1 Veneer

OLELLC	23" or 24" R/L	29" or 30" L/R	40"W	40"W—42"W	N.A.	N.A.	► See page 244	► See page 244	► See page 244	► See page 244	► See page 244
	23" or 24" R/L	29" or 30" L/R	46"W	42 ¹ / ₁₆ "W—48"W	N.A.	N.A.	\$3734	\$3838	\$3941	\$4048	\$4157
	23" or 24" R/L	29" or 30" L/R	52"W	48 ¹ / ₁₆ "W—52"W	► See page 244	\$3734	\$3838	\$3941	\$4048	\$4157	\$4269
	23" or 24" R/L	29" or 30" L/R	58"W	52 ¹ / ₁₆ "W—60"W	\$3734	\$3838	\$3941	\$4048	\$4157	\$4269	\$4384
	23" or 24" R/L	29" or 30" L/R	64"W	60 ¹ / ₁₆ "W—66"W	\$3838	\$3941	\$4048	\$4157	\$4269	\$4384	\$4501
	23" or 24" R/L	29" or 30" L/R	70"W	66 ¹ / ₁₆ "W—72"W	\$3941	\$4048	\$4157	\$4269	\$4384	\$4501	\$4621
	23" or 24" R/L	29" or 30" L/R	76"W	72 ¹ / ₁₆ "W—78"W	\$4048	\$4157	\$4269	\$4384	\$4501	\$4621	\$4746

Tip: At least one side must be 52"W or greater.

Tip: Equal corner widths are parametric to ¹/₁₆" from 52"W—78"W.

Tip: 90° desks, 60¹/₁₆"W x 60¹/₁₆"W and wider, are manufactured in two pieces. The worksurface split is located on the left side of an equal corner and on the longest side of an extended corner.

► Specification Information, continued on next page

Height-Adjustable
Worksurfaces

Olgy Height-Adjustable Corner Desks, High-Pressure Laminate or Wood Veneer, continued

SIN 711.2

► Specification Information, continued from previous page

Specification Information											
• Style Number	• Dimensions D			• Base Prices							
	• Modular Left Width	• Parametric Left Width	• Modular Right Width	• Parametric Right Width	40"W	46"W	52"W	58"W	64"W	70"W	76"W
					40"W	42 ¹ / ₁₆ "W	48 ¹ / ₁₆ "W	52 ¹ / ₁₆ "W	60 ¹ / ₁₆ "W	66 ¹ / ₁₆ "W	72 ¹ / ₁₆ "W
					42"W	48"W	52"W	60"W	66"W	72"W	78"W

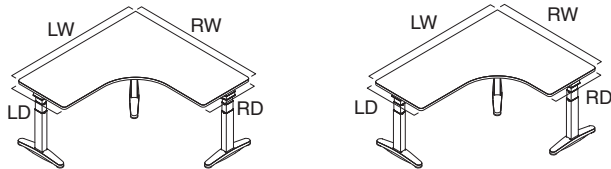

90° Corner Desks — Extended Height (Same Depth Both Ends 29"/30")

Wood Group 1 Veneer

OLELLC	29" or 30"	40"W	40"W–42"W	N.A.	N.A.	N.A.	N.A.	N.A.	N.A.	N.A.
	29" or 30"	46"W	42 ¹ / ₁₆ "W–48"W	N.A.	N.A.	\$3814	\$3924	\$4032	\$4142	\$4254
	29" or 30"	52"W	48 ¹ / ₁₆ "W–52"W	N.A.	\$3814	\$3924	\$4032	\$4142	\$4254	\$4369
	29" or 30"	58"W	52 ¹ / ₁₆ "W–60"W	N.A.	\$3924	\$4032	\$4142	\$4254	\$4369	\$4486
	29" or 30"	64"W	60 ¹ / ₁₆ "W–66"W	N.A.	\$4032	\$4142	\$4254	\$4369	\$4486	\$4603
	29" or 30"	70"W	66 ¹ / ₁₆ "W–72"W	N.A.	\$4142	\$4254	\$4369	\$4486	\$4603	\$4725
	29" or 30"	76"W	72 ¹ / ₁₆ "W–78"W	N.A.	\$4254	\$4369	\$4486	\$4603	\$4725	\$4850

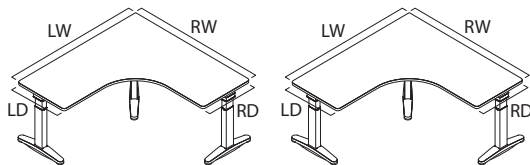

90° Corner Desks — Basic Height (Same Depth Both Ends 23"/24")

High-Pressure Laminate Desks

OLSLLC	23" or 24"	40"W	40"W–42"W	N.A.	N.A.	\$2420	\$2420	\$2495	\$2570	\$2647
	23" or 24"	46"W	42 ¹ / ₁₆ "W–48"W	N.A.	N.A.	\$2495	\$2495	\$2570	\$2647	\$2730
	23" or 24"	52"W	48 ¹ / ₁₆ "W–52"W	\$2420	\$2495	\$2495	\$2495	\$2730	\$2814	\$2900
	23" or 24"	58"W	52 ¹ / ₁₆ "W–60"W	\$2420	\$2495	\$2495	\$2647	\$2730	\$2814	\$2900
	23" or 24"	64"W	60 ¹ / ₁₆ "W–66"W	\$2495	\$2570	\$2730	\$2730	\$2814	\$2990	\$2990
	23" or 24"	70"W	66 ¹ / ₁₆ "W–72"W	\$2570	\$2647	\$2814	\$2814	\$2990	\$2990	\$3175
	23" or 24"	76"W	72 ¹ / ₁₆ "W–78"W	\$2647	\$2730	\$2900	\$2900	\$2990	\$3175	\$3175

Tip: At least one side must be 52"W or greater.

Tip: Equal corner widths are parametric to 1/16" from 52"W–78"W.

Tip: 90° desks, 60¹/₁₆"W x 60¹/₁₆"W and wider, are manufactured in two pieces. The worksurface split is located on the left side of an equal corner and on the longest side of an extended corner.

► Specification Information, continued on next page

► Specification Information, continued from previous page

Specification Information											
Style Number	Dimensions D			Base Prices							
	Modular Left Width	Parametric Left Width	Parametric Right Width	Modular Right Width	40"W	46"W	52"W	58"W	64"W	70"W	76"W
					40"W—42"W	42 ¹ / ₁₆ "W—48"W	48 ¹ / ₁₆ "W—52"W	52 ¹ / ₁₆ "W—60"W	60 ¹ / ₁₆ "W—66"W	66 ¹ / ₁₆ "W—72"W	72 ¹ / ₁₆ "W—78"W

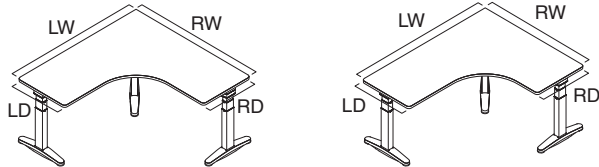

90° Corner Desks — Basic Height (Different Depth Opposite Ends 23"/24" Right/Left and 29"/30" Left/Right)

High-Pressure Laminate Desks

OLSLLC	23" or 24" R/L	29" or 30" L/R	40"W	40"W–42"W	N.A.	N.A.	► See page 244	► See page 244	► See page 244	► See page 244	► See page 244
	23" or 24" R/L	29" or 30" L/R	46"W	42 ¹ / ₁₆ "W–48"W	N.A.	N.A.	\$2588	\$2672	\$2755	\$2838	\$2926
	23" or 24" R/L	29" or 30" L/R	52"W	48 ¹ / ₁₆ "W–52"W	► See page 244	\$2588	\$2672	\$2755	\$2838	\$2926	\$3016
	23" or 24" R/L	29" or 30" L/R	58"W	52 ¹ / ₁₆ "W–60"W	\$2588	\$2672	\$2755	\$2838	\$2926	\$3016	\$3108
	23" or 24" R/L	29" or 30" L/R	64"W	60 ¹ / ₁₆ "W–66"W	\$2672	\$2755	\$2838	\$2926	\$3016	\$3108	\$3202
	23" or 24" R/L	29" or 30" L/R	70"W	66 ¹ / ₁₆ "W–72"W	\$2755	\$2838	\$2926	\$3016	\$3108	\$3202	\$3298
	23" or 24" R/L	29" or 30" L/R	76"W	72 ¹ / ₁₆ "W–78"W	\$2838	\$2926	\$3016	\$3108	\$3202	\$3298	\$3396

Tip: At least one side must be 52"W or greater.

Tip: Equal corner widths are parametric to 1/16" from 52"W–78"W.

Tip: 90° desks, 60¹/₁₆"W x 60¹/₁₆"W and wider, are manufactured in two pieces. The worksurface split is located on the left side of an equal corner and on the longest side of an extended corner.

► Specification Information, continued on next page

Height-Adjustable Worksurfaces

Olgy Height-Adjustable Corner Desks, High-Pressure Laminate or Wood Veneer, continued

SIN 711.2

► Specification Information, continued from previous page

Specification Information											
• Style Number	• Dimensions D			• Base Prices							
	• Modular Left Width	• Parametric Left Width	• Modular Right Width	• Parametric Right Width	40"W	46"W	52"W	58"W	64"W	70"W	76"W
					40"W—42"W	42 ¹ / ₁₆ "W—48"W	48 ¹ / ₁₆ "W—52"W	52 ¹ / ₁₆ "W—60"W	60 ¹ / ₁₆ "W—66"W	66 ¹ / ₁₆ "W—72"W	72 ¹ / ₁₆ "W—78"W

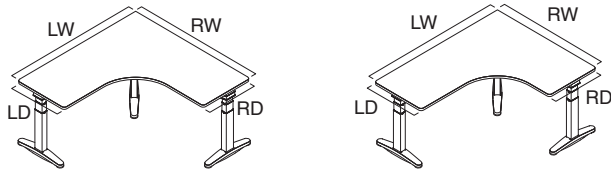

90° Corner Desks — Basic Height (Same Depth Both Ends 29"/30")

High-Pressure Laminate Desks

OLSLLC	29" or 30"	40"W	40"W—42"W	N.A.	N.A.	N.A.	N.A.	N.A.	N.A.	N.A.
	29" or 30"	46"W	42 ¹ / ₁₆ "W—48"W	N.A.	N.A.	\$2662	\$2751	\$2839	\$2924	\$3014
	29" or 30"	52"W	48 ¹ / ₁₆ "W—52"W	N.A.	\$2662	\$2751	\$2839	\$2924	\$3014	\$3108
	29" or 30"	58"W	52 ¹ / ₁₆ "W—60"W	N.A.	\$2751	\$2839	\$2924	\$3014	\$3108	\$3201
	29" or 30"	64"W	60 ¹ / ₁₆ "W—66"W	N.A.	\$2839	\$2924	\$3014	\$3108	\$3201	\$3297
	29" or 30"	70"W	66 ¹ / ₁₆ "W—72"W	N.A.	\$2924	\$3014	\$3108	\$3201	\$3297	\$3397
	29" or 30"	76"W	72 ¹ / ₁₆ "W—78"W	N.A.	\$3014	\$3108	\$3210	\$3297	\$3397	\$3492

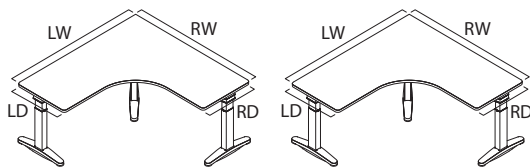

90° Corner Desks — Basic Height (Same Depth Both Ends 23"/24")

Wood Group 1 Veneer Desks

OLSLLC	23" or 24"	40"W	40"W—42"W	N.A.	N.A.	\$3309	\$3309	\$3397	\$3484	\$3578
	23" or 24"	46"W	42 ¹ / ₁₆ "W—48"W	N.A.	N.A.	\$3397	\$3397	\$3484	\$3578	\$3674
	23" or 24"	52"W	48 ¹ / ₁₆ "W—52"W	\$3309	\$3397	\$3397	\$3397	\$3674	\$3771	\$3872
	23" or 24"	58"W	52 ¹ / ₁₆ "W—60"W	\$3309	\$3397	\$3397	\$3578	\$3674	\$3771	\$3872
	23" or 24"	64"W	60 ¹ / ₁₆ "W—66"W	\$3397	\$3484	\$3674	\$3674	\$3771	\$3975	\$3975
	23" or 24"	70"W	66 ¹ / ₁₆ "W—72"W	\$3484	\$3578	\$3771	\$3771	\$3975	\$3975	\$4193
	23" or 24"	76"W	72 ¹ / ₁₆ "W—78"W	\$3578	\$3674	\$3872	\$3872	\$3975	\$4193	\$4193

Tip: At least one side must be 52"W or greater.

Tip: Equal corner widths are parametric to 1/16" from 52"W—78"W.

Tip: 90° desks, 60¹/₁₆"W x 60¹/₁₆"W and wider, are manufactured in two pieces. The worksurface split is located on the left side of an equal corner and on the longest side of an extended corner.

► Specification Information, continued on next page

► Specification Information, continued from previous page

Specification Information											
Style Number	Dimensions D			Base Prices							
	Modular Left Width	Parametric Left Width	Parametric Right Width	Modular Right Width	40"W	46"W	52"W	58"W	64"W	70"W	76"W
					40"W—42"W	42 ¹ / ₁₆ "W—48"W	48 ¹ / ₁₆ "W—52"W	52 ¹ / ₁₆ "W—60"W	60 ¹ / ₁₆ "W—66"W	66 ¹ / ₁₆ "W—72"W	72 ¹ / ₁₆ "W—78"W

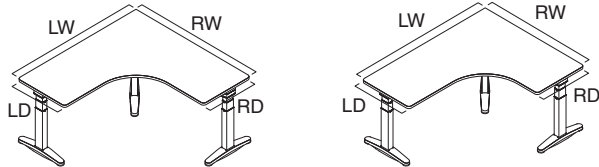

90° Corner Desks — Basic Height (Different Depth Opposite Ends 23"/24" Right/Left and 29"/30" Left/Right)

Wood Group 1 Veneer

OLSLLC	23" or 24" R/L	29" or 30" L/R	40"W	40"W–42"W	N.A.	N.A.	► See page 244	► See page 244	► See page 244	► See page 244	► See page 244
	23" or 24" R/L	29" or 30" L/R	46"W	42 ¹ / ₁₆ "W–48"W	N.A.	N.A.	\$3514	\$3610	\$3706	\$3806	\$3908
	23" or 24" R/L	29" or 30" L/R	52"W	48 ¹ / ₁₆ "W–52"W	► See page 244	\$3514	\$3610	\$3706	\$3806	\$3908	\$4011
	23" or 24" R/L	29" or 30" L/R	58"W	52 ¹ / ₁₆ "W–60"W	\$3514	\$3610	\$3706	\$3806	\$3908	\$4011	\$4119
	23" or 24" R/L	29" or 30" L/R	64"W	60 ¹ / ₁₆ "W–66"W	\$3610	\$3706	\$3806	\$3908	\$4011	\$4119	\$4227
	23" or 24" R/L	29" or 30" L/R	70"W	66 ¹ / ₁₆ "W–72"W	\$3706	\$3806	\$3908	\$4011	\$4119	\$4227	\$4337
	23" or 24" R/L	29" or 30" L/R	76"W	72 ¹ / ₁₆ "W–78"W	\$3806	\$3908	\$4011	\$4119	\$4227	\$4337	\$4455

Tip: At least one side must be 52"W or greater.

Tip: Equal corner widths are parametric to 1/16" from 52"W–78"W.

Tip: 90° desks, 60¹/₁₆"W x 60¹/₁₆"W and wider, are manufactured in two pieces. The worksurface split is located on the left side of an equal corner and on the longest side of an extended corner.

► Specification Information, continued on next page

Height-Adjustable
Worksurfaces

Office Height-Adjustable Corner Desks, High-Pressure Laminate or Wood Veneer, continued

SIN 711.2

► Specification Information, continued from previous page

Specification Information										
Style Number	Dimensions D		Modular Right Width	Base Prices						
	Modular Left Width	Parametric Left Width		40"W	46"W	52"W	58"W	64"W	70"W	76"W
			Parametric Right Width	40"W	42 ¹ / ₁₆ "W	48 ¹ / ₁₆ "W	52 ¹ / ₁₆ "W	60 ¹ / ₁₆ "W	66 ¹ / ₁₆ "W	72 ¹ / ₁₆ "W
				42"W	48"W	52"W	60"W	66"W	72"W	78"W

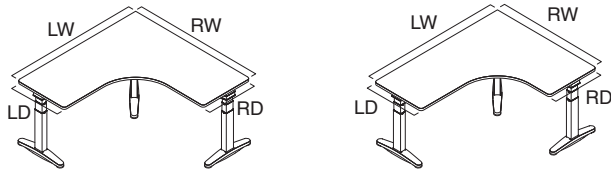

90° Corner Desks — Basic Height (Same Depth Both Ends 29"/30")

Wood Group 1 Veneer

OLSLLC	29" or 30"	40"W	40"W-42"W	N.A.	N.A.	N.A.	N.A.	N.A.	N.A.	N.A.
	29" or 30"	46"W	42 ¹ / ₁₆ "W-48"W	N.A.	N.A.	\$3587	\$3689	\$3790	\$3892	\$3996
	29" or 30"	52"W	48 ¹ / ₁₆ "W-52"W	N.A.	\$3587	\$3689	\$3790	\$3892	\$3996	\$4103
	29" or 30"	58"W	52 ¹ / ₁₆ "W-60"W	N.A.	\$3689	\$3790	\$3892	\$3996	\$4103	\$4212
	29" or 30"	64"W	60 ¹ / ₁₆ "W-66"W	N.A.	\$3790	\$3892	\$3996	\$4103	\$4212	\$4321
	29" or 30"	70"W	66 ¹ / ₁₆ "W-72"W	N.A.	\$3892	\$3996	\$4103	\$4212	\$4321	\$4432
	29" or 30"	76"W	72 ¹ / ₁₆ "W-78"W	N.A.	\$3996	\$4103	\$4212	\$4321	\$4432	\$4551

Tip: At least one side must be 52"W or greater.

Tip: Equal corner widths are parametric to 1/16" from 52"W-78"W.

Tip: 90° desks, 60¹/₁₆"W x 60¹/₁₆"W and wider, are manufactured in two pieces. The worksurface split is located on the left side of an equal corner and on the longest side of an extended corner.

► Specification Information, continued on next page

► Specification Information, continued from previous page

Specification Information									
Style Number	Dimensions D		Base Prices						
	Modular Left Width	Parametric Left Width	Modular Right Width	34"W	40"W	46"W	52"W	58"W	64"W
			Parametric Right Width	34"W—	36 ¹ / ₁₆ "W—	42 ¹ / ₁₆ "W—	48 ¹ / ₁₆ "W—	54 ¹ / ₁₆ "W—	60 ¹ / ₁₆ "W—
				36"W	42"W	48"W	54"W	60"W	66"W

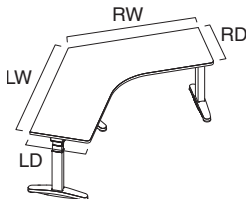

120° Corner Desks—Extended Height

High-Pressure Laminate Desks

OLELWC	23" or 24"	34"W	34"W–36"W	\$2320	\$2506	\$2661	\$2661	\$2661	\$2745
	23" or 24"	40"W	36 ¹ / ₁₆ "W–42"W	\$2506	\$2506	\$2661	\$2745	\$2745	\$2830
	23" or 24"	46"W	42 ¹ / ₁₆ "W–48"W	\$2661	\$2661	\$2661	\$2830	\$2830	\$2916
	23" or 24"	52"W	48 ¹ / ₁₆ "W–54"W	\$2661	\$2745	\$2830	\$2830	\$3007	\$3007
	23" or 24"	58"W	54 ¹ / ₁₆ "W–60"W	\$2661	\$2745	\$2830	\$3007	\$3007	\$3100
	23" or 24"	64"W	60 ¹ / ₁₆ "W–66"W	\$2745	\$2830	\$2916	\$3007	\$3100	\$3195

Wood Group 1 Veneer Desks

OLELWC	23" or 24"	34"W	34"W–36"W	\$3019	\$3417	\$3594	\$3594	\$3594	\$3690
	23" or 24"	40"W	36 ¹ / ₁₆ "W–42"W	\$3417	\$3417	\$3594	\$3690	\$3690	\$3789
	23" or 24"	46"W	42 ¹ / ₁₆ "W–48"W	\$3594	\$3594	\$3594	\$3789	\$3789	\$3890
	23" or 24"	52"W	48 ¹ / ₁₆ "W–54"W	\$3594	\$3690	\$3789	\$3789	\$3983	\$3983
	23" or 24"	58"W	54 ¹ / ₁₆ "W–60"W	\$3594	\$3690	\$3789	\$3983	\$3983	\$4088
	23" or 24"	64"W	60 ¹ / ₁₆ "W–66"W	\$3690	\$3789	\$3890	\$3983	\$4088	\$4197

► Specification Information, continued on next page

Height-Adjustable Worksurfaces

Olgy Height-Adjustable Corner Desks, High-Pressure Laminate or Wood Veneer, continued

SIN 711.2

► Specification Information, continued from previous page

Specification Information										
Style Number	Dimensions D			Modular Right Width	Base Prices					
	Modular Left Width	Parametric Left Width			34"W	40"W	46"W	52"W	58"W	64"W
				Parametric Right Width	34"W—36"W	36 ¹ / ₁₆ "W—42"W	42 ¹ / ₁₆ "W—48"W	48 ¹ / ₁₆ "W—54"W	54 ¹ / ₁₆ "W—60"W	60 ¹ / ₁₆ "W—66"W

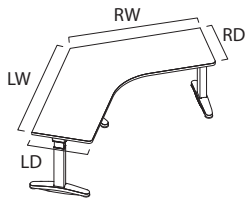

120° Corner Desks — Basic Height

High-Pressure Laminate Desks

OLSLWC	23" or 24"	34"W	34"W—36"W	\$2139	\$2310	\$2452	\$2452	\$2452	\$2530
	23" or 24"	40"W	36 ¹ / ₁₆ "W—42"W	\$2310	\$2310	\$2452	\$2530	\$2530	\$2608
	23" or 24"	46"W	42 ¹ / ₁₆ "W—48"W	\$2452	\$2452	\$2452	\$2608	\$2608	\$2687
	23" or 24"	52"W	48 ¹ / ₁₆ "W—54"W	\$2452	\$2530	\$2608	\$2608	\$2771	\$2771
	23" or 24"	58"W	54 ¹ / ₁₆ "W—60"W	\$2452	\$2530	\$2608	\$2771	\$2771	\$2856
	23" or 24"	64"W	60 ¹ / ₁₆ "W—66"W	\$2530	\$2608	\$2687	\$2771	\$2856	\$2944

Wood Group 1 Veneer Desks

OLSLWC	23" or 24"	34"W	34"W—36"W	\$2838	\$3221	\$3385	\$3385	\$3385	\$3475
	23" or 24"	40"W	36 ¹ / ₁₆ "W—42"W	\$3221	\$3221	\$3385	\$3475	\$3475	\$3567
	23" or 24"	46"W	42 ¹ / ₁₆ "W—48"W	\$3385	\$3385	\$3385	\$3567	\$3567	\$3661
	23" or 24"	52"W	48 ¹ / ₁₆ "W—54"W	\$3385	\$3475	\$3567	\$3567	\$3747	\$3747
	23" or 24"	58"W	54 ¹ / ₁₆ "W—60"W	\$3385	\$3475	\$3567	\$3747	\$3747	\$3844
	23" or 24"	64"W	60 ¹ / ₁₆ "W—66"W	\$3475	\$3567	\$3661	\$3747	\$3844	\$3946

Ology
Height-Adjustable
Corner Desks

SIN 711.2

Ology Height-Adjustable Bases

SIN 711.2

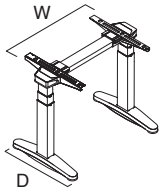

Tip: Any storage higher than 19" will impede lowest height range of worksurface. Do not place storage underneath controller.

Tip: Only single and dual flat panel monitor arm applications are permitted for use with 2-leg height-adjustable desks.

▶ See Steelcase Worktools Specification Guide.

Tip: Base supports a maximum distributed weight capacity of 314 pounds (2-leg) and 471 pounds (3-leg). When calculating lifting capacity, subtract the weight of the worksurface and understructure.

▶ See page 228 for understructure weights.

Tip: Antimicrobial can be specified only when specifying up/down controller.

Tip: Attachment hardware is intended for worksurfaces 1" thick only.

Tip: 9" overhang is available on desks 64"W and larger. Overhang on both sides is available on 70"W and 76"W only.

Tip: Overhang is available on rectangular bases only.

⚠ WARNING

Read base only warranty limitations.

▶ See page 219 for Workstation Design Guidelines and Requirements.

Standard Includes	Required to Specify
<ul style="list-style-type: none"> • Electric height-adjustable sit-to-stand base: paint • Active touch controller • Modular width: <ul style="list-style-type: none"> – Rectangular base: 34"–76" – Tapered base: 58"–76" – 90° equal corner base: 52"–76" – 90° extended corner base: 40"–76" – 120° equal corner base: 34"–64" • 1/2" adjustable glides • Power cord: 9' • Attachment hardware 	<ol style="list-style-type: none"> 1 Style number 2 Desk depth 3 Desk width 4 Paint color number for base: <ul style="list-style-type: none"> 4799 Platinum Metallic 7207 Black 7241 Arctic White 7360 Merle 5 Antimicrobial or non-antimicrobial surface, if up/down controller selected (see below under Required Selections) 6 Options, if selected (see below) <ul style="list-style-type: none"> ▶ See <i>Surface Materials</i>, page 346.

	Required Selections	Price	Required to Specify
Antimicrobial Surface	<ul style="list-style-type: none"> • Non-antimicrobial surface • Antimicrobial surface 	No cost No cost	Specify with non-antimicrobial surface. Specify with antimicrobial surface.

	Options	Price	Required to Specify
Surface Materials	Bases <ul style="list-style-type: none"> • Paint price group 1 • Paint price group 2 for rectangular and tapered bases • Paint price group 2 for corner bases 	No cost +\$ 28 +\$ 42	Specify paint color number. Specify paint color number. Specify paint color number.
			▶ See <i>Surface Materials</i> , page 346.

Desk Type	• Parametric width desk	No cost	Specify with parametric desk type.
Overhang	<ul style="list-style-type: none"> • Desk overhang on left • Desk overhang on right • Desk overhang left and right 	+\$ 56 +\$ 56 +\$112	Specify with desk overhang left. Specify with desk overhang right. Specify with desk overhang left and right.
Glides	• 1" adjustable glides	+\$ 14 per leg	Specify with 1" glides.
Controller	<ul style="list-style-type: none"> • Up/down controller • 4 Pre-set controller 	–\$ 52 +\$ 63	Specify with up/down controller. Specify with 4 pre-set controller.

SIN 711.2

Specification Information

Style Number	Dimension D	Desk Type	Base Prices							
			34"W	40"W	46"W	52"W	58"W	64"W	70"W	76"W
		Modular	34"W	40"W	46"W	52"W	58"W	64"W	70"W	76"W
		Parametric	34"W	36 ¹ / ₁₆ "W	42 ¹ / ₁₆ "W	48 ¹ / ₁₆ "W	54 ¹ / ₁₆ "W	60 ¹ / ₁₆ "W	66 ¹ / ₁₆ "W	72 ¹ / ₁₆ "W
			-36"W	-42"W	-48"W	-54"W	-60"W	-66"W	-72"W	-78"W

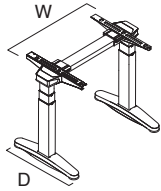

Rectangular Bases—Extended Height

OLELRQB	23" or 24"	\$1905	\$1905	\$1916	\$1916	\$1931	\$1943	\$1943	\$1943
	29" or 30"	\$1926	\$1926	\$1937	\$1937	\$1948	\$1964	\$1964	\$1964
	35" or 36"	\$1946	\$1946	\$1957	\$1957	\$1966	\$1984	\$1984	\$1984

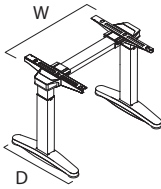

Rectangular Bases — Basic Height

OLSLRQB	23" or 24"	\$1449	\$1495	\$1544	\$1594	\$1643	\$1698	\$1752	\$1792
	29" or 30"	\$1633	\$1685	\$1739	\$1786	\$1796	\$1811	\$1811	\$1811
	35" or 36"	\$1794	\$1794	\$1805	\$1805	\$1813	\$1829	\$1829	\$1829

► Specification Information, continued on next page

Height-Adjustable
Worksurfaces

Ology Height-Adjustable Bases, continued

SIN 711.2

► Specification Information, continued from previous page

Specification Information

• Style Number	• Dimensions		• Desk Type	• Base Prices			
	LD	RD		58"W	64"W	70"W	76"W
			Modular				
			Parametric	58½"W-60"W	60½"W-66"W	66½"W-72"W	72½"W-78"W

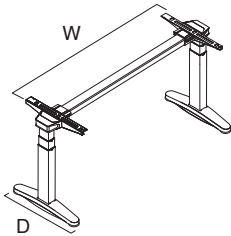

Tapered Bases—Extended Height

OLELRTB	23" or 24"	29" or 30"	\$1948	\$1964	\$1964	\$1964
	29" or 30"	23" or 24"	\$1948	\$1964	\$1964	\$1964

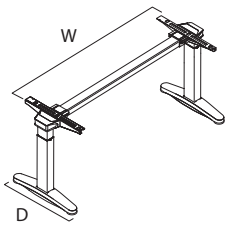

Tapered Bases — Basic Height

OLSLRTB	23" or 24"	29" or 30"	\$1796	\$1811	\$1811	\$1811
	29" or 30"	23" or 24"	\$1796	\$1811	\$1811	\$1811

► Specification Information, continued on next page

► Specification Information, continued from previous page

Specification Information										
Style Number	Dimensions		Base Prices							
	D		Modular Right Width	40"W	46"W	52"W	58"W	64"W	70"W	76"W
	• Modular Left Width	• Parametric Left Width	Parametric Right Width	40"W	42 ¹ / ₁₆ "W	48 ¹ / ₁₆ "W	52 ¹ / ₁₆ "W	60 ¹ / ₁₆ "W	66 ¹ / ₁₆ "W	72 ¹ / ₁₆ "W
				42"W	48"W	52"W	60"W	66"W	72"W	78"W

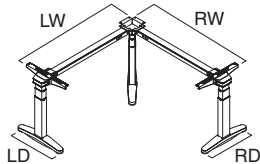

90° Corner Bases—Extended Height (Same Depth Both Ends 23"/24")

OLELLCB	23" or 24"	40"W	40"W—42"W	N.A.	N.A.	\$2485	\$2485	\$2501	\$2501	\$2501
	23" or 24"	46"W	42 ¹ / ₁₆ "W—48"W	N.A.	N.A.	\$2501	\$2501	\$2505	\$2505	\$2505
	23" or 24"	52"W	48 ¹ / ₁₆ "W—52"W	\$2485	\$2501	\$2501	\$2501	\$2510	\$2510	\$2510
	23" or 24"	58"W	52 ¹ / ₁₆ "W—60"W	\$2485	\$2501	\$2501	\$2501	\$2510	\$2510	\$2510
	23" or 24"	64"W	60 ¹ / ₁₆ "W—66"W	\$2501	\$2505	\$2510	\$2510	\$2520	\$2594	\$2594
	23" or 24"	70"W	66 ¹ / ₁₆ "W—72"W	\$2501	\$2505	\$2510	\$2510	\$2594	\$2795	\$2795
	23" or 24"	76"W	72 ¹ / ₁₆ "W—78"W	\$2501	\$2505	\$2510	\$2510	\$2594	\$2795	\$2795

Tip: At least one side must be 52"W or greater.

► Specification Information, continued on next page

Height-Adjustable Worksurfaces

Olgy Height-Adjustable Bases, continued

SIN 711.2

► Specification Information, continued from previous page

Specification Information												
Style Number	Dimensions				Base Prices							
	D		Modular Left Width	Parametric Left Width	Modular Right Width	40"W	46"W	52"W	58"W	64"W	70"W	76"W
					Parametric Right Width	40"W—42"W	42 ¹ / ₁₆ "W—48"W	48 ¹ / ₁₆ "W—52"W	52 ¹ / ₁₆ "W—60"W	60 ¹ / ₁₆ "W—66"W	66 ¹ / ₁₆ "W—72"W	72 ¹ / ₁₆ "W—78"W

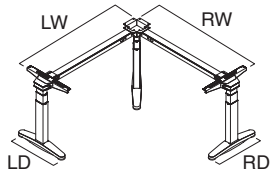

90° Corner Base — Extended Height (Different Depth Opposite Ends 23"/24" Right/Left and 29"/30" Left/Right)

OLELLCB	23" or 24" R/L	29" or 30" L/R	40"W	40"W—42"W	N.A.	N.A.	► See page 244	► See page 244	► See page 244	► See page 244	► See page 244
	23" or 24" R/L	29" or 30" L/R	46"W	42 ¹ / ₁₆ "W—48"W	N.A.	N.A.	\$2653	\$2693	\$2733	\$2773	\$2813
	23" or 24" R/L	29" or 30" L/R	52"W	48 ¹ / ₁₆ "W—52"W	► See page 244	\$2653	\$2693	\$2733	\$2773	\$2813	\$2853
	23" or 24" R/L	29" or 30" L/R	58"W	52 ¹ / ₁₆ "W—60"W	\$2653	\$2693	\$2733	\$2773	\$2813	\$2853	\$2893
	23" or 24" R/L	29" or 30" L/R	64"W	60 ¹ / ₁₆ "W—66"W	\$2693	\$2733	\$2773	\$2813	\$2853	\$2893	\$2933
	23" or 24" R/L	29" or 30" L/R	70"W	66 ¹ / ₁₆ "W—72"W	\$2733	\$2773	\$2813	\$2853	\$2893	\$2933	\$2973
	23" or 24" R/L	29" or 30" L/R	76"W	72 ¹ / ₁₆ "W—78"W	\$2773	\$2813	\$2853	\$2893	\$2933	\$2973	\$3015

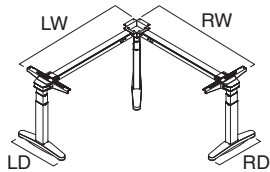

90° Corner Bases — Extended Height (Same Depth Both Ends 29"/30")

OLELLCB	29" or 30"	40"W	40"W—42"W	N.A.	N.A.	N.A.	N.A.	N.A.	N.A.	N.A.
	29" or 30"	46"W	42 ¹ / ₁₆ "W—48"W	N.A.	N.A.	\$2763	\$2803	\$2843	\$2883	\$2923
	29" or 30"	52"W	48 ¹ / ₁₆ "W—52"W	N.A.	\$2763	\$2803	\$2843	\$2883	\$2923	\$2963
	29" or 30"	58"W	52 ¹ / ₁₆ "W—60"W	N.A.	\$2803	\$2843	\$2883	\$2923	\$2963	\$3003
	29" or 30"	64"W	60 ¹ / ₁₆ "W—66"W	N.A.	\$2843	\$2883	\$2923	\$2963	\$3003	\$3043
	29" or 30"	70"W	66 ¹ / ₁₆ "W—72"W	N.A.	\$2883	\$2923	\$2963	\$3003	\$3043	\$3083
	29" or 30"	76"W	72 ¹ / ₁₆ "W—78"W	N.A.	\$2923	\$2963	\$3003	\$3043	\$3083	\$3125

Tip: At least one side must be 52"W or greater.

► Specification Information, continued on next page

SIN 711.2

► **Specification Information, continued from previous page**

Specification Information											
Style Number	Dimensions D	Modular		Base Prices							
		Left Width	Parametric Left Width	Right Width	40"W	46"W	52"W	58"W	64"W	70"W	76"W
				Modular Right Width	40"W	46"W	52"W	58"W	64"W	70"W	76"W
				Parametric Right Width	40"W	42 ¹ / ₁₆ "W	48 ¹ / ₁₆ "W	52 ¹ / ₁₆ "W	60 ¹ / ₁₆ "W	66 ¹ / ₁₆ "W	72 ¹ / ₁₆ "W
					42"W	48"W	52"W	60"W	66"W	72"W	78"W

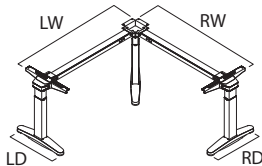

90° Corner Bases — Basic Height (Same Depth Both Ends 23"/24")

OLSLLCB	23" or 24"	40"W	40"W—42"W	N.A.	N.A.	\$2290	\$2290	\$2305	\$2305	\$2305
	23" or 24"	46"W	42 ¹ / ₁₆ "W—48"W	N.A.	N.A.	\$2305	\$2305	\$2309	\$2309	\$2309
	23" or 24"	52"W	48 ¹ / ₁₆ "W—52"W	\$2290	\$2305	\$2305	\$2305	\$2313	\$2313	\$2313
	23" or 24"	58"W	52 ¹ / ₁₆ "W—60"W	\$2290	\$2305	\$2305	\$2305	\$2313	\$2313	\$2313
	23" or 24"	64"W	60 ¹ / ₁₆ "W—66"W	\$2305	\$2309	\$2313	\$2313	\$2323	\$2391	\$2391
	23" or 24"	70"W	66 ¹ / ₁₆ "W—72"W	\$2305	\$2309	\$2313	\$2313	\$2391	\$2576	\$2576
	23" or 24"	76"W	72 ¹ / ₁₆ "W—78"W	\$2305	\$2309	\$2313	\$2313	\$2391	\$2576	\$2576

Tip: At least one side must be 52"W or greater.

► **Specification Information, continued on next page**

Height-Adjustable Worksurfaces

Ology Height-Adjustable Bases, continued

SIN 711.2

► Specification Information, continued from previous page

Specification Information		Base Prices									
Style Number	Dimensions D	Modular Left Width	Parametric Left Width	Modular							
				Right Width	40"W	46"W	52"W	58"W	64"W	70"W	76"W
				Parametric Right Width	40"W—42"W	42 ¹ / ₁₆ "W—48"W	48 ¹ / ₁₆ "W—52"W	52 ¹ / ₁₆ "W—60"W	60 ¹ / ₁₆ "W—66"W	66 ¹ / ₁₆ "W—72"W	72 ¹ / ₁₆ "W—78"W

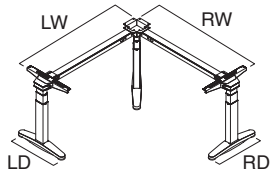

90° Corner Base — Basic Height (Different Depth Opposite Ends 23"/24" Right/Left and 29"/30" Left/Right)

OLSLLCB	23" or 24" R/L	29" or 30" L/R	40"W	40"W—42"W	N.A.	N.A.	► See page 244	► See page 244	► See page 244	► See page 244	► See page 244
	23" or 24" R/L	29" or 30" L/R	46"W	42 ¹ / ₁₆ "W—48"W	N.A.	N.A.	\$2445	\$2481	\$2518	\$2555	\$2592
	23" or 24" R/L	29" or 30" L/R	52"W	48 ¹ / ₁₆ "W—52"W	► See page 244	\$2445	\$2481	\$2518	\$2555	\$2592	\$2629
	23" or 24" R/L	29" or 30" L/R	58"W	52 ¹ / ₁₆ "W—60"W	\$2445	\$2481	\$2518	\$2555	\$2592	\$2629	\$2655
	23" or 24" R/L	29" or 30" L/R	64"W	60 ¹ / ₁₆ "W—66"W	\$2481	\$2518	\$2555	\$2592	\$2629	\$2655	\$2702
	23" or 24" R/L	29" or 30" L/R	70"W	66 ¹ / ₁₆ "W—72"W	\$2518	\$2555	\$2592	\$2629	\$2655	\$2702	\$2739
	23" or 24" R/L	29" or 30" L/R	76"W	72 ¹ / ₁₆ "W—78"W	\$2555	\$2592	\$2629	\$2655	\$2702	\$2739	\$2778

Tip: At least one side must be 52"W or greater.

► Specification Information, continued on next page

► Specification Information, continued from previous page

Specification Information										
Style Number	Dimensions D		Base Prices							
	Modular Left Width	Parametric Left Width	Modular Right Width	40"W	46"W	52"W	58"W	64"W	70"W	76"W
			Parametric Right Width	40"W—42"W	42 ¹ / ₁₆ "W—48"W	48 ¹ / ₁₆ "W—52"W	52 ¹ / ₁₆ "W—60"W	60 ¹ / ₁₆ "W—66"W	66 ¹ / ₁₆ "W—72"W	72 ¹ / ₁₆ "W—78"W

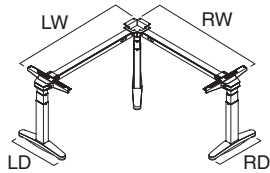

90° Corner Base — Basic Height (Same Depth Both Ends 29"/30")

OLSLLCB	29" or 30"	40"W	40"W—42"W	N.A.	N.A.	N.A.	N.A.	N.A.	N.A.	N.A.
	29" or 30"	46"W	42 ¹ / ₁₆ "W—48"W	N.A.	N.A.	\$2546	\$2583	\$2619	\$2656	\$2693
	29" or 30"	52"W	48 ¹ / ₁₆ "W—52"W	N.A.	\$2546	\$2583	\$2619	\$2656	\$2693	\$2730
	29" or 30"	58"W	52 ¹ / ₁₆ "W—60"W	N.A.	\$2583	\$2619	\$2656	\$2693	\$2730	\$2767
	29" or 30"	64"W	60 ¹ / ₁₆ "W—66"W	N.A.	\$2619	\$2656	\$2693	\$2730	\$2767	\$2803
	29" or 30"	70"W	66 ¹ / ₁₆ "W—72"W	N.A.	\$2656	\$2693	\$2730	\$2767	\$2803	\$2840
	29" or 30"	76"W	72 ¹ / ₁₆ "W—78"W	N.A.	\$2693	\$2730	\$2767	\$2803	\$2840	\$2879

Tip: At least one side must be 52"W or greater.

► Specification Information, continued on next page

Height-Adjustable Worksurfaces

Ology Height-Adjustable Bases, continued

SIN 711.2

► Specification Information, continued from previous page

Specification Information										
Style Number	Dimensions D	Dimensions			Base Prices					
		Modular Left Width	Parametric Left Width	Modular Right Width	34"W	40"W	46"W	52"W	58"W	64"W
				Parametric Right Width	34"W	36 ¹ / ₁₆ "W	42 ¹ / ₁₆ "W	48 ¹ / ₁₆ "W	54 ¹ / ₁₆ "W	60 ¹ / ₁₆ "W
				Parametric Right Width	36"W	42"W	48"W	54"W	60"W	66"W

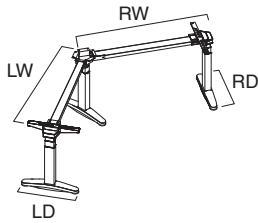

120° Corner Bases—Extended Height

OLELWCB	23" or 24"	34"W	34"W—36"W	\$2468	\$2468	\$2468	\$2468	\$2480	\$2485
		40"W	36 ¹ / ₁₆ "W—42"W	\$2468	\$2468	\$2468	\$2485	\$2485	\$2493
		46"W	42 ¹ / ₁₆ "W—48"W	\$2468	\$2468	\$2493	\$2493	\$2493	\$2498
		52"W	48 ¹ / ₁₆ "W—54"W	\$2468	\$2485	\$2493	\$2493	\$2493	\$2498
		58"W	54 ¹ / ₁₆ "W—60"W	\$2480	\$2485	\$2493	\$2493	\$2493	\$2510
		64"W	60 ¹ / ₁₆ "W—66"W	\$2485	\$2493	\$2498	\$2498	\$2510	\$2515

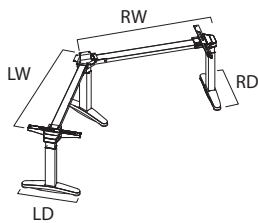

120° Corner Bases — Basic Height

OLSLWCB	23" or 24"	34"W	34"W—36"W	\$2275	\$2275	\$2275	\$2275	\$2286	\$2290
		40"W	36 ¹ / ₁₆ "W—42"W	\$2275	\$2275	\$2275	\$2290	\$2290	\$2298
		46"W	42 ¹ / ₁₆ "W—48"W	\$2275	\$2275	\$2298	\$2298	\$2298	\$2302
		52"W	48 ¹ / ₁₆ "W—54"W	\$2275	\$2290	\$2298	\$2298	\$2298	\$2302
		58"W	54 ¹ / ₁₆ "W—60"W	\$2286	\$2290	\$2298	\$2298	\$2298	\$2313
		64"W	60 ¹ / ₁₆ "W—66"W	\$2290	\$2298	\$2302	\$2302	\$2313	\$2318

Ology Modesty Panels

High-Pressure Laminate or Wood Veneer

SIN 711.2

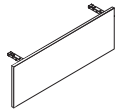

Tip: Modesty panel can match the width of the desk or be shorter than desk.

Tip: Modesty panels cannot be used on desks with integrated rail. To use with the integrated rail, the modesty panel must be undersized by a minimum of 12" (rectangular and tapered) or 7" (90°) and inset from the edge of the worksurface.

For laminate price group 2 pricing, please refer to the electronic catalog or SmartTools.

Tip: Modular modesty panels are undersized 2½" to account for desks with radius corners.

Tip: Modesty panels are defaulted in the horizontal grain direction for both laminate and wood veneer. Optional vertical grain direction can be specified, however, laminate specification is only allowed up to 60" wide.

Standard Includes	Required to Specify
<ul style="list-style-type: none"> Panel: High-Pressure Laminate price group 1 or wood group 1 veneer Modular widths: 34"—76" Attachment hardware 	<ol style="list-style-type: none"> Style number Panel type (see below under Required Selections) Panel width High-Pressure Laminate or wood color for panel Options, if selected (see below) <p>▶ See <i>Surface Materials</i>, page 346.</p>

Panel Type	Required Selections	Price	Required to Specify
	<ul style="list-style-type: none"> Modular width panel Parametric width panel 	No cost No cost	Specify with <i>modular panel type</i> . Specify with <i>parametric panel type</i> .

Surface Materials	Options	Price	Required to Specify
	High-Pressure Laminate <ul style="list-style-type: none"> Laminate price group 2 Open Line laminate 	See information at left +\$ 69 plus cost of laminate	Specify laminate color number. ▶ See <i>Surface Materials Reference Manual</i> .
	Wood veneer <ul style="list-style-type: none"> Wood group 2 Wood group 3 Customiz stain 	+\$ 69 +\$242 No cost	Specify wood color number. Specify wood color number. Specify with <i>customiz stain</i> . ▶ See <i>Surface Materials Reference Manual</i> . Specify full-fill finish number.
	<ul style="list-style-type: none"> Full-fill finish on wood group 1 	+\$ 69	
	Grain direction <ul style="list-style-type: none"> Horizontal grain direction Vertical grain direction 	No cost No cost	Specify with <i>horizontal grain direction</i> . Specify with <i>vertical grain direction</i> .

Height-Adjustable Worksurfaces

Specification Information									
Style Number	Panel Type	Base Prices							
	Modular	34"W	40"W	46"W	52"W	58"W	64"W	70"W	76"W
	Parametric	34"W	36½"W	42½"W	48½"W	54½"W	60½"W	66½"W	72½"W
		36"W	42"W	48"W	54"W	60"W	66"W	72"W	78"W
	Weight	15.2 lb	17.6 lb	20.0 lb	22.4 lb	24.8 lb	27.3 lb	29.7 lb	32.1 lb

High-Pressure Laminate									
OLMP		\$194	\$195	\$198	\$201	\$205	\$212	\$215	\$222

Wood Group 1 Veneer									
OLMP		\$241	\$246	\$251	\$254	\$258	\$266	\$271	\$279

Fixed Personal/Modesty Screens

SIN 711.2

Tip: When using COM fabric, it is recommended that non-patterned fabric be used to provide a consistent visual between adjacent screens, and from one side to the other.

Tip: 19½"H and 24"H are for personal only.

Standard Includes	Required to Specify
-------------------	---------------------

- Personal/modesty screens: fabric price group 1
- Brackets: 4799 Platinum

- 1 Style number
 - 2 Fabric color number for screen
 - 3 Options, if selected (see below)
- ▶ See *Surface Materials*, page 346.

Options		Price			Required to Specify
---------	--	-------	--	--	---------------------

Surface Materials	Fabric	12"H	19½"H	24"H	Required to Specify
	• Fabric price group 1	No cost	No cost	No cost	Specify fabric color number. Specify fabric color number. Specify fabric color number. Specify fabric color number. ▶ See <i>Surface Materials Reference Manual</i> .
	• Fabric price group 2	+\$25	+\$ 34	+\$ 40	
	• Fabric price group 3	+\$66	+\$ 89	+\$114	
	• Fabric price group 4	+\$85	+\$114	+\$139	
	• Customer's Own Material (COM)	+\$16	+\$ 16	+\$ 16	

Specification Information

Width	Weight	Style Number	Base Price
-------	--------	--------------	------------

12"H Screens

30"	3.4 lb	CQSF3012	\$166
36"	3.9 lb	CQSF3612	\$194
42"	4.3 lb	CQSF4212	\$219
48"	4.7 lb	CQSF4812	\$247
•	•	•	•

19½"H Screens

30"	4.2 lb	CQSF3019	\$256
36"	4.7 lb	CQSF3619	\$284
42"	5.5 lb	CQSF4219	\$311
48"	6.5 lb	CQSF4819	\$337
•	•	•	•

24"H Screens

30"	4.9 lb	CQSF3024	\$345
36"	5.5 lb	CQSF3624	\$374
42"	6.1 lb	CQSF4224	\$400
48"	7.4 lb	CQSF4824	\$427
•	•	•	•

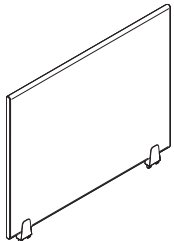
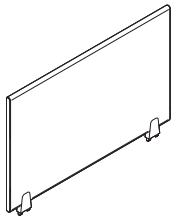
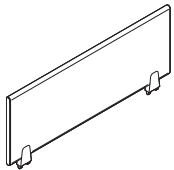

Tip: 19½"H and 24"H screens are not intended for use in the modesty position when used with a height-adjustable desk.

Ology Cable and Power Management

SIN 711.2

Cable Riser

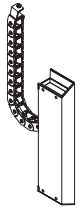

Tip: Cable risers are compatible with Ology desks only.

Standard Includes	Required to Specify
-------------------	---------------------

- Cable riser: 7360 Merle paint
- Attachment hardware

Style number

Specification Information		
---------------------------	--	--

Style Number	Price
OLCR	\$70

Cable Basket

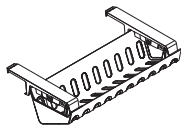

Tip: Cable baskets are compatible with rectangular, tapered, or 90° corner desks 46¹/₆"W or larger and 120° corner desks 40¹/₆"W or larger.

Standard Includes	Required to Specify
-------------------	---------------------

- Cable basket: 6527 Merle plastic

Style number

Specification Information		
---------------------------	--	--

Style Number	Weight	Price
OLCB	1.0 lb	\$56

Cable Brackets

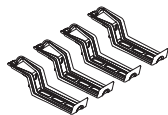

Standard Includes	Required to Specify
-------------------	---------------------

- Cable brackets, quantity of four: 6527 Merle plastic

Style number

Specification Information		
---------------------------	--	--

Style Number	Weight	Price
OLCBK4	0.5 lb	\$34

Height-Adjustable
Worksurfaces

Universal Steel One-High Open Laterals

for Ology Application

SIN 711.2

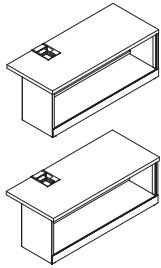

Drawings show right-hand application, left hand is also available.

Tip: Right-hand or left-hand application is determined by which leg of the Ology desk is located inside the storage.

For laminate price group 2 pricing, please refer to the electronic catalog or SmartTools.

Standard Includes	Required to Specify
<ul style="list-style-type: none"> Lateral case: paint price group 1 1$\frac{3}{8}$"H top: laminate price group 1, if selected <ul style="list-style-type: none"> – Edge: plastic 1$\frac{3}{8}$"H top: wood group 1, if selected Four adjustable leveling glides Grommet Wire manager Ganging hardware 	<ol style="list-style-type: none"> Style number Paint color number for lateral case Width (see below under Required Selections) Laminate color number for top, if laminate top selected Plastic color number for edge, if laminate top selected Wood color number for top, if wood top selected Front style (see below under Required Selections) Application (see below under Required Selections) Options, if selected (see below) <p>▶ See <i>Surface Materials</i>, page 346.</p>

Required Selections	Price	Required to Specify
Width <ul style="list-style-type: none"> 30"W 36"W 42"W 	Prices at right Prices at right Prices at right	Specify with 30" width. Specify with 36" width. Specify with 42" width.
Front Style <ul style="list-style-type: none"> Flush steel front Proud steel front 	Prices at right Prices at right	Specify with flush steel front. Specify with proud steel front.
Application <ul style="list-style-type: none"> Right hand Left hand 	No cost No cost	Specify with right-hand application. Specify with left-hand application.

Options	Price	Required to Specify
Surface Materials <ul style="list-style-type: none"> Paint price group 1 Paint price group 2 Paint price group 3 	No cost +\$ 75 +\$128	Specify paint color number. Specify paint color number. Specify paint color number.
Tops <ul style="list-style-type: none"> No top <ul style="list-style-type: none"> For use beneath a common top Laminate top <ul style="list-style-type: none"> Laminate price group 2 Open Line laminate Wood veneer top <ul style="list-style-type: none"> Wood group 1 Wood group 2 Wood group 3 Customiz stain 	–\$ 96 See information at left +\$ 69 plus cost of laminate +\$404 +\$ 28 +\$ 94 No cost	Specify with no top. Specify laminate color number. ▶ See <i>Surface Materials Reference Manual</i> . Specify with wood veneer top and indicate wood finish number. Specify with wood veneer top and indicate wood color number. Specify with wood veneer top and indicate wood color number. Specify with customiz stain. ▶ See <i>Surface Materials Reference Manual</i> .
Related Products <ul style="list-style-type: none"> Universal common tops Universal steel shrouds Universal steel filler 		▶ Page 286 ▶ Page 288 ▶ Page 289

Specification Information

Style Number	Dimensions			Base Prices	
	D	W	H	Flush Steel Front	Proud Steel Front
RSCHAD	18"	18 ⁷ / ₈ "	30"	\$ 953	\$1008
	18"	18 ⁷ / ₈ "	36"	\$1052	\$1119
	18"	18 ⁷ / ₈ "	42"	\$1148	\$1223

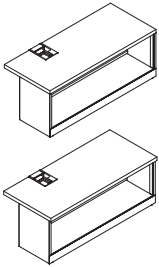

Height-Adjustable Worksurfaces

Universal Common Tops

for Ology Application

SIN 711.2

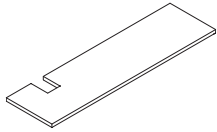

Drawing shows right-hand application, left hand is also available.

Tip: Right-hand or left-hand application is determined by which leg of the Ology desk is located inside the storage.

For wood group 2, wood group 3, and laminate price group 2 pricing please refer to the electronic catalog or SmartTools.

Standard Includes	Required to Specify
<ul style="list-style-type: none"> 1 3/16"H top: laminate price group 1, if selected – Edge: plastic 1 3/16"H top: wood group 1, if selected 	<ol style="list-style-type: none"> 1 Style number 2 Width (see below under Required Selections) 4 Laminate color number for top, if laminate top selected 5 Plastic color number for edge, if laminate top selected 6 Wood color number on top, if wood top selected 7 Front style (see below under Required Selections) 8 Application (see below under Required Selections) 9 Options, if selected (see below) <p>▶ See <i>Surface Materials</i>, page 346.</p>

Required Selections	Price	Required to Specify
Width <ul style="list-style-type: none"> • 60"W • 66"W • 72"W • 78"W • 84"W • 90"W • 96"W • 108"W 	<ul style="list-style-type: none"> Prices at right Prices at right Prices at right Prices at right Prices at right Prices at right Prices at right Prices at right 	<ul style="list-style-type: none"> Specify with 60" width. Specify with 66" width. Specify with 72" width. Specify with 78" width. Specify with 84" width. Specify with 90" width. Specify with 96" width. Specify with 108" width.
Front Style <ul style="list-style-type: none"> • Flush front • Proud front 	<ul style="list-style-type: none"> No cost No cost 	<ul style="list-style-type: none"> Specify with flush front. Specify with proud front.
Application <ul style="list-style-type: none"> • Right hand • Left hand 	<ul style="list-style-type: none"> No cost No cost 	<ul style="list-style-type: none"> Specify with right-hand application. Specify with left-hand application.

Options	Price	Required to Specify
Surface Materials <ul style="list-style-type: none"> • Laminate top • Laminate price group 2 • Open Line laminate 	<ul style="list-style-type: none"> See information at left +\$69 plus cost of laminate 	<ul style="list-style-type: none"> Specify laminate color number. ▶ See <i>Surface Materials Reference Manual</i>.
<ul style="list-style-type: none"> • Wood veneer top • Wood group 2 • Wood group 3 • Customiz stain • Full-fill finish on wood group 1 	<ul style="list-style-type: none"> See information at left See information at left No cost Prices at right 	<ul style="list-style-type: none"> Specify with wood veneer top and indicate wood color number. Specify with wood veneer top and indicate wood color number. Specify with customiz stain. ▶ See <i>Surface Materials Reference Manual</i>. Specify with full-fill finish and select wood finish number. ▶ See <i>Surface Materials Reference Manual</i>.
Related Products <ul style="list-style-type: none"> • Universal Steel One-High open lateral files • Universal shrouds • Universal filler 		<ul style="list-style-type: none"> ▶ Page 284 ▶ Page 288 ▶ Page 289

SIN 711.2

Specification Information

Style Number	Dimensions		W	Base Prices		Options
	Flush Front	Proud Front		Laminate	Wood Group 1	(Add \$ to Base Price) Full-Fill Finish on Wood Group 1
RATCTHAD	18"	18 ⁷ / ₈ "	60"	\$302	\$ 981	+\$47
	18"	18 ⁷ / ₈ "	66"	\$349	\$1064	+\$47
	18"	18 ⁷ / ₈ "	72"	\$392	\$1143	+\$47
	18"	18 ⁷ / ₈ "	78"	\$498	\$1396	+\$47
	18"	18 ⁷ / ₈ "	84"	\$563	\$1584	+\$69
	18"	18 ⁷ / ₈ "	90"	\$627	\$1707	+\$69
	18"	18 ⁷ / ₈ "	96"	\$690	\$1880	+\$69
	18"	18 ⁷ / ₈ "	108"	\$830	N.A.	N.A.

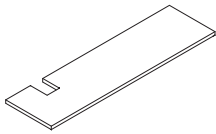

Tip: Can not order veneer on 108"W Universal common top.

Universal Shrouds

for Ology Application

SIN 711.2

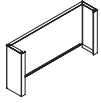

Tip: Universal shroud width must match width of the universal steel One-High open lateral for Ology application.

Standard Includes	Required to Specify
<ul style="list-style-type: none"> • Shroud: paint price group 1 • Attachment hardware 	<ol style="list-style-type: none"> 1 Style number 2 Width (see below under Required Selections) 3 Paint color number for shroud 4 Options, if selected (see below) <p>▶ See <i>Surface Materials</i>, page 346.</p>

Required Selections	Price	Required to Specify
Width		
• 30"W	No cost	Specify with 30" width.
• 36"W	No cost	Specify with 36" width.
• 42"W	No cost	Specify with 42" width.

Options	Price	Required to Specify
Surface Materials		
• Paint price group 1	No cost	Specify paint color number.
• Paint price group 2	+\$30	Specify paint color number.
• Paint price group 3	+\$49	Specify paint color number.

Related Products	• Universal Steel One-High open lateral files	▶ Page 284
-------------------------	---	------------

Specification Information			
• Dimensions		• Style	• Base
D	H	Number	Price
6"	16"	RPXSHAD	\$72
:	:	:	:

Universal Filler

for Ology Application

SIN 711.2



Standard Includes	Required to Specify
-------------------	---------------------

- Filler: paint
- Attachment hardware

- 1 Style number
- 2 Paint color number for filler
- ▶ See *Surface Materials*, page 346.

Required Products	
-------------------	--

Related Products

- Universal Steel One-High open lateral files
- ▶ Page 284

Specification Information			
---------------------------	--	--	--

• Dimensions		• Style	• Price
D	H	Number	
6"	16"	RPXFHAD	\$51

Airtouch Height-Adjustable Worksurfaces

High-Pressure Laminate Universal Tables

SIN 711.1

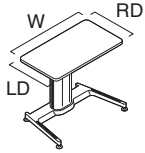

Tip: Airtouch height-adjustable base requires assembly and attachment to the worksurface.

Tip: Worksurfaces ship with pre-drilled holes for mounting bases.

Tip: Any storage higher than 24½"H will impede the lower height range of the worksurface. Do not place storage underneath paddle.

For laminate price group 2 pricing, please refer to the electronic catalog or SmartTools.

Tip: An adjustment feature on the column allows the unit to function properly with any load up to 150 lb, including the worksurface.

Tip: Counterweights may be necessary to order if there is not enough load on the worksurface. Order service part (946900053SR).

Tip: For help determining privacy/modesty screen, cableway, SOTO rail, and SlatRail width compatibility, see Worktools Compatibility Charts, page 224.

Tip: Knife edge, urethane profile and wood veneer worksurface options are available through specials.

Tip: Paint surface options apply to base only. Paint surface option does not apply to column.

Tip: To specify 3 mm edge profile, no suffix is required. For P-edge profile, add suffix P to the style number (for example, BAPSS2442P).

Standard Includes	Required to Specify
-------------------	---------------------

- High-Pressure Laminate price group 1
- High-Pressure Laminate worksurface edge: plastic 3 mm edge or P-edge profile on all sides
- Worksurface corners: radius
- Height-adjustable column mechanism: 4799 Platinum
- Height-adjustable mechanism base: paint
- Dual-arm spring assist mechanism for bi-level worksurface, if selected
- Attachment hardware

- 1 Style number with appropriate edge profile suffix:
P Laminate with plastic P-edge
 ▶ See edge profiles on next page.
- 2 High-Pressure Laminate color number for worksurface
- 3 Plastic color number for profile edge on laminate worksurface
- 4 Paint color number for base:
 4799 Platinum Metallic
 7207 Black
 7246 Midnight Metallic
- 5 Options, if selected (see below)
 ▶ See *Surface Materials*, page 346.

Options	Price	Required to Specify
---------	-------	---------------------

Surface Materials

- Paint price group 1
 - Paint price group 2
 - Laminate price group 2
 - Open Line laminate
- No cost
 +\$39
 See information at left
 +\$69
 plus cost of laminate

- Specify paint color number.
 Specify paint color number.
 Specify laminate color number.
 ▶ See *Surface Materials Reference Manual*.

Related Products

- Slatwall, SlatRail, and freestanding worktools
- SOTO rail/shelves and worktools
- Flat panel arms
- Privacy/modesty screens and cableways
- Cable and power management

- ▶ Page 33
- ▶ Page 45
- ▶ Page 148
- ▶ Page 300
- ▶ Page 303

Tip: Only single and dual flat panel monitor arm applications are permitted for use with single column height-adjustable worksurfaces.

Tip: Monitor arms with C-clamp brackets should not be specified with P-edge worksurfaces.

Tip: To specify 3 mm edge profile, no suffix is required. For P-edge profile, add suffix **P** to the style number (for example, BAPSS2442P).

Tip: Eyesite and cableways should not be specified with 22¹/₄"D rectangular worksurfaces.

Tip: 58" privacy/modesty screens should not be specified with 22¹/₄"D rectangular worksurfaces.

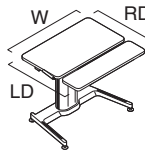
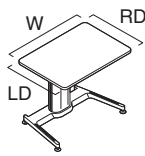
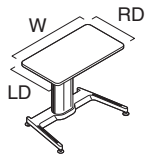

Tip: Base supports a maximum distributed weight capacity of 150 pounds. When calculating lifting capacity, subtract the weight of the worksurface.
▶ See page 240 for worksurface weights.

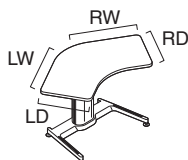
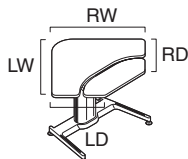
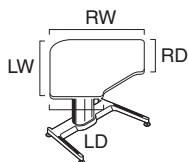

Specification Information

• Dimensions W LD RD	• Style Number	Base Prices High-Pressure Laminate	
		• Plastic 3 mm Edge No Suffix	• Plastic P-Edge Suffix P

Rectangular Tables

22¹/₄"D						
40"	22 ¹ / ₄ "	22 ¹ / ₄ "	BAPSS2442	\$2292	\$2345	
46"	22 ¹ / ₄ "	22 ¹ / ₄ "	BAPSS2448	\$2325	\$2378	
58"	22 ¹ / ₄ "	22 ¹ / ₄ "	BAPSS2460	\$2397	\$2460	
28¹/₄"D						
40"	28 ¹ / ₄ "	28 ¹ / ₄ "	BAPSS3042	\$2386	\$2439	
46"	28 ¹ / ₄ "	28 ¹ / ₄ "	BAPSS3048	\$2422	\$2475	
58"	28 ¹ / ₄ "	28 ¹ / ₄ "	BAPSS3060	\$2497	\$2560	

Rectangular Bi-Level Tables

40"	34 ¹ / ₄ "	34 ¹ / ₄ "	BAPDS3642	\$3214	\$3312	
46"	34 ¹ / ₄ "	34 ¹ / ₄ "	BAPDS3648	\$3244	\$3342	

90° Corner Tables

39 ¹ / ₄ "	22 ¹ / ₄ "	39 ¹ / ₄ "	22 ¹ / ₄ "	BAPSC2442	\$2510	\$2634
45 ¹ / ₄ "	22 ¹ / ₄ "	45 ¹ / ₄ "	22 ¹ / ₄ "	BAPSC2448	\$2551	\$2675

90° Corner Bi-Level Tables

39 ¹ / ₄ "	22 ¹ / ₄ "	39 ¹ / ₄ "	22 ¹ / ₄ "	BAPDC2442	\$3290	\$3487
45 ¹ / ₄ "	22 ¹ / ₄ "	45 ¹ / ₄ "	22 ¹ / ₄ "	BAPDC2448	\$3331	\$3528

120° Equal Table

34"	22 ¹ / ₄ "	34"	22 ¹ / ₄ "	BAPB2436	\$2832	\$2956
-----	----------------------------------	-----	----------------------------------	-----------------	--------	--------

Height-Adjustable Worksurfaces

Airtouch Height-Adjustable Worksurfaces

High-Pressure Laminate For Use with Universal Systems

SIN 711.1

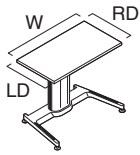

Tip: Airtouch height-adjustable base requires assembly and attachment to the worksurface.

Tip: Worksurfaces ship with pre-drilled holes for mounting bases.

Tip: Any storage higher than 24½"H will impede the lower height range of the worksurface. Do not place storage underneath paddle.

For laminate price group 2 pricing, please refer to the electronic catalog or SmartTools.

Tip: An adjustment feature on the column allows the unit to function properly with any load up to 150 lb, including the worksurface.

Tip: Counterweights may be necessary to order if there is not enough load on the worksurface. Order service part (946900053SR).

Tip: For help determining privacy/modesty screen, cableway, SOTO rail, and SlatRail width compatibility, see Worktools Compatibility Charts, page 224.

Tip: Knife edge, urethane profile, and wood veneer worksurface options are available through specials.

Tip: Paint surface options apply to base only. Paint surface option does not apply to column.

*Tip: To specify 3 mm edge profile, no suffix is required. For P-edge profile, add suffix **P** to the style number (for example, UAPSS2442P).*

Tip: Only single and dual flat panel monitor arm applications are permitted for use with single column height-adjustable worksurfaces.

Standard Includes	Required to Specify
<ul style="list-style-type: none"> High-Pressure Laminate price group 1 High-Pressure Laminate worksurface edge: plastic 3 mm edge or P-edge profile on front edge of worksurface with matching 1 mm plastic on sides and back Worksurface corners: 90° Height-adjustable column mechanism: 4799 Platinum Height-adjustable mechanism base: paint Dual-arm spring assist mechanism for bi-level worksurfaces, if selected Attachment hardware 	<ol style="list-style-type: none"> Style number with appropriate edge profile suffix: <ul style="list-style-type: none"> P Laminate with plastic P-edge High-Pressure Laminate color number for worksurface Plastic color number for profile edge on laminate worksurface Paint color number for base: <ul style="list-style-type: none"> 4799 Platinum Metallic 7207 Black 7246 Midnight Metallic Options, if selected (see below) <ul style="list-style-type: none"> ▶ See <i>Surface Materials</i>, page 346.

Surface Materials	Options	Price	Required to Specify
	<ul style="list-style-type: none"> Paint price group 1 Paint price group 2 Laminate price group 2 Open Line laminate 	<p>No cost</p> <p>+\$39</p> <p>See information at left</p> <p>+\$69</p> <p>plus cost of laminate</p>	<p>Specify paint color number.</p> <p>Specify paint color number.</p> <p>Specify laminate color number.</p> <p>▶ See <i>Surface Materials Reference Manual</i>.</p>

Related Products	Options	Price	Required to Specify
<ul style="list-style-type: none"> Slatwall, SlatRail, and freestanding worktools SOTO rail/shelves and worktools Flat panel arms Privacy/modesty screens and cableways Cable and power management 			<ul style="list-style-type: none"> ▶ Page 33 ▶ Page 45 ▶ Page 148 ▶ Page 300 ▶ Page 303

Tip: To specify 3 mm edge profile, no suffix is required. For P-edge profile, add suffix **P** to the style number (for example, UAPSS2442P).

Tip: Eyesite and cableways should not be specified with 22¹/₄"D rectangular worksurfaces.

Tip: 58" privacy/modesty screens should not be specified with 22¹/₄"D rectangular worksurfaces.

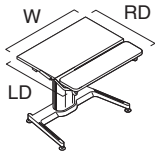
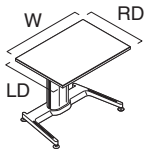

Tip: Base supports a maximum distributed weight capacity of 150 pounds. When calculating lifting capacity, subtract the weight of the worksurface.
 ▶ See page 240 for worksurface weights.

Specification Information

Dimensions			Style Number	Base Prices High-Pressure Laminate	
W	LD	RD		Plastic 3 mm Edge No Suffix	Plastic P-Edge Suffix P

Rectangular Worksurfaces

22¹/₄"D					
40"	22 ¹ / ₄ "	22 ¹ / ₄ "	UAPSS2442	\$2245	\$2298
46"	22 ¹ / ₄ "	22 ¹ / ₄ "	UAPSS2448	\$2276	\$2329
58"	22 ¹ / ₄ "	22 ¹ / ₄ "	UAPSS2460	\$2337	\$2400
28¹/₄"D					
40"	28 ¹ / ₄ "	28 ¹ / ₄ "	UAPSS3042	\$2325	\$2378
46"	28 ¹ / ₄ "	28 ¹ / ₄ "	UAPSS3048	\$2361	\$2414
58"	28 ¹ / ₄ "	28 ¹ / ₄ "	UAPSS3060	\$2432	\$2495

Rectangular Bi-Level Worksurfaces

40"	34 ¹ / ₄ "	34 ¹ / ₄ "	UAPDS3642	\$3165	\$3218
46"	34 ¹ / ₄ "	34 ¹ / ₄ "	UAPDS3648	\$3195	\$3248

▶ **Specification Information, continued on next page**

Height-Adjustable Worksurfaces

Airtouch Height-Adjustable Worksurfaces, High-Pressure Laminate For Use with Universal Systems, continued



SIN 711.1

Tip: To specify 3 mm edge profile, no suffix is required. For P-edge profile, add suffix **P** to the style number (for example, BAPSS2442P).

► Specification Information, continued from previous page

Specification Information

**Base Prices
High-Pressure Laminate**

	
• Plastic • 3 mm • Edge	• Plastic • P-Edge
• No Suffix	• Suffix P

• Dimensions				• Style • Number	• Plastic	
LW	LD	RW	RD		3 mm Edge	P-Edge
•	•	•	•	•	•	•
•	•	•	•	•	•	•

90° Corner Worksurfaces

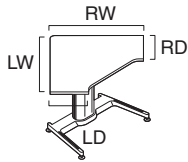

39 ¹ / ₄ "	16 ¹ / ₄ "	39 ¹ / ₄ "	16 ¹ / ₄ "	UAPSC1842	\$2406	\$2530
39 ¹ / ₄ "	22 ¹ / ₄ "	39 ¹ / ₄ "	22 ¹ / ₄ "	UAPSC2442	\$2421	\$2545
45 ¹ / ₄ "	22 ¹ / ₄ "	45 ¹ / ₄ "	22 ¹ / ₄ "	UAPSC2448	\$2459	\$2583
•	•	•	•	•	•	•

90° Corner Bi-Level Worksurfaces

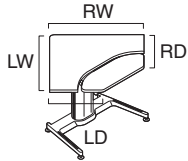

39 ¹ / ₄ "	22 ¹ / ₄ "	39 ¹ / ₄ "	22 ¹ / ₄ "	UAPDC2442	\$3201	\$3325
45 ¹ / ₄ "	22 ¹ / ₄ "	45 ¹ / ₄ "	22 ¹ / ₄ "	UAPDC2448	\$3239	\$3363
•	•	•	•	•	•	•

120° Equal Worksurface

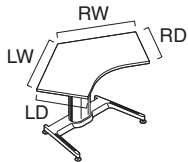

34"	22 ¹ / ₄ "	34"	22 ¹ / ₄ "	UAPB2436	\$2737	\$2861
•	•	•	•	•	•	•

SIN 711.1

Series 5 Height-Adjustable Worksurfaces

High-Pressure Laminate or Wood Veneer

SIN 711.2

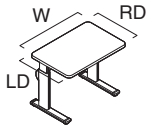

Tip: Series 5 height-adjustable base requires assembly and attachment to the worksurface.

Tip: Worksurface ships with pre-drilled holes for mounting bases.

Tip: Maximum distributed weight capacity is 195 pounds per table. When calculating lifting capacity, subtract the weight of the worksurface.

▶ See page 242, for worksurface weights.

Tip: Maximum distributed load-bearing capacity is 195 lb per table including worksurface.

Tip: Any storage higher than 20"H will impede the lowest height range of worksurface. If the overhang is installed, 24"H storage can be used.

Tip: Only single and dual flat panel monitor arm applications are permitted for use with 2-leg height-adjustable worksurfaces.

Tip: Worksurface overhang for pedestal storage varies by shape and size.

For wood group 2, wood group 3, and laminate price group 2 pricing please refer to the electronic catalog or SmartTools.

Tip: For help determining privacy/modesty screen, cableway, SOTO rail, and SlatRail width compatibility, see Worktools Compatibility Charts, page 224.

Standard Includes	Required to Specify
<ul style="list-style-type: none"> High-Pressure Laminate price group 1 or wood group 1 veneer High-Pressure Laminate worksurface edges: <ul style="list-style-type: none"> –Universal Tables: plastic 3 mm edge profile on all sides –Universal Systems worksurfaces: plastic 3 mm edge profile on front edge with matching 1 mm plastic on sides and back Wood worksurface edges: <ul style="list-style-type: none"> –Wood veneer square 3 mm radius on front edge with 1 mm matching veneer flat profile on side and back edges Worksurface corners: <ul style="list-style-type: none"> –Radius corners on Universal Tables, if selected –90° corners on Universal Systems and wood worksurface profiles, if selected Electric height-adjustable sit-to-stand base: paint Push button up/down controller Telescoping stretchers Dual-arm spring assist mechanism for bi-level table, if selected 5/8" adjustable glides Wire manager Drive shaft cover Power cord: 9' Attachment hardware 	<ol style="list-style-type: none"> Style number with appropriate edge profile suffix: <ul style="list-style-type: none"> U Universal Tables Y Universal Systems V Wood veneer High-Pressure Laminate or wood color number for worksurface Plastic color number for profile edge on laminate worksurface, if selected Paint color for base: <ul style="list-style-type: none"> 0835 Black 4799 Platinum Options, if selected (see below) <ul style="list-style-type: none"> ▶ See <i>Surface Materials</i>, page 346.

Options	Price	Required to Specify
Surface Materials	High-Pressure Laminate worksurfaces	
	<ul style="list-style-type: none"> Open Line laminate +\$69 plus cost of laminate 	▶ See <i>Surface Materials Reference Manual</i> .
Related Products	Wood veneer worksurfaces	
	<ul style="list-style-type: none"> Wood group 2 See information at left Wood group 3 See information at left Customiz stain No cost 	Specify wood color number. Specify wood color number. Specify <i>with Customiz stain</i> . ▶ See <i>Surface Materials Reference Manual</i> . Specify full-fill finish number.
	<ul style="list-style-type: none"> Full-fill finish on wood group 1 Prices at right 	▶ Page 33 ▶ Page 45 ▶ Page 148 ▶ Page 300 ▶ Page 303

Specification Information

Tip: For all edge profiles, add a suffix to the style number. (For example, A5RQ462929 becomes A5RQ462929V for wood with square edge profile.)

Tip: Only single and dual flat panel monitor arm applications are permitted for use with 2-leg height-adjustable tables.

Base Prices

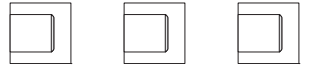

• Dimensions W LD RD	• Style Number	• Universal Tables	• Universal Systems	• Wood Group 1	• Option (Add \$ to Base Price)
		• Suffix U	• Suffix Y	• Suffix V	• Full-Fill Finish on Wood Group 1

Rectangular Worksurfaces

29"D							
W	LD	RD	Style Number	Universal Tables	Universal Systems	Wood Group 1	Option
46"	29"	29"	A5RQ462929	\$2031	\$1967	\$2540	+\$47
52"	29"	29"	A5RQ522929	\$2093	\$2028	\$2611	+\$69
58"	29"	29"	A5RQ582929	\$2155	\$2091	\$2680	+\$69
64"	29"	29"	A5RQ642929	\$2222	\$2155	\$2755	+\$69
70"	29"	29"	A5RQ702929	\$2289	\$2221	\$2829	+\$69
76"	29"	29"	A5RQ762929	\$2359	\$2290	\$2907	+\$69

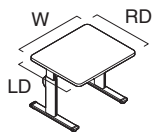

Series 5 Bases

SIN 711.2

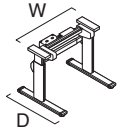

Tip: Maximum distributed weight capacity is 195 pounds per table. When calculating lifting capacity, subtract the weight of the worksurface.
 ▶ See page 242, for worksurface weights.

Tip: Maximum distributed load-bearing capacity is 195 lb per table including worksurface.

Tip: Any storage higher than 20"H will impede the lowest height range of worksurface. If the overhang is installed, 24"H storage can be used.

Tip: Attachment hardware is intended for worksurfaces 1³/₁₆" thick only.

Tip: Only single and dual flat panel monitor arm applications are permitted for use with 2-leg height-adjustable worksurfaces.

WARNING

Read base only warranty limitations.
 ▶ See page 219 for Workstation Design Guidelines and Requirements.

Standard Includes	Required to Specify
<ul style="list-style-type: none"> • Electric height-adjustable sit-to-stand base: paint • Push button up/down controller • Telescoping stretchers • 5/8" adjustable glides • Power cord: 9' • Attachment hardware 	<ul style="list-style-type: none"> 1 Style number 2 Paint color number for base: <ul style="list-style-type: none"> 0835 Black 4799 Platinum 3 Handedness of 90° base, if selected 4 Options, if selected (see below) ▶ See <i>Surface Materials</i>, page 346.

Options	Price	Required to Specify
Glides • 1" adjustable glides	+\$29	Specify with 1" glides.
Handedness (For use with 90° worksurfaces) • Right-hand, 90° extended bases	No cost	Specify with right-hand configuration.
• Left-hand, 90° extended bases	No cost	Specify with left-hand configuration.

Specification Information		
Worksurface Dimensions	Style Number	Base Price
W D	:	:

Rectangular Bases

29" D			
Worksurface W	Worksurface D	Style Number	Base Price
46"–52"	29"	A5RQ46TO5229B	\$1914
58"	29"	A5RQ5829B	\$1925
64"–76"	29"	A5RQ64TO7629B	\$1940

FitWork: Walkstation and Sit-to-Walkstation

Fitwork: Walkstation and Sit-to-Walkstation

SIN 711.99

Standard Includes	Required to Specify
<ul style="list-style-type: none"> • Worksurface: High-Pressure Laminate price group 1 • Worksurface front user's edge: urethane • Back and side edges: matching laminate • Base: paint • Treadmill: 7270 Silverstone • High-torque motor • Digital display and keypad console • Magnetic safety clip • Glides 	<ol style="list-style-type: none"> 1 Style number 2 High-Pressure Laminate color for worksurface 3 Urethane edge color number: 6000 Black 6278 Felt 4 Paint color number for base 5 Options, if selected (see below) ▶ See <i>Surface Materials</i>, page 346.

Options	Price	Required to Specify
Surface Materials High-Pressure Laminate worksurfaces <ul style="list-style-type: none"> • Laminate price group 2 • Open Line laminate 	See information at left +\$69 plus cost of laminate	Specify laminate color number. ▶ See <i>Surface Materials Reference Manual</i> .

For laminate price group 2 pricing, please refer to the electronic catalog or SmartTools.

Specification Information						
Overall Footprint		Worksurface Dimensions		Weight	Style Number	Base Price
W	D	W	D			

Walkstations

66"	67"	66"	32"	330 lb	A7TG660606H	\$7134
-----	-----	-----	-----	--------	--------------------	--------

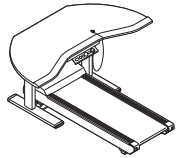

66"	67"	66"	32"	330 lb	A7TR663232H	\$7134
-----	-----	-----	-----	--------	--------------------	--------

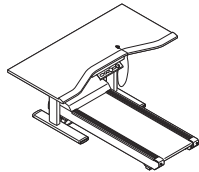

38"	67"	38"	30"	330 lb	A7TR383030H	\$7134
-----	-----	-----	-----	--------	--------------------	--------

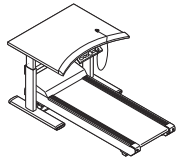

Sit-to-Walkstation

78"	67"	78"	29"	330 lb	A7TR782929H	\$7413
-----	-----	-----	-----	--------	--------------------	--------

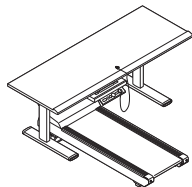

Height-Adjustable Worksurfaces

Acrylic Screens

SIN 711.2

Tip: Screen may need to be shorter than worksurface width. To determine screen/cableway and height-adjustable worksurface compatibility, see Worktools Compatibility Charts, page 224.

Tip: 58"W and 64"W screens are not recommended for use with 22 1/4"D rectangular Airtouch worksurfaces.



Tip: 58"W and 64"W screens ship with three Universal clamps. All other screen widths ship with two Universal clamps.



Standard Includes	Required to Specify
<ul style="list-style-type: none"> • Screen: 6544 Frost only • Universal clamps: paint 	<ul style="list-style-type: none"> 1 Style number 2 Paint color number for Universal clamp: <ul style="list-style-type: none"> 0835 Black 4799 Platinum

Specification Information

Screen Width	Cableway Width	Style Number	Price
--------------	----------------	--------------	-------

Privacy Screens Only

22"	N.A.	AP22	\$321
28"	N.A.	AP28	\$337
34"	N.A.	AP34	\$355
40"	N.A.	AP40	\$373
46"	N.A.	AP46	\$392
52"	N.A.	AP52	\$410
58"	N.A.	AP58	\$458
64"	N.A.	AP64	\$476
:	:	:	:

Privacy Screens with Cableway

28"	25"	ACP28	\$405
34"	31"	ACP34	\$440
40"	37"	ACP40	\$474
46"	43"	ACP46	\$510
52"	49"	ACP52	\$546
58"	55"	ACP58	\$613
64"	61"	ACP64	\$648
:	:	:	:

Modesty Screens Only

22"	N.A.	AM22	\$292
28"	N.A.	AM28	\$312
34"	N.A.	AM34	\$328
40"	N.A.	AM40	\$345
46"	N.A.	AM46	\$363
52"	N.A.	AM52	\$381
58"	N.A.	AM58	\$428
64"	N.A.	AM64	\$445
:	:	:	:

► **Specification Information, continued on next page**

► Specification Information, continued from previous page

Specification Information

Screen Width	Cableway Width	Style Number	Price
--------------	----------------	--------------	-------

Modesty Screens with Cableway

28"	25"	ACM28	\$381
34"	31"	ACM34	\$416
40"	37"	ACM40	\$450
46"	43"	ACM46	\$488
52"	49"	ACM52	\$520
58"	55"	ACM58	\$585
64"	61"	ACM64	\$620
.	.	.	.

Modesty and Privacy Screens

22"	N.A.	AMP22	\$522
28"	N.A.	AMP28	\$559
34"	N.A.	AMP34	\$593
40"	N.A.	AMP40	\$629
46"	N.A.	AMP46	\$665
52"	N.A.	AMP52	\$702
58"	N.A.	AMP58	\$766
64"	N.A.	AMP64	\$802
.	.	.	.

Modesty and Privacy Screens with Cableway

28"	25"	ACMP28	\$629
34"	31"	ACMP34	\$683
40"	37"	ACMP40	\$737
46"	43"	ACMP46	\$790
52"	49"	ACMP52	\$844
58"	55"	ACMP58	\$927
64"	61"	ACMP64	\$980
.	.	.	.

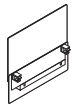
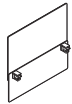

Cableways

SIN 711.2

Tip: Cableway with Universal clamp can be used in combination with privacy and modesty screens.

▶ See page 300

Tip: Cableways may need to be shorter than worksurface width. To determine screen/cableway and height-adjustable worksurface compatibility, see Worktools Compatibility Charts, page 224.

Tip: Cableways are not recommended for use with 22 1/4"D rectangular Airtouch worksurfaces.

Tip: Cableways with Universal clamp are 3" shorter than privacy and modesty screen widths.

Tip: 55"W and 61"W cableways ship with three Universal clamps or horizontal brackets. All other cableway widths ship with two Universal clamps or horizontal brackets.

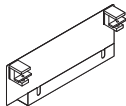
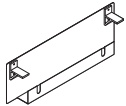

Standard Includes	Required to Specify
<ul style="list-style-type: none"> • Cableway: paint • Universal clamp, if selected: paint to match cableway • Horizontal mounting bracket, if selected: paint to match cableway 	1 Style number 2 Paint color number for cableway: 0835 Black 4799 Platinum

Specification Information

• Dimensions			• Weight	• Style Number	• Price
D	W	H			

With Horizontal Mounting Bracket					
2 1/2"	25"	8"	7.45 lb	AHORZ25	\$ 74
2 1/2"	31"	8"	8.40 lb	AHORZ31	\$ 94
2 1/2"	37"	8"	9.35 lb	AHORZ37	\$114
2 1/2"	43"	8"	10.30 lb	AHORZ43	\$130
2 1/2"	49"	8"	11.25 lb	AHORZ49	\$152
2 1/2"	55"	8"	14.20 lb	AHORZ55	\$181
2 1/2"	61"	8"	15.15 lb	AHORZ61	\$199

With Universal Clamp					
2 1/2"	25"	8"	4.70 lb	AC25	\$158
2 1/2"	31"	8"	5.65 lb	AC31	\$175
2 1/2"	37"	8"	6.60 lb	AC37	\$194
2 1/2"	43"	8"	7.55 lb	AC43	\$211
2 1/2"	49"	8"	8.50 lb	AC49	\$228
2 1/2"	55"	8"	9.95 lb	AC55	\$276
2 1/2"	61"	8"	10.91 lb	AC61	\$292

Cable and Power Management

SIN 711.2

Power/Data with C-clamp

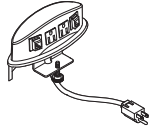

Tip: Power/data extends 1¼" off the back of the worksurface.

Tip: Power/data does not fit between worksurface and screens/cableway.

Standard Includes	Required to Specify
<ul style="list-style-type: none"> Power/data: 6544 Frost 6' cord: black plastic only 	Style number

Specification Information

Dimensions			Weight	Style Number	Price
D	W	H			
3½"	8½"	2½"	1.5 lb	AP2D2CC	\$169

Power/Data with C-clamp

3½"	8½"	2½"	1.5 lb	AP2D2CC	\$169
-----	-----	-----	--------	---------	-------

USB Two-Outlet Powerstrip with Clamp Mount

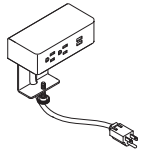

Tip: Clamp accommodates worksurface thicknesses ½" – 1½".

Tip: Each USB port can utilize up to 2.1 amps. Each port is independent of the other.

Standard Includes	Required to Specify
<ul style="list-style-type: none"> Clamp mount bracket: paint Housing with two USB ports and two power outlets: plastic 9' white cord 	1 Style number 2 Paint color number for bracket: 4140 Arctic White 4799 Platinum Metallic 7360 Merle 3 Plastic color number for housing: 6009 Arctic White 6527 Merle

Specification Information

Dimensions			Weight	Style Number	Price
D	W	H			
3½"	5½"	1½"	4.175 lb	DSPSDUOC	\$286

3½"	5½"	1½"	4.175 lb	DSPSDUOC	\$286
-----	-----	-----	----------	----------	-------

USB Two-Outlet Powerstrip with Rail Mount

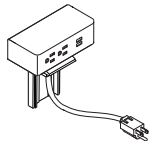

Tip: Each USB port can utilize up to 2.1 amps. Each port is independent of the other.

Standard Includes	Required to Specify
<ul style="list-style-type: none"> Rail mount bracket: 4799 Platinum Metallic Housing with two USB ports and two power outlets: plastic 9' white cord 	1 Style number 2 Plastic color number for housing: 6009 Arctic White 6527 Merle

Specification Information

Dimensions			Weight	Style Number	Price
D	W	H			
3½"	5½"	1½"	4.175 lb	DSPSDUOR	\$296

3½"	5½"	1½"	4.175 lb	DSPSDUOR	\$296
-----	-----	-----	----------	----------	-------

Height-Adjustable Worksurfaces

Cable and Power Management, continued

SIN 711.2

USB Three-Outlet Powerstrip with Clamp Mount

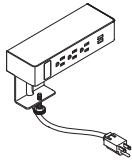

Tip: Clamp accommodates worksurface thicknesses 1/2" – 1 1/2".

Tip: Each USB port can utilize up to 2.1 amps. Each port is independent of the other.

Tip: Data opening accommodates RJ45, HDMI, and VGA faceplates. All three faceplates ship with powerstrip. A filler is also included if termination of data is not required.

Tip: L-com data jacks must be used and are purchased separately through L-com.

Standard Includes	Required to Specify
-------------------	---------------------

- Clamp mount bracket: paint
- Housing with two USB ports, one data port with filler, and three power outlets: plastic
- 9' white cord

- 1 Style number
- 2 Paint color number for bracket:
 - 4140 Arctic White
 - 4799 Platinum Metallic
 - 7360 Merle
- 3 Plastic color number for housing:
 - 6009 Arctic White
 - 6527 Merle

Specification Information					
• Dimensions			• Weight	• Style	• Price
D	W	H		Number	

3 1/8"	8"	1 4/5"	5.043 lb	DSPSTRIOC	\$340
:	:	:	:	:	:
:	:	:	:	:	:

USB Three-Outlet Powerstrip with Rail Mount

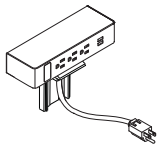

Tip: Each USB port can utilize up to 2.1 amps. Each port is independent of the other.

Tip: Data opening accommodates RJ45, HDMI, and VGA faceplates. All three faceplates ship with powerstrip. A filler is also included if termination of data is not required.

Tip: L-com data jacks must be used and are purchased separately through L-com.

Standard Includes	Required to Specify
-------------------	---------------------

- Rail mount bracket: 4799 Platinum Metallic
- Housing with two USB ports, one data port with filler, and three power outlets: plastic
- 9' white cord

- 1 Style number
- 2 Plastic color number for housing:
 - 6009 Arctic White
 - 6527 Merle

Specification Information					
• Dimensions			• Weight	• Style	• Price
D	W	H		Number	

3 1/8"	8"	1 4/5"	5.043 lb	DSPSTRIOR	\$351
:	:	:	:	:	:
:	:	:	:	:	:

Height-Adjustable Benching

Statement of Line	306
--------------------------	------------

Understanding

Workstation Design Guidelines and Requirements	310
Basics of Ergonomic Seating	311
Basics of Standing and Monitor Arm Positioning	312

Specifying

Ology Height-Adjustable Benching (SIN 711.2)	314
Universal Centered Screens and Aligners (SIN 711.2)	342
Fixed Personal Screen (SIN 711.2)	344

Statement of Line

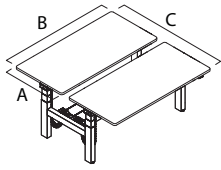

Specifying
▶ Pages 314

Ology Height-Adjustable Dual-Sided Benches

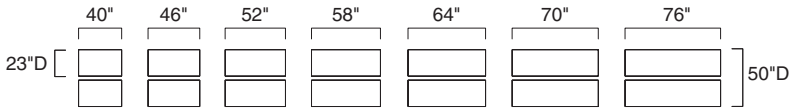

Tip: Widths are parametric to 1/16" from 40"W—78"W.



Specifying
▶ Page 316

Ology Height-Adjustable Single-Sided Benches

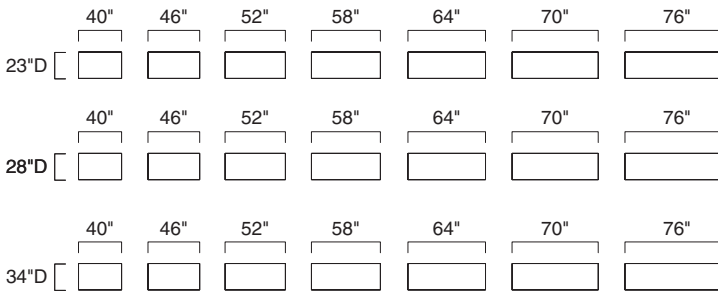

Tip: Widths are parametric to 1/16" from 40"W—78"W.



Specifying
▶ Page 320

Ology Height-Adjustable 120° Corner Single-Sided Benches

	34"W	40"W	46"W	52"W	58"W	64"W
23"D	•	•	•	•	•	•
28"D	•	•	•	•	•	•

Tip: Widths are parametric to 1/16" from 34"W—66"W.

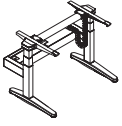

Specifying
▶ Page 324

Ology Height-Adjustable Single-Sided Bases

	40"W	46"W	52"W	58"W	64"W	70"W	76"W
23"D	●	●	●	●	●	●	●
28"D	●	●	●	●	●	●	●
34"D	●	●	●	●	●	●	●

Tip: Widths are parametric to 1/16" from 40"W—78"W.



Specifying
▶ Page 326

Ology Height-Adjustable 120° Corner Single-Sided Bases

	34"W	40"W	46"W	52"W	58"W	64"W
23"D	●	●	●	●	●	●
28"D	●	●	●	●	●	●

Tip: Widths are parametric to 1/16" from 34"W—66"W.

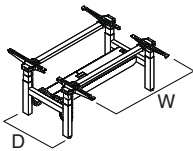

Specifying
▶ Pages 328

Ology Height-Adjustable Dual-Sided Bases

	40"W	46"W	52"W	58"W	64"W	70"W	76"W
28"D	●	●	●	●	●	●	●

Tip: Widths are parametric to 1/16" from 40"W—78"W.

Statement of Line, continued

Accessories for Ology

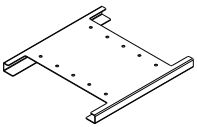

Connection Kit
Specifying
▶ Page 336

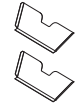

End of Run Tray Covers
Specifying
▶ Page 336

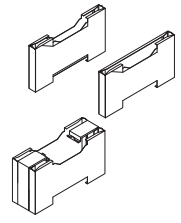

Infill
Specifying
▶ Page 338

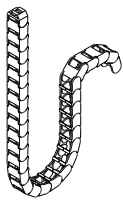

Cable Manager
Specifying
▶ Page 338



90° Mini Extension Cord
Specifying
▶ Page 339



Specifying
▶ Page 339



Specifying
▶ Page 339

Cable Basket

Cable Brackets

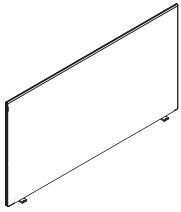

26"H

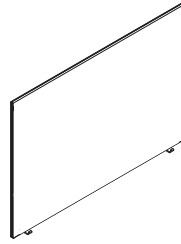

32"H

Specifying
▶ Page 342



Specifying
▶ Page 344

Universal Screens for Use with Ology Dual-Sided Benches

	42"W	48"W	54"W	60"W	66"W	72"W	78"W
26"H	●	●	●	●	●	●	●
32"H	●	●	●	●	●	●	●

Fixed Personal Screens

	30"W	36"W	42"W	48"W
12"H	●	●	●	●
19½"H	●	●	●	●
24"H	●	●	●	●

Workstation Design Guidelines and Requirements

Overview

Designed for movement with dynamic seating, adjustable worktools and height-adjustable benches are important for today's office workers.

To determine the best height-adjustable solution, consider these four criteria:

1. **Adjustability Needed**
What is the height range requirement? (seated or sit-to-stand)
2. **Worksurface Size Needed**
What does the physical space look like?
3. **Equipment/Tools Used**
What type of computer equipment and other worktools are being used on the worksurface? (weight capacity)
4. **Use**
What is the height-adjustable desk being used for (individual or shared, touchdown space or full workstation, sit-to-stand or seated)?

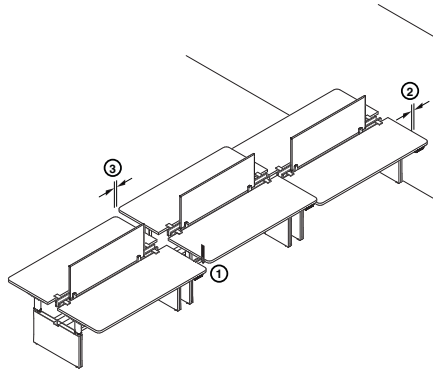

WARNING

Risk of Serious Injury. If not used as intended, moving work-surfaces can pinch or injure people, or damage property. Always follow these Instructions:

1. Keep height-adjustment range free from obstructions above and below the worksurface.
2. Plan for a minimum 1" gap against a panel or wall.
3. Plan for a minimum 1" gap to adjacent furniture.

Tips

Obstructions

Moving worksurfaces can collide with other objects. Do not install overhead storage, stationary pedestals or components in the path of height-adjustable desks.

Weight

The maximum allowable load (varies by height-adjustable bench) should be evenly distributed and must not be exceeded.

Width

Specify a minimum 1" gap to adjacent furniture. This eliminates any pinch points between a height-adjustable desk and a fixed object.

Managing Technology

Design workstations with computer equipment in mind so that the height-adjustment range of the height-adjustable desk is not impeded because of cables.

Power

Plan easy and unobstructed access to power for users at worksurface height through the use of the power access door or power strip.

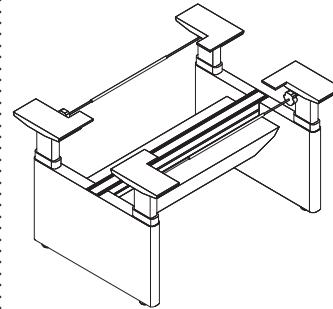

WARNING

Risk of serious injury.

Bases-only warranty limitations and potential for injury: The use of worksurfaces that do not comply with the Steelcase defined criteria and limitations could cause personal injury or property damage due to pinch points, instability, or other problems, and voids all Steelcase Warranties, expressed or implied.

The use of worksurfaces that do not comply with Steelcase criteria voids any Steelcase claims of compliance with ANSI/BIFMA, UL, LEED, or other applicable requirements. The use of non-Steelcase worksurfaces on Steelcase adjustable-height bases may not be accepted as compliant to municipal electrical codes or OSHA federal workplace standards, because this use does not create an NRTL (UL, ETL, etc.) listed product. Steelcase is not responsible for the ultimate determinations of compliance for height-adjustable bases with non-Steelcase worksurface, and assumes no liability for their compliance with standards when height adjustable bases are used without a Steelcase worksurface as intended.

Worksurface Criteria and Limitations

The use of non-Steelcase worksurfaces is not recommended. Any use of a non-Steelcase worksurface requires additional investigation by the customer regarding the appropriateness for use. It is the sole responsibility of the customer to determine the suitability and safety of the selected worksurface construction and attachment means. The following information is provided as a guideline, but does not address all potential issues. Customers should seek professional guidance as to the appropriateness of their chosen worksurface.

Tips

Height-adjustable bases include fasteners intended for use with Steelcase worksurfaces. These fasteners may be suitable for worksurfaces meeting the following criteria:

- Medium-density or higher particleboard or fiberboard cores, with High- or Low-Pressure Laminates and backers.
- Thickness of 1" or greater (Ology)
- Thickness of 1 $\frac{3}{16}$ " or greater (Series 5 and 8 bases)
- Fasteners located a minimum distance of 1" from any edge

Basics of Ergonomic Seating

A well-designed, ergonomically advanced chair that allows a full range of healthy postures throughout the day and can contribute to worker wellness and productivity.

Neck is straight or slightly forward.

Shoulders are relaxed so arms hang naturally.

Back has full contact with the backrest (sit all the way back in your chair).

Elbows and forearms can rest comfortably on the arms of your chair, or on worksurfaces.

Lower back fits into curved lumbar support.

Tension is adjusted so backrest reclines easily, yet provides smooth, even support, and encourages postural change.

Top of monitor should be at eye level.

Screen is 20 to 30 inches from the eyes. Screen is at eye level slightly lower and directly in front of worker so head is not turned.

Wrists should be straight when keying or mousing, not bent up or down.

When keying or mousing, forearms are parallel to the floor.

Thighs are parallel to the floor.

Feet are flat on the floor or on a footrest.

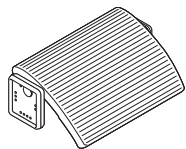
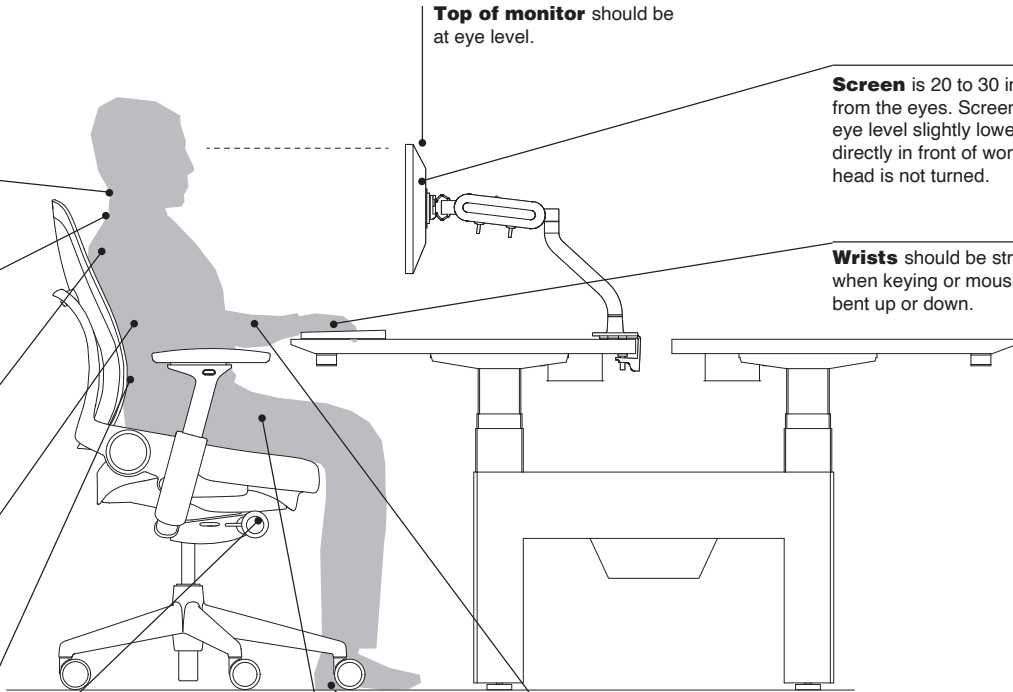

If worksurfaces and keyboard support are not height-adjustable, raise your chair's seat height to achieve the appropriate relationship to your tasks. If this leaves your feet dangling above the floor, use a footrest.

Basics of Standing and Monitor Arm Positioning

Height-adjustable benches, when combined with monitor arms, allow a full range of healthy postures throughout the day and can contribute to worker wellbeing and productivity.

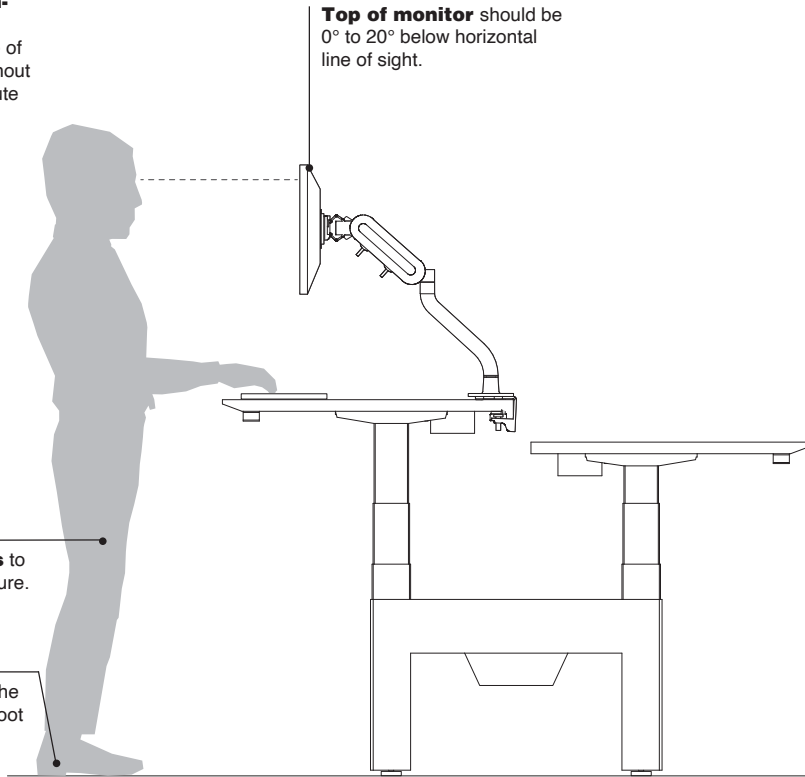

Avoid locking knees to help maintain good posture.

Feet should be flat on the floor or use foot rest or foot pad.

Height

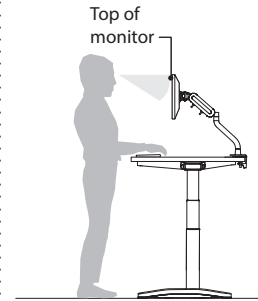

Top of the monitor should be positioned at or slightly below eye level.

Distance

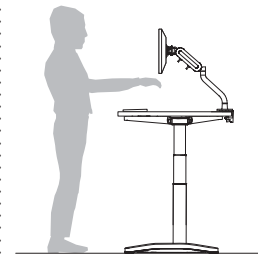

Monitor should be 20" to 30" from the eyes or approximately an arm's length away.

Alignment

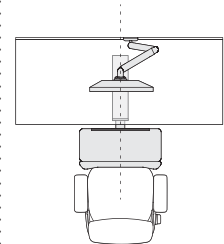

Proper alignment is the key to preventing strain. Computer monitor, keyboard, and mouse should be centered to allow user to see the display without looking downward or to either side. Mouse should be accessible without twisting or reaching. Reference documents should never be flat on desk and should be at the same height as or aligned with the monitor or above keyboard and below the monitor.

**Dual Monitor
Alignment**

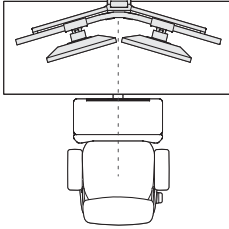

If using two monitors,
position the monitor used
more often closer. If equally
used, center monitors
directly in front and angle
them in a slight inward "V"
shape.

Ology Height-Adjustable Dual-Sided Benches

High-Pressure Laminate or Wood Veneer

SIN 711.2

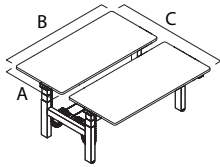

Tip: On extended height bases, any storage higher than 19", or 16 1/2" if the power access door is optional, will impede lowest height range of bench worksurface. On basic height bases, any storage higher than 23 7/10", or 21 1/8" if the power access door is optional, will impede lowest height range of bench worksurface. Do not place storage underneath controller.

Tip: Only single and dual flat panel monitor arm applications are permitted for use with 2-leg height-adjustable benches.

▶ See *Steelcase Worktools Specification Guide*.

Tip: Base supports a maximum distributed weight capacity of 314 pounds (2-leg). When calculating lifting capacity, subtract the weight of the worksurface, understructure, and options selected.

▶ See *Steelcase Benching Specification Guide*.

For laminate price group 2 pricing, please refer to the electronic catalog or SmartTools.

Tip: Antimicrobial can be specified only when specifying simple touch controller and/or soft edge.

Standard Includes	Required to Specify
-------------------	---------------------

- Two worksurfaces: High-Pressure Laminate price group 1 with 3 mm plastic edge or wood group 1 veneer
- Two electric height-adjustable sit-to-stand bases: paint
- Two active touch controllers
- 2" adjustable glides
- Two power cords: 9'
- Attachment hardware
- Two perpendicular cable managers
- Cable tray and covers: paint to match base

- 1 Style number
- 2 Bench width
- 3 High-Pressure Laminate or wood color for worksurface
- 4 Plastic color number for profile edge on laminate worksurfaces, if selected
- 5 Bench corner style, if laminate bench selected (see below under Required Selections)
- 6 Paint color number for base:
4799 Platinum Metallic
7207 Black
7241 Arctic White
7360 Merle
- 7 Integrated rail (see below under Required Selections)
- 8 Antimicrobial or non-antimicrobial surface, if simple touch controller selected (see below under Required Selections)
- 9 Options, if selected (see below)
▶ See *Surface Materials*, page 346.

Required Selections	Price	Required to Specify
---------------------	-------	---------------------

Bench Corner Style (Laminate Benches Only)	<ul style="list-style-type: none"> • Square corners • Radius corners 	No cost +\$124	Specify <i>with square corners</i> . Specify <i>with radius corners</i> .
Integrated Rail	<ul style="list-style-type: none"> • Without integrated rail • With integrated rail 	No cost +\$598	Specify <i>without integrated rail</i> . Specify <i>with integrated rail</i> .
Antimicrobial Surface	<ul style="list-style-type: none"> • Non-antimicrobial surface • Antimicrobial surface 	No cost No cost	Specify <i>with non-antimicrobial surface</i> . Specify <i>with antimicrobial surface</i> .

Options	Price	Required to Specify
---------	-------	---------------------

Surface Materials	High-Pressure Laminate benches <ul style="list-style-type: none"> • Laminate price group 2 • Open Line laminate 	See information at left +\$ 69 plus cost of laminate	Specify laminate color number. ▶ See <i>Surface Materials Reference Manual</i> .
	Wood veneer benches <ul style="list-style-type: none"> • Wood group 2 • Wood group 3 • Customiz stain 	+\$138 +\$484 No cost	Specify wood color number. Specify wood color number. Specify <i>with Customiz stain</i> . ▶ See <i>Surface Materials Reference Manual</i> . Specify full-fill finish number.
	Base <ul style="list-style-type: none"> • Paint price group 1 • Paint price group 2 	No cost +\$ 56	Specify paint color number. Specify paint color number. ▶ See <i>Surface Materials</i> , page 346.
Bench Type	<ul style="list-style-type: none"> • Parametric width bench 	No cost	Specify <i>with parametric bench type</i> .
Data Tray	<ul style="list-style-type: none"> • With data tray 	+\$ 69	Specify <i>with data tray</i> .
Cable Manager Application	<ul style="list-style-type: none"> • Parallel 	+\$ 40	Specify <i>with parallel application</i> .
Controllers	<ul style="list-style-type: none"> • Two simple touch controllers 	-\$104	Specify <i>with simple touch controllers</i> .

▶ Options, continued on next page

SIN 711.2

► Options, continued from previous page

Tip: Soft edge is available on benches 58"W and larger.

Tip: Rectangular benches accommodate either power and data access door or grommet, but not both.

Options	Price	Required to Specify
Soft Edge • With soft edge	+\$ 412	Specify with soft edge.
Power and Data Access Door, Tray, and USB • Power and data access door, tray and USB: paint price group 1 or 2	+\$1586	Specify with power and data access door and select paint color number.
• Power and data access door, tray and USB: anodized aluminum	+\$1606	Specify with power and data access door and select anodized aluminum.
Power and Data Access Door and Soft Edge Position • Centered	No cost	Specify with centered position.
• Left	No cost	Specify with left position.
• Right	No cost	Specify with right position.
Grommet • Grommet	+\$ 80	Specify with grommet.
Related Products • Cable manager		► Page 336

Specification Information

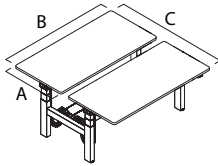

Style Number	Dimension D	Bench Type	Base Prices						
			40"W	46"W	52"W	58"W	64"W	70"W	76"W
Modular			40"W	46"W	52"W	58"W	64"W	70"W	76"W
			40"W	42 ¹ / ₁₆ "W	48 ¹ / ₁₆ "W	54 ¹ / ₁₆ "W	60 ¹ / ₁₆ "W	66 ¹ / ₁₆ "W	72 ¹ / ₁₆ "W
Parametric			-42"W	-48"W	-54"W	-60"W	-66"W	-72"W	-78"W

Dual-Sided Laminate Benches — Extended Height

OLBELRQD	23"D	\$4207	\$4356	\$4505	\$4652	\$4815	\$4969	\$5121
	28"D	\$4451	\$4608	\$4765	\$4920	\$5086	\$5249	\$5412
	34"D	\$5043	\$5222	\$5395	\$5574	\$5755	\$5943	\$6129

Dual-Sided Veneer Benches — Extended Height

OLBELRQD	23"D	\$5291	\$5454	\$5623	\$5786	\$5969	\$6139	\$6313
	28"D	\$5581	\$5754	\$5929	\$6098	\$6288	\$6465	\$6646
	34"D	\$6217	\$6416	\$6607	\$6798	\$7003	\$7203	\$7407

Dual-Sided Laminate Benches — Basic Height

OLBSLRQD	23"D	\$3845	\$3981	\$4117	\$4252	\$4401	\$4541	\$4679
	28"D	\$4103	\$4248	\$4392	\$4535	\$4687	\$4837	\$4987
	34"D	\$4681	\$4847	\$5007	\$5174	\$5341	\$5515	\$5687

► Specification Information, continued on next page

Height-Adjustable
Benching

Ology Height-Adjustable Single-Sided Benches

High-Pressure Laminate or Wood Veneer

SIN 711.11

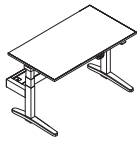

Tip: On extended height bases, any storage higher than 19", or 16 1/2" if the power access door is optional, will impede lowest height range of bench worksurface. On basic height bases, any storage higher than 23 7/10", or 21 1/8" if the power access door is optional, will impede lowest height range of bench worksurface. Do not place storage underneath controller.

Tip: Base supports a maximum distributed weight capacity of 314 pounds (2-leg). When calculating lifting capacity, subtract the weight of the worksurface, understructure, and options selected.

▶ See *Steelcase Benching Specification Guide*.

Tip: Fixed height does not have a controller option or a power cord.

Tip: Antimicrobial can be specified only when specifying simple touch controller and/or soft edge.

For laminate price group 2 pricing, please refer to the electronic catalog or SmartTools.

Standard Includes	Required to Specify
<p>▶ Need help? See <i>Benching Specification Guide</i>.</p> <ul style="list-style-type: none"> • One worksurface: High-Pressure Laminate price group 1 with 3 mm plastic edge or wood group 1 veneer • One electric height-adjustable sit-to-stand bases: paint • One active touch controller, if extended height or basic height is selected • 1/2" adjustable glides • One power cords: 9' • Attachment hardware • One perpendicular cable managers • Cable tray and covers: paint to match base 	<ol style="list-style-type: none"> 1 Style number 2 Bench depth and width 3 High-Pressure Laminate or wood color for worksurface 4 Plastic color number for profile edge on laminate worksurfaces, if selected 5 Bench corner style, if laminate bench selected (see below under Required Selections) 6 Paint color number for base: <ul style="list-style-type: none"> 4799 Platinum Metallic 7207 Black 7241 Arctic White 7360 Merle 7 Integrated rail (see below under Required Selections) 8 Antimicrobial or non-antimicrobial surface, if simple touch controller selected (see below under Required Selections) 9 Options, if selected (see below) <p>▶ See <i>Surface Materials</i>, page 346.</p>

Required Selections	Price	Required to Specify
<p>Bench Corner Style (Laminate Benches Only)</p> <ul style="list-style-type: none"> • Square corners • Radius corners 	<p>No cost</p> <p>+\$ 62</p>	<p>Specify <i>with square corners</i>.</p> <p>Specify <i>with radius corners</i>.</p>
<p>Integrated Rail</p> <ul style="list-style-type: none"> • Without integrated rail • With integrated rail 	<p>No cost</p> <p>+\$299</p>	<p>Specify <i>without integrated rail</i>.</p> <p>Specify <i>with integrated rail</i>.</p>
<p>Antimicrobial Surface</p> <ul style="list-style-type: none"> • Non-antimicrobial surface • Antimicrobial surface 	<p>No cost</p> <p>No cost</p>	<p>Specify <i>with non-antimicrobial surface</i>.</p> <p>Specify <i>with antimicrobial surface</i>.</p>

Options	Price	Required to Specify
<p>Surface Materials</p> <ul style="list-style-type: none"> • High-Pressure Laminate benches • Laminate price group 2 • Open Line laminate 	<p>See information at left</p> <p>+\$ 69</p> <p>plus cost of laminate</p>	<p>Specify laminate color number.</p> <p>▶ See <i>Surface Materials Reference Manual</i>.</p>
<ul style="list-style-type: none"> • Wood veneer benches • Wood group 2 • Wood group 3 • Customiz stain 	<p>+\$ 69</p> <p>+\$242</p> <p>No cost</p>	<p>Specify wood color number.</p> <p>Specify wood color number.</p> <p>Specify <i>with Customiz stain</i>.</p> <p>▶ See <i>Surface Materials Reference Manual</i>.</p> <p>Specify full-fill finish number.</p>
<ul style="list-style-type: none"> • Base • Paint price group 1 • Paint price group 2 	<p>No cost</p> <p>+\$ 28</p>	<p>Specify paint color number.</p> <p>Specify paint color number.</p> <p>▶ See <i>Surface Materials</i>, page 346.</p>
<p>Bench Type</p> <ul style="list-style-type: none"> • Parametric width bench 	<p>No cost</p>	<p>Specify <i>with parametric bench type</i>.</p>
<p>Data Tray</p> <ul style="list-style-type: none"> • With data tray 	<p>+\$ 69</p>	<p>Specify <i>with data tray</i>.</p>
<p>Cable Manager Application</p> <ul style="list-style-type: none"> • Parallel 	<p>+\$ 20</p>	<p>Specify <i>with parallel application</i>.</p>
<p>Controller</p> <ul style="list-style-type: none"> • Extended height and basic height • Simple touch controller 	<p>-\$ 52</p>	<p>Specify <i>with simple touch controller</i>.</p>

▶ Options, continued on next page

SIN 711.11

► Options, continued from previous page

Tip: Soft edge is available on benches 58"W and larger.

Tip: Rectangular benches accommodate either power and data access door or grommet, but not both.

Options	Price	Required to Specify
Soft Edge • With soft edge	+\$206	Specify with soft edge.
Power and Data Access Door, Tray, and USB • Power and data access door, tray and USB: paint price group 1 or 2	+\$793	Specify with power and data access door and select paint color number.
• Power and data access door, tray and USB: anodized aluminum	+\$803	Specify with power and data access door and select anodized aluminum.
Power and Data Access Door and Soft Edge Position • Centered	No cost	Specify with centered position.
• Left	No cost	Specify with left position.
• Right	No cost	Specify with right position.
Grommet • Without grommet	No cost	Specify without grommet.
• With grommet	+\$ 40	Specify with grommet.
Glides • 1/2" glides	No cost	Specify with 1/2" glides.
• 1" glides	+\$ 14	Specify with 1" glides.
Related Products • Cable manager		► Page 336
• Data kit		► See Steelcase Benching Specification Guide
• Universal screens		► Page 342
• Conversion kit for Ology single-sided bench		► Page 337

Specification Information

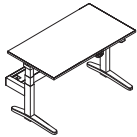

Style Number	Dimension D	Bench Type	Base Prices							
			40"W	46"W	52"W	58"W	64"W	70"W	76"W	
		Modular	40"W	46"W	52"W	58"W	64"W	70"W	76"W	
		Parametric	40"W	42 1/16"W	48 1/16"W	54 1/16"W	60 1/16"W	66 1/16"W	72 1/16"W	
			42"W	48"W	54"W	60"W	66"W	72"W	78"W	

Single-Sided Laminate Benches — Extended Height

OLBELRQS	Dimension	40"W	46"W	52"W	58"W	64"W	70"W	76"W
	23"D	\$2719	\$2816	\$2913	\$3008	\$3114	\$3214	\$3313
	28"D	\$2991	\$3097	\$3203	\$3307	\$3420	\$3530	\$3640
	34"D	\$3262	\$3379	\$3491	\$3608	\$3725	\$3847	\$3968

Single-Sided Veneer Benches — Extended Height

OLBELRQS	Dimension	40"W	46"W	52"W	58"W	64"W	70"W	76"W
	23"D	\$3261	\$3365	\$3472	\$3575	\$3691	\$3799	\$3909
	28"D	\$3556	\$3670	\$3785	\$3896	\$4021	\$4138	\$4257
	34"D	\$3849	\$3976	\$4097	\$4220	\$4349	\$4477	\$4607

► Specification Information, continued on next page

Height-Adjustable
Benching

Ology Height-Adjustable Single-Sided Benches, High-Pressure Laminate or Wood Veneer, continued

SIN 711.11

► Specification Information, continued from previous page

Specification Information

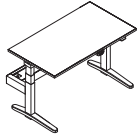

Style Number	Dimension D	Bench Type	Base Prices						
			40"W	46"W	52"W	58"W	64"W	70"W	76"W
		Modular	40"W	46"W	52"W	58"W	64"W	70"W	76"W
		Parametric	40"W	42 ¹ / ₁₆ "W	48 ¹ / ₁₆ "W	54 ¹ / ₁₆ "W	60 ¹ / ₁₆ "W	66 ¹ / ₁₆ "W	72 ¹ / ₁₆ "W
			42"W	48"W	54"W	60"W	66"W	72"W	78"W

Single-Sided Laminate Benches — Basic Height

OLBSLRQS	Dimension D	40"W	46"W	52"W	58"W	64"W	70"W	76"W
	23"D	\$2505	\$2595	\$2684	\$2772	\$2869	\$2961	\$3052
	28"D	\$2755	\$2853	\$2951	\$3047	\$3151	\$3252	\$3353
	34"D	\$3005	\$3113	\$3216	\$3323	\$3431	\$3544	\$3655

Single-Sided Veneer Benches — Basic Height

OLBSLRQS	Dimension D	40"W	46"W	52"W	58"W	64"W	70"W	76"W
	23"D	\$3047	\$3144	\$3243	\$3339	\$3446	\$3546	\$3648
	28"D	\$3320	\$3426	\$3533	\$3636	\$3752	\$3860	\$3970
	34"D	\$3592	\$3710	\$3822	\$3935	\$4055	\$4174	\$4294

Single-Sided Laminate Benches — Fixed Height

OLBFLRQS	Dimension D	40"W	46"W	52"W	58"W	64"W	70"W	76"W
	23"D	\$1760	\$1824	\$1888	\$1951	\$2021	\$2087	\$2152
	28"D	\$1939	\$2009	\$2079	\$2149	\$2223	\$2296	\$2368
	34"D	\$2119	\$2196	\$2270	\$2347	\$2424	\$2505	\$2585

Single-Sided Veneer Benches — Fixed Height

OLBFLRQS	Dimension D	40"W	46"W	52"W	58"W	64"W	70"W	76"W
	23"D	\$2302	\$2373	\$2447	\$2518	\$2598	\$2672	\$2748
	28"D	\$2504	\$2582	\$2661	\$2738	\$2824	\$2904	\$2985
	34"D	\$2706	\$2793	\$2876	\$2959	\$3048	\$3135	\$3224

Ology
Height-Adjustable
Single-Sided Benches

SIN 711.11

Ology Height-Adjustable 120° Corner Single-Sided Benches

High-Pressure Laminate or Wood Veneer

SIN 711.11



Tip: On extended height bases, any storage higher than 19", or 16 1/2" if the power access door is optioned, will impede lowest height range of bench worksurface. On basic height bases, any storage higher than 23 7/10", or 21 1/8" if the power access door is optioned, will impede lowest height range of bench worksurface. Do not place storage underneath controller.

Tip: Base supports a maximum distributed weight capacity of 314 pounds (2-leg). When calculating lifting capacity, subtract the weight of the worksurface, understructure, and options selected.

▶ See *Steelcase Benching Specification Guide*.

Tip: Fixed height does not have a controller option or a power cord.

Tip: Antimicrobial can be specified only when specifying simple touch controller and/or soft edge.

For laminate price group 2 pricing, please refer to the electronic catalog or SmartTools.

Standard Includes		Required to Specify
▶ Need help? See <i>Benching Specification Guide</i> .	<ul style="list-style-type: none"> One worksurface: High-Pressure Laminate price group 1 with 3 mm plastic edge or wood group 1 veneer One electric height-adjustable sit-to-stand bases: paint One active touch controller, if extended height or basic height is selected 1/2" adjustable glides One power cords: 9' Attachment hardware One perpendicular cable managers Cable tray and covers: paint to match base 	<ol style="list-style-type: none"> Style number Bench depth and width High-Pressure Laminate or wood color for worksurface Plastic color number for profile edge on laminate worksurfaces, if selected Bench corner style, if laminate bench selected (see below under Required Selections) Paint color number for base: <ul style="list-style-type: none"> 4799 Platinum Metallic 7207 Black 7241 Arctic White 7360 Merle Integrated rail (see below under Required Selections) Antimicrobial or non-antimicrobial surface, if simple touch controller selected (see below under Required Selections) Options, if selected (see below) <p>▶ See <i>Surface Materials</i>, page 346.</p>

Required Selections	Price	Required to Specify
Bench Corner Style (Laminate Benches Only)	<ul style="list-style-type: none"> Square corners: No cost Radius corners: +\$ 62 	Specify with <i>square corners</i> . Specify with <i>radius corners</i> .

Integrated Rail	<ul style="list-style-type: none"> Without integrated rail: No cost With integrated rail: +\$299 	Specify <i>without integrated rail</i> . Specify <i>with integrated rail</i> .
------------------------	--	---

Antimicrobial Surface	<ul style="list-style-type: none"> Non-antimicrobial surface: No cost Antimicrobial surface: No cost 	Specify <i>with non-antimicrobial surface</i> . Specify <i>with antimicrobial surface</i> .
------------------------------	--	--

Options	Price	Required to Specify
Surface Materials	<p>High-Pressure Laminate benches</p> <ul style="list-style-type: none"> Laminate price group 2: See information at left Open Line laminate: +\$ 69 plus cost of laminate <p>Wood veneer benches</p> <ul style="list-style-type: none"> Wood group 2: +\$ 69 Wood group 3: +\$242 Customiz stain: No cost Full-fill finish on wood group 1: +\$ 69 <p>Base</p> <ul style="list-style-type: none"> Paint price group 1: No cost Paint price group 2: +\$ 42 	Specify laminate color number. ▶ See <i>Surface Materials Reference Manual</i> .
		Specify wood color number. Specify wood color number. Specify <i>with Customiz stain</i> . ▶ See <i>Surface Materials Reference Manual</i> . Specify full-fill finish number.
		Specify paint color number. Specify paint color number. ▶ See <i>Surface Materials</i> , page 346.

Bench Type	<ul style="list-style-type: none"> Parametric width bench: No cost 	Specify <i>with parametric bench type</i> .
-------------------	---	---

Data Tray	<ul style="list-style-type: none"> With data tray: +\$138 	Specify <i>with data tray</i> .
------------------	--	---------------------------------

Cable Manager Application	<ul style="list-style-type: none"> Parallel: +\$ 20 	Specify <i>with parallel application</i> .
----------------------------------	--	--

Controller	<p>Extended height and basic height</p> <ul style="list-style-type: none"> Simple touch controller: -\$ 52 	Specify <i>with simple touch controller</i> .
-------------------	--	---

▶ Options, continued on next page

► Options, continued from previous page

Tip: Benches accommodate either power and data access door or grommet, but not both.

Tip: Power and data access door and grommet cannot be located on the same side of the desk.

Tip: Power and data access door is available on desks 58"W or greater.

Tip: When selecting power and data access door or grommet on one side, a cord drop will be standard on opposite side if integrated rail is present.

Options	Price	Required to Specify
Power and Data Access Door, Tray, and USB	<ul style="list-style-type: none"> No power or data access door: No cost Power and data access door, left or right: paint group 1 or 2: +\$ 793 Power and data access door on left or right: anodized aluminum: +\$ 803 Power and data access door on left and right: paint group 1 or 2: +\$1586 Power and data access door on left and right: anodized aluminum: +\$1606 	<p>Specify without power and data access door.</p> <p>Specify with power and data access door left or right and select paint color number.</p> <p>Specify with power and data access door left or right and select anodized aluminum.</p> <p>Specify with power and data access door left and right and select paint color number.</p> <p>Specify with power and data access door left and right and select anodized aluminum.</p>
Power and Data Access Door	<ul style="list-style-type: none"> Centered: No cost Left: No cost Right: No cost 	<p>Specify with centered position.</p> <p>Specify with left position.</p> <p>Specify with right position.</p>
Grommet	<ul style="list-style-type: none"> No grommet: No cost Grommet on left- or right-hand side: +\$ 40 Grommet on left- and right-hand side: +\$ 80 	<p>Specify without grommet.</p> <p>Specify with grommet and select left- or right-hand side.</p> <p>Specify with grommet and select left- and right-hand side.</p>
Glides	<ul style="list-style-type: none"> 1/2" glides: No cost 1" glides: +\$ 14 	<p>Specify with 1/2" glides.</p> <p>Specify with 1" glides.</p>
Related Products	<ul style="list-style-type: none"> Cable manager Data kit Universal screens 	<p>► Page 338</p> <p>► See Steelcase Benching Specification Guide</p> <p>► Page 342</p>

Specification Information



Style Number	Dimension D	Bench Type	Base Prices					
			34"W	40"W	46"W	52"W	58"W	64"W
		Modular						
		Parametric	34"W	36 1/16"W	42 1/16"W	48 1/16"W	54 1/16"W	60 1/16"W
			-36"W	-42"W	-48"W	-54"W	-60"W	-66"W

120° Corner Single-Sided Laminate Benches — Extended Height

OLBELWCS	23"D	\$4455	\$4610	\$4765	\$4934	\$5111	\$5299
	28"D	\$4669	\$4819	\$4981	\$5157	\$5341	\$5534

120° Corner Single-Sided Veneer Benches — Extended Height

OLBELWCS	23"D	\$5154	\$5521	\$5698	\$5879	\$6070	\$6273
	28"D	\$5483	\$5880	\$6067	\$6258	\$6458	\$6669

120° Corner Single-Sided Laminate Benches — Basic Height

OLBSLWCS	23"D	\$4103	\$4246	\$4388	\$4544	\$4707	\$4879
	28"D	\$4300	\$4438	\$4587	\$4749	\$4918	\$5096

► Specification Information, continued on next page

Ology Height-Adjustable 120° Corner Single-Sided Benches, High-Pressure Laminate or Wood Veneer, continued

SIN 711.11

► Specification Information, continued from previous page

Specification Information



Style Number	Dimension D	Bench Type	Base Prices					
			34"W	40"W	46"W	52"W	58"W	64"W
		Modular	34"W	40"W	46"W	52"W	58"W	64"W
		Parametric	34"W	36 ¹ / ₁₆ "W	42 ¹ / ₁₆ "W	48 ¹ / ₁₆ "W	54 ¹ / ₁₆ "W	60 ¹ / ₁₆ "W
			36"W	42"W	48"W	54"W	60"W	66"W

120° Corner Single-Sided Veneer Benches — Basic Height

OLBSLWCS	Dimension D	34"W	40"W	46"W	52"W	58"W	64"W
	23"D	\$4802	\$5157	\$5321	\$5489	\$5666	\$5853
	28"D	\$5114	\$5499	\$5673	\$5850	\$6035	\$6231

120° Corner Single-Sided Laminate Benches — Fixed Height

OLBFLWCS	Dimension D	34"W	40"W	46"W	52"W	58"W	64"W
	23"D	\$2906	\$3008	\$3111	\$3222	\$3339	\$3463
	28"D	\$3047	\$3146	\$3253	\$3369	\$3491	\$3618

120° Corner Single-Sided Veneer Benches — Fixed Height

OLBFLWCS	Dimension D	34"W	40"W	46"W	52"W	58"W	64"W
	23"D	\$3605	\$3919	\$4044	\$4167	\$4298	\$4437
	28"D	\$3861	\$4207	\$4339	\$4470	\$4608	\$4753

Ology
Height-Adjustable
120° Corner Single-Sided
Benches
SIN 711.11

Ology Height-Adjustable Single-Sided Bases

SIN 711.11

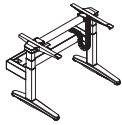

Tip: On extended height bases, any storage higher than 19", or 16½" if the power access door is optioned, will impede lowest height range of bench worksurface. On basic height bases, any storage higher than 23⅞", or 21½" if the power access door is optioned, will impede lowest height range of bench worksurface. Do not place storage underneath controller.

Tip: Base supports a maximum distributed weight capacity of 314 pounds (2-leg). When calculating lifting capacity, subtract the weight of the worksurface, understructure, and options selected.

▶ See *Steelcase Benching Specification Guide*.

Tip: Fixed height does not have a controller option or a power cord.

Tip: Antimicrobial can be specified only when specifying simple touch controller and/or soft edge.

Standard Includes		Required to Specify
▶ Need help? See <i>Benching Specification Guide</i> .	<ul style="list-style-type: none"> One electric height-adjustable sit-to-stand bases: paint One active touch controller, if extended height or basic height is selected ½" adjustable glides One power cords: 9' Attachment hardware One perpendicular cable managers Cable tray and covers: paint to match base 	<ol style="list-style-type: none"> Style number Bench depth and width Paint color number for bases: <ul style="list-style-type: none"> 4799 Platinum Metallic 7207 Black 7241 Arctic White 7360 Merle Antimicrobial or non-antimicrobial surface, if simple touch controller selected (see below under Required Selections) Options, if selected (see below) ▶ See <i>Surface Materials</i> , page 346.

	Required Selections	Price	Required to Specify
Antimicrobial Surface	• Non-antimicrobial surface	No cost	Specify with <i>non-antimicrobial surface</i> .
	• Antimicrobial surface	No cost	Specify with <i>antimicrobial surface</i> .

	Options	Price	Required to Specify
Surface Materials	Bases		
	<ul style="list-style-type: none"> Paint price group 1 Paint price group 2 	No cost +\$28	Specify paint color number. Specify paint color number. ▶ See <i>Surface Materials</i> , page 346.
Bench Type	• Parametric width bench	No cost	Specify with <i>parametric bench type</i> .
Data Tray	• With data tray	+\$69	Specify with <i>data tray</i> .
Cable Manager Application	• Parallel	+\$20	Specify with <i>parallel application</i> .
Controller	Extended height and basic height		
	• Simple touch controller	-\$52	Specify with <i>simple touch controller</i> .
Glides	• ½" glides	No cost	Specify with <i>½" glides</i> .
	• 1" glides	+\$14	Specify with <i>1" glides</i> .

Specification Information

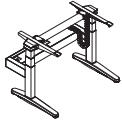

Style Number	Dimension D	Bench Type	Base Prices						
			40"W	46"W	52"W	58"W	64"W	70"W	76"W
		Modular	40"W	46"W	52"W	58"W	64"W	70"W	76"W
		Parametric	40"W	42 ¹ / ₁₆ "W	48 ¹ / ₁₆ "W	54 ¹ / ₁₆ "W	60 ¹ / ₁₆ "W	66 ¹ / ₁₆ "W	72 ¹ / ₁₆ "W
			42"W	48"W	54"W	60"W	66"W	72"W	78"W

Single-Sided Base — Extended Height

OLBELRQSB	Dimension D	40"W	46"W	52"W	58"W	64"W	70"W	76"W
	23"D	\$2585	\$2678	\$2770	\$2860	\$2961	\$3056	\$3150
	28"D	\$2844	\$2944	\$3045	\$3145	\$3252	\$3356	\$3461
	34"D	\$3102	\$3212	\$3319	\$3430	\$3542	\$3658	\$3772

Single-Sided Base — Basic Height

OLBSLRQSB	Dimension D	40"W	46"W	52"W	58"W	64"W	70"W	76"W
	23"D	\$2383	\$2468	\$2552	\$2636	\$2728	\$2816	\$2902
	28"D	\$2620	\$2713	\$2806	\$2897	\$2996	\$3092	\$3188
	34"D	\$2858	\$2960	\$3058	\$3160	\$3262	\$3369	\$3475

Single-Sided Base — Fixed Height

OLBFLRQSB	Dimension D	40"W	46"W	52"W	58"W	64"W	70"W	76"W
	23"D	\$1672	\$1733	\$1794	\$1854	\$1920	\$1983	\$2044
	28"D	\$1842	\$1909	\$1975	\$2041	\$2112	\$2181	\$2250
	34"D	\$2013	\$2086	\$2156	\$2229	\$2303	\$2380	\$2455

Height-Adjustable
Benching

Ology Height-Adjustable 120° Corner Single-Sided Bases

SIN 711.11

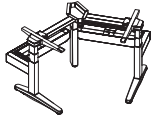

Tip: On extended height bases, any storage higher than 19", or 16½" if the power access door is optional, will impede lowest height range of bench worksurface. On basic height bases, any storage higher than 23⅞", or 21½" if the power access door is optional, will impede lowest height range of bench worksurface. Do not place storage underneath controller.

Tip: Base supports a maximum distributed weight capacity of 314 pounds (2-leg). When calculating lifting capacity, subtract the weight of the worksurface, understructure, and options selected.

► See *Steelcase Benching Specification Guide*.

Tip: Fixed height does not have a controller option or a power cord.

Tip: Antimicrobial can be specified only when specifying simple touch controller and/or soft edge.

Standard Includes		Required to Specify
► Need help? See <i>Benching Specification Guide</i> .	<ul style="list-style-type: none"> • Single electric height-adjustable sit-to-stand bases: paint • One active touch controller, if extended height or basic height is selected • ½" adjustable glides • Single power cords: 9' • Attachment hardware • Single perpendicular cable managers • Cable tray and covers: paint to match base 	<ol style="list-style-type: none"> 1 Style number 2 Bench depth and width 3 Paint color number for bases: <ul style="list-style-type: none"> 4799 Platinum Metallic 7207 Black 7241 Arctic White 7360 Merle 4 Antimicrobial or non-antimicrobial surface, if simple touch controller selected (see below under Required Selections) 5 Options, if selected (see below) <p>► See <i>Surface Materials</i>, page 346.</p>

	Required Selections	Price	Required to Specify
Antimicrobial Surface	• Non-antimicrobial surface	No cost	Specify with <i>non-antimicrobial surface</i> .
	• Antimicrobial surface	No cost	Specify with <i>antimicrobial surface</i> .

	Options	Price	Required to Specify
Surface Materials	Bases		
	• Paint price group 1	No cost	Specify paint color number.
	• Paint price group 2	+\$ 42	Specify paint color number. ► See <i>Surface Materials</i> , page 346.
Bench Type	• Parametric width bench	No cost	Specify with <i>parametric bench type</i> .
Data Tray	• With data tray	+\$138	Specify with <i>data tray</i> .
Cable Manager Application	• Parallel	+\$ 20	Specify with <i>parallel application</i> .
Controller	Extended height and basic height		
	• Simple touch controller	–\$ 52	Specify with <i>simple touch controller</i> .
Glides	• ½" glides	No cost	Specify with <i>½" glides</i> .
	• 1" glides	+\$ 14	Specify with <i>1" glides</i> .

Specification Information

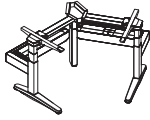

Style Number	Dimension D	Bench Type	Base Prices					
			34"W	40"W	46"W	52"W	58"W	64"W
		Modular	34"W	40"W	46"W	52"W	58"W	64"W
		Parametric	34"W	36 ¹ / ₁₆ "W	42 ¹ / ₁₆ "W	48 ¹ / ₁₆ "W	54 ¹ / ₁₆ "W	60 ¹ / ₁₆ "W
			36"W	42"W	48"W	54"W	60"W	66"W

120° Corner Single-Sided Base — Extended Height

OLBELWCSB	Dimension D	34"W	40"W	46"W	52"W	58"W	64"W
	23"D	\$4331	\$4442	\$4553	\$4575	\$4597	\$4619
	28"D	\$4501	\$4651	\$4813	\$4820	\$4827	\$4854

120° Corner Single-Sided Base — Basic Height

OLBSLWCSB	Dimension D	34"W	40"W	46"W	52"W	58"W	64"W
	23"D	\$3989	\$4091	\$4193	\$4213	\$4234	\$4254
	28"D	\$4145	\$4283	\$4432	\$4439	\$4445	\$4470

120° Corner Single-Sided Base — Fixed Height

OLBFLWCSB	Dimension D	34"W	40"W	46"W	52"W	58"W	64"W
	23"D	\$2824	\$2898	\$2971	\$2985	\$3000	\$3014
	28"D	\$2937	\$3036	\$3142	\$3147	\$3152	\$3170

Height-Adjustable
Benching

Ology Height-Adjustable Dual-Sided Bases

SIN 711.2

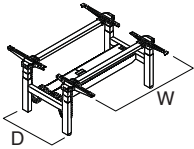

Tip: On extended height bases, any storage higher than 19" will impede lowest height range of bench worksurface. On basic height bases, any storage higher than 23⁷/₁₆" will impede lowest height range of bench worksurface. Do not place storage underneath controller.

Tip: Only single and dual flat panel monitor arm applications are permitted for use with 2-leg height-adjustable benches.
 ▶ See *Steelcase Worktools Specification Guide*.

Tip: Base supports a maximum distributed weight capacity of 314 pounds (2-leg). When calculating lifting capacity, subtract the weight of the worksurface, understructure, and options selected.
 ▶ See *Steelcase Benching Specification Guide*.

Tip: Antimicrobial can be specified only when specifying simple touch controller.

Tip: Attachment hardware is intended for worksurfaces 1" thick only.

Standard Includes	Required to Specify
<ul style="list-style-type: none"> • Two electric height-adjustable sit-to-stand bases: paint • Two active touch controllers • 2" adjustable glides • Two power cords: 9' • Attachment hardware • Two perpendicular cable managers • Cable tray and covers: paint to match base 	<ol style="list-style-type: none"> 1 Style number 2 Bench width 3 Paint color number for bases: <ul style="list-style-type: none"> 4799 Platinum Metallic 7207 Black 7241 Arctic White 7360 Merle 4 Antimicrobial or non-antimicrobial surface, if simple touch controller selected (see below under Required Selections) 5 Options, if selected (see below) ▶ See <i>Surface Materials</i> , page 346.

	Required Selections	Price	Required to Specify
Antimicrobial Surface	<ul style="list-style-type: none"> • Non-antimicrobial surface • Antimicrobial surface 	No cost No cost	Specify <i>with non-antimicrobial surface</i> . Specify <i>with antimicrobial surface</i> .

	Options	Price	Required to Specify
Surface Materials	Bases <ul style="list-style-type: none"> • Paint price group 1 • Paint price group 2 	No cost +\$ 56	Specify paint color number. Specify paint color number. ▶ See <i>Surface Materials</i> , page 346.
Bench Type	<ul style="list-style-type: none"> • Parametric width bench 	No cost	Specify <i>with parametric bench type</i> .
Data Tray	<ul style="list-style-type: none"> • With data tray 	+\$ 69	Specify <i>with data tray</i> .
Cable Manager Application	<ul style="list-style-type: none"> • Parallel 	+\$ 40	Specify <i>with parallel application</i> .
Controllers	<ul style="list-style-type: none"> • Two simple touch controllers 	-\$104	Specify <i>with simple touch controllers</i> .

SIN 711.2

Specification Information

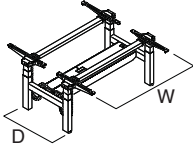

Style Number	Dimension D	Bench Type	Base Prices									
			40"W	46"W	52"W	58"W	64"W	70"W	76"W			
		Modular										
		Parametric	40"W 42"W	42 ¹ / ₁₆ "W 48"W	48 ¹ / ₁₆ "W 54"W	54 ¹ / ₁₆ "W 60"W	60 ¹ / ₁₆ "W 66"W	66 ¹ / ₁₆ "W 72"W	72 ¹ / ₁₆ "W 78"W			

Dual-Sided Base — Extended Height

OLBELRQDB	Dimension D	40"W	46"W	52"W	58"W	64"W	70"W	76"W
	23"D	\$4200	\$4254	\$4294	\$4433	\$4594	\$4745	\$4857
	28"D	\$4439	\$4502	\$4535	\$4588	\$4658	\$4689	\$4714
	34"D	\$4678	\$4714	\$4752	\$4803	\$4880	\$4913	\$4939

Dual-Sided Base — Basic Height

OLBSLRQDB	Dimension D	40"W	46"W	52"W	58"W	64"W	70"W	76"W
	23"D	\$3873	\$3922	\$3959	\$4087	\$4235	\$4373	\$4476
	28"D	\$4092	\$4150	\$4181	\$4229	\$4294	\$4322	\$4345
	34"D	\$4312	\$4345	\$4380	\$4427	\$4498	\$4528	\$4552

Height-Adjustable
Benching

Ology Height-Adjustable Combo Dual-Sided Benches

High-Pressure Laminate or Wood Veneer

SIN 711.2

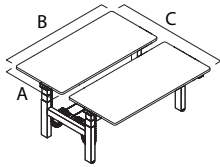

Tip: On extended height bases, any storage higher than 19", or 16½" if the power access door is optional, will impede lowest height range of bench work surface. On basic height bases, any storage higher than 23⅞", or 21½" if the power access door is optional, will impede lowest height range of bench work surface. Do not place storage underneath controller.

Tip: Base supports a maximum distributed weight capacity of 314 pounds (2-leg). When calculating lifting capacity, subtract the weight of the work surface, understructure, and options selected.

► See *Steelcase Benching Specification Guide*.

Tip: If selecting the same leg type position for both sides of the bench, the non-combo style benches should be used.

Tip: Antimicrobial can be specified only when specifying simple touch controller and/or soft edge

For laminate price group 2 pricing, please refer to the electronic catalog or *SmartTools*.

Standard Includes	Required to Specify
<ul style="list-style-type: none"> • Two work surfaces, one basic height and one extended height: High-Pressure Laminate with 3 mm plastic edge or wood group 1 veneer • Two electric height-adjustable sit-to-stand bases: paint • Two active touch controllers, if fixed height is not selected on either side • One active touch controller, if fixed height is selected on one side • 2" adjustable glides • Two power cords: 9' • Attachment hardware • Two perpendicular cable managers • Cable tray and covers: paint to match base 	<ol style="list-style-type: none"> 1 Style number 2 Bench width 3 Leg type position one (see below under Required Selections) 4 Leg type position two (see below under Required Selections) 5 High-Pressure Laminate or wood color for work surface 6 Plastic color number for profile edge on laminate work surfaces, if selected 7 Bench corner style, if laminate bench selected (see below under Required Selections) 8 Paint color number for base 4799 Platinum Metallic 7207 Black 7241 Arctic White 7360 Merle 9 Integrated rail (see below under Required Selections) 10 Antimicrobial or non-antimicrobial surface, if simple touch controller selected (see below under Required Selections) 11 Options, if selected (see below) ► See <i>Surface Materials</i>, page 346.

Required Selections	Price	Required to Specify
Leg Type Position One <ul style="list-style-type: none"> • Basic height • Extended height • Fixed height 	Prices at right Prices at right Prices at right	Specify <i>with basic height</i> . Specify <i>with extended height</i> . Specify <i>with fixed height</i> .
Leg Type Position Two <ul style="list-style-type: none"> • Basic height • Extended height • Fixed height 	Prices at right Prices at right Prices at right	Specify <i>with basic height</i> . Specify <i>with extended height</i> . Specify <i>with fixed height</i> .
Bench Corner Style (Laminate Benches Only) <ul style="list-style-type: none"> • Square corners • Radius corners 	No cost +\$124	Specify <i>with square corners</i> . Specify <i>with radius corners</i> .
Integrated Rail <ul style="list-style-type: none"> • Without integrated rail • With integrated rail 	No cost +\$598	Specify <i>without integrated rail</i> . Specify <i>with integrated rail</i> .
Antimicrobial Surface <ul style="list-style-type: none"> • Non-antimicrobial surface • Antimicrobial surface 	No cost No cost	Specify <i>with non-antimicrobial surface</i> . Specify <i>with antimicrobial surface</i> .

Options	Price	Required to Specify
Surface Materials <ul style="list-style-type: none"> • High-Pressure Laminate benches <ul style="list-style-type: none"> • Laminate price group 2 • Open Line laminate • Wood veneer benches <ul style="list-style-type: none"> • Wood group 2 • Wood group 3 • Customiz stain • Full-fill finish on wood group 1 • Base <ul style="list-style-type: none"> • Paint price group 1 • Paint price group 2 	See information at left +\$ 69 plus cost of laminate +\$138 +\$484 No cost +\$138 No cost +\$ 56	Specify laminate color number. ► See <i>Surface Materials Reference Manual</i> . Specify wood color number. Specify wood color number. Specify <i>with Customiz stain</i> . ► See <i>Surface Materials Reference Manual</i> . Specify full-fill finish number. Specify paint color number. Specify paint color number. ► See <i>Surface Materials</i> , page 346.

► Options, continued on next page

SIN 711.2

► Options, continued from previous page

	Options	Price	Required to Specify
Bench Type	• Parametric width bench	No cost	Specify with parametric bench type.
Data Tray	• With data tray	+\$ 69	Specify with data tray.
Cable Manager Application	• Parallel	+\$ 40	Specify with parallel application.
Controllers	• Two simple touch controllers	-\$ 104	Specify with simple touch controllers.
Soft Edge	• With soft edge	+\$ 412	Specify with soft edge.
Power and Data Access Door, Tray, and USB	• Power and data access door, tray and USB: paint price group 1 or 2	+\$1586	Specify with power and data access door and select paint color number.
	• Power and data access door, tray and USB: anodized aluminum	+\$1606	Specify with power and data access door and select anodized aluminum.
Power and Data Access Door and Soft Edge Position	• Centered	No cost	Specify with centered position.
	• Left	No cost	Specify with left position.
	• Right	No cost	Specify with right position.
Grommet	• Grommet	+\$ 80	Specify with grommet.
Related Products	• Cable manager		► Page 338
	• Universal screens		► Page 342

► Specification Information, on next page

Tip: Fixed height does not have a controller option or a power cord.

Tip: Soft edge is available on benches 58"W and larger.

Tip: Rectangular benches accommodate either power and data access door or grommet, but not both.

Ology Height-Adjustable Combo Dual-Sided Benches, High-Pressure Laminate or Wood Veneer, continued

SIN 711.2

► Options, on previous page

Specification Information

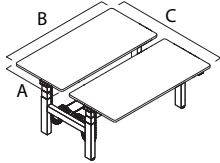

Tip: Prices below are shown only for one worksurface. You must add the price of leg type position one and two for the total price of the bench.

Style Number	Dimension D	Bench Type	Base Prices						
			40"W	46"W	52"W	58"W	64"W	70"W	76"W
		Modular	40"W	46"W	52"W	58"W	64"W	70"W	76"W
		Parametric	40"W	42 ¹ / ₁₆ "W	48 ¹ / ₁₆ "W	54 ¹ / ₁₆ "W	60 ¹ / ₁₆ "W	66 ¹ / ₁₆ "W	72 ¹ / ₁₆ "W
			-42"W	-48"W	-54"W	-60"W	-66"W	-72"W	-78"W

Combo Dual-Sided Laminate Benches — Extended Height

OLBRQD	Dimension D	40"W	46"W	52"W	58"W	64"W	70"W	76"W
	23"D	\$2103	\$2178	\$2253	\$2326	\$2408	\$2485	\$2560
	28"D	\$2225	\$2304	\$2382	\$2460	\$2543	\$2625	\$2706
	34"D	\$2521	\$2611	\$2698	\$2787	\$2878	\$2972	\$3064

Combo Dual-Sided Veneer Benches — Extended Height

OLBRQD	Dimension D	40"W	46"W	52"W	58"W	64"W	70"W	76"W
	23"D	\$2645	\$2727	\$2812	\$2898	\$2985	\$3070	\$3156
	28"D	\$2790	\$2877	\$2964	\$3049	\$3144	\$3233	\$3323
	34"D	\$3108	\$3208	\$3304	\$3399	\$3502	\$3602	\$3703

Combo Dual-Sided Laminate Benches — Basic Height

OLBRQD	Dimension D	40"W	46"W	52"W	58"W	64"W	70"W	76"W
	23"D	\$1923	\$1991	\$2059	\$2126	\$2200	\$2270	\$2339
	28"D	\$2052	\$2124	\$2196	\$2267	\$2344	\$2419	\$2494
	34"D	\$2341	\$2424	\$2504	\$2587	\$2670	\$2757	\$2843

Combo Dual-Sided Veneer Benches — Basic Height

OLBRQD	Dimension D	40"W	46"W	52"W	58"W	64"W	70"W	76"W
	23"D	\$2465	\$2540	\$2618	\$2693	\$2777	\$2855	\$2935
	28"D	\$2617	\$2697	\$2778	\$2856	\$2945	\$3027	\$3111
	34"D	\$2928	\$3021	\$3110	\$3199	\$3294	\$3387	\$3482

Combo Dual-Sided Laminate Benches — Fixed Height

OLBRQD	Dimension D	40"W	46"W	52"W	58"W	64"W	70"W	76"W
	23"D	\$1283	\$1330	\$1377	\$1423	\$1475	\$1523	\$1570
	28"D	\$1492	\$1546	\$1600	\$1653	\$1710	\$1766	\$1822
	34"D	\$1701	\$1763	\$1822	\$1884	\$1945	\$2010	\$2074

Combo Dual-Sided Veneer Benches — Fixed Height

OLBRQD	Dimension D	40"W	46"W	52"W	58"W	64"W	70"W	76"W
	23"D	\$1825	\$1879	\$1936	\$1990	\$2052	\$2108	\$2166
	28"D	\$2057	\$2119	\$2182	\$2242	\$2311	\$2374	\$2439
	34"D	\$2288	\$2360	\$2428	\$2496	\$2569	\$2640	\$2713

SIN 711.2

Ology Height-Adjustable Combo Dual-Sided Bases

SIN 711.2

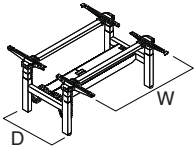

Tip: On extended height bases, any storage higher than 19" will impede lowest height range of bench worksurface. On basic height bases, any storage higher than 23⁷/₁₆" will impede lowest height range of bench worksurface. Do not place storage underneath controller.

Tip: Fixed height does not have a controller option or a power cord.

Tip: If selecting the same leg type position for both sides of the bench, the non-combo style benches should be used.

Tip: Base supports a maximum distributed weight capacity of 314 pounds (2-leg). When calculating lifting capacity, subtract the weight of the worksurface, understructure, and options selected.

▶ See *Steelcase Benching Specification Guide*.

Tip: Antimicrobial can be specified only when specifying simple touch controller.

Tip: Attachment hardware is intended for worksurfaces 1" thick only.

Standard Includes	Required to Specify
<ul style="list-style-type: none"> • Two electric height-adjustable sit-to-stand bases, one basic height and one extended height: paint • Two active touch controllers, if fixed height is not selected on either side • One active touch controller, if fixed height is selected on one side • 2" adjustable glides • Two power cords: 9' • Attachment hardware • Two perpendicular cable managers • Cable tray and covers: paint to match base 	<ol style="list-style-type: none"> 1 Style number 2 Bench width 3 Leg type position one (see below under Required Selections) 4 Leg type position two (see below under Required Selections) 5 Paint color number for bases 4799 Platinum Metallic 7207 Black 7241 Arctic White 7360 Merle 6 Antimicrobial or non-antimicrobial surface, if simple touch controller selected (see below under Required Selections) 7 Options, if selected (see below) <p>▶ See <i>Surface Materials</i>, page 346.</p>

	Required Selections	Price	Required to Specify
Leg Type Position One	<ul style="list-style-type: none"> • Basic height • Extended height • Fixed height 	Prices at right Prices at right Prices at right	Specify with <i>basic height</i> . Specify with <i>extended height</i> . Specify with <i>fixed height</i> .
Leg Type Position Two	<ul style="list-style-type: none"> • Basic height • Extended height • Fixed height 	Prices at right Prices at right Prices at right	Specify with <i>basic height</i> . Specify with <i>extended height</i> . Specify with <i>fixed height</i> .
Antimicrobial Surface	<ul style="list-style-type: none"> • Non-antimicrobial surface • Antimicrobial surface 	No cost No cost	Specify with <i>non-antimicrobial surface</i> . Specify with <i>antimicrobial surface</i> .

	Options	Price	Required to Specify
Surface Materials	Bases <ul style="list-style-type: none"> • Paint price group 1 • Paint price group 2 	No cost +\$ 56	Specify paint color number. Specify paint color number. ▶ See <i>Surface Materials</i> , page 346.
Bench Type	<ul style="list-style-type: none"> • Parametric width bench 	No cost	Specify with <i>parametric bench type</i> .
Data Tray	<ul style="list-style-type: none"> • With data tray 	+\$ 69	Specify with <i>data tray</i> .
Cable Manager Application	<ul style="list-style-type: none"> • Parallel 	+\$ 40	Specify with <i>parallel application</i> .
Controllers	<ul style="list-style-type: none"> • Two simple touch controllers 	-\$104	Specify with <i>simple touch controllers</i> .

Specification Information

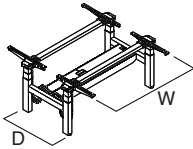

Tip: Prices below are shown only for one base. You must add the price of leg type position one and two for the total price of the bench.

Style Number	Dimension D	Bench Type	Base Prices						
			40"W	46"W	52"W	58"W	64"W	70"W	76"W
		Modular	40"W	46"W	52"W	58"W	64"W	70"W	76"W
		Parametric	40"W	42 ¹ / ₁₆ "W	48 ¹ / ₁₆ "W	54 ¹ / ₁₆ "W	60 ¹ / ₁₆ "W	66 ¹ / ₁₆ "W	72 ¹ / ₁₆ "W
			42"W	48"W	54"W	60"W	66"W	72"W	78"W

Combo Dual-Sided Bases — Extended Height

OLBRQDB	Dimension D	40"W	46"W	52"W	58"W	64"W	70"W	76"W
	23"D	\$2100	\$2127	\$2147	\$2216	\$2297	\$2372	\$2428
	28"D	\$2219	\$2251	\$2267	\$2294	\$2329	\$2345	\$2357
	34"D	\$2339	\$2357	\$2376	\$2401	\$2440	\$2456	\$2469

Combo Dual-Sided Bases — Basic Height

OLBRQDB	Dimension D	40"W	46"W	52"W	58"W	64"W	70"W	76"W
	23"D	\$1936	\$1961	\$1979	\$2043	\$2117	\$2187	\$2238
	28"D	\$2046	\$2075	\$2090	\$2115	\$2147	\$2161	\$2173
	34"D	\$2156	\$2173	\$2190	\$2213	\$2249	\$2264	\$2276

Combo Dual-Sided Bases — Fixed Height

OLBRQDB	Dimension D	40"W	46"W	52"W	58"W	64"W	70"W	76"W
	23"D	\$1352	\$1369	\$1383	\$1429	\$1482	\$1531	\$1568
	28"D	\$1488	\$1509	\$1521	\$1539	\$1563	\$1574	\$1582
	34"D	\$1509	\$1521	\$1534	\$1551	\$1576	\$1587	\$1595

Height-Adjustable
Benching

Accessories for Use with Ology Dual-Sided Benches

SIN 711.2

Connection Kit

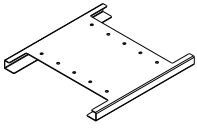

Tip: Must order connection kit when combining two or more benches.

Standard Includes	Required to Specify
-------------------	---------------------

- Connection kit: paint
- Hardware

- 1 Style number
- 2 Paint color number for connection kit:
 - 4799 Platinum Metallic
 - 7207 Black
 - 7241 Arctic White
 - 7360 Merle

Specification Information	
• Style Number	• Price

• Style Number	• Price
OLBCK	\$66

End of Run Tray Covers



Tip: Tray covers can be added to finish off the ends of the cable tray.

Standard Includes	Required to Specify
-------------------	---------------------

- Pair of tray covers: paint

- 1 Style number
- 2 Paint color number for tray covers:
 - 4799 Platinum Metallic
 - 7207 Black
 - 7241 Arctic White
 - 7360 Merle

Specification Information	
• Style Number	• Price

• Style Number	• Price
OLBEC	\$50

End-of-Run Trim Kit for Single-Sided Applications

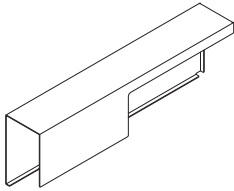

Tip: End-of-run trim kit must be specified to cover cross tube. One pair needed per run.

Standard Includes		Required to Specify	
<ul style="list-style-type: none"> • Pair of end-of-run trim kit 		1 Style number 2 Paint color number for end-of-run trim kit: 4799 Platinum Metallic 7207 Black 7241 Arctic White 7360 Merle	
Specification Information			
•Style Number	•Price		
OLBCCS	\$50		
•	•		

Ology Stabilizer Post for Use with Single-Sided Application



Tip: See Application Topics for Ology Bench Stabilizer Post.

▶ See *Benching Specification Guide*.

Standard Includes		Required to Specify	
▶ Need help? See <i>Benching Specification Guide</i> .		<ul style="list-style-type: none"> • Stabilizer post: paint 	
		1 Style number 2 Paint color number for stabilizer post ▶ See <i>Surface Materials</i> , page 346.	
Specification Information			
•Style Number	•Price		
OLBSP	\$95		
•	•		

Accessories for Use with Ology Dual-Sided Benches, continued

SIN 711.2

Infill

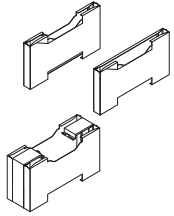

Tip: Intermediate shared application is used when large capacity is required.

Standard Includes	Required to Specify
-------------------	---------------------

Standard Includes	Required to Specify
<ul style="list-style-type: none"> Infill: paint price group 1 End of run: pair Intermediate: pair Intermediate shared: pair and L-bracket fillers Brackets and caps 	<ol style="list-style-type: none"> Style number Infill application (see below under Required Selections) Paint color number for infill Options, if selected (see below) <p>▶ See <i>Surface Materials</i>, page 346.</p>

Required Selections	Price	Required to Specify
---------------------	-------	---------------------

Required Selections	Price	Required to Specify
Infill Application <ul style="list-style-type: none"> End of run Intermediate Intermediate shared 	<ul style="list-style-type: none"> No cost No cost No cost 	<ul style="list-style-type: none"> Specify with <i>end of run</i>. Specify with <i>intermediate</i>. Specify with <i>intermediate shared</i>.

Options	Price	Required to Specify
---------	-------	---------------------

Options	Price	Required to Specify
Surface Materials <ul style="list-style-type: none"> Paint price group 1 Paint price group 2 	<ul style="list-style-type: none"> No cost +\$29 	<ul style="list-style-type: none"> Specify paint color number. Specify paint color number.

Specification Information	
Style Number	Base Price

Style Number	Base Price
OLBFL	\$240

Cable Manager

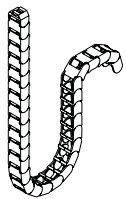

Tip: Cable manager is compatible with Ology bench only. Two cable managers come standard with each dual-sided bench.

Standard Includes	Required to Specify
-------------------	---------------------

Standard Includes	Required to Specify
<ul style="list-style-type: none"> Perpendicular cable manager Attachment hardware 	<ol style="list-style-type: none"> Style number Options, if selected (see below)

Options	Price	Required to Specify
---------	-------	---------------------

Options	Price	Required to Specify
Cable Manager Application <ul style="list-style-type: none"> Parallel 	<ul style="list-style-type: none"> +\$20 	<ul style="list-style-type: none"> Specify with <i>parallel application</i>.

Specification Information	
Style Number	Base Price

Style Number	Base Price
OLBCM	\$50

Cable Basket

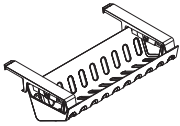

Tip: Cable baskets are compatible with rectangular, tapered, or 90° corner desks 46¹/₆"W or larger and 120° corner desks 40¹/₆"W or larger.

Standard Includes	Required to Specify
• Cable basket: 6527 Merle plastic	Style number

Specification Information

• Style Number	• Weight	• Price
OLCB	1.0 lb	\$56
•	•	•

Cable Brackets

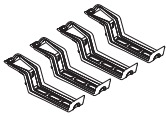

Standard Includes	Required to Specify
• Cable brackets, quantity of four: 6527 Merle plastic	Style number

Specification Information

• Style Number	• Weight	• Price
OLCBK4	0.5 lb	\$34
•	•	•

90° Mini Extension Cord



Tip: 90° mini extension cord can be used with Ology bench, FrameOne, or where power receptacles are located in confined spaces.

Standard Includes	Required to Specify
• 10"L molded NEMA mini extension cord	Style number

Specification Information

• Style Number	• Price
LMINICORD	\$40
•	•

Height-Adjustable
Benching

Accessories for Use with Ology Dual-Sided Benches, continued

SIN 711.2

Conversion Kit Fixed to Height Adjustable for Ology Single-Sided Benches

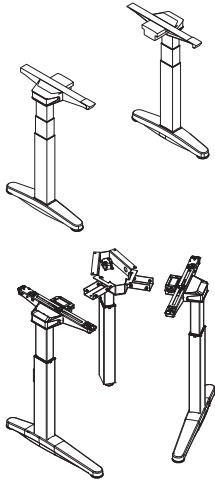

Standard Includes	Required to Specify
-------------------	---------------------

Standard Includes	Required to Specify
<ul style="list-style-type: none"> • Infill: paint price group 1 • Center three piece brackets • One active touch controller 	<ol style="list-style-type: none"> 1 Style number 2 Bench depth (see below under Required Selections) 3 Antimicrobial or non-antimicrobial surface, if simple touch controller selected (see below under Required Selections) 4 Paint color number for bases: <ul style="list-style-type: none"> 4799 Platinum Metallic 7207 Black 7241 Arctic White 7360 Merle <p>▶ See <i>Surface Materials</i>, page 346.</p>

Required Selections	Price	Required to Specify
---------------------	-------	---------------------

Bench Depth	<ul style="list-style-type: none"> • 23"D • 28"D • 34"D 	<ul style="list-style-type: none"> No cost No cost No cost
Antimicrobial Surface	<ul style="list-style-type: none"> • Non-antimicrobial surface • Antimicrobial surface 	<ul style="list-style-type: none"> No cost No cost

Antimicrobial Surface	<ul style="list-style-type: none"> • Non-antimicrobial surface • Antimicrobial surface 	<ul style="list-style-type: none"> No cost No cost 	<ul style="list-style-type: none"> Specify with <i>non-antimicrobial surface</i>. Specify with <i>antimicrobial surface</i>.
------------------------------	--	--	--

Options	Price	Required to Specify
---------	-------	---------------------

Surface Materials	<ul style="list-style-type: none"> • Paint price group 1 • Paint price group 2 	<ul style="list-style-type: none"> No cost +\$28 	<ul style="list-style-type: none"> Specify paint color number. Specify paint color number. <p>▶ See <i>Surface Materials</i>, page 346.</p>
Glides	<ul style="list-style-type: none"> • 1/2" glides • 1" glides 	<ul style="list-style-type: none"> No cost +\$14 	<ul style="list-style-type: none"> Specify with <i>1/2" glides</i>. Specify with <i>1" glides</i>.
Controller	<ul style="list-style-type: none"> • Simple touch controller 	<ul style="list-style-type: none"> -\$52 	<ul style="list-style-type: none"> Specify with <i>simple touch controller</i>.

Specification Information	
---------------------------	--

Style Number	Base Price
.....

Extended Height for Ology Single-Sided Rectangle

OLBELRQSK \$1627

Basic Height for Ology Single-Sided Rectangle

OLBSLRQSK \$1501

Extended Height for Ology 120° Single-Sided

OLBELWCCK \$2251

Basic Height for Ology 120° Single-Sided

OLBSLWCCK \$2075

SIN 711.2

Universal Centered Screens and Aligners

For Use with Ology Benches

SIN 711.2

Universal Centered Screens

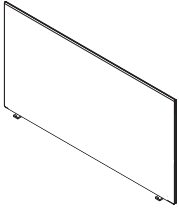

Standard Includes	Required to Specify
<ul style="list-style-type: none"> • Screen: fabric price group 1 • Edge (upper segment): 7360 Merle • Edge (lower segment): felt • Brackets: 7360 Merle 	<ol style="list-style-type: none"> 1 Style number 2 Height (see below under Required Selections) 3 Width (see below under Required Selections) 4 Edge (lower segment) felt color: <ul style="list-style-type: none"> P630 Light Heather Grey P631 Dark Heather Grey 4 Fabric color number for screen 5 Options, if selected (see below) <p>▶ See <i>Surface Materials</i>, page 346.</p>

	Required Selections	Price	Required to Specify
Height	<ul style="list-style-type: none"> • 26"H • 32"H 	Prices below Prices below	Specify with 26"H. Specify with 32"H.
Width	<ul style="list-style-type: none"> • 42"W • 48"W • 54"W • 60"W • 66"W • 72"W • 78"W 	Prices below Prices below Prices below Prices below Prices below Prices below Prices below	Specify with 42"W. Specify with 48"W. Specify with 54"W. Specify with 60"W. Specify with 66"W. Specify with 72"W. Specify with 78"W.

	Options	Price	Required to Specify
Surface Materials	<ul style="list-style-type: none"> • Fabric price group 1 • Fabric price group 2 • Fabric price group 3 • Fabric price group 4 • Fabric price group 5 • Fabric price group 6 • Fabric price group 7 • Fabric price group 8 • Fabric price group 9 • Fabric price group 10 • Customer's Own Material (COM) 	No cost +\$ 47 +\$102 +\$124 +\$154 +\$184 +\$214 +\$244 +\$274 +\$304 +\$ 16	Specify fabric color number. Specify fabric color number. Specify fabric color number. Specify fabric color number. Specify fabric color number. Specify fabric color number. Specify fabric color number. Specify fabric color number. Specify fabric color number. Specify fabric color number. Specify fabric color number. ▶ See <i>Surface Materials Reference Manual</i> .

Specification Information								
• Style Number	• Height	• Base Prices						
:	:	: 42"W	: 48"W	: 54"W	: 60"W	: 66"W	: 72"W	: 78"W
• OLBSC	26"	\$688	\$708	\$728	\$748	\$768	\$788	\$808
	32"	\$826	\$846	\$866	\$886	\$906	\$926	\$946

Tip: 26"H screen will align at a 42" datum. 32"H screen will align at a 48" datum.

Aligners for Use with Universal Screens



Tip: Aligners are for use with Universal screens in in-line applications only.

Standard Includes	Required to Specify
<ul style="list-style-type: none"> Aligners, package of 10: 6527 Merle 	Style number

Specification Information

Style Number	Price
UFAL	\$25
.	.

Fixed Personal Screens

SIN 711.2

Standard Includes	Required to Specify
-------------------	---------------------

- Personal screens: fabric price group 1
- Brackets: 4799 Platinum

- 1 Style number
 - 2 Fabric color number for screen
 - 3 Options, if selected (see below)
- ▶ See *Surface Materials*, page 346.

Options	Price			Required to Specify
---------	-------	--	--	---------------------

Surface Materials	Fabric	12"H	19 1/2"H	24"H	Required to Specify
	• Fabric price group 1	No cost	No cost	No cost	Specify fabric color number.
	• Fabric price group 2	+\$25	+\$ 34	+\$ 40	Specify fabric color number.
	• Fabric price group 3	+\$66	+\$ 89	+\$114	Specify fabric color number.
	• Fabric price group 4	+\$85	+\$114	+\$139	Specify fabric color number.
	• Customer's Own Material (COM)	+\$16	+\$ 16	+\$ 16	▶ See <i>Surface Materials Reference Manual</i> .

Tip: When using COM fabric, it is recommended that non-patterned fabric be used to provide a consistent visual between adjacent screens, and from one side to the other.

Specification Information		
---------------------------	--	--

Width	Style Number	Base Price
-------	--------------	------------

12"H Screens

30"	CQSF3012	\$166
36"	CQSF3612	\$194
42"	CQSF4212	\$219
48"	CQSF4812	\$247

19 1/2"H Screens

30"	CQSF3019	\$256
36"	CQSF3619	\$284
42"	CQSF4219	\$311
48"	CQSF4819	\$337

24"H Screens

30"	CQSF3024	\$345
36"	CQSF3624	\$374
42"	CQSF4224	\$400
48"	CQSF4824	\$427

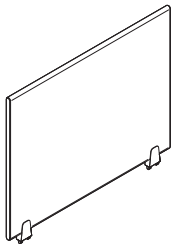
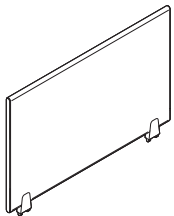
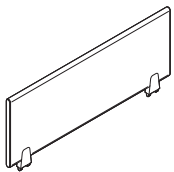

Surface Materials

Surface Materials	346
Directional Laminate Grain Directions	352
Wood Veneer Grain Directions	353

Surface Materials

This listing includes all the surface material choices that are available for the products in this specification guide.

Resources

For more information about surface materials, refer to the following resources:

- *Steelcase Surface Materials Reference Manual*
- Steelcase Wood Finish Swatch Card
- www.steelcase.com

Additional surface materials specification tools are available to assist you in the specification process—the Surface Materials Binders.

Surface Materials

Binders include:

- A complete set of swatch cards for hard surfaces, vertical surface fabrics, and seating upholstery

Paint

Tip: All products may not be available in all colors listed below.

Applies to:

- Lighting
- Computer support tools
- Organizational worktools
- Flat panel arm

- 0835 Black
- 4140 Arctic White
- 4231 Arctic White Gloss
- 4710 Low Gloss Black
- 4750 Champagne
- 4799 Platinum Metallic
- 7018 Pewter
- 7021 Dark Champagne
- 7027 Charcoal
- 7360 Merle
- ZW01 Pearl Snow

Applies to:

- dash LED light
- dash mini LED light
- LED radial desktop lights
- LED linear desktop lights
- SOTO shelves, rails, and cableways
- FYI monitor arms

▶ *See Worktools Specification Guide for FYI monitor arms and SOTO shelves, rails, and cableways defaulted color matrix.*

Select Surfaces

Price Group 3

Accent paint

Accent paints allow you to choose from a pre-matched color palette of trend driven colors. Refer to the *Surface Materials Reference Manual* for more information.

Custom Surfaces

Price Group 3

PerfectMatch

PerfectMatch is a service that allows you to create your own paint color. Refer to the *Surface Materials Reference Manual* for more information about this program.

Tip: Price Group 3 paints are not available on height-adjustable worksurface bases.

Applies to:

- Ology bench and power and data access door

Price Group 1

Textured Paint

- 7207 Black
- 7241 Arctic White
- 7360 Merle

Price Group 2

Smooth Metallic Paint

- 4799 Platinum Metallic

Metal/Accessory Paint

Applies to:

- Ology bench power and data access door
- 8043 Clear Anodized Aluminum

Laminate and Edge Finishes

Edge finish is specified separately for all worksurface options, except wood veneer. Urethane profile edge finishes are Black 6000 and Felt 6278. The recommended edge finishes for Universal and knife edge worksurfaces are below.

Applies to:

- Ology desks
- Ology modesty panels
- Series 5 worksurfaces with Universal and knife edges
- Airtouch
- Universal Steel One-High open lateral tops for Ology
- Universal Common tops for Ology

Laminate Color	Recommended 3 mm or 1 mm Edge Color	Recommended P-Edge Color
Fiber Laminate		
2850 Vanadium Fiber	6654 Sand*	6697 Fog
2851 Rhyme Fiber	6631 Cream*	6654 Sand
2852 Tungsten Fiber	6636 Mist*	6654 Sand
2854 Vellum Fiber	6655 Warm White*	6697 Fog
2859 Novell Fiber	6001 Coffee*	6697 Fog
2860 Granite Fiber	6000 Black*	6000 Black
2861 Coconut Fiber	6654 Sand*	6654 Sand
2862 Stucco Fiber	6053 Seagull*	6053 Seagull
Micro Laminate		
2920 Marl Micro	6053 Seagull*	6053 Seagull
2921 Gypsum Micro	6654 Sand*	6654 Sand
2922 Clay Micro	6654 Sand*	6654 Sand
2923 Shadow Micro	6249 Platinum Solid*	6249 Platinum Solid
Patina Laminate		
2870 Blonde Bronze Patina	6654 Sand*	6654 Sand
2871 Blackened Bronze Patina	6615 Grey V5*	6000 Black
2873 Instant Iron Patina	6615 Grey V5*	6000 Black
Pulp Laminate		
2766 Warm Brown V1	6631 Cream*	6654 Sand
2782 Grey V1	6053 Seagull*	6053 Seagull
Solid Laminate		
2722 Cream	6631 Cream*	6654 Sand
2730 Arctic White	6009 Arctic White*	6009 Arctic White
2746 Black	6000 Black*	6000 Black
2759 Warm White	6655 Warm White*	6654 Sand
2811 Mist	6636 Mist*	6697 Fog
2883 Seagull	6053 Seagull*	6053 Seagull
2884 Milk	6052 Milk*	6052 Milk
2885 Dune	6654 Sand*	6654 Sand
2HMG Merle	6527 Merle	6527 Merle
Speckle Laminate		
2820 Coffee Speckle	6631 Cream*	6654 Sand
2822 Woodrose Speckle	6635 Dawn*	6000 Black
2823 Driftwood Speckle	6631 Cream*	6000 Black
2824 Smoke Speckle	6636 Mist*	6654 Sand
2825 Vanadium Speckle	6619 Ice*	6697 Fog

Laminate and Edge Finishes, continued

Laminate Color	Recommended 3 mm or 1 mm Edge Color	Recommended P-Edge Color
----------------	---	-----------------------------

Textured Woodgrain Laminate—Select Surfaces

2TH2 Fawn Cypress	6T02 Fawn Cypress	6654 Sand
2TH3 Weathered Char	6T03 Weathered Char	6615 Grey V5
2TH4 Saddle Oak	6T04 Saddle Oak	— —
2TH5 Veranda Teak	6T05 Veranda Teak	6612 Grey V2
2TH6 Persian Cherry	6T06 Persian Cherry	— —
2TH7 Walnut Heights	6T07 Walnut Heights	— —

Textured Industrial Laminate—Select Surfaces

2UH1 Reclaimed Aggregate	6T08 Aggregate	6612 Grey V2
2UH2 Reclaimed Gravel	6T09 Gravel	6615 Grey V5
2UH4 Cement	6T10 Cement	6636 Mist
2UH6 Sheetrock	6T12 Sheetrock	6654 Sand

Woodgrain Laminate

2406 Clear Cherry	6234 Clear Cherry*	6000 Black
2409 Clear Maple	6237 Clear Maple*	6654 Sand
2410 Graphite Walnut	6231 Graphite Walnut*	6000 Black
2412 Natural Cherry	6034 Natural Cherry	6000 Black
2422 Medium Cherry	6036 Medium Cherry	6000 Black
2511 Winter on Maple	6037 Winter on Maple	6654 Sand
2538 Clear Walnut	6245 Clear Walnut*	6000 Black
2539 Warm Oak	6246 Warm Oak*	6246 Warm Oak
2592 Blonde on Maple	6038 Blonde on Maple	6654 Sand
2714 Natural Walnut	6041 Natural Walnut	6000 Black
2772 Medium Mahogany on Walnut	6045 Medium Mahogany on Walnut	6000 Black
2HAT Acacia	6213 Acacia	6654 Sand
2HAW Ash Wenge	6703 Ash Wenge	6654 Sand
2HBW Bisque Wenge	6705 Bisque Wenge	6631 Cream
2HCW Clay Wenge	6706 Clay Wenge	6612 Grey V2
2HSW Storm Wenge	6704 Storm Wenge	6615 Grey V5

Turnstone Laminate Collection**

2535 Virginia Walnut	6242 Virginia Walnut	6000 Black
2536 Blackwood	6243 Blackwood	6000 Black
2612 Marbled Maple	6676 Marbled Maple	6000 Black
2614 Chocolate Walnut	6677 Chocolate Walnut	6000 Black
2615 Marbled Cherry	6678 Marbled Cherry	6000 Black

* PVC-free edge banding (also includes: 6689 Brushed Silver, 6694 Slate, 6695 Midnight, and 6698 Fieldstone)

** A selection of laminates and edge bands in this collection are available on Steelcase brand products. This collection is available with standard leadtimes and supported like standard laminates to help make ordering easy.

Tip: Woodgrain Laminates and the Turnstone Laminate Collection are not available as matched sets. The grain patterns will not align.

Laminate**Steelcase Surfaces****High-Pressure Laminate****Price Group 1**

Applies to:

- Ology bench worksurfaces

Fiber Laminate

2850 Vanadium Fiber
2851 Rhyme Fiber
2852 Tungsten Fiber
2854 Vellum Fiber
2859 Novell Fiber
2860 Granite Fiber
2861 Coconut Fiber
2862 Stucco Fiber

Micro Laminate

2920 Marl Micro
2921 Gypsum Micro
2922 Clay Micro
2923 Shadow Micro

Patina Laminate

2870 Blonde Bronze Patina
2871 Blackened Bronze Patina
2873 Instant Iron Patina

Solid Laminate

2722 Cream
2730 Arctic White
2746 Black
2759 Warm White
2811 Mist
2883 Seagull
2884 Milk
2885 Dune
2HMG Merle

Speckle Laminate

2820 Coffee Speckle
2822 Woodrose Speckle
2823 Driftwood Speckle
2824 Smoke Speckle
2825 Vanadium Speckle

Tip: Some wood veneer finishes and woodgrain laminates share the same name. Because of the difference in materials, veneers and laminates of the same name are not an exact match but do coordinate with each other.

Woodgrain Laminate

2406 Clear Cherry
2409 Clear Maple
2410 Graphite Walnut
2412 Natural Cherry
2422 Medium Cherry
2511 Winter on Maple
2538 Clear Walnut
2539 Warm Oak
2592 Blonde on Maple
2714 Natural Walnut
2772 Medium Mahogany on Walnut
2HAK Clear Oak
2HAN Ash Noce
2HAT Acacia
2HAW Ash Wenge
2HBN Bisque Noce
2HBW Bisque Wenge
2HCN Clay Noce
2HCW Clay Wenge
2HSN Storm Noce
2HSW Storm Wenge

Select Surfaces**High-Pressure Laminate****Price Group 1****Textured Woodgrain Laminate**

2TH2 Fawn Cypress
2TH3 Weathered Char
2TH4 Saddle Oak
2TH5 Veranda Teak
2TH6 Persian Cherry
2TH7 Walnut Heights

Price Group 2**Textured Industrial Laminate**

2UH1 Reclaimed Aggregate
2UH2 Reclaimed Gravel
2UH4 Cement
2UH6 Sheetrock

Surface Materials, continued

Custom Surfaces**Open Line Laminate (OLL)**

This service allows you to order non-standard laminate at an additional processing fee of \$69 per unit, plus the cost of the laminate.

High-Pressure Laminate pricing does not include premium or digitally printed patterns from any suppliers. Laminate cost may also vary for basic or standard laminates from other suppliers. Please contact the OLL consultant at 616.475.2426 for pricing. The cost of the laminate will be added to your invoice as a separate line on the acknowledgement.

When processing orders for Open Line laminate on worksurfaces, specify 2900 in the laminate finish field and enter the OLL manufacturer information. Enter the required edge finish as you would a standard laminate.

Laminate Approval and Material Requirements

To confirm whether a particular laminate has already been tested for use on a specific Steelcase product or to determine material square foot requirements:

- Visit www.steelcase.com

For additional information, refer to the *Steelcase Surface Materials Reference Manual*.

Wood

Applies to:

- Ology desks
- Ology modesty panels
- Series 5 height-adjustable worksurfaces
- Ology bench worksurface

Steelcase carefully selects veneer and solid wood for consistent color and grain structure. Wood is a natural material and variations will occur in color, grain and texture. These variations are part of the inherent natural beauty of wood and are not considered defects.

All wood products will darken with age and exposure to ultraviolet light. This is especially apparent with cherry and maple veneer. We recommend that desk accessories be rearranged periodically to ensure even aging of wood surfaces.

When storing your wood furniture, please follow the following guidelines:

- Do not store products in trailers
- Store products in areas that simulate office temperatures (60°F to 90°F)
- Store products in areas that maintain constant, office-like humidity levels
- Keep product away from light. Cover products to make sure they are not exposed to light.

Steelcase Surfaces**Veneer**

Veneers are matched for proper balance and consistency. Veneers are available flat cut or quarter cut, except for Oak, which is rift cut. Refer to the *Surface Materials Reference Manual* for descriptions of each cut.

Open-pore finish is a medium gloss finish that leaves the wood grain texture visible to the eye and distinguishable to the touch.

Flat-cut open-pore finish choices**Wood Group 1**

- 3062 FC/OP Graphite Walnut
- 3402 FC/OP Clear Cherry (Aged)
- 3412 FC/OP Natural Cherry
- 3422 FC/OP Medium Cherry
- 3522 FC/OP Clear Maple*
- 3572 FC/OP Amber on Maple
- 3592 FC/OP Blonde on Maple
- 3702 FC/OP Clear Walnut
- 3712 FC/OP Natural Walnut
- 3722 FC/OP Dark Mahogany on Walnut
- 3752 FC/OP Medium Walnut
- 3762 FC/OP Dark Walnut
- 3772 FC/OP Medium Mahogany on Walnut

Quarter-cut open-pore finish choices**Wood Group 1**

- 3042 QC/OP Ash*
- 3222 QC/OP Clear Maple*
- 3272 QC/OP Amber on Maple
- 3292 QC/OP Blonde on Maple
- 3302 QC/OP Clear Walnut
- 3312 QC/OP Natural Walnut
- 3322 QC/OP Dark Mahogany on Walnut
- 3352 QC/OP Medium Walnut
- 3362 QC/OP Dark Walnut
- 3372 QC/OP Medium Mahogany on Walnut
- 3382 QC/OP Graphite Walnut

Rift-cut open-pore finish choices**Wood Group 1**

- 3602 RC/OP Desert Oak
- 3612 RC/OP Warm Oak
- 3692 RC/OP Espresso Oak

Full-fill finish is a medium-gloss finish that completely fills the grain texture, yet allows the grain pattern to be seen. The wood has a lustrous, satiny look, and it is smooth to the touch.

Flat-cut full-fill finish choices**Wood Group 1**

- 3064 FC/FF Graphite Walnut
- 3404 FC/FF Clear Cherry (Aged)
- 3414 FC/FF Natural Cherry
- 3424 FC/FF Medium Cherry
- 3524 FC/FF Clear Maple*
- 3544 FC/FF Blonde on Maple
- 3574 FC/FF Amber on Maple
- 3704 FC/FF Clear Walnut
- 3714 FC/FF Natural Walnut
- 3724 FC/FF Dark Mahogany on Walnut
- 3754 FC/FF Medium Walnut
- 3764 FC/FF Dark Walnut
- 3774 FC/FF Medium Mahogany on Walnut

Quarter-cut full-fill finish choices**Wood Group 1**

- 3224 QC/FF Clear Maple*
- 3274 QC/FF Amber on Maple
- 3294 QC/FF Blonde on Maple
- 3304 QC/FF Clear Walnut
- 3314 QC/FF Natural Walnut
- 3324 QC/FF Dark Mahogany on Walnut
- 3354 QC/FF Medium Walnut
- 3364 QC/FF Dark Walnut
- 3374 QC/FF Medium Mahogany on Walnut
- 3384 QC/FF Graphite Walnut

Rift-cut full-fill finish choices**Wood Group 1**

- 3604 RC/FF Desert Oak
- 3614 RC/FF Warm Oak
- 3694 RC/FF Espresso Oak

**To ensure an understanding of the color ranges and characteristic variations of natural veneer, a sign-off sheet is required prior to orders being accepted for this clear-coat finish. The sign-off sheet is available through Steelcase advertising stock. Please use form number 09-0000756 for 3042, form number 05-0001370 for 3222 and 3224.*

Premium Veneers

A selection of Premium veneers in this collection are available on most Steelcase brand products. The collection will be available as close to standard leadtimes as possible. However, because adequate supplies of veneer and solids must be secured, all orders will be scheduled individually. Leadtimes will vary based on Premium veneer and Premium solids availability at the time the order is placed. The collection is Graded-In as Wood Group 2 and Wood Group 3, and supported like standard veneers to make ordering easy. Please see the Steelcase surface materials section on village.steelcase.com for sample information and product line availability. All premium veneers are in clear-coat.

Quarter-cut open-pore finish choices**Wood Group 2**

- 3032 QC/OP Dark Thin Line Bamboo
- 3052 QC/OP Ribbon Sapele

Wood Group 3

- 3832 QC/OP Figured Anegre
- 3842 QC/OP Figured Makore

To ensure an understanding of the color ranges and characteristic variations of natural veneer, a sign-off sheet is required prior to orders being accepted for this clear-coat finish. The sign-off sheet is available through Steelcase advertising stock. Please use form number 09-0000755 for 3032, form number 09-0000757 for 3052, form number 09-0000758 for 3832, and form number 09-0000759 for 3842.

Quarter-cut full-fill finish choices**Wood Group 1**

3104	QC/FF Clear Cherry (aged)
3224	QC/FF Clear Maple*
3274	QC/FF Amber on Maple
3294	QC/FF Blonde on Maple
3304	QC/FF Clear Walnut
3314	QC/FF Natural Walnut
3324	QC/FF Dark Mahogany on Walnut
3354	QC/FF Medium Walnut
3364	QC/FF Dark Walnut
3374	QC/FF Medium Mahogany on Walnut
3384	QC/FF Graphite Walnut

Rift-cut full-fill finish choices**Wood Group 1**

3604	RC/FF Desert Oak
3614	RC/FF Warm Oak
3694	RC/FF Espresso Oak

*To ensure an understanding of the color ranges and characteristic variations of natural veneer, a sign-off sheet is required prior to orders being accepted for this clear-coat finish. The sign-off sheet is available through Steelcase advertising stock. Please use form number 09-0000756 for 3042, and form number 05-0001370 for 3222 or 3224.

Select Surfaces

For information on products within Select Surfaces, including accent paints and fabrics from Designtex, Gabriel, Kvadrat, and Pollack, please refer to the *Surface Materials Reference Manual* or visit steelcase.com/surface-materials under the Select Surfaces section.

Composite Veneer

Composite veneers are an engineered wood intended to create specific grain patterns and characteristics. They are pre-stained and finished with Steelcase's Clarity water-borne UV topcoat, which protects the environment while providing durability and clarity. Only open-pore finishes are available on composite wood. Composite veneer and matching edge bands are available on most Steelcase brand products. Composites, for use as a solid nosing substitute, are not available. Steelcase does not recommend mixing composite veneers with natural solid nosings because composite and natural wood grain and color matching are rarely compatible. Composite veneers are Graded-In as Wood Group 1 pricing.

Flat-cut open-pore finish choices**Wood Group 1**

3JDX	FC/OP Oak Composite
3JFX	FC/OP Maple Composite
3JHX	FC/OP Cherry Composite
3JXX	FC/OP Walnut Composite

Quarter-cut open-pore finish choices**Wood Group 1**

3F8X	QC/OP European Walnut Composite
3GAX	QC/OP Gold Teak Composite
3GFX	QC/OP Rosewood Composite
3GGX	QC/OP Zebrano Composite
3HGX	QC/OP Oak Composite
3HVX	QC/OP Walnut Composite
3JEX	QC/OP Maple Composite
3JGX	QC/OP Cherry Composite
3ZNX	QC/OP Night Cerused Oak Composite

Natural Veneer

Natural veneer is available in the Select Surfaces offering. Natural veneer may have extended leadtimes. Place your order as you normally would for any other finish, calling out the appropriate finish code.

The following finishes are available through the natural veneer offering:

Flat-cut open-pore finish choices**Wood Group 1**

3342	FC/OP Black Walnut
35A2	FC/OP Blanch Maple
37A2	FC/OP Thunder Walnut

Wood Group 3

3082	FC/OP Washed Walnut
------	---------------------

Flat-cut full-fill finish choices**Wood Group 1**

3734	FC/FF Black Walnut
------	--------------------

Wood Group 3

3084	FC/FF Washed Walnut
------	---------------------

Quarter-cut open-pore finish choices**Wood Group 1**

32A2	QC/OP Blanch Maple
33A2	QC/OP Thunder Walnut
3392	QC/OP Black Walnut

Quarter-cut full-fill finish choices**Wood Group 1**

3394	QC/FF Black Walnut
------	--------------------

Rift-cut open-pore finish choices**Wood Group 1**

36A2	RC/OP Volcanic Oak
------	--------------------

Planked Veneer

Planked veneer is available in the Select Surfaces offering. Planked veneer may have extended leadtimes. Place your order as you normally would for any other finish, calling out the appropriate finish code.

The following finishes are available through the planked veneer offering:

Wood Group 1

3P41	OP Planked Cherry
3P51	OP Planked Maple
3P61	OP Planked Oak
3P71	OP Planked Walnut

Tip: Known for its uniqueness, planked veneer has intentional and natural variations that include, but are not limited to: character marks, grain pattern, color, and natural color aging.

Custom Surfaces

Customiz stain is a service that allows you to create your own stain colors and finishes on standard veneer. Customiz stain color is available on all product lines that offer wood veneer.

A \$500 stain-matching fee applies on CUSTOMIZ requests (Exception: The \$500 fee does not apply on matches to Coalesse standard finishes or for a low-gloss finish request on a standard color). The \$500 fee covers the cost of formulating the Customiz color finish and applies regardless of whether or not an order for product is placed.

In addition, an approval form must be signed to indicate customer acceptance of Customiz match. A \$1,500 initiation fee will be charged prior to first order entry. This initiation fee activates the finish for unlimited use on any Steelcase product for an 18 month time period. After the 18 month time period has lapsed, the Customiz finish may be reactivated for another 18 months for a \$1,000 fee at any point within five years after the \$1,500 initiation fee was paid. If the finish is not reactivated within five years after the \$1,500 initiation fee was paid, the finish will be culled and the customer will need to pay the \$1,500 initiation fee again. All style number related Customiz charges products are no cost as of April 2014. The matching and initiation fees are not discountable.

Customiz stain takes 10 days to formulate. Consult the *Surface Materials Reference Manual* for more information. Custom veneers are also available and must be quoted by Steelcase specials group. Customiz stain on custom veneers takes 2 to 4 weeks to formulate.

Requirements and information on ordering a Customiz stain color are found in the *Surface Materials Reference Manual*.

Surface Materials, continued

Plastic

Steelcase Surfaces

- 6000 Black
- 6009 Arctic White
- 6059 Sterling Dark Solid
- 6288 Charcoal
- 6527 Merle
- 6544 Frost
- 6546 Rain

Tip: Light color plastic edges are susceptible to degradation due to normal wear and tear. Staining (e.g., ball point pen or clothing dyes such as blue jeans) and dirt effects are more pronounced in light colors and are not considered defects.

Applies to:

- 3 mm edge profile on Ology desks and modesty panels
- Series 5 Universal and knife edges
- Airtouch worksurfaces
- 1 mm square edge profile on Universal Steel One-High open lateral laminate tops for Ology
- Universal Common tops for Ology

- 6000 Black
- 6001 Coffee
- 6009 Arctic White
- 6034 Natural Cherry
- 6036 Medium Cherry
- 6037 Winter on Maple
- 6038 Blonde on Maple
- 6041 Natural Walnut
- 6045 Medium Mahogany on Walnut
- 6052 Milk
- 6053 Seagull
- 6213 Acacia
- 6219 Clear Oak
- 6231 Graphite Walnut
- 6234 Clear Cherry
- 6237 Clear Maple
- 6242 Virginia Walnut
- 6243 Blackwood
- 6245 Clear Walnut
- 6246 Warm Oak
- 6249 Platinum Solid
- 6271 Plywood
- 6527 Merle
- 6615 Grey V5
- 6619 Ice
- 6631 Cream
- 6635 Dawn
- 6636 Mist
- 6654 Sand
- 6655 Warm White
- 6676 Marbled Maple
- 6677 Chocolate Walnut
- 6678 Marbled Cherry
- 6689 Brushed Silver
- 6694 Slate
- 6695 Midnight
- 6697 Fog
- 6698 Fieldstone
- 6703 Ash Wenge
- 6704 Storm Wenge
- 6705 Bisque Wenge
- 6706 Clay Wenge

Applies to:

- SOTO storage
- 6009 Arctic White
- 6302 Baltic
- 6338 Chili
- 6527 Merle
- 6BE2 Light Peacock
- 6BE3 Cotton Candy

Applies to:

- SOTO functional screen
- SOTO mobile caddy
- SOTO launch pad
- SOTO monitor bridge
- 6009 Arctic White
- 6527 Merle

Applies to:

- 3 mm edge profile on Ology desks and modesty panels
- Series 5 Universal and knife edges
- Airtouch worksurfaces
- 1 mm square edge profile on Universal Steel One-High open lateral laminate tops for Ology
- Universal Common tops for Ology

Select Surfaces

- 6T02 Fawn Cypress
- 6T03 Weathered Char
- 6T04 Saddle Oak
- 6T05 Veranda Teak
- 6T06 Persian Cherry
- 6T07 Walnut Heights
- 6T08 Aggregate
- 6T09 Gravel
- 6T10 Cement
- 6T12 Sheetrock

Steelcase Surfaces

Applies to:

- Ology bench worksurfaces
- 6000 Black*
- 6001 Coffee
- 6009 Arctic White*
- 6034 Natural Cherry
- 6036 Medium Cherry
- 6037 Winter on Maple
- 6038 Blonde on Maple
- 6041 Natural Walnut
- 6045 Medium Mahogany on Walnut
- 6052 Milk*
- 6053 Seagull*
- 6213 Acacia*
- 6219 Clear Oak
- 6231 Graphite Walnut
- 6234 Clear Cherry
- 6237 Clear Maple*
- 6242 Virginia Walnut
- 6243 Blackwood
- 6245 Clear Walnut
- 6246 Warm Oak
- 6249 Platinum Solid
- 6271 Plywood
- 6527 Merle
- 6612 Grey V2
- 6615 Grey V5
- 6619 Ice
- 6631 Cream
- 6635 Dawn
- 6636 Mist
- 6654 Sand*
- 6655 Warm White
- 6676 Marbled Maple
- 6677 Chocolate Walnut
- 6678 Marbled Cherry
- 6694 Slate
- 6695 Midnight
- 6697 Fog
- 6698 Fieldstone
- 6703 Ash Wenge
- 6704 Storm Wenge
- 6705 Bisque Wenge
- 6706 Clay Wenge
- 6707 Ash Noce
- 6708 Bisque Noce
- 6709 Clay Noce
- 6710 Storm Noce

Acrylic

Applies to:

- Modesty and privacy screens
- 6544A Acrylic Frost

Vertical Surface Fabric

▶ See *Surface Materials Reference Manual* for a listing of available fabrics for c:scape and FrameOne Privacy/Modesty Screens.

SOTO Fabric Pads

Applies to:

- SOTO mobile caddy
- SOTO launch pad

Standard Fabric Pad

Dark grey felt

Cogent: Connect Fabric Set 1

- 5S17 Tangerine
- 5S18 Scarlet
- 5S21 Blue Jay
- 5S23 Wasabi
- 5S25 Graphite
- 5S27 Malt

Cogent: Connect Fabric Set 2

- 5S15 Coconut
- 5S16 Turmeric/Honey
- 5S19 Concord
- 5S20 Maya Blue
- 5S22 Basil
- 5S24 Nickel
- 5S26 Licorice
- 5S28 Root Beer
- 5S93 Blue Print
- 5S94 Lizard/Jungle
- 5S95 Sailor
- 5S96 Quicksilver
- 5S98 Canary
- 5S99 Lipstick/Merlot
- 5SD0 Royal Blue
- 5SD1 Aubergine
- 5SD2 Peacock
- 5SD3 Lagoon
- 5SD4 Saffron

Select Surfaces

For information on products within Select Surfaces, including accent paints and fabrics from Designtex, Gabriel, Kvadrat, and Pollack, please refer to the *Surface Materials Reference Manual* or visit steelcase.com/surface-materials under the Select Surfaces section.

Custom Surfaces

Price Group COM (Customer's Own Material)

Fabric Approval and Yardage

To confirm whether a particular COM material has already been tested for use on a specific Steelcase product or to determine actual yardage requirements:

- Visit www.steelcase.com

Directional Laminate Grain Directions

Directional laminates are standard with the grain directions shown.

Height-Adjustable Worksurfaces—High-Pressure Laminate



Rectangular
Ology
Series 5
Airtouch

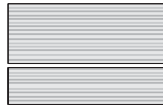

Rectangular Bi-Level
Airtouch



Tapered
Ology



90° Corner
Series 5
Airtouch



90° Corner Bi-level
Airtouch

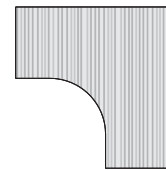

90° Equal
Ology
Series 5

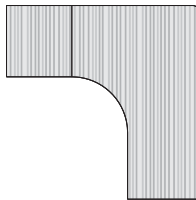

90° Equal
Ology
Series 5

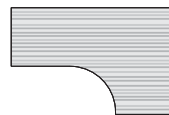

90° Extended
Ology

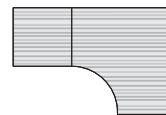

90° Extended
Ology

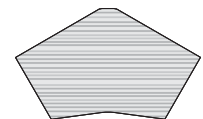

120° Equal
Ology
Airtouch



**Modesty Panel Horizontal
Grain Direction**
Ology



**Modesty Panel Vertical
Grain Direction**
Ology

Wood Veneer Grain Directions

The appearance of wood veneer may change slightly depending on the angle from which it is viewed. This natural phenomenon is called polarization, and it can be seen on natural veneer, and to a lesser extent on composite veneer. Polarization is often noticed on worksurfaces installed at a 90° angle with each other. Please refer to the following illustrations for an understanding of grain direction on your installation.

Wood veneer is available on Series 5 worksurfaces only.

Height-Adjustable Worksurfaces—Wood Veneer



Rectangular
Ology
Series 5
Airtouch



Rectangular Bi-Level
Airtouch



Tapered
Ology



90° Corner
Series 5
Airtouch



90° Corner Bi-level
Airtouch

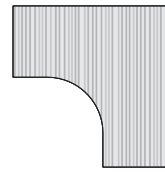

90° Equal
Ology
Series 5

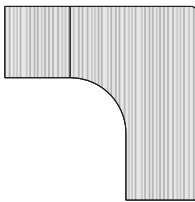

90° Equal
Ology
Series 5

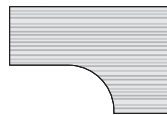

90° Extended
Ology

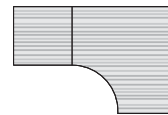

90° Extended
Ology

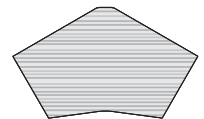

120° Equal
Ology
Airtouch



Modesty Panel Horizontal Grain Direction
Ology



Modesty Panel Vertical Grain Direction
Ology

Resources

Style Number Index

356

Style Number Index

Style Number	Page	Description
14474101SR	205	FYI Flat Monitor Arm Mounting Bracket
14474501SR	205	FYI Flat Monitor Arm Mounting Bracket
1710EF	103	21" Diagonal Keyboard Pltfrm
1810EF	103	18" Radius Keyboard Pltfrm
19AM00	107	19" Keyboard Pltfrm w/Articulating Mouse
19AMGG	107	19" Keyboard Pltfrm w/Articulating Mouse
19MD00	106	19" Keyboard Pltfrm
19MDGG	106	19" Keyboard Pltfrm
19ML00	106	19" Keyboard Pltfrm
19MLGG	106	19" Keyboard Pltfrm
19MR00	106	19" Keyboard Pltfrm
19MRGG	106	19" Keyboard Pltfrm
2110EF	103	21" Diagonal Keyboard Pltfrm
261000	105	26" Keyboard Pltfrm
261026GG	105	26" Keyboard Pltfrm
2610GG	105	26" Keyboard Pltfrm
26GG	111	26" Green-Gel Palm Rest
A5RQ462929	297	Series 5 Hgt-Adj Wksf, 29"D Rectangular
A5RQ46T05229B	298	Series 5 Base, 29"D Rectangular
A5RQ522929	297	Series 5 Hgt-Adj Wksf, 29"D Rectangular
A5RQ582929	297	Series 5 Hgt-Adj Wksf, 29"D Rectangular
A5RQ5829B	298	Series 5 Base, 29"D Rectangular
A5RQ642929	297	Series 5 Hgt-Adj Wksf, 29"D Rectangular
A5RQ64T07629B	298	Series 5 Base, 29"D Rectangular
A5RQ702929	297	Series 5 Hgt-Adj Wksf, 29"D Rectangular
A5RQ762929	297	Series 5 Hgt-Adj Wksf, 29"D Rectangular
A7TG660606H	299	FitWork: Walkstation
A7TR383030H	299	FitWork: Walkstation
A7TR663232H	299	FitWork: Walkstation
A7TR782929H	299	FitWork: Sit-to-Walkstation
AC25	146, 302	Cableway w/Universal Clamp
AC31	146, 302	Cableway w/Universal Clamp
AC37	146, 302	Cableway w/Universal Clamp
AC43	146, 302	Cableway w/Universal Clamp
AC49	146, 302	Cableway w/Universal Clamp
AC55	146, 302	Cableway w/Universal Clamp
AC61	146, 302	Cableway w/Universal Clamp
ACM28	301	28" Modesty Screen w/Cableway
ACM34	301	34" Modesty Screen w/Cableway
ACM40	301	40" Modesty Screen w/Cableway
ACM46	301	46" Modesty Screen w/Cableway
ACM52	301	52" Modesty Screen w/Cableway
ACM58	301	58" Modesty Screen w/Cableway
ACM64	301	64" Modesty Screen w/Cableway
ACMP28	301	28" Modesty and Privacy Screen w/Cableway
ACMP34	301	34" Modesty and Privacy Screen w/Cableway
ACMP40	301	40" Modesty and Privacy Screen w/Cableway
ACMP46	301	46" Modesty and Privacy Screen w/Cableway
ACMP52	301	52" Modesty and Privacy Screen w/Cableway
ACMP58	301	58" Modesty and Privacy Screen w/Cableway
ACMP64	301	64" Modesty and Privacy Screen w/Cableway
ACP28	300	28" Privacy Screen w/Cableway
ACP34	300	34" Privacy Screen w/Cableway
ACP40	300	40" Privacy Screen w/Cableway
ACP46	300	46" Privacy Screen w/Cableway

Style Number	Page	Description
ACP52	300	52" Privacy Screen w/Cableway
ACP58	300	58" Privacy Screen w/Cableway
ACP64	300	64" Privacy Screen w/Cableway
AHCC	144	Vertical Cable Carrier
AHORZ25	146, 302	Cableway w/Horizontal Mounting Brkt
AHORZ31	146, 302	Cableway w/Horizontal Mounting Brkt
AHORZ37	146, 302	Cableway w/Horizontal Mounting Brkt
AHORZ43	146, 302	Cableway w/Horizontal Mounting Brkt
AHORZ49	146, 302	Cableway w/Horizontal Mounting Brkt
AHORZ55	146, 302	Cableway w/Horizontal Mounting Brkt
AHORZ61	146, 302	Cableway w/Horizontal Mounting Brkt
AM22	300	22" Modesty Screen
AM28	300	28" Modesty Screen
AM34	300	34" Modesty Screen
AM40	300	40" Modesty Screen
AM46	300	46" Modesty Screen
AM52	300	52" Modesty Screen
AM58	300	58" Modesty Screen
AM64	300	64" Modesty Screen
AMP22	301	22" Modesty and Privacy Screen
AMP28	301	28" Modesty and Privacy Screen
AMP34	301	34" Modesty and Privacy Screen
AMP40	301	40" Modesty and Privacy Screen
AMP46	301	46" Modesty and Privacy Screen
AMP52	301	52" Modesty and Privacy Screen
AMP58	301	58" Modesty and Privacy Screen
AMP64	301	64" Modesty and Privacy Screen
AP22	300	22" Privacy Screen
AP28	300	28" Privacy Screen
AP34	300	34" Privacy Screen
AP40	300	40" Privacy Screen
AP46	300	46" Privacy Screen
AP52	300	52" Privacy Screen
AP58	300	58" Privacy Screen
AP64	300	64" Privacy Screen
AWM06	147	6" Wire Manager
AWM12	147	12" Wire Manager
AWM18	147	18" Wire Manager
AWM23	147	23" Wire Manager
AWM30	147	30" Wire Manager
AWM35	147	35" Wire Manager
AWM42	147	42" Wire Manager
AWM48	147	48" Wire Manager
AWMXL30	147	6"D Wire Manager
AWMXL36	147	6"D Wire Manager
AWMXL42	147	6"D Wire Manager
AWMXL48	147	6"D Wire Manager
AWMXL54	147	6"D Wire Manager
AWMXL60	147	6"D Wire Manager
BAPB2436	291	Airtouch Hgt-Adj Wksf, 120° Equal
BAPDC2442	291	Airtouch Hgt-Adj Wksf, 90° Corner Bi-Level
BAPDC2448	291	Airtouch Hgt-Adj Wksf, 90° Corner Bi-Level
BAPDS3642	291	Airtouch Hgt-Adj Wksf, Rectangular Bi-Level
BAPDS3648	291	Airtouch Hgt-Adj Wksf, Rectangular Bi-Level
BAPSC2442	291	Airtouch Hgt-Adj Wksf, 90° Corner

Style Number	Page	Description	Style Number	Page	Description
BAPSC2448	291	Airtouch Hgt-Adj Wksf, 90° Corner	CFMTSWP	192	CF Series Triple Static Monitor Arm
BAPSS2442	291	Airtouch Hgt-Adj Wksf, 22¼"D Rectangular	CFP14	182	CF Series Flat Panel Pole No Arm
BAPSS2448	291	Airtouch Hgt-Adj Wksf, 22¼"D Rectangular	CFP20	182	CF Series Flat Panel Pole
BAPSS2460	291	Airtouch Hgt-Adj Wksf, 22¼"D Rectangular	CFP28	182	CF Series Flat Panel Pole No Arm
BAPSS3042	291	Airtouch Hgt-Adj Wksf, 28¼"D Rectangular	CFQRTH2	194	Standard Tilt Head Mechanism
BAPSS3048	291	Airtouch Hgt-Adj Wksf, 28¼"D Rectangular	CFSARM	195	CF Series Single Pole Arm
BAPSS3060	291	Airtouch Hgt-Adj Wksf, 28¼"D Rectangular	CFSHA	181	CF Series Flat Pnl Monitor Pole Mount, Sgl
CCWS18125	142	18" Corner Filler	CFSPC	198	CF Series Flat Pnl Monitor Brkt
CCWS18150	142	18" Corner Filler	CFSPCS	199	CF Series Flat Pnl Monitor Brkt
CCWS22125	142	22" Corner Filler	CFSPCTM	198	CF Series Dsk-Clamp/Grom Thru-Mnt Brkt
CCWS22150	142	22" Corner Filler	CFSPFO	199	CF Series Flat Pnl Monitor Brkt
CDFIS14	142	Freestanding In-Line Document Support	CFSPMOD	199	CF Series Modular Pole
CF1000	175	CF Series Flat Pnl Monitor Arm, Heavy-Duty	CFSPSGLBASE	199	CF Series Max-Duty Arm Brkt
CF1000DUALBAR	177	CF Series Max-Dt Monitor Arm Assy w/Dl Brkt	CFSPSW	198	CF Series Flat Pnl Monitor Brkt
CF1000MDDL	189	CF Series Dual Dynamic Monitor Arm	CFSPTM	198	CF Series Flat Pnl Monitor Brkt
CF1000MDDP	188	CF Series Dual Dynamic Monitor Arm	CFSPTSHAPEBASE	199	CF Series T-Shape Dual-Base Brkt
CF1000MSP	185	CF Series Single Dynamic Monitor Arm	CFSPWM	198	CF Series Flat Pnl Monitor Brkt
CF2500	176	CF Series Max-Duty Monitor Arm	CFTECHCRD	202	CF Series Technology Cradle
CF2500DUALBAR	178	CF Series Max-Dt Monitor Arm Assy w/Dl Brkt	CFTHSLIDE	194	CF Series Adjustable Monitor Adapter
CF450	175	CF Series Flat Pnl Monitor Arm, Light-Duty	CFTHSLIDEHD	194	CF Series Adjustable Monitor Adapter
CF450MDDL	189	CF Series Dual Dynamic Monitor Arm	CFTHSLIDEWO	194	CF Series Adjustable Monitor Adapter
CF450MDDP	188	CF Series Dual Dynamic Monitor Arm	CFTR	143	Adjustable Foot Rest
CF450MSP	185	CF Series Single Dynamic Monitor Arm	CFWM	201	CF Series Wall-Mount Support
CF500	175	CF Series Light-Duty Monitor Arm	CFXP12H	200	CF Series Arm Extensions for Pole Mount
CF500MDDL	189	CF Series Dual Dynamic Monitor Arm	CFXP4H	200	CF Series Arm Extensions for Pole Mount
CF500MDDP	188	CF Series Dual Dynamic Monitor Arm	CFXP8H	200	CF Series Arm Extensions for Pole Mount
CF500MSP	185	CF Series Single Dynamic Monitor Arm	CFXT6H	200	CF Series 6"H Flat Pnl Arm Extender
CF600	175	CF Series Standard Monitor Arm	CMLSA	143	Mobile Collapsible Laptop Support
CF600MDDL	189	CF Series Dual Dynamic Monitor Arm	CPRCCL	143	Vertical Locking CPU Cradle
CF600MDDP	188	CF Series Dual Dynamic Monitor Arm	CPRCN	144	Vertical Non-Locking CPU Cradle
CF600MSP	185	CF Series Single Dynamic Monitor Arm	CPRSL	145	Vert Processor Sling, Freestanding
CF800	175	CF Series Flat Pnl Monitor Arm, Standard	CPRSLFO	145	Vert Processor Sling, Fixed
CF800DUALBAR	177	CF Series Max-Dt Monitor Arm Assy w/Dl Brkt	CQSF3012	56, 282, 344	12"H Fixed Personal/Modesty Screen
CF800MDDL	189	CF Series Dual Dynamic Monitor Arm	CQSF3019	56, 282, 344	19"H Fixed Personal/Modesty Screen
CF800MDDP	188	CF Series Dual Dynamic Monitor Arm	CQSF3024	56, 282, 344	24"H Fixed Personal/Modesty Screen
CF800MSP	185	CF Series Single Dynamic Monitor Arm	CQSF3612	56, 282, 344	12"H Fixed Personal/Modesty Screen
CFDARM	195	CF Series Flat Panel Dual Pole Arm	CQSF3619	56, 282, 344	19"H Fixed Personal/Modesty Screen
CFDHA	181	CF Series Flat Pnl Monitor Pole Mount, Dbt	CQSF3624	56, 282, 344	24"H Fixed Personal/Modesty Screen
CFDUALBAR	199	CF Series Dual-Bar Brkt	CQSF4212	56, 282, 344	12"H Fixed Personal/Modesty Screen
CFEDARMCKG	191	CF Series Dual Evol Monitor Arm Cnvrns K	CQSF4219	56, 282, 344	19"H Fixed Personal/Modesty Screen
CFEDARMG	191	CF Series Dual Evolution Monitor Arm	CQSF4224	56, 282, 344	24"H Fixed Personal/Modesty Screen
CFESARMG	190	CF Series Single Evolution Monitor Arm	CQSF4812	56, 282, 344	12"H Fixed Personal/Modesty Screen
CFHDQRTH2	194	Heavy Duty Tilt Head Mechanism	CQSF4819	56, 282, 344	19"H Fixed Personal/Modesty Screen
CFLHS	196	CF Series Laptop Holder Tray Platform	CQSF4824	56, 282, 344	24"H Fixed Personal/Modesty Screen
CFMDC	201	CF Series Dual Connector Monitor Bracket	CR1000	104	Classic Rectangular Keyboard Pltfrm
CFMDSDSP	187	CF Series Dual Static Monitor Arm	CR10FA	104	Classic Rectangular Keyboard Pltfrm
CFMDSDWP	187	CF Series Dual Static Monitor Arm	CR10FF	104	Classic Rectangular Keyboard Pltfrm
CFMDSP	186	CF Series Dual Static Monitor Arm	CR10PP	104	Classic Rectangular Keyboard Pltfrm
CFMDSWP	186	CF Series Dual Static Monitor Arm	CSWP	110	Cushioned Replacement Pad
CFMSC	201	CF Series Single Connector Monitor Bracket	CSWPD	110	Cushioned Replacement Pad
CFMSP	183	CF Series Single Static Monitor Arm	D6	100	Dial Indicator6 Mechanism
CFMSSP	184	CF Series Single Static Monitor Arm	D623	98	Dial Indicator6 Mechanism w/23" Track
CFMTSP	192	CF Series Triple Static Monitor Arm	D6231710EF	139	Dial Indicator6 KB Assy, Diagonal Pltfrm
CFMTSTSP	193	CF Series Triple Static Monitor Arm	D6231810EF	139	Dial Indicator6 KB Assy, Radius Pltfrm
CFMTSTWP	193	CF Series Triple Static Monitor Arm	D62319AM00	140	Dial Indicator6 KB Assy, 19" Pltfrm

Style Number Index, continued

Style Number	Page	Description
D62319AMGG	140	Dial Indicator6 KB Assy, 19" Pltfrm
D62319MD00	140	Dial Indicator6 KB Assy, 19" Pltfrm
D62319MDGG	140	Dial Indicator6 KB Assy, 19" Pltfrm
D62319ML00	140	Dial Indicator6 KB Assy, 19" Pltfrm
D62319MLGG	140	Dial Indicator6 KB Assy, 19" Pltfrm
D62319MR00	140	Dial Indicator6 KB Assy, 19" Pltfrm
D62319MRGG	140	Dial Indicator6 KB Assy, 19" Pltfrm
D6232110EF	139	Dial Indicator6 KB Assy, Diagonal Pltfrm
D623261000	141	Dial Indicator6 KB Assy, 26" Pltfrm
D623261026GG	141	Dial Indicator6 KB Assy, 26" Pltfrm
D6232610GG	141	Dial Indicator6 KB Assy, 26" Pltfrm
D623CR1000	139	Dial Indicator6 KB Assy, Classic Rect Pltfrm
D623CR10FA	139	Dial Indicator6 KB Assy, Classic Rect Pltfrm
D623CR10FF	139	Dial Indicator6 KB Assy, Classic Rect Pltfrm
D623CR10PP	139	Dial Indicator6 KB Assy, Classic Rect Pltfrm
D623EN1000	141	Dial Indicator6 KB Assy, Enviro Pltfrm
D623EN10GG	141	Dial Indicator6 KB Assy, Enviro Pltfrm
D623JP1000	138	Dial Indicator6 KB Assy, Jules Pltfrm
D623JP10SF	138	Dial Indicator6 KB Assy, Jules Pltfrm
D623SL1000	138	Dial Indicator6 KB Assy, Slider Pltfrm
D623SL10DA	138	Dial Indicator6 KB Assy, Slider Pltfrm
D623SL10SA	138	Dial Indicator6 KB Assy, Slider Pltfrm
DCCLIP	53	SOTO Cable Clip
DFPASINGLECS	203	FYI c:scape Mounting Brkt
DPHOOK	53	SOTO Personal Hook
DRCY	42	Wastebasket Recycling Labels
DSCW20	46	SOTO Cableway
DSCW30	46	SOTO Cableway
DSDFB	49	SOTO Diag File Box
DSEE	54	SOTO Ergo Edge
DSFS	52	SOTO Functional Screen
DSLEDEF	69	SOTO Extended LED Light, Freestanding
DSLEDER	69	SOTO Extended LED Light, Rail-Mount
DSLEDF	68	SOTO LED Task Lgt., Freestanding
DSLEDR	68	SOTO LED Task Lgt., Rail-Mount
DSLLB	48	SOTO Landscape Letter Box
DSL PDS	52	SOTO Launch Pad Div Screen
DSLPLNP	51	SOTO Launch Pad
DSLPLP	51	SOTO Launch Pad
DSLS	54	SOTO Freestand Laptop Shelf
DSL SRM	54	SOTO Rail-Mount Laptop Shelf
DSMB	53	SOTO Monitor Bridge
DSMC	51	SOTO Mobile Caddy
DSPB	49	SOTO Personal Box
DSPC	50	SOTO Personal Caddy
DSPP	52	SOTO Personal Pocket
DSPS DUOC	303	USB Duo Powerstrip w/Clamp Mount
DSPS DUOR	303	USB Two-Outlet Powerstrip w/Rail Mount
DSPSTRIOC	304	USB Triple Powerstrip w/Clamp Mount
DSPSTRIOR	304	USB Three-Outlet Powerstrip w/Rail Mount
DSR28	45	28" SOTO Rail
DSR34	45	34" SOTO Rail
DSR40	45	40" SOTO Rail
DSR46	45	46" SOTO Rail
DSR52	45	52" SOTO Rail

Style Number	Page	Description
DSR58	45	58" SOTO Rail
DSR64	45	64" SOTO Rail
DSRT52	46	52" SOTO Tour Rail
DSRT58	46	58" SOTO Tour Rail
DSRT64	46	64" SOTO Tour Rail
DSSA1410	47	SOTO Shelf
DSSA1410H	47	SOTO Shelf
DSSA143	47	SOTO Shelf
DSSA143H	47	SOTO Shelf
DSSA146	47	SOTO Shelf
DSSA146H	47	SOTO Shelf
DSSA2410	47	SOTO Shelf
DSSA2410H	47	SOTO Shelf
DSSA246	47	SOTO Shelf
DSSA246H	47	SOTO Shelf
DSSA363	47	SOTO Shelf
DSSA363H	47	SOTO Shelf
DSSB	50	SOTO Stg Box Shelf Set of 3
DSSPB	48	SOTO Pile Box
DSTB	48	SOTO Tool Box
DSUB	49	SOTO Utility Box
DSWIRELESS	55	SOTO Wireless Charger
DWBE	42	Wastebasket
EF	113	Extended Foam Palm Rest
EN1000	108	Enviro Keyboard Pltfrm
EN10GG	108	Enviro Keyboard Pltfrm
FA	112	Full-Width, Hgt-Adj Palm Rest
FF	112	Full-Width, Fixed-Hgt Palm Rest
FOCSML00	109	FrameOne/c:scape Keyboard Pltfrm
FOCSMLGG	109	FrameOne/c:scape Keyboard Pltfrm
FOCSMR00	109	FrameOne/c:scape Keyboard Pltfrm
FOCSMRGG	109	FrameOne/c:scape Keyboard Pltfrm
FPAC1CC	148	Eyesite Sgl Display Support, Std Crank Adj
FPAC1CS	148	Eyesite Sgl Display Support, Std Crank Adj
FPAC1FO	149	Eyesite Sgl Display Support, Std Crank Adj
FPAC1OL	148	Eyesite Sgl Display Support, Std Crank Adj
FPAC1TM	149	Eyesite Sgl Display Support, Std Crank Adj
FPAC2BBDCC	158	Eyesite Two-Over-Two Display
FPAC2BBDOL	158	Eyesite Two-Over-Two Display
FPAC2BBDTM	159	Eyesite Two-Over-Two Display
FPAC2BBSCC	159	Eyesite Static One-Over-One Disp Support
FPAC2BBSFO	160	Eyesite Static One-Over-One Disp Support
FPAC2BBSOL	159	Eyesite Static One-Over-One Disp Support
FPAC2BBSTM	159	Eyesite Static One-Over-One Disp Support
FPAC2CC	150	Eyesite Dual Display Support, Std Crank Adj
FPAC2CS	150	Eyesite Dual Display Support, Std Crank Adj
FPAC2FO	151	Eyesite Dual Display Support, Std Crank Adj
FPAC2OL	150	Eyesite Dual Display Support, Std Crank Adj
FPAC2TM	151	Eyesite Dual Display Support, Std Crank Adj
FPAC3BBSCC	161	Eyesite Mounting Brkt, FrameOne
FPAC3BBSFO	161	Eyesite Mounting Brkt, FrameOne
FPAC3BBSTM	161	Eyesite Mounting Brkt, FrameOne
FPAEC1BIVI	149	Eyesite Sgl Display Support, Ext Crank Adj
FPAEC1CC	149	Eyesite Sgl Display Support, Ext Crank Adj
FPAEC1CS	149	Eyesite Sgl Display Support, Ext Crank Adj

Style Number	Page	Description	Style Number	Page	Description
FPAEC1FO	149	Eyesite Sgl Display Support, Ext Crank Adj	FPASYNMCT	206	FYI Sync Hardware Pack
FPAEC1OL	149	Eyesite Sgl Display Support, Ext Crank Adj	FPASYNCSWR	206	FYI Sync Lower Monitor Arm, Sltwl/Sltrl
FPAEC1TM	149	Eyesite Sgl Display Support, Ext Crank Adj	FPASYNCU	206	FYI Sync Upper Monitor Arm
FPAEC2BIVI	152	Eyesite Dual Display Support, Ext Crank Adj	FPATILTPAN	205	FYI Tilt/Pan
FPAEC2CC	151	Eyesite Dual Display Support, Ext Crank Adj	FPAUPPER	204	FYI Upper Arm
FPAEC2CS	151	Eyesite Dual Display Support, Ext Crank Adj	FPAWALL	205	FYI Flat Pnl Monitor Arm Brkt, Wall-Mt
FPAEC2FO	152	Eyesite Dual Display Support, Ext Crank Adj	FPC1	168	Eyesite Single Arm Assembly
FPAEC2OL	151	Eyesite Dual Display Support, Ext Crank Adj	FPC2	168	Eyesite Dual Yolk Arm Assembly
FPAEC2TM	152	Eyesite Dual Display Support, Ext Crank Adj	FPC2SB	168	Eyesite Dual Static Yoke
FPAELC1BIVI	163	Eyesite Flat Pnl Mon Arm w/Sgl Lptp Sprt	FPC3	168	Eyesite Triple Yolk Arm Assembly
FPAELC1CC	163	Eyesite Flat Pnl Mon Arm w/Sgl Lptp Sprt	FPCBIVI	172	Eyesite Mounting Brkt, Bivi
FPAELC1CS	163	Eyesite Flat Pnl Mon Arm w/Sgl Lptp Sprt	FPCCC	172	Eyesite Mounting Brkt, C-clamp
FPAELC1FO	163	Eyesite Flat Pnl Mon Arm w/Sgl Lptp Sprt	FPCCS	172	Eyesite Mounting Brkt, c:scape
FPAELC1OL	163	Eyesite Flat Pnl Mon Arm w/Sgl Lptp Sprt	FPCGCC	169	Eyesite 18" Extended Crank Column
FPAELC1TM	163	Eyesite Flat Pnl Mon Arm w/Sgl Lptp Sprt	FPCESC	169	Eyesite 26" Extended Static Column
FPAELC2BIVI	166	Eyesite Flat Pnl Mon Arm w/Dual Lptp Sprt	FPCFO	172	Eyesite Mounting Brkt, FrameOne
FPAELC2CC	166	Eyesite Flat Pnl Mon Arm w/Dual Lptp Sprt	FPCFTV	170	Eyesite VESA Brkt Assembly
FPAELC2CS	166	Eyesite Flat Pnl Mon Arm w/Dual Lptp Sprt	FPCHTV	170	Eyesite VESA Brkt/Hook
FPAELC2FO	166	Eyesite Flat Pnl Mon Arm w/Dual Lptp Sprt	FPCL	170	Eyesite Laptop Component
FPAELC2OL	166	Eyesite Flat Pnl Mon Arm w/Dual Lptp Sprt	FPCL1	168	Eyesite Single Arm
FPAELC2TM	166	Eyesite Flat Pnl Mon Arm w/Dual Lptp Sprt	FPCOL	172	Eyesite Mounting Brkt, Ology
FPAFC3CC	154	Eyesite Triple Display Support, Std Crank Adj	FPSCCC	169	Eyesite 12" Standard Crank Column
FPAFC3CS	154	Eyesite Triple Display Sprt, Std Crank Adj	FPCTM	172	Eyesite Mounting Brkt, Through Mount
FPAFC3OL	154	Eyesite Triple Display Support, Ext Crank Adj	FTH	43	Flat Top Hanger
FPAFC3TM	155	Eyesite Triple Display Support, Std Crank Adj	GG	111	19" Green-Gel Palm Rest
FPAFEC3CC	155	Eyesite Triple Display Support, Ext Crank Adj	HCCHT	39	Chart/File Holder
FPAFEC3CS	155	Eyesite Triple Display Sprt, Ext Crank Adj	HCCPUS	145	Slatwall/SlatRail Mounted CPU Cradle
FPAFEC3FO	155	Eyesite Triple Display Support, Ext Crank Adj	HCGB	40	Glove Box
FPAFEC3OL	155	Eyesite Triple Display Support, Ext Crank Adj	JP1000	102	Jules Keyboard Pltfrm
FPAFEC3TM	155	Eyesite Triple Display Support, Ext Crank Adj	JP10SF	102	Jules Keyboard Pltfrm
FPAHANDLE	206	FYI Sync Handle	KCR	42	Cable Rings
FPALC1CC	162	Eyesite Flat Pnl Mon Arm w/Sgl Lptp Sprt	KMINI	37	Mini Shelf
FPALC1CS	162	Eyesite Flat Pnl Mon Arm w/Sgl Lptp Sprt	L5	99	5" Lift & Lock Mechanism
FPALC1FO	163	Eyesite Flat Pnl Mon Arm w/Sgl Lptp Sprt	L518	96	5" Lift & Lock Mechanism w/18" Track
FPALC1OL	162	Eyesite Flat Pnl Mon Arm w/Sgl Lptp Sprt	L51819AM00	122	5" Lift & Lock KB Assy w/18"L Track
FPALC1TM	162	Eyesite Flat Pnl Mon Arm w/Sgl Lptp Sprt	L51819AMGG	123	5" Lift & Lock KB Assy w/18"L Track
FPALC2CC	164	Eyesite Flat Pnl Mon Arm w/Dual Lptp Sprt	L51819MD00	122	5" Lift & Lock KB Assy w/18"L Track
FPALC2CS	164	Eyesite Flat Pnl Mon Arm w/Dual Lptp Sprt	L51819MDGG	123	5" Lift & Lock KB Assy w/18"L Track
FPALC2FO	165	Eyesite Flat Pnl Mon Arm w/Dual Lptp Sprt	L51819ML00	122	5" Lift & Lock KB Assy w/18"L Track
FPALC2OL	164	Eyesite Flat Pnl Mon Arm w/Dual Lptp Sprt	L51819MLGG	123	5" Lift & Lock KB Assy w/18"L Track
FPALC2TM	164	Eyesite Flat Pnl Mon Arm w/Dual Lptp Sprt	L51819MR00	122	5" Lift & Lock KB Assy w/18"L Track
FPALED	202	LED w/bracket, CF Series/FYI	L51819MRGG	123	5" Lift & Lock KB Assy w/18"L Track
FPAS101	171	Eyesite Modular Assy, Ext Static Column	L518EN1000	123	5" Lift & Lock KB Assy w/18"L Track
FPAS101CC	156	Eyesite Static One-Over-One Disp Support	L518EN10GG	123	5" Lift & Lock KB Assy w/18"L Track
FPAS101CS	156	Eyesite Static One-Over-One Disp Support	L522	97	5" Lift & Lock Mechanism w/22"L Track
FPAS101FO	157	Eyesite Static One-Over-One Disp Support	L5221710EF	125	5" Lift & Lock KB Assy w/22"L Track
FPAS101OL	156	Eyesite Static One-Over-One Disp Support	L5221810EF	125	5" Lift & Lock KB Assy w/22"L Track
FPAS101TM	157	Eyesite Static One-Over-One Disp Support	L52219AM00	126	5" Lift & Lock KB Assy w/22"L Track
FPASINGLE	204	FYI Flat Pnl Monitor Arm	L52219AMGG	126	5" Lift & Lock KB Assy w/22"L Track
FPASINGLECC	203	FYI C-clamp Mounting Brkt	L52219MD00	126	5" Lift & Lock KB Assy w/22"L Track
FPASINGLEFO	203	FYI FrameOne Mounting Brkt	L52219MDGG	126	5" Lift & Lock KB Assy w/22"L Track
FPASINGLETM	203	FYI Through Mount Mounting Brkt	L52219ML00	126	5" Lift & Lock KB Assy w/22"L Track
FPASWR	205	FYI Flat Pnl Monitor Arm Brkt, Sltwl/Sltrl	L52219MLGG	126	5" Lift & Lock KB Assy w/22"L Track
FPASYNCL	206	FYI Sync Lower Monitor Arm	L52219MR00	126	5" Lift & Lock KB Assy w/22"L Track
FPASYNCLEd	202	LED w/bracket, Sync	L52219MRGG	126	5" Lift & Lock KB Assy w/22"L Track

Style Number Index, continued

Style Number	Page	Description
L5222110EF	125	5" Lift & Lock KB Assy w/22"L Track
L522CR1000	125	5" Lift & Lock KB Assy w/22"L Track
L522CR10FA	125	5" Lift & Lock KB Assy w/22"L Track
L522CR10FF	125	5" Lift & Lock KB Assy w/22"L Track
L522CR10PP	125	5" Lift & Lock KB Assy w/22"L Track
L522EN1000	127	5" Lift & Lock KB Assy w/22"L Track
L522EN10GG	127	5" Lift & Lock KB Assy w/22"L Track
L522JP1000	124	5" Lift & Lock KB Assy w/22"L Track
L522JP10SF	124	5" Lift & Lock KB Assy w/22"L Track
L522SL1000	124	5" Lift & Lock KB Assy w/22"L Track
L522SL10DA	124	5" Lift & Lock KB Assy w/22"L Track
L522SL10SA	124	5" Lift & Lock KB Assy w/22"L Track
L523	97	5" Lift & Lock Mechanism w/23" Track
L5231710EF	129	5" Lift & Lock KB Assy, Diagonal Pltfrm
L5231810EF	129	5" Lift & Lock KB Assy, Radius Pltfrm
L52319AM00	130	5" Lift & Lock KB Assy, 19" Pltfrm
L52319AMGG	130	5" Lift & Lock KB Assy, 19" Pltfrm
L52319MD00	130	5" Lift & Lock KB Assy, 19" Pltfrm
L52319MDGG	130	5" Lift & Lock KB Assy, 19" Pltfrm
L52319ML00	130	5" Lift & Lock KB Assy, 19" Pltfrm
L52319MLGG	130	5" Lift & Lock KB Assy, 19" Pltfrm
L52319MR00	130	5" Lift & Lock KB Assy, 19" Pltfrm
L52319MRGG	130	5" Lift & Lock KB Assy, 19" Pltfrm
L5232110EF	129	5" Lift & Lock KB Assy, Diagonal Pltfrm
L523261000	131	5" Lift & Lock KB Assy, 26" Pltfrm
L523261026GG	131	5" Lift & Lock KB Assy, 26" Pltfrm
L5232610GG	131	5" Lift & Lock KB Assy, 26" Pltfrm
L523CR1000	129	5" Lift & Lock KB Assy, Classic Rect Pltfrm
L523CR10FA	129	5" Lift & Lock KB Assy, Classic Rect Pltfrm
L523CR10FF	129	5" Lift & Lock KB Assy, Classic Rect Pltfrm
L523CR10PP	129	5" Lift & Lock KB Assy, Classic Rect Pltfrm
L523EN1000	131	5" Lift & Lock KB Assy, Enviro Pltfrm
L523EN10GG	131	5" Lift & Lock KB Assy, Enviro Pltfrm
L523JP1000	128	5" Lift & Lock KB Assy, Jules Pltfrm
L523JP10SF	128	5" Lift & Lock KB Assy, Jules Pltfrm
L523SL10DA	128	5" Lift & Lock KB Assy, Slider Pltfrm
L523SL10SA	128	5" Lift & Lock KB Assy, Slider Pltfrm
L52FT	82	Bottomline
L52FTCHI	82	Bottomline
L52FTS	82	Bottomline
L52FTY	82	Bottomline
L53FT	82	Bottomline
L53FTCHI	82	Bottomline
L53FTS	82	Bottomline
L53FTY	82	Bottomline
L54FT	82	Bottomline
L54FTCHI	82	Bottomline
L54FTS	82	Bottomline
L54FTY	82	Bottomline
L7	99	7" Lift & Lock Mechanism
L718	97	7" Lift & Lock Mechanism w/18" Track
L71819AM00	132	7" Lift & Lock KB Assy w/18"L Track
L71819AMGG	132	7" Lift & Lock KB Assy w/18"L Track
L71819MDGG	132	7" Lift & Lock KB Assy w/18"L Track
L71819MLGG	132	7" Lift & Lock KB Assy w/18"L Track

Style Number	Page	Description
L71819MRGG	132	7" Lift & Lock KB Assy w/18"L Track
L718EN10GG	133	7" Lift & Lock KB Assy w/18"L Track
L726	98	7" Lift & Lock Mechanism w/26" Track
L7261710EF	135	7" Lift & Lock KB Assy, Diagonal Pltfrm
L7261810EF	135	7" Lift & Lock KB Assy, Radius Pltfrm
L72619AM00	136	7" Lift & Lock KB Assy, 19" Pltfrm
L72619AMGG	136	7" Lift & Lock KB Assy, 19" Pltfrm
L72619MD00	136	7" Lift & Lock KB Assy, 19" Pltfrm
L72619MDGG	136	7" Lift & Lock KB Assy, 19" Pltfrm
L72619ML00	136	7" Lift & Lock KB Assy, 19" Pltfrm
L72619MLGG	136	7" Lift & Lock KB Assy, 19" Pltfrm
L72619MR00	136	7" Lift & Lock KB Assy, 19" Pltfrm
L72619MRGG	136	7" Lift & Lock KB Assy, 19" Pltfrm
L7262110EF	135	7" Lift & Lock KB Assy, Diagonal Pltfrm
L726261000	137	7" Lift & Lock KB Assy, 26" Pltfrm
L726261026GG	137	7" Lift & Lock KB Assy, 26" Pltfrm
L7262610GG	137	7" Lift & Lock KB Assy, 26" Pltfrm
L726CR1000	135	7" Lift & Lock KB Assy, Classic Rect Pltfrm
L726CR10FA	135	7" Lift & Lock KB Assy, Classic Rect Pltfrm
L726CR10FF	135	7" Lift & Lock KB Assy, Classic Rect Pltfrm
L726CR10PP	135	7" Lift & Lock KB Assy, Classic Rect Pltfrm
L726EN1000	137	7" Lift & Lock KB Assy, Enviro Pltfrm
L726EN10GG	137	7" Lift & Lock KB Assy, Enviro Pltfrm
L726JP1000	134	7" Lift & Lock KB Assy, Jules Pltfrm
L726JP10SF	134	7" Lift & Lock KB Assy, Jules Pltfrm
L726SL10DA	134	7" Lift & Lock KB Assy, Slider Pltfrm
L726SL10SA	134	7" Lift & Lock KB Assy, Slider Pltfrm
LDASHC	64	dash LED Light, C-clamp Mount
LDASHF	64	dash LED Light, Freestanding
LDASHMINIC	66	dash mini LED Light, C-clamp Mount
LDASHMINIF	66	dash mini LED Light, Freestanding
LDASHMINIOC	67	dash mini LED Light, C-clamp Mount
LDASHMINIOF	67	dash mini LED Light, Freestanding
LDASHMINIOP	67	dash mini LED Light, Pnl-Mount
LDASHMINIOR	67	dash mini LED Light, Rail-Mount
LDASHMINIOS	67	dash mini LED Light, Slatwall/SlatRail Mount
LDASHMINIOU	67	dash mini LED Light, Free USB, Occ Snsr
LDASHMINIP	66	dash mini LED Light, Pnl-Mount
LDASHMINIR	66	dash mini LED Light, Rail-Mount
LDASHMINIS	66	dash mini LED Light, Slatwall/SlatRail Mount
LDASHMINIU	66	dash mini LED Light, Freestanding USB
LDASHOC	65	dash LED Light, C-clamp Mount
LDASHOF	65	dash LED Light, Freestanding
LDASHOP	65	dash LED Light, Pnl-Mount
LDASHOR	65	dash LED Light, Rail-Mount
LDASHOS	65	dash LED Light, Slatwall/SlatRail Mount
LDASHOU	65	dash LED Light, Freestanding USB, Occ Snsr
LDASHP	64	dash LED Light, Pnl-Mount
LDASHR	64	dash LED Light, Rail-Mount
LDASHS	64	dash LED Light, Slatwall/SlatRail Mount
LDASHU	64	dash LED Light, Freestanding USB
LLL17	74	LED Linear Shelf Light
LLL17YA	74	LED Linear Shelf Light
LLL17YB	74	LED Linear Shelf Light
LLL31	74	LED Linear Shelf Light

Style Number	Page	Description	Style Number	Page	Description
LLL31YB	74	LED Linear Shelf Light	OLBEC	336	Tray Covers for Ology-Dual Sided Benche
LLL44	75	LED Linear Shelf Light	OLBELRQD	315	Ology Height-Adjustable Dual-Sided Bchs, Ext
LLL44YB	75	LED Linear Shelf Light	OLBELRQDB	329	Ology Height-Adjustable Dual-Sided Base, Ext
LLL58	75	LED Linear Shelf Light	OLBELRQS	317	Ology Bench Single-Sided
LLL58YB	75	LED Linear Shelf Light	OLBELRQSB	325	Ology Base Single-Sided
LLLDD	73	LED Linear Desktop Light	OLBELRQSCK	340	Ology Conversion Kit
LLLDS	73	LED Linear Desktop Light	OLBELWCS	321	Ology 120 Bench Single-Sided
LLRDD	72	LED Radial Desktop Light	OLBELWCSB	327	Ology 120 Base Single-Sided
LLRDS	72	LED Radial Desktop Light	OLBELWCSCK	340	Ology 120 Conversion Kit
LMINICORD	339	Mini Extension Cord	OLBFL	338	Infills for Ology-Dual Sided Benches
LMINILED	70	Mini SOTO LED Light	OLBFLRQS	318	Ology Bench Single-Sided
LMINILEDE	71	Mini SOTO Extended LED Light	OLBFLRQSB	325	Ology Base Single-Sided
LPTL30	77	LED Personal Task Light	OLBFLWCS	322	Ology Bench Single-Sided
LPTL30NR	77	LED Personal Task Light	OLBFLWCSCB	327	Ology 120 Base Single-Sided
LS1FSC	83	Daisy Chain Cord	OLBRQD	332	Ology Height-Adjust Dual-Side Benches, Cmb
LS6FSC	83	Daisy Chain Cord	OLBRQDB	335	Ology Height-Adjust Dual-Sided Bases, Cmb
LSB24K2	80	Utility2 Shelf Light	OLBSC	342	Universal Screens for Ology Dual-Sided Bches
LSB24KC2	80	Utility2 Shelf Light	OLBSLRQD	315	Ology Height-Adjust Dual-Sided Benches, Lmt
LSB24KD2	80	Utility2 Shelf Light	OLBSLRQDB	329	Ology Height-Adjust Dual-Sided Bases, Lmt
LSB24KS2	80	Utility2 Shelf Light	OLBSLRQS	318	Ology Bench Single-Sided
LSB24M2	81	Utility2 Shelf Light	OLBSLRQSB	325	Ology Base Single-Sided
LSB24MC2	81	Utility2 Shelf Light	OLBSLRQSCK	340	Ology Conversion Kit
LSB24MD2	81	Utility2 Shelf Light	OLBSLWCS	321-322	Ology 120 Bench Single-Sided
LSB24MS2	81	Utility2 Shelf Light	OLBSLWCSB	327	Ology 120 Base Single-Sided
LSB36K2	80	Utility2 Shelf Light	OLBSLWCSCK	340	Ology 120 Conversion Kit
LSB36KC2	80	Utility2 Shelf Light	OLBSP	337	Ology Single-Sided Stabilizer Post
LSB36KD2	80	Utility2 Shelf Light	OLCB	283, 339	Ology, Cable Basket
LSB36KS2	80	Utility2 Shelf Light	OLCBK4	283, 339	Ology, Cable Bracket
LSB36M2	81	Utility2 Shelf Light	OLCR	283	Ology, Cable Riser
LSB36MC2	81	Utility2 Shelf Light	OLELLC	259-264	Ology, Hgt-Adj Desk, 90° Corner
LSB36MD2	81	Utility2 Shelf Light	OLELLCB	275-276	Ology, Hgt-Adj Bases, 90° Corner
LSB36MS2	81	Utility2 Shelf Light	OLELRQ	251	Ology, Hgt-Adj Desk, Rectangular
LSB48K2	80	Utility2 Shelf Light	OLELRQB	273	Ology, Hgt-Adj Desk, Rectangular
LSB48KC2	80	Utility2 Shelf Light	OLELRT	255	Ology, Hgt-Adj Desk, Tapered
LSB48KD2	80	Utility2 Shelf Light	OLELRTB	274	Ology, Hgt-Adj Base, Tapered
LSB48KS2	80	Utility2 Shelf Light	OLELWC	269	Ology, Hgt-Adj Desk, 120° Corner
LSB48M2	81	Utility2 Shelf Light	OLELWCB	280	Ology, Hgt-Adj Base, 120° Corner
LSB48MC2	81	Utility2 Shelf Light	OLMP	281	Ology, Modesty Panels
LSB48MD2	81	Utility2 Shelf Light	OLSLLC	264-268	Ology, Hgt-Adj Desk, 90° Corner
LSB48MS2	81	Utility2 Shelf Light	OLSLLCB	277-279	Ology, Hgt-Adj Bases, 90° Corner
LSL18	76	LED Light	OLSLRQ	252	Ology, Hgt-Adj Desk, Rectangular
LSL18YA	76	LED Light	OLSLRQB	273	Ology, Hgt-Adj Bases, Rectangular
LSL18YB	76	LED Light	OLSLRT	256	Ology, Hgt-Adj Desk, Tapered
LSM24K	78	Standard Light	OLSLRTB	274	Ology, Hgt-Adj Bases, Tapered
LSM24KC	78	Standard Light	OLSLWC	270	Ology, Hgt-Adj Desk, 120° Corner
LSM24KD	78	Standard Light	OLSLWCB	280	Ology, Hgt-Adj Bases, 120° Corner
LSM36K	78	Standard Light	PP	112	Positionable Palm Rest
LSM36KC	78	Standard Light	Q11T	100	11" Track
LSM36KD	78	Standard Light	Q12T	100	12" Track
LSM48K	78	Standard Light	Q17T	100	17" Track
LSM48KC	78	Standard Light	Q18T	100	18" Track
LSM48KD	78	Standard Light	Q20T	100	20" Track
OLBCCS	337	Ology Trim Kit Single-Sided application	Q22T	100	22" Track
OLBCK	336	Connection Kit for Ology-Dual Sided Benches	Q23T	100	23" Track
OLBCM	338	Cable Manager for Ology-Dual Sided Benches	Q26T	100	26" Track

Style Number Index, continued

Style Number	Page	Description
QACPUT	145	CPU Trolley
RATCTHAD	287	Common Top
RPXFHAD	289	Filler
RPXSHAD	288	Shroud
RSCHAD	285	Univ One-High Open Lat
SA	110	Standard Adj Foam Palm Rest
SE	99	Stella Ext Mechanism
SE23	96	Stella Ext Mechanism w/23" Track
SE231710EF	119	Stella Ext KB Assy, Diagonal Pltfrm
SE231810EF	119	Stella Ext KB Assy, Radius Pltfrm
SE2319AM00	120	Stella Ext KB Assy, 19" Pltfrm
SE2319AMGG	120	Stella Ext KB Assy, 19" Pltfrm
SE2319MD00	120	Stella Ext KB Assy, 19" Pltfrm
SE2319MDGG	120	Stella Ext KB Assy, 19" Pltfrm
SE2319ML00	120	Stella Ext KB Assy, 19" Pltfrm
SE2319MLGG	120	Stella Ext KB Assy, 19" Pltfrm
SE2319MR00	120	Stella Ext KB Assy, 19" Pltfrm
SE2319MRGG	120	Stella Ext KB Assy, 19" Pltfrm
SE232110EF	119	Stella Ext KB Assy, Diagonal Pltfrm
SE23261000	121	Stella Ext KB Assy, 26" Pltfrm
SE23261026GG	121	Stella Ext KB Assy, 26" Pltfrm
SE232610GG	121	Stella Ext KB Assy, 26" Pltfrm
SE23CR1000	119	Stella Ext KB Assy, Classic Rect Pltfrm
SE23CR10FA	119	Stella Ext KB Assy, Classic Rect Pltfrm
SE23CR10FF	119	Stella Ext KB Assy, Classic Rect Pltfrm
SE23CR10PP	119	Stella Ext KB Assy, Classic Rect Pltfrm
SE23EN1000	121	Stella Ext KB Assy, Enviro Pltfrm
SE23EN10GG	121	Stella Ext KB Assy, Enviro Pltfrm
SE23JP1000	118	Stella Ext KB Assy, Jules Pltfrm
SE23JP10SF	118	Stella Ext KB Assy, Jules Pltfrm
SE23SL10DA	118	Stella Ext KB Assy, Slider Pltfrm
SE23SL10SA	118	Stella Ext KB Assy, Slider Pltfrm
SF	113	Standard Foam Palm Rest
SL1000	101	Slider Keyboard Pltfrm
SL10DA	101	Slider Keyboard Pltfrm
SL10SA	101	Slider Keyboard Pltfrm
SMPRS	111	Slider Mousing Surface Palm Rest
SS	98	Stella Standard Mechanism
SS20	96	Stella Std Mechanism w/20" Track
SS201710EF	115	Stella Std KB Assy, Diagonal Pltfrm
SS201810EF	115	Stella Std KB Assy, Radius Pltfrm
SS2019AM00	116	Stella Std KB Assy, 19" Pltfrm
SS2019AMGG	116	Stella Std KB Assy, 19" Pltfrm
SS2019MD00	116	Stella Std KB Assy, 19" Pltfrm
SS2019MDGG	116	Stella Std KB Assy, 19" Pltfrm
SS2019ML00	116	Stella Std KB Assy, 19" Pltfrm
SS2019MLGG	116	Stella Std KB Assy, 19" Pltfrm
SS2019MR00	116	Stella Std KB Assy, 19" Pltfrm
SS2019MRGG	116	Stella Std KB Assy, 19" Pltfrm
SS202110EF	115	Stella Std KB Assy, Diagonal Pltfrm
SS20261000	117	Stella Std KB Assy, 26" Pltfrm
SS20261026GG	117	Stella Std KB Assy, 26" Pltfrm
SS202610GG	117	Stella Std KB Assy, 26" Pltfrm
SS20CR1000	115	Stella Std KB Assy, Classic Rect Pltfrm
SS20CR10FA	115	Stella Std KB Assy, Classic Rect Pltfrm

Style Number	Page	Description
SS20CR10FF	115	Stella Std KB Assy, Classic Rect Pltfrm
SS20CR10PP	115	Stella Std KB Assy, Classic Rect Pltfrm
SS20EN1000	117	Stella Std KB Assy, Enviro Pltfrm
SS20EN10GG	117	Stella Std KB Assy, Enviro Pltfrm
SS20JP1000	114	Stella Std KB Assy, Jules Pltfrm
SS20JP10SF	114	Stella Std KB Assy, Jules Pltfrm
SS20SL1000	114	Stella Std KB Assy, Slider Pltfrm
SS20SL10DA	114	Stella Std KB Assy, Slider Pltfrm
SS20SL10SA	114	Stella Std KB Assy, Slider Pltfrm
TS7PVWM	83	Vertical Wire Mgr
UAPB2436	294	Airtouch Hgt-Adj Wksf, 120° Equal
UAPDC2442	294	Airtouch Hgt-Adj Wksf, 90° Corner Bi-Level
UAPDC2448	294	Airtouch Hgt-Adj Wksf, 90° Corner Bi-Level
UAPDS3642	293	Airtouch Hgt-Adj Wksf, Rectangular Bi-Level
UAPDS3648	293	Airtouch Hgt-Adj Wksf, Rectangular Bi-Level
UAPSC1842	294	Airtouch Hgt-Adj Wksf, 90° Corner
UAPSC2442	294	Airtouch Hgt-Adj Wksf, 90° Corner
UAPSC2448	294	Airtouch Hgt-Adj Wksf, 90° Corner
UAPSS2442	293	Airtouch Hgt-Adj Wksf, 22¼"D Rectangular
UAPSS2448	293	Airtouch Hgt-Adj Wksf, 22¼"D Rectangular
UAPSS2460	293	Airtouch Hgt-Adj Wksf, 22¼"D Rectangular
UAPSS3042	293	Airtouch Hgt-Adj Wksf, 28¼"D Rectangular
UAPSS3048	293	Airtouch Hgt-Adj Wksf, 28¼"D Rectangular
UAPSS3060	293	Airtouch Hgt-Adj Wksf, 28¼"D Rectangular
UFAL	343	Aligners
WBHS	34	Binder Holder
WCH	42	Coat Hook
WDPDL	43	Pelican Pencil Drawer, Locking
WDPDNL	43	Pelican Pencil Drawer, Non-Locking
WDPL	43	Pelican Pencil Drawer, Security Lid
WFCS	26	Freestanding Slatwall Stanchions
WHB	35	Hanging Brackets
WHOOK	41	Utility Hook
WIB	44	Pelican Installation Bar
WLG15L	33	Landscape Legal Tray
WLT12L	33	Landscape Letter Tray
WLTS	33	Portrait Letter Tray
WMB	41	Markerboard
WOF5	37	Office in a File
WPCS	36	Pen/Pencil Cup
WPFS	34	PaperFlo Manager
WS24	27	12"H Slatwall Tile
WS2418H	27	18"H Slatwall Tile
WS30	27	12"H Slatwall Tile
WS3018H	27	18"H Slatwall Tile
WS36	27	12"H Slatwall Tile
WS3618H	27	18"H Slatwall Tile
WS42	27	12"H Slatwall Tile
WS4218H	27	18"H Slatwall Tile
WS45	27	12"H Slatwall Tile
WS4518H	27	18"H Slatwall Tile
WS48	27	12"H Slatwall Tile
WS4818H	27	18"H Slatwall Tile
WS60	27	12"H Slatwall Tile
WS6018H	27	18"H Slatwall Tile

Style Number	Page	Description
WSPS	39	Personal Shelf
WSQS	36	Double Square Dish
WSR24	31	24" SlatRail
WSR30	31	30" SlatRail
WSR36	31	36" SlatRail
WSR42	31	42" SlatRail
WSR48	31	48" SlatRail
WSR60	31	60" SlatRail
WSRFS	30	Freestanding SlatRail Stanchions
WSRU1	32	SlatRail Pnl-Mount Brkts
WSRW	32	SlatRail Wall-Mount Brkts
WSS12L	38	Slatshelf, Landscape
WSS18L	38	Slatshelf, Landscape
WSS18P	38	Slatshelf, Portrait
WSS24L	38	Slatshelf, Landscape
WSS24P	38	Slatshelf, Portrait
WSSD	39	Slatshelf Dividers
WSSL	38	Slatshelf Labels
WSW42AN	28	Slatwall Brkt, 12"H Pnl-Mount
WSW42AV	28	Slatwall Brkt, 12"H Pnl-Mount
WSWANS	28	Slatwall Brkt, 12"H Pnl-Mount
WSWANS18	28	Slatwall Brkt, 18"H Pnl-Mount
WSWM	29	Slatwall Brkt, 12"H Wall-Mount
WSWM18	29	Slatwall Brkt, 18"H Wall-Mount
WSWPBOF12	29	Slatwall Brkt, 12"H Wall-Mount
WSWUSA	28	Slatwall Brkt, 12"H Pnl-Mount
WSWUSA18	28	Slatwall Brkt, 18"H Pnl-Mount
WTBS	40	Tackstrip
WTCS	40	Telephone Caddy
WUS	35	Universal Shelf, Single
WUS3	35	Universal Shelves, 3-Pack
WWT	41	Work Tags
X04815	100	Dual Pivot Plate

Trademark List

- The following are registered trademarks for products of Steelcase Inc. or one of its related corporate entities: 4 o'clock, 900 Series, à la carte, Airtouch, Ally, Amia, Answer, Archipelago, Avenir, Ballet, Bix, Brayton International, Cachet, Canopy, Canto, Chancellor, Coalesse, Confidante, Context, Convene, CopyCam, Criterion, Crushed Can, Currency, dash, Designtex, Details, Detour, Drive, Elective Elements, Ellipse, Ember Chrome, Emerge, E-Table 2, FYI, Garland, Gentry, Ginkgo Biloba, Groupwork, Ideo, Jacket, Jenny, Jersey, Kart, Kick, LaCosta, Leap, Let's B, LiveBack, Max-Stacker, media:scape, Metro, Migrations, Mitra, Montage, Nurture, Oriana, Parade, Pathways, PCT, Permiso, Player, Portal, Power Pincher, Progeny, Protégé, R2, Rally, Relevant, Reply, Rizzi Arc, Sensor, Series 9000, Siento, Sieste, Sine, Softcare, Springboard, Steelcase, Steelcase Design Partnership, Stella, Stow Davis, Swathmore, Sylvi, TeamWork, Technique, Texpress, Think, Thunder, Topo, Train, turnstone, Underline, Unison, Vecta, Viridian, Walden, Wernld, and X-Stack.
- The following registered trademarks are under license from AWI Licensing Company, Dover, DE: SoundScapes, DuraBrite, BioBlock, and Armstrong.
- The following registered trademarks are under license from Byrne Electrical, Rockford, MI: Interport, Mini-Port, Axil Z, and Ellora.
- The following is a registered trademark of DuPont, Wilmington, DE: Corian.
- The following is a registered trademark of Genlyte Thomas Company, Louisville, KY: Lightolier.
- The following is a registered trademark of Hilti Corporation, FL-9494 Schaan, Principality of Liechtenstein: Hilti.
- The following is a registered trademark of Leviton Manufacturing Company, Little Neck, NY: Decora.
- The following is a registered trademark of Mechanical Plastics Corp, Elmsford, NY: Toggler.
- The following is a registered trademark of Microsoft Corporation, Redmond, WA: Microsoft.
- The following is a registered trademark of Panduit Corporation, Lockport, IL: Panduit.
- The following is a registered trademark of Trav (Press), Cuneo, Italy: Assisa.
- The following is a registered trademark of Virtual Ink, Boston, MA: mimioActive.
- The following registered trademarks are under license from Wilkhahn Furniture Products: Avera, Senzo, Versal, and Wilkhahn FS.

- The following is a registered trademark of Wilsonart International, Temple, TX: Chemsurf.
- The following is a registered trademark of Wiremold, West Hartford, CT: Wiremold.
- The following is a registered trademark of EMU Group S.P.A., Perugia, Italy: Emu.
- The following is a registered trademark of Security People, Inc.: Digilock.
- The following are trademarks for products of Steelcase Inc. or one of its related corporate entities: Access, Active/Passive Shelf, Ainsley, Akira, Alcove, Alerion, Alight, Amaris, American Elect, American Tradition, ap40, Arbor, Arriva, Asana, Ascot, Aspekt, Astor, Await, Bassline, B-Free, Bira, Bivi, Bixby, Bottomline, Brody, Brook, Buoy, Burton, c:scape, Calla, Calm, Camber, Campfire, Capa, Cappuccino, Cesar, Chester, Chord, Circa, Clarendon, Classic Rectangular, Clipper, cobì, Collaboration, Community, Company, Convey, Cortex, Coupe, Crea, Crew, Cura, Cypress, Davenport, Dearborn, Deck, Déjà, Denizen, Denska, Derby, Divisio, Donovan, Dune, Duo, Echo, Edge, Elsna, Empath, Empress, Enea, ēno, EnSync, Enviro, Escapade, Exchange, Exponents, Field, Flat Top, FlexFrame, Flip Top, Flute, Folio, FrameOne, FreeFlow, Frontier, Galliei, Gesture, Ginger, Ginkgo, Go Wall, Grip, Groove, Hatchback, Hawthorne, Hitch, Host Collection, Hosu, Huddleboard, i2i, Impact, Indy, InfoLink, IOS, I-Solve, Jack, Jarrah, Jetty, Juice, Kami, Kast, Kathryn, Lagunitas, Lark, L'Attitude, LearnLab, Leela, LessThanFive, Lincoln, Linden, LiveSeat, Loria, Lyric, Malibu, Malibu Too, Mansfield, Marathon, Martini, Mason, Masque, Migration, Millbrae, Mineral, Mingle, Mystic, Mystic Metal, Mystic Wood, Montara650, Montreal, Move, Nadia, Neighbor, nesso, Nickel, Nikko, Nod, Node, Norfolk, Ology, Ontrak, Oom, Opus, Orchid, Outlook Collection, Ovation, Paloma, Paperflo, Parliament, Pasio, Passerelle, Patriarch, Payback, Peek, Pile File, Pisa, Pool, Potrero415, PUCK, QiVi, Quba, Rave, Reed, Regard, Relay, Reunion, Ripple, Riser, Roam, Rocco, Rocky, RoomWizard, Runner, Satellite, Sawyer, ScapeSeries, Senti, Sentinel, Senza, Sequoia, Session, ShareLink, Shield, Shortcut, Sidewalk, SILQ, Skylar, Slumber, Smoke, Snug, Soft Leaf, Sonata, Sorrel, SOTO, Southside, Stationkits, Steelcase Series, Stiletto, Surprise!, Surround, Switch, Symphony, Sync, TagWizard, Tava, TeamStudio, TeamTheater, Tenaro, Terrazzo, Theorem, Thread, Topaz, Touchdown, Tour, Tower Too, Trees, Trillium, Trolley, tX2, U-Free, Umami, Underscore, Uno, V.I.A., Verb, Verge, Verlay, Victor2, Visalia, Waldorf, Woodruff, Workspring, and X-tenz.
- The following is a trademark of Microsoft Corporation, Redmond, WA: Windows.
- The following is a trademark of Rodman Industries, Inc., Oconomowoc, WI: ResinCore1.
- The following is a trademark of Ultrafabrics, LLC, Elmsford, NY: Ultraleather.

- The following trademarks are under license from Wilkhahn Furniture products: Cana, Linus, Logon, Picto, Range, Stitz, Thema, Timetable, and Tubis.
 - The following trademark is used under license from Cradle to Cradle Products Innovation Institute, Oakland, CA: Cradle to Cradle Certified.
 - The following trademarks are under license from Walter Knoll: Andoo, Bob, Lazlo, Lox, Ribbon, and Together.
 - The following trademarks are under license from PP Møbler: Bar and Flag Halyard.
 - The following trademarks are under license from Viccarbe: Davos, Holy Day, Last Minute, RS, Sistema, and Wrapp.
 - The following trademarks are under license from Carl Hansen: Elbow, Paddle, Shell, Wing, and Wishbone.
 - The following trademarks are under license from Cambridge Sound Management, LLC, Cambridge, MA: QtPro Soundmasking, Qt Quiet Technology, and Sonet Qt.
 - The following is a trademark of Electri-Cable Assemblies, Shelton, CT: Interact.
 - The following is a trademark of Clestra Hauserman: IRYS.
 - The following is a trademark of Wiesner-Hager Möbel GmbH: Nooi.
 - The following are trademarks of PolyVision: a³, e³, Flow, Motif, PolyVision, Sans, and Serif.
 - The following is a trademark of Bostock Company, Inc: SnapCab.
 - The following is a trademark of Williams-Sonoma, Inc: West Elm.
 - The following is a trademark of Elena Marquina Testor: nanimarquina.
 - The following is a trademark of Forbo International SA: Forbo.
- Trademarks used here in are the property of Steelcase, Inc. or of their respective owners.*